

Owner's Manual

2022 CR-V
Hybrid

California Proposition 65 Warning

⚠ WARNING: Operating, servicing and maintaining a passenger vehicle or off-highway motor vehicle can expose you to chemicals including engine exhaust, carbon monoxide, phthalates, and lead, which are known to the State of California to cause cancer and birth defects or other reproductive harm.

To minimize exposure, avoid breathing exhaust, do not idle the engine except as necessary, service your vehicle in a well-ventilated area and wear gloves or wash your hands frequently when servicing your vehicle. For more information go to www.P65Warnings.ca.gov/passenger-vehicle.

Event Data Recorders

This vehicle is equipped with an event data recorder (EDR). The main purpose of an EDR is to record, in certain crash or near crash-like situations, such as an air bag deployment or hitting a road obstacle, data that will assist in understanding how a vehicle's systems performed. **The EDR is designed to record data related to vehicle dynamics and safety systems for a short period of time, typically 30 seconds or less.** The EDR in this vehicle is designed to record such data as:

- How various systems in your vehicle were operating;
- Whether or not the driver and passenger safety belts were buckled/fastened;
- How far (if at all) the driver was depressing the accelerator and/or brake pedal; and,
- How fast the vehicle was traveling.

These data can help provide a better understanding of the circumstances in which crashes and injuries occur. NOTE: EDR data are recorded by your vehicle only if a non-trivial crash situation occurs; no data are recorded by the EDR under normal driving conditions and no personal data (e.g., name, gender, age, and crash location) are recorded. However, other parties, such as law enforcement, could combine the EDR data with the type of personally identifying data routinely acquired during a crash investigation.

To read data recorded by an EDR, special equipment is required, and access to the vehicle or the EDR is needed. In addition to the vehicle manufacturer, other parties, such as law enforcement, that have the special equipment, can read the information if they have access to the vehicle or the EDR.

The data belongs to the vehicle owner and may not be accessed by anyone else except as legally required or with the permission of the vehicle owner.

Service Diagnostic Recorders

This vehicle is equipped with service-related devices that record information about powertrain performance. The data can be used to verify emissions law requirements and/or help technicians diagnose and solve service problems. It may also be combined with data from other sources for research purposes, but it remains confidential. Some diagnostic and maintenance information is uploaded to Honda upon vehicle start up.

California Perchlorate Contamination Prevention Act

The airbags, seat belt tensioners, and CR type batteries in this vehicle may contain perchlorate materials - special handling may apply. See www.dtsc.ca.gov/hazardouswaste/perchlorate/

As you read this manual, you will find information that is preceded by a **NOTICE** symbol. This information is intended to help you avoid damage to your vehicle, other property, or the environment.

Software End User License Agreement

Your vehicle comes equipped with software, which is governed by the End User License Agreement in Owner's Manual, and which contains a binding arbitration clause. Please refer to the End User License Agreement for the terms and conditions governing your use of the installed software, as well as the applications, services, functions, and content provided through the software. Your use of the installed software will serve as your consent to the terms and conditions of the End User License Agreement.

You may opt out within 30 days of your initial use of the Software by sending a signed, written notice to HONDA at American Honda Motor Co., Inc. Honda Automobile Customer Services Mail Stop CHI-5, 1919 Torrance Blvd., Torrance, CA 90501-2746.

Privacy Notice

This vehicle may share location and usage information. To manage this setting, visit www.hondalink.com/vehicle-data-choices.

To learn more about how we collect and use Personal Information, please read our Privacy Policy, accessible at www.honda.com.

A Few Words About Safety

Your safety, and the safety of others, is very important. And operating this vehicle safely is an important responsibility.

To help you make informed decisions about safety, we have provided operating procedures and other information on labels and in this manual. This information alerts you to potential hazards that could hurt you or others.

Of course, it is not practical or possible to warn you about all the hazards associated with operating or maintaining your vehicle. You must use your own good judgment.

You will find this important safety information in a variety of forms, including:

- **Safety Labels** - on the vehicle.
- **Safety Messages** - preceded by a safety alert symbol  and one of three signal words: **DANGER**, **WARNING**, or **CAUTION**. These signal words mean:

 **DANGER**

You WILL be KILLED or SERIOUSLY HURT if you don't follow instructions.

 **WARNING**

You CAN be KILLED or SERIOUSLY HURT if you don't follow instructions.

 **CAUTION**

You CAN be HURT if you don't follow instructions.

- **Safety Headings** - such as Important Safety Precautions.
- **Safety Section** - such as Safe Driving.
- **Instructions** - how to use this vehicle correctly and safely.

This entire book is filled with important safety information - please read it carefully.

This owner's manual should be considered a permanent part of the vehicle and should remain with the vehicle when it is sold.

The Navigation Manual is available online at owners.honda.com. **If you are the first registered owner of your vehicle, you may request a complimentary printed copy of the Navigation Manual within the first six months of vehicle purchase.** To request a copy, visit owners.honda.com.

This owner's manual covers all models of your vehicle. You may find descriptions of equipment and features that are not on your particular model.

Images throughout this owner's manual (including the front cover) represent features and equipment that are available on some, but not all, models. Your particular model may not have some of these features.

This owner's manual is for vehicles sold in the United States.

The information and specifications included in this publication were in effect at the time of approval for printing. Honda Motor Co., Ltd. reserves the right, however, to discontinue or change specifications or design at any time without notice and without incurring any obligation.

➤ Safe Driving P. 41

For Safe Driving P. 42 Seat Belts P. 47 Airbags P. 56

➤ Instrument Panel P. 89

Indicators P. 90 Gauges and Driver Information Interface P. 126

➤ Controls P. 149

Clock P. 150 Locking and Unlocking the Doors P. 152
Moonroof* P. 185
Seats P. 208 Interior Convenience Items P. 218

➤ Features P. 243

Audio System P. 244 Audio System Basic Operation P. 251, 272
Customized Features P. 362, 369 HomeLink® Universal Transceiver* P. 395

➤ Driving P. 459

Before Driving P. 460 Towing a Trailer P. 465
Parking Your Vehicle P. 559 Multi-View Rear Camera P. 570

➤ Maintenance P. 577

Before Performing Maintenance P. 578 Maintenance Minder™ P. 581
Checking and Maintaining Wiper Blades P. 601
Climate Control System Maintenance P. 618

➤ Handling the Unexpected P. 627

Tools P. 628 If a Tire Goes Flat P. 629
Overheating P. 649 Indicator, Coming On/Blinking P. 652
If You Cannot Open the Tailgate P. 664

➤ Information P. 667

Specifications P. 668 Identification Numbers P. 670
Emissions Testing P. 673 Warranty Coverages P. 675

Contents

Child Safety P. 72

Exhaust Gas Hazard P. 86

Safety Labels P. 87

Tailgate P. 167

Security System P. 178

Windows P. 181

Operating the Switches Around the Steering Wheel P. 186

Mirrors P. 206

Climate Control System P. 235

Audio Error Messages P. 340

General Information on the Audio System P. 345

Bluetooth® HandsFreeLink® P. 398, 422

Compass* P. 456

Off-Highway Driving Guidelines P. 467

When Driving P. 469

Honda Sensing® P. 503

Braking P. 551

Refueling P. 572

Fuel Economy and CO₂ Emissions P. 575

Maintenance Under the Hood P. 586

Replacing Light Bulbs P. 598

Checking and Maintaining Tires P. 606

12-volt Battery P. 615

Remote Transmitter Care P. 617

Cleaning P. 619

Accessories and Modifications P. 624

Handling of the Jack P. 643

Power System Won't Start P. 644

If the 12-Volt Battery Is Dead P. 647

Fuses P. 659

Emergency Towing P. 663

Refueling P. 665

Devices that Emit Radio Waves P. 671

Reporting Safety Defects P. 672

Authorized Manuals P. 678

Customer Service Information P. 679

Quick Reference Guide P. 6

Safe Driving P. 41

Instrument Panel P. 89

Controls P. 149

Features P. 243

Driving P. 459

Maintenance P. 577

Handling the Unexpected P. 627

Information P. 667

Index P. 681

Visual Index

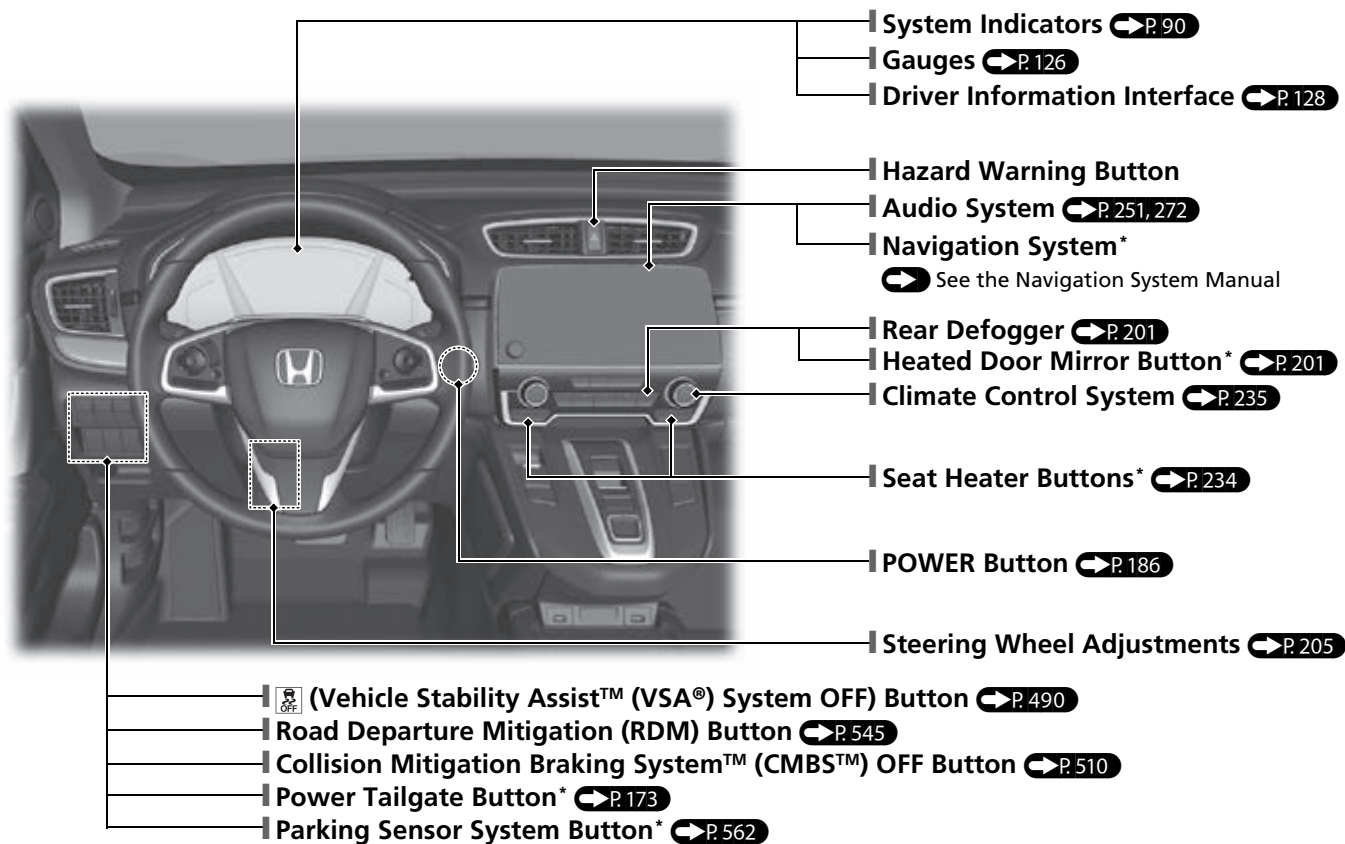

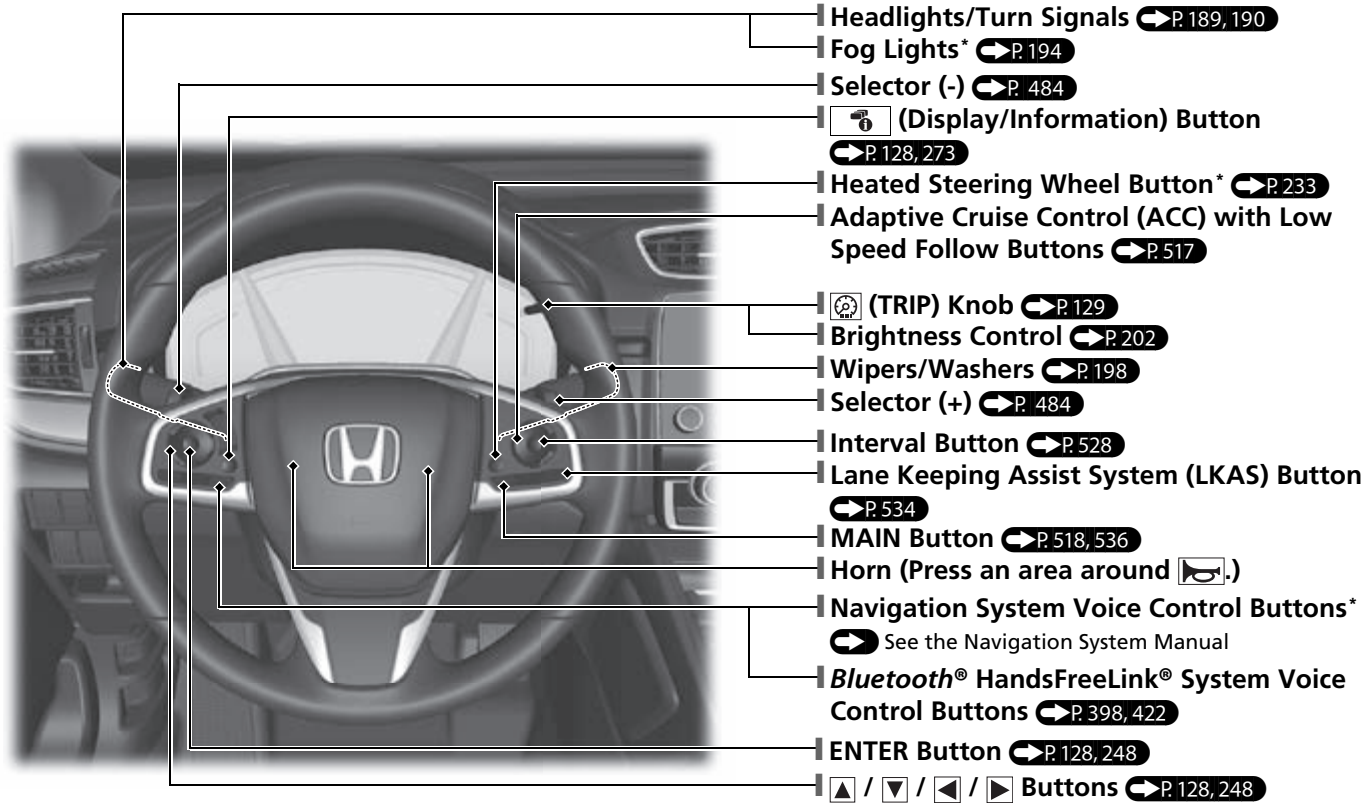

Visual Index

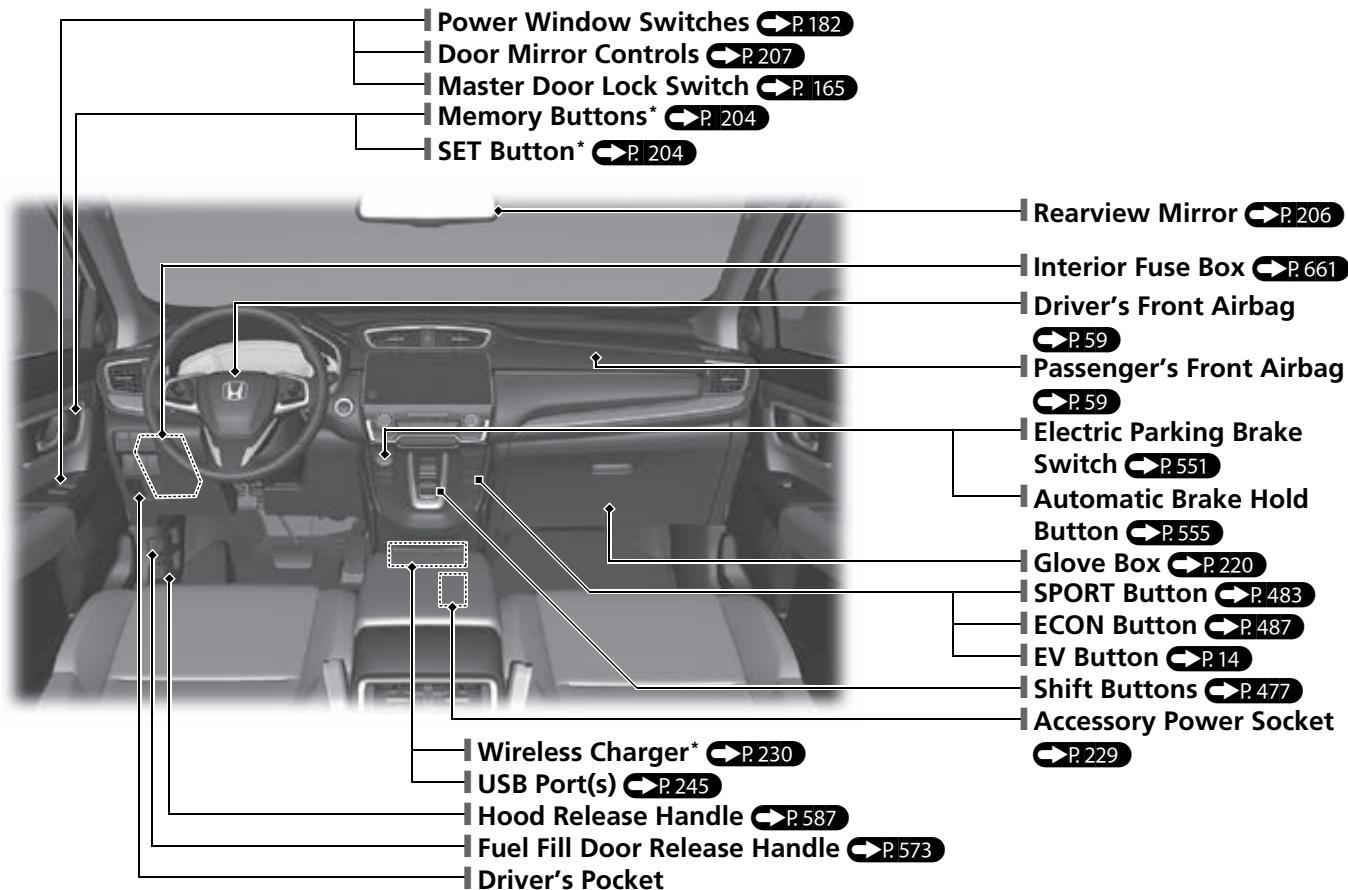

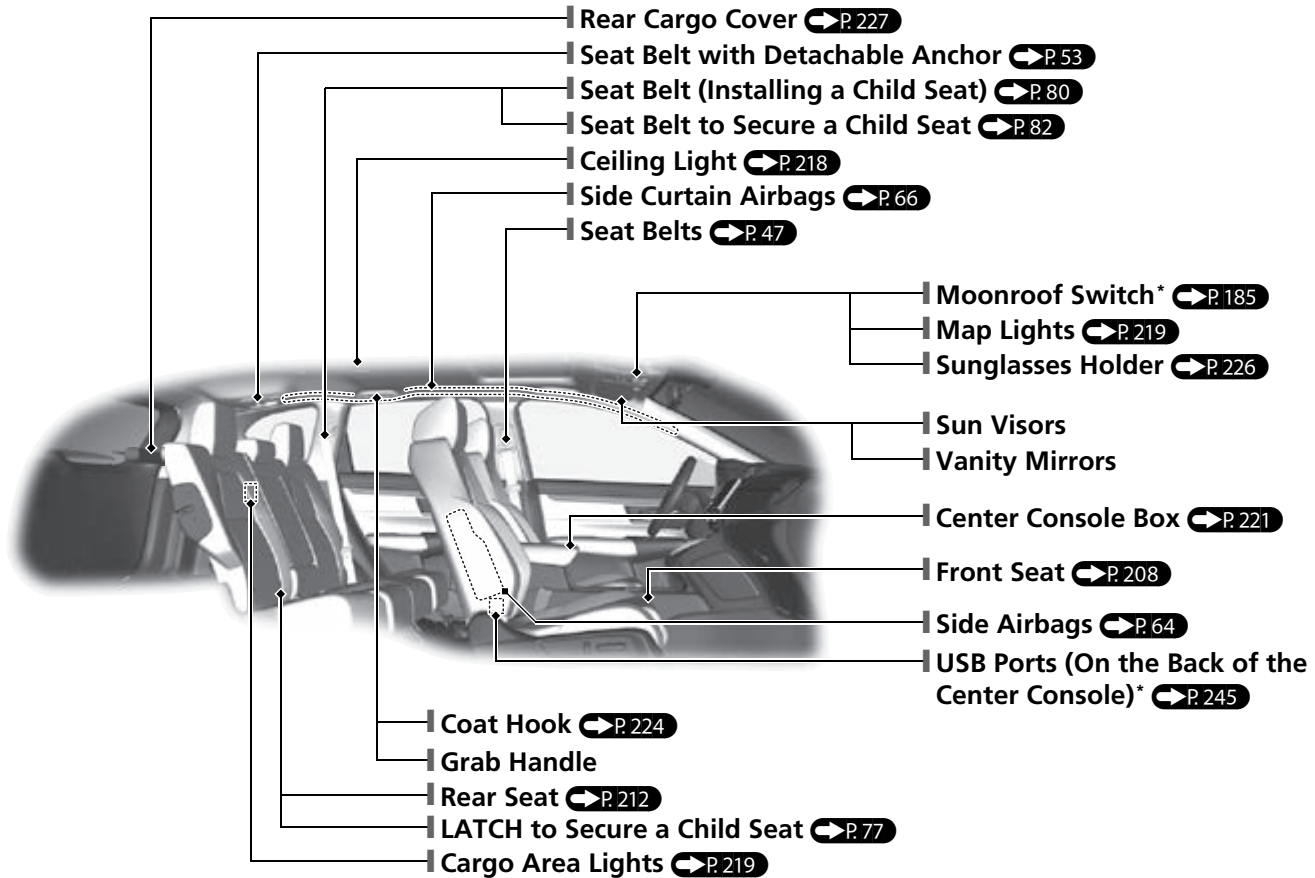

* Not available on all models

Visual Index

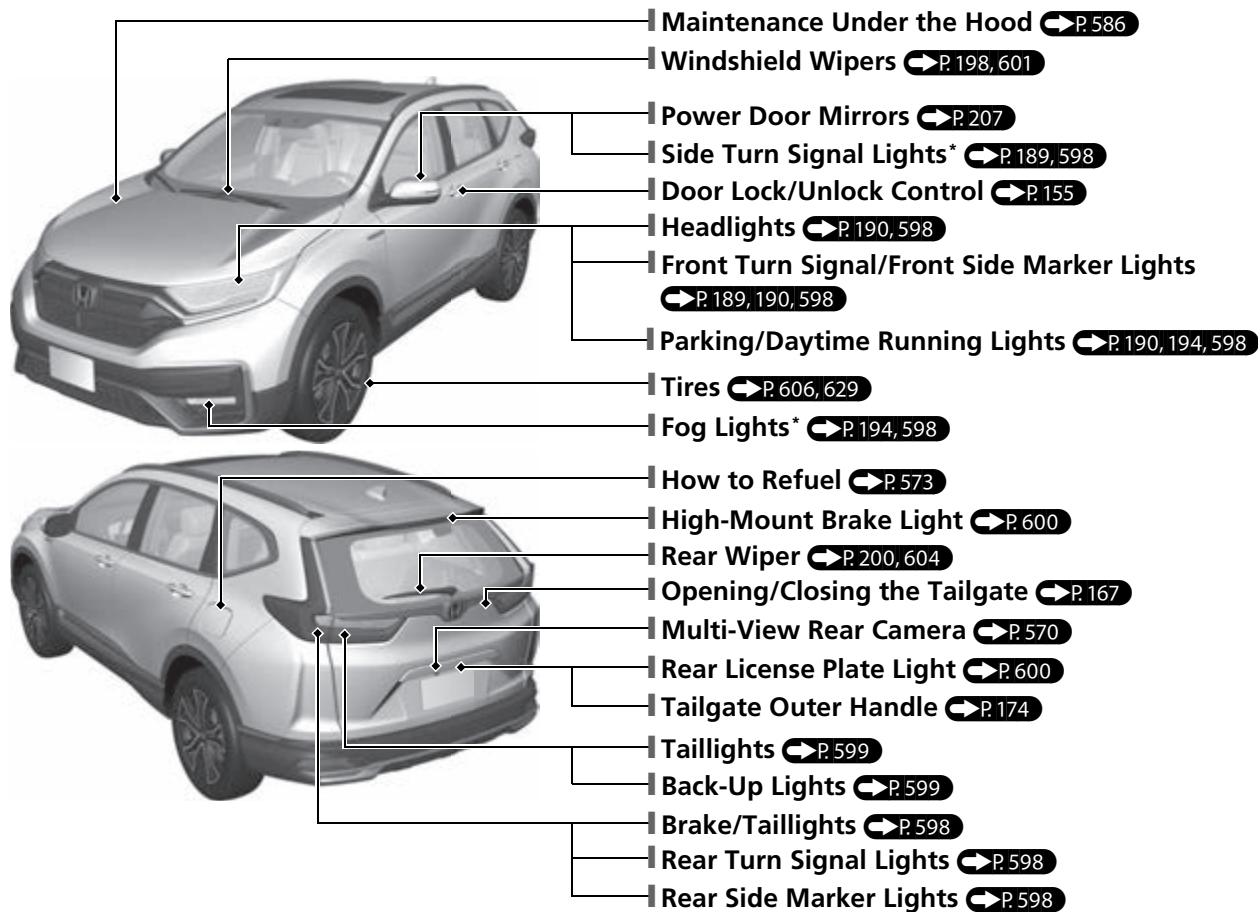

SPORT HYBRID i-MMD (intelligent Multi-Mode Drive)

Your SPORT HYBRID i-MMD vehicle uses both an electric motor and a gasoline engine as propulsion sources, with the electric motor receiving electricity from an internal High Voltage battery and/or internal generator. The High Voltage battery is charged from the generator driven by the engine or regenerative braking.

When driving, your vehicle is propelled exclusively by the electric motor, exclusively by the gasoline engine, or by a combination of the two. The system selects which propulsion source is most appropriate and automatically switches to it. Under certain circumstances, pressing the EV button can manually enable EV (driven only on electricity) mode.

● Energy efficiency

As with a gasoline-powered vehicle, hybrid vehicle fuel efficiency and driving range is most impacted by your driving style. Aggressive acceleration and high-speed driving can easily trigger the system to switch the propulsion source to the gasoline-powered engine. In addition, heavy climate control system use negatively affects vehicle range and efficiency. Either of these use patterns will more quickly reduce the High Voltage battery's state of charge.

● Battery types

There are two types of batteries used in this vehicle; a standard 12-volt battery that powers the airbags, the interior and exterior lights, and other standard 12-volt systems; and a high voltage battery that is used to power the propulsion motor and recharge the 12-volt battery.

SPORT HYBRID i-MMD SYSTEM MAIN COMPONENTS

Gasoline Engine– Runs the generator and under certain conditions, drives the wheels directly.

Generator– Starts the engine and generates electric power when driven by the gasoline engine to supply electricity to power the electric motor and/or to charge the High Voltage battery.

Electric Motor– Provides propulsion to drive the wheels in conjunction with the gasoline engine in certain conditions and provides electricity to the High Voltage battery through regenerative braking.

High Voltage Battery– Provides electrical storage and serves as a power source for the electric motor. Learning about the High Voltage battery's characteristics will help you get the best handling and maximize the range of your electric vehicle. [➔ P. 502](#)

High Voltage Battery Charge Level Indicator– Displays battery state of charge.

When the indicator:

- Displays two or less segments, EV mode is no longer available.
- Displays ten segments, battery charge level is full.

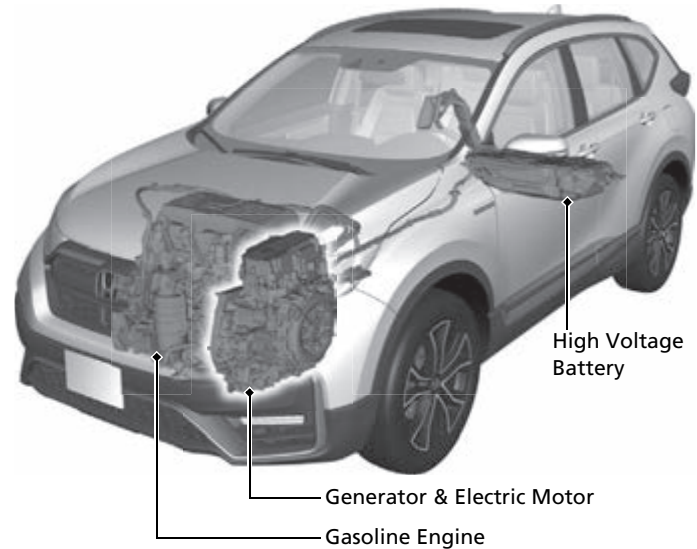



Operating mode	Electric Vehicle (EV)	Hybrid (HV)	Engine (Direct Drive)	Regeneration
Driving state	<p>Stopped or driven at low speeds:</p> <ul style="list-style-type: none"> Only the electric motor provides propulsion to the wheels. 	<p>Driven in high-load conditions (e.g., when accelerating, going uphill):</p> <ul style="list-style-type: none"> The Electric Motor provides propulsion to the wheels. The gasoline engine drives the generator, supplying electricity to the electric motor for added propulsion or to the High Voltage battery for charging. 	<p>Driven in high-speed, low-load conditions:</p> <ul style="list-style-type: none"> The gasoline engine provides propulsion to the wheels. The High Voltage battery supplies electricity to the electric motor for added propulsion. The electric motor provides electricity to the High Voltage battery through regenerative braking. 	<p>The accelerator pedal is released and the vehicle is decelerating.</p> <ul style="list-style-type: none"> The electric motor provides electricity to the High Voltage battery through regenerative braking.
Power Flow Monitor				
Electric motor	Stopped/Running	Running	Generating/Running	Regenerating
Generator	Stopped	Generating	No Output	Stopped/No Output
Engine	Stopped	Running	Running	Stopped/No Output
High Voltage battery	Discharge	Charging/Discharge	Charging/Discharge	Charging

EV Button

EV mode is enabled by pressing the **EV** button near the shift button.

The **EV** mode indicator comes on in the instrument panel when EV mode is enabled.

Press the **EV** button again to switch back to HV mode.

Some conditions, such as a low High Voltage battery level and a high vehicle speed, may keep the system from manually switching into EV mode. The beeper sounds and a message appears on the driver information interface with the button pressed when EV mode is disabled.

Shifts in vehicle, driving, or road conditions may automatically cancel EV mode and switch back to HV mode.

A message will appear on the driver information interface and EV mode may be canceled automatically when:

- The High Voltage battery charge level is low.
- Your vehicle speed is too high.
- Your vehicle speed is above 25 mph (40 km/h) while the engine is in warming-up operation.
- You fully depress the accelerator pedal.
- You are driving on hilly road.

➔ **Driver Information Interface Warning and Information Messages** ➔ P. 109

In EV mode, the acoustic vehicle alerting system is on.

➔ **Acoustic Vehicle Alerting System** ➔ P. 488

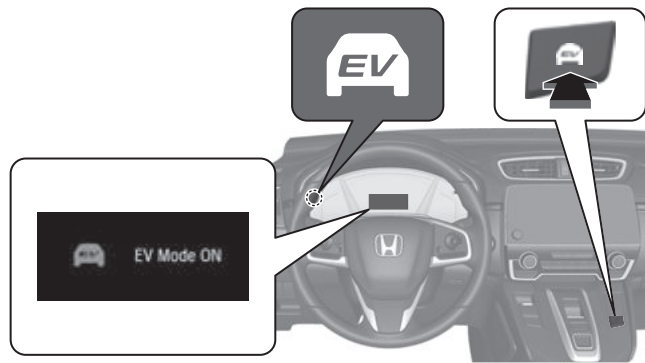

● Regenerative Energy and Regenerative Braking

When regenerative braking is in operation

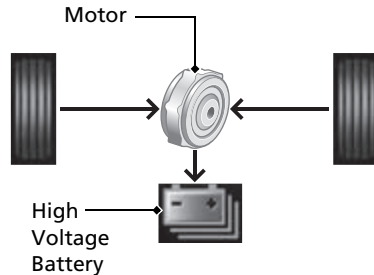

When decelerating without the accelerator being depressed or the brake pedal being applied, or while driving downhill, the electric motor acts as a generator that recovers a portion of the electrical energy that was used to accelerate the vehicle. This regenerative braking slows the vehicle in a manner similar to engine braking in a gasoline-powered vehicle. You can control the rate of deceleration by using the deceleration paddle selector.

● Auto Engine Stop/Start

Your vehicle's gasoline engine automatically stops running during vehicle operation or restarts while the vehicle is stationary when it is appropriate.

In the following cases, however, auto engine stop may not activate.

- The vehicle momentarily needs additional power for aggressive acceleration, or driving uphill or at high speed.
- The climate control system is in heavy use.
- The High Voltage battery temperature is high or low.
- The High Voltage battery is too low on charge.

● Sounds Unique to the SPORT HYBRID i-MMD System

When you first start driving this vehicle, you will likely hear some unfamiliar sounds, particularly when you turn on the power system, or while you are driving or accelerating from a stop. Some of these sounds are unique to this vehicle's powertrain, fuel, and climate control systems; others are similar to sounds generated by conventional automobiles that typically are masked by louder noises absent from a vehicle of this design. These sounds are not a cause for concern, and you will soon recognize them as normal and thus be able to detect any new or unusual noise should one develop.

After shutting off the engine, you may hear certain noises coming from the vehicle. Here's the lowdown:

● **Noise from Under Vehicle:** This noise is caused by the vacuum pump inside the fuel evaporation leakage check module (ELCM).

Depending on conditions, the pump will come on for about **15 minutes** about **5 to 10 hours** after engine shutoff. This noise is just normal vehicle operation and doesn't indicate a vehicle problem.

Safety Precautions



Do not cover the air intake.

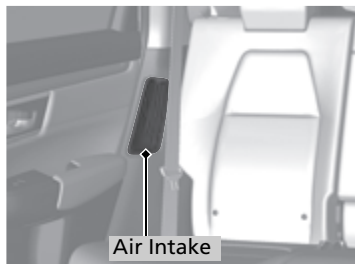

If the air intake is obstructed during vehicle operation, the High Voltage battery can become too hot. To protect the battery, the system may start to limit the battery's output and cause the power system and 12-volt battery charging system indicators to come on.

Do not touch the High Voltage system

Attempting to take a High Voltage system component apart or disconnect one of its wires can cause severe electrical shock. Make sure that any maintenance or repairs to the High Voltage system are performed by a Honda dealer.

If a crash occurs

- Be careful of electric shock hazard.
 - ▶ If a severe crash damages your vehicle's High Voltage system, there is a possibility of electrical shock due to exposed High Voltage components or wires. If this happens, do not touch any of the High Voltage system components or any of its orange wires.
- Avoid contact with High Voltage battery fluid.
 - ▶ The High Voltage battery contains a flammable electrolyte that could leak as a result of a severe crash. Avoid skin or eye contact with the electrolyte as it is corrosive. If you accidentally come into contact with the electrolyte, rinse the exposed skin or flush your eyes with copious amounts of water for at least five minutes, and seek medical attention immediately.
- Use a fire extinguisher for an electrical fire.
 - ▶ Attempting to extinguish an electrical fire with even a small quantity of water, from a garden hose for instance, can be dangerous.
- Any time the vehicle is damaged in a crash, have it repaired by a dealer.

Emergency Shutdown System for the High Voltage System

If the vehicle is involved in a crash, the emergency shutdown system will activate depending on the severity of the impact. When the system activates, the High Voltage system automatically shuts down, and the vehicle can no longer move under its own power. To return the High Voltage system back to normal operation, consult a dealer.

Honda collects and recycles High Voltage batteries used in its vehicles – consult a dealer for more information.

Eco Assist® System P. 487

Ambient Meter

- With SPORT mode off, the color of the ambient meter changes to green to indicate that the vehicle is being driven in a fuel efficient manner.



ECON Mode Indicator P. 102

Comes on when the ECON button is pressed.

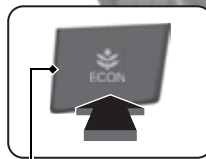

ECON Button P. 487

Helps maximize fuel economy.

Drive Cycle Score/Lifetime Points

- Comes on when the power mode is in VEHICLE OFF.



Eco Drive Display P. 132

- Keep the vehicle icon near the center of the circle.

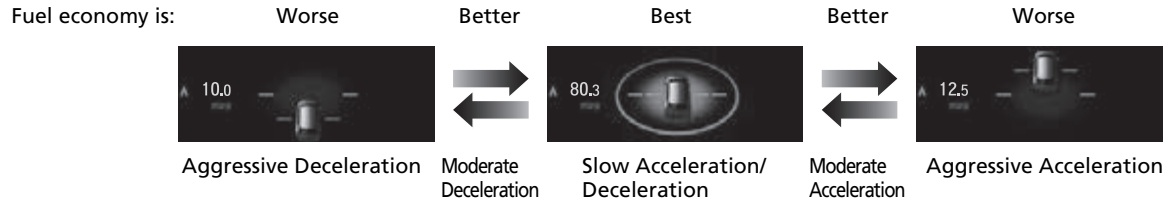

Safe Driving P.41

Airbags P.56

- Your vehicle is fitted with airbags to help protect you and your passengers during a moderate-to-severe collision.

Child Safety P.72

- All children 12 and younger should be seated in the rear seat.
- Smaller children should be properly restrained in a forward-facing child seat.
- Infants must be properly restrained in a rear-facing child seat.

Exhaust Gas Hazard P.86

- Your vehicle emits dangerous exhaust gases that contain carbon monoxide. Do not run the engine in confined spaces where carbon monoxide gas can accumulate.

Seat Belts P.47

- Fasten your seat belt and sit upright well back in the seat.
- Check that your passengers are wearing their seat belts correctly.

Before Driving Checklist P.46

- Before driving, check that the front seats, head restraints, steering wheel, and mirrors have been properly adjusted.

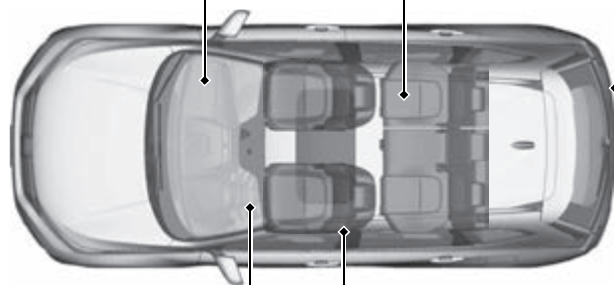

Fasten your lap belt as low as possible.

Instrument Panel P.89

Indicators  P. 90 / Gauges  P. 126 / Driver Information Interface  P. 128

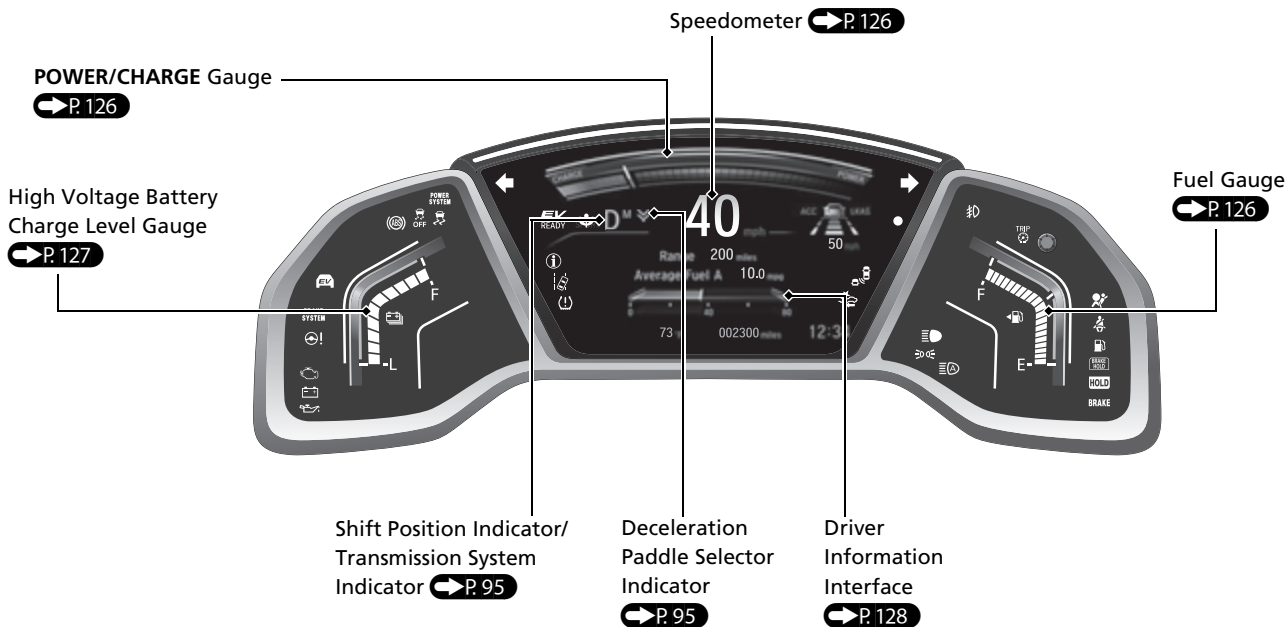





Controls P.149

Clock P.150

Models with color audio system



- 1 Press and hold the **MENU/CLOCK** button, then select **Adjust Clock**.
- 2 Rotate  to change hour, then press .
- 3 Rotate  to change minute, then press .
- 4 Select **SET**, then press .



These indications are used to show how to operate the selector knob.

- Rotate  to select.
- Press  to enter.

Models with Display Audio

The clock is automatically updated through the audio system. You can also adjust the time manually.



- 1 Select the  (Home) icon, then select **Settings**.
- 2 Select **Clock**, then **Clock Adjustment**.
- 3 Touch the respective  /  icon to adjust the hours or minutes up or down.
- 4 Select **OK**.

POWER Button P.186

Press the button to change the vehicle's power mode.

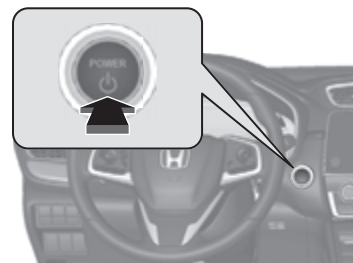

Turn Signals P.189

Turn Signal Control Lever



Lights P.190

Light Control Switches

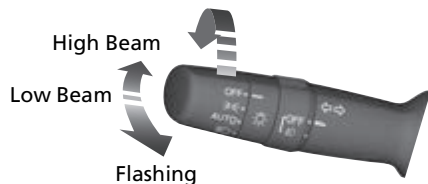

Wipers and Washers

 P.198

Wiper/Washer Control Lever

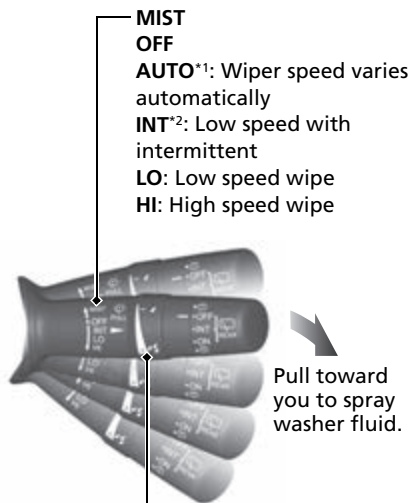

MIST
OFF





AUTO*1: Wiper speed varies automatically

INT*2: Low speed with intermittent

LO: Low speed wipe

HI: High speed wipe

Adjustment Ring

- : Low Sensitivity*1
- : Lower speed, fewer sweeps*2
- : High Sensitivity*1
- : Higher speed, more sweeps*2

*1: Models with automatic intermittent wipers

*2: Models without automatic intermittent wipers

Models with automatic intermittent wipers

AUTO should always be turned **OFF** before the following situations in order to prevent severe damage to the wiper system:

- Cleaning the windshield
- Driving through a car wash
- No rain present

Steering Wheel P.205

- To adjust, pull the adjustment lever towards you, adjust to the desired position, then lock the lever back in place.

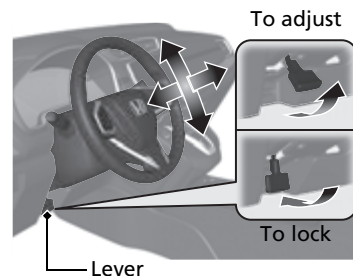

Unlocking the Front Doors from the Inside

➔ P.163

- Pull either front door inner handle to unlock and open it at the same time.

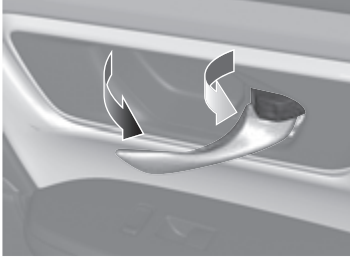

Tailgate ➔ P.167

- Press the tailgate outer handle to unlock and open the tailgate when you have the keyless remote on you.

Models with power tailgate

- Press the power tailgate button on the driver's side control panel, or press the remote transmitter to unlock and open the tailgate when you have the keyless remote on you.

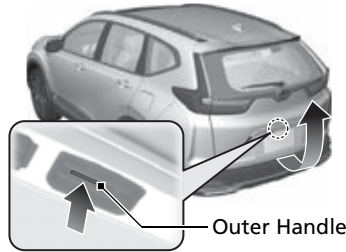

Models with hands free access

Use a forward and back kicking motion under the center of the rear bumper to open or close the power tailgate while carrying the keyless remote.

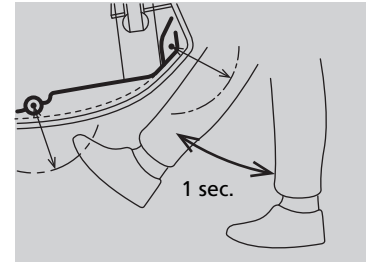

Power Door Mirrors

➔ P. 207

- With the power mode in ON, move the selector switch to L or R.
- Push the appropriate edge of the adjustment switch to adjust the mirror.

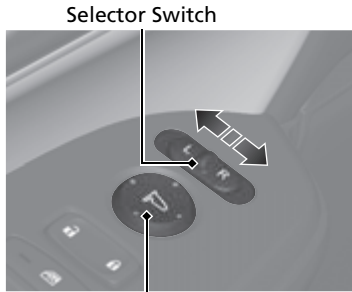

Adjustment Switch

Power Windows ➔ P. 181

- With the power mode in ON, open and close the power windows.
- If the power window lock button is in the off position, each passenger's window can be opened and closed with its own switch.
- If the power window lock button is in the on position (indicator on), each passenger's window switch is disabled.

Auto-open/close function on driver's window

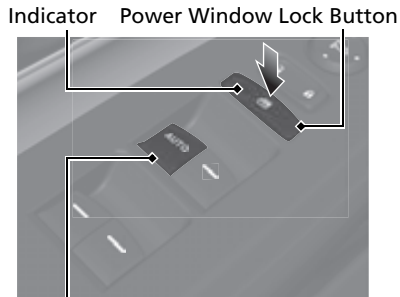

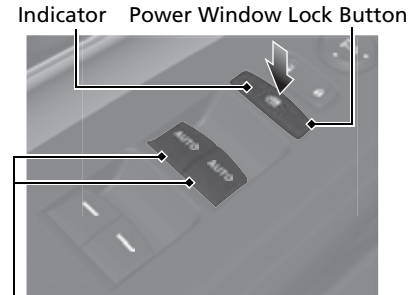

Window Switch

Auto-open/close function on front windows







Window Switches

Climate Control System P.235

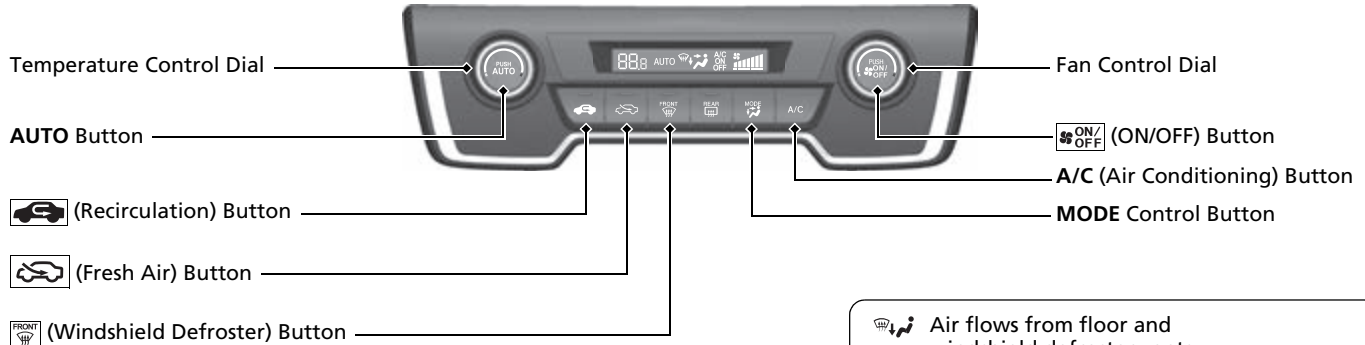
- Press the **AUTO** button to activate the climate control system.
- Press the  button to turn the system on or off.
- Press the  button to defrost the windshield.

Models without SYNC button



-  Air flows from floor and windshield defroster vents.
-  Air flows from floor vents.
-  Air flows from floor and dashboard vents, and back of the center console.
-  Air flows from dashboard vents, and back of the center console.





Fan Control Buttons

Driver's side Temperature Control Dial

AUTO Button

 (ON/OFF) Button

 (Recirculation) Button

 (Fresh Air) Button



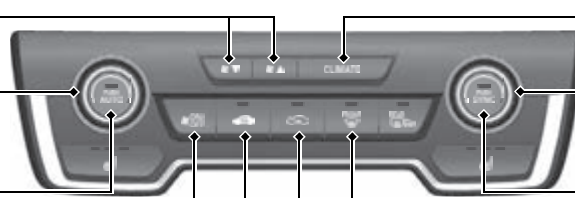

 (Windshield Defroster) Button



 (CLIMATE) Button

Passenger's side Temperature Control Dial

 (Synchronization) Button

-  Air flows from floor and windshield defroster vents.
-  Air flows from floor vents.
-  Air flows from floor and dashboard vents, and back of the center console.
-  Air flows from dashboard vents, and back of the center console.

Features ➔ P.243

Audio Remote Controls

➔ P.248

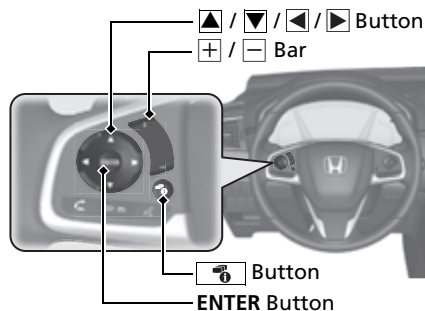

- **+ / - Bar**
Press to adjust the volume up/down.
- **▲ / ▼ Button**
Press **▲** or **▼** to cycle through the audio mode as follows:

Models with color audio system

FM1/FM2/AM/USB or iPod/Pandora®/
Bluetooth® Audio

Models with Display Audio

FM/AM/SiriusXM®/USB/iPod/
Bluetooth® Audio/Pandora®/Apps/
Audio Apps

Models with Display Audio





- **ENTER Button**
- When listening to a USB flash drive
 - 1 Press **ENTER** to display the folder list.
 - 2 Press **▲** or **▼** to select a folder.
 - 3 Press **ENTER** to display a list of tracks in that folder.
 - 4 Press **▲** or **▼** to select a track, then press **ENTER**.
- When listening to an iPod
 - 1 Press **ENTER** to display the iPod music list.
 - 2 Press **▲** or **▼** to select a category.
 - 3 Press **ENTER** to display a list of items in the category.
 - 4 Press **▲** or **▼** to select an item, then press **ENTER**.
 - ▶ Press **ENTER** and press **▲** or **▼** repeatedly until a desired item you want to listen is displayed.

- When listening to Pandora®

- 1 Press **ENTER** to display the station list.
- 2 Press **▲** or **▼** to select an item, then press **ENTER**.

- When listening to *Bluetooth*® Audio

- 1 Press **ENTER** to display the track list.
- 2 Press **▲** or **▼** to select a track, then press **ENTER**.

-  /  Button
 - Radio: Press to change the preset station.
Press and hold to select the next or previous strong station.
 - USB device:
Press to skip to the beginning of the next song or return to the beginning of the current song.
Press and hold to change a folder.
 - Pandora®:
Press to skip to the next track.
Press and hold to select the next or previous station.
-  (Display/Information) Button:
Press to change contents.
 -  **Driver Information Interface**
 - 

Audio System P.244

Models with color audio system  P.251



For navigation system operation See the Navigation System Manual

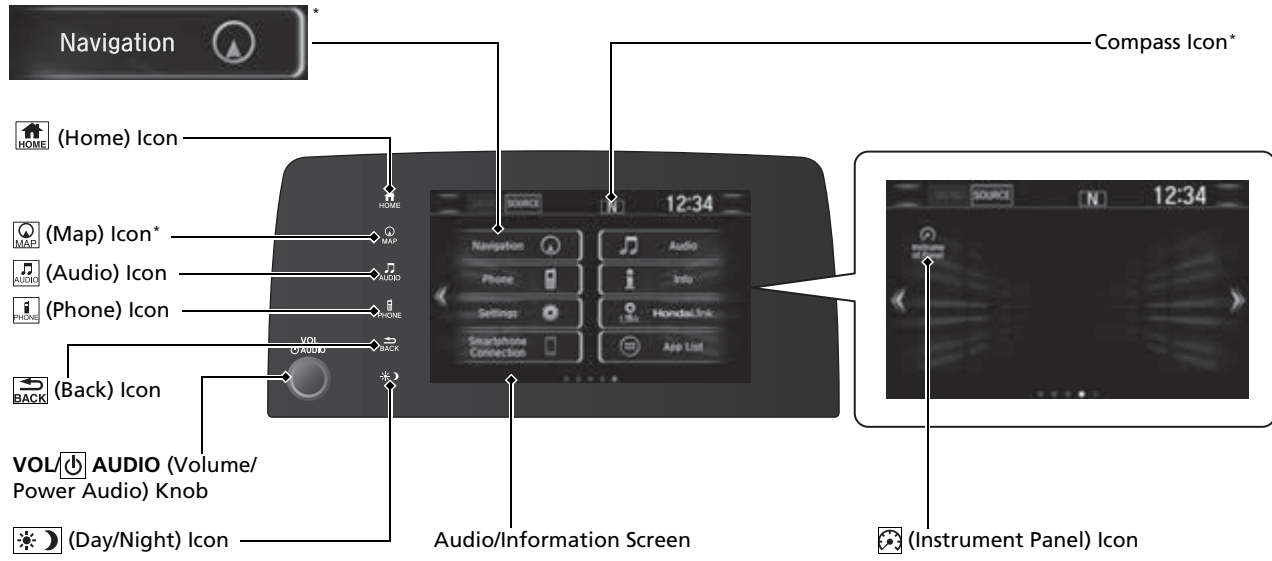

Driving P. 459

Transmission P. 476

- Select **P** and depress the brake pedal when turning on the power.
- Shift selection

READY Indicator

On: You can start to drive.

READY

Shift Position Indicator

The shift position indicator and the shift button indicator indicate the current shift selection.

D

Shift Position Indicator

Shift Button Indicator



P **Park**
Press the **P** button.
Used when parking or before turning off or starting the power system.
Transmission is locked.

R **Reverse**
Press back the **R** button.
Used when reversing.

N **Neutral**
Press the **N** button.
Transmission is not locked.

D **Drive**
Press the **D** button.
Used for normal driving.
The deceleration paddle selector can be used temporarily.
The deceleration paddle selector can be used when SPORT mode is on.

Deceleration Paddle Selector  P. 484

When you release the accelerator pedal, you can control the rate of deceleration without releasing your hands from the steering wheel. Using the deceleration paddle selector situated on the steering wheel, you can sequentially shift through four stages of deceleration.

Pull the  selector for a few seconds when you want to cancel the deceleration paddle selector.

- **When SPORT mode is OFF**

If you pull back the paddle selector, the rate of deceleration will change temporarily, and the stage will appear in the instrument panel.

- **When SPORT mode is ON**

If you pull back the paddle selector, the rate of deceleration will change and the stage along with **M** will appear in the instrument panel.



 Paddle Selector



 Paddle Selector

When SPORT mode is OFF, the deceleration stage appears.



Deceleration stage

When SPORT mode is ON, the deceleration stage and **M** appear.



VSA® On and Off P.490

- The Vehicle Stability Assist™ (VSA®) system helps stabilize the vehicle during cornering and helps maintain traction while accelerating on loose or slippery road surfaces.
- VSA® comes on automatically every time you turn on the power system.
- To partially disable VSA® functionality/features, press and hold it until you hear a beep.

Tire Pressure Monitoring System (TPMS) P.493

- Detects a change in tire conditions and overall dimensions due to decrease in tire pressures.
- The TPMS is turned on automatically every time you turn on the power system.
- A calibration procedure must be performed when certain conditions arise.

CMBS™ On and Off

 P.510

- When a possible frontal collision is likely unavoidable, the CMBS™ can help you to reduce the vehicle speed and the severity of the collision.
- The CMBS™ is turned on every time you turn on the power system.
- To turn the CMBS™ on or off, press and hold the button until you hear a beep.

Refueling P.572

Fuel recommendation: Unleaded gasoline, pump octane number 87 or higher
Fuel tank capacity: 14 US gal (53 L)

- 1 Pull the fuel fill door release handle.



- 2 After refueling, wait for about five seconds before removing the filler nozzle.

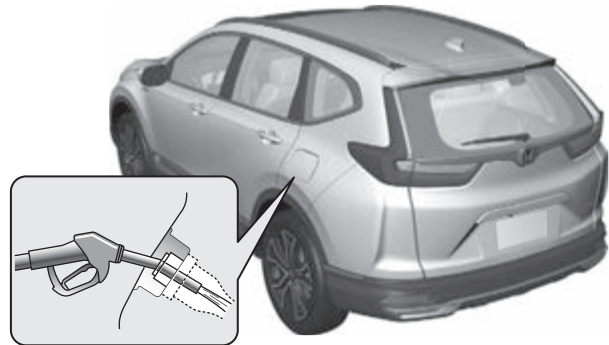

Honda Sensing®

➔ P.503

Honda Sensing® is a driver support system which employs the use of two distinctly different kinds of sensors, a radar sensor located in the front grille and a front sensor camera mounted to the interior side of the windshield, behind the rear view mirror.

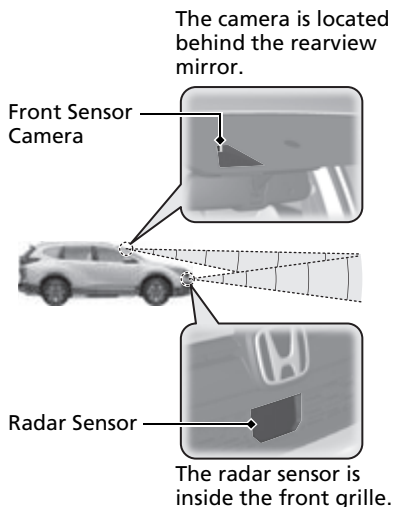

Collision Mitigation Braking System™ (CMBS™)

➔ P.506

The system can assist you when it determines there is a possibility of your vehicle colliding with a vehicle or a pedestrian detected in front of your vehicle. The CMBS™ is designed to alert you when the potential for a collision is determined, as well as to reduce your vehicle speed to help minimize collision severity when a collision is deemed unavoidable.

Adaptive Cruise Control (ACC) with Low Speed Follow

➔ P.517

Helps maintain a constant vehicle speed and a set following-interval behind a vehicle detected ahead of yours and, if the detected vehicle comes to a stop, can decelerate and stop your vehicle, without you having to keep your foot on the brake or the accelerator.

Lane Keeping Assist System (LKAS)

➔ P.534

Provides steering input to help keep the vehicle in the middle of a detected lane and provides tactile and visual alerts if the vehicle is detected drifting out of its lane.

Road Departure Mitigation (RDM) System

➔ P.543

Alerts and helps to assist you when the system detects a possibility of your vehicle unintentionally crossing over detected lane markings and/or leaving the roadway altogether.

Maintenance P.577

Under the Hood P.586

- Check engine oil, engine coolant, and windshield washer fluid. Add when necessary.
- Check brake fluid.
- Check the 12-volt battery condition monthly.

- 1 Pull the hood release handle under the corner of the dashboard.



- 2 Locate the hood latch lever, push it to the side, and then raise the hood. Once you have raised the hood slightly, you can release the lever.

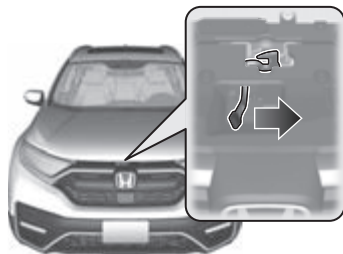

- 3 When finished, close the hood and make sure it is firmly locked in place.

Wiper Blades P.601

- Replace blades if they leave streaks across the windshield or become noisy.



Tires P.606

- Inspect tires and wheels regularly.
- Check tire pressures regularly.
- Install snow tires for winter driving.

Lights P.598

- Inspect all lights regularly.

Handling the Unexpected P.627

Flat Tire P.629

- Park in a safe location and repair the flat tire using the tire repair kit in the cargo area.



Power System Won't Start P.644

- If the 12-volt battery is dead, jump start using a booster battery.



Overheating P.649

- Park in a safe location. If you do not see steam under the hood, open the hood, and let the power system cool down.



Indicators Come On

 P.652

- Identify the indicator and consult the owner's manual.

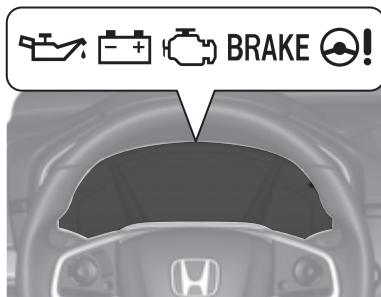

Blown Fuse P.659

- Check for a blown fuse if an electrical device does not operate.

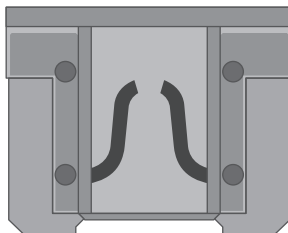

Emergency Towing P.663

- Call a professional towing service if you need to tow your vehicle.



What to Do If

Q Why does the brake pedal pulsate slightly when applying the brakes?

A This can occur when the ABS activates and does not indicate a problem. Apply firm, steady pressure on the brake pedal. Never pump the brake pedal.

➤ Anti-lock Brake System (ABS) ➔ P.557

Q The rear door cannot be opened from inside the vehicle. Why?

A Check if the childproof lock is in the lock position. If so, open the rear door with the outside door handle.

To cancel this function, slide the lever up to the unlock position.

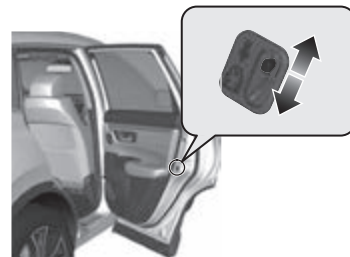

Q Why do the doors lock after I unlocked the doors?

A If you do not open the doors within 30 seconds, the doors are relocked automatically for security.

Q Why does the beeper sound when I open the driver's door?

A The beeper sounds when:

- The exterior lights are left on.
- The power mode is in ACCESSORY.

Q Why does a beeper sound when I walk away from the vehicle after I close the door?

A The beeper sounds if you move outside the walk away auto lock operating range before the door completely closes.
🔊 Locking the doors and tailgate (Walk away auto lock®) ➔ P.158

Q Why does the beeper sound when I start driving?

A The beeper sounds when the driver and/or front passenger are not wearing their seat belts.

Q Pressing the electric parking brake switch does not release the parking brake. Why?

A Press the electric parking brake switch with the brake pedal depressed.

Q Depressing the accelerator pedal does not release the parking brake automatically. Why?

A

- Fasten the driver's seat belt.
- Check if the transmission is in **P** or **N**. If so, select any other position.

Q Why do I hear a screeching sound when I apply the brake pedal?

A The brake pads may need to be replaced. Have your vehicle inspected by a dealer.



I'm seeing an amber indicator of a tire with an exclamation point. What is that?



The Tire Pressure Monitoring System (TPMS) needs attention. If you recently inflated or changed a tire, you have to recalibrate the system.

➤ Tire Pressure Monitoring System (TPMS) ➔ P. 493



Why does the shift position automatically change to **P** when I open the driver's door to check for parking space lines when reversing?



- Fasten the driver's seat belt.
- Close the driver's door and manually change the shift position.

➤ When opening the driver's door ➔ P. 480

Safe Driving

You can find many safety recommendations throughout this chapter, and throughout this manual.

For Safe Driving

Important Safety Precautions.....	42
Important Handling Information.....	44
Your Vehicle's Safety Features.....	45
Safety Checklist	46

Seat Belts

About Your Seat Belts	47
Fastening a Seat Belt	51
Seat Belt Inspection.....	55

Airbags

Airbag System Components.....	56
Types of Airbags	59

Front Airbags (SRS)	59
Side Airbags.....	64
Side Curtain Airbags.....	66
Airbag System Indicators.....	68
Airbag Care	71

Child Safety

Protecting Child Passengers	72
Safety of Infants and Small Children.....	74
Safety of Larger Children	84

Exhaust Gas Hazard

Carbon Monoxide Gas.....	86
--------------------------	----

Safety Labels

Label Locations	87
-----------------------	----

The following pages explain your vehicle's safety features and how to use them properly. The safety precautions below are ones that we consider to be among the most important.

Important Safety Precautions

■ Always wear your seat belt

A seat belt is your best protection in all types of collisions. Airbags are designed to supplement seat belts, not replace them. So even though your vehicle is equipped with airbags, make sure you and your passengers always wear your seat belts, and wear them properly.

■ Restrain all children

Children ages 12 and under should ride properly restrained in a back seat, not the front seat. Infants and small children should be restrained in a child seat. Larger children should use a booster seat and a lap/shoulder seat belt until they can use the belt properly without a booster seat.

■ Be aware of airbag hazards

While airbags can save lives, they can cause serious or fatal injuries to occupants who sit too close to them, or are not properly restrained. Infants, young children, and short adults are at the greatest risk. Be sure to follow all instructions and warnings in this manual.

■ Don't drink and drive

Alcohol and driving don't mix. Even one drink can reduce your ability to respond to changing conditions, and your reaction time gets worse with every additional drink. So don't drink and drive, and don't let your friends drink and drive, either.

ⓘ Important Safety Precautions

Some states prohibit the use of cell phones other than hands-free devices by the driver while driving.

■ Pay appropriate attention to the task of driving safely

Engaging in cell phone conversation or other activities that keep you from paying close attention to the road, other vehicles, and pedestrians could lead to a crash. Remember, situations can change quickly, and only you can decide when it is safe to divert some attention away from driving.

■ Control your speed

Excessive speed is a major factor in crash injuries and deaths. Generally, the higher the speed, the greater the risk, but serious injuries can also occur at lower speeds. Never drive faster than is safe for current conditions, regardless of the maximum speed posted.

■ Keep your vehicle in safe condition

Having a tire blowout or a mechanical failure can be extremely hazardous. To reduce the possibility of such problems, check your tire pressures and condition frequently, and perform all regularly scheduled maintenance.

■ Do not leave children unattended in the vehicle

Children, pets and people needing assistance left unattended in the vehicle may be injured if they activate one or more of the vehicle controls. They may also cause the vehicle to move, resulting in a crash in which they and/or another person(s) can be injured or killed. Also, depending on the ambient temperature, the temperature of the interior may reach extreme levels, which can result in harm or death. Even if the climate control system is on, never leave them in the vehicle unattended as the climate control system can shut off at any time.

Important Handling Information

Your vehicle has higher ground clearance than a passenger vehicle designed for use only on pavement. Higher ground clearance has many advantages for off-highway driving. It allows you to travel over bumps, obstacles, and rough terrain. It also provides good visibility so you can anticipate problems earlier.

These advantages come at some cost. Because your vehicle is taller and rides higher off the ground, it has a higher center gravity making it more susceptible to tipping or rollover if you make abrupt turns. Utility vehicles have a significantly higher rollover rate than other types of vehicles. In a rollover crash, an unbelted person is significantly more likely to die than a person wearing a seat belt. As a reminder, make sure you and your passengers always wear seat belts.

Important Handling Information

For information on how to reduce the risk of rollover, read:

► **Precautions While Driving** P. 475

► **Off-Highway Driving Guidelines** P. 467

Failure to operate your vehicle correctly might result in a crash or a rollover.

Your Vehicle's Safety Features

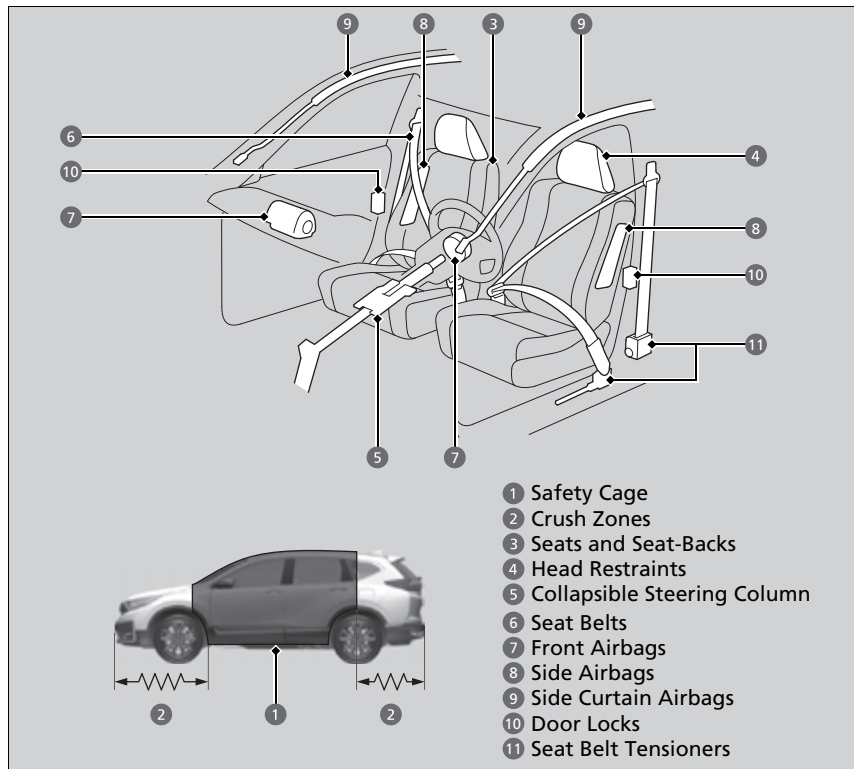

The following checklist will help you take an active role in protecting yourself and your passengers.

▣ Your Vehicle's Safety Features

Your vehicle is equipped with many features that work together to help protect you and your passengers during a crash.

Some features do not require any action on your part. These include a strong steel framework that forms a safety cage around the passenger compartment, front and rear crush zones, a collapsible steering column, and tensioners that tighten the front seat belts in a sufficient crash.

However, you and your passengers cannot take full advantage of these features unless you remain seated in the correct position and always wear your seat belts. In fact, some safety features can contribute to injuries if they are not used properly.

Safety Checklist

For the safety of you and your passengers, make a habit of checking these items each time before you drive.

- After everyone has entered the vehicle, be sure all doors and the tailgate are closed and locked. Locking the doors and the tailgate helps prevent an occupant from being ejected and an outsider from unexpectedly opening a door or the tailgate.
 - **Locking/Unlocking the Doors from the Inside** P. 163
- Adjust your seat to a position suitable for driving. Be sure the front seats are adjusted as far to the rear as possible while allowing the driver to control the vehicle. Sitting too close to a front airbag can result in serious or fatal injury in a crash.
 - **Seats** P. 208
- Adjust head restraints to the proper position. Head restraints are most effective when the center of the head restraint aligns with the center of your head. Taller persons should adjust their head restraint to the highest position.
 - **Adjusting the Front Head Restraints** P. 215
- Always wear your seat belt, and make sure you wear it properly. Confirm that any passengers are properly belted as well.
 - **Fastening a Seat Belt** P. 51
- Protect children by using seat belts or child seats according to a child's age, height and weight.
 - **Child Safety** P. 72

► Safety Checklist

If the door and/or tailgate open message appears on the driver information interface, a door and/or the tailgate is not completely closed. Close all doors and the tailgate tightly until the message disappears.

➤ **Driver Information Interface Warning and Information Messages** P. 109



About Your Seat Belts

Seat belts are the single most effective safety device because they keep you connected to the vehicle so that you can take advantage of many built-in safety features. They also help keep you from being thrown against the inside of the vehicle, against any passengers, or out of the vehicle. When worn properly, seat belts also keep your body properly positioned in a crash so that you can take full advantage of the additional protection provided by the airbags.

In addition, seat belts help protect you in almost every type of crash, including:

- frontal impacts
- side impacts
- rear impacts
- rollovers

■ Lap/shoulder seat belts

All five seating positions are equipped with lap/shoulder seat belts with emergency locking retractors. In normal driving, the retractor lets you move freely while keeping some tension on the belt. During a collision or sudden stop, the retractor locks to restrain your body.

The front passenger's and rear seat belts also have a lockable retractor for use with child seats.

➤ **Installing a Child Seat with a Lap/Shoulder Seat Belt** P. 80

ⓘ About Your Seat Belts

⚠ WARNING

Not wearing a seat belt properly increases the chance of serious injury or death in a crash, even though your vehicle has airbags.

Be sure you and your passengers always wear seat belts and wear them properly.

If you extend the seat belt too quickly, it will lock in place. If this happens, slightly retract the seat belt, then extend it slowly.

Seat belts cannot completely protect you in every crash. But in most cases, seat belts can reduce your risk of serious injury.

Most states require you to wear seat belts.

■ Proper use of seat belts

Follow these guidelines for proper use:

- All occupants should sit upright, well back in the seat, and remain in that position for the duration of the trip. Slouching and leaning reduce the effectiveness of the belt and can increase the chance of serious injury in a crash.
- Never place the shoulder part of a lap/shoulder seat belt under your arm or behind your back. This could cause very serious injuries in a crash.
- Two people should never use the same seat belt. If they do, they could be very seriously injured in a crash.
- Do not put any accessories on the seat belts. Devices intended to improve comfort or reposition the shoulder part of a seat belt can reduce the protective capability and increase the chance of serious injury in a crash.

🔍 About Your Seat Belts

If a rear seat passenger moves around and extends the seat belt, the lockable retractor may activate. If this happens, release the retractor by unfastening the seat belt and allow the belt to retract completely. Then, refasten the belt.

Seat Belt Reminder

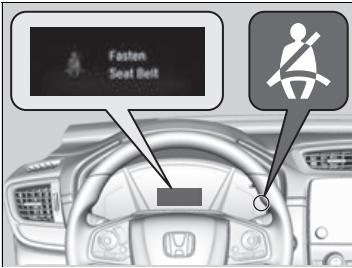

The seat belt system includes an indicator on the instrument panel to remind the driver or a front passenger or both to fasten their seat belts.

If you set the power mode to ON and a seat belt is not fastened, a beeper will sound and the indicator will blink. After a few seconds, the beeper will stop and the indicator will come on and remain illuminated until the seat belt is fastened.

The beeper will periodically sound and the indicator will blink while the vehicle is moving until the seat belt is fastened.

⊞ Seat Belt Reminder

The indicator will also come on if a front passenger does not fasten their seat belt within six seconds after the power mode is set to ON.

When no one is sitting in the front passenger's seat, the indicator will not come on and the beeper will not sound.

The indicator also may not come on and the beeper may not sound when the occupant is not heavy enough to trigger the weight sensor. Such occupants (e.g., infants and smaller children) should be moved to the rear seat as a deploying front airbag likely will injure or kill them.

➤ **Protecting Child Passengers** P. 72

■ Automatic Seat Belt Tensioners

The front seats are equipped with automatic seat belt tensioners to enhance safety.

The tensioners automatically tighten the front seat belts during a moderate-to-severe frontal collision, sometimes even if the collision is not severe enough to inflate the front airbags.

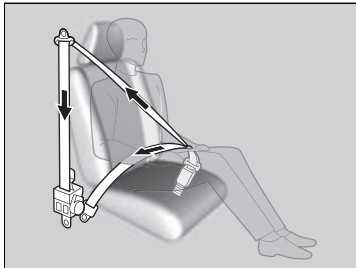

⌘ Automatic Seat Belt Tensioners

The seat belt tensioners can only operate once. If a tensioner is activated, the SRS indicator will come on. Have a dealer replace the tensioner and thoroughly inspect the seat belt system as it may not offer protection in a subsequent crash.

During a moderate-to-severe side impact, the tensioner on that side of the vehicle also activates.

Fastening a Seat Belt

After adjusting a front seat to the proper position, and while sitting upright and well back in the seat:

➤ **Seats** P. 208

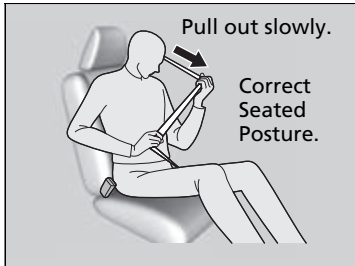

1. Pull the seat belt out slowly.

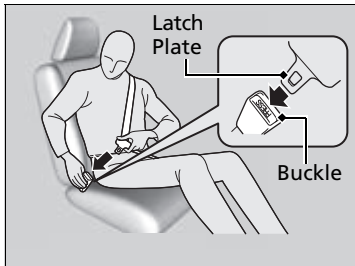

2. Insert the latch plate into the buckle, then tug on the belt to make sure the buckle is secure.

▶ Make sure that the belt is not twisted or caught on anything.

Fastening a Seat Belt

No one should sit in a seat with an inoperative seat belt or one that does not appear to be working correctly. Using a seat belt that is not working properly may not protect the occupant in a crash. Have a dealer check the belt as soon as possible.

Never insert any foreign objects into the buckle or retractor mechanism.

If the seat belt appears to be locked in a fully retracted position, firmly pull out on the shoulder belt once, then push it back in.

Then, smoothly pull it out of the retractor and fasten. If you are unable to release the seat belt from a fully retracted position, do not allow anyone to sit in the seat, and take your vehicle to a dealer for repair.

➤ **About Your Seat Belts** P. 47

➤ **Seat Belt Inspection** P. 55

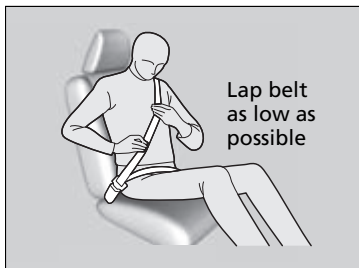

3. Position the lap part of the belt as low as possible across your hips, then pull up on the shoulder part of the belt so the lap part fits snugly. This lets your strong pelvic bones take the force of a crash and reduces the chance of internal injuries.
4. If necessary, pull up on the belt again to remove any slack, then check that the belt rests across the center of your chest and over your shoulder. This spreads the forces of a crash over the strongest bones in your upper body.

■ Adjusting the Shoulder Anchor

The front seats have adjustable shoulder anchors to accommodate taller and shorter occupants.

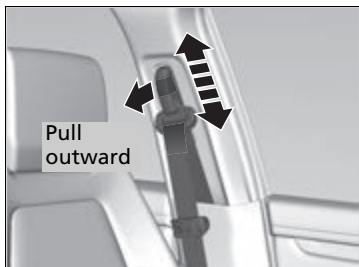

1. Move the anchor up and down while pulling the shoulder anchor outward.
2. Position the anchor so that the belt rests across the center of your chest and over your shoulder.

▶▶ Fastening a Seat Belt

⚠ WARNING

Improperly positioning the seat belts can cause serious injury or death in a crash.

Make sure all seat belts are properly positioned before driving.

To release the belt, push the red **PRESS** button and then guide the belt by hand until it has retracted completely.

When exiting the vehicle, be sure the belt is properly stowed so that it will not get caught in the closing door.

▶▶ Adjusting the Shoulder Anchor

The shoulder anchor height can be adjusted to four levels. If the belt contacts your neck, lower the height one level at a time.

After an adjustment, make sure that the shoulder anchor position is secure.

Seat Belt with Detachable Anchor

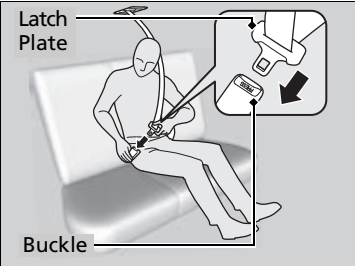
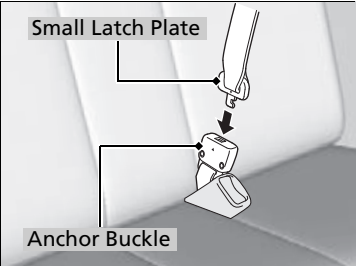
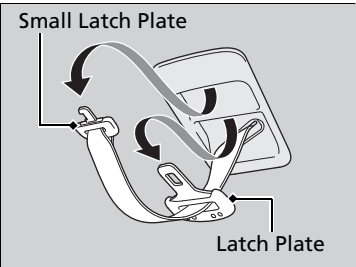

1. Pull out the seat belt's small latch plate and the latch plate from each holding slot in the ceiling.

2. Line up the triangle marks on the small latch plate and anchor buckle. Make sure the seat belt is not twisted. Attach the belt to the anchor buckle.

3. Insert the latch plate into the buckle. Properly fasten the seat belt the same way you fasten the lap/shoulder seat belt.

Seat Belt with Detachable Anchor

⚠ WARNING

Using the seat belt with the detachable anchor unlatched increases the chance of serious injury or death in a crash.

Before using the seat belt, make sure the detachable anchor is correctly latched.

To unlatch the detachable anchor, insert the latch plate into the slot on the side of the anchor buckle.

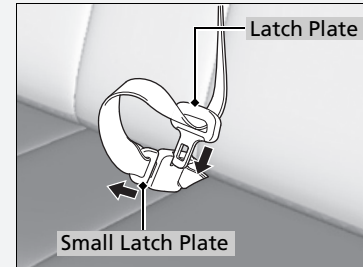

■ Advice for Pregnant Women

If you are pregnant, the best way to protect yourself and your unborn child when driving or riding in a vehicle is to always wear a seat belt and keep the lap part of the belt as low as possible across the hips.

Wear the shoulder belt across the chest avoiding the abdomen.



Wear the lap part of the belt as low as possible across the hips.

▣ Advice for Pregnant Women

Each time you have a checkup, ask your doctor if it is okay for you to drive.

To reduce the risk of injuries to both you and your unborn child that can be caused by an inflating front airbag:

- When driving, sit upright and adjust the seat as far back as possible while allowing full control of the vehicle.
- When sitting in the front passenger's seat, adjust the seat as far back as possible.

Seat Belt Inspection

Regularly check the condition of your seat belts as follows:

- Pull each belt out fully, and look for frays, cuts, burns, and wear.
- Check that the latch plates and buckles work smoothly and the belts retract easily.
 - ▶ If a belt does not retract easily, cleaning the belt may correct the problem. Only use a mild soap and warm water. Do not use bleach or cleaning solvents. Make sure the belt is completely dry before allowing it to retract.

Any belt that is not in good condition or working properly will not provide proper protection and should be replaced as soon as possible.

A belt that has been worn during a crash may not provide the same level of protection in a subsequent crash. Have your seat belts inspected by a dealer after any collision.

▶▶ Seat Belt Inspection

WARNING

Not checking or maintaining seat belts can result in serious injury or death if the seat belts do not work properly when needed.

Check your seat belts regularly and have any problem corrected as soon as possible.

Airbag System Components

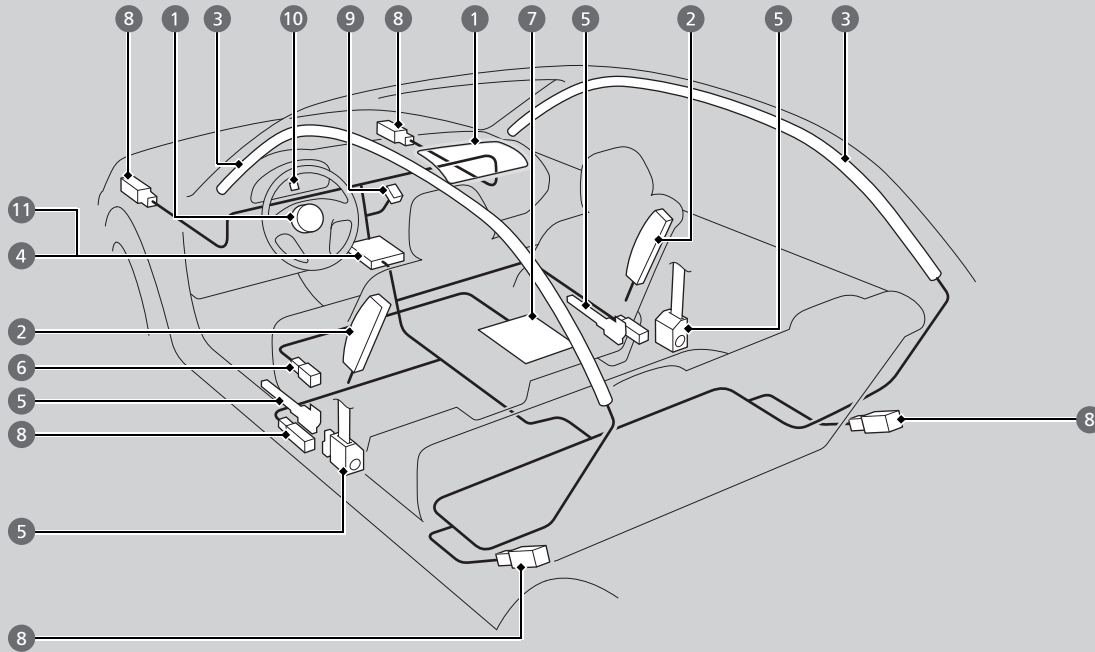

The front, side, and side curtain airbags are deployed according to the direction and severity of impact. Both side curtain airbags are deployed in a rollover. The airbag system includes:

- 1 Two SRS (Supplemental Restraint System) front airbags. The driver's airbag is stored in the center of the steering wheel; the front passenger's airbag is stored in the dashboard. Both are marked **SRS AIRBAG**.
- 2 Two side airbags, one for the driver and one for the front passenger. The airbags are stored in the outer edges of the seat-backs. Both are marked **SIDE AIRBAG**.
- 3 Two side curtain airbags, one for each side of the vehicle. The airbags are stored in the ceiling, above the side windows. The front and rear pillars are marked **SIDE CURTAIN AIRBAG**.
- 4 An electronic control unit that, when the power mode is in ON, continually monitors information about the various impact sensors, seat and buckle sensors, rollover sensor, airbag activators, seat belt tensioners, and other vehicle information. During a crash event the unit can record such information.
- 5 Automatic front seat belt tensioners. In addition, the driver's and front passenger's seat belt buckles incorporate sensors that detect whether or not the belts are fastened.
- 6 Driver's seat position sensor. This sensor detects the driver's seat slide position to help determine the optimal deployment of the driver's airbag.
- 7 Weight sensors in the front passenger's seat. The sensors are used for occupant classification to activate or deactivate the front passenger's airbag.
- 8 Impact sensors that can detect a moderate-to-severe front or side impact.
- 9 An indicator on the dashboard that alerts you that the front passenger's front airbag has been turned off.
- 10 An indicator on the instrument panel that alerts you to a possible problem with your airbag system or seat belt tensioners.
- 11 A rollover sensor that can detect if your vehicle is about to roll over and signal the control unit to deploy both side curtain airbags.

■ Important Facts About Your Airbags

Airbags can pose serious hazards. To do their job, airbags must inflate with tremendous force. So, while airbags help save lives, they can cause burns, bruises, and other minor injuries, sometimes even fatal ones if occupants are not wearing their seat belts properly and sitting correctly.

What you should do: Always wear your seat belt properly and sit upright and as far back from the steering wheel as possible while allowing full control of the vehicle. A front passenger should move their seat as far back from the dashboard as possible.

Remember, however, that no safety system can prevent all injuries or deaths that can occur in a severe crash, even when seat belts are properly worn and the airbags deploy.

Do not place hard or sharp objects between yourself and a front airbag.

Carrying hard or sharp objects on your lap, or driving with a pipe or other sharp object in your mouth, can result in injuries if your front airbag inflates.

Do not attach or place objects on the front airbag covers. Objects on the covers marked **SRS AIRBAG** could interfere with the proper operation of the airbags or be propelled inside the vehicle and hurt someone if the airbags inflate.

▣ Important Facts About Your Airbags

Do not attempt to deactivate your airbags. Together, airbags and seat belts provide the best protection.

When driving, keep hands and arms out of the deployment path of the front airbag by holding each side of the steering wheel. Do not cross an arm over the airbag cover.

Types of Airbags

Your vehicle is equipped with three types of airbags:

- **Front airbags:** Airbags in front of the driver's and front passenger's seats.
- **Side airbags:** Airbags in the driver's and front passenger's seat-backs.
- **Side curtain airbags:** Airbags above the side windows.

Each is discussed in the following pages.

Front Airbags (SRS)

The front SRS airbags inflate in a moderate-to-severe frontal collision to help protect the head and chest of the driver and/or front passenger.

SRS (Supplemental Restraint System) indicates that the airbags are designed to supplement seat belts, not replace them. Seat belts are the occupant's primary restraint system.

Housing Locations

The front airbags are housed in the center of the steering wheel for the driver, and in the dashboard for the front passenger. Both airbags are marked **SRS AIRBAG**.

Types of Airbags

The airbags can inflate whenever the power mode is in ON.

After an airbag inflates in a crash, you may see a small amount of smoke. This is from the combustion process of the inflator material and is not harmful. People with respiratory problems may experience some temporary discomfort. If this occurs, get out of the vehicle as soon as it is safe to do so.

Front Airbags (SRS)

During a frontal crash severe enough to cause one or both front airbags to deploy, the airbags can inflate at different rates, depending on the severity of the crash, whether or not the seat belts are latched, and/or other factors. Frontal airbags are designed to supplement the seat belts to help reduce the likelihood of head and chest injuries in frontal crashes.

■ Operation

Front airbags are designed to inflate during moderate-to-severe frontal collisions. When the vehicle decelerates suddenly, the sensors send information to the control unit which signals one or both front airbags to inflate.

A frontal collision can be either head-on or angled between two vehicles, or when a vehicle crashes into a stationary object, such as a concrete wall.

■ How the Front Airbags Work

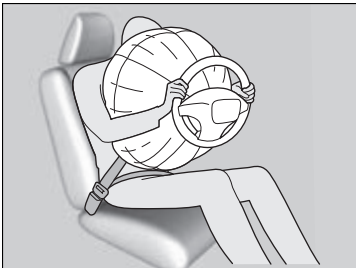

While your seat belt restrains your torso, the front airbag provides supplemental protection for your head and chest.

The front airbags deflate immediately so that they won't interfere with the driver's visibility or the ability to steer or operate other controls.

The total time for inflation and deflation is so fast that most occupants are not aware that the airbags deployed until they see them lying in front of them.

☒ How the Front Airbags Work

Although the driver's and front passenger's airbags normally inflate within a split second of each other, it is possible for only one airbag to deploy. This can happen if the severity of a collision is at the margin, or threshold that determines whether or not the airbags will deploy. In such cases, the seat belt will provide sufficient protection, and the supplemental protection offered by the airbag would be minimal.

■ When front airbags should not deploy

Minor frontal crashes: Front airbags were designed to supplement seat belts and help save lives, not to prevent minor scrapes, or even broken bones that might occur during a less than moderate-to-severe frontal crash.

Side impacts: Front airbags can provide protection when a sudden deceleration causes a driver or front passenger to move toward the front of the vehicle. Side airbags and side curtain airbags have been specifically designed to help reduce the severity of injuries that can occur during a moderate-to-severe side impact which can cause the driver or passenger to move toward the side of the vehicle.

Rear impacts: Head restraints and seat belts are your best protection during a rear impact. Front airbags cannot provide any significant protection and are not designed to deploy in such collisions.

Rollovers: In a rollover, your best form of protection is a seat belt or, if your vehicle is equipped with a rollover sensor, both a seat belt and a side curtain airbag. Front airbags, however, are not designed to deploy in a rollover as they would provide little if any protection.

■ When front airbags deploy with little or no visible damage

Because the airbag system senses sudden deceleration, a strong impact to the vehicle framework or suspension might cause one or more of the airbags to deploy. Examples include running into a curb, the edge of a hole, or other low fixed object that causes a sudden deceleration in the vehicle chassis. Since the impact is underneath the vehicle, damage may not be readily apparent.

■ When front airbags may not deploy, even though exterior damage appears severe

Since crushable body parts absorb crash energy during an impact, the amount of visible damage does not always indicate proper airbag operation. In fact, some collisions can result in severe damage but no airbag deployment because the airbags would not have been needed or would not have provided protection even if they had deployed.

■ Advanced Airbags

The airbags have advanced features to help reduce the likelihood of airbag related injuries to smaller occupants.

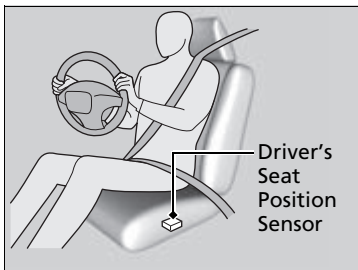

The driver's advanced airbag system includes a seat position sensor.

Based on information from this sensor and the severity of the impact, the advanced airbag system determines the optimal deployment of the driver's airbag.

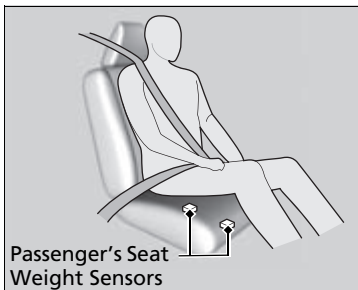

The front passenger's advanced airbag system has weight sensors. The sensors are used for occupant classification to activate or deactivate the front passenger's airbag.

For adult size occupants, the system will automatically activate the front passenger's airbag. If a small adult sits in the front passenger seat and the system does not recognize him/her as an adult, see

➤ **Passenger Airbag Off Indicator** P. 69

➤ Advanced Airbags

If there is a problem with the driver's seat position sensor or the passenger's seat weight sensors, the SRS indicator will come on, and in the event of a crash, the airbag will deploy (regardless of the driver's seating position or passenger's occupant classification) with a force corresponding to the severity of the impact.

➤ **Supplemental Restraint System (SRS) Indicator** P. 68

For the advanced front airbags to work properly, confirm that:

- The occupant is sitting in an upright position, wearing the seat belt properly and the seat-back is not excessively reclined.
- The occupant is not leaning against the door or center console.
- The occupant's feet are placed on the floor in front of them.
- There are no objects hanging from the front passenger's seat.
- Only small, lightweight objects are in the seat-back pocket.
- The steering wheel and passenger's side dashboard are not obstructed by any object.
- No liquid has been spilled on or under the seat.

We advise against allowing a child age 12 or under to ride in the front passenger's seat. However, if you do allow a small child or infant to ride in the front passenger's seat, the system is designed to automatically deactivate the front passenger's airbag. Do not let a small child or infant ride in the front passenger's seat if the airbag does not automatically deactivate.

▶▶ Advanced Airbags

- There is no child seat or other object pressing against the rear of the seat or seat-back.
- There is no rear passenger pushing or pulling on the back of the front passenger's seat.
- There are no objects placed under or beside the front passenger's seat. Improperly positioned objects can interfere with the advanced airbag sensors.
- The head restraint is not contacting the roof.
 - ▶ **Passenger Airbag Off Indicator** P. 69
- The floor mat behind the front passenger's seat is set in the correct position evenly on the floor. An improperly placed mat can interfere with the advanced airbag sensors.
 - ▶ **Floor Mats** P. 620

Side Airbags

The side airbags help protect the torso and pelvis of the driver or a front passenger during a moderate-to-severe side impact.

Housing Locations

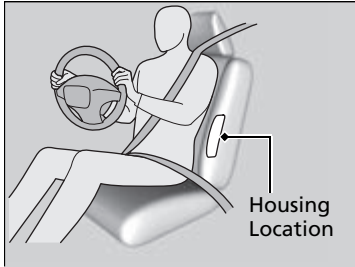

The side airbags are housed in the outside edge of the driver's and passenger's seat-backs.

Both are marked **SIDE AIRBAG**.

Operation

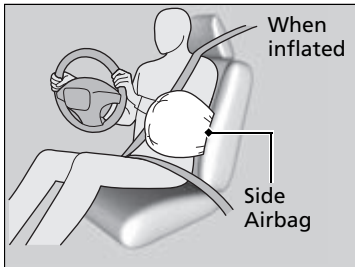

When the sensors detect a moderate-to-severe side impact, the control unit signals the side airbag on the impact side to immediately inflate.

Side Airbags

Make sure you and your front seat passenger always sit upright. Leaning into the path of a side airbag can prevent the airbag from deploying properly and increases your risk of serious injury.

Do not attach accessories on or near the side airbags. They can interfere with the proper operation of the airbags, or hurt someone if an airbag inflates.

Do not cover or replace the front seat-back covers without consulting a dealer. Improperly replacing or covering front seat-back covers can prevent your side airbags from properly deploying during a side impact.

■ When a side airbag deploys with little or no visible damage

Because the airbag system senses sudden acceleration, a strong impact to the side of the vehicle's framework can cause a side airbag to deploy. In such cases, there may be little or no damage, but the side impact sensors detected a severe enough impact to deploy the airbag.

■ When a side airbag may not deploy, even though visible damage appears severe

It is possible for a side airbag not to deploy during an impact that results in apparently severe damage. This can occur when the point of impact was toward the far front or rear of the vehicle, or when the vehicle's crushable body parts absorbed most of the crash energy. In either case, the side airbag would not have been needed nor provided protection even if it had deployed.

Side Curtain Airbags

The side curtain airbags help protect the heads of the driver and passengers in the outer seating positions during a moderate-to-severe side impact. The side curtain airbags equipped in this vehicle are also designed to help reduce the likelihood of partial and complete ejection of vehicle occupants through side windows in crashes, particularly rollover crashes.

Housing Locations

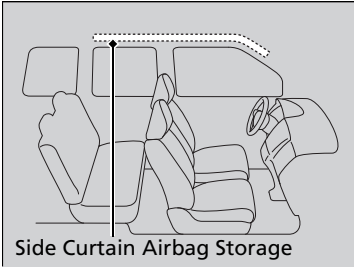

The side curtain airbags are located in the ceiling above the side windows on both sides of the vehicle.

Side Curtain Airbags

To get the best protection from the side curtain airbags, occupants should wear their seat belts properly and sit upright and well back in their seats.

Do not attach any objects to the side windows or roof pillars as they can interfere with the proper operation of the side curtain airbags.

If the impact is on the passenger's side, the passenger's side curtain airbag deploys even if there are no occupants on that side of the vehicle.

If the SRS control unit senses that your vehicle is about to rollover, it immediately deploys both side curtain airbags and activates both front seat belt tensioners.

■ Operation

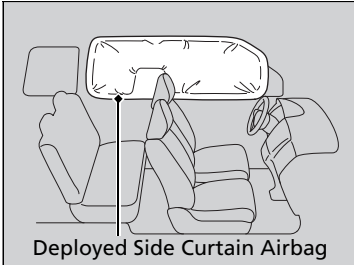

The side curtain airbag is designed to deploy in a rollover or a moderate-to-severe side impact.

■ When side curtain airbags deploy in a frontal collision

One or both side curtain airbags may also inflate in a moderate-to-severe angled frontal collision.

Airbag System Indicators

If a problem occurs in the airbag system, the SRS indicator will come on and a message appears on the driver information interface.

■ Supplemental Restraint System (SRS) Indicator

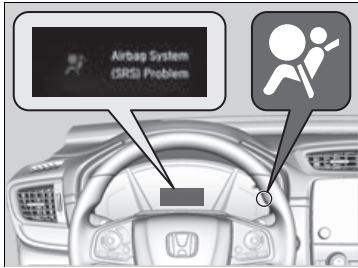

■ **When the power mode is set to ON**
The indicator comes on for a few seconds, then goes off. This tells you the system is working properly.

If the indicator comes on at any other time, or does not come on at all, have the system checked by a dealer as soon as possible. If you don't, your airbags and seat belt tensioners may not work properly when they are needed.

⊗ Supplemental Restraint System (SRS) Indicator

⚠ WARNING

Ignoring the SRS indicator can result in serious injury or death if the airbag systems or tensioners do not work properly.

Have your vehicle checked by a dealer as soon as possible if the SRS indicator alerts you to a possible problem.

■ Passenger Airbag Off Indicator

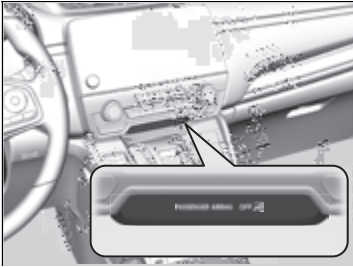

■ When the passenger airbag off indicator comes on

The indicator comes on to alert you that the passenger's airbag has been turned off.

This occurs if the seat is empty or when the weight sensors determine that a small child or infant is on the passenger seat.

Children age 12 or under should always ride properly restrained in a back seat.

➤ **Child Safety** P. 72

If the indicator is on in the event of a crash, the passenger's airbag will not deploy.

⊠ Passenger Airbag Off Indicator

To ensure the passenger is detected properly, confirm that:

- The occupant is sitting in an upright position, wearing the seat belt properly and the seat-back is not excessively reclined.
- The occupant is not leaning against the door or center console.
- The occupant's feet are placed on the floor in front of them.
- There are no objects hanging from the front passenger's seat.
- Only small, lightweight objects are in the seat-back pocket.
- No liquid has been spilled on or under the seat.
- There is no child seat or other object pressing against the rear of the seat or seat-back.
- There is no rear passenger pushing or pulling on the back of the front passenger's seat.
- There are no objects placed under or beside the front passenger's seat. Improperly positioned objects can interfere with the advanced airbag sensors.
- The floor mat behind the front passenger's seat is set in the correct position evenly on the floor. An improperly placed mat can interfere with the advanced airbag sensors.
- The head restraint is not contacting the roof.

▶▶ Passenger Airbag Off Indicator

The passenger airbag off indicator may come on and go off periodically if the total weight on the seat is near the airbag cutoff threshold. For a small adult, depending on physique and posture, the system may not recognize him/her as an adult and thus deactivate the passenger's airbag.

If this occurs, please confirm that the conditions set forth in the above bullet points on the previous page are met.

If the above conditions are met and the indicator is still on, then with the transmission in park, turn the ignition off and back on.

Have your vehicle checked by a dealer as soon as possible if:

- All of the above conditions are met, and the indicator comes on with an adult seated in the front passenger seat.
- The seat is empty and the indicator is off.

Do not allow an adult passenger to ride in the front seat when the indicator is on.

Airbag Care

You do not need to, and should not, perform any maintenance on or replace any airbag system components yourself. However, you should have your vehicle inspected by a dealer in the following situations:

■ When the airbags have deployed

If an airbag has inflated, the control unit and other related parts must be replaced. Similarly, once an automatic seat belt tensioner has been activated, it must be replaced.

■ When the vehicle has been in a moderate-to-severe collision

Even if the airbags did not inflate, have your dealer inspect the following: the driver's seat position sensor, weight sensors in the passenger's seat, front seat belt tensioners, and each seat belt that was worn during the crash.

■ Do not remove or modify a front seat without consulting a dealer

This would likely disable or affect the proper operation of the driver's seat position sensor or the weight sensors in the passenger's seat. If it is necessary to remove or modify a front seat to accommodate a person with disabilities, contact a Honda dealer, or American Honda Automobile Customer Service at 1-800-999-1009.

✘ Airbag Care

We recommend against the use of salvaged airbag system components, including the airbag, tensioners, sensors, and control unit.

Protecting Child Passengers

Each year, many children are injured or killed in vehicle crashes because they are either unrestrained or not properly restrained. In fact, vehicle crashes are the number one cause of death of children ages 12 and under.

To reduce the number of child deaths and injuries, every state requires that infants and children be properly restrained when they ride in a vehicle.

Children should sit properly restrained in a rear seat. This is because:

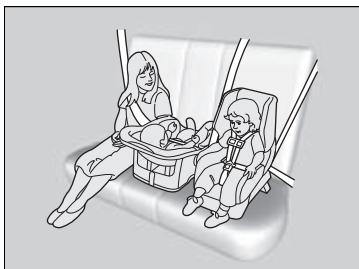

- An inflating front airbag can injure or kill a child sitting in the front seat.
- A child in the front seat is more likely to interfere with the driver's ability to safely control the vehicle.
- Statistics show that children of all sizes and ages are safer when they are properly restrained in a rear seat.

Protecting Child Passengers

WARNING

Children who are unrestrained or improperly restrained can be seriously injured or killed in a crash.

Any child too small for a seat belt should be properly restrained in a child seat. A larger child should be properly restrained with a seat belt, using a booster seat if necessary.

The National Highway Traffic Safety Administration recommends that all children ages 12 and under be properly restrained in a rear seat. Some states have laws restricting where children may ride.

- Never hold a child on your lap because it is impossible to protect them in the event of a collision.
- Never put a seat belt over yourself and a child. During a crash, the belt would likely press deep into the child and cause serious or fatal injuries.
- Never let two children use the same seat belt. Both children could be very seriously injured in a crash.
- Any child who is too small to wear a seat belt correctly must be restrained in an approved child seat that is properly secured to the vehicle using either the seat belt or the lower anchors of the LATCH system.
- Do not allow children to operate the doors, windows or seat adjustments.
- Do not leave children in the vehicle unattended, especially in hot weather when the inside of the vehicle can get hot enough to kill them. They could also activate vehicle controls causing it to move unexpectedly.

▶▶ Protecting Child Passengers

⚠ WARNING

Allowing a child to play with a seat belt or wrap one around their neck can result in serious injury or death.

Instruct children not to play with any seat belt and make sure any unused seat belt a child can reach is buckled, fully retracted, and locked.

To deactivate a lockable retractor, release the buckle and allow the seat belt to wind up all the way.

To remind you of the passenger's front airbag hazards and child safety, your vehicle has warning labels on the dashboard and on the front visors. Please read and follow the instructions on these labels.

▶▶ Safety Labels P. 87

Safety of Infants and Small Children

■ Protecting Infants

An infant must be properly restrained in a rear-facing child seat until the infant reaches the seat manufacturer's weight or height limit for the seat.



■ Positioning a rear-facing child seat

Child seats must be placed and secured in a rear seating position.

When properly installed, a rear-facing child seat may prevent the driver or a front passenger from moving their seat all the way back, or from locking their seat-back in the desired position. Make sure that there is no contact between the child seat and the seat in front of it.

It can also interfere with proper operation of the passenger's advanced front airbag system.

➤ **Airbags** P. 56

If this occurs, we recommend that you install the child seat directly behind the front passenger's seat, move the seat as far forward as needed, and leave it unoccupied. Or, you may wish to get a smaller rear-facing child seat.

ⓘ Protecting Infants

⚠ WARNING

Placing a rear-facing child seat in the front seat can result in serious injury or death during a crash.

Always place a rear-facing child seat in the rear seat, not the front.

Experts recommend use of a rear-facing seat for a child so long as the child's height and weight are appropriate for a rear-facing seat.

Infants should never be seated in a forward-facing position.

Always refer to the child seat manufacturer's instructions before installation.

Do not allow a front seat to rest against a child seat installed in a rear seating position. The weight sensor in the front seat may not correctly detect the actual weight of the occupant.

■ Protecting Smaller Children

If a child has exceeded the weight and height limitations of a rearward-facing child seat, the child should be properly restrained in a firmly secured forward-facing child seat until they exceed the weight and height limitations for the forward-facing child seat.

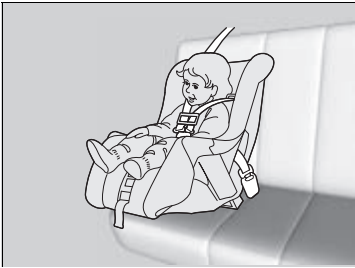

■ Forward-facing child seat placement

We strongly recommend placing a forward-facing child seat in a rear seating position.

Placing a forward-facing child seat in the front seat can be hazardous, even with advanced front airbags that automatically turn the passenger's front airbag off. A rear seat is the safest place for a child.

⚠ Protecting Smaller Children

⚠ WARNING

Placing a forward-facing child seat in the front seat can result in serious injury or death if the front airbag inflates.

If you must place a forward-facing child seat in front, move the vehicle seat as far back as possible, and properly restrain the child.

Educate yourself about the laws and regulations regarding child seat use where you are driving, and follow the child seat manufacturer's instructions.

■ Selecting a Child Seat

Most child seats are LATCH-compatible (Lower Anchors and Tethers for Children). Some have a rigid-type connector while others have a flexible-type connector. Both are equally easy to use. Some existing and previously owned child seats can only be installed using the seat belt. Whichever type you choose, follow the child seat manufacturer's use and care instructions including recommended expiration dates as well as the instructions in this manual. Proper installation is key to maximizing your child's safety.

In seating positions and vehicles not equipped with LATCH, a LATCH-compatible child seat can be installed using the seat belt and a top tether for added security. This is because all child seats are required to be designed so that they can be secured with a lap belt or the lap part of a lap/shoulder belt. In addition, the child seat manufacturer may advise that a seat belt be used to attach a LATCH-compatible seat once a child reaches a specified weight. Please read the child seat owner's manual for proper installation instructions.

■ Important consideration when selecting a child seat

Make sure the child seat meets the following three requirements:

- The child seat is the correct type and size for the child.
- The child seat is the correct type for the seating position.
- The child seat is compliant with Federal Motor Vehicle Safety Standard 213.

►► Selecting a Child Seat

Installation of a LATCH-compatible child seat is simple.

LATCH-compatible child seats have been developed to simplify the installation process and reduce the likelihood of injuries caused by incorrect installation.

■ Installing a LATCH-Compatible Child Seat

A LATCH-compatible child seat can be installed in any of the rear seats. A child seat is attached to the lower anchors with either the rigid or flexible type of connectors.

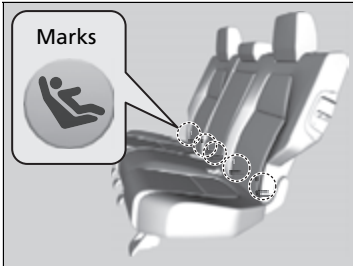

1. Locate the lower anchors under the marks.
2. Make sure to lock the seat-back in the upright position.

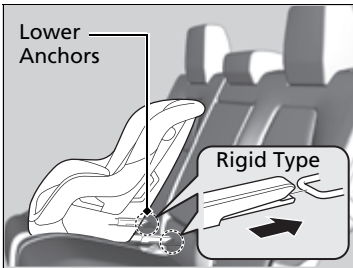

3. Place the child seat on the vehicle seat, then attach the child seat to the lower anchors according to the instructions that came with the child seat.
 - ▶ When installing the child seat, make sure that the lower anchors are not obstructed by the seat belt or any other object.

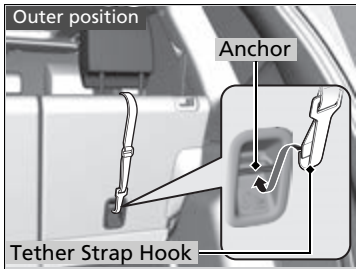
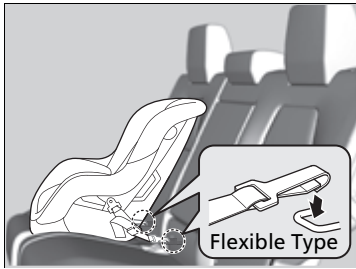

Outer position

4. Put the head restraint to its upper-most position, then route the tether strap between the head restraint legs, and secure the tether strap hook to the anchor.
5. Go to step 8.

►► Installing a LATCH-Compatible Child Seat

⚠ WARNING

Never attach two child seats to the same anchor. In a collision, one anchor may not be strong enough to hold two child seat attachments and may break, causing serious injury or death.

For your child's safety, when using a child seat installed using the LATCH system, make sure that the child seat is properly secured to the vehicle. A child seat that is not properly secured will not adequately protect a child in a crash and may cause injury to the child or other vehicle occupants.

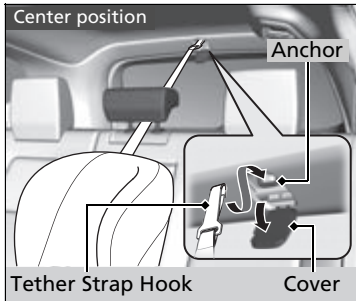

Center position

4. Put the head restraint to its upper-most position.
5. Open the anchor cover.
6. Route the tether strap through the head restraint legs. Make sure the strap is not twisted.
7. Secure the tether strap hook to the anchor.

All models

8. Tighten the tether strap as instructed by the child seat manufacturer.
9. Make sure the child seat is firmly secured by rocking it forward and back and side to side; little movement should be felt.
10. Make sure any unused seat belt that a child can reach is buckled, the lockable retractor is activated, and the belt is fully retracted and locked.

■ Installing a Child Seat with a Lap/Shoulder Seat Belt

A child seat can be installed with a lap/shoulder belt in any rear seat or, if absolutely necessary, the front passenger seat.

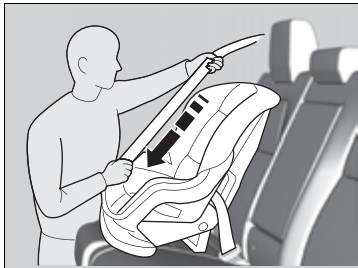

1. Make sure to lock the seat-back in the upright position.
2. Place the child seat on the vehicle seat.
3. Route the seat belt through the child seat according to the seat manufacturer's instructions, and insert the latch plate into the buckle.
 - Insert the latch plate fully until it clicks.
4. Slowly pull the shoulder part of the belt all the way out until it stops. This activates the lockable retractor.
5. Let the seat belt retract a few inches and check that the retractor has switched modes by pulling on the webbing. It should not pull out again until it is reset by removing the latch plate from the buckle.
 - If you are able to pull the shoulder belt out, the lockable retractor is not activated. Slowly pull the seat belt all the way out, and repeat steps 4 – 5.

▣ Installing a Child Seat with a Lap/Shoulder Seat Belt

A child seat that is not properly secured will not adequately protect a child in a crash and may cause injury to the child or other vehicle occupants.

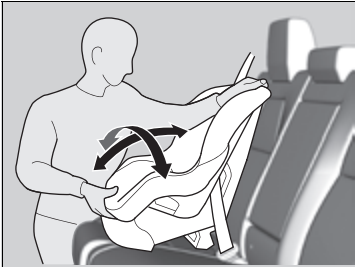
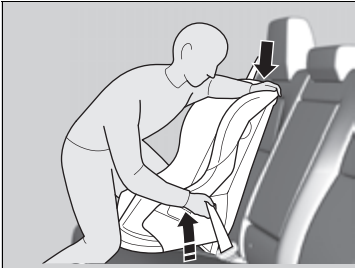

6. Grab the shoulder part of the seat belt near the buckle, and pull up to remove any slack from the lap part of the belt.

▶ When doing this, place your weight on the child seat and push it into the vehicle seat.

7. Make sure the child seat is firmly secured by rocking it forward and back and side to side; less than one inch of movement should occur near the seat belt.

8. Make sure any unused seat belt that a child can reach is buckled, the lockable retractor is activated, and the belt is fully retracted and locked.

▶▶ Installing a Child Seat with a Lap/Shoulder Seat Belt

To deactivate a lockable retractor, release the buckle and allow the seat belt to wind up all the way.

■ Adding Security with a Tether

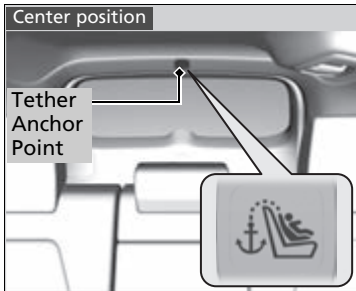
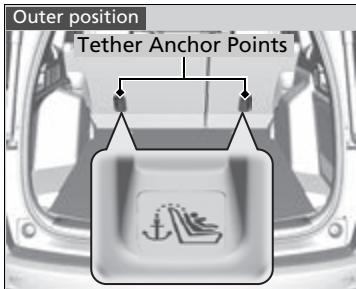

A tether anchor point is provided behind the rear outer seating position and in the ceiling for the rear center.

If you have a child seat that comes with a tether but can be installed with a seat belt, the tether may be used for additional security.

►► Adding Security with a Tether

Always use a tether for forward-facing child seats whether using the seat belt or lower anchors.

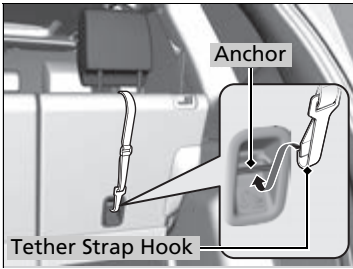

■ **Using an outer anchor**

1. Put the head restraint to its upper-most position, then route the tether strap through the head restraint legs. Make sure the strap is not twisted.
2. Secure the tether strap hook to the anchor.
3. Tighten the tether strap as instructed by the child seat manufacturer.

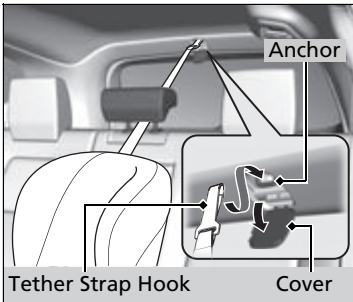

■ **Using the center anchor**

1. Put the head restraint to its upper-most position.
2. Open the anchor cover.
3. Route the tether strap through the head restraint legs. Make sure the strap is not twisted.
4. Secure the tether strap hook to the anchor.
5. Tighten the tether strap as instructed by the child seat manufacturer.

Safety of Larger Children

■ Protecting Larger Children

The following pages give instructions on how to check proper seat belt fit, what kind of booster seat to use if one is needed, and important precautions for a child who must sit in front.

■ Checking Seat Belt Fit

When a child is too big for a child seat, secure the child in a rear seat using the lap/shoulder seat belt. Have the child sit upright and all the way back, then answer the following questions.



■ Checklist

- Do the child's knees bend comfortably over the edge of the seat?
- Does the shoulder belt cross between the child's neck and arm?
- Is the lap part of the seat belt as low as possible, touching the child's thighs?
- Will the child be able to stay seated like this for the whole trip?

If you answer yes to all these questions, the child is ready to wear the lap/shoulder seat belt correctly. If you answer no to any question, the child needs to ride on a booster seat until the seat belt fits properly without a booster seat.

▶ Safety of Larger Children

⚠ WARNING

Allowing a child age 12 or under to sit in front can result in injury or death if the passenger's front airbag inflates.

If a larger child must ride in front, move the vehicle seat as far to the rear as possible, have the child sit up properly and wear the seat belt properly, using a booster seat if needed.

■ Booster Seats



If a lap/shoulder seat belt cannot be used properly, position the child in a booster seat in the rear seat. For the child's safety, check that the child meets the booster seat manufacturer's recommendations.

■ Protecting Larger Children - Final Checks

Your vehicle has a rear seat where children can be properly restrained. If you ever have to carry a group of children, and a child must ride in front:

- Make sure you read and fully understand the instructions and safety information in this manual.
- Move the front passenger seat as far back as possible.
- Have the child sit upright and well back in the seat.
- Check that the seat belt is properly positioned so that the child is secure in the seat.

■ Monitoring child passengers

We strongly recommend that you keep an eye on child passengers. Even older, more mature children sometimes need to be reminded to fasten their seat belts and sit up properly.

▣ Booster Seats

When installing a booster seat, make sure to read the instructions that came with it, and install the seat accordingly.

There are high- and low-type booster seats. Choose a booster seat that allows the child to wear the seat belt correctly.

Some U.S. states require children to use a booster seat until they reach a given age or weight (e.g. 6 years or 60 lbs). Be sure to check current laws in the state where you intend to drive.

Carbon Monoxide Gas

The engine exhaust from this vehicle contains carbon monoxide, a colorless, odorless, and highly toxic gas. As long as you properly maintain your vehicle, carbon monoxide gas will not get into the interior.

■ Have the exhaust system inspected for leaks whenever

- The exhaust system is making an unusual noise.
- The exhaust system may have been damaged.
- The vehicle is raised for an oil change.

When you operate a vehicle with the tailgate open, airflow can pull exhaust gas into the interior and create a hazardous condition. If you must drive with the tailgate open, open all the windows and set the climate control system as shown below.

1. Select the fresh air mode.
2. Select the  mode.
3. Set the fan speed to high.
4. Set the temperature control to a comfortable setting.

Adjust the climate control system in the same manner if you sit in your parked vehicle with the engine running.

ⓘ Carbon Monoxide Gas

WARNING

Carbon monoxide gas is toxic.

Breathing it can cause unconsciousness and even kill you.

Avoid any enclosed areas or activities that expose you to carbon monoxide.

An enclosed area such as a garage can quickly fill up with carbon monoxide gas. Do not run the engine with the garage door closed. Even when the garage door is open, drive out of the garage immediately after starting the engine.

Label Locations

These labels are in the locations shown. They warn you of potential hazards that can cause serious injury or death. Read these labels carefully.

If a label comes off or becomes hard to read (except for the dashboard label which may be removed by the owner), contact a dealer for a replacement.

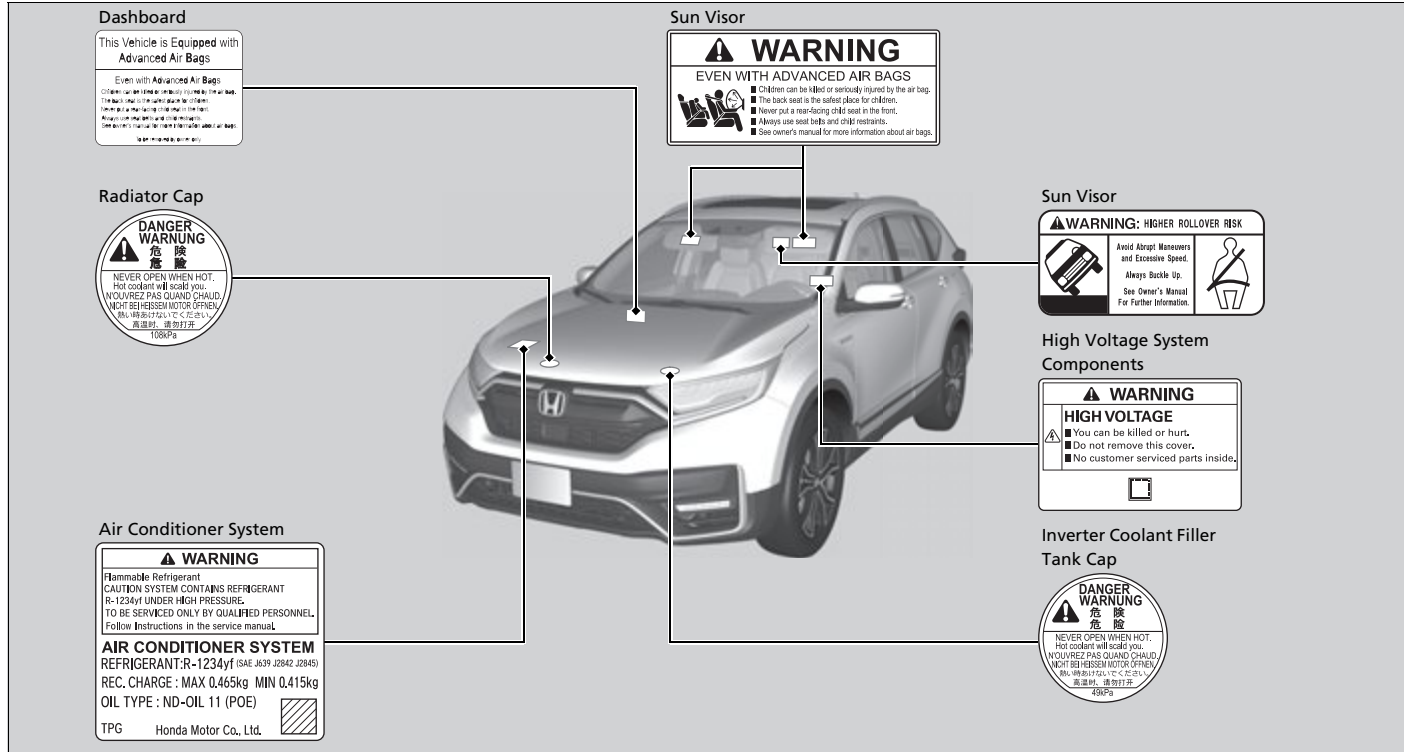

This page intentionally left blank.





























Instrument Panel

This chapter describes the buttons, indicators, and gauges that are used while driving.







Indicators	90
Driver Information Interface Warning and Information Messages	109
Gauges and Driver Information Interface	
Gauges	126
Driver Information Interface	128



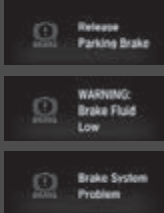



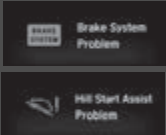
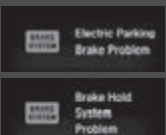
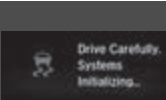

Indicators

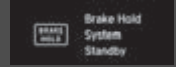



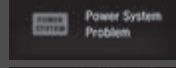

BRAKE *1	Parking Brake and Brake System Indicator (Red)	→P. 91		Low Fuel Indicator	→P. 96	SPORT	SPORT Mode Indicator	→P. 96
BRAKE SYSTEM *1	Parking Brake and Brake System Indicator (Amber)	→P. 92		Anti-lock Brake System (ABS) Indicator	→P. 97	EV *1	EV Indicator	→P. 94
	Automatic Brake Hold System Indicator	→P. 93		Supplemental Restraint System Indicator	→P. 97		EV Mode Indicator	→P. 94
HOLD *1	Automatic Brake Hold Indicator	→P. 93		Auto High-Beam Indicator	→P. 101		Road Departure Mitigation (RDM) Indicator	→P. 103
	Low Oil Pressure Indicator	→P. 93		Vehicle Stability Assist™ (VSA®) System Indicator	→P. 97		Collision Mitigation Braking System™ (CMBS™) Indicator	→P. 107
	Malfunction Indicator Lamp	→P. 94		Vehicle Stability Assist™ (VSA®) OFF Indicator	→P. 98		Blind spot information System Indicator*	→P. 102
	12-Volt Battery Charging System Indicator	→P. 95		Electric Power Steering (EPS) System Indicator	→P. 98		Immobilizer System Indicator	→P. 101
	Shift Position Indicator	→P. 95		Low Tire Pressure/TPMS Indicator	→P. 99		Security System Alarm Indicator	→P. 102
	Deceleration Paddle Selector Indicator	→P. 95		Turn Signal and Hazard Warning Indicators	→P. 100	ACC *1	Adaptive Cruise Control (ACC) with Low Speed Follow Indicator (Amber)	→P. 105
	Transmission System Indicator	→P. 95		High Beam Indicator	→P. 100	ACC	Adaptive Cruise Control (ACC) with Low Speed Follow Indicator (Green)	→P. 106
READY	READY Indicator	→P. 93		Lights On Indicator	→P. 101	LKAS *1	Lane Keeping Assist System (LKAS) Indicator (Amber)	→P. 106
POWER SYSTEM *1	POWER SYSTEM Indicator	→P. 93		Fog Light Indicator*	→P. 101	LKAS	Lane Keeping Assist System (LKAS) Indicator (Green)	→P. 106
	Seat Belt Reminder Indicator	→P. 96		System Message Indicator	→P. 100			
				ECON Mode Indicator	→P. 102			





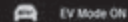

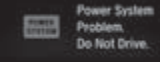

*1: When you set the power mode to ON, these indicators come on to indicate that system checks are being performed. They go off a few seconds later or after the power system has started. If an indicator does not come on or turn off, there may be a malfunction in the corresponding system. To resolve the issue, follow the instructions in the owner's manual.







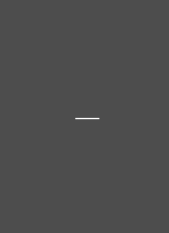

Indicator	Name	On/Blinking	Explanation	Message
<p>BRAKE (Red)</p>	<p>Parking Brake and Brake System Indicator (Red)</p>	<ul style="list-style-type: none"> • Comes on when the parking brake is applied and goes off when it is released. • Comes on when the brake fluid level is low. • Comes on if there is a problem with the brake system. • The beeper sounds and the indicator comes on if you drive with the parking brake applied. • Comes on for about 15 seconds when you apply the electric parking brake while the power mode is in ACCESSORY or VEHICLE OFF, then goes off. • Stays on for about 15 seconds when you set the power mode to VEHICLE OFF while the electric parking brake is applied, then goes off. 	<ul style="list-style-type: none"> • Comes on while driving - Make sure the parking brake is released. Check the brake fluid level. <ul style="list-style-type: none"> ▶ What to do when the indicator comes on while driving P. 654 • Comes on along with the Parking Brake and Brake System Indicator (Amber) - Immediately stop in a safe place. Contact a dealer for repair. The brake pedal becomes harder to operate. Depress the pedal further than you normally do. <ul style="list-style-type: none"> ▶ If the Brake System Indicator (Red) Comes On or Blinks at the Same Time When the Brake System Indicator (Amber) Comes On P. 655 • Comes on along with the ABS indicator - Have your vehicle checked by a dealer. <ul style="list-style-type: none"> ▶ If the Brake System Indicator (Red) Comes On or Blinks P. 654 • Blinks and the Parking Brake and Brake System Indicator (Amber) comes on at the same time - There is a problem with the electric parking brake system. The parking brake may not be set. Avoid using the parking brake and have your vehicle checked by a dealer immediately. <ul style="list-style-type: none"> ▶ If the Brake System Indicator (Red) Comes On or Blinks at the Same Time When the Brake System Indicator (Amber) Comes On P. 655 	







Indicator	Name	On/Blinking	Explanation	Message
	Parking Brake and Brake System Indicator (Amber)	<ul style="list-style-type: none"> • Comes on if there is a problem with a system related to braking other than the conventional brake system. • Comes on if there is a problem with the cooperative control with regenerative braking, the electric servo brake system, or the hill start assist system. 	<ul style="list-style-type: none"> • Comes on while driving - Avoid high speeds and sudden braking. Take the vehicle to a dealer immediately. 	
		<ul style="list-style-type: none"> • Comes on if there is a problem with the electric parking brake system or the automatic brake hold system. 	<ul style="list-style-type: none"> • Stays on constantly - Avoid using the parking brake and have your vehicle checked by a dealer immediately. 	
		<ul style="list-style-type: none"> • Comes on if the brake system is deactivated temporarily after the 12-volt battery has been disconnected, then re-connected. 	<ul style="list-style-type: none"> • Drive a short distance at more than 12 mph (20 km/h). The indicator should go off. If it does not, have your vehicle checked by a dealer. 	
		<ul style="list-style-type: none"> • Comes on if there is a problem with the radar sensor. • Indicator may come on temporarily when the Maximum Load Limit is exceeded. 	<ul style="list-style-type: none"> • Make sure the total load is within the Maximum Load Limit. •  Maximum Load Limit P. 463 • Stays on constantly - Have your vehicle checked by a dealer. 	

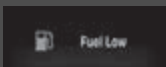
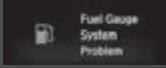





Indicator	Name	On/Blinking	Explanation	Message
	Automatic Brake Hold System Indicator	<ul style="list-style-type: none"> Comes on when the automatic brake hold system is on. 	<ul style="list-style-type: none"> ➤ Automatic Brake Hold P. 555 	
	Automatic Brake Hold Indicator	<ul style="list-style-type: none"> Comes on when the automatic brake hold is activated. 	<ul style="list-style-type: none"> ➤ Automatic Brake Hold P. 555 	—
	Low Oil Pressure Indicator	<ul style="list-style-type: none"> Comes on when the engine oil pressure is low. 	<ul style="list-style-type: none"> Comes on while driving - Immediately stop in a safe place. ➤ If the Low Oil Pressure Indicator Comes On P. 652 	
	Power System Indicator	<ul style="list-style-type: none"> Comes on if there is a problem with the electric vehicle system. Comes on when the High Voltage battery temperature becomes high. 	<ul style="list-style-type: none"> Stays on constantly - Have your vehicle checked by a dealer immediately. 	 
	READY Indicator	<ul style="list-style-type: none"> Comes on when the vehicle is ready to drive. 	<ul style="list-style-type: none"> ➤ Turning on the Power P. 469 	





Indicator	Name	On/Blinking	Explanation	Message
	EV Indicator	<ul style="list-style-type: none"> Comes on when the vehicle is moved by the motor, and the engine is not operating. 	—	—
	EV Mode Indicator	<ul style="list-style-type: none"> Comes on when the vehicle is in EV mode. 	<ul style="list-style-type: none">  SPORT HYBRID i-MMD (intelligent Multi-Mode Drive) P. 11 	
	Malfunction Indicator Lamp	<ul style="list-style-type: none"> After you have set the power mode to ON, the vehicle performs system checks. However, if the readiness codes have not been set by that time, this indicator will blink five times and then go off. Comes on if there is a problem with the emissions control systems or electric vehicle system. Blinks when a misfire in the engine's cylinders is detected. 	<ul style="list-style-type: none"> Readiness codes are part of the on board diagnostics for the emissions control systems. <ul style="list-style-type: none">  Testing of Readiness Codes P. 673 Comes on while driving - Have your vehicle checked by a dealer. Comes on when there is no gasoline in the fuel tank, and goes off after vehicle is refueled, power mode is turned on, vehicle is driven, and the power system is turned off multiple times. If it does not go off, have your vehicle checked by a dealer. Blinks while driving - Stop in a safe place where there are no flammable objects. Stop the power system for 10 minutes or more, and wait for it to cool down. Then, take your vehicle to a dealer. <ul style="list-style-type: none">  If the Malfunction Indicator Lamp Comes On or Blinks P. 653 	 





Indicator	Name	On/Blinking	Explanation	Message
	12-volt Battery Charging System Indicator	<ul style="list-style-type: none"> Comes on when there is a problem with the charging system. 	<ul style="list-style-type: none"> Stop in a safe place and have your vehicle checked by a dealer immediately. <ul style="list-style-type: none"> ➤ If the 12-volt Battery Charging System Indicator Comes On P. 652 	
	Shift Position Indicator	<ul style="list-style-type: none"> Indicates the current shift position. 	<ul style="list-style-type: none"> ➤ Shifting P. 477 	
	Transmission System Indicator	<ul style="list-style-type: none"> The indicated current shift position blinks if there is a problem with the transmission system. 	<ul style="list-style-type: none"> Avoid sudden start and acceleration, and stop in a safe place immediately. Have your vehicle checked by a dealer. 	
		<ul style="list-style-type: none"> The indicated current shift position or all the shift positions blink if you cannot select P due to the transmission system failure. 	<ul style="list-style-type: none"> Set the parking brake when parking. Have your vehicle checked by a dealer immediately. 	
	Deceleration Paddle Selector Indicator	<ul style="list-style-type: none"> Comes on when the paddle selector is pulled. Blinks when the deceleration does not occur while pulling the paddle selector. Comes on with M when SPORT mode is selected and pulling the paddle selector. 	<ul style="list-style-type: none"> ➤ Deceleration Paddle Selector P. 484 	





Indicator	Name	On/Blinking	Explanation	Message
	SPORT Mode Indicator	<ul style="list-style-type: none"> Comes on when you press the SPORT button. 	<ul style="list-style-type: none"> The ambient meter remains lit up in red as long as sport mode is on.  SPORT Mode P. 483 	
	Seat Belt Reminder Indicator	<ul style="list-style-type: none"> Blinks and the beeper sounds for a few seconds if you are not wearing a seat belt when you set the power mode to ON, then the indicator comes on. If the front passenger is not wearing a seat belt, the indicator comes on a few seconds later. Blinks while driving if you and/or the front passenger has not fastened a seat belt. The beeper sounds and the indicator blinks at regular intervals. 	<ul style="list-style-type: none"> The beeper stops and the indicator goes off when you and the front passenger fasten their seat belts. Stays on after you and/or the front passenger has fastened the seat belt(s) - A detection error may have occurred in the sensor. Have your vehicle checked by a dealer.  Seat Belt Reminder P. 49 	 
	Low Fuel Indicator	<ul style="list-style-type: none"> Comes on when the fuel reserve is running low (approximately 2.1 U.S. gal/8.0 Liter left). Blinks if there is a problem with the fuel gauge. 	<ul style="list-style-type: none"> Comes on - Refuel your vehicle as soon as possible. Blinks - Have your vehicle checked by a dealer. 	 

Indicator	Name	On/Blinking	Explanation	Message
	Anti-lock Brake System (ABS) Indicator	<ul style="list-style-type: none"> Comes on if there is a problem with the ABS. 	<ul style="list-style-type: none"> Stays on constantly - Have your vehicle checked by a dealer. With this indicator on, your vehicle still has normal braking ability but no anti-lock function. ▶ Anti-lock Brake System (ABS) P. 557 	
	Supplemental Restraint System Indicator	<ul style="list-style-type: none"> Comes on if a problem with any of the following is detected: <ul style="list-style-type: none"> Supplemental restraint system Side airbag system Side curtain airbag system Seat belt tensioner 	<ul style="list-style-type: none"> Stays on constantly - Have your vehicle checked by a dealer. 	
	Vehicle Stability Assist™ (VSA®) System Indicator	<ul style="list-style-type: none"> Blinks when VSA® is active. Comes on if there is a problem with the VSA® system. 	<ul style="list-style-type: none"> Stays on constantly - Have your vehicle checked by a dealer. ▶ Vehicle Stability Assist™ (VSA®), aka Electronic Stability Control (ESC), System P. 489 	
		<ul style="list-style-type: none"> Comes on if the VSA® system is deactivated temporarily after the 12-volt battery has been disconnected, then re-connected. 	<ul style="list-style-type: none"> Drive a short distance at more than 12 mph (20 km/h). The indicator should go off. If it does not, have your vehicle checked by a dealer. 	

Indicator	Name	On/Blinking	Explanation	Message
	Vehicle Stability Assist™ (VSA®) OFF Indicator	<ul style="list-style-type: none"> Comes on when you partially disable VSA®. 	 VSA® On and Off P. 490	
		<ul style="list-style-type: none"> Comes on if the VSA® system is deactivated temporarily after the 12-volt battery has been disconnected, then re-connected. 	<ul style="list-style-type: none"> Drive a short distance at more than 12 mph (20 km/h). The indicator should go off. If it does not, have your vehicle checked by a dealer. 	
	Electric Power Steering (EPS) System Indicator	<ul style="list-style-type: none"> Comes on if there is a problem with the EPS System. 	<ul style="list-style-type: none"> Stays on constantly - Have your vehicle checked by a dealer. <ul style="list-style-type: none">  If the Electric Power Steering (EPS) System Indicator Comes On P. 656 	





Indicator	Name	On/Blinking	Explanation	Message
	Low Tire Pressure/TPMS Indicator	<ul style="list-style-type: none"> • May come on briefly if the power mode is set to ON and the vehicle is not moved within 45 seconds, to indicate the calibration process is not yet complete. • Comes on and stays on when: <ul style="list-style-type: none"> - One or more tires' pressures are determined to be significantly low. - The system has not been calibrated. 	<ul style="list-style-type: none"> • Comes on while driving - Stop in a safe place, check tire pressures, and inflate the tire(s) if necessary. • Stays on after the tires are inflated to the recommended pressures - The system needs to be calibrated. <ul style="list-style-type: none"> ▶ TPMS Calibration P. 494 	
		<ul style="list-style-type: none"> • Blinks for about one minute, and then stays on if there is a problem with the TPMS. 	<ul style="list-style-type: none"> • Blinks and remains on - Have your vehicle checked by a dealer. 	
		<ul style="list-style-type: none"> • Comes on if the TPMS is deactivated temporarily after the 12-volt battery has been disconnected, then reconnected. 	<ul style="list-style-type: none"> • Drive a short distance at more than 12 mph (20 km/h). The indicator should go off. If it does not, have your vehicle checked by a dealer. 	



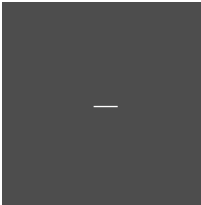

Indicator	Name	On/Blinking	Explanation	Message
	System Message Indicator	<ul style="list-style-type: none"> Comes on along with a beep when a problem is detected. A system message on the driver information interface appears at the same time. 	<ul style="list-style-type: none"> While the indicator is on, press the  (display/information) button to see the message again. Refer to the Indicators information in this chapter when a system message appears on the driver information interface. Respond to the message accordingly. The driver information interface does not return to the normal screen unless the warning is canceled, or the  button is pressed. 	—
	Turn Signal and Hazard Warning Indicators	<ul style="list-style-type: none"> Blinks when you operate the turn signal lever. Blink along with all turn signals when you press the hazard warning button. 	<ul style="list-style-type: none"> Does not blink or blinks rapidly - Have your vehicle checked by a dealer. 	—
	High Beam Indicator	<ul style="list-style-type: none"> Comes on when the high beam headlights are on. 	—	—



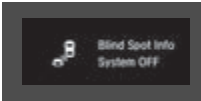
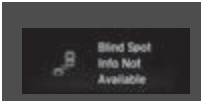
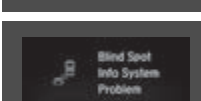



Indicator	Name	On/Blinking	Explanation	Message
	Lights On Indicator	<ul style="list-style-type: none"> Comes on when the parking, tail, and other external lights are on. 	<p>➤ Light Switches P. 190</p>	—
	Fog Light Indicator*	<ul style="list-style-type: none"> Comes on when the fog lights are on. 	<p>➤ Fog Lights* P. 194</p>	—
	Auto High-Beam Indicator	<ul style="list-style-type: none"> Comes on when all the operating conditions of the auto high-beam are met. 	<p>➤ Auto High-Beam P. 195</p>	—
 Indicator	Immobilizer System Indicator	<ul style="list-style-type: none"> Blinks if the immobilizer system cannot recognize the key information. 	<ul style="list-style-type: none"> Blinks - You cannot start the power system. Set the power mode to VEHICLE OFF, then select the ON mode again. Repeatedly blinks - The system may be malfunctioning. Have your vehicle checked by a dealer. Do not attempt to alter this system or add other devices to it. Electrical problems can occur. 	—



Instrument Panel

* Not available on all models



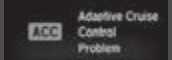

Indicator	Name	On/Blinking	Explanation	Message
 Indicator	Security System Alarm Indicator	<ul style="list-style-type: none"> Blinks when the security system alarm has been set. 	<p>➤ Security System Alarm * P. 178</p>	
	ECON Mode Indicator	<ul style="list-style-type: none"> Comes on when the ECON mode is on. 	<p>➤ ECON Mode P. 487</p>	
	Blind spot information System Indicator*	<ul style="list-style-type: none"> Stays on while the blind spot information system is turned off. 	<p>➤ Blind spot information System * P. 499</p>	
		<ul style="list-style-type: none"> Comes on when mud, snow, or ice accumulates in the vicinity of sensor. 	<ul style="list-style-type: none"> Comes on while driving - Remove the obstacle in the vicinity of the sensor. <p>➤ Blind spot information System * P. 499</p>	
		<ul style="list-style-type: none"> Comes on if there is a problem with the system. 	<ul style="list-style-type: none"> Comes on while driving - Have your vehicle checked by a dealer. 	





Indicator	Name	On/Blinking	Explanation	Message
	Road Departure Mitigation (RDM) Indicator	<ul style="list-style-type: none"> • Comes on if there is a problem with the RDM system. 	<ul style="list-style-type: none"> • Stays on constantly - Have your vehicle checked by a dealer. 	
		<ul style="list-style-type: none"> • Comes on if the RDM is deactivated temporarily after the 12-volt battery has been disconnected, then re-connected. 	<ul style="list-style-type: none"> • Drive a short distance at more than 12 mph (20 km/h). The indicator should go off. If it does not, have your vehicle checked by a dealer. 	
		<ul style="list-style-type: none"> • Comes on when the RDM system shuts itself off. 	<ul style="list-style-type: none"> • Stays on - The temperature inside the camera is too high. Use the climate control system to cool down the camera. The system activates when the temperature inside the camera cools down. <p>➤ Front Sensor Camera P. 548</p>	





Indicator	Name	On/Blinking	Explanation	Message
	Road Departure Mitigation (RDM) Indicator	<ul style="list-style-type: none"> Comes on when the RDM system shuts itself off. 	<ul style="list-style-type: none"> Stays on - The area around the camera is blocked by dirt, mud, etc. Stop your vehicle in a safe place and wipe the debris off with a soft cloth. Have your vehicle checked by a dealer if the indicator and message come back on after you cleaned the area around the camera.  Front Sensor Camera P. 548 	
		<ul style="list-style-type: none"> Indicator may come on temporarily when passing through an enclosed space, such as a tunnel. The area around the radar sensor is blocked by dirt, mud, etc. Stop your vehicle in a safe place and wipe the debris off with a soft cloth. Indicator may take some time to go off after the radar sensor is cleaned. Have your vehicle checked by a dealer if the indicator does not go off even after you cleaned the radar sensor.  Radar Sensor P. 550 	<ul style="list-style-type: none"> Indicator may come on temporarily when passing through an enclosed space, such as a tunnel. The area around the radar sensor is blocked by dirt, mud, etc. Stop your vehicle in a safe place and wipe the debris off with a soft cloth. Indicator may take some time to go off after the radar sensor is cleaned. Have your vehicle checked by a dealer if the indicator does not go off even after you cleaned the radar sensor.  Radar Sensor P. 550 	
		<ul style="list-style-type: none"> Indicator may come on temporarily when the Maximum Load Limit is exceeded. 	<ul style="list-style-type: none"> Make sure the total load is within the Maximum Load Limit.  Maximum Load Limit P. 463 Stays on constantly - Have your vehicle checked by a dealer. 	—

Indicator	Name	On/Blinking	Explanation	Message
<div style="background-color: #333; color: white; padding: 5px; text-align: center; font-weight: bold;">ACC</div>	Adaptive Cruise Control (ACC) with Low Speed Follow Indicator (Amber)	<ul style="list-style-type: none"> • Comes on if there is a problem with ACC with Low Speed Follow. 	<ul style="list-style-type: none"> • Comes on while driving - Have your vehicle checked by a dealer. 	
		<ul style="list-style-type: none"> • Comes on if the ACC with Low Speed Follow is deactivated temporarily after the 12-volt battery has been disconnected, then re-connected. 	<ul style="list-style-type: none"> • Drive a short distance at more than 12 mph (20 km/h). The indicator should go off. If it does not, have your vehicle checked by a dealer. 	
		<ul style="list-style-type: none"> • Comes on if there is a problem with ACC with Low Speed Follow. • Indicator may come on temporarily when Maximum Load Limit is exceeded. • ACC with Low Speed Follow has been automatically canceled. 	<ul style="list-style-type: none"> • Make sure the total load is within the Maximum Load Limit. ➤ Maximum Load Limit P. 463 • Stays on constantly - Have your vehicle checked by a dealer. 	

Instrument Panel



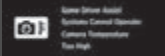

Indicator	Name	On/Blinking	Explanation	Message
ACC	Adaptive Cruise Control (ACC) with Low Speed Follow Indicator (Green)	<ul style="list-style-type: none"> Comes on when you press the MAIN button. 	<ul style="list-style-type: none">  Adaptive Cruise Control (ACC) with Low Speed Follow P. 517 	
LKAS	Lane Keeping Assist System (LKAS) Indicator (Amber)	<ul style="list-style-type: none"> Comes on if there is a problem with the LKAS. 	<ul style="list-style-type: none"> Stays on constantly - Have your vehicle checked by a dealer. 	
LKAS	Lane Keeping Assist System (LKAS) Indicator (Green)	<ul style="list-style-type: none"> Comes on when you press the MAIN button. 	<ul style="list-style-type: none">  Lane Keeping Assist System (LKAS) P. 534 	





Indicator	Name	On/Blinking	Explanation	Message
	Collision Mitigation Braking System™ (CMBS™) Indicator	<ul style="list-style-type: none"> • Comes on when you deactivate the CMBS™. A driver information interface message appears for five seconds. • Comes on if there is a problem with the CMBS™. 	<ul style="list-style-type: none"> • Stays on constantly without the CMBS™ off - Have your vehicle checked by a dealer. <ul style="list-style-type: none"> ▶ Collision Mitigation Braking System™ (CMBS™) P. 506 	 
		<ul style="list-style-type: none"> • Comes on if the CMBS™ is deactivated temporarily after the 12-volt battery has been disconnected, then re-connected. 	<ul style="list-style-type: none"> • Drive a short distance at more than 12 mph (20 km/h). The indicator should go off. If it does not, have your vehicle checked by a dealer. 	
		<ul style="list-style-type: none"> • Comes on when the CMBS™ shuts itself off. 	<ul style="list-style-type: none"> • Stays on - The area around the camera is blocked by dirt, mud, etc. Stop your vehicle in a safe place, and wipe it off with a soft cloth. <ul style="list-style-type: none"> ▶ Front Sensor Camera P. 548 • Have your vehicle checked by a dealer if the indicator does not go off even after you cleaned the camera. 	





Indicator	Name	On/Blinking	Explanation	Message
	Collision Mitigation Braking System™ (CMBS™) Indicator	<ul style="list-style-type: none"> Comes on when the CMBS™ shuts itself off. 	<ul style="list-style-type: none"> Indicator may come on temporarily when passing through an enclosed space, such as a tunnel. The area around the radar sensor is blocked by dirt, mud, etc. Stop your vehicle in a safe place, and wipe it off with a soft cloth. Indicator may take some time to go off after the radar sensor is cleaned. Have your vehicle checked by a dealer if the indicator does not go off even after you clean the sensor cover. <ul style="list-style-type: none"> ➤ Radar Sensor P. 550 	
		<ul style="list-style-type: none"> Indicator may come on temporarily when the Maximum Load Limit is exceeded. 	<ul style="list-style-type: none"> Stays on - The temperature inside the camera is too high. Use the climate control system to cool down the camera. The system activates when the temperature inside the camera cools down. <ul style="list-style-type: none"> ➤ Front Sensor Camera P. 548 	
			<ul style="list-style-type: none"> Make sure the total load is within the Maximum Load Limit. <ul style="list-style-type: none"> ➤ Maximum Load Limit P. 463 Stays on constantly - Have your vehicle checked by a dealer. 	



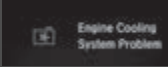

Driver Information Interface Warning and Information Messages

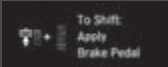



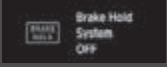

The following messages appear only on the driver information interface. Press the  (display/information) button to see the message again with the system message indicator on.



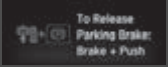

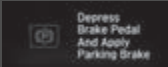
Message	Condition	Explanation
	<ul style="list-style-type: none"> • Appears if any door or the tailgate is not completely closed. • Appears if any door or the tailgate is opened while driving. The beeper sounds. 	<ul style="list-style-type: none"> • Disappears when all doors and the tailgate are closed.
	<p>Models with parking sensor system</p> <ul style="list-style-type: none"> • Appears if there is a problem with the parking sensor system. • If there is a problem with any of the sensors, the all sensor indicator(s) comes on in red. 	<ul style="list-style-type: none"> • Check if the area around the sensor(s) is covered with mud, ice, snow, etc. If the indicator(s) stays on even after you clean the area, have the system checked by a dealer.
	<ul style="list-style-type: none"> • Appears if there is a problem with the acoustic vehicle alerting system. 	<ul style="list-style-type: none"> • Have your vehicle checked by a dealer immediately.
	<ul style="list-style-type: none"> • Appears when the scheduled maintenance is due soon. • Consequently, Maintenance Due Now and Maintenance Past Due follow. 	<p> Maintenance Minder Messages on the Driver Information Interface P. 583</p>



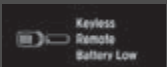

Message	Condition	Explanation
 <p>Shutter Grille Problem. Power Reduced</p>	<ul style="list-style-type: none"> Appears if there is a problem with the shutter grille, and the radiator coolant temperature is too high. 	<ul style="list-style-type: none"> Power output will be reduced, so you may not be able to accelerate or maintain your current speed. Have your vehicle checked by a dealer.
 <p>Charging System Problem</p>	<ul style="list-style-type: none"> Appears when there is a problem with the 12-volt battery charging system. 	<ul style="list-style-type: none"> Have your vehicle checked by a dealer.
 <p>Brake Hold Disabled. Apply Brake Pedal</p>	<ul style="list-style-type: none"> Appears if the automatic brake hold is automatically canceled while it is in operation. 	<ul style="list-style-type: none"> Immediately depress the brake pedal.
 <p>Stop Driving When Safe. Engine Temperature Too High</p>	<ul style="list-style-type: none"> Appears when the engine coolant temperature gets abnormally high. 	<p>➤ Overheating P. 649</p>
 <p>Avoid Acceleration and High Speed. Engine Temperature Near Limit</p>	<ul style="list-style-type: none"> Appears when the engine coolant temperature is near its upper limit. 	<ul style="list-style-type: none"> Drive slowly to prevent overheating.



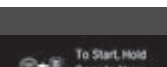

Message	Condition	Explanation
 <p>Engine Cooling System Problem</p>	<ul style="list-style-type: none"> Appears if there is a problem with the cooling system. 	<ul style="list-style-type: none"> Drive slowly to prevent overheating and have your vehicle checked by a dealer as soon as possible.
 <p>Fasten Seat Belt</p> <p>(White)</p>	<ul style="list-style-type: none"> Appears when you set the power mode to ON without fastening the driver's seat belt. 	<ul style="list-style-type: none"> Fasten the seat belt properly before you start to drive.
 <p>To Shift, Apply Brake Pedal</p>	<ul style="list-style-type: none"> Appears when you try to change the transmission without depressing the brake pedal. 	<ul style="list-style-type: none"> Depress the brake pedal, then change the transmission.
 <p>To Shift, Release Accelerator Pedal</p>	<ul style="list-style-type: none"> Appears when you try to change the transmission without releasing your foot off the accelerator pedal. 	<ul style="list-style-type: none"> Release your foot off the accelerator pedal, then change the transmission.
 <p>To Shift, Vehicle Must Be Stopped</p>	<ul style="list-style-type: none"> Appears when the P button is pressed while the vehicle is moving. Appears if you put the transmission into R while the vehicle is moving forward, or into D while the vehicle is reversing. 	<ul style="list-style-type: none"> Make sure that the vehicle comes to a stop before operating the shift button.



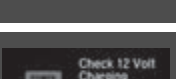
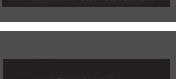

Message	Condition	Explanation
	<ul style="list-style-type: none"> • Appears if there is a problem with the electric system. • Appears when you set the power mode to OFF while driving. 	<ul style="list-style-type: none"> • Immediately stop in a safe place and set the parking brake, then restart the power system. If the message disappears, continue driving. • Continue driving if the message goes off soon after. • If there is a problem with the transmission system, the transmission indicator system comes on. ➤ Transmission System Indicator P. 95
	<ul style="list-style-type: none"> • Appears when the automatic brake hold system is turned off. 	<p>➤ Automatic Brake Hold P. 555</p>
	<ul style="list-style-type: none"> • Appears when the automatic brake hold button is pressed without wearing the driver's seat belt. 	<ul style="list-style-type: none"> • Fasten the driver's seat belt. ➤ Automatic Brake Hold P. 555
	<ul style="list-style-type: none"> • Appears when the automatic brake hold button is pressed without depressing the brake pedal while the automatic brake hold is in operation. 	<ul style="list-style-type: none"> • Press the automatic brake hold button with the brake pedal depressed. ➤ Automatic Brake Hold P. 555
	<ul style="list-style-type: none"> • Appears when the parking brake is applied automatically while it is in operation. 	<p>➤ Automatic Brake Hold P. 555 ➤ Parking Brake P. 551</p>







Message	Condition	Explanation
	<ul style="list-style-type: none"> Appears when the electric parking brake switch is pressed without depressing the brake pedal while the electric parking brake is in operation. 	<ul style="list-style-type: none"> Press the electric parking brake switch with the brake pedal depressed. <ul style="list-style-type: none"> ► Parking Brake P. 551
	<ul style="list-style-type: none"> Appears when the vehicle is no longer able to run due to a malfunction. 	<ul style="list-style-type: none"> Immediately stop in a safe place.
	<ul style="list-style-type: none"> Appears when there is a risk that the vehicle will move unexpectedly after you have stopped due to a malfunction with the vehicle. 	<ul style="list-style-type: none"> While the vehicle is stopped, apply the parking brake. <ul style="list-style-type: none"> ► Parking Brake P. 551 Have your vehicle checked by a dealer.
 	<ul style="list-style-type: none"> Appears as soon as a problem is detected in the keyless access system or push button starting system. 	<ul style="list-style-type: none"> Appears constantly - Have your vehicle checked by a dealer.
	<ul style="list-style-type: none"> Appears when you close the door with the power mode in ON without the keyless remote inside the vehicle. 	<ul style="list-style-type: none"> Disappears when you bring the keyless remote back inside the vehicle and close the door. <ul style="list-style-type: none"> ► Keyless Remote Reminder P. 188







Message	Condition	Explanation
 <p>Keyless Remote Battery Low</p>	<ul style="list-style-type: none"> Appears when the keyless remote battery becomes weak. 	<p>➤ Replacing the Remote Battery P. 617</p>
 <p>To Start Vehicle: Brake + Push</p>	<ul style="list-style-type: none"> Appears when you set the power mode to ACCESSORY or ON. 	<p>➤ Turning on the Power P. 469</p>
 <p>Pressing Button Again To Or Holding Will Cause System OFF & Power Loss</p>	<ul style="list-style-type: none"> Appears if you press the POWER button while the vehicle is moving. 	<p>➤ Emergency Power System Off P. 646</p>
 <p>Accessory Mode</p>	<ul style="list-style-type: none"> Appears when the power mode is in ACCESSORY. 	<p>—</p>
 <p>To Switch Vehicle OFF: Push Twice</p>	<ul style="list-style-type: none"> Appears after the driver's door is opened when the power mode is in ACCESSORY. 	<ul style="list-style-type: none"> Change the power mode to VEHICLE OFF. <p>➤ POWER Button P. 186</p>
 <p>To Start, Hold Remote Near Start Button</p>	<ul style="list-style-type: none"> Appears if the keyless remote's battery is too weak to turn on the power system or the key is not within operating range to turn on the power system. The beeper sounds six times. 	<ul style="list-style-type: none"> Bring the back of the keyless remote into contact with the POWER button. <p>➤ If the Keyless Remote Battery is Weak P. 645</p>





Message	Condition	Explanation
	<ul style="list-style-type: none"> Appears when you press and hold N button for more than two seconds. 	<ul style="list-style-type: none"> Disappears when you set the shift position to a shift other than N. <ul style="list-style-type: none"> ▶ If you want to keep the transmission in N position [car wash mode] P. 481
	<ul style="list-style-type: none"> Appears when the vehicle is stopped with the driver's seat belt unfastened and there is a chance that the vehicle may roll unintentionally. 	<ul style="list-style-type: none"> Press the P button before release the brake pedal when idling, parking or exiting the vehicle. <ul style="list-style-type: none"> ▶ Shift Operation P. 479
	<ul style="list-style-type: none"> Appears when the power system temperature is high. 	<ul style="list-style-type: none"> Your vehicle has less ability to accelerate and may be harder to start on an incline. Park in a safe place, and cool the system down. <ul style="list-style-type: none"> ▶ Overheating P. 649
	<ul style="list-style-type: none"> Appears when the High Voltage battery temperature is low. 	<ul style="list-style-type: none"> Your vehicle has less ability to accelerate and may be harder to start on an incline. Goes off once you start driving as the High Voltage battery warms up.
	<ul style="list-style-type: none"> Appears after the 12-volt battery charging system indicator comes on. 	<ul style="list-style-type: none"> Your vehicle has less ability to accelerate and may be harder to start on an incline. Contact a dealer immediately.
	<ul style="list-style-type: none"> Appears when the High Voltage battery temperature is too low to operate (approx. -22°F [-30°C] or below). 	<ul style="list-style-type: none"> You can start the engine and use the climate control system to warm up the interior, which will also warm the High Voltage battery enough for you to drive the vehicle.





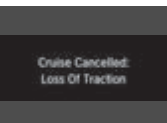

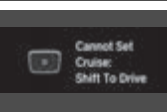
Message	Condition	Explanation
	<ul style="list-style-type: none"> Appears when the High Voltage battery and other system control temperatures are too low to operate (approx. -40°F [-40°C] or below). 	<ul style="list-style-type: none"> You must wait for an increase in the ambient temperature or move the vehicle to a warmer location. Consult a dealer if necessary.
	<ul style="list-style-type: none"> Appears if the power system is in diagnostic mode. 	<ul style="list-style-type: none"> You may notice a decrease in available power. Have your vehicle checked by a dealer. As a result of diagnostics, the power system indicator may come on.  Power System Indicator P. 93
	<ul style="list-style-type: none"> Appears when you have met following situations and EV mode is canceled. <ul style="list-style-type: none"> - Battery Temperature At Limit. - Battery Charge Too Low. - Engine Too Cold. - Cabin Being Heated. - Speed Too High. - Hard Acceleration Requested. 	<ul style="list-style-type: none"> EV mode is available once the condition is improved or the cause that canceled EV mode is cleared.
	<ul style="list-style-type: none"> Appears when you depress the accelerator pedal while the shift position is in N. 	<ul style="list-style-type: none"> Remove your foot off the accelerator pedal. When driving, depress the brake pedal and operate the shift position.



Message	Condition	Explanation
	<ul style="list-style-type: none"> Appears when you put the transmission into N, then release the N button. 	<ul style="list-style-type: none"> ➤ If you want to keep the transmission in N position [car wash mode] P. 481
	<ul style="list-style-type: none"> Appears when you repeatedly change the shift position between P and other positions in short period. 	<ul style="list-style-type: none"> Take some time before changing the shift position.
	<ul style="list-style-type: none"> Appears if the engine needs to be started when you press the EV button. 	—
	<ul style="list-style-type: none"> Appears when you have met following situations and EV mode has been automatically canceled. <ul style="list-style-type: none"> - When the High Voltage battery charge is low. - When the velocity of your vehicle is high. - When your vehicle's speed exceeds 25 mph (40 km/h) before the engine warms up enough. - When depressing the accelerator pedal deeply. - When driving on a slope. 	<ul style="list-style-type: none"> EV mode is available once the condition is improved or the cause that canceled EV mode is cleared.
	<ul style="list-style-type: none"> Appears when the High Voltage battery is running extremely low. 	<ul style="list-style-type: none"> Contact a dealer immediately.





Message	Condition	Explanation
	<ul style="list-style-type: none"> Appears if there is a problem with the automatic lighting control system. 	<ul style="list-style-type: none"> Appears while driving - Manually turn the lights on, and have your vehicle checked by a dealer.
	<ul style="list-style-type: none"> Appears if there is a problem with the headlights. 	<ul style="list-style-type: none"> Appears while driving - The headlights may not be on. When conditions allow you to drive safely, have your vehicle checked by a dealer as soon as possible.
	<ul style="list-style-type: none"> Appears when you unlock and open the driver's door while the power system is on by remote engine start. 	<p>➤ Remote Engine Start P. 471</p>
 	<ul style="list-style-type: none"> Appears if the vehicle is being driven in a manner consistent with drowsy or inattentive driving. 	<p>➤ Driver Attention Monitor P. 135</p>
	<ul style="list-style-type: none"> Appears when ACC with Low Speed Follow has been automatically canceled. 	<ul style="list-style-type: none"> You can resume the set speed after the condition that caused ACC with Low Speed Follow to cancel improves. Press the RES/+ button. ➤ Adaptive Cruise Control (ACC) with Low Speed Follow P. 517

Message	Condition	Explanation
	<ul style="list-style-type: none"> Appears when the distance between your vehicle and the vehicle ahead of you is too close while ACC with Low Speed Follow is in operation. 	<ul style="list-style-type: none"> ACC with Low Speed Follow has been automatically canceled. <ul style="list-style-type: none"> ► Adaptive Cruise Control (ACC) with Low Speed Follow P. 517
	<ul style="list-style-type: none"> Appears when pressing the -/SET button while the distance between your vehicle and the vehicle ahead of you is too close. 	<ul style="list-style-type: none"> ACC with Low Speed Follow cannot be set. <ul style="list-style-type: none"> ► Adaptive Cruise Control (ACC) with Low Speed Follow P. 517
	<ul style="list-style-type: none"> Appears when the driver's seat belt is unfastened while your vehicle is automatically stopped by ACC with Low Speed Follow. 	<ul style="list-style-type: none"> ACC with Low Speed Follow has been automatically canceled. <ul style="list-style-type: none"> ► Adaptive Cruise Control (ACC) with Low Speed Follow P. 517
	<ul style="list-style-type: none"> Appears when pressing the -/SET button while the driver's seat belt is unfastened. 	<ul style="list-style-type: none"> ACC with Low Speed Follow cannot be set. <ul style="list-style-type: none"> ► Adaptive Cruise Control (ACC) with Low Speed Follow P. 517
	<ul style="list-style-type: none"> Appears when the speed of the vehicle is too high for you to set ACC. 	<ul style="list-style-type: none"> Reduce the speed, then set ACC. <ul style="list-style-type: none"> ► Adaptive Cruise Control (ACC) with Low Speed Follow P. 517
	<ul style="list-style-type: none"> Appears when ACC is canceled due to excessive high vehicle speed. 	<ul style="list-style-type: none"> Reduce the speed, then reset ACC. <ul style="list-style-type: none"> ► Adaptive Cruise Control (ACC) with Low Speed Follow P. 517



Message	Condition	Explanation
	<ul style="list-style-type: none"> Appears when the vehicle ahead of you resumes driving, after your vehicle has been stopped automatically by ACC with Low Speed Follow. 	<ul style="list-style-type: none"> Press the RES/+ button or -/SET button or depress the accelerator pedal. <ul style="list-style-type: none"> ➤ Adaptive Cruise Control (ACC) with Low Speed Follow P. 517
	<ul style="list-style-type: none"> Appears if the VSA® or traction control function operates while ACC with Low Speed Follow is in operation. 	<ul style="list-style-type: none"> ACC with Low Speed Follow has been automatically canceled. <ul style="list-style-type: none"> ➤ Adaptive Cruise Control (ACC) with Low Speed Follow P. 517
	<ul style="list-style-type: none"> Appears when the shift position is changed to any position other than D while ACC with Low Speed Follow is in operation. 	<ul style="list-style-type: none"> ACC with Low Speed Follow has been automatically canceled. <ul style="list-style-type: none"> ➤ Adaptive Cruise Control (ACC) with Low Speed Follow P. 517
	<ul style="list-style-type: none"> Appears when pressing the -/SET button while the shift position is in any position other than D. 	<ul style="list-style-type: none"> ACC with Low Speed Follow cannot be set. <ul style="list-style-type: none"> ➤ Adaptive Cruise Control (ACC) with Low Speed Follow P. 517
	<ul style="list-style-type: none"> Appears when the vehicle is stopped on a very steep slope while ACC with Low Speed Follow is in operation. 	<ul style="list-style-type: none"> ACC with Low Speed Follow has been automatically canceled. <ul style="list-style-type: none"> ➤ Adaptive Cruise Control (ACC) with Low Speed Follow P. 517

Message	Condition	Explanation
 	<ul style="list-style-type: none"> Appears when pressing the –/SET button while the vehicle is stopped on a very steep slope. 	<ul style="list-style-type: none"> ACC with Low Speed Follow cannot be set. <ul style="list-style-type: none"> ► Adaptive Cruise Control (ACC) with Low Speed Follow P. 517
	<ul style="list-style-type: none"> Appears when the parking brake is applied automatically while ACC with Low Speed Follow is in operation. 	<ul style="list-style-type: none"> ACC with Low Speed Follow has been automatically canceled. <ul style="list-style-type: none"> ► Adaptive Cruise Control (ACC) with Low Speed Follow P. 517 ► Parking Brake P. 551
	<ul style="list-style-type: none"> Appears when pressing the –/SET button while the parking brake is applied. 	<ul style="list-style-type: none"> ACC with Low Speed Follow cannot be set. <ul style="list-style-type: none"> ► Adaptive Cruise Control (ACC) with Low Speed Follow P. 517 ► Parking Brake P. 551
	<ul style="list-style-type: none"> Appears when pressing the –/SET button while the vehicle is moving and the brake pedal is depressed. 	<ul style="list-style-type: none"> ACC with Low Speed Follow cannot be set. <ul style="list-style-type: none"> ► Adaptive Cruise Control (ACC) with Low Speed Follow P. 517
	<ul style="list-style-type: none"> Appears if ACC with Low Speed Follow is canceled while your vehicle is automatically stopped by ACC with Low Speed Follow. 	<ul style="list-style-type: none"> Immediately depress the brake pedal.

Message	Condition	Explanation
	<ul style="list-style-type: none"> Flashes when the system senses a likely collision with a vehicle in front of you. 	<ul style="list-style-type: none"> Take appropriate action to prevent a collision (apply the brakes, change lanes, etc.) <ul style="list-style-type: none"> ➤ Adaptive Cruise Control (ACC) with Low Speed Follow P. 517 ➤ Collision Mitigation Braking System™ (CMBS™) P. 506
	<p>Lane Keeping Assist System (LKAS)</p> <ul style="list-style-type: none"> Appears when the vehicle is driving out of a detected lane. The steering wheel vibrates rapidly. <p>Road Departure Mitigation (RDM) System</p> <ul style="list-style-type: none"> Appears when the vehicle is driving out of a detected lane. <ul style="list-style-type: none"> When you selected Warning Only <ul style="list-style-type: none"> The steering wheel vibrates rapidly when the vehicle is drifting out of a detected lane. When you selected Narrow, Normal or Wide <ul style="list-style-type: none"> The steering wheel vibrates rapidly when the vehicle is drifting out of a detected lane. The system also steers the vehicle to help you remain within your driving lane. 	<ul style="list-style-type: none"> Keep the vehicle within the lane you are driving. <ul style="list-style-type: none"> ➤ Lane Keeping Assist System (LKAS) P. 534 Keep the vehicle within the lane you are driving. <ul style="list-style-type: none"> ➤ Road Departure Mitigation (RDM) System P. 543 You can change the setting for the road departure mitigation system. Narrow, Normal, Wide, and Warning Only can be selected. <ul style="list-style-type: none"> ➤ Customized Features P. 140, 369

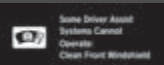
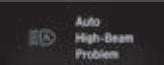
Message	Condition	Explanation
	<p>Road Departure Mitigation (RDM) System</p> <p>When you selected Narrow</p> <ul style="list-style-type: none"> • Appears when the vehicle is likely to drive out of a detected lane. The RDM system also steers the vehicle to help you remain within your driving lane. 	<p>—</p>
	<ul style="list-style-type: none"> • Blinks when you fail to steer the vehicle. The beeper sounds simultaneously. 	<ul style="list-style-type: none"> • Operate the steering wheel to resume the LKAS.
	<ul style="list-style-type: none"> • Appears when the LKAS is in operation, or the LKAS button is pressed, but there is a problem with a system related to the LKAS. The LKAS cancels automatically. The beeper sounds simultaneously if selected by customization. 	<ul style="list-style-type: none"> • If any other system indicators come on, such as the VSA®, ABS and brake system, take appropriate action. <ul style="list-style-type: none"> ▶ Indicators P. 90
	<ul style="list-style-type: none"> • Appears if anything covers the radar sensor cover and prevents the sensor from detecting a vehicle in front. • May appear when driving in bad weather (rain, snow, fog, etc.) 	<ul style="list-style-type: none"> • When the radar sensor gets dirty, stop your vehicle in a safe place, and wipe off dirt using a soft cloth. The message may take some time to go off. • Have your vehicle checked by a dealer if the message does not disappear even after you clean the sensor cover. <ul style="list-style-type: none"> ▶ Radar Sensor P. 550 ▶ Honda Sensing® P. 503

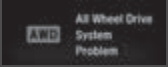
Message	Condition	Explanation
	<ul style="list-style-type: none"> Appears if the temperature inside the front sensor camera is too high and some driver assist systems cannot be activated. 	<ul style="list-style-type: none"> Use the climate control system to cool down the camera. Disappears - The camera has been cooled down and the systems are activated normally. <ul style="list-style-type: none"> ➤ Front Sensor Camera P. 548 ➤ Honda Sensing® P. 503
	<ul style="list-style-type: none"> Appears if the area around the front sensor camera is blocked by dirt, mud, etc. and be prevented from detecting a vehicle in front. May appear when driving in bad weather (rain, snow, fog, etc.) 	<ul style="list-style-type: none"> When the front window gets dirty, stop your vehicle in a safe place, and wipe it off with a soft cloth. Have your vehicle checked by a dealer if the message does not disappear even after you cleaned the area around the camera. <ul style="list-style-type: none"> ➤ Front Sensor Camera P. 548 ➤ Honda Sensing® P. 503
	<ul style="list-style-type: none"> Appears if there is a problem with the auto high-beam. 	<ul style="list-style-type: none"> Manually operate the headlight switch. If you are driving with the high beam headlights when this happens, the headlights are changed to low beams.

Message	Condition	Explanation
	<ul style="list-style-type: none"> Appears if there is a problem with the real time AWD with intelligent control system™. 	<ul style="list-style-type: none"> The engine drives the front wheels only in this state. Have your vehicle checked by a dealer.
	<ul style="list-style-type: none"> Appears when the differential temperature is too high. 	<ul style="list-style-type: none"> Stop in a safe place, change to [P], and idle the engine until the message disappears. If the message does not disappear, have your vehicle checked by a dealer. <ul style="list-style-type: none"> ➤ Real Time AWD with Intelligent Control System™ P. 492

Models with power tailgate

Message	Condition	Explanation
	<ul style="list-style-type: none"> Appears when there is a problem with the power tailgate system. 	<ul style="list-style-type: none"> Manually open or close the power tailgate. Have your vehicle checked by a dealer.

Models with color audio system

Message	Condition	Explanation
	<ul style="list-style-type: none"> Appears while you are customizing the settings and the shift position changed out of [P]. 	<ul style="list-style-type: none"> ➤ Customized Features P. 140

Gauges

Gauges include the speedometer, fuel gauge, and other related indicators. They are displayed when the power mode is in ON.

■ Speedometer

Displays your driving speed in mph or km/h.

■ Fuel Gauge

Displays the amount of fuel left in the fuel tank.

■ POWER/CHARGE Gauge



■ Electric motor

The degree to which the electric motor is being powered is displayed by the readings on the **POWER** side.

■ Battery charge in progress

The degree to which the High Voltage battery is being charged is displayed by the readings on the **CHARGE** side.

» Gauges

Press the  (display/information) button repeatedly until the  icon is shown on the driver information interface. Press **ENTER**, then press and hold it again. The speedometer reading and the displayed measurements will switch between mph and km/h.

» Fuel Gauge

NOTICE

You should refuel when the reading approaches **[E]**. Running out of fuel can cause the engine to misfire, damaging the catalytic converter.

The actual amount of remaining fuel may differ from the fuel gauge reading.

■ High Voltage Battery Charge Level Gauge

Shows the remaining High Voltage battery charge level.

⌘ High Voltage Battery Charge Level Gauge

The High Voltage battery charge level may decrease under the following conditions:

- When the 12-volt battery has been replaced.
- When the 12-volt battery has been disconnected.
- When the High Voltage battery control system corrects its reading.

The charge level reading will be corrected automatically while driving.



Changes in the temperature of the High Voltage battery can increase or decrease the battery's charging capacity. If temperature changes cause the battery's capacity to change, the number of indicators in the battery charge level gauge may also change, even if the amount of charge remains the same.

Driver Information Interface

The driver information interface shows information such as the estimated travelable distance and fuel economy of the vehicle. It also displays messages such as warnings and other helpful information.

Switching the Display

Main displays

Press the  (display/information) button, and then press  or  to change the display. Press **ENTER** to see detailed information.

Instrument Panel

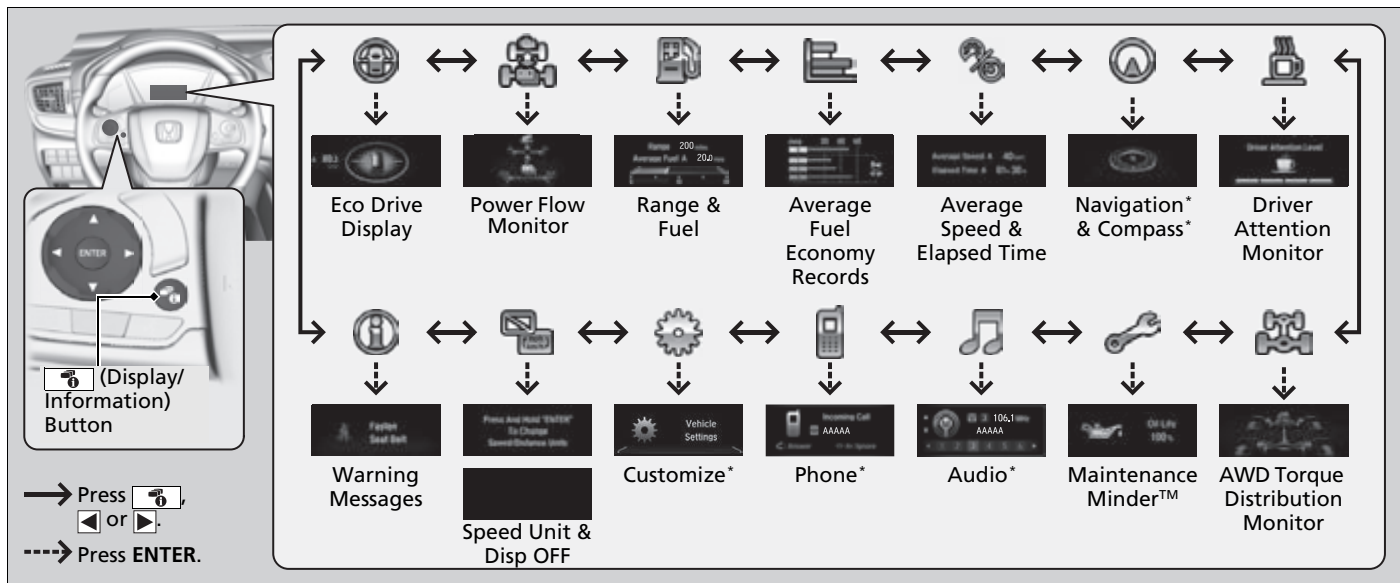

■ Trip computer

Press the  (TRIP) knob to change display.

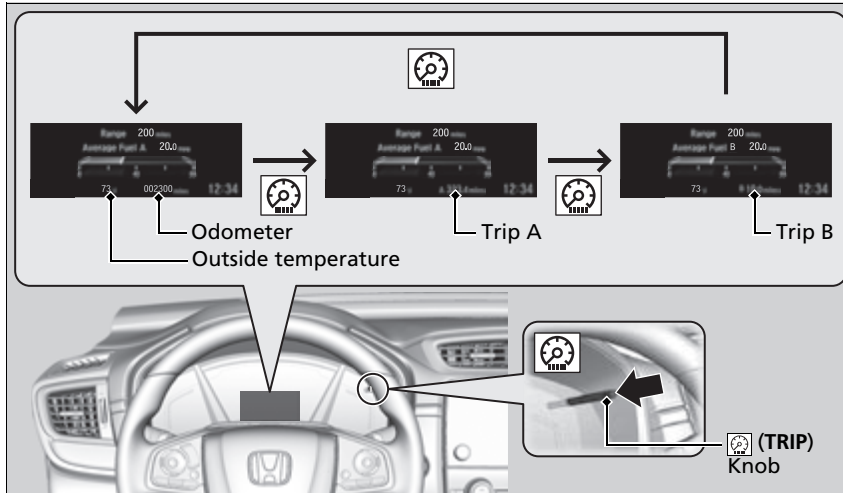

■ Odometer

Shows the total number of miles or kilometers that your vehicle has accumulated.

■ Trip Meter

Shows the total number of miles or kilometers driven since the last reset. Meters A and B can be used to measure two separate trips.

▶ Trip Meter

Switch between trip meter A and trip meter B by pressing the  knob.

■ Resetting a trip meter

To reset a trip meter, display it, then press and hold the  knob. The trip meter is reset to **0.0**.

■ Average Fuel Economy

Shows the estimated average fuel economy of each trip meter in mpg or l/100 km. The display is updated at set intervals. When a trip meter is reset, the average fuel economy is also reset.

■ Range

Shows the estimated distance you can travel on the remaining power and fuel. This estimated distance is based on the vehicle's current fuel economy.

■ Elapsed Time

Shows the time elapsed since Trip A or Trip B was reset.

■ Average Speed

Shows the average speed in mph or km/h since Trip A or Trip B was reset.

■ Instant Fuel Economy Gauge

Shows the instant fuel economy as a bar graph in mpg or l/100 km.

▶▶ Average Fuel Economy

You can change when to reset the average fuel economy.

▶ **Customized Features** P. 140, 369

▶▶ Elapsed Time

You can change when to reset the elapsed time.

▶ **Customized Features** P. 140, 369

▶▶ Average Speed

You can change when to reset the average speed.

▶ **Customized Features** P. 140, 369

■ Maintenance Minder™

Shows the remaining oil life and Maintenance Minder™.

➤ **Maintenance Minder™** P. 581

■ Average Fuel Economy Records

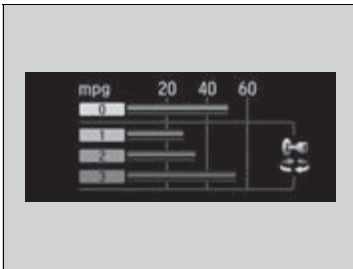

Shows the average fuel economy for the last three driving cycles (1-3), and the current driving cycle (0) in mpg or l/100 km.

Each time you set the power mode to ON, the display is updated, and the oldest record is deleted.

■ Eco Drive Display/Drive Cycle Score/Lifetime Points

■ Eco Drive Display

The vehicle icon on the display moves forward or backward while driving.

The more aggressive the acceleration is, the further the icon moves forward.

The more aggressive the deceleration is, the further the icon moves backward.

Keep the icon near the center of the circle for better fuel economy while driving.

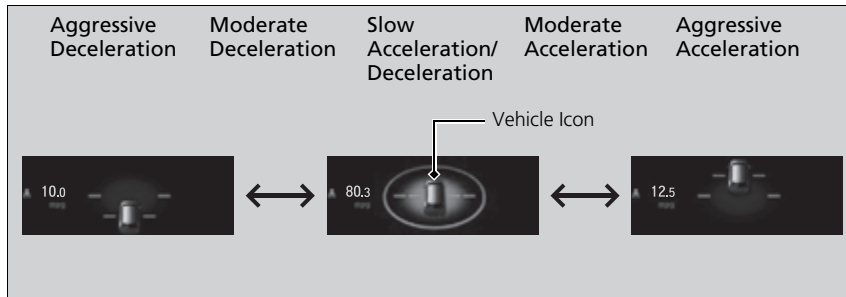

■ Drive Cycle Score/Lifetime Points

Appear for a few seconds when you set the power mode to VEHICLE OFF. Each has three stages. Depending on your driving style, the leaf icon(s) and the gauge increase or decrease to indicate that you have reached a different stage of fuel economy.

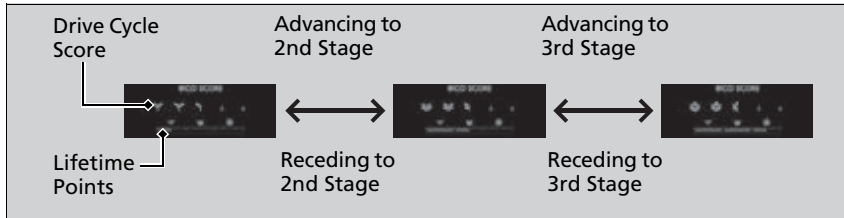

■ Resetting the Drive Cycle Score

1. Make sure the shift position is in **[P]**. Turn the power mode to ON.
2. If ECON mode is on, press the **ECON** button to turn it off.
3. Turn the power mode to VEHICLE OFF.
4. Turn the power mode to ON again.
 - ▶ Make sure to complete steps from 4 through 6 within 30 seconds.
5. Depress the brake pedal twice.
6. Press the **ECON** button twice.
 - ▶ The color of the ambient meter will turn to monochrome.
7. Turn the power mode to VEHICLE OFF.

■ Power Flow Monitor

Displays the power flow of the motor and engine, indicating the vehicle's power source and whether the battery is being charged.

Power Flow

Engine

Engine ON

Engine OFF

<p>Hybrid (HV) Power is supplied by the motor and the engine.</p>	<p>Electric Vehicle (EV) Power is supplied by the motor.</p>	<p>Engine (Direct Drive) The engine is running and the motor is charging the High Voltage battery.</p>
<p>Regeneration The motor is charging the High Voltage battery.</p>	<p>Power is being supplied by the engine only.</p>	<p>The engine is running and the motor is charging the High Voltage battery.</p>

▶▶ Power Flow Monitor

While the vehicle is stationary with the engine running, the following may appear on the driver information interface.

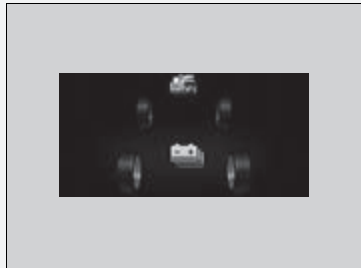

Driver Attention Monitor

The Driver Attention Monitor analyzes steering inputs to determine if the vehicle is being driven in a manner consistent with drowsy or inattentive driving. If it determines that the vehicle is being driven in such a manner, it will display the degree of the driver's attention on the driver information interface.

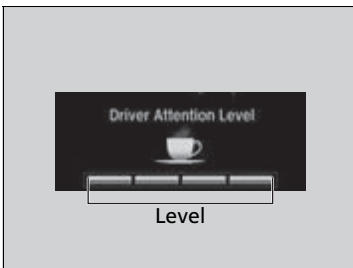
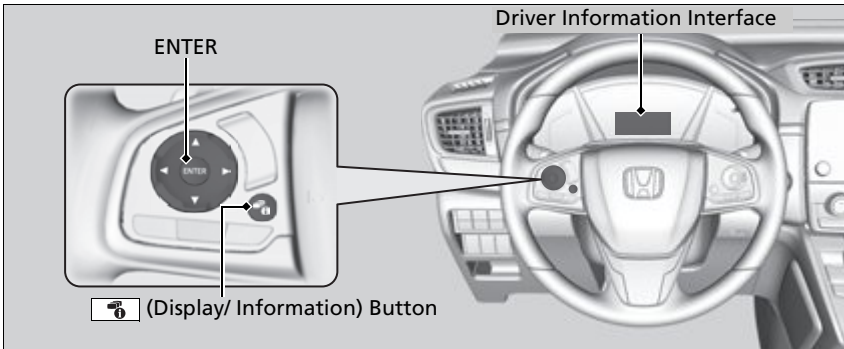

When the  (display/information) button is pressed, bars in the Driver Information Interface light up in white to indicate the degree of the driver's attention.

➤ **Switching the Display** P. 128

Driver Attention Monitor

The Driver Attention Monitor cannot always detect if the driver is tired or inattentive. Regardless of the system's feedback, if you are feeling tired, stop in a safe location and rest for as long as needed.

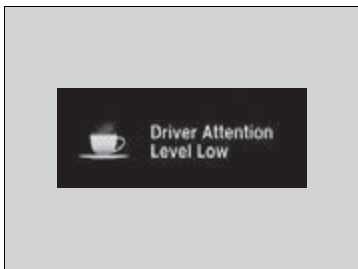

If two bars light up, the **Driver Attention Level Low** message will appear.

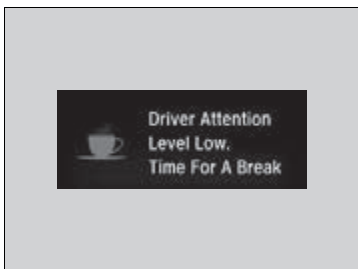

If one bar lights up, the **Driver Attention Level Low. Time For A Break** message will appear, a beep will sound, and the steering wheel will vibrate.

If this message appears, stop in a safe location and rest for as long as needed.

The message will disappear when the **ENTER** button is pressed or when the system has determined that the driver is driving normally.

If the driver does not take a break and the monitor continues to detect that the driver is very tired, the message will appear again after approximately 15 minutes, accompanied by a beep and steering wheel vibrations.

The message does not appear when the traveling time is 30 minutes or less.

■ **The Driver Attention Monitor resets when**

- the power system is turned off.
- the driver unfastens the seat belt and opens the door while the vehicle is stopped.

■ **For the Driver Attention Monitor to function**

- the vehicle must be traveling above 25 mph (40 km/h).
- the electric power steering (EPS) system indicator must be off.

■ **Depending on driving conditions or other factors, the Driver Attention Monitor may not function in the following circumstances.**

- the steering assist function of the Lane Keeping Assist System (LKAS) is active.
 - **Lane Keeping Assist System (LKAS)** P. 534
- the condition of the road is poor, e.g. the surface is unpaved or bumpy.
- it is windy.
- the driver is frequently operating the vehicle in an assertive manner such as changing lanes or accelerating.

■ **Customizing**

You can change the Driver Attention Monitor settings. Select **Tactile And Audible Alert, Tactile Alert, or OFF**.

- **Customized Features** P. 140, 369

☒ **For the Driver Attention Monitor to function**

The bars in the Driver Information Interface remain grayed out unless the Driver Attention Monitor is functioning.

■ AWD Torque Distribution Monitor



The indicators on the display show the amount of torque being transferred to the right front, left front, right rear, and left rear wheels.

▶ **Real Time AWD with Intelligent Control System™** P. 492

■ Outside Temperature

Shows the outside temperature in Fahrenheit.

■ Adjusting the outside temperature display

Adjust the temperature reading by up to $\pm 5^{\circ}\text{F}$ if the temperature reading seems incorrect.

▶▶ Outside Temperature

The temperature sensor is in the front bumper. Road heat and exhaust from another vehicle can affect the temperature reading when your vehicle speed is less than 19 mph (30 km/h).

It may take several minutes for the display to be updated after the temperature reading has stabilized.

You can adjust the temperature reading.
▶ **Customized Features** P. 140, 369

■ Navigation *

■ Compass*

Shows the compass screen.

■ Turn-by-Turn Directions

When driving guidance is provided by the navigation system* or Android Auto, turn-by-turn directions to your destination appear.

➤ **Refer to the Navigation System Manual**

➤ **Android Auto™** P. 336

■ Audio *

Show the current audio information.

➤ **Audio System Basic Operation** P. 272

■ Phone *

Show the current phone information.

➤ **Bluetooth® HandsFreeLink®** P. 422

☒ Navigation*

You can select whether to have the turn-by-turn display come on or not during the route guidance.



➤ **Customized Features** P. 369

Models with color audio system

■ Customized Features



Use the driver information interface to customize certain features.

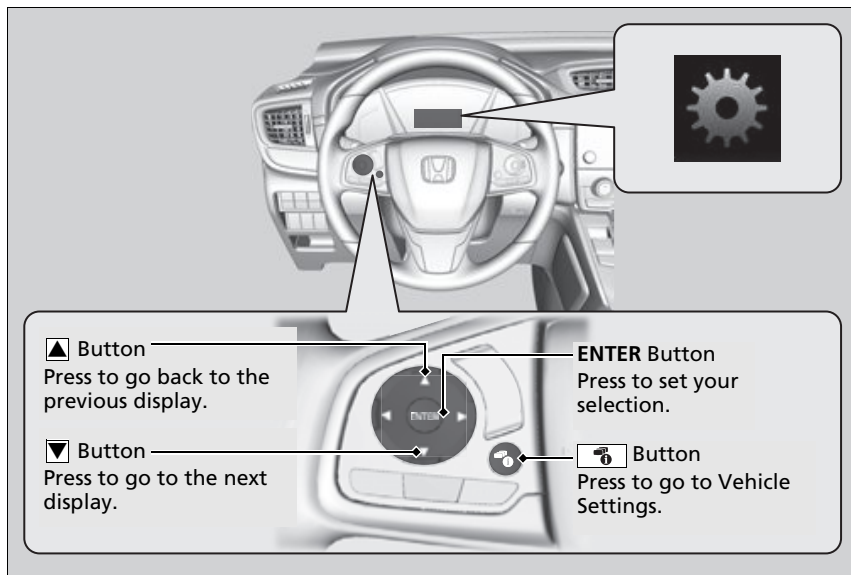

■ How to customize

Select the  screen by pressing the  button while the power mode is in ON, and the vehicle is at a complete stop, and the shift position is in **P**. Select , then press the **ENTER** button.



Customized Features

To customize other features, press the  /  button.

-  **List of customizable options** P. 143
-  **Example of customization settings** P. 147

Put the transmission into **P** before you attempt to change any customized setting.

■ **Customization flow**

Press the  button.

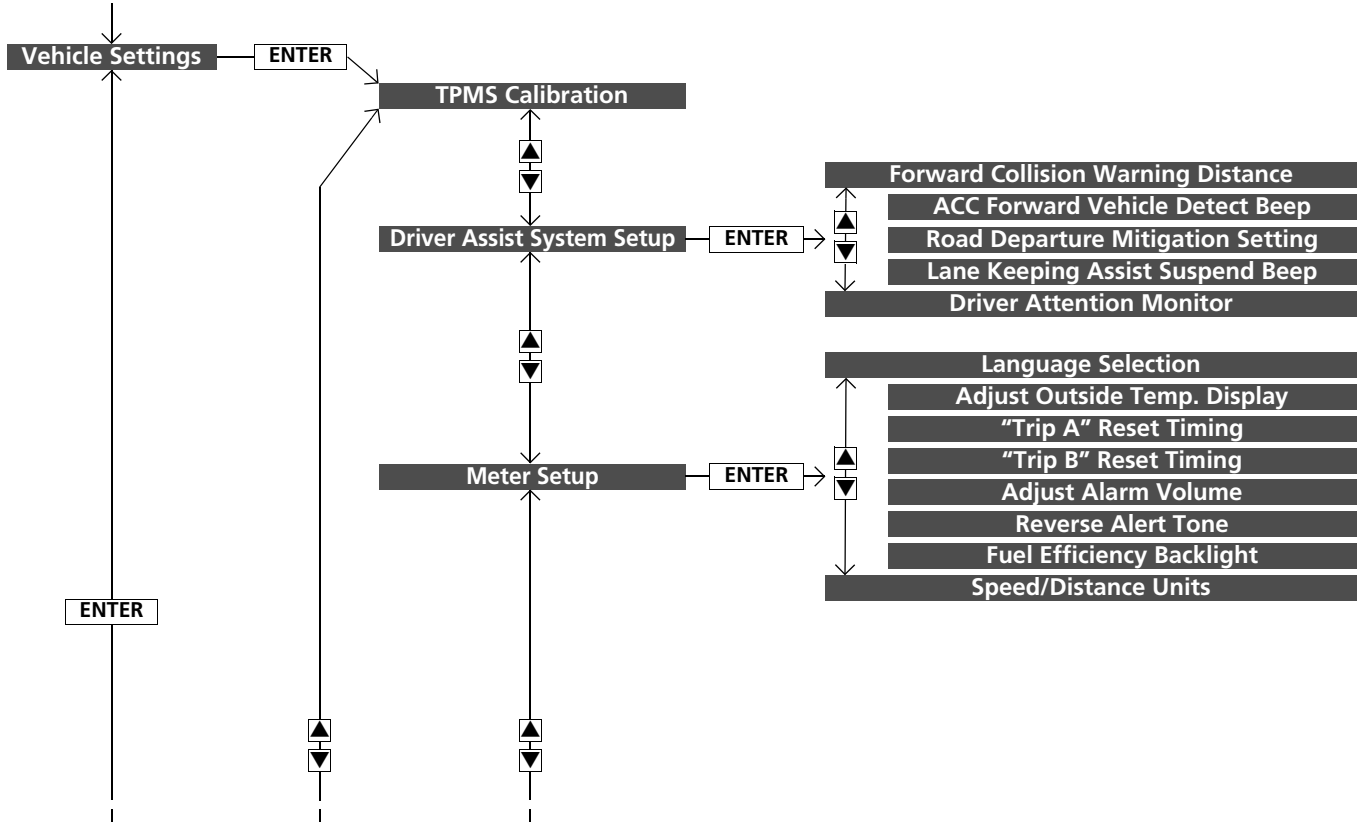

Instrument Panel

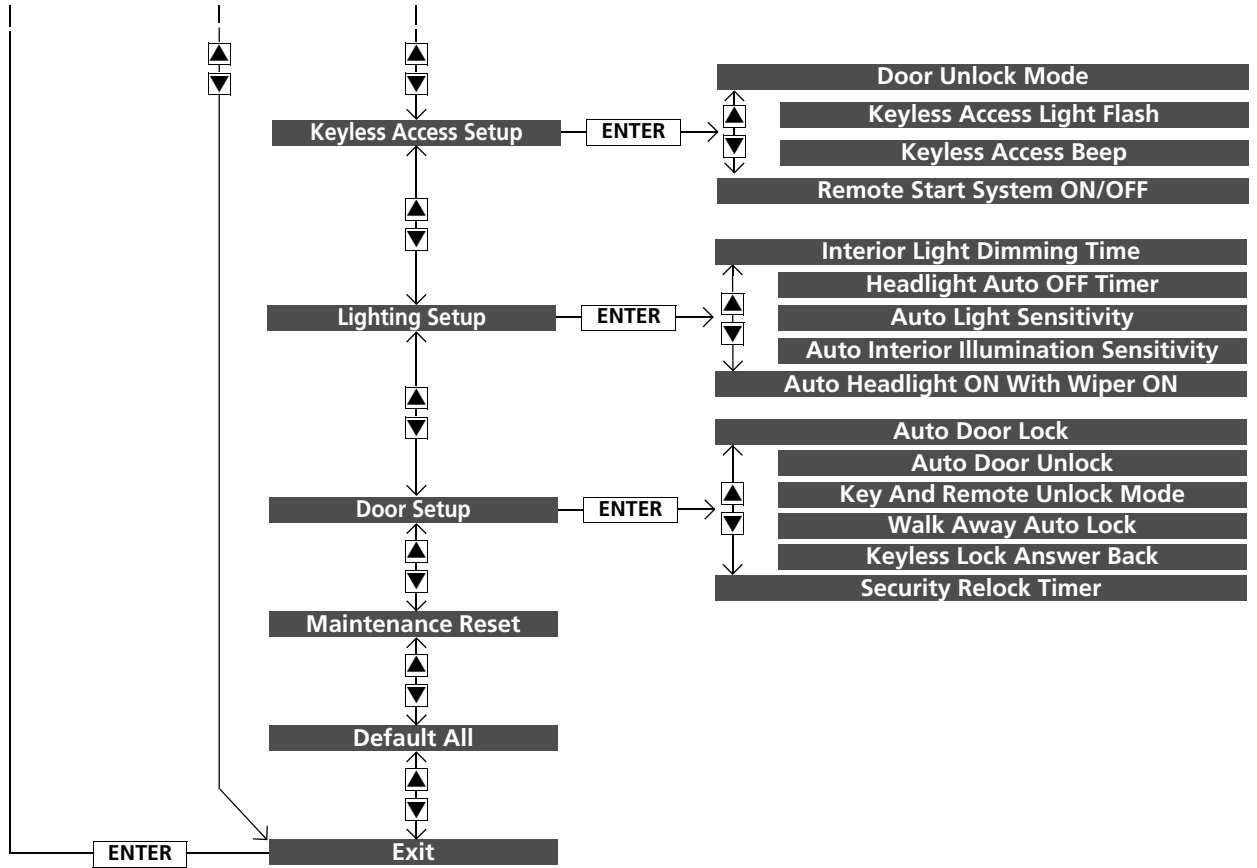

■ List of customizable options

Setup Group	Customizable Features	Description	Selectable Settings
TPMS Calibration	—	Calibrates the TPMS.	Cancel/Calibrate
	Forward Collision Warning Distance	Changes the distance at which CMBS™ alerts.	Long/Normal*¹/Short
Driver Assist System Setup	ACC Forward Vehicle Detect Beep	Causes the system to beep when the system detects a vehicle, or when the vehicle goes out of ACC range.	ON/OFF*¹
	Road Departure Mitigation Setting	Changes the setting for the road departure mitigation system.	Narrow/Normal*¹/Wide/Warning Only
	Lane Keeping Assist Suspend Beep	Causes the system to beep when the LKAS is suspended.	ON/OFF*¹
	Driver Attention Monitor	Changes the setting for the driver attention monitor.	Tactile And Audible Alert*¹/Tactile Alert/OFF

*1:Default Setting

Setup Group	Customizable Features	Description	Selectable Settings
Meter Setup	Language Selection	Changes the displayed language.	English^{*1}/Français/Español
	Adjust Outside Temp. Display	Adjusts the temperature reading by a few degrees.	-5°F ~ ±0°F^{*1} ~ +5°F
	“Trip A” Reset Timing	Changes the setting of how to reset trip meter A, average fuel economy A, average speed A, and elapsed time A.	When Fully Refueled/IGN OFF/ Manually Reset^{*1}
	“Trip B” Reset Timing	Changes the setting of how to reset trip meter B, average fuel economy B, average speed B, and elapsed time B.	When Fully Refueled/IGN OFF/ Manually Reset^{*1}
	Adjust Alarm Volume	Changes the alarm volume, such as buzzers, warnings, turn signal sound, and so on.	High/Mid^{*1}/Low
	Reverse Alert Tone	Causes the beeper to sound once when the shift position is changed to R .	ON^{*1}/OFF
	Fuel Efficiency Backlight	Turns the ambient meter feature on and off.	ON^{*1}/OFF
	Speed/Distance Units	Selects the trip computer units.	km/h-km/mpg-miles^{*1}

*1:Default Setting

Setup Group	Customizable Features	Description	Selectable Settings
Keyless Access Setup	Door Unlock Mode	Changes which doors unlock when you grab the driver's door handle.	Driver Door Only*¹/All Doors
	Keyless Access Light Flash	Causes some exterior lights to flash when you unlock/lock the doors.	ON*¹/OFF
	Keyless Access Beep	Sets the beeper sound or not when you grab either front door handle.	ON*¹/OFF
	Remote Start System ON/OFF	Turns the remote engine start feature on and off.	ON*¹/OFF
Lighting Setup	Interior Light Dimming Time	Changes the length of time the interior lights stay on after you close the doors.	60sec/30sec*¹/15sec
	Headlight Auto OFF Timer	Changes the length of time the exterior lights stay on after you close the driver's door.	60sec/30sec/15sec*¹/0sec
	Auto Light Sensitivity	Changes the timing for the headlights to come on.	Max/High/Mid*¹/Low/Min
	Auto Interior Illumination Sensitivity	Changes the sensitivity of the brightness of the instrument panel when the headlight switch is in the AUTO position.	Max/High/Mid*¹/Low/Min
	Auto Headlight ON With Wiper ON	Changes the settings for the wiper operation when the headlights automatically come on while the headlight switch is in the AUTO position.	ON*¹/OFF

* 1: Default Setting

Setup Group	Customizable Features	Description	Selectable Settings
Door Setup	Auto Door Lock	Changes the setting for when the doors and the tailgate automatically lock.	With Vehicle Speed*¹/Shift From P/OFF
	Auto Door Unlock	Changes the setting for when the doors and the tailgate automatically unlock.	When Driver's Door Opens*¹/ When Shifting Into Park/ When Ignition Switched OFF/OFF
	Key And Remote Unlock Mode	Sets up either the driver's door or all doors to unlock on the first operation of the keyless remote.	Driver Door*¹/All Doors
	Walk Away Auto Lock	Changes the settings for the automatic locking the doors when you walk away from the vehicle while carrying the keyless remote.	ON/OFF*¹
	Keyless Lock Answer Back	LOCK/UNLOCK- The exterior lights flash. LOCK (2nd push)- The beeper sounds.	ON*¹/OFF
	Security Relock Timer	Changes the time it takes for the doors to relock and the security system to set after you unlock the vehicle without opening any door.	90sec/60sec/30sec*¹
Maintenance Reset	—	Resets the Maintenance Minder™ display when you have performed the maintenance service.	Cancel/All Due Items
Default All	—	Cancels customized changes you have made or restores them to their default setting.	Cancel/Set

*1: Default Setting

■ Example of customization settings

The steps for changing the “Trip A” Reset Timing setting to **When Fully Refueled** are shown below. The default setting for “Trip A” Reset Timing is **Manually Reset**.







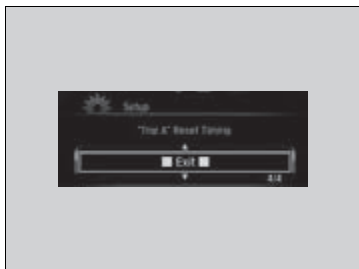
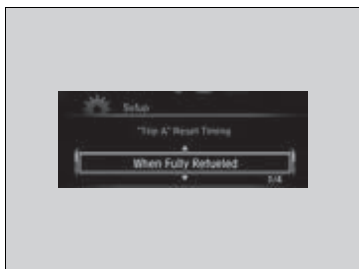

1. Press the button to select , then press the **ENTER** button.



2. Press the / button until **Meter Setup** appears on the display.
3. Press the **ENTER** button.
 - ▶ **Language Selection** appears first in the display.



4. Press the  /  button until **"Trip A"** **Reset Timing** appears on the display, then press the **ENTER** button.
 - ▶ The display switches to the customization setup screen, where you can select **When Fully Refueled**, **IGN OFF**, **Manually Reset**, or **Exit**.
5. Press the  /  button and select **When Fully Refueled**, then press the **ENTER** button.
 - ▶ The **When Fully Refueled Setup** screen appears, then the display returns to the customization menu screen.
6. Press the  /  button until **Exit** appears on the display, then press the **ENTER** button.
7. Repeat Step 6 until you return to the normal screen.

Controls

This chapter explains how to operate the various controls necessary for driving.

Clock	150	Windows	181	Rear Defogger/Heated Door Mirror*	
Locking and Unlocking the Doors		Moonroof*	185	Button	201
Key	152	Operating the Switches Around the		Brightness Control	202
Low Keyless Remote Signal Strength ...	154	Steering Wheel		Driving Position Memory System*	203
Locking/Unlocking the Doors from the		POWER Button.....	186	Adjusting the Steering Wheel	205
Outside	155	Turn Signals	189	Mirrors	206
Locking/Unlocking the Doors from the		Light Switches.....	190	Seats	208
Inside	163	Fog Lights*	194	Interior Convenience Items	218
Childproof Door Locks	165	Daytime Running Lights	194	Climate Control System	
Auto Door Locking/Unlocking	166	Auto High-Beam	195	Using Automatic Climate Control	235
Tailgate	167	Wipers and Washers	198	Automatic Climate Control Sensors	241
Security System					
Immobilizer System	178				
Security System Alarm*	178				

* Not available on all models

Adjusting the Clock

Models with Display Audio

The clock is automatically updated through the audio system.

All models





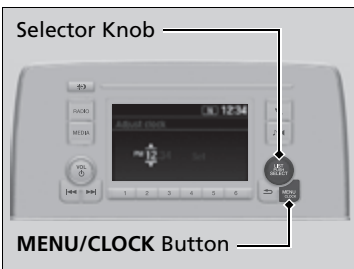

You can adjust the time manually in the audio/information screen, with the power mode is in ON.

Adjusting the Time



Models with color audio system

Using the MENU/CLOCK button

1. Press and hold the **MENU/CLOCK** button.
 - ▶ **Adjust Clock** is selected.
2. Rotate  to change hour, then press .
3. Rotate  to change minute, then press .
4. To enter the selection, rotate  and select **Set**, then press .

Adjusting the Clock

The clock in the driver information interface is automatically adjusted along with the audio system's clock display.

Using the MENU/CLOCK button

These indications are used to show how to operate the selector knob.

Rotate  to select.

Press  to enter.



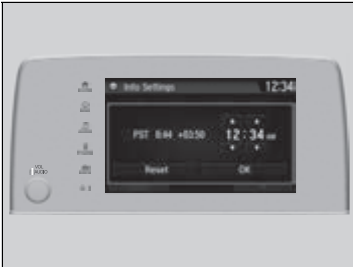

You can customize the clock display to show the 12 hour clock or 24 hour clock.

➔ **Customized Features** P. 362



Models with Display Audio

■ Using the Settings menu on the audio/information screen





1. Select **Settings**.
2. Select **Clock**.
3. Select **Clock Adjustment**.
4. Select  or  to change hour.
5. Select  or  to change minute, then select **OK**.

☒ Using the Settings menu on the audio/information screen

You can customize the clock display to show the 12 hour clock or 24 hour clock and turn the clock display on and off.

☒ **Customized Features** P. 369

You can also adjust the clock by touching the clock displayed on the upper right corner of the display.

1. Touch the clock on the display for a few seconds.
2. Select **Settings**.
3. Select **Clock**.
4. Select **Clock Adjustment**.
5. Select  or  to change hour.
6. Select  or  to change minute, then select **OK**.

You cannot adjust the time while the vehicle is moving.

Key

This vehicle comes with the following keys:

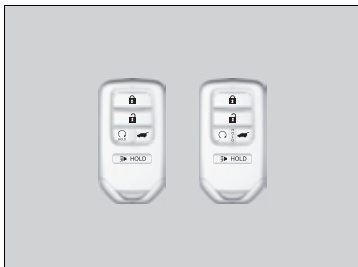

Use the keys to turn on and off the power system, and to lock and unlock the doors and tailgate.

Built-in Key

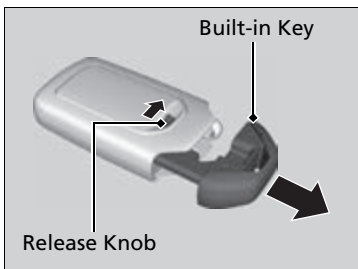

The built-in key can be used to lock/unlock the doors when the keyless remote battery becomes weak and the power door lock/unlock operation is disabled.

To remove the built-in key, slide the release knob and then pull out the key. To reinstall the built-in key, push the built-in key into the keyless remote until it clicks.

Key

All the keys have an immobilizer system. The immobilizer system helps protect against vehicle theft.

Immobilizer System P. 178

Follow the advice below to prevent damage to the keys:

- Do not leave the keys in direct sunlight, or in locations with high temperature or high humidity.
- Do not drop the keys or set heavy objects on them.
- Keep the keys away from liquids.
- Do not take the keys apart except for replacing the battery.

If the circuits in the keys are damaged, the power system may not activate, and the remote transmitter may not work.

If the keys do not work properly, have them inspected by a dealer.

You can remotely turn the power system on using the remote engine start.

Remote Engine Start P. 471

■ Key Number Tag

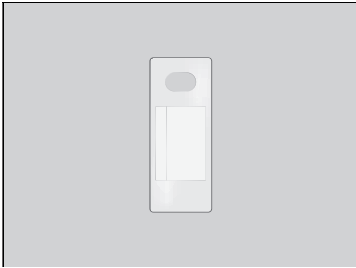

Contains a number that you will need if you purchase a replacement key.

☒ Key Number Tag

Keep the key number tag separate from the key in a safe place outside of your vehicle.

If you wish to purchase an additional key, contact a dealer.

If you lose your key and you cannot activate the power system, contact a dealer.

Low Keyless Remote Signal Strength

The vehicle transmits radio waves to locate the keyless remote when locking/unlocking the doors, opening the tailgate, or to activate the power system.

In the following cases, locking/unlocking the doors, opening the tailgate, or activating the power system may be inhibited or operation may be unstable:

- Strong radio waves are being transmitted by nearby equipment.
- You are carrying the keyless remote together with telecommunications equipment, laptop computers, cell phones, or wireless devices.
- A metallic object is touching or covering the keyless remote.

Low Keyless Remote Signal Strength

Communication between the keyless remote and the vehicle consumes the keyless remote's battery.

Battery life is about two years, but this varies depending on regularity of use.

The battery is consumed whenever the keyless remote is receiving strong radio waves. Avoid placing it near electrical appliances such as televisions and personal computers.

Locking/Unlocking the Doors from the Outside

■ Using the Keyless Access System

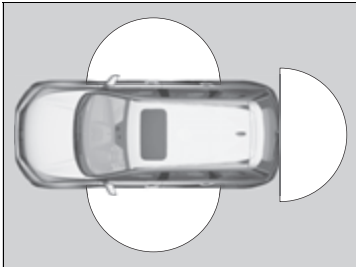

When you carry the keyless remote, you can lock/unlock the doors and open the tailgate. You can lock/unlock the doors within a radius of about 32 inches (80 cm) of the outside door handle or tailgate outer handle.

☒ Locking/Unlocking the Doors from the Outside

If the interior light switch is in the door activated position, the interior light comes on when you unlock the doors and tailgate.

No doors opened: The light fades out after 30 seconds.

Doors and tailgate relocked: The light goes off immediately.

➤ **Interior Lights** P. 218



■ Locking the doors and tailgate

Touch the door lock sensor on the front door or press the lock button on the tailgate.

- ▶ Some exterior lights flash; the beeper sounds; all the doors and tailgate lock; and the security system* sets.

▣ Using the Keyless Access System

If you do not open a door or the tailgate within 30 seconds of unlocking the vehicle with the keyless access system, the doors and tailgate will automatically relock.

You can lock or unlock doors using the keyless access system only when the power mode is in VEHICLE OFF.

The keyless access system will not lock the vehicle when a door is open.

- Do not leave the keyless remote in the vehicle when you get out. Carry it with you.
- Even if you are not carrying the keyless remote, you can lock/unlock the doors and tailgate while someone else with the keyless remote is within range.
- The door may be unlocked if the door handle is covered with water in heavy rain or in a car wash if the keyless remote is within range.
- If you grip a front door handle or touch a door lock sensor wearing gloves, the door sensor may be slow to respond or may not respond by locking or unlocking the doors.

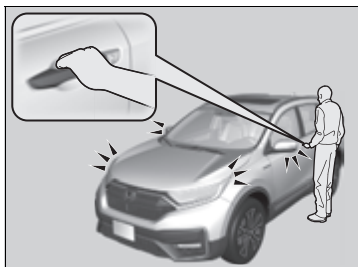

■ Unlocking the doors and tailgate

Grab the driver's door handle:

- ▶ The driver's door unlocks.
- ▶ Some exterior lights flash twice and the beeper sounds twice.

Grab the front passenger's door handle:

- ▶ All the doors and tailgate unlock.
- ▶ Some exterior lights flash twice and the beeper sounds twice.

Press the tailgate outer handle:

- ▶ The tailgate unlocks.
- ▶ Some exterior lights flash twice and the beeper sounds twice.

➤ **Opening/Closing the Tailgate** P. 168

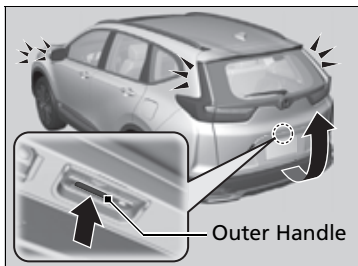

⊞ Using the Keyless Access System

- After locking the door, you have up to 2 seconds during which you can pull the door handle to confirm whether the door is locked. If you need to unlock the door immediately after locking it, wait at least 2 seconds before gripping the handle, otherwise the door will not unlock.
- The door might not open if you pull it immediately after gripping the door handle. Grip the handle again and confirm that the door is unlocked before pulling the handle.
- Even within the 32 inches (80 cm) radius, you may not be able to lock/unlock the doors and the tailgate with the keyless remote if it is above or below the outside handle.
- The keyless remote may not operate if it is too close to the door, door glass and tailgate.

The light flashes, and beeper sounds and unlock settings can be customized using the driver information interface* or audio/information screen*.

Models with color audio system

➤ **Customized Features** P. 140

Models with Display Audio

➤ **Customized Features** P. 369

Models with power tailgate

You can also unlock and open with the power tailgate.

➤ **Using the Tailgate Outer Handle** P. 174

* Not available on all models

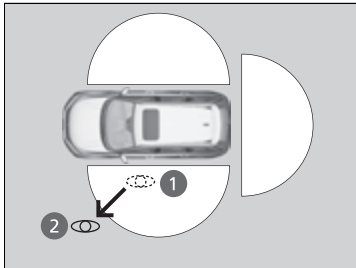
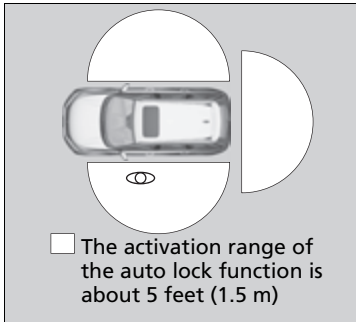

■ Locking the doors and tailgate (Walk away auto lock®)

When you walk away from the vehicle with all doors and tailgate closed while carrying the keyless remote, the doors and tailgate will automatically lock.

The auto lock function activates when all doors and tailgate are closed, and the keyless remote is within about 5 feet (1.5 m) radius of the outside door handle or tailgate outer handle.

Exit vehicle while carrying keyless remote and close door(s) and tailgate.

1. While within about 5 feet (1.5 m) radius of the vehicle.
 - ▶ The beeper sounds; the auto lock function will be activated.
2. Carry the keyless remote beyond about 5 feet (1.5 m) from the vehicle and remain outside this range for 2 or more seconds.
 - ▶ Some exterior lights flash; the beeper sounds; all doors and tailgate will then lock.

▶ Locking the doors and tailgate (Walk away auto lock®)

The auto lock function is set to **OFF** as the factory default setting. The auto lock function can be set to **ON** using the driver information interface* or audio/information screen*.

If you set the auto lock function to **ON** using the driver information interface* or audio/information screen*, only the keyless remote that was used to unlock the driver's door prior to the setting change can activate auto lock.

Models with color audio system

▶ Customized Features P. 140

Models with Display Audio

▶ Customized Features P. 369

After the auto lock function has been activated, when you stay within the locking/unlocking operation range, the indicator on the keyless remote will continue to flash until the doors and tailgate are locked.

When you stay beside the vehicle within the operation range, the doors and tailgate will automatically lock approximately 30 seconds after the auto lock function activating beeper sounds.

When you open a door or tailgate after the auto lock function activating beeper sounds, the auto lock function will be canceled.

To temporarily deactivate the function:

1. Set the power mode to OFF.
2. Open the driver's door.
3. Using the master door lock switch, operate the lock as follows:
Lock → Unlock → Lock → Unlock.
▶ The beeper sounds and the function is deactivated.

To restore the function:

- Set the power mode to ON.
- Lock the vehicle without using the auto lock function.
- With the keyless remote on you, move out of the auto lock function operation range.
- Open any door.

⌘ Locking the doors and tailgate (Walk away auto lock®)

Under the following circumstances, the auto lock function will not activate:

- The keyless remote is inside the vehicle.
▶ The beeper will not sound.
- The keyless remote is taken out of its operational range before all doors and tailgate are closed.
▶ The beeper will sound.

Models with power tailgate

If equipped, the user must wait until the power tailgate fully closes before the auto lock function will be activated.

The auto lock function does not operate when any of the following conditions are met.

- The keyless remote is inside the vehicle.
- A door, tailgate or the hood is not closed.
- The power mode is set to any mode other than OFF.
- The keyless remote is not located within a radius of about 5 feet (1.5 m) from the vehicle when you get out of the vehicle and close the doors and tailgate.

Auto lock function operation stop beeper

After the auto lock function has been activated, the auto lock operation stop beeper sounds for approximately two seconds in the following cases.

- The keyless remote is put inside the vehicle through a window.
- You are located too close to the vehicle.
- The keyless remote is put inside the tailgate.

If the warning beeper sounds, check that you are carrying the keyless remote. Then, open/close a door and confirm the auto lock activation beeper sounds once.

■ Using the Remote Transmitter

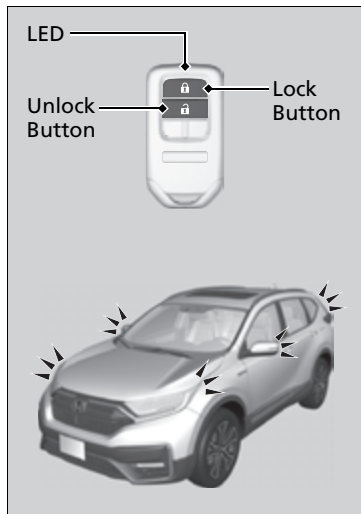

■ Locking the doors and tailgate

Press the lock button.

Once:

- ▶ Some exterior lights flash, all the doors and tailgate lock, and the security system* sets.

Twice (within five seconds after the first push):

- ▶ The beeper sounds and verifies the security system* is set.

■ Unlocking the doors and tailgate

Press the unlock button.

Once:

- ▶ Some exterior lights flash twice, and the driver's door unlocks.

Twice:

- ▶ The remaining doors and tailgate unlock.

▶▶ Using the Remote Transmitter

If you do not open a door or the tailgate within 30 seconds of unlocking the vehicle with the remote transmitter, the doors and tailgate will automatically relock.

You can change the relock timer setting.

Models with color audio system

▶ **Customized Features** P. 140

Models with Display Audio

▶ **Customized Features** P. 369

You can lock or unlock doors using the remote transmitter only when the power mode is in VEHICLE OFF.

The remote transmitter uses low-power signals, so the operating range may vary depending on the surroundings.

The remote will not lock the vehicle when a door is open.

If the distance at which the remote transmitter works varies, the battery is probably low.

If the LED does not come on when you press a button, the battery is dead.

▶ **Replacing the Remote Battery** P. 617

You can customize the door unlock mode setting.

Models with color audio system

▶ **Customized Features** P. 140

Models with Display Audio

▶ **Customized Features** P. 369

■ Locking/Unlocking the Doors Using a Key

If the lock or unlock button of the remote transmitter does not work, use the key instead.



Fully insert the key and turn it.

▣ Locking/Unlocking the Doors Using a Key

When you lock the driver's door with a key, all the other doors and tailgate lock at the same time. When unlocking, the driver's door unlocks first. Turn the key a second time within a few seconds to unlock the remaining doors and the tailgate.

You can customize the door unlock mode setting.

Models with color audio system

➤ **Customized Features** P. 140

Models with Display Audio

➤ **Customized Features** P. 369

■ Locking a Door Without Using a Key

If you do not have the key on you, or if for some reason you cannot lock a door using the key, you can lock the door without it.

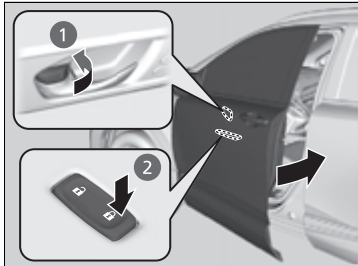

■ Locking the driver's door

Push the lock tab forward ① or push the master door lock switch in the lock direction ②, and close the door.

■ Locking the passenger's doors

Push the lock tab forward and close the door.

■ Lockout prevention system

The doors and tailgate cannot be locked when the keyless remote is inside the vehicle.

▶ Locking a Door Without Using a Key

When you lock the driver's door, all the other doors and tailgate lock at the same time.

Before locking a door, make sure that the key is not inside the vehicle.

Locking/Unlocking the Doors from the Inside

■ Using the Lock Tab

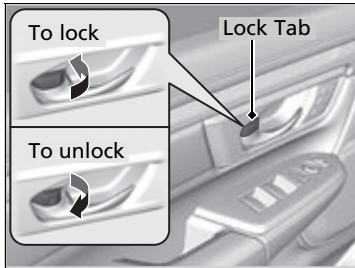

■ Locking a door

Push the lock tab forward.

■ Unlocking a door

Pull the lock tab rearward.

☒ Using the Lock Tab

When you lock the door using the lock tab on the driver's door, all of the other doors and tailgate lock at the same time.

When you unlock the door using the lock tab on the driver's door, only the driver's door will unlock.

■ Unlocking Using the Front Door Inner Handle

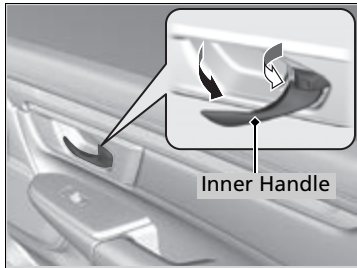

Pull the front door inner handle.

- ▶ The door unlocks and opens in one motion.

Unlocking and opening the driver's door from the inner handle unlocks all the other doors.

To avoid all the doors unlocking use the lock tab on the driver's door to unlock, then lock again before opening the door.

- ▶ This setting works for one time only. If you do not want all the doors to unlock all the time, customize the **Auto Door Unlock** setting to **OFF**^{*1}/**Off**^{*2} using the driver information interface* or audio/information screen*.

Models with color audio system

- ▶ **Customized Features** P. 140

Models with Display Audio

- ▶ **Customized Features** P. 369

*1: Models with color audio

*2: Models with Display Audio

* Not available on all models

▶▶ Unlocking Using the Front Door Inner Handle

The front door inner handles are designed to allow front seat occupants to open the door in one motion. However, this feature requires that front seat occupants never pull a front door inner handle while the vehicle is in motion.

Children should always ride in a rear seat where childproof door locks are provided.

- ▶ **Childproof Door Locks** P. 165

■ Using the Master Door Lock Switch

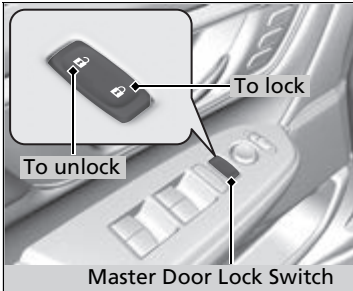

Press the master door lock switch in as shown to lock or unlock all doors and the tailgate.

☒ Using the Master Door Lock Switch

When you lock/unlock either front door using the master door lock switch, all the other doors and the tailgate lock/unlock at the same time.

Childproof Door Locks

The childproof door locks prevent the rear doors from being opened from the inside regardless of the position of the lock tab.

☒ Childproof Door Locks

To open the door from the inside when the childproof door lock is on, put the lock tab in the unlock position, lower the rear window, put your hand out of the window, and pull the outside door handle.

■ Setting the Childproof Door Locks

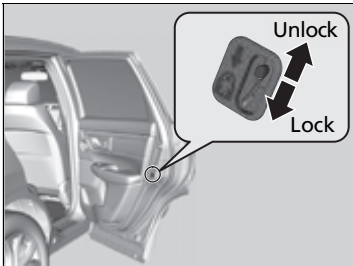

Slide the lever in the rear door to the lock position, and close the door.

■ When opening the door

Open the door using the outside door handle.

Auto Door Locking/Unlocking

Your vehicle locks or unlocks all doors automatically when a certain condition is met.

■ Auto Door Locking

■ Drive lock mode

All doors and tailgate lock when the vehicle's speed reaches about 10 mph (15 km/h).

■ Auto Door Unlocking

■ Driver's door open mode

All doors unlock when the driver's door is opened.

▶▶ Auto Door Locking/Unlocking

You can turn off or change to another auto door locking/unlocking setting using the driver information interface* or audio/information screen*.

Models with color audio system

▶ **Customized Features** P. 140

Models with Display Audio

▶ **Customized Features** P. 369

Precautions for Opening/Closing the Tailgate

Always make sure individuals and objects are clear of the tailgate before opening or closing it.

Models without power tailgate

- Open the tailgate all the way.
 - ▶ If it is not fully opened, the tailgate may begin to close under its own weight.
- Be careful when it is windy. The wind may cause the tailgate to close.

All models

Keep the tailgate closed while driving to:

- ▶ Avoid possible damage.
- ▶ Prevent exhaust gas from leaking into the vehicle.
- ▶ **Carbon Monoxide Gas** P. 86

Precautions for Opening/Closing the Tailgate

⚠ WARNING

Anyone caught in the path of a tailgate that is being opened or closed can be seriously injured.

Make sure that all people are clear of the tailgate before opening or closing it.

Be careful not to hit your head on the tailgate or to put your hands between the tailgate and the cargo area when closing the tailgate.

When you are storing or picking up cargo from the cargo area, or by using a forward and back kicking motion under the center of the rear bumper for hands free access*, while the engine is idling, do not stand in front of the exhaust pipe. You may get burned.

Do not allow any passenger in the cargo space. They may get hurt during hard braking, a sudden acceleration, or a crash.

* Not available on all models

Opening/Closing the Tailgate

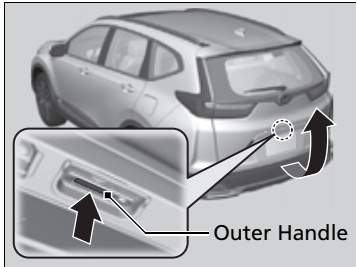

When all the doors are unlocked or you press the tailgate unlock button on the remote transmitter, the tailgate is unlocked. Press the outer handle and lift open the tailgate.

If you are carrying the keyless remote, you do not have to unlock the tailgate before opening it.

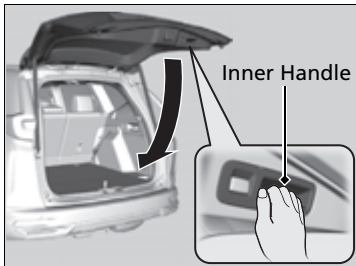

To close the tailgate, grab the inner handle, pull the tailgate down, and push it closed from outside.

If you close the tailgate when all the doors are locked, the tailgate locks automatically.

- Some exterior lights flash.

⚠ Precautions for Opening/Closing the Tailgate

Make sure cargo or other items do not touch the tailgate support struts.

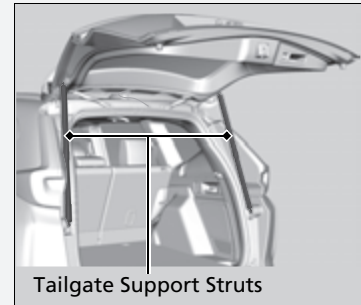

⚠ Opening/Closing the Tailgate

- Do not leave the keyless remote, in the vehicle when you get out. Carry it with you.
- Even if you are not carrying the keyless remote, you can lock/unlock the tailgate while someone else with the keyless remote is within range.
- Do not leave the keys inside the cargo area and close the tailgate. The beeper sounds and the tailgate cannot be closed.

■ Using the Remote Transmitter

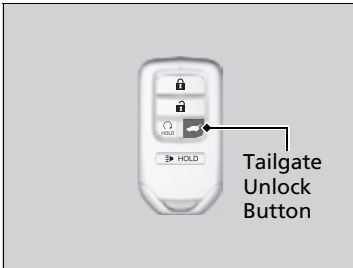

Press the tailgate unlock button to unlock the tailgate.

▣ Using the Remote Transmitter

If you have unlocked and opened the tailgate using the remote transmitter, when closing, the tailgate locks automatically.

Opening/Closing the Power Tailgate*

The power tailgate can be operated by pressing the power tailgate button on the remote transmitter, pressing the power tailgate button in the driver's side control panel, pressing the button on the tailgate, or by raising and lowering your foot under the center of the rear bumper for hands free access*.

The power tailgate can be opened/closed when the transmission is in **P**.

► Opening/Closing the Power Tailgate*

WARNING

Opening or closing a power tailgate while any part of a passenger is in the tailgate's operating path can cause serious injury.

Make sure all passengers or objects are clear of the tailgate operating range before opening or closing the tailgate.

NOTICE

Do not push or pull on the power tailgate when it is being automatically opened or closed. Forcibly opening or closing the power tailgate while in operation can deform the tailgate frame.

When operating the power tailgate, make sure there is enough space around your vehicle. People near the tailgate may be seriously hurt if the tailgate hits or closes on their heads. Be especially cautious if children are around.

The power tailgate may not open or close under the following conditions:

- You activate the power system while the tailgate is automatically opening or closing.
- The vehicle is parked on a steep hill.
- The vehicle is swayed in a strong wind.
- The tailgate or the roof is covered with snow or ice.

If you close the power tailgate when all the doors are locked, the power tailgate locks automatically.

■ Using the Hands Free Access*

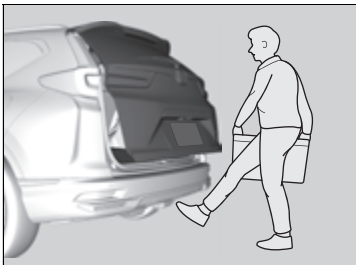

Use a forward and back kicking motion for about 1 second under the center of the rear bumper to open or close the power tailgate while carrying the keyless remote.

- Some exterior lights flash and a beeper sound, then the tailgate begins to move.

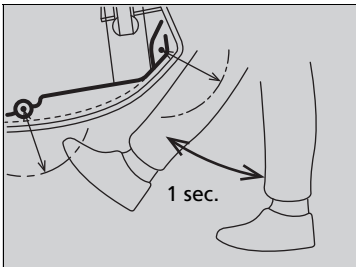

▣ Using the Hands Free Access*

During rain or in other instances when the vehicle becomes wet, the sensor may not properly detect your foot motion.

When performing work on or around the rear section of the vehicle, you may inadvertently open or close the tailgate.

To prevent this from happening, select Customized Features on the audio/information screen and then select **OFF** for the feature.

► **Customized Features** P. 369

If you hold your foot under the bumper for too long or sweep your foot from side to side, the power tailgate does not open or close.

This function will not operate if you don't have the keyless remote on you. Please make sure you have the keyless remote on you.

* Not available on all models

■ Using the Remote Transmitter

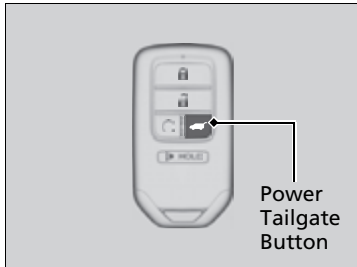

Press the power tailgate button for more than one second to operate when the power mode is in VEHICLE OFF.

- ▶ Some exterior lights flash and the beeper sounds.

If you press the button again while the power tailgate is moving, it will stop. Press the button for more than one second, and the power tailgate will reverse direction.

■ Customizing when to open the tailgate

Anytime: The power tailgate unlocks and opens at the same time. This is the default setting.

When Unlocked: The tailgate opens when all doors are unlocked.

▶ **Customized Features** P. 369

▶ Opening/Closing the Power Tailgate*

If you replace the 12-volt battery or the power tailgate fuse while the tailgate is open, the power tailgate may be disabled. The power tailgate resumes once you manually close the tailgate.

Installing aftermarket components other than Honda genuine accessories on the power tailgate may prevent it from fully opening or closing.

Make sure the power tailgate is fully open before you get your cargo in and out.

The beeper sounds when you start driving while the power tailgate is still open, or closing.

■ Using the Power Tailgate Button

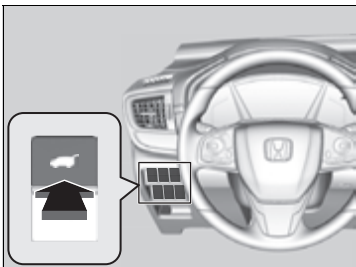

To open or close the power tailgate, press the power tailgate button for about one second.

- Some exterior lights flash and the beeper sounds.

If you press the button again while the power tailgate is moving, it will stop. Press the button for about one second, and the power tailgate will reverse direction.

⊠ Opening/Closing the Power Tailgate*

If the power tailgate meets resistance while opening or closing, the auto reverse feature reverses the direction. The beeper sounds three times.

The auto reverse function stops sensing when the tailgate is almost closed to make sure that it fully closes.

Do not touch the sensors located on both sides of the tailgate. The power tailgate does not close if you touch either sensor when you are trying to close the tailgate.

Be careful not to scratch the sensors with a sharp object. If scratched, they can be damaged, and the power tailgate closing feature malfunctions.

* Not available on all models

■ Using the Tailgate Outer Handle

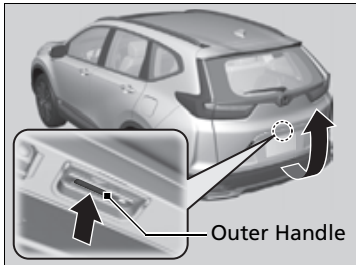

If you press the outer handle of the tailgate for no longer than one second, the tailgate opens automatically.

- ▶ The beeper sounds.
- ▶ If you want to open the tailgate manually, press the button for more than one second.

🔧 **Tailgate** P. 167

If you are carrying the keyless remote, you do not have to unlock the tailgate before opening it.

If you press the outer handle again while the power tailgate is moving, it will stop. Press the outer handle, and the power tailgate will reverse direction.

🔧 Using the Tailgate Outer Handle

- Do not leave the keyless remote in the vehicle when you get out. Carry it with you.
- Even if you are not carrying the keyless remote, you can lock/unlock the tailgate while someone else with the keyless remote is within range.
- Do not leave the keyless remote inside the cargo area and close the tailgate. The beeper sounds and the tailgate cannot be closed.

You can change the power tailgate operation setting on and off.

🔧 **Customized Features** P. 369

■ Using the Tailgate Inner Button

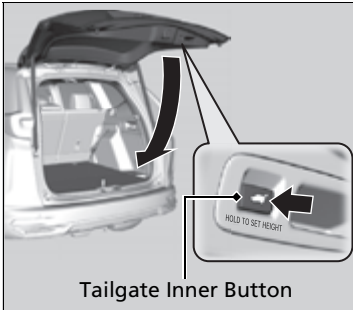

Tailgate Inner Button

Press the tailgate inner button on the tailgate to close the power tailgate.

▶ The beeper sounds.

If you press the button again while the power tailgate is moving, it will stop. Press and release the button again, and the power tailgate will reverse direction.

■ Programming Tailgate Position

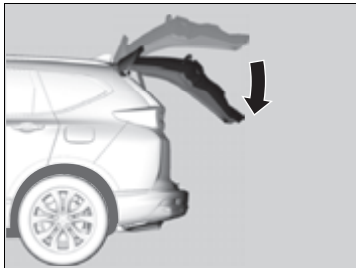

The extent to which the power tailgate automatically opens can be programmed.

To program:

1. Open the tailgate to the desired position.
2. Press and hold the tailgate inner button. You will hear one long beep, followed by two short beeps.

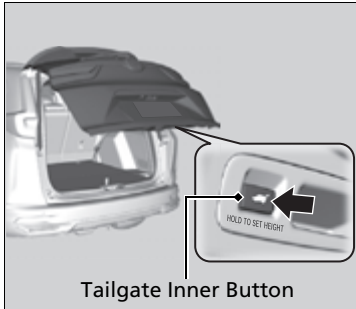

▣ Programming Tailgate Position

If the tailgate is only slightly opened, the position cannot be programmed, even if you push the tailgate inner button.

If you want to reprogram the power tailgate to open all the way, manually raise the tailgate to its upper most position and follow the directions step 2.

■ Auto-Closer

If you manually close the power tailgate, it latches automatically.

■ Power Tailgate Fall Detection

Automatically lowers the power tailgate when there is a possibility that the fully opened power tailgate can fall down by its own weight (for example, by snow on the tailgate). The beeper sounds while the power tailgate lowers.

☒ Auto-Closer

The auto-closer feature does not activate if you press the tailgate outer handle while the power tailgate is closing.

NOTICE

Do not put any force on the tailgate while the power tailgate is latching.

Keep your hands away from the tailgate when you manually close the tailgate and let it latch automatically. It is dangerous to put your hands around the tailgate as it starts to latch itself.

☒ Power Tailgate Fall Detection

If you try to manually close the power tailgate immediately after it fully opens, the power tailgate fall detection may activate.

Once the power tailgate fall detection activates, wait until the power tailgate fully closes. Keep away from the power tailgate when it is in motion.

If the power tailgate fall detection constantly activates, consult a dealer.

Immobilizer System

This system prevents a key that has not been pre-registered from starting the power system.

Pay attention to the following when pressing the **POWER** button:

- Do not allow objects that emit strong radio waves near the **POWER** button.
- Make sure the key is not covered by or touching a metal object.
- Do not bring a key from another vehicle's immobilizer system near the **POWER** button.
- Do not put the key near magnetic items. Electronic device, such as televisions and audio systems emit strong magnetic fields. Note that even a key chain can become magnetic.

Security System Alarm *

The security system alarm activates when the tailgate, hood or doors are forcibly opened. The alarm does not activate if the tailgate or doors are opened with the key, remote transmitter or keyless access system.

However, the alarm activates if a door is opened with the key and then the hood is opened before the power mode is set to ON.

■ When the security system alarm activates

The horn sounds intermittently, and some exterior lights flash.

» Immobilizer System

NOTICE

Leaving the key in the vehicle can result in theft or accidental movement of the vehicle. Always take the key with you whenever you leave the vehicle unattended.

Do not alter the system or add other devices to it. Doing so may damage the system and make your vehicle inoperable.

» Security System Alarm *

The security system alarm continues for a maximum of two minutes until the security system alarm deactivates.

■ To deactivate the security system alarm

Unlock the vehicle using the key, remote transmitter or keyless access system, or turn the power mode is set to ON. The system, along with the horn and flashing lights, is deactivated.

■ Setting the security system alarm

The security system alarm automatically sets when the following conditions have been met:

- The power mode is set to VEHICLE OFF.
- The hood and tailgate are closed.
- All doors and tailgate are locked from outside with the key, remote transmitter, or keyless access system.

■ When the security system alarm sets

The security system alarm indicator in the instrument panel blinks and the blinking interval changes after about 15 seconds.

■ To cancel the security system alarm

The security system alarm is canceled when the vehicle is unlocked using the remote transmitter or keyless access system, or when the power mode is set to ON. The security system alarm indicator goes off at the same time.

ⓘ Security System Alarm*

Do not set the security system alarm when someone is in the vehicle or a window is open. The system can accidentally activate when:

- Unlocking the door with the lock tab.
- Opening the hood with the hood release handle.

Models with power tailgate

- Opening the tailgate with the power tailgate button on the dashboard.

If the 12-volt battery goes dead after you have set the security system alarm, the security alarm may go off once the 12-volt battery is recharged or replaced. If this occurs, deactivate the security system alarm by unlocking a door using the key, remote transmitter, or keyless access system.

Do not alter the system or add other devices to it. Doing so may damage the system and make your vehicle inoperable.

■ Panic Mode

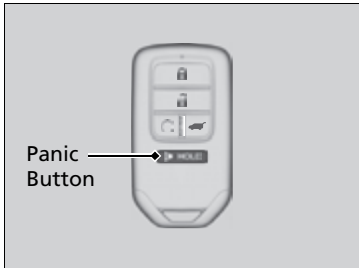

■ The panic button on the remote transmitter

If you press the panic button for approximately one second, the following will occur for about 30 seconds:

- The horn sounds.
- Some exterior lights flash.

■ Canceling panic mode

- Press any button on the remote transmitter.
- Set the power mode to ON.

Opening/Closing the Power Windows

The power windows can be opened and closed when the power mode is in ON, using the switches on the doors. The driver's side switches can be used to open and close all the windows.

The power window lock button on the driver's side must be switched off (not pushed in, indicator off) to open and close the windows from anywhere other than the driver's seat.

When the power window lock button is switched on (pushed in, indicator on), you can only operate the driver's window. Turn the power window lock button on if a child is in the vehicle.

Opening/Closing the Power Windows

WARNING

Closing a power window on someone's hands or fingers can cause serious injury.

Make sure your passengers are away from the windows before closing them.

The power windows can be operated for up to 10 minutes after you set the power mode to VEHICLE OFF.

Opening either front door cancels this function.

■ Opening/Closing the Windows with Auto-Open/Close Function

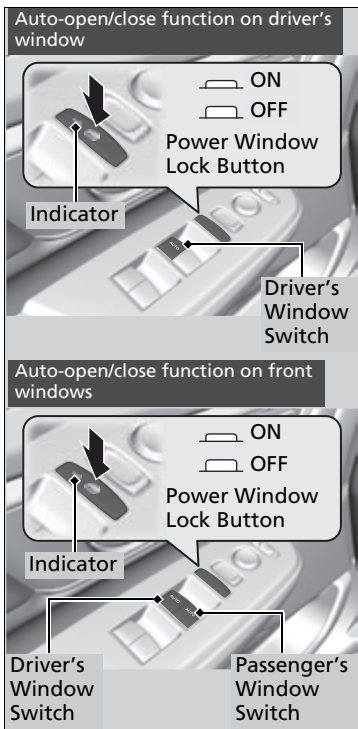

■ Manual operation

To open: Push the switch down lightly, and hold it until the desired position is reached.

To close: Pull the switch up lightly, and hold it until the desired position is reached.

■ Automatic operation

To open: Push the switch down firmly.

To close: Pull the switch up firmly.

The window opens or closes completely. To stop the window at any time, push or pull the switch briefly.

▶▶ Opening/Closing the Power Windows

Auto Reverse

If a power window senses resistance when closing automatically, it stops closing and reverse direction.

The driver's window auto reverse function is disabled when you continuously pull up the switch.

The auto reverse function stops sensing when the window is almost closed to ensure that it fully closes.

While driving with any of the windows open, you may hear a booming, throbbing, or helicopter-type noise or pressure. This is called wind buffeting. This is a normal occurrence that can be minimized.

If you hear a wind buffeting noise with any of the windows open, lower all of the other windows slightly or open the moonroof*.

■ Opening/Closing Windows without Auto-Open/Close Function

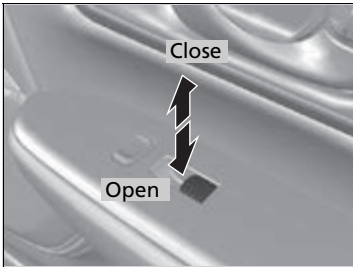

To open: Push the switch down.

To close: Pull the switch up.

Release the switch when the window reaches the desired position.

■ Opening the Windows with the Remote

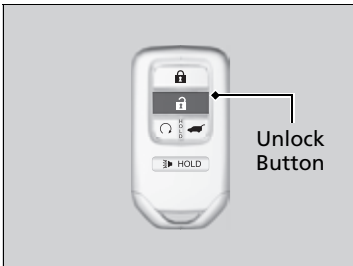

To open: Press the unlock button, and then within 10 seconds, press it again and keep it pressed. If the windows stop midway, repeat the procedure.

☒ Opening the Windows with the Remote

Models with moonroof

If you open the windows with the remote, the moonroof will open automatically along with them.

■ Opening/Closing the Windows with the Key

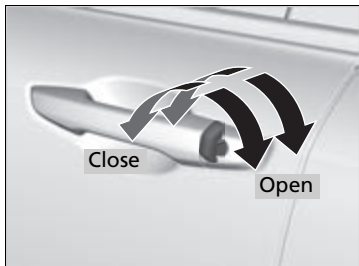

To open: Unlock the driver's door with the key. Within 10 seconds of returning the key to the central position, turn the key in the unlock direction and hold it there.

To close: Lock the driver's door with the key. Within 10 seconds of returning the key to the central position, turn the key in the lock direction and hold it there.

Release the key to stop the windows at the desired position. If you want further adjustment, repeat the same operation.

▶ Opening/Closing the Windows with the Key

Models with moonroof

If you open/close the windows with the key, the moonroof will close automatically along with them.

Opening/Closing the Moonroof

You can operate the moonroof when the power mode is in ON. Use the switch in the front of the ceiling to open and close the moonroof.

Using the Moonroof Switch

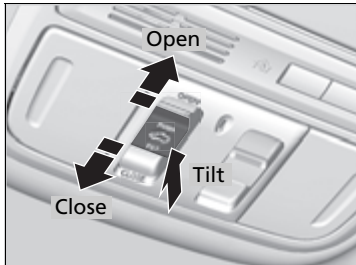

Automatic operation

To open: Pull the switch back firmly.

To close: Push the switch forward firmly.

The moonroof automatically opens or closes all the way. To stop the moonroof midway, pull or push the switch briefly.

Manual operation

To open: Pull the switch back lightly, and hold it until the desired position is reached.

To close: Push the switch forward lightly, and hold it until the desired position is reached.

Tilting the moonroof up

To tilt: Push on the center of the moonroof switch.

To close: Push the switch forward firmly, then release.

Using the Moonroof Switch

⚠ WARNING

Opening or closing the moonroof on someone's hands or fingers can cause serious injury.

Make sure all hands and fingers are clear of the moonroof before opening or closing it.

NOTICE

Opening the moonroof in below freezing temperature or when it is covered with snow or ice can damage the moonroof panel or motor.

The moonroof can be operated for up to 10 minutes after you set the power mode to VEHICLE OFF. Opening either front door cancels this function.

When resistance is detected, the auto reverse function causes the moonroof to change directions, then stop. Auto reverse stops sensing when the moonroof is almost closed to ensure that it fully closes.

You can use the remote transmitter or the key to operate the moonroof.

➤ **Opening the Windows with the Remote** P. 183

➤ **Opening/Closing the Windows with the Key**
P. 184

POWER Button

■ Changing the Power Mode

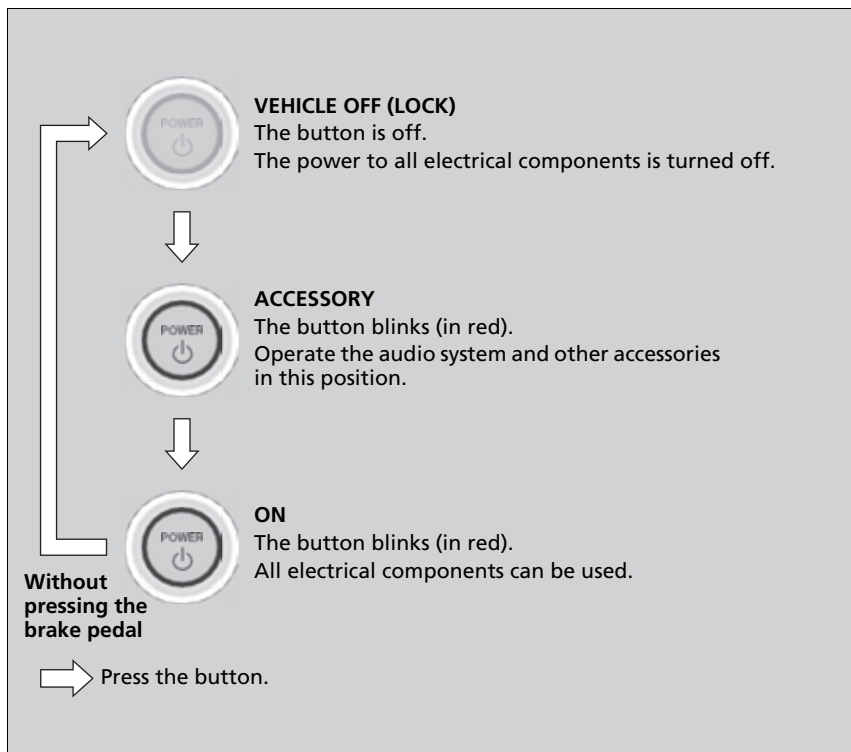

▶ POWER Button

POWER Button Operating Range

You can start the power system when the keyless remote is inside the vehicle.

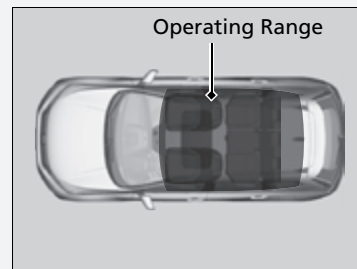

The power system may also start if the keyless remote is close to the door or window, even if it is outside the vehicle.

ON mode:

The **POWER** button is on (in red), if the power system is on.

If the battery of the keyless remote is getting low, the power system may not start when you push the **POWER** button. If the power system does not start, refer to the following link.

▶ **If the Keyless Remote Battery is Weak**
P. 645

Do not leave the power mode in ACCESSORY or ON when you get out.

■ Automatic Power Off

If you leave the vehicle for 30 to 60 minutes with the transmission in **P** and the power mode in ACCESSORY, the vehicle automatically goes into the mode similar to VEHICLE OFF (LOCK) to avoid draining the 12-volt battery.

■ Power Mode Reminder

If you open the driver's door when the power mode is set to ACCESSORY, a warning buzzer sounds.

■ Keyless Remote Reminder

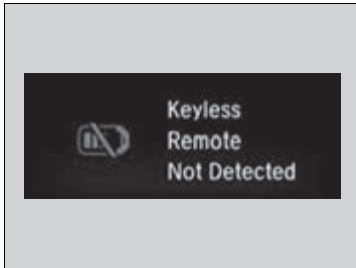

When the power mode is set to any mode other than OFF and you remove the keyless remote from the vehicle and shut the door, an alarm will sound. If the alarm continues to sound, place the keyless remote in another location.

■ When the power mode is in **ACCESSORY**

The alarm will sound from outside the vehicle.

■ When the power mode is in **ON**

An alarm will sound both inside and outside the vehicle. In addition, a warning indicator will appear on the instrument panel.

⊠ Keyless Remote Reminder

When the keyless remote is within the system's operational range, and all the doors are closed, the warning function cancels.

If the keyless remote is taken out of the vehicle after the power system has been started, you can no longer change the **POWER** button mode or restart the power system. Always make sure if the keyless remote is in your vehicle when you operate the **POWER** button.

Removing the keyless remote from the vehicle through a window does not activate the warning buzzer.

Do not put the keyless remote on the dashboard or in the glove box. It may cause the warning buzzer to go off. Under some other conditions that can prevent the vehicle from locating the keyless remote, the warning buzzer may also go off even if the keyless remote is within the system's operational range.

Turn Signals

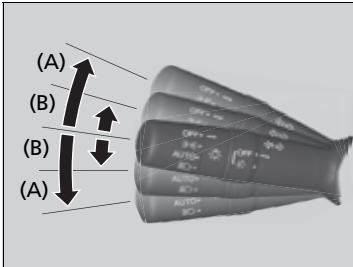

The turn signals can be used when the power mode is in ON.

■ (A): Turn signal

Push the lever up or down based on the direction you want to turn, and the turn signal will blink.

■ (B): One-touch turn signal

When you lightly push the lever up or down and release it, the turn signal will blink 3 times.

- ▶ If you lightly push the lever in the opposite direction while it is blinking, the blinking will stop.

☒ Turn Signals

The turn signal indicator on the instrument panel will blink when the external turn signal blinks.

☒ **Indicators** P. 90

Light Switches

Manual Operation

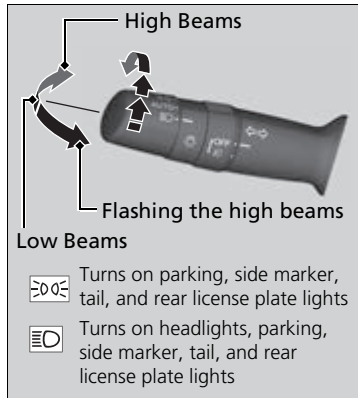

Rotating the light switch turns the lights on and off, regardless of the power mode setting.

■ High beams

Push the lever forward until you hear a click.

■ Low beams

When in high beams, pull the lever back to return to low beams.

■ Flashing the high beams

Pull the lever back, and release it.

Light Switches

If you leave the power mode in VEHICLE OFF while the lights are on, a chime sounds when the driver's door is opened.

When the lights are on, the lights on indicator in the instrument panel will be on.

➤ **Indicators** P. 90

Do not leave the lights on when the power system is off because it will cause the 12-volt battery to discharge.

If you sense that the level of the headlights is abnormal, have the vehicle inspected by a dealer.

Automatic Operation (automatic lighting control)

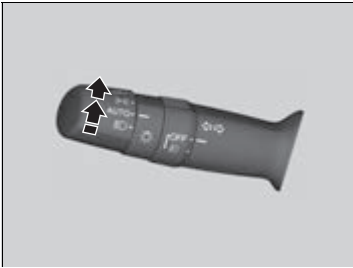

Automatic lighting control can be used when the power mode is in ON.

When you turn the light switch to **AUTO**, the headlights and other exterior lights will switch on and off automatically depending on the ambient brightness.

The headlights come on when you unlock a door in dark areas with the headlight switch in **AUTO**.

- ▶ Once you lock the door, the headlights will go off.

Automatic Operation (automatic lighting control)

We recommend that you turn on the lights manually when driving at night, in a dense fog, or in dark areas such as long tunnels or parking facilities.

The light sensor is in the location shown below. Do not cover this light sensor with anything; otherwise, the automatic lighting system may not work properly.

Models without automatic intermittent wipers

Light Sensor

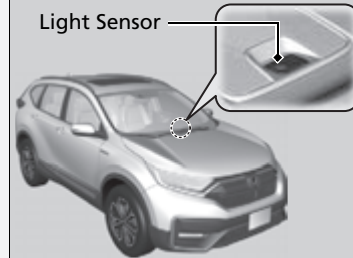

Models with automatic intermittent wipers

Light Sensor

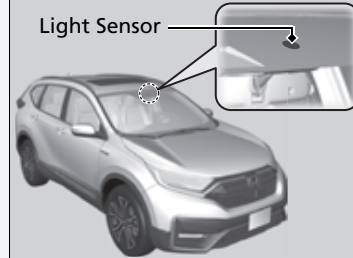

■ Headlight Integration with Wipers

The headlights automatically come on when the wipers are used several times within a certain number of intervals with the headlight switch in **AUTO**.

The headlights automatically go off a few minutes later if the wipers are stopped.

⌘ Automatic Operation (automatic lighting control)

You can adjust the auto light sensitivity as follows:

Setting	The exterior lights come on when the ambient light is at
Max	 <p>Bright</p> <p>Dark</p>
High	
Mid	
Low	
Min	

Models with color audio system

➤ **Customized Features** P. 140

Models with Display Audio

➤ **Customized Features** P. 369

⌘ Headlight Integration with Wipers

This feature activates while the headlights are off in **AUTO**.

The instrument panel brightness does not change when the headlights come on.

At dark ambient light levels, the automatic lighting control feature turns on the headlights, regardless of the number of wiper sweeps.

You can turn the headlight integration with wipers function on and off.

Models with color audio system

➤ **Customized Features** P. 140

Models with Display Audio

➤ **Customized Features** P. 369

■ Automatic Lighting Off Feature

The headlights, all other exterior lights, and the instrument panel lights turn off 15 seconds after you set the power mode to VEHICLE OFF, take the keyless remote with you, and close the driver's door.

If you set the power mode to VEHICLE OFF with the headlight switch on, but do not open the door, the lights turn off after 10 minutes (3 minutes, if the switch is in the **AUTO** position).

The lights turn on again when you unlock or open the driver's door. If you unlock the door, but do not open it within 15 seconds, the lights go off. If you open the driver's door, you will hear a reminder chime alerting you that the lights are on.

⌘ Automatic Lighting Off Feature

You can change the headlight auto off timer setting.

Models with color audio system

➤ **Customized Features** P. 140

Models with Display Audio

➤ **Customized Features** P. 369

Fog Lights*

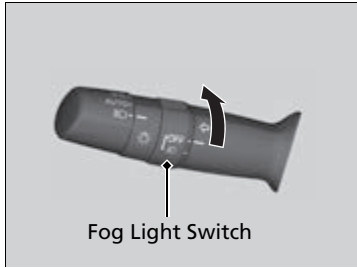

When the low beam headlights are on, turn the fog light switch on to use the fog lights.

Daytime Running Lights

The parking/daytime running lights come on when the following conditions have been met:

- The power mode is in ON.
- The headlight switch is **AUTO** or **OFF**.
- The parking brake is released.

The lights remain on even if you set the parking brake. Setting the power mode to VEHICLE OFF will turn off the daytime running lights.

The daytime running lights are off once the headlight switch is turned on, or when the headlight switch is in **AUTO** and it is getting darker outside.

Auto High-Beam

The front sensor camera detects the light sources ahead of the vehicle such as the lights of a preceding or oncoming vehicle, or street lights. When you are driving at night, the system automatically switches the headlights between low beam and high beam depending on the situation.

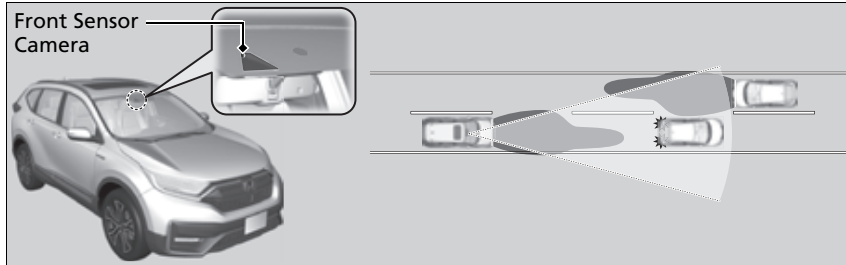

How to Use the Auto High-Beam

When all of the following conditions have been met, the auto high-beam indicator comes on and the auto high-beam is activated.

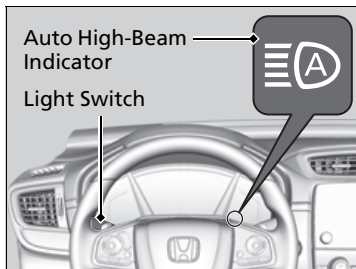

- The power mode is in ON.
- The light switch is in **AUTO**.
- The lever is in the low beam position.
- The headlights have been automatically activated.
- It is dark outside the vehicle.

If the auto high-beam indicator does not come on even when all the conditions have been met, carry out the following procedure and the indicator will come on.

- Pull the lever toward you for flashing the high beams then release it while driving.

Auto High-Beam

The auto high-beam system does not always operate in every situation. This system is just for assisting the driver. Always observe your surroundings and switch the headlights between high beam and low beam manually if necessary.

If you find the timing of beam changes inconvenient for driving, change the headlight beams manually.

The range and the distance at which the camera can recognize varies depending on conditions surrounding your vehicle.

Regarding the handling of the camera mounted to the inside of the windshield, refer to the following.

Front Sensor Camera P. 548

For the auto high-beam to work properly:

- Do not place an object that reflects light on the dashboard.
- Keep the windshield around the camera clean.
- When cleaning the windshield, be careful not to apply the windshield cleanser to the camera lens.
- Do not attach an object, sticker or film to the area around the camera.
- Do not touch the camera lens.

If the camera receives a strong impact, or repairing of the area near the camera is required, consult a dealer.

■ Automatic switching between high-beam and low-beam

When auto-high beam is active, the headlights switch between high beam and low beam based on the following conditions.

Switching to high beam:

All of the following conditions must be met before the high beams turn on.

- Your vehicle speed is 25 mph (40 km/h) or more.
- There are no preceding or oncoming vehicle with headlights or taillights turned on.
- There are few street lights on the road ahead.



Switching to low beam:

One of the following conditions must be met before the low beams turn on.

- Your vehicle speed is 15 mph (24 km/h) or less.
- There is a preceding or oncoming vehicle with headlights or taillights turned on.
- There are many street lights on the road ahead.

■ Manual switching between high-beam and low-beam

If you want to manually switch the headlights between high beam and low beam, follow either of the procedures below. Note that when you do this, the auto high-beam indicator will turn off and the auto high-beam will be deactivated.

Using the lever:

Pull the lever toward you for flashing the high beams then release it within about one second while driving.

- To reactivate the auto high-beam, pull the lever toward you for flashing the high beams then release it while driving. The auto high-beam indicator will come on.

Using the light switch:

Turn the light switch to .

- To reactivate the auto high-beam, turn the light switch to **AUTO** when the lever is in the low beam position, the auto high-beam indicator will come on.

⌘ How to Use the Auto High-Beam

In the following cases, the auto high-beam system may not switch the headlights properly or the switching timing may be changed. In case of the automatic switching operation does not fit for your driving habits, please switch the headlights manually.

- The brightness of the lights from the preceding or oncoming vehicle is intense or poor.
- Visibility is poor due to the weather (rain, snow, fog, windshield frost, etc.).
- Surrounding light sources, such as street lights, electric billboards and traffic lights are illuminating the road ahead.
- The brightness level of the road ahead constantly changes.
- The road is bumpy or has many curves.
- A vehicle suddenly appears in front of you, or a vehicle in front of you is not in the preceding or oncoming direction.
- Your vehicle is tilted with a heavy load in the rear.
- A traffic sign, mirror, or other reflective object ahead is reflecting strong light toward the vehicle.
- The oncoming vehicle frequently disappears under roadside trees or behind median barriers.
- The preceding or oncoming vehicle is a motorcycle, bicycle, mobility scooter, or other small vehicle.

The auto high-beam system keeps the headlight low beam when:

- Windshield wipers are operating at a high speed.
- The camera has detected dense fog.

■ How to Turn Off the Auto High-Beam

You can turn the auto high-beam system off. If you want to turn the system off or on, set the power mode to ON, then carry out the following procedures while the vehicle is stationary.

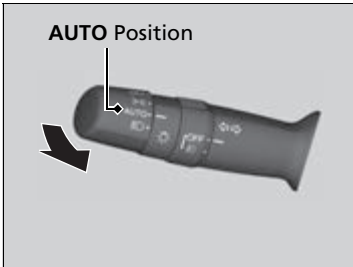

To turn the system off:

With the light switch is in **AUTO**, pull the lever toward you and hold it for at least 40 seconds. After the auto high-beam indicator light blinks twice, release the lever.

To turn the system on:

With the light switch is in **AUTO**, pull the lever toward you and hold it for at least 30 seconds. After the auto high-beam indicator light blinks once, release the lever.

☒ How to Use the Auto High-Beam

If the **Some Driver Assist Systems Cannot Operate: Camera Temperature Too High** message appears:

- Use the climate control system to cool down the interior and, if necessary, also use defroster mode with the airflow directed toward the camera.
- Start driving the vehicle to lower the windshield temperature, which cools down the area around the camera.

If the **Some Driver Assist Systems Cannot Operate: Clean Front Windshield** message appears:

- Park your vehicle in a safe place, and clean the windshield. If the message does not disappear after you have cleaned the windshield and driven for a while, have your vehicle checked by a dealer.

☒ How to Turn Off the Auto High-Beam

If you turn the auto high-beam system off, the system does not operate until you turn the system on.

Park in a safe place before turning the system off or on.

Wipers and Washers

■ Windshield Wiper/Washer

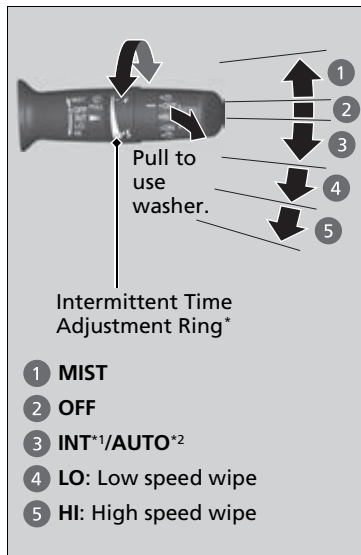

The windshield wipers and washers can be used when the power mode is in ON.

■ MIST

The wipers run at high speed until you release the lever.

■ Wiper switch (OFF, INT*¹, AUTO*², LO, HI)

Move the lever up or down to change the wiper settings.

■ Adjusting wiper operation*

Turn the adjustment ring to adjust the wiper operation.

– / Lower speed, fewer sweeps

+ / Higher speed, more sweeps

■ Washer

Sprays while you pull the lever toward you. When you release the lever for more than one second, the spray stops, the wipers sweep two or three more times to clear the windshield, then stop.

» Wipers and Washers

NOTICE

Do not use the wipers when the windshield is dry. The windshield will get scratched, or the rubber blades will get damaged.

NOTICE

In cold weather, the blades may freeze to the windshield. Operating the wipers in this condition may damage the wipers. Use the defogger to warm the windshield, then turn the wipers on.

NOTICE

Turn the washers off if no washer fluid comes out. The pump may get damaged.

Models with intermittent time adjustment ring

If the vehicle speeds up while the wipers are operating intermittently, the length of the wipe interval shortens.

When the vehicle speeds up, the wiper operation's shortest delay setting (🔊) and the **LO** setting become the same.

If the wipers stop operating due to an obstacle such as the buildup of snow, park the vehicle in a safe place. Rotate the wiper switch to **OFF**, and set the power mode to ACCESSORY or VEHICLE OFF, then remove the obstacle.

*1: Models with manual intermittent operation

*2: Models with automatic intermittent operation

* Not available on all models

■ Automatic Intermittent Wipers*

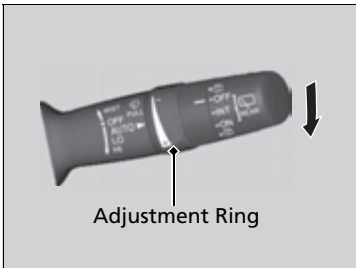

When you push the lever down to **AUTO**, the windshield wipers sweep once, and go into the automatic mode.

The wipers operate intermittently, at low speed, or at high speed and stop in accordance with the amount of rainfall the rainfall sensor detects.

■ AUTO sensitivity adjustment

When the wiper function is set to **AUTO**, you can adjust the sensitivity of the rainfall sensor (using the adjustment ring) so that wipers will operate in accordance with your preference.

Sensor sensitivity

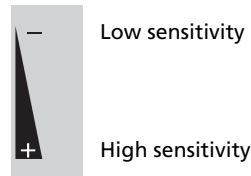

⌘ Wipers and Washers

The wiper motor may stop motor operation temporarily to prevent an overload. Wiper operation will return to normal within a few minutes, once the circuit has returned to normal.

⌘ Automatic Intermittent Wipers*

The rainfall sensor is in the location shown below.

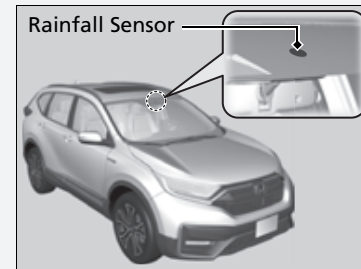

NOTICE

AUTO should always be turned **OFF** before the following situations in order to prevent severe damage to the wiper system:

- Cleaning the windshield
- Driving through a car wash
- No rain present

* Not available on all models

■ Rear Wiper/Washer

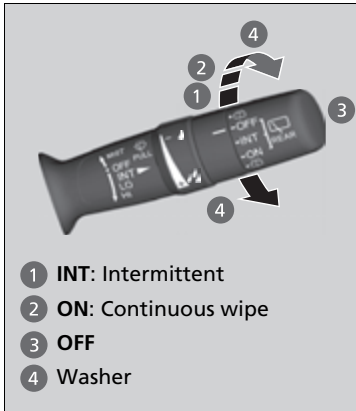

- 1 INT: Intermittent
- 2 ON: Continuous wipe
- 3 OFF
- 4 Washer

The rear wiper and washer can be used when the power mode is in ON.

■ Wiper switch (OFF, INT, ON)

Change the wiper switch setting according to the amount of rain.

■ Washer ()

Sprays while you rotate the switch to this position.

Hold it to activate the wiper and to spray the washer. Once released, the washer spray will stop and the rear wiper will return to its selected switch setting after a few sweeps.

■ Operating in reverse

When you put the transmission into **R** with the windshield wipers activated, the rear wiper operates automatically as follows even if its switch is off.

Front Wiper Position	Rear Wiper Operation
INT *1 (Intermittent) AUTO *2 (Intermittent)	Intermittent
LO (Low speed wipe) HI (High speed wipe)	Continuous

*1: Models with manual intermittent operation

*2: Models with automatic intermittent operation

Rear Defogger/Heated Door Mirror* Button

■ Rear Defogger/Heated Door Mirror* Button

Press the rear defogger and heated door mirror* button to defog the rear window and mirrors* when the power mode is in ON.

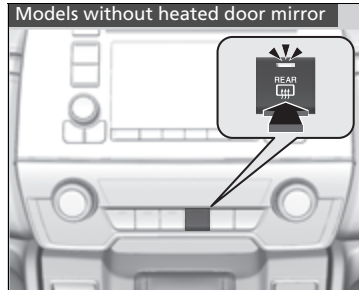

The rear defogger and heated door mirror* automatically switch off after 10-30 minutes depending on the outside temperature. However, if the outside temperature is 32°F (0°C) or below, it does not automatically switch off.

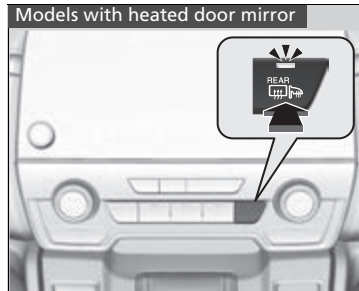

⌘ Rear Defogger/Heated Door Mirror* Button

This system consumes a lot of power, so turn it off when the window has been defogged. Also, do not use the system for a long time while the power system is stopped. This may weaken the 12-volt battery, making it difficult to turn the power system on.

Models with heated door mirror

When the power mode is set to ON and the outside temperature is below 41°F (5°C), the heated door mirror may automatically activate for 10 minutes.

* Not available on all models

Brightness Control

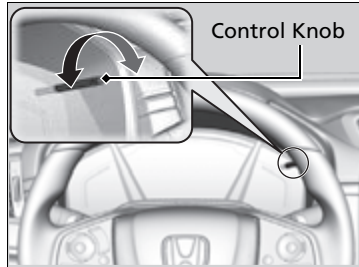

When the brightness of the meter will be reduced, you can use the brightness control knob to adjust instrument panel brightness.
Brighten: Turn the knob to the right.
Dim: Turn the knob to the left.

You will hear a beeper when the brightness reaches minimum or maximum. Several seconds after adjusting the brightness, you will be returned to the previous screen.

■ Brightness level indicator

The brightness level is shown on the driver information interface while you are adjusting it.

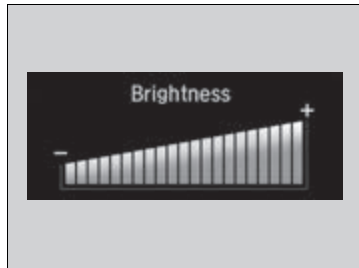

☒ Brightness Control

The brightness of the instrument panel will be reduced when the following conditions have been met:

- The power mode is in ON.
- The parking lights are turned on.
- The ambient lighting is low.

The brightness can be set differently for when the exterior lights are on, and when they are off.

Driving Position Memory System*

You can store two driver's seat positions (except for power lumbar) with the driving position memory system.

When you unlock and open the driver's door with a remote transmitter or the keyless access system, the seat adjusts automatically to one of the two preset positions.

When you enter the vehicle, the driver information interface briefly shows you which remote transmitter you used to unlock the vehicle.

- **DRIVER 1** transmitter is linked to memory button **1**.
- **DRIVER 2** transmitter is linked to memory button **2**.



* Not available on all models

Continued

▣ Driving Position Memory System*

Using the audio/information screen, you can disable the automatic seat adjustment function.

▣ **Customized Features** P. 369

System Operation

The system will not operate if:

- The transmission is out of the **P** position.
- Either memory button is pressed while the seat is in motion.
- The seat position is adjusted while in operation.
- Either of the memorized positions set fully to the rear.

The system may not recognise a key if:

- The key is in close proximity to a mobile phone or other wireless device.
- Both keys are in the vehicle at the same time.
- The Driving Position Memory System is disabled in customized features.
- Opening driver's door without fully grabbing door handle.

■ Storing a Position in Memory

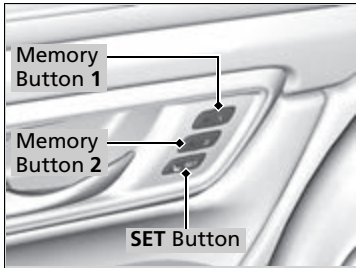

1. Set the power mode to ON. Adjust the driver's seat to the desired position.
2. Press the **SET** button.
 - ▶ You will hear a beep, and the memory button indicator light will blink.
3. Press and hold memory button **[1]** or **[2]** within five seconds of pressing the **SET** button.
 - ▶ Once the seat position has been memorized, the indicator light on the button you pressed stays on.

■ Recalling the Stored Position

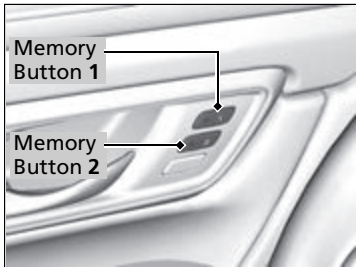

1. Put the transmission into **[P]**.
2. Apply the parking brake.
3. Press a memory button (**[1]** or **[2]**).
 - ▶ You will hear a beep, and the indicator light will blink.

The seat will automatically move to the memorized position. When it has finished moving, you will hear a beep, and the indicator light stays on.

⌘ Storing a Position in Memory

After you press the **SET** button, the storing operation will be canceled when:

- You do not press the memory button within five seconds.
- You readjust the seat position before the double-beep.
- You set the power mode to any position except ON.

⌘ Recalling the Stored Position

The seat will stop moving if you:

- Press the **SET** button, or a memory button (**[1]** or **[2]**).
- Adjust the seat position.
- Put the transmission into a position other than **[P]**.

Adjusting the Steering Wheel

The steering wheel height and distance from your body can be adjusted so that you can comfortably grip the steering wheel in an appropriate driving posture.

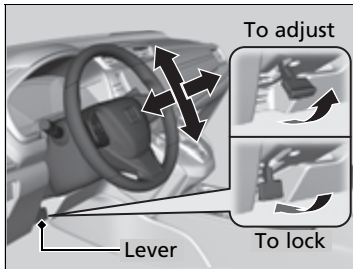

1. While the vehicle is stopped, pull the steering wheel adjustment lever up.
 - ▶ The steering wheel adjustment lever is under the steering column.
2. Move the steering wheel up or down, and in or out.
 - ▶ Make sure you can see the instrument panel gauges and indicators.
3. Push the steering wheel adjustment lever down to lock the steering wheel in position.
 - ▶ After adjusting the position, make sure you have securely locked the steering wheel in place by trying to move it up, down, in, and out.

Adjusting the Steering Wheel

⚠ WARNING

Adjusting the steering wheel position while driving may cause you to lose control of the vehicle and be seriously injured in a crash.

Adjust the steering wheel only when the vehicle is stopped.

Interior Rearview Mirror

Adjust the angle of the rearview mirror when you are sitting in the correct driving position.

■ Rearview Mirror with Day and Night Positions*

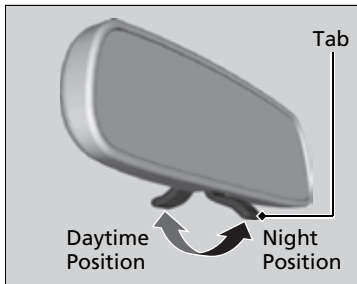

Flip the tab to switch the position. The night position will help to reduce the glare from headlights behind you when driving after dark.

■ Automatic Dimming Rearview Mirror*

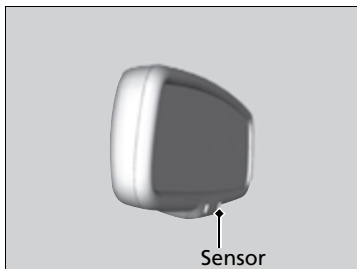

When you are driving after dark, the automatic dimming rearview mirror reduces the glare from headlights behind you. This feature is always active.

☒ Mirrors

Keep the inside and outside mirrors clean and adjusted for best visibility.

Adjust the mirrors before you start driving.

➤ **Front Seats** P. 208

☒ Automatic Dimming Rearview Mirror*

The auto dimming function cancels when the transmission is in **[R]**.

Power Door Mirrors

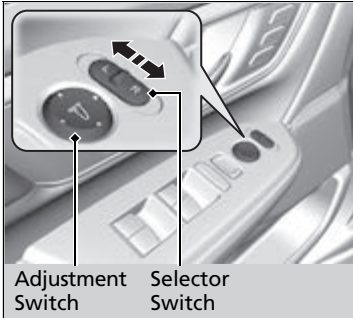

You can adjust the door mirrors when the power mode is in ON.

■ Mirror position adjustment

L/R selector switch: Select the left or right mirror. After adjusting the mirror, return the switch to the center position.

Mirror position adjustment switch: Press the switch left, right, up, or down to move the mirror.

Front Seats

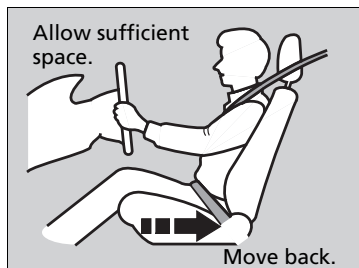

Adjust the driver's seat as far back as possible while allowing you to maintain full control of the vehicle. You should be able to sit upright, well back in the seat and be able to adequately press the pedals without leaning forward, and grip the steering wheel comfortably. The passenger's seat should be adjusted in a similar manner, so that it is as far back from the front airbag in the dashboard as possible.

Seats

Always make seat adjustments before driving.

Front Seats

WARNING

Sitting too close to a front airbag can result in serious injury or death if the front airbags inflate.

Always sit as far back from the front airbags as possible while maintaining control of the vehicle.

The National Highway Traffic Safety Administration recommends that driver's allow at least 10 inches (25 cm) between the center of the steering wheel and the chest.

Adjusting the Seat Positions

Adjusting the front power seat*

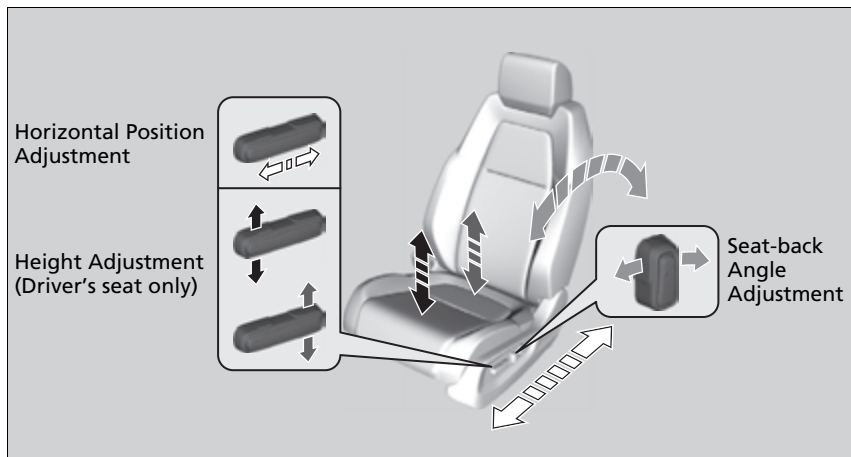

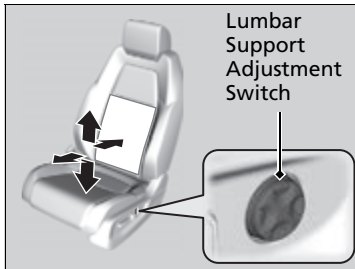

Lumbar
Support
Adjustment
Switch

■ Lumbar Support Adjustment Switch* (Driver's seat only)

Press the top: To move the lumbar support up.

Press the bottom: To move the lumbar support down.

Press the front: To increase the entire lumbar support.

Press the rear: To decrease the entire lumbar support.

■ Adjusting the front manual seat(s)*

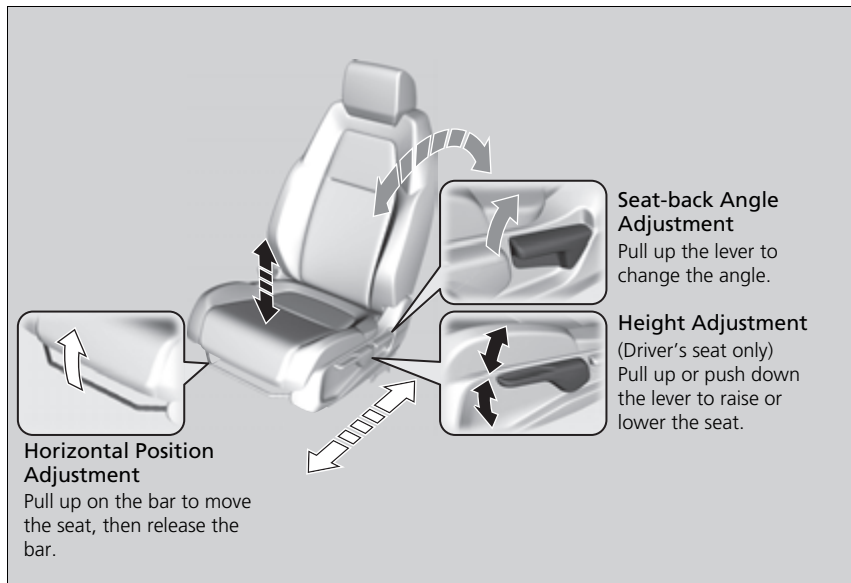

►► Adjusting the front manual seat(s)*

Once a seat is adjusted correctly, rock it back and forth to make sure it is locked in position.

■ Adjusting the Seat-Backs

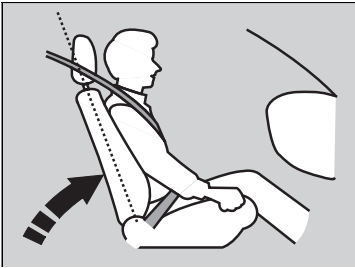

Adjust the driver's seat-back to a comfortable, upright position, leaving ample space between your chest and the airbag cover in the center of the steering wheel.

The front seat passenger should also adjust their seat-back to a comfortable, upright position.

Reclining a seat-back so that the shoulder part of the belt no longer rests against the occupant's chest reduces the protective capability of the belt. It also increases the chance of sliding under the belt in a crash and being seriously injured. The farther a seat-back is reclined, the greater the risk of injury.

▣ Adjusting the Seat-Backs

⚠ WARNING

Reclining the seat-back too far can result in serious injury or death in a crash.

Adjust the seat-back to an upright position, and sit well back in the seat.

Do not put a cushion, or other object, between the seat-back and your back.

Doing so may interfere with proper seat belt or airbag operation.

If you cannot get far enough away from the steering wheel and still reach the controls, we recommend that you investigate whether some type of adaptive equipment may help.

Rear Seats

■ Adjusting the Seat Positions

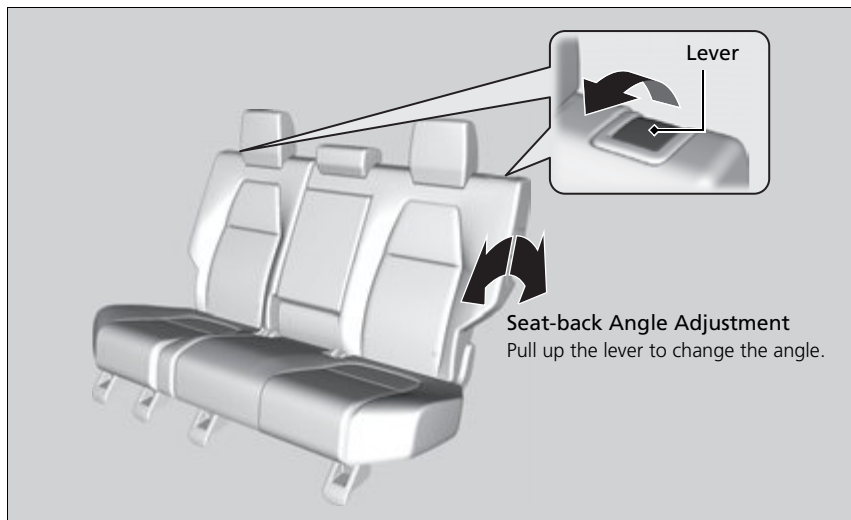

▣ Rear Seats

Once a seat is adjusted correctly, rock it back and forth to make sure it is locked in position.

Folding Down the Rear Seats

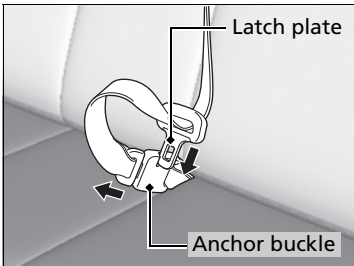

1. Store the center seat belt first. Insert the latch plate into the slot on the side of the anchor buckle.
2. Retract the seat belt into the holder on the ceiling.
3. Lower the rear seat head restraint to its lowest position. Put the armrest back into the seat-back.

➤ **Seat Belt with Detachable Anchor** P. 53

From the rear seat side

4. Pull the release lever and fold down the seat.

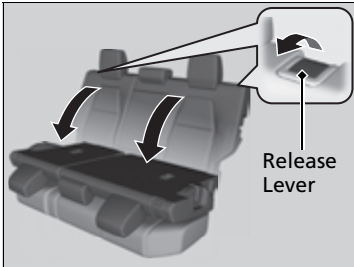

From the cargo area side

4. Pull the release lever and fold down the seat.

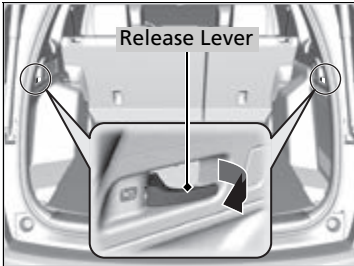

Folding Down the Rear Seats

The rear seat-backs can be folded down to accommodate bulkier items in the cargo area.

Remove any items from the rear seat cushion and floor before you fold down the rear seat.

When returning the seat-back to its original position, push it firmly back. Also, make sure all rear shoulder belts are positioned in front of the seat-back.

Make sure all items in the cargo area or items extending through the opening into the rear seats are properly secured. Loose items can fly forward if you have to brake hard.

Make sure that the folded seat-back does not press against the front passenger seat, as this can cause the weight sensors in the front passenger seat to work improperly.

➤ **Passenger Airbag Off Indicator** P. 69

Make sure the seat-back, head restraints and seat cushion are securely latched back into place before driving.

Maintain a Proper Sitting Position

After all occupants have adjusted their seats and head restraints, and put on their seat belts, it is very important that they continue to sit upright, well back in their seats, with their feet on the floor, until the vehicle is safely parked and the power system is off.

Sitting improperly can increase the chance of injury during a crash. For example, if an occupant slouches, lies down, turns sideways, sits forward, leans forward or sideways, or puts one or both feet up, the chance of injury during a crash is greatly increased.

In addition, an occupant who is out of position in the front seat can be seriously or fatally injured in a crash by striking interior parts of the vehicle or being struck by an inflating front airbag.

► Maintain a Proper Sitting Position

WARNING

Sitting improperly or out of position can result in serious injury or death in a crash.

Always sit upright, well back in the seat, with your feet on the floor.

Head Restraints

Your vehicle is equipped with head restraints in all seating positions.

■ Adjusting the Front Head Restraints

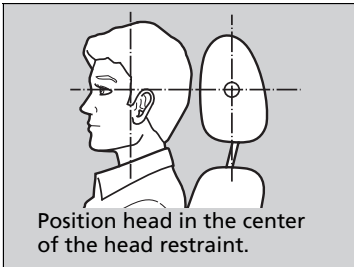

Head restraints are most effective for protection against whiplash and other rear-impact crash injuries when the center of the back of the occupant's head rests against the center of the restraint. The tops of the occupant's ears should be level with the center height of the restraint.

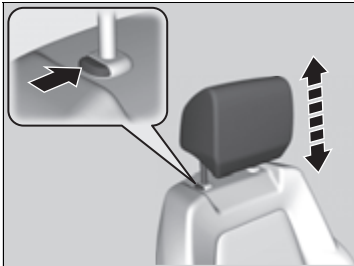

To raise the head restraint: Pull it upward.

To lower the head restraint: Push it down while pressing the release button.

▶▶ Adjusting the Front Head Restraints

⚠ WARNING

Improperly positioning head restraints reduces their effectiveness and increases the likelihood of serious injury in a crash.

Make sure head restraints are in place and positioned properly before driving.

In order for the head restraint system to work properly:

- Do not hang any items on the head restraints, or from the restraint legs.
- Do not place any objects between an occupant and the seat-back.
- Install each restraint in its proper location.

■ Changing the Rear Seat Head Restraint Position

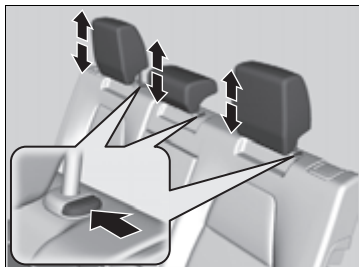

A passenger sitting in the rear seat should adjust the height of their head restraint to an appropriate position before the vehicle begins moving.

To raise the head restraint:

Pull it upward.

To lower the head restraint:

Push it down while pressing the release button.

■ Removing and Reinstalling the Head Restraints

Head restraints can be removed for cleaning or repair.

To remove a head restraint:

Pull the restraint up as far as it will go. Then, push the release button and pull the restraint up and out.

To reinstall a head restraint:

Insert the legs back in place, then adjust the head restraint to an appropriate height while pressing the release button. Pull up on the restraint to make sure it is locked in position.

► Removing and Reinstalling the Head Restraints

⚠ WARNING

Failure to reinstall, or correctly reinstall, the head restraints can result in severe injury during a crash.

Always replace the head restraints before driving.

Armrest

■ Using the Front Seat Armrest

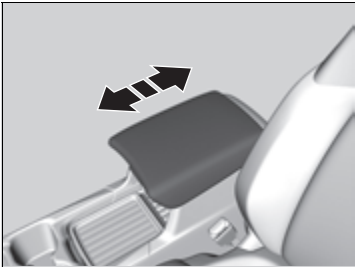

The console lid can be used as an armrest.

To adjust:

Slide the armrest to a desired position.

■ Using the Rear Seat Armrest

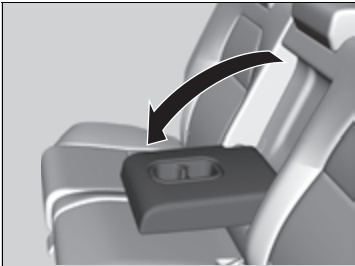

Pull down the armrest in the center seat-back.

Interior Lights

Interior Light Switches

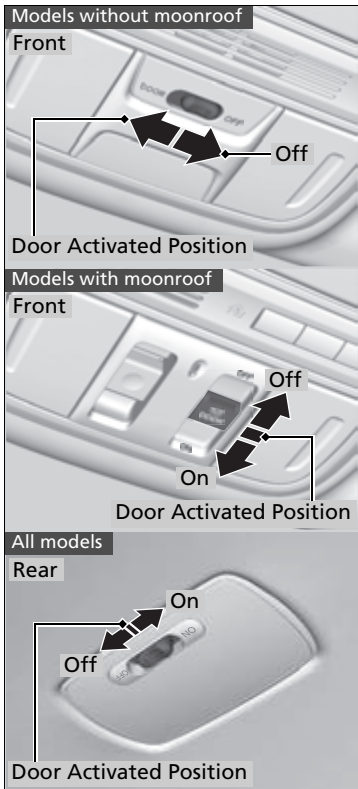

■ ON

The interior lights come on regardless of whether the doors are open or closed.

■ Door activated

The interior lights come on in the following situations:

- When any doors are opened.
- You unlock the driver's door.
- When the power mode is set to VEHICLE OFF.

■ OFF

The interior lights remain off regardless of whether the doors are open or closed.

Interior Light Switches

In the door activated position, the interior lights fade out and go off about 30 seconds after the doors are closed.

The lights go off after about 30 seconds in the following situations:

- When you unlock the driver's door but do not open it.
- When you set the power mode to VEHICLE OFF but do not open a door.

You can change the interior lights dimming time.

Models with color audio system

➤ **Customized Features** P. 140

Models with Display Audio

➤ **Customized Features** P. 369

The interior lights go off immediately in the following situations:

- When you lock the driver's door.
- When you close the driver's door in ACCESSORY mode.
- When you set the power mode to ON.

To avoid draining the 12-volt battery, do not leave the interior light on for an extended length of time when the power system is off.

If you leave any of the doors open in VEHICLE OFF mode, the interior lights go off after about 15 minutes.

■ Map Light Switches

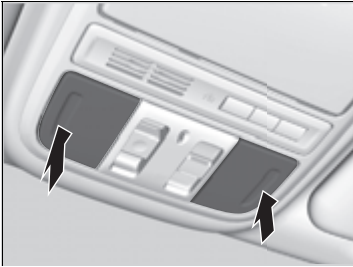

The map lights can be turned on and off by pressing the lenses.

■ Cargo Area Lights



The cargo area lights come on when you open the tailgate.

☒ Map Light Switches

When the interior light switch is in the door activated position and any door is open, the map light will not go off when you press the lenses.

☒ Cargo Area Lights

The cargo area lights do not have an on/off switch. In case the tailgate is left open for an extended period of time, they automatically go out in 30 minutes.

Storage Items

■ Glove Box

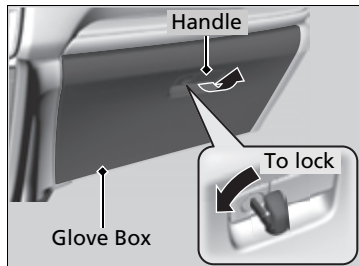

Pull the handle to open the glove box. You can lock the glove box with the built-in key.

» Glove Box

⚠ WARNING

An open glove box can cause serious injury to your passenger in a crash, even if the passenger is wearing the seat belt.

Always keep the glove box closed while driving.

Center Console Box

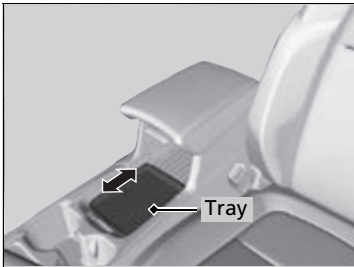

You can change the position of the tray by sliding it forward or back.

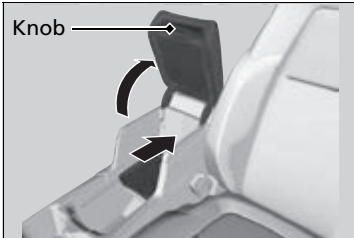

If you want to make greater use of the console box:

1. Pull the knob to open the armrest.
2. Slide the tray back.

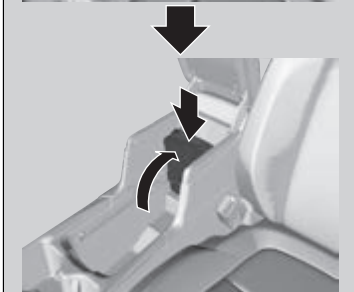

3. Hold the front of the tray and pull it up.

■ Beverage Holders

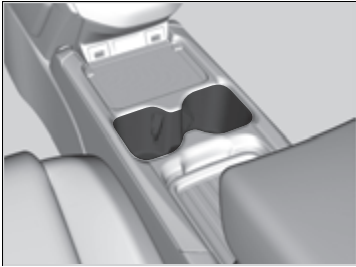

■ Front seat beverage holders

Are located in the console between the front seats.

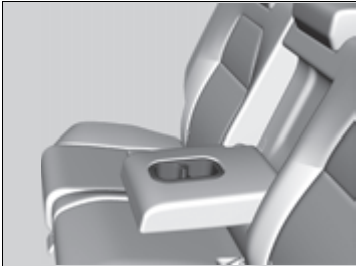

■ Rear seat beverage holders

Fold the armrest down to use the rear seat beverage holders.

⌘ Beverage Holders

NOTICE

Spilled liquids can damage the upholstery, carpeting, and electrical components in the interior.

Be careful when you are using the beverage holders. Hot liquid can scald you.

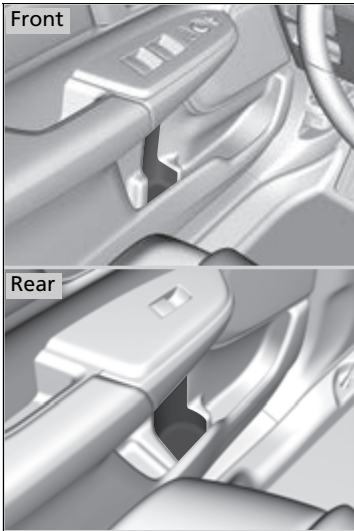

■ **Door side beverage holders**

Located in the side pockets of all doors.

■ Coat Hook

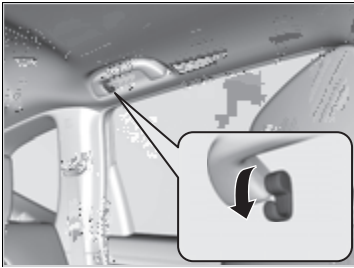

There is a coat hook on the rear left grab handle. Pull it down to use it.

☒ Coat Hook

The coat hook is not designed for large or heavy items.

■ Tie-down Anchors

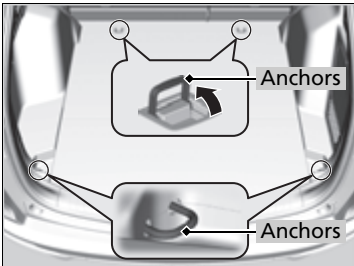

The tie-down anchors on the cargo area floor can be used to install a net for securing items.

☒ Tie-down Anchors

Do not let anyone access items in the cargo area while driving. Loose items can cause injury if you have to brake hard.

■ Cargo Hook

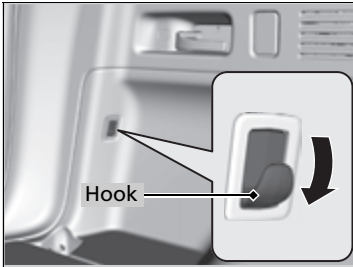

The cargo hook on the driver's side of the cargo area can be used to hang light items.

» Cargo Hook

NOTICE

Do not hang a large object or an object that weighs more than 6 lbs (3 kg) on the cargo hook. Hanging heavy or large objects may damage the hook.

■ Sunglasses Holder



To open the sunglasses holder, press and release the indent. To close, press it again until it latches.

You can store eyeglasses and other small items in this holder.



■ Conversation mirror

The sunglasses holder comes with a mirror. Open the sunglasses holder fully, then push it back to the first detent.

You can use the mirror to view the rear seats.

☞ Sunglasses Holder

Keep the holder closed while driving except when accessing stored items.

■ Rear Cargo Cover

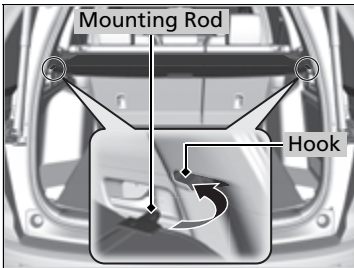
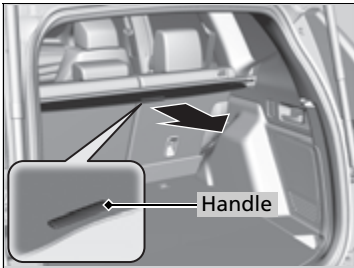

The rear cargo cover can be used to conceal items in the cargo area and protect them from direct sunlight.

■ To extend:

Lift up on the handle at the center edge of the cover to unhook each end, then pull the cover rearward and clip the mounting rods in the hooks at both sides of the tailgate opening.

▣ Rear Cargo Cover

Do not let anyone access items in the cargo area while driving. Loose items can cause injury if you have to brake hard.

Do not stack objects higher than the top of the seat in the cargo area. They could block your view and be thrown about the vehicle during a sudden stop.

To prevent rear cargo cover damage:

- Do not place items on the rear cargo cover.
- Do not put weight on the rear cargo cover.

Be sure that each mounting rod sets in its respective retention groove when you retract the rear cargo cover. If they are not set in the grooves, the rods may rattle as they contact the surrounding surfaces.

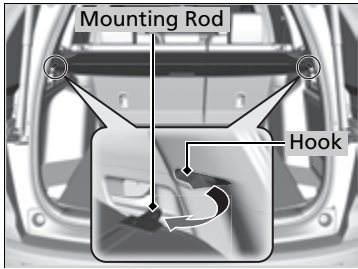

■ **To retract:**

Slip the rods out of the hooks, then slowly roll it back until it is completely retracted.

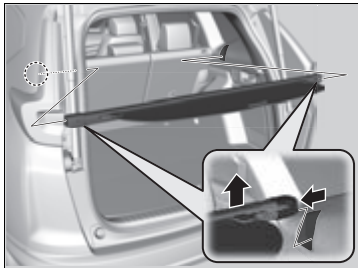

■ **To remove:**

Push either end of the housing inward, then lift it out of its position.

Other Interior Convenience Items

■ Accessory Power Socket

The accessory power socket can be used when the power mode is in ACCESSORY or ON.

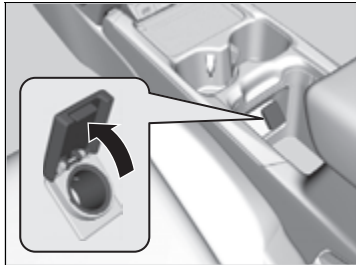

■ Accessory power socket in the center console box

Slide the tray back and open the cover to use it.

ⓘ Accessory Power Socket

NOTICE

Do not insert an automotive type cigarette lighter element.

This can overheat the accessory power socket.

The accessory power socket is designed to supply power for 12-volt DC accessories that are rated 180 watts (15 amps) or less.

To prevent 12-volt battery drain, only use the accessory power socket with the power system on.

When the accessory power socket is not in use, close the cover to prevent any small foreign objects from getting into the accessory power socket.

■ Wireless Charger*

To use the wireless charger, the power mode must be in ACCESSORY or ON. Charge a compatible device on the area indicated by the  mark as follows:

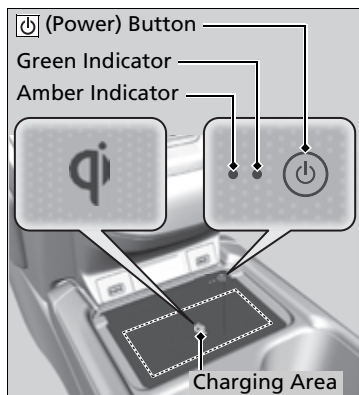

1. To turn the system on and off, press and hold the  (power) button.
 - When the system is activated, the green indicator light comes on.
2. Place the device you want to charge on the charging area.
 - The system will automatically start charging the device, and the amber indicator light will come on.
 - Make sure that the device is compatible with the system, and placed with the chargeable side in the center of the charging area.
3. When charging is completed, the green indicator light will come on.
 - Depending on the device, the amber indicator light will stay on.

⚠️ Wireless Charger*

⚠️ CAUTION

Metal objects between the charge pad and the device to be charged will get hot and can burn you.

- Always remove foreign objects from the charge pad before charging the device.
- Be sure the surface is clear of dust and other debris before charging.
- Do not spill liquids (i. e. water, drinks, etc.) on the charger and the device.
- Do not use oil, grease, alcohol, benzine or thinner for cleaning the charge pad.
- Do not cover the system with towels, clothing, or other objects while charging etc.
- Avoid spraying aerosols which may come in contact with the charge pad surface.

This system consumes a lot of power. Do not use the system for a long time when the power system is off. This may weaken the 12-volt battery, making it difficult to turn the power system on.

When using the wireless charger, check the user's manual that came with the compatible device you want to charge.

■ When charging does not start

Perform one of the solutions in the following table.

Indicator		Cause	Solution
Green & Amber	Blinking simultaneously	There is an obstacle(s) between the charging area and the device.	Remove the obstacle(s).
		The device is not within the charging area.	Pick up and reset the device to the center of the charging area where  is located.
Amber	Blinking	The wireless charger is faulty.	Contact a dealer for repairs.

Wireless Charger*

NOTICE

Do not place any magnetic recording media or precision machines within the charging area while charging. The data on your cards such as credit cards can be lost because of the magnetic effect. Also, precision machines such as watches may malfunction.

“Qi” and  marks are the registered trademarks owned by Wireless Power Consortium (WPC).

In the following cases, charging may stop or not start:

- The device is already fully charged.
- The temperature of the device is extremely high while charging.
- You are at a place that emits strong electromagnetic waves or noises such as TV station, electric power plant, or gas station.

A device may not charge if the size or shape of its chargeable side is not appropriate for use with the charging area.

Not all devices are compatible with the system.

During the charging phase, it is normal for the charging area and device to heat up.

Charging may be briefly interrupted when:

- All the doors or the tailgate are closed - to avoid interference with the proper functioning of the keyless access system.
- The position of the device is altered.

Do not charge more than one device at a time on a charging area.

* Not available on all models

■ **FCC statement**

RF Exposure Notice:

This wireless charger complies with FCC RF exposure guidelines at the distance of 3.94 inches (10 cm).

Keep a distance of at least 3.94 inches (10 cm) between all occupants and the wireless charger when charging.

Don't remove the wireless charger yourself; contact a dealer for assistance.

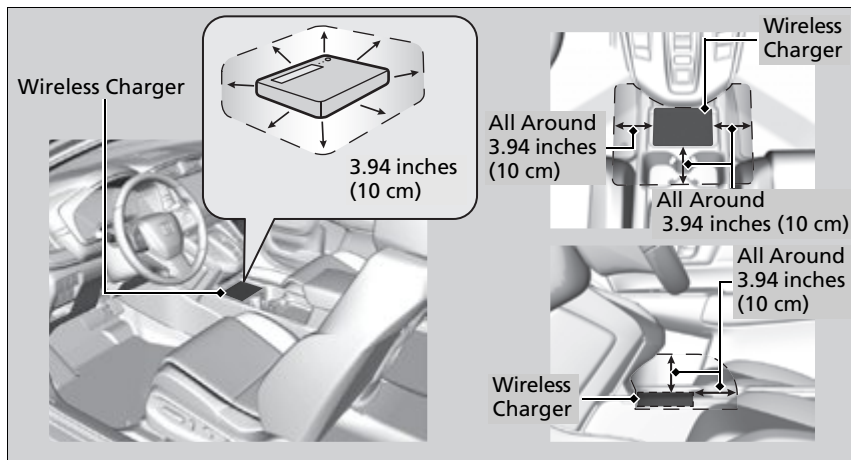

Controls

⌘ **Wireless Charger***

⌘ appears on the audio/information screen when the device is being charged by the wireless charger.

FCC statement

This product complies with the appropriate requirements or the required standards of FCC (Federal Communication Commission), described below:

This device complies with Part 18 of the FCC rules. This equipment generates, uses, and can radiate radio frequency energy and, if not installed and used per the instructions, may cause harmful interference to radio communications.

In order to use safely:

- Remove any metal objects from the charge pad before charging a device.
- Do not open the charger case.
- Do not use the charger if it malfunctions. Contact a dealer.

If the charger interferes with radio communications, attempt to correct the interference:

- Press and hold the switch on the charger for a few seconds to turn off the charger.

■ Heated Steering Wheel*

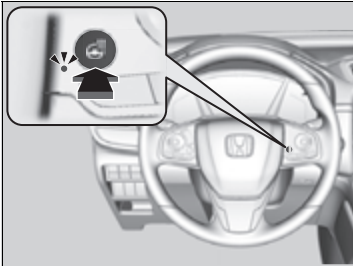

The heated steering wheel can be used when the power mode is in ON.

Press the button on the right side of the steering wheel.

When a comfortable temperature is reached, press the button again to turn it off.

The heated steering wheel is turned off every time you start the power system, even if you turned it on the last time you drove the vehicle.

▣ Heated Steering Wheel*

Do not use the heated steering wheel continuously when the power system is off. Under such conditions, the 12-volt battery may be weakened, making the power system difficult to start.

* Not available on all models

■ Seat Heaters*



The seat heaters can be used when the power mode is in ON.

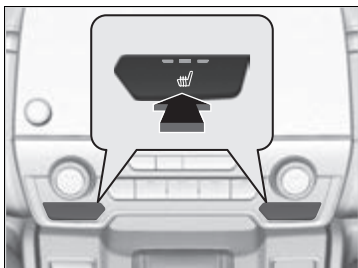

Press the seat heater button:

Once - The HI setting (three indicators on)

Twice - The MID setting (two indicators on)

Three times - The LO setting (one indicator on)

Four times - The OFF setting (no indicators on)

When the power mode is turned on after it is turned off, the previous setting is maintained.

☞ Seat Heaters*

⚠ WARNING

Heat induced burns are possible when using seat heaters.

Persons with a diminished ability to sense temperature (e.g., persons with diabetes, lowerlimb nerve damage, or paralysis) or with sensitive skin should not use seat heaters.

Do not use the seat heaters even in LO when the power system is off. Under such conditions, the 12-volt battery may be weakened, making the power system difficult to start.

After a certain period of time, the strength setting for the seat heater will automatically be reduced by one level at a time until the seat heater shuts off. The elapsed time varies according to the interior environment.

Using Automatic Climate Control

The automatic climate control system maintains the interior temperature you select. The system also selects the proper mix of heated or cooled air that raises or lowers the interior temperature to your preference as quickly as possible.

Models without SYNC button

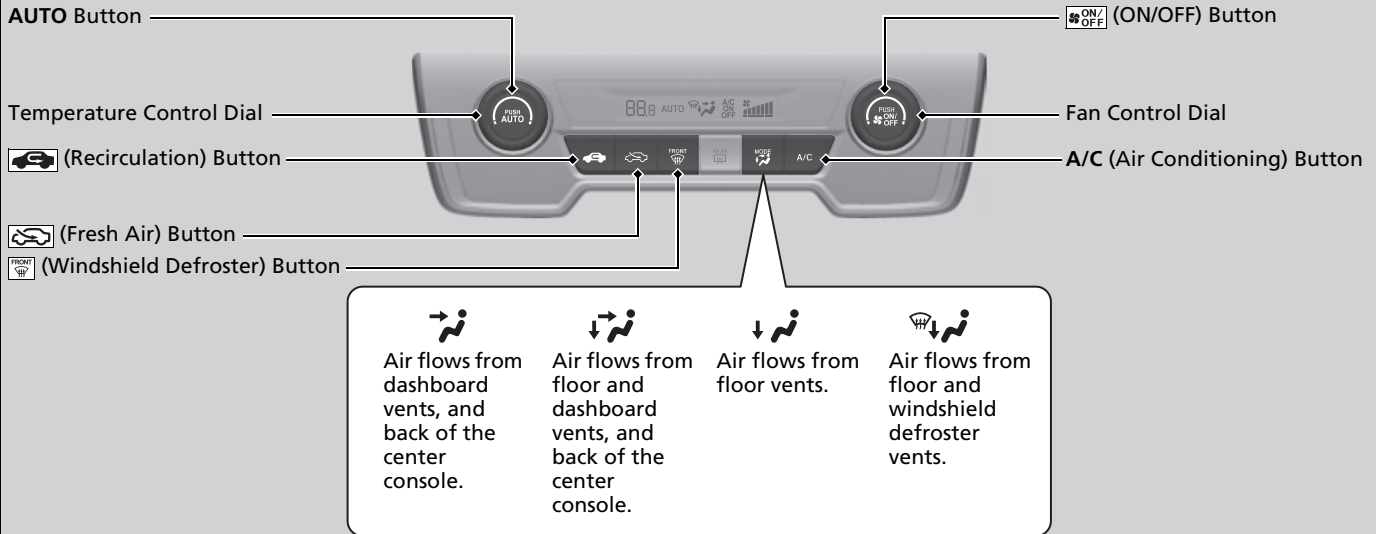

Models with SYNC button



Air flows from dashboard vents, and back of the center console.	Air flows from floor and dashboard vents, and back of the center console.	Air flows from floor vents.	Air flows from floor and windshield defroster vents.

Fan Control Buttons

CLIMATE Button

Driver's Side Temperature Control Dial

Passenger's Side Temperature Control Dial

AUTO Button

SYNC (Synchronization) Button

(ON/OFF) Button

(Windshield Defroster) Button

(Recirculation) Button

(Fresh Air) Button

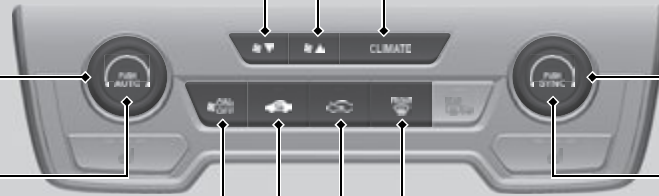

Use the system when the power system is on.

1. Press the **AUTO** button.

Models without SYNC button

2. Adjust the interior temperature using the temperature control dial.

Models with SYNC button

2. Adjust the interior temperature using the driver's side or passenger's side control dial.

All models

3. Press the  (ON/OFF) button to cancel.

▶▶ Using Automatic Climate Control

Models with SYNC button

Press the **CLIMATE** button to display **A/C, MODE**, and fan control information on the audio/information screen to operate manually. Select icon to turn **On** or **Off A/C**, change the vent mode, or change the fan speed. If any buttons are pressed while using the climate control system in auto, the function of the button that was pressed will take priority.

All models

The **AUTO** indicator will go off, but functions unrelated to the button that were pressed will be controlled automatically.

To prevent cold air from blowing in from outside, the fan may not start immediately when the **AUTO** button is pressed.



If the interior is very warm, you can cool it down more rapidly by partially opening the windows, turning the system on auto, and setting the temperature to low. Change the fresh mode to recirculation mode until the temperature cools down.

When you set the temperature to the lower or upper limit, **Lo** or **Hi** is displayed.

Pressing the  button switches the climate control system between on and off. When turned on, the system returns to your last selection.

While **ECON** mode is active, the climate control system may have reduced cooling performance.

■ Switching between the recirculation and fresh air modes

Press the  (recirculation) or  (fresh air) button to switch the mode depending on environmental conditions.

 Recirculation mode (indicator on): Recirculates air from the vehicle's interior through the system.

 Fresh air mode (indicator on): Maintains outside ventilation. Keep the system in fresh air mode in normal situations.

■ Defrosting the Windshield and Windows

Models without SYNC button

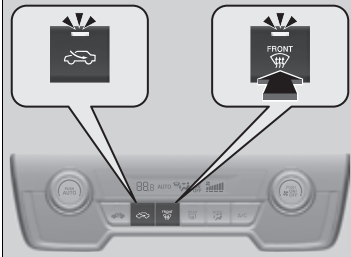

Pressing the  (windshield defroster) button turns the air conditioning system on and automatically switches the system to fresh air mode.

Press the  button again to turn off, the system returns to the previous settings.

Models with SYNC button

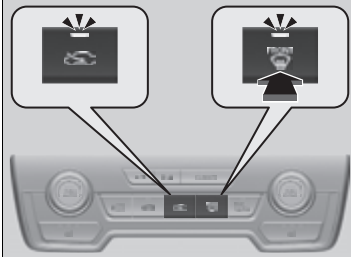

» Defrosting the Windshield and Windows

For your safety, make sure you have a clear view through all the windows before driving.

Do not set the temperature near the upper or lower limit.

When cold air hits the windshield, the outside of the windshield may fog up.

■ To rapidly defrost the windows

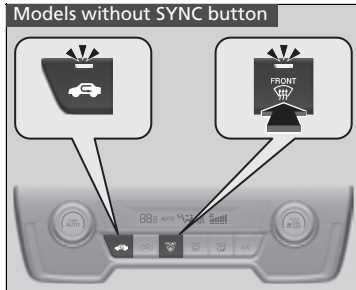

1. Press the  button.
2. Press the  button.

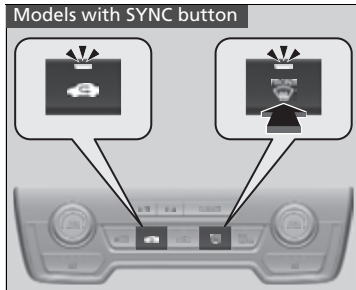

☒ To rapidly defrost the windows

After defrosting the windows, switch over to fresh air mode. If you keep the system in recirculation mode, the windows may fog up from humidity. This impedes visibility.

■ Synchronization Mode*

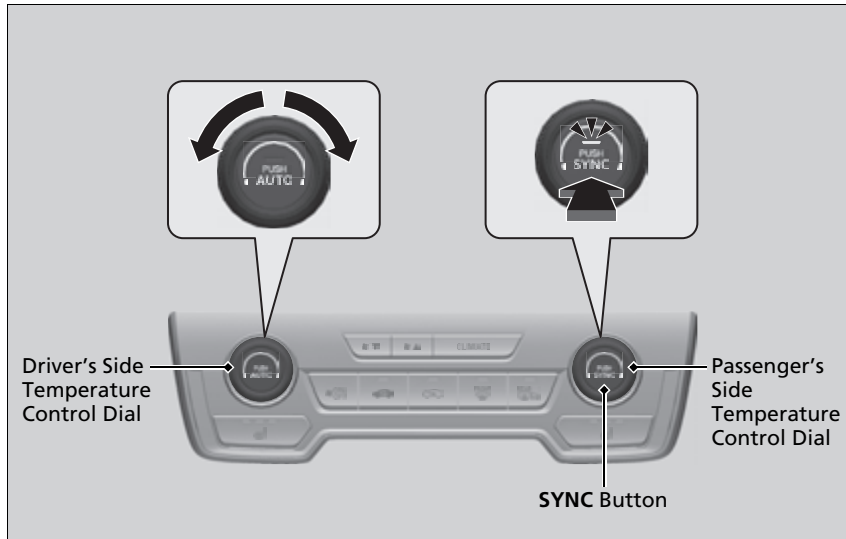

You can set the temperature synchronously for the driver's side and the passenger's side in synchronization mode.

1. Press the **SYNC** button.
 - The system switches to synchronization mode.
2. Adjust the temperature using the driver's side temperature control dial.

Press the **SYNC** button to return to dual mode.

☒ Synchronization Mode*

When you press the  button, the system changes to synchronization mode.

When the system is in dual mode, the driver's side temperature and the passenger's side temperature can be set separately.

Automatic Climate Control Sensors

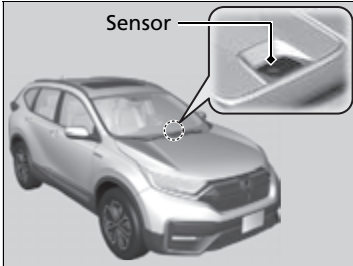

The automatic climate control system is equipped with sensors. Do not cover or spill any liquid on them.

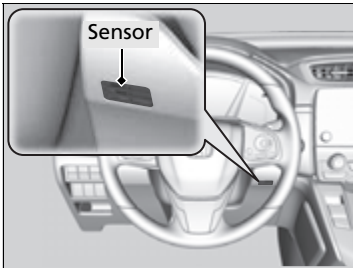

This page intentionally left blank.

Features

This chapter describes how to operate technology features.

Audio System

About Your Audio System	244
USB Port(s)	245
Audio System Theft Protection	247
Audio Remote Controls	248

Models with color audio system

Audio System Basic Operation

Audio/Information Screen	252
Adjusting the Sound	256
Display Setup	257
Playing AM/FM Radio	258
Playing an iPod	260
Playing Pandora®	263
Playing a USB Flash Drive	265

Playing <i>Bluetooth</i> ® Audio	268
Siri® Eyes Free	271

Models with Display Audio

Audio System Basic Operation

Audio/Information Screen	273
Adjusting the Sound	294
Display Setup	295
Voice Control Operation	297
Playing AM/FM Radio	301
Playing SiriusXM® Radio	305
Playing an iPod	312
Song By Voice™ (SBV)	315
Playing Pandora®	319
Playing a USB Flash Drive	321

Playing <i>Bluetooth</i> ® Audio	324
HondaLink®	326
Wi-Fi Connection	331
Siri® Eyes Free	332
Apple CarPlay™	333
Android Auto™	336

Audio Error Messages

General Information on the Audio

System	345
Customized Features	362, 369
HomeLink® Universal Transceiver* ..	395
<i>Bluetooth</i> ® HandsFreeLink®	398, 422
Compass*	456

* Not available on all models

About Your Audio System

The audio system features AM/FM radio and SiriusXM® Radio service*. It can also play USB flash drives, iPod, iPhone and *Bluetooth*® devices.

You can operate the audio system from the buttons and switches on the panel, the remote controls on the steering wheel, or the icons on the touchscreen interface*.

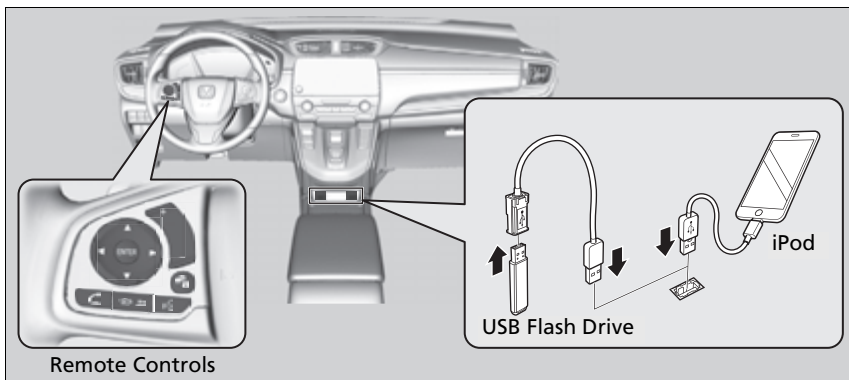

About Your Audio System

SiriusXM® Radio* is available on a subscription basis only. For more information on SiriusXM® Radio*, contact a dealer.

General Information on the Audio System P. 345

SiriusXM® Radio* is available in the United States and Canada, except Hawaii, Alaska, and Puerto Rico.

SiriusXM®* is a registered trademark of SiriusXM Radio, Inc.

iPod®, iPhone® and iTunes® are trademarks of Apple Inc.

State or local laws may prohibit the operation of handheld electronic devices while operating a vehicle.

USB Port(s)

Install the USB connector or the USB flash drive to the USB port.

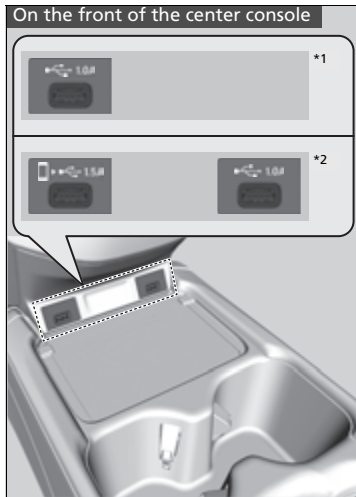

On the front of the center console

■ On the front of the center console

USB Port (1.0A)

The USB port (1.0A) is for playing audio files on a USB flash drive, connecting a cellular phone, and charging devices.

USB Port (1.5A)*

The USB port (1.5A) is for charging devices, playing audio files and connecting compatible phones with Apple CarPlay™ or Android Auto™.

- ▶ To prevent any potential issues, be sure to use an Apple MFi Certified Lightning Connector for Apple CarPlay™, and for Android Auto™, the USB cables should be certified by USB-IF to be compliant with USB 2.0 Standard.

*1: Models with color audio system

*2: Models with Display Audio

* Not available on all models

▶▶ USB Port(s)

- Do not leave the iPod or USB flash drive in the vehicle. Direct sunlight and high temperatures may damage it.
- We recommend that you use a USB cable if you are attaching a USB flash drive to the USB port.
- Do not connect the iPod or USB flash drive using a hub.
- Do not use a device such as a card reader or hard disk drive, as the device or your files may be damaged.
- We recommend backing up your data before using the device in your vehicle.
- Displayed messages may vary depending on the device model and software version.

If the audio system does not recognize the iPod, try reconnecting it a few times or reboot the device. To reboot, follow the manufacturer's instructions provided with the iPod or visit www.apple.com/ipod.

The USB port can supply up to 1.5A/2.5A of power. It does not output 1.5A/2.5A unless the device requests.

For amperage details, read the operating manual of the device that needs to be charged.

Under certain conditions, a device connected to the port may generate noise to the radio station you are listening to.

Continued

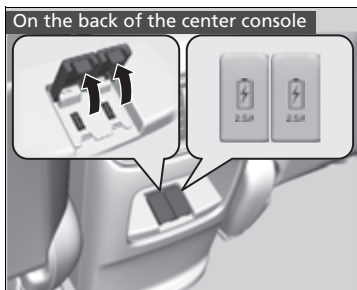

■ **On the back of the center console***

The USB ports (2.5A) are only for charging devices.

- ▶ You cannot play music even if you have connected music players to them.

Audio System Theft Protection

The audio system is disabled when it is disconnected from the power source, such as when the battery is disconnected or goes dead. In certain conditions, the system may display a code entry screen. If this occurs, reactivate the audio system.

■ Reactivating the audio system

1. Set the power mode to ON.
2. Turn on the audio system.
3. Press and hold the audio system power button for more than two seconds.
 - ▶ The audio system is reactivated when the audio control unit establishes a connection with the vehicle control unit. If the control unit fails to recognize the audio unit, you must go to a dealer and have the audio unit checked.

Audio Remote Controls

Allow you to operate the audio system while driving. The information is shown on the driver information interface.

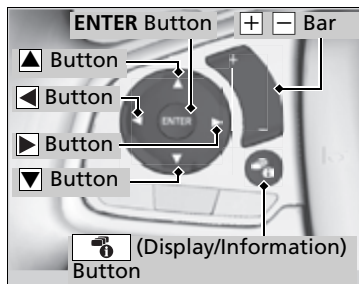

▲ ▼ Buttons

Press ▲ or ▼ to cycle through the audio mode as follows:

Models with color audio system

FM1 → FM2 → AM → USB/iPod → Pandora® → Bluetooth® Audio

Models with Display Audio

FM → AM → SiriusXM® → USB → iPod → Bluetooth® Audio → Pandora® → Apps → Audio Apps

Audio Remote Controls

Some modes appear only when an appropriate device or medium is used.

Depending on the *Bluetooth*® device you connect, some functions may not be available.

Press the (Hang-up/back) button to go back to the previous command or cancel a command.











Press the (Display/information) button to switch display.

Switching the Display P. 128

Models with Display Audio

ENTER Button

- When listening to a USB flash drive
1. From the audio screen in the driver information interface, press **ENTER** to display the folder list.
 2. Press ▲ or ▼ to select a folder.
 3. Press **ENTER** to display a list of tracks in that folder.
 4. Press ▲ or ▼ to select a track, then press **ENTER**.











- When listening to an iPod
 1. From the audio screen in the driver information interface, press **ENTER** to display the iPod music list.
 2. Press  or  to select a category.
 3. Press **ENTER** to display a list of items in the category.
 4. Press  or  to select an item, then press **ENTER**.
 - ▶ Press **ENTER** and press  or  repeatedly until the desired mode you want to listen to is displayed.
- When listening to Pandora®
 1. From the audio screen in the driver information interface, press **ENTER** to display the station list.
 2. Press  or  to select an item, then press **ENTER**.
- When listening to *Bluetooth*® Audio
 1. From the audio screen in the driver information interface, press **ENTER** to display the track list.
 2. Press  or  to select a track, then press **ENTER**.

(Volume) Bar

Press : To increase the volume.

Press : To decrease the volume.

Buttons

- When listening to the radio
 - Press** : To select the next preset radio station.
 - Press** : To select the previous preset radio station.
 - Press and hold** : To select the next strong station.
 - Press and hold** : To select the previous strong station.
- When listening to an iPod, USB flash drive, or *Bluetooth*® Audio
 - Press** : To skip to the next song.
 - Press** : To go back to the beginning of the current or previous song.
- When listening to a USB flash drive or *Bluetooth*® Audio*
 - Press and hold** : To skip to the next folder.
 - Press and hold** : To go back to the previous folder.
- When listening to Pandora®
 - Press** : To skip to the next track.
 - Press and hold** : To select the next station.
 - Press and hold** : To select the previous station.

Audio System Basic Operation

Models with color audio system

To use the audio system, the power mode must be in ACCESSORY or ON.

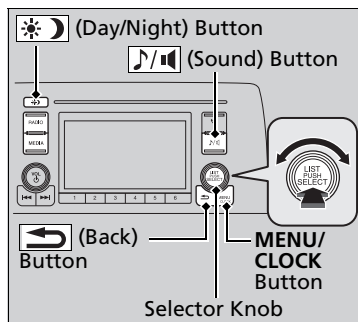

Use the selector knob or **MENU/CLOCK** button to access some audio functions.

Press  to switch between the normal and extended display for some functions.

Selector knob: Rotate left or right to scroll through the available choices. Press  to set your selection.

MENU/CLOCK button: Press to select any mode.

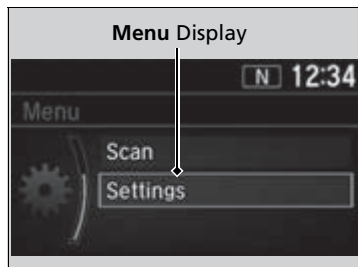

The available modes include wallpaper, display, clock, language setup, and play modes. Play mode choices include scan, random, repeat, and so on.



 **(Back) button:** Press to go back to the previous display.

 **(Sound) button:** Press to select the sound setting mode.

 **(Day/Night) button:** Press to change the audio/information screen brightness.

Press the  button, then adjust the brightness using .

- ▶ Each time you press the  button, the mode switches between the daytime mode, nighttime mode and off mode.

Audio System Basic Operation

These indications are used to show how to operate the selector knob.

Rotate  to select.

Press  to enter.

Menu Items

- ▶ **Adjust Clock** P. 150
- ▶ **Wallpaper Setup** P. 254
- ▶ **Display Setup** P. 257
- ▶ **Customized Features** P. 362

Press the buttons on the steering wheel to change any audio setting.

- ▶ **Audio Remote Controls** P. 248

Audio/Information Screen

Displays the audio status and wallpaper. From this screen, you can go to various setup options.

■ Switching the Display

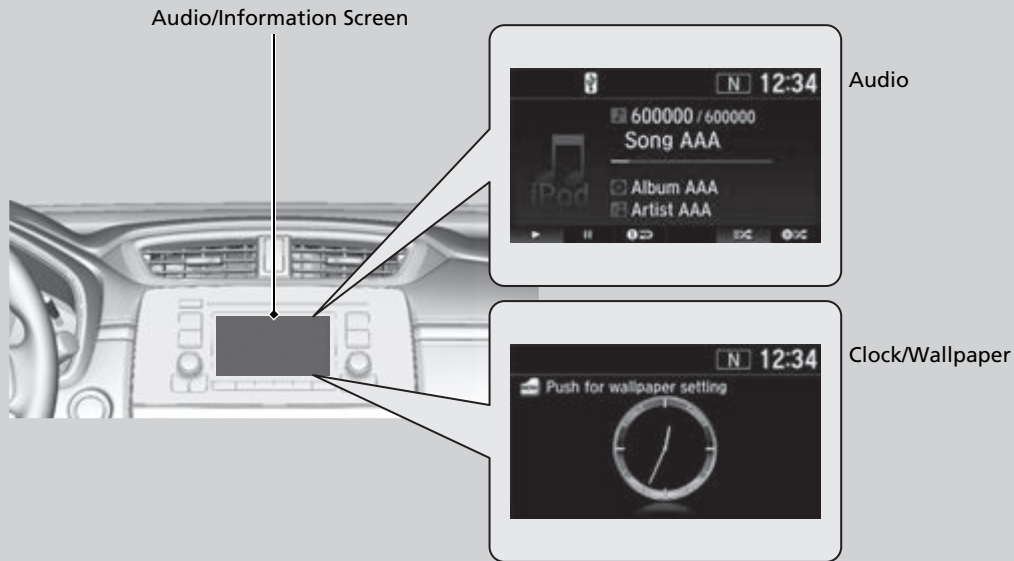







■ Audio

Shows the current audio information.

■ Clock/Wallpaper

Shows a clock screen or an image you import.

■ Change display

1. Press the **MENU/CLOCK** button.
2. Rotate  to select **Settings**, then press .
3. Rotate  to select **Display Change**, then press .
4. Rotate  to select **Wallpaper**, then press 
 - ▶ If you want to return to the audio/information screen, select **Audio**.

■ Wallpaper Setup

You can change, store, and delete the wallpaper on the audio/information screen.

■ Import wallpaper

You can import up to three images, one at a time, for wallpaper from a USB flash drive.

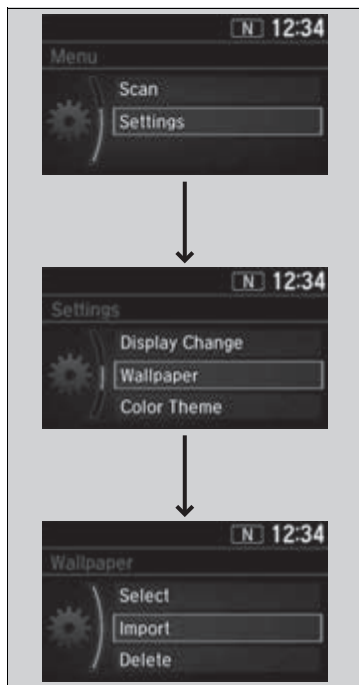









1. Connect the USB flash drive to the USB port.
 ▶ **USB Port(s)** P. 245
2. Press the **MENU/CLOCK** button.
3. Rotate to select **Settings**, then press .
4. Rotate to select **Wallpaper**, then press .
5. Rotate to select **Import**, then press .
 ▶ The picture name is displayed on the list.
6. Rotate to select a desired picture, then press .
 ▶ The selected picture is displayed.
7. Press to save the picture.
8. Press to select **OK**.
9. Rotate to select a location to save the picture, then press .
 ▶ The display will return to the wallpaper setting screen.







▶▶ Wallpaper Setup

- When importing wallpaper files, the image must be in the USB flash drive's root directory. Images in a folder cannot be imported.
- The file name must be fewer than 64 characters.
- The file format of the image that can be imported is BMP (bmp) or JPEG (jpg).
- The individual file size limit is 2 MB.
- The maximum image size is 1,920 x 936 pixels. If the image size is less than 480 x 234 pixels, the image is displayed in the middle of the screen with the extra area appearing in black.
- Up to 255 files can be selected.
- If the USB flash drive does not have any pictures, the error message appears.
- The wallpaper setup is limited while driving.







■ Select wallpaper

1. Press the **MENU/CLOCK** button.
2. Rotate  to select **Settings**, then press .
3. Rotate  to select **Wallpaper**, then press .
4. Rotate  to select **Select**, then press .
 - ▶ The screen changes to the wallpaper list.
5. Rotate  to select a desired wallpaper, then press .

■ To view wallpaper once it is set

1. Press the **MENU/CLOCK** button.
2. Rotate  to select **Settings**, then press .
3. Rotate  to select **Display Change**, then press .
4. Rotate  to select **Wallpaper**, then press .
5. Press the  (Back) button until the top screen is displayed.

■ Delete wallpaper

1. Press the **MENU/CLOCK** button.
2. Rotate  to select **Settings**, then press .
3. Rotate  to select **Wallpaper**, then press .
4. Rotate  to select **Delete**, then press .
 - ▶ The screen changes to the wallpaper list.
5. Rotate  to select a wallpaper that you want to delete, then press .
6. Rotate  to select **Yes**, then press .
 - ▶ The display will return to the wallpaper setting screen.

▶▶ Wallpaper Setup

To go back to the previous screen, press the  (Back) button.

When the file size is large, it takes a while to be previewed.

Adjusting the Sound

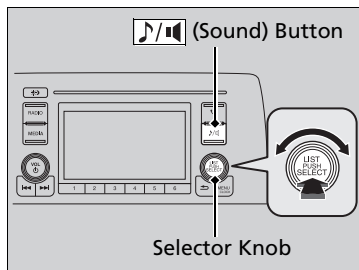

Press the (Sound) button, and rotate to scroll through the following choices:

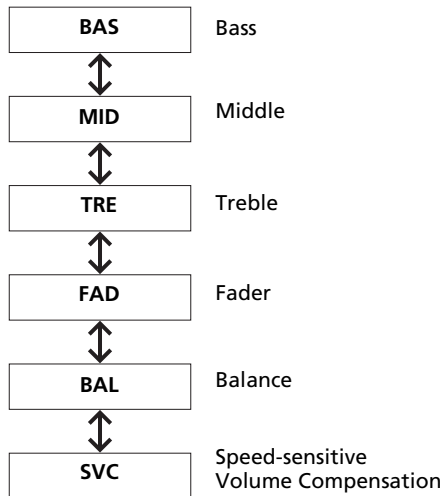
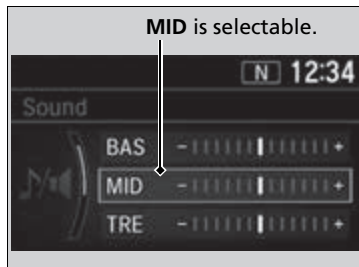

Rotate to adjust the sound setting, then press .

▶▶ Adjusting the Sound









The **SVC** has four modes: **Off**, **Low**, **Mid**, and **High**. **SVC** adjusts the volume level based on the vehicle speed. As you go faster, audio volume increases. As you slow down, audio volume decreases.

Display Setup

You can change the brightness or color theme of the audio/information screen.







■ Changing the Screen Brightness

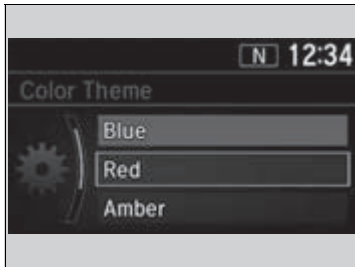

1. Press the **MENU/CLOCK** button.
2. Rotate  to select **Settings**, then press .
3. Rotate  to select **Display Adjustment**, then press .
4. Rotate  to select **Brightness**, then press .
5. Rotate  to adjust the setting, then press .

■ Changing the Screen's Color Theme



1. Press the **MENU/CLOCK** button.
2. Rotate  to select **Settings**, then press .
3. Rotate  to select **Color Theme**, then press .
4. Rotate  to select the setting you want, then press .

▶▶ Changing the Screen Brightness

You can change the **Contrast** and **Black Level** settings in the same manner.

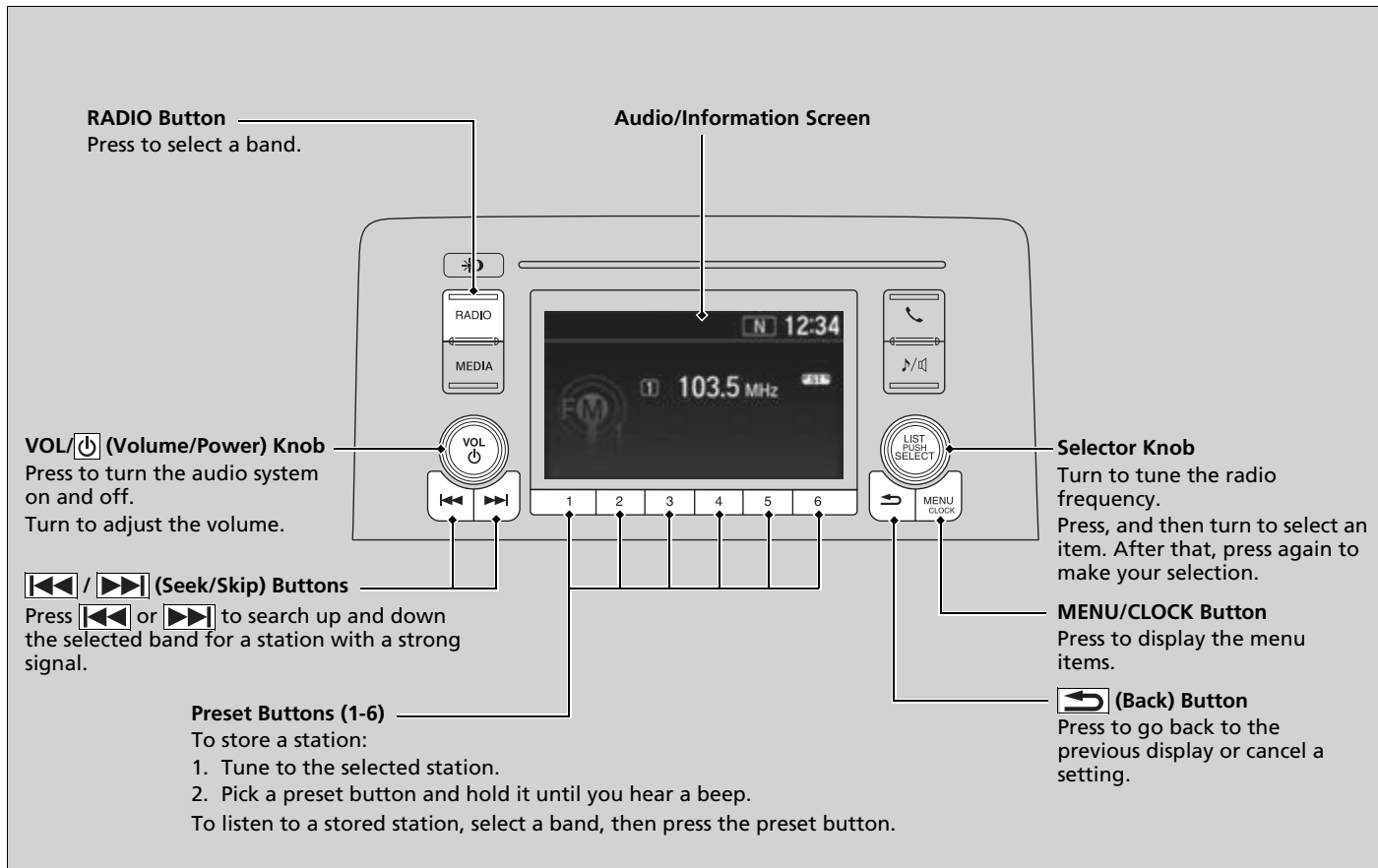

Playing AM/FM Radio



Radio Data System (RDS)

Provides text data information related to your selected RDS capable FM station.

■ To find an RDS station from Station List

1. Press  while listening to an FM station.
2. Rotate  to select the station, then press .



■ Update List

Updates your available station list at any time.

1. Press  while listening to an FM station.
2. Rotate  to select **Update List**, then press .

■ Radio text

Displays the radio text information of the selected RDS station.

1. Press the **MENU/CLOCK** button.
2. Rotate  to select **Settings**, then press .
3. Rotate  to select **RDS Settings**, then press .
4. Rotate  to select **Radio Text**, then press .

■ Scan

Samples each of the strongest stations on the selected band for 10 seconds.

1. Press the **MENU/CLOCK** button.
2. Rotate  to select **Scan**, then press .

To turn off scan, press .

▶▶ Playing AM/FM Radio

The **ST** indicator appears on the display indicating stereo FM broadcasts.
Stereo reproduction in AM is not available.

You can store 6 AM stations and 12 FM stations into the preset memory. FM1 and FM2 let you store 6 stations each.

Switching the Audio Mode
Press the audio source selecting buttons on the steering wheel.

▶▶ **Audio Remote Controls** P. 248

▶▶ Radio Data System (RDS)

When you select an RDS-capable FM station, the RDS automatically turns on, and the frequency display changes to the station name. However, when the signals of that station become weak, the display changes from the station name to the frequency.

Playing an iPod

Using your USB connector, connect the iPod to the USB port, then select the USB mode.

➔ **USB Port(s)** P. 245

Features

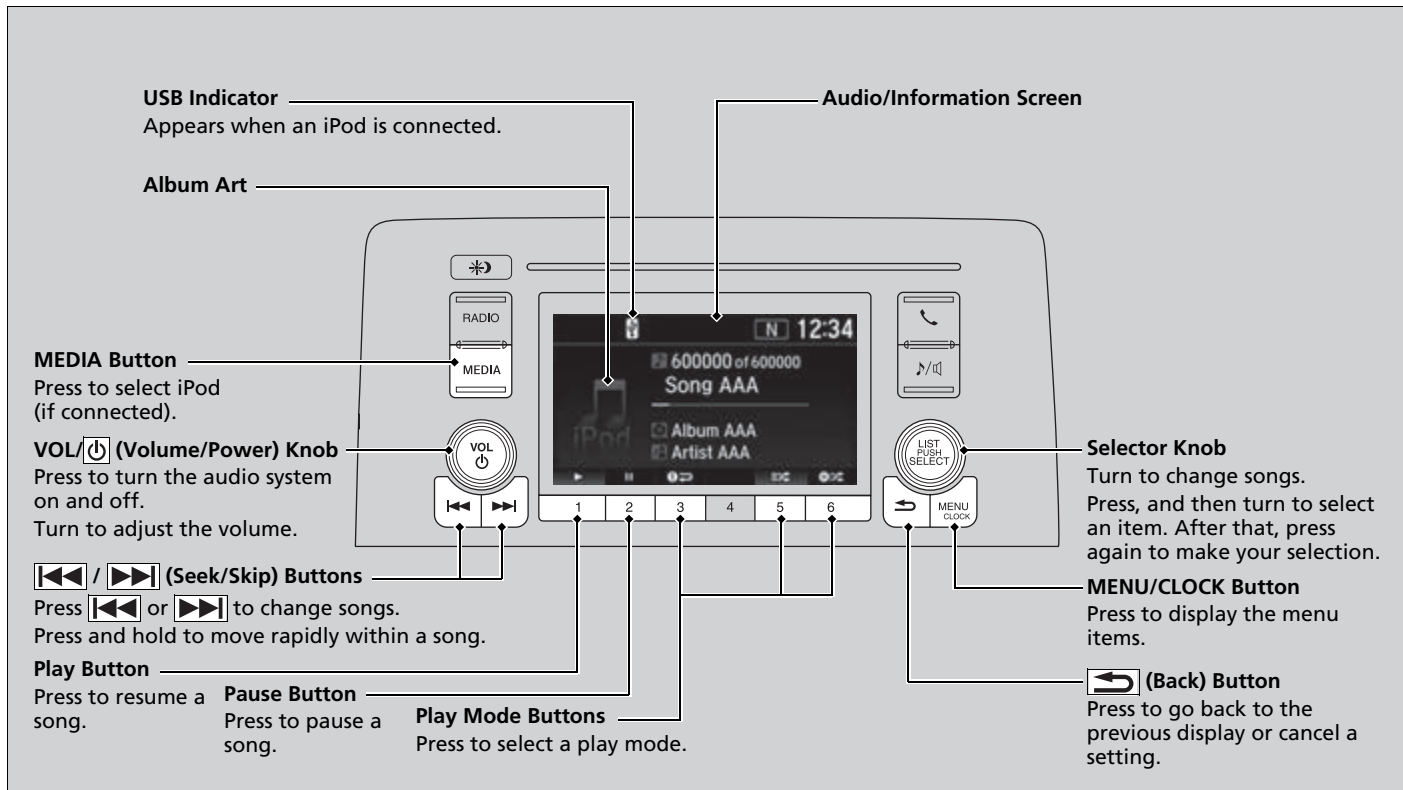

How to Select a Song from the iPod Music List with the Selector Knob

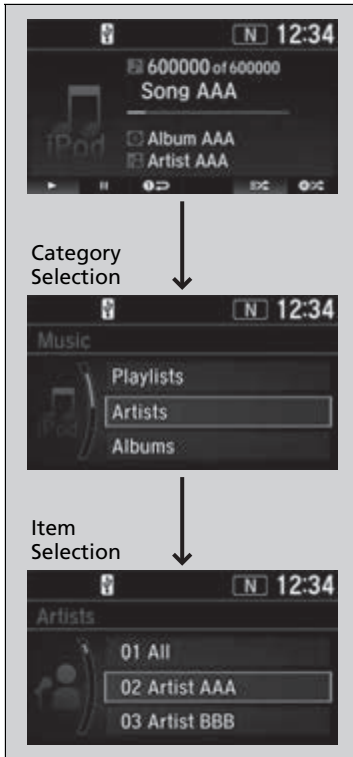

1. Press to display the iPod music list.

2. Rotate to select a category.

3. Press to display a list of items in the category.

4. Rotate to select an item, then press .

- ▶ Press and rotate repeatedly until a desired item you want to listen to is displayed.

▶▶ Playing an iPod

Available operating functions vary on models or versions. Some functions may not be available on the vehicle's audio system.

If there is a problem, you may see an error message on the audio/information screen.

▶ **iPod/USB Flash Drive** P. 340

■ How to Select a Play Mode

You can select repeat and shuffle modes when playing a song.

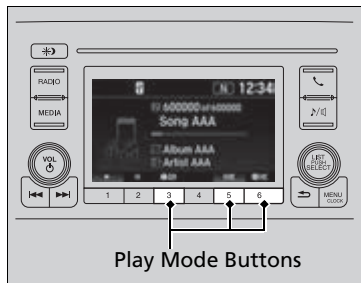

Available mode icons appear above the play mode buttons.

Press the button corresponding to the mode you want to select.

■ To turn off a play mode

Press the selected button.

▶▶ How to Select a Play Mode

Play Mode Menu Items

Shuffle Albums: Plays all available albums in a selected category (playlists, artists, albums, songs, genres, or podcasts, audiobooks, and composers) in random order.

Shuffle All: Plays all available songs in a selected category (playlists, artists, albums, songs, genres, podcasts, audiobooks, and composers) in random order.

Repeat One Track: Repeats the current song.

You can also select a play mode by pressing the **MENU/CLOCK** button.

Rotate to select **Play Mode**, then press .

Rotate to select a mode, then press .

To turn it off, rotate to select **Normal Play**, then press .

Playing Pandora®

Your audio system allows you to listen to music from the Pandora® app on a compatible smartphone.

This function is available when the phone is paired and connected to the vehicle's *Bluetooth*® HandsFreeLink® (HFL) system, or with an iPhone, you can connect using your USB cable to the USB port.

▶ **Phone Setup** P. 404

▶ **USB Port(s)** P. 245

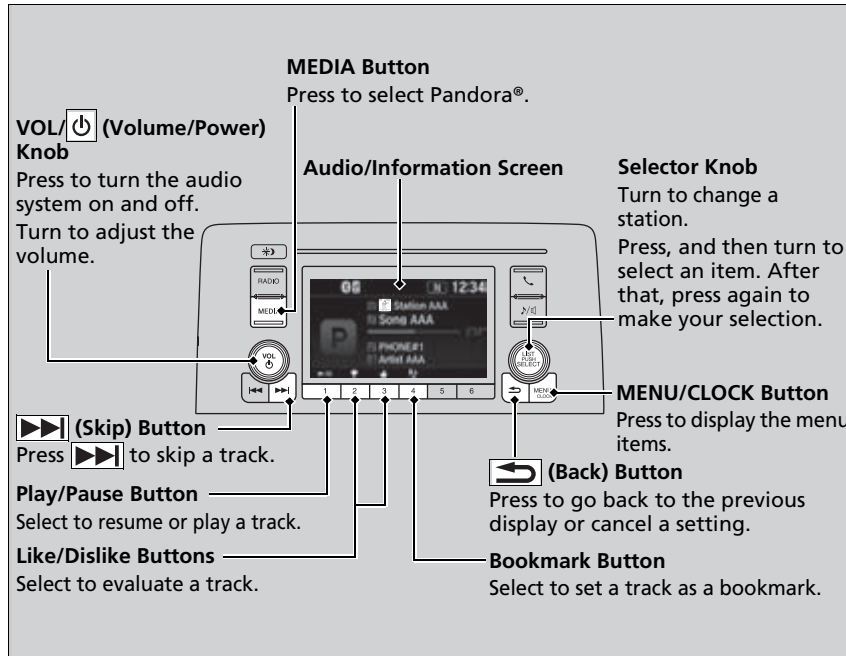

Continued

▶▶ Playing Pandora®

Pandora®, the Pandora logo, and the Pandora trade dress are trademarks or registered trademarks of Pandora Media, Inc., used with permission. Pandora is only available in certain countries. Visit the Pandora website for more information.

To find out if your phone is compatible with this feature, visit automobiles.honda.com/handsfreelink/, or call 1-888-528-7876.

To use this service in your vehicle, the Pandora® app must first be installed on your phone. Visit www.pandora.com for more information.

Pandora® is free, personalized radio that plays music and comedy you'll love. Just start with the name of one of your favorite artists, tracks, comedians or composers and Pandora® will create a custom station that plays similar tracks. Pandora® also features hundreds of genre stations ranging from Dubstep to Smooth Jazz to Power Workout.

If you cannot operate Pandora® through the audio system, it may be streaming through *Bluetooth*® Audio. Make sure Pandora® mode on your audio system is selected.



■ How to Create a Station

You can create a station when playing Pandora®.



1. Press the **MENU/CLOCK** button.

2. Rotate  to select **New Station**, then press .

3. Rotate  to select an item, then press .
▶ You can select **Genre**, **Current Artist**, or **Current Track**.



▶▶ How to Create a Station

Available operating functions vary on software versions. Some functions may not be available on the vehicle's audio system.

If there is a problem, you may see an error message on the audio/information screen.

▶ **Pandora®** P. 342

Pandora® may limit the total number of skips allowed on the service. If you dislike a track after the skip limit has been reached, your feedback will be saved but the current track will continue to play.

To change stations, press  on the main Pandora® screen, and rotate  to select **Station List**, and then select a new station.

Playing a USB Flash Drive

Your audio system reads and plays sound files on a USB flash drive in either MP3, WMA, AAC*1 or WAV format.

Connect your USB flash drive to the USB port, then press the **MEDIA** button.

📌 **USB Port(s)** P. 245

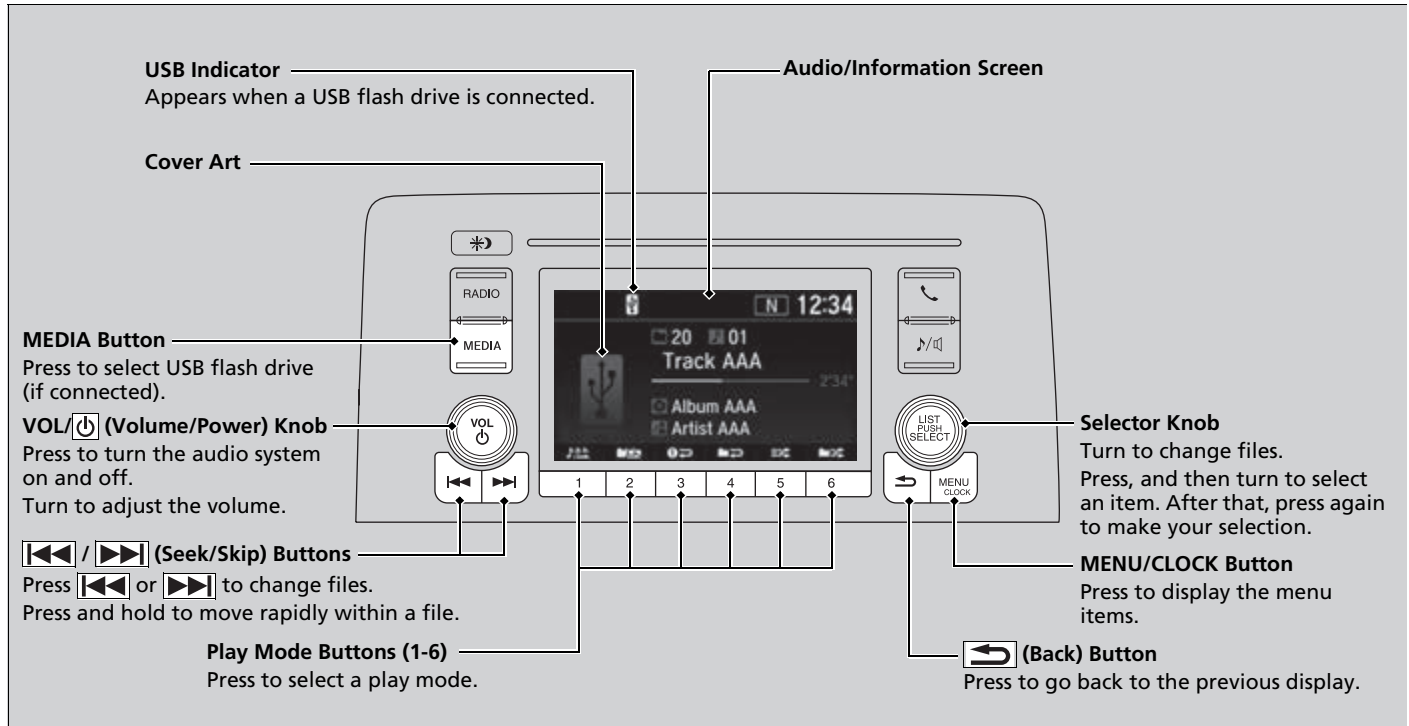

*1: Only AAC format files recorded with iTunes are playable on this unit.

■ How to Select a File from a Folder with the Selector Knob

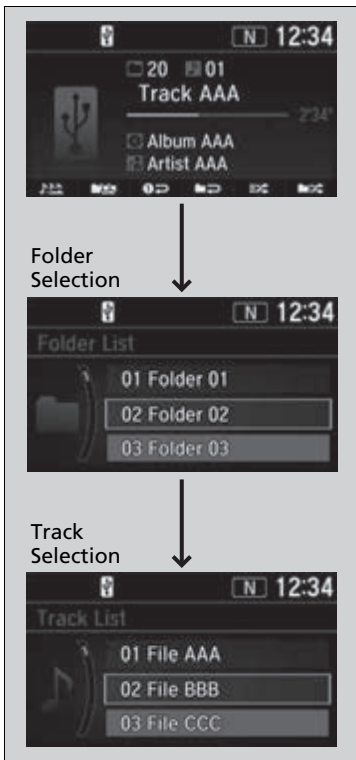

1. Press to display a folder list.
2. Rotate to select a folder.
3. Press to display a list of files in that folder.
4. Rotate to select a file, then press .

▶▶ Playing a USB Flash Drive

Use the recommended USB flash drives.

▶ **General Information on the Audio System**
P. 345

Files in WMA format protected by digital rights management (DRM) cannot be played.

The audio system displays **Unplayable File**, and then skips to the next file.

If there is a problem, you may see an error message on the audio/information screen.

▶ **iPod/USB Flash Drive** P. 340

How to Select a Play Mode

You can select repeat, random, and scan modes when playing a file.

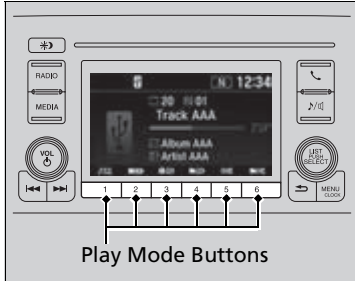

Available mode icons appear above the play mode buttons.

Press the button corresponding to the mode you want to select.

To turn off a play mode

Press the selected button.

How to Select a Play Mode

Play Mode Menu Items

Repeat

 **Repeat One Folder:** Repeats all files in the current folder.

 **Repeat One Track:** Repeats the current file.

Random

 **Random in Folder:** Plays all files in the current folder in random order.

 **Random All:** Plays all files in random order.



Scan



 **Scan Folders:** Provides 10-second sampling of the first file in each of the main folders.

 **Scan Tracks:** Provides 10-second sampling of all files in the current folder.

You can also select a play mode by pressing the **MENU/CLOCK** button.

Rotate  to select **Play Mode**, then press .

Rotate  to select a mode, then press .

To turn it off, rotate  to select **Normal Play**, then press .

Playing *Bluetooth*® Audio

Your audio system allows you to listen to music from your *Bluetooth*-compatible phone.

This function is available when the phone is paired and connected to the vehicle's *Bluetooth*® HandsFreeLink® (HFL) system.

➤ **Phone Setup** P. 404

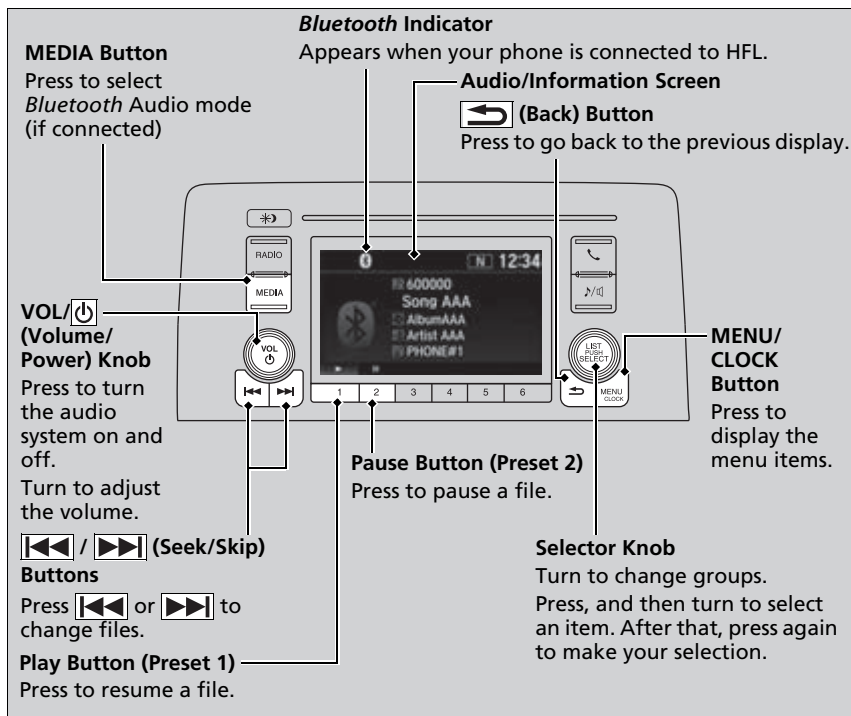

▶▶ Playing *Bluetooth*® Audio

Not all *Bluetooth*-enabled phones with streaming audio capabilities are compatible with the system. For a list of compatible phones, visit automobiles.honda.com/handsfreelink/, or call 1-888-528-7876.

In some states, it may be illegal to perform some data device functions while driving.

Only one phone can be used with HFL at a time. When there are more than two paired phones in the vehicle, the system automatically connects to the prioritized phone. You can assign priority to a phone in the **Priority Device Setup**.

➤ **Customized Features** P. 362

If more than one phone is paired to the HFL system, there will be a delay before the system begins to play.

In some cases, the name of the artist, album, or track may not appear correctly.

Some functions may not be available on some devices.

■ To Play *Bluetooth*® Audio Files

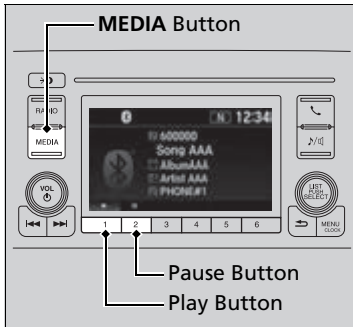

1. Make sure that your phone is paired and connected to HFL.
2. Press the **MEDIA** button until the *Bluetooth*® Audio mode is selected.

If the phone is not recognized, another HFL-compatible phone, which is not compatible for *Bluetooth*® Audio, may already be connected.

■ To pause or resume a file

Press the **Play** or **Pause** button to select a mode.

▶▶ To Play *Bluetooth*® Audio Files

To play the audio files, you may need to operate your phone. If so, follow the phone maker's operating instructions.

The pause function may not be available on some phones.

If any audio device is connected to the USB port, you may need to press the **MEDIA** button repeatedly to select the *Bluetooth*® Audio system.

Switching to another mode pauses the music playing from your phone.

■ How to Select a Song from the Music Search List with the Selector Knob

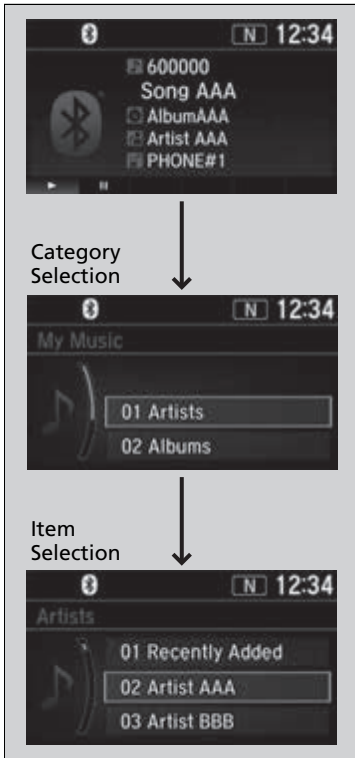

1. Press to display the music search list.

2. Rotate to select a category.

3. Press to display a list of items in the category.

4. Rotate to select an item, then press .

▶ Press and rotate repeatedly until a desired item you want to listen to is displayed.

▶▶ How to Select a Song from the Music Search List with the Selector Knob

Depending on the *Bluetooth*® device you connect, some or all of the categories may not be displayed.

Siri® Eyes Free

You can talk to Siri using the  (Talk) button on the steering wheel when your iPhone is paired to the *Bluetooth*® HandsFreeLink® (HFL) system.

 **Phone Setup** P. 404

■ Using Siri® Eyes Free

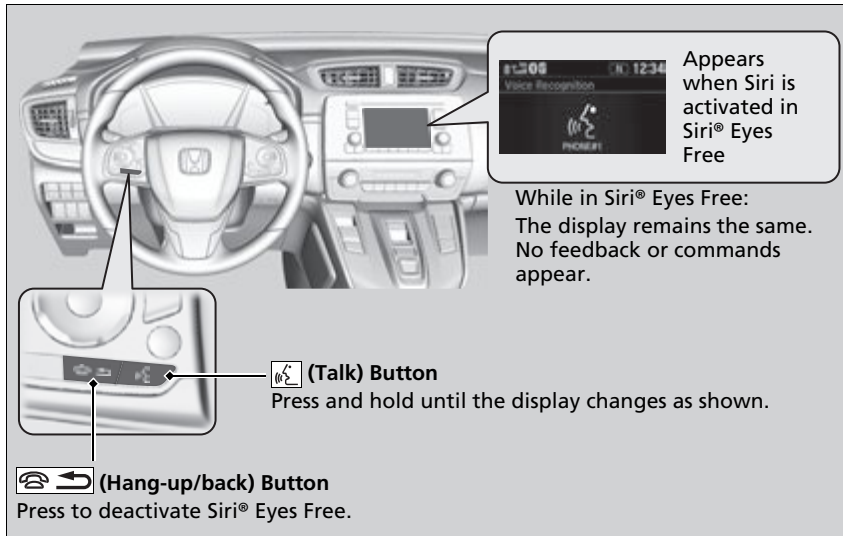

▶ Siri® Eyes Free

Siri is a trademark of Apple Inc.

Check Apple Inc. website for features available for Siri.

We recommend against using Siri other than in Siri® Eyes Free while operating a vehicle.

▶ Using Siri® Eyes Free

Some commands work only on specific phone features or apps.

This audio system cannot operate the audio functions by using Siri® Eyes Free.

Models with Display Audio

To use the audio system function, the power mode must be in ACCESSORY or ON.

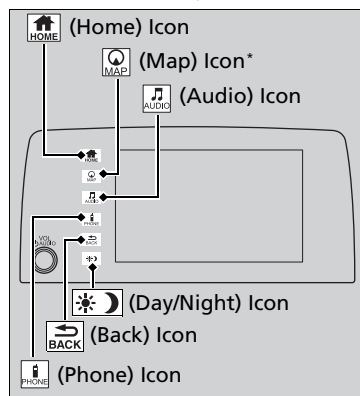



 (Home): Select to go to the home screen.

 **Switching the Display** P. 273

 (Map)*: Select to display the map screen.



 **Refer to the Navigation System Manual**

 (Audio): Select to display the audio screen.

 (Phone): Select to display the phone screen.

 (Back): Select to go back to the previous screen when the icon is illuminated.

 (Day/Night): Select to change the audio/information screen brightness.

Select  once and select  or  to make an adjustment.

► Each time you select , the mode switches among the daytime mode, nighttime mode and off mode.

Audio System Basic Operation

Audio Menu Items

 **Station List** P. 302, 304

 **Music Search List** P. 313, 322

 **Scan** P. 303, 311, 323

 **Play Mode** P. 314, 323

Audio/Information Screen

Displays the audio status and wallpaper. From this display, you can go to various setup options.

■ Switching the Display

■ Using the (display/information) button

Press the  (display/information) button to change the display.

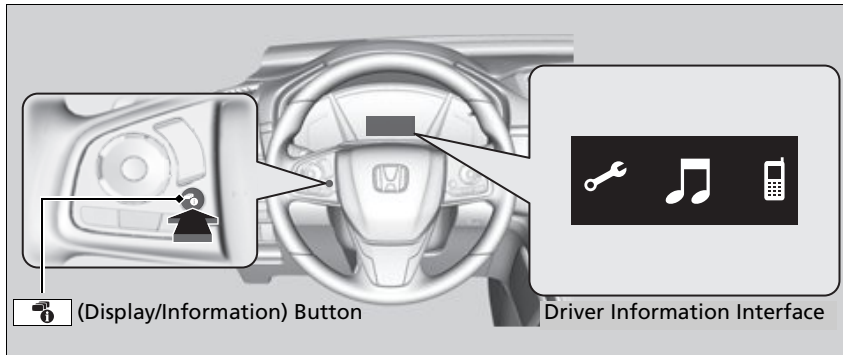



☒ Using the (display/information) button

You can edit, add, and delete the contents shown on the driver information interface.

☒ Customizing the Meter P. 278

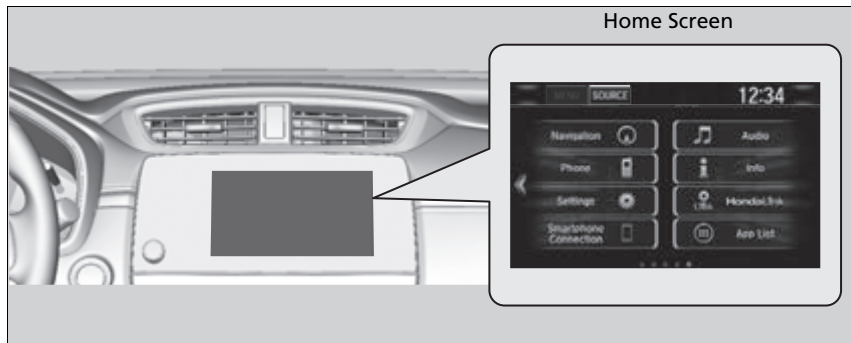
■ Using the audio/information screen



Select  to go to the home screen.
Select the following icons on the home screen.

■ Phone

Displays the HFL information.

➤ **Bluetooth® HandsFreeLink®** P. 422

▶▶ Using the audio/information screen

Touchscreen operation

- Use simple gestures - including touching, swiping and scrolling - to operate certain audio functions.
- Some items may be grayed out during driving to reduce the potential for distraction.
- You can select them when the vehicle is stopped or use voice commands.
- Wearing gloves may limit or prevent touchscreen response.

You can change the touchscreen sensitivity setting.

➤ **Customized Features** P. 369

■ Info

Displays **Trip Computer**, **Voice Info**, **Clock/Wallpaper**, or **System/Device Information**. Select **MENU** on the **Info Menu** screen to see all available options: **Trip Computer**, **Voice Info**, **Clock/Wallpaper** and **System/Device Information**.

Trip Computer:

- **Current Drive** tab: Displays the current trip information.
- **History of Trip A** tab: Displays information for the three previous drives. The information is stored every time you reset Trip A.
To delete the history manually, select **Delete history** on the **History of Trip A** tab. The confirmation message appears on the screen, then select **Yes**.

Voice Info: Displays the All Commands list.

Clock/Wallpaper: Displays the clock and wallpaper.

System/Device Information:

- **System Info**: Displays the software version of the audio system.
- **USB Info**: Displays the memory usage of the USB device.

■ Audio

Displays the current audio information.

■ Settings

Enters the customizing menu screen.

- ☒ **Customized Features** P. 369

■ Navigation*

Displays the navigation screen.

- ☒ **Refer to the Navigation System Manual**

* Not available on all models

■ **HondaLink**

Displays the HondaLink® screen.

➤ **HondaLink®** P. 326

■ **Smartphone Connection**

Displays the Apple CarPlay™ or Android Auto™.

➤ **Apple CarPlay™** P. 333

➤ **Android Auto™** P. 336

■ **App List**

Adds or removes apps or widgets on the home screen.

➤ **Home Screen** P. 284

■ **Instrument Panel**

Selects from three customizable settings for the driver information interface.

Changing the Home Screen Icon Layout



1. Select .
2. Select and hold an icon.
 - ▶ The screen switches to the customization screen.
3. Drag and drop the icon to where you want it to be.
4. Select **OK**.
 - ▶ The screen will return to the home screen.

■ Customizing the Meter

You can edit, add, or delete the meter contents on the driver information interface.

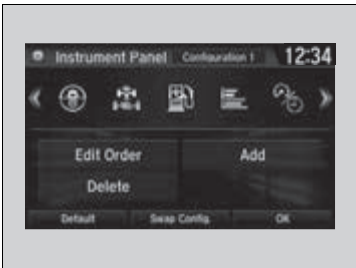

1.  HOME
2. **Settings**
3. **System**
4. **Configuration of Instrument Panel**

» Customizing the Meter

You can store up to three customized configurations. To select or customize a configuration, select **Swap Config.**

When you select **Swap Config.** during customization, the settings you changed will be saved.

When you select  BACK during customization, the settings you changed will not be saved and you will be returned to the **Instrument Panel** screen.

■ Editing order

To change the order of the icons on the driver information interface, first select:

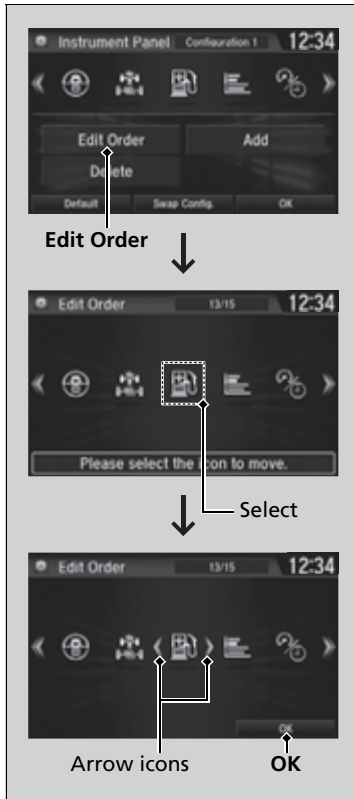

1. Edit Order

2. Select the icon you want to move.

- ▶ You will see arrows on both sides of the selected icon.

3. Select the left or right arrow repeatedly to move the icon to your desired position.

4. Select **OK**.

- ▶ The screen will return to the **Instrument Panel** screen.

▶▶ Editing order

You can use an alternative method to change the order of the icons. First select:

1. **Edit Order**

2. Select and hold the icon you want to move.

3. Drag and drop the icon to where you want it to be.

4. Select **OK**.

- ▶ The screen will return to the **Instrument Panel** screen.

■ Adding contents

You can add icons to the driver information interface. To add icons, first select:

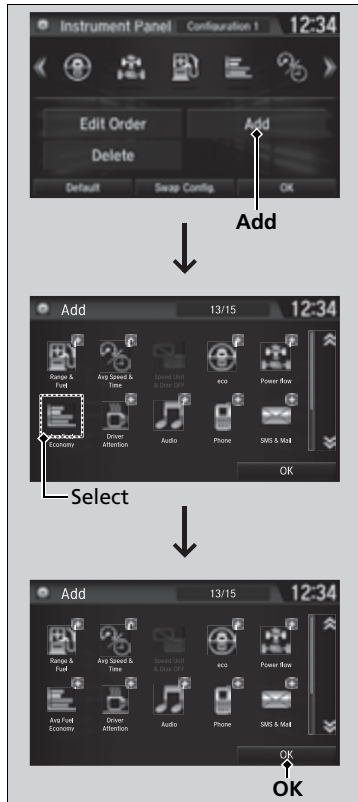

1. Add

2. Select an icon you want to add.

- ▶ You will see a plus mark on the upper right hand corner of the selected icon.

3. Select **OK**.

- ▶ The screen will return to the **Instrument Panel** screen.

▶▶ Adding contents

Icons that are grayed out cannot be selected.

If an icon has a plus mark in the upper-right corner, it means that the icon has already been added.

■ Deleting contents

To delete contents on the driver information interface, first select:

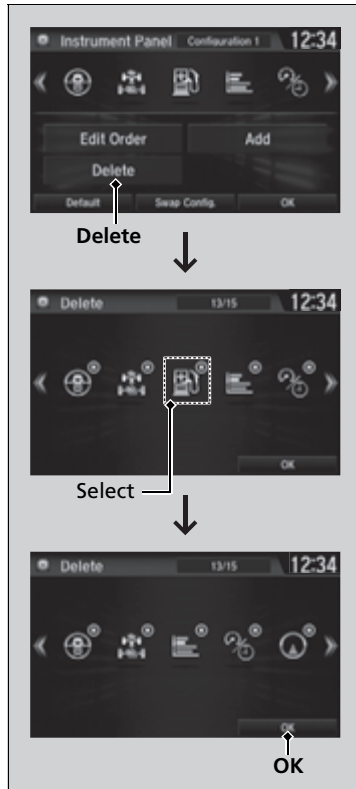

1. Delete

2. Select an icon you want to delete.

- ▶ The icon with an X on the upper right hand corner can be deleted.

3. Select OK.

- ▶ The screen will return to the **Instrument Panel** screen.

▶▶ Deleting contents

You can also delete contents by selecting:

1. **Delete** or **Edit Order**

2. Select and hold an icon you want to delete.
3. Drag and drop the icon to the trash icon.

4. Select **OK**.

- ▶ The screen will return to the **Instrument Panel** screen.

■ Wallpaper Setup

You can change, store, and delete the wallpaper on the audio/information screen.

■ Import wallpaper

You can import up to five images, one at a time, for wallpaper from a USB flash drive.

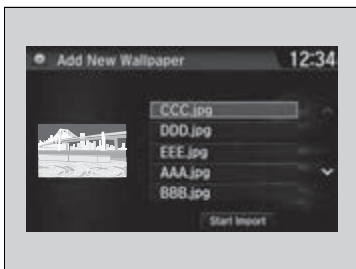
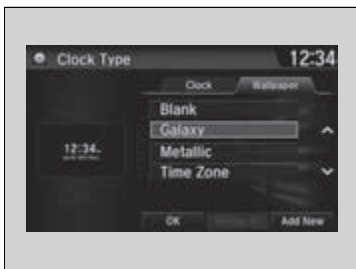



1. Connect the USB flash drive to the USB port.
 ▶ **USB Port(s)** P. 245
2. Select **Settings**.
3. Select **Clock**.
4. Select **Clock/Wallpaper Type**, select **Next**, then open the **Wallpaper** tab.
5. Select **Add New**.
 ▶ The picture name is displayed on the list.
6. Select a desired picture.
 ▶ The preview is displayed on the left side on the screen.
7. Select **Start Import** to save the data.
 ▶ The display will return to the wallpaper list.

▶▶ Wallpaper Setup

The wallpaper you set up on **Clock/Wallpaper Type** cannot be displayed on the driver information interface.

- When importing wallpaper files, the image must be in the USB flash drive's root directory. Images in a folder cannot be imported.
- The file name must be fewer than 256 bytes.
- The file format of the image that can be imported is BMP (bmp) or JPEG (jpg).
- The individual file size limit is 5 MB.
- The maximum image size is 4,096 × 4,096 pixels. If the image size is less than 800 × 480 pixels, the image is displayed in the middle of the screen with the extra area appearing in black.
- If the USB flash drive does not have any pictures, the **No files detected** message appears.

After changing the screen interface design, you can change the wallpaper by following procedure.

1. Select .
2. Select .
3. Select and hold empty space on the home screen. The pop-up menu appears on the screen.
4. Select **Change wallpaper**.
5. Select **Gallery**, **Live wallpapers**, or **Wallpapers**.

■ Select wallpaper

1. Select **Settings**.
2. Select **Clock**.
3. Select **Clock/Wallpaper Type**, select **Next**, then open the **Wallpaper** tab.
 - ▶ The screen changes to the wallpaper list.
4. Select a desired wallpaper.
 - ▶ The preview is displayed on the left side on the screen.
 - ▶ The pop-up menu appears on the screen.
5. Select **Set**.
 - ▶ The display will return to the wallpaper list.

■ To view wallpaper once it is set

1. Select .
2. Select **Info**.
3. Select **MENU**.
4. Select **Clock/Wallpaper**.

■ Delete wallpaper

1. Select **Settings**.
2. Select **Clock**.
3. Select **Clock/Wallpaper Type**, select **Next**, then open the **Wallpaper** tab.
 - ▶ The screen changes to the wallpaper list.
4. Select a wallpaper that you want to delete.
 - ▶ The preview is displayed on the left side on the screen.
 - ▶ The pop-up menu appears on the screen.
5. Select **Delete**.
 - ▶ A confirmation message appears on the screen.
6. Select **Yes** to delete completely.
 - ▶ The display will return to the wallpaper list.

Wallpaper Setup

From the pop-up menu, select **Preview** to see a preview at full-size screen.

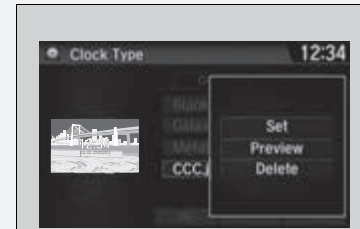

To go back to the previous screen, select **OK**, or select .

When the file size is large, it takes a while to be previewed.

To delete all wallpapers you add, select **Delete All**, then **Yes**.

Continued

■ Home Screen

■ To move to the next screen

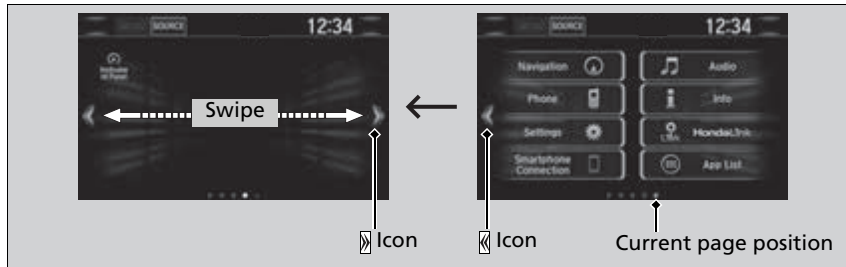

Selecting ◀◀ or ▶▶, or swiping the screen left or right changes to the next screen.



▶▶ Home Screen

The home screen has 5 pages (fixed). You cannot add any more pages.

Select  to go directly back to the first page of the home screen from any page.

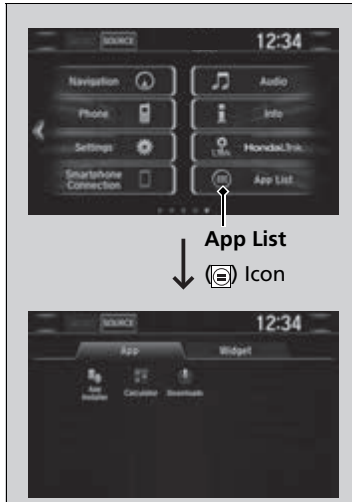
■ To use apps or widgets



1. Select .
2. Select **App List** .
- ▶ The apps screen appears.
3. Select the app or widget you want to use.

Preinstalled app list:

- **Calculator**: Displays Calculator.
- **Downloads***1: Displays the data downloaded from the web browser and so on.
- **App Installer**: Check with a Honda dealer for apps that are available for installation.

*1: Downloads app cannot be used because there is no Browser function in this system.

▶▶ To use apps or widgets

Select and hold a selected app or widget to add that app's or widget's shortcut on the home screen.

Pre-installed apps may not start up normally. If this occurs, you need to reset the system.

▶ **Defaulting All the Settings** P. 394

If you perform **Factory Data Reset**, it may reset all the settings to their factory default.

▶ **Defaulting All the Settings** P. 394

In case those apps still do not startup normally even after **Factory Data Reset**, contact your dealer.

Do not install apps other than those confirmed by a Honda dealer. Installation of unauthorized apps may introduce data corruption risks to your vehicle's information and your privacy.

You can delete user installed apps by the following procedure.



1. Select .
2. Select **Settings**.
3. Select **System**.
4. Select the **Others** tab.
5. Select **Detail Information**.
6. Select an App that you want to delete.
7. Select **Delete**.

Pre-installed apps cannot be deleted.

■ To add app or widget icons on the home screen

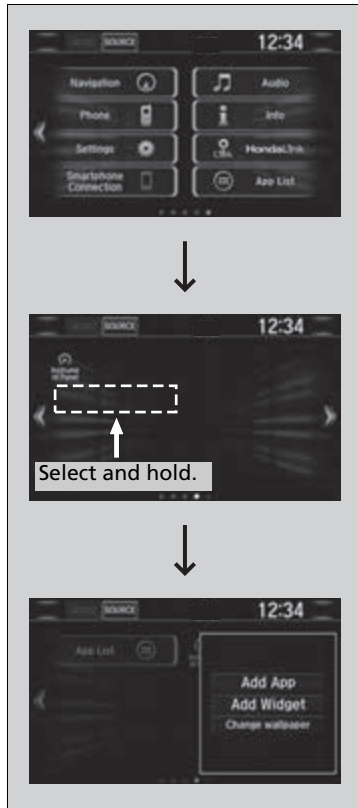
App or widget icons can be added on the home screen.



1. Select .
2. Select .

3. Select and hold empty space on the home screen.
▶ The pop-up menu appears on the screen.

4. Select **Add App** or **Add Widget**.
▶ The apps/widget screen appears.

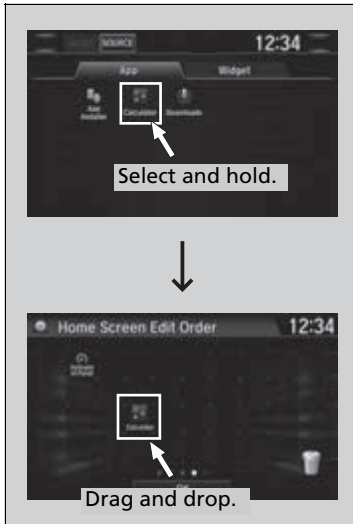

5. Select and hold an app or widget icon you want to add.
 - ▶ The screen switches to the customization screen.
6. Drag and drop the icon to where you want it to be.
7. Select **OK**.
 - ▶ The screen will return to the home screen.

■ To move icons on the home screen

You can change location on the home screen.

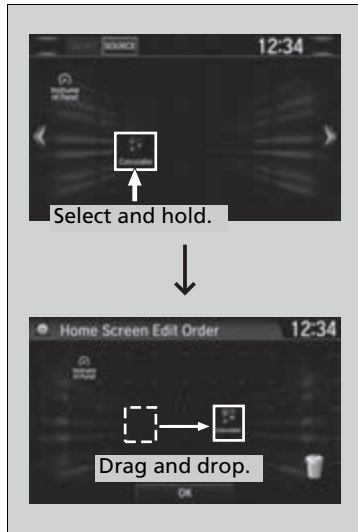

1. Select and hold an icon.

▶ The screen switches to the customization screen.

2. Drag and drop the icon to where you want it to be.

3. Select **OK**.

▶ The screen will return to the home screen.

▶▶ To move icons on the home screen

You can also move the **Phone, Info, Audio, Settings, Navigation*, HondaLink, Smartphone Connection, App List** (📱), and **Instrument Panel** icons in the same manner.

■ To remove icons on the home screen

You can delete the icons on the home screen.

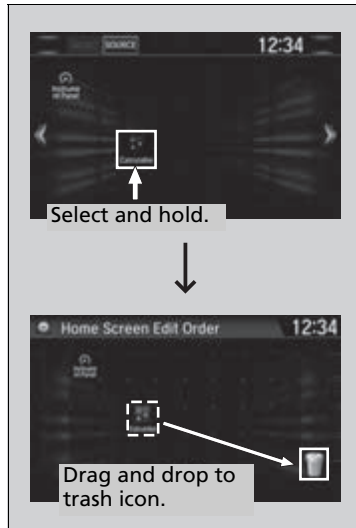

1. Select and hold an icon.
 - ▶ The screen switches to the customization screen.
2. Drag and drop the icon you want to remove to the trash icon.
 - ▶ The icon is removed from the home screen.
3. Select **OK**.
 - ▶ The screen will return to the home screen.

☒ To remove icons on the home screen

You cannot delete the **Phone, Info, Audio, Settings, Navigation**, **HondaLink, Smartphone Connection, App List** (☒), and **Instrument Panel** icons.

Apps or widgets will not be deleted by deleting the icon on the home screen.

■ Status Area



1. Swipe down from the top of the screen.
 - ▶ The status area appears.
2. Select an item to see the details.
3. Select  or swipe up from the bottom bar to close the area.

Changing the Screen Interface



You can change the screen interface design.



1. Select .
2. Select **Settings**.
3. Select **System**.
4. Select the **Others** tab.
5. Select **Change Skin**.
6. Select **Next**, then a confirmation message appears on the screen. Select **Yes**.

Changing the Screen Interface

After changing the screen interface design, you can change the wallpaper by following procedure.

1. Select .
2. Select .
3. Select and hold empty space on the home screen. The pop-up menu appears on the screen.
4. Select **Change wallpaper**.
5. Select **Gallery**, **Live wallpapers**, or **Wallpapers**.

If you change the screen interface, some of the setting items will change.

 **Customized Features** P. 369

■ Menu Customize

You can change menu icons on the right side of **Audio**, **Phone**, and **Info** screen.

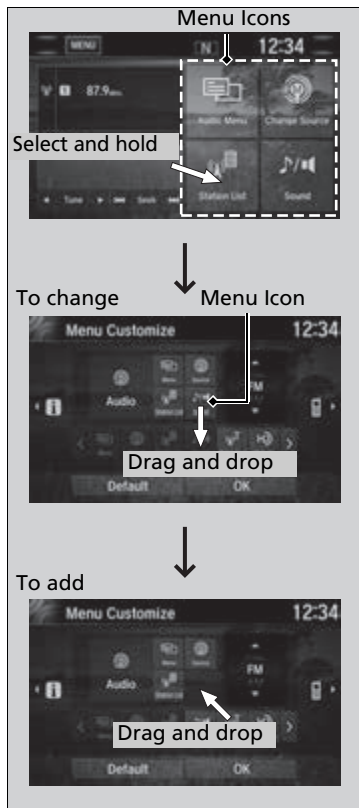

1. Select any of the three icons (**Audio/Phone/Info**) on the screen, then select and hold the menu icon.

▶ Selecting the ◀ or ▶ icon, you can change **Audio**, **Phone**, or **Info** on the **Menu Customize** screen.

2. Select and hold the menu icon you want to change, then drag and drop the icon to the bottom.

3. Select and hold the menu icon you want to add, then drag and drop the icon above.
4. Select **OK**.

☞ Menu Customize

You can also use the method below to change the menu icon:

Select **Settings**→**System**→**Home tab**→**Menu Icon Position**

■ Closing Apps

You can close specific apps running in the background on the system.



1. Select and hold .
2. Select the **Active** tab.
 - ▶ If you select the **Active/History** tab, you can close the apps that are currently running and delete the app activity history simultaneously.
3. Select an app you want to close.
4. Select **Clear**.
 - ▶ The display will return to the app list.

☒ Closing Apps

If you have a number of apps running in the background and something goes wrong with the audio system, some of those apps may not work properly. If this happens, close all the apps and re-launch the app/apps that you want to use.

To close all apps on the system, select **Clear All**, then **Yes**.

You cannot close the HondaLink® and Garmin* apps.

* Not available on all models

Adjusting the Sound

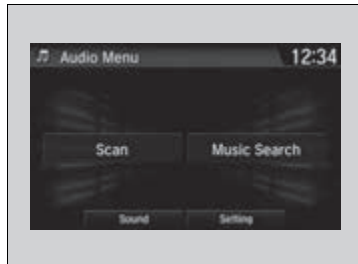

1. Select .
2. Select **MENU**.
3. Select **Sound**.

Select a tab from the following choices:

- **BAS-MID-TRE:** Bass, Middle, Treble
- **FAD-BAL-SUBW*:** Fader, Balance, Subwoofer*
- **SVC:** Speed Volume Compensation

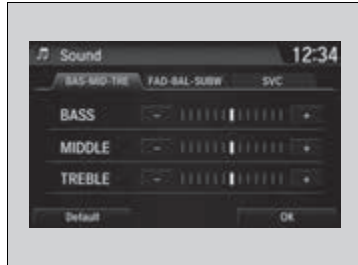

▶▶ Adjusting the Sound

The SVC has four modes: **Off**, **Low**, **Mid**, and **High**. SVC adjusts the volume level based on the vehicle speed. As you go faster, audio volume increases. As you slow down, audio volume decreases.

You can also adjust the sound by the following procedure.

1. Select .
2. Select **Settings**.
3. Select **Audio**.
4. Select **Sound**.

Display Setup

You can change the brightness or color theme of the audio/information screen.

Changing the Screen Brightness

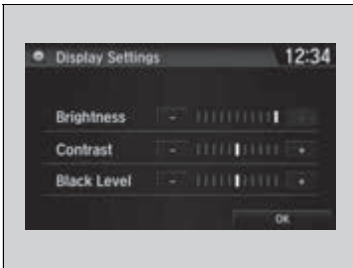

1. Select .
2. Select **Settings**.
3. Select **System**.
4. Select the **Display** tab.
5. Select **Display Settings**.
6. Select the setting you want.
7. Select **OK**.

Changing the Screen's Color Theme

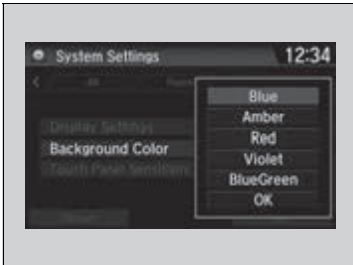

1. Select .
2. Select **Settings**.
3. Select **System**.
4. Select the **Display** tab.
5. Select **Background Color**.
6. Select **Next**, then select the setting you want.
7. Select **OK**.

Changing the Screen Brightness

You can change the **Contrast** and **Black Level** settings in the same manner.

Changing the Screen's Color Theme

You cannot change the **Background Color** if you change the screen interface design.

■ Selecting an Audio Source

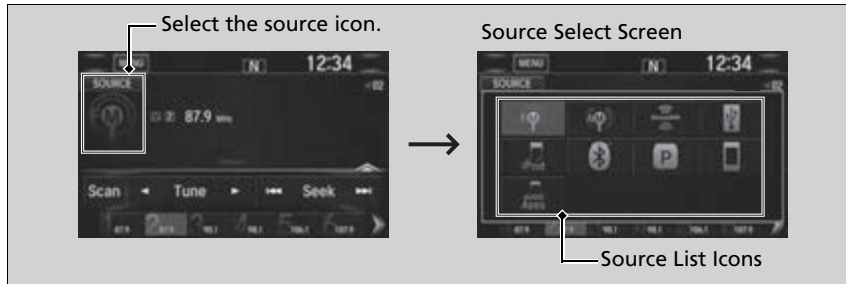

Select the current source icon, then select an icon on the source list to switch the audio source.

■ Limitations for Manual Operation



Certain manual functions are disabled or inoperable while the vehicle is in motion. You cannot select a grayed-out option until the vehicle is stopped.

▶▶ Selecting an Audio Source

If you startup preinstalled audio apps, **AUDIO Apps** is displayed on the screen. These preinstalled apps cannot be displayed on the source select screen. You can startup those audio apps from **AUDIO Apps**.

Voice Control Operation

Your vehicle has a voice control system that allows hands-free operation.

The voice control system uses the  (Talk) and  (hang-up/back) buttons on the steering wheel and a microphone near the map lights on the ceiling.

Voice Recognition

To achieve optimum voice recognition when using the voice control system:

- Make sure the correct screen is displayed for the voice command that you are using.



The system recognizes only certain commands.

Available voice commands.

 **Voice Portal Screen** P. 298

- Close the windows and moonroof.
- Adjust the dashboard and side vents so air does not blow onto the microphone on the ceiling.
- Speak clearly in a natural speaking voice without pausing between words.
- Reduce any background noise if possible. The system may misinterpret your command if more than one person is speaking at the same time.

Voice Control Operation

When you press the  button, a helpful prompt asks what you would like to do. Press and release the  button again to bypass this prompt and give a command.

Voice Recognition

The voice control system can only be used from the driver's seat because the microphone unit removes noises from the front passenger's side.

Continued

■ Voice Portal Screen

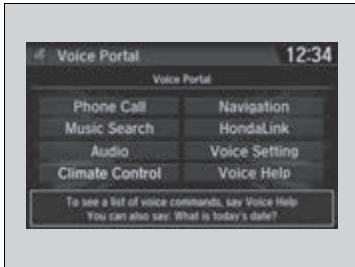

When the  (Talk) button is pressed, available voice commands appear on the screen.

For a complete list of commands, say "Voice Help" after the beep or select **Voice Help**.

You can see the list of commands in **Voice Info** on the **Info Menu** screen. Select **Info**, then select **MENU**.

The system only recognizes the commands on the following pages, at certain screens. Free form voice commands are not recognized.

* 1: Models with navigation system

■ Phone Call

This can be only used when the phone is connected. When the system recognizes the *Phone call* command, the screen will change to the voice recognition screen for phone commands.

- Dial by number
- Call history
- Redial
- Call <Your Contact Name>
- Call <Phone Number>
- Call Police
- Call 911

Phone Call commands are not available if using Apple CarPlay™.

■ Music Search

This can be only used when the iPod or USB device is connected.

■ Climate Control*1

When the system recognizes the *Climate Control* command, the screen will change the dedicated screen to the climate control voice recognition screen.

➤ **Climate Control Commands*1** P. 300

■ Audio*1

When the system recognizes the *Audio* command, the screen will change to the audio voice recognition screen.

- Audio On/Off
- Radio FM/AM/ISXM
- PANDORA
- iPod
- USB
- Other Sources

Pandora® cannot be used while Android Auto™ is active.

■ Navigation*1

The screen changes to the navigation screen.

➤ **Refer to the Navigation System Manual**

■ HondaLink

This can be only used when the phone is connected.

■ Voice Setting

The screen changes to the **Voice Recog.** tab on the **System Settings** screen.

■ Voice Help

You can see a list of the available commands on the screen.

- *Useful Commands*
- *Phone Commands*
- *Audio Commands**
- *Climate Control Commands**
- *General Commands*
- *Music Search Commands*
- *On Screen Commands*

■ Useful Commands

The system accepts these commands on the voice portal top screen.

- *Call <Phone Number>*
- *Call <Your contact Name>*
- *What time is it?*
- *What is today's date?*

*1: Models with navigation system

* Not available on all models

■ Phone Commands

The system accepts these commands on the dedicated screen for the voice recognition of the phone.

- *Call by number*
- *Call by name*
- *Call <Phone Number>*
- *Call <Your contact Name>*

■ Audio Commands*¹

The system accepts these commands on the dedicated screen for the voice recognition of the audio.

■ Radio FM Commands

- *Radio tune to <87.7-107.9> FM*
- *Radio tune to <87.7 -107.9> HD <1-8> FM*
- *Radio FM preset # (#:1-12)*

■ Radio AM Commands

- *Radio tune to <530-1710> AM*
- *Radio AM preset # (#:1-6)*

■ Radio SXM Commands

- *SXM channel <1-999>*

- *SXM channel <channel name, category name, traffic and weather city name, sports team name>*
- *Radio SXM preset <1-12>*

■ Pandora® Commands

- *PANDORA play*

■ iPod Commands

- *iPod play*
- *iPod play track # (#:1-30)*
- *Music Search*
- *What album is this?*
- *What am I listening to?*

■ USB Commands

- *USB play*
- *USB play track # (#:1-30)*
- *Music Search*
- *What album is this?*
- *What am I listening to?*

■ Bluetooth® audio Commands

- *Bluetooth audio play*

NOTE:

Bluetooth® Audio commands may not work on some phones or *Bluetooth®* Audio devices.

■ On Screen Commands

When **On Screen Commands** is selected, the explanation screen is displayed.

■ Music Search Commands

The system accepts these commands on the **Music Search** screen.

■ Using Song By Voice

Song By Voice™ is a feature that allows you to select music from your iPod or USB device using Voice Commands. To activate this mode, you must press the  (Talk) button and say: "Music search".

■ Song By Voice Commands

- *What am I listening to?*
- *Who am I listening to?*
- *Who is this?*
- *What's playing?*
- *Who's playing?*
- *What album is this?*

■ Play Commands

- *Play artist <Name>*
- *Play track/song <Name>*
- *Play album <Name>*
- *Play genre/category <Name>*
- *Play playlist <Name>*
- *Play composer <Name>*

■ List Commands

- *List artist <Name>*
- *List album <Name>*
- *List genre/category <Name>*
- *List playlist <Name>*
- *List composer <Name>*

■ General Commands

- *What time is it?*
- *What is today's date?*

■ Climate Control Commands*1

- *Climate Control On*
- *Climate Control Off*
- *Fan Speed <1-7>*
- *Temperature max heat*
- *Temperature max cool*
- *Temperature <57-87> degrees*
- *Defrost On*
- *Defrost Off*
- *Air conditioner On*
- *Air conditioner Off*
- *More*
- *Vent*
- *Dash and floor*
- *Floor vents*
- *Floor and Defrost*
- *Climate Control Automatic*
- *Fan Speed up/down*
- *Temperature up*
- *Temperature down*

NOTE:

These commands toggle the function on and off, so the command may not match your intended action.

*1: Models with navigation system

Playing AM/FM Radio

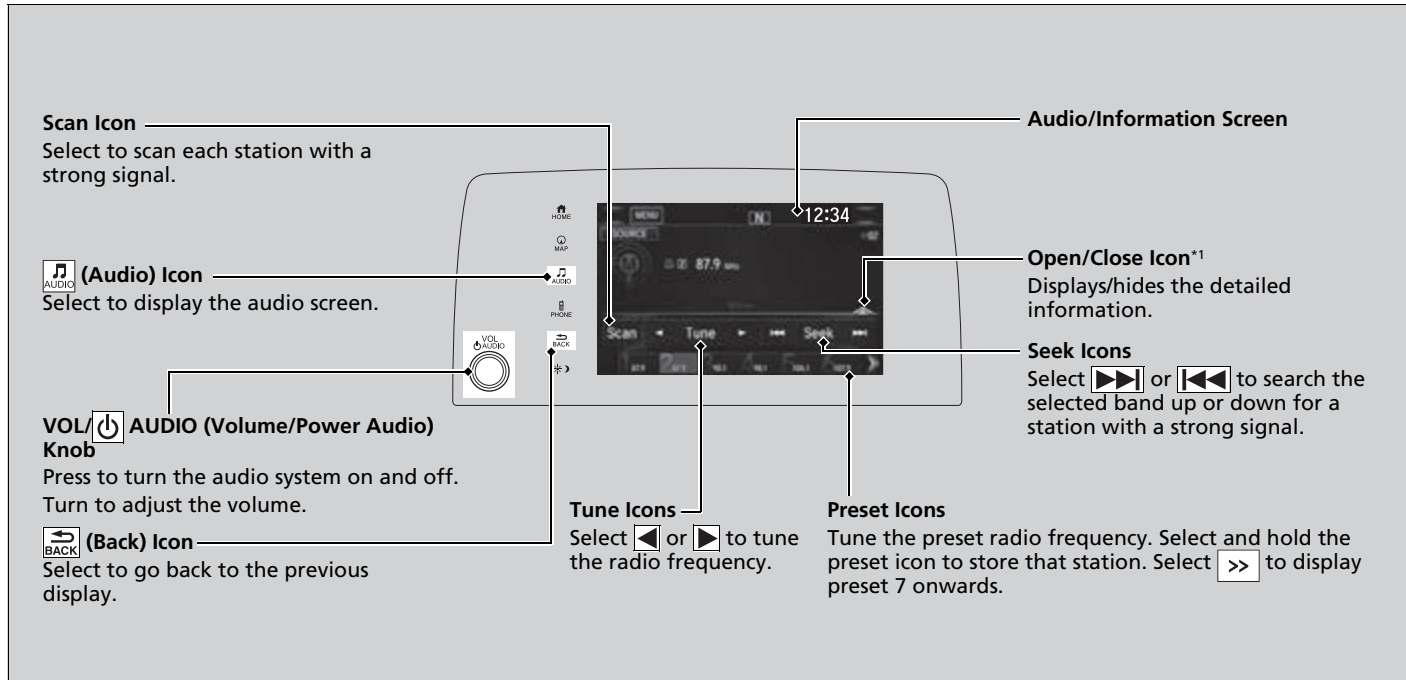

*1:Some or all of the lists may not be displayed.

■ Preset Memory

To store a station:

1. Tune to the selected station.
2. Select and hold the preset number for the station you want to store.

You can also store a preset station by the following procedure.

1. Tune to the selected station.
2. Select the open/close icon to display a list.
3. Select the **Preset** tab.
4. Select and hold the preset number for the station you want to store.

■ Station List

Lists the strongest stations on the selected band.

1. Select the open/close icon to display a list.
2. Select the **Station List** tab.
3. Select the station.

■ Manual update



Updates your available station list at any time.

1. Select the open/close icon to display a list.
2. Select the **Station List** tab.
3. Select **Refresh**.

▶▶ Preset Memory

The **ST** indicator appears on the display indicating stereo FM broadcasts. Stereo reproduction in AM is not available.

Switching the Audio Mode

Press the  or  button on the steering wheel or select **SOURCE** on the screen.

 **Audio Remote Controls** P. 248

You can store 6 AM stations and 12 FM stations into preset memory.

HD Radio Technology manufactured under license from iBiquity Digital Corporation. U.S. and Foreign Patents. HD Radio™ and the HD, HD Radio, and "Arc" logos are proprietary trademarks of iBiquity Digital Corp.



■ Scan

Samples each of the strongest stations on the selected band for 10 seconds. To turn off scan, select **Cancel** or .

■ HD Subchannel

Displays the subchannel list when an HD Radio™ station is selected while listening to an FM station.

1. Select **MENU**.
2. Select **HD Radio Subchannel**.
3. Select the channel number.

■ Radio Data System (RDS)

Provides text data information related to your selected RDS-capable FM station.

■ To find an RDS station from Station List

1. Select the open/close icon to display a list while listening to an FM station.
2. Select the **Station List** tab.
3. Select the station.

■ Manual update

Updates your available station list at any time.

1. Select the open/close icon to display a list while listening to an FM station.
2. Select the **Station List** tab.
3. Select **Refresh**.

■ Radio text

Displays the radio text information of the selected RDS station.

1. Select **MENU**.
2. Select **View Radio Text**.

☒ Radio Data System (RDS)

When you select an RDS-capable FM station, the RDS automatically turns on, and the frequency display changes to the station name. However, when the signals of that station become weak, the display changes from the station name to the frequency.

Playing SiriusXM® Radio

Category Icons
Select ◀ or ▶ to display and select a SiriusXM® Radio category.

Scan Icon
Select to scan each channel.

(Audio) Icon
Select to display the audio screen.

VOL/AUDIO (Volume/Power Audio) Knob
Press to turn the audio system on and off.
Turn to adjust the volume.

(Back) Icon
Select to go back to the previous display.

Channel Icons
Select ◀◀ or ▶▶ to the previous or next channel.
Select and hold to rapidly skip 10 channels at a time.

Audio/Information Screen

Station Art

Open/Close Icon*1
Displays/hides the detailed information.

Preset Icons
Tune the preset radio station. Select and hold the preset icon to store that station. Select >> to display preset 7 onwards.

Skip Icons
Select ◀◀ or ▶▶ to change section in the channel. Select and hold to move rapidly within the section.

*1:Some or all of the lists may not be displayed.

■ To Change the Tune Mode

1. Select **MENU**.
2. Select **Tune Mode**.
3. Select **Channel Mode** or **Category Mode**.



▶▶ Playing SiriusXM® Radio

In the channel mode, all available channels are selectable. In the category mode, you can select a channel within a category (Jazz, Rock, Classical, etc.).

There may be instances when SiriusXM® Radio does not broadcast all the data fields (artist name, title). This does not indicate a problem with your audio system.

SiriusXM® Radio stations load in ascending order, which can take about a minute. Once they have loaded you will be able to scroll up or down to make your selections.

Switching the Audio Mode

Press the  or  button on the steering wheel or select **SOURCE** on the screen.

▶▶ **Audio Remote Controls** P. 248

Tune Start:

When you change to a preset channel, a song being played on that channel restarts from the beginning with this function. This can be turned on or off from the **Audio Settings** screen.

▶▶ **Customized Features** P. 369

■ Preset Memory

To store a channel:

1. Tune to the selected channel.
2. Press and hold the preset number for the station you want to store.
3. Select **OK**.

You can also store a channel by the following procedure.

1. Tune to the selected channel.
2. Select the open/close icon to display a list.
3. Select the **Preset** tab.
4. Select and hold the preset number for the station you want to store.

■ Multi-channel preset (for music channels only)

You can store up to five of your preferred music channels in total.



1. Tune a station.
2. Select the open/close icon to display a list.
3. Select the **Preset** tab.
4. Select and hold the preset number you want to add a music channel.
 - ▶ A message appears if there are no available presets.
5. Select **Combine**.

▶▶ Playing SiriusXM® Radio

You can store 12 SiriusXM® channels into the preset memory.

▶▶ Multi-channel preset (for music channels only)

To store a multi-channel preset, you need to setup the **Multiple Channel Mix Preset** setting to **On**.

▶ **Customized Features** P. 369

■ Listening to Featured Channels

Suggested channel listing received from SiriusXM® can be displayed and selected.

1. Select the open/close icon to display a channel list.
2. Select the **Channel** tab.
3. Select the featured channel list title you want to listen to.
 - ▶ The selected channel list of the title is displayed.
4. Select the channel.

▶▶ Listening to Featured Channels

Up to three featured channels by SiriusXM® can be displayed.

Featured channel lists are at the top of the channel list.

■ Replay Function

The system can record up to the last 60 minutes of your currently tuned channel's broadcast, as well as the last 30 minutes of your preset channel's broadcast, starting from the moment you turn the vehicle on. If you tuned to a preset channel, the system records up to 60 minutes of a broadcast instead of up to 30 minutes. You can rewind and replay the last 30 or 60 minutes of a broadcast.

1. Select **MENU**.
2. Select **Playback**.
3. Move the time marker to the position you want to replay.

The following items are available on the pop-up screen:

⏮ (Skip Down): Skips to the previously stored channel. Select and hold to fast-rewind the current selection.

⏭ (Skip Up): Skips to the next channel. Select and hold to fast-forward the current selection.

⏮ (15sec Back): Select to skip back 15 seconds in the current selection. Select and hold to fast-rewind the current selection.

⏭ (15sec Skip): Select to skip forward 15 seconds in the current selection. Select and hold to fast-forward the current selection.

- ▶ Select **OK** to close the pop-up menu. Replay in playback mode continues.

To play or pause on playback mode:

1. Select **MENU**.
2. Select **Play/Pause**.

■ Returning to real-time broadcast

1. Select **MENU**.
2. Select **Go to Live**.

▶▶ Replay Function

The system starts storing broadcast in memory when the power mode is turned ON. You can go back to the program from that point.

You can no longer replay any program once the power mode is turned off as it erases memory. You can check how long the program has been stored in memory from the audio/information screen.

After 30 or 60 minutes of recording the system will automatically start deleting the oldest data.

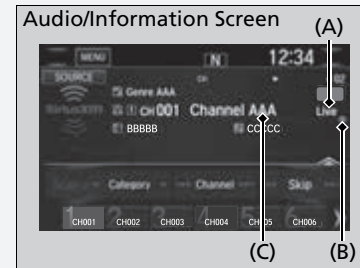

(A): Shows how much time the replayed segment is behind the real-time broadcast

(B): Replayed segment

(C): Length stored in memory

■ Live Sports Alert

While listening to other channels, you can receive sports alerts such as scores from the games of your favorite teams.

■ To set up a favorite team

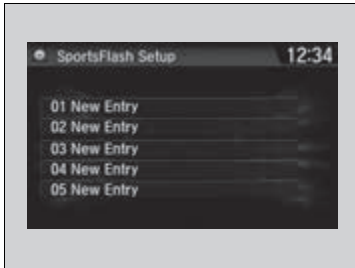

1. Select .
2. Select **Settings**.
3. Select **Audio**.
4. Select **SportsFlash Setup**.
5. Select **Favorite Team**.
6. Select a team.

■ To set up an alert message

1. Select .
2. Select **Settings**.
3. Select **Audio**.
4. Select **SportsFlash Setup**.
5. Select **Interrupt**.
6. Select **On(One Time)** or **On(Continue)**.

▶▶ Live Sports Alert

The sports alert function is available in SiriusXM® mode only.

▶▶ To set up a favorite team

Sports alerts cut in only when SiriusXM® mode is on. Selecting **On(One Time)** from the customize settings disables the alert feature next time you turn the power mode to ON.

 **Customized Features** P. 369

You can also set up a favorite team by the following procedure.

1. Select **Audio**.
2. Select **MENU**.
3. Select **Setting**.
4. Select **SportsFlash Setup**.

■ To set up an alert beep

1. Select .
2. Select **Settings**.
3. Select **Audio**.
4. Select **SportsFlash Setup**.
5. Select **Interrupt Beep**.
6. Select **On**.

■ Traffic and Weather Information

You can receive traffic and weather information.

1. Select .
2. Select **Settings**.
3. Select **Audio**.
4. Select **Traffic & Weather Setup**.
5. Select the region.
 - ▶ When you do not want to receive the information, select **Unregistered**.

■ Scan

Sample each channel on the selected mode for 10 seconds.

1. Select **Scan**.
2. Select **Scan Channels**.
 - ▶ You can select the desired channel by songs using **Scan Song in Preset**.

To turn off scan, select **Cancel**.

☒ To set up an alert beep

You can also set up an alert beep by the following procedure.

1. Select **Audio**.
2. Select **MENU**.
3. Select **Setting**.
4. Select **SportsFlash Setup**.

☒ Traffic and Weather Information

The traffic and weather information function at SiriusXM® mode only.

You can also set up the traffic and weather information by the following procedure.

1. Select **Audio**.
2. Select **MENU**.
3. Select **Setting**.
4. Select **Traffic & Weather Setup**.

☒ Scan

The "Scan Songs in Preset" function is based on TuneScan™ technology of SiriusXM®.

The "Featured Channels" function is based on Featured Favorites™ technology of SiriusXM®.

TuneScan™ and Featured Favorites™ are registered trademarks of SiriusXM® Radio, Inc.

Playing an iPod

Connect the iPod using your USB connector to the USB port, then select the iPod mode.

➤ **USB Port(s)** P. 245

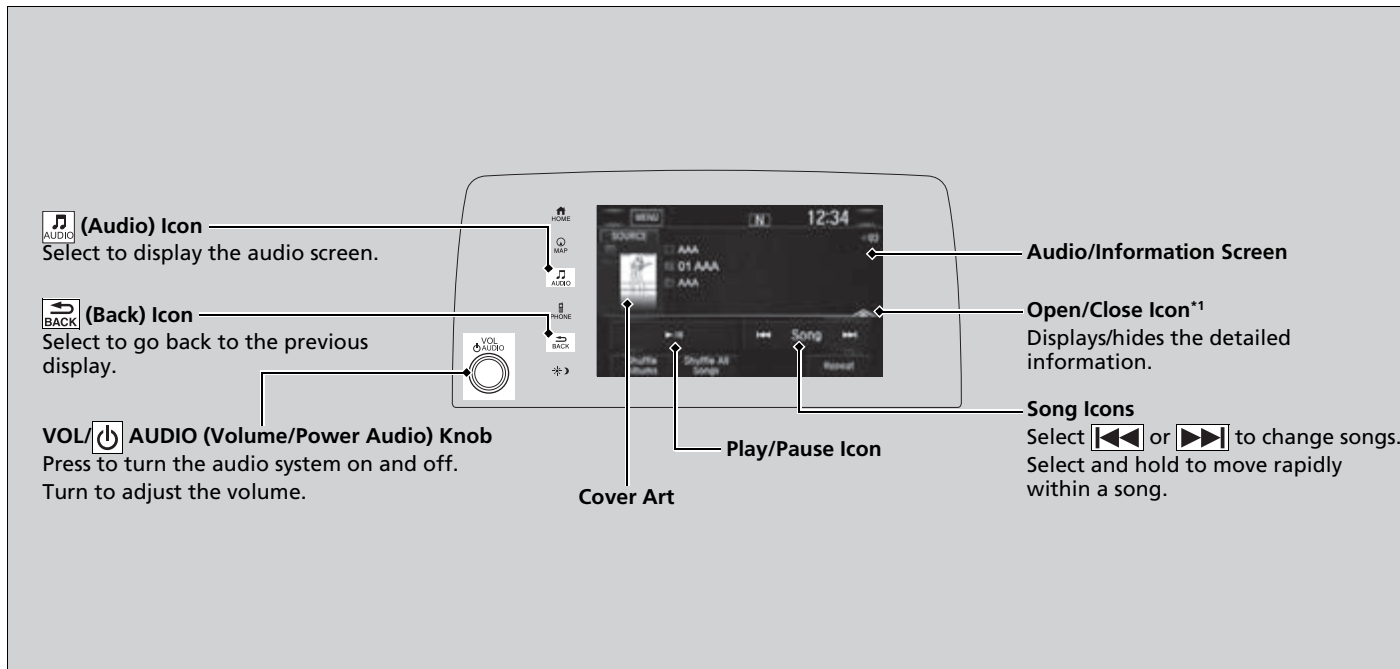

*1:Some or all of the lists may not be displayed.

How to Select a Song from the Music Search List

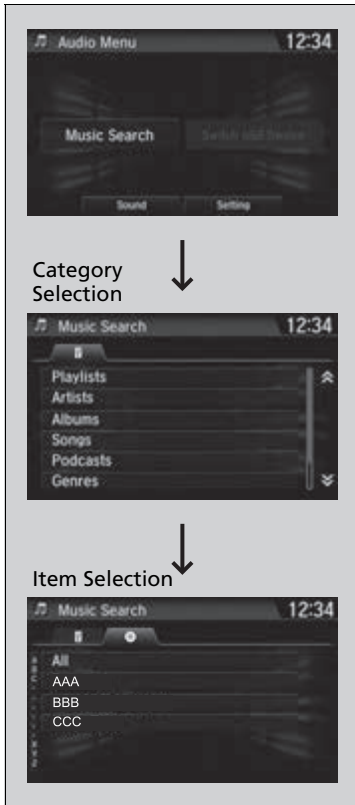

1. Select **MENU** and select **Music Search**.

2. Select the items on that menu.

▶▶ Playing an iPod

Available operating functions vary on models or versions. Some functions may not be available on the vehicle's audio system.

If there is a problem, you may see an error message on the audio/information screen.

▶ **iPod/USB Flash Drive** P. 340

If you operate any music app on your iPhone/iPod while the phone is connected to the audio system, you may no longer be able to operate the same app on the audio/information screen. Reconnect the device if necessary.

Select **Switch USB Device** in the **Audio Menu** screen to switch to another USB device.

If an iPhone is connected via Apple CarPlay™, the iPod/USB source is unavailable and audio files on the phone can only be played within Apple CarPlay™.

■ How to Select a Play Mode

You can select shuffle and repeat modes when playing a file.
Select a play mode.

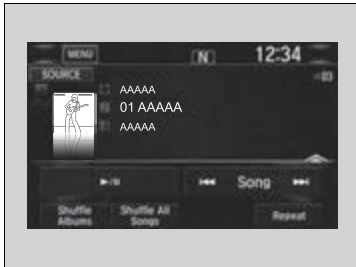

■ To turn off a play mode

Select the mode you want to turn off.

▶▶ How to Select a Play Mode

Play Mode Menu Items

Shuffle Albums: Plays all available albums in a selected list in random order.

Shuffle All Songs: Plays all available files in a selected list in random order.

Repeat: Repeats the current track.

Song By Voice™ (SBV)

Use SBV to search for and play music from your USB flash drive or iPod using voice commands.

■ To enable SBV

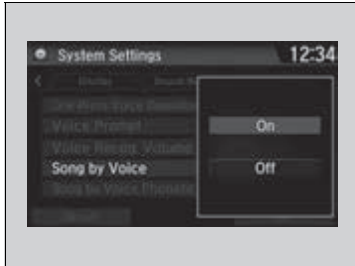

1. Select .
2. Select **Settings**.
3. Select **System**.
4. Select the **Voice Recog.** tab.
5. Select **Song by Voice**.
6. Select **Next**, then select **On** or **Off**.



☒ Song By Voice™ (SBV)

Setting options:

- **On** (factory default): Song By Voice™ commands are available.
- **Off**: Disable the feature.

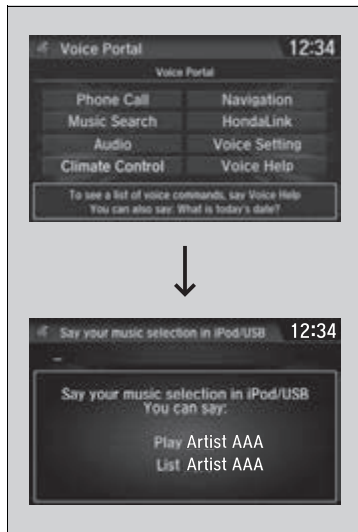
■ Searching for music using SBV



1. Set the **Song by Voice** setting to **On**.
2. Press the  (Talk) button and say "Music Search" to activate the SBV feature for the USB flash drive and iPod.
3. Then, say a next command.
 - ▶ Example 1: Say "(List)'Artist A'" to view a list of songs by that artist. Select the desired song to start playing.
 - ▶ Example 2: Say "Play 'Artist A'" to start playing songs by that artist.
4. To cancel SBV, press the  (hang-up/back) button on the steering wheel. The selected song continues playing.

Once you have canceled this mode, you need to press the  button and say "Music Search" again to re-activate this mode.

▶▶ Searching for music using SBV

Song By Voice™ Commands List

▶ **Song By Voice Commands** P. 300

NOTE:

Song By Voice™ commands are available for tracks stored on the USB flash drive or iPod.

You can add phonetic modifications of difficult words so that it is easier for SBV to recognize artists, songs, albums, and composers in voice commands.

▶ **Phonetic Modification** P. 317

SBV is not available when using Apple CarPlay™. Use Siri® Eyes Free instead.

Phonetic Modification

Add phonetic modifications of difficult or foreign words so that it is easier for SBV to recognize artists, songs, albums, and composers in voice commands when searching for music on the USB flash drive or iPod.



1. Select .
2. Select **Settings**.
3. Select **System**.
4. Select the **Voice Recog.** tab.
5. Select **Song by Voice Phonetic Modification**.
6. Select **New Modification**.
7. Select **USB** or **iPod**.

Phonetic Modification

Song by Voice Phonetic Modification is grayed out when **Song By Voice** is set to **Off**.

You can store up to 2,000 phonetic modification items.



8. Select the item to modify (e.g., **Artist**).
 - ▶ The list of the selected item appears on the screen.
9. Select an entry to modify.
 - ▶ The pop-up menu appears on the screen.
 - ▶ To listen to the current phonetic modification, select **Play**.
 - ▶ To delete the current phonetic modification, select **Delete**.
10. Select **Modify**.
11. Select the phonetic spelling you want to use (e.g., "Artist A") when prompted.
12. Select **Done**.
 - ▶ The artist "No Name" is phonetically modified to "Artist A." When in the SBV mode, you can press the  (Talk) button and use the voice command "Play 'Artist A'" to play songs by the artist "No Name."

Playing Pandora®

Your audio system allows you to listen to music from the Pandora® app on a compatible smartphone.

This function is available when the phone is paired and connected to the vehicle's *Bluetooth*® HandsFreeLink® (HFL) system, or with an iPhone, you can connect using your USB cable to the USB port.

📖 **Phone Setup** P. 430

📖 **USB Port(s)** P. 245

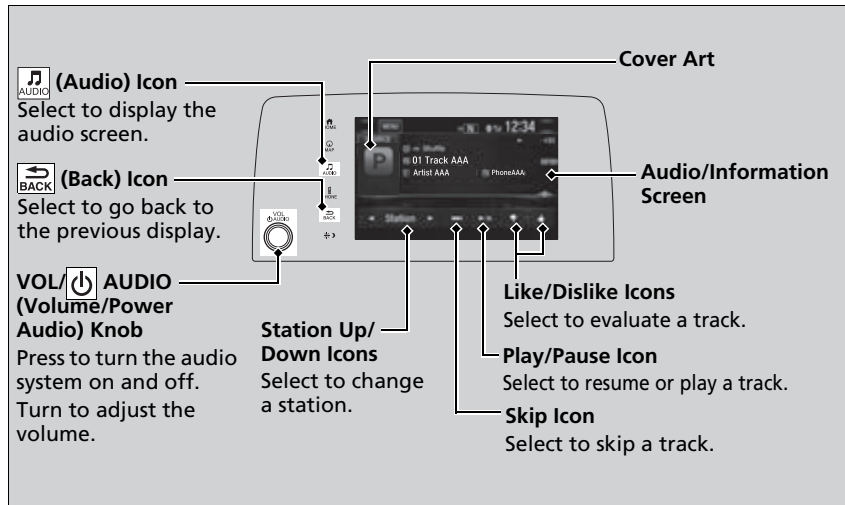

*1:Some or all of the lists may not be displayed.

▶▶ Playing Pandora®

Pandora®, the Pandora logo, and the Pandora trade dress are trademarks or registered trademarks of Pandora Media, Inc., used with permission. Pandora is only available in certain countries. Visit the Pandora website for more information.

To find out if your phone is compatible with this feature, visit automobiles.honda.com/handsfreelink/, or call 1-888-528-7876.

To use this service in your vehicle, the Pandora® app must first be installed on your phone. Visit www.pandora.com for more information.

Pandora® is free, personalized radio that plays music and comedy you'll love. Just start with the name of one of your favorite artists, tracks, comedians or composers and Pandora® will create a custom station that plays similar tracks. Pandora® also features hundreds of genre stations ranging from Dubstep to Smooth Jazz to Power Workout.

If you cannot operate Pandora® through the audio system, it may be streaming through *Bluetooth*® Audio. Make sure Pandora® mode on your audio system is selected.

If your phone is connected to Android Auto™, Pandora® is only available through the Android Auto™ interface. Visit the Android Auto™ website to check compatibility.

■ Pandora® Menu

You can operate some of the Pandora® menu items from your vehicle's audio system. The available items are:

- **Bookmark**
- **Station List**
- **New Station**
- **Switch USB device**
- **Sound**
- **Setting**

■ Operating a menu item

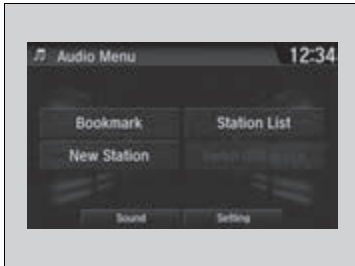

1. Select **MENU**.
2. Select an item.

▶▶ Pandora® Menu

Available operating functions vary on software versions. Some functions may not be available on the vehicle's audio system.

If there is a problem, you may see an error message on the audio/information screen.

▶▶ **Pandora®** P. 342

Pandora® may limit the total number of skips allowed on the service. If you dislike a track after the skip limit has been reached, your feedback will be saved but the current track will continue to play.

To change stations, activate the Pandora® menu, select **Station List**, and then select a new station. It also changes stations on the main Pandora® screen.

Playing a USB Flash Drive

Your audio system reads and plays sound files on a USB flash drive in either MP3, WMA, AAC*1 or WAV format.

Connect your USB flash drive to the USB port, then select the USB mode.

🔌 **USB Port(s)** P. 245

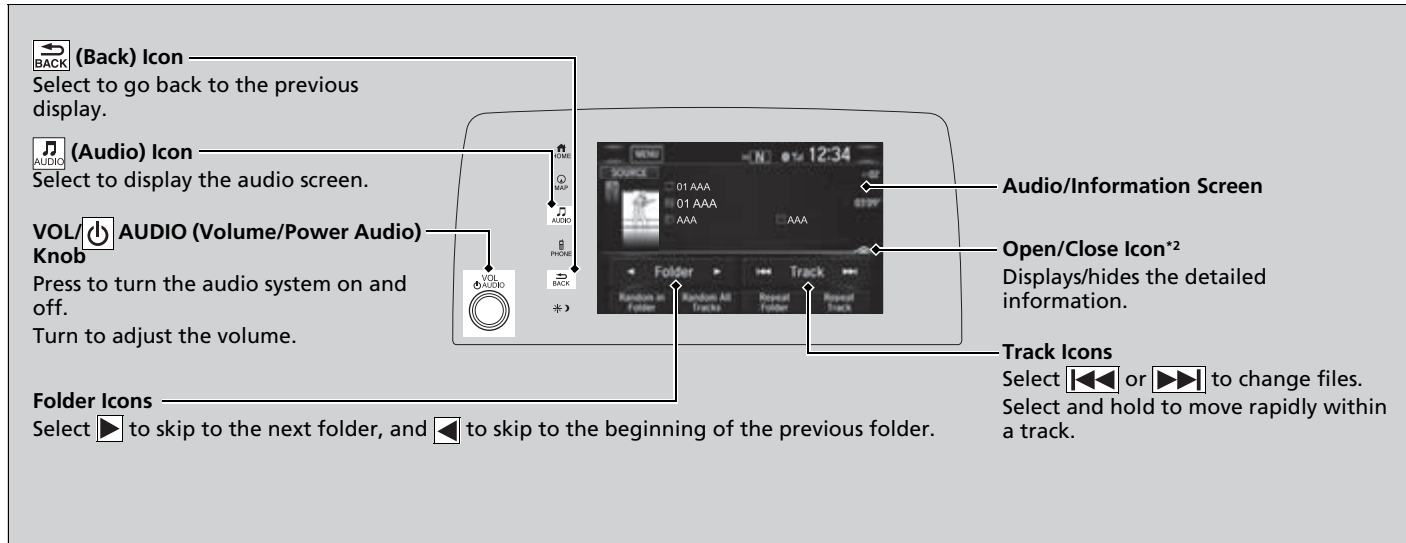

*1: Only AAC format files recorded with iTunes are playable on this unit.

*2: Some or all of the lists may not be displayed.

■ How to Select a File from the Music Search List



1. Select **MENU** and select **Music Search**.

2. Select a folder.

3. Select a track.

▶▶ Playing a USB Flash Drive

Use the recommended USB flash drives.

▶ **General Information on the Audio System**
P. 345

WMA files protected by digital rights management (DRM) cannot be played.

The audio system displays **Unplayable File**, then skips to the next file.

If there is a problem, you may see an error message on the audio/information screen.

▶ **iPod/USB Flash Drive** P. 340

Select **Switch USB Device** in the **Audio Menu** screen to switch to another USB device.

How to Select a Play Mode

You can select scan, repeat, and random modes when playing a file.

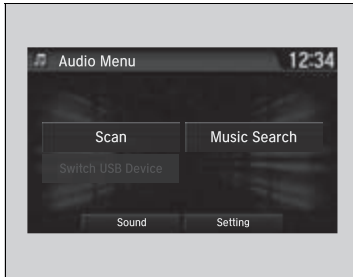

■ Scan

1. Select **MENU**.
2. Select **Scan**.
3. Select a play mode.

■ Random/Repeat

Select a play mode.

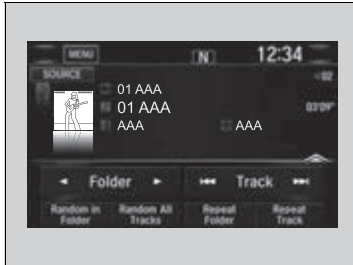

■ To turn off a play mode

To turn off Scan, select  or **Cancel**.

To turn off Random or Repeat, select the mode you want to turn off.

How to Select a Play Mode

Play Mode Menu Items

Scan

Scan Folders: Provides 10-second sampling of the first file in each of the main folders.

Scan Tracks: Provides 10-second sampling of all files in the current folder.

Random/Repeat

Random in Folder: Plays all files in the current folder in random order.

Random All Tracks: Plays all files in random order.

Repeat Folder: Repeats all files in the current folder.

Repeat Track: Repeats the current file.

Playing *Bluetooth*® Audio

Your audio system allows you to listen to music from your *Bluetooth*-compatible phone.

This function is available when the phone is paired and connected to the vehicle's *Bluetooth*® HandsFreeLink® (HFL) system.

🔧 **Phone Setup** P. 430

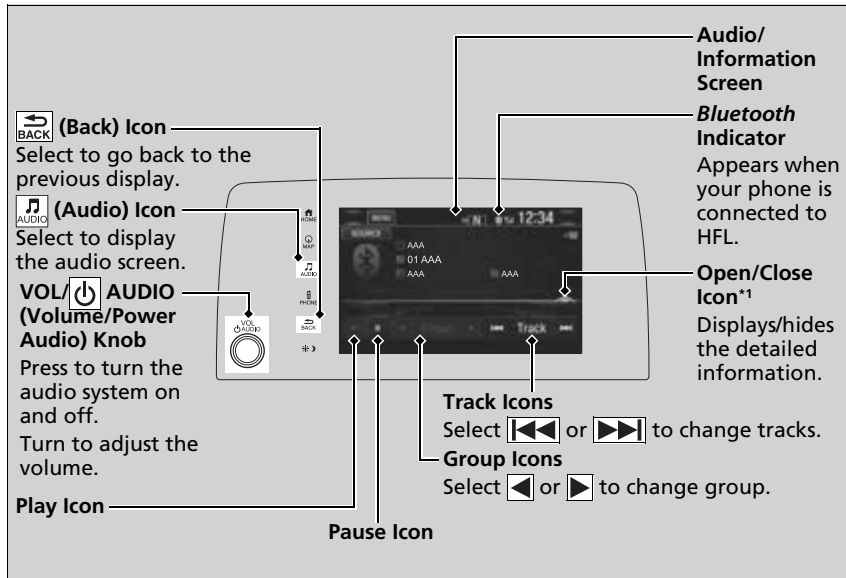

*1: Depending on the *Bluetooth*® device you connect, some or all of the lists may not be displayed.

▶▶ Playing *Bluetooth*® Audio

Not all *Bluetooth*-enabled phones with streaming audio capabilities are compatible with the system. For a list of compatible phones, visit automobiles.honda.com/handsfreelink/, or call 1-888-528-7876.

It may be illegal to perform some data device functions while driving.

Only one phone can be used with HFL at a time. When there are more than two paired phones in the vehicle, the system automatically connects to the prioritized phone. You can assign priority to a phone in the **Priority Device Settings**.

🔧 **Customized Features** P. 369

The connected phone for *Bluetooth*® Audio can be different.

If more than one phone is paired to the HFL system, there may be a delay before the system begins to play.

In some cases, the name of the artist, album, or track may not appear correctly.

Some functions may not be available on some devices.

If a phone is currently connected via Apple CarPlay™ or Android Auto™, *Bluetooth*® Audio from that phone is unavailable. However, a second previously paired phone can stream *Bluetooth*® Audio by selecting **Connect** [🎵] from the **Bluetooth Device List** screen.

🔧 **Phone Setup** P. 430

■ To Play *Bluetooth*® Audio Files

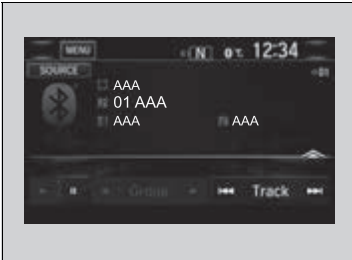

1. Make sure that your phone is paired and connected to the system.

➤ **Phone Setup** P. 430

2. Select the *Bluetooth*® Audio mode.

If the phone is not recognized, another HFL-compatible phone, which is not compatible for *Bluetooth*® Audio, may already be connected.

■ To play or pause a file

Select the play icon or pause icon.

■ Searching for Music

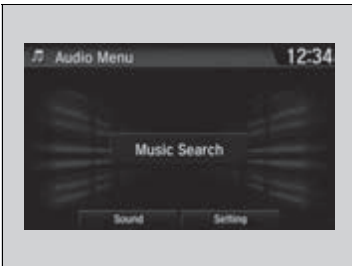

1. Select **MENU**.
2. Select **Music Search**.
3. Select a search category (e.g., Albums).
4. Select an item.

▶ The selection begins playing.

☒ To Play *Bluetooth*® Audio Files

To play the audio files, you may need to operate your phone. If so, follow the phone maker's operating instructions.

Switching to another mode pauses the music playing from your phone.

You can change the connected phone in the *Bluetooth*® settings on the **Audio Menu** screen by the following procedure.

1. Select **MENU**.
2. Select **Setting**.

☒ Searching for Music

Depending on the *Bluetooth*® device you connect, some or all of the lists may not be displayed.

HondaLink®

HondaLink® connects you to the latest information from Honda. You can connect your phone wirelessly through Wi-Fi or *Bluetooth*®.

➤ **Wi-Fi Connection** P. 331

➤ **Phone Setup** P. 430

HondaLink® Menu

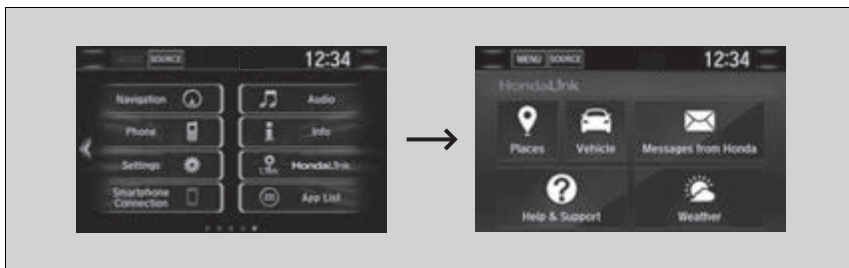

■ Places*

Displays restaurants, gas stations, Honda dealers, etc. and provides navigation instructions to those locations via the navigation system.

■ Vehicle

Displays instruction messages when the vehicle needs service.

■ Help & Support

Displays tips on vehicle usage and provides information on roadside assistance and the customer service center.

▶▶ HondaLink®

The HondaLink® connect app is compatible with most iPhone and Android phones.

Some cell phone carriers charge for tethering and smartphone data use. Check your phone's data subscription package.

If there is an active connection to Apple CarPlay™ or Android Auto™, HondaLink® can only be connected through Wi-Fi.

■ Messages from Honda

Displays helpful and important information from Honda.

■ Weather*

Displays a weekly five-day weather forecast for any location you want. You can change the ZIP Code at any time.

■ To Set Up to Connect HondaLink® Service

Use the following procedure to connect to the HondaLink® service.

■ To enable the HondaLink® service

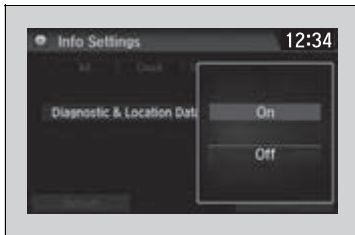

1. Select .
2. Select **Settings**.
3. Select **Info**.
4. Select the **HondaLink** tab.
5. Select **Diagnostics & Location Data**.
6. Select **On**.

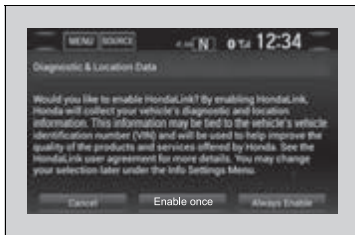

To complete the procedure, you must consent to the collection and transmission of data pertaining to your vehicle.

Enable once: Allows only one time. (Prompt shows again next time.)

Always Enable: Allows anytime. (Prompt does not show again.)

Cancel: Does not allow this consent.

* Not available on all models

Continued

■ To link with HondaLink®

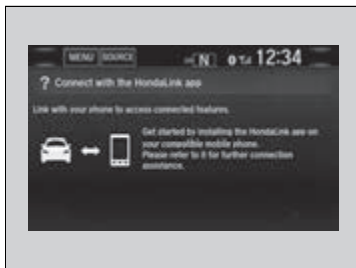

You can see this screen after launching HondaLink®.

Vehicle Information and Message from Honda Tips

Using the shortcut operation, you can quickly gain access to new messages.



1. In the header area, a message appears to notify you of a new message.

▶ When the message is received, a notification ring can be heard.

2. The notification message is replaced by an icon which remains displayed until the new message is read.



3. From the top of the screen, swipe down to see the messages.

4. Select a new message to open.
▶ If you have selected the update option for HondaLink®, follow the directions on the screen to complete the process.

Vehicle Information and Message from Honda Tips

When you update HondaLink®, you must keep the engine running and maintain a constant connection with HondaLink®.

If the update is interrupted, the system will automatically resume the process. If, however, a week has elapsed since the process was first interrupted, you must repeat the process from the beginning.



You can update HondaLink® by selecting **Message from Honda** on the HondaLink® menu.

Wi-Fi Connection

This vehicle is equipped with Wi-Fi connectivity. You can connect to an external Wi-Fi hotspot or communication device.

Connect the Vehicle to a Wi-Fi Hotspot



1. Select .
2. Select **Settings**.
3. Select **Bluetooth / Wi-Fi**.
4. Select the **Wi-Fi** tab.
5. Select **Wi-Fi On/Off Status**, select **Next**, then **On**.
6. Select **Yes**.
7. Select **Wi-Fi Device List**.
 - ▶ Make sure your phone's Wi-Fi setting is in access point (tethering) mode.
 - ▶ Select the phone you want to connect to the system.
 - ▶ If you do not find the phone you want to connect in the list, select **Scan**.
8. Select **Add**.
 - ▶ If needed, enter a password for your phone and select **Done**.
 - ▶ When the connection is successful, the  icon is displayed on the top of the screen.
9. Select  to go back to the home screen.

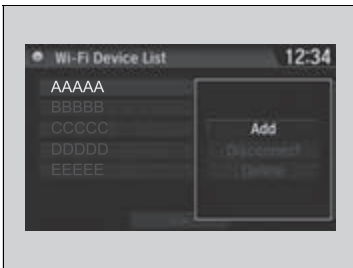

Wi-Fi Connection

Wi-Fi and Wi-Fi Direct are registered trademarks of Wi-Fi Alliance®.



Connect the Vehicle to a Wi-Fi Hotspot

You cannot go through the setting procedure while a vehicle is moving. Park in a safe place to set the audio system in Wi-Fi mode.

Some cell phone carriers charge for tethering and smartphone data use. Check your phone's data subscription package.

Check your phone manual to find out if the phone has Wi-Fi connectivity.

You can confirm whether Wi-Fi connection is on or off with the  icon on the **Wi-Fi Device List** screen. Network speed will not be displayed on this screen.

Siri® Eyes Free

You can talk to Siri using the  (Talk) button on the steering wheel when your iPhone is paired to the *Bluetooth*® HandsFreeLink® (HFL) system.

➔ **Phone Setup** P. 430

☒ Siri® Eyes Free

Siri is a trademark of Apple Inc.

Check Apple Inc. website for features available for Siri.

We recommend against using Siri other than in Siri® Eyes Free while operating a vehicle.

☒ Using Siri® Eyes Free

Some commands work only on specific phone features or apps.

■ Using Siri® Eyes Free

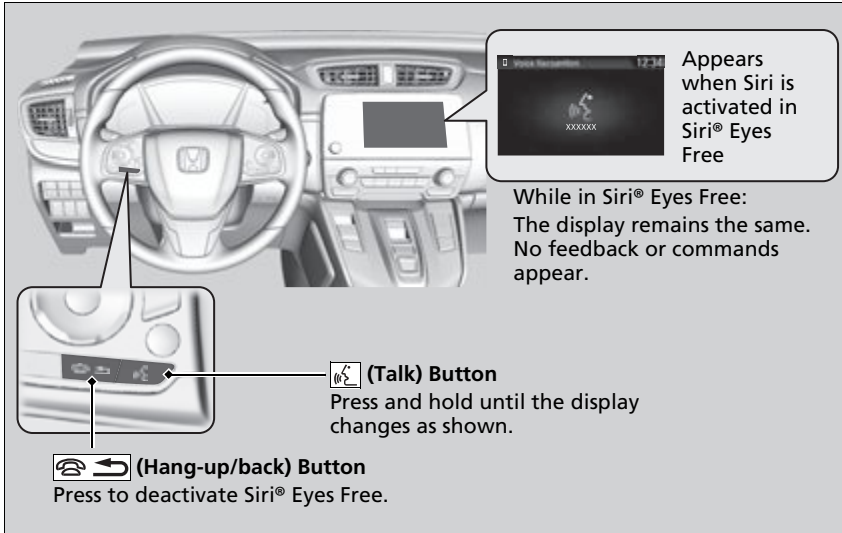

Apple CarPlay™

If you connect an Apple CarPlay™-compatible iPhone to the system via the 1.5A USB port, you can use the audio/information screen, instead of the iPhone display, to make a phone call, listen to music, view maps (navigation), and access messages.

➤ **USB Port(s)** P. 245

■ Apple CarPlay™ Menu

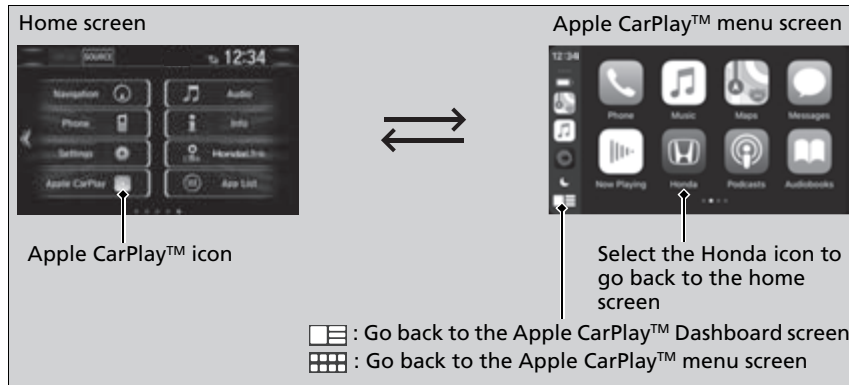

■ Phone

Access the contact list, make phone calls, or listen to voice mail.

■ Messages

Check and reply to text messages, or have messages read to you.

■ Music

Play music stored on your iPhone.

▶▶ Apple CarPlay™

Only iPhone 5 or newer versions with iOS 8.4 or later are compatible with Apple CarPlay™.

Park in a safe place before connecting your iPhone to Apple CarPlay™ and when launching any compatible apps.

To directly access the Apple CarPlay™ phone function, select **Phone** on the home screen. While connected to Apple CarPlay™, calls are only made through Apple CarPlay™. If you want to make a call with *Bluetooth®* HandsFreeLink®, turn Apple CarPlay™ OFF or detach the USB cable from your iPhone.

➤ **Setting Up Apple CarPlay™** P. 334

When your iPhone is connected to Apple CarPlay™, it is not possible to use the *Bluetooth®* Audio or *Bluetooth®* HandsFreeLink®. However, other previously paired phones can stream audio via *Bluetooth®* while Apple CarPlay™ is connected.

➤ **Phone Setup** P. 430

For details on countries and regions where Apple CarPlay™ is available, as well as information pertaining to function, refer to the Apple homepage.

■ Maps

Display Apple Maps and use the navigation function just as you would on your iPhone.

Models with navigation system

Only one navigation system (pre-installed navigation or Apple CarPlay™) can give directions at a time. When you are using one system, directions to any prior destination set on the other system will be canceled, and the system you are currently using will direct you to your destination.

■ Setting Up Apple CarPlay™

After you have connected your iPhone to the system via the 1.5A USB port, use the following procedure to set up Apple CarPlay™. Use of Apple CarPlay™ will result in the transmission of certain user and vehicle information (such as vehicle location, speed, and status) to your iPhone to enhance the Apple CarPlay™ experience. You will need to consent to the sharing of this information on the audio/information screen.

■ Enabling Apple CarPlay™

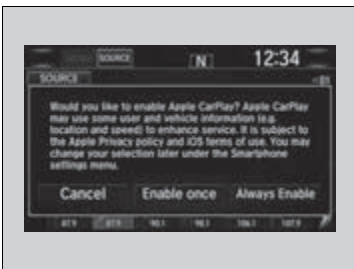

Enable once: Allows only once. (Prompt shows again next time.)

Always Enable: Allows anytime. (Prompt does not show again.)

Cancel: Does not allow this consent.

You may change the consent settings under the **Smartphone** settings menu.

▶▶ Apple CarPlay™

Apple CarPlay™ Operating Requirements & Limitations

Apple CarPlay™ requires a compatible iPhone with an active cellular connection and data plan. Your carrier's rate plans will apply.

Changes in operating systems, hardware, software, and other technology integral to providing Apple CarPlay™ functionality, as well as new or revised governmental regulations, may result in a decrease or cessation of Apple CarPlay™ functionality and services. Honda cannot and does not provide any warranty or guarantee of future Apple CarPlay™ performance or functionality.

It is possible to use 3rd party apps if they are compatible with Apple CarPlay™. Refer to the Apple homepage for information on compatible apps.

▶▶ Setting Up Apple CarPlay™

You can also use the method below to set up Apple CarPlay™:
Select HOME→Settings→Smartphone→Apple CarPlay

Use of user and vehicle information

The use and handling of user and vehicle information transmitted to/from your iPhone by Apple CarPlay™ is governed by the Apple iOS terms and conditions and Apple's Privacy Policy.

■ Operating Apple CarPlay™ with Siri®

Press and hold the  (Talk) button to activate Siri®.

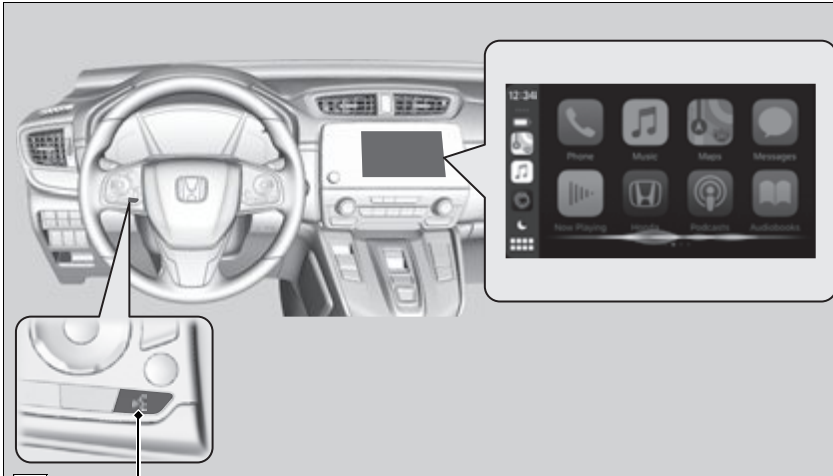

(Talk) button:

Press and hold to activate Siri®.

Press again to deactivate Siri®.

Press and release to activate standard voice recognition system.

☒ Operating Apple CarPlay™ with Siri®

Below are examples of questions and commands for Siri®.

- What movies are playing today?
- Call dad at work.
- What song is this?
- How's the weather tomorrow?
- Read my latest email.
- Find a table for four tonight in Chicago.

For more information, please visit
www.apple.com/ios/siri.

Android Auto™

When you connect an Android phone to the Display Audio system via the 1.5A USB port, Android Auto™ is automatically initiated. When connected via Android Auto™, you can use the audio/information screen to access the Phone, Google Maps (Navigation), Google Play Music, and Google Now functions. When you first use Android Auto™, a tutorial will appear on the screen.

We recommend that you complete this tutorial while safely parked before using Android Auto™.

➤ **USB Port(s)** P. 245

➤ **Auto Pairing Connection** P. 338

Android Auto™

To use Android Auto™, you need to download the Android Auto™ app from Google Play to your smartphone.

Only Android 5.0 (Lollipop) or later versions are compatible with Android Auto™. *Bluetooth* A2DP cannot be used while your phone is connected to Android Auto.

Park in a safe place before connecting your Android phone to Android Auto™ and when launching any compatible apps.

When your Android phone is connected to Android Auto™, it is not possible to use the *Bluetooth*® Audio. However, other previously paired phones can stream audio via *Bluetooth*® while Android Auto™ is connected.

➤ **Phone Setup** P. 430

Android Auto™ Menu

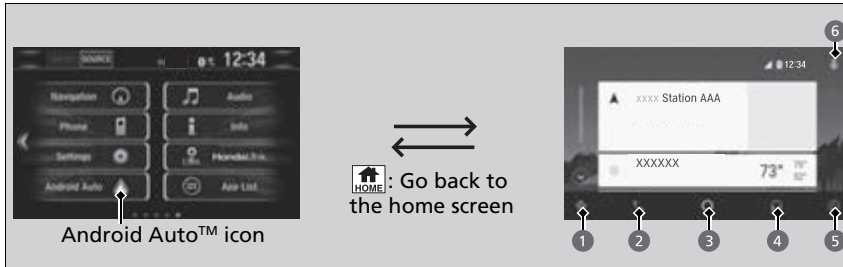

1 Maps (Navigation)

Display Google Maps and use the navigation function just as you would with your Android phone. When the vehicle is in motion, it is not possible to make keyboard entries. Stop the vehicle in a safe location to undertake a search or provide other inputs.

Models with navigation system

Only one navigation system (pre-installed navigation or Android Auto™) can give directions at a time. When you are using one system, directions to any prior destination set on the other system will be canceled, and the system you are currently using will direct you to your destination.

The audio/information screen shows you turn-by-turn driving directions to your destination.

2 Phone (Communication)

Make and receive phone calls as well as listen to voicemail.

3 Google Now (Home screen)

Display useful information organized by Android Auto™ into simple cards that appear just when they're needed.

Android Auto™

For details on countries and regions where Android Auto™ is available, as well as information pertaining to function, refer to the Android Auto™ homepage.

Screens may differ depending on the version of the Android Auto app you are using.

Android Auto™ Operating Requirements & Limitations

Android Auto™ requires a compatible Android phone with an active cellular connection and data plan. Your carrier's rate plans will apply.

Changes in operating systems, hardware, software, and other technology integral to providing Android Auto™ functionality, as well as new or revised governmental regulations, may result in a decrease or cessation of Android Auto™ functionality and services. Honda cannot and does not provide any warranty or guarantee of future Android Auto™ performance or functionality.

It is possible to use 3rd party apps if they are compatible with Android Auto™. Refer to the Android Auto™ homepage for information on compatible apps.

4 Music and audio

Play Google Play Music and music apps that are compatible with Android Auto™. To switch between music apps, press this icon.

5 Go back to the Home Screen.

6 Voice

Operate Android Auto™ with your voice.

■ Auto Pairing Connection

When you connect an Android phone to the unit via the 1.5A USB port, Android Auto™ is automatically initiated.

■ Enabling Android Auto™



Enable once: Allows only once. (Prompt shows again next time.)

Always Enable: Allows anytime. (Prompt does not show again.)

Cancel: Does not allow this consent.

You may change the consent settings under the **Smartphone** settings menu.

☒ Enabling Android Auto™

Only initialize Android Auto™ when you are safely parked. When Android Auto™ first detects your phone, you will need to set up your phone so that auto pairing is possible. Refer to the instruction manual that came with your phone.

You can use the method below to change Android Auto™ settings after you have completed the initial setup:
Select HOME→Settings→Smartphone→Android Auto

Use of user and vehicle information

The use and handling of user and vehicle information transmitted to/from your phone by Android Auto™ is governed by the Google's Privacy Policy.

■ Operating Android Auto™ with Voice Recognition

Press and hold the  (Talk) button to operate Android Auto™ with your voice.

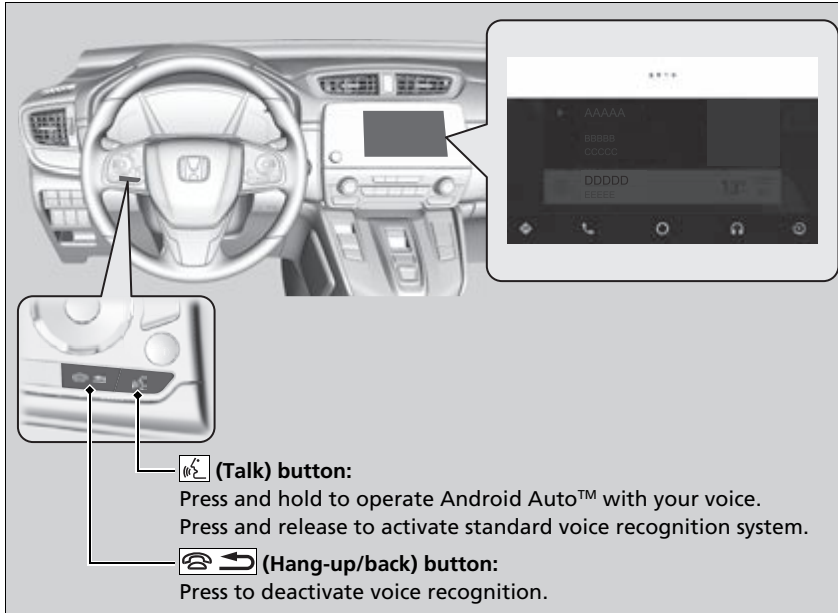

☒ Operating Android Auto™ with Voice Recognition

Below are examples of commands you can give with voice recognition:

- Reply to text.
- Call my wife.
- Navigate to Honda.
- Play my music.
- Send a text message to my wife.
- Call flower shop.

For more information, please refer to the Android Auto™ homepage.

You can also activate the voice recognition function by pressing the  icon in the upper-right corner of the screen.

iPod/USB Flash Drive

If an error occurs while playing an iPod or USB flash drive, you may see the following error messages. If you cannot clear the error message, contact a dealer.

Error Message	Solution
USB Error ^{*1, *2}	Appears when there is a problem with the audio system. Check if the device is compatible with the audio system.
A charging error has occurred with the connected USB device. When safe please check the compatibility of the device and USB cable and try again. ^{*2}	Appears when an incompatible device is connected. Disconnect the device. Then turn the audio system off, and turn it on again. Do not reconnect the device that caused the error.
Unsupported Ver ^{*1} Unsupported Version ^{*2}	Appears when an unsupported iPod is connected. If it appears when a supported iPod is connected, update the iPod software to the newer version.
Connect Retry ^{*1, *2}	Appears when the system does not acknowledge the iPod. Reconnect the iPod.
Unplayable File ^{*1, *2}	Appears when the files in the USB flash drive are copyright protected or an unsupported format. This error message appears for about three seconds, then plays the next song.
No Song ^{*1} No Data ^{*2}	iPod Appears when the iPod is empty. USB flash drive Appears when the USB flash drive is empty or there are no MP3, WMA, AAC, or WAV files in the USB flash drive. iPod and USB flash drive Check that compatible files are stored on the device.
Unsupported ^{*1, *2}	Appears when an unsupported device is connected. If it appears when a supported device is connected, reconnect the device.

*1:Models with color audio system

*2:Models with Display Audio

Error Message	Solution
Device No Response ^{*1}	Appears when the system does not communicate with a connected device. If it appears when a device is connected, contact your place of device purchase.
HUB Unsupported ^{*1}	Appears when only a HUB is connected. If it appears, connect a USB flash drive to the HUB.

*1:Models with color audio system

Pandora®

If an error occurs while playing Pandora®, you may see the following error messages.

If you cannot clear the error message, contact a dealer.

Models with color audio system

Error Message	Solution
No Device Connected	Appears when no device is connected. Check the <i>Bluetooth</i> ® and USB connection.
No Data	Appears when no data is available with Pandora® activated. Reboot the app and reconnect the device.
To begin listening, select a station from the stations list.	Appears when any station is not selected. Select a station from the station list on the device.
PANDORA ver unsupport.	Appears when Pandora® version is not supported. Update Pandora® to the latest version.
No station list on device. Use device to create station.	Appears when there is no station list on the device. Use the device to create a station.
PANDORA system maintenance.	Appears when the Pandora® server is in maintenance. Try again later.
Unable to play PANDORA. When stopped, log-in to PANDORA.	Appears you do not log in to Pandora®. Log in to Pandora®.
No network connectivity.	Appears when the network is deteriorated. Move the vehicle and check the reception of the signal.
Unable to play PANDORA. Please try again later.	Appears when the sending the data is failed for ten times and the device may have a malfunction. Try again later. Move the vehicle and check the reception of the signal.

Error Message	Solution
Unable to play PANDORA. Music licensing restricts play in this area.	Appears when the vehicle is in the restricted area to listen the music. Move the vehicle and check the reception of the signal.
Please check owners manual	Appears when an incompatible device is connected. In order to have any problems on a connected device, there is a possibility that the audio system cannot be recognized the device. Contact a dealer.
Models with Display Audio	
Error Message	Solution
To begin listening, select a station from the Stations list.	Appears when there is no station list on the device. Use the device to create a station.
Unable to rate track. Please try again.	Appears when you try to skip a song or select Like/Dislike over the predetermined number of times in an hour.
Unable to play PANDORA. Please try again later.	Appears when the commanded operation fails. Try again later.
No Data	Appears when no data is available with Pandora® activated. Reboot the app and reconnect the device.
PANDORA App version is not supported.	Appears when Pandora® version is not supported. Update Pandora® to the latest version.
PANDORA system maintenance.	Appears when the Pandora® server is in maintenance. Try again later.

Error Message	Solution
Unable to connect Pandora. When stopped, check your mobile phone	Appears when Pandora® is unable to play music. Check your device.
	Appears when Pandora® app is not installed on your device. Install Pandora® app to your device.

Models with Display Audio

Android/Apps

If an error occurs while using the audio system or apps, you may see the following error messages. If you cannot clear the error message, contact a dealer.

Error Message*1	Solution
Unfortunately, **** has stopped.	Error has occurred within app, select OK on the screen to close the app.
**** is not responding. Would you like to close it?	App is not responding. Select Wait if you can wait for a response from app a little longer. If it does not respond even if you keep waiting, select OK to close the app and start it up. If the error message continues, perform Factory Data Reset .  Defaulting All the Settings P. 394

*1:****part is variable characters, and will change depending upon where an error occurs.

SiriusXM® Radio Service*

■ Subscribing to SiriusXM® Radio

1. You need your radio ID ready before registering for subscription. To see the ID on the screen, select **Channel 0**.
2. Have your radio ID ready, and either call SiriusXM® or visit the SiriusXM® website to subscribe.

■ Receiving SiriusXM® Radio

Switch to the SiriusXM® mode by using the audio remote controls on the steering wheel, or through the audio/information screen, and stay in this mode for about 30 minutes until the service is activated. Make sure your vehicle is in an open area with good reception.

■ SiriusXM® Radio Display Messages

Requested Channel Not Subscribed:

You are not subscribed to the channel selected.

Subscription Updated.:

SiriusXM® radio is receiving information update from the network.

Channel Not Available:

No such channel exists, or the artist or title information is unavailable.

No Signal:

The signal is too weak in the current location.

Check Tuner:

There is a problem with the SiriusXM® tuner. Contact a dealer.

Check Antenna:

The SiriusXM® antenna is disconnected. Contact a dealer.

✉ Subscribing to SiriusXM® Radio

Contact Information for SiriusXM® Radio:
SiriusXM® Radio at
www.siriusxm.com/subscribenow
or 1-866-635-2349

✉ Receiving SiriusXM® Radio

The SiriusXM® satellites are in orbit over the equator; therefore, objects south of the vehicle may cause satellite reception interruptions. Satellite signals are more likely to be blocked by tall buildings and mountains the farther north you travel from the equator.

You may experience reception problems under the following circumstances:

- In a location with an obstruction to the south of your vehicle.
- In tunnels
- On the lower level of a multi-tiered road
- Large items carried on the roof rack

* Not available on all models

Compatible iPod, iPhone, and USB Flash Drives

■ iPod and iPhone Model Compatibility

Models with color audio system

Model
Made for iPod (5th generation)
Made for iPod classic 80GB/160GB (launch in 2007)
Made for iPod classic 120GB (launch in 2008)
Made for iPod classic 160GB (launch in 2009)
Made for iPod nano (1st to 7th generation) released between 2005 and 2012
Made for iPod touch (1st to 5th generation) released between 2007 and 2012
Made for iPhone 3G/iPhone 3GS/iPhone 4/iPhone 4s/iPhone 5/iPhone 5s/iPhone 5c/iPhone 6/iPhone 6 Plus

Models with Display Audio

Model
Made for iPod touch (6th generation) released 2015
Made for iPhone 5s/iPhone 6/iPhone 6 Plus/iPhone 6s/iPhone 6s Plus/iPhone SE/iPhone 7/iPhone 7 Plus/iPhone 8/iPhone 8 Plus/iPhone X/iPhone XS/iPhone XS Max/iPhone XR

■ USB Flash Drives

- A USB flash drive of 256 MB or higher is recommended.
- Some digital audio players may not be compatible.
- Some USB flash drives (e.g., a device with security lockout) may not work.
- Some software files may not allow for audio play or text data display.
- Some versions of MP3, WMA, AAC, or WAV formats may be unsupported.

►► iPod and iPhone Model Compatibility

This system may not work with all software versions of these devices.

►► USB Flash Drives

Files on the USB flash drive are played in their stored order. This order may be different from the order displayed on your PC or device.

Honda App License Agreement

END USER LICENSE AGREEMENT

PLEASE CAREFULLY READ THIS END USER LICENSE AGREEMENT (THIS "AGREEMENT") WHICH GOVERNS YOUR USE OF THE SOFTWARE INSTALLED ON YOUR HONDA OR ACURA VEHICLE (YOUR "VEHICLE") AS WELL AS THE APPLICATIONS, SERVICES, FUNCTIONS, AND CONTENT PROVIDED THROUGH THE SOFTWARE (COLLECTIVELY, THE "SERVICES"). YOUR USE OF THE SOFTWARE OR SERVICES WILL SERVE AS YOUR CONSENT TO THE TERMS OF THIS AGREEMENT. THE SOFTWARE IS OWNED (OR LICENSED), PROVIDED, AND/OR OPERATED BY AMERICAN HONDA MOTOR CO. INC., ("HONDA," "US," "WE," OR "OUR"), WITH ITS BUSINESS ADDRESS AT 1919 TORRANCE BLVD., TORRANCE, CA 90501. REFERENCE TO "HONDA" IN THIS AGREEMENT INCLUDES HONDA'S PARENT COMPANY AND ITS AFFILIATES AND DESIGNATED AGENTS. THE SERVICES ARE OWNED (OR LICENSED), PROVIDED, AND/OR OPERATED BY HONDA OR A THIRD-PARTY SERVICE PROVIDER (A "PROVIDER"). REFERENCE TO A "PROVIDER" IN THIS AGREEMENT INCLUDES SUCH PROVIDER'S PARENT COMPANY, AFFILIATES, AND DESIGNATED AGENTS.

A. Description of the Software. The SOFTWARE includes the software, firmware and the like, installed and executing on your VEHICLE during manufacture, and thereafter updated from time to time by HONDA, you or an authorized HONDA dealer (a "DEALER"). The SOFTWARE allows you to access and use a variety of SERVICES, including but not limited to: (a) HONDA applications, services, and content provided through the SOFTWARE (together, "HONDA SERVICES"); and (b) PROVIDER applications, services, and content provided through the SOFTWARE (together, "PROVIDER SERVICES"), each of which may provide access to various information, media, content, and services.

B. SOFTWARE Licensing and Intellectual Property.

1. SOFTWARE. This AGREEMENT grants you a non-exclusive, limited, and revocable license to use the SOFTWARE and SERVICES solely (a) as installed on your VEHICLE by HONDA, (b) as updated on your Vehicle by HONDA, you (but only as and when directed by HONDA), or a DEALER and (c) as permitted under the terms of this AGREEMENT.

2. HONDA Services. The SOFTWARE may provide you with access to various HONDA SERVICES. Installation, activation, or use of HONDA SERVICES may require your consent to additional terms, conditions, and privacy policies applicable to those HONDA SERVICES (the "HONDA TERMS"). You acknowledge and agree that any collection, use, sharing of data generated by your VEHICLE or your use of your VEHICLE, and your use of the HONDA SERVICES shall be subject to this AGREEMENT and any additional HONDA TERMS that may be specifically applicable to such HONDA SERVICES or data generation. The HONDA SERVICES may collect, use, and share such data while you are using the SOFTWARE.

3. Open-Source Software. The SOFTWARE and SERVICES may incorporate software licensed to HONDA under free or open-source licenses which govern HONDA's distribution and your use of such software. HONDA and the third-party authors, licensors, and distributors of such software disclaim all warranties and all liability arising from any and all use or distribution of the software. To the extent such software is provided under terms that differ from the applicable free or open-source licenses, those terms are offered by HONDA alone. Additional information regarding free and open-source software incorporated in the SOFTWARE and SERVICES is available in this manual or within the SOFTWARE.

4. Provider Services. The SOFTWARE may provide you with access to various PROVIDER SERVICES. Installation or use of such PROVIDER SERVICES may require your consent to additional terms, conditions, and privacy policies of the applicable PROVIDER (the "PROVIDER TERMS"). This AGREEMENT restricts the manner in which you can install and use PROVIDER SERVICES but does not grant you a license or permission to use such PROVIDER SERVICES. Your permission to use PROVIDER SERVICES is limited and subject to any license grants, conditions, and limitations included in the PROVIDER TERMS. You acknowledge that any collection, use, sharing of your information, targeted advertising practices by PROVIDERS, and your use of the PROVIDER SERVICES shall be subject to both this AGREEMENT and any applicable PROVIDER TERMS. The PROVIDER SERVICES may collect, use, and share such information while you are using the SOFTWARE.

5. License Limitations and Restrictions on Use.

(a) Limited License. You understand and agree that the SOFTWARE and SERVICES are licensed, not sold, to you solely for use in accordance with this AGREEMENT and any applicable PROVIDER TERMS, and any documentation for the VEHICLE made available to you by HONDA (any "DOCUMENTATION"). HONDA and its licensors reserve all rights in the SOFTWARE and HONDA SERVICES not expressly granted to you under this AGREEMENT. PROVIDERS and their licensors reserve all rights in the PROVIDER SERVICES not expressly granted to you under the applicable PROVIDER TERMS.

(b) Restrictions on Use. The licenses granted under this AGREEMENT do not permit you to use the SOFTWARE or SERVICES on a device other than your VEHICLE. As a condition of using the SOFTWARE and SERVICES, you agree that you may not and will not:

- (1) copy, download, distribute, modify, publish, sell, rent, lease, lend, license, sublicense, reuse, or create derivative works of the SOFTWARE or SERVICES or any of the content or other material within the SOFTWARE or SERVICES, including without limitation, HONDA or PROVIDER names, logos, or any other trademarks of HONDA or PROVIDERS or used in association with the SOFTWARE or any SERVICES, except as required to use the SOFTWARE or SERVICES in accordance with this AGREEMENT, any applicable PROVIDER TERMS, and the DOCUMENTATION;
- (2) access or use the SOFTWARE or SERVICES in any manner intended to damage or impair the operation of the SOFTWARE or SERVICES or interfere with anyone else's use and enjoyment of the SOFTWARE or SERVICES;
- (3) access or attempt to access any system or server on which the SOFTWARE or SERVICES is hosted or modify or alter the SOFTWARE or SERVICES in any way;
- (4) use the SOFTWARE or SERVICES for any unlawful purpose, or in violation of any third party rights;
- (5) use the SOFTWARE or SERVICES in violation of any applicable traffic regulations, rules or laws, including but not limited to any driver distraction laws, rules or regulations;
- (6) violate the terms of this AGREEMENT, any HONDA TERMS, any PROVIDER TERMS or other applicable third-party terms, conditions, and privacy policies; or
- (7) reverse engineer, decompile, disassemble, attempt to derive the source code of, nor permit others to reverse engineer, decompile, or disassemble, or attempt to derive the source code of the SOFTWARE or SERVICES, except and only to the extent that such activity is expressly permitted (a) by applicable law notwithstanding this limitation or (b) the terms of applicable free or opensource software licenses.

6. Intellectual Property Rights. All title and intellectual property rights in and to the SOFTWARE and SERVICES, the accompanying DOCUMENTATION, and all copies of the SOFTWARE or SERVICES are owned by HONDA, PROVIDERS, or their suppliers or licensors. This AGREEMENT does not grant you any rights in connection with any trademarks or service marks of HONDA, PROVIDERS, or their licensors, affiliates, or suppliers.

7. Export Restrictions: You acknowledge that the SOFTWARE and SERVICES are subject to U.S., European Union, and other export jurisdictions. You agree to comply with all applicable international and national laws that apply to the SOFTWARE and SERVICES, including the U.S. Export Administration Regulations, as well as end-user, end-use, and destination restrictions issued by the U.S. and other governments.

C. SOFTWARE Operation

1. HONDA reserves the right to suspend or terminate your access to and use of the SOFTWARE or SERVICES if you are found to be in violation of this AGREEMENT or as reasonably deemed necessary by HONDA.

2. Eligibility/Registration/Activation. The SOFTWARE is intended for and available to individuals who (a) are of legal age of majority in their jurisdiction of residence (and at least 18 years of age), or are younger than 18 years of age and possess a valid driver's license issued by their jurisdiction of residence, and (b) own or have permissive access to a compatible VEHICLE. We do not knowingly collect any information, including personal information, from children under 13. If we learn or are notified that we have collected personal information of a child under 13, we will immediately take steps to delete such information.

3. Use of PROVIDER SERVICES through the SOFTWARE. Certain PROVIDER SERVICES made available through the SOFTWARE may require that you register or otherwise have an account with the PROVIDER and agree to PROVIDER TERMS. Any use of any of such PROVIDER SERVICES within the SOFTWARE is subject to this AGREEMENT and the applicable PROVIDER TERMS. HONDA does not exercise control over such PROVIDER SERVICES and is not responsible or liable for the availability, security, or content of such PROVIDER SERVICES, and the inclusion of any PROVIDER SERVICES does not imply a referral from, the approval of, or the endorsement by HONDA of such PROVIDER SERVICES. HONDA is not responsible or liable, directly or indirectly, for any damage relating to or resulting from your use of the PROVIDER SERVICES.

4. Links to Third Party Sites: The SOFTWARE may provide you with the ability to access third-party sites and content through the use of the SOFTWARE or SERVICES. The third-party sites and content are not under the control of HONDA. HONDA is not responsible or liable, directly or indirectly, for such third-party websites and their content or for any damage relating to or resulting from your access or use of such websites and content.

5. Unauthorized Use and Abuse. You are responsible for ensuring your (and any authorized third parties') use of the SOFTWARE and SERVICES remains in compliance with this AGREEMENT and all other applicable HONDA TERMS and PROVIDER TERMS. You acknowledge and agree that any use of the SOFTWARE or SERVICES occurring through your VEHICLE will be deemed your actions and that HONDA and PROVIDERS may rely upon such actions. You agree to immediately notify us if you suspect fraudulent or abusive activity involving the SOFTWARE or SERVICES. If you so notify us or if we otherwise suspect fraudulent or abusive activity, you agree to cooperate with us in any fraud investigation and to use any fraud prevention measures we prescribe. Your failure to immediately notify us or cooperate to use such measures will result in your liability for all fraudulent usage or abusive activity associated with your VEHICLE.

6. SOFTWARE Updates. The SOFTWARE and SERVICES may be updated when your VEHICLE is serviced by a DEALER or remotely, over-the-air, by HONDA from time to time; such updates may occur with or without further notice or your future consent. The SOFTWARE may be updated at HONDA's discretion and for any purpose including, without limitation, to patch or otherwise improve the SOFTWARE or SERVICES functionality, security, or stability. All updates to the SOFTWARE and SERVICES are subject to this AGREEMENT and any other applicable HONDA TERMS and PROVIDER TERMS.

7. Uninstalling, Removing, and Replacing the SOFTWARE. Replacing SOFTWARE or HONDA SERVICES with software or firmware not provided and installed by HONDA or a DEALER will render all representations and warranties for the SOFTWARE, HONDA SERVICES, and VEHICLE functionality reliant upon the SOFTWARE or HONDA SERVICES null and void.

D. SOFTWARE Operational Notices and Warnings

1. Vehicle Geolocation Information. You acknowledge that your VEHICLE may be equipped with certain traffic and map features. The traffic feature will automatically collect and transmit, through GPS technology, your Vehicle's current location (longitude and latitude), travel direction and speed ("VEHICLE GEOLOCATION INFORMATION") to HONDA and PROVIDERS. The VEHICLE GEOLOCATION INFORMATION is used by HONDA and PROVIDERS to provide traffic and navigation-related information to you, but may also be used to provide other SERVICES or offers to you. HONDA will not use such VEHICLE GEOLOCATION INFORMATION for its own marketing efforts, or provide such information to unaffiliated third parties for their own purposes, without your express consent.

2. Potential Map Inaccuracy and Route Safety. Maps used by this system may be inaccurate because of changes in roads, traffic controls, routing, or driving conditions. Always use good judgment and common sense when following suggested routes. Do not follow the route suggestions if doing so would result in an unsafe or illegal driving maneuver, if you would be placed in an unsafe situation, or if you would be directed into an area that you consider unsafe. Do not rely on any navigation features included in the system to route you to emergency services. Not all emergency services such as police, fire stations, hospitals, or clinics are likely to be contained in the map database for such navigation features. Ask local authorities or an emergency services operator for such locations and routes. The driver is ultimately responsible for the safe operation of the vehicle and therefore, must evaluate whether it is safe to follow the suggested directions. Any navigation features are provided only as an aid. Make your driving decisions based on your observations of local conditions and existing traffic regulations. Navigation features are not a substitute for your personal judgment. Any route suggestions made by the SOFTWARE or SERVICES should never replace any local traffic regulations or your personal judgment or knowledge of safe driving practices.

3. Speech Recognition: You acknowledge and understand that HONDA and PROVIDERS may record, retain, and use voices commands when you use the speech recognition components of the SOFTWARE or SERVICES. You and all VEHICLE operators and passengers (a) consent to the recording and retention of voice commands in support of providing speech recognition components and (b) release HONDA and PROVIDERS from all claims, liabilities, and losses that may result from any use of such recorded voice commands. Recognition errors are inherent in speech recognition. It is your responsibility to monitor any speech recognition functions included in the system and address any errors. Neither HONDA nor PROVIDERS will be liable for any damages arising out of errors in the speech recognition process.

4. Distraction Hazards. Navigation features may require manual (non-verbal) input or setup. Attempting to perform such set-up or insert data while driving can seriously distract your attention and could cause a crash or other serious consequences; the ability to undertake such interactions may also be limited by state or local law, which laws you are responsible to know and follow. Even occasional short scans of the screen may be hazardous if your attention has been diverted away from your driving at a critical time. Pull over and stop the vehicle in a safe and legal manner before attempting to access a function of the system requiring prolonged attention. Do not raise the volume excessively. Keep the volume at a level where you can still hear outside traffic and emergency signals while driving. Driving while unable to hear these sounds could result in a crash.

E. Information Collection and Storage

1. Information Collection, Use, Transmission and Storage of Data. Consent to Use of Data: You agree that HONDA and PROVIDERS may collect and use your information gathered in any manner as part of product support services related to the SOFTWARE or related services. HONDA may share such information with third parties, including, without limitation, PROVIDERS, third party software and services suppliers, their affiliates and/or their designated agents, solely to improve their products or to provide services or technologies to you. HONDA, third party software and systems suppliers, their affiliates and/or their designated agent may disclose this information to others, but not in a form that personally identifies you.

2. Information Storage. Depending on the type of multimedia system you have in your VEHICLE, certain information may be stored for ease of use of the SOFTWARE including, without limitation, search history, location history in certain applications, previous and saved destinations, map locations within certain applications, and device numbers and contact information.

(a) Vehicle Health Information. Your VEHICLE may remotely transmit information regarding the status and health of your VEHICLE (“VEHICLE INFORMATION”) to HONDA without notification to you. VEHICLE INFORMATION may contain VEHICLE maintenance and malfunction status that is derived from VEHICLE diagnostic data and includes, but is not limited to, status of powered doors and windows, battery life data, battery charging data, VEHICLE speed, coolant temperature, air compressor revolution, output power, warning codes, diagnostic trouble codes, fuel injection volume, and engine rotations per minute. VEHICLE HEALTH INFORMATION may be used by HONDA for research and development, to deliver HONDA SERVICES and information to you, and to contact you, and is retained only for a period of time necessary to fulfill these goals.

(b) VEHICLE Geolocation Data (non-navigation/map based). If you opt-in to geolocation-based SERVICES, your vehicle’s geolocation data (latitude and longitude) will be automatically sent from your VEHICLE to HONDA and PROVIDERS.

(c) You understand that the inputting or uploading of information to your VEHICLE’s multimedia system or the SOFTWARE or SERVICES is at your own risk and that HONDA is not responsible for unauthorized access to or use of any personal or other information. All information uploaded to the SOFTWARE and SERVICES may be stored on your VEHICLES’s multimedia system and you understand that the security and safety of your VEHICLE’s multimedia system is your sole responsibility.

F. NO WARRANTY. You understand and agree that your use of the SOFTWARE and SERVICES are solely at your own risk and that you will be solely responsible for any damage to your VEHICLE's multimedia system or any other equipment or any loss of data that may result from your use of the SOFTWARE or SERVICES. THE SOFTWARE AND SERVICES ARE PROVIDED ON AN "AS IS" AND "AS AVAILABLE" BASIS WITHOUT ANY WARRANTY OF ANY KIND, EXPRESSED, IMPLIED OR STATUTORY. WE SPECIFICALLY DISCLAIM ANY IMPLIED WARRANTIES OF MERCHANTABILITY, FITNESS FOR A PARTICULAR PURPOSE, AND NON-INFRINGEMENT. HONDA makes no warranties that the SOFTWARE or SERVICES will meet your requirements, or that the SOFTWARE or SERVICES will be uninterrupted, timely, secure, non-infringing or error free. You understand and agree that you are responsible for any and all charges, costs or expenses associated with your use of the SOFTWARE or SERVICES. Advice or information, whether oral or written, obtained by you from us or through the SOFTWARE or SERVICES are provided for informational purposes only and will not create any warranty not expressly made herein. You should not rely on any such information or advice. We assume no liability or responsibility for any errors or omissions in the SOFTWARE or SERVICES. We do not make any warranty or representation that your use of the material displayed on, or obtained through, the SOFTWARE or SERVICES is non-infringing of any rights of any third party. Any decision or action taken by you on the basis of information or content provided via the application is at your sole discretion and risk. HONDA and PROVIDERS are not responsible or liable for any such decision, or for the accuracy, completeness, usefulness, or availability of any content or information displayed, transmitted, or otherwise made available via the SOFTWARE or SERVICES. To the extent jurisdictions do not allow the exclusion of certain warranties, some of the above exclusions may not apply to you.

G. LIMITATIONS ON LIABILITY. You and HONDA are each waiving important rights.

1. Limitations on YOUR liability. HONDA cannot recover from you any consequential, indirect, incidental, or special damages, or attorney's fees in connection with your use of the SOFTWARE or HONDA SERVICES. HONDA WAIVES TO THE FULLEST EXTENT ALLOWED BY LAW ANY CLAIM FOR DAMAGES OTHER THAN DIRECT, COMPENSATORY DAMAGES AS LIMITED IN THIS AGREEMENT.

2. Limitation on HONDA and PROVIDER liability. Neither HONDA nor PROVIDERS will be liable to you or any other party for consequential, indirect, incidental, special, or punitive damages (including without limitation lost profits) in connection with your use of the SOFTWARE or SERVICES, even if HONDA or PROVIDERS are aware of the possibility of such damages. These limitations apply to all claims, including, without limitation, claims in contract and tort (such as negligence, product liability and strict liability). To the extent that a jurisdiction does not permit the exclusion or limitation of liability as set forth herein our liability is limited to the maximum extent permitted by law in such states. If HONDA or PROVIDERS are found liable to you for any reason, you agree that the aggregate liability of all these parties to you for any claim is limited to ten U.S. dollars (US \$10.00). Neither HONDA nor any PROVIDER would have agreed to provide the SOFTWARE or SERVICES to you if you did not agree to this limitation. This amount is the sole and exclusive liability of HONDA and PROVIDERS to you, and is payable as liquidated damages and not as a penalty. Except where prohibited by law, you may not bring any claim against HONDA or any third-party beneficiary more than two (2) years after the claim arises. We do not have any liability for SOFTWARE or SERVICES interruptions of any length.

(a) **Release of HONDA and PROVIDERS** For yourself and anyone else claiming under you, you agree to release and discharge HONDA, PROVIDERS, their respective officers, directors, and employees, and each third-party beneficiary from all claims, liabilities and losses in connection with the SOFTWARE or SERVICES, including, but not limited to claims for personal injury or property damage arising from the total or partial failure of performance of the SOFTWARE or SERVICES, even if caused by or based upon the negligence, gross negligence, strict products liability, Deceptive Trade Practices Act violations, bad faith, or breach of warranty of us or the malfunction of the SOFTWARE or SOFTWARE SERVICES. YOU AGREE TO WAIVE TO THE FULLEST EXTENT ALLOWED BY LAW, ANY CLAIM FOR DAMAGES OTHER THAN DIRECT, COMPENSATORY DAMAGES AS LIMITED IN THIS AGREEMENT. YOU HEREBY RELEASE AND DISCHARGE HONDA AND ITS LICENSORS AND CONTRACTORS (INCLUDING ANY THIRD PARTIES PROVIDING ALL OR PART OF THE SOFTWARE OR SERVICES) FROM AND AGAINST ANY CLAIMS, DAMAGES, EXPENSES AND LIABILITY ARISING FROM OR RELATED TO ANY INJURIES, DAMAGES, OR LOSSES TO ANY PERSON (INCLUDING DEATH) OR PROPERTY OF ANY KIND RESULTING IN WHOLE OR PART, DIRECTLY OR INDIRECTLY, FROM YOUR USE OF THE SOFTWARE OR SERVICES.

H. Survival. You agree that the limitations of liability and indemnities in this AGREEMENT will survive even after the AGREEMENT has ended. These limitations of liability apply not only to you, but to anyone using the SOFTWARE or SERVICES via your VEHICLE, to anyone making a claim on your behalf, and to any claims made by your family, employees, customers, or others arising out of or relating to your VEHICLE, the SOFTWARE, or SERVICES.

I. Availability/Interruption. The SOFTWARE and certain SERVICES are made available through your VEHICLE's compatible multimedia system when the VEHICLE is turned on. Certain SERVICES may be available only through your compatible mobile device when it is within the operating range of the VEHICLE and a wireless carrier. The availability of the SOFTWARE and SERVICES may be subject to transmission limitation or interruption, including but not limited to technical obsolescence or sunset of the hardware, software or firmware, inside of or external to the Vehicle, required for data transmission or receipt. HONDA does not guarantee that the SOFTWARE, SERVICES, or any portion thereof will be available at all times or in all areas. You acknowledge and agree that HONDA is not responsible for performance degradation, interruption or delays. You acknowledge that HONDA shall not be liable to you if the SOFTWARE or SERVICES in a given location are not available. If the SOFTWARE or SERVICES are not available within your intended location, you agree that your sole remedy shall be to cease using the SOFTWARE and SERVICES.

J. PRODUCT SUPPORT: Product support for the SOFTWARE is provided by HONDA. For product support, please refer to HONDA instructions provided in the DOCUMENTATION. Should you have any questions concerning this AGREEMENT, or if you desire to contact HONDA for any other reason, please refer to the HONDA contact information provided in the DOCUMENTATION.

K. Termination and Transfer.

1. Termination. This AGREEMENT is effective until terminated by you or US. WE may terminate this AGREEMENT for any or no reason, and with or without notice to you. Your rights under this AGREEMENT will terminate automatically without notice from US if you fail to comply with any term of this AGREEMENT. Upon termination of this AGREEMENT, you shall cease all use of the SOFTWARE and SERVICES.

2. Transfer: You may permanently transfer your rights under this AGREEMENT only as part of a sale or transfer of the VEHICLE, provided you retain no copies, you transfer all of the SOFTWARE and HONDA SERVICES (including all component parts, the media and printed materials, and any upgrades), and the recipient agrees to the terms of this AGREEMENT. You agree to notify HONDA upon the sale or transfer of the VEHICLE. To contact HONDA, please refer to the HONDA contact information provided in the DOCUMENTATION.

L. Changes to the SOFTWARE or SERVICES. WE may change, modify, or update the SOFTWARE or SERVICES from time to time. Unless explicitly stated otherwise, any new features or services that augment or enhance the SOFTWARE or SERVICES in the future shall respectively be considered part of the SOFTWARE or SERVICES and subject to this AGREEMENT. WE reserve the right at any time and from time to time to interrupt, restrict, modify, suspend, discontinue, temporarily or permanently, the SOFTWARE or SERVICES (or any portion thereof), with or without notice to you, and you agree that HONDA shall not be liable to you or to any third party for any modification, suspension or discontinuance of the SOFTWARE or SERVICES.

M. ARBITRATION:

PLEASE READ THIS ARBITRATION PROVISION CAREFULLY TO UNDERSTAND YOUR RIGHTS. YOU AGREE THAT ANY CLAIM THAT YOU MAY HAVE IN THE FUTURE MUST BE RESOLVED THROUGH BINDING ARBITRATION. YOU WAIVE THE RIGHT TO HAVE YOUR DISPUTE HEARD IN COURT AND WAIVE THE RIGHT TO BRING CLASS CLAIMS. YOU UNDERSTAND THAT DISCOVERY AND APPEAL RIGHTS ARE MORE LIMITED IN ARBITRATION.

Arbitration is a method of resolving a claim, dispute or controversy without filing a lawsuit. By agreeing to arbitrate, the right to go to court is waived and instead claims, disputes or controversies are submitted to binding arbitration. This provision sets forth the terms and conditions of our agreement. YOU and HONDA agree and acknowledge that this Agreement affects interstate commerce and the Federal Arbitration Act ("FAA") applies. By using the Software, Vehicle, or Services, YOU elect to have disputes resolved by arbitration. YOU, HONDA or any involved third party may pursue a Claim. "Claim" means any dispute between YOU, HONDA, or any involved third party relating to your use of the Software, the Vehicle, or the Services, this Agreement, or our relationship, including any representations, omissions or warranties. "Claim" does not include personal injury or wrongful death claims. YOU or HONDA may seek remedies in small claims court or provisional judicial remedies without arbitrating. In addition, notwithstanding anything herein to the contrary, YOU or HONDA may seek equitable relief in a court of competent jurisdiction.

YOU or HONDA may select arbitration with American Arbitration Association, JAMS or National Arbitration and Mediation. Contact these sponsors for their rules. The hearing will be in the federal district where YOU reside. If agreed, it may be by telephone or written submissions. Filing and arbitrator fees to be paid per the sponsor rules. You may contact the sponsor for a fee waiver. If no fee waivers, HONDA will pay filing and arbitrator fees up to \$5,000, unless law requires more. Each party is responsible for other fees. Arbitrator may award costs or fees to prevailing party, if permitted by law. HONDA will not seek fees, unless the claims are frivolous.

Arbitrator shall be an attorney or current or retired judge familiar with automotive or consumer software. The arbitrator shall follow substantive law, statute of limitations and decide all issues relating to the interpretation, construction, enforceability and applicability of this provision. The arbitrator may order relief permitted by law. This provision is governed and enforceable by the FAA. An award shall include a written opinion and be final, subject to appeal by the FAA.

This provision survives termination of this Agreement or relationship, bankruptcy, assignment or transfer. If part of this provision is unenforceable, the remainder remains in effect. If unenforceability allows arbitration as a class action, then this provision is entirely unenforceable. YOU may opt out within 30 days of your initial use of the Software by sending a signed, written notice to HONDA at Honda Financial Services, P.O. Box 165007, Irving, TX 75016. HONDA reserves the right to make changes to this provision after providing written notice and an opportunity to opt out.

N. Miscellaneous: You may not assign this AGREEMENT without HONDA's prior written consent. This AGREEMENT and any additional HONDA TERMS and PROVIDER TERMS represents the entire agreement between you and US. HONDA may amend the terms of this AGREEMENT by providing you with notices of such updated terms. If you do not consent to be bound by the updated terms, your sole remedy will be to cease using the SOFTWARE and SERVICES. If any part of this AGREEMENT is found invalid, void, or unenforceable, the balance of the AGREEMENT will remain valid and enforceable according to its terms. To the fullest extent permitted by law, and except as explicitly provided otherwise, this AGREEMENT and any disputes arising out of or relating to it will be governed by the laws of the State of California, except that California laws concerning choice of law or conflicts shall not apply if they would cause the substantive law of another jurisdiction to apply. Notwithstanding the foregoing, Section M shall be governed by the Federal Arbitration Act and the laws of the State of California, as applicable, as set forth therein. The failure to enforce any term of this AGREEMENT on one occasion shall not prevent enforcement on any other occasion or the enforcement of any other term. Headings and captions shall not be considered included for purposes of interpretation or application hereof, but are for convenience only.

Models with Display Audio

Legal Information on Apple CarPlay™/Android Auto™

OWNER'S MANUAL LICENSE/LIABILITY STATEMENTS

USE OF APPLE CARPLAY IS SUBJECT TO YOUR AGREEMENT TO THE CARPLAY TERMS OF USE, WHICH ARE INCLUDED AS PART OF THE APPLE iOS TERMS OF USE. IN SUMMARY, THE CARPLAY TERMS OF USE DISCLAIM APPLE AND ITS SERVICE PROVIDERS' LIABILITY IF THE SERVICES FAIL TO PERFORM CORRECTLY OR ARE DISCONTINUED, STRICTLY LIMIT APPLE AND ITS SERVICE PROVIDERS' OTHER LIABILITIES, DESCRIBE THE KINDS OF USER INFORMATION (INCLUDING, FOR EXAMPLE, VEHICLE LOCATION, VEHICLE SPEED, AND VEHICLE STATUS) BEING GATHERED AND STORED BY APPLE AND ITS SERVICE PROVIDERS, AND DISCLOSE CERTAIN POSSIBLE RISKS ASSOCIATED WITH THE USE OF CARPLAY, INCLUDING THE POTENTIAL FOR DRIVER DISTRACTION. SEE APPLE'S PRIVACY POLICY FOR DETAILS REGARDING APPLE'S USE AND HANDLING OF DATA UPLOADED BY CARPLAY.

USE OF ANDROID AUTO IS SUBJECT TO YOUR AGREEMENT TO THE ANDROID AUTO TERMS OF USE WHICH MUST BE AGREED TO WHEN THE ANDROID AUTO APPLICATION IS DOWNLOADED TO YOUR ANDROID PHONE. IN SUMMARY, THE ANDROID AUTO TERMS OF USE DISCLAIM GOOGLE AND ITS SERVICE PROVIDERS' LIABILITY IF THE SERVICES FAIL TO PERFORM CORRECTLY OR ARE DISCONTINUED, STRICTLY LIMIT GOOGLE AND ITS SERVICE PROVIDERS' OTHER LIABILITIES, DESCRIBE THE KINDS OF USER INFORMATION (INCLUDING, FOR EXAMPLE, VEHICLE LOCATION, VEHICLE SPEED, AND VEHICLE STATUS) BEING GATHERED AND STORED BY GOOGLE AND ITS SERVICE PROVIDERS, AND DISCLOSE CERTAIN POSSIBLE RISKS ASSOCIATED WITH THE USE OF ANDROID AUTO, INCLUDING THE POTENTIAL FOR DRIVER DISTRACTION. SEE GOOGLE'S PRIVACY POLICY FOR DETAILS REGARDING GOOGLE'S USE AND HANDLING OF DATA UPLOADED BY ANDROID AUTO.

■ **DISCLAIMER OF WARRANTIES; LIMITATION ON LIABILITY**

YOU EXPRESSLY ACKNOWLEDGE AND AGREE THAT USE OF APPLE CARPLAY OR ANDROID AUTO (“THE APPLICATIONS”) IS AT YOUR SOLE RISK AND THAT THE ENTIRE RISK AS TO SATISFACTORY QUALITY, PERFORMANCE, ACCURACY AND EFFORT IS WITH YOU TO THE MAXIMUM EXTENT PERMITTED BY APPLICABLE LAW, AND THAT THE APPLICATIONS AND INFORMATION ON THE APPLICATIONS IS PROVIDED “AS IS” AND “AS AVAILABLE,” WITH ALL FAULTS AND WITHOUT WARRANTY OF ANY KIND, AND HONDA HEREBY DISCLAIMS ALL WARRANTIES AND CONDITIONS WITH RESPECT TO THE APPLICATIONS AND INFORMATION ON THE APPLICATIONS, EITHER EXPRESS, IMPLIED OR STATUTORY, INCLUDING, BUT NOT LIMITED TO, THE IMPLIED WARRANTIES AND/OR CONDITIONS OF MERCHANTABILITY, SATISFACTORY QUALITY, FITNESS FOR A PARTICULAR PURPOSE, ACCURACY, QUIET ENJOYMENT, AND NON-INFRINGEMENT OF THIRD PARTY RIGHTS. NO ORAL OR WRITTEN INFORMATION OR ADVICE GIVEN BY HONDA OR AN AUTHORIZED REPRESENTATIVE SHALL CREATE A WARRANTY. AS EXAMPLES, AND WITHOUT LIMITATION, HONDA DISCLAIMS ANY WARRANTY REGARDING THE ACCURACY OF DATA PROVIDED BY THE APPLICATIONS, SUCH AS THE ACCURACY OF DIRECTIONS, ESTIMATED TRAVEL TIME, SPEED LIMITS, ROAD CONDITIONS, NEWS, WEATHER, TRAFFIC, OR OTHER CONTENT PROVIDED BY APPLE, GOOGLE, THEIR AFFILIATES, OR THIRD PARTY PROVIDERS; HONDA DOES NOT GUARANTEE AGAINST LOSS OF APPLICATION DATA, WHICH MAY BE LOST AT ANY TIME; HONDA DOES NOT GUARANTEE THAT THE APPLICATIONS OR ANY SERVICES PROVIDED THROUGH THEM WILL BE PROVIDED AT ALL TIMES OR THAT ANY OR ALL SERVICES WILL BE AVAILABLE AT ANY PARTICULAR TIME OR LOCATION. FOR EXAMPLE, SERVICES MAY BE SUSPENDED OR INTERRUPTED WITHOUT NOTICE FOR REPAIR, MAINTENANCE, SECURITY FIXES, UPDATES, ETC., SERVICES MAY BE UNAVAILABLE IN YOUR AREA OR LOCATION, ETC. IN ADDITION, YOU UNDERSTAND THAT CHANGES IN THIRD PARTY TECHNOLOGY OR GOVERNMENT REGULATION MAY RENDER THE SERVICES AND/OR APPLICATIONS OBSOLETE AND/OR UNUSABLE.

TO THE EXTENT NOT PROHIBITED BY LAW, IN NO EVENT SHALL HONDA OR ITS AFFILIATES BE LIABLE FOR PERSONAL INJURY, OR ANY INCIDENTAL, SPECIAL, INDIRECT OR CONSEQUENTIAL DAMAGES WHATSOEVER, INCLUDING, WITHOUT LIMITATION, DAMAGES FOR LOSS OF PROFITS, CORRUPTION OR LOSS OF DATA, FAILURE TO TRANSMIT OR RECEIVE ANY DATA, BUSINESS INTERRUPTION OR ANY OTHER COMMERCIAL DAMAGES OR LOSSES, ARISING OUT OF OR RELATED TO THE APPLICATIONS OR YOUR USE OF OR INABILITY TO USE THE APPLICATIONS OR INFORMATION ON THE APPLICATIONS, HOWEVER CAUSED, REGARDLESS OF THE THEORY OF LIABILITY (CONTRACT, TORT OR OTHERWISE) AND EVEN IF HONDA WERE ADVISED OF THE POSSIBILITY OF SUCH DAMAGES. SOME STATES AND JURISDICTIONS DISALLOW THE EXCLUSION OR LIMITATION OF LIABILITY FOR DAMAGES, SO THESE LIMITATIONS AND EXCLUSIONS MAY NOT APPLY TO YOU. IN NO EVENT SHALL HONDA’S TOTAL LIABILITY TO YOU FOR ALL DAMAGES (OTHER THAN AS MAY BE REQUIRED BY APPLICABLE LAW IN CASES INVOLVING PERSONAL INJURY) EXCEED THE AMOUNT OF FIVE DOLLARS (\$5.00). THE FOREGOING LIMITATIONS WILL APPLY EVEN IF THE ABOVE STATED REMEDY FAILS OF ITS ESSENTIAL PURPOSE.

About Open Source Licenses

To see the open source license information, follow these steps.

Models with color audio system

1. Press the **MENU/CLOCK** button.
2. Rotate  to select **Settings**, then press .
3. Rotate  to select **License**, then press .

Models with Display Audio

1. Select .
2. Select **Settings**.
3. Select **System**.
4. Select the **Others** tab.
5. Select **Detail Information**.
6. Select **About device**.
7. Select **Legal information**.
8. Select **Open source licenses**.

▶▶ About Open Source Licenses

Models with color audio system

LICENSE: Copyright © 2001 Bob Trower, Trantor Standard Systems Inc.

Permission is hereby granted, free of charge, to any person obtaining a copy of this software and associated documentation files (the "Software"), to deal in the Software without restriction, including without limitation the rights to use, copy, modify, merge, publish, distribute, sublicense, and/or sell copies of the Software, and to permit persons to whom the Software is furnished to do so, subject to the following conditions:

The above copyright notice and this permission notice shall be included in all copies or substantial portions of the Software.

THE SOFTWARE IS PROVIDED "AS IS", WITHOUT WARRANTY OF ANY KIND, EXPRESS OR IMPLIED, INCLUDING BUT NOT LIMITED TO THE WARRANTIES OF MERCHANTABILITY, FITNESS FOR A PARTICULAR PURPOSE AND NONINFRINGEMENT. IN NO EVENT SHALL THE AUTHORS OR COPYRIGHT HOLDERS BE LIABLE FOR ANY CLAIM, DAMAGES OR OTHER LIABILITY, WHETHER IN AN ACTION OF CONTRACT, TORT OR OTHERWISE, ARISING FROM, OUT OF OR IN CONNECTION WITH THE SOFTWARE OR THE USE OR OTHER DEALINGS IN THE SOFTWARE.

Models with color audio system

Use the audio/information screen to customize certain features.

■ How to customize

While the vehicle is at a complete stop with the power mode in ON, press the **MENU/CLOCK** button, then select **Settings**. To customize the phone settings, press the  button, then select **Phone Setup**.

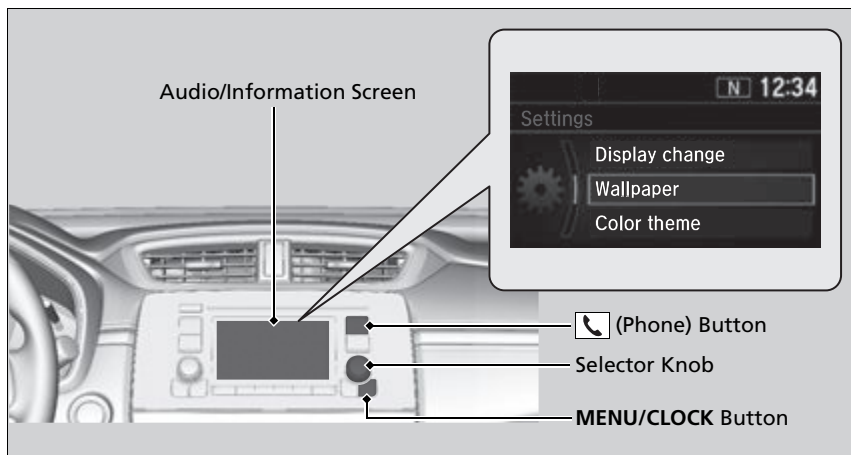

» Customized Features

When you customize settings:

- Make sure that the vehicle is at a complete stop.
- Put the transmission into **P**.

» How to customize

These indications are used to show how to operate the selector knob.

Rotate  to select.

Press  to enter.

■ Customization flow

Press the MENU/CLOCK button.

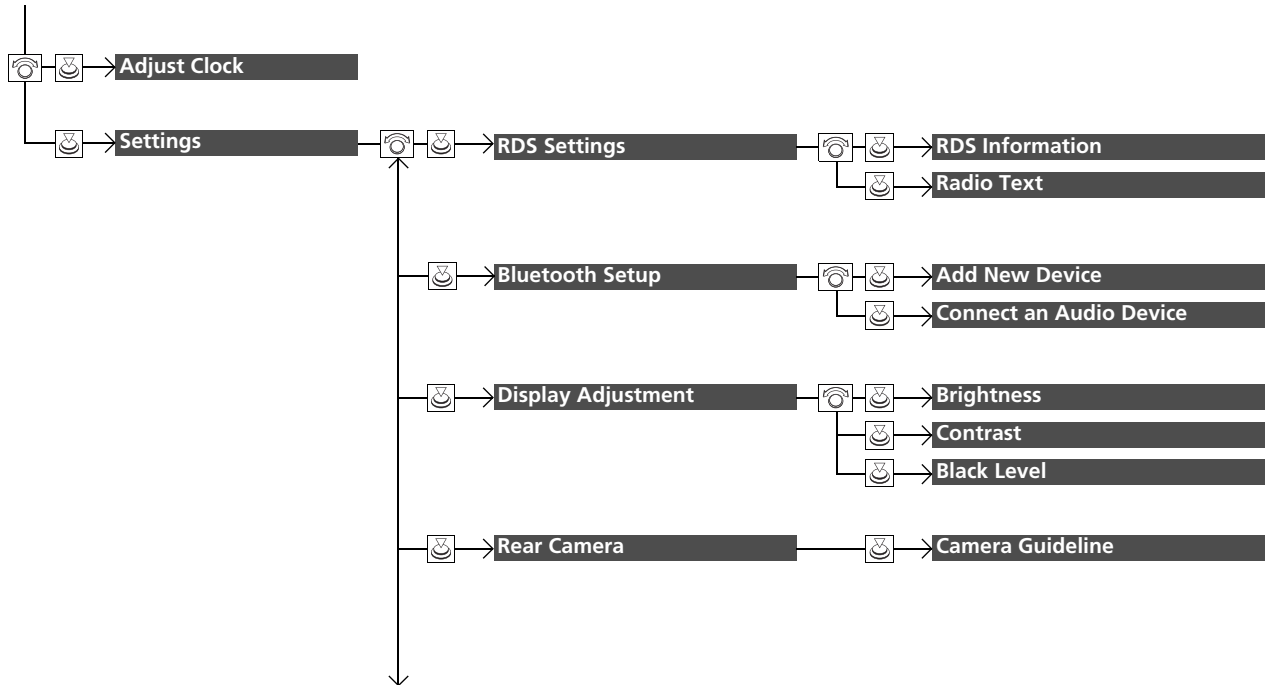

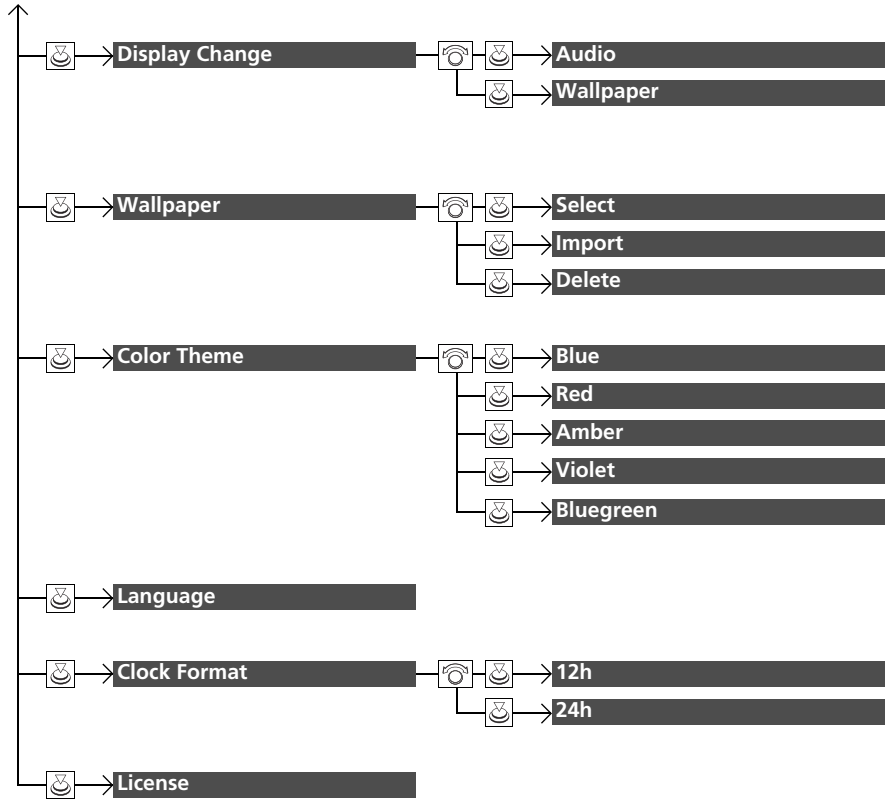

Press the  button and rotate  to select **Phone Setup**, then press .

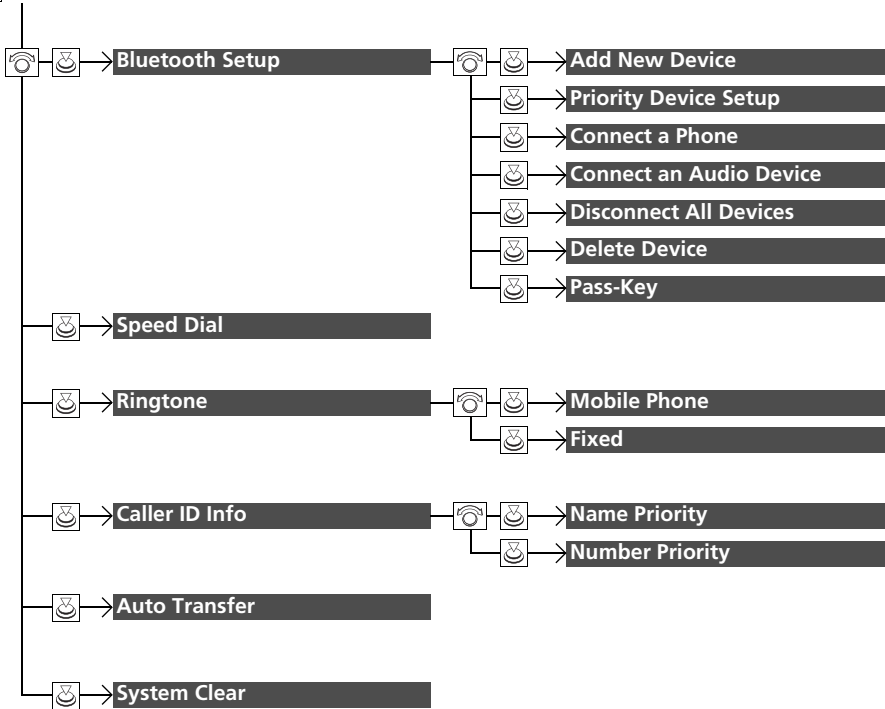



■ List of customizable options

Setup Group	Customizable Features	Description	Selectable Settings	
Settings	Adjust Clock	Adjust Clock. ▶ Clock P. 150	—	
	RDS Settings	RDS Information	Selects whether the RDS information comes on.	On*1/Off
		Radio Text	Displays the radio text information of the selected RDS station.	—
	Bluetooth Setup	Add New Device	Pairs a new phone to HFL, edits and deletes a paired phone, and create a code for a paired phone. ▶ Phone Setup P. 404	—
		Connect an Audio Device	Connects, disconnects or pairs a <i>Bluetooth</i> ® Audio device to HFL.	—
	Display Adjustment	Brightness	Changes the brightness of the audio/information screen.	—
		Contrast	Changes the contrast of the audio/information screen.	—
		Black Level	Changes the black level of the audio/information screen.	—
	Rear Camera	Camera Guideline	Selects whether the guidelines come on the audio/information screen.	On*1/Off

*1:Default Setting

Setup Group	Customizable Features	Description	Selectable Settings	
Settings	Display Change	Changes the display type.	Audio^{*1}/Wallpaper	
	Wallpaper	Select	Changes the wallpaper type.	Clock^{*1}/Image 1/Image 2/ Image 3
		Import	Imports an image file for a new wallpaper.  Wallpaper Setup P. 254	—
		Delete	Deletes an image file for a wallpaper.	Image 1/Image 2/Image 3
	Color Theme	Changes the background color of the audio/ information screen.	Blue^{*1}/Red/Amber/Violet/ Bluegreen	
	Language	Changes the display language.	English^{*1}/French/Spanish	
	Clock Format	Selects the digital clock display from 12H to 24H.	12h^{*1}/24h	
	License	Shows the legal information.	—	

*1:Default Setting

Setup Group	Customizable Features	Description	Selectable Settings		
Phone Setup	Add New Device	Pairs a new phone to HFL.  Phone Setup P. 404	—		
	Bluetooth Setup	Priority	Enables the system to or disables it from automatically establishing a connection with a <i>Bluetooth</i> ® device which has been assigned priority.	On*¹/Off	
		Priority Device Setup	Phone Priority	Selects the priority device over another paired phone(s).	—
			Audio Priority	Selects the priority device over another paired audio device(s).	—
		Connect a Phone	Pairs a new phone or connects a paired phone to HFL.  Phone Setup P. 404	—	
	Connect an Audio Device	Connects a <i>Bluetooth</i> ® Audio device to HFL.	—		
	Disconnect All Devices	Disconnects a paired phone from HFL.	—		
	Delete Device	Deletes a paired phone.	—		
	Pass-Key	Inputs and changes a code for a paired phone.	—		
	Speed Dial	Edits, adds or deletes a speed dial entry.  Speed Dial P. 413	—		
	Ringtone	Selects the ring tone.	Mobile Phone*¹/Fixed		
	Caller ID Info	Prioritizes the caller's name or phone number as the caller ID.	Name Priority*¹/Number Priority		
	Auto Transfer	Sets calls to automatically transfer from your phone to HFL when you enter the vehicle.	On*¹/Off		
System Clear	Cancels/Resets all customized items in the Phone Setup group as default.	—			

*1:Default Setting

Customized Features

Models with Display Audio

Use the audio/information screen to customize certain features.

■ How to customize

While the vehicle is at a complete stop with the power mode in ON, select , and **Settings**, then select a setting item.

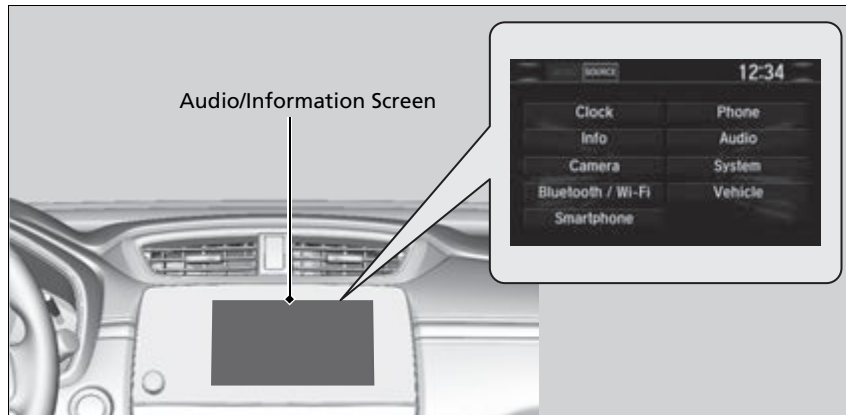

Customized Features

When you customize settings, make sure that the vehicle is at a complete stop and put the transmission into **P**.

To customize features detail, refer to the following.

➤ **Customization flow** P. 370

➤ **List of customizable options** P. 378

Continued

■ Customization flow

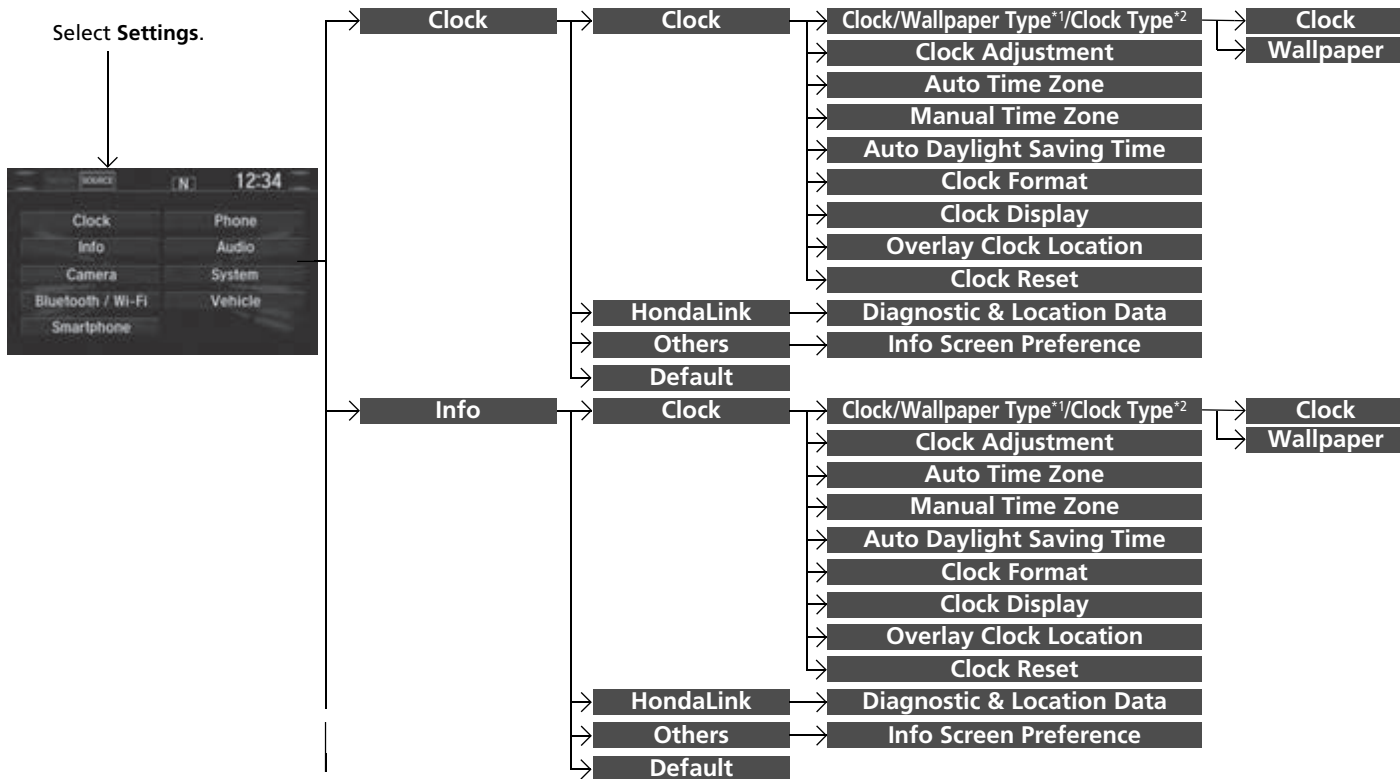

*1 : Does not appear when you change the screen interface design.

*2 : Appears only when you change the screen interface design.

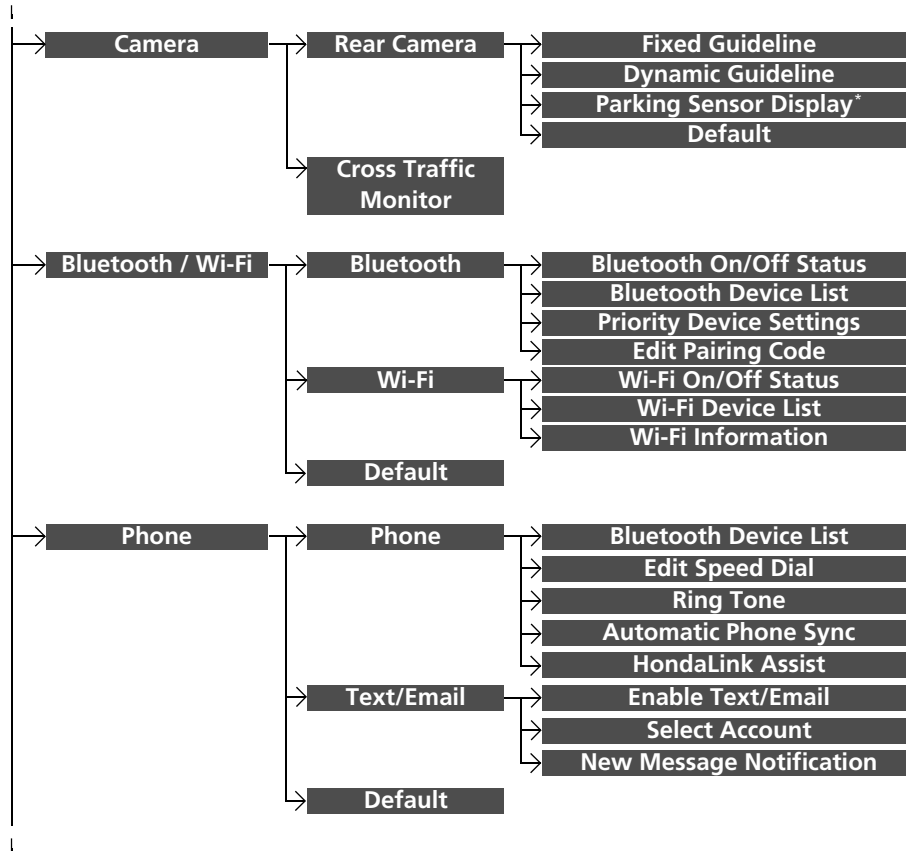

* Not available on all models

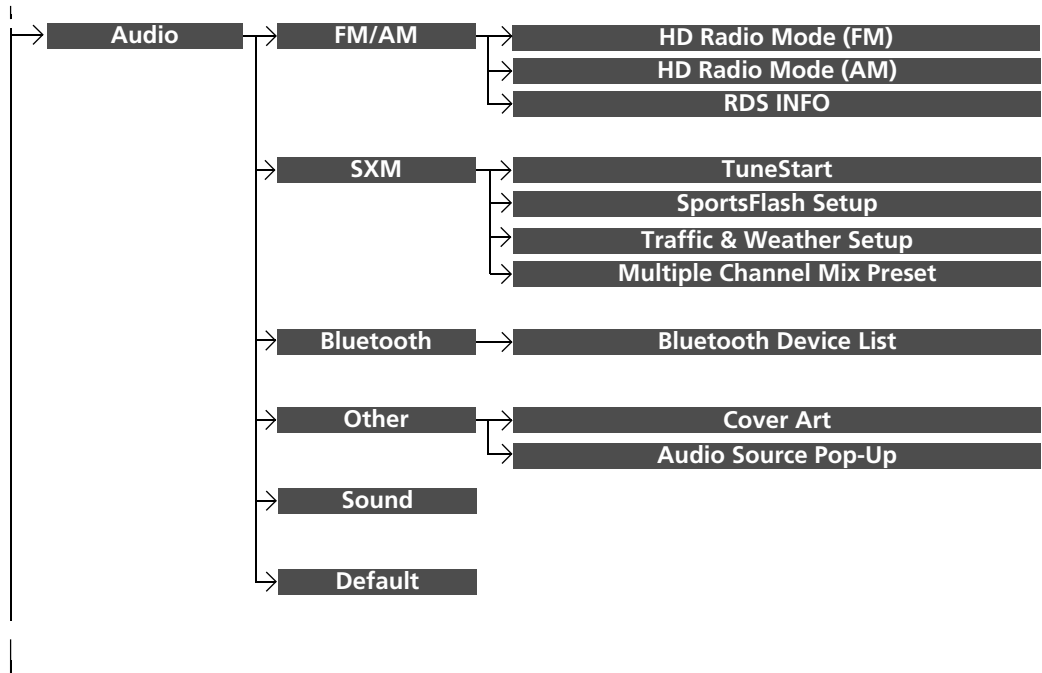

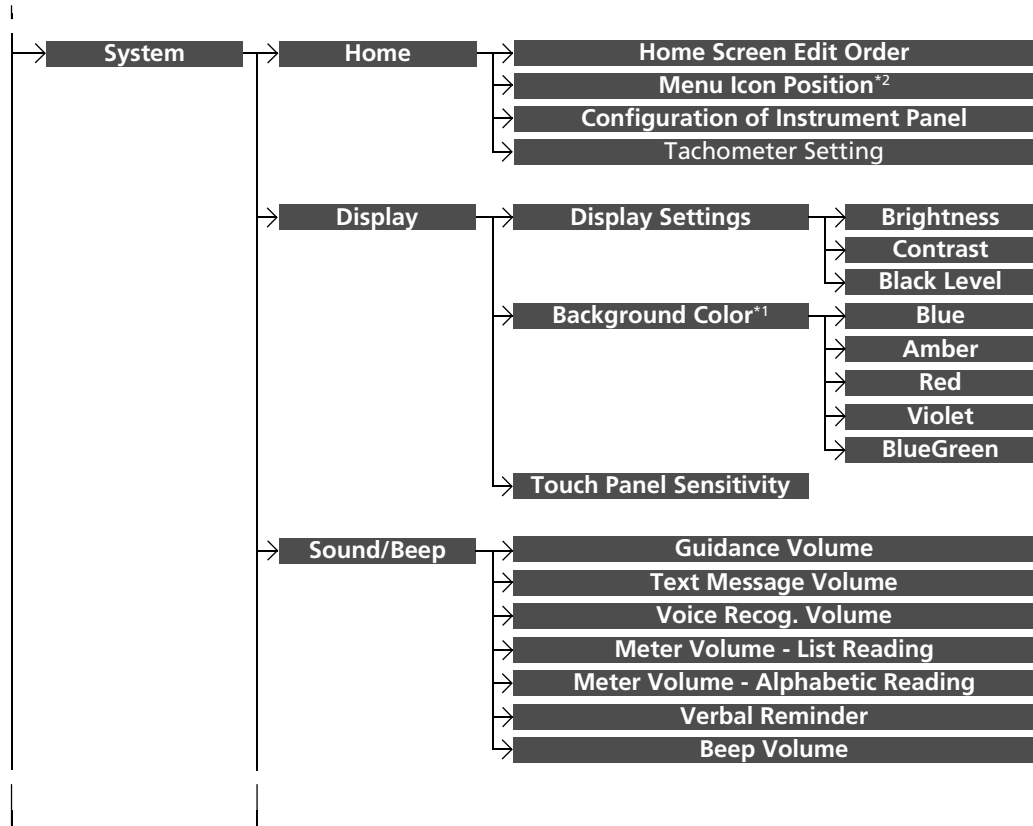

*1: Does not appear when you change the screen interface design.

*2: Appears only when you change the screen interface design.

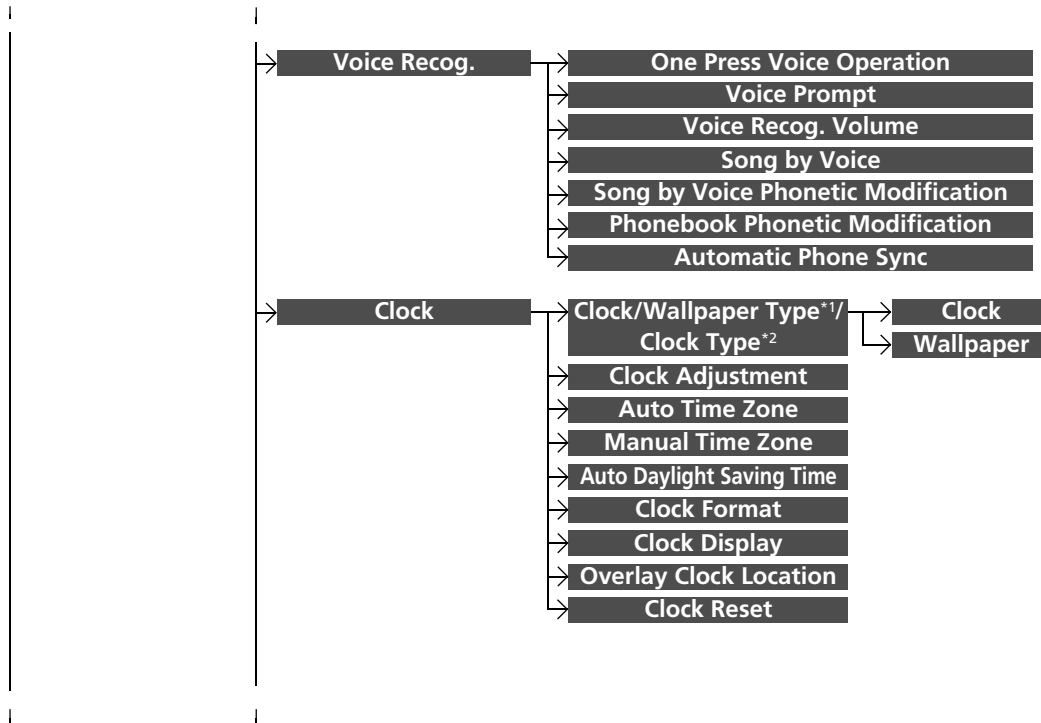

*1 : Does not appear when you change the screen interface design.

*2 : Appears only when you change the screen interface design.

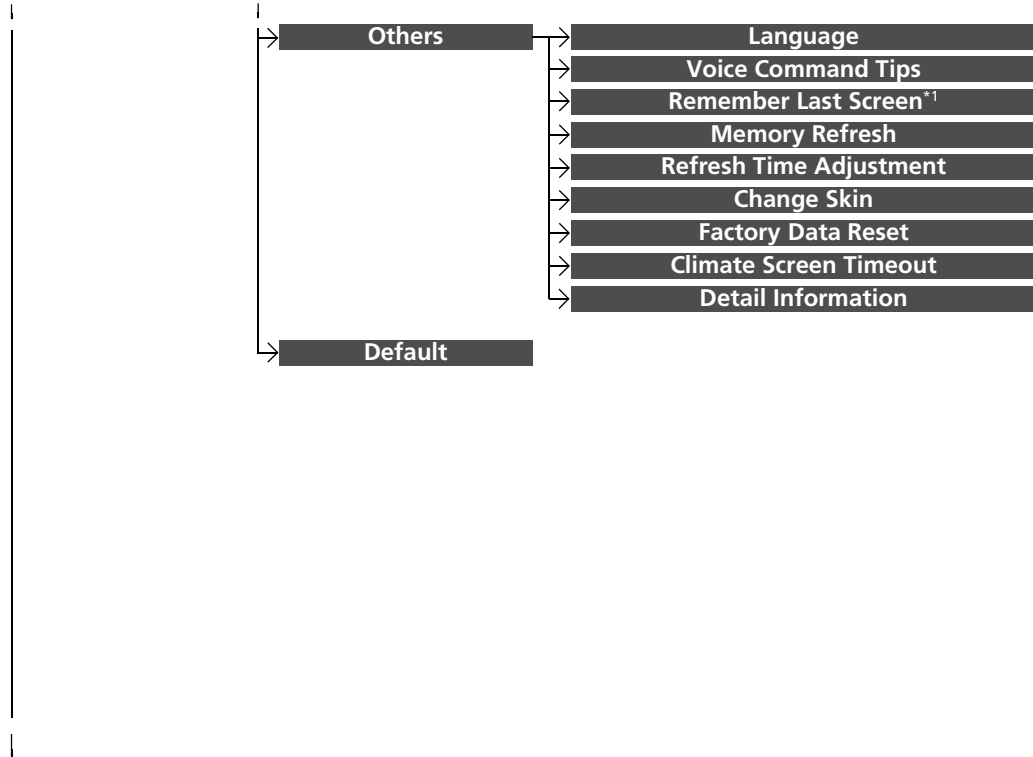

*1: Does not appear when you change the screen interface design.

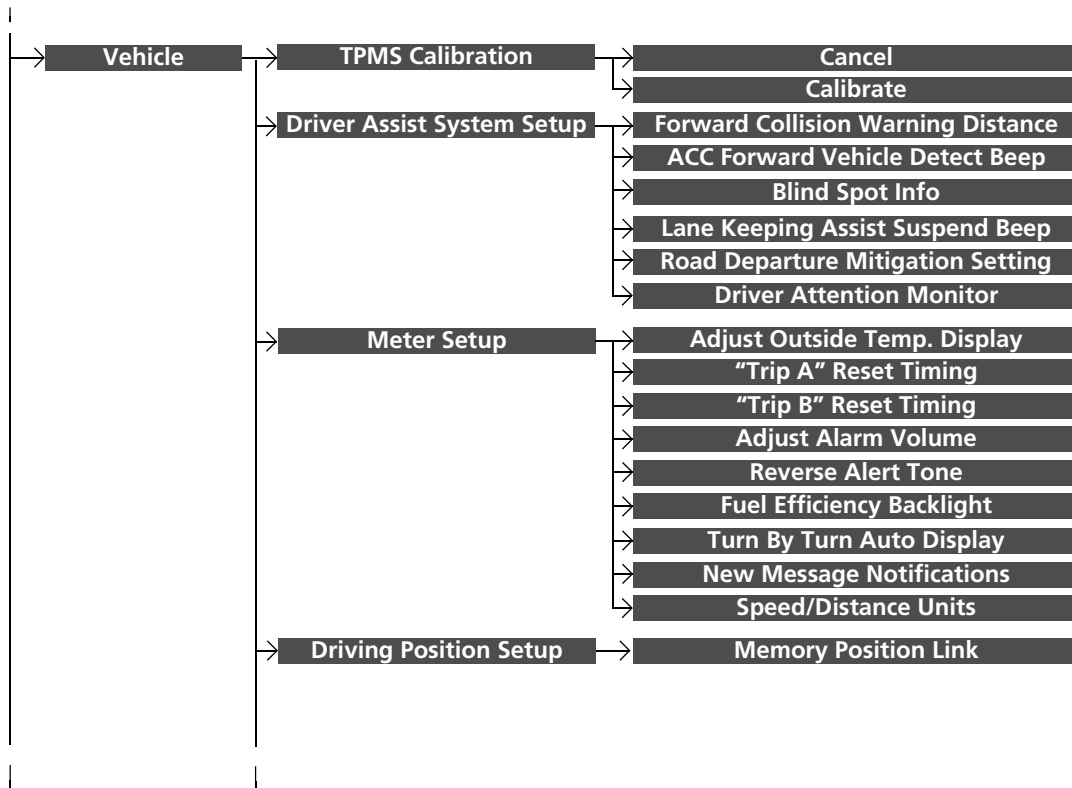

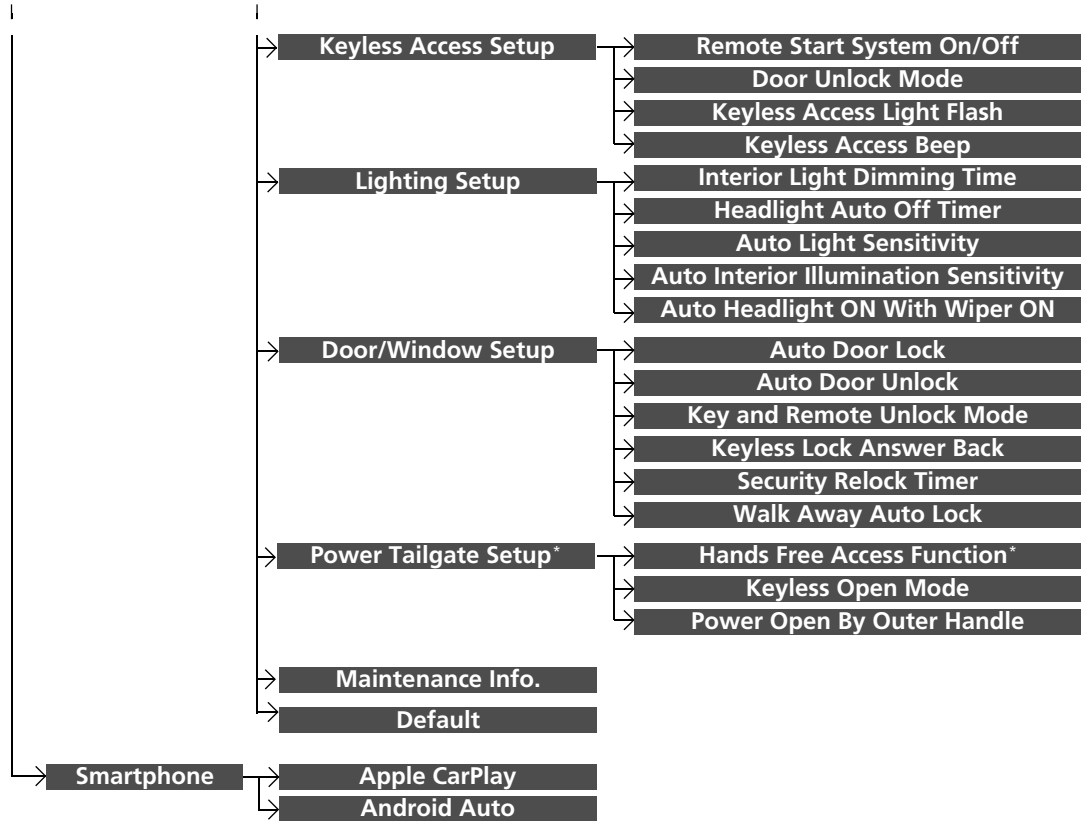

Features

* Not available on all models

■ List of customizable options

Setup Group	Customizable Features	Description	Selectable Settings
Clock	Clock/ Wallpaper Type* ¹ /Clock Type* ²	Clock Wallpaper	
	Clock Adjustment		
	Auto Time Zone		
	Manual Time Zone		
	Auto Daylight Saving Time		See Info on P. 379
	Clock Format		
	Clock Display		
	Overlay Clock Location		
	Clock Reset		
	HondaLink	Diagnostic & Location Data	
Others	Info Screen Preference		
Default		Cancels/Resets all customized items in the Clock settings group as default.	Yes/No

*1: Does not appear when you change the screen interface design.

*2: Appears only when you change the screen interface design.



Setup Group	Customizable Features	Description	Selectable Settings	
Info	Clock	Clock/ Wallpaper Type^{*2/} Clock	Changes the clock display type.	Analog/Digital^{*1/} Small Digital/Off
		Clock Type^{*3} Wallpaper	<ul style="list-style-type: none"> • Changes the wallpaper type. • Imports an image file for a new wallpaper. • Deletes an image file for a wallpaper. 	Blank/Galaxy^{*1/} Metallic/Time Zone[*]
		Clock Adjustment	Adjusts Clock.	—
		Auto Time Zone	Automatically adjusts the clock when driving through different time zones.	On^{*1/}Off
		Manual Time Zone	Changes the time zone manually.	—
		Auto Daylight Saving Time	Select On to have the GPS automatically adjust the clock to daylight savings time. Select Off to cancel this function.	On^{*1/}Off
		Clock Format	Selects the digital clock display from 12H to 24H.	12H^{*1/}24H
		Clock Display	Selects whether the clock display comes on.	On^{*1/}Off
		Overlay Clock Location	Changes the clock display layout.	Upper Right^{*1/}Upper Left/Lower Right/ Lower Left/Off
		Clock Reset	Resets the clock settings to the factory default.	Yes/No

*1:Default Setting



*2:Does not appear when you change the screen interface design.

*3:Appears only when you change the screen interface design.



* Not available on all models

Setup Group	Customizable Features		Description	Selectable Settings
Info	HondaLink	Diagnostic & Location Data	Turns HondaLink® on and off.	On* ¹ /Off
	Others	Info Screen Preference	Selects the top menu when the  (display/information) button is pressed. <ul style="list-style-type: none"> • Info Top- A brief menu pops up. • Info Menu- A full menu pops up. • Off- A menu does not pop up. 	Info Top/Info Menu* ¹ /Off
	Default		Cancels/Resets all customized items in the Info settings group as default.	Yes/No
Camera	Rear Camera	Fixed Guideline	Selects whether the fixed guidelines come on the rear camera monitor.  Multi-View Rear Camera P. 570	On* ¹ /Off
		Dynamic Guideline	Selects whether the guidelines adjust to the movement of the steering wheel.  Multi-View Rear Camera P. 570	On* ¹ /Off
		Parking Sensor Display*	Selects whether to turn on the parking sensor display.	Normal View/Split View* ¹
		Default	Cancels/Resets all customized items in the Rear Camera setting group as default.	Yes/No
	Cross Traffic Monitor		Turns on and off the cross traffic monitor.	On* ¹ /Off

*1:Default Setting

Setup Group	Customizable Features	Description	Selectable Settings		
Bluetooth / Wi-Fi	Bluetooth On/Off Status	Changes the <i>Bluetooth</i> ® status.	On*¹/Off		
	Bluetooth Device List	Pairs a new phone to HFL, edits or deletes a paired phone.  Phone Setup P. 430	—		
	Bluetooth	Priority On/Off Status	Enables the system to or disables it from automatically establishing a connection with a <i>Bluetooth</i> ® device which has been assigned priority.	On*¹/Off	
		Priority Device Settings	Audio	Selects the priority device over another paired audio device(s).	—
			Phone	Selects the priority device over another paired phone(s).	—
		Edit Pairing Code	Edits a pairing code.  To change the pairing code setting P. 431	Random/Fixed*¹	
	Wi-Fi	Wi-Fi On/Off Status	Changes the Wi-Fi mode.	On/Off*¹	
		Wi-Fi Device List	Connects, disconnects, or deletes the Wi-Fi device.	—	
		Wi-Fi Information	Shows the Wi-Fi information of the head unit.	—	
	Default		Cancels/Resets all customized items in the Bluetooth / Wi-Fi group as default.	Yes/No	

*1:Default Setting

Setup Group	Customizable Features	Description	Selectable Settings
Phone	Bluetooth Device List	Pairs a new phone to HFL, connects or disconnects a paired phone.  Phone Setup P. 430	—
	Edit Speed Dial	Edits, adds or deletes a speed dial entry.  Speed Dial P. 436	—
	Ring Tone	Selects the ring tone.	Fixed/Mobile Phone * ¹
	Automatic Phone Sync	Sets a phonebook and call history data to be automatically imported when a phone is paired to HFL.	On * ¹ / Off
	HondaLink Assist	Turns HondaLink Assist on and off.	On * ¹ / Off
	Enable Text/Email	Turns the text/e-mail message function on and off.	On * ¹ / Off
	Select Account	Selects a text or e-mail message account.	—
	New Message Notification	Selects whether a pop-up alert comes on the screen when HFL receives a new text/e-mail message.	On/Off * ¹
	Default	Cancels/Resets all customized items in the Phone settings group as default.	Yes/No

*1:Default Setting

Setup Group	Customizable Features	Description	Selectable Settings	
Audio	FM/AM mode FM/AM	HD Radio Mode (FM) HD Radio Mode (AM)	Selects whether the audio system automatically switches to the digital radio waves or receives the analog waves only.	Auto^{*1}/Analog Only
		RDS INFO	Turns on and off the RDS information.	On^{*1}/Off
	TuneStart	Turns on and off, starts the song from the beginning as you change preset stations.	On^{*1}/Off	
	Interrupt	Turns on and off the sports alert function.	Off^{*1}/On(One Time)/On(Continue)	
	SiriusXM[®] mode SXM	SportsFlash Setup Favorite Team	Selects your favorite sports teams.  Live Sports Alert P. 310	—
		Interrupt Beep	Causes the system to beep when the sports alert is notified.	On^{*1}/Off
		Traffic & Weather Setup	Selects the region you want to receive the information.	—
	Multiple Channel Mix Preset	Turns multiple channel mix preset on and off.	On^{*1}/Off	

*1:Default Setting

Setup Group	Customizable Features	Description	Selectable Settings	
Audio	Bluetooth <small>Bluetooth® mode</small>	Bluetooth Device List Pairs a new phone to HFL, edits or deletes a paired phone. ☞ Phone Setup P. 430	—	
	Other	Cover Art <small>iPod or USB mode</small> [Your selected media]	Turns the cover art display on and off.	On* ¹ /Off
		Audio Source Pop-Up	Selects whether the list of selectable audio source comes on when Audio is selected on the home screen.	On/Off* ¹
	Sound	Adjusts the settings of the audio speakers' sound. ☞ Adjusting the Sound P. 294	—	
	Default	Cancels/Resets all customized items in the Audio settings group as default.	Yes/No	
System	Home	Home Screen Edit Order	Changes the home screen icon layout.	—
		Menu Icon Position * ²	Changes the position of the menu icons on the Audio , Phone , and Info screen.	—
		Configuration of Instrument Panel	Changes the Instrument Panel screen icon layout.	—
		Tachometer Setting	Not available on this model	—



*1:Default Setting

*2:Appears only when you change the screen interface design.

Setup Group	Customizable Features	Description	Selectable Settings	
System	Display Settings	Brightness	Changes the brightness of the audio/information screen.	—
		Contrast	Changes the contrast of the audio/information screen.	—
		Black Level	Changes the black level of the audio/information screen.	—
	Display	Background Color *2	Changes the background color of the audio/information screen.	Blue *1/ Amber/Red/Violet/BlueGreen
		Touch Panel Sensitivity	Sets the sensitivity of the touch panel screen.	High/Low *1
	Sound/Beep	Guidance Volume	Changes the sound volume. Adjusts the guidance volume of the navigation system.	1~6 *1~ 11
		Text Message Volume	Changes the text/e-mail message reading volume.	1~6 *1~ 11

*1:Default Setting

*2:Does not appear when you change the screen interface design.

Setup Group	Customizable Features	Description	Selectable Settings
Sound/ Beep	Voice Recog. Volume	Changes the volume of the voice prompt.	1~6*1~11
	Meter Volume - List Reading	Changes the list reading volume.	1~6*1~11
	Meter Volume - Alphabetic Reading	Changes the alphabetic reading volume.	1~6*1~11
	Verbal Reminder	Turns the verbal reminders on and off.	On*1/Off
	Beep Volume	Changes the beep volume.	Off/1/2*1/3
System	One Press Voice Operation	Changes the setting of the  (Talk) button operation when using the voice operation.	On*1/Off
	Voice Prompt	Turns the voice prompt on and off.	On*1/Off
	Voice Recog. Volume	Changes the volume of the voice prompt.	1~6*1~11
	Song by Voice	Turns the Song By Voice™ on and off.	On*1/Off
	Song by Voice Phonetic Modification	Modifies a voice command for music stored in the system or an iPod/iPhone.  Phonetic Modification P. 317	—
	Phonebook Phonetic Modification	Modifies a voice command for the phonebook.  Phonetic Modification P. 317	—
	Automatic Phone Sync	Sets phonebook and call history data to be automatically imported when a phone is paired to HFL.	On/Off

*1:Default Setting

Setup Group	Customizable Features	Description	Selectable Settings																		
System	<table border="1"> <tr> <td>Clock/Wallpaper Type^{*2}/Clock Type^{*3}</td> <td>Clock Wallpaper</td> </tr> <tr> <td>Clock Adjustment</td> <td></td> </tr> <tr> <td>Auto Time Zone</td> <td></td> </tr> <tr> <td>Manual Time Zone</td> <td></td> </tr> <tr> <td>Auto Daylight Saving Time</td> <td></td> </tr> <tr> <td>Clock Format</td> <td></td> </tr> <tr> <td>Clock Display</td> <td></td> </tr> <tr> <td>Overlay Clock Location</td> <td></td> </tr> <tr> <td>Clock Reset</td> <td></td> </tr> </table>	Clock/Wallpaper Type ^{*2} /Clock Type ^{*3}	Clock Wallpaper	Clock Adjustment		Auto Time Zone		Manual Time Zone		Auto Daylight Saving Time		Clock Format		Clock Display		Overlay Clock Location		Clock Reset		See Info on P. 379	
	Clock/Wallpaper Type ^{*2} /Clock Type ^{*3}	Clock Wallpaper																			
	Clock Adjustment																				
	Auto Time Zone																				
	Manual Time Zone																				
	Auto Daylight Saving Time																				
	Clock Format																				
	Clock Display																				
	Overlay Clock Location																				
	Clock Reset																				
Others	Language	Change the display language.	English (United States) ^{*1} /Français/ Español																		
	Voice Command Tips	Alerts you when manual control of the system is disabled to prevent distraction while driving. Only voice commands are available.	On ^{*1} /Off																		

*1:Default Setting

*2:Does not appear when you change the screen interface design.

*3:Appears only when you change the screen interface design.

Setup Group	Customizable Features	Description	Selectable Settings
System	Remember Last Screen *2	Selects whether the device remembers the last screen.	On/Off *1
	Memory Refresh	Turns on the audio system automatically and restores the fragmentation of a memory when the power mode is VEHICLE OFF (LOCK).	On *1/Off
	Refresh Time Adjustment	Sets the time for Memory Refresh .	—
	Change Skin	Changes the screen interface design.	Yes/No
	Factory Data Reset	Resets all the settings to their factory default.  Defaulting All the Settings P. 394	Yes/No
	Climate Screen Timeout	Changes the length of time the climate control display stays on when you press the CLIMATE button.	Never/5 Seconds/10 Seconds *1/ 20 Seconds
	Detail Information	Displays the details of the head unit and operating system information.	—
Default	Cancels /Resets all customized items in the System group as default.	Yes/No	

*1:Default Setting

*2:Does not appear when you change the screen interface design.

Setup Group	Customizable Features	Description	Selectable Settings
Vehicle	TPMS Calibration	Cancels/Calibrates the tire pressure monitoring system (TPMS).	Cancel/Calibrate
	Forward Collision Warning Distance	Changes CMBS™ alert distance.	Long/Normal*¹/Short
	ACC Forward Vehicle Detect Beep	Causes the system to beep when the system detects a vehicle, or when the vehicle goes out of the ACC with Low Speed Follow range.	On/Off*¹
	Blind Spot Info	Changes the setting for the blind spot information.	Audible and Visual Alert*¹/Visual Alert/Off
	Lane Keeping Assist Suspend Beep	Causes the system to beep when LKAS is suspended.	On/Off*¹
	Road Departure Mitigation Setting	Changes the setting for the road departure mitigation system.	Normal*¹/Wide/Warning Only/Narrow
	Driver Attention Monitor	Changes the setting for the driver attention monitor.	Tactile And Audible Alert*¹/Tactile Alert/OFF

* 1:Default Setting

Setup Group	Customizable Features	Description	Selectable Settings
Vehicle Meter Setup	Adjust Outside Temp. Display	Adjusts the temperature reading by a few degrees.	-5°F ~ ±0°F*¹ ~ +5°F
	“Trip A” Reset Timing	Changes the setting of how to reset trip meter A and average fuel economy A.	When Refueled/IGN Off/Manually Reset*¹
	“Trip B” Reset Timing	Changes the setting of how to reset trip meter B and average fuel economy B.	When Refueled/IGN Off/Manually Reset*¹
	Adjust Alarm Volume	Changes the alarm volume, such as buzzers, warnings, turn signal sound, and so on.	High/Mid*¹/Low
	Reverse Alert Tone	Causes the beeper to sound when you move to [R] .	On*¹/Off
	Fuel Efficiency Backlight	Turns the ambient meter feature on and off.	On*¹/Off
	Turn By Turn Auto Display	Selects whether the turn-by-turn display comes on during the route guidance.	On*¹/Off
	New Message Notifications	Used to select whether a pop-up alert comes on the screen when HFL receives a new text/e-mail message.	On*¹/Off
	Speed/Distance Units	Selects the trip computer units.	mph · miles*¹/km/h · km

*1: Default Setting

Setup Group	Customizable Features	Description	Selectable Settings	
Vehicle	Driving Position Setup	Memory Position Link	Turns the driving position memory system on and off.	On^{*1}/Off
	Keyless Access Setup	Remote Start System On/Off	Turns the remote engine start feature on and off.	On^{*1}/Off
		Door Unlock Mode	Changes which doors unlock when you grab the driver's door handle.	Driver Door Only^{*1}/All Doors
		Keyless Access Light Flash	Causes some exterior lights to flash when you unlock/lock the doors.	On^{*1}/Off
		Keyless Access Beep	Causes the beeper to sound when you unlock/lock the doors.	On^{*1}/Off
	Lighting Setup	Interior Light Dimming Time	Changes the length of time the interior lights stay on after you close the doors.	60seconds/30seconds^{*1}/15seconds
		Headlight Auto Off Timer	Changes the length of time the exterior lights stay on after you close the driver's door.	60seconds/30seconds/15seconds^{*1}/0seconds
		Auto Light Sensitivity	Changes the timing for the headlights to come on.	Max/High/Mid^{*1}/Low/Min
		Auto Interior Illumination Sensitivity	Changes the sensitivity of the brightness of the instrument panel when the headlight switch is in the AUTO position.	Min/Low/Mid^{*1}/High/Max

*1:Default Setting

Setup Group	Customizable Features	Description	Selectable Settings	
Vehicle	Lighting Setup	Auto Headlight ON With Wiper ON	Changes the settings for the wiper operation when the headlights automatically come on while the headlight switch is in the AUTO position.	On*¹/Off
		Auto Door Lock	Used to change the setting for when the doors automatically lock.	With Vehicle Speed*¹/Shift from P/Off
		Auto Door Unlock	Changes the setting for when the doors unlock automatically.	All Doors When Driver's Door Opens*¹/All Doors When Shifted to Park/All Doors When Ignition Switched Off/Off
	Door/Window Setup	Key and Remote Unlock Mode	Sets up the driver's door or all the doors to unlock on the first push of the remote.	Driver Door*¹/All Doors
		Keyless Lock Answer Back	LOCK/UNLOCK- The exterior lights flash. LOCK (2nd push)- The beeper sounds.	On*¹/Off
		Security Relock Timer	Changes the time it takes for the doors to relock and the security system to set after you unlock the vehicle without opening any door.	90seconds/60seconds/30seconds*¹
		Walk Away Auto Lock	Changes the settings for the auto lock function when you walk away from the vehicle.	On/Off*¹

*1:Default Setting

Setup Group	Customizable Features	Description	Selectable Settings	
Vehicle	Hands Free Access Function*	Changes the setting to open power tailgate by a swift forward in and out kicking motion under the rear bumper.	On*¹/Off	
	Power Tailgate Setup*	Keyless Open Mode	Changes the keyless setting for when the power tailgate opens.	Anytime*¹/When Unlocked
	Power Open By Outer Handle	Changes the setting to open power tailgate by tailgate outer handle.	Off (Manual only)/ On (Power/ Manual)*¹	
	Maintenance Info.	Used to reset the maintenance minder information display when the maintenance service has been performed.	—	
	Default	Cancels/Resets all customized items in the Vehicle settings group as default.	Yes/No	
Smartphone	Apple CarPlay	Sets up the Apple CarPlay™ connection.	—	
	Android Auto	Sets up the Android Auto™ connection.	—	

*1:Default Setting

* Not available on all models

Defaulting All the Settings

Reset all the menu and customized settings as the factory defaults.

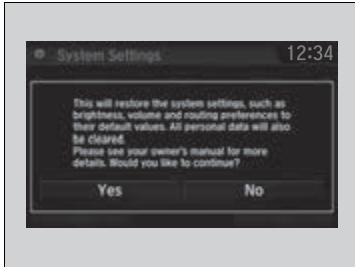

1. Select .
2. Select **Settings**.
3. Select **System**.
4. Select the **Others** tab.
5. Select **Factory Data Reset**.
 - A confirmation message appears on the screen.
6. Select **Next**, then select **Yes** to reset the settings.
7. Select **Yes** again to reset the settings.
 - A confirmation message appears on the screen. Select **OK**.
 - After selecting **OK**, the system will reboot.

►► Defaulting All the Settings

When you transfer the vehicle to a third party, reset all settings to default and delete all personal data.

If you perform **Factory Data Reset**, it will reset the preinstalled apps to their factory default.

If you perform **Factory Data Reset**, you cannot use the HondaLink® because it becomes off line.

► **HondaLink®** P. 326

The HomeLink® Universal Transceiver can be programmed to operate up to three remote controlled devices around your home, such as garage doors, lighting, or home security systems.

■ Important Safety Precautions

Refer to the safety information that came with your garage door opener to test that the safety features are functioning properly. If you do not have the safety information, contact the manufacturer.

Before programming HomeLink, make sure that people and objects are out of the way of the garage or gate to prevent potential injury or damage.

When programming a garage door opener, park just outside the garage door's path.

⌘ HomeLink® Universal Transceiver*

Before programming HomeLink to operate a garage door opener, confirm that the opener has an external entrapment protection system, such as an "electronic eye," or other safety and reverse stop features. If it does not, HomeLink may not be able to operate it.

NOTE:

Some LED lightbulbs installed in the garage door opener can interfere with the training and consistent operation of your HomeLink device. Please consider use of Low RF interference bulbs in your garage door opener.

* Not available on all models

Training HomeLink

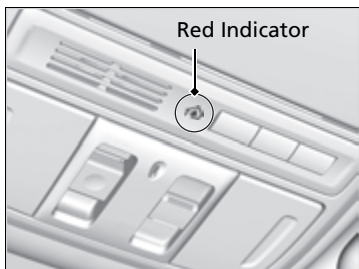

If it is necessary to erase a previously entered learned code:

- Press and hold the two outside buttons for about 20 seconds, until the red indicator blinks. Release the buttons, and proceed to step 1.
- If you are training the second or third button, go directly to step 1.

The instructions on the next page should work for most gate or garage openers, but may not work for all. For detailed instructions about your specific remote opener, visit <http://www.homelink.com> or call (800)355-3515.

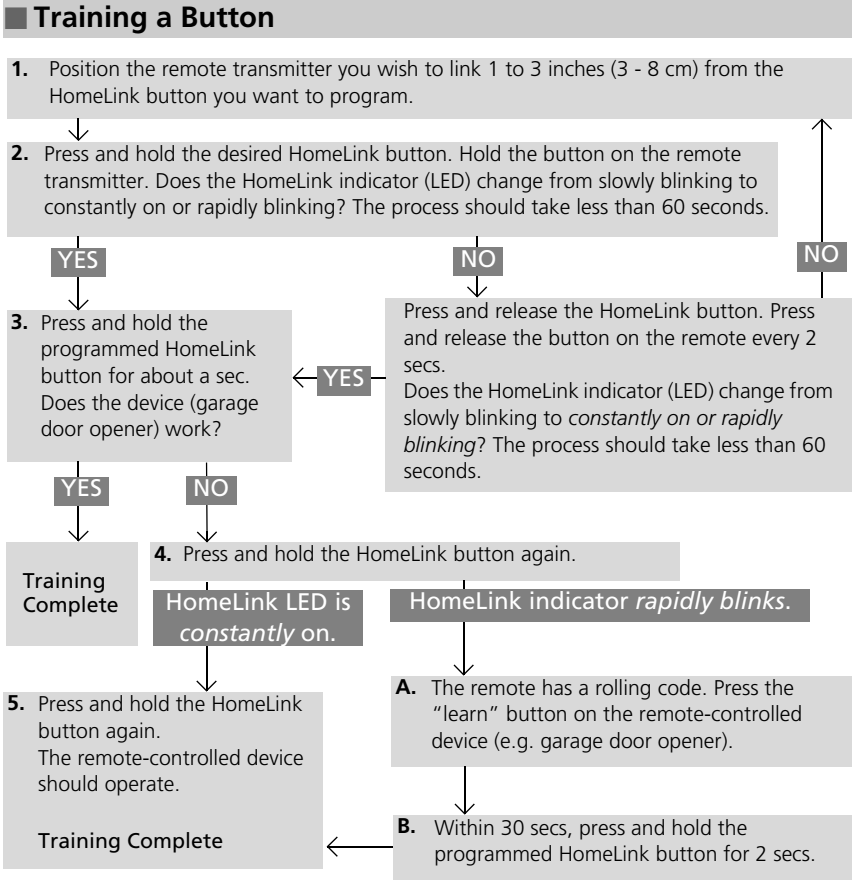

Training HomeLink

Retraining a Button
 If you want to retrain a programmed button for a new device, you do not have to erase all button memory. You can replace the existing memory code using this procedure:

- Press and hold the desired HomeLink button until the HomeLink indicator begins to blink.
 - Indicator remains on for about 25 secs.
- Quickly release the HomeLink button and follow steps 1 - 3 under "Training a Button." You do not need to press and release the HomeLink button again in step 2.

Erasing Codes
 To erase all the codes, press and hold the two outside buttons until the HomeLink indicator begins to blink (about 10 to 20 secs). You should erase all codes before selling the vehicle.

If you have any problems, see the device's instructions, visit www.homelink.com, or call HomeLink at (800) 355-3515.

HomeLink® is a registered trademark of Gentex Corporation.

Models with color audio system

Bluetooth® HandsFreeLink® (HFL) allows you to place and receive phone calls using your vehicle's audio system, without handling your cell phone.

Using HFL

HFL Buttons

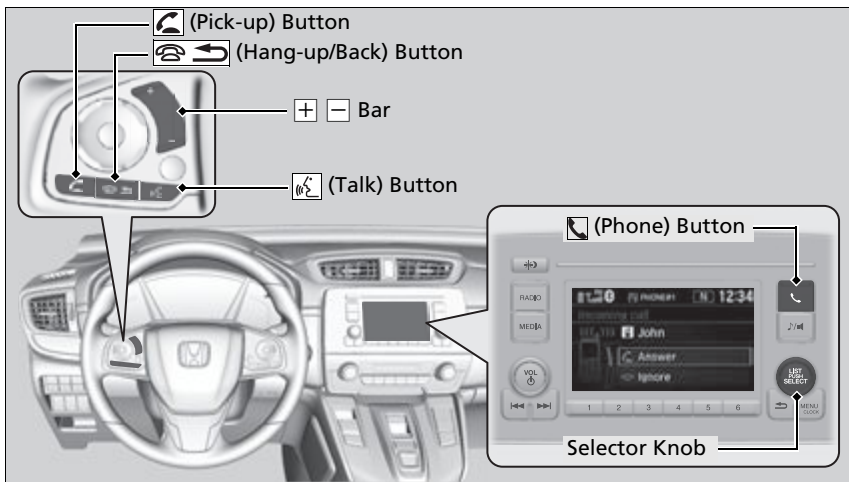

(Pick-up) button: Press to go directly to the phone screen or to answer an incoming call.

(Hang-up/back) button: Press to end a call or to cancel a command.

(Talk) button: Press to call a number with a stored voice tag.

(Phone) button: Press to go directly to the phone screen.

Selector knob: Rotate to select an item on the screen, then press .

Bluetooth® HandsFreeLink®

Place your phone where you can get good reception.

To use HFL, you need a *Bluetooth*-compatible cell phone. For a list of compatible phones, pairing procedures, and special feature capabilities: Visit automobiles.honda.com/handsfreelink/, or call 1-888-528 -7876.

Voice control tips

- Aim the vents away from the ceiling and close the windows, as noise coming from them may interfere with the microphone.
- Press and release the button when you want to call a number using a stored voice tag. Speak clearly and naturally after a beep.
- If the microphone picks up voices other than yours, the command may be misinterpreted.

State or local laws may prohibit the operation of handheld electronic devices while operating a vehicle.

Up to 20 speed dial entries can be stored. If there is no entry in the system, Speed Dial is disabled.

Speed Dial P. 413

Up to 20 call histories can be stored. If there is no call history, Call History is disabled.

HFL Status Display

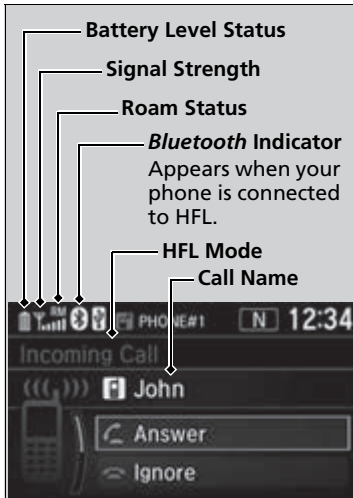

The audio/information screen notifies you when there is an incoming call.

Limitations for Manual Operation

Certain manual functions are disabled or inoperable while the vehicle is in motion. You cannot select a grayed-out option until the vehicle is stopped.

Only previously stored speed dial entries can be called using voice commands while the vehicle is in motion.

➤ **Speed Dial** P. 413

Bluetooth® HandsFreeLink®

Bluetooth® Wireless Technology

The *Bluetooth*® word mark and logos are registered trademarks owned by *Bluetooth* SIG, Inc., and any use of such marks by Honda Motor Co., Ltd., is under license. Other trademarks and trade names are those of their respective owners.

HFL Limitations

An incoming call on HFL will interrupt the audio system when it is playing. It will resume when the call is ended.

HFL Status Display

The information that appears on the audio/information screen varies between phone models.

HFL Menu

The power mode must be in ACCESSORY or ON to use the system.

HFL Menu

To use HFL, you must first pair your *Bluetooth*-compatible cell phone to the system while the vehicle is parked.

Some functions are limited while driving. A message appears on the screen when the vehicle is moving and the operation is canceled.

Select a phone number from the call history to store as a speed dial number.

Select a phone number from the phonebook to store as a speed dial number.

Enter a phone number to store as a speed dial number.

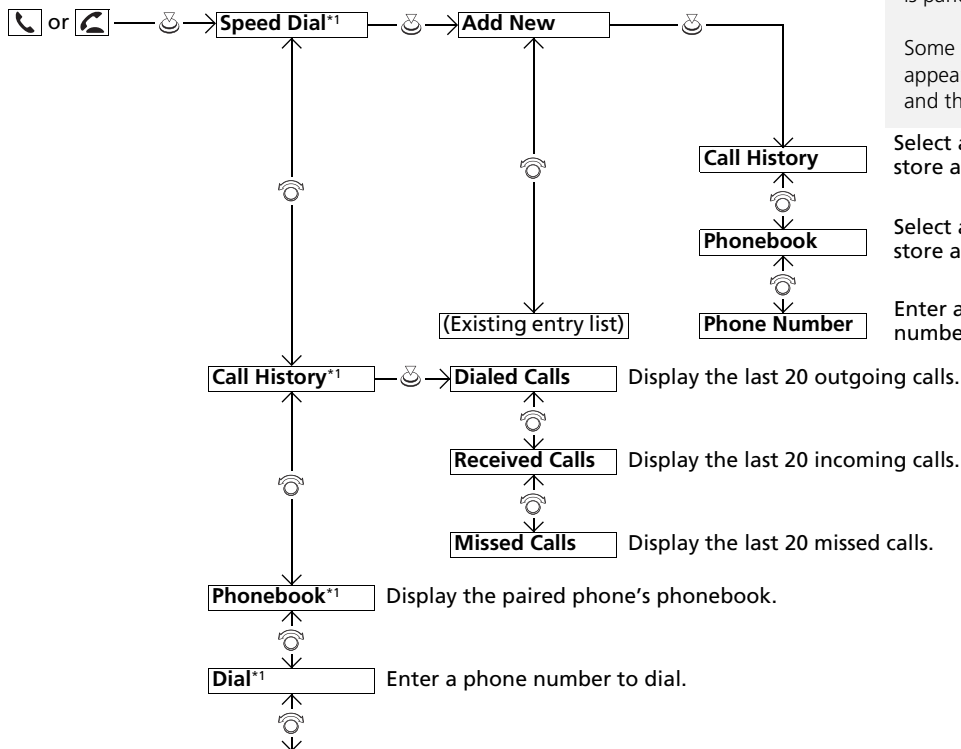

*1: Appears only when a phone is connected to HFL.

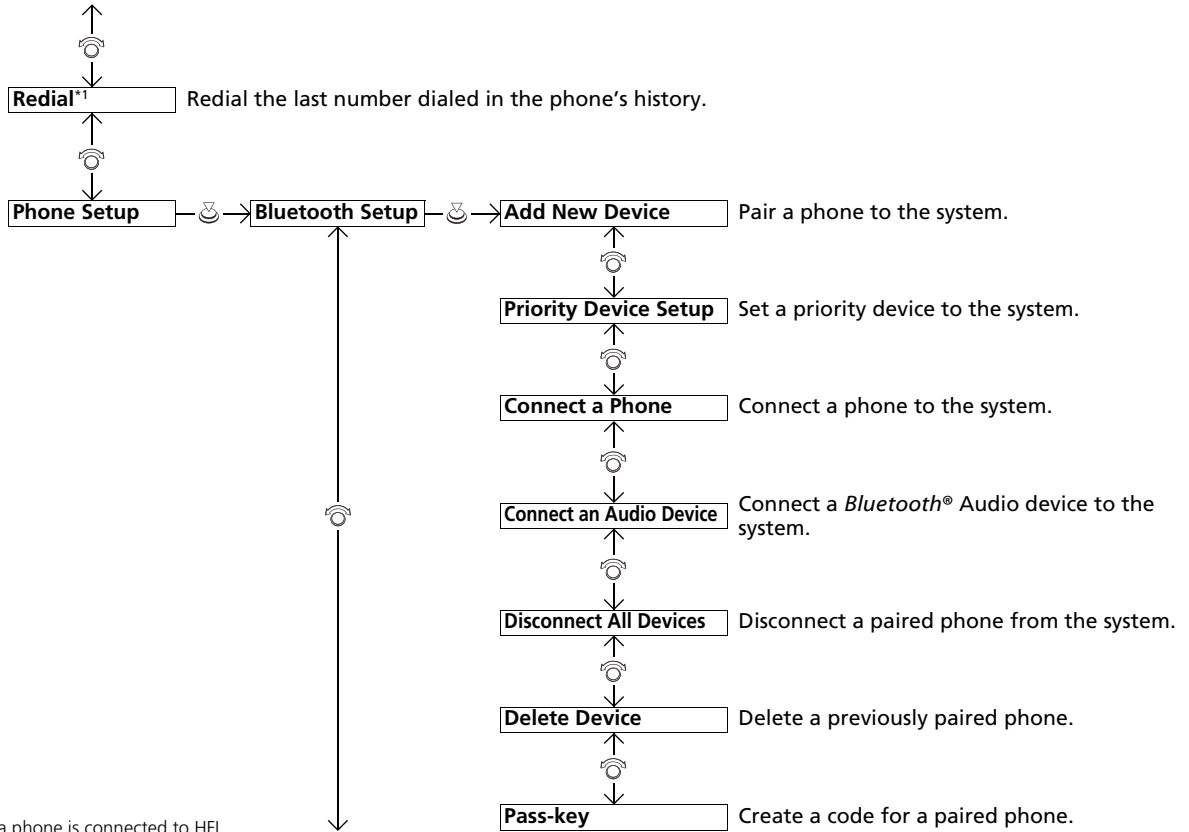

*1: Appears only when a phone is connected to HFL.

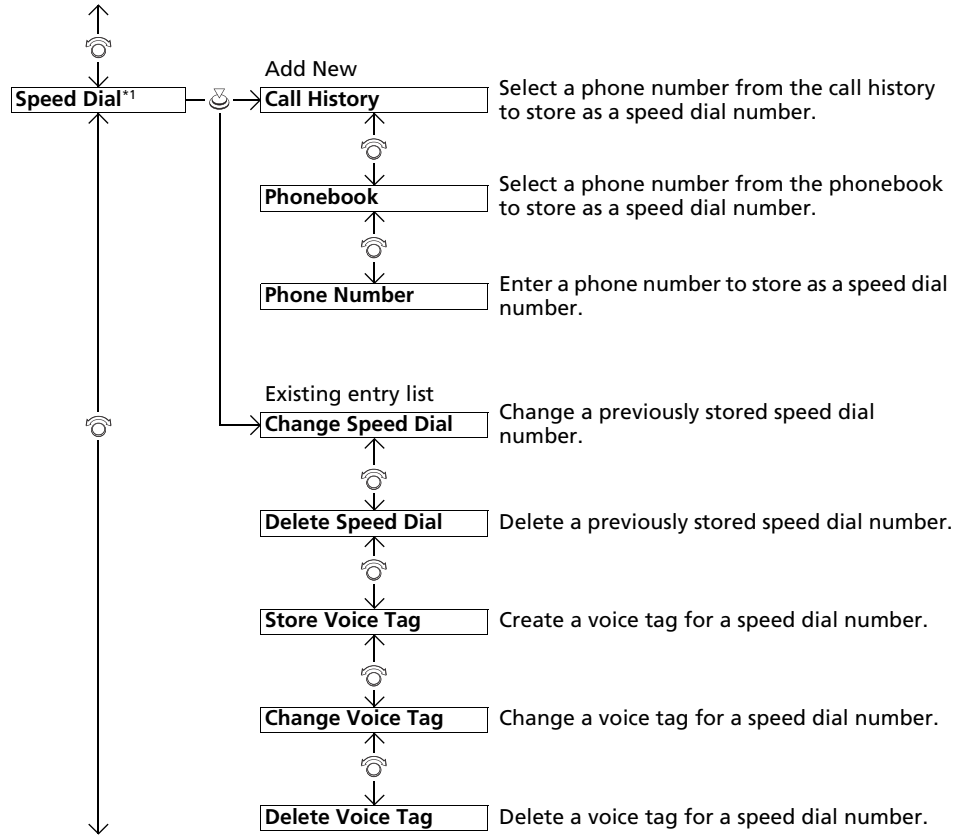

*1: Appears only when a phone is connected to HFL.

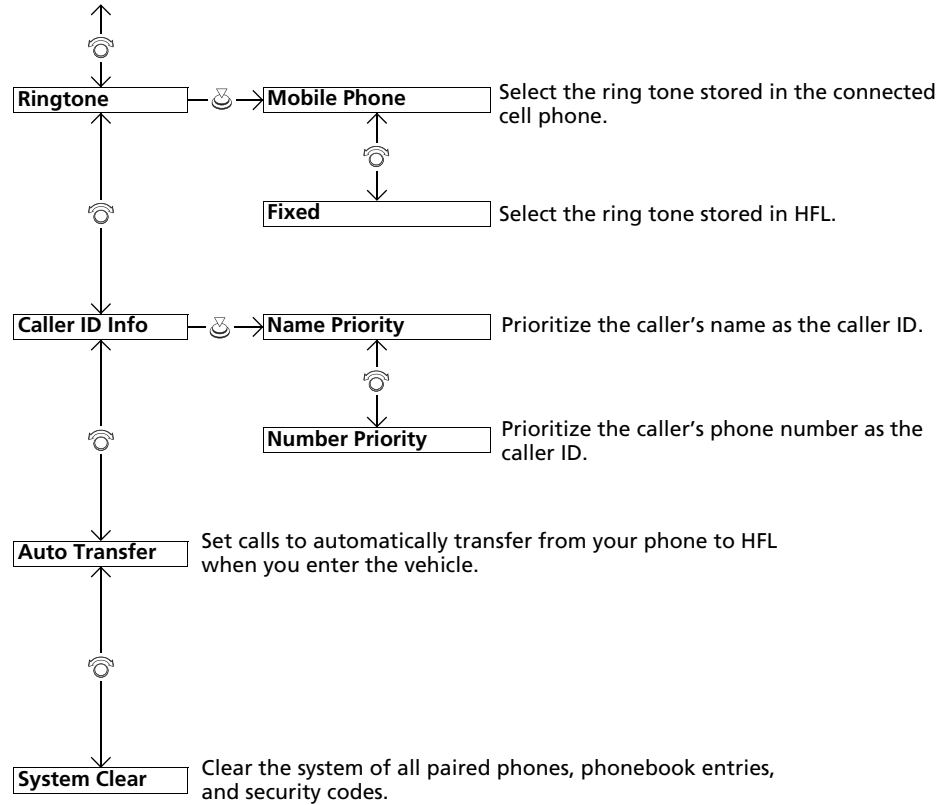

Phone Setup



■ To pair a cell phone (No phone has been paired to the system)

1. Press the button or the button.
2. Make sure your phone is in search or discoverable mode.
3. Rotate to select **Yes**, then press .
 - ▶ The audio system will enter a waiting mode for pairing.
4. Select **HandsFreeLink®** from your phone.
 - ▶ If you want to pair a phone from this audio system, press and follow the prompts. When your phone appears on the list, select it by pressing .
5. The system gives you a pairing code on the audio/information screen.
 - ▶ Confirm if the pairing code on the screen and your phone match. This may vary by phone.
6. A notification appears on the screen if pairing is successful.

☒ Phone Setup

Your *Bluetooth*-compatible phone must be paired to HFL before you can make and receive hands-free calls.

Phone Pairing Tips:

- You cannot pair your phone while the vehicle is moving.
- Up to six phones can be paired.
- Your phone's battery may drain faster when it is paired to HFL.
- If your phone is not ready for pairing or not found by the system within 30 seconds, the system will time out and return to idle.

Once you have paired a phone, you can see it displayed on the screen with one or two icons on the right side.

These icons indicate the following:

- : The phone can be used with HFL.
- : The phone is compatible with *Bluetooth*® Audio.

When pairing a phone from this audio system: If your phone doesn't appear on the audio/information screen, select **Refresh** and search for *Bluetooth*® devices using your phone. From your phone, select **HandsFreeLink**®.

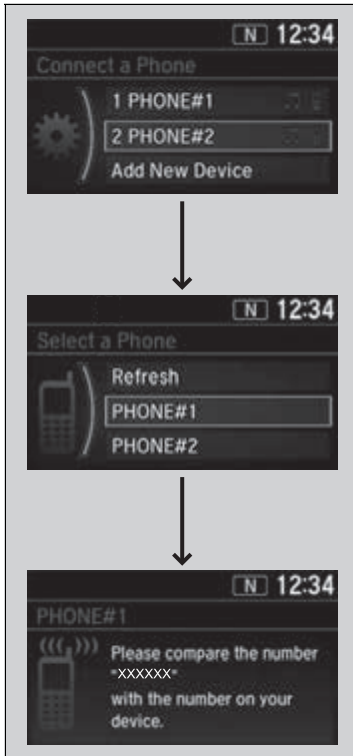

■ **To pair a cell phone (when a phone has already been paired to the system)**

1. Press the button or the button.
2. Rotate to select **Yes**, then press .
3. Rotate to select **Add New Device**, then press .
4. Press to select **OK**.
 - ▶ The screen changes to device list.
5. Make sure your phone is in search or discoverable mode, then press .
 - ▶ HFL automatically searches for a *Bluetooth®* device.
6. When your phone appears on the list, select it by pressing .
 - ▶ If your phone does not appear, select **Refresh** and search for *Bluetooth®* devices using your phone. From your phone, select **HandsFreeLink®**.
7. The system gives you a pairing code on the audio/information screen.
 - ▶ Confirm if the pairing code on the screen and your phone match. This may vary by a phone.



■ **To change the currently paired phone**

1. Press the button or the button.
2. Rotate to select **Phone Setup**, then press .
3. Rotate to select **Bluetooth Setup**, then press .
4. Rotate to select **Connect a Phone**, then press .
 - ▶ The screen changes to a device list.
5. Rotate to select a desired device name, then press .
 - ▶ HFL disconnects the connected phone and starts searching for another paired phone.

▶▶ To change the currently paired phone

To change the *Bluetooth*® connection priority device setting, select **Priority Device Setup** from the **Bluetooth Setup** screen.

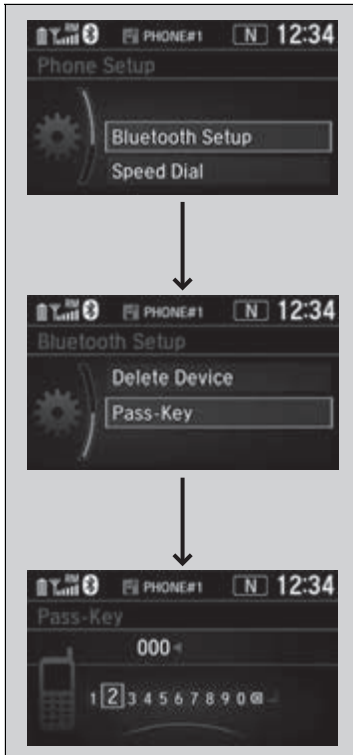

■ To change the pairing code setting

1. Press the button or the button.
2. Rotate to select **Phone Setup**, then press .
3. Rotate to select **Bluetooth Setup**, then press .
4. Rotate to select **Pass-Key**, then press .
5. Input a new pairing code, then press .



■ To delete a paired phone

1. Press the button or the button.
2. Rotate to select **Phone Setup**, then press .
3. Rotate to select **Bluetooth Setup**, then press .
4. Rotate to select **Delete Device**, then press .
▶ The screen changes to a device list.
5. Rotate to select a phone you want to delete, then press .
6. A confirmation message appears on the screen. Rotate to select **Yes**, then press .

Ring Tone

You can change the ring tone setting.



1. Press the button or the button.
2. Rotate to select **Phone Setup**, then press .
3. Rotate to select **Ringtone**, then press .
4. Rotate to select **Mobile Phone** or **Fixed**, then press .

Caller's ID Information

You can select a caller's information to be displayed when you have an incoming call.



1. Press the button or the button.
2. Rotate to select **Phone Setup**, then press .
3. Rotate to select **Caller ID Info**, then press .
4. Rotate to select a mode you want, then press .

Ring Tone

Mobile Phone: Depending on the make and model of the cell phone, the ring tone stored in the phone will sound if the phone is connected.

Fixed: The fixed ring tone sounds from the speakers.

Caller's ID Information

Name Priority: A caller's name is displayed if it is stored in the phonebook.

Number Priority: A caller's phone number is displayed.

■ Automatic Transferring

If pairing between your phone and the system is executed while you are on the phone, the call can be automatically transferred to HFL.

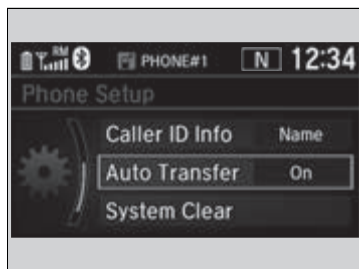

1. Press the button or the button.
2. Rotate to select **Phone Setup**, then press .
3. Rotate to select **Auto Transfer**.
4. Press to select **On** or **Off**.

■ To Clear the System

Pairing codes, paired phones, all stored voice tags, all speed dial entries, all call history data, and all imported phonebook data are erased.

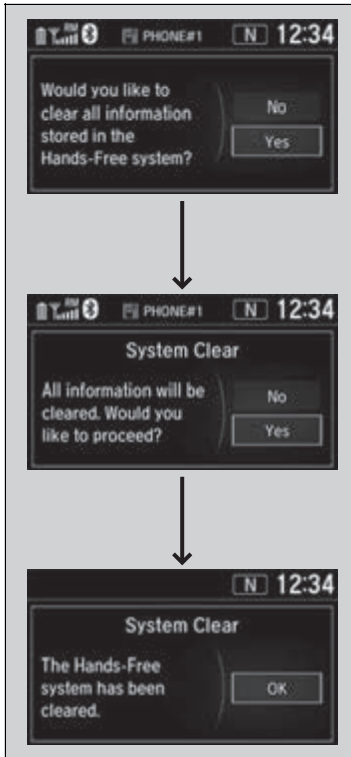

1. Press the button or the button.
2. Rotate to select **Phone Setup**, then press .
3. Rotate to select **System Clear**, then press .
4. Rotate to select **Yes**, then press .
5. A confirmation message appears on the screen. Rotate to select **Yes**, then press .
6. A notification appears on the screen. Press .

Continued

■ Automatic Import of Cellular Phonebook and Call History

When your phone is paired, the contents of its phonebook and call history are automatically imported to HFL.

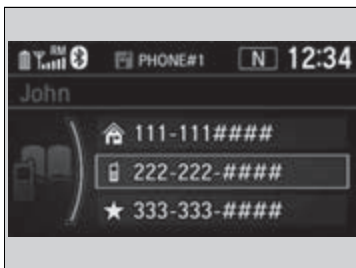

▶▶ Automatic Import of Cellular Phonebook and Call History

When you select a person from the list in the cellular phonebook, you can see up to three category icons. The icons indicate what types of numbers are stored for that name.

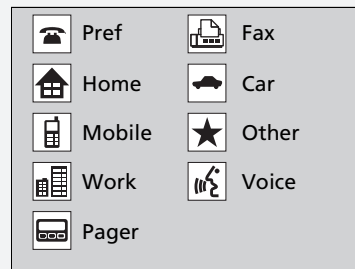

If a name has four or more numbers, ... appears instead of category icons.

On some phones, it may not be possible to import the category icons to HFL.

The phonebook is updated after every connection. Call history is updated after every connection or call.

Speed Dial

Up to 20 speed dial numbers can be stored per phone.



To store a speed dial number:

1. Press the button or the button.
2. Rotate to select **Speed Dial**, then press .
3. Rotate to select **Add New**, then press .
4. Rotate to select a place to choose a number from, then press .
 - From **Call History**:
 - ▶ Select a number from the call history.
 - From **Phonebook**:
 - ▶ Select a number from the connected cell phone's imported phonebook.
 - From **Phone Number**:
 - ▶ Input the number manually.
5. When the speed dial is successfully stored, you are asked to create a voice tag for the number. Rotate to select **Yes** or **No**, then press .
6. Using the button, follow the prompts to say the name for the speed dial entry.

Speed Dial

When any preset button is pressed, the **Speed Dial** screen is displayed.

When a voice tag is stored, you can press the button and call the number using voice commands.

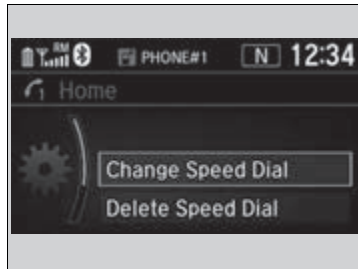

■ To edit a speed dial

1. Press the button or the button.
2. Rotate to select **Phone Setup**, then press .
3. Rotate to select **Speed Dial**, then press .
4. Select an existing speed dial entry.
5. Rotate to select **Change Speed Dial**, then press .
6. Select a new speed dial number, then press .

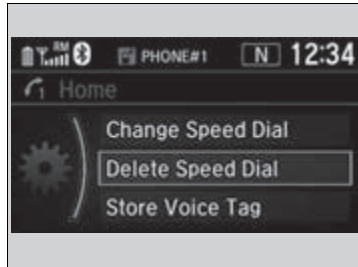

■ To delete a speed dial number

1. Press the button or the button.
2. Rotate to select **Phone Setup**, then press .
3. Rotate to select **Speed Dial**, then press .
4. Select an existing speed dial entry.
5. Rotate to select **Delete Speed Dial**, then press .
 - ▶ A confirmation message appears on the screen. Rotate to select **Yes**, then press .



■ **To add a voice tag to a stored speed dial number**

1. Press the button or the button.
2. Rotate to select **Phone Setup**, then press .
3. Rotate to select **Speed Dial**, then press .
4. Select an existing speed dial entry.
5. Rotate to select **Store Voice Tag**, then press .
6. Using the button, follow the prompts to complete the voice tag.



■ **To change a voice tag**

1. Press the button or the button.
2. Rotate to select **Phone Setup**, then press .
3. Rotate to select **Speed Dial**, then press .
4. Select an existing speed dial entry.
5. Rotate to select **Change Voice Tag**, then press .
6. Using the button, follow the prompts to complete the voice tag.

Speed Dial

Avoid using duplicate voice tags.
 Avoid using "home" as a voice tag.
 It is easier for HFL to recognize a longer name. For example, use "John Smith" instead of "John."

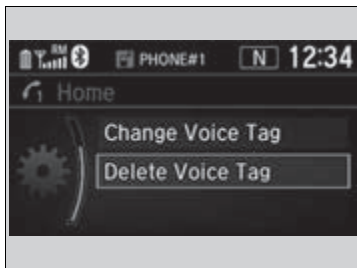

■ To delete a voice tag

1. Press the button or the button.
2. Rotate to select **Phone Setup**, then press .
3. Rotate to select **Speed Dial**, then press .
4. Select an existing speed dial entry.
5. Rotate to select **Delete Voice Tag**, then press .
 - ▶ A confirmation message appears on the screen. Rotate to select **Yes**, then press .

■ Making a Call

You can make calls by inputting any phone number, or by using the imported phonebook, call history, speed dial entries, or redial.



☒ Making a Call

Any voice-tagged speed dial entry can be dialed by voice from any screen.

Press the button and follow the prompts.

Once a call is connected, you can hear the voice of the person you are calling through the audio speakers.



■ **To make a call using the imported phonebook**

When your phone is paired, the contents of its phonebook are automatically imported to HFL.

1. Press the button or the button.
2. Rotate to select **Phonebook**, then press .
3. The phonebook is stored alphabetically. Rotate to select the initial, then press .
4. Rotate to select a name, then press .
5. Rotate to select a number, then press .
 - ▶ Dialing starts automatically.

■ **To make a call using a phone number**

1. Press the button or the button.
2. Rotate to select **Dial**, then press .
3. Rotate to select a number, then press .
4. Rotate to select , then press .
 - ▶ Dialing starts automatically.

☒ **To make a call using the imported phonebook**

This function is disabled while the vehicle is moving. However, you can call a stored voice-tagged speed dial number using voice commands.

- ☒ **Limitations for Manual Operation** P. 399
- ☒ **Speed Dial** P. 413

☒ **To make a call using a phone number**

This function is disabled while the vehicle is moving. However, you can call a stored voice-tagged speed dial number using voice commands.

- ☒ **Limitations for Manual Operation** P. 399
- ☒ **Speed Dial** P. 413

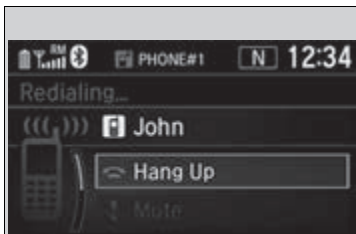

■ To make a call using redial

1. Press the button or the button.
2. Rotate to select **Redial**, then press .
- ▶ Dialing starts automatically.

■ To make a call using the call history

Call history is stored by **Dialed Calls**, **Received Calls**, and **Missed Calls**.

1. Press the button or the button.
2. Rotate to select **Call History**, then press .
3. Rotate to select **Dialed Calls**, **Received Calls**, or **Missed Calls**, then press .
4. Rotate to select a number, then press .
- ▶ Dialing starts automatically.

▶▶ To make a call using redial

Press and hold the button to redial the last number dialed in your phone's call history.

▶▶ To make a call using the call history

The call history appears only when a phone is connected to HFL, and displays the last 20 dialed, received, or missed calls.



■ **To make a call using a speed dial entry**

1. Press the button or the button.
2. Rotate to select **Speed Dial**, then press .
3. Rotate to select a number, then press .
 - ▶ Dialing starts automatically.

☒ To make a call using a speed dial entry

When any preset button is pressed, the **Speed Dial** screen is displayed.

Select **Others** to view another paired phone's speed dial list.

When a voice tag is stored, press the button and call the number using voice commands.

▶ **Speed Dial** P. 413

Any voice-tagged speed dial entry can be dialed by voice from any screen. Press the button and follow the prompts.

■ Receiving a Call

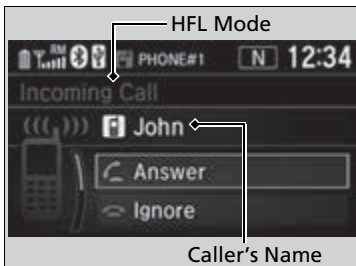

When there is an incoming call, an audible notification sounds and the **Incoming Call** screen appears.

Press the  button to answer the call.

Press the  button to decline or end the call.

▣ Receiving a Call





Call Waiting

Press the  button to put the current call on hold to answer the incoming call.

Press the  button again to return to the current call.

Select **Ignore** to ignore the incoming call if you do not want to answer it.

Press the  button if you want to hang up the current call.

You can select the icons on the audio/information screen instead of the  and  buttons. Rotate  to select the icon, then press .

Options During a Call

The following options are available during a call.



Swap Call: Put the current call on hold to answer the incoming call.

Mute: Mute your voice.

Transfer Call: Transfer a call from HFL to your phone.

Dial Tones: Send numbers during a call. This is useful when you call a menu-driven phone system.



1. To view the available options, press the  button.
2. Rotate  to select the option, then press .
 - ▶ Select **Mute** again to turn it off.

Options During a Call

Dial Tones: Available on some phones.

Models with Display Audio

Bluetooth® HandsFreeLink® (HFL) allows you to place and receive phone calls using your vehicle's audio system, without handling your cell phone.

Using HFL

HFL Buttons

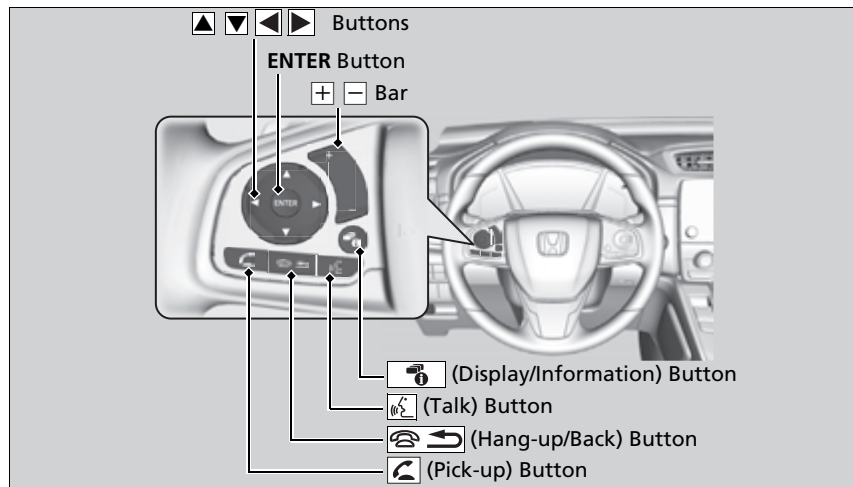

Bluetooth® HandsFreeLink®

Place your phone where you can get good reception.

To use HFL, you need a *Bluetooth*-compatible cell phone. For a list of compatible phones, pairing procedures, and special feature capabilities: Visit automobiles.honda.com/handsfreelink/, or call 1-888-528-7876.

To use the system, the **Bluetooth On/Off Status** setting must be **On**. If there is an active connection to Apple CarPlay™ or Android Auto™, HFL is unavailable.

➤ **How to customize** P. 369

Voice control tips

- Aim the vents away from the ceiling and close the windows, as noise coming from them may interfere with the microphone.
- Press the  button when you want to call a number using a stored voice tag, a phonebook name, or a number. Speak clearly and naturally after a beep.
- If the microphone picks up voices other than yours, the command may be misinterpreted.
- To change the volume level, select the audio system's **VOL** (Volume) or use the remote audio controls on the steering wheel.

Up to three speed dial entries can be displayed among a total of 20 that can be entered.

➤ **Speed Dial** P. 436

Up to three previous calls can be displayed at a time among a total of 20 that can be entered. If there is no call history, Call History is disabled.

 **(Pick-up) button:** Press to go directly to the phone menu on the driver information interface, or to answer an incoming call.

 **(Hang-up/back) button:** Press to end a call, go back to the previous command, or cancel a command.

 **(Talk) button:** Press to access Voice Portal.

 **buttons:** Press to select an item displayed on the phone menu in the driver information interface.

ENTER button: Press to call a number listed in the selected item on the phone menu in the driver information interface.

 **(display/information) button:** Select and press **ENTER** to display **Speed Dial**, **Call History**, or **Phonebook** on the phone menu in the driver information interface.

To go to the **Phone Menu** screen:

1. Select  to switch the display to the phone screen.
2. Select **MENU**.

Bluetooth® HandsFreeLink®

Bluetooth® Wireless Technology

The *Bluetooth®* word mark and logos are registered trademarks owned by *Bluetooth SIG, Inc.*, and any use of such marks by Honda Motor Co., Ltd., is under license. Other trademarks and trade names are those of their respective owners.

HFL Limitations

An incoming call on HFL will interrupt the audio system when it is playing. It will resume when the call is ended.

■ HFL Status Display

The audio/information screen notifies you when there is an incoming call.

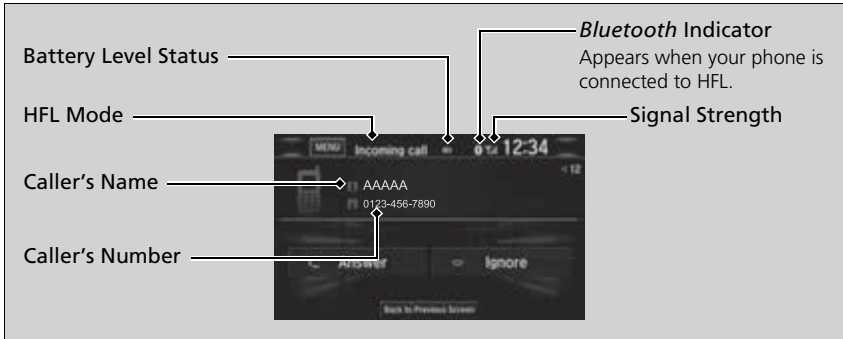

▣ HFL Status Display

The information that appears on the audio/information screen varies between phone models.

■ Limitations for Manual Operation

Certain manual functions are disabled or inoperable while the vehicle is in motion. You cannot select a grayed-out option until the vehicle is stopped.

Only previously stored speed dial entries with voice tags, phonebook names, or numbers can be called using voice commands while the vehicle is in motion.

▶ **Speed Dial** P. 436

HFL Menu

The power mode must be in ACCESSORY or ON to use the system.

■ Phone Settings screen



1. Select .
2. Select **Settings**.
3. Select **Phone**.

▶▶ HFL Menu

To use HFL, you must first pair your *Bluetooth*-compatible cell phone to the system while the vehicle is parked.

Some functions are limited while driving.

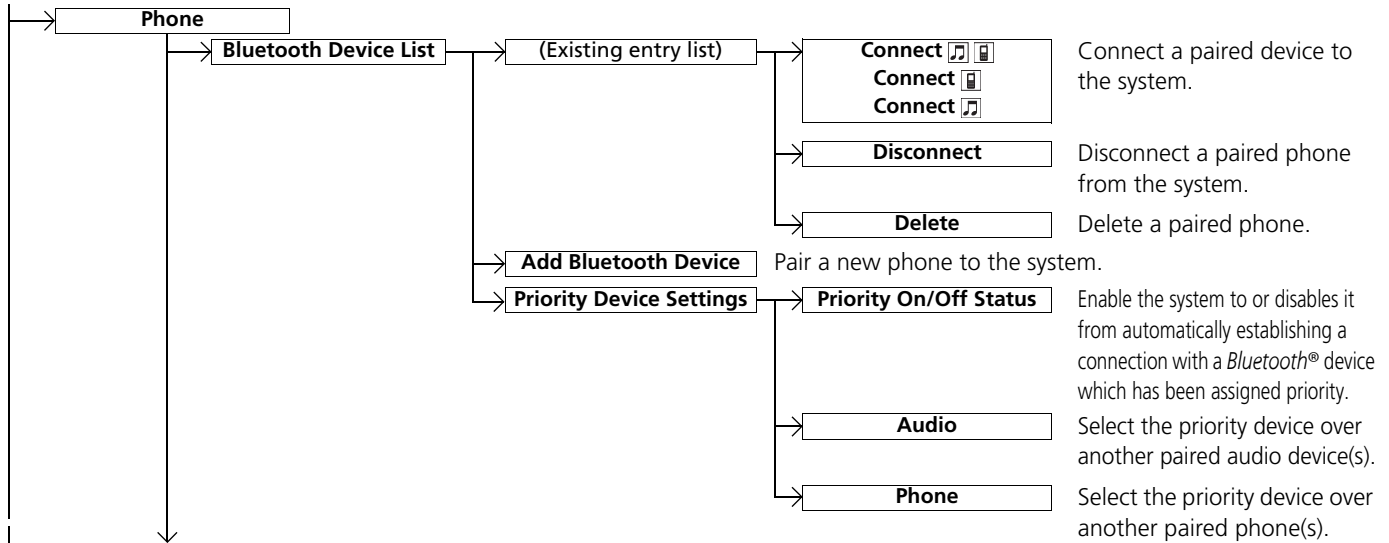

Continued

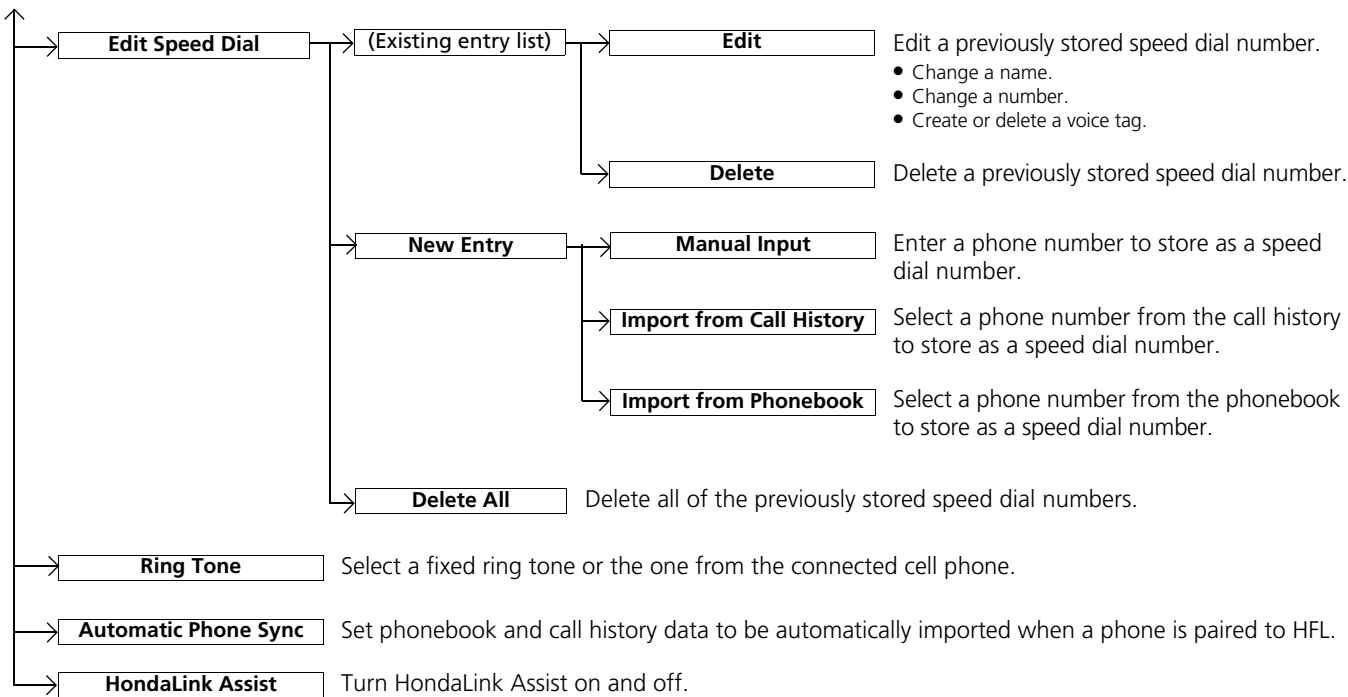

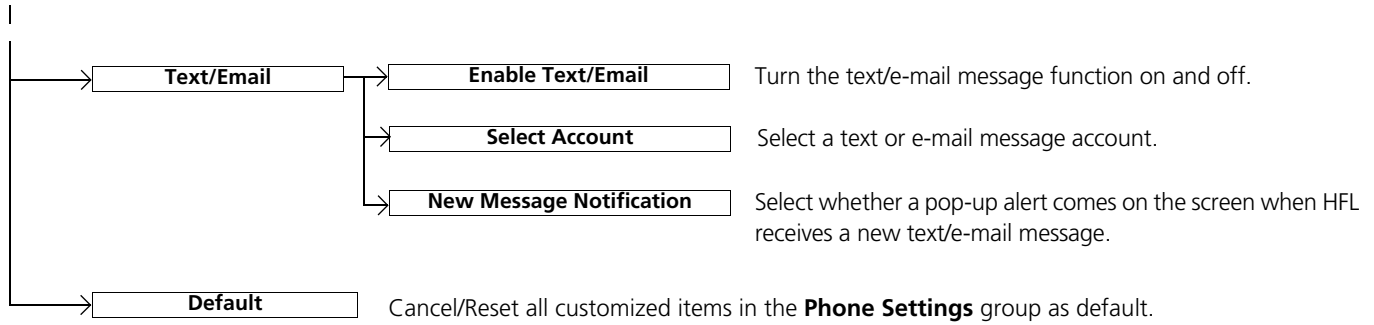

■ Phone Menu screen

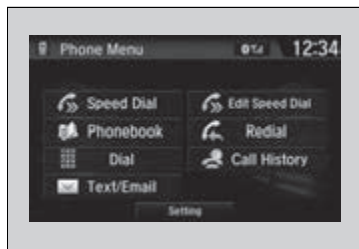

1. Select .
2. Select **MENU**.

Features

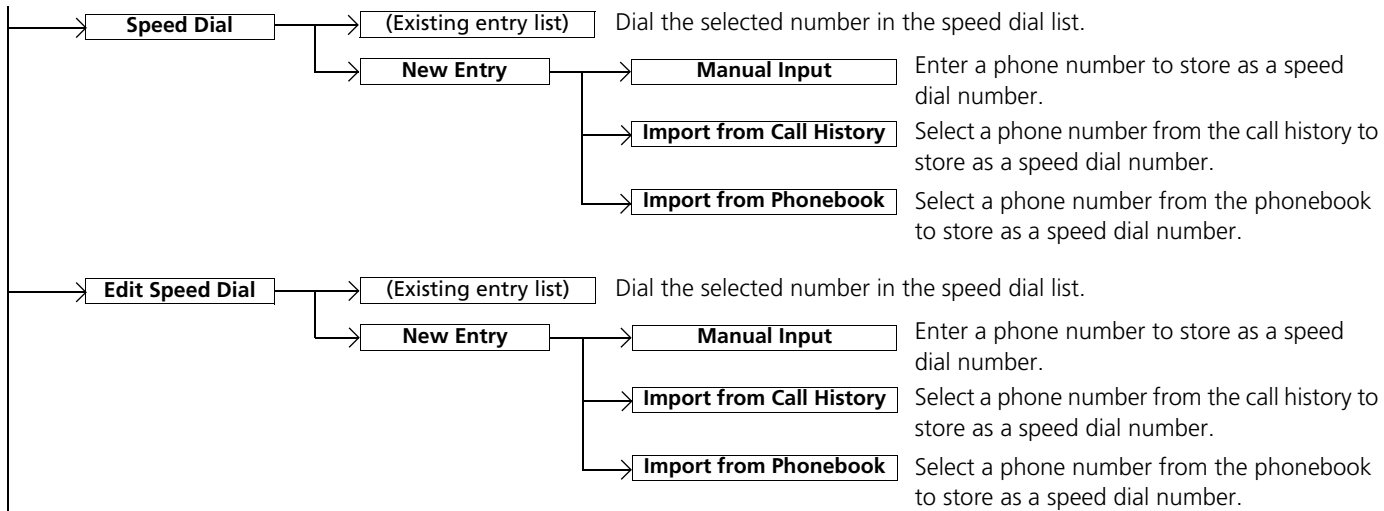

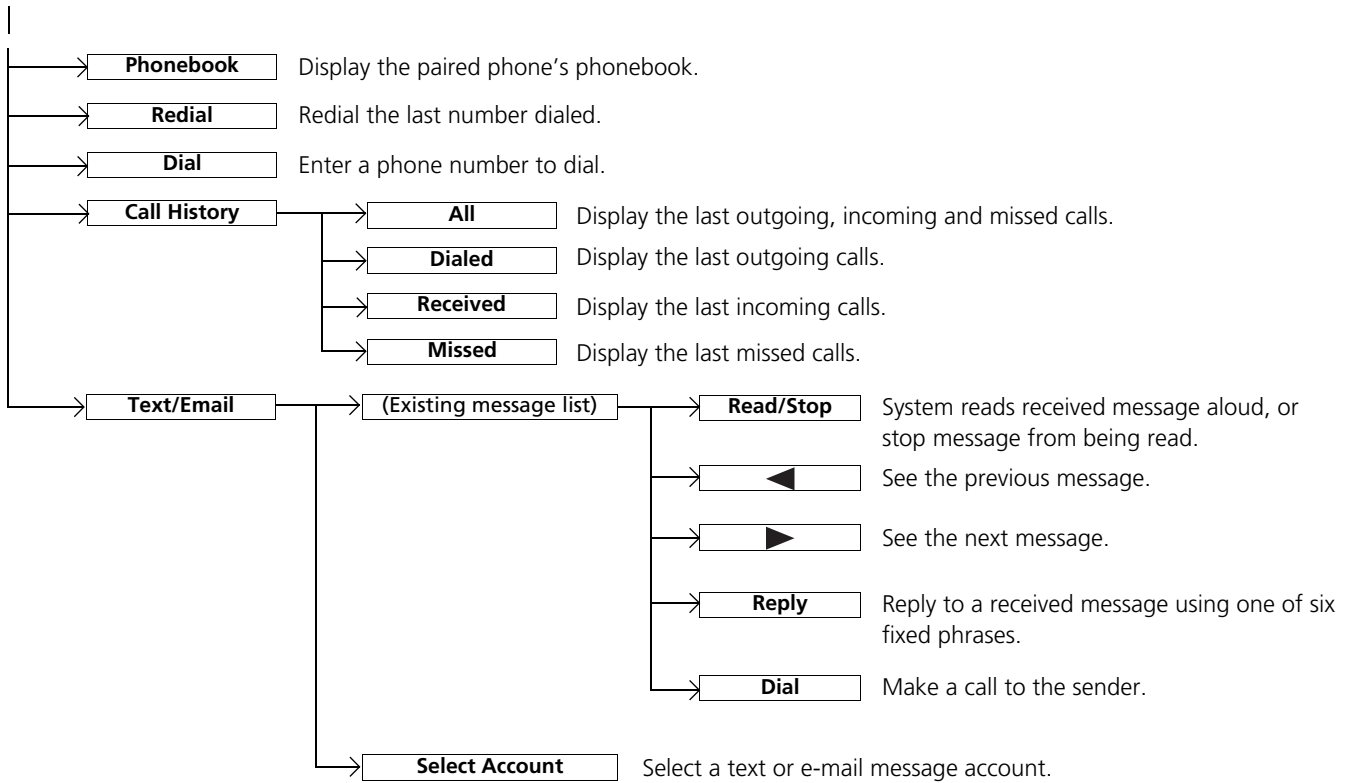

Phone Setup

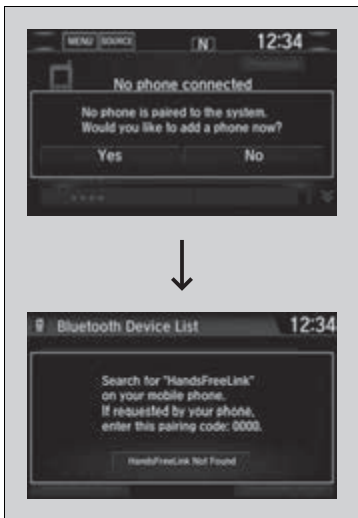

■ To pair a cell phone (when there is no phone paired to the system)

1. Select .
2. Select **Yes**.
3. Make sure your phone is in search or discoverable mode.
4. Select **HandsFreeLink** from your phone.
 - ▶ If you want to pair a phone from this audio system, select **HandsFreeLink Not Found, Continue**, and then select your phone when it appears on the list. If your phone does not appear, you can select **Refresh** to search again.
5. The system gives you a pairing code on the audio/information screen.
 - ▶ Confirm if the pairing code on the screen and your phone match. This may vary by phone.
6. A notification appears on the screen if pairing is successful.
 - ▶ You can prioritize a *Bluetooth*® device at the same time. Select **Yes** and then a device you want to prioritize.

☒ Phone Setup



Your *Bluetooth*-compatible phone must be paired to the system before you can make and receive hands-free calls.

Phone Pairing Tips:

- You cannot pair your phone while the vehicle is moving.
- Up to six phones can be paired.
- Your phone's battery may drain faster when it is paired to the system.
- If your phone is not ready for pairing or not found by the system within three minutes, the system will time out and return to idle.

Once you have paired a phone, you can see it displayed on the screen with one or two icons on the right side.





These icons indicate the following:

- : The phone can be used with HFL.
- : The phone is compatible with *Bluetooth*® Audio.

If there is an active connection to Apple CarPlay™, pairing of additional *Bluetooth*-compatible devices is unavailable.



■ **To change the currently paired phone**

1. Go to the **Phone Settings** screen.
 - ▶ **Phone Settings screen** P. 425
2. Select **Bluetooth Device List**.
3. Select a phone to connect.
 - ▶ HFL disconnects the connected phone and starts searching for another paired phone.
4. Select **Connect**  , **Connect** , or **Connect** .

■ **To change the pairing code setting**

1. Select .
2. Select **Settings**.
3. Select **Bluetooth / Wi-Fi**.
4. Select the **Bluetooth** tab.
5. Select **Edit Pairing Code**.
6. Select **Random** or **Fixed**.

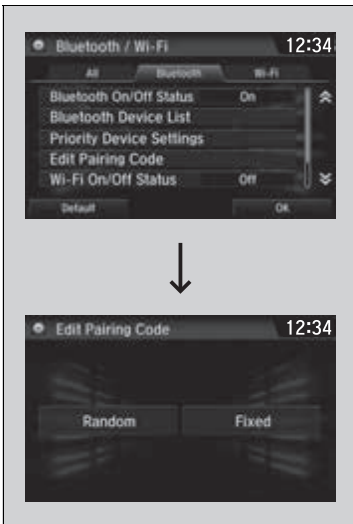

☒ To change the currently paired phone

If no other phones are found or paired when trying to switch to another phone, HFL will inform you that the original phone is connected again.

To pair other phones, select **Add Bluetooth Device** from the **Bluetooth Device List** screen.

To change the *Bluetooth*® connection priority device setting, select **Priority Device Settings** from the **Bluetooth Device List** screen.

☒ To change the pairing code setting

The default pairing code is **0000** until you change the setting.

To create your own, select **Fixed**, and delete the current code, then enter a new one.

For a randomly generated pairing code each time you pair a phone, select **Random**.

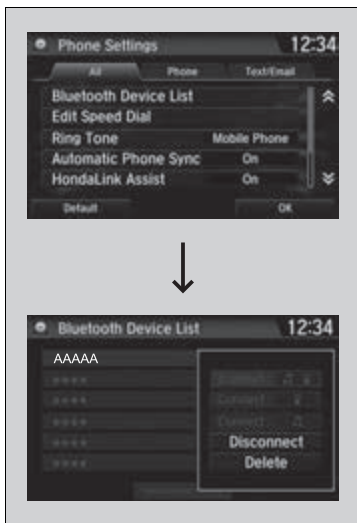

■ **To delete a paired phone**

1. Go to the **Phone Settings** screen.
 - ▶ **Phone Settings screen** P. 425
2. Select **Bluetooth Device List**.
3. Select a phone you want to delete.
4. Select **Delete**.
5. A confirmation message appears on the screen. Select **Yes**.

To Set Up Text/E-mail Message Options

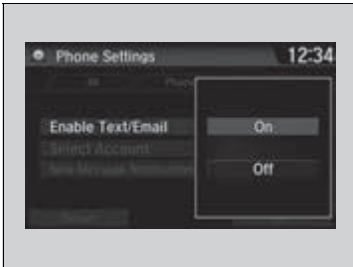

■ To turn on or off the text/e-mail message function

1. Go to the **Phone Settings** screen.
 ▶ **Phone Settings screen** P. 425
2. Select the **Text/Email** tab, then **Enable Text/Email**.
3. Select **Next**.
 ▶ A pop-up menu appears on the screen.
4. Select **On** or **Off**.

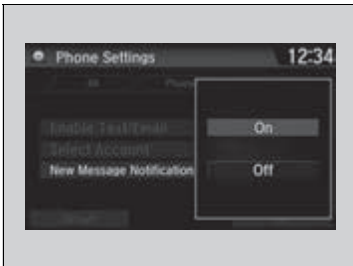

■ To turn on or off the text/e-mail message notice

1. Go to the **Phone Settings** screen.
 ▶ **Phone Settings screen** P. 425
2. Select the **Text/Email** tab, then **New Message Notification**.
3. Select **Next**.
 ▶ A pop-up menu appears on the screen.
4. Select **On** or **Off**.

☒ To Set Up Text/E-mail Message Options

To use the text/e-mail message function, it may be necessary to set up on your phone.

☒ To turn on or off the text/e-mail message notice

On: A pop-up notification comes on every time you receive a new message.

Off: The message you receive is stored in the system without notification.

■ Ring Tone

You can change the ring tone setting.

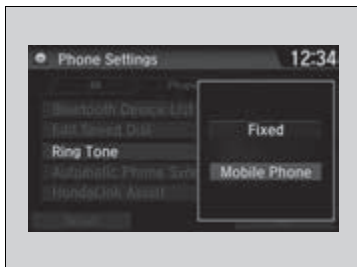

1. Go to the **Phone Settings** screen.
 ▶ **Phone Settings screen** P. 425
2. Select **Ring Tone**.
3. Select **Next**, then select **Fixed** or **Mobile Phone**.

⌘ Ring Tone

Fixed: The fixed ring tone sounds from the speakers.
Mobile Phone: Depending on the make and model of the cell phone, the ring tone stored in the phone will sound if the phone is connected.

Automatic Import of Cellular Phonebook and Call History

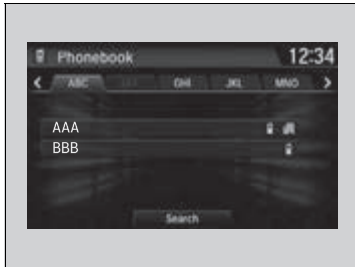

■ When Automatic Phone Sync is set to On:

When your phone is paired, the contents of its phonebook and call history are automatically imported to the system.

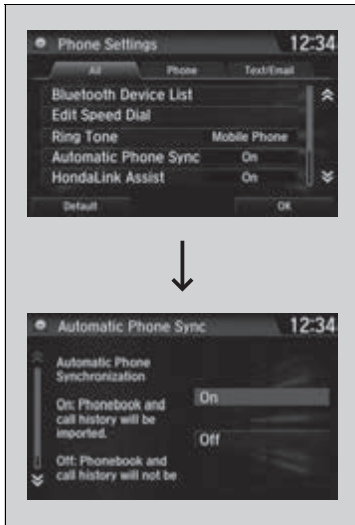

■ Changing the Automatic Phone Sync setting

1. Go to the **Phone Settings** screen.
 ▶ **Phone Settings** screen P. 425
2. Select **Automatic Phone Sync**.
3. Select **On** or **Off**.

Automatic Import of Cellular Phonebook and Call History

When you select a name from the list in the cellular phonebook, you can see up to three category icons. The icons indicate what types of numbers are stored for that name.

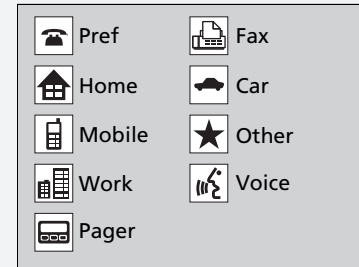

On some phones, it may not be possible to import the category icons to the system.

The phonebook is updated after every connection. Call history is updated after every connection or call.

■ Speed Dial

Up to 20 speed dial numbers can be stored per phone.



To store a speed dial number:

1. Go to the **Phone Menu** screen.
 - ▶ **Phone Menu screen** P. 428
2. Select **Speed Dial**.
3. Select **New Entry**.
 - From **Import from Call History**:
 - ▶ Select a number from the call history.
 - From **Manual Input**:
 - ▶ Input the number manually.
 - From **Import from Phonebook**:
 - ▶ Select a number from the connected cell phone's imported phonebook.
4. When the speed dial is successfully stored, you are asked to create a voice tag for the number. Select **Yes** or **No**.
5. Select **Record**, or use the  button and follow the prompts to complete the voice tag.

▶▶ Speed Dial

When a voice tag is stored, press the  button to call the number using the voice tag. Say the voice tag name.



■ **To add a voice tag to a stored speed dial number**

1. Go to the **Phone Settings** screen.
 ▶ **Phone Settings screen** P. 425
2. Select **Edit Speed Dial**.
3. Select an existing speed dial entry.
 ▶ From the pop-up menu, select **Edit**.
4. Select **Voice Tag**.
 ▶ From the pop-up menu, select **Record**.
5. Select **Record**, or use the  button and follow the prompts to complete the voice tag.

■ **To delete a voice tag**

1. Go to the **Phone Settings** screen.
 ▶ **Phone Settings screen** P. 425
2. Select **Edit Speed Dial**.
3. Select an existing speed dial entry.
 ▶ From the pop-up menu, select **Edit**.
4. Select **Voice Tag**.
 ▶ From the pop-up menu, select **Clear**.
5. A confirmation message appears on the screen. Select **Yes**.

☒ **Speed Dial**

Avoid using duplicate voice tags.
 Avoid using "home" as a voice tag.
 It is easier for the system to recognize a longer name.
 For example, use "John Smith" instead of "John."



■ To edit a speed dial

1. Go to the **Phone Settings** screen.
 - ▶ **Phone Settings screen** P. 425
2. Select **Edit Speed Dial**.
3. Select an existing speed dial entry.
 - ▶ From the pop-up menu, select **Edit**.
4. Select a setting you want.

■ To delete a speed dial

1. Go to the **Phone Settings** screen.
 - ▶ **Phone Settings screen** P. 425
2. Select **Edit Speed Dial**.
3. Select an existing speed dial entry.
 - ▶ From the pop-up menu, select **Delete**.
4. A confirmation message appears on the screen. Select **Yes**.

Phonebook Phonetic Modification

Add phonetic modifications or a new voice tag to the phone's contact name so that it is easier for HFL to recognize voice commands.

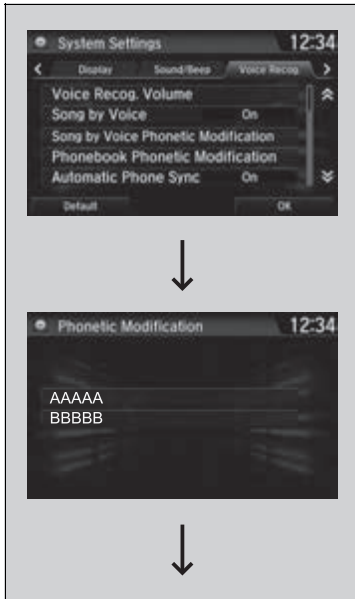

■ To add a new voice tag

1. Select .
2. Select **Settings**.
3. Select **System**.
4. Select the **Voice Recog.** tab.
5. Select **Phonebook Phonetic Modification**.
6. Select the phone you want to add phonetic modification to.

☒ Phonebook Phonetic Modification

You can store up to 20 phonetic modification items.



7. Select **[New Voice Tag]**.

8. Select a contact name you want to add to.

- ▶ The pop-up menu appears on the screen.

9. Select **Modify**.

10. Using **Record** or the  button, follow the prompts to complete the voice tag.

11. You will receive a confirmation message on the screen, then select **OK**.

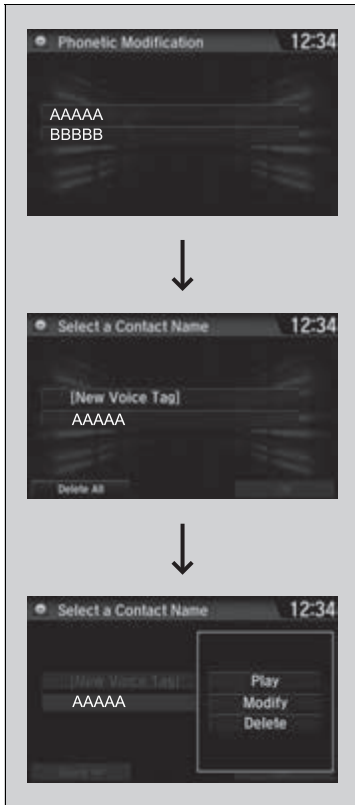

■ **To modify a voice tag**

1. Select .
2. Select **Settings**.
3. Select **System**.
4. Select the **Voice Recog.** tab.
5. Select **Phonebook Phonetic Modification**.

6. Select the phone you want to modify phonetic modification.
7. Select a contact name you want to modify.
 - ▶ The pop-up menu appears on the screen.

8. Select **Modify**.
9. Using **Record** or the  button, follow the prompts to complete the voice tag.
10. You will receive a confirmation message on the screen, then select **OK**.

☒ Phonebook Phonetic Modification

You can only modify or delete contact names for the currently connected phone.

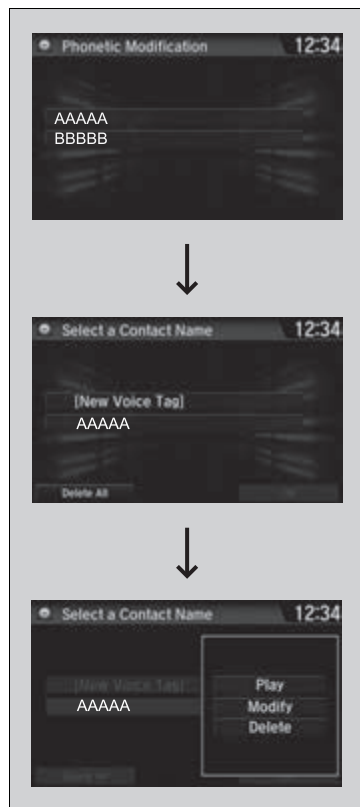

■ **To delete a modified voice tag**

1. Select .
 2. Select **Settings**.
 3. Select **System**.
 4. Select the **Voice Recog.** tab.
 5. Select **Phonebook Phonetic Modification**.
-
6. Select the phone for which you want to delete phonetic modification.
 7. Select a contact name you want to delete.
 - ▶ The pop-up menu appears on the screen.
-
8. Select **Delete**.
 - ▶ The selected contact name has been selected.
 9. Select **OK**.

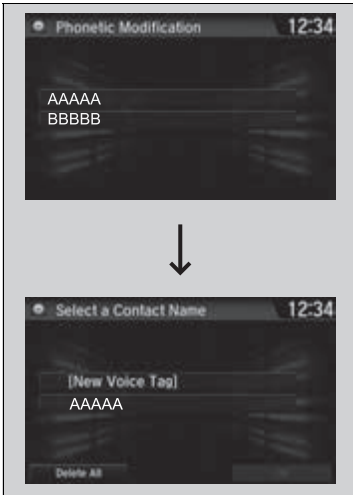

■ **To delete all modified voice tags**

1. Select .
2. Select **Settings**.
3. Select **System**.
4. Select the **Voice Recog.** tab.
5. Select **Phonebook Phonetic Modification**.
6. Select the phone you want to delete phonetic modification.
 - ▶ The contact name list appears.
7. Select **Delete All**.
8. You will receive a confirmation message on the screen, then select **Yes**.

■ **Making a Call**



You can make calls by inputting any phone number, or by using the imported phonebook, call history, speed dial entries, or redial.

⌘ **Making a Call**

Any voice-tagged speed dial entry can be dialed by voice from most screens.

Press the  button and say the voice tag name.

Once a call is connected, you can hear the voice of the person you are calling through the audio speakers.

While there is an active connection with Apple CarPlay™, phone calls can be made only from Apple CarPlay™.

Continued



■ To make a call using the imported phonebook

1. Select .
2. Select **Phonebook**.
3. Select a name.
 - ▶ You can also search by letter. Select **Search**.
 - ▶ Use the keyboard on the touch screen for entering name, if multiple numbers exist select a number.
4. Select a number.
 - ▶ Dialing starts automatically.

▶▶ To make a call using the imported phonebook

You can also select **Phonebook** on the **Phone Menu** screen.

You can call a stored voice-tagged speed dial number using voice commands.

▶ **Speed Dial** P. 436



■ **To make a call using a phone number**

1. Go to the **Phone Menu** screen.
 - ▶ **Phone Menu screen** P. 428
2. Select **Dial**.
3. Select a number.
 - ▶ Use the keyboard on the touch screen for entering numbers.
4. Select .
 - ▶ Dialing starts automatically.



■ **To make a call using redial**

1. Go to the **Phone Menu** screen.
 - ▶ **Phone Menu screen** P. 428
2. Select **Redial**.
 - ▶ Dialing starts automatically.

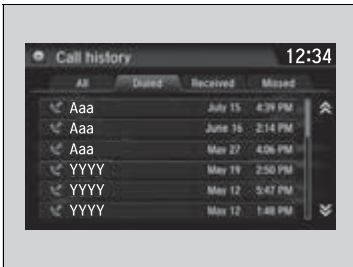

■ **To make a call using the Call History**

Call history is stored by **All, Dialed, Received, and Missed**.

1. Go to the **Phone Menu** screen.
 - ▶ **Phone Menu screen** P. 428
2. Select **Call History**.
3. Select **All, Dialed, Received, or Missed**.
4. Select a number.
 - ▶ Dialing starts automatically.

☒ **To make a call using a phone number**

You can call a stored voice-tagged speed dial number using voice commands.

- ▶ **Speed Dial** P. 436

☒ **To make a call using the Call History**

The call history displays the last 20 all, dialed, received, or missed calls. (Appears only when a phone is connected to the system.)

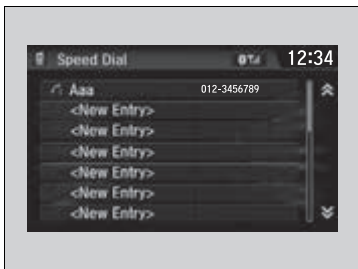



■ **To make a call using a Speed Dial entry**

1. Go to the **Phone Menu** screen.
 - ▶ **Phone Menu screen** P. 428
2. Select **Speed Dial**.
3. Select a number.
 - ▶ Dialing starts automatically.

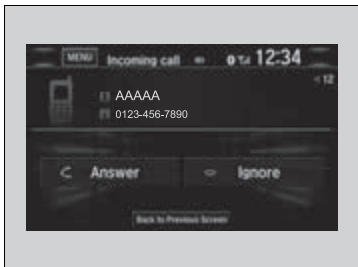
■ **Receiving a Call**



When there is an incoming call, an audible notification sounds (if activated) and the **Incoming call** screen appears.

Press the  button to answer the call.
 Press the  button to decline or end the call.

▶▶ To make a call using a Speed Dial entry

When a voice tag is stored, press the  button to call the number using the voice tag.

▶ **Speed Dial** P. 436

Any voice-tagged speed dial entry can be dialed by voice from any screen.
 Press the  button and follow the prompts.

▶▶ Receiving a Call



Call Waiting

Press the  button to put the current call on hold to answer the incoming call.

Press the  button again to return to the current call.

Select **Ignore** to ignore the incoming call if you do not want to answer it.

Press the  button if you want to hang up the current call.

You can select the icons on the audio/information screen instead of the  and  buttons.

Options During a Call

The following options are available during a call.

Mute: Mute your voice.

Transfer: Transfer a call from the system to your phone.

Touch Tones: Send numbers during a call. This is useful when you call a menu-driven phone system.

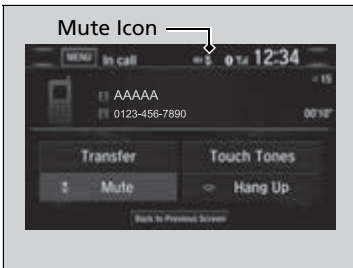

The available options are shown on the lower half of the screen.

Select the option.

- ▶ The mute icon appears when **Mute** is selected. Select **Mute** again to turn it off.

Options During a Call

Touch Tones: Available on some phones.

You can select the icons on the audio/information screen.

■ Receiving a Text/E-mail Message

HFL can display newly received text or e-mail messages as well as 20 of the most recently received messages on a linked cell phone. Each received message can be read aloud and replied to using a fixed common phrase.



1. A pop-up appears and notifies you of a new text or e-mail message.
2. Select **Read** to listen to the message.
 - ▶ The text or e-mail message is displayed. The system automatically starts reading out the message.
3. To discontinue the message read-out, select **Stop**.

▣ Receiving a Text/E-mail Message

The system does not display any received messages while you are driving. You can only hear them read aloud.

The system can only receive messages that are sent as text (SMS) messages. Messages sent using the data services will not be displayed in the list.

With some phones, you may be able to display up to 20 most recent text and e-mail message.

State or local laws may limit your use of the HFL text/e-mail message feature. Only use the text/e-mail message feature when conditions allow you to do so safely.

When you receive a text or e-mail message for the first time since the phone is paired to HFL, you are asked to turn the **New Message Notification** setting to **On**.

▣ **To turn on or off the text/e-mail message notice** P. 433

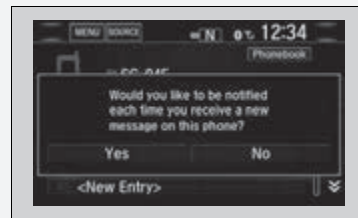

Selecting a Text/E-mail Message Account

If a paired phone has text or e-mail message accounts, you can select one of them to be active and receive notifications.

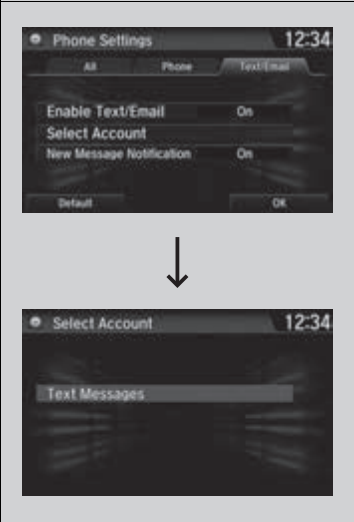

1. Go to the **Phone Settings** screen.
 ▶ **Phone Settings screen** P. 425
2. Select the **Text/Email** tab, then **Select Account**.
 ▶ A pop-up menu appears on the screen.
3. Select **Text Messages** or an e-mail message account you want.

Selecting a Text/E-mail Message Account

You can also select an e-mail message account from the folder list screen or the message list screen.

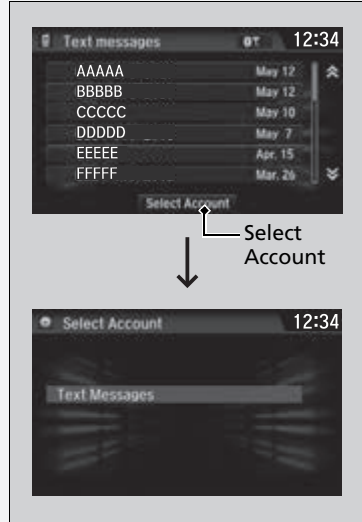

You can only receive notifications from one text or e-mail message account at a time.

■ Displaying Messages





■ Displaying text messages

1. Go to the **Phone Menu** screen.
 - ▶ **Phone Menu screen** P. 428
2. Select **Text/Email**.
 - ▶ Select account if necessary.
3. Select a message.
 - ▶ The text message is displayed. The system automatically starts reading the message aloud.

» Displaying Messages

The  icon appears next to an unread message.

If you delete a message on the phone, the message is also deleted in the system. If you send a message from the system, the message goes to your phone's mailbox.

To see the previous or next message, select  (previous) or  (next) on the message screen.

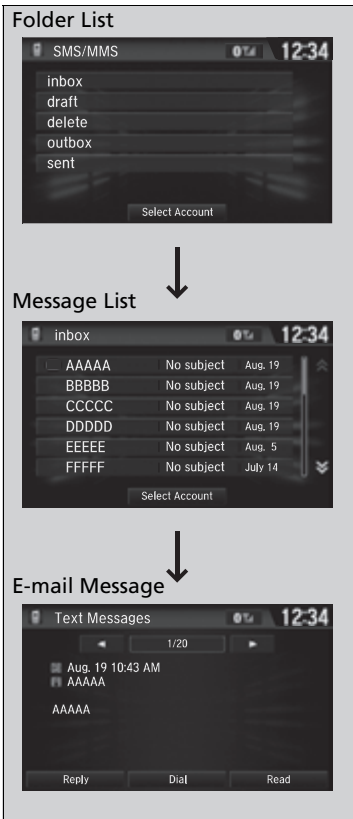

■ **Displaying e-mail messages**

1. Go to the **Phone Menu** screen.
▶ **Phone Menu screen** P. 428
2. Select **Text/Email**.
▶ Select **Select Account** if necessary.
3. Select a folder.
4. Select a message.
▶ The e-mail message is displayed. The system automatically starts reading the message aloud.

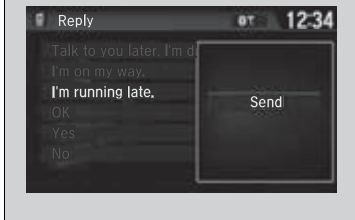
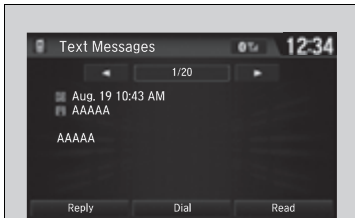
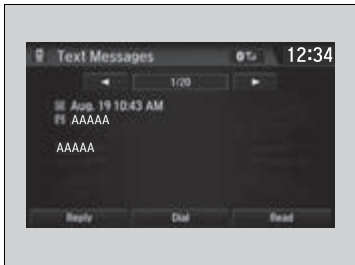

■ Read or Stop reading a message

1. Go to the text or e-mail message screen.
 - ▶ The system automatically starts reading the message aloud.
 - ☑ **Displaying Messages** P. 450
2. Select **Stop** to stop reading.
 - Select **Read** again to start reading the message from the beginning.

■ Reply to a message

1. Go to the text or e-mail message screen.
 - ▶ The system automatically starts reading the message aloud.
 - ☑ **Displaying Messages** P. 450
2. Select **Reply**.
3. Select the reply message.
 - ▶ The pop-up menu appears on the screen.
4. Select **Send** to send the message.
 - ▶ **Complete** appears on the screen when the reply message was successfully sent.

☒ Reply to a message

The available fixed reply messages are as follows:

- **Talk to you later, I'm driving.**
- **I'm on my way.**
- **I'm running late.**
- **OK**
- **Yes**
- **No**

You cannot add, edit, or delete reply messages.

Only certain phones receive and send messages when paired and connected. For a list of compatible phones, visit automobiles.honda.com/handsfreelink/, or call 1-888-528-7876.

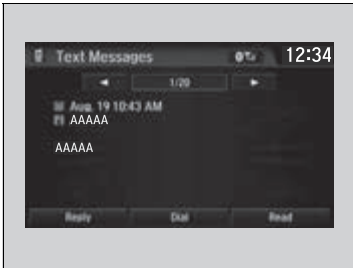

■ Making a call to a sender

1. Go to the text message screen.
2. Select **Dial**.

■ In Case of Emergency

■ Automatic collision notification

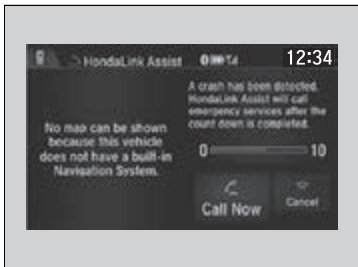

If your vehicle’s airbags deploy or if the unit detects that the vehicle is severely impacted, your vehicle automatically will attempt to connect to the HondaLink operator. If connected, information about your vehicle, its location, and its condition can be sent to the operator*1; you also can speak to the operator when connected.

IMPORTANT: For vehicles equipped with HondaLink Assist, owner activation constitutes authorization for Honda to collect information from your vehicle needed to provide the service, and agreement to the Terms of Use at www.hondalink.com/TermsAndConditions. In a crash, HondaLink Assist will attempt to notify emergency services but NEITHER Honda-PRO NOR ITS SERVICE PROVIDERS GUARANTEE THAT SUCH NOTIFICATION WILL OCCUR.

Honda reserves the right to terminate HondaLink Assist services at any time or for any reason, and in the future may not be able to provide services due to changes in, or obsolescence of, technology integral to the service or changes in governmental regulation.

*1: Depending on your phone and adequate cellular coverage, your vehicle’s location may not be sent to the operator.

☞ In Case of Emergency

Your vehicle may not be able to connect to the operator if the battery level is low, the line is disconnected, or you do not have adequate cellular coverage.

You cannot use this emergency service when:

- You travel outside the HondaLink service coverage areas.
- There is a problem with the connecting devices, such as the microphones, speakers, or the unit itself.

You cannot operate other phone-related functions using the screen while talking to the operator. Select **Hang Up** to terminate the connection to your vehicle.

☞ Automatic collision notification

If the unit fails to connect to the operator, it repeatedly tries until it succeeds.

■ To enable notification

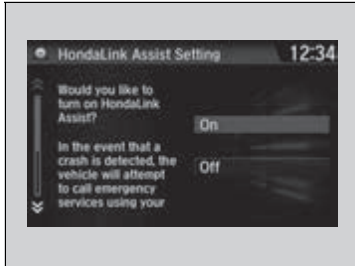

1. Go to the **Phone Settings** screen.
 - ▶ **Phone Settings screen** P. 425
2. Select the **Phone** tab, then **HondaLink Assist**.
 - ▶ A pop-up menu appears on the screen.
3. Select **On** or **Off**.

☒ To enable notification

Setting options:





- **On:** Notification is available.
- **Off:** Disable the feature.

When you set the power mode to ON, the compass self-calibrates, and the compass display appears.

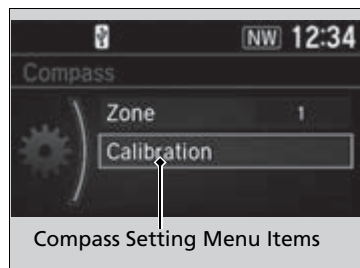
Compass Calibration

If the compass indicates the wrong direction, or the **CAL** indicator blinks, you need to manually calibrate the system.



1. Set the power mode to ON.
2. Press and hold the  (day/night) button until the display shows the compass setting menu.
3. Rotate  to select **Calibration**, then press .
4. When the display changes to **Push CAL Start**, press .
5. Drive the vehicle slowly in two circles.
 - ▶ The compass starts to show a direction after the calibration. The **CAL** indicator goes off.

Compass*

Compass operation can be affected under the following conditions:

- Driving near power lines or stations
- Crossing a bridge
- Passing a large vehicle, or driving near a large object that can cause a magnetic disturbance
- When accessories such as antennas and roof racks are mounted by magnets

Compass Calibration





Calibrate the compass in an open area.

While setting the compass:

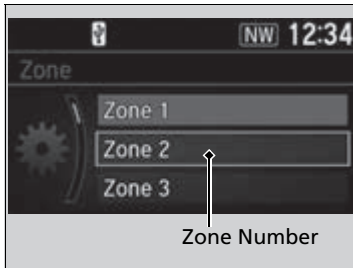
- The  (Back) button returns to the previous screen.

Compass Zone Selection



1. Set the power mode to ON.
2. Press and hold the  (day/night) button until the display shows the compass setting menu.
3. Rotate  to select **Zone**, then press . The display shows the current zone number.
4. Rotate  to select the zone number of your area (See Zone Map), then press .

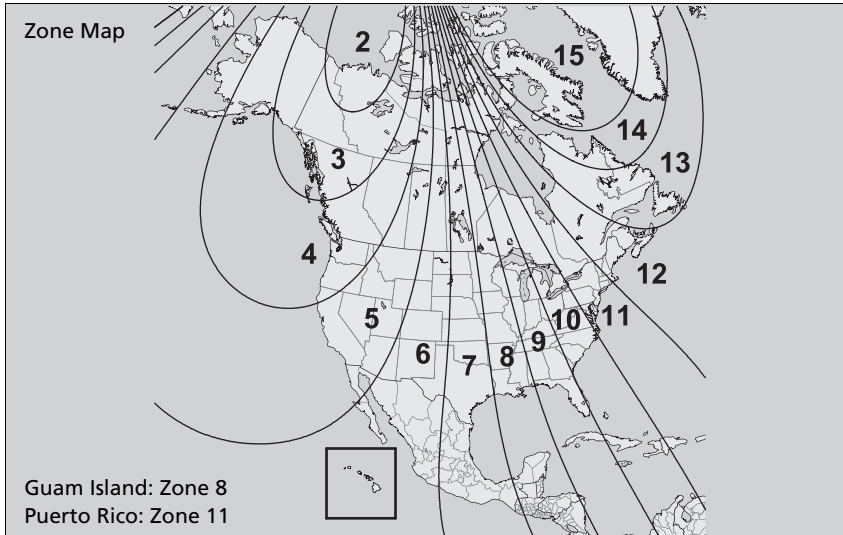

Compass Zone Selection

The zone selection is done to compensate the variation between magnetic north and true north.

If the calibration starts while the audio system is in use, the display returns to normal after the calibration is completed.

This page intentionally left blank.



Driving

This chapter discusses driving and refueling.

Before Driving	460
Towing a Trailer	465
Towing Behind a Motorhome	466
Off-Highway Driving Guidelines	
General Information.....	467
Important Safety Precautions.....	467
Avoiding Trouble	468
When Driving	
Turning on the Power	469
Precautions While Driving.....	475
Transmission	476
Shifting	477
SPORT Mode.....	483

Deceleration Paddle Selector	484
ECON Mode	487
Acoustic Vehicle Alerting System.....	488
Vehicle Stability Assist™ (VSA®), aka Electronic Stability Control (ESC), System	489
Agile Handling Assist	491
Real Time AWD with Intelligent Control System™	492
Tire Pressure Monitoring System (TPMS)...	493
Tire Pressure Monitoring System (TPMS) - Required Federal Explanation	497
Blind spot information System*	499
High Voltage Battery.....	502

Honda Sensing®	503
Collision Mitigation Braking System™ (CMBS™)....	506
Adaptive Cruise Control (ACC) with Low Speed Follow	517
Lane Keeping Assist System (LKAS) ..	534
Road Departure Mitigation (RDM) System.....	543
Front Sensor Camera	548
Radar Sensor	550
Braking	
Brake System	551
Anti-lock Brake System (ABS)	557
Brake Assist System	558
Parking Your Vehicle	559
Multi-View Rear Camera	570
Refueling	572
Fuel Economy and CO₂ Emissions	575

* Not available on all models

Driving Preparation

Check the following items before you start driving.

Exterior Checks

- Make sure there are no obstructions on the windows, door mirrors, exterior lights, or other parts of the vehicle.
 - ▶ Remove any frost, snow, or ice.
 - ▶ Remove any snow on the roof, as this can slip down and obstruct your field of vision while driving. If frozen solid, remove ice once it has softened.
 - ▶ When removing ice from around the wheels, be sure not to damage the wheel or wheel components.
- Make sure the hood is securely closed.
 - ▶ If the hood opens while driving, your front view will be blocked.
- Make sure the tires are in good condition.
 - ▶ Check air pressures, and check for damage and excessive wear.
 - ✎ **Checking and Maintaining Tires** P. 606
- Make sure there are no people or objects behind or around the vehicle.
 - ▶ There are blind spots from the inside.

Exterior Checks

NOTICE

When doors are frozen shut, use warm water around the door edges to melt any ice. Do not try to force them open, as this can damage the rubber trim around the doors. When done, wipe dry to avoid further freezing.

Do not pour warm water into the key cylinder. You will be unable to insert the key if the water freezes in the hole.

Heat from the engine and exhaust can ignite flammable materials left under the hood, causing a fire. If you've parked your vehicle for an extended period, inspect and remove any debris that may have collected, such as dried grass and leaves that have fallen or have been carried in for use as a nest by a small animal. Also, check under the hood for leftover flammable materials after you or someone else has performed maintenance on your vehicle.

Interior Checks

- Store or secure all items on board properly.
 - ▶ Carrying too much cargo, or improperly storing it, can affect your vehicle's handling, stability, stopping distance, and tires, and make it unsafe.
 - ✦ **Maximum Load Limit** P. 463
- Do not pile items higher than the seat height.
 - ▶ They can block your view and may be thrown forward in the event of sudden braking.
- Do not place anything in the front seat footwells. Make sure to secure the floor mat.
 - ▶ An object or unsecured floor mat can interfere with your brake and accelerator pedal operation while driving.
- If you have any animals on board, do not let them move around in the vehicle.
 - ▶ They may interfere with driving and a crash could occur.
- Securely close and lock all doors and the tailgate.
 - ✦ **Locking/Unlocking the Doors from the Inside** P. 163
- Adjust your seating position properly.
 - ▶ Adjust the head restraint, too.
 - ✦ **Seats** P. 208
 - ✦ **Adjusting the Front Head Restraints** P. 215
- Adjust the mirrors and steering wheel properly.
 - ▶ Adjust them while sitting in the proper driving position.
 - ✦ **Adjusting the Steering Wheel** P. 205
 - ✦ **Mirrors** P. 206

Interior Checks

The headlight aim is set by the factory, and does not need to be adjusted. However, if you regularly carry heavy items in the cargo area, have the aiming readjusted at a dealer or by a qualified technician.

- Be sure items placed on the floor behind the front seats cannot roll under the seats.
 - ▶ They can interfere with the driver's ability to operate the pedals, the operation of the seats, or the operation of the sensors under the seats.
- Everyone in the vehicle must fasten their seat belt.
 - 📄 **Fastening a Seat Belt** P. 51
- Make sure that the indicators in the instrument panel come on when you start the vehicle, and go off soon after.
 - ▶ Always have a dealer check the vehicle if a problem is indicated.
 - 📄 **Indicators** P. 90

Maximum Load Limit

The maximum load for your vehicle is 850 lbs (385 kg). See the Tire and Loading Information label attached to the driver's doorjamb.

Label Example

TIRE	SIZE	COLD TIRE PRESSURE	SEE OWNER'S MANUAL FOR ADDITIONAL INFORMATION
FRONT	XXXX/XXXXX XXX	XXXKPA, XXPSI	
REAR	XXXX/XXXXX XXX	XXXKPA, XXPSI	
SPARE	XXXX/XXXXX XXX	XXXKPA, XXPSI	

This figure includes the total weight of all occupants, cargo, and accessories, and the tongue load if you are towing a trailer.

Steps for Determining Correct Load Limit -

- (1)** Locate the statement "The combined weight of occupants and cargo should never exceed XXX kg or XXX lbs." on your vehicle's placard.
- (2)** Determine the combined weight of the driver and passengers that will be riding in your vehicle.
- (3)** Subtract the combined weight of the driver and passengers from XXX kg or XXX lbs.
- (4)** The resulting figure equals the available amount of cargo and luggage load capacity. For example, if the "XXX" amount equals 1,400 lbs. and there will be five 150 lb. passengers in your vehicle, the amount of available cargo and luggage load capacity is 650 lbs. (1,400 - 750 (5 x 150) = 650 lbs.)

Continued

Maximum Load Limit

⚠ WARNING

Overloading or improper loading can affect handling and stability and cause a crash in which you can be hurt or killed.

Follow all load limits and other loading guidelines in this manual.

Gross Vehicle Weight Rating (GVWR):

The maximum allowable weight of the vehicle, all occupants, all accessories and all cargo.

➤ **Specifications** P. 668

Gross Axle Weight Rating (GAWR):

The maximum allowable weight of the vehicle axle.

➤ **Specifications** P. 668

- (5) Determine the combined weight of luggage and cargo being loaded on the vehicle. That weight may not safely exceed the available cargo and luggage load capacity calculated in step 4.
- (6) If your vehicle will be towing a trailer, load from your trailer will be transferred to your vehicle. Consult this manual to determine how this reduces the available cargo and luggage load capacity of your vehicle.

In addition, the total weight of the vehicle, all occupants, accessories, cargo, and trailer tongue load must not exceed the Gross Vehicle Weight Rating (GVWR) or the Gross Axle Weight Rating (GAWR). Both are on a label on the driver's doorjamb.







▶▶ Maximum Load Limit

Towing a Trailer:
See Towing a Trailer to determine whether your vehicle is designed to tow a trailer.

▶ **Towing a Trailer** P. 465

Driving

Load Limits Example

Example 1				
	\geq		+	
Max Load 850 lbs (385 kg)		Passenger Weight 150 lbs x 2 = 300 lbs (68 kg x 2 = 136 kg)		Cargo Weight 550 lbs (249 kg)
Example 2				
	\geq		+	
Max Load 850 lbs (385 kg)		Passenger Weight 150 lbs x 5 = 750 lbs (68 kg x 5 = 340 kg)		Cargo Weight 100 lbs (45 kg)

Towing a Trailer

Your vehicle is not designed to tow a trailer. Attempting to do so can void your warranties.

Towing Behind a Motorhome

Your vehicle is not designed to be towed behind a motor home. If your vehicle needs to be towed in an emergency, refer to the emergency towing information.

➤ **Emergency Towing** P. 663

General Information

Your vehicle has been designed primarily for use on pavement, however, its higher ground clearance allows you to occasionally travel on unpaved roads. It is not designed for trail-blazing, or other challenging off-highway activities.

If you decide to drive on unpaved roads, you will find that it requires somewhat different driving skills and that your vehicle will handle somewhat differently than it does on pavement. Pay attention to the precautions and tips in this section, and get acquainted with your vehicle before leaving the pavement.

Important Safety Precautions

To avoid loss of control or rollover, be sure to follow all precautions and recommendations:

- Be sure to store cargo properly and do not exceed your cargo load limits.
 - **Maximum Load Limit** P. 463
- Whenever you drive, make sure you and your passengers always wear seat belts.
- Keep your speed low, and never go faster than the conditions allow.
- It's up to you to continually assess the situation and drive within the limits.

Off-Highway Driving Guidelines

WARNING

Improperly operating this vehicle on or off-pavement can cause a crash or rollover in which you and your passengers could be seriously injured or killed.

- Follow all instructions and guidelines in this owner's manual.
- Keep your speed low, and don't drive faster than conditions permit.

Failure to operate your vehicle correctly might result in a crash or a rollover.

- **Important Handling Information** P. 44
- **Precautions While Driving** P. 475

Avoiding Trouble

- **Check Out Your Vehicle** before you leave the pavement and make sure that all scheduled maintenance has been completed. Pay special attention to the condition of the tires, and check the tire pressures.
- **Remember** the route you choose presents limits (too steep or bumpy), you have limits (driving skill and comfort), and your vehicle has limits (traction, stability, and power). Failing to recognize these limits will likely put you and your passengers in a hazardous situation.
- **Accelerating and Braking** should be done slowly and gradually. Trying to start or stop too fast can cause a loss of traction and you could lose control.
- **Avoiding Obstacles and Debris** in the road reduces the likelihood of a rollover or damage to your suspension or other components.
- **Driving on Slopes** increases your risk of a rollover, particularly if you attempt to drive across a slope that is too steep. Going straight up or down a slope is usually the safest. If you can't clearly see all conditions or obstacles on a slope, walk it before you drive it. If there is any doubt whether you can safely pass, don't try it. Find another route. If you get stuck when climbing, do not try to turn around. Back down slowly following the same route you took up the hill.
- **Crossing a Stream** - Avoid driving through deep water. If you encounter water in your route (a small stream or large puddle, for example), evaluate it carefully before going ahead. Make sure it is shallow, flowing slowly, and has firm ground underneath. If you are not sure of the depth or the ground, turn around and find another route. Driving through deep water can also damage your vehicle. The water can get into the transmission and differential, diluting the lubricant and causing an eventual failure. It can also wash the grease out of the wheel bearings.
- **If You Get Stuck**, carefully go in the direction that you think will get you unstuck. Do not spin the tires as this will only make things worse and could damage the transmission. If you are unable to free yourself, your vehicle will need to be towed. Front and rear tow hooks are provided for this purpose.

Turning on the Power

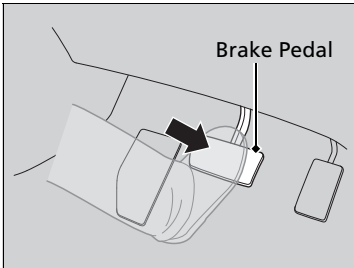

1. Make sure the parking brake is applied.
 - ▶ The parking brake and brake system indicator (red) comes on for 15 seconds when you pull up the electric parking brake switch.
2. Depress the brake pedal.

Turning on the Power

Keep your foot firmly on the brake pedal when starting the power system.

The engine is harder to start in cold weather and in thinner air found at altitudes above 8,000 feet (2,400 meters).

When turning on the power system in cold weather, turn off all electrical accessories such as the lights, climate control system, and rear defogger in order to reduce 12V-battery drain.

If the exhaust system sounds abnormal or you can smell exhaust gas inside the vehicle, have your vehicle checked by a dealer. There may be a problem with the engine or exhaust system.

The immobilizer system protects your vehicle from theft. If an improperly coded device is used, the power system does not activate.

Immobilizer System P. 178

When you set the power mode to ON, you may feel as if the brake pedal is sinking down. This is normal.

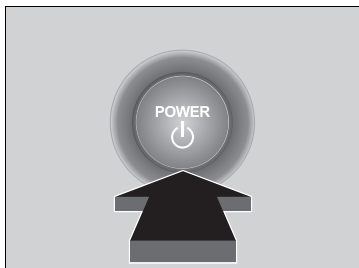

3. Without depressing the accelerator pedal, press the **POWER** button while depressing the brake pedal.
4. Check the **READY** indicator.
 - ▶ Keep depressing the brake pedal until the **READY** indicator comes on.
 - ▶ The **READY** indicator comes on when the power system is on and you can start driving.
 - ▶ If the outside temperature is extremely low, you cannot drive until conditions are improved. In this case, the **READY** indicator does not come on and a warning message appears on the driver information interface.
 - ❏ **Driver Information Interface**
Warning and Information Messages
P. 109

❏ Turning on the Power

Bring the keyless remote close to the **POWER** button if the battery in the keyless remote is weak.

- ❏ **If the Keyless Remote Battery is Weak**
P. 645

The power system may not activate if the keyless remote is subjected to strong radio waves.

Do not hold the **POWER** button to start the power system.

If the power system does not start, wait at least 30 seconds before trying again.

The engine may not run when the vehicle is ready for driving.

You can start driving with the **READY** indicator on. If you press the **POWER** button while depressing the brake pedal with the **READY** indicator on, the power mode is set to VEHICLE OFF and you cannot start driving.

- ❏ **READY Indicator** P. 93

■ Stopping the Power System

You can turn the power system off when the vehicle is completely stopped.



1. Put the transmission into **P**.
2. Press the **POWER** button.

Remote Engine Start

You can remotely turn the power system on using the keyless remote.

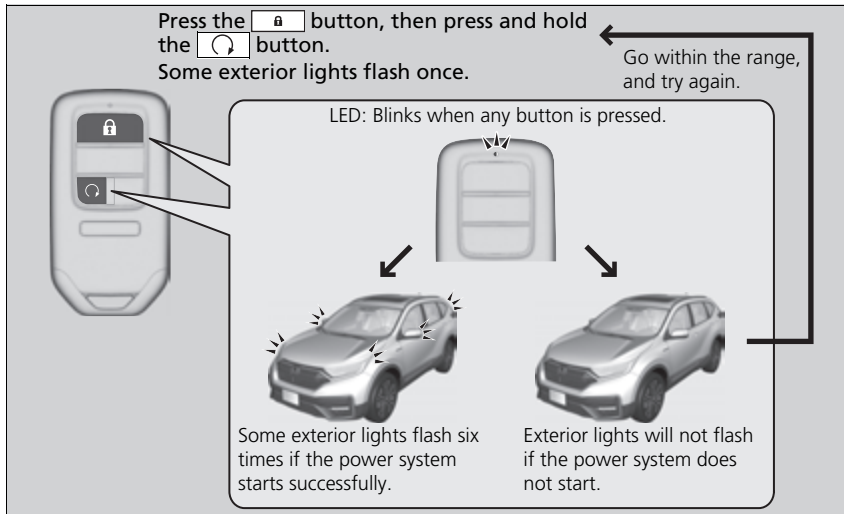
To turn the power system on



The power system is on for up to 10 minutes without you starting the vehicle. To extend the time for another 10 minutes during the first 10 minutes, press the  button, then press and hold the  button.

- ▶ Some exterior lights flash six times if a 10-minute extension request was transmitted successfully.

Remote Engine Start

⚠ WARNING

Carbon monoxide gas is toxic and can rapidly accumulate in closed or even partly enclosed areas.

Breathing it can cause unconsciousness and even kill you.

Never use the remote engine starter with the vehicle parked in a garage or other areas with limited ventilation.

The remote engine start may violate local laws. Before using the remote engine start, check your local laws.

If there are buildings and obstacles between your vehicle and the remote, the range will be reduced. This distance may vary by external electrical interference.

■ To turn the power system off

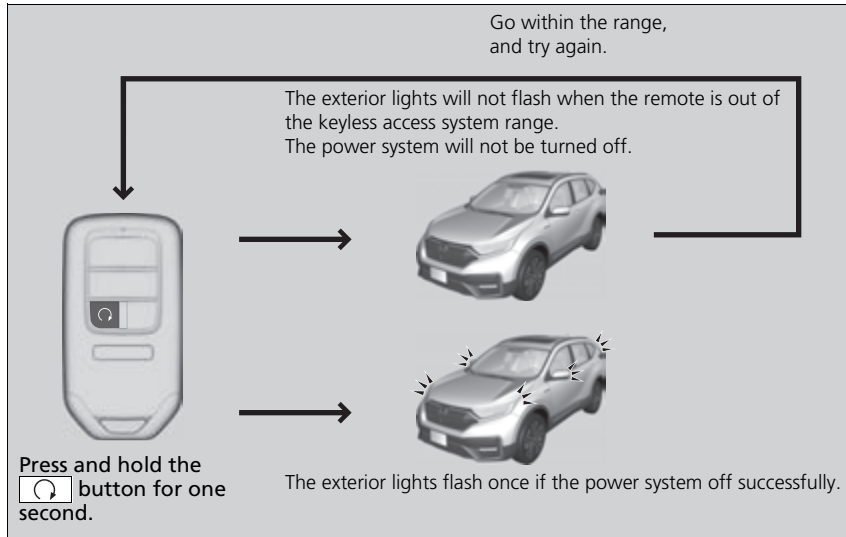

⌘ Remote Engine Start

The power system may not be turned on by the remote engine start if:

- You have disabled a remote engine start setting using the driver information interface* or audio/information screen*.

⌘ Customized Features P. 140, 369

- The power mode is not in VEHICLE OFF (LOCK).
- The transmission is in a position other than **[P]**.
- The hood is open, or any door or the tailgate is unlocked.
- You have already used the remote twice to turn the power system on.
- Another registered keyless remote is in the vehicle.
- There is an antenna failure.
- The door is unlocked with the built-in key.
- The engine oil pressure is low.
- The engine coolant temperature is extremely high.
- The security system alarm is not set.

⌘ To turn the power system off

The power system may be turned off while it is on if:

- You do not start the vehicle within 10 minutes of turning the power system on with the button on the keyless remote.
- The power system is turned off by using the keyless remote.
- The door is unlocked with the built-in key.
- The hood is open.
- The transmission is in a position other than **[P]**.
- The engine coolant temperature is extremely high.
- The engine oil pressure is low.
- The Malfunction Indicator Lamp comes on if there is a problem with the emissions control systems.

▶▶ Remote Engine Start

While the power system is on, the vehicle will automatically precondition inside the vehicle.

When it is warm outside:

- The climate control system is activated in recirculation mode.

When it is cold outside:

- The defroster is activated at a moderately warm temperature.
- The rear defogger and door mirror heaters* are activated.
- The seat and heated steering wheel are activated*

▶ **Heated Steering Wheel*** P. 233

▶ **Seat Heaters*** P. 234



* Not available on all models

■ Starting to Drive

When the power system is turned on using the  button on the keyless remote

1. Depress and hold the brake pedal, then press the **POWER** button.



When the power system is turned on in any case

2. Keeping your right foot on the brake pedal, check that the **READY** indicator is on, then put the transmission into . Select  when reversing.
3. With the parking brake is applied, release the brake pedal and gently depress the accelerator pedal.

▶ Make sure the parking brake and brake system indicator (red) goes off.

➤ **Parking Brake** P. 551

■ Hill start assist system

Hill start assist keeps the brake engaged briefly to help prevent the vehicle from rolling on inclines as you move your foot from the brake pedal to the accelerator. Put the transmission into  when facing uphill, or  when facing downhill, then release the brake pedal.

» Starting to Drive

When the power system is turned on using the  button on the keyless remote

The power system is turned off when the transmission is taken out of  before the **POWER** button is pressed. Follow step 1 when starting to drive.

You can also release the parking brake by pressing the electric parking brake switch while depressing the brake pedal. When facing downhill, you can start your vehicle more smoothly by manually releasing it with the electric parking brake switch than by releasing it with the accelerator pedal.

As a hybrid vehicle, the sounds and vibrations from the engine may be absent even though the vehicle is ready for driving. It also makes you fail to recognize that you can start.

Make sure to check if the **READY** indicator is on before you start to drive.

» Hill start assist system

Hill start assist may not prevent the vehicle from rolling downhill on a very steep or slippery slope, and will not operate on small inclines.

Hill start assist is not a replacement for the parking brake.

Hill start assist will operate even when VSA® is switched off.

Precautions While Driving

■ Driving Guidelines for Your Utility Vehicle

Utility vehicles have a significantly higher rollover rate than other types of vehicles. To prevent rollovers or loss of control:

- Take corners at slower speeds than you would with a passenger vehicle.
- Avoid sharp turns and abrupt maneuvers whenever possible.
- Do not modify your vehicle in any way that you would raise the center of gravity.
- Do not carry heavy cargo on roof.
- Roof load capacity is 165 lbs (75 kg), available roof racks/carriers may have lower capacities. Please check accessory's information (Honda accessory).

■ In Rain

Avoid driving in deep water and on flooded roads. This can damage the engine or driveline, or cause electrical component failure.

■ Other Precautions

If there is a strong impact with something under the vehicle, stop in a safe location. Check the underside of the vehicle for damage or any fluid leaks.

⊠ Precautions While Driving

NOTICE

Do not change the shift position while pressing the accelerator pedal. You could damage the transmission.

NOTICE

If you repeatedly turn the steering wheel at an extremely low speed, or hold the steering wheel in the full left or right position for a while, the electric power steering (EPS) system heats up. The system goes into a protective mode, and limits its performance. The steering wheel becomes harder and harder to operate. Once the system cools down, the EPS system is restored. Repeated operation under these conditions can eventually damage the system.

Transmission

■ Creeping

As with a conventional gasoline-powered vehicle with an automatic transmission, this vehicle will creep.

Keep the brake pedal firmly depressed when stopped.

■ Kickdown

Quickly depressing the accelerator pedal while driving uphill may cause the vehicle to react similar to an automatic transmission vehicle, unexpectedly increasing vehicle speed. Depress the accelerator pedal carefully, especially on slippery roads and curves.

⌘ Precautions While Driving

If the power mode is set to ACCESSORY while driving, the engine will shut down and all steering and brake power assist functions will stop, making it difficult to control the vehicle.

Do not select **N** while driving as you will lose regenerative braking (and acceleration) performance.

During the first 600 miles (1,000 km) of operation, avoid sudden acceleration or full throttle operation so as not to damage the engine or powertrain.

Avoid hard braking for the first 200 miles (300 km) after purchasing your new vehicle or replacing the brake pads or rotors, to allow for proper break-in.

⌘ Driving Guidelines for Your Utility Vehicle

Failure to operate your vehicle correctly might result in a crash or a rollover.

- **Important Handling Information** P. 44
- **Precautions While Driving** P. 475

Shifting

Change the shift position in accordance with your driving needs.

■ Shift button positions



- P** **Park**
Used when parking or turning the power on or off.
Transmission is locked.
- R** **Reverse**
Used when reversing.
- N** **Neutral**
Transmission is not locked.
- D** **Drive**
- Used for normal driving.
 - The deceleration paddle selector can be used temporarily.
 - The deceleration paddle selector can be used when SPORT mode is on.

▶▶ Shifting

⚠ WARNING

The vehicle can roll away if left unattended without confirming that Park is engaged.

A vehicle that rolls away could cause a crash resulting in serious injury or death.

Always keep your foot on the brake pedal until you have confirmed that **P** is shown on the shift position indicator.

While the High Voltage battery level is full, or the High Voltage battery temperature is low, regenerative braking may become less effective.

To prevent malfunction and unintended engagement:

- Do not spill any liquids on or around shift buttons.
- Do not place or drop any objects on or around shift buttons.
- Do not let passengers or children operate the shift buttons.

■ **P (parking) button**

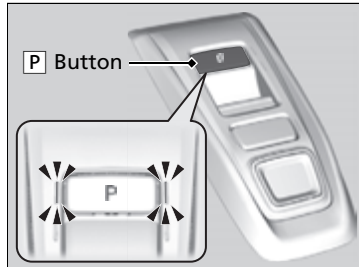

The shift position changes to **P** when you press the **P** button while the vehicle is parked with the power mode in ON. The indicators on the sides of the **P** button come on.

▶▶ Shifting

The beeper sounds and the message appears on the driver information interface when you depress the accelerator pedal with the shift position in **N**.

▶ **Driver Information Interface Warning and Information Messages** P. 109

Change the shift position to **D** or **R** with the brake pedal depressed.

You may occasionally find that it takes longer than usual for the vehicle to start moving when you select **R**, release the brake pedal, and/or depress the accelerator pedal. This may occur when the High Voltage battery level is extremely low, and does not indicate a vehicle malfunction.

Shift Operation

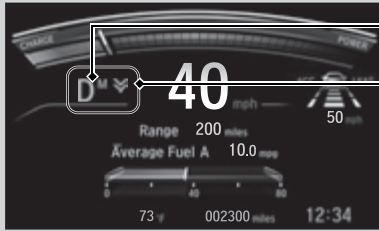

Shift Position Indicator
(Transmission System Indicator)

Deceleration Paddle Selector
Indicator

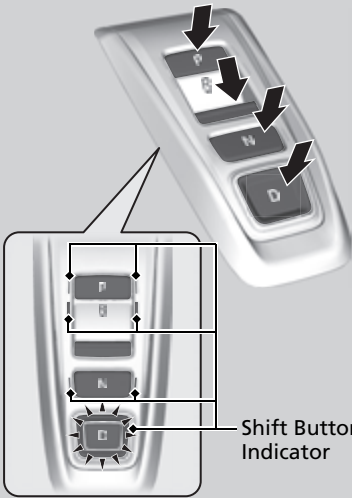

- P** Press the **P** button.
- R** Press back the **R** button.
- N** Press the **N** button.
- D** Press the **D** button.

Shift Button
Indicator

Shift Operation

NOTICE

When you change **D** to **R** and vice versa, come to a complete stop and keep the brake pedal depressed. Operating the shift button before the vehicle has come to a complete standstill can damage the transmission.

Use the shift position indicator and the shift button indicator to check the shift position before selecting a shift button.

If the indicator of the currently selected shift position, or all the shift position indicators are blinking simultaneously, there is a problem with the transmission.

Avoid sudden acceleration and have the transmission checked by a dealer as soon as possible.

When shifting positions in extremely low temperatures (-22°F/-30°C), there may be a short delay before the shift position is displayed. Always confirm you are in the correct shift position before driving.

The beeper sounds once when you change to **R**.

▶ **Customized Features** P. 140, 369

■ When opening the driver's door

If you open the driver's door under the following conditions, the shift position automatically changes to **P**.

- The vehicle is stationary with the power mode in ON, or moving at 1 mph (2 km/h) or slower.
- The transmission is in other than **P**.
- You have unfastened the driver side seat belt.
 - ▶ If you manually change the shift position from **P** with the brake pedal depressed, the shift position will automatically return to **P** once you release the brake pedal.

■ When turning off the power mode

If you turn the power system off while the vehicle is stationary, and the transmission is in other than **P**, the shift position automatically changes to **P**.

⌘ When opening the driver's door

While the system is designed to automatically change the shift position to **P** under the described conditions, in the interest of safety you should always select **P** before opening the driver's door. Make sure to park the vehicle in a safe place.

➤ **When Stopped** P. 559

If you want to drive the vehicle after the shift position has automatically changed to **P** under the described conditions, close the door, fasten the seat belt, depress the brake pedal, then change the shift position.

If you leave the vehicle, turn off the power system and lock the doors.

■ If you want to keep the transmission in **[N]** position [car wash mode]

With the power system on:

1. Press and hold the brake pedal.
 2. Press and release the **[N]** button.
 - ▶ **[N]** (Neutral) hold mode will appear on the driver information interface.
 3. Press the **[N]** button again and hold it for two seconds.
 - ▶ The vehicle will enter car wash mode, which must be used when your vehicle is pulled through a conveyor type automatic car wash where you or an attendant do not remain in the vehicle.
- If you want to cancel car wash mode, select a position other than **[N]**.

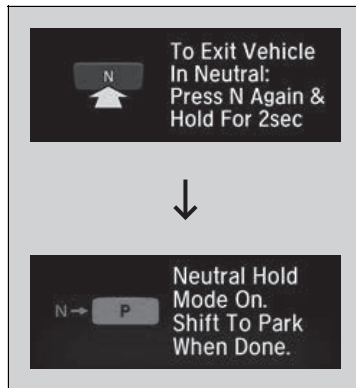

If the **POWER** button is pressed after car wash mode has been activated, the power mode will change to **ACCESSORY** and a message will be displayed on the driver information interface.

- ▶ For 15 minutes the transmission remains in **[N]** with the power mode will remain in **ACCESSORY**. After that, the transmission automatically changes to **[P]**.
- ▶ Manually changing to **[P]** cancels **ACCESSORY** mode. The **[P]** indicator comes on and the power mode changes to **OFF**. You must always put the transmission into **[P]** when car wash mode is no longer needed.

ⓘ If you want to keep the transmission in **[N]** position [car wash mode]

To keep the vehicle in **[N]** position, you can also follow this procedure:

While the power system is on, select **[N]**, and then within five seconds, press the **POWER** button.

Note that the transmission may not stay in **[N]** position while any of the following indicators is on:

- Transmission system indicator.
- Malfunction indicator lamp.
- Charging system indicator.

■ Restrictions on selecting a shift position

You cannot select a shift position under certain circumstances that may lead to a crash.

When the transmission is in:	1. Under these circumstances:	2. If you try to change to the following:	3. The shift position remains in/changes to:	How to change the shift position
P	The brake pedal is not depressed. The accelerator pedal is depressed.	Other shift position	P	Release the accelerator pedal and depress the brake pedal.
N	The vehicle is moving at low speed without the brake pedal depressed. The vehicle is moving at low speed with the accelerator pedal depressed.		N	
N or D	The vehicle is moving forward.		R	Park your vehicle in a safe place.
R or N	The vehicle is moving backward.	D		
R , N , or D	The vehicle is moving.	P		
P or N	The READY indicator is not on.	A shift position other than P or N	P or N	Make sure that the READY indicator comes on.

SPORT Mode

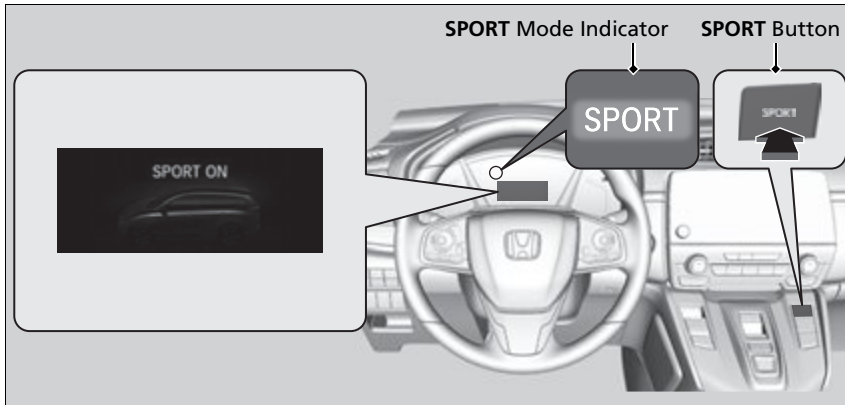

To turn the SPORT mode on and off, press the **SPORT** button.

The SPORT mode increases engine performance and handling.

This mode is not recommended for fuel economy enhancement, but suitable for driving on hills or through curves on mountain roads.

The SPORT mode is turned off every time you turn on the power system, even if you turned it on the last time you drove the vehicle.

Deceleration Paddle Selector

When you release the accelerator pedal, you can control the rate of deceleration without removing your hands from the steering wheel. Using the deceleration paddle selector situated on the steering wheel, you can sequentially shift through four stages of deceleration.

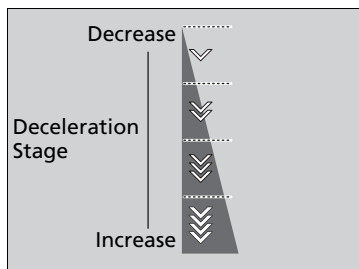

When descending a hill, you can use the deceleration paddle selector to help maintain the rate of deceleration, thereby allowing you to keep a safe distance between your vehicle and the vehicle ahead.



The default deceleration stage is . Each paddle selector operation makes a single stage deceleration change.

- The deceleration stage may not change if you keep the paddle selector pulled back.

To select the different stages of deceleration:

- Pull back the  selector (right side) to decrease the deceleration stage.
- Pull back the  selector (left side) to increase the deceleration stage.



Pull the  selector for a few seconds when you want to cancel the deceleration paddle selector.

►► Deceleration Paddle Selector

⚠ CAUTION

Rapidly increasing the deceleration rate by quickly shifting the deceleration paddle selector can cause the tires to skid, resulting in a crash that could injure or kill someone.

Always maintain a reasonable rate of deceleration.

If you are descending a hill when you select stage , the vehicle may enter stage .

If you pull back right and left paddle selector at the same time, the deceleration stage may not change.

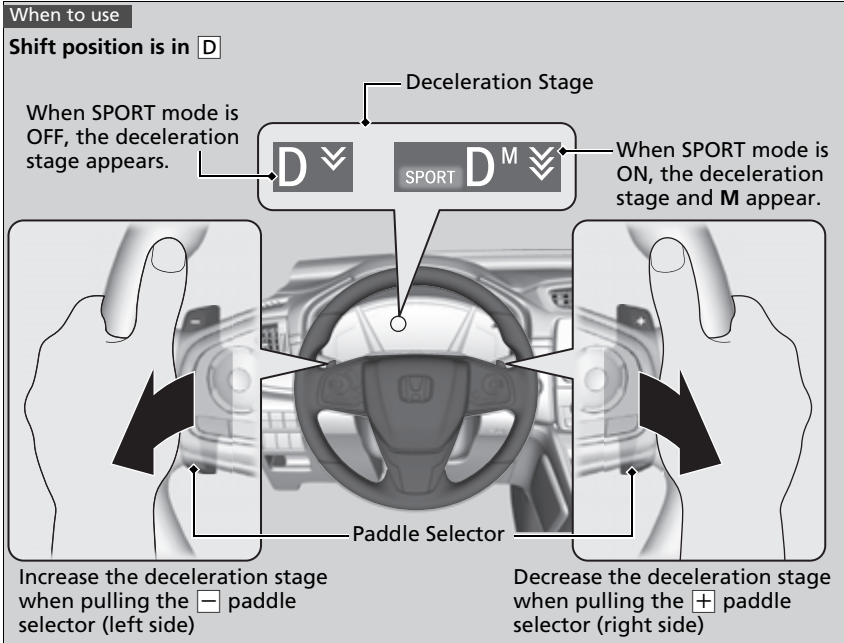

▶▶ Deceleration Paddle Selector

In the following situations, the stage may not change and the stage icon will blink even if you pull back the selector. The deceleration stage may decrease or cancel automatically:

- The High Voltage battery is fully charged or its temperature is too cold or too hot.
- The speed of the vehicle is beyond the deceleration range with SPORT mode off.
- Hybrid system protection is needed.
- The paddle selector is operated while your vehicle is stopped automatically by ACC with Low Speed Follow.

If either paddle selector is operated, ACC with Low Speed Follow will cancel automatically.

■ **When SPORT mode is OFF**

If you pull back the paddle selector, the rate of deceleration will change temporarily, and the stage will appear in the driver information interface.

When you want to cancel the deceleration paddle selector, pull the  selector (right side) for a few seconds.

The deceleration paddle selector will cancel automatically and deceleration stage in the driver information interface disappear when you drive with constant speed, situations of acceleration and decelerate just before stopping your vehicle.

■ **When SPORT mode is ON**

If you pull back the paddle selector, the rate of deceleration will change and the stage along with **M** will appear in the driver information interface. The deceleration stage will not cancel automatically while SPORT mode is ON.

When you want to cancel the deceleration paddle selector, turn the SPORT mode OFF, or pull the  selector (right side) for a few seconds. When canceled, deceleration stage in the driver information interface disappears.

ECON Mode

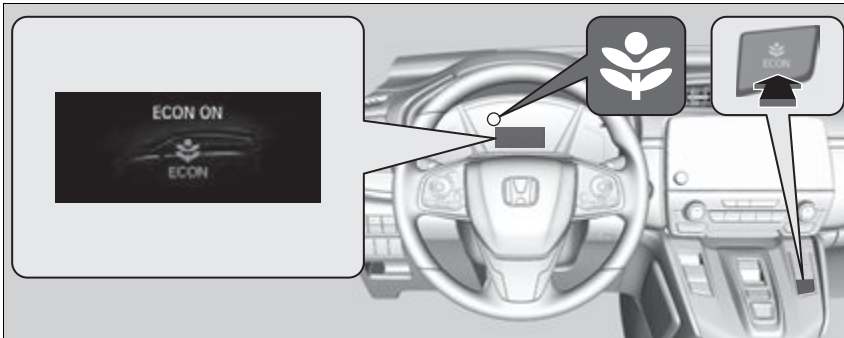

The **ECON** button turns the ECON mode on and off.
The ECON mode helps you improve your fuel economy by adjusting the performance of the climate control system and the accelerator pedal response.

▶▶ ECON Mode

While in ECON mode, the climate control system has greater temperature fluctuation.

Acoustic Vehicle Alerting System

Alerts pedestrians when the vehicle transmission is in a position other than **P** and is traveling at speeds of 22 mph (36 km/h) or less.

Vehicle Stability Assist™ (VSA®), aka Electronic Stability Control (ESC), System

VSA® helps to stabilize the vehicle during cornering if the vehicle turns more or less than what was intended. It also assists in maintaining traction on slippery surfaces. It does so by regulating engine output and selectively applying the brakes.

■ VSA® Operation

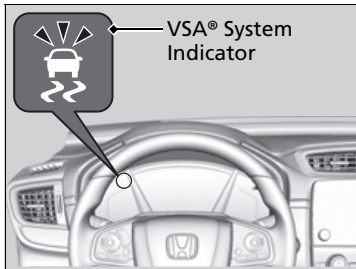

When VSA® activates, you may notice that the engine and motor do not respond to the accelerator. You may also notice some noise from the hydraulic brake system. You will also see the indicator blink.

▣ Vehicle Stability Assist™ (VSA®), aka Electronic Stability Control (ESC), System

The VSA® may not function properly if tire type and size are mixed. Make sure to use the same size and type of tire, and the air pressures as specified.

When the VSA® system indicator comes on and stays on while driving, there may be a problem with the system. While this may not interfere with normal driving, have your vehicle checked by a dealer immediately.

VSA® cannot enhance stability in all driving situations and does not control the entire braking system. You still need to drive and corner at speeds appropriate for the conditions and always leave a sufficient margin of safety.

The main function of the VSA® system is generally known as Electronic Stability Control (ESC). The system also includes a traction control function.

The indicators for the Adaptive Cruise Control (ACC) with Low Speed Follow, Road Departure Mitigation (RDM), Vehicle Stability Assist™ (VSA®) system, Vehicle Stability Assist™ (VSA®) OFF, low tire pressure/TPMS, Collision Mitigation Braking System™ (CMBS™), and Parking Brake and Brake System (Amber) may come on along with a message in the Driver Information Interface after reconnecting the 12V-battery. Drive a short distance at more than 12 mph (20 km/h). The indicator should go off. If it does not, have your vehicle checked by a dealer.

■ VSA® On and Off

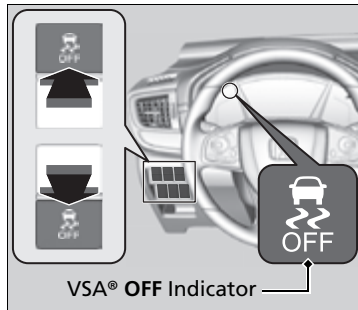

This button is on the driver side control panel. To partially disable VSA® functionality/features, press and hold it until you hear a beep.

Your vehicle will have normal braking and cornering ability, but traction control function will be less effective.

To restore VSA® functionality/features, press the  (VSA® OFF) button until you hear a beep.

VSA® is turned on every time you turn the power system on, even if you turned it off the last time you drove the vehicle.

▶▶ Vehicle Stability Assist™ (VSA®), aka Electronic Stability Control (ESC), System

In certain unusual conditions when your vehicle gets stuck in shallow mud or fresh snow, it may be easier to free it with the VSA® temporarily switched off.

When the  button is pressed, the traction control function becomes less effective. This allows for the wheels to spin more freely at low speed. You should only attempt to free your vehicle with the VSA® off if you are not able to free it when the VSA® is on.

Immediately after freeing your vehicle, be sure to switch VSA® on again. We do not recommend driving your vehicle with the VSA® system switched off.

You may hear a motor sound coming from the engine compartment while system checks are being performed immediately after turning the power system on or while driving. This is normal.

Agile Handling Assist

Lightly brakes each of the front and rear wheels, as needed, when you turn the steering wheel, and helps support the vehicle's stability and performance during cornering.

ⓘ Agile Handling Assist

The agile handling assist cannot enhance stability in all driving situations. You still need to drive and corner at speeds appropriate for the conditions and always leave a sufficient margin of safety.

When the VSA® system indicator comes on and stays on while driving, the agile handling assist does not activate.

You may hear a sound coming from the engine compartment while the agile handling assist is activated. This is normal.

Real Time AWD with Intelligent Control System™

Your vehicle is equipped with the AWD system. When the system senses a loss of front wheel traction, it automatically transfers some power to the rear wheels. This allows you to utilize all available traction and may increase mobility.

You still need to exercise the same care when accelerating, steering, and braking that you would in a two wheel drive vehicle.

If you excessively spin all four wheels and overheat the AWD system, only the front wheels receive power. Stop until the system cools down.

ⓘ Real Time AWD with Intelligent Control System™

NOTICE

Do not continuously spin the front tires of your vehicle. Continuously spinning the front tires can cause transmission or rear differential damage.

The AWD system may not function properly if tire type and size are mixed. Make sure to use the same size and type of tire, and the air pressures as specified.

➤ **Tire and Wheel Replacement** P. 612

Tire Pressure Monitoring System (TPMS)

Instead of directly measuring the pressure in each tire, the TPMS on this vehicle monitors and compares the rolling radius and rotational characteristics of each wheel and tire while you are driving to determine if one or more tires are significantly under-inflated.

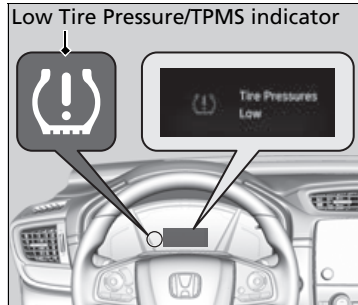

This will cause the low tire pressure/TPMS indicator to come on and a message to appear on the driver information interface.

▣ Tire Pressure Monitoring System (TPMS)

The system does not monitor the tires when driving at low speed.

Conditions such as low ambient temperature and altitude change directly affect tire pressure and can trigger the low tire pressure/TPMS indicator to come on.

Tire pressure checked and inflated in:

- Warm weather can become under-inflated in colder weather.
- Cold weather can become overinflated in warmer weather.

The low tire pressure/TPMS indicator will not come on as a result of overinflation.

The TPMS may not function properly if tire type and size are mixed. Make sure to use the same size and type of tire.

▣ Checking and Maintaining Tires P. 606

The low tire pressure/TPMS indicator may come on with a delay or may not come on at all when:

- You rapidly accelerate, decelerate, or turn the steering wheel.
- You drive on snowy or slippery roads.
- Tire chains are used.

The low tire pressure/TPMS indicator may come on under the following conditions:

- There is a heavier and uneven load on the tires, such as when towing a trailer, than the condition at calibration.
- Tire chains are used.

■ TPMS Calibration

You must start TPMS calibration every time you:

- Adjust the pressure in one or more tires.
- Rotate the tires.
- Replace one or more tires.

Before calibrating the TPMS:

- Set the cold tire pressure in all four tires.
 - ▶ **Checking Tires** P. 606

Make sure:

- The vehicle is at a complete stop.
- Change the shift position to **P**.
- The power mode is in ON.

▶▶ Tire Pressure Monitoring System (TPMS)

The indicators for the Adaptive Cruise Control (ACC) with Low Speed Follow, Road Departure Mitigation (RDM), Vehicle Stability Assist™ (VSA®) system, Vehicle Stability Assist™ (VSA®) OFF, low tire pressure/TPMS, Collision Mitigation Braking System™ (CMBS™), and Parking Brake and Brake System (Amber) may come on along with a message in the Driver Information Interface after reconnecting the 12V-battery. Drive a short distance at more than 12 mph (20 km/h). The indicator should go off. If it does not, have your vehicle checked by a dealer.

▶▶ TPMS Calibration

The calibration process requires approximately 30 minutes of cumulative driving at speeds between 30-65 mph (48-105 km/h).

During this period, if the ignition is turned on and the vehicle is not moved within 45 seconds, you may notice the low tire pressure/TPMS indicator comes on briefly. This is normal and indicates that the calibration process is not yet complete.

If the tire chains are installed, remove them before calibrating the TPMS.

If the low tire pressure/TPMS indicator comes on even when the properly inflated specified regular tires are installed, have your vehicle checked by a dealer.

We recommend that the tires be replaced with the same brand, model, and size as the originals. Ask a dealer for details.

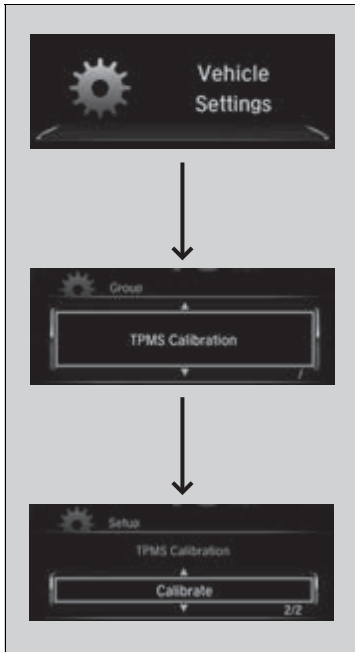

Models with color audio system

You can calibrate the system from the customized features on the driver information interface.

1. Press the then / button to select **Vehicle Settings**, then press the **ENTER** button.
 - ▶ **TPMS Calibration** appears on the display.
 2. Press the **ENTER** button.
 - ▶ The display switches to the customization setup screen, where you can select **Cancel** or **Calibrate**.
 3. Press the / button and select **Calibrate**, then press the **ENTER** button.
 - ▶ **Calibration Started** screen appears, then the display returns to the customization menu screen.
- If the **Calibration Failed to Start** message appears, repeat steps 2-3.
 - The calibration process finishes automatically.



Models with Display Audio

You can calibrate the system from the customized feature on the audio/information screen.

1. Set the power mode to ON.
2. Select .
3. Select **Settings**.
4. Select **Vehicle**.
5. Select **TPMS Calibration**.
6. Select **Cancel** or **Calibrate**.
 - ▶ When the calibration is complete, the display returns to the customization menu screen.

- If the **Unable to initialize TPMS** message appears, repeat step 6.
- The calibration process finishes automatically.

Tire Pressure Monitoring System (TPMS) - Required Federal Explanation

Each tire, including the spare (if provided), should be checked monthly when cold and inflated to the inflation pressure recommended by the vehicle manufacturer on the vehicle placard or tire inflation pressure label.

(If your vehicle has tires of a different size than the size indicated on the vehicle placard or tire inflation pressure label, you should determine the proper tire inflation pressure for those tires.)

As an added safety feature, your vehicle has been equipped with a tire pressure monitoring system (TPMS) that illuminates a low tire pressure telltale



when one or more of your tires is significantly under-inflated.

Accordingly, when the low tire pressure telltale illuminates, you should stop and check your tires as soon as possible, and inflate them to the proper pressure.

Driving on a significantly under-inflated tire causes the tire to overheat and can lead to tire failure. Under-inflation also reduces fuel efficiency and tire tread life, and may affect the vehicle's handling and stopping ability.

Please note that the TPMS is not a substitute for proper tire maintenance, and it is the driver's responsibility to maintain correct tire pressure, even if under-inflation has not reached the level to trigger illumination of the TPMS low tire pressure telltale.

Your vehicle has also been equipped with a TPMS malfunction indicator to indicate when the system is not operating properly. The TPMS malfunction indicator is combined with the low tire pressure telltale. When the system detects a malfunction, the telltale will flash for approximately one minute and then remain continuously illuminated. This sequence will continue upon subsequent vehicle start-ups as long as the malfunction exists.

When the malfunction indicator is illuminated, the system may not be able to detect or signal low tire pressure as intended.

TPMS malfunctions may occur for a variety of reasons, including the installation of replacement or alternate tires or wheels on the vehicle that prevent the TPMS from functioning properly.

Always check the TPMS malfunction telltale after replacing one or more tires or wheels on your vehicle to ensure that the replacement or alternate tires and wheels allow the TPMS to continue to function properly.

Blind spot information System*

Is designed to detect vehicles in specified alert zones adjacent to your vehicle, particularly in harder to see areas commonly known as “blind spots.”

When the system detects vehicles approaching from behind in adjacent lanes, the appropriate indicator comes on for a few seconds, providing assistance when you change lanes.

■ How the system works

- The transmission is in **D**.
- Your vehicle speed is between 20 mph (32 km/h) and 100 mph (160 km/h)

Alert zone range

- A: Approx. 1.6 ft. (0.5 m)
- B: Approx. 10 ft. (3 m)
- C: Approx. 10 ft. (3 m)

Radar Sensors:
underneath the
rear bumper
corners

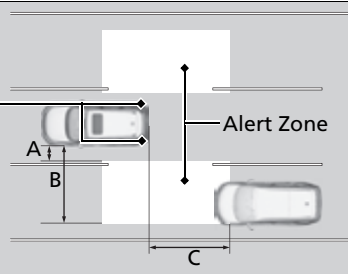

Blind spot information System*

⚠ WARNING

Failure to visually confirm that it is safe to change lanes before doing so may result in a crash and serious injury or death. Do not rely only on the blind spot information system when changing lanes.

Always look in your mirrors, to either side of your vehicle, and behind you for other vehicles before changing lanes.

Important Safety Reminder

Like all assistance systems, blind spot information system has limitations. Overreliance on blind spot information system may result in a collision.

The system is for your convenience only. Even if an object is within the alert zone, the following situations may occur.

- The blind spot information system alert indicator may not come on due to obstruction (splashes, etc.) even without the **Blind Spot Info Not Available** driver information interface appearing.
- The blind spot information system alert indicator may come on even with the message appearing.

* Not available on all models

■ When the system detects a vehicle

Blind spot information System Alert Indicator:
Located on the outside rearview mirror on both sides.

■ Comes on when:

- A vehicle enters the alert zone from behind to overtake you with a speed difference of no more than 31 mph (50 km/h) from your vehicle.
- You pass a vehicle with a speed difference of no more than 12 mph (20 km/h).

■ Blinks and the beeper sounds when:

You move the turn signal lever in the direction of the detected vehicle. The beeper sounds three times.

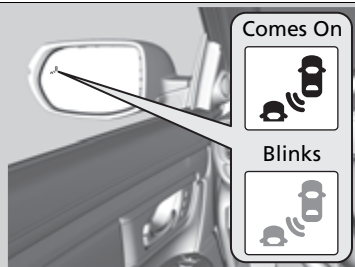

▣ Blind spot information System*

The blind spot information system alert indicator may not come on under the following conditions:

- A vehicle does not stay in the alert zone for more than two seconds.
- A vehicle is parked in a side lane.
- The speed difference between your vehicle and the vehicle you are passing is greater than 6 mph (10 km/h).
- An object not detected by the radar sensors approaches or passes your vehicle.
- A vehicle running in the adjacent lane is a motorcycle or other small vehicle.

You can change the setting for the blind spot information system.

▣ **Customized Features** P. 369

▶▶ Blind spot information System*

Blind spot information system may be adversely affected when:

- Objects (guard rails, poles, trees, etc.) are detected.
- An object that does not reflect radio waves well, such as a motorcycle, is in the alert zone.
- Driving on a curved road.
- A vehicle is moving from a far lane to the adjacent lane.
- The system picks up external electrical interference.
- The rear bumper or the sensors have been improperly repaired or the rear bumper has been deformed.
- The orientation of the sensors has been changed.
- In bad weather (Heavy rain, snow, and fog).
- Making a turn at an intersection.
- Driving on a bumpy road.
- Making a short turn that slightly tilts the vehicle.

For proper blind spot information system operation:

- Always keep the rear bumper corner area clean.
- Do not cover the rear bumper corner area with labels or stickers of any kind.
- Take your vehicle to a dealer if you need the rear bumper corner area or the radar sensors to be repaired, or the rear bumper corner area is strongly impacted.

High Voltage Battery

The High Voltage battery gradually discharges even if the vehicle is not in use. As a result, if your vehicle is parked for an extended period of time, the battery charge level will become low. Extended periods of time at a low state of charge will shorten battery life. To maintain the battery state of charge, drive your vehicle for more than 30 minutes at least once every three months.

Extreme high temperatures can affect the battery life. You can minimize the effects by parking the vehicle in the shade during the summer.

⚠ High Voltage Battery

Be careful not to let the High Voltage battery drain too much. If the battery level becomes close to zero, it will make it impossible to start the engine.

Honda Sensing® is a driver support system which employs the use of two distinctly different kinds of sensors: a radar sensor located inside the front grille and a front sensor camera mounted to the interior side of the windshield, behind the rearview mirror.

Honda Sensing® has following functions.

■ **The functions which do not require switch operations to activate**

- Collision Mitigation Braking System™ (CMBS™) 📄 P. 506
- Road Departure Mitigation (RDM) System 📄 P. 543

■ **The functions which require switch operations to activate**

- Adaptive Cruise Control (ACC) with Low Speed Follow 📄 P. 517
- Lane Keeping Assist System (LKAS) 📄 P. 534

■ Operation Switches for the ACC with Low Speed Follow/ LKAS

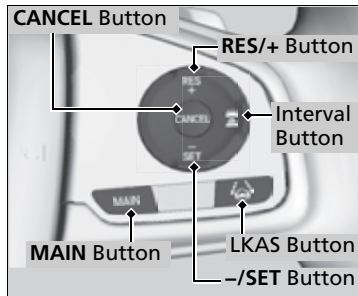

■ MAIN Button

Press to activate standby mode for ACC with Low Speed Follow and LKAS. Or press to cancel these systems.

■ LKAS Button

Press to activate or cancel the LKAS.

■ RES/+ and -/SET Buttons

Press **RES/+** button to resume the ACC with Low Speed Follow or increase the vehicle speed.

Press **-/SET** button to set the ACC with Low Speed Follow or decrease the vehicle speed.

■ Interval Button

Press the  (interval) button to change the ACC with Low Speed Follow following-interval.

■ CANCEL Button

Press to cancel ACC with Low Speed Follow.

■ Driver Information Interface Content

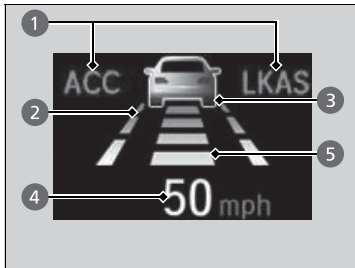

You can see the current state of ACC with Low Speed Follow, and LKAS.

- ① Indicates that ACC with Low Speed Follow, and LKAS are ready to be activated.
- ② Indicates that LKAS is activated and whether or not traffic lane lines are detected.
- ③ Indicates whether or not ACC with Low Speed Follow detected the vehicle ahead.
- ④ Indicates that ACC with Low Speed Follow shows the set vehicle speed.
- ⑤ Indicates that ACC with Low Speed Follow shows the set vehicle interval.

Collision Mitigation Braking System™ (CMBS™)

The system can assist you when it determines there is a possibility of your vehicle colliding with a vehicle or a pedestrian detected in front of your vehicle. The CMBS™ is designed to alert you when the potential for a collision is determined, as well as to reduce your vehicle speed to help minimize collision severity when a collision is deemed unavoidable.

Collision Mitigation Braking System™ (CMBS™)

Important Safety Reminder

The CMBS™ is designed to reduce the severity of an unavoidable collision. It does not prevent collisions nor stop the vehicle automatically. It is still your responsibility to operate the brake pedal and steering wheel appropriately according to the driving conditions.

The CMBS™ may not activate or may not detect a vehicle in front of your vehicle under certain conditions:

➤ **CMBS™ Conditions and Limitations** P. 511

For directions on the proper handling of the radar sensor, refer to the following page.

➤ **Radar Sensor** P. 550

You can read about handling information for the camera equipped with this system.

➤ **Front Sensor Camera** P. 548

How the system works

When to use

The camera is located behind the rearview mirror.

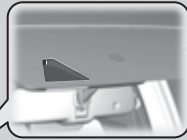

The radar sensor is in the front grille.

The system starts monitoring the roadway ahead when your vehicle speed is about 3 mph (5 km/h) or above and will search for a vehicle in front of you.

The CMBS™ activates when:

- The speed difference between your vehicle and a vehicle or pedestrian detected in front of you becomes about 3 mph (5 km/h) and over with a chance of a collision.
- Your vehicle speed is about 62 mph (100 km/h) or less and the system determines there is a chance of a collision with:
 - Vehicles detected in front of you that are stationary, oncoming, or traveling in your same direction.
 - A pedestrian who is detected in front of you.
- Your vehicle speed is above 62 mph (100 km/h), and the system determines there is a chance of a collision with a vehicle detected in front of you traveling in your same direction.

How the system works

When the CMBS™ activates, it may automatically apply the brake. It will be canceled when your vehicle stops or a potential collision is not determined.

■ When the system activates

The system provides visual and audible alerts of a possible collision, and stops if the collision is avoided.

- ▶ Take appropriate action to prevent a collision (apply the brakes, change lanes, etc.)

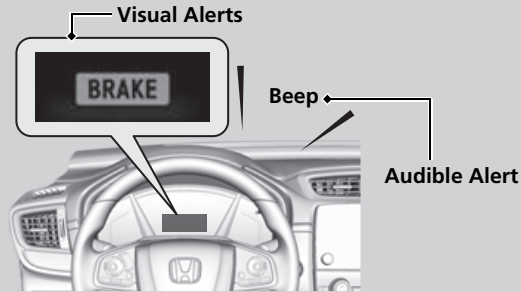

You can change the distance (**Long/Normal/Short**) between vehicles at which the system's earliest collision alert will come on through driver information interface* or audio/information screen* setting options.

- ▶ **Customized Features** P. 140, 369

☞ How the system works

The camera in the CMBS™ is also designed to detect pedestrians.

However, this pedestrian detection feature may not activate or may not detect a pedestrian in front of your vehicle under certain conditions.

Refer to the ones indicating the pedestrian detection limitations from the list.

- ▶ **CMBS™ Conditions and Limitations** P. 511

■ Collision Alert Stages

The system has three alert stages for a possible collision. However, depending on circumstances, the CMBS™ may not go through all of the stages before initiating the last stage.

Distance between vehicles		CMBS™		
		The sensors detect a vehicle	Audible & Visual WARNINGS	Braking
Stage one		There is a risk of a collision with the vehicle ahead of you.	When in Long , visual and audible alerts come on at a longer distance from a vehicle ahead than in Normal setting, and in Short , at a shorter distance than in Normal .	—
Stage two		The risk of a collision has increased, time to respond is reduced.	Visual and audible alerts.	Lightly applied
Stage three		The CMBS™ determines that a collision is unavoidable.		Forcefully applied

Driving

■ CMBS™ On and Off

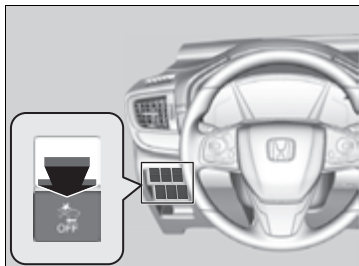

Press and hold the button until the beeper sounds to switch the system on or off.

When the CMBS™ is off:

- The CMBS™ indicator in the instrument panel comes on.
- A message on the driver information interface reminds you that the system is off.

The CMBS™ is turned on every time you turn the power system on, even if you turned it off the last time you drove the vehicle.

▣ Collision Mitigation Braking System™ (CMBS™)

The CMBS™ may automatically shut off, and the CMBS™ indicator will come and stay on under certain conditions.

▣ **CMBS™ Conditions and Limitations** P. 511

When the CMBS™ is activated, it will continue to operate even if the accelerator pedal is partially depressed. However, it will be canceled if the accelerator pedal is fully depressed.

The indicators for the Adaptive Cruise Control (ACC) with Low Speed Follow, Road Departure Mitigation (RDM), Vehicle Stability Assist™ (VSA®) system, Vehicle Stability Assist™ (VSA®) OFF, low tire pressure/TPMS, Collision Mitigation Braking System™ (CMBS™), and Parking Brake and Brake System (Amber) may come on along with a message in the Driver Information Interface after reconnecting the 12V-battery. Drive a short distance at more than 12 mph (20 km/h). The indicator should go off. If it does not, have your vehicle checked by a dealer.

Have your vehicle checked by a dealer if you find any unusual behavior of the system (e.g. the warning message appears too frequently).

■ CMBS™ Conditions and Limitations

The system may automatically shut off and the CMBS™ indicator will come on under certain conditions. Some examples of these conditions are listed below. Other conditions may reduce some of the CMBS™ functions.

📷 **Front Sensor Camera** P. 548

📷 **Radar Sensor** P. 550

■ Environmental conditions

- Driving in bad weather (rain, fog, snow, etc.).
- Sudden changes between light and dark, such as an entrance or exit of a tunnel.
- There is little contrast between objects and the background.
- Driving into low sunlight (e.g., at dawn or dusk).
- Strong light is reflected onto the roadway.
- Driving in the shadows of trees, buildings, etc.
- Roadway objects or structures are misinterpreted as vehicles and pedestrians.
- Reflections on the interior of the front windshield.
- Driving at night or in a dark place such as a tunnel (due to low-light conditions, pedestrians or other vehicles may not be detected).

■ Roadway conditions

- Driving on a snowy or wet roadway (obscured lane marking, vehicle tracks, reflected lights, road spray, high contrast).
- Driving on curvy, winding, or undulating roads.
- The road is hilly or the vehicle is approaching the crest of a hill.

■ **Vehicle conditions**

- Headlight lenses are dirty or the headlights are not properly adjusted.
- The outside of the windshield is blocked by dirt, mud, leaves, wet snow, etc.
- The inside of the windshield is fogged.
- An abnormal tire or wheel condition (incorrect sizes, varied sizes or construction, improperly inflated, etc.).
- When tire chains are installed.
- The vehicle is tilted due to a heavy load or suspension modifications.
- The camera temperature gets too high.
- Driving with the parking brake applied.
- When the radar sensor in the front grille gets dirty.
- Driving at night or in a dark place (e.g., a tunnel) with the headlights off.

■ Detection limitations

- A vehicle or pedestrian suddenly crosses in front of you.
- The distance between your vehicle and the vehicle or pedestrian ahead of you is too short.
- A vehicle cuts in front of you at a slow speed, and it brakes suddenly.
- When you accelerate rapidly and approach the vehicle or pedestrian ahead of you at high speed.
- The vehicle ahead of you is a motorcycle, bicycle, mobility scooter or other small vehicle.
- When there are animals in front of your vehicle.
- When you drive on a curved, winding or undulating road that makes it difficult for the sensor to properly detect a vehicle in front of you.
- The speed difference between your vehicle and a vehicle or pedestrian in front of you is significantly large.
- An oncoming vehicle suddenly comes in front of you.
- Another vehicle suddenly comes in front of you at an intersection, etc.
- Your vehicle abruptly crosses over in front of an oncoming vehicle.
- When driving through a narrow iron bridge.
- When the lead vehicle suddenly slows down.

Limitations applicable to pedestrian detection only

- When there is a group of people in front of your vehicle walking together side by side.
- Surrounding conditions or belongings of the pedestrian alter the pedestrian's shape, preventing the system from recognizing that the person is a pedestrian.
- When the pedestrian is slouching or squatting.
- When the pedestrian is shorter than about 3 feet (1 meter) or taller than about 7 feet (2 meter) in height.
- When a pedestrian blends in with the background.
- When a pedestrian is bent over or squatting, or when their hands or raised or they are running.
- When several pedestrians are walking ahead in a group.
- When the camera cannot correctly identify that a pedestrian is present due to an unusual shape (holding luggage, body position, size).

■ **Automatic shutoff**

CMBS™ may automatically shut itself off and the CMBS™ indicator comes and stays on when:

- The temperature inside the system is high.
- You drive off-road or on a mountain road, or curved and winding road for an extended period.
- An abnormal tire condition is detected (incorrect tire size, flat tire, etc.).
- The camera behind the rearview mirror, or the area around the camera, including the windshield, gets dirty.

Once the conditions that caused CMBS™ to shut off improve or are addressed (e.g., cleaning), the system comes back on.

■ With Little Chance of a Collision

The CMBS™ may activate even when you are aware of a vehicle ahead of you, or when there is no vehicle ahead. Some examples of this are:

■ When Passing

Your vehicle approaches another vehicle ahead of you and you change lanes to pass.

■ At an intersection

Your vehicle approaches or passes another vehicle that is making a left or right turn.

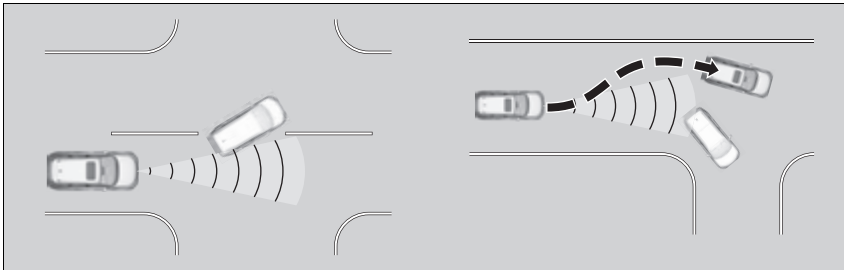

■ **On a curve**

When driving through curves, your vehicle comes to a point where an oncoming vehicle is right in front of you.

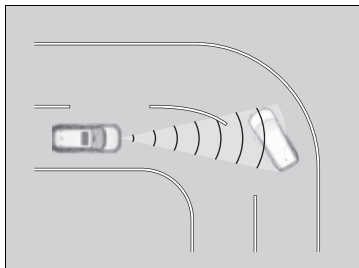

■ **Through a low bridge at high speed**

You drive under a low or narrow bridge at high speed.

■ **Speed bumps, road work sites, train tracks, roadside objects, etc.**

You drive over speed bumps, steel road plates, etc., or your vehicle approaches train tracks or roadside objects (such as a traffic sign and guard rail) on a curve or, when parking, stationary vehicles and walls.

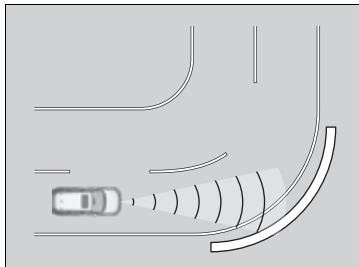

Adaptive Cruise Control (ACC) with Low Speed Follow

Helps maintain a constant vehicle speed and a set following-interval behind a vehicle detected ahead of yours and, if the detected vehicle comes to a stop, can decelerate and stop your vehicle, without you having to keep your foot on the brake or the accelerator.

When ACC with Low Speed Follow slows your vehicle by applying the brakes, your vehicle's brake lights will illuminate.

When to use

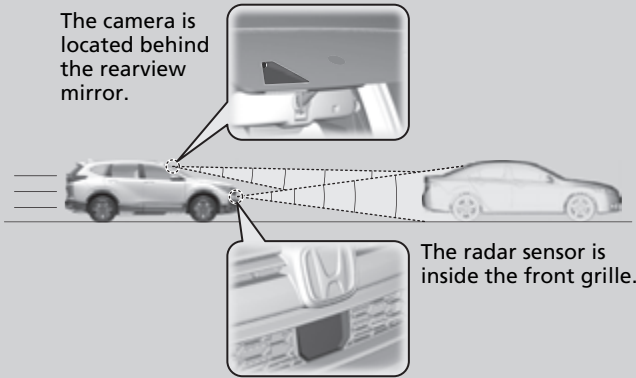

The camera is located behind the rearview mirror.

The radar sensor is inside the front grille.

- Vehicle speed for ACC with Low Speed Follow: **A vehicle is detected ahead within ACC with Low Speed Follow range** – ACC with Low Speed Follow operates at speeds up to 90 mph (145 km/h).
- **No vehicle is detected within ACC with Low Speed Follow range** – ACC with Low Speed Follow operates at the speed of 25 mph (40 km/h) or above.
- Shift position for ACC with Low Speed Follow: In **D**.

Adaptive Cruise Control (ACC) with Low Speed Follow

⚠ WARNING

Improper use of ACC with Low Speed Follow can lead to a crash.

Use ACC with Low Speed Follow only when driving on expressways or freeways and in good road and weather conditions.

⚠ WARNING

ACC with Low Speed Follow has limited braking capability and may not stop your vehicle in time to avoid a collision with a vehicle that quickly stops in front of you.

Always be prepared to apply the brake pedal if the conditions require.

Important Reminder

As with any system, there are limits to ACC with Low Speed Follow. Use the brake pedal whenever necessary, and always keep a safe interval between your vehicle and other vehicles.

For directions on the proper handling of the radar sensor, refer to the following page.

▶ **Radar Sensor** P. 550

■ How to activate the system

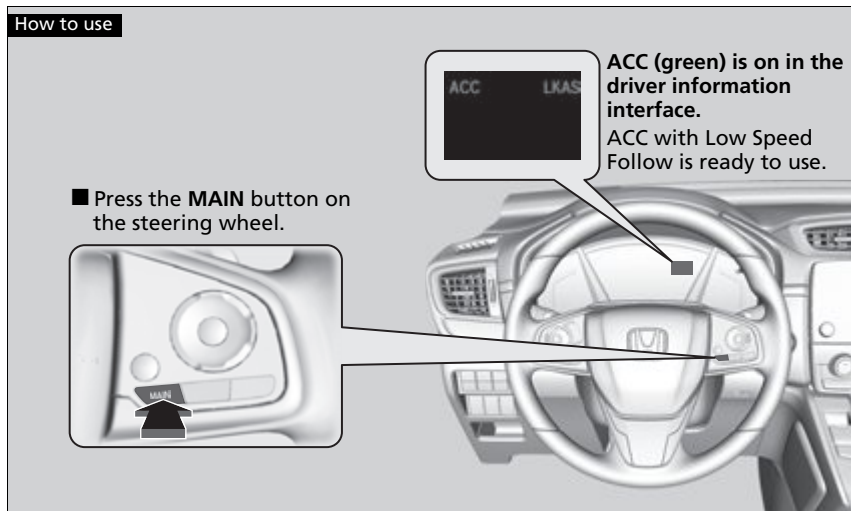

▶ Adaptive Cruise Control (ACC) with Low Speed Follow

You can read about handling information for the camera equipped with this system.

▶ **Front Sensor Camera** P. 548

When the **MAIN** button is pressed, both ACC with Low Speed Follow and the Lane Keeping Assist System (LKAS) are either turned on or off.

ACC with Low Speed Follow may not work properly under certain conditions.

▶ **ACC with Low Speed Follow Conditions and Limitations** P. 524

When not using ACC with Low Speed Follow: Turn off adaptive cruise by pressing the **MAIN** button. This also will turn off the Lane Keeping Assist System (LKAS).

Do not use ACC with Low Speed Follow under the following conditions:

- On roads with heavy traffic or while driving in continuous stop and go traffic.
- On roads with sharp turns.
- On roads with steep downhill sections, as the set vehicle speed can be exceeded by coasting. In such cases, ACC with Low Speed Follow will not apply the brakes to maintain the set speed.
- On roads with toll collection facilities or other objects between lanes of traffic, or in parking areas, or facilities with drive through access.

■ To Set the Vehicle Speed

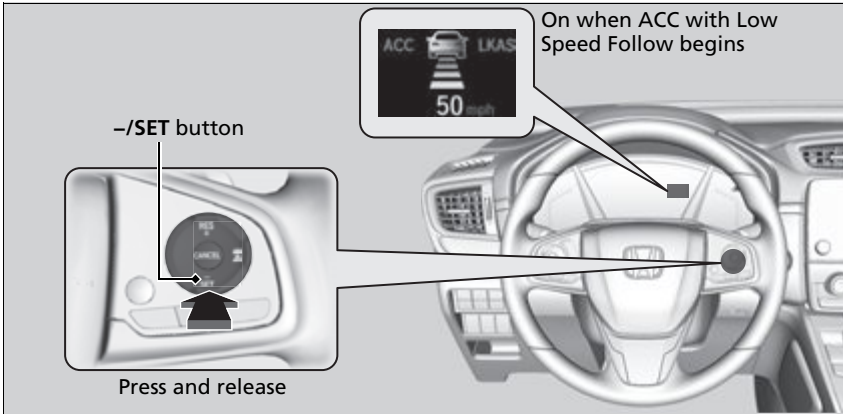

When driving at about 25 mph (40 km/h) or above: Take your foot off the pedal and press the **-/SET** button when you reach the desired speed. The moment you release the button, the set speed is fixed, and ACC with Low Speed Follow begins.

When driving slower than about 25 mph (40 km/h): If the vehicle is moving and the brake pedal is not depressed, pressing the button fixes the set speed to about 25 mph (40 km/h) regardless of current vehicle speed. If the vehicle is stationary, you can set the vehicle speed even with the brake pedal depressed.

▣ Adaptive Cruise Control (ACC) with Low Speed Follow

The indicators for the Adaptive Cruise Control (ACC) with Low Speed Follow, Road Departure Mitigation (RDM), Vehicle Stability Assist™ (VSA®) system, Vehicle Stability Assist™ (VSA®) OFF, low tire pressure/TPMS, Collision Mitigation Braking System™ (CMBS™), and Parking Brake and Brake System™ (Amber) may come on along with a message in the Driver Information Interface after reconnecting the 12V-battery. Drive a short distance at more than 12 mph (20 km/h). The indicator should go off. If it does not, have your vehicle checked by a dealer.

▣ To Set the Vehicle Speed

You can switch the displayed set speed measurements on the driver information interface* or audio/information screen* between mph and km/h.

▶ **Customized Features** P. 140, 369

* Not available on all models

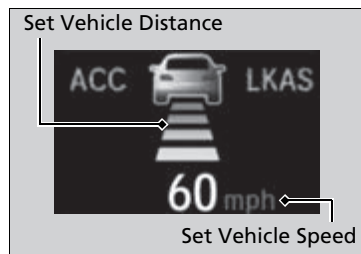

When ACC with Low Speed Follow starts operating, the vehicle icon, distance bars and set speed appear on the driver information interface.

When you use ACC with Low Speed Follow, Straight Driving Assist (a feature of the Electric Power Steering system) is activated. By enabling the steering system to automatically compensate for natural steering pull, Straight Driving Assist makes it easier for you to keep your vehicle in a straight line.

■ When in Operation

■ There is a vehicle ahead

ACC with Low Speed Follow monitors if a vehicle ahead of you enters the ACC with Low Speed Follow range. If a vehicle is detected doing so, the ACC with Low Speed Follow system maintains or decelerates your vehicle's set speed in order to keep the vehicle's set following-interval from the vehicle ahead.

📄 **To Set or Change Following-Interval** P. 528

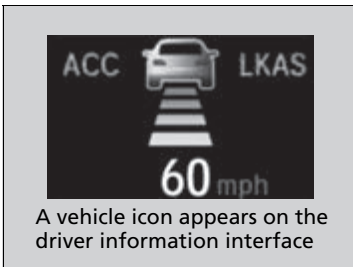
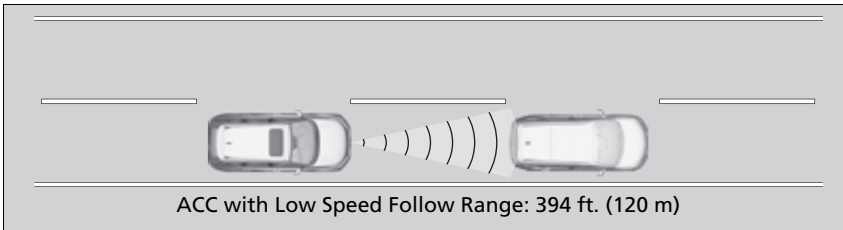

When a vehicle whose speed is slower than your set speed is detected in front of you, your vehicle starts to slow down.

📄 When in Operation

If the vehicle ahead of you slows down abruptly, or if another vehicle cuts in front of you, a beeper sounds, a message appears on the driver information interface.

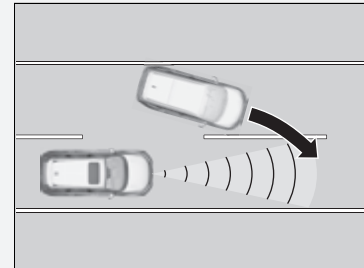

Depress the brake pedal, and keep an appropriate interval from the vehicle ahead.

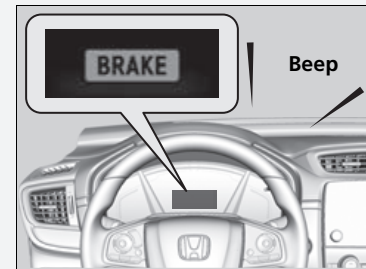

■ There is no vehicle ahead

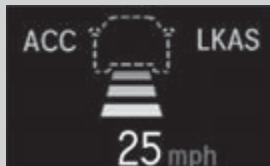

A vehicle icon with dotted-line contour appears on the driver information interface

Your vehicle maintains the set speed without having to keep your foot on the brake or accelerator pedal.

If there previously was a vehicle detected ahead that kept your vehicle from traveling at the set speed, ACC with Low Speed Follow accelerates your vehicle to the set speed, and then maintains it.

■ When you depress the accelerator pedal

You can temporarily increase the vehicle speed. In this case, there is no audible or visual alert even if a vehicle is in the ACC with Low Speed Follow range.

ACC with Low Speed Follow stays on unless you cancel it. Once you release the accelerator pedal, the system resumes an appropriate speed for keeping the following-interval while a vehicle ahead is within the ACC with Low Speed Follow range.

🔗 When in Operation

Even if the distance between your vehicle and the vehicle ahead is short, ACC with Low Speed Follow may start accelerating your vehicle under the following circumstances:

- The vehicle ahead of you is going at almost the same speed as, or faster than, your vehicle.
- A vehicle that cuts in front of you is going faster than your vehicle, gradually increasing the interval between the vehicles.

You can also set the system to beep when a vehicle in front of you comes in and goes out of the ACC with Low Speed Follow detecting range. Change the **ACC Forward Vehicle Detect Beep** setting.

🔗 **Customized Features** P. 140, 369

Limitations

You may need to use the brake to maintain a safe interval when using ACC with Low Speed Follow. Additionally, ACC with Low Speed Follow may not work properly under certain conditions.

🔗 **ACC with Low Speed Follow Conditions and Limitations** P. 524

■ A vehicle detected ahead is within ACC with Low Speed Follow range and slows to a stop



Your vehicle also stops, automatically. The **Stopped** message appears on the driver information interface.

When the vehicle ahead of you starts again, the vehicle icon on the driver information interface blinks. If you press the **RES/+** or **-/SET** button, or depress the accelerator pedal, ACC with Low Speed Follow operates again within the prior set speed.

If no vehicle is ahead of you before you resume driving, depressing the accelerator pedal will resume operation of ACC with Low Speed Follow within the prior set speed.



⊠ A vehicle detected ahead is within ACC with Low Speed Follow range and slows to a stop

⚠ WARNING

Exiting a vehicle that has been stopped while the ACC with Low Speed Follow system is operating can result in the vehicle moving without operator control.

A vehicle that moves without operator control can cause a crash, resulting in serious injury or death.

Never exit a vehicle when the vehicle is stopped by ACC with Low Speed Follow.

■ ACC with Low Speed Follow Conditions and Limitations

The system may automatically shut off under certain conditions. Some examples of these conditions are listed below. Other conditions may reduce some of the ACC functions.

➤ **Front Sensor Camera** P. 548

➤ **Radar Sensor** P. 550

■ Environmental conditions

- Driving in bad weather (rain, fog, snow, etc.).

■ Roadway conditions

- Driving on a snowy or wet roadway (obscured lane marking, vehicle tracks, reflected lights, road spray, high contrast).

■ Vehicle conditions

- The outside of the windshield is blocked by dirt, mud, leaves, wet snow, etc.
- An abnormal tire or wheel condition (incorrect sizes, varied sizes or construction, improperly inflated, etc.).
- The camera temperature gets too high.
- The parking brake is applied.
- When the front grille is dirty.
- The vehicle is tilted due to a heavy load or suspension modifications.
- When tire chains are installed.

⌘ ACC with Low Speed Follow Conditions and Limitations

The radar sensor for ACC with Low Speed Follow is shared with the collision mitigation braking system™ (CMBS™).

➤ **Collision Mitigation Braking System™ (CMBS™)** P. 506

If you need the radar sensor to be repaired, or removed, or the radar sensor cover is strongly impacted, turn off the system by pressing the **MAIN** button and take your vehicle to a dealer.

Have your vehicle checked by a dealer if you find any unusual behavior of the system (e.g., the warning message appears too frequently).

If the front of the vehicle is impacted in any of the following situations, the radar sensor may not work properly. Have your vehicle checked by a dealer:

- The vehicle mounted onto a bump, curb, chock, embankment, etc.
- You drive the vehicle where water is deep.
- Your vehicle has a frontal collision.

■ Detection limitations

- A vehicle or pedestrian suddenly crosses in front of you.
- The interval between your vehicle and the vehicle or pedestrian ahead of you is too short.
- A vehicle cuts in front of you at a slow speed, and it brakes suddenly.
- When you accelerate rapidly and approach the vehicle or pedestrian ahead of you at high speed.
- The vehicle ahead of you is a motorcycle, bicycle, mobility scooter, or other small vehicle.
- When there are animals in front of your vehicle.
- When you drive on a curved or winding or undulating road that makes it difficult for the sensor to properly detect a vehicle or a pedestrian in front of you.

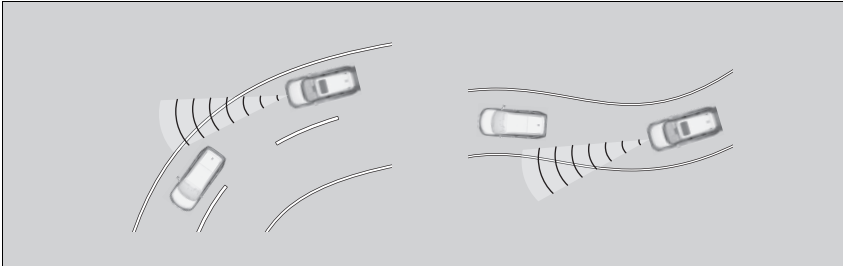

- The speed difference between your vehicle and a vehicle or pedestrian in front of you is significantly large.
- An oncoming vehicle suddenly comes in front of you.
- Your vehicle abruptly crosses over in front of an oncoming vehicle.

- When driving through a narrow metal bridge.

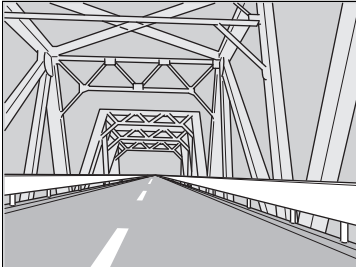

- When the vehicle ahead of you brakes suddenly.
- When the vehicle ahead of you has a unique shape.

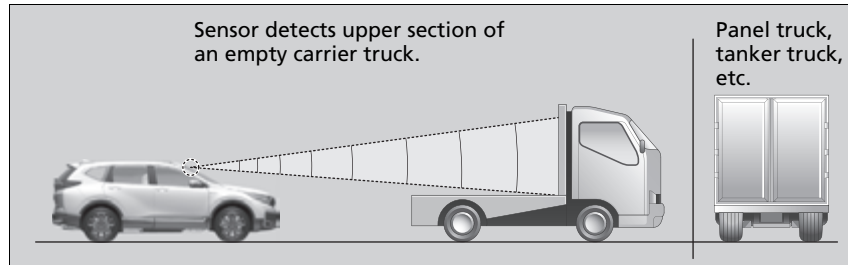

- When your vehicle or the vehicle ahead of you is driving on one edge of the lane.

■ To Adjust the Vehicle Speed

Increase or decrease the vehicle speed using the **RES/+** or **-/SET** button on the steering wheel.

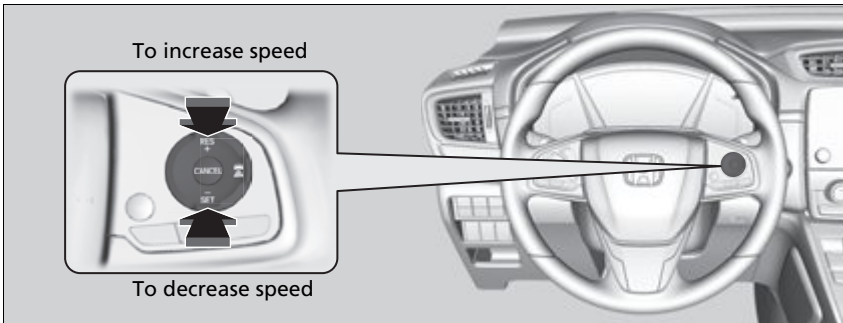

- Each time you press the **RES/+** or **-/SET** button, the vehicle speed is increased or decreased by about 1 mph or 1 km/h accordingly.
- If you keep pressing the **RES/+** or **-/SET** button, the vehicle speed increases or decreases by about 5 mph or 5 km/h accordingly.

☒ To Adjust the Vehicle Speed

If a vehicle detected ahead is going at a speed slower than your increased set speed, ACC with Low Speed Follow may not accelerate your vehicle. This is to maintain the set interval between your vehicle and the vehicle ahead.

You can switch the displayed set speed measurements on the driver information interface* or audio/information screen* between mph and km/h.

☒ **Customized Features** P. 140, 369

When you depress the accelerator pedal and then push and release the **-/SET** button, the current speed of the vehicle is set.

* Not available on all models

■ To Set or Change Following-Interval

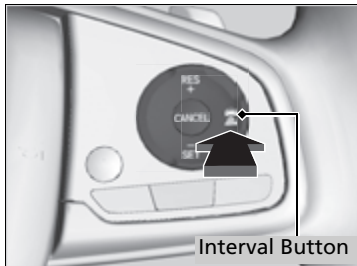





Press the  (Interval) button to change the ACC with Low Speed Follow following-interval.

Each time you press the button, the following-interval (the interval behind a vehicle detected ahead of you) setting cycles through extra long, long, middle, and short following-interval.

Determine the most appropriate following-interval setting based on your specific driving conditions. Be sure to adhere to any following-interval requirements set by local regulation.

The higher your vehicle's following-speed is, the longer the short, middle, long or extra long following-interval becomes. See the following examples for your reference.

Following-Interval		When the Set Speed is:	
		50 mph (80 km/h)	65 mph (104 km/h)
Short		81.0 feet 24.7 meters 1.1 sec	103.3 feet 31.5 meters 1.1 sec
Middle		112.2 feet 34.2 meters 1.5 sec	142.4 feet 43.4 meters 1.5 sec
Long		153.5 feet 46.8 meters 2.1 sec	199.4 feet 60.8 meters 2.1 sec
Extra Long		208.3 feet 63.5 meters 2.9 sec	273.6 feet 83.4 meters 2.9 sec

When your vehicle stops automatically because a vehicle detected ahead of you has stopped, the interval between the two vehicles will vary based on the ACC with Low Speed Follow interval setting.

■ To Cancel

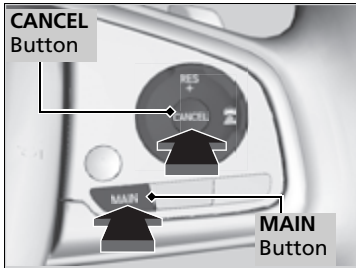

To cancel ACC with Low Speed Follow, do any of the following:

- Press the **CANCEL** button.
- Press the **MAIN** button.
 - ▶ ACC with Low Speed Follow indicator goes off.
- Depress the brake pedal while the vehicle is moving forward.

▶▶ To Cancel

Resuming the prior set speed: After you have canceled ACC with Low Speed Follow, you can resume the prior set speed while it is still displayed. Press the **RES/+** button.

The set speed cannot be set or resumed when ACC with Low Speed Follow has been turned off using the **MAIN** button. Press the **MAIN** button to activate the system, then set the desired speed.

■ Automatic cancellation

The beeper sounds and a message appears on the driver information interface when ACC with Low Speed Follow is automatically canceled. Any of these conditions may cause the ACC with Low Speed Follow to automatically cancel:

- Bad weather (rain, fog, snow, etc.)
- When the radar sensor in the front grille gets dirty.
- The vehicle ahead of you cannot be detected.
- An abnormal tire condition is detected, or the tires are skidding.
- Driving on a mountainous road, or driving off road for extended periods.
- Abrupt steering wheel movement.
- When the ABS, VSA®, or CMBS™ is activated.
- When the ABS or VSA® system indicator comes on.
- When the vehicle is stopped on a very steep slope.
- When you manually apply the parking brake.
- When the detected vehicle within the ACC with Low Speed Follow range is too close to your vehicle.
- The camera behind the rearview mirror, or the area around the camera, including the windshield, gets dirty.
- When the Maximum Load Limit is exceeded.
- When passing through an enclosed space, such as tunnel.

The ACC with Low Speed Follow automatic cancellation can be also triggered by the following causes. In these cases, the parking brake will be automatically applied.

- The driver's seat belt is unfastened when the vehicle is stationary.
- The vehicle stops for more than 10 minutes.
- The power system is turned off.

⌘ Automatic cancellation

Even though ACC with Low Speed Follow has been automatically canceled, you can still resume the prior set speed. Wait until the condition that caused ACC with Low Speed Follow to cancel improves, then press the **RES/SET** button.

■ To Switch ACC with Low Speed Follow to Cruise Control

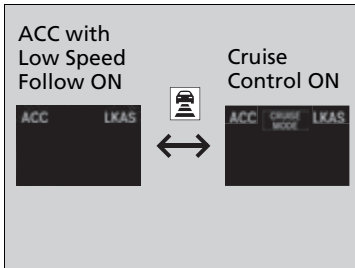

Press and hold the  (interval) button for one second. **Cruise Mode Selected** appears on the driver information interface for two seconds, and then the mode switches to Cruise.

To switch back to ACC with Low Speed Follow, press and hold the  button again for one second.

☒ To Switch ACC with Low Speed Follow to Cruise Control

Always be aware which mode you are in. When you are driving in Cruise mode, the system will not assist you to maintain a following-interval from a vehicle ahead of you.

You can switch the displayed set speed measurements on the driver information interface* or audio/information screen* between mph and km/h.

☒ **Customized Features** P. 140, 369

■ When to use

Desired speed in a range above roughly 25 mph (40 km/h) ~.

■ To Set the Vehicle Speed

Take your foot off the pedal and press the **-/SET** button when you reach the desired speed.

The moment you release the **-/SET** button, the set speed is fixed, and cruise control begins. The **CRUISE CONTROL** indicator comes on.

When you use cruise control, Straight Driving Assist (a feature of the Electric Power Steering system) is activated.

By enabling the steering system to automatically compensate for natural steering pull, Straight Driving Assist makes it easier for you to keep your vehicle in a straight line.

■ To Adjust the Vehicle Speed

- Each time you press the **RES/+** or **-/SET** button, the vehicle speed is increased or decreased by about 1 mph or 1 km/h accordingly.
- If you keep pressing the **RES/+** or **-/SET** button, the vehicle speed increases or decreases by about 5 mph or 5 km/h accordingly.

■ To Cancel

To cancel cruise control, do any of the following:

- Press the **CANCEL** button.
- Press the **MAIN** button.
- Depress the brake pedal.

The **CRUISE CONTROL** indicator goes off.

☒ To Cancel

Resuming the prior set speed:

After cruise control has been canceled, you can still resume the prior set speed by pressing the **RES/+** button while driving at a speed of at least 25 mph (40 km/h) or more.

You cannot set or resume in the following situations:

- When vehicle speed is less than 25 mph (40 km/h)
- When the **MAIN** button is turned off.

At vehicle speeds of 22 mph (35 km/h) or less, cruise control canceled automatically.

Lane Keeping Assist System (LKAS)

Provides steering input to help keep the vehicle in the middle of a detected lane and provides tactile and visual alerts if the vehicle is detected drifting out of its lane.

■ Tactile and visual alerts

Rapid vibrations on the steering wheel and a warning display alert you that the vehicle is drifting out of a detected lane.

■ Front sensor camera
Monitors the lane lines

■ Steering input assist

The system applies torque to the steering to keep the vehicle between the left and right lane lines. The applied torque becomes stronger as the vehicle gets closer to either of the lane lines.

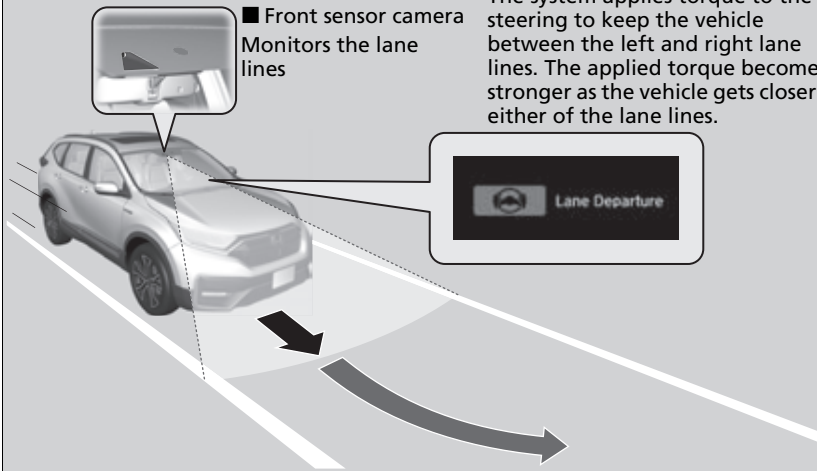

When you operate the turn signals to change lanes, the system is suspended, and resumes after the signals are off.

If you make a lane change without operating the turn signals, the LKAS alerts activate, and torque is applied to the steering.

▶ Lane Keeping Assist System (LKAS)

Important Safety Reminders

The LKAS is for your convenience only. It is not an autonomous driving system and always requires driver attention and control. The system does not work if you take your hands off the steering wheel or fail to steer the vehicle.

The LKAS is convenient when it is used on freeways.

Do not place objects on the instrument panel. Objects may reflect on the front windshield and prevent correct detection of the traffic lanes.

The LKAS only alerts you when lane drift is detected without a turn signal in use. The LKAS may not detect all lane markings or lane departures; accuracy will vary based on weather, speed, and lane marker condition. It is always your responsibility to safely operate the vehicle and avoid collisions.

The LKAS may not work properly or may work improperly under the certain conditions:

▶ **LKAS Conditions and Limitations** P. 540

You can read about handling information for the camera equipped with this system.

▶ **Front Sensor Camera** P. 548

■ Lane Keep Support Function

Provides assistance to keep the vehicle in the center of the lane, when the vehicle nears a white or yellow line, steering force of the electric power steering will become stronger.

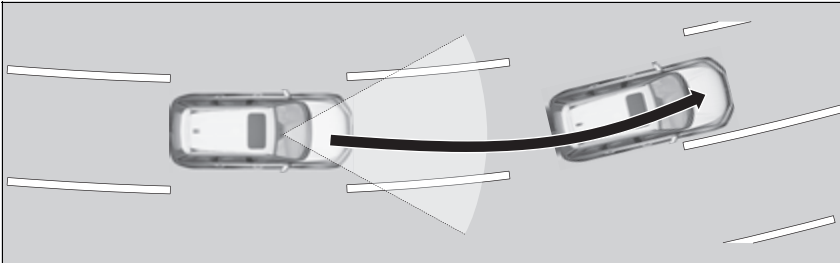

■ Lane Departure Warning Function

When the vehicle enters the warning area, the LKAS alerts you with slight steering wheel vibration as well as a warning display.

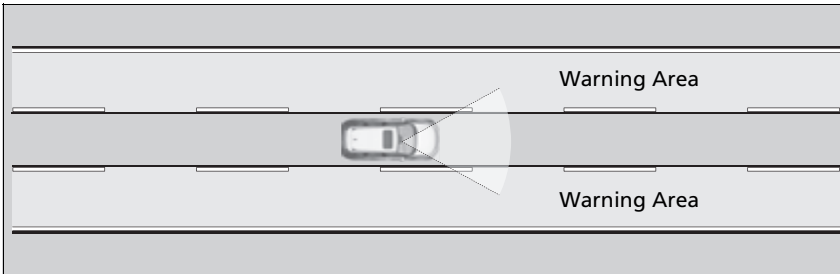

☒ Lane Keeping Assist System (LKAS)

The LKAS may not function as designed while driving in frequent stop and go traffic, or on roads with sharp curves.

When it fails to detect lanes, the system will temporarily be canceled. When a lane is detected, the system will recover automatically.

■ When the System can be Used

The system can be used when the following conditions are met.

- The lane in which you are driving has detectable lane markers on both sides, and your vehicle is in the center of the lane.
- The vehicle is traveling between about 45 and 90 mph (72 and 145 km/h).
- You are driving on a straight or slightly curved road.
- The turn signals are off.
- The brake pedal is not depressed.
- The wipers are not in continuous operation.

■ How to activate the system

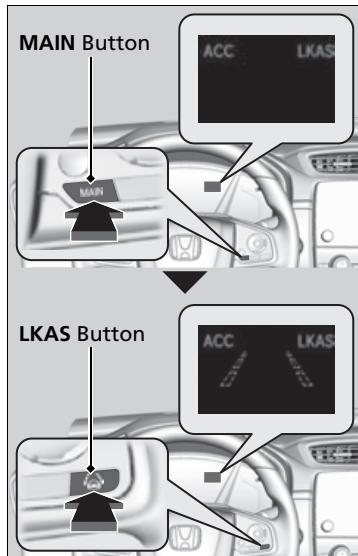

1. Press the **MAIN** button.

- ▶ The LKAS is on in the driver information interface.
The system is ready to use.

2. Press the LKAS button.

- ▶ Lane outlines appear on the driver information interface.
The system is activated.

▶ Lane Keeping Assist System (LKAS)

If the vehicle drifts toward either left or right lane line due to the system applying torque, turn off the LKAS and have your vehicle checked by a dealer.

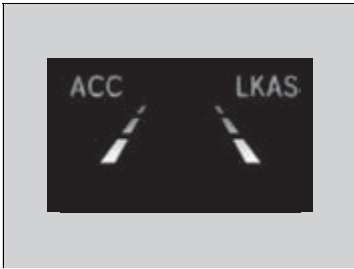

3. Keep your vehicle near the center of the lane while driving.
 - ▶ The dotted outer lines change to solid ones once the system starts operating after detecting the left and right lane markings.

■ To cancel

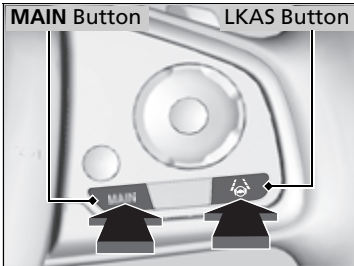

To cancel the LKAS:
Press the **MAIN** or LKAS button.

The LKAS is turned off every time you turn the power system off, even if you turned it on the last time you drove the vehicle.

▣ To cancel

Pressing the **MAIN** button also turns ACC with Low Speed Follow on and off.

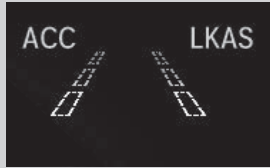

When the LKAS is suspended, the lane lines on the driver information interface change to contour lines, and the beeper sounds (if activated).

■ **The system operation is suspended if you:**

- Set the wipers to **HI**.
 - ▶ Turning the wipers off or setting it to **LO** resumes the LKAS.

■ **Models with automatic intermittent wipers**

- Set the wiper switch to **AUTO** and the wipers operate at high speed.
 - ▶ The LKAS resumes when the wipers stop or operate at low speed.

■ **All models**

- Decrease the vehicle speed to 40 mph (64 km/h) or less.
 - ▶ Increasing the vehicle speed to 45 mph (72 km/h) or more resumes the LKAS.
- Depress the brake pedal.
 - ▶ The LKAS resumes and starts detecting the lane lines again once you release the brake pedal.

▶▶ The system operation is suspended if you:

You can change the setting for the LKAS. LKAS suspended beep on and off can be selected.

▶▶ **Customized Features** P. 140, 369

■ The LKAS may be automatically suspended when:

- The system fails to detect lane lines.
- The steering wheel is quickly turned.
- You fail to steer the vehicle.
- Driving through a sharp curve.
- Driving at a speed in excess of approximately 90 mph (145 km/h).

Once these conditions no longer exist, the LKAS automatically resumes.

■ The LKAS may be automatically canceled when:

- The camera temperature gets extremely high or low.
- The camera behind the rearview mirror, or the area around the camera, including the windshield, gets dirty.
- The ABS or VSA® systems engage.

The beeper sounds if the LKAS is automatically canceled.

■ LKAS Conditions and Limitations

The system may not detect lane markings and therefore may not keep the vehicle in the middle of the lane under certain conditions, including the following:

■ Environmental conditions

- Driving in bad weather (rain, fog, snow, etc.).
- Sudden changes between light and dark, such as an entrance or exit of a tunnel.
- There is little contrast between lane lines and the roadway surface.
- Driving into low sunlight (e.g., at dawn or dusk).
- Strong light is reflected onto the roadway.
- Driving in the shadows of trees, buildings, etc.
- Shadows of adjacent objects are parallel to lane markings.
- Roadway objects or structures are misinterpreted as lane markings.
- Reflections on the interior of the front windshield.
- Driving at night or in a dark condition such as a tunnel.

■ Roadway conditions

- Driving on a snowy or wet roadway (obscured lane marking, vehicle tracks, reflected lights, road spray, high contrast).
- Driving on a road with temporary lane markings.
- Faint, multiple, or varied lane markings are visible on the roadway due to road repairs or old lane markings.

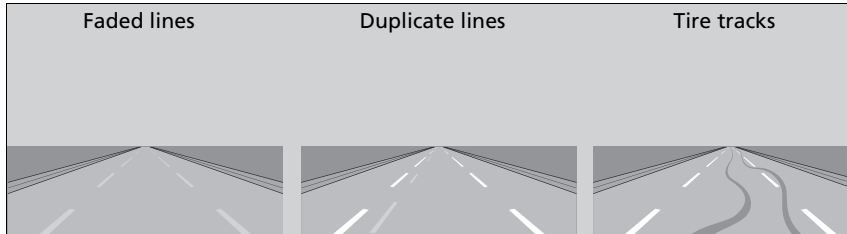

- The roadway has merging, split, or crossing lines (e.g., such as at an intersection or crosswalk).
- The lane markings are extremely narrow, wide, or changing.

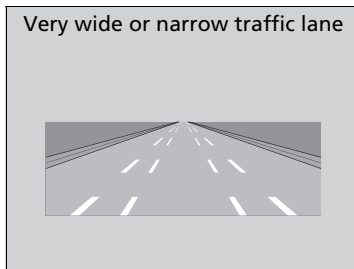

- The vehicle in front of you is driving near the lane lines.
- The road is hilly or the vehicle is approaching the crest of a hill.
- Driving on rough or unpaved roads, or over bumpy surfaces.

Continued

- When objects on the road (curb, guard rail, pylons, etc.) are recognized as white lines (or yellow lines).
- Driving on roads with double lines.

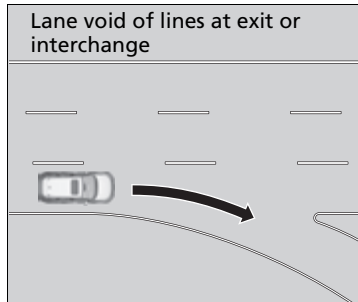

■ Vehicle conditions

- Headlight lenses are dirty or the headlights are not properly adjusted.
- The outside of the windshield is streaked or blocked by dirt, mud, leaves, wet snow, etc.
- The inside of the windshield is fogged.
- The camera temperature gets too high.
- An abnormal tire or wheel condition (incorrect sizes, varied sizes or construction, improperly inflated, etc.).
- The vehicle is tilted due to a heavy load or suspension modifications.

Road Departure Mitigation (RDM) System

Alerts and helps to assist you when the system detects a possibility of your vehicle unintentionally crossing over detected lane markings and/or leaving the roadway altogether.

How the System Works

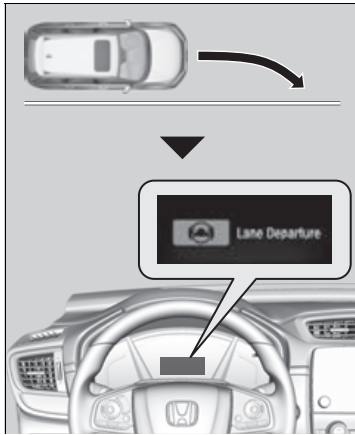

The front camera behind the rearview mirror monitors left and right lane markings (in white or yellow). If your vehicle is getting too close to detected lane markings without a turn signal activated, the system, in addition to a visual alert, applies steering torque and alerts you with rapid vibrations on the steering wheel, to help you remain within the detected lane.

As a visual alert, the **Lane Departure** message appears on the driver information interface.

If the system determines that its steering input is insufficient to keep your vehicle on the roadway, it may apply braking.

- ▶ Braking is applied only when the lane markings are solid continuous lines.

The system cancels assisting operations when you turn the steering wheel to avoid crossing over detected lane markings.

If the system operates several times without detecting driver response, the system beeps to alert you.

ⓘ Road Departure Mitigation (RDM) System

Important Safety Reminder

Like all assistance systems, the RDM system has limitations.

Overreliance on the RDM system may result in a collision. It is always your responsibility to keep the vehicle within your driving lane.

The RDM system only alerts you when lane drift is detected without a turn signal in use. The RDM system may not detect all lane markings or lane or roadway departures; accuracy will vary based on weather, speed and lane marker condition. It is always your responsibility to safely operate the vehicle and avoid collisions.

You can read about handling information for the camera equipped with this system.

📖 **Front Sensor Camera** P. 548

The RDM system may not work properly or may work improperly under the certain conditions:

📖 **RDM Conditions and Limitations** P. 546

There are times when you may not notice RDM functions due to your operation of the vehicle, or road surface conditions.

■ How the System Activates

The system activates when all the following conditions are met:

- The vehicle is traveling between about 45 and 90 mph (72 and 145 km/h).
- The vehicle is on a straight or slightly curved road.
- The turn signals are off.
- The brake pedal is not depressed.
- The wipers are not in continuous operation.
- The system makes a determination that the driver is not actively accelerating, braking, or steering.

⌘ Road Departure Mitigation (RDM) System

If LKAS is off and you have selected **Narrow** from the customized options using the driver information interface* or audio/information screen*, the message below will appear in case the system determines a possibility of your vehicle crossing over detected lane markings.

➤ **Driver Information Interface Warning and Information Messages** P. 109

➤ **Customized Features** P. 140, 369



⌘ How the System Activates

The RDM system may automatically shut off and the  indicator comes and stays on.

➤ **Indicators** P. 90

RDM system function can be impacted when the vehicle is:

- Not driven within a traffic lane.
- Driven on the inside edge of a curve, or outside of a lane.
- Driven in a narrow lane.

RDM On and Off

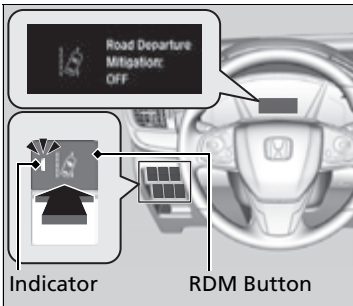

Press the RDM button to turn the system on and off.

- ▶ The indicator in the button comes on and the message appears on the driver information interface when the system is on.

RDM On and Off

When you have selected **Warning Only** from the customized options using the driver information interface* or audio/information screen*, the system does not operate the steering wheel and braking.

➤ **Customized Features** P. 140, 369

The indicators for the Adaptive Cruise Control (ACC) with Low Speed Follow, Road Departure Mitigation (RDM), Vehicle Stability Assist™ (VSA®) system, Vehicle Stability Assist™ (VSA®) OFF, low tire pressure/TPMS, Collision Mitigation Braking System™ (CMBS™), and Parking Brake and Brake System™ (Amber) may come on along with a message in the Driver Information Interface after reconnecting the 12V-battery. Drive a short distance at more than 12 mph (20 km/h). The indicator should go off. If it does not, have your vehicle checked by a dealer.

* Not available on all models

Continued

■ RDM Conditions and Limitations

The system may not properly detect lane markings and the position of your vehicle under certain conditions. Some examples of these conditions are listed below.

■ Environmental conditions

- Driving in bad weather (rain, fog, snow, etc.).
- Sudden changes between light and dark, such as an entrance or exit of a tunnel.
- There is little contrast between lane lines and the roadway surface.
- Driving into low sunlight (e.g., at dawn or dusk).
- Strong light is reflected onto the roadway.
- Driving in the shadows of trees, buildings, etc.
- Shadows of adjacent objects are parallel to lane markings.
- Roadway objects or structures are misinterpreted as lane markers.
- Reflections on the interior of the front windshield.
- Driving at night or in a dark condition such as a tunnel.

■ Roadway conditions

- Driving on a snowy or wet roadway (obscured lane marking, vehicle tracks, reflected lights, road spray, high contrast).
- Driving on a road with temporary lane markings.
- Faint, multiple, or varied lane markings are visible on the roadway due to road repairs or old lane markings.
- The roadway has merging, split, or crossing lines (e.g., such as at an intersection or crosswalk).
- The lane markings are extremely narrow, wide, or changing.
- The vehicle in front of you is driving near the lane lines.
- The road is hilly or the vehicle is approaching the crest of a hill.
- Driving on rough or unpaved roads, or over bumpy surfaces.
- When objects on the road (curb, guard rail, pylons, etc.) are recognized as white lines (or yellow lines).
- Driving on roads with double lines.

■ Vehicle conditions

- Headlight lenses are dirty or the headlights are not properly adjusted.
- The outside of the windshield is streaked or blocked by dirt, mud, leaves, wet snow, etc.
- The inside of the windshield is fogged.
- The camera temperature gets too high.
- An abnormal tire or wheel condition (incorrect sizes, varied sizes or construction, improperly inflated, etc.).
- The vehicle is tilted due to a heavy load or suspension modifications.
- When tire chains are installed.

Front Sensor Camera

The camera, used in systems; such as RDM, LKAS, ACC with Low Speed Follow and CMBS™, is designed to detect an object that triggers any of the systems to operate their functions.

■ Camera Location and Handling Tips

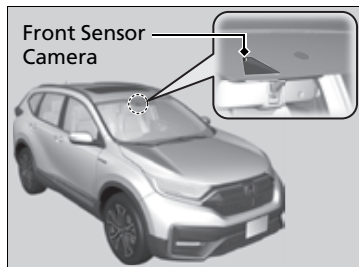

This camera is located behind the rearview mirror.

To help reduce the likelihood that high interior temperatures will cause the camera's sensing system to shut off, when parking, find a shady area or face the front of the vehicle away from the sun. If you use a reflective sun shade, do not allow it to cover the camera housing. Covering the camera can concentrate heat on it.

⌘ Front Sensor Camera

Never apply a film or attach any objects to the windshield, the hood, or the front grille that could obstruct the camera's field of vision and cause the system to operate abnormally. Scratches, nicks, and other damage to the windshield within the camera's field of vision can cause the system to operate abnormally. If this occurs, we recommend that you replace the windshield with a genuine Honda replacement windshield. Making even minor repairs within the camera's field of vision or installing an aftermarket replacement windshield may also cause the system to operate abnormally. After replacing the windshield, have a dealer recalibrate the camera. Proper calibration of the camera is necessary for the system to operate properly.

Front Sensor Camera

Do not place an object on the top of the instrument panel. It may reflect onto the windshield and prevent the system from detecting lane lines properly.

If the **Some Driver Assist Systems Cannot Operate:Camera Temperature Too High:**  message appears:

- Use the climate control system to cool down the interior and, if necessary, also use defroster mode with the air flow directed toward the camera.
- Start driving the vehicle to lower the windshield temperature, which cools down the area around the camera.

If the **Some Driver Assist Systems Cannot Operate:Clean Front Windshield:**  message appears:

- Park your vehicle in a safe place, and clean the windshield. If the message does not disappear after you have cleaned the windshield and driven for a while, have your vehicle checked by a dealer.

Radar Sensor

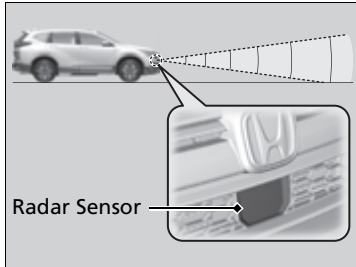

The radar sensor is in the front grille.

▣ Radar Sensor

Avoid strong impacts to the radar sensor cover.

For the CMBS™ to work properly:

- Always keep the radar sensor cover clean.
- Never use chemical solvents or polishing powder for cleaning the sensor cover. Clean it with water or a mild detergent.
- Do not put a sticker on the radar sensor cover or replace the radar sensor cover.

If you need the radar sensor to be repaired, or removed, or the radar sensor cover is strongly impacted, turn off the system by using the CMBS™ OFF button and take your vehicle to a dealer.

▣ **CMBS™ On and Off** P. 510

If the vehicle is involved in any of the following situations, the radar sensor may not work properly. Have your vehicle checked by a dealer:

- Your vehicle is involved in a frontal collision.
- Your vehicle drives through deep water or is submerged in deep water.
- Your vehicle strongly strikes a bump, curb, chock, or embankment that could jar the radar sensor.

Brake System

■ Parking Brake

Use the parking brake to keep the vehicle stationary when parked. When the parking brake is applied, you can manually or automatically release it.



■ To apply

The electric parking brake can be applied any time the vehicle has battery, no matter which position the power mode is in.

Pull the electric parking brake switch up gently and securely.

- ▶ The parking brake and brake system indicator (red) comes on.

■ To release

The power mode must be in ON in order to release the electric parking brake.

1. Depress the brake pedal.
2. Press the electric parking brake switch.
 - ▶ The parking brake and brake system indicator (red) goes off.

Manually releasing the parking brake using the switch helps your vehicle to start slowly and smoothly when facing downhill on steep hills.

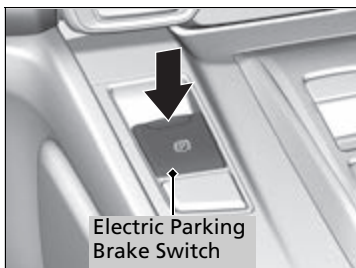

⊗ Braking

When you depress the brake pedal, you may hear a whirring sound from the engine compartment. This is because the brake system is in operation, and it is normal.

⊗ Parking Brake

You may hear the electric parking brake system motor operating from the rear wheel area when you apply or release the parking brake. This is normal.

The brake pedal may slightly move due to the electric parking brake system operation when you apply or release the parking brake. This is normal.

You cannot apply or release the parking brake if the 12V-battery goes dead.

➤ **If the 12-Volt Battery Is Dead** P. 647

If you pull up and hold the electric parking brake switch while driving, the brakes on all four wheels are applied by the electric servo brake system until the vehicle come to a stop. The electric parking brake then applies, and the switch should be released.

■ Automatic parking brake feature operation

If the automatic parking brake feature has been activated:

- The parking brake is applied automatically when you set the power mode to OFF.
- To confirm that the parking brake is applied, check if the parking brake and brake system indicator (red) is on.

✎ **Activating and deactivating the automatic parking brake feature** P. 553

■ To release automatically

Depressing the accelerator pedal releases the parking brake.

Use the accelerator pedal to release the brake when you are starting the vehicle facing uphill, or in a traffic jam.

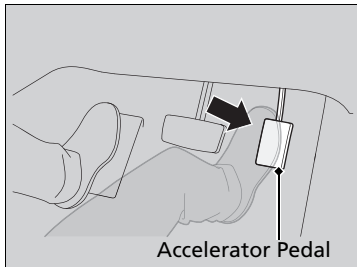

Gently depress the accelerator pedal.

When on a hill, it may require more accelerator input to release.

- The parking brake and brake system indicator (red) goes off.

You can release the parking brake automatically when:

- You are wearing the driver's seat belt.
- The power system is on.
- The transmission is not in **P** or **N**.

✎ Parking Brake

In the following situations, the parking brake automatically operates.

- When the vehicle stops more than 10 minutes while ACC with Low Speed Follow is activated.
- When the driver's seat belt is unfastened while your vehicle is stopped automatically by ACC with Low Speed Follow.
- When the power system is turned off while ACC with Low Speed Follow is activated.
- When the vehicle stops with the automatic brake hold system activated for more than 10 minutes.
- When the driver's seat belt is unfastened while your vehicle is stopped and brake hold is applied.
- When the power system is turned off while brake hold is applied.
- When there is a problem with the Brake Hold System while brake hold is applied.

If the parking brake cannot be released automatically, release it manually.

When the vehicle is traveling uphill, the accelerator pedal may need to be pressed farther to automatically release the electric parking brake.

The parking brake cannot be released automatically while the following indicators are on:

- Malfunction indicator lamp
- Transmission system indicator

■ Activating and deactivating the automatic parking brake feature

With the power mode is ON, carry out the following steps to either activate or deactivate the automatic parking brake feature.

1. Put the transmission into **P**.
2. Without depressing the brake pedal, pull up the electric parking brake switch.
 - ▶ Check that the parking brake and brake system indicator (red) has come on.
3. Pull up and hold the electric parking brake switch. When you hear a beeping sound, release the switch and within 3 seconds pull up and hold the switch again.
4. When you hear a sound indicating that the procedure is completed, release the switch.
 - ▶ Two beeps indicates that the feature has been activated.
 - ▶ One beep indicates that the feature has been deactivated.
 - ▶ When you have completed activating the feature, the parking brake will remain applied after you turn off the power system.
 - ▶ To confirm that the parking brake is applied, check if the parking brake and brake system indicator (red) is on.

If you need to temporarily deactivate the feature while putting your vehicle through a conveyor type car wash. You can follow the procedure explained below.

1. Depress the brake pedal and bring the vehicle to a stop.
2. Set the power mode to VEHICLE OFF and then within 2 seconds push down the electric parking brake switch.
 - ▶ Activation and deactivation settings for the feature will not be affected.
 - ▶ Before temporarily deactivating the feature, make sure to first turn off both ACC with Low Speed Follow and the automatic brake hold system.
 - ▶ To confirm that the parking brake is applied, check if the parking brake and brake system indicator (red) is on.

▣ Parking Brake

The parking brake may not be released automatically while the following indicators are on:

- Parking brake and brake system indicator (amber)
- VSA® system indicator
- **ABS** indicator
- Supplemental restraint system indicator

In cold climates, the parking brake may freeze in place if applied.

When parking the vehicle, chock the wheels and make sure the automatic parking brake feature is deactivated.

Also, when putting your vehicle through a conveyor-type car wash or when having your vehicle towed, deactivate the automatic parking brake feature and leave the parking brake released.

■ Foot Brake

Your vehicle is equipped with disc brakes at all four wheels. The brake assist system increases the stopping force when you depress the brake pedal hard in an emergency situation. The anti-lock brake system (ABS) helps you retain steering control when braking very hard.

➤ **Brake Assist System** P. 558

➤ **Anti-lock Brake System (ABS)** P. 557

☒ Foot Brake

Check the brakes after driving through deep water, or if there is a buildup of road surface water. If necessary, dry the brakes by lightly depressing the pedal several times.

If you hear a continuous metallic friction sound when applying the brakes, this is caused by the brake wear indicator rubbing on the brake rotor and indicates that the brake pads need to be replaced. Have the vehicle checked by a dealer. If you hear only an occasional squeak or squeal when you initially apply the brake pedal, this may be normal and caused by high frequency vibration of the brake pads against the rotating brake disc.

Applying constant pressure to the brakes while going down a long hill can cause the brakes to heat up, resulting in a loss of stopping power. Therefore, when descending a long hill, release the accelerator pedal and allow regenerative braking to slow the vehicle down. To adjust the rate of deceleration, use the deceleration paddle selector.

When the high voltage battery has fully recharged, regenerative braking may not be possible.

➤ **POWER/CHARGE Gauge** P. 126

➤ **High Voltage Battery Charge Level Gauge** P. 127

➤ **Deceleration Paddle Selector** P. 484

Do not rest your foot on the brake pedal while driving, as it will lightly apply the brakes and cause them to lose effectiveness over time and reduce pad life. It will also confuse drivers behind you.

Automatic Brake Hold

Keeps the brake applied after releasing the brake pedal until the accelerator pedal is pressed. You can use this system while the vehicle is temporarily stopped, like at traffic lights and in heavy traffic.

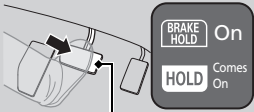
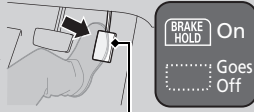
<p>■ Turning on the system</p>  <p>Automatic Brake Hold Button</p> <p>Fasten your seat belt properly, then start the power system. Press the automatic brake hold button.</p> <ul style="list-style-type: none"> The automatic brake hold system indicator comes on. The system is turned on. 	<p>■ Activating the system</p>  <p>Brake Pedal</p> <p>Depress the brake pedal to come to a complete stop. The transmission must not be in P or R.</p> <ul style="list-style-type: none"> The automatic brake hold indicator comes on. Braking is kept for up to 10 minutes. Release the brake pedal after the automatic brake hold indicator comes on. 	<p>■ Canceling the system</p>  <p>Accelerator Pedal</p> <p>Depress the accelerator pedal while the transmission is in a position other than P or N. The system is cancelled and the vehicle starts to move.</p> <ul style="list-style-type: none"> The automatic brake hold indicator goes off. The system continues to be on.
---	---	--

Automatic Brake Hold

⚠ WARNING

Activating the automatic brake hold system on steep hills or slippery roads may still allow the vehicle to move if you remove your foot from the brake pedal.

If a vehicle unexpectedly moves, it may cause a crash resulting in serious injury or death.

Never activate the automatic brake hold system or rely on it to keep a vehicle from moving when stopped on a steep hill or slippery roads.

⚠ WARNING

Using the automatic brake hold system to park the vehicle may result in the vehicle unexpectedly moving.

If a vehicle moves unexpectedly, it may cause a crash, resulting in serious injury or death.

Never leave the vehicle when braking is temporarily kept by automatic brake hold and always park the vehicle by putting the transmission in **P** and applying the parking brake.

Continued

■ **The system automatically cancels when:**

- You engage the parking brake.
- You depress the brake pedal and put the transmission into **P** or **R**.

■ **The system automatically cancels and the parking brake is applied when:**

- Braking is kept for more than 10 minutes.
- The driver's seat belt is unfastened.
- The power system is turned off.
- There is a problem with automatic brake hold system.

■ **Turning off the automatic brake hold system**

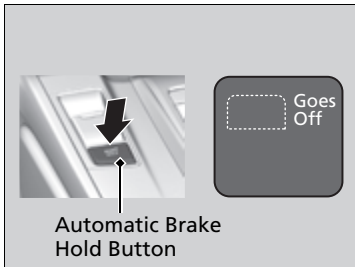

While the system is on, press the automatic brake hold button again.

- The automatic brake hold system indicator goes off.

If you want to turn off automatic brake hold while the system is in operation, press the automatic brake hold button with the brake pedal depressed.

►► Automatic Brake Hold

While the system is activated, you can turn off the power system or park the vehicle through the same procedure as you normally do.

► **When Stopped** P. 559

Whether the system is on, or the system is activated, the automatic brake hold turns off once the power system is off.

►► Turning off the automatic brake hold system

Make sure to turn off the automatic brake hold system before using an automated car wash.

You may hear an operating noise if the vehicle moves while the automatic brake hold system is in operation.

Anti-lock Brake System (ABS)

■ ABS

Helps prevent the wheels from locking up, and helps you retain steering control by pumping the brakes rapidly, much faster than you can.

The electronic brake distribution (EBD) system, which is part of the ABS, also balances the front-to-rear braking distribution according to vehicle loading.

You should never pump the brake pedal. Let the ABS work for you by always keeping firm, steady pressure on the brake pedal. This is sometimes referred to as “stomp and steer.”

■ ABS operation

The brake pedal may pulsate slightly when the ABS is working. Depress the brake pedal and keep holding the pedal firmly down. On dry pavement, you will need to press on the brake pedal very hard before the ABS activates. However, you may feel the ABS activate immediately if you are trying to stop on snow or ice.

ABS may activate when you depress the brake pedal when driving on:

- Wet or snow covered roads.
- Roads paved with stone.
- Roads with uneven surfaces, such as potholes, cracks, manholes, etc.

When the vehicle speed goes under 6 mph (10 km/h), the ABS stops.

▶▶ Anti-lock Brake System (ABS)

NOTICE

The ABS may not function correctly if you use a tire of the incorrect size or type.

If the **ABS** indicator comes on while driving, there may be a problem with the system. While normal braking is not affected, there is a possibility that the ABS will not be operating. Have your vehicle checked by a dealer immediately.

The ABS is not designed for the purpose of reducing the time or distance it takes for a vehicle to stop: It is designed to limit brake lockup which can lead to skidding and loss of steering control.

In the following cases, your vehicle may need more distance to stop than a vehicle without the ABS:

- You are driving on rough or uneven road surfaces, such as gravel or snow.

The following may be observed with the ABS system:

- Motor sounds coming from the engine compartment when the brakes are applied, or when system checks are being performed after the engine has been started and while the vehicle accelerates.
- Brake pedal and/or the vehicle body vibration when ABS activates.

These vibrations and sounds are normal to ABS systems and are no cause for concern.

Brake Assist System

Designed to assist the driver by generating greater braking force when you depress the brake pedal hard during emergency braking.

■ Brake assist system operation

Press the brake pedal firmly for more powerful braking.

When brake assist operates, the pedal may wiggle slightly and an operating noise may be heard. This is normal. Keep holding the brake pedal firmly down.

When Stopped

1. Depress the brake pedal firmly.
2. With the brake pedal depressed, pull up the electric parking brake switch slowly, but fully.
3. Change the shift position to **P**.
4. Turn off the power system.
 - ▶ The parking brake and brake system indicator (red) goes off in about 15 seconds.

Always set the parking brake, in particular if you are parked on an incline.

▣ Parking Your Vehicle

⚠ WARNING

The vehicle can roll away if left unattended without confirming that Park is engaged.

A vehicle that rolls away could cause a crash resulting in serious injury or death.

Always keep your foot on the brake pedal until you have confirmed that **P** is shown on the shift position indicator.

Do not park your vehicle near flammable objects, such as dry grass, oil, or timber. Heat from the exhaust can cause a fire.

Continued

» When Stopped

NOTICE

The following can damage the driveline:

- Depressing the accelerator and brake pedals simultaneously.
- Changing to **P** before the vehicle stops completely.

When facing uphill, do not hold the vehicle by depressing the accelerator pedal.

Doing so may cause the power system to overheat and fail.

In extremely cold temperatures, the parking brake may freeze up if applied. If such temperatures are expected, do not apply the parking brake but, if parking on a slope, either turn the front wheels so they will contact the curb if the vehicle rolls down the slope or block the wheels to keep the vehicle from moving. If you do not take either precaution, the vehicle may roll unexpectedly, leading to a crash.

Parking Sensor System*

The corner and center sensors monitor obstacles around your vehicle, and the beeper, driver information interface and audio/information screen let you know the approximate distance between your vehicle and the obstacle.

■ The sensor location and range

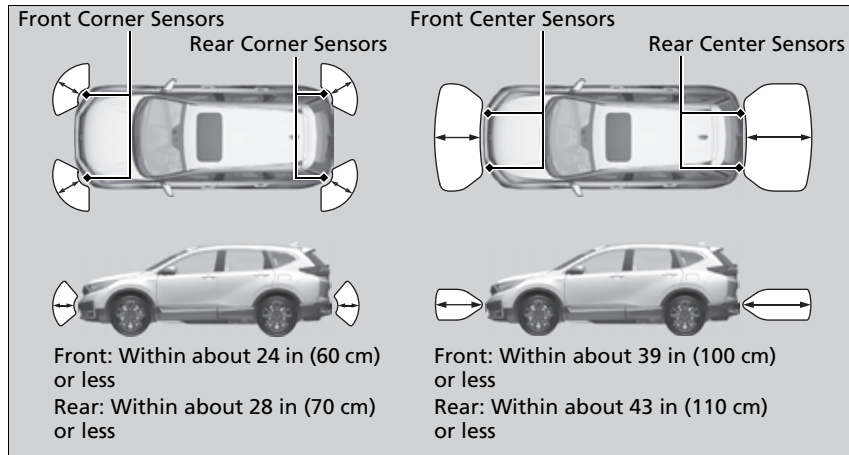

⊠ Parking Sensor System*

Even when the system is on, always confirm if there is no obstacle near your vehicle before parking.

The system may not work properly when:

- The sensors are covered with snow, ice, mud, or dirt.
- The vehicle is on uneven surface, such as grass, bumps, or a hill.
- The vehicle has been out in hot or cold weather.
- The system is affected by devices that emit ultrasonic waves.
- Driving in bad weather.

The system may not sense:

- Thin or low objects.
- Sonic-absorptive materials, such as snow, cotton, or sponge.
- Objects directly under the bumper.

Do not put any accessories on or around the sensors.

* Not available on all models

Continued

■ Parking sensor system on and off

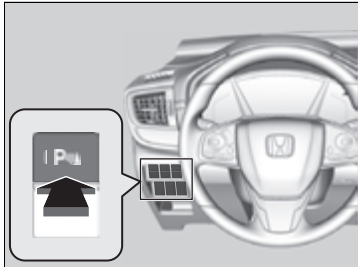

With the power mode in ON, press the parking sensor system button to turn on or off the system. The indicator in the button comes on when the system is on.

The front corner and front center sensors start to detect an obstacle when the transmission is in any position other than **P** or **R**, and the vehicle speed is less than 5 mph (8 km/h).

The front corner, rear corner and rear center sensors start to detect an obstacle when the transmission is in **R**, and the vehicle speed is less than 5 mph (8 km/h).

☒ Parking sensor system on and off

When you set the power mode to ON, the system will be in the previously selected condition.

■ Screen Operation

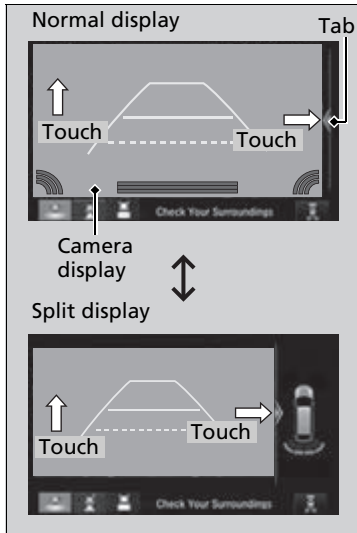

You can switch the display to normal display or split display by touching the tab vicinity or on the camera display.

☒ Screen Operation

If the parking sensor system is off or there is a malfunction in the system, the tab disappears, and the split display returns to the normal display.

You can also switch the display to normal display or split display using the audio/information screen.

➤ **Customized Features** P. 369

■ When the distance between your vehicle and obstacles behind becomes shorter

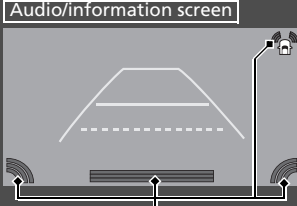
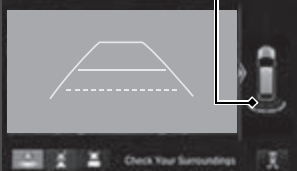
Interval between beeps	Distance between the Bumper and Obstacle		Indicator	Driver Information Interface/ Audio/Information Screen
	Corner Sensors	Center Sensors		
Moderate	—	Front: About 41-26 in (105-65 cm) Rear: About 45-26 in (115-65 cm)	Blinks in Yellow*1	 <p>Audio/information screen</p> <p>Indicators light up where the sensor detects an obstacle</p>
Short	Front: About 26-19 in (65-50 cm) Rear: About 30-19 in (75-50 cm)	About 26-19 in (65-50 cm)	Blinks in Amber	 <p>Driver information interface</p> <p>WARNING: Approaching Object</p> <p>Indicators light up where the sensor detects an obstacle</p>
Very short	About 19-16 in (50-40 cm)	About 19-16 in (50-40 cm)		
Continuous	About 16 in (40 cm) or less	About 16 in (40 cm) or less	Blinks in Red	

*1: At this stage, only the center sensors detect obstacles.

■ Turning off All Rear Sensors

1. Make sure that the parking sensor system is not activated. Set the power mode to VEHICLE OFF (LOCK).
2. Press and hold the parking sensor system button, and set the power mode to ON.
3. Keep pressing the button for 10 seconds. Release the button when the indicator in the button flashes.
4. Press the button again. The indicator in the button goes off.
 - ▶ The beeper sounds twice. The rear sensors are now turned off.

To turn the rear sensors on again, follow the above procedure. The beeper sounds three times when the rear sensors come back on.

☒ Turning off All Rear Sensors

When you shift to **[R]**, the indicator in the parking sensor system button blinks as a reminder that the rear sensors have been turned off.

Cross Traffic Monitor*

Monitors the rear corner areas using the radar sensors when reversing, and alerts you if a vehicle approaching from a rear corner is detected.

The system is convenient when you are backing out of a parking space.

ⓘ Cross Traffic Monitor*

CAUTION

Cross Traffic Monitor cannot detect all approaching vehicles and may not detect an approaching vehicle at all.

Failure to visually confirm that it is safe to back up the vehicle before doing so may result in a collision.

Do not solely rely on the system when reversing; always also use your mirrors, and look behind and to the sides of your vehicle before reversing.

■ How the System Works

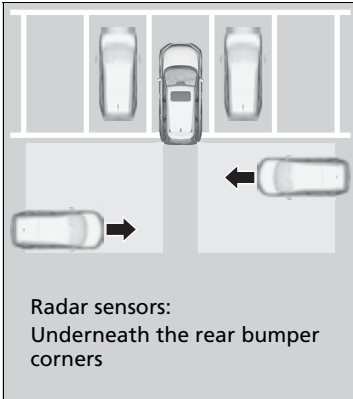

The system activates when:

- The power mode is in ON.
- The Cross Traffic Monitor system is turned on.
 - ▶ **Cross Traffic Monitor On and Off** P. 569
- The transmission is in **R**.
- Your vehicle is moving at 3 mph (5 km/h) or lower.

When a vehicle is detected approaching from a rear corner, Cross Traffic Monitor alerts you with a buzzer and a displayed warning.

The system will not detect a vehicle that approaches from directly behind your vehicle, nor will it provide alerts about a detected vehicle when it moves directly behind your vehicle.

The system does not detect or provide alerts for a vehicle that is moving away from your vehicle, and it may alert for pedestrians, bicycles, or stationary objects.

⊠ Cross Traffic Monitor*

Cross Traffic Monitor may not detect or may delay alerting an approaching vehicle, or may alert without an approaching vehicle under the following conditions:

- An obstacle, such as another vehicle and a wall, near your vehicle's rear bumper, is blocking the radar sensor's scope.
- Your vehicle is moving at the speed of about 3 mph (5 km/h) or higher.
- A vehicle is approaching at the speed other than between about 6 mph (10 km/h) and 16 mph (25 km/h).
- The system picks up external interference such as other radar sensors from another vehicle or strong radio wave transmitted from a facility nearby.
- Either corner of the rear bumper is covered with snow, ice, mud or dirt.
- When there is bad weather.
- Your vehicle is on an incline.
- Your vehicle is tilted due to a heavy load in the rear.
- Your vehicle is reversing towards a wall, a pole, a vehicle, and so on.

The rear bumper or the sensors have been improperly repaired or the rear bumper has been deformed. Have your vehicle checked by a dealer.

For proper operation, always keep the rear bumper corner area clean. Do not cover the rear bumper corner area with labels or stickers of any kind.

■ When the System Detects a Vehicle

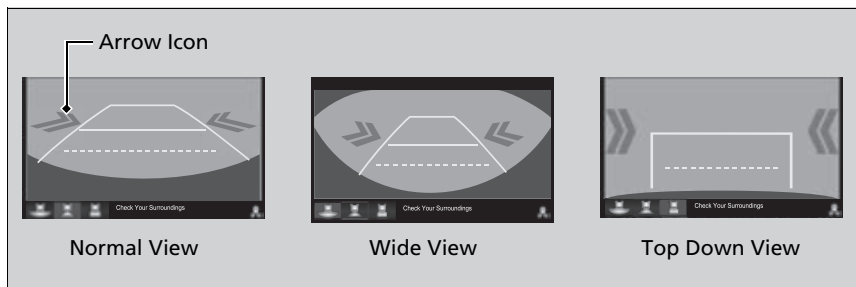

An arrow icon appears on the side a vehicle is approaching on the audio/information screen.

▶▶ When the System Detects a Vehicle

If the on the lower right changes to when the transmission is in **[R]**, mud snow or ice may have accumulated in the vicinity of the sensor. Check the bumper corners for any obstructions, and thoroughly clean the area if necessary.

If the comes on when the transmission is in **[R]**, there may be a problem with the Cross Traffic Monitor system. Do not use the system and have your vehicle checked by a dealer.

If the display remains the same with the transmission in **[R]**, there may be a problem with the rear camera system and the Cross Traffic Monitor system. Do not use the system and have your vehicle checked by a dealer.

■ Cross Traffic Monitor On and Off

You can switch on and off the system using the audio/information screen.

1. Select .
2. Select **Settings**.
3. Select **Camera**.
4. Select **Cross Traffic Monitor**.
5. Select **On** or **Off**, then select **OK**.

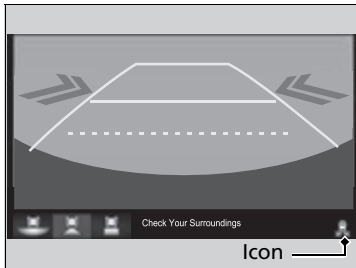

The system can also be turned on and off on the audio/information screen by pressing the CTM icon.

About Your Multi-View Rear Camera

The audio/information screen can display your vehicle's rear view.

The display automatically changes to a rear view when the transmission is put into **R**.

About Your Multi-View Rear Camera

The rear camera view is restricted. You cannot see the corner ends of the bumper or what is underneath the bumper. Its unique lens also makes objects appear closer or farther than they actually are.

Visually confirm that it is safe to drive before backing up. Certain conditions (such as weather, lighting, and high temperatures) may also restrict the rear view. Do not rely on the rearview display which does not give you all information about conditions at the back of your vehicle.

If the camera lens is covered with dirt or moisture, use a soft, moist cloth to keep the lens clean and free of debris.

Models with Display Audio

You can change the **Fixed Guideline** and **Dynamic Guideline** settings.

➔ **Customized Features** P. 369

Fixed Guideline

On: Guidelines appear when you put the transmission into **R**.

Off: Guidelines do not appear.

Dynamic Guideline

On: Guidelines move according to the steering wheel direction.

Off: Guidelines do not move.

Multi-View Rear Camera Display Area

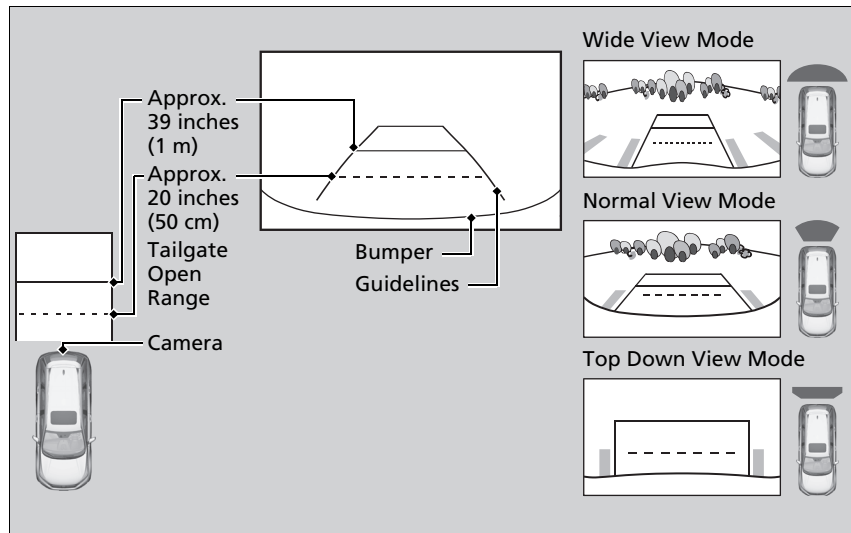

You can view three different camera angles on the rearview display.

Models with color audio system

Press the selector knob to switch the angle.

Models with Display Audio

Touch the appropriate icon to switch the angle.

 : Wide view mode

 : Normal view mode

 : Top down view mode

All models

- If you were last using Wide view mode or Normal view mode, the same view mode will be activated the next time you put the transmission into **[R]**.
- If you were using Top down view mode before you turned off the power system, Wide view mode will be activated the next time you set the power mode to ON and put the transmission into **[R]**.
- If you were using Top down view mode and 10 seconds elapsed after you took the transmission out of **[R]**, Wide view mode will be activated the next time you put the transmission into **[R]**.

▶▶ About Your Multi-View Rear Camera

Models with color audio system

You can change the **Camera Guideline On** or **Off** settings.

➔ **Customized Features** P. 362

Camera Guideline

On: Guidelines appear when you put the transmission into **[R]**.

Off: Guidelines do not appear.

Fuel Information

■ Fuel recommendation

Unleaded gasoline, pump octane number 87 or higher

Use of lower octane gasoline can cause a persistent, heavy metallic knocking noise that can lead to engine damage.

■ Top tier detergent gasoline

Because the level of detergency and additives in gasoline vary in the market, Honda endorses the use of “TOP TIER Detergent Gasoline” where available to help maintain the performance and reliability of your vehicle. TOP TIER Detergent Gasoline meets a new gasoline standard jointly established by leading automotive manufacturers to meet the needs of today’s advanced engines.

Qualifying gasoline retailers will, in most cases, identify their gasoline as having met “TOP TIER Detergent Gasoline” standards at the retail location. This fuel is guaranteed to contain the proper level of detergent additives and be free of metallic additives. The proper level of detergent additives, and absence of harmful metallic additives in gasoline, help avoid buildup of deposits in your engine and emission control system.

For further important fuel-related information for your vehicle, or on information on gasoline that does not contain MMT, visit www.hondacars.com. For additional information on gasoline. For more information on top tier gasoline, visit www.toptiergas.com.

■ Fuel tank capacity: 14 US gal (53 L)

» Fuel Information

NOTICE

We recommend quality gasoline containing detergent additives that help prevent fuel system and engine deposits. In addition, in order to maintain good performance, fuel economy, and emissions control, we strongly recommend the use of gasoline that does NOT contain harmful manganese-based fuel additives such as MMT, if such gasoline is available.

Use of gasoline with these additives may adversely affect performance, and cause the malfunction indicator lamp on your instrument panel to come on. If this happens, contact a dealer for service.

Some gasoline today is blended with oxygenates such as ethanol. Your vehicle is designed to operate on oxygenated gasoline containing up to 15% ethanol by volume. Do not use gasoline containing methanol. If you notice any undesirable operating symptoms, try another service station or switch to another brand of gasoline.

How to Refuel

Your fuel tank is not equipped with a fuel filler cap. You can insert the filler nozzle directly into the filler neck. The tank seals itself again when you pull out the filler nozzle.

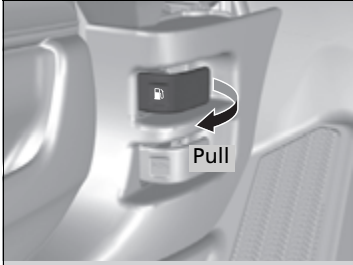

1. Stop your vehicle with the service station pump on the left side of the vehicle in the rear.
2. Turn off the power system.
3. Pull on the fuel fill door release handle under the lower left corner of the dashboard.
 - ▶ The fuel fill door opens.

How to Refuel

⚠ WARNING

Gasoline is highly flammable and explosive. You can be burned or seriously injured when handling fuel.

- Stop the engine, and keep heat, sparks, and flames away.
- Handle fuel only outdoors.
- Wipe up spills immediately.

The fuel filler opening is designed to accept only service station filler nozzles for refueling. Use of smaller diameter tubes (e.g., those used to siphon fuel for other uses) or other non-service station devices can damage the area in and around the filler opening.

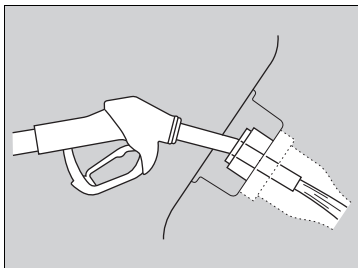

4. Place the end of the filler nozzle on the lower part of filler opening, then insert it slowly and fully.
 - ▶ Make sure that the end of the filler nozzle goes down along with the filler pipe.
 - ▶ Keep the filler nozzle level.
 - ▶ When the tank is full, the filler nozzle will click off automatically.
 - ▶ After filling, wait about five seconds before removing the filler nozzle.
 - ▶ If you do not fill up the tank to full, always add a minimum of **1.3 US gal (5.0 L)** of fuel.
5. Shut the fuel fill door by hand.

How to Refuel

If the filler nozzle keeps turning off when the tank is not full, there may be a problem with the pump's fuel vapor recovery system. Try filling at another pump. If this does not fix the problem, consult a dealer.

If you repeatedly fill the tank with less than the specified minimum amount of fuel, the malfunction indicator lamp may come on. If this happens, have your vehicle checked by a dealer.

The filler nozzle automatically stops to leave space in the fuel tank so that fuel does not overflow as a result of changes in air temperature.

Do not continue to add fuel after the filler nozzle has automatically stopped. Additional fuel can exceed the full tank capacity.

If you have to refuel your vehicle from a portable container, use the funnel provided with your vehicle.

Refueling From a Portable Fuel Container

P. 665

Improving Fuel Economy and Reducing CO₂ Emissions

Achieving fuel economy and reducing CO₂ emissions is dependent on several factors, including driving conditions, load weight, idling time, driving habits, and vehicle condition. Depending on these and other factors, you may not achieve the rated fuel economy of this vehicle.

Maintenance and Fuel Economy

You can optimize your fuel economy with proper maintenance of your vehicle. Always maintain your vehicle in accordance with the messages displayed on the driver information interface.

- Use engine oil with the viscosity recommended.
 - **Recommended Engine Oil** P. 588
- Maintain the specified tire pressure.
- Do not load the vehicle with excess cargo.
- Keep your vehicle clean. A buildup of snow or mud on your vehicle's underside adds weight and increases wind resistance.

Improving Fuel Economy and Reducing CO₂ Emissions

Direct calculation is the recommended method to determine actual fuel consumed while driving.

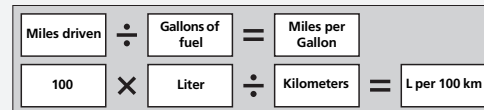

This page intentionally left blank.

Maintenance

This chapter discusses basic maintenance.



Before Performing Maintenance

Inspection and Maintenance	578
Safety When Performing Maintenance ..	579
Parts and Fluids Used in Maintenance	
Service	580

Maintenance Minder™	581
----------------------------------	-----

Maintenance Under the Hood

Maintenance Items Under the Hood ..	586
Opening the Hood	587
Recommended Engine Oil	588
Oil Check	589
Adding Engine Oil	590
Changing the Engine Oil and Oil Filter ...	591

Cooling System	593
Transmission Fluid	595
Brake Fluid	596
Refilling Window Washer Fluid	597
Replacing Light Bulbs	598
Checking and Maintaining Wiper Blades ..	601
Checking and Maintaining Tires	
Checking Tires	606
Tire and Loading Information Label	607
Tire Labeling	607
DOT Tire Quality Grading (U.S. Vehicles) ..	609
Wear Indicators	611
Tire Service Life	611

Tire and Wheel Replacement	612
Tire Rotation	613
Winter Tires	614
12-volt Battery	615
Remote Transmitter Care	
Replacing the Remote Battery	617
Climate Control System Maintenance ..	618
Cleaning	
Interior Care	619
Exterior Care	621
Accessories and Modifications	624

Inspection and Maintenance

For your safety, perform all listed inspections and maintenance to keep your vehicle in good condition. If you become aware of any abnormality (noise, smell, insufficient brake fluid, oil residue on the ground, etc.), have your vehicle inspected by a dealer. (Note, however, that service at a dealer is not mandatory to keep your warranties in effect.)

Types of Inspection and Maintenance

■ Routine inspections

Perform inspections before long distance trips, when washing the vehicle, or when refueling.

➤ **Maintenance** P. 36

■ Periodic inspections

- Check the brake fluid level monthly.
 - **Checking the Brake Fluid** P. 596
- Check the tire pressure monthly. Examine the tread for wear and foreign objects.
 - **Checking and Maintaining Tires** P. 606
- Check the operation of the exterior lights monthly.
 - **Replacing Light Bulbs** P. 598
- Check the condition of the wiper blades at least every six months.
 - **Checking and Maintaining Wiper Blades** P. 601

Inspection and Maintenance

Maintenance, replacement, or repair of emissions control devices and systems may be done by any automotive repair establishment or individuals using parts that are “certified” to EPA standards.

According to state and federal regulations, failure to perform maintenance on the maintenance main items marked with # will not void your emissions warranties. However, all maintenance services should be performed in accordance with the intervals indicated by the driver information interface.

➤ **Maintenance Service Items** P. 584

If you want to perform complex maintenance tasks that require more skills and tools, you can purchase a subscription to the Service Express website at www.techinfo.honda.com.

➤ **Authorized Manuals** P. 678

If you want to perform maintenance yourself, make sure that you have the necessary tools and skills first. After performing maintenance, update the records in the separate maintenance booklet.

Safety When Performing Maintenance

Some of the most important safety precautions are given here. However, we cannot warn you of every conceivable hazard that can arise in performing maintenance. Only you can decide whether you should perform a given task.

Maintenance Safety

- To reduce the possibility of fire or explosion, keep cigarettes, sparks, and flames away from the 12-volt battery, all High Voltage system, and all fuel related parts.
- Never leave rags, towels, or other flammable objects under the hood.
 - ▶ Heat from the engine and exhaust can ignite them, causing a fire.
- To clean parts, use a commercially available degreaser or parts cleaner, not gasoline.
- Wear eye protection and protective clothing when working with the 12-volt battery or compressed air.
- Engine exhaust contains carbon monoxide, which is poisonous and can kill you.
 - ▶ Only operate the engine if there is sufficient ventilation.

⚠ Safety When Performing Maintenance

⚠ WARNING

Improperly maintaining this vehicle or failing to correct a problem before driving can cause a crash in which you can be seriously hurt or killed.

Always follow the inspection and maintenance recommendations according to the schedules in this owner's manual.

⚠ WARNING

Failure to properly follow maintenance instructions and precautions can cause you to be seriously hurt or killed.

Always follow the procedures and precautions in this owner's manual.

■ Vehicle Safety

- The vehicle must be in a stationary condition.
 - ▶ Make sure your vehicle is parked on level ground, the parking brake is set, and the power system is turned off.
- Be aware that hot parts can burn you.
 - ▶ Make sure to let the power system including the engine and exhaust system cool thoroughly before touching vehicle parts.
- Be aware that moving parts can injure you.
 - ▶ Do not activate the power system unless instructed, and keep your hands and limbs away from moving parts. When the power system is on, the engine can automatically start, or the radiator fan may start operating without the engine running.
- Do not touch the high-voltage battery and wiring (orange).

Parts and Fluids Used in Maintenance Service

The use of Honda genuine parts and fluids is recommended when maintaining and servicing your vehicle. Honda genuine parts are manufactured according to the same high quality standards used in Honda vehicles.

Select the Maintenance Minder to see maintenance items that are due soon and to see the percentage of life remaining in the engine oil.



When the engine oil life is less than 15%, a Maintenance Minder message will appear every time you set the power mode to ON, reminding you to bring your vehicle to a dealer for service.

To Use Maintenance Minder™

■ Displaying the Maintenance Minder Information

Maintenance items, which should be serviced at the same time that you replace the engine oil, appear on the driver information interface.

You can view them on the Maintenance Minder screen at any time.

1. Set the power mode to ON.
2. Press the  button several times until  is displayed.
3. Press **ENTER** to go to the Maintenance Minder screen. The engine oil life appears on the driver information interface along with maintenance items due soon.

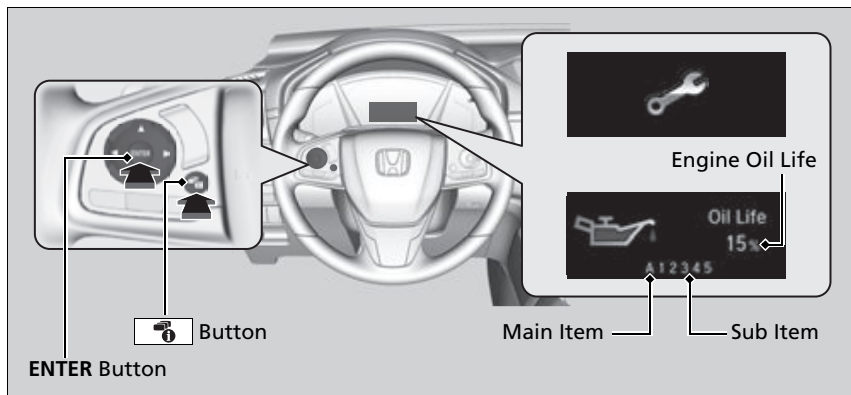

►► Displaying the Maintenance Minder Information









Based on the engine operating conditions, the remaining engine oil life is calculated and displayed as a percentage.

Displayed Engine Oil Life (%)	Calculated Engine Oil Life (%)
100	100 to 91
90	90 to 81
80	80 to 71
70	70 to 61
60	60 to 51
50	50 to 41
40	40 to 31
30	30 to 21
20	20 to 16
15	15 to 11
10	10 to 6
5	5 to 1
0	0

There is a list of maintenance main and sub items you can view on the driver information interface.

►► **Maintenance Service Items** P. 584

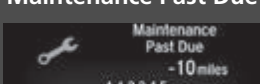
Maintenance Minder Messages on the Driver Information Interface

Maintenance Message	Oil Life Display	Explanation	Information
		When you select the Maintenance Minder screen, it displays codes for maintenance items due at the next engine oil change, along with the percentage of engine oil life remaining.	—
Maintenance Due Soon 		The engine oil life indicator starts to appear along with other due-soon maintenance item codes when the remaining oil life drops to 15 percent.	The engine oil is approaching the end of its service life.
Maintenance Due Now 		The remaining engine oil life is 5 to 1 percent. Press the  button to switch to another display.	The engine oil has almost reached the end of its service life, and the maintenance items should be inspected and serviced as soon as possible.
Maintenance Past Due 		The engine oil has passed its service life, and a negative distance appears after driving over 10 miles. The negative distance on the display blinks.	The engine oil life has passed. The maintenance items must be inspected and serviced immediately.

The system message indicator (ⓘ) comes on along with the Maintenance Minder message.

■ Maintenance Service Items

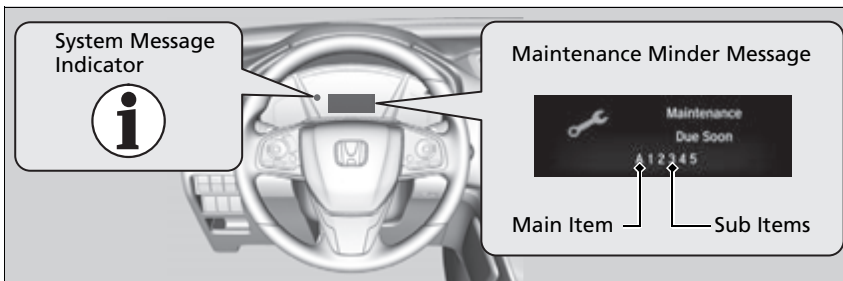

▣ Maintenance Service Items

- Adjust the valves during services A, B, 1, 2, or 3 if they are noisy.

CODE	Maintenance Main Items
A	<ul style="list-style-type: none"> • Replace engine oil*¹
B	<ul style="list-style-type: none"> • Replace engine oil*¹ and oil filter • Inspect front and rear brakes • Check expiration date for tire repair kit bottle • Inspect these items: <ul style="list-style-type: none"> • Tie rod ends, steering gearbox, and boots • Suspension components • Driveshaft boots • Brake hoses and lines (including ABS/VSA®) • All fluid levels and condition of fluids • Exhaust system# • Fuel lines and connections#

CODE	Maintenance Sub Items
1	<ul style="list-style-type: none"> • Rotate tires
2	<ul style="list-style-type: none"> • Replace air cleaner element*² • Replace dust and pollen filter*³
3	<ul style="list-style-type: none"> • Replace transmission fluid*⁴
4	<ul style="list-style-type: none"> • Replace spark plugs • Inspect valve clearance
5	<ul style="list-style-type: none"> • Replace engine coolant
6	<ul style="list-style-type: none"> • Replace rear differential fluid
7	<ul style="list-style-type: none"> • Replace brake fluid*⁵

*1: If a Maintenance Minder message does not appear more than 12 months after the display is reset, change the engine oil every year.

#: See information on maintenance and emissions warranty.

*2: If you drive in dusty conditions, replace the air cleaner element every 15,000 miles (24,000 km).

*3: If you drive primarily in urban areas that have high concentrations of soot in the air from industry and from diesel-powered vehicles, replace the dust and pollen filter every 15,000 miles (24,000 km).





*4: Driving in mountainous areas at very low vehicle speeds or trailer towing results in higher transmission temperatures. This requires transmission fluid changes more frequently than recommended by the Maintenance Minder. If you regularly drive your vehicle under these conditions, have the transmission fluid changed every 47,500 miles (75,000 km) or 3 years.

*5: If a Maintenance Minder message does not appear more than 36 months after the display for item 7 is reset, change the brake fluid every 3 years.

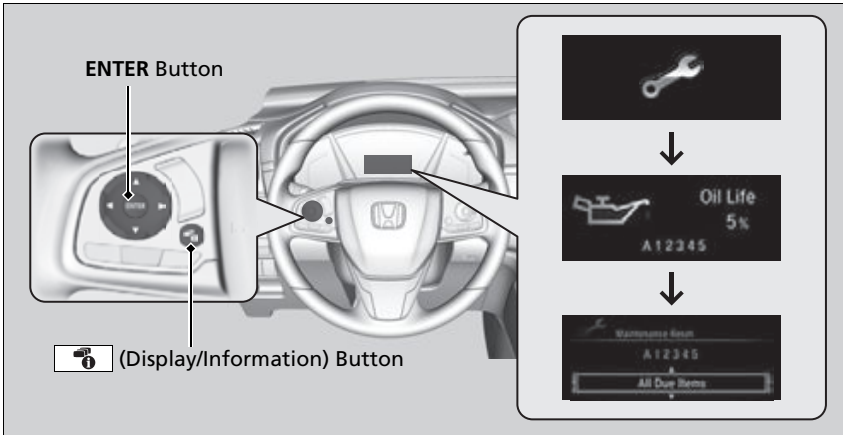
Resetting the Display

Reset the maintenance minder information display if you have performed the maintenance service.



1. Set the power mode to ON.
2. Press the  (display/information) button repeatedly until the  appears.
3. Press the **ENTER** button.
4. Press and hold the **ENTER** button for about 10 seconds to enter the reset mode.
5. Press  /  to select a maintenance item to reset, or to select **All Due Items** (You can also select **Cancel** to end the process).
6. Press the **ENTER** button to reset the selected item.
7. Repeat from step 4 for other items you wish to reset.

Resetting the Display

NOTICE

Failure to reset the Maintenance Minder™ display after a maintenance service results in the system showing incorrect maintenance intervals, which can lead to serious mechanical problems.

The dealer will reset the Maintenance Minder™ display after completing the required maintenance service. If someone other than a dealer performs maintenance service, reset the Maintenance Minder™ display yourself.

Models with Display Audio

You can also reset the Maintenance Minder™ display using the audio/information screen.

 **How to customize** P. 369

Maintenance Items Under the Hood

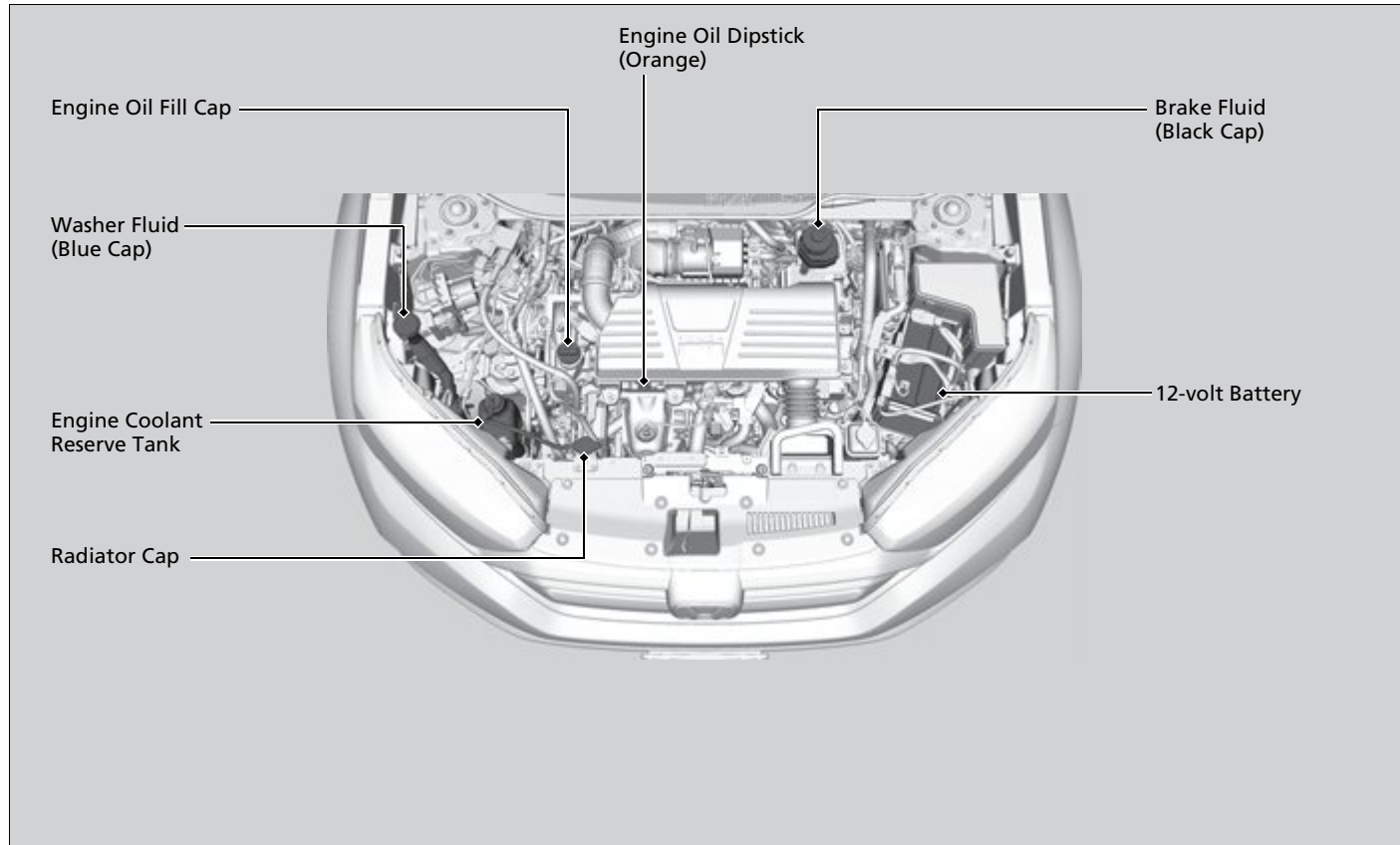

Opening the Hood

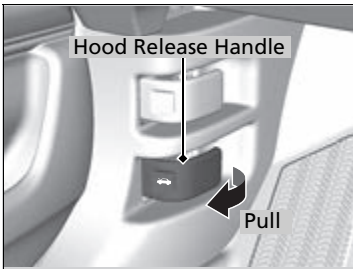

1. Park the vehicle on a level surface, and set the parking brake.
2. Pull the hood release handle under the driver's side lower corner of the dashboard.
 - The hood will pop up slightly.

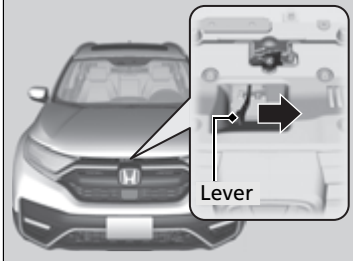

3. Push the hood latch lever (located under the front edge of the hood to the center) to the side and raise the hood. Once you have raised the hood slightly, you can release the lever.

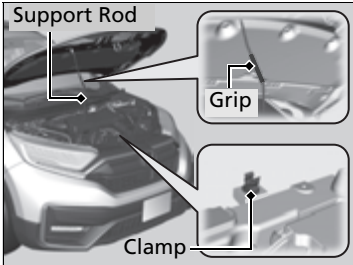

4. Remove the support rod from the clamp using the grip. Mount the support rod in the hood.

When closing, remove the support rod, and stow it in the clamp, then gently lower the hood. Remove your hand at a height of approximately 12 inches (30 cm) and let the hood close.

Opening the Hood

⚠ WARNING

The hood support rod can become very hot due to heat from the engine. To ensure against possible burns, do not handle the metal section of the rod: Use the foam grip instead.

NOTICE

Do not open the hood when the wiper arms are raised. The hood will strike the wipers, resulting in possible damage to the hood and/or the wipers.

When closing the hood, check that the hood is securely latched.

If the hood latch lever moves stiffly, or if you can open the hood without lifting the lever, the latch mechanism should be cleaned and lubricated.

Recommended Engine Oil

Use a genuine engine oil or another commercial engine oil of suitable type and viscosity (for the ambient temperature) as shown in the image that follows.

Oil is a major contributor to your engine's performance and longevity. If you drive the vehicle with insufficient or deteriorated oil, the engine may fail or be damaged.

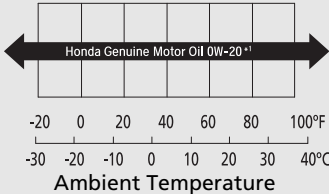
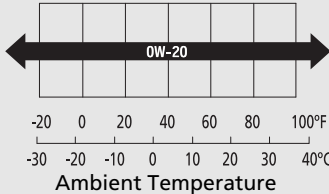
Genuine Engine Oil	Commercial Engine Oil
<ul style="list-style-type: none"> • Honda Genuine Motor Oil 	<ul style="list-style-type: none"> • Premium-grade 0W-20 detergent oil with an API Certification Seal on the container
 <p style="text-align: center;">Ambient Temperature</p>	 <p style="text-align: center;">Ambient Temperature</p>

*1: Formulated to improve fuel economy.

■ Synthetic oil

You may also use synthetic motor oil if it is labeled with the API Certification Seal and is the specified viscosity grade.

►► Recommended Engine Oil

Engine Oil Additives

Your vehicle does not require oil additives. In fact, they may adversely affect the engine performance and durability.

The following seal indicates the oil is energy conserving and that it meets the American Petroleum Institute's latest requirements.



Oil Check

We recommend that you check the engine oil level every time you refuel.

Park the vehicle on level ground.

Turn off the power system. You can check the oil level without the engine having run beforehand. If the engine has been running, wait approximately three minutes before you check the oil.

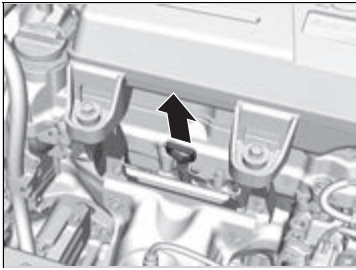

1. Remove the dipstick (orange).
2. Wipe the dipstick with a clean cloth or paper towel.
3. Insert the dipstick back all the way into its hole.

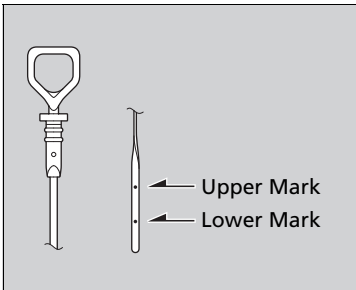

4. Remove the dipstick again, and check the level. It should be between the upper and lower marks. Add oil if necessary.

Oil Check

If the oil level is near or below the lower mark, slowly add oil, being careful not to overfill.

Adding Engine Oil

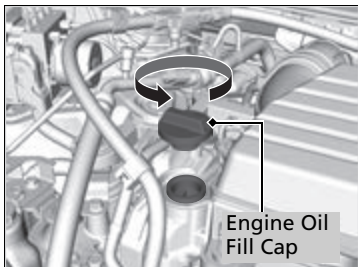

1. Unscrew and remove the engine oil fill cap.
2. Add oil slowly.
3. Reinstall the engine oil fill cap, and tighten it securely.
4. Wait for three minutes and recheck the engine oil dipstick.

► Adding Engine Oil

NOTICE

Do not fill the engine oil above the upper mark. Overfilling the engine oil may result in leaks and engine damage.

If any oil spills, wipe it away immediately. Spilled oil may damage the engine compartment components.

Changing the Engine Oil and Oil Filter

You must change the engine oil and oil filter regularly in order to maintain the engine's lubrication. The engine may be damaged if they are not changed regularly.

Turning the power system on automatically starts the engine if the High Voltage battery charge level gauge shows two segments or less.

🔧 **High Voltage Battery Charge Level Gauge** P. 127

Change the oil and filter in accordance with the maintenance message on the driver information interface.

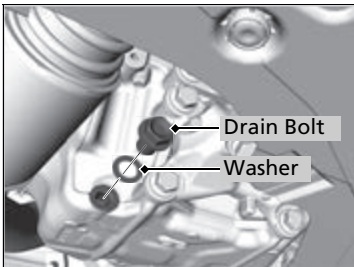
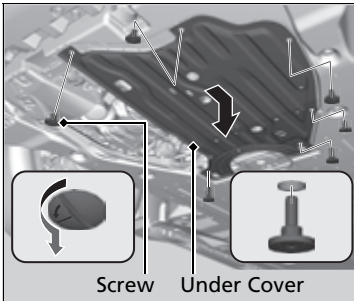

1. Run the engine until it reaches normal operating temperature, and then turn the engine off.
2. Open the hood and remove the engine oil fill cap.
3. Remove the Phillips-head screws and slotted head screws by turning 90° counter-clockwise on the undercarriage and remove the under cover.
4. Remove the drain bolt and washer from the bottom of the engine, and drain the oil into a suitable container.

🔧 Changing the Engine Oil and Oil Filter

NOTICE

You may damage the environment if you do not dispose of the oil in a suitable way. If you are changing the oil by yourself, appropriately dispose of the used oil. Put the oil in a sealed container and take it to a recycling center. Do not throw the oil away into a garbage can or onto the ground.

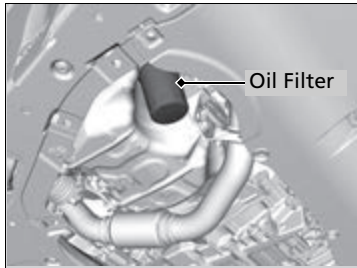

5. Remove the oil filter and dispose of the remaining oil.
6. Check that the filter gasket is not stuck to the engine contact surface.
 - If it is stuck, you must detach it.
7. Wipe away dirt and dust adhering to the contact surface of the engine block, and install a new oil filter.
 - Apply a light coat of new engine oil to the filter gasket.
8. Put a new washer on the drain bolt, then reinstall the drain bolt.
 - Tightening torque:
30 lbf·ft (40 N·m, 4.0 kgf·m)
9. Pour the recommended engine oil into the engine.
 - Engine oil change capacity (including filter):
4.0 US qt (3.8 L)
10. Reinstall the engine oil fill cap securely and start the engine.
11. Run the engine for a few minutes, and then check that there is no leak from the drain bolt or oil filter.
12. Stop the engine, wait for three minutes, and then check the oil level on the dipstick.
 - If necessary, add more engine oil.
13. Reinstall the under cover in the same order it was removed.

✎ Changing the Engine Oil and Oil Filter

You will need a special wrench to replace the oil filter. You can buy this wrench from a dealer.

When installing the new oil filter, follow the instructions supplied with the oil filter.

Reinstall the engine oil fill cap. Start the engine. The low oil pressure indicator should go off within five seconds. If it does not, turn off the engine, and check your work.

Be sure to verify that the oil filter is designed for your vehicle. A genuine Honda oil filter is recommended for optimum lubrication flow and filtration properties to assure the reliability of the engine.

Cooling System

Specified coolant: Honda Long Life Antifreeze/Coolant Type 2

This coolant is premixed with 50% antifreeze and 50% water. Do not add any straight antifreeze or water.

We recommend you check the engine coolant level every time you refuel. Check the reserve tank first. If it is completely empty, also check the coolant level in the radiator. Add the engine coolant accordingly.

Reserve Tank

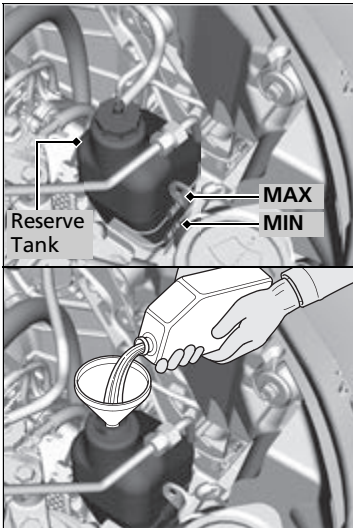

1. **Make sure the engine and radiator are cool.**
2. Check the amount of coolant in the reserve tank.
 - If the coolant level is below the **MIN** mark, add the specified coolant until it reaches the **MAX** mark.
3. Inspect the cooling system for leaks.

⊠ Cooling System

⚠ WARNING

Removing the radiator cap while the engine is hot can cause the coolant to spray out, seriously scalding you.

Always let the engine and radiator cool down before removing the radiator cap.

NOTICE

Genuine Honda engine coolant is a 50/50 mixture of antifreeze and water that can withstand freezing at temperatures as low as about -31°F (-35°C). If your vehicle is consistently subjected to temperatures below this, the concentration of antifreeze in the coolant should be increased. Consult a dealer for details.

If Honda antifreeze/coolant is not available, you may use another major brand of non-silicate coolant as a temporary replacement. Check that it is a high quality coolant recommended for aluminum engines. Continued use of any non-Honda coolant can result in corrosion, causing the cooling system to malfunction or fail. Have the cooling system flushed and refilled with Honda antifreeze/coolant as soon as possible.

Do not add rust inhibitors or other additives to your vehicle's cooling system. They may not be compatible with the coolant or with the engine components.

Continued

■ Radiator

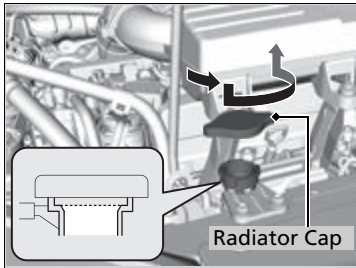

- 1. Make sure the engine and radiator are cool.**
- 2. Turn the radiator cap 1/8 turn counter-clockwise and relieve any pressure in the cooling system.**
- 3. Push down and turn the radiator cap counter-clockwise to remove it.**
- 4. The coolant level should be up to the base of the filler neck. Add coolant if it is low.**
- 5. Put the radiator cap back on, and tighten it fully.**

✎ Radiator

NOTICE

Pour the fluid slowly and carefully so you do not spill any. Clean up any spills immediately; they can damage components in the engine compartment.

Transmission Fluid

Specified fluid: Honda ATF DW-1

Have a dealer check the fluid level and replace if necessary.

Do not attempt to check or change the transmission fluid yourself.

Transmission Fluid

NOTICE

Do not mix Honda ATF DW-1 with other transmission fluids.

Using a transmission fluid other than Honda ATF DW-1 may adversely affect the operation and durability of your vehicle's transmission, and damage the transmission.

Any damage caused by using a transmission fluid that is not equivalent to Honda ATF DW-1 is not covered by Honda's new vehicle limited warranty.

Brake Fluid

Specified fluid: Honda Heavy Duty Brake Fluid DOT 3

■ Checking the Brake Fluid

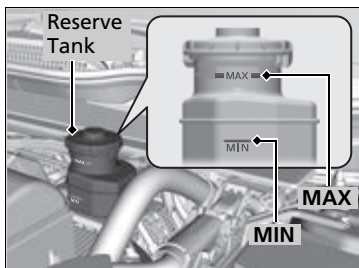

The fluid level should be between the **MIN** and **MAX** marks on the side of the reserve tank.

►► Brake Fluid

NOTICE

Brake fluid marked DOT 5 is not compatible with your vehicle's braking system and can cause extensive damage.

If the specified brake fluid is not available, you should use only DOT 3 or DOT 4 fluid from a sealed container as a temporary replacement.

Using any non-Honda brake fluid can cause corrosion and decrease the longevity of the system. Have the brake system flushed and refilled with Honda Heavy Duty Brake Fluid DOT 3 as soon as possible.

If the brake fluid level is at or below the **MIN** mark, have a dealer inspect the vehicle for leaks or worn brake pads as soon as possible.

Refilling Window Washer Fluid

Check the amount of window washer fluid by looking at the reservoir.

If the level is low, fill the washer reservoir.

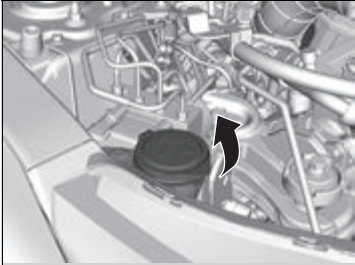

Pour the washer fluid carefully. Do not overflow the reservoir.

» Refilling Window Washer Fluid

NOTICE

Do not use engine antifreeze or a vinegar/water solution in the windshield washer reservoir. Antifreeze can damage your vehicle's paint. A vinegar/water solution can damage the windshield washer pump.

Use only commercially available windshield washer fluid.

Avoid prolonged use of hard water to prevent lime scale buildup.

Headlights

Headlights are LED type. Have an authorized Honda dealer inspect and replace the light assembly.

Fog Lights*

Fog lights are LED type. Have an authorized Honda dealer inspect and replace the light assembly.

Parking/Daytime Running Lights

Parking/daytime running lights are LED type. Have an authorized Honda dealer inspect and replace the light assembly.

Front Turn Signal/Front Side Marker Lights

Front turn signal lights/front side marker lights are LED type. Have an authorized Honda dealer inspect and replace the light assembly.

Side Turn Signal/Emergency Indicator Lights*

Door mirror side turn signal lights are LED type. Have an authorized Honda dealer inspect and replace the light assembly.

Brake/Taillights, Rear Turn Signal Lights and Rear Side Marker Lights

Brake/taillights, rear turn signal lights and rear side marker lights are LED type. Have an authorized Honda dealer inspect and replace the light assembly.

Headlights

The headlight aim is set by the factory, and does not need to be adjusted. However, if you regularly carry heavy items in the cargo area, have the aiming readjusted at a dealer or by a qualified technician.

Taillights and Back-Up Light Bulbs

When replacing, use the following bulbs.

Taillight: LED
Back-Up Light: 16W

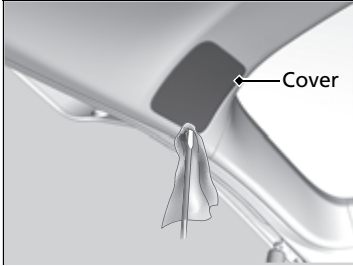

1. Remove the cover by prying on the edge using a flat-tip screwdriver.
 - ▶ Wrap the flat-tip screwdriver with a cloth to prevent scratches.

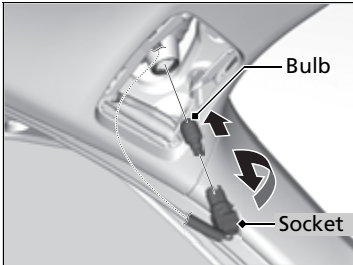

2. Turn the socket counter-clockwise and remove it. Remove the old bulb.
3. Insert a new bulb.

⌘ Taillights and Back-Up Light Bulbs

Taillights are LED type. Have an authorized Honda dealer inspect and replace the light assembly.

Rear License Plate Light

Rear license plate light is LED type. Have an authorized Honda dealer inspect and replace the light assembly.

High-Mount Brake Light

High-mount brake light is LED type. Have an authorized Honda dealer inspect and replace the light assembly.

Checking Wiper Blades

If the wiper blade rubber has deteriorated, it will leave streaks, become noisy, and the hard surfaces of the blade may scratch the window glass.

Changing the Front Wiper Blade Rubber

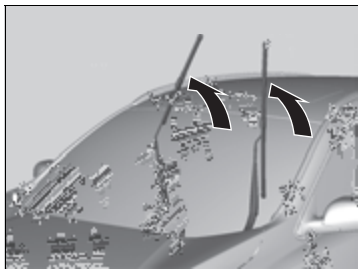
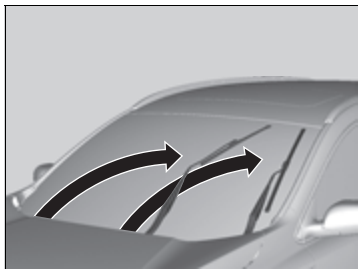

1. Set the power mode to VEHICLE OFF.
2. While holding the wiper switch in the **MIST** position, set the power mode to ON, then to VEHICLE OFF.
 - ▶ Both wiper arms are set to the maintenance position as shown in the image.
3. Lift the driver side wiper arm first, then the passenger side.

Changing the Front Wiper Blade Rubber

NOTICE

Avoid dropping the wiper arm onto the windshield, it may damage the wiper arm and/or the windshield.

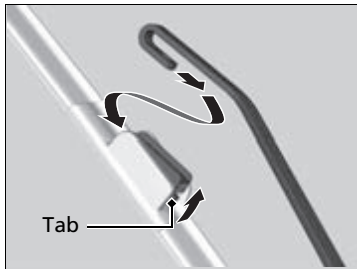

4. Press up on and hold the tab, then slide the holder off the wiper arm.

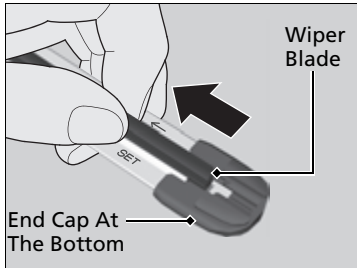

5. Pull the end of the wiper blade in the direction of the arrow in the image until it is out of the holder's end cap.

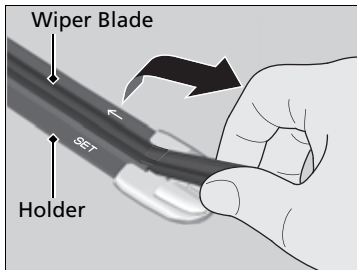

6. Pull the wiper blade in the opposite direction to slide it out of the holder.

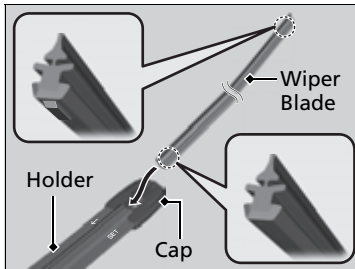

7. Slide the new wiper blade onto the holder from the bottom end.
 - ▶ The tab on the holder should fit in the indent of the wiper blade.
8. Slide the holder onto the wiper arm, then push down the lock tab.
9. Lower the passenger side wiper arm first, then the driver side.
10. Set the power mode to ON and hold the wiper switch in the **MIST** position until both wiper arms return to the standard position.

Changing the Rear Wiper Blade Rubber

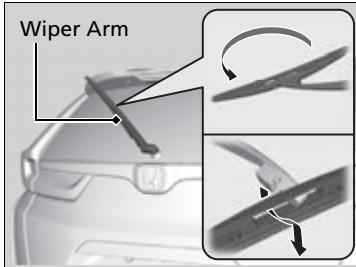

1. Raise the wiper arm off.
2. Pivot the bottom end of the holder up until it comes off from the wiper arm.

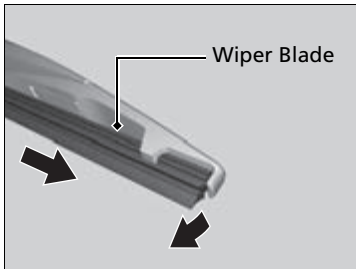

3. Slide the blade out of the holder.

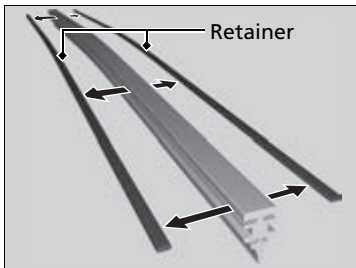

4. Remove the retainers from wiper blade and mount to a new rubber blade.

Changing the Rear Wiper Blade Rubber

NOTICE

Avoid dropping the wiper arm, it may damage the rear window.

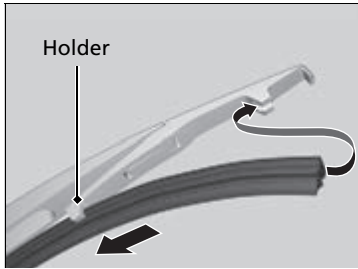

5. Slide the new wiper blade onto the holder.
 - ▶ Make sure it is engaged correctly, then install the wiper blade assembly onto the wiper arm.

Checking Tires

To safely operate your vehicle, your tires must be of the proper type and size, in good condition with adequate tread, and properly inflated.

■ Inflation guidelines

Properly inflated tires provide the best combination of handling, tread life, and comfort. Refer to the driver's doorjamb label or specifications page for the specified pressure.

Underinflated tires wear unevenly, adversely affect handling and fuel economy, and are more likely to fail from overheating.

Overinflated tires make your vehicle ride harshly, are more prone to road hazards, and wear unevenly.

Every day before you drive, look at each of the tires. If one looks lower than the others, check the pressure with a tire gauge.

At least once a month or before long trips, use a gauge to measure the pressure in all tires. Even tires in good condition can lose 1–2 psi (10–20 kPa, 0.1–0.2 kgf/cm²) per month.

■ Inspection guidelines

Every time you check inflation, also examine the tires and valve stems.

Look for:

- Bumps or bulges on the side or in the tread. Replace the tire if you find any cuts, splits, or cracks in the side of the tire. Replace it if you see fabric or cord.
- Remove any foreign objects and inspect for air leaks.
- Uneven tread wear. Have a dealer check the wheel alignment.
- Excessive tread wear.

➤ **Wear Indicators** P. 611

- Cracks or other damage around valve stem.

➤ Checking Tires

⚠ WARNING

Using tires that are excessively worn or improperly inflated can cause a crash in which you can be seriously hurt or killed.

Follow all instructions in this owner's manual regarding tire inflation and maintenance.

Measure the air pressure when tires are cold. This means the vehicle has been parked for at least three hours, or driven less than 1 mile (1.6 km). If necessary, add or release air until the specified pressure is reached.

If checked when hot, tire pressure can be as much as 4–6 psi (30–40 kPa, 0.3–0.4 kgf/cm²) higher than if checked when cold.

Whenever tire pressure is adjusted, you must calibrate the TPMS.

➤ **Tire Pressure Monitoring System (TPMS)**
P. 493

Have a dealer check the tires if you feel a consistent vibration while driving. New tires and any that have been removed and reinstalled should be properly balanced.

Tire and Loading Information Label

The label attached to the driver's doorjamb provides necessary tire and loading information.

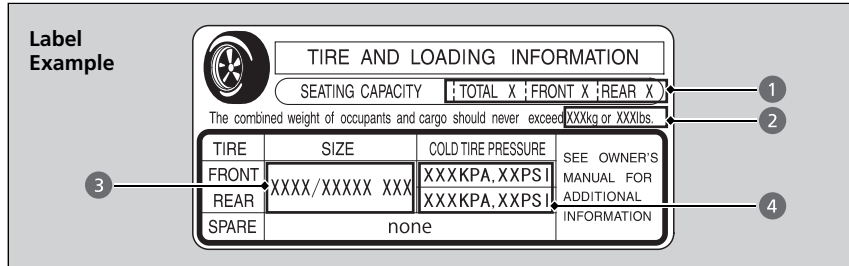

☒ Tire and Loading Information Label

The tire and loading information label attached to the driver's doorjamb contains:

- 1 The number of people your vehicle can carry.
- 2 The total weight your vehicle can carry. Do not exceed this weight.
- 3 The original tire sizes for front, rear, and spare.
- 4 The proper cold tire pressure for front, rear, and spare.

Tire Labeling

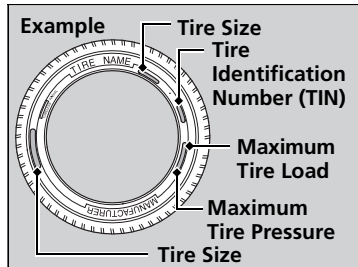

The tires that came on your vehicle have a number of markings. Those you should be aware of are described as shown.

☒ Tire Sizes

Following is an example of tire size with an explanation of what each component means.

P235/60 R18 102T

P: Vehicle type (P indicates passenger vehicle).

235: Tire width in millimeters.

60: Aspect ratio (the tire's section height as a percentage of its width).

R: Tire construction code (R indicates radial).

18: Rim diameter in inches.

102: Load index (a numerical code associated with the maximum load the tire can carry).

T: Speed symbol (an alphabetical code indicating the maximum speed rating).

■ Tire Sizes

Whenever tires are replaced, they should be replaced with tires of the same size.

■ Tire Identification Number (TIN)

The tire identification number (TIN) is a group of numbers and letters that look like the example in the side column. TIN is located on the sidewall of the tire.

■ Glossary of Tire Terminology

Cold Tire Pressure – The tire air pressure when the vehicle has been parked for at least three hours or driven less than 1 mile (1.6 km).

Load Rating – Means the maximum load that a tire is rated to carry for a given inflation pressure.

Maximum Inflation Pressure – The maximum tire air pressure that the tire can hold.

Maximum Load Rating – Means the load rating for a tire at the maximum permissible inflation pressure for that tire.

Recommended Inflation Pressure – The cold tire inflation pressure recommended by the manufacturer.

Treadwear Indicators (TWI) – Means the projections within the principal grooves designed to give a visual indication of the degrees of wear of the tread.

▶▶ Tire Identification Number (TIN)

DOT B97R FW6X 2209

DOT: This indicates that the tire meets all requirements of the U.S. Department of Transportation.

B97R: Manufacturer's identification mark.

FW6X: Tire type code.

22 09: Date of manufacture.

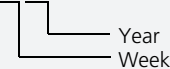

DOT Tire Quality Grading (U.S. Vehicles)

The tires on your vehicle meet all U.S. Federal Safety Requirements. All tires are also graded for treadwear, traction, and temperature performance according to Department of Transportation (DOT) standards. The following explains these gradings.

■ Uniform Tire Quality Grading

Quality grades can be found where applicable on the tire sidewall between tread shoulder and maximum section width.

■ Treadwear

The treadwear grade is a comparative rating based on the wear rate of the tire when tested under controlled conditions on a specified government test course. For example, a tire graded 150 would wear one and one-half (1 1/2) times as well on the government course as a tire graded 100. The relative performance of tires depends upon the actual conditions of their use, however, and may depart significantly from the norm due to variations in driving habits, service practices and differences in road characteristics and climate.

▣ Uniform Tire Quality Grading

For example:
Treadwear 200
Traction AA
Temperature A

All passenger car tires must conform to Federal Safety Requirements in addition to these grades.

■ Traction

The traction grades, from highest to lowest, are AA, A, B, and C. Those grades represent the tire's ability to stop on wet pavement as measured under controlled conditions on specified government test surfaces of asphalt and concrete. A tire marked C may have poor traction performance.

■ Temperature

The temperature grades are A (the highest), B, and C, representing the tire's resistance to the generation of heat and its ability to dissipate heat when tested under controlled conditions on a specified indoor laboratory test wheel. Sustained high temperature can cause the material of the tire to degenerate and reduce tire life, and excessive temperature can lead to sudden tire failure. The grade C corresponds to a level of performance which all passenger car tires must meet under the Federal Motor Vehicle Safety Standard No. 109. Grades B and A represent higher levels of performance on the laboratory test wheel than the minimum required by law.

⌘ Traction

Warning: The traction grade assigned to this tire is based on straight-ahead braking traction tests, and does not include acceleration, cornering, hydroplaning, or peak traction characteristics.

⌘ Temperature

Warning: The temperature grade for this tire is established for a tire that is properly inflated and not overloaded. Excessive speed, underinflation, or excessive loading, either separately or in combination, can cause heat buildup and possible tire failure.

Wear Indicators

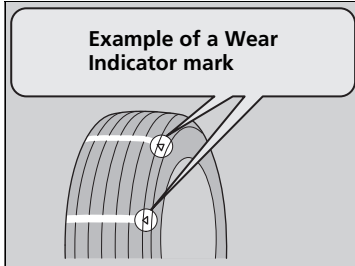

The groove where the wear indicator is located is about 1/16 inch (about 1.6 mm) shallower than elsewhere on the tire. If the tread has worn so that the indicator is exposed, replace the tire.

Worn out tires have poor traction on wet roads.

Tire Service Life

The life of your tires is dependent on many factors, including driving habits, road conditions, vehicle loading, inflation pressure, maintenance history, speed, and environmental conditions (even when the tires are not in use).

In addition to regular inspections and inflation pressure maintenance, it is recommended that you have annual inspections performed once the tires reach five years old. All tires should be removed from service after 10 years from the date of manufacture, regardless of their condition or state of wear.

Tire and Wheel Replacement

Replace your tires with radials of the same size, load range, speed rating, and maximum cold tire pressure rating (as shown on the tire's sidewall). Using tires of a different size or construction can cause certain vehicle systems such as the ABS and Vehicle Stability Assist™ (VSA®) system to work incorrectly.

It is best to replace all four tires at the same time. If that isn't possible, replace the front or rear tires in pairs.

Make sure that the wheel's specifications match those of the original wheels.

▶ Tire and Wheel Replacement

WARNING

Installing improper tires on your vehicle can affect handling and stability. This can cause a crash in which you can be seriously hurt or killed.

Always use the size and type of tires recommended in this owner's manual.

Tire Rotation

Rotating tires according to the maintenance messages on the driver information interface helps to distribute wear more evenly and increase tire life.

■ Tires without rotation marks

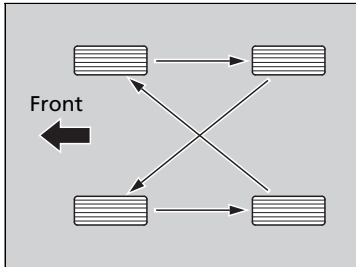

Rotate the tires as shown here.

■ Tires with rotation marks

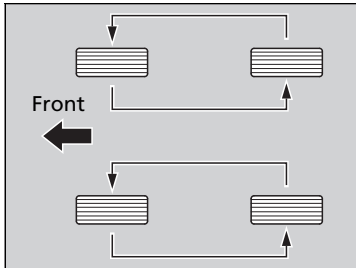

Rotate the tires as shown here.

☒ Tire Rotation

Tires with directional tread patterns should only be rotated front to back (not from one side to the other). Directional tires should be mounted with the rotation indication mark facing forward, as shown below.

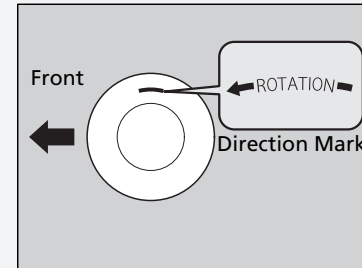

Whenever tires are rotated, you must calibrate the TPMS.

☒ Tire Pressure Monitoring System (TPMS)

P. 493

Winter Tires

If driving on snowy or frozen roads, mount all season marked M+S tires, snow tires, or tire chains; reduce speed; and maintain sufficient distance between vehicles when driving.

Be particularly careful when operating the steering wheel or brakes to prevent skidding.

Use tire chains, snow tires, or all season tires when necessary or according to the law.

When mounting, refer to the following points.

For winter tires:

- Select the size and load ranges that are the same as the original tires.
- Mount the tires to all four wheels.

For tire chains:

- Install them on the front tires only.
- Because your vehicle has limited tire clearance, we strongly recommend using the chains listed below:

Models with 235/65R17 tires

Models with 235/55R19 tires

Cable-type: SCC RADIAL CHAIN TC211MM

Models with 235/60R18 tires

Cable-type: SCC RADIAL CHAIN TC2212MM

- Follow the chain manufacturer's instruction when installing. Mount them as tightly as you can.
- Check that the chains do not touch the brake lines or suspension.
- Drive slowly.

Winter Tires

⚠ WARNING

Using the wrong chains, or not properly installing chains, can damage the brake lines and cause a crash in which you can be seriously injured or killed.

Follow all instructions in this owner's manual regarding the selection and use of tire chains.

NOTICE

Traction devices that are the wrong size or improperly installed can damage your vehicle's brake lines, suspension, body, and wheels. Stop driving if they are hitting any part of the vehicle.

When tire chains are mounted, follow the chain manufacturer's instructions regarding vehicle operational limits.

If your vehicle is equipped with summer tires, be aware that these tires are not designed for winter driving conditions. For more information, contact a dealer.

Checking the 12-volt Battery

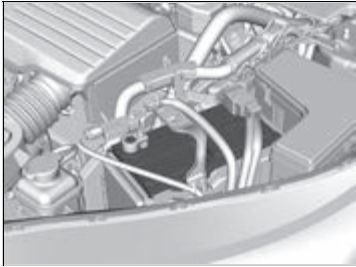

The condition of the battery is monitored by a sensor located on the negative terminal of the battery. If there is a problem with this sensor, the driver information interface will display a warning message. If this happens, have your vehicle inspected by a dealer.

Check the battery terminals for corrosion monthly.

If your vehicle's battery is disconnected or goes dead:

- The audio system is disabled.
 - **Audio System Theft Protection** P. 247
- The clock resets*.
 - **Clock** P. 150

* Not available on all models

12-volt Battery

⚠ WARNING

The battery gives off explosive hydrogen gas during normal operation.

A spark or flame can cause the battery to explode with enough force to kill or seriously hurt you.

When conducting any battery maintenance, wear protective clothing and a face shield, or have a skilled technician do it.

WARNING: Battery post, terminals, and related accessories contain lead and lead compounds.
Wash your hands after handling.

Charging the 12-volt Battery

Disconnect both battery cables to prevent damaging your vehicle's electrical system. Always disconnect the negative (–) cable first, and reconnect it last.

✎ 12-volt Battery

When you find corrosion, clean the battery terminals by applying a baking powder and water solution. Clean the terminals with a damp towel. Cloth/towel dry the battery. Coat the terminals with grease to help prevent future corrosion.

When replacing the battery, the replacement must be of the same specifications. Consult a dealer for more information.

The indicators for the Adaptive Cruise Control (ACC) with Low Speed Follow, Road Departure Mitigation System, Vehicle Stability Assist™ (VSA®) system, Vehicle Stability Assist™ (VSA®) OFF, Collision Mitigation Braking System™ (CMBS™), Low Tire Pressure/TPMS, and Parking Brake and Brake System (Amber) may come on along with a message in the Driver Information Interface after reconnecting the 12-volt battery. Drive a short distance at more than 12 mph (20 km/h). The indicator should go off. If it does not, have your vehicle checked by a dealer.

Replacing the Remote Battery

If the indicator does not come on when the button is pressed, replace the battery.



Battery type: CR2032

1. Remove the built-in key.
2. Remove the upper half of the cover by carefully prying on the edge with a coin.
 - ▶ Wrap a coin with a cloth to prevent scratching the keyless remote.
 - ▶ Remove carefully to avoid losing the buttons.
3. Make sure to replace the battery with the correct polarity.

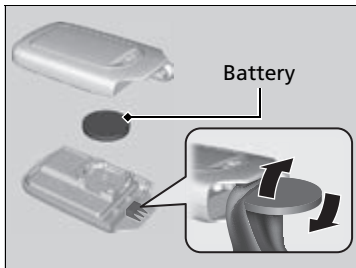

Replacing the Remote Battery

⚠ WARNING

CHEMICAL BURN HAZARD

The battery that powers the remote transmitter can cause severe internal burns and can even lead to death if swallowed. Keep new and used batteries away from children.

If you suspect that a child has swallowed the battery, seek medical attention immediately.

NOTICE

An improperly disposed of battery can damage the environment. Always confirm local regulations for battery disposal.

Replacement batteries are commercially available or at a dealer.

Air Conditioning

To ensure proper and safe operation, the Society of Automotive Engineers (SAE J2845) recommends that the refrigerant system only be serviced by trained and certified technicians.

Never repair or replace the air conditioning evaporator (cooling coil) with one removed from a used or salvaged vehicle.

New replacement mobile air conditioning evaporators must be certified (and labeled) as meeting SAE Standard J2842.

Dust and Pollen Filter

The climate control system is equipped with a dust and pollen filter that collects pollen, dust, and other debris in the air. The Maintenance Minder™ messages will let you know when to replace the filter.

We recommend that you replace the dust and pollen filter sooner when using your vehicle in areas with high concentrations of dust.

Climate Control System Maintenance

NOTICE

Vented refrigerant is harmful to the environment. To avoid refrigerant from venting, never replace the evaporator with one removed from a used or salvaged vehicle.

Refrigerant in your vehicle's air conditioning system is flammable and can be ignited during servicing if proper procedures are not followed.

The air conditioner label is found under the hood:

➤ **Safety Labels** P. 87

➤ **Specifications** P. 668

Dust and Pollen Filter

If the airflow from the climate control system deteriorates noticeably, and the windows fog up easily, the filter may need to be replaced. Please contact a dealer for replacement.

Interior Care

Use a damp cloth with a mixture of mild detergent and warm water to remove dirt. Use a clean cloth to remove detergent residue.

■ Cleaning Seat Belts

Use a soft brush with a mixture of mild soap and warm water to clean the seat belts. Let the belts air dry. Wipe the loops of the seat belt anchors using a clean cloth.

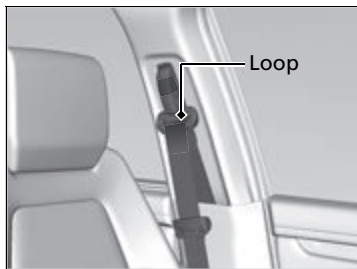

■ Cleaning the Window

Wipe using a glass cleaner.

⌘ Interior Care

Do not spill liquids inside the vehicle. Electrical devices and systems may malfunction if liquids are splashed on them.

Do not use silicone based sprays on electrical devices such as audio devices and switches. Doing so may cause the items to malfunction or cause a fire inside the vehicle.

If a silicone based spray is inadvertently used on electrical devices, consult a dealer.

Depending on their composition, chemicals and liquid aromatics may cause discoloration, wrinkles, and cracking to resin-based parts and textiles. Do not use alkali solvents or organic solvents such as benzene or gasoline.

After using chemicals, make sure to gently wipe them away using a dry cloth.

Do not place used cloths on top of resin based parts or textiles for long periods of time without washing.

⌘ Cleaning the Window

Wires are mounted to the inside of the rear window. Wipe along the same direction as the wires with a soft cloth so as not to damage them.

Be careful not to spill fluids, such as water or glass cleaner, on or around the cover of both the front sensor camera and the rainfall/light sensor*.

* Not available on all models

■ Floor Mats

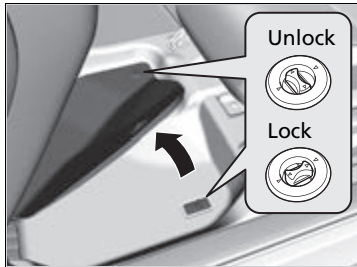

The driver's floor mat hooks over floor anchors, which keep them from sliding forward. To remove a mat for cleaning, turn the anchor knobs to the unlock position. When reinstalling the mat after cleaning, turn the knobs to the lock position.

Do not put additional floor mats on top of the anchored mat.

■ Maintaining Genuine Leather*

To properly clean leather:

1. Use a vacuum or soft dry cloth first to remove any dirt or dust.
2. Clean the leather with a soft cloth dampened with a solution comprised of 90% water and 10% neutral soap.
3. Wipe away any soap residue with a clean damp cloth.
4. Wipe away residual water and allow leather to air dry in the shade.

☒ Floor Mats

If you use any floor mats that were not originally provided with your vehicle, make sure they are designed for your specific vehicle, fit correctly, and are securely anchored by the floor anchors. Position the rear seat floor mats properly. If not properly positioned, the floor mats can interfere with the front seat functions.

☒ Maintaining Genuine Leather*

It is important to clean or wipe away dirt or dust as soon as possible. Spills can soak into leather resulting in stains. Dirt or dust can cause abrasions in the leather. In addition, please note that some dark colored clothing can rub onto the leather seats resulting in discoloration or stains.

Exterior Care

Dust off the vehicle body after you drive.

Regularly inspect your vehicle for scratches on painted surfaces. A scratch on a painted surface can result in body rust. If you find a scratch, promptly repair it.

■ Washing the Vehicle

Wash the vehicle regularly. Wash more frequently when driving in the following conditions:

- If driving on roads with road salt.
- If driving in coastal areas.
- If tar, soot, bird droppings, insects, or tree sap are stuck to painted surfaces.

■ Using an Automated Car Wash

- Make sure to follow the instructions indicated on the automated car wash.
- Fold in the door mirrors.
- For models equipped with automatic intermittent wipers, turn the wipers off.

■ Using High Pressure Cleaners

- Keep sufficient distance between the cleaning nozzle and the vehicle body.
- Take particular care around the windows. Standing too close may cause water to enter the vehicle interior.
- Do not spray high pressure water directly into the engine compartment. Instead, use low pressure water and a mild detergent.

▶▶ Washing the Vehicle

Do not spray water into the air intake vents. It can cause a malfunction.



Do not spray water onto the capless unit when the fuel fill door is open. It can cause damage to the fuel system or engine.

If you need to lift the wiper arms away from the windshield, first set the wiper arms to the maintenance position.

▶ **Changing the Front Wiper Blade Rubber**
P. 601

▶▶ Using an Automated Car Wash

When using an automated car wash that pulls the vehicle through with a conveyor, make sure the transmission is in **N** position.

▶ **If you want to keep the transmission in **N** position** P. 481

■ Applying Wax

A good coat of automotive body wax helps protect your vehicle's paint from the elements. Wax will wear off over time and expose your vehicle's paint to the elements, so reapply as necessary.

■ Maintaining the Bumpers and Other Resin Coated Parts

If you get gasoline, oil, engine coolant, or battery fluid on resin coated parts, they may be stained or the coating may peel. Promptly wipe it away using a soft cloth and clean water.

■ Cleaning the Window

Wipe using a glass cleaner.

■ Maintaining Aluminum Wheels

Aluminum is susceptible to deterioration caused by salt and other road contaminants. When necessary, as early as possible use a sponge and mild detergent to wipe away these contaminants. Do not use a stiff brush or harsh chemicals (including some commercial wheel cleaners). These can damage the protective finish on aluminum alloy wheels, resulting in corrosion. Depending on the type of finish, the wheels also may lose their luster or appear burnished. To avoid water stains, wipe the wheels dry with a cloth while they are still wet.

►► Applying Wax

NOTICE

Chemical solvents and strong cleaners can damage the paint, metal, and plastic on your vehicle. Wipe away spills immediately.

►► Maintaining the Bumpers and Other Resin Coated Parts

Ask a dealer about the correct coating material when you want to repair the painted surface of the parts made of resin.

■ Fogged Exterior Light Lenses

The inside lenses of exterior lights (headlights, brake lights, etc.) may fog temporarily if you have driven in the rain, or after the vehicle has been run through a car wash. Dew condensation also may build up inside the lenses when there is a significant enough difference between the ambient and inside lens temperatures (similar to vehicle windows fogging up in rainy conditions). These conditions are natural processes, not structural design problems in the exterior lights.

Lens design characteristics may result in moisture developing on the light lens frame surfaces. This also is not a malfunction.

However, if you see large amounts of water accumulation, or large water drops building up inside the lenses, have your vehicle inspected by a dealer.

Accessories

When installing accessories, check the following:

- Do not install accessories on the windshield. They can obstruct your view and delay your reaction to driving conditions.
- Do not install any accessories over areas marked SRS Airbag, on the sides or backs of the front seats, on front or side pillars, or near the side windows. Accessories installed in these areas may interfere with proper operation of the vehicle's airbags or may be propelled into you or another occupant if the airbags deploy.
- Be sure electronic accessories do not overload electrical circuits or interfere with proper operation of your vehicle.
 - **Fuses** P. 659
- Before installing any electronic accessory, have the installer contact a dealer for assistance. If possible, have a dealer inspect the final installation.

Accessories and Modifications

WARNING

Improper accessories or modifications can affect your vehicle's handling, stability, and performance, and cause a crash in which you can be seriously hurt or killed.

Follow all instructions in this owner's manual regarding accessories and modifications.

WARNING

Use of improperly designed, engineered or manufactured high-voltage battery assemblies could cause a fire in your vehicle.

A vehicle fire could result in a crash or injury.

Only use a genuine Honda high-voltage battery assembly, or its equivalent, in your vehicle.

Honda Genuine accessories are recommended to ensure proper operation on your vehicle.

Modifications

Do not modify your vehicle in a manner that may affect its handling, stability, or reliability, or install non-genuine Honda parts or accessories that may have a similar effect.

Even minor modifications to vehicle systems can affect overall vehicle performance. Always make sure all equipment is properly installed and maintained, and do not make any modification to your vehicle or its systems that might cause your vehicle to no longer meet federal, state, province, territory, and local regulations.

The on-board diagnostic port (OBD-II/SAE J1962 connector) installed on this vehicle is intended to be used with automobile system diagnostic devices or with other devices that Honda has approved. Use of any other type of device may adversely affect the vehicle's electronic systems or allow them to be compromised, possibly resulting in a system malfunction, drained battery, or other unexpected problems.

Do not modify or attempt to repair your vehicle's high-voltage hybrid power system or otherwise modify vehicle electrical systems. Disassembling or modifying electrical equipment can result in a crash or a fire.

If you ever need to replace your vehicle's high-voltage battery assembly outside of warranty coverage, we highly recommend that you only use a genuine Honda high-voltage battery assembly. Genuine Honda high-voltage battery assemblies are designed to work with your vehicle's hybrid power system and have been designed, engineered and manufactured to avoid overcharging situations. Non-genuine high-voltage battery assemblies may not have been similarly designed, engineered and manufactured, and installation of such assemblies could result in overcharging, fires, loss of power, or other conditions that may increase the likelihood of a crash or injury.

This page intentionally left blank.

Handling the Unexpected

This chapter explains how to handle unexpected troubles.

Tools

Types of Tools..... 628

If a Tire Goes Flat

Temporarily Repairing a Flat Tire..... 629

Handling of the Jack..... 643

Power System Won't Start

Checking the Procedure..... 644

If the Keyless Remote Battery is Weak... 645

Emergency Power System Off..... 646

If the 12-Volt Battery Is Dead 647

Overheating

How to Handle Overheating..... 649

Indicator, Coming On/Blinking

If the Low Oil Pressure Indicator Comes On 652

If the 12-volt Battery Charging System

Indicator Comes On 652

If the Malfunction Indicator Lamp Comes On or Blinks 653

If the Brake System Indicator (Red) Comes On or Blinks 654

If the Brake System Indicator (Red) Comes On or Blinks at the Same Time When the Brake System Indicator (Amber) Comes On.. 655

If the Electric Power Steering (EPS) System Indicator Comes On 656

If the Low Tire Pressure/TPMS Indicator Comes On or Blinks 657

If the Transmission System Indicator Blinks along with the Warning Message... 658

Fuses

Fuse Locations 659

Inspecting and Changing Fuses..... 662

Emergency Towing..... 663

If You Cannot Open the Tailgate 664

Refueling 665

Types of Tools

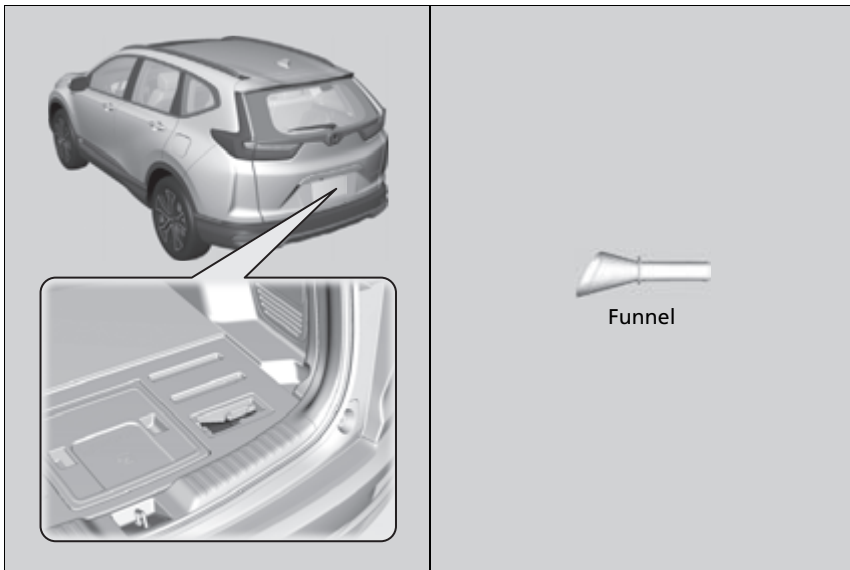

Types of Tools

The tools are stored in the cargo area.

Temporarily Repairing a Flat Tire

If the tire has a large cut or is otherwise severely damaged, you will need to have the vehicle towed. If the tire only has a small puncture, from a nail for instance, you can use the temporary tire repair kit so that you can drive to the nearest service station for a more permanent repair.

If a tire goes flat while driving, grasp the steering wheel firmly, and brake gradually to reduce speed. Then, stop in a safe place.

1. Park the vehicle on a firm, level, non-slippery surface and apply the parking brake.
2. Put the transmission into **P**.
3. Turn on the hazard warning lights and set the power mode to VEHICLE OFF (LOCK).

Temporarily Repairing a Flat Tire

The kit should not be used in the following situations. Instead, contact a dealer or roadside assistance to have the vehicle towed.

- The tire sealant has expired.
- More than one tire is punctured.
- The puncture or cut is larger than 3/16 inch (4.8 mm).
- The tire side wall is damaged or the puncture is outside the contact area.



When the puncture is:	Kit Use
Smaller than 3/16 inch (4.8 mm)	Yes
Larger than 3/16 inch (4.8 mm)	No

- Damage has been caused by driving with the tire extremely under inflated.
- The tire bead is no longer seated.
- The rim is damaged.

Do not remove a nail or screw that punctured the tire. If you remove it from the tire, you may not be able to repair the puncture using the kit.

■ Getting Ready to Temporarily Repair the Flat Tire

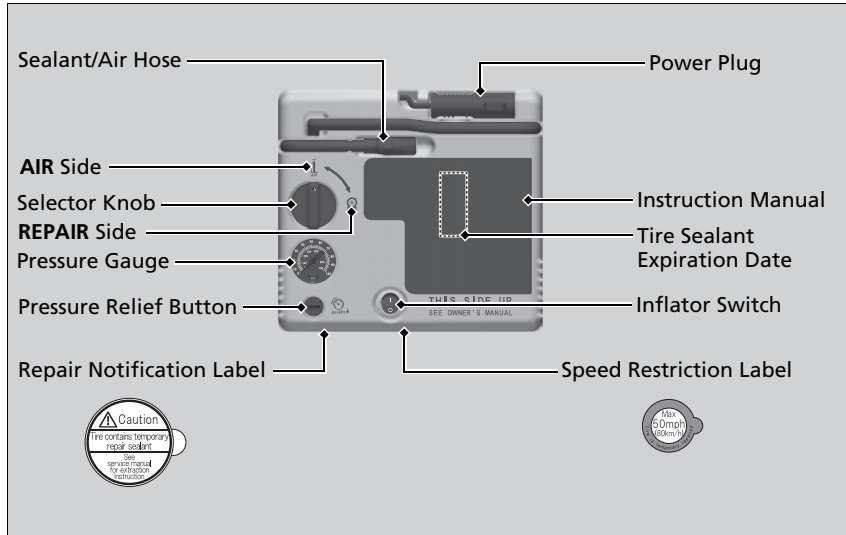

▶▶ Getting Ready to Temporarily Repair the Flat Tire

Repair notification label and speed restriction label are applied to the side of the temporary tire repair kit.

When making a temporary repair, carefully read the instruction manual provided with the kit.

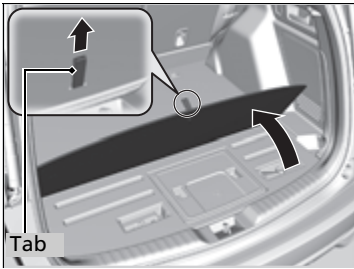

1. Using the tab, fold back the cargo area floor lid.

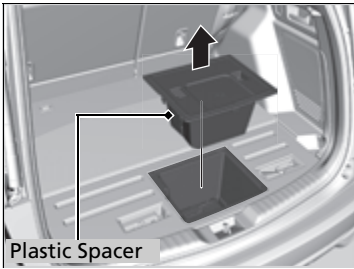

2. Remove the plastic spacer from the cargo area.

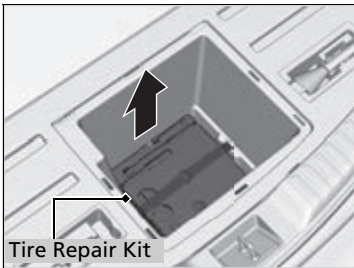

3. Unfasten the strap and remove the tire repair kit.

4. Place the kit face up, on flat ground near the flat tire, and away from traffic. Do not place the kit on its side.

■ Injecting Sealant and Air

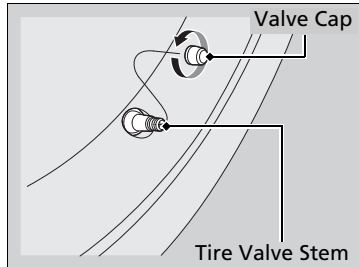

1. Remove the valve cap from the tire valve stem.

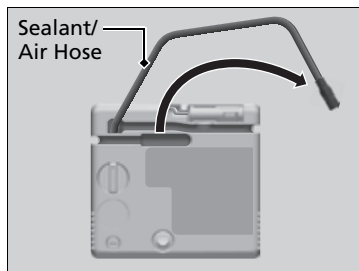

2. Unwind the sealant/air hose from the kit.

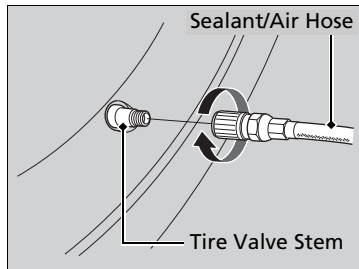

3. Attach the sealant/air hose onto the tire valve stem. Screw it clockwise until it is tight.

▶▶ Injecting Sealant and Air

⚠ CAUTION

Tire sealant contains substances that are harmful if inhaled, ingested or if contact is made with the eyes or skin.

Always use in a well-ventilated area and use gloves and safety glasses for protection; do not ingest.

For skin or eye contact, flush with cool water; if ingested, rinse mouth with water. In all cases, seek medical attention if necessary.

In cold temperatures, the sealant may not flow easily. In this situation, warm it up for five minutes before using.

The sealant can permanently stain clothing and other materials. Be careful during handling and wipe away any spills immediately.

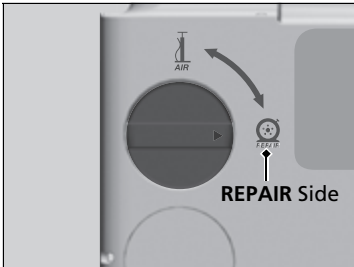
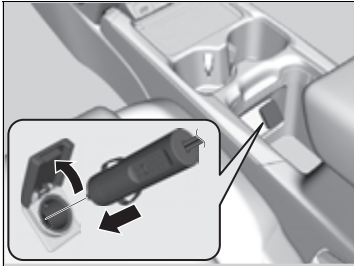

4. Plug in the compressor to the accessory power socket.
 - ▶ Be careful not to pinch the cord in a door or window.
 - ✦ **Accessory Power Socket** P. 229
5. Turn on the vehicle's power system.
 - ✦ **Turning on the Power** P. 469
 - ▶ Keep the power system on while injecting sealant and air.
 - ✦ **Carbon Monoxide Gas** P. 86
6. Turn the selector knob to **REPAIR**.

✦ Injecting Sealant and Air

⚠ WARNING

Running the engine with the vehicle in an enclosed or even partly enclosed area can cause a rapid buildup of toxic carbon monoxide.

Breathing this colorless, odorless gas can cause unconsciousness and even death. Only run the engine to power the air compressor with the vehicle outdoors.

NOTICE

Do not operate the temporary tire repair kit compressor for more than 15 minutes. The compressor can overheat and become permanently damaged.

Until the sealant injection is complete, the pressure shown on the pressure gauge will appear higher than actual. After the sealant injection is complete the pressure will drop and then begin to rise again as the tire is inflated with air. This is normal. To accurately measure the air pressure using the gauge, turn the air compressor off only after the sealant injection is complete.

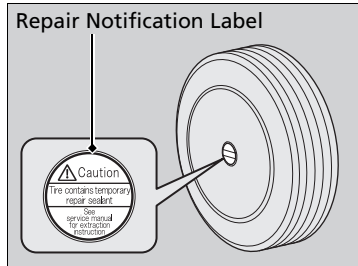
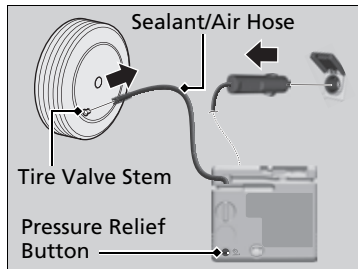
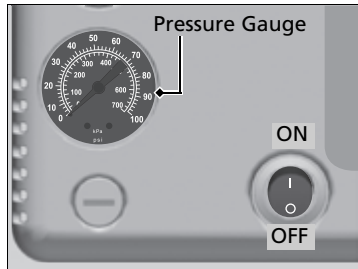

7. Press the inflator switch to turn on the kit.
 - ▶ The compressor starts injecting sealant and air into the tire.
 - ▶ When the sealant injection is complete, continue to add air.
8. After the tire reaches the specified air pressure, turn off the kit.
 - ▶ To check the pressure, periodically turn off the compressor and read the gauge.
 - ▶ Refer to the driver's doorjamb label for the specified pressure.
9. Unplug the power plug from the accessory power socket.
10. Unscrew the sealant/air hose from the tire valve stem. Reinstall the valve cap.
11. Press the pressure relief button until the gauge returns to 0 psi (0 kPa).
12. Apply the repair notification label to the flat surface of the wheel.
 - ▶ The wheel surface must be clean to ensure the label adheres properly.

▶▶ Injecting Sealant and Air

If the required air pressure is not reached within 10 minutes, the tire may be too severely damaged for the kit to provide the necessary seal, and your vehicle will need to be towed.

See a dealer for a replacement sealant bottle and proper disposal of an empty bottle.

■ Distributing the Sealant in the Tire

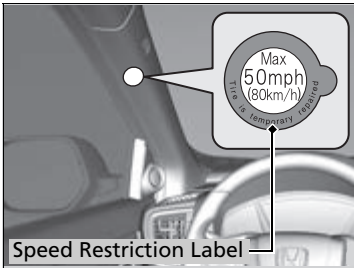

1. Apply the speed restriction label to the location as shown.
2. Drive the vehicle for about 10 minutes.
 - ▶ Do not exceed 50 mph (80 km/h).
3. Stop the vehicle in a safe place.

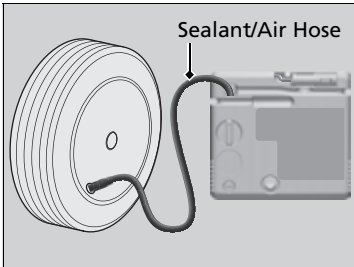

4. Recheck the air pressure using the sealant/air hose on the compressor.

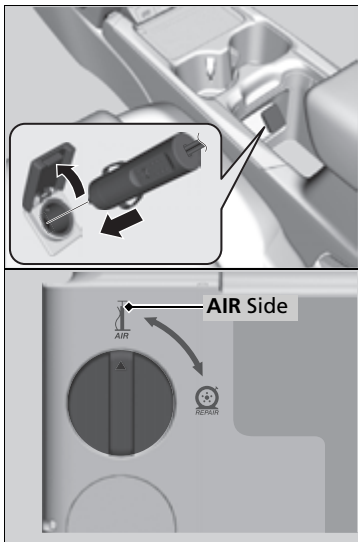

5. Turn the selector knob to **AIR**.

- ▶ Do not turn the air compressor on while checking the pressure.

☑ **Inflating an Under-inflated Tire** P. 640

▶▶ Distributing the Sealant in the Tire

⚠ WARNING

Running the engine with the vehicle in an enclosed or even partly enclosed area can cause a rapid buildup of toxic carbon monoxide.

Breathing this colorless, odorless gas can cause unconsciousness and even death. Only run the engine to power the air compressor with the vehicle outdoors.

6. If the air pressure is

- Less than 25 psi (175 kPa):

Do not add air or continue driving. The leak is too severe. Call for help and have your vehicle towed.

➤ **Emergency Towing** P. 663

Models with 235/65R17 104H tires

- Front: 32 psi (220 kPa)/rear: 30 psi (210 kPa) or more:

Models with 235/60R18 103H tires

- Front: 35 psi (240 kPa)/rear: 32 psi (220 kPa) or more:

Models with 235/55R19 101H tires

- 33 psi (230 kPa) or more:

Continue driving for another 10 minutes or until you reach the nearest service station, whichever is sooner. Do not exceed 50 mph (80 km/h). If you have not reached a service station, stop and check the tire pressure.

▶ If the air pressure does not go down after the 10 minute driving, you do not need to check the pressure any more.

Models with 235/65R17 104H tires

- Greater than 25 psi (175 kPa), but less than front: 32 psi (220 kPa)/rear: 30 psi (210 kPa):

Turn the air compressor on to inflate the tire until the tire pressure reaches front: 32 psi (220 kPa)/rear: 30 psi (210 kPa).

➔ **Inflating an Under-inflated Tire** P. 640

Models with 235/60R18 103H tires

- Greater than 25 psi (175 kPa), but less than front: 35 psi (240 kPa)/rear: 32 psi (220 kPa):

Turn the air compressor on to inflate the tire until the tire pressure reaches front: 35 psi (240 kPa)/rear: 32 psi (220 kPa).

➔ **Inflating an Under-inflated Tire** P. 640

Models with 235/55R19 101H tires

- Greater than 25 psi (175 kPa), but less than 33 psi (230 kPa):

Turn the air compressor on to inflate the tire until the tire pressure reaches 33 psi (230 kPa).

➔ **Inflating an Under-inflated Tire** P. 640

All models

Then, drive carefully for 10 more minutes or until you reach the nearest service station, whichever is sooner. Do not exceed 50 mph (80 km/h). If you have not reached a service station, stop and check the tire pressure.

- ▶ You should repeat this procedure as long as the air pressure is not within the range indicated for the tire size.

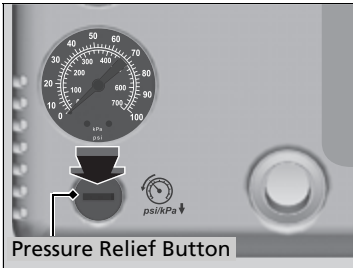

7. Unplug the kit from the accessory power socket.
8. Unscrew the sealant/air hose from the tire valve stem. Reinstall the valve cap.
9. Press the pressure relief button until the gauge returns to 0 psi (0 kPa).
10. Repackage and properly stow the kit.

■ Inflating an Under-inflated Tire

You can use the kit to inflate a non-punctured under-inflated tire.

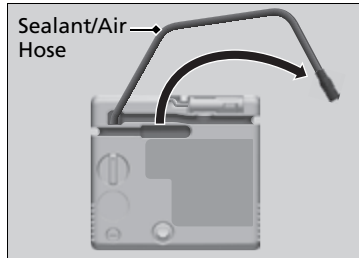

1. Open the trunk floor lid.
 ✘ Getting Ready to Temporarily Repair the Flat Tire P. 630
2. Remove the kit from the case.
3. Place the kit, face up, on flat ground near the tire to be inflated, away from traffic.
 Do not place the kit on its side.
4. Remove the sealant/air hose from the kit.
5. Remove the valve cap.

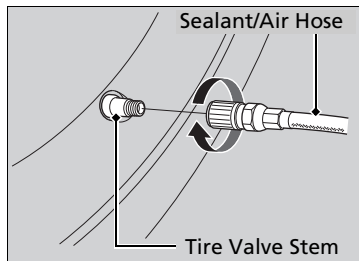
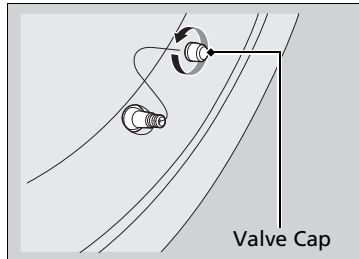

6. Attach the sealant/air hose onto the tire valve stem. Screw it clockwise until it is tight.

▶▶ Inflating an Under-inflated Tire

NOTICE

Do not operate the temporary tire repair kit compressor for more than 15 minutes. The compressor can overheat and become permanently damaged.

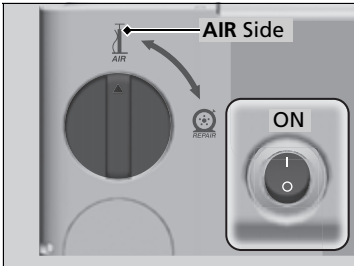
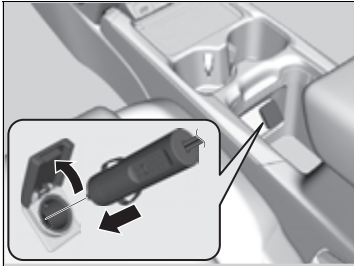

7. Plug in the kit to the accessory power socket.
 - ▶ Be careful not to pinch the cord in a door or window.
 - ✦ **Accessory Power Socket** P. 229
8. Turn on the vehicle's power system.
 - ✦ **Turning on the Power** P. 469
 - ▶ Keep the power system on while injecting sealant and air.
 - ✦ **Carbon Monoxide Gas** P. 86
9. Turn the selector knob to **AIR**.
10. Press the inflator switch to turn on the kit.
 - ▶ The compressor starts to inject air into the tire.
11. Inflate the tire to the specified air pressure.

▶▶ Inflating an Under-inflated Tire

⚠ WARNING

Running the engine with the vehicle in an enclosed or even partly enclosed area can cause a rapid buildup of toxic carbon monoxide.

Breathing this colorless, odorless gas can cause unconsciousness and even death. Only run the engine to power the air compressor with the vehicle outdoors.

Continued

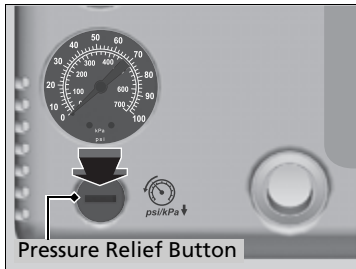

- 12.** Turn off the kit.
 - ▶ Check the pressure gauge on the air compressor.
 - ▶ If overinflated, press the pressure relief button.
- 13.** Unplug the kit from the accessory power socket.
- 14.** Unscrew the sealant/air hose from the tire valve stem. Reinstall the valve cap.
- 15.** Press the pressure relief button until the gauge returns to 0 psi (0 kPa).
- 16.** Repackage and properly stow the kit.

Handling of the Jack

Your vehicle has jacking points as shown.
When replacing your tires, consult a dealer.

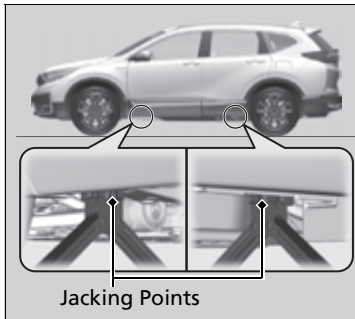

Checking the Procedure

When the **READY** indicator does not come on and the **Ready To Drive** message does not appear on the driver information interface, check the following items and take appropriate action.

☒ Checking the Procedure

If you must start the vehicle immediately, use an assisting vehicle or booster battery to jump start it.

☒ **If the 12-Volt Battery Is Dead** P. 647

Checklist	Condition	What to Do
Check if the related indicator or driver information interface messages come on.	The Temperature Is Too Cold For Vehicle To Operate message appears.	☒ Driver Information Interface Warning and Information Messages P. 109
	The To Start, Hold Remote Near Start Button message appears. ▶ Make sure the keyless remote is in its operating range. ☒ POWER Button Operating Range P. 186	
	The POWER SYSTEM indicator comes on.	Have your vehicle checked by a dealer.
	The transmission system indicator blinks and Transmission Problem. Apply Parking Brake When Parked message appears.	☒ If the Transmission System Indicator Blinks along with the Warning Message P. 658
Check the brightness of the interior lights.	The interior lights are dim or do not come on at all.	Have the 12-volt battery checked by a dealer.
	The interior lights come on normally.	Check all fuses, or have your vehicle checked by a dealer. ☒ Inspecting and Changing Fuses P. 662
Check the shift position.	The transmission is not in P .	Put the transmission into P .
Check the immobilizer system indicator.	When the immobilizer system indicator is blinking, the power system cannot be turned on.	☒ Immobilizer System Indicator P. 101

If the Keyless Remote Battery is Weak

If the beeper sounds, the **To Start, Hold Remote Near Start Button** message appears on the driver information interface, the **POWER** button flashes, and the **READY** indicator does not come on, turn on the power system as follows:

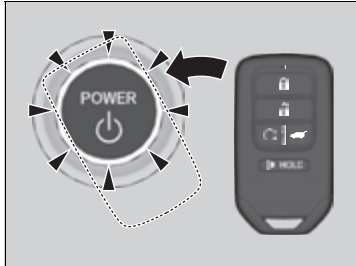

1. Touch the center of the **POWER** button with the **H** logo on the keyless remote while the **POWER** button is flashing. The buttons on the keyless remote should be facing you.
 - ▶ The **POWER** button flashes for about 30 seconds.

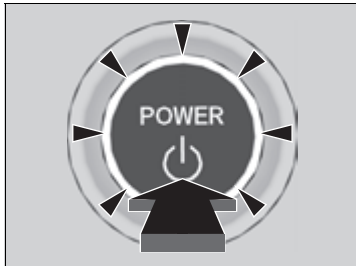

2. Depress the brake pedal and press the **POWER** button within 10 seconds after the beeper sounds and the **POWER** button changes from flashing to on.
 - ▶ The **READY** indicator comes on.
 - ▶ If you don't depress the pedal, the mode will change to ACCESSORY.

Emergency Power System Off

The **POWER** button may be used to turn the power system off due to an emergency situation even while driving. If you must turn the power system off, do either of the following operations:

- Press and hold the **POWER** button for about two seconds.
- Firmly press the **POWER** button three times.

The steering wheel will not lock. However, because turning off the power system disables the power assist the power system provides to the steering and braking systems, it will require significantly more physical effort and time to steer and slow the vehicle. Use both feet on the brake pedal to slow down the vehicle and stop immediately in a safe place.

The transmission automatically changes to **P** after the vehicle comes to a complete stop. Then, the power mode changes to VEHICLE OFF.

⌘ Emergency Power System Off

Do not press the **POWER** button while driving unless it is absolutely necessary for the power system to be turned off.

If you press the **POWER** button while driving, the beeper sounds.

If the 12-Volt Battery Is Dead

Jump Starting Procedure

Turn off the power to electric devices, such as audio and lights. Turn off the power system, then open the hood.

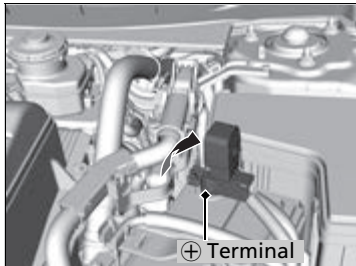

1. Open the terminal cover on your vehicle's 12-volt battery positive \oplus terminal.

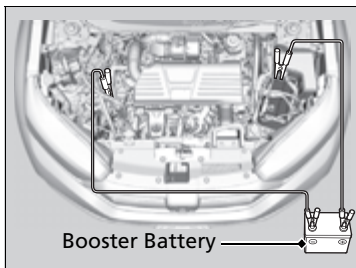

2. Connect the first jumper cable to your vehicle's 12-volt battery \oplus terminal.
3. Connect the other end of the first jumper cable to the booster battery \oplus terminal.
 - ▶ Use a 12-volt booster battery only.
 - ▶ When using an automotive battery charger to boost your 12-volt battery, select a lower charging voltage than 15-volt. Check the charger manual for the proper setting.
4. Connect the second jumper cable to the booster battery \ominus terminal.

Jump Starting Procedure

⚠ WARNING

A 12-volt battery can explode if you do not follow the correct procedure, seriously injuring anyone nearby.

Keep all sparks, open flames, and smoking materials away from the 12-volt battery.

Securely attach the jumper cables clips so that they do not come off when the engine vibrates. Be careful not to tangle the jumper cables or allow the cable ends to touch each other while attaching or detaching the jumper cables.

12-volt battery performance degrades in cold conditions and may prevent the engine from starting.

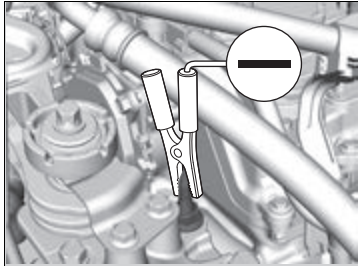

5. Connect the other end of the second jumper cable to the engine mounting bolt as shown. Do not connect this jumper cable to any other part.
6. If your vehicle is connected to another vehicle, start the assisting vehicle's engine and increase its rpm slightly.
7. Attempt to start your vehicle's engine. If it turns over slowly, check that the jumper cables have good metal-to-metal contact.

■ What to Do After the Engine Starts

Once your vehicle's engine has started, remove the jumper cables in the following order.

1. Disconnect the jumper cable from your vehicle's ground.
2. Disconnect the other end of the jumper cable from the booster battery ⊖ terminal.
3. Disconnect the jumper cable from your vehicle's 12-volt battery ⊕ terminal.
4. Disconnect the other end of the jumper cable from the booster battery ⊕ terminal.

Have your vehicle inspected by a nearby service station or a dealer.

▶▶ Jump Starting Procedure

The indicators for the Adaptive Cruise Control (ACC) with Low Speed Follow, Road Departure Mitigation, Vehicle Stability Assist™ (VSA®) system, Vehicle Stability Assist™ (VSA®) OFF, Collision Mitigation Braking System™ (CMBS™), low tire pressure/TPMS, and Parking Brake and Brake System (Amber) may come on along with a message in the Driver Information Interface when you set the power mode to ON after reconnecting the 12-volt battery. Drive a short distance at more than 12 mph (20 km/h). Each indicator should go off. If any do not, have your vehicle checked by a dealer.

How to Handle Overheating

Overheating symptoms are as follows:

- The **High Temperature. Power Reduced.** message appears on the driver information interface.
- The **Stop Driving When Safe. Engine Temperature Too Hot** message appears on the driver information interface.
- Steam or spray comes out of the engine compartment.

■ The High Temperature. Power Reduced. Message Appears on the Driver Information Interface

The **High Temperature. Power Reduced.** message appears on the driver information interface when the power system temperature is high.

🔔 **Driver Information Interface Warning and Information Messages** P. 109

1. Immediately park the vehicle in a safe place.
 - ▶ Set the parking brake, and put the transmission into **P**. Turn off all accessories and turn on the hazard warning lights.
2. Keep the power mode in ON, and wait until the message disappears.
 - ▶ If the message does not disappear, have your vehicle inspected at a dealer.

■ The Stop Driving When Safe. Engine Temperature Too Hot Message Appears on the Driver Information Interface

■ First thing to do

1. Immediately park the vehicle in a safe place.
2. Turn off all accessories and turn on the hazard warning lights.
 - ▶ **No steam or spray present:** Keep the power system on and open the hood.
 - ▶ **Steam or spray is present:** Turn off the power system and wait until it subsides. Then, open the hood.

⌘ How to Handle Overheating

⚠ WARNING

Steam and spray from an overheated engine can seriously scald you.

Do not open the hood if steam is coming out.

NOTICE

Continuing to drive with the **Stop Driving When Safe. Engine Temperature Too Hot** message on the driver information interface may damage the engine.

■ Next thing to do

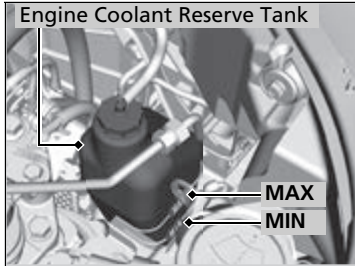

1. Check that the cooling fan is operating and turn the power system off once the **Stop Driving When Safe. Engine Temperature Too Hot** message on the driver information interface disappears.
 - ▶ If the cooling fan is not operating, immediately turn the power system off.
2. Once the engine has cooled down, inspect the coolant level and check the cooling system components for leaks.
 - ▶ If the coolant level in the engine coolant reserve tank is low, add coolant until it reaches the **MAX** mark.
 - ▶ If there is no coolant in the engine coolant reserve tank, check that the radiator is cool. Cover the radiator cap with a heavy cloth and open the cap. If necessary, add coolant up to the base of the filler neck, and put the cap back on.

■ Last thing to do

Once the engine has cooled sufficiently, turn the power system on.

If the **Stop Driving When Safe. Engine Temperature Too Hot** message does not appear, resume driving. If it appears again, contact a dealer for repairs.

▶▶ How to Handle Overheating

⚠ WARNING

Removing the radiator cap while the engine is hot can cause the coolant to spray out, seriously scalding you.

Always let the engine and radiator cool down before removing the radiator cap.

If the coolant is leaking, contact a dealer for repairs.

Use water as an emergency/temporary measure only. Have a dealer flush the system with proper antifreeze as soon as possible.

If the Low Oil Pressure Indicator Comes On



■ Reasons for the indicator to come on

Comes on when the engine oil pressure is low.

■ What to do as soon as the indicator comes on

1. Immediately park the vehicle on level ground in a safe place.
2. If necessary, turn the hazard warning lights on.

■ What to do after parking the vehicle

1. Turn the power system off and let the engine sit for approximately three minutes.
2. Open the hood and check the oil level.
 - ▶ Add oil as necessary.
 - 📖 **Oil Check** P. 589
3. Start the engine and check the low oil pressure indicator.
 - ▶ The indicator goes off: Start driving again.
 - ▶ The indicator does not go off within 10 seconds: Immediately turn the power system off and contact a dealer for repairs.

If the 12-volt Battery Charging System Indicator Comes On



■ Reasons for the indicator to come on

Comes on when there is a problem with the charging system.

■ What to do when the indicator comes on

Turn off the climate control system, rear defogger, and other electrical systems, and immediately contact a dealer for repairs.

🔗 If the Low Oil Pressure Indicator Comes On

NOTICE

Running the engine with low oil pressure can cause serious mechanical damage almost immediately.

🔗 If the 12-volt Battery Charging System Indicator Comes On

If you need to stop temporarily, do not turn off the power system. The power system uses the 12-volt battery to activate. You may not be able to turn the power system on again if you have turned it off with this indicator on.

This indicator may come on when the outside temperature is below -40°F (-40°C). It will go off after the battery warms up.

If the Malfunction Indicator Lamp Comes On or Blinks



■ Reasons for the indicator lamp to come on or blink

- Comes on when there is a problem with the engine emissions control system.
- Blinks when engine misfiring is detected.

■ What to do when the indicator lamp comes on

Avoid high speeds and immediately get your vehicle inspected at a dealer.

■ What to do when the indicator lamp blinks

Park the vehicle in a safe place with no flammable items and wait at least 10 minutes or more with the engine stopped until it cools.

▶▶ If the Malfunction Indicator Lamp Comes On or Blinks

NOTICE

If you drive with the malfunction indicator lamp on, the emissions control system and the engine could be damaged.

If the malfunction indicator lamp blinks again when restarting the engine, drive to the nearest dealer at 31 mph (50 km/h) or less. Have your vehicle inspected.

If the Brake System Indicator (Red) Comes On or Blinks



■ Reasons for the indicator to come on

- The brake fluid is low.
- There is a malfunction in the brake system.

■ What to do when the indicator comes on while driving

Depress the brake pedal lightly to check pedal pressure.

- If normal, check the brake fluid level the next time you stop.
- If abnormal, take immediate action. If necessary, use the deceleration paddle selector to slow the vehicle using regenerative braking.

■ Reasons for the indicator to blink

- There is a problem with the electric parking brake system.

■ What to do when the indicator blinks

Avoid using the parking brake and have your vehicle checked by a dealer immediately.

☒ If the Brake System Indicator (Red) Comes On or Blinks

Have your vehicle repaired immediately.

It is dangerous to drive with low brake fluid. If there is no resistance from the brake pedal, stop immediately in a safe place. If necessary use the deceleration paddle selector to slower your vehicle's speed.

If the brake system indicator (red) and **ABS** indicator come on simultaneously, the electronic brake distribution system is not working. This can result in vehicle instability under sudden braking. Have your vehicle inspected by a dealer immediately.

If the brake system indicator (red) blinks at the same time when the brake system indicator (amber) comes on, the parking brake may not work. Avoid using the parking brake and have your vehicle checked by a dealer immediately.

☒ **If the Brake System Indicator (Red) Comes On or Blinks at the Same Time When the Brake System Indicator (Amber) Comes On**
P. 655

If the Brake System Indicator (Red) Comes On or Blinks at the Same Time When the Brake System Indicator (Amber) Comes On

BRAKE

**BRAKE
SYSTEM**

■ **If the brake system indicator (red) comes on or blinks at the same time when the brake system indicator (amber) comes on, release the parking brake manually or automatically**

➤ **Parking Brake** P. 551

- If the brake system indicator (red) continuously comes on or blinks at the same time when the brake system indicator (amber) comes on, stop the vehicle in a safe place and have it inspected by a dealer immediately.
 - Preventing the vehicle from moving, put the transmission into **P**.
- If only the brake system indicator (red) is turned off, avoid using the parking brake and have your vehicle checked by a dealer immediately.

⌘ If the Brake System Indicator (Red) Comes On or Blinks at the Same Time When the Brake System Indicator (Amber) Comes On

If you apply the parking brake, you may not be able to release it.

If the brake system indicator (red) and the brake system indicator (amber) come on at the same time, the parking brake is working.

If the brake system indicator (red) blinks at the same time when the brake system indicator (amber) comes on, the parking brake may not work because it is checking the system.

If the Electric Power Steering (EPS) System Indicator Comes On



■ Reasons for the indicator to come on

- Comes on when there is a problem with the EPS system.

■ What to do when the indicator comes on

- Stop the vehicle in a safe place and turn on the power system again. If the indicator comes on and stays on, immediately have your vehicle inspected by a dealer.

If the Low Tire Pressure/TPMS Indicator Comes On or Blinks



■ Reasons for the indicator to come on or blink

A tire pressure is significantly low, or the TPMS has not been calibrated. If there is a problem with the TPMS, the indicator blinks for about one minute, and then stays on.

■ What to do when the indicator comes on

Drive carefully and avoid abrupt cornering and hard braking. Stop your vehicle in a safe place. Check the tire pressure and adjust the pressure to the specified level. The specified tire pressure is on a label on the driver side doorjamb.

▶ Calibrate the TPMS after the tire pressure is adjusted.

➤ **TPMS Calibration** P. 494

■ What to do when the indicator blinks, then remains on

Have the tire inspected by a dealer as soon as possible.

▶▶ If the Low Tire Pressure/TPMS Indicator Comes On or Blinks

NOTICE

Driving on an extremely underinflated tire can cause it to overheat. An overheated tire can fail. Always inflate your tires to the prescribed level.

If the Transmission System Indicator Blinks along with the Warning Message

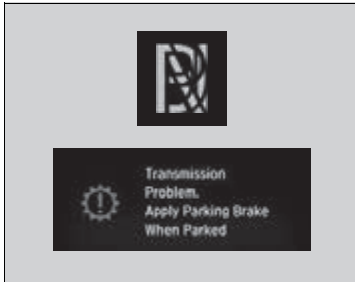

■ Reasons for the indicator to blink

The transmission is malfunctioning.

■ What to do when the indicator blinks

- Immediately have your vehicle inspected by a dealer.

⚠ If the Transmission System Indicator Blinks along with the Warning Message

You may not be able to turn on the power system.

Make sure to set the parking brake when parking your vehicle.

Call a professional towing service if you need to tow your vehicle.

➡ **Emergency Towing** P. 663

Fuse Locations

If any electrical devices are not working, set the power mode to VEHICLE OFF and check the power mode to VEHICLE OFF and check to see if any applicable fuse is blown.

■ Engine Compartment Fuse Box Type A

Located near the brake fluid reservoir. Push the tabs to open the box.

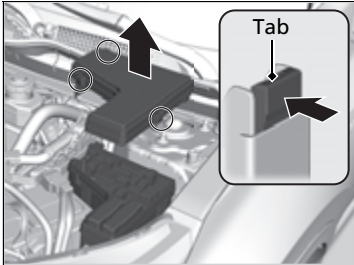

Fuse locations are shown on the fuse box cover. Locate the fuse in question by the fuse number and box cover number.

■ Circuit protected and fuse rating

	Circuit Protected	Amps
1	OP BLOCK 2	40 A
	ESB	(40 A)
	ABS/VSA FSR	40 A
	R/M 1	30 A
	IG MAIN 2	30 A
	R/M 2	30 A
	MAIN FUSE	150 A
2	EPS	70 A
	IG MAIN 1	30 A
	FUSE BOX OPTION	40 A
	FUSE BOX 1	60 A
	FRONT WIPER MOTOR	30 A
3	P-ACT	30 A
	REAR DEFROSTER	40 A
	–	(30 A)
	FUSE BOX 2	40 A
	ABS/VSA MOTOR	40 A
	–	(40 A)
	BLOWER MOTOR	40 A
POWER TAILGATE*	(40 A)	
4	OP BLOCK 1*	(40 A)
	AWD	(20 A)
	IG HOLD 2	(20 A)
5	–	–
6	WASHER	15 A

	Circuit Protected	Amps
7	IGP	15 A
8	FI SUB	15 A
9	STOP LIGHTS	10 A
10	IG HOLD 1	10 A
11	IGPS	7.5 A
12	FI ECU	10 A
13	PCU EWP	10 A
14	HAZARD	10 A
15	IG COIL	15 A
16	RFC COIL	5 A
17	FRONT DEICER*	(15 A)
18	BACK UP	10 A
19	AUDIO	15 A
20	AUDIO AMP*	(20 A)
21	–	–
22	SHUTTER GRILLE	10 A
23	A/C WATER PUMP	10 A
24	HORN	10 A
25	–	–
26	–	–
27	–	–

* Not available on all models

■ Engine Compartment Fuse Box Type B

Located inside the driver side of the front bumper.

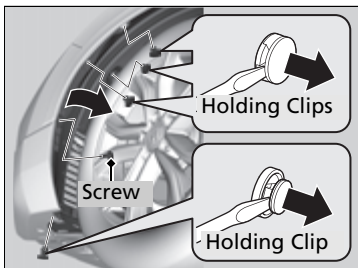

1. Turn the steering wheel to the right.
2. Remove the holding clips and screw, and pull the inner fender back.

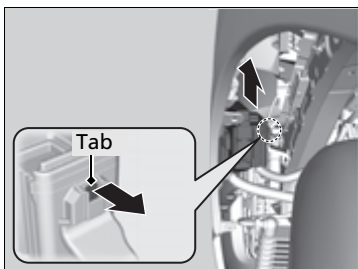

3. Pull the tab to remove the fuse box.

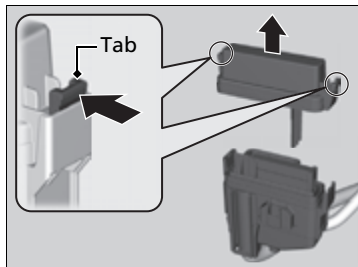

4. Pull out the fuse box inside the inner fender, then push the tabs to open the box.

Fuse locations are shown on the fuse box cover. Locate the fuse in question by the fuse number and box cover number.

■ Circuit protected and fuse rating

	Circuit Protected	Amps
1	PTC2	(40 A)
	—	(20 A)
	PTC4	(40 A)
	EVTC	(20 A)
	MAIN FAN	(40 A)
	E/W PUMP	(30 A)

Interior Fuse Box

Located under the dashboard.

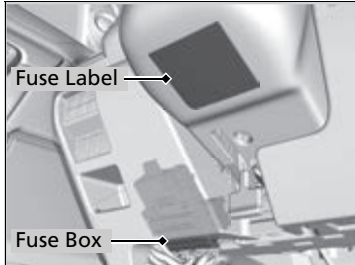

Fuse locations are shown on the label on the steering column lower cover. Locate the fuse in question by the fuse number and label number.

■ Circuit protected and fuse rating

	Circuit Protected	Amps
1	ACCESSORY	10 A
2	ACC KEY LOCK	5 A
3	IG1 P-DRV	5 A
4	IG1 OPTION 2	5 A
5	IG1 OPTION	10 A
6	IG1 SRS 2	10 A
7	IG1 METER	10 A
8	IG1 FUEL PUMP	15 A
9	IG2 A/C	10 A
10	CTR ACCESSORY SOCKET	(20 A)
11	IG1 MONITOR	5 A
12	R SIDE DOOR LOCK	10 A
13	L SIDE DOOR UNLOCK	10 A
14	P/W RR L	20 A
15	P/W AS	20 A
16	DOOR LOCK	20 A
17	IG1 TCU	(10 A)
18	DR POWER LUMBAR*	(10 A)
19	MOONROOF*	(20 A)
20	IG1 STARTER	10 A
21	IG1 ACG	10 A
22	IG2 DAYTIME LIGHT	10 A
23	USB CHARGER*	(7.5 A)
24	+B OPTION	5 A
25	DR DOOR LOCK	(10 A)

	Circuit Protected	Amps
26	R SIDE DOOR UNLOCK	10 A
27	P/W RR R	20 A
28	P/W DR	20 A
29	FR ACCESSORY SOCKET*	20 A
30	SMART	10 A
31	DR P/SEAT RECLINE*	(20 A)
32	FR HEATED SEAT*	(20 A)
33	DR P/SEAT SLIDE*	(20 A)
34	IG1 ABS/VSA	10 A
35	IG1 SRS	10 A
36	HAC OPTION	20 A
37	+B TRAILER	15 A
38	L SIDE DOOR LOCK	10 A
39	DR DOOR UNLOCK	(10 A)
a	PTG*	(20 A)
b	AS P/SEAT SLIDE*	(20 A)
c	AS P/SEAT RECLINE*	(20 A)
d	SUNSHADE*	(20 A)
e	IMA 1	10 A
f	RR HEATED SEAT*	(20 A)
g	HEATED STRG*	(10 A)
h	SBW	15 A

* Not available on all models

Inspecting and Changing Fuses

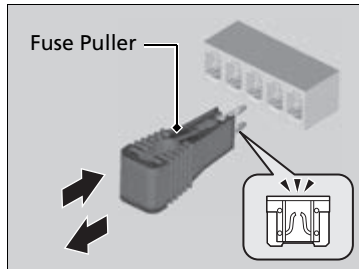
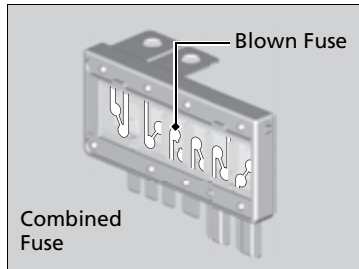

1. Set the power mode to VEHICLE OFF. Turn headlights and all accessories off.
2. Remove the fuse box cover.
3. Check the large fuse in the engine compartment.
 - If the fuse is blown, use a Phillips-head screwdriver to remove the screw and replace it with a new one.
4. Inspect the small fuses in the engine compartment and the vehicle interior.
 - If there is a blown fuse, remove it with the fuse puller and replace it with a new one.

► Inspecting and Changing Fuses

NOTICE

Replacing a fuse with one that has a higher rating greatly increases the chances of damaging the electrical system.

Use the charts to locate the fuse in question and confirm the specified amperage on the fuse label.

► **Fuse Locations** P. 659

Replace fuse with a spare fuse of the same specified amperage.

There is a fuse puller in the engine compartment fuse box type A.

Call a professional towing service if you need to tow your vehicle.

■ Flatbed equipment

The operator loads your vehicle on the back of a truck.

This is the only way you can safely transport your vehicle.

Any other towing method will damage the vehicle's drive system.

» Emergency Towing

NOTICE

Trying to lift or tow your vehicle by the bumpers will cause serious damage. The bumpers are not designed to support the vehicle's weight.

Improper towing such as towing behind a motorhome or other motor vehicle can damage the transmission.

Never tow your vehicle with just a rope or chain. It is very dangerous since ropes or chains may shift from side to side or break.

If You Cannot Open the Tailgate

What to Do If Unable to Open the Tailgate

If you cannot open the tailgate, use the following procedure.

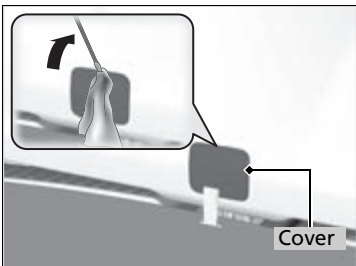

1. Use a flat-tip screwdriver and remove the cover on the inside of the tailgate.
 - ▶ Wrap the flat-tip screwdriver with a cloth to prevent scratches.

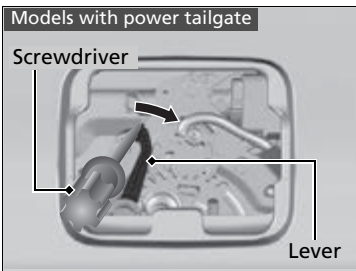

2. To open the tailgate, push the tailgate while pushing the lever to the right with the flat-tip screwdriver.

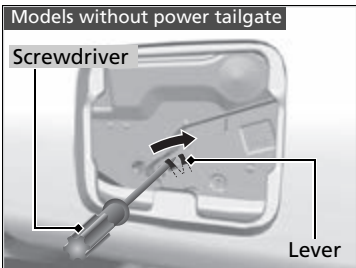

What to Do If Unable to Open the Tailgate

Following up:

After taking these steps, contact a dealer to have the vehicle checked.

When you open the tailgate from inside, make sure there is enough space around the tailgate, and it does not hit anyone or any object.

Refueling From a Portable Fuel Container

If you have run out of fuel and need to refuel your vehicle from a portable fuel container, use the funnel provided with your vehicle.

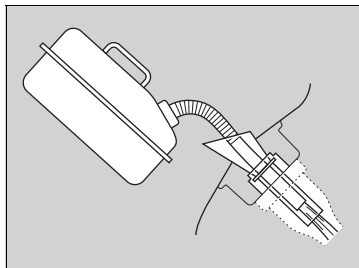
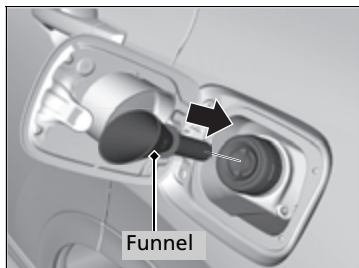

1. Turn off the power system.
2. Pull on the fuel fill door release handle under the lower left corner of the dashboard.
 - ▶ The fuel fill door opens.
3. Take the funnel out of the tool case in the cargo area.
 - ▶ **Types of Tools** P. 628
4. Place the end of the funnel on the lower part of filler opening, then insert it slowly and fully.
 - ▶ Make sure that the end of the funnel goes down along with the filler pipe.
5. Fill the tank with fuel from the portable fuel container.
 - ▶ Pour fuel carefully so you do not spill any.
6. Remove the funnel from the filler neck.
 - ▶ Wipe up any fuel from the funnel before storing it.
7. Shut the fuel fill door by hand.

Refueling From a Portable Fuel Container

WARNING

Gasoline is highly flammable and explosive. You can be burned or seriously injured when handling fuel.

- Turn the power system off, and keep heat, sparks, and flames away.
- Handle fuel only outdoors.
- Wipe up spills immediately.

NOTICE

Do not insert the nozzle of a portable fuel container or any funnel other than the one provided with your vehicle. Doing so can damage the fuel system. Do not try to pry open or push open the sealed fuel tank with foreign objects. This can damage the fuel system and its seal.

Make sure the fuel in the portable fuel container is gasoline before you refuel.

This page intentionally left blank.

Information

This chapter includes your vehicle's specifications, locations of identification numbers, and other information required by regulation.

Specifications	668
Identification Numbers	
Vehicle Identification Number (VIN), Engine Number, Motor Number, and Transmission Number.....	670
Devices that Emit Radio Waves	671
Reporting Safety Defects	672
Emissions Testing	
Testing of Readiness Codes.....	673
Warranty Coverages	675
Authorized Manuals	678
Customer Service Information	679

■ Vehicle Specifications

Model	CR-V
No. of Passengers:	
Front	2
Rear	3
Total	5
Weights:	
Gross Vehicle Weight Rating	See the certification label on the driver's doorjamb
Gross Axle Weight Rating (Front)	See the certification label on the driver's doorjamb
Gross Axle Weight Rating (Rear)	See the certification label on the driver's doorjamb

■ Air Conditioning

Refrigerant Type	HFO-1234yf (R-1234yf)
Charge Quantity	14.6 – 16.4 oz (415 – 465 g)
Lubricant Type	ND-OIL 11 (POE)
Quantity	7.32 – 8.24 cu-in (120 – 135 cm ³)

■ Engine Specifications

Displacement	121.6 cu-in (1,993 cm ³)
Spark Plugs	NGK DILZKAR7D11S

■ Fuel

Type	Unleaded gasoline, Pump octane number of 87 or higher
Fuel Tank Capacity	14 US gal (53 L)

■ Washer Fluid

Tank Capacity	2.6 US qt (2.5 L)
---------------	-------------------

■ Light Bulbs

Headlights (Low Beam)	LED
Headlights (High Beam)	LED
Fog Lights*	LED
Front Turn Signal Lights	LED
Front Side Marker Lights	LED
Parking/Daytime Running Lights	LED
Side Turn Signal Lights (on Door Mirrors)*	LED
Brake/Taillights	LED
Rear Side Marker Lights	LED
Rear Turn Signal Lights	LED
Back-Up Lights	16 W
Taillights	LED
High-Mount Brake Light	LED
Rear License Plate Light	LED
Interior Lights	
Map Lights	8 W
Ceiling Light	8 W
Cargo Area Lights	5 W
Vanity Mirror Lights*	1.4 W
Front Door Inner Handle Lights*	LED
Foot Lights*	LED

■ Brake Fluid

Specified	Honda Heavy Duty Brake Fluid DOT 3
-----------	------------------------------------

■ Transmission Fluid

Specified	Honda ATF DW-1
Capacity	Change 2.5 US qt (2.4 L)

■ Rear Differential Fluid

Specified	Honda DPSF-II
Capacity	Change 1.32 US qt (1.247 L)

■ Engine Oil

Recommended	-Honda Genuine Motor Oil 0W-20
	-API Premium-grade 0W-20 detergent oil
	Change 3.7 US qt (3.5 L)
Capacity	Change including filter 4.0 US qt (3.8 L)

■ Engine Coolant

Specified	Honda Long Life Antifreeze/Coolant Type2
Ratio	50/50 with distilled water
	1.46 US gal (5.52 L)
Capacity	(change including the remaining 0.17 US gal (0.65 L) in the reserve tank)

■ Tire

Regular	Size*1		235/65R17 104H	
			235/60R18 103H	
	Pressure psi (kPa [kgf/cm ²])	Front		32 (220 [2.2]) ^{*2}
				35 (240 [2.4]) ^{*3}
Rear			33 (230 [2.3]) ^{*4}	
			30 (210 [2.1]) ^{*2}	
Wheel Size	Regular		32 (220 [2.2]) ^{*3}	
			33 (230 [2.3]) ^{*4}	
			17 x 7 1/2 ^{*2}	
			18 x 7 1/2 ^{*3}	
			19 x 7 1/2 ^{*4}	

*1: Original tire size is mentioned on the tire information label on the driver's doorjamb.

*2: Models with 17 inch wheel

*3: Models with 18 inch wheel

*4: Models with 19 inch wheel

Vehicle Identification Number (VIN), Engine Number, Motor Number, and Transmission Number

Your vehicle has a 17-digit vehicle identification number (VIN) used to register your vehicle for warranty purposes, and for licensing and insuring your vehicle. The locations of your vehicle's VIN, engine number, motor number, and transmission number are shown as follows.

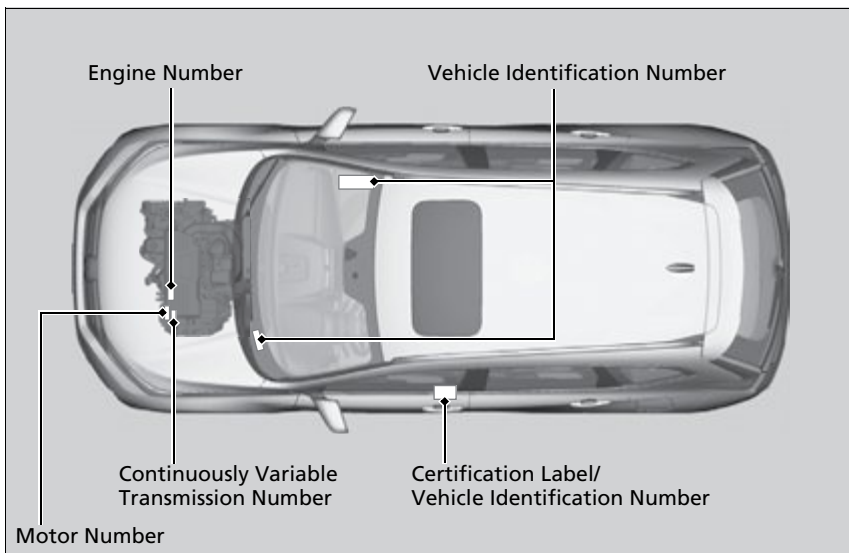

Vehicle Identification Number (VIN), Engine Number, Motor Number, and Transmission Number

The interior vehicle identification number (VIN) is located under the cover.

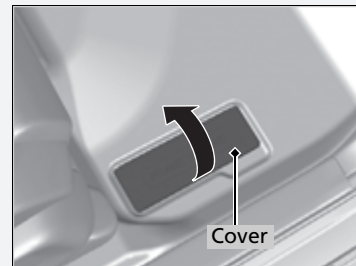

Each radio frequency device installed in the vehicle conforms to the requirements and standards of the regulation listed below:

As required by the FCC:

This device complies with Part 15 of the FCC rules. Operation is subject to the following two conditions: (1) This device may not cause harmful interference, and (2) this device must accept any interference received, including interference that may cause undesired operation.

Changes or modifications not expressly approved by the party responsible for compliance could void the user's authority to operate the equipment.

In the U.S.

If you believe that your vehicle has a defect which could cause a crash or could cause injury or death, you should immediately inform the National Highway Traffic Safety Administration (NHTSA) in addition to notifying American Honda Motor Co., Inc.

If NHTSA receives similar complaints, it may open an investigation, and if it finds that a safety defect exists in a group of vehicles, it may order a recall and remedy campaign. However, NHTSA cannot become involved in individual problems between you, your dealer, or American Honda Motor Co., Inc.

To contact NHTSA, you may call the Vehicle Safety Hotline toll-free at 1-888-327-4236 (TTY: 1-800-424-9153); go to <http://www.safercar.gov>; or write to: Administrator, NHTSA, 1200 New Jersey Avenue, SE., Washington, DC 20590. You can also obtain other information about motor vehicle safety from <http://www.safercar.gov>.

Testing of Readiness Codes

Your vehicle has readiness code as part of the onboard self diagnostic system. Some states use these codes for testing to verify whether your vehicle's emissions components are working properly. The codes may not be read properly if testing is performed just after the 12-volt battery has gone dead or been disconnected.

To check if they are set, set the power mode to ON, without turning the power system on. The malfunction indicator lamp will come on for several seconds. If it then goes off, the readiness codes are set. If it blinks five times, the readiness codes are not set.

If you are required to have your vehicle tested before the readiness codes are ready, prepare the vehicle for retesting by doing the following:

1. Fill the gas tank to approximately 3/4 full.
2. Park the vehicle and leave the power system off for six hours or more.
3. Make sure the ambient temperature is between 40°F and 95°F (4°C and 35°C).
4. Turn the power system on.

Testing of Readiness Codes

The readiness codes are erased when the 12-volt battery is disconnected, and set again only after several days of driving under a variety of conditions.

If a testing facility determines that the readiness codes are not set, you may be requested to return at a later date to complete the test.

If the testing facility determines the readiness codes are still not set, see a dealer.

5. Select a nearby, lightly traveled major highway where you can maintain a speed of 50 to 60 mph (80 to 97 km/h) for at least 20 minutes. Drive on the highway in **D**. Do not use cruise control. When traffic allows, drive for 90 seconds without moving the accelerator pedal. (Vehicle speed may vary slightly; this is okay.) If you cannot do this for a continuous 90 seconds because of traffic conditions, drive for at least 30 seconds, then repeat it two more times (for a total of 90 seconds).
6. Drive in city or suburban traffic for at least 10 minutes. When traffic conditions allow, let the vehicle coast for several seconds without using the accelerator pedal or the brake pedal.
7. Park the vehicle and leave the power system off for 40 minutes.

■ U.S. Owners

Your new vehicle is covered by these warranties:

New Vehicle Limited Warranty – covers your new vehicle, except for the emissions control systems and accessories, against defects in materials and workmanship.

Emissions Control Systems Defects Warranty and Emissions Performance Warranty – these two warranties cover your vehicle's emissions control systems. Time, mileage, and coverage are conditional. Please read your warranty booklet for exact information.

Seat Belt Limited Warranty – a seat belt that fails to function properly is covered by a limited warranty. Please read your warranty booklet for details.

Rust Perforation Limited Warranty – all exterior body panels are covered against rusting from the inside out for the specified time period, regardless of mileage.

Accessory Limited Warranty – Honda accessories are covered under this warranty. Time and mileage limits depend on the type of accessory and other factors. Please read your warranty booklet for details.

Replacement Parts Limited Warranty – covers all Honda replacement parts against defects in materials and workmanship.

Replacement 12-Volt Battery Limited Warranty – provides prorated coverage for a replacement battery purchased from your dealer.

Replacement Muffler Lifetime Limited Warranty – provides coverage for as long as the purchaser of the muffler owns the vehicle.

Restrictions and exclusions apply to all these warranties. Please read the Honda warranty information booklet that came with your vehicle for precise information on warranty coverages. Your vehicle's original tires are covered by their manufacturer. Tire warranty information is in a separate booklet.

■ **Statement on Warranty Coverage for Aftermarket and Recycled Parts**

The Magnuson-Moss Warranty Act, 15 U.S.C. s.2301 et seq., makes it illegal for motor vehicle manufacturers to void a motor vehicle warranty or deny warranty coverage solely because an aftermarket or recycled part has been used to repair the vehicle or someone other than the authorized service provider performed service on the vehicle. This provision does not apply to a new motor vehicle purchased solely for commercial or industrial use.

Under federal law, a manufacturer may deny warranty coverage and charge for repairs to a vehicle if it is discovered that an aftermarket or recycled part installed on the vehicle is defective or was installed incorrectly and caused damage to another part of the vehicle otherwise covered under warranty. The Federal Trade Commission requires that a manufacturer demonstrate that an aftermarket or recycled part or service performed by a person other than an authorized service provider caused damage to another part of the vehicle otherwise covered under warranty before denying warranty coverage. Additionally, federal law allows a manufacturer to void a motor vehicle warranty or deny warranty coverage if the manufacturer provides the article or service to consumers free of charge under the warranty or the manufacturer has secured a waiver from the Federal Trade Commission.

■ EPA Contact Information

An owner may obtain further information concerning emission warranties or report violations of the terms of the emission warranties by contacting:

Director,
Light-Duty Vehicle Center,
U.S. Environmental Protection Agency,
Attention: Warranty Claim
2000 Traverwood Drive,
Ann Arbor, MI 48105;
complianceinfo@epa.gov

■ Service Express

For electronic copies of service publications, you can purchase a subscription to Service Express. Visit www.techinfo.honda.com for pricing and options.

■ For U.S. Owners

Manuals can be purchased from Helm Incorporated. You can order a manual by phone at 1 (800) 782-4356 (credit card orders only), or online at www.helminc.com.

Honda dealership personnel are trained professionals who should be able to deal with any problems you may encounter with your vehicle. If, however, you are faced with a problem that they cannot resolve to your satisfaction, contact Honda Customer Services.

U.S. Owners

American Honda Motor Co., Inc.
Honda Automobile Customer Service
Mail Stop CHI-5
1919 Torrance Blvd.
Torrance, CA 90501-2746
Tel: 1 (800) 999-1009

In Puerto Rico and the U.S. Virgin Islands

Bella International
P.O. Box 190816
San Juan, PR 00919-0816
Tel: 1 (787) 620-7546

Customer Service Information

When you call or write, please give us the following information:

- Vehicle Identification Number
 - ▣ **Vehicle Identification Number (VIN), Engine Number, Motor Number, and Transmission Number** P. 670
- Date of purchase
- Odometer reading of your vehicle
- Your name, address, and telephone number
- A detailed description of the problem
- Name of the dealer who sold the vehicle to you

■ Disclaimer of Pandora®

Requirements to access Pandora®

- Latest version of the Pandora app installed on your Android, Blackberry, or iPhone.
- Registered Pandora account (you can create a free account at www.pandora.com <<http://www.pandora.com/>> or on your smartphone)
- Connection to the internet via Wi-Fi or cellular data network.

Limitations

- Access to Pandora requires an active internet connection
- Ability to access Pandora through this system is subject to change without notice
- Certain functionality of Pandora service is not available when accessing the service through this system including, but not limited to, creating new stations, deleting stations, emailing current stations, buying tracks, viewing additional text information, logging in to Pandora, and adjusting Cell Network Audio Quality. Pandora internet radio is a music service not affiliated with HONDA. More information is available at <http://www.pandora.com> <<http://www.pandora.com/>>. Pandora, the Pandora logo, and the Pandora trade dress are trademarks or registered trademarks of Pandora Media, Inc., used with permission.
- Mobile access requires a smartphone with an active data plan. Standard data rates may apply.
- Pandora is only available in the United States.

Numbers

12-volt Battery	615
Charging System Indicator	95, 652
Maintenance (Checking the 12-volt Battery)	615
12-volt Battery Charging System Indicator	95, 652
4WD	492

A

AAC	265, 321
ABS (Anti-lock Brake System)	557
Accessories and Modifications	624
Accessory Power Socket	229
Adaptive Cruise Control (ACC) with Low Speed Follow	105, 517
Additives	
Coolant	593
Engine Oil	588
Washer	597
Additives, Engine Oil	588
Adjusting	
Armrest	217
Front Seats	208
Head Restraints	215
Mirrors	206
Rear Seats	212
Steering Wheel	205
Temperature	138

Adjusting the Sound	256, 294
Agile Handling Assist	491
Air Conditioning System (Climate Control System)	235
Changing the Mode	238
Defrosting the Windshield and Windows	238
Dust and Pollen Filter	618
Recirculation/Fresh Air Mode	238
Sensor	241
Synchronized Mode	240
Using Automatic Climate Control	235
Air Pressure	607, 669
Airbags	56
Advanced Airbags	62
Airbag Care	71
Event Data Recorder	0
Front Airbags (SRS)	59
Indicator	68, 97
Passenger Airbag Off Indicator	69
Sensors	56
Side Airbags	64
Side Curtain Airbags	66
All-Wheel Drive (AWD)	492
AM/FM Radio	258, 301
Android Auto™	336
Anti-lock Brake System (ABS)	557
Indicator	97
Apple CarPlay™	333
Armrest	217
Audio Remote Controls	248

Audio System	244, 251, 272
Adjusting the Sound	256, 294
AM/FM Radio	258, 301
Android Auto™	336
Apple CarPlay™	333
Audio/Information Screen	252, 273
Changing the Home Screen Icon Layout ..	277
Changing the Screen Interface	291
Closing Apps	293
Customizing the Meter	278
Display Setup	257, 295
Error Messages	340
General Information	345
Home Screen	284
HondaLink®	326
How to use Siri® Eyes Free	271, 332
iPod	260, 312
Limitations for Manual Operation	296
Menu Customize	292
MP3/WMA/AAC	265, 321
Pandora®	263, 319
Playing Bluetooth® Audio	268, 324
Playing SiriusXM® Radio	305
Reactivating	247
Recommended Devices	346
Remote Controls	248
Security Code	247
Selecting an Audio Source	296
Song By Voice™ (SBV)	315
Status Area	290

Theft Protection.....	247
USB Flash Drives	265, 321, 346
USB Port(s).....	245
Voice Control Operation.....	297
Wallpaper Setup.....	254, 282
Wi-Fi Connection.....	331
Audio/Information Screen.....	252, 273
Authorized Manuals.....	678
Auto Door Locking/Unlocking.....	166
Auto High-Beam.....	195
Indicator.....	101
Automatic Brake Hold.....	555
Indicator.....	93, 555
Automatic Brake Hold System	
Indicator.....	93
Automatic Intermittent Wipers.....	199
Automatic Lighting.....	191
Average Fuel Economy.....	130
Average Fuel Economy Records.....	131
Average Speed.....	130
AWD (All-Wheel Drive).....	492
B	
Battery.....	12
Charging System Indicator.....	95
High Voltage.....	12, 502
If the 12-Volt Battery Is Dead.....	647
Maintenance (Replacing).....	617
Belts (Seat).....	47

Beverage Holders.....	222
Blind spot information System.....	499
Indicator.....	102
Bluetooth® Audio.....	268, 324
Bluetooth® HandsFreeLink®.....	398, 422
Booster Seats (For Children).....	85
Brake System.....	551
Anti-lock Brake System (ABS).....	557
Automatic Brake Hold.....	555
Brake Assist System.....	558
Fluid.....	596
Foot Brake.....	554
Indicator.....	91, 92
Indicator (Red).....	654, 655
Parking Brake.....	551
Brightness Control (Instrument Panel)....	202
Bulb Replacement.....	598
Brake/Taillights, Rear Turn Signal Lights and	
Rear Side Marker Lights.....	598
Front Turn Signal/ Front Side Marker	
Lights.....	598
Headlights.....	598
High-Mount Brake Light.....	600
Parking/Daytime Running Lights.....	598
Rear License Plate Light.....	600
Side Turn Signal/Emergency Indicator	
Lights.....	598
Taillights and Back-Up Lights.....	599
Bulb Specifications.....	668

C

Carbon Monoxide Gas.....	86
Cargo Hook.....	225
Carrying Cargo.....	461, 463
Certification Label.....	670
Changing Bulbs.....	598
Charging System Indicator.....	95, 652
Child Safety.....	72
Childproof Door Locks.....	165
Child Seat.....	72
Booster Seats.....	85
Child Seat for Infants.....	74
Child Seat for Small Children.....	75
Installing a Child Seat with a Lap/Shoulder Seat	
Belt.....	80
Larger Children.....	84
Rear-facing Child Seat.....	74
Selecting a Child Seat.....	76
Childproof Door Locks.....	165
Cleaning the Exterior.....	621
Cleaning the Interior.....	619
Climate Control System.....	235
Changing the Mode.....	235
Defrosting the Windshield and	
Windows.....	238
Dust and Pollen Filter.....	618
Recirculation/Fresh Air Mode.....	238
Sensors.....	241
Synchronization Mode.....	240
Using Automatic Climate Control.....	235

Clock	150
CMBS™ (Collision Mitigation Braking System™)	506
Coat Hook	224
Collision Mitigation Braking System™ (CMBS™)	506
Compass	456
Continuously Variable Transmission	
Creeping.....	476
Kickdown	476
Controls	149
Coolant (Engine)	593
Adding to the Radiator	594
Adding to the Reserve Tank	593
Overheating	649
Creeping (Continuously Variable Transmission)	476
Cross Traffic Monitor	566
Cup Holders	222
Customer Service Information	679
Customized Features	140, 362, 369

D

Daytime Running Lights	194
Deceleration Paddle Selector	484
Indicator	95
Defaulting All the Settings	394
Deflation Warning System	
Indicator	99

Defrosting the Windshield and Windows	238
Detachable Anchor.....	53
Devices that Emit Radio Waves	671
Dimming	
Headlights	190
Rearview Mirror.....	206
Dipstick (Engine Oil)	589
Directional Signals (Turn Signal)	189
Display Setup	257, 295
Display/Information Button	128
Door Mirrors	207
Doors	152
Auto Door Locking	166
Auto Door Unlocking.....	166
Keys	152
Locking/Unlocking the Doors from the Inside.....	163
Locking/Unlocking the Doors from the Outside.....	155
Lockout Prevention System	162
DOT Tire Quality Grading	609
Driver Information Interface	128
Driver's Seat Lumbar Support	209
Driving.....	459
Braking.....	551
Off-Highway Driving Guidelines.....	467
Shifting	477
Transmission.....	476
Driving Position Memory System.....	203
Dust and Pollen Filter	618

E

Eco Assist® System	18
Eco Drive Display	19, 132
ECON Mode	487
Elapsed Time.....	130
Electric Power Steering (EPS) System	
Indicator.....	98, 656
Electronic Stability Control (ESC).....	489
Emergency	663
Emissions Testing (Readiness Codes).....	673
Engine	
Coolant.....	593
If the 12-Volt Battery Is Dead.....	647
Number.....	670
Oil.....	588
Switch Buzzer.....	187
Engine Coolant	593
Adding to the Radiator.....	594
Adding to the Reserve Tank.....	593
Overheating	649
Engine Oil	588
Adding.....	590
Checking.....	589
Displaying Oil Life.....	582
Low Oil Pressure Indicator	93, 652
Recommended Engine Oil	588
EPS (Electric Power Steering) System	98, 656
EV Button.....	14
EV Indicator	94
EV Mode Indicator	94

Exhaust Gas Hazard (Carbon Monoxide) ..	86
Exterior Care (Cleaning)	621
Exterior Mirrors	207

F

Features	243
Filters	
Dust and Pollen	618
Oil	591
Flat Tire	629
Floor Mats	620
Fluids	
Brake	596
Engine Coolant	593
Windshield Washer	597
FM/AM Radio	258, 301
Fog Light Indicator	101
Folding Down the Rear Seats	213
Foot Brake	554
Front Airbags (SRS)	59
Front Seats	208
Adjusting	208
Front Sensor Camera	548
Fuel	34, 572
Fuel Economy and CO ₂ Emissions	575
Gauge	126
Instant Fuel Economy	130
Low Fuel Indicator	96
Range	130
Recommendation	572

Refueling	572
Fuel Economy and CO ₂ Emissions	575
Fuel Fill Door	34, 573
Fuses	659
Inspecting and Changing	662
Locations	659, 660, 661

G

Gasoline (Fuel)	
Fuel Economy and CO ₂ Emissions	575
Information	572
Refueling	572
Gauges	126
Glass (care)	619, 622
Glove Box	220

H

Handling of the Jack	643
Handling the Unexpected	627
HandsFreeLink® (HFL)	398, 422
Automatic Import of Cellular Phonebook and Call History	412, 435
Caller's ID Information	409
Displaying Messages	450
HFL Buttons	398, 422
HFL Menu	400, 425
HFL Status Display	399, 424
In Case of Emergency	454
Limitations for Manual Operation	399, 424

Making a Call	416, 443
Options During a Call	421, 447
Phone Setup	404, 430
Phonebook Phonetic Modification	439
Receiving a Call	420, 446
Receiving a Text/E-mail Message	448
Ring Tone	409, 434
Selecting a Text/E-mail Message Account	449
Speed Dial	413, 436
To Clear the System	411
To Set Up Text/E-mail Message Options ..	433
Hazard Warning Button	6
HD Radio™	303
Head Restraints	215
Headlights	190
Aiming	598
Auto High-Beam	195
Automatic Operation	191
Dimming	190
Operating	190
Heated Door Mirror Button	201
Heated Steering Wheel	233
Heaters	234
HFL (HandsFreeLink®)	398, 422
High Beam Indicator	100
High Voltage Battery	502
Hill Start Assist System	474
HomeLink® Universal Transceiver	395
Honda App License Agreement	347
Honda Sensing®	35, 503

HondaLink®	326
Hybrid Vehicle	
SPORT HYBRID i-MMD (intelligent Multi-Mode Drive)	11

I

Identification Numbers	670
Engine, Motor and Transmission	670
Vehicle Identification	670
If the 12-Volt Battery Is Dead	647
Illumination Control	202
Knob	202
Immobilizer System	178
Indicator	101
Indicators	90
12-volt Battery Charging System	95, 652
ABS (Anti-lock Brake System)	97
Adaptive Cruise Control (ACC) with Low Speed Follow	105, 106, 518
Auto High-Beam	101
Automatic Brake Hold	93, 555
Automatic Brake Hold System	93
Blind spot information System	102
Collision Mitigation Braking System (CMBS)	107, 108
Deceleration Paddle Selector	95
ECON Mode	102, 487
Electric Power Steering (EPS) System	98, 656
EV	94

EV Mode	94
Fog Light	101
High Beam	100
Immobilizer System	101
Lane Keeping Assist System (LKAS)	106
Lights On	101
Low Fuel	96
Low Oil Pressure	93, 652
Low Tire Pressure/TPMS	99, 497, 657
Malfunction Indicator Lamp	94, 653
Parking Brake and Brake System (Amber)	92, 655
Parking Brake and Brake System (Red)	91, 654, 655
Power System	93
READY	93
Road Departure Mitigation (RDM)	103, 104
Seat Belt Reminder	49, 96
Security System Alarm	102
Shift Position	95
SPORT Mode	96, 483
Supplemental Restraint System	68, 97
System Message	100
Transmission System	95, 658
Turn Signal and Hazard Warning	100
Vehicle Stability Assist™ (VSA®) System	97, 489
VSA® OFF	98, 490
Information	667
Instrument Panel	89
Brightness Control	202

Interior Lights	218
Interior Rearview Mirror	206
iPod	260, 312

K

Key Number Tag	153
Keyless Access System	155
Keyless Lockout Prevention	162
Keys	152
Lockout Prevention	162
Master Keys	152
Number Tag	153
Rear Door Won't Open	165
Remote Transmitter	160
Types and Functions	152
Kickdown (Continuously Variable Transmission)	476

L

Lane Keeping Assist System (LKAS)	534
LATCH (Child Seats)	77, 82
Lights	190, 598
Auto High-Beam	195
Automatic	191
Bulb Replacement	598
Daytime Running Lights	194
Fog Lights	194
High Beam Indicator Light	100
Interior	218

Passenger Airbag Off Indicator.....	69
Passing Indicators.....	190
Playing <i>Bluetooth</i> ® Audio.....	268, 324
POWER Button.....	186
Power System	
Won't Start.....	644
Power System Indicator.....	93
Power Tailgate.....	170
Power Windows.....	181
POWER/CHARGE Gauge.....	126
Precautions While Driving.....	475
Driving Guidelines for Your Utility	
Vehicle.....	475
Rain.....	475
Pregnant Women.....	54
Puncture (Tire).....	629

R

Radiator.....	594
Radio (FM/AM).....	258, 301
Radio (SiriusXM®).....	305
Radio Data System (RDS).....	259, 304
RDS (Radio Data System).....	259, 304
Readiness Codes (Emissions Testing).....	673
READY Indicator.....	93
Real Time AWD with Intelligent Control	
System™.....	492
Rear Seats (Folding Down).....	213
Rearview Mirror.....	206
Refueling.....	572

Fuel Gauge.....	126
Gasoline.....	572, 668
Low Fuel Indicator.....	96
Regulations.....	497, 609, 671
Remote Transmitter.....	160
Replacement	
Battery.....	617
Bulbs.....	598
Front Wiper Blade Rubber.....	601
Fuses.....	659, 660, 661
Rear Wiper Blade Rubber.....	604
Tires.....	612
Reporting Safety Defects.....	672
Resetting a Trip Meter.....	130
Road Departure Mitigation (RDM).....	543
On and Off.....	545

S

Safe Driving.....	41
Safety Check.....	46
Safety Labels.....	87
Safety Message.....	2
Seat Belts.....	47
Adjusting the Shoulder Anchor.....	52
Automatic Seat Belt Tensioners.....	50
Checking.....	55
Detachable Anchor.....	53
Fastening.....	51
Installing a Child Seat with a Lap/Shoulder Seat	
Belt.....	80

Pregnant Women.....	54
Reminder.....	49
Warning Indicator.....	49, 96
Seat Heaters.....	234
Seats.....	208
Adjusting.....	208
Driver's Seat Lumbar Support.....	208
Front Seats.....	208
Heaters.....	234
Rear Seats.....	212
Seat Heaters.....	234
Security System.....	178
Immobilizer System Indicator.....	101
Security System Alarm Indicator.....	102
Select Button	
Operation.....	32, 479
Selecting a Child Seat.....	76
Selector Knob (Audio).....	251
Setting the Clock.....	150
Shift Button.....	32
Shift Button Positions	
Transmission.....	32, 477
Shift Position Indicator.....	95, 479
Shoulder Anchor.....	52
Side Airbags.....	64
Side Curtain Airbags.....	66
Siri® Eyes Free.....	271, 332
SiriusXM® Radio.....	305
Snow Tires.....	614
Song By Voice™ (SBV).....	315
Spark Plugs.....	668

Specifications	668
Specified Fuel	572, 668
Speedometer	126
SPORT Mode	
Indicator	96, 483
SRS Airbags (Airbags)	59
Starting the Engine	
Engine Switch Buzzer	187
If the 12-Volt Battery Is Dead	647
Steering Wheel	205
Adjusting	205
Stopping	559
Summer Tires	614
Sunglasses Holder	226
Supplemental Restraint System (SRS)	59
Switches (Around the Steering Wheel)	6, 7, 186
System Message Indicator	100

T

Tailgate	167
Unable to Open	664
Temperature	
Outside Temperature Display	138
Temperature Sensor	138
Temporary Repair Kit (TRK)	629
Theft Protection	247
Time (Setting)	150
Tire Pressure Monitoring System (TPMS)	493

Tires	606
Air Pressure	607, 669
Checking and Maintaining	606
Inspection	606
Labeling	607
Puncture (Flat Tire)	629
Regulations	609
Rotation	613
Summer	614
Temporary Repair Kit (TRK)	629
Tire Chains	614
Wear Indicators	611
Winter	614
Tonneau Cover	227
Tools	628
Towing a Trailer	465
Towing Behind a Motorhome	466
Towing Your Vehicle	
Emergency	663
TPMS (Tire Pressure Monitoring System)	493
Transmission	476, 477
Number	670
Operating the Shift Button	479
Operation	32
Shift Position Indicator	95, 479
Shifting	477
Transmission System	
Indicator	95, 658
TRIP Knob	129
Trip Meter	129

TRK (Temporary Repair Kit)	629
Troubleshooting	627
Blown Fuse	659, 660, 661
Brake Pedal Vibrates	38
Buzzer Sounds When Opening Door	38
Emergency Towing	663
If the 12-Volt Battery Is Dead	647
Noise When Braking	39
Overheating	649
Power System Won't Start	644
Puncture/Flat Tire	629
Rear Door Won't Open	38, 165
Warning Indicators	90
Turn Signals	189
Turn signals	
Indicators (Instrument Panel)	100
Turning on the Power	
Does Not Activate	644

U

Unlocking the Doors	155
Unlocking the Front Doors from the Inside	163
USB Flash Drives	265, 321, 346
USB Port(s)	245

V

Vanity Mirrors	9
Vehicle Identification Number	670

Vehicle Stability Assist™ (VSA®)	489
Off Button	490
OFF Indicator	98
System Indicator	97
Viscosity (Oil).....	588, 669
Voice Control Operation	297
Audio Commands.....	299
Climate Control Commands.....	300
General Commands.....	300
Music Search Commands.....	300
On Screen Commands	300
Phone Commands	299
Useful Commands	299
Voice Portal Screen	298
Voice Recognition	297
VSA® (Vehicle Stability Assist™)	489

W

Wallpaper.....	254, 282
Warning and Information Messages	109
Warning Indicator On/Blinking.....	652
Warning Labels	87
Warranties (Warranty Manual provided separately)	675
Watts	668
WAV.....	265, 321
Wear Indicators (Tire)	611
Wi-Fi Connection	331
Window Washers	198
Adding/Refilling Fluid	597

Switch	198
Windows (Opening and Closing).....	181
Windshield	198
Cleaning.....	619, 622
Defrosting/Defogging	238
Washer Fluid	597
Wiper Blades	601
Wipers and Washers	198
Winter Tires	614
Snow Tires.....	614
Tire Chains	614
Wiper and Washer	198
Front	198
Wipers and Washers.....	198
Automatic Intermittent Wipers.....	199
Checking and Replacing Wiper Blades	601
Rear	200
Wireless Charger.....	230
WMA	265, 321
Worn Tires.....	606



owners.honda.com

31TPG620
OM-16953
00X31-TPG-6200

2022 Honda CR-V Hybrid Owner's Manual
© 2021 Honda Motor Co., Ltd. — All Rights Reserved

Printed in U.S.A.