

# 2022 LINCOLN NAUTILUS Owner's Manual





The information contained in this publication was correct at the time of going to print. In the interest of continuous development, we reserve the right to change specifications, design or equipment at any time without notice or obligation. No part of this publication may be reproduced, transmitted, stored in a retrieval system or translated into any language in any form by any means without our written permission. Errors and omissions excepted.

© Ford Motor Company 2021

All rights reserved.

Part Number: 202108 20210915184308

## California Proposition 65



**WARNING:** Operating, servicing and maintaining a passenger vehicle or off-highway motor vehicle can expose you to chemicals including engine exhaust, carbon monoxide, phthalates, and lead, which are known to the State of California to cause cancer and birth defects or other reproductive harm. To minimize exposure, avoid breathing exhaust, do not idle the engine except as necessary, service your vehicle in a well-ventilated area and wear gloves or wash your hands frequently when servicing your vehicle. For more information go to [www.P65Warnings.ca.gov/passenger-vehicle](http://www.P65Warnings.ca.gov/passenger-vehicle).



**WARNING:** Battery posts, terminals and related accessories contain lead and lead compounds, chemicals known to the State of California to cause cancer and reproductive harm. **Wash your hands after handling.**





# Table of Contents

## Contacting Us

Contacting Us .....15

## Introduction

About This Publication .....17

Using This Publication .....18

## Symbols Glossary

Symbols Used on Your Vehicle .....19

## Data Privacy

Data Privacy .....22

Service Data .....23

Event Data .....24

Settings Data .....24

Connected Vehicle Data .....25

Mobile Device Data .....25

Emergency Call System Data .....26

## Visual Search

Steering Wheel .....27

Instrument Panel .....29

Center Console .....31

Vehicle Interior .....33

Front Exterior .....35

Rear Exterior .....37

## Child Safety

Child Safety Precautions .....39

Child Restraint Anchor Points .....40

Child Restraints .....41

Installing Child Restraints .....44

Booster Seats .....49

Child Safety Locks .....52

## Seatbelts

Seatbelt Precautions .....53

Fastening and Unfastening the Seatbelts  
.....54

Sensitive Locking Mode .....55

Automatic Locking Mode .....55

Adjusting the Seatbelts During Pregnancy  
.....56

Adjusting the Seatbelt Height .....57

Seatbelt Reminder .....57

Checking the Seatbelts .....61

Seatbelt Extensions .....61

## Personal Safety System™

What Is the Personal Safety System .....63

How Does the Personal Safety System  
Work .....63

Personal Safety System Components  
.....63

## Airbags

How Do the Front Airbags Work .....64

How Do the Side Airbags Work .....64

How Do the Knee Airbags Work .....65

How Does the Safety Canopy™ Work .....66

Airbag Precautions .....67

Properly Adjusting the Driver and Front  
Passenger Seats .....68

Children and Airbags .....68

Front Passenger Sensing System .....68

Crash Sensors and Airbag Indicator .....72

Disposing of Airbags .....73

## 911 Assist

What Is 911 Assist .....74

# Table of Contents

How Does 911 Assist Work .....	74
Emergency Call Requirements .....	74
Emergency Call Limitations .....	75

## Keys and Remote Controls

Remote Control Limitations .....	76
Using the Remote Control .....	76
Sounding the Panic Alarm .....	77
Locating Your Vehicle .....	77
Changing the Remote Control Battery .....	77
Replacing a Lost Key or Remote Control .....	78
Programming the Remote Control .....	78
Keys and Remote Controls – Troubleshooting .....	80

## Phone as a Key

What Is Phone As a Key .....	81
Phone as a Key Limitations .....	81
Programming Your Phone .....	81
Using the Valet Mode .....	82
Using the Backup Start Passcode .....	82
Phone as a Key – Troubleshooting .....	83

## MyKey™

Principle of Operation .....	85
Creating a MyKey .....	86
Clearing All MyKeys .....	87
Checking MyKey System Status .....	88
Using MyKey With Remote Start Systems .....	88
MyKey – Troubleshooting .....	88

## Doors and Locks

Operating the Doors From Outside Your Vehicle .....	90
Operating the Doors From Inside Your Vehicle .....	91
Autounlock .....	91
Autolock .....	92
Mislock .....	92
Doors and Locks Audible Warnings .....	92
Doors and Locks – Troubleshooting .....	93

## Keyless Entry

Locating the Keyless Entry Keypad .....	94
Keyless Entry Limitations .....	94

Keyless Entry Settings .....	94
Using Keyless Entry .....	94
Locking and Unlocking the Doors Using Keyless Entry .....	95
Keyless Entry – Troubleshooting .....	96

## Keyless Entry Keypad

What Is the Keyless Entry Keypad .....	97
Keyless Entry Keypad Limitations .....	97
Locating the Keyless Entry Keypad .....	97
Keyless Entry Keypad Master Access Code .....	97
Keyless Entry Keypad Personal Access Codes .....	98
Using the Keyless Entry Keypad .....	99
Keyless Entry Keypad – Troubleshooting .....	100

## Easy Entry and Exit

How Does Easy Entry and Exit Work .....	101
Switching Easy Entry and Exit On and Off .....	101

# Table of Contents

## Liftgate

Liftgate Precautions .....	102
Opening the Liftgate .....	102
Setting the Liftgate Opening Height .....	104
Closing the Liftgate .....	105
Stopping the Liftgate Movement .....	107
Liftgate Obstacle Detection .....	107
Liftgate – Troubleshooting .....	107

## Security

Passive Anti-Theft System .....	110
Anti-Theft Alarm System .....	110
Anti-Theft Alarm System Settings .....	111
Security – Troubleshooting .....	112

## Steering Wheel

Adjusting the Steering Wheel - Vehicles With: Manual Adjustable Steering Column .....	114
Adjusting the Steering Wheel - Vehicles With: Power Adjustable Steering Column .....	114

Resetting the Stopping Position - Vehicles With: Power Adjustable Steering Column .....	115
Horn .....	115
Switching the Heated Steering Wheel On and Off .....	115

## Wipers and Washers

Wipers .....	116
Autowipers .....	116
Switching the Rear Window Wiper On and Off .....	117
Reverse Wipe .....	117
Checking the Wiper Blades .....	118
Replacing the Front Wiper Blades .....	118
Replacing the Rear Wiper Blades .....	118
Washers .....	119
Wipers and Washers – Troubleshooting .....	120

## Exterior Lighting

Exterior Lighting Control .....	121
Headlamps .....	121
Headlamps – Troubleshooting .....	122

Autolamps .....	122
Exterior Lamps .....	123
Automatic High Beam Control .....	124
Automatic High Beam Control – Troubleshooting .....	127
Adaptive Front Lighting .....	127

## Interior Lighting

Switching All of the Interior Lamps On and Off .....	129
Switching the Front Interior Lamps On and Off .....	129
Switching the Rear Interior Lamps On and Off .....	129
Interior Lamp Function .....	130
Adjusting the Instrument Panel Lighting Brightness .....	130
Ambient Lighting .....	130
Interior Lighting – Troubleshooting .....	130

## Windows

Opening and Closing the Windows .....	131
Global Opening and Closing .....	132
Window Bounce-Back .....	132

# Table of Contents

---

Locking the Rear Window Controls .....133

## **Interior Mirror**

Interior Mirror Precautions .....134

Auto-Dimming Interior Mirror .....134

## **Exterior Mirrors**

Adjusting the Exterior Mirrors .....135

Folding the Exterior Mirrors - Vehicles  
With: Manual Folding Mirrors .....135

Folding the Exterior Mirrors - Vehicles  
With: Power Folding Mirrors .....135

Auto-Dimming Exterior Mirror .....136

## **Moonroof**

Opening and Closing the Sun Shade .....137

Opening and Closing the Moonroof .....137

Venting the Moonroof .....138

Moonroof Bounce-Back .....138

## **Instrument Cluster**

Instrument Cluster Overview .....139

Tachometer .....140

Speedometer .....140

Fuel Gauge .....140

Engine Coolant Temperature Gauge .....141

Engine Oil Pressure Gauge .....141

Transmission Fluid Temperature Gauge  
.....141

12V Battery Gauge .....141

What Are the Instrument Cluster Warning  
Lamps .....141

Instrument Cluster Warning Lamps .....141

What Are the Instrument Cluster Indicators  
.....143

Instrument Cluster Indicators .....143

## **Instrument Cluster Display**

Using the Instrument Cluster Display  
Controls .....145

Instrument Cluster Display Main Menu  
.....146

Trip Computer .....147

Customizing the Instrument Cluster Display  
.....149

Personalized Settings .....150

## **Remote Start**

What Is Remote Start .....153

Remote Start Precautions .....153

Remote Start Limitations .....153

Enabling Remote Start .....153

Remotely Starting and Stopping the  
Vehicle .....153

Extending the Remote Start Duration  
.....154

Remote Start Remote Control Indicators  
.....154

Remote Start Settings .....154

## **Climate Control**

Identifying the Climate Control Unit .....156

Switching Climate Control On and Off  
.....156

Switching Recirculated Air On and Off  
.....156

Switching Air Conditioning On and Off  
.....156

Switching Maximum Defrost On and Off  
.....156

Switching Maximum Cooling On and Off  
.....156

# Table of Contents

---

Switching the Heated Rear Window On and Off .....	157
Setting the Blower Motor Speed .....	157
Switching the Heated Mirrors On and Off .....	157
Setting the Temperature .....	157
Directing the Flow of Air .....	157
Auto Mode .....	158
Climate Control – Troubleshooting .....	159

## Interior Air Quality

What Is the Cabin Air Filter .....	160
Replacing the Cabin Air Filter .....	160

## Front Seats

Front Seat Precautions .....	161
Sitting in the Correct Position .....	161
Power Seats .....	162
Massage Seats .....	165
Heated Seats .....	166
Ventilated Seats .....	166

## Rear Seats

Manual Seats .....	168
Power Seats .....	170
Heated Seats .....	170

## Rear Occupant Alert System

What is the Rear Occupant Alert System .....	172
How Does the Rear Occupant Alert System Work .....	172
Rear Occupant Alert System Precautions .....	172
Rear Occupant Alert System Limitations .....	172
Switching Rear Occupant Alert System On and Off .....	173
Rear Occupant Alert System Indicators .....	173
Rear Occupant Alert System Audible Warnings .....	173

## Memory Function

How Does the Memory Function Work .....	174
Memory Function Precautions .....	174

Locating the Memory Function Buttons .....	174
Saving a Preset Position .....	174
Recalling a Preset Position .....	174

## Garage Door Opener

What Is the Garage Door Opener .....	176
How Does the Garage Door Opener Work .....	176
Garage Door Opener Precautions .....	176
Garage Door Opener Limitations .....	177
Programming the Garage Door Opener to Your Hand-Held Transmitter .....	177
Programming the Garage Door Opener to Your Garage Door Opener Motor .....	178
Programming the Garage Door Opener to Your Gate Opener Motor .....	178
Clearing the Garage Door Opener .....	179
Reprogramming the Garage Door Opener .....	179
Garage Door Opener Radio Frequencies .....	179

## USB Ports

Locating the USB Ports .....	181
------------------------------	-----

# Table of Contents

Playing Media Using the USB Port .....	181
Charging a Device .....	181

## **Power Outlet - Vehicles With: 110V Power Outlet**

What Is the Power Outlet .....	183
Power Outlet Precautions .....	183
Locating the Power Outlets .....	183
Power Outlet Indicators .....	183

## **Power Outlet - Vehicles With: 12V Power Outlet**

What Is the Power Outlet .....	185
Power Outlet Precautions .....	185
Locating the Power Outlets .....	185

## **Wireless Accessory Charger**

What Is the Wireless Accessory Charger .....	186
Wireless Accessory Charger Precautions .....	186
Locating the Wireless Accessory Charger .....	186
Charging a Wireless Device .....	186

## **Storage**

Cup Holders .....	188
Under Floor Storage .....	188
Glasses Holder .....	189

## **Starting and Stopping the Engine**

Starting and Stopping the Engine – Precautions .....	190
Push Button Ignition Switch .....	190
Starting the Engine .....	191
Engine Block Heater .....	192
Stopping the Engine .....	193
Automatic Engine Stop .....	193
Accessing the Passive Key Backup Position .....	194
Starting and Stopping the Engine – Troubleshooting .....	195

## **Auto-Start-Stop**

What Is Auto-Start-Stop .....	198
Auto-Start-Stop Precautions .....	198
Switching Auto-Start-Stop On and Off .....	198

Stopping the Engine .....	198
Restarting the Engine .....	198
Auto-Start-Stop Indicators .....	198
Auto-Start-Stop – Troubleshooting .....	199

## **Fuel and Refueling**

Fuel and Refueling Precautions .....	201
Fuel Quality .....	202
Locating the Fuel Filler Funnel .....	202
Running Out of Fuel .....	203
Refueling .....	204
Fuel Tank Capacity .....	206
Fuel and Refueling – Troubleshooting .....	207

## **Catalytic Converter**

What Is the Catalytic Converter .....	208
Catalytic Converter Precautions .....	208
Catalytic Converter – Troubleshooting .....	209

## **Automatic Transmission**

Automatic Transmission Precautions .....	210
--	-----

# Table of Contents

---

Automatic Transmission Positions .....	210	Checking the Brake Fluid .....	220	Hill Start Assist – Troubleshooting .....	227
Shifting Your Vehicle Into Gear .....	211	Brake Fluid Specification .....	221	<b>Auto Hold</b>	
Automatic Transmission Position Indicators .....	211	Brakes – Troubleshooting .....	221	How Does Auto Hold Work .....	228
Manually Shifting Gears .....	212	<b>Electric Parking Brake</b>		Switching Auto Hold On and Off .....	228
Temporary Neutral Mode .....	212	What Is the Electric Parking Brake .....	223	Using Auto Hold .....	228
Automatic Return to Park (P) .....	213	Applying the Electric Parking Brake .....	223	Auto Hold Indicators .....	229
Manual Park Release .....	214	Applying the Electric Parking Brake in an Emergency .....	223	<b>Traction Control</b>	
Automatic Transmission Audible Warnings .....	216	Manually Releasing the Electric Parking Brake .....	223	How Does Traction Control Work .....	230
Automatic Transmission – Troubleshooting .....	216	Automatically Releasing the Electric Parking Brake .....	224	Switching Traction Control On and Off .....	230
<b>All-Wheel Drive</b>		Electric Parking Brake Audible Warning .....	224	Traction Control Indicator .....	230
How Does All-Wheel Drive Work .....	218	Releasing the Electric Parking Brake if the Vehicle Battery Has Run Out of Charge .....	224	Traction Control – Troubleshooting .....	230
All-Wheel Drive Precautions .....	218	Electric Parking Brake – Troubleshooting .....	224	<b>Stability Control</b>	
All-Wheel Drive Limitations .....	218	<b>Hill Start Assist</b>		How Does Stability Control Work .....	231
All-Wheel Drive – Troubleshooting .....	219	What Is Hill Start Assist .....	227	Switching Stability Control On and Off .....	232
<b>Brakes</b>		How Does Hill Start Assist Work .....	227	Stability Control Indicator .....	232
Brake Precautions .....	220	Hill Start Assist Precautions .....	227	Stability Control – Troubleshooting .....	233
Anti-Lock Braking System .....	220				
Brake Over Accelerator .....	220				
Locating the Brake Fluid Reservoir .....	220				

# Table of Contents

---

## Steering

Electric Power Steering .....	234
Steering – Troubleshooting .....	235

## Parking Aids

Parking Aid Precautions .....	236
Switching Parking Aid On and Off .....	237
Rear Parking Aid .....	237
Front Parking Aid .....	238
Side Parking Aid .....	239
Parking Aid Indicators .....	240
Parking Aids – Troubleshooting .....	240

## Rear View Camera

What Is the Rear View Camera .....	242
Rear View Camera Precautions .....	242
Locating the Rear View Camera .....	242
Rear View Camera Guide Lines .....	242
Rear View Camera Object Distance Indicators .....	243
Rear View Camera Settings .....	243

## 360 Degree Camera

What Is the 360 Degree Camera .....	245
How Does the 360 Degree Camera Work .....	245
360 Degree Camera Precautions .....	245
360 Degree Camera Limitations .....	246
Locating the 360 Degree Cameras .....	246
360 Degree Camera Guide Lines .....	246
360 Degree Camera Settings .....	247

## Active Park Assist

What Is Active Park Assist .....	249
How Does Active Park Assist Work .....	249
Active Park Assist Precautions .....	249
Switching Active Park Assist On and Off .....	249
Entering a Parallel Parking Space .....	249
Entering a Perpendicular Parking Space .....	250
Exiting a Parking Space .....	251
Active Park Assist – Troubleshooting .....	251

## Cruise Control

What Is Cruise Control .....	254
Switching Cruise Control On and Off .....	254
Setting the Cruise Control Speed .....	254
Canceling the Set Speed .....	255
Resuming the Set Speed .....	255
Cruise Control Indicators .....	255

## Adaptive Cruise Control

How Does Adaptive Cruise Control With Stop and Go Work .....	256
Adaptive Cruise Control Precautions .....	256
Adaptive Cruise Control Limitations .....	257
Switching Adaptive Cruise Control On and Off .....	259
Adaptive Cruise Control Automatic Cancellation .....	260
Setting the Adaptive Cruise Control Speed .....	260
Setting the Adaptive Cruise Control Gap .....	261
Canceling the Set Speed .....	262
Resuming the Set Speed .....	262
Overriding the Set Speed .....	262



# Table of Contents

---

Adaptive Cruise Control Indicators .....	263
Switching From Adaptive Cruise Control to Cruise Control .....	263
Lane Centering .....	263
Adaptive Cruise Control – Troubleshooting .....	266

## Drive Mode Control

What Is Drive Mode Control .....	268
How Does Drive Mode Control Work .....	268
Selecting a Drive Mode .....	268
Drive Modes .....	268

## Lane Keeping System

What Is the Lane Keeping System .....	269
How Does the Lane Keeping System Work .....	269
Lane Keeping System Precautions .....	269
Lane Keeping System Limitations .....	270
Switching the Lane Keeping System On and Off .....	270
Switching the Lane Keeping System Mode .....	270
Lane Keeping System Settings .....	271

Alert Mode .....	271
Aid Mode .....	271
Alert and Aid Mode .....	272
Lane Keeping System Indicators .....	272
Lane Keeping System – Troubleshooting .....	274

## Blind Spot Information System

What Is Blind Spot Information System .....	277
How Does Blind Spot Information System Work .....	277
Blind Spot Information System Precautions .....	277
Blind Spot Information System Limitations .....	277
Blind Spot Information System Requirements .....	278
Switching Blind Spot Information System On and Off .....	278
Locating the Blind Spot Information System Sensors .....	278
Blind Spot Information System Indicators .....	279

Blind Spot Information System – Troubleshooting .....	279
--	-----

## Cross Traffic Alert

What Is Cross Traffic Alert .....	280
How Does Cross Traffic Alert Work .....	280
Cross Traffic Alert Precautions .....	280
Cross Traffic Alert Limitations .....	281
Switching Cross Traffic Alert On and Off .....	281
Locating the Cross Traffic Alert Sensors .....	281
Cross Traffic Alert Indicators .....	281
Cross Traffic Alert – Troubleshooting .....	282

## Pre-Collision Assist

What Is Pre-Collision Assist .....	283
How Does Pre-Collision Assist Work .....	283
Pre-Collision Assist Precautions .....	284
Pre-Collision Assist Limitations .....	284
Locating the Pre-Collision Assist Sensors .....	285
Distance Indication .....	286

# Table of Contents

Distance Alert .....	287
Automatic Emergency Braking .....	288
Evasive Steering Assist .....	288
Pre-Collision Assist – Troubleshooting .....	289

## Driver Alert

What Is Driver Alert .....	291
How Does Driver Alert Work .....	291
Driver Alert Precautions .....	291
Driver Alert Limitations .....	292
Switching Driver Alert On and Off .....	292
Driver Alert – Troubleshooting .....	292

## Load Carrying

Load Carrying Precautions .....	293
Locating the Safety Compliance Certification Labels .....	294
What Is the Gross Axle Weight Rating .....	294
What Is the Gross Vehicle Weight Rating .....	294
What Is the Maximum Loaded Trailer Weight .....	294

What Is the Gross Combined Weight Rating .....	294
Calculating Payload .....	296
Calculating the Load Limit .....	296
Roof Rack .....	298

## Luggage Compartment

Installing and Removing the Luggage Compartment Cargo Net .....	300
Installing and Removing the Luggage Compartment Cover .....	300

## Connecting a Trailer

Connecting a Trailer Precautions .....	302
Connecting a Trailer .....	302

## Towing a Trailer

Towing a Trailer Precautions .....	304
Trailer Brake Precautions .....	304
Towing a Trailer Limitations .....	305
Loading Your Trailer .....	305
Trailer Towing Hints .....	305
Launching or Retrieving a Boat or Personal Watercraft .....	306

Towing Weights and Dimensions .....	307
-------------------------------------	-----

## Trailer Sway Control

How Does Trailer Sway Control Work .....	309
Trailer Sway Control Precautions .....	309
Switching Trailer Sway Control On and Off .....	309

## Driving Hints

Reduced Engine Performance .....	310
Cold Weather Precautions .....	310
Breaking-In .....	310
Driving Economically .....	310
Driving in Special Conditions .....	311
Driving Through Shallow Water .....	313
Floor Mats .....	313

## Crash and Breakdown Information

Roadside Assistance .....	315
Switching the Hazard Flashers On and Off .....	316
Jump Starting the Vehicle .....	316

# Table of Contents

---

Post-Crash Alert System .....	318
Automatic Crash Shutoff .....	319
Transporting the Vehicle .....	319

## **Towing Your Vehicle**

Towing Your Vehicle Precautions .....	321
Recreationally Towing Your Vehicle - 2.0L, AWD .....	321
Recreationally Towing Your Vehicle - 2.0L, FWD .....	321
Recreationally Towing Your Vehicle - 2.7L .....	321
Emergency Towing .....	322

## **Fuses**

Fuse Precautions .....	323
Under Hood Fuse Box .....	323
Body Control Module Fuse Box .....	333
Identifying Fuse Types .....	338
Fuses – Troubleshooting .....	338

## **Maintenance**

Maintenance Precautions .....	339
Opening and Closing the Hood .....	339

Under Hood Overview - 2.0L .....	341
Under Hood Overview - 2.7L .....	343
Engine Oil .....	345
Checking the Coolant .....	347
Changing the Engine Air Filter .....	351
Changing the Fuel Filter .....	352
Drive Belt Routing Overview - 2.0L .....	352
Drive Belt Routing Overview - 2.7L .....	352
Changing the 12V Battery .....	353
Adjusting the Headlamps .....	355
Exterior Bulbs .....	358
Interior Bulbs .....	361

## **Vehicle Care**

Cleaning Products .....	362
Cleaning the Exterior .....	363
Waxing .....	365
Cleaning the Interior .....	365
Repairing Minor Paint Damage .....	367

## **Body Styling Kits**

Body Styling Kit Precautions .....	368
------------------------------------	-----

## **Storing Your Vehicle**

Preparing Your Vehicle for Storage .....	369
Removing Your Vehicle From Storage .....	370

## **Wheel and Tire Information**

Locating the Tire label .....	371
Department of Transportation Uniform Tire Quality Grades .....	371
Information on the Tire Sidewall .....	372
Glossary of Tire Terminology .....	377
Tire Replacement Requirements .....	377
Using Snow Chains .....	380

## **Tire Care**

Checking the Tire Pressures .....	382
Inflating the Tires .....	382
Inspecting the Tire for Wear .....	382
Inspecting the Tire for Damage .....	383
Inspecting the Wheel Valve Stems .....	384
Tire Rotation .....	384

# Table of Contents

## **Tire Sealant and Inflator Kit**

What Is the Tire Sealant and Inflator Kit .....	385
Tire Sealant and Inflator Kit Precautions .....	385
Locating the Tire Sealant and Inflator Kit .....	385
Tire Sealant and Inflator Kit Components .....	386
Using the Tire Sealant and Inflator Kit .....	386

## **Tire Pressure Monitoring System**

What Is the Tire Pressure Monitoring System .....	392
Tire Pressure Monitoring System Overview .....	392
Tire Pressure Monitoring System Precautions .....	393
Tire Pressure Monitoring System Limitations .....	393
Viewing the Tire Pressures .....	394
Resetting Tire Pressure Monitoring System .....	394

Tire Pressure Monitoring System – Troubleshooting .....	395
---	-----

## **Changing a Road Wheel**

Changing a Flat Tire .....	397
Wheel Nuts .....	402

## **Capacities and Specifications**

Engine Specifications - 2.0L .....	404
Engine Specifications - 2.7L .....	405
Motorcraft Parts - 2.0L .....	406
Motorcraft Parts - 2.7L .....	407
Engine Oil Capacity and Specification - 2.0L .....	408
Engine Oil Capacity and Specification - 2.7L .....	410
Cooling System Capacity and Specification - 2.0L .....	413
Cooling System Capacity and Specification - 2.7L .....	414
Fuel Tank Capacity .....	415
Air Conditioning System Capacity and Specification - 2.0L .....	416
Air Conditioning System Capacity and Specification - 2.7L .....	418

Washer Fluid Specification .....	419
Brake Fluid Specification .....	420

## **Vehicle Identification**

Vehicle Identification Number .....	422
-------------------------------------	-----

## **Connected Vehicle**

What Is a Connected Vehicle .....	423
Connected Vehicle Requirements .....	423
Connected Vehicle Limitations .....	423
Connecting the Vehicle to a Mobile Network .....	423
Connecting the Vehicle to a Wi-Fi Network .....	423
Connected Vehicle – Troubleshooting .....	424

## **Vehicle Wi-Fi Hotspot**

Creating a Vehicle Wi-Fi Hotspot .....	427
Changing the Vehicle Wi-Fi Hotspot Name or Password .....	427

## **Audio System**

Audio System Precautions .....	429
--------------------------------	-----

# Table of Contents

---

Identifying the Audio Unit .....	429
Switching the Audio Unit On and Off .....	429
Selecting the Audio Source .....	429
Playing or Pausing the Audio Source .....	429
Adjusting the Volume .....	430
Switching Shuffle Mode On and Off .....	430
Switching Repeat Mode On and Off .....	430
Setting a Memory Preset .....	430
Muting the Audio .....	430
Adjusting the Sound Settings .....	430
Setting the Clock and Date .....	431
AM/FM Radio .....	431
Switching the Display On and Off .....	432
Digital Radio .....	432
Satellite Radio .....	434

## Center Display Overview

Center Display Precautions .....	437
Center Display Limitations .....	437
Status Bar .....	437
Feature Bar .....	438
Information On Demand Screen .....	438

## Voice Interaction

What is Voice Interaction .....	440
Setting the Wake Word .....	440
Beginning a Voice Interaction .....	440
Voice Interaction Examples .....	440

## Phone

Phone Precautions .....	442
Connecting Your Phone .....	442
Phone Menu .....	442
Making and Receiving a Phone Call .....	444
Sending and Receiving a Text Message .....	446
Switching Text Message Notification On and Off .....	447

## Bluetooth®

Connecting a Bluetooth® Device .....	448
Playing Media Using Bluetooth® .....	448

## Apps

App Precautions .....	449
App Requirements .....	449

Accessing Apps .....	449
Enabling Apps on an iOS Device .....	449
Enabling Apps on an Android Device .....	449
Switching Apple CarPlay On and Off .....	450
Switching Android Auto On and Off .....	450

## Personal Profiles

How Do Personal Profiles Work .....	452
Enabling or Disabling Personal Profiles .....	452
Creating a Personal Profile .....	452
Linking or Unlinking a Personal Profile to a Remote Control .....	453
Linking or Unlinking a Personal Profile to a Device .....	453

## Navigation

Accessing Navigation .....	454
Navigation Map Updates .....	454
Adjusting the Map .....	454
Live Traffic .....	454
Setting a Destination .....	454
Waypoints .....	455

# Table of Contents

---

Route Guidance .....	455	The Mediation and Arbitration Program .....	477
<b>Vehicle System Updates</b>		Ordering a Canadian French Owner's Manual .....	478
Updating the Vehicle Systems Wirelessly .....	456	Reporting Safety Defects in the United States .....	478
Performing a Master Reset .....	457	Reporting Safety Defects in Canada .....	479
<b>Accessories</b>		Declaration of Conformity .....	480
Accessories .....	458	Radio Frequency Certification Labels .....	481
<b>Lincoln Protect</b>		Perchlorate .....	523
What Is Lincoln Protect .....	460	Replacement Parts Recommendation .....	523
<b>Scheduled Maintenance</b>		Mobile Communications Equipment .....	523
General Maintenance Information .....	463	End User License Agreement .....	524
Normal Scheduled Maintenance .....	467	Emission Law .....	554
Special Operating Conditions Scheduled Maintenance .....	471	<b>Appendices</b>	
<b>Customer Information</b>		Electromagnetic Compatibility .....	556
Rollover Warning .....	476		
The Better Business Bureau Auto Line Program .....	476		

# Contacting Us

---

If you require assistance or clarification on policies or procedures, please contact the customer relationship center.

## United States

Lincoln  
Lincoln Concierge  
P.O. Box 6248  
Dearborn, MI 48126  
1-800-521-4140  
TDD for the hearing impaired:  
7-1-1 (where offered by your telephone  
service provider)  
[www.owner.lincoln.com](http://www.owner.lincoln.com)

## Lincoln Automotive Financial Services - US Only

Lincoln Automotive Financial Services offers a full range of financing and lease plans to help you acquire your vehicle. We are dedicated to providing answers, information and a truly extraordinary experience.

For assistance call 1-888-498-8801, or for more information about Lincoln Automotive Financial Services and access to an account manager, visit [www.lincoln.com/finance](http://www.lincoln.com/finance).

## Canada

Lincoln  
Customer Relationship Center  
P.O. Box 2000  
Oakville, Ontario L6K 0C8  
1-800-387-9333  
TDD for the hearing impaired:  
7-1-1 (where offered by your telephone  
service provider)  
[www.lincolncanada.com](http://www.lincolncanada.com)

## Australia

Ford Motor Company  
Attention: Customer Relationship Centre  
Private Mail Bag 5  
Fairlane Business Park #3  
Campbellfield, Victoria, 3061  
Telephone: 13 3673 (FORD)  
E-mail: [foacust1@ford.com](mailto:foacust1@ford.com)

## New Zealand

Ford Motor Company  
Attention: Customer Relationship Centre  
Private Bag 76912  
Manukau City 2241  
Telephone: 0800 367 369 (FORDNZ)  
E-mail: [fncust@ford.com](mailto:fncust@ford.com)

## China

Customer Relationship Center  
Telephone: 400-988-6789  
Email: [info12@lincoln.com](mailto:info12@lincoln.com)  
Wechat Account: Lincoln\_in\_China  
Weibo Account: Lincoln China

## Asia Pacific

E-mail: [expcac@ford.com](mailto:expcac@ford.com)

# Contacting Us

---

## **Caribbean, Central America and Israel**

Ford Motor Company  
Ford Export Operations  
Attention: Owner Relations  
1555 Fairlane Drive  
Fairlane Business Park #3  
Allen Park, MI 48101  
Fax: (313) 390-0804  
Telephone: (313) 594-4857  
E-mail: expcac@ford.com

## **U.S. Virgin Islands and Puerto Rico**

Ford Motor Company  
Ford Export Operations  
Attention: Owner Relations  
1555 Fairlane Drive  
Fairlane Business Park #3  
Allen Park, MI 48101  
Telephone: (800) 841-3673  
E-mail: prcac@ford.com

## **Chile**

Ford Customer Service  
Telephone: 800-470-408

## **Argentina**

Telephone: 0800-888-3673

## **Brazil**

www.ford.com.br

## **North Africa**

E-mail: nafcrc@ford.com

## **Sub-Saharan Africa**

E-mail: ssacrc@ford.com

## **Puerto Rico**

Ford International Business Development,  
Inc.  
P.O. Box 11957  
Caparra Heights Station  
San Juan, PR 00922-1957  
1-800-392-3673 (FORD)  
Fax: (313) 390-0804  
E-mail: prcac@ford.com  
www.ford.com.pr

## **Middle East**

Ford Middle East Customer Relationship  
Center  
P.O. Box 21740  
Dubai, United Arab Emirates  
Telephone: 80004441066  
Toll-free number for the Kingdom of Saudi  
Arabia: 8008443673  
Mobily and Zain cell phone users in Saudi  
Arabia: 800850078  
Kuwait: 22280384  
Local telephone number for Kuwait: +965 1  
898900  
Fax: +971 4 3327266  
E-mail: menacac@ford.com  
www.me.ford.com

## **South Korea**

Telephone: +82-02-1600-6003  
E-mail: infokr1@ford.com



# Introduction

## ABOUT THIS PUBLICATION



**WARNING:** Driving while distracted can result in loss of vehicle control, crash and injury. We strongly recommend that you use extreme caution when using any device that may take your focus off the road. Your primary responsibility is the safe operation of your vehicle. We recommend against the use of any hand-held device while driving and encourage the use of voice-operated systems when possible. Make sure you are aware of all applicable local laws that may affect the use of electronic devices while driving.



**WARNING:** You risk death, fire, or serious injury to yourself and others if you do not follow the instruction highlighted by the warning symbol.

Thank you for choosing Lincoln. We recommend that you take some time to get to know your vehicle in order to benefit from greater safety and pleasure from driving it. Use this digital manual, that we have also made available for your continued use through the Lincoln Way app and your local Lincoln website to familiarize yourself with the basics.

**Note:** *To download the Lincoln Way app, visit your device's app store.*

**Note:** *To find the local Ford website, visit <https://corporate.ford.com/operations/locations/global-links.html>.*

**Note:** *Use and operate your vehicle in line with all applicable laws and regulations.*

**Note:** *Pass on all printed owner's information when selling this vehicle.*

Our digital resources include a comprehensive digital owner's manual that is dynamically created according to the features on your vehicle by using the vehicle identification number. See **Locating the Vehicle Identification Number** (page 422). The digital owner's manual includes visual

and full text search functions so that you can quickly locate the information you are looking for. It also includes links to a number of how-to videos created to help you understand some of the advanced technologies on your vehicle.

## Features and Options

This publication describes product features and options available throughout the range of available models, sometimes even before they are generally available. It may describe options that are not available on the vehicle you have bought.

## Illustrations

Some of the illustrations in this manual could show features as used in different models, some can appear different to you on your vehicle.

## Location of Components

This manual may qualify the location of a component as left-hand side or right-hand side. The side is determined when facing forward in the seat.

# Introduction

---

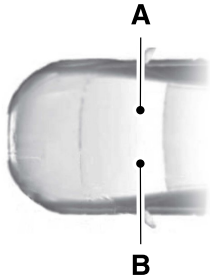

- A Right-hand side.
- B Left-hand side.

## USING THIS PUBLICATION

To quickly locate information about your vehicle, use the word search within the Owner's Manual application.

# Symbols Glossary

## SYMBOLS USED ON YOUR VEHICLE

These are some of the symbols you may see on your vehicle.



Air conditioning system



Air conditioning system lubricant type



Anti-lock braking system



Avoid smoking, flames or sparks



Battery



Battery acid



Brake fluid - non petroleum based



Brake system



Brake system



Cabin air filter



Check fuel cap



Child safety door lock or unlock



Child seat lower anchor



Child seat tether anchor



Cruise control



Do not open when hot



Electric Parking brake



Engine air filter



Engine coolant



Engine coolant temperature



Engine oil



Explosive gas



Fan warning



Fasten seatbelt



Flammable







Airbag



Front fog lamps

# Symbols Glossary

	Fuel pump reset		Low tire pressure warning		Power window lockout
	Fuse compartment		Maintain correct fluid level		Requires registered technician
	Hazard flashers		Note operating instructions		Safety alert
	Heated rear window		Horn control		See Owner's Manual
	Windshield defrosting system		Panic alarm		See Service Manual
	Interior luggage compartment release		Parking aid		Malfunction Indicator Lamp (MIL)
	Jack		Passenger airbag activated		Side airbag
	Keep out of reach of children		Passenger airbag deactivated		Shield the eyes
	Lighting control		Power steering fluid		Stability control
			Power windows front/rear		Hill descent control

# Symbols Glossary

---



Trail control



Windshield wiping system



Windshield wash and wipe

# Data Privacy

---



**WARNING:** Do not connect wireless plug-in devices to the data link connector. Unauthorized third parties could gain access to vehicle data and impair the performance of safety related systems. Only allow repair facilities that follow our service and repair instructions to connect their equipment to the data link connector.

We respect your privacy and are committed to protecting it. The information contained in this manual was correct at the time of publication but as technology rapidly changes, we recommend that you visit the local Lincoln website for the latest information.

Your vehicle has electronic control units that have data recording functionality and the ability to permanently or temporarily store data. This data could include information on the condition and status of your vehicle, vehicle maintenance requirements, events and malfunctions. The types of data that can be recorded are described in this section. Some of the data recorded is stored in event logs or error logs.

**Note:** *Error logs are reset following a service or repair.*

**Note:** *We may provide information in response to requests from law enforcement, other government authorities and third parties acting with lawful authority or through a legal process. Such information could be used by them in legal proceedings.*

Data recorded includes, for example:

- Operating states of system components, for example fuel level, tire pressure and battery charge level.
- Vehicle and component status, for example wheel speed, deceleration, lateral acceleration and seatbelt status.
- Events or errors in essential systems, for example headlamps and brakes.
- System responses to driving situations, for example airbag deployment and stability control.
- Environmental conditions, for example temperature.

Some of this data, when used in combination with other information, for example an accident report, damage to a vehicle or eyewitness statements, could be associated with a specific person.

## Services That We Provide

If you use our services, we collect and use data, for example account information, vehicle location and driving characteristics, that could identify you. We transmit this data through a dedicated, protected connection. We only collect and use data to enable your use of our services to which you have subscribed, with your consent or where permitted by law. For additional information, see the terms and conditions of the services to which you have subscribed.

For additional information about our privacy policy, refer to the local Lincoln website.

# Data Privacy

---

## Services That Third Parties Provide

We recommend that you review the terms and conditions and data privacy information for any services equipped with your vehicle or to which you subscribe. We take no responsibility for services that third parties provide.

Where equipped, SiriusXM with 360L may use the modem. To disable, turn off the SiriusXM 360L or Vehicle Connectivity setting. See **Enabling and Disabling the Modem** (page 423).

## SERVICE DATA

Service data recorders in your vehicle are capable of collecting and storing diagnostic information about your vehicle. This potentially includes information about the performance or status of various systems and modules in the vehicle, such as engine, throttle, steering or brake systems. In order to properly diagnose and service your vehicle, Ford Motor Company (Ford of Canada in Canada), and service and repair facilities may access or share among them

vehicle diagnostic information received through a direct connection to your vehicle when diagnosing or servicing your vehicle. Additionally, Ford Motor Company (Ford of Canada, in Canada) may, where permitted by law, use vehicle diagnostic information for vehicle improvement or with other information we may have about you, for example, your contact information, to offer you products or services that may interest you. Data may be provided to our service providers such as part suppliers that may help diagnose malfunctions, and who are similarly obligated to protect data. We retain this data only as long as necessary to perform these functions or to comply with law. We may provide information where required in response to official requests to law enforcement or other government authorities or third parties acting with lawful authority or court order, and such information may be used in legal proceedings. For U.S. only (if equipped), if you choose to use connected apps and services, you consent that certain diagnostic information may also be accessed electronically by Ford Motor Company and Ford authorized service facilities, and that the diagnostic information

may be used to provide services to you, personalizing your experience, troubleshoot, and to improve products and services and offer you products and services that may interest you, where permitted by law. For Canada only, for more information, please review the Ford of Canada privacy policy at [www.ford.ca](http://www.ford.ca), including our U.S. data storage and use of service providers in other jurisdictions who may be subject to legal requirements in Canada, the United States and other countries applicable to them, for example, lawful requirements to disclose personal information to governmental authorities in those countries.

# Data Privacy

---

## EVENT DATA

This vehicle is equipped with an event data recorder. The main purpose of an event data recorder is to record, in certain crash or near crash-like situations, such as an airbag deployment or hitting a road obstacle; this data will assist in understanding how a vehicle's systems performed. The event data recorder is designed to record data related to vehicle dynamics and safety systems for a short period of time, typically 30 seconds or less.

The event data recorder in this vehicle is designed to record such data as:

- How various systems in your vehicle were operating.
- Whether or not the driver and passenger seatbelts were buckled/fastened.
- How far (if at all) the driver was depressing the accelerator and/or the brake pedal.
- How fast the vehicle was traveling.
- Where the driver was positioning the steering wheel.

This data can help provide a better understanding of the circumstances in which crashes and injuries occur.

**Note:** *Event data recorder data is recorded by your vehicle only if a non-trivial crash situation occurs; no data is recorded by the event data recorder under normal driving conditions and no personal data or information (for example name, gender, age, and crash location) is recorded. However, parties, such as law enforcement, could combine the event data recorder data with the type of personally identifying data routinely acquired during a crash investigation.*

To read data recorded by an event data recorder, special equipment is required, and access to the vehicle or the event data recorder is needed. In addition to the vehicle manufacturer, other parties, such as law enforcement, that have such special equipment, can read the information if they have access to the vehicle or the event data recorder.

## SETTINGS DATA

Your vehicle has electronic control units that have the ability to store data based on your personalized settings. The data is stored locally in the vehicle or on devices that you connect to it, for example, a USB drive or digital music player. You can delete some of this data and also choose whether to share it through the services to which you subscribe.

### Comfort and Convenience Data

Data recorded includes, for example:

- Seat and steering wheel position.
- Climate control settings.
- Radio presets.

### Entertainment Data

Data recorded includes, for example:

- Music, videos or album art.
- Contacts and corresponding address book entries.
- Navigation destinations.



# Data Privacy

---

## CONNECTED VEHICLE DATA



The modem has a SIM. The modem was enabled when your vehicle was built and periodically sends messages to stay connected to the cell phone network, receive automatic software updates and send vehicle-related information to us, for example diagnostic information. These messages could include information that identifies your vehicle, the SIM and the electronic serial number of the modem. Cell phone network service providers could have access to additional information, for example cell phone network tower identification. For additional information about our privacy policy, visit [www.ConnectedLincoln.com](http://www.ConnectedLincoln.com) or refer to your local Lincoln website.

**Note:** *The modem continues to send this information unless you disable the modem or stop the modem from sharing vehicle data by changing the modem settings. See **Connected Vehicle** (page 423).*

**Note:** *The service can be unavailable or interrupted for a number of reasons, for example environmental or topographical conditions and data plan coverage.*

**Note:** *To find out if your vehicle has a modem, visit [www.ConnectedLincoln.com](http://www.ConnectedLincoln.com).*

## MOBILE DEVICE DATA

If you connect a mobile device to your vehicle, you can display data from your device on the touchscreen for example, music and album art. You can share your vehicle data with mobile apps on your device through the system. See **App Requirements** (page 449).

The mobile apps function operates by your connected device sending data to us in the United States. The data is encrypted and includes, for example, the vehicle identification number of your vehicle, the SYNC module serial number, odometer, enabled apps, usage statistics and

debugging information. We retain it only as long as necessary to provide the service, to troubleshoot, for continuous improvement and to offer you products and services that may be of interest to you according to your preferences and where allowed by law.

If you connect a cell phone to the system, the system creates a profile that links to that cell phone. The cell phone profile enables more mobile features and efficient operation. The profile contains, for example data from your phonebook, read and unread text messages and call history, including history of calls when your cell phone was not connected to the system.

If you connect a media device, the system creates and retains a media device index of supported media content. The system also records a short diagnostic log of approximately 10 minutes of all recent system activity.

# Data Privacy

---

The cell phone profile, media device index and diagnostic log remain in your vehicle unless you delete them and are generally accessible only in your vehicle when you connect your cell phone or media device. If you no longer plan to use the system or your vehicle, we recommend you use the master reset function to erase the stored information. See **Performing a Master Reset** (page 457).

System data cannot be accessed without special equipment and access to your vehicle's module.

For additional information about our privacy policy, refer to the local Lincoln website.

**Note:** *To find out if your vehicle has connectivity technology, visit [www.ConnectedLincoln.com](http://www.ConnectedLincoln.com).*

## **EMERGENCY CALL SYSTEM DATA**

When the emergency call system is active, it may disclose to emergency services that your vehicle has been in a crash involving the deployment of an airbag or activation of the fuel pump shut-off. Certain versions or updates to the emergency call system may also be capable of electronically or verbally disclosing to emergency services operators your vehicle location or other details about your vehicle or crash to assist emergency services operators to provide the most appropriate emergency services. If you do not want to disclose this information, do not activate the emergency call system.

**Note:** *You cannot deactivate emergency call systems that are required by law.*

# Visual Search

---

## STEERING WHEEL

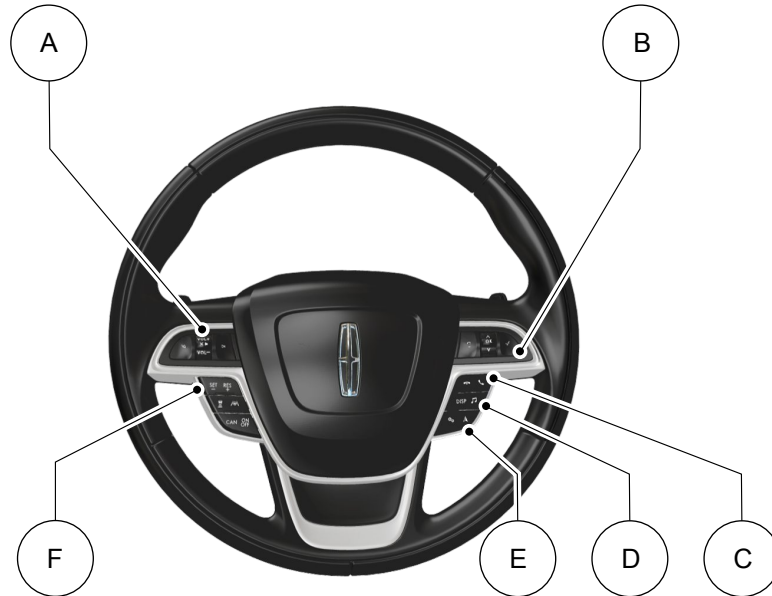

# Visual Search

---

- A See **Adjusting the Volume** (page 430).
- B See **Beginning a Voice Interaction** (page 440).
- C See **Making and Receiving a Phone Call** (page 444).
- D See **Selecting the Audio Source** (page 429).
- E See **Accessing Navigation** (page 454).
- F See **Switching Adaptive Cruise Control On and Off** (page 259).

# Visual Search

---

## INSTRUMENT PANEL

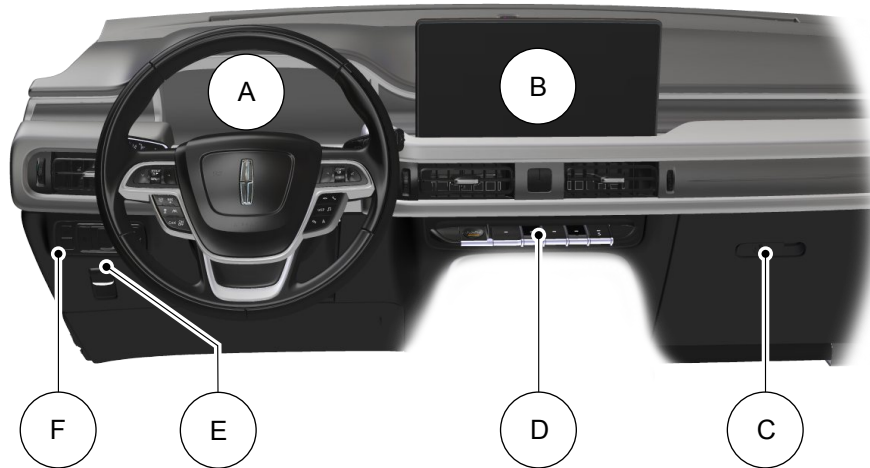

# Visual Search

---

- A See **Instrument Cluster Overview** (page 139).
- B See **Feature Bar** (page 438).
- C See **Replacing the Cabin Air Filter** (page 160).
- D See **Shifting Your Vehicle Into Gear** (page 211).
- E See **Applying the Electric Parking Brake** (page 223).
- F See **Exterior Lighting Control** (page 121).

# Visual Search

---

## CENTER CONSOLE

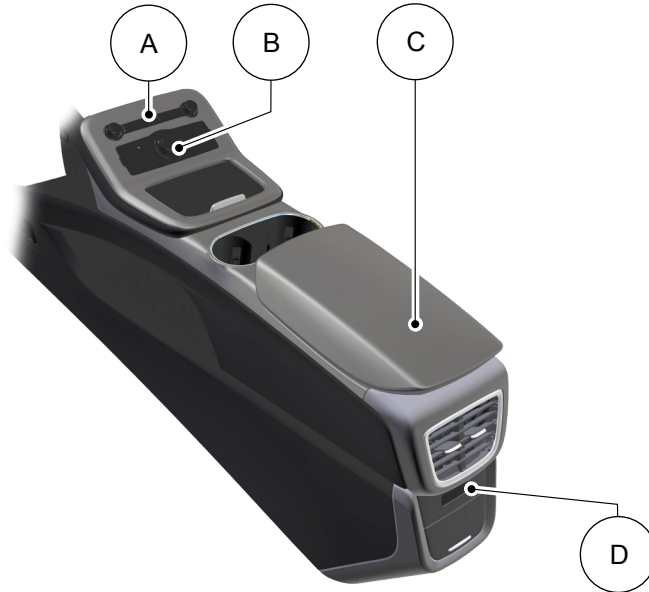

# Visual Search

---

- A See **Switching the Hazard Flashers On and Off** (page 316).
- B See **Switching the Audio Unit On and Off** (page 429).
- C See **Locating the Power Outlets** (page 185).
- D See **Switching the Heated Seats On and Off** (page 170).



# Visual Search

---

## VEHICLE INTERIOR

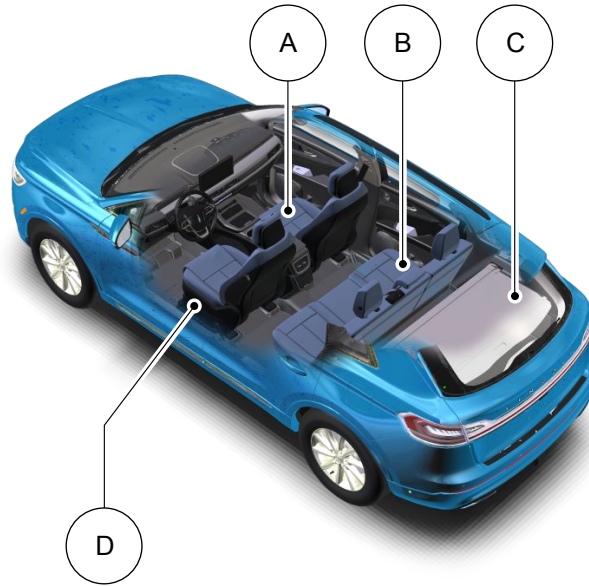

# Visual Search

---

- A See **Moving the Seat Backward and Forward** (page 163).
- B See **Folding the Seat Backrest** (page 170).
- C See **Installing and Removing the Luggage Compartment Cover** (page 300).
- D See **Adjusting the Lumbar Support** (page 165).

# Visual Search

---

## FRONT EXTERIOR

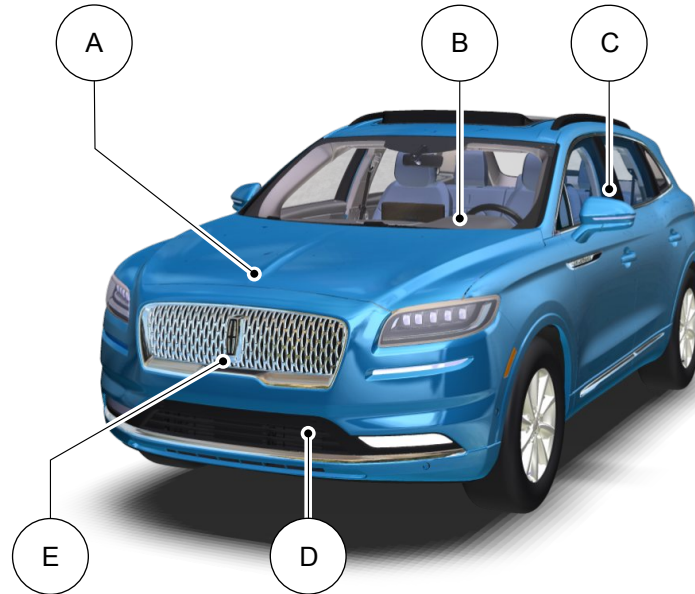

# Visual Search

---

- A See **Opening and Closing the Hood** (page 339).
- B See **Replacing the Front Wiper Blades** (page 118).
- C See **Locating the Keyless Entry Keypad** (page 97).
- D See **Locating the Front Parking Aid Sensors** (page 238).
- E See **Locating the 360 Degree Cameras** (page 246).

# Visual Search

---

## REAR EXTERIOR

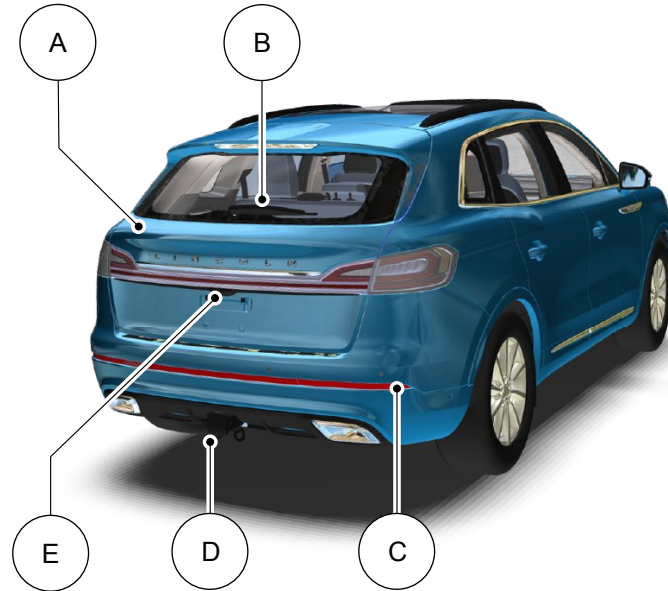

# Visual Search

---

- A See **Opening the Hands-Free Liftgate** (page 103).
- B See **Replacing the Rear Wiper Blades** (page 118).
- C See **Locating the Rear Parking Aid Sensors** (page 237).
- D See **Connecting a Trailer** (page 302).
- E See **Locating the Rear View Camera** (page 242).

# Child Safety

## CHILD SAFETY PRECAUTIONS



**WARNING:** Always make sure your child is secured properly in a device that is appropriate for their height, age and weight. Child safety restraints must be bought separately from your vehicle. Failure to follow these instructions and guidelines may result in an increased risk of serious injury or death to your child.



**WARNING:** All children are shaped differently. The National Highway Traffic Safety Administration and other safety organizations, base their recommendations for child restraints on probable child height, age and weight thresholds, or on the minimum requirements of the law. We recommend that you check with a NHTSA Certified Child Passenger Safety Technician (CPST) to make sure that you properly install the child restraint in your vehicle and that you consult your pediatrician to make sure you have a child restraint appropriate for your child. To locate a child restraint fitting station and

CPST, contact NHTSA toll free at 1-888-327-4236 or go to [www.nhtsa.dot.gov](http://www.nhtsa.dot.gov). In Canada, contact Transport Canada toll free at 1-800-333-0371 or go to [www.tc.gc.ca](http://www.tc.gc.ca) to find a Child Car Seat Clinic in your area. Failure to properly restrain children in child restraints made especially for their height, age and weight, may result in an increased risk of serious injury or death to your child.



**WARNING:** On hot days, the temperature inside the vehicle can rise very quickly. Exposure of people or animals to these high temperatures for even a short time can cause death or serious heat related injuries, including brain damage. Small children are particularly at risk.



**WARNING:** Do not place a rearward facing child restraint in front of an active airbag. Failure to follow this instruction could result in personal injury or death.



**WARNING:** Properly secure children 12 years old and under in a rear seating position whenever possible. If you are unable to properly secure all children in a rear seating position, properly secure the largest child on the front seat. If you must use a forward facing child restraint on the front seat, move the seat as far back as possible. Failure to follow these instructions could result in personal injury or death.





**WARNING:** Always carefully follow the instructions and warnings provided by the manufacturer of any child restraint to determine if the restraint device is appropriate for your child's size, height, weight, or age. Follow the child restraint manufacturer's instructions and warnings provided for installation and use in conjunction with the instructions and warnings provided by your vehicle

# Child Safety

manufacturer. A safety seat that is improperly installed or utilized, is inappropriate for your child's height, age, or weight or does not properly fit the child may increase the risk of serious injury or death.

 **WARNING:** Do not allow a passenger to hold a child on their lap when your vehicle is moving. Failure to follow this instruction could result in personal injury or death in the event of a sudden stop or crash.

 **WARNING:** Do not use pillows, books or towels to boost your child's height. Failure to follow this instruction could result in personal injury or death.

 **WARNING:** Properly secure child restraints or booster seats when they are not in use. They could become projectiles in a sudden stop or crash. Failure to follow this instruction could result in personal injury or death.

 **WARNING:** Do not put the shoulder section of the seatbelt or allow the child to put the shoulder section of the seatbelt under their arm or behind their back. Failure to follow this instruction could reduce the effectiveness of the seatbelt and increase the risk of injury or death in a crash.

 **WARNING:** Do not leave children or pets unattended in your vehicle. Failure to follow this instruction could result in personal injury or death.

When installing a child restraint with seatbelts:

- Place the vehicle seat in the upright position before you install the child restraint.
- Use the correct seatbelt buckle for that seating position.
- Insert the belt tongue into the buckle. Make sure the tongue is securely fastened in the buckle.

- Keep the buckle release button pointing up and away from the child restraint, with the tongue between the child restraint and the release button, to prevent accidental unbuckling.
- Put the seatbelt in the automatic locking mode.

## CHILD RESTRAINT ANCHOR POINTS

### WHAT ARE THE CHILD RESTRAINT ANCHOR POINTS

Anchor points allow you to quickly and safely install a child restraint.



# Child Safety

## LOCATING THE CHILD RESTRAINT LOWER ANCHOR POINTS

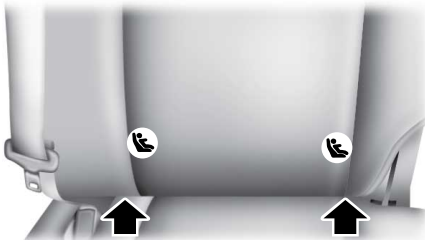

## LOCATING THE CHILD RESTRAINT TOP TETHER ANCHOR POINTS

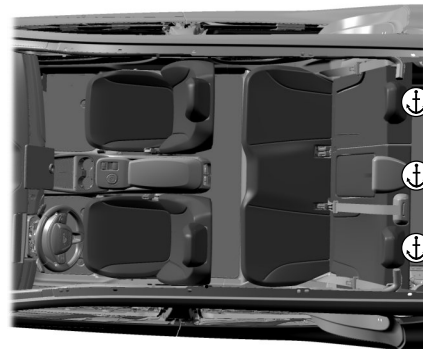

## CHILD RESTRAINTS

### CHILD RESTRAINT POSITION INFORMATION

Install the child restraint tightly against the vehicle seat. It may be necessary to lift or remove the head restraint.

# Child Safety

---

## Rear Facing Child Restraints

Combined Weight of Child and Child Restraint	LATCH (Lower Anchors Only)	Seatbelt Only
Up to 65 lb (29 kg)	X	X
Over 65 lb (29 kg)		X

## Forward Facing Child Restraints

Combined Weight of Child and Child Restraint	LATCH (Lower Anchors and Top Tether Anchor)	Seatbelt and Top Tether Anchor	Seatbelt and LATCH (Lower Anchors and Top Tether Anchor)
Up to 65 lb (29 kg)	X	X	X
Over 65 lb (29 kg)		X	X

# Child Safety

## CHILD RESTRAINTS RECOMMENDATION

Child Size, Height, Weight, or Age	Recommended Restraint Type
Children weighing 40 lb (18 kg) or less (generally age four or younger).	Use a child restraint (sometimes called an infant carrier, convertible seat, or toddler seat).
Children who have outgrown or no longer properly fit in a child restraint (generally children who are less than 57 in (1.45 m) tall, are greater than age four and less than age 12, and between 40 lb (18 kg) and 80 lb (36 kg) and upward to 100 lb (45 kg) if recommended by your child restraint manufacturer).	Use a belt-positioning booster seat.
Children who have outgrown or no longer properly fit in a belt-positioning booster seat (generally children who are at least 57 in (1.45 m) tall or greater than 80 lb (36 kg) or 100 lb (45 kg) if recommended by child restraint manufacturer).	Use a vehicle seatbelt having the lap belt snug and low across the hips, shoulder belt centered across the shoulder and chest, and seat backrest upright.

You are required by law to properly use child restraints for infants and toddlers in the United States, Canada and Mexico.

Many states and provinces require that small children use approved booster seats until they reach age eight, a height of 57 in (1.45 m) tall, or 80 lb (36 kg). Check your local and state or provincial laws for specific requirements about the safety of children in your vehicle.

When possible, properly restrain children 12 years of age and under in a rear seating position of your vehicle. Accident statistics suggest that children are safer when properly restrained in the rear seating positions than in a front seating position.

When installing a rear facing child restraint, adjust the vehicle seats to avoid interference between the child restraint and the vehicle seat in front of the child restraint.

# Child Safety

## INSTALLING CHILD RESTRAINTS

### USING SEATBELTS



**WARNING:** Depending on where you secure a child restraint, and depending on the child restraint design, you may block access to certain seatbelt buckle assemblies and LATCH lower anchors, rendering those features potentially unusable. To avoid risk of injury, make sure occupants only use seating positions where they are able to be properly restrained.

**Note:** *Although the child restraint illustrated is a forward-facing child restraint, the steps are the same for installing a rear-facing child restraint.*

Perform the following steps when installing the child restraint with seatbelts:

1. Position the child restraint in a seat with a seatbelt.



2. After positioning the child restraint in the proper seating position, pull down on the shoulder belt and then grasp the shoulder belt and lap belt together behind the belt tongue.

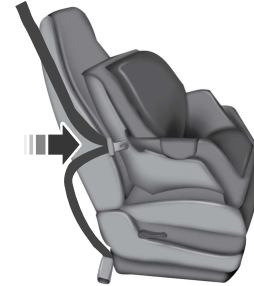

3. While holding the shoulder and lap belt portions together, route the tongue through the child restraint according to the child restraint manufacturer's instructions. Make sure that you did not twist the belt webbing.

# Child Safety

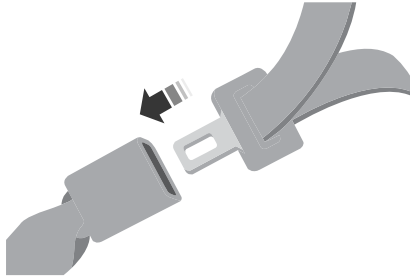

4. Insert the belt tongue into the proper buckle (the buckle closest to the direction the tongue is coming from) for that seating position until you hear a snap and feel the latch engage. Make sure the tongue is latched securely by pulling on it.



5. To put the retractor in the automatic locking mode, grasp the shoulder portion of the belt and pull downward until you pull all of the belt out.

**Note:** *The automatic locking mode is available on the front passenger and rear seats.*

6. Allow the belt to retract to remove slack. The belt clicks as it retracts to indicate it is in the automatic locking mode.

7. Try to pull the belt out of the retractor to make sure the retractor is in the automatic locking mode. You should not be able to pull more belt out. If the retractor did not lock, unbuckle the belt and repeat Steps 5 and 6.



8. Remove remaining slack from the belt. Force the seat down with extra weight, for example, by pressing down or kneeling on the child restraint while pulling up on the shoulder belt in order to force slack from the belt. This is necessary to remove the remaining slack that exists once you add the extra weight

# Child Safety

of the child to the child restraint. It also helps to achieve the proper snugness of the child restraint to your vehicle. Sometimes, a slight lean toward the buckle will provide extra help to remove remaining slack from the belt.

9. If the child restraint has a tether strap, attach it.

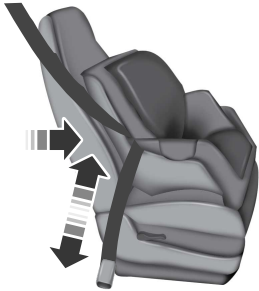

10. Before placing the child in the seat, forcibly move the seat forward and back to make sure the seat is securely held in place. To check this, grab the seat at the belt path and attempt to move it side to side and forward and back. There should be no more than 1 in (2.5 cm) of movement.

We recommend checking with a NHTSA Certified Child Passenger Safety Technician to make certain the child restraint is properly installed. In Canada, check with Transport Canada for referral to a Child Car Seat Clinic.

## USING LOWER ANCHORS AND TETHERS FOR CHILDREN

**WARNING:** Do not attach two child safety restraints to the same anchor. In a crash, one anchor may not be strong enough to hold two child safety restraint attachments and may break, causing serious injury or death.

**WARNING:** Depending on where you secure a child restraint, and depending on the child restraint design, you may block access to certain seatbelt buckle assemblies and LATCH lower anchors, rendering those features potentially unusable. To avoid risk of injury, make sure occupants only use seating positions where they are able to be properly restrained.

The LATCH (Lower Anchors and Tethers for Children) system has three vehicle anchor points.

- Two lower anchors where the seat backrest and seat cushion meet, called the seat bight.
- One top tether anchor behind that seating position.

# Child Safety

LATCH-compatible child restraints have two rigid or webbing mounted attachments that connect to the two lower anchors at the LATCH-equipped seating positions in your vehicle. This type of attachment method eliminates the need to use seatbelts to attach the child restraint.

However, you can still use the seatbelt to attach the child restraint. For forward-facing child restraints, you must also attach the top tether strap to the proper top tether anchor if a top tether strap has been provided with your child restraint.

Follow the instructions on attaching child restraints with tether straps.

## INSTALLING A CHILD RESTRAINT IN A CENTER SEAT



**WARNING:** The standardized spacing for LATCH lower anchors is 11 in (280 mm) center to center. Do not use LATCH lower anchors for the center seating position unless the child restraint manufacturer's instructions permit and specify using anchors spaced at least as far apart as those in this vehicle.

The lower anchors at the center of the second row rear seat are spaced 20 in (51 cm) apart. You cannot install a child restraint with rigid LATCH attachments at the center seating position. You can only use LATCH-compatible child restraints with attachments on belt webbing at this seating position provided that the child restraint manufacturer's instructions permit use with the anchor spacing stated. Do not attach a child restraint to any lower anchor if an adjacent child restraint is attached to that anchor.

Each time you use the child restraint, check that the seat is properly attached to the lower anchors and tether anchor, if applicable. Tug the child restraint from side to side and forward and back where it is secured to your vehicle. The seat should move less than 1 in (2.5 cm).

If you did not properly anchor the child restraint, the risk of a child being injured in a crash greatly increases.

## COMBINING THE SEATBELT AND LOWER ANCHORS FOR ATTACHING CHILD RESTRAINTS

When used in combination, you may attach either the seatbelt or the LATCH lower anchors first, provided a proper installation is achieved. Attach the tether strap afterward, if it is included with the child restraint.

# Child Safety

## USING TETHER STRAPS

Many forward-facing child restraints include a tether strap which extends from the back of the child restraint and hooks to an anchoring point called the top tether anchor. Tether straps are available as an accessory for many older child restraints.

Contact the manufacturer of your child restraint for information about ordering a tether strap, or to obtain a longer tether strap if the tether strap on your child restraint does not reach the appropriate top tether anchor in your vehicle.

Once you install the child restraint using either the seatbelt, the lower anchors of the LATCH system, or both, you can attach the top tether strap.

Perform the following steps to install a child restraint with tether anchors.

**Note:** *If you install a child restraint with rigid LATCH attachments, do not tighten the tether strap enough to lift the child restraint off your vehicle seat cushion when the child is seated in it. Keep the tether strap just snug without lifting the front of the child restraint. Keeping the child restraint just touching your vehicle seat gives the best protection in a severe crash.*

1. Route the child restraint tether strap over the back of the seat. For the outermost seating positions, route the tether strap under the head restraint and between the head restraint posts. For the center seating position, route the tether strap over the top of the head restraint. If needed, you can also remove the head restraints.

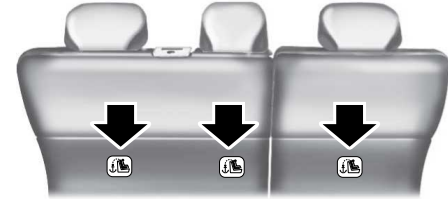

2. Locate the correct anchor behind the gap cover for the selected seating position.



3. Clip the tether strap to the anchor as shown.



# Child Safety

4. Tighten the child restraint tether strap according to the manufacturer's instructions.

If your child restraint system has a tether strap, and the child restraint manufacturer recommends its use, we also recommend its use.

## BOOSTER SEATS

Use a belt-positioning booster seat for children who have outgrown or no longer properly fit in a child restraint and meet the following criteria.

- Generally children who are less than 57 in (1.45 m) tall.
- Are greater than age four (4) and less than age twelve (12).
- Are between 40 lb (18 kg) and 80 lb (36 kg) and upward to 100 lb (45 kg).

Many state and provincial laws require that children use approved booster seats until they reach age eight, a height of 57 in (1.45 m) tall, or 80 lb (36 kg).

Booster seats should be used until you can answer yes to all of these questions when seated without a booster seat:

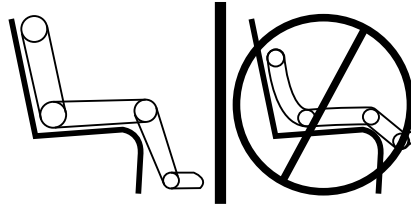

- Can the child sit all the way back against their vehicle seat backrest with knees bent comfortably at the edge of the seat cushion?
- Can the child sit without slouching?
- Does the lap belt rest low across the hips?
- Is the shoulder belt centered on the shoulder and chest?
- Can the child stay seated like this for the whole trip?

Always use booster seats in conjunction with your vehicle lap and shoulder belt.

## Types of Booster Seats



- Backless booster seats

If your backless booster seat has a removable shield, remove the shield.

## Child Safety

---

If a vehicle seating position has a low seat backrest or no head restraint, a backless booster seat may place your child's head, as measured at the tops of the ears, above the top of the seat. In this case, move the backless booster to another seating position with a higher seat backrest or head restraint and lap and shoulder belts, or consider using a high-back booster seat.



- High-back booster seats

If, with a backless booster seat, you cannot find a seating position that adequately supports your child's head, a high-back booster seat would be a better choice.

Children and booster seats vary in size and shape. Choose a booster that keeps the lap belt low and snug across the hips, never up across the stomach, and lets you adjust the shoulder belt to cross the chest and rest snugly near the center of the shoulder.

The following drawings compare the ideal fit to a shoulder belt uncomfortably close to the neck and a shoulder belt that could slip off the shoulder. The drawings also show how the lap belt should be low and snug across the child's hips.

# Child Safety



# Child Safety

If the booster seat slides on the vehicle seat upon which it is being used, placing a rubberized mesh sold as shelf or carpet liner under the booster seat may improve this condition. Do not use any item thicker than this under the booster seat. Check with the booster seat manufacturer's instructions.

## CHILD SAFETY LOCKS



**WARNING:** You cannot open the rear doors from inside if you have put the child safety locks on.



### Right-Hand Side

Turn the key clockwise to switch the child lock off and counterclockwise to switch it on.

A child safety lock is on the rear edge of each rear door. You must switch the child safety lock separately on each door.

### Left-Hand Side

Turn the key counterclockwise to switch the child lock off and clockwise to switch it on.

# Seatbelts

## SEATBELT PRECAUTIONS

 **WARNING:** Always drive and ride with your seatback upright and the lap belt snug and low across the hips.

 **WARNING:** Children must always be properly restrained.

 **WARNING:** Do not allow a passenger to hold a child on their lap when your vehicle is moving. Failure to follow this instruction could result in personal injury or death in the event of a sudden stop or crash.

 **WARNING:** All occupants of your vehicle, including the driver, should always properly wear their seatbelts, even when an airbag supplemental restraint system is provided. Failure to properly wear your seatbelt could seriously increase the risk of injury or death.

 **WARNING:** It is extremely dangerous to ride in a cargo area, inside or outside of a vehicle. In a crash, people riding in these areas are more likely to be seriously injured or killed. Do not allow people to ride in any area of your vehicle that is not equipped with seats and seatbelts. Make sure everyone in your vehicle is in a seat and properly using a seatbelt. Failure to follow this warning could result in serious personal injury or death.

 **WARNING:** In a rollover crash, an unbelted person is significantly more likely to die than a person wearing a seatbelt.

 **WARNING:** Each seating position in your vehicle has a specific seatbelt assembly made up of one buckle and one tongue designed to be used as a pair. Use the shoulder belt on the outside shoulder only. Never wear the shoulder belt under the arm. Never use a single seatbelt for more than one person.

 **WARNING:** Even with advanced restraints systems, properly restrain children 12 and under in a rear seating position. Failure to follow this could seriously increase the risk of injury or death.

 **WARNING:** Seatbelts and seats may be hot in a vehicle that is in the sunshine. The hot seatbelts or seats may burn a small child. Check seat covers and buckles before you place a child anywhere near them.

 **WARNING:** If your vehicle is involved in a crash, have the seatbelts and associated components inspected as soon as possible. Failure to follow this instruction could result in personal injury or death.

All seating positions in your vehicle have lap and shoulder seatbelts. All occupants of the vehicle should always properly wear their seatbelts, even when an airbag supplemental restraint system is provided.

# Seatbelts

The seatbelt system consists of:

- Lap and shoulder seatbelts.
- Shoulder seatbelt with automatic locking mode, except driver seatbelt.
- Height adjuster at the front outermost seating positions.
- Seatbelt pretensioners at the front outermost and second row outermost seating positions.
- Belt tension sensor at the front outermost passenger seating position.



- Seatbelt warning light and chime.



- Crash sensors and monitoring system with readiness indicator.

The seatbelt pretensioners are designed to tighten the seatbelts when activated. In frontal and near-frontal crashes, the seatbelt pretensioners may be activated alone or, if the crash is of sufficient severity, together with the front airbags. The pretensioners may also activate when a Safety Canopy airbag deploys.

## FASTENING AND UNFASTENING THE SEATBELTS

All seatbelts in your vehicle are a three-point combination lap and shoulder seatbelt.

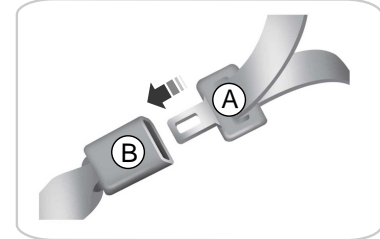

- A Seatbelt tongue.
- B Seatbelt buckle.

1. Pull the seatbelt out steadily.

**Note:** It may lock if you pull it sharply or if the vehicle is on a slope.

2. Insert the tongue into the buckle.

# Seatbelts

3. Pull the seatbelt tight to remove any slack.

## Unfastening the Seatbelts

1. Press the red button on the buckle to release the seatbelt.
2. Hold the seatbelt tongue and let it retract completely and smoothly to its stowed position.

## Using a Sliding Clip (If Equipped)

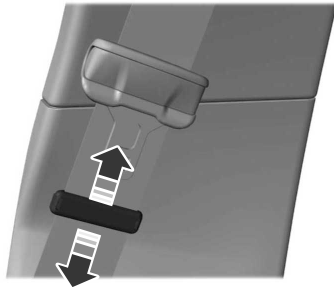

Slide the clip away from the tongue so there is no loose webbing when an occupant or child seat is buckled up. You can also use the sliding clip to raise the tongue and prevent it from rattling or to ease access to the tongue.

## SENSITIVE LOCKING MODE

### WHAT IS SENSITIVE LOCKING MODE

Sensitive locking mode is a seatbelt retractor feature that allows shoulder belt length adjustment according to your movements and locking in response to vehicle movement.

### HOW DOES SENSITIVE LOCKING MODE WORK

If the driver suddenly brakes, turns a corner sharply, or the vehicle receives an impact of about 5 mph (8 km/h) or more, the seatbelts lock to help reduce forward movement of the driver and passengers.

In addition, the seatbelt retractor locks if you pull the seatbelt webbing out too quickly. If the retractor locks, slowly lower the height adjuster to allow the seatbelt to retract.

If the retractor does not unlock, pull the seatbelt out slowly then feed a small length of webbing back toward the stowed position.

For rear seatbelts, recline the rear seat backrest or push the seat backrest cushion away from the seatbelt. Feed a small length of webbing back toward the stowed position.

## AUTOMATIC LOCKING MODE

### WHAT IS AUTOMATIC LOCKING MODE

This is a safety feature built into the seatbelt retractors that keeps the seatbelts pre-locked.

# Seatbelts

## ENGAGING AUTOMATIC LOCKING MODE



1. Fasten the combination lap and shoulder belt.
2. Grasp the shoulder portion and pull downward until you pull the entire belt out.
3. Allow the belt to retract. As the belt retracts, you will hear a clicking sound. This indicates the seatbelt is now in the automatic locking mode.

## DISENGAGING AUTOMATIC LOCKING MODE

Unbuckle the combination lap and shoulder belt and allow it to retract completely to disengage the automatic locking mode and activate the vehicle sensitive locking mode.

## ADJUSTING THE SEATBELTS DURING PREGNANCY



**WARNING:** Always ride and drive with your seatback upright and properly fasten your seatbelt. Fit the lap portion of the seatbelt snugly and low across the hips. Position the shoulder portion of the seatbelt across your chest. Pregnant women must follow this practice. See the following figure.

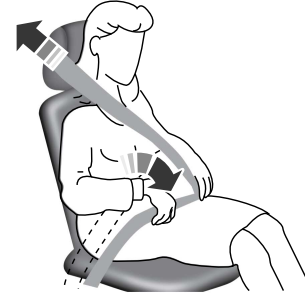

Pregnant women should always wear their seatbelt. Position the lap belt portion of a combination lap and shoulder belt low across the hips below the belly and worn as tight as comfort allows. Position the shoulder belt to cross the middle of the shoulder and the center of the chest.



# Seatbelts

## ADJUSTING THE SEATBELT HEIGHT



**WARNING:** Position the seatbelt height adjuster so that the seatbelt rests across the middle of your shoulder. Failure to adjust the seatbelt correctly could reduce its effectiveness and increase the risk of injury in a crash.



1. Press the button and slide the height adjuster up or down.
2. Release the button and pull down on the height adjuster to make sure it is locked in place.

## SEATBELT REMINDER

### HOW DOES THE SEATBELT REMINDER WORK

This feature supplements the seatbelt warning function by providing additional reminders that intermittently sound a tone and illuminate the seatbelt warning lamp when you are in the driver seat or you have a front seat passenger and a seatbelt is unbuckled.

The system uses information from the front passenger sensing system to determine if a front seat passenger is present and therefore potentially in need of a warning. To avoid the system switching on the Belt-Minder feature for objects you place on the front passenger seat, only the front seat passengers receive warnings as determined by the front passenger sensing system.

If the Belt-Minder warnings expire (warnings for about five minutes) for one passenger (driver or front passenger), the other passenger can still cause the Belt-Minder feature to switch on.

# Seatbelts

---

<b>If</b>	<b>Then</b>
You and the front seat passenger buckle your seatbelts before you switch the ignition on or less than 1–2 minutes elapse after you switch the ignition on...	The Belt-Minder feature will not activate.
You or the front seat passenger do not buckle your seatbelts before your vehicle reaches at least 6.0 mph (9.7 km/h) and 1–2 minutes elapse after you switch the ignition on...	The Belt-Minder feature activates, the seatbelt warning lamp illuminates and an indicator tone sounds for 6 seconds every 25 seconds, repeating for about 5 minutes or until you and the front seat passenger buckle your seatbelts.
The seatbelt for the driver or front passenger is unbuckled for about 1 minute while the vehicle is traveling at least 6.0 mph (9.7 km/h) and more than 1–2 minutes elapse after you switch the ignition on...	The Belt-Minder feature activates, the seatbelt warning lamp illuminates and an indicator tone sounds for 6 seconds every 25 seconds, repeating for about 5 minutes or until you and the front seat passenger buckle your seatbelts.

# Seatbelts

## SEATBELT REMINDER INDICATORS



This lamp illuminates and a warning tone sounds if you do not fasten your seatbelt when you switch the ignition on. The lamp switches off when you fasten your seatbelt or about one minute has elapsed.

When the initial warning expires for the driver, more warnings are provided for the driver and front passenger. This lamp illuminates and a warning tone sounds if driver or your front passenger do not fasten the seatbelt buckle and the vehicle speed exceeds 6 mph (10 km/h).

**Note:** To avoid inadvertent warnings, (front seat only) do not place large objects on the seat.

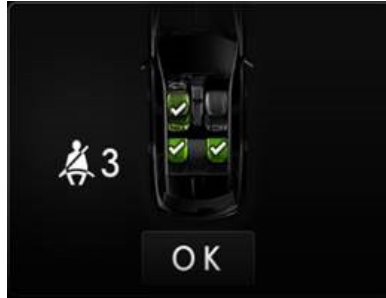

This lamp illuminates when you switch the ignition on, identifying the number of seating positions with fastened buckles. It illuminates again when a seating position changes from unfastened to fastened.

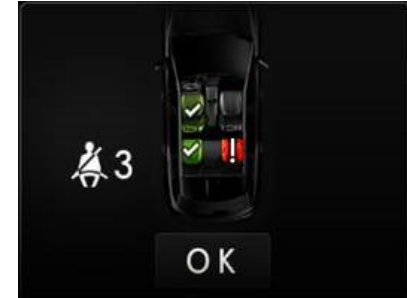

This warning displays if an occupant unfastens the rear outboard seatbelt buckle or it becomes unfastened.

**Note:** If a rear outboard seat is unoccupied, or an occupant never fastens the seatbelt buckle to begin with, the warning will not display.

**Note:** Front seating positions appear in this warning display. Warnings for unfastened front seatbelt buckles appear in the initial warning lamp.

# Seatbelts

## Seatbelt Status

To view the seatbelt status, use the information display controls on the steering wheel.

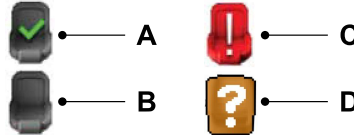
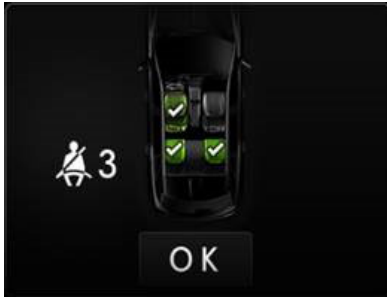

- A Seatbelt fastened.
- B Seatbelt not fastened.
- C Seatbelt recently unfastened.
- D Fault.

## SEATBELT REMINDER AUDIBLE WARNINGS

A warning tone sounds if the warning lamp illuminates and your vehicle exceeds a relatively low speed.

The warning tone sounds for up to five minutes or until you fasten your seatbelt.

## SWITCHING THE SEATBELT REMINDER ON AND OFF



**WARNING:** While the system allows you to deactivate it, this system is designed to improve your chances of being safely belted and surviving an accident. We recommend you leave the system activated for yourself and others who may use the vehicle.

**Note:** The driver and front passenger warnings switch off independently. When you perform this procedure for one seating position, do not buckle the other position as this cancels the process.

**Note:** If you are using MyKey, you cannot disable the seatbelt reminder. Also, if the seatbelt reminder has been previously disabled, it will be re-enabled during the use of MyKey. See **MyKey™** (page 85).

Read Steps 1 - 4 before proceeding with the programming procedure.

# Seatbelts

Make sure that:

- The parking brake is set.
  - The transmission is in park (P).
  - The ignition is off.
  - The driver and front passenger seatbelts are unfastened.
1. Switch the ignition on. Do not start the engine.
  2. After Step 1, wait an additional five seconds before proceeding with Step 3. Once you start Step 3, you must complete the procedure within 30 seconds.
  3. For the seating position you are switching off, buckle then unbuckle the seatbelt four times at a moderate speed, ending in the unbuckled state. After Step 3, the seatbelt warning light switches on.
  4. When the seatbelt warning light is on, buckle then unbuckle the seatbelt. After Step 4, the seatbelt warning light flashes for confirmation.

This switches the feature off for that seating position if it is currently on.

This switches the feature on for that seating position if it is currently off.

## CHECKING THE SEATBELTS

Check the seatbelts and child restraints periodically to make sure they work properly and are not damaged. Make sure there are no nicks, tears or cuts. Replace if necessary.

Check the following seatbelt assemblies after a crash.

- Retractors.
- Buckles.
- Front seatbelt buckle assemblies.
- Shoulder belt height adjusters.
- Shoulder belt guide on seat backrest.
- Child restraint LATCH and tether anchors.
- Attaching hardware.

Read the child restraint manufacturer's instructions for additional inspection and maintenance information specific to the child restraint.

We recommend that all seatbelt assemblies in use in vehicles involved in a crash be replaced. However, if the crash was minor and an authorized dealer finds that the belts do not show damage and continue to operate properly, they do not need to be replaced. Seatbelt assemblies not in use during a crash should also be checked and replaced if either damage or improper operation is noted.

Properly care for seatbelts. See **Cleaning Seatbelts** (page 366).

## SEATBELT EXTENSIONS



**WARNING:** Persons who fit into the vehicle's seatbelt should not use an extension. Unnecessary use could result in serious personal injury in the event of a crash.

# Seatbelts

---



**WARNING:** Only use extensions provided free of charge by our dealers. The dealer will provide an extension designed specifically for this vehicle, model year and seating position. The use of an extension intended for another vehicle, model year or seating position may not offer you the full protection of your vehicle's seatbelt restraint system.



**WARNING:** Never use seatbelt extensions to install child restraints.



**WARNING:** Do not use extensions to change the way the seatbelt fits across the torso, over the lap or to make the seatbelt buckle easier to reach.

If, because of body size or driving position, it is not possible to properly fasten the seatbelt over your lap and shoulder, an extension that is compatible with the seatbelts is available free of charge from our dealers. Only use our seatbelt extensions made by the original equipment seatbelt manufacturer with our seatbelts. Ask your authorized dealer if your extension is compatible with your vehicle restraint system.

## WHAT IS THE PERSONAL SAFETY SYSTEM

An advanced safety system that protects occupants in frontal crashes.

## HOW DOES THE PERSONAL SAFETY SYSTEM WORK

This system provides an improved level of frontal crash protection to front seat occupants and is designed to reduce the risk of airbag-related injuries. The system analyzes occupant conditions and crash severity before activating the appropriate safety devices. During a crash, the restraints control module may deploy the seatbelt pretensioners, and one or both stages of the dual-stage airbags based on crash severity and occupant conditions.

## PERSONAL SAFETY SYSTEM COMPONENTS

- Driver and passenger dual-stage airbag supplemental restraints.
- Front seat outermost seatbelts with pretensioners, energy management retractors and seatbelt usage sensors.
- Driver seat position sensor.
- Passenger seat position sensor.
- Front passenger sensing system.
- Passenger airbag off and on indicators.
- Front crash severity sensors.
- Restraints control module with impact and safing sensors.
- Restraint system warning light and tone.
- The electrical wiring for the airbags, crash sensors, seatbelt pretensioners, front seatbelt usage sensors, front passenger sensing system and indicator lights.

# Airbags

## HOW DO THE FRONT AIRBAGS WORK

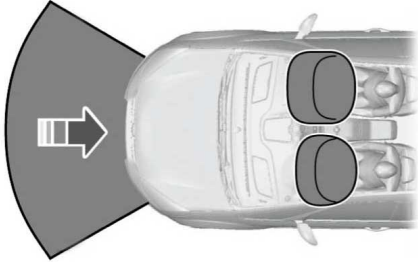

The driver and front passenger airbags deploy during significant frontal and near frontal crashes.

The driver and passenger front airbag system consists of:

- Driver and passenger airbag modules.
- Front passenger sensing system.
- Crash sensors and monitoring system with readiness indicator. See **Crash Sensors and Airbag Indicator** (page 72).

The airbags are a supplemental restraint system and are designed to work with the seatbelts to help protect the driver and right front passenger from certain upper body injuries. Airbags do not inflate slowly; there is a risk of injury from a deploying airbag.

**Note:** *You will hear a loud bang and see a cloud of harmless powdery residue if an airbag deploys. This is normal.*

The airbags inflate and deflate rapidly upon activation. After airbag deployment, it is normal to notice a smoke-like, powdery residue or smell the burnt propellant. This may consist of cornstarch, talcum powder (to lubricate the bag) or sodium compounds (for example, baking soda) that result from the combustion process that inflates the airbag. Small amounts of sodium hydroxide may be present which may irritate the skin and eyes, but none of the residue is toxic.

Contact with a deploying airbag may cause abrasions or swelling. Temporary hearing loss is also a possibility as a result of the noise associated with a deploying airbag.

Because airbags must inflate rapidly and with considerable force, there is the risk of death or serious injuries such as fractures, facial and eye injuries or internal injuries, particularly to occupants who are not properly restrained or are otherwise out of position at the time of airbag deployment. Thus, it is extremely important that occupants be properly restrained as far away from the airbag module as possible while maintaining vehicle control.

Routine maintenance of the airbags is not required.

## HOW DO THE SIDE AIRBAGS WORK

 **WARNING:** Do not place objects or mount equipment on or near the airbag cover, on the side of the front or rear seatbacks, or in areas that may come into contact with a deploying airbag. Failure to follow these instructions may increase the risk of personal injury in the event of a crash.



# Airbags



**WARNING:** Do not use accessory seat covers. The use of accessory seat covers may prevent the deployment of the side airbags and increase the risk of injury in an accident.



**WARNING:** Do not lean your head on the door. The side airbag could injure you as it deploys from the side of the seatback.

The side airbags are on the outermost side of the seat backrests of the front seats. In certain sideways crashes or rollovers, the airbags will be inflated. The airbag was designed to inflate between the door panel and occupant to further enhance the protection provided occupants in side impact crashes.



The system consists of the following:

- A label or embossed side panel indicating that side airbags are fitted to your vehicle.
- Side airbags inside the driver and front passenger seat backrests.
- Crash sensors and monitoring system with readiness indicator. See **Crash Sensors and Airbag Indicator** (page 72).

## HOW DO THE KNEE AIRBAGS WORK



**WARNING:** Close the glove box door when your vehicle is moving. Failure to follow this instruction could reduce the effectiveness of the passenger knee airbag and increase the risk of injury in a crash.

A driver knee airbag is under or within the instrument panel. A passenger knee airbag is within or under the glove box door. During a crash, the restraints control module may activate the driver and passenger knee airbags based on crash severity and occupant conditions. Under certain crash and occupant conditions, the driver and passenger knee airbag may deploy but the driver front airbag may not activate. As with front and side airbags, it is important to be properly seated and restrained to reduce the risk of death or serious injury.

# Airbags



Make sure the knee airbags are operating properly. See **Crash Sensors and Airbag Indicator**

(page 72).

## HOW DOES THE SAFETY CANOPY™ WORK



**WARNING:** Do not place objects or mount equipment on or near the headliner at the siderail that may come into contact with a deploying curtain airbag. Failure to follow these instructions may increase the risk of personal injury in the event of a crash.



**WARNING:** Do not lean your head on the door. The curtain airbag could injure you as it deploys from the headliner.



**WARNING:** To reduce risk of injury, do not obstruct or place objects in the deployment path of the airbag.

The Safety Canopy deploys during significant side crashes or when a certain likelihood of a rollover event is detected by the rollover sensor. The Safety Canopy is mounted to the roof side-rail sheet metal, behind the headliner, above each row of seats. In certain sideways crashes or rollover events, the Safety Canopy will be activated, regardless of which seats are occupied. The Safety Canopy inflates between the side window area and occupants to further enhance protection provided in side impact crashes and rollover events.

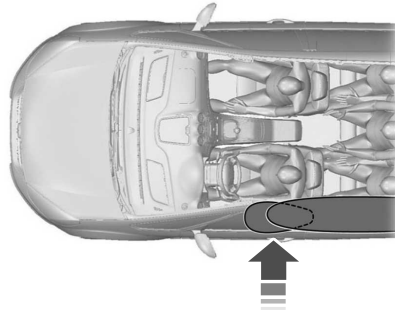

The system consists of the following:

- Safety Canopy curtain airbags above the trim panels over the front and rear side windows identified by a label or wording on the headliner or roof-pillar trim.
- A flexible headliner which opens above the side doors to allow air curtain deployment





• Crash sensors and monitoring system with a readiness indicator. See **Crash Sensors and Airbag Indicator** (page 72).

Properly restrain children 12 years old and under in the rear seats. The Safety Canopy will not interfere with children restrained using a properly installed child or booster seat because it is designed to inflate downward from the headliner above the doors along the side window opening.

# Airbags

## AIRBAG PRECAUTIONS

 **WARNING:** Airbags do not inflate slowly or gently, and the risk of injury from a deploying airbag is the greatest close to the trim covering the airbag module.

 **WARNING:** All occupants of your vehicle, including the driver, should always properly wear their seatbelts, even when an airbag supplemental restraint system is provided. Failure to properly wear your seatbelt could seriously increase the risk of injury or death.

 **WARNING:** Properly secure children 12 years old and under in a rear seating position whenever possible. If you are unable to properly secure all children in a rear seating position, properly secure the largest child on the front seat. If you must use a forward facing child restraint on the front seat, move the seat as far back as possible. Failure to follow these instructions could result in personal injury or death.

 **WARNING:** Do not place your arms on the airbag cover or through the steering wheel. Failure to follow this instruction could result in personal injury.

 **WARNING:** Keep the areas in front of the airbags free from obstruction. Do not affix anything to or over the airbag covers. Objects could become projectiles during airbag deployment. Failure to follow this instruction could result in personal injury or death.

 **WARNING:** To reduce risk of injury, do not obstruct or place objects in the deployment path of the airbag.

 **WARNING:** Do not place a rearward facing child restraint in front of an active airbag. Failure to follow this instruction could result in personal injury or death.

 **WARNING:** Do not attempt to service, repair, or modify the supplementary restraint system or associated components. Failure to follow this instruction could result in personal injury or death.

 **WARNING:** Several airbag system components get hot after inflation. To reduce the risk of injury, do not touch them after inflation.

 **WARNING:** If a supplementary restraint system component has deployed, it will not function again. Have the system and associated components inspected as soon as possible. Failure to follow this instruction could result in personal injury or death.

# Airbags

## PROPERLY ADJUSTING THE DRIVER AND FRONT PASSENGER SEATS

 **WARNING:** National Highway Traffic Safety Administration (NHTSA) recommends a minimum distance of at least 10 in (25 cm) between an occupant's chest and the driver airbag module.

To properly position yourself away from the airbag:

- Move your seat to the rear as far as you can while still reaching the pedals comfortably.
- Recline the seat slightly one or two degrees from the upright position.

After all occupants have adjusted their seats and put on seatbelts, it is very important that they continue to sit properly. Properly seated occupants sit upright, lean against the seat backrest, and center themselves on the seat cushion, with their feet comfortably extended on the floor. Sitting improperly can increase

the chance of injury in a crash event. For example, if an occupant slouches, lies down, turns sideways, sits forward, leans forward or sideways, or puts one or both feet up, the chance of injury during a crash greatly increases.

## CHILDREN AND AIRBAGS

 **WARNING:** Do not place a rearward facing child restraint in front of an active airbag. Failure to follow this instruction could result in personal injury or death.



Children must always be properly restrained. Accident statistics suggest that children are safer when properly restrained in the rear seating positions than in the front seating position. Failure to follow these instructions may increase the risk of injury in a crash.

## FRONT PASSENGER SENSING SYSTEM

### WHAT IS THE FRONT PASSENGER SENSING SYSTEM

This system detects a properly seated occupant and determines if the front passenger airbag should be enabled.

### HOW DOES THE FRONT PASSENGER SENSING SYSTEM WORK

The system uses a passenger airbag status indicator which illuminates indicating that the front passenger frontal airbag is either enabled or disabled.

# Airbags

**Note:** When you first switch the ignition on, the passenger airbag status indicator off and on lamps illuminate for a short period to confirm they are functional.

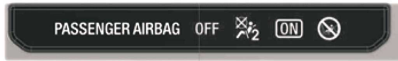

The indicator lamps are in the overhead console.

The front passenger sensing system is designed to disable the front passenger frontal airbag under these conditions:

- The front passenger seat is unoccupied.
- The system determines an infant is present in a child restraint.
- A passenger takes their weight off of the seat for a period of time.
- If there is a problem with the airbag system or the passenger sensing system.

Even with this technology, parents are strongly encouraged to always properly restrain children in the rear seat.

- When the front passenger sensing system disables the front passenger frontal airbag, the passenger airbag status indicator illuminates the off lamp.
- If you have installed the child restraint and the passenger airbag status indicator illuminates the on lamp, switch your vehicle off, remove the child restraint from your vehicle and reinstall the restraint following the child restraint manufacturer's instructions.

The front passenger sensing system works with sensors that are part of the front passenger seat and seatbelt. The sensors are designed to detect the presence of a properly seated occupant and determine if the front passenger frontal airbag should be enabled.

- When the front passenger sensing system enables the front passenger frontal airbag, the passenger airbag status indicator illuminates the on lamp.

If a person of adult size is sitting in the front passenger seat, but the passenger airbag status indicator off lamp is illuminated, it is possible that the person is not sitting properly in the seat. If this happens:

- Switch your vehicle off and ask the person to place the seat backrest in an upright position.
- Have the person sit upright in the seat, centered on the seat cushion, with the person's legs comfortably extended.
- Restart your vehicle and have the person remain in this position for about two minutes. This allows the system to detect that person and enable the passenger frontal airbag.
- If the indicator off lamp remains illuminated even after this, you should advise the person to ride in the rear seat.

After all occupants have adjusted their seats and put on seatbelts, it is very important that they continue to sit upright, leaning against the seat backrest, and centered on the seat cushion, with their feet comfortably extended on the floor.

# Airbags

Sitting improperly can increase the chance of injury in a crash event. For example, if an occupant slouches, lies down, turns sideways, sits forward, leans forward or sideways, or puts one or both feet up, the chance of injury during a crash greatly increases.

If you think that the state of the passenger airbag status indicator lamp is incorrect, check for the following:

- Objects lodged underneath the seat.
- Objects between the seat cushion and the center console.
- Objects hanging off the seat backrest.
- Objects stowed in the seat backrest map pocket.
- Objects placed on the occupant's lap.
- Cargo interference with the seat
- Other passengers pushing or pulling on the seat.
- Rear passenger feet and knees resting or pushing on the seat.

The listed conditions could cause the weight of a properly seated occupant to be incorrectly interpreted by the front passenger sensing system. The person in the front passenger seat could appear heavier or lighter due to the conditions listed.



Make sure the front passenger sensing system is operating properly. See **Crash Sensors and Airbag Indicator** (page 72).

If the airbag readiness light is on, do the following:

- Pull your vehicle over.
- Switch your vehicle off.
- Check for any objects lodged underneath the front passenger seat or cargo interfering with the seat.
- Remove the obstruction if found.
- Restart your vehicle.

- Wait at least two minutes and verify that the airbag readiness light in the instrument cluster is no longer illuminated.
- If the airbag readiness light in the instrument cluster remains illuminated, there may be a problem due to the front passenger sensing system.

Do not attempt to repair or service the system. Take your vehicle in for service immediately.

If it is necessary to modify an advanced front airbag system to accommodate a person with disabilities, contact your Customer Relationship Center. See **Contacting Us** (page 15).

# Airbags

## FRONT PASSENGER SENSING SYSTEM PRECAUTIONS



**WARNING:** Sitting improperly, out of position or with the seatback reclined too far can take weight off the seat cushion

and affect the decision of the passenger sensing system, resulting in serious injury or death in the event of a crash. Always sit upright against your seat back, with your feet on the floor.



**WARNING:** Any alteration or modification to the front passenger seat may affect the performance of the front passenger sensing system. This could seriously increase the risk of injury or death.

## FRONT PASSENGER SENSING SYSTEM INDICATORS

Occupant	Passenger Airbag Status Indicator	Passenger Airbag
Empty	OFF: Illuminated	Disabled
	ON: Not Illuminated	
Child	OFF: Illuminated	Disabled
	ON: Not Illuminated	
Adult	OFF: Not Illuminated	Enabled
	ON: Illuminated	

# Airbags

## CRASH SENSORS AND AIRBAG INDICATOR



**WARNING:** Modifying or adding equipment to the front of your vehicle could affect the performance of the airbag system, increasing the risk of injury. This includes the hood, bumper system, frame, front body structure, tow hooks, hood pins, push bar and snowplows.

Your vehicle has a collection of crash and occupant sensors. These sensors provide information to the restraints control module which activates the following:

- Front and rear seatbelt pretensioners.
- Driver airbag.
- Passenger airbag.
- Knee airbag(s).
- Seat mounted side airbags.
- Safety Canopy.

Based on the type of crash, the restraints control module deploys the appropriate safety devices.

The restraints control module also monitors the readiness of the above safety devices plus the crash and occupant sensors. The readiness of the safety system is indicated by a warning indicator light in the instrument cluster or by a backup tone if the warning light is not working. Routine maintenance of the airbag is not required.

A difficulty with the system is indicated by one or more of the following:



The readiness light will not illuminate immediately after you switch the ignition on.

- The readiness light either flashes or stays on.
- You hear a series of five tones. The tone pattern repeats periodically until the problem, the light or both are repaired.

If any of these things happen, even intermittently, have the supplemental restraint system serviced immediately. Unless serviced, the system may not function properly in the event of a crash.

The fact that the seatbelt pretensioners or front airbags did not activate for both front seat occupants in a crash does not mean that something is wrong with the system. Rather, it means the restraints control module determined the accident conditions (crash severity, seatbelt usage) were not appropriate to activate these safety devices.

- The front airbags activate only in frontal and near-frontal crashes. Front airbags may activate in rollovers, side impacts or rear impacts if the crash causes sufficient frontal deceleration.
- The seatbelt pretensioners activate in frontal, near-frontal and side crashes, and in rollovers.
- The knee airbag(s) deploy based on crash severity and occupant conditions.



# Airbags

---

- The side airbags inflate in certain side impact crashes or rollover events. Side airbags may activate in other types of crashes if the vehicle experiences sufficient sideways motion or deformation.
- The Safety Canopy inflates in certain side impact crashes or rollover events. The Safety Canopy may activate in other types of crashes if the vehicle experiences sufficient sideways motion or deformation, or a certain likelihood of rollover.

## **DISPOSING OF AIRBAGS**

Contact your authorized dealer as soon as possible. Airbags must be disposed of by qualified personnel.

# 911 Assist

## WHAT IS 911 ASSIST

911 Assist is a SYNC system feature that can call for help.

For more information, please refer to the regional Lincoln website.

## HOW DOES 911 ASSIST WORK

If a crash deploys an airbag, excluding knee airbags and rear inflatable seatbelts, or activates the fuel pump shut-off, your vehicle may be able to contact emergency services by dialing 911 through a paired and connected **Bluetooth**®-enabled phone.

Not all crashes will deploy an airbag or activate the fuel pump shut-off. If a connected cell phone sustains damage or loses its connection to SYNC during a crash, SYNC will search for and try to connect to a previously paired cell phone. SYNC will then attempt to call the emergency services.

Before making the call:

- SYNC provides about 10 seconds to cancel the call. If you fail to cancel the call, SYNC attempts to dial 911.
- SYNC says the following, or a similar message: "SYNC will attempt to call 911, to cancel the call, press Cancel on your screen or press and hold the phone button on your steering wheel."

If you do not cancel the call and SYNC makes a successful call a pre-recorded message plays for the 911 operator. The occupants in your vehicle are able to talk with the operator. Be prepared to provide your name, phone number and location immediately because not all 911 systems are capable of receiving this information electronically.

During an emergency call the system transmits vehicle data to the emergency service.

## EMERGENCY CALL REQUIREMENTS



**WARNING:** Do not wait for 911 Assist to make an emergency call if you can do it yourself. Dial emergency services immediately to avoid delayed response time which could increase the risk of serious injury or death after a crash. If you do not hear 911 Assist within five seconds of the crash, the system or phone may be damaged or non-functional.



**WARNING:** Always place your phone in a secure location in your vehicle so it does not become a projectile or get damaged in a crash. Failure to do so may cause serious injury to someone or damage the phone which could prevent 911 Assist from working properly.



**WARNING:** Unless the 911 Assist setting is set on before a crash, the system will not dial for help which could delay response time, potentially increasing the risk of serious injury or death after a crash.

# 911 Assist

---

- SYNC must be powered and working properly at the time of the incident and throughout feature activation and use.
- The 911 Assist feature must be set on before the incident.
- You must pair and connect a **Bluetooth®** enabled and compatible cell phone to SYNC.
- A connected **Bluetooth®** enabled phone must have the ability to make and maintain an outgoing call at the time of the incident.
- A connected **Bluetooth®** enabled phone must have adequate network coverage, battery power and signal strength.
- The vehicle must have battery power and be located in the U.S., Canada or in a territory in which 911 is the emergency number.

**Note:** *If any user sets 911 Assist to on or off, that setting applies for all paired phones. If 911 Assist is switched off and the phone is connected to SYNC, an icon displays on the status bar.*

**Note:** *Every phone operates differently. While SYNC 911 Assist works with most cellular phones, some may have trouble using this feature.*

## EMERGENCY CALL LIMITATIONS

The SYNC 911 Assist feature only operates in the U.S., Canada or in a territory in which 911 is the emergency number.

- Your cellular phone or 911 Assist hardware sustains damage in a crash.
- The vehicle's battery or the SYNC system has no power.
- The phone(s) thrown from your vehicle are the ones paired and connected to the system.

# Keys and Remote Controls

## REMOTE CONTROL LIMITATIONS



**WARNING:** Changes or modifications not expressly approved by the party responsible for compliance could void the user's authority to operate the equipment. The term "IC:" before the radio certification number only signifies that Industry Canada technical specifications were met.

This device complies with Part 15 of the FCC Rules and with Industry Canada license-exempt RSS standard(s). Operation is subject to the following two conditions: (1) This device may not cause harmful interference, and (2) This device must accept any interference received, including interference that may cause undesired operation.

Make sure a valid remote control is within 5 ft (1.5 m) from the front door handles and rear of vehicle.

The system may not function if:

- The remote control remains stationary for about a minute.
- The vehicle battery has no charge.
- The remote control battery has no charge.
- There is interference causing issues with the remote control frequencies.
- The remote control is too close to metal objects or electronic devices, for example keys or a cell phone.

## USING THE REMOTE CONTROL

Use your remote control to access various vehicle systems.

**Note:** *The buttons on your remote may vary depending on the vehicle region or options.*

### Unlock



Press the button to unlock all doors. See **Unlocking and Locking the Doors Using the Remote Control** (page 90).

### Lock



Press the button to lock all doors. See **Unlocking and Locking the Doors Using the Remote Control** (page 90).

### Remote Start (If Equipped)



Press the button to remote start. See **Remotely Starting and Stopping the Vehicle** (page 153).

### Liftgate (If Equipped)



Press the button to open or close the liftgate. See **Opening the Liftgate** (page 102).

### Panic Alarm (If Equipped)



Press the button to sound the panic alarm. See **Sounding the Panic Alarm** (page 77).

# Keys and Remote Controls

## SOUNDING THE PANIC ALARM



Press the button to sound the panic alarm. Press the button again or switch the ignition on to turn it off.

**Note:** *The panic alarm only operates when the ignition is off.*

## LOCATING YOUR VEHICLE



Press the lock button twice within three seconds. The turn signal lamps flash. We recommend you use this method to locate your vehicle.

## CHANGING THE REMOTE CONTROL BATTERY



**WARNING:** Keep batteries away from children to prevent ingestion. Failure to follow this instruction could result in personal injury or death. If ingested, immediately seek medical attention.



**WARNING:** If the battery compartment does not securely close, stop using the remote control and replace it as soon as possible. In the meantime, keep the remote control away from children. Failure to follow this instruction could result in personal injury or death.

The remote control uses one coin-type 3-volt lithium battery CR2450 or equivalent.



1. Push the release button and pull the key blade out.

# Keys and Remote Controls

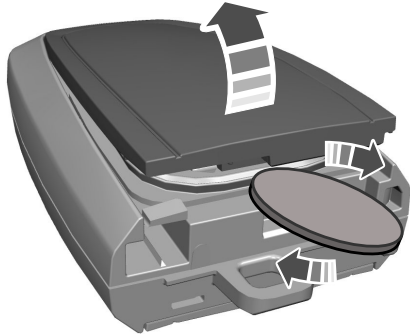
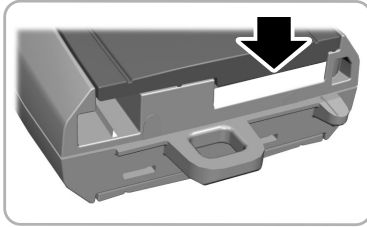

2. Twist a thin coin under the tab hidden behind the key blade head to remove the battery cover.

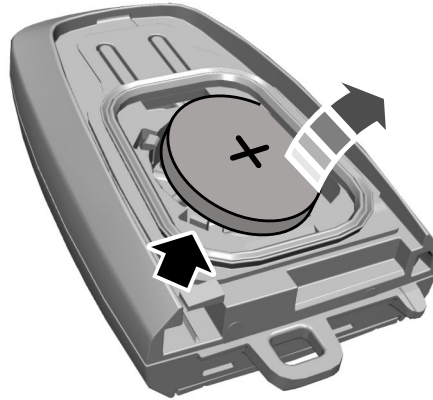

3. Insert a screwdriver, and carefully remove the battery.
4. Install a new battery with the + facing upward.
5. Reinstall the battery housing cover onto the transmitter and install the key blade.



Dispose of old batteries in an environmentally friendly way. Seek advice from your local authority about recycling old batteries.

**Note:** Do not wipe off any grease on the battery terminals or on the back surface of the circuit board.

**Note:** Replacing the battery does not erase the programmed key from your vehicle. The remote control should operate normally.

## REPLACING A LOST KEY OR REMOTE CONTROL

You can purchase replacement keys or remote controls from an authorized dealer. Authorized dealers can program remote controls for your vehicle.

## PROGRAMMING THE REMOTE CONTROL

**Note:** You can program a maximum of four remote controls to your vehicle.

## Keys and Remote Controls

**Note:** *If your programmed remote controls are lost or stolen and you do not have an extra coded remote, you need to have your vehicle towed to an authorized dealer. Store an extra programmed remote away from your vehicle in a safe place to help prevent any inconvenience. Contact an authorized dealer to purchase additional spare or replacement remotes.*

You must have two previously programmed remote controls inside your vehicle and the new unprogrammed remote controls readily accessible. Contact an authorized dealer to have the spare remote control programmed if two previously programmed remotes are not available. Make sure that your vehicle is off before beginning this procedure. Make sure that you close all the doors before beginning and that they remain closed throughout the procedure. Perform all steps within 30 seconds of starting the sequence. Stop and wait for at least one minute before starting again if you perform any steps out of sequence.

Read and understand the entire procedure before you begin.

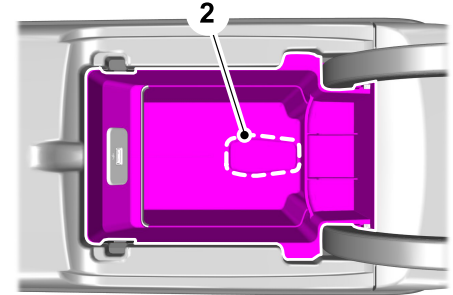
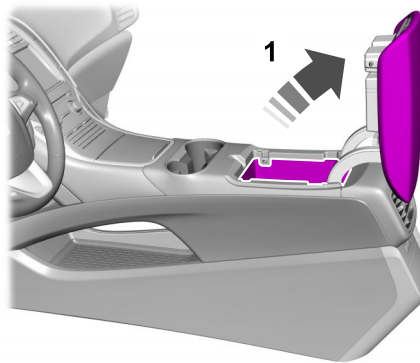

1. Place the first programmed remote in the backup slot inside the center console, with your foot off the brake pedal press and release the push button ignition switch.
2. Wait five seconds and then press and release the push button ignition switch again.
3. Remove the remote control.

# Keys and Remote Controls

---

4. Within 10 seconds, place a second programmed remote control in the backup slot. Press and release the push button ignition switch.
5. Wait five seconds and then press and release the push button ignition switch again. Keep the ignition on for at least three seconds, but no more than 10 seconds.
6. Remove the remote control.
7. Place the unprogrammed remote control in the backup slot and press and release the push button ignition switch.

Programming is now complete. With your foot on the brake pedal, press the push button ignition switch to verify the remote control functions operate and your vehicle starts with the new remote control.

If programming was not successful, wait 10 seconds and repeat Steps 1 through 7. If you are still unsuccessful, take your vehicle to an authorized dealer.

## KEYS AND REMOTE CONTROLS – TROUBLESHOOTING

## KEYS AND REMOTE CONTROLS – INFORMATION MESSAGES

Message	Action
Key Battery Low Replace Soon	Replace remote control battery.



# Phone as a Key (If Equipped)

## WHAT IS PHONE AS A KEY

Phone as a Key allows you to use your phone in place of a passive key.

You can use your phone for the following functions:

- Remote locking and unlocking.
- Passive entry and exit.
- Passive start and drive the vehicle.
- Remote start.
- Memory function recall.

## PHONE AS A KEY LIMITATIONS

Limitations can vary based on the make and model of your phone, phone location and physical obstructions.

The following items could impact Phone as a Key performance or prevent functionality in some cases:

- The typical operating range for Phone as a Key is 131 ft (40 m).

- Your **Bluetooth**® connection is not enabled, is disrupted, or out of range.
- Your Phone as a Key is not active or enabled on at least one phone.
- Your vehicle battery has depleted.
- Your phone battery has depleted.
- Interference from other devices using radio frequencies or physical obstructions.
- Your phone is too close to metal objects or other electronic devices.

**Note:** Do not leave a duplicate coded key in the vehicle. Always take your keys and phone and lock all doors when leaving the vehicle.

## PROGRAMMING YOUR PHONE

To program your smartphone as Phone as a Key:

1. Visit your device's app store to download the Lincoln Way app.

2. Create or sign-in to the Lincoln Way app and add the vehicle identification number to your account.
3. Once you add the vehicle identification number, follow the prompts in the Lincoln Way app to complete the Sync Connect Authorization process.
4. After the vehicle authorizes, you can setup Phone as a Key following the prompts in the Lincoln Way app.
5. After Phone as a Key is setup, you can setup the Backup Start Passcode by following the prompts on your touchscreen.

**Note:** Keep your new Backup Start Passcode with you in case of an emergency.

## Resetting Phone as a Key

If the Phone as a Key belongs to your account, you can delete it from your phone. If not, reset Phone as a Key using the following steps:

1. Press **Settings** on the touchscreen.
2. Press **General**.
3. Press **Reset**.

## Phone as a Key (If Equipped)

4. Press **Lincoln Way Connect Reset**.
5. Press **Reset All**.
6. Confirm you would like to continue with erasing all Phone as a Key, Backup Start Passcodes.
7. Press **Continue**.
8. Confirm you are aware you are de-authorizing all authorized users and Lincoln Way Connect settings.
9. Press **Continue**.

**Note:** Please wait while the vehicle resets all the Phone as a Key, Backup Start Passcodes, Lincoln Way Connect Settings and de-authorize previously authorized users.

### USING THE VALET MODE

1. Press Settings on the touchscreen.
2. Press Valet Mode.

**Note:** Have your Backup Start Passcode completely setup before using Valet Mode.

**Note:** Once the system detects a valid Phone as a Key, the temporary passcode displays in both the touchscreen and mobile app. If the system does not detect a valid Phone as a Key, it prompts you to enter your Backup Start Passcode. Once validated, the temporary passcode displays on the touchscreen.

3. Enter the first five digits of the passcode on the keyless entry keypad to unlock your vehicle.
4. Enter the eight-digit passcode on the touchscreen to start and drive your vehicle.

To disable Valet Mode, press Exit Valet Mode on the touchscreen. Once the system detects an authorized Phone as a Key, it disables. If the system does not detect a valid Phone as a Key, it prompts you to enter your Backup Start Passcode. Once validated, Valet Mode disables.

### USING THE BACKUP START PASSCODE

If you are unable to start your vehicle with Phone as a Key, follow the steps below:

1. Press the brake pedal and the ignition button. If the system does not detect a valid Phone as a Key, a message appears and the system prompts you for your Backup Start Passcode.

**Note:** Make sure you have Phone as a Key active on at least one phone to use the previously created Backup Start Passcode.

**Note:** If the Backup Start Passcode screen does not appear, it is necessary to press the ignition button again.

2. Use the touchscreen to enter your Backup Start Passcode.
3. After entering your Backup Start Passcode, you must press Enter within 30 seconds.
4. Once the system validates the Backup Start Passcode, a message alerts you to start your vehicle.

## Phone as a Key (If Equipped)

---

5. Press the brake pedal and the ignition button within 20 seconds to start the vehicle.
6. If your vehicle does not start, repeat steps 1-5.

### System Lockout

The system locks after five attempts of trying to enter a Backup Start Passcode, resetting a current passcode or entering an incorrect Valet Mode passcode.

**Note:** *The system remains locked for five minutes. After five minutes the system allows codes to be entered again.*

### PHONE AS A KEY – TROUBLESHOOTING

#### PHONE AS A KEY – FREQUENTLY ASKED QUESTIONS

##### How can I tell if my vehicle has Phone as a Key?

The touchscreen shows the Phone as a Key reset option if your vehicle has Phone as a Key. If you have registered your vehicle through the Lincoln Way app, a control button appears on the home screen of the Lincoln Way app.

##### What happens if I cannot unlock the vehicle with Phone as a Key?

Attempt to move your phone closer to the vehicle. Check that the Lincoln Way app is still running and that the Phone as a Key control screen shows connected. If the phone is connected, attempt to press the remote unlock button in the Lincoln Way app. If the phone is not connected or the remote unlock button does not work in the Lincoln Way app, attempt to force close and restart the app.

##### Why do I get a No Key Detected message in the instrument cluster display when I am using Phone as a Key and my phone is in the car?

Your phone's Bluetooth connection has been disrupted or is not connected. Try reconnecting your phone's Bluetooth connection. Move the phone closer to the center of the vehicle near the cup holder or center console. Verify your Phone as a Key is still active, enabled and has not been revoked.

## Phone as a Key (If Equipped)

---

### **What do I do if my phone is lost, damaged, or the battery has depleted?**

Use the Backup Start Passcode that you created to protect you in the event that you lose your phone, damage it, or the battery depletes. See **Using the Backup Start Passcode** (page 82).

### **How many phones can I use for Phone as a Key?**

You can program and activate up to four phones with Phone as a Key to your vehicle.

### **How does a valet drive my car if I only use my Phone as a Key?**

Have the valet use the temporary valet passcode that you created when using valet mode. See **Using the Valet Mode** (page 82).

### **I uninstalled my Lincoln Way app and reinstalled it. Why am I not able to get a new Phone as a Key?**

Remove the Phone as a Key that was previously associated with your phone or reset Phone as a Key from your vehicle, and then request a new Phone as a Key. See **Programming Your Phone** (page 81).

### **Why can I not remotely start the vehicle with my Phone as a Key?**

Using the Lincoln Way app, verify your Phone as a Key setup is complete and enabled via Bluetooth connection on at least one phone. If Bluetooth has connected but Phone as a Key setup is not complete, complete the setup of your Phone as a Key, as prompted from the Lincoln Way app. See **Programming Your Phone** (page 81).

## PRINCIPLE OF OPERATION

MyKey allows you to program keys with restricted driving modes to promote good driving habits. All but one of the keys can be activated with these restricted modes.

Any keys that remain unprogrammed are referred to as administrator keys or admin keys. They can be used to:

- Create a MyKey.
- Program configurable MyKey settings.
- Clear all MyKey features.

When you have created a MyKey, you can access the following information by using the information display to determine:

- How many admin keys and MyKeys are programmed to your vehicle.
- The total distance your vehicle traveled with a MyKey.

**Note:** *Switch the vehicle on to use the system.*

**Note:** *All MyKeys are programmed to the same settings. You cannot program them individually.*

**Note:** *For vehicles with push-button start, when both a MyKey and an admin key are present, the vehicle will recognize the admin key when you switch the vehicle on.*

## Non-Configurable Settings

The following settings cannot be changed by an admin key user:

- Seatbelt reminder. You cannot disable this feature. The audio system will mute when the driver and front-seat passenger seatbelts are not fastened.
- Early low fuel or charge. The low-fuel or low charge warning activates earlier, giving the MyKey user more time to refuel or recharge.
- Restricted touchscreen operation in some markets. For example, MyKey may prevent manual navigation destination input when the vehicle is in any gear other than park (P), or when the vehicle reaches a certain rate of speed.
- Satellite radio adult content restrictions, if available on your vehicle.

**Note:** *If a phone is connected using Apple CarPlay or Android Auto when driving with a MyKey, the driver can receive phone calls and text messages even if the do not disturb restriction is on. If the vehicle comes with satellite radio, the adult content is not restricted.*

**Note:** *The audio system may not mute with a basic AM/FM radio.*

**Note:** *You may be able to turn the lane departure warning feature off, but the feature will automatically re-activate with every new key cycle.*

## Configurable Settings

With an admin key, you can configure certain MyKey settings when you first create a MyKey and before you restart the vehicle. You can also change the settings afterward with an admin key.

**Note:** *Available vehicle features will appear in your information display, providing you with choices to switch them on or off, or to select a more specific setting.*



**WARNING:** Do not set MyKey maximum speed limit to a limit that will prevent the driver from maintaining a safe speed considering posted speed limits and prevailing road conditions. The driver is always responsible to drive in accordance with local laws and prevailing conditions. Failure to do so could result in accident or injury.

- A vehicle speed limit can be set. Warnings will be shown in the display followed by an audible tone when your vehicle reaches the set speed. You cannot override the set speed by fully depressing the accelerator pedal or by setting cruise control.

- Various vehicle speed minders can be set. Once you select a speed, it will be shown in the display, followed by an audible tone when the preselected vehicle speed is exceeded.
- Audio system maximum volume of 45%. A message will be shown in the display when you attempt to exceed the limited volume. Also, the speed-sensitive or compensated automatic volume control will be disabled.
- Always on setting. When this is selected, you will not be able to switch off AdvanceTrac™ or traction control, 911 Assist or Emergency Assistance, or the do not disturb feature, if your vehicle comes with these features.

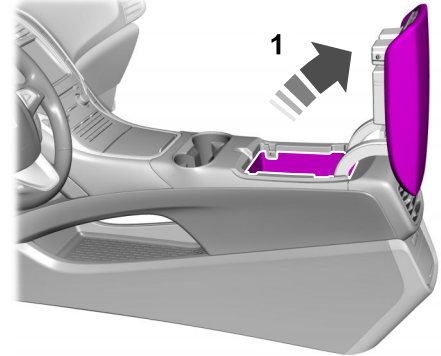

## CREATING A MYKEY

Use the information display to create a MyKey:

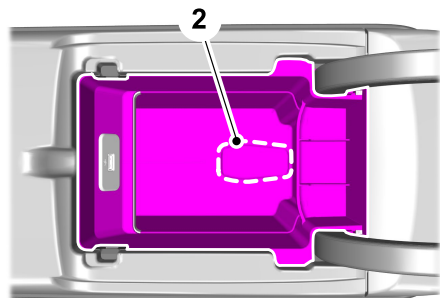

1. Insert the key you want to program into the ignition. If your vehicle has a push-button start, place the remote control in the backup slot.
2. Switch the ignition on.
3. Access the main menu in the information display and then scroll through the menus to change the settings of your MyKey. From the MyKey menu select the option Create MyKey. See **Instrument Cluster Display** (page 145).

4. When prompted, hold the OK button until you see a message informing you to label this key as a MyKey. The programmed restrictions apply when you switch the vehicle off, open and close the driver door and restart your vehicle with the programmed key or remote control.
5. Switch the ignition off.

You successfully created a MyKey. Make sure you label it so you can distinguish it from the admin keys.

You can also program configurable settings for the keys.

## Programming and Changing Configurable Settings

Use the information display to access your configurable MyKey settings.

1. Switch the ignition on using an admin key or remote control you want to program.
2. Access the main menu in the information display and then scroll through the menus to change the settings of the MyKey. See **Instrument Cluster Display** (page 145).

3. Follow the instructions in the display. The programmed restrictions apply when you switch the vehicle off, open and close the driver door and restart your vehicle with the programmed key or remote control.

**Note:** *You can clear or change your MyKey settings at any time during the same key cycle as you created the MyKey. Once you have switched the vehicle off, however, you need an admin key to change or clear your MyKey settings. When you make any changes to your MyKey settings, you change the settings for every MyKey. You cannot make individual changes to apply to certain MyKeys.*

## CLEARING ALL MYKEYS

When you clear your MyKeys, you remove all restrictions and return all MyKeys to their original admin key status at once. To clear all MyKeys of all MyKey settings, use the information display.

1. Switch the ignition on using an admin key.

2. Access the main menu in the information display and then scroll through the menus to begin clearing your MyKey programming.
3. Follow the instructions in the display.
4. A confirmation message appears in the display after you finish clearing your MyKeys.

**Note:** *When you clear your MyKeys, you remove all restrictions and return all MyKeys to their original admin key status. You cannot remove the MyKey restrictions individually.*

## CHECKING MYKEY SYSTEM STATUS

You can find information about your programmed MyKeys by using the information display.

## MYKEY – TROUBLESHOOTING

Condition	Potential Causes
I cannot create a MyKey.	The key or transmitter used to start the vehicle does not have admin privileges.

### MyKey Distance

Tracks the distance when drivers use a MyKey. The only way to delete the accumulated distance is by using an admin key to clear all MyKeys. If the distance does not accumulate as expected, then the intended user is not using the MyKey, or an admin key user recently cleared and then recreated a MyKey.

### Number of MyKeys

Indicates the number of MyKeys programmed to your vehicle. Use this feature to detect how many MyKeys you have for your vehicle and determine when all MyKeys have been deleted.

### Number of Admin Keys

Indicates how many admin keys are programmed to your vehicle. Use this feature to determine how many admin keys you have for your vehicle, and detect if an additional MyKey has been programmed.

## USING MYKEY WITH REMOTE START SYSTEMS

MyKey is not compatible with non Lincoln-approved, aftermarket remote start systems. If you choose to install a remote start system, see an authorized dealer for a Lincoln-approved remote start system.



# MyKey™

Condition	Potential Causes
	<p>Vehicles with keyless start: Make sure you place the transmitter into the backup slot. See <b>What Is the Passive Anti-Theft System</b> (page 110).</p> <p>The key or transmitter used to start the vehicle is the only admin key. There always has to be at least one admin key.</p> <p>The passive anti-theft system is disabled or in unlimited mode.</p>
I cannot program the configurable settings.	<p>The transmitter used to start your vehicle does not have admin privileges.</p> <p>There are no MyKeys programmed to the vehicle. See <b>Creating a MyKey</b> (page 86).</p>
I cannot clear the MyKeys.	<p>The key or transmitter used to start the vehicle does not have admin privileges.</p> <p>No MyKeys are created. See <b>Creating a MyKey</b> (page 86).</p>
I lost the only admin key.	<p>Purchase a new key or transmitter from an authorized dealer.</p>
I lost a key.	<p>Program a spare key or transmitter. You may need to see an authorized dealer. See <b>What Is the Passive Anti-Theft System</b> (page 110).</p>
The MyKey distance does not accumulate.	<p>The MyKey user is not using the MyKey.</p> <p>An admin key holder cleared the MyKeys and created new MyKeys.</p> <p>The key system has been reset.</p>
No MyKey functions with the transmitter.	<p>An admin transmitter is present at vehicle start.</p> <p>There are no MyKeys programmed to your vehicle. See <b>Creating a MyKey</b> (page 86).</p>

# Doors and Locks

## OPERATING THE DOORS FROM OUTSIDE YOUR VEHICLE

### UNLOCKING AND LOCKING THE DOORS USING THE REMOTE CONTROL

You can only use the remote control when your vehicle is stationary.

#### Unlocking the Doors



Press the button to unlock all doors.

#### Locking the Doors



Press the button to lock all doors. One short flash of the turn signal lamps confirms that your vehicle has locked.

### UNLOCKING AND LOCKING THE DOORS USING THE KEY BLADE

If there is a power door lock fault you can use the key blade to lock and unlock the doors.

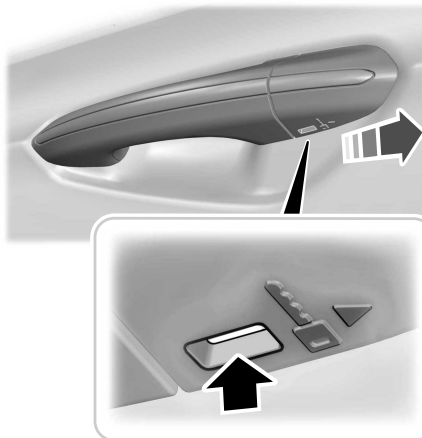

If the central locking function does not operate, lock the doors individually using the key in the position shown.

#### Left-Hand Side

Turn clockwise to lock.

#### Right-Hand Side

Turn counterclockwise to lock.

#### Unlocking the Doors

If the central locking function does not operate, unlock the driver door and then unlock all other doors individually by pulling the interior door handles.

**Note:** When the doors have been unlocked using this method, the doors must be locked individually until the central locking function has been repaired.

### INDIVIDUALLY UNLOCKING AND LOCKING THE DOORS USING THE KEY BLADE

If there is a power door lock fault you can use the key blade to lock and unlock the doors.

# Doors and Locks

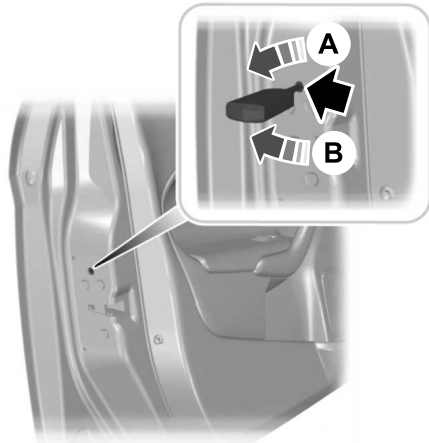

- A Lock.
- B Unlock.

## OPERATING THE DOORS FROM INSIDE YOUR VEHICLE

### INDIVIDUALLY UNLOCKING AND LOCKING THE DOORS USING THE LOCKING BUTTON

The power door lock control is on the driver and front passenger door panels.

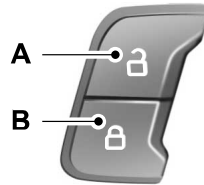

- A Unlock.
- B Lock.

## OPENING THE DOORS FROM INSIDE YOUR VEHICLE

Pull the interior door handle twice to unlock and open a rear door. The first pull unlocks the door and the second pull opens the door.

## AUTOUNLOCK

### WHAT IS AUTOUNLOCK

Autounlock is an unlocking feature that unlocks the vehicle doors when your vehicle comes to a stop.

### AUTOUNLOCK REQUIREMENTS

Autounlock unlocks all the doors when all of the following occur:

- The ignition is on, all the doors are closed and your vehicle is moving at a speed greater than 12 mph (20 km/h).
- Your vehicle comes to a stop.
- You open the driver door within 10 minutes of switching the ignition off or to the accessory position.

# Doors and Locks

---

## SWITCHING AUTOUNLOCK ON AND OFF

1. Press the menu button on the steering wheel to enter the information display main menu.
2. Select **Settings**.
3. Select **Vehicle**.
4. Select **Locks**.
5. Switch **Autounlock** on or off.

## AUTOLOCK

### WHAT IS AUTOLOCK

Autolock is a locking feature that locks your vehicle doors when you start driving.

## AUTOLOCK REQUIREMENTS

Autolock locks all the doors when all of the following occur:

- All doors are closed.
- The ignition is on.
- Your vehicle reaches a speed greater than 12 mph (20 km/h).

## MISLOCK

### WHAT IS MISLOCK

Mislock is a locking feature that warns you if your vehicle has not locked.

### MISLOCK LIMITATIONS

When you press the lock button once, the direction indicators do not flash if any door or the liftgate or hood is open.

1. If any door or the liftgate is open.
2. The hood is open.

## SWITCHING MISLOCK ON AND OFF

1. Press the menu button on the steering wheel to enter the information display main menu.
2. Select **Settings**.
3. Select **Vehicle**.
4. Select **Locks**.
5. Switch **Mislock Chirp** on or off.

## DOORS AND LOCKS AUDIBLE WARNINGS

### Door Ajar Audible Warning

Sounds when a door is not fully closed and your vehicle is moving.

# Doors and Locks

## DOORS AND LOCKS – TROUBLESHOOTING

## DOORS AND LOCKS – WARNING LAMPS

### Door Ajar Warning Lamp



It illuminates when you switch the ignition on and remains on if any door or the hood is open.

## DOORS AND LOCKS – INFORMATION MESSAGES

Message	Action
Driver Door Ajar	Displays if a door is open. Fully close the door.
Passenger Door Ajar	
Rear Left Door Ajar	
Rear Right Door Ajar	

# Keyless Entry

## LOCATING THE KEYLESS ENTRY KEYPAD

The keypad is near the driver window and illuminates when you touch it.



## KEYLESS ENTRY LIMITATIONS

Make sure your remote control is within 3 ft (1 m) from the front door handles and the tailgate.

The system could not function if:

- The remote control remains stationary for about a minute.
- The vehicle battery has no charge.
- The remote control battery has no charge.
- There is interference causing issues with the remote control frequencies.
- The remote control is too close to metal objects or electronic devices, for example keys or a cell phone.

## KEYLESS ENTRY SETTINGS

### Switching Keyless Entry On and Off

1. Switch the ignition on using an original key that has not been created as a MyKey.
2. Press **Settings** on the touchscreen.
3. Press **Vehicle Settings**.
4. Press **Locks**.

## Reprogramming the Unlocking Function

You can enable two-stage unlocking function allowing you to unlock only the driver door when you touch the unlock sensor.

Press and hold both the lock and unlock buttons on the remote control for four seconds to disable or enable two-stage unlocking.

If you program the unlocking function so that only the driver door unlocks, you can unlock all of the other doors from inside your vehicle using the power door lock control. You can unlock individual doors by pulling the interior door handles on those doors.

## USING KEYLESS ENTRY

### Unlocking the Doors



# Keyless Entry

With the remote control within 3 ft (1 m) of your vehicle, touch the unlock sensor on the back of the door handle for a brief period and then pull on the door handle to unlock, being careful not to touch the lock sensor at the same time or pull on the door handle too quickly. The system requires a brief delay to authenticate the remote control.

## Locking the Doors



With your passive key within 3 ft (1 m) of your vehicle, touch the outer door handle lock sensor for approximately one second to lock, being careful not to touch the unlock sensor on the back of the door handle at the same time. After locking, you can immediately pull on the door handle to confirm locking occurred without inadvertently unlocking.

## Opening the Liftgate with the Remote Control

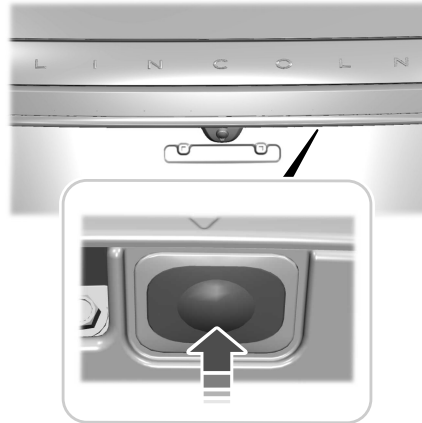

Press the exterior liftgate release button inside of the liftgate handle. The liftgate unlocks and opens. See **Opening the Liftgate From Outside Your Vehicle** (page 102).

## LOCKING AND UNLOCKING THE DOORS USING KEYLESS ENTRY

### UNLOCKING THE DOORS

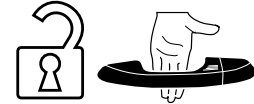

With the remote control within 3 ft (1 m) of your vehicle, touch the unlock sensor on the back of the door handle for a brief period and then pull on the door handle to unlock, being careful not to touch the lock sensor at the same time or pull on the door handle too quickly. The system requires a brief delay to authenticate the remote control.

# Keyless Entry

## Opening the Liftgate with the Remote Control



Press the exterior liftgate release button inside of the liftgate handle. The liftgate unlocks and opens. See **Opening the Liftgate From Outside Your Vehicle** (page 102).

## KEYLESS ENTRY – TROUBLESHOOTING

### KEYLESS ENTRY – FREQUENTLY ASKED QUESTIONS

#### Why does the keypad not accept the access code?

If you enter the access code too fast on the keypad, the unlock function may not work. Slowly re-enter the access code.

#### Why does the passive key not work?

The system deactivates passive keys left inside your vehicle when you lock it. You cannot switch the ignition on using a deactivated passive key. Press the unlock button on the remote control to reactivate a passive key.

#### Why does the keypad not function?

The keypad goes into an anti-scan mode if you enter a wrong code seven times. The anti-scan mode disables the keypad for one minute and the red light flashes.



# Keyless Entry Keypad

## WHAT IS THE KEYLESS ENTRY KEYPAD

The keyless entry keypad allows you to lock and unlock your vehicle using the keypad on the window trim.

## KEYLESS ENTRY KEYPAD LIMITATIONS

The system may not function if:

- The vehicle battery has no charge.

## LOCATING THE KEYLESS ENTRY KEYPAD

The keypad is near the driver window and illuminates when you touch it.

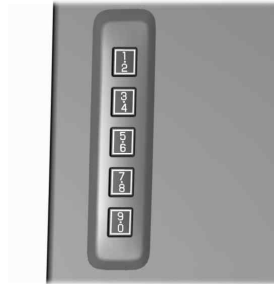

## KEYLESS ENTRY KEYPAD MASTER ACCESS CODE

### Unlocking the Doors

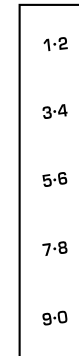

Enter the factory-set five-digit code or your personal code. You must press each number within five seconds of each other.

- Press 3-4 within five seconds to unlock all doors.

# Keyless Entry Keypad

## Locking the Doors

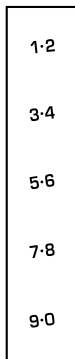

Press and hold **7-8** and **9-0** at the same time with the driver door closed.

**Note:** *You do not need to enter the code first.*

## KEYLESS ENTRY KEYPAD PERSONAL ACCESS CODES

### Programming a Personal Entry Code

1. Enter the five-digit master code.
2. Press **1-2** on the keypad within five seconds.
3. Enter your personal five-digit code. You must do this within five seconds of completing Step 2.
4. Press **1-2** on the keypad to save personal code 1.

The doors lock then unlock to confirm that programming was successful.

To program additional personal entry codes, repeat Steps 1 through 3, then for Step 4:

- Press **3-4** to save personal code 2.
- Press **5-6** to save personal code 3.
- Press **7-8** to save personal code 4.
- Press **9-0** to save personal code 5.

If your vehicle comes with SYNC, you can also program the system with a personal entry code.

Hints:

- Do not set a code that uses five of the same number.
- Do not use five numbers in sequential order.
- The five-digit master code works even if you have set your own personal code.

### Erasing a Personal Code

1. Enter the five-digit master code.
2. Press and release **1-2** on the keypad within five seconds.
3. Press and hold **1-2** for two seconds. You must do this within five seconds of completing Step 2.

All personal codes erase and only the five-digit master code works.

### Anti-Scan Feature

The keypad goes into an anti-scan mode if you enter the wrong code seven times. This mode turns off the keypad for one minute and the keypad lamp flashes.

# Keyless Entry Keypad

The anti-scan feature turns off after:

- One minute of keypad inactivity.
- You press the unlock button on the remote control.
- You switch the ignition on.
- You unlock your vehicle using keyless entry.

## USING THE KEYLESS ENTRY KEYPAD

### Unlocking the Doors

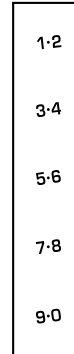

Enter the factory-set five-digit code or your personal code. You must press each number within five seconds of each other.

- Press 3-4 within five seconds to unlock all doors.

### Locking the Doors

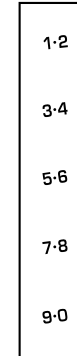

Press and hold **7-8** and **9-0** at the same time with the driver door closed.

**Note:** *You do not need to enter the code first.*

# Keyless Entry Keypad

---

## **KEYLESS ENTRY KEYPAD – TROUBLESHOOTING**

### **KEYLESS ENTRY KEYPAD – FREQUENTLY ASKED QUESTIONS**

#### **Why does the keypad not accept the access code?**

If you enter the access code too fast on the keypad, the unlock function may not work. Slowly re-enter the access code.

#### **Why does the keypad not function?**

The keypad goes into an anti-scan mode if you enter a wrong code seven times. The anti-scan mode disables the keypad for one minute and the red light flashes.

# Easy Entry and Exit

---

## HOW DOES EASY ENTRY AND EXIT WORK

Easy entry and exit moves the driver seat rearward up to 2 in (5 cm) and the steering column up when you switch the ignition off. The driver seat and steering column return to their previous positions when you switch the ignition on.

**Note:** *Depending on your vehicle, the column may move up and in.*

## SWITCHING EASY ENTRY AND EXIT ON AND OFF

1. Using the touchscreen, select **Settings**.
2. Select **Vehicle**.
3. Select **Easy Entry/Exit**.

If you press any adjustment or memory button when in easy exit mode, the system cancels the operation.

# Liftgate

## LIFTGATE PRECAUTIONS

 **WARNING:** It is extremely dangerous to ride in a cargo area, inside or outside of a vehicle. In a crash, people riding in these areas are more likely to be seriously injured or killed. Do not allow people to ride in any area of your vehicle that is not equipped with seats and seatbelts. Make sure everyone in your vehicle is in a seat and properly using a seatbelt. Failure to follow this warning could result in serious personal injury or death.

 **WARNING:** Make sure that you fully close the liftgate to prevent exhaust fumes from entering your vehicle. If you are unable to fully close the liftgate, open the air vents or the windows to allow fresh air to enter your vehicle. Failure to follow this instruction could result in personal injury or death.



**WARNING:** Keep keys out of reach of children. Do not allow children to operate or play near an open or moving power liftgate. You should supervise the operation of the power liftgate at all times.

## OPENING THE LIFTGATE

### OPENING THE LIFTGATE FROM INSIDE YOUR VEHICLE



With the transmission in park (P), press the button on the instrument panel.

**Note:** *Be careful when opening or closing the liftgate in a garage or other enclosed area to avoid damaging the liftgate.*

**Note:** *Do not hang anything, for example a bike rack, from the glass or liftgate. This could damage the liftgate and its components.*

**Note:** *Do not leave the liftgate open while driving. This could damage the liftgate and its components.*

### OPENING THE LIFTGATE FROM OUTSIDE YOUR VEHICLE

1. Unlock the liftgate with the remote control or power door unlock control. If a passive key is within 3 ft (1 m) of the liftgate, the liftgate unlocks when you press the liftgate release button.

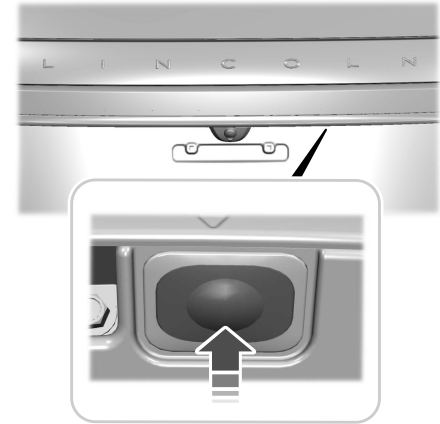

2. Press and release the liftgate control button.

# Liftgate

**Note:** Allow the power system to open the liftgate. Manually pushing or pulling the liftgate could activate the system's obstacle detection feature and stop the power operation or reverse its direction, replicate a strut failure, or damage mechanical components.

**Note:** Be careful when opening or closing the liftgate in a garage or other enclosed area to avoid damaging the liftgate.

**Note:** Do not hang anything, for example a bike rack, from the glass or liftgate. This could damage the liftgate and its components.

**Note:** Do not leave the liftgate open while driving. This could damage the liftgate and its components.

## Switching the Power Liftgate On or Off

You can switch the power liftgate on or off through the vehicle settings on your touchscreen.

**Note:** When switched off, the liftgate only unlatches and will not power open or close.

## OPENING THE LIFTGATE USING THE REMOTE CONTROL



Press the button twice within three seconds.

**Note:** Be careful when opening or closing the liftgate in a garage or other enclosed area to avoid damaging the liftgate.

**Note:** Do not hang anything, for example a bike rack, from the glass or liftgate. This could damage the liftgate and its components.

**Note:** Do not leave the liftgate open while driving. This could damage the liftgate and its components.

## OPENING THE HANDS-FREE LIFTGATE

(If Equipped)

Make sure you have the passive key within 3 ft (1 m) of the liftgate.

1. Stand behind your vehicle, and face the liftgate.

2. Move your foot, in a single-kick motion, without pausing, under and away from the rear bumper detection area.

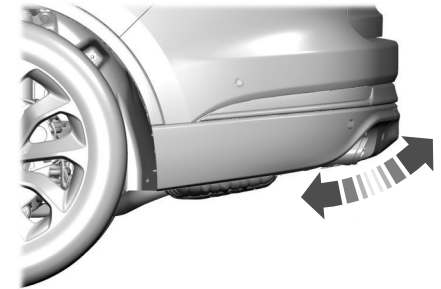

3. The liftgate opens.

Avoid the following actions when using the hands-free opening feature:

- Making physical contact with the bumper.
- Holding your foot under the bumper.
- Sweeping your foot from side to side, or kicking at an odd angle.

# Liftgate

## Detection Zones

### Vehicles Without a Trailer Hitch

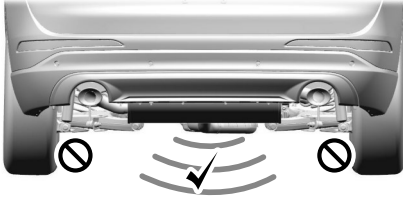

The detection area is in the center of the rear bumper.

### Vehicles With a Trailer Hitch

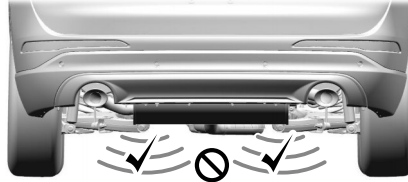

The detection area is on the left-hand side and right-hand side of the hitch, between the exhaust and the hitch.

**Note:** Allow the power system to open the liftgate. Manually pushing or pulling the liftgate may activate the system's obstacle detection feature and stop the power operation or reverse its direction, replicate a strut failure, or damage mechanical components.

**Note:** Any physical actions that mimic a kicking motion such as splashing water, trailer chains or vacuum hoses may cause the hands-free liftgate to activate. Switch the power liftgate off through your vehicle settings or keep the passive key away from the rear bumper detection area.

## SETTING THE LIFTGATE OPENING HEIGHT

1. Open the liftgate.
2. Stop the liftgate movement by pressing the control button on the liftgate when it reaches the desired height.
3. Press and hold the control button on the liftgate until a tone sounds, indicating programming is complete.

**Note:** You can only use the liftgate control button to program the height.

**Note:** You cannot program the height if the liftgate position is too low.



# Liftgate

- The power liftgate now opens at the programmed height. To change the programmed height, repeat the steps.

**Note:** You can fully open the liftgate by manually pushing it upward to the maximum open position if it opens in a lower position.

**Note:** The system recalls the new programmed height until you reprogram it, even if you disconnect the battery.

## CLOSING THE LIFTGATE

### CLOSING THE LIFTGATE FROM INSIDE YOUR VEHICLE



**WARNING:** Make sure all persons are clear of the power liftgate area before using the power liftgate control.



With the transmission in park (P), press the button on the instrument panel.

**Note:** Make sure that you close the liftgate before operating or moving your vehicle, especially in an enclosure, like a garage or a parking structure. This could damage the liftgate and its components.

**Note:** Make sure the area behind your vehicle is free from obstruction and that there is enough room for you to operate the liftgate. Objects too close to your vehicle, for example a wall, garage door or another vehicle may come into contact with the moving liftgate. This could damage the liftgate and its components.

**Note:** Make sure that you fully close the liftgate to prevent cargo from falling out.

### CLOSING THE LIFTGATE FROM OUTSIDE YOUR VEHICLE



**WARNING:** Make sure all persons are clear of the power liftgate area before using the power liftgate control.

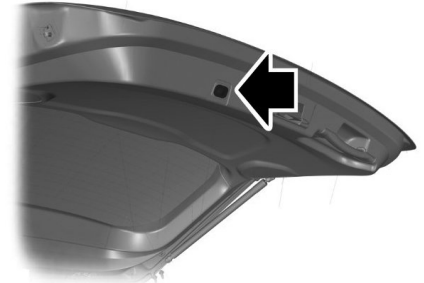

Press and release the liftgate button.

**Note:** Make sure that you close the liftgate before operating or moving your vehicle, especially in an enclosure, like a garage or a parking structure. This could damage the liftgate and its components.

**Note:** Make sure the area behind your vehicle is free from obstruction and that there is enough room for you to operate the liftgate. Objects too close to your vehicle, for example a wall, garage door or another vehicle may come into contact with the moving liftgate. This could damage the liftgate and its components.

# Liftgate

**Note:** Make sure that you fully close the liftgate to prevent cargo from falling out.

## CLOSING THE LIFTGATE USING THE REMOTE CONTROL



**WARNING:** Make sure all persons are clear of the power liftgate area before using the power liftgate control.



Press the button twice within three seconds.

**Note:** Make sure that you close the liftgate before operating or moving your vehicle, especially in an enclosure, like a garage or a parking structure. This could damage the liftgate and its components.

**Note:** Make sure the area behind your vehicle is free from obstruction and that there is enough room for you to operate the liftgate. Objects too close to your vehicle, for example a wall, garage door or another vehicle may come into contact with the moving liftgate. This could damage the liftgate and its components.

**Note:** Make sure that you fully close the liftgate to prevent cargo from falling out.

## CLOSING THE HANDS-FREE LIFTGATE

(If Equipped)

Make sure you have the remote control within 3 ft (1 m) of the liftgate.

1. Stand behind your vehicle, and face the liftgate.
2. Move your foot, in a single-kick motion, without pausing, under and away from the rear bumper detection area.

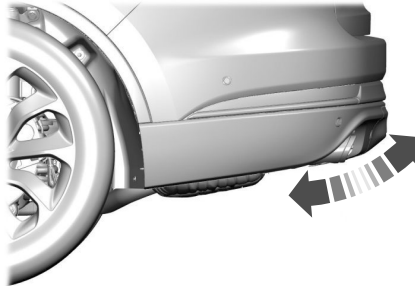

3. The liftgate closes.

Avoid the following actions when using the hands-free opening feature:

- Making physical contact with the bumper.
- Holding your foot under the bumper.
- Sweeping your foot from side to side, or kicking at an odd angle.

## Detection Zones

### Vehicles Without a Trailer Hitch

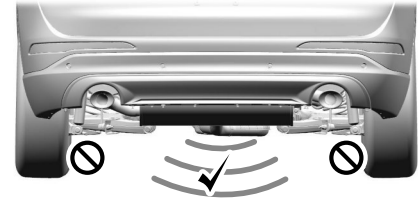

The detection area is in the center of the rear bumper.

# Liftgate

## Vehicles With a Trailer Hitch

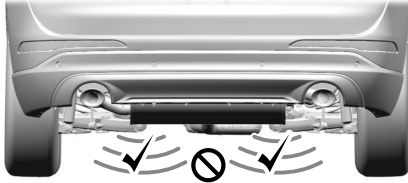

The detection area is on the left-hand side and right-hand side of the hitch, between the exhaust and the hitch.

**Note:** Allow the power system to close the liftgate. Manually pushing the liftgate may activate the system's obstacle detection feature and stop the power operation or reverse its direction, replicate a strut failure, or damage mechanical components.

## STOPPING THE LIFTGATE MOVEMENT

**Note:** Do not apply sudden excessive force to the liftgate while it is in motion. This could damage the power liftgate and its components.

**Note:** Selections will vary depending on region or options.

You can stop the liftgate movement by doing any of the following:

- Pressing the liftgate control button on the liftgate.
- Pressing the liftgate control button inside the vehicle.
- Pressing the liftgate button on the remote control twice.
- Pressing the liftgate button on an authorized device.
- Moving your foot under and away from the center rear bumper in a single-kick motion.

## LIFTGATE OBSTACLE DETECTION

### Closing the Liftgate

The system stops when it detects an obstacle. A tone sounds and the system reverses to open. Once you remove the obstacle, you can power close the liftgate.

**Note:** To prevent accidental obstacle detection, let the power liftgate close completely before you enter your vehicle.

### Opening the Liftgate

The system stops when it detects an obstacle and a tone sounds. Once you remove the obstacle, you can continue to operate the liftgate.

## LIFTGATE – TROUBLESHOOTING

### LIFTGATE – WARNING LAMPS



Illuminates when the liftgate is not completely closed.

# Liftgate

---

## LIFTGATE – INFORMATION MESSAGES

Message	Action
Liftgate Ajar	The liftgate is not completely closed. Close the liftgate.

# Liftgate

---

## **LIFTGATE – FREQUENTLY ASKED QUESTIONS**

### **Why won't my power liftgate function?**

Make sure the transmission is in park (P), ensure nothing is obstructing the liftgate path and there is not excessive weight on the liftgate. If there are continued issues, the battery voltage may be low or other system issues. See an authorized dealer.

# Security

---

## PASSIVE ANTI-THEFT SYSTEM

### WHAT IS THE PASSIVE ANTI-THEFT SYSTEM

The passive anti-theft system prevents someone from starting the vehicle with an incorrectly coded key.

**Note:** *Do not leave a duplicate coded key in your vehicle. Always take the keys and lock all the doors when leaving your vehicle.*

### HOW DOES THE PASSIVE ANTI-THEFT SYSTEM WORK

The passive anti-theft system arms when you switch the ignition off.

It disarms when the ignition is switched on with a correctly coded key.

**Note:** *The system is not compatible with non-Ford aftermarket remote start systems.*

**Note:** *Do not leave a duplicate coded key in your vehicle. Always take the keys and lock all doors when leaving your vehicle.*

## ANTI-THEFT ALARM SYSTEM

### WHAT IS THE ANTI-THEFT ALARM SYSTEM

The Anti-Theft Alarm System warns you of an unauthorized entry to your vehicle.

### HOW DOES THE ANTI-THEFT ALARM SYSTEM WORK

When armed, the anti-theft alarm is triggered in any of the following ways:

- If someone opens a door, the liftgate or the hood without a correctly coded key or remote control.
- If you turn the power on without a correctly coded key.
- If the interior sensors detect movement inside your vehicle.
- If the inclination sensors detect an attempt to raise your vehicle.
- If someone disconnects the vehicle battery or the battery backup alarm.

If the anti-theft alarm is triggered, the alarm horn sounds for 30 seconds and the direction indicators flash for 5 minutes.

Any further attempts to carry out one of the above sounds the alarm again.

## WHAT IS THE PERIMETER ALARM

The perimeter alarm is designed to detect unauthorized access to your vehicle.

## WHAT ARE THE INTERIOR SENSORS

The interior sensors are designed to detect any movement inside your vehicle.

The interior sensors are in the overhead console.

**Note:** *Do not cover the interior sensors.*

## WHAT ARE THE INCLINATION SENSORS (If Equipped)

The inclination sensor is designed to detect an attempt to raise your vehicle, for example to remove a wheel or to tow it away.

# Security

---

## ANTI-THEFT ALARM SYSTEM SETTINGS

### WHAT ARE THE ALARM SECURITY LEVELS

You can select two levels of alarm security, all sensors and perimeter sensing.

#### All Sensors

All sensors is the standard setting.

In all sensors, all equipped sensors are on when you arm the alarm.

**Note:** *Do not arm the alarm with all sensors if passengers, animals or other moving objects are inside your vehicle.*

### Perimeter Sensing

In perimeter sensing, the interior sensors are off when you arm the alarm.

All the other equipped sensors activate when you arm the alarm in this mode.

### SETTING THE ALARM SECURITY LEVEL

1. Press **Settings** on the touchscreen.
2. Press **Vehicle Settings**.
3. Press **Alarm System**.
4. Press **Motion Sensors**.
5. Press a setting.

### WHAT IS ASK ON EXIT

You can choose which level of security you require after you switch the ignition off.

**Note:** *If you do not choose a setting, the system defaults to all sensors.*

### SWITCHING ASK ON EXIT ON AND OFF

1. Press **Settings** on the touchscreen.
2. Press **Vehicle Settings**.
3. Press **Alarm System**.
4. Switch **Ask on Exit** on or off.

# Security

---

## SECURITY – TROUBLESHOOTING

### SECURITY – INFORMATION MESSAGES

Message	Action
No Key Detected	The system has not detected a correctly coded key.
Starting System Fault	The system has malfunctioned. Have your vehicle checked as soon as possible.
Vehicle Alarm To Stop Alarm, Start Vehicle.	Displays when the alarm has been triggered due to unauthorized entry.
Alarm Announcement	



## **SECURITY – FREQUENTLY ASKED QUESTIONS**

### **What should I do if there is any potential alarm problem with my vehicle?**

Take all remote controls to an authorized dealer if there is any potential alarm problem with your vehicle.

### **What should I do if the vehicle is unable to start with a correctly coded key?**

Have your vehicle checked as soon as possible.

# Steering Wheel

## ADJUSTING THE STEERING WHEEL - VEHICLES WITH: MANUAL ADJUSTABLE STEERING COLUMN

 **WARNING:** Do not adjust the steering wheel when your vehicle is moving.

**Note:** Make sure that you are sitting in the correct position. See **Sitting in the Correct Position** (page 161).

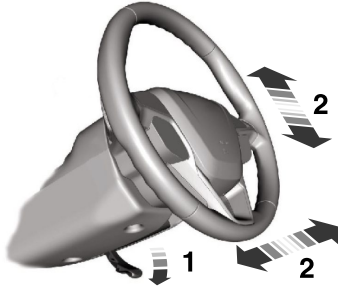

1. Unlock the steering column.
2. Adjust the steering wheel to the desired position.



3. Lock the steering column.

## ADJUSTING THE STEERING WHEEL - VEHICLES WITH: POWER ADJUSTABLE STEERING COLUMN

 **WARNING:** Do not adjust the steering wheel when your vehicle is moving.

**Note:** Make sure that you are sitting in the correct position. See **Sitting in the Correct Position** (page 161).



Press the top or bottom of the control to move the steering wheel up or down.

Press the front or rear of the control to move the steering wheel in or out.

# Steering Wheel

---

## RESETTING THE STOPPING POSITION - VEHICLES WITH: POWER ADJUSTABLE STEERING COLUMN

**Note:** *The steering wheel stops when it detects an obstruction. This sets a new stopping position.*

To reset the steering column to its normal stopping position:

1. Confirm there is nothing obstructing the motion of the steering column.
2. Press and hold the steering column control until the steering column stops moving.
3. Press the steering column control again.

**Note:** *The steering column may start to move again.*

4. When the steering column stops, continue holding the control for a few seconds.
5. Repeat for each direction, as necessary.

## HORN



Press on the center of the steering wheel near the horn icon to activate the horn.

## SWITCHING THE HEATED STEERING WHEEL ON AND OFF (IF EQUIPPED)

1. Press the menu button on the climate control.
2. Press the heated steering wheel button on the touchscreen.

**Note:** *A sensor regulates the temperature of the steering wheel.*

# Wipers and Washers

## WIPERS

### WIPER PRECAUTIONS

Do not operate the wipers on a dry windshield. This could scratch the glass or damage the wiper blades. Use the windshield washers before wiping a dry windshield.

Fully defrost the windshield before you switch the windshield wipers on.

Switch the windshield wipers off before entering a car wash.

### SWITCHING WINDSHIELD WIPERS ON AND OFF

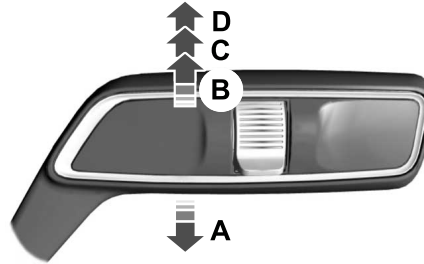

- A Single wipe.
- B Intermittent wipe.
- C Normal wipe.
- D High-speed wipe.



Push the lever up or down to operate the windshield wipers.

## AUTOWIPERS

### WHAT ARE AUTOWIPERS

Autowipers turns on and controls the speed and frequency of the windshield wipers.

### AUTOWIPERS SETTINGS

1. Using the instrument cluster controls on the steering wheel, select **Settings**.
2. Select **Vehicle**.
3. Select **Wipers**.
4. Switch **Rain Sensing** on or off.

**Note:** When you switch the feature off, the wipers do not operate based on the rain sensor. When you switch on the windshield wipers to the intermittent wipe position with the feature off, the wipers use the wipe speed set by the rotary control.

# Wipers and Washers

## ADJUSTING THE SENSITIVITY OF THE RAIN SENSOR

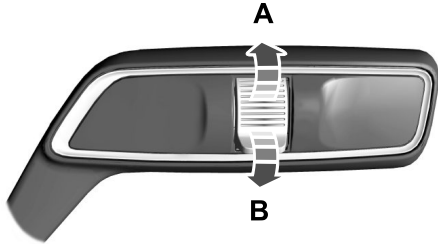

- A High sensitivity.
- B Low sensitivity.

Use the rotary control to set the sensitivity of the rain sensor.

When you select high sensitivity, the wipers operate when the sensor detects a small amount of water on the windshield.

When you select low sensitivity, the wipers operate when the sensor detects a large amount of water on the windshield.

## SWITCHING THE REAR WINDOW WIPER ON AND OFF

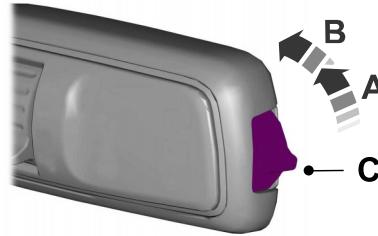

- A Intermittent wipe.
- B Continuous wipe.
- C Rear window wiper off.

## REVERSE WIPE

### WHAT IS REVERSE WIPE

Reverse wipe turns on the rear window wiper when you shift into reverse (R) and the windshield wipers are on.

### REVERSE WIPE SETTINGS

1. Using the instrument cluster controls on the steering wheel, select **Settings**.
2. Select **Vehicle**.
3. Select **Wipers**.
4. Switch **Reverse Wiper** on or off.

# Wipers and Washers

## CHECKING THE WIPER BLADES



Run the tip of your fingers over the edge of the blade to check for roughness.

## REPLACING THE FRONT WIPER BLADES

Make sure your vehicle is off before beginning this procedure.

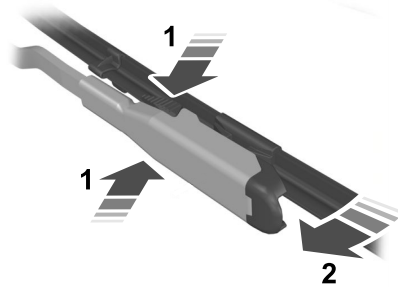

1. Lift the wiper arm and then press the wiper blade locking buttons together.

**Note:** Do not hold the wiper blade to lift the wiper arm.

**Note:** Make sure that the wiper arm does not spring back against the glass when the wiper blade is not attached.

2. Slightly rotate the wiper blade.
3. Remove the wiper blade.
4. To install, reverse the removal procedure.

**Note:** Make sure that the wiper blade locks into place.

## REPLACING THE REAR WIPER BLADES

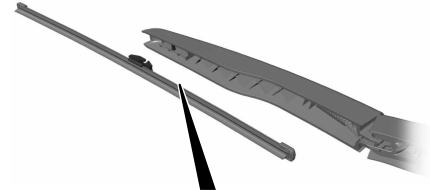

1. Lift the wiper arm.

**Note:** Do not hold the wiper blade to lift the wiper arm.

2. Remove the wiper blade.

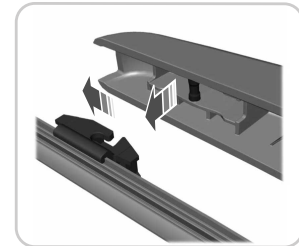

# Wipers and Washers

**Note:** Make sure that the wiper arm does not spring back against the glass when the wiper blade is not attached.

3. To install, reverse the removal procedure.

**Note:** Make sure that the wiper blade locks into place.

## WASHERS

### WASHER PRECAUTIONS



**WARNING:** If you operate your vehicle in temperatures below 41°F (5°C), use washer fluid with antifreeze protection. Failure to use washer fluid with antifreeze protection in cold weather could result in impaired windshield vision and increase the risk of injury or accident.

Do not operate the washers when the washer reservoir is empty. This could cause the washer pump to overheat.

Keep the outside of the windshield clean. The rain sensor is very sensitive and the wipers may operate if dirt, mist or insects hit the windshield.

### USING THE WINDSHIELD WASHER

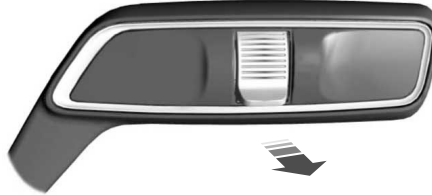

Pull the lever toward you to operate the windshield washer.

**Note:** A courtesy wipe occurs a short time after the wipers stop to clear any remaining washer fluid when switched on. See **Switching the Courtesy Wipe On and Off** (page 119).

### SWITCHING THE COURTESY WIPE ON AND OFF

1. Using the instrument cluster controls on the steering wheel, select **Settings**.
2. Select **Vehicle**.
3. Select **Wipers**.
4. Switch **Courtesy Wipe** on or off.

### USING THE REAR WINDOW WASHER

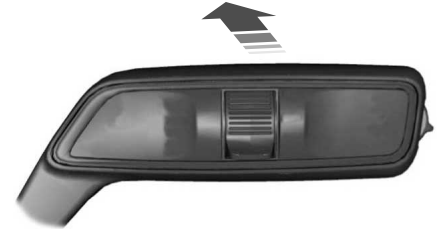

Push the lever away from you to operate the rear window washer.

# Wipers and Washers

**Note:** A courtesy wipe occurs a short time after the wipers stop to clear any remaining washer fluid when switched on. See **Switching the Courtesy Wipe On and Off** (page 119).

## ADDING WASHER FLUID

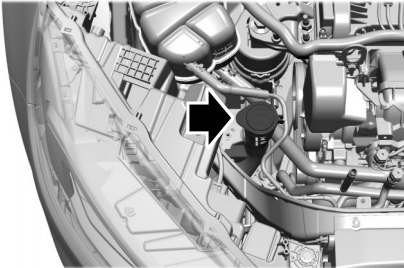

## WASHER FLUID SPECIFICATION

See **Washer Fluid Specification** (page 419).

## WIPERS AND WASHERS – TROUBLESHOOTING

### WIPERS AND WASHERS – WARNING LAMPS



Illuminates when the windshield washer fluid is low.

### WIPERS AND WASHERS – FREQUENTLY ASKED QUESTIONS

#### Why are there streaks and smears on the windshield?

The wiper blades could be dirty, worn or damaged. Check the wiper blades. See **Checking the Wiper Blades** (page 118). If the wiper blades are dirty, clean them with washer fluid or water applied with a soft sponge or cloth. If the wiper blades are worn or damaged, install new ones. See **Replacing the Front Wiper Blades** (page 118).



# Exterior Lighting

## EXTERIOR LIGHTING CONTROL

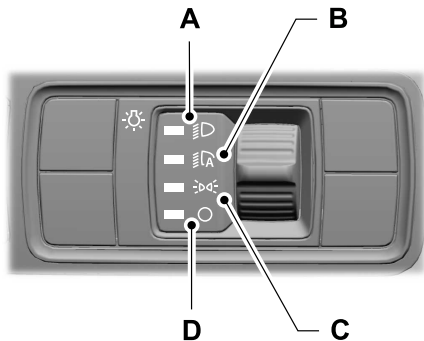

- A Headlamps on.
- B Autolamps on.
- C Parking lamps on.
- D Lamps off.

Press the toggle switch upward or downward to make a selection.

**Note:** The lighting control defaults to autolamps each time you switch your vehicle on.

## HEADLAMPS

### USING THE HIGH BEAM HEADLAMPS

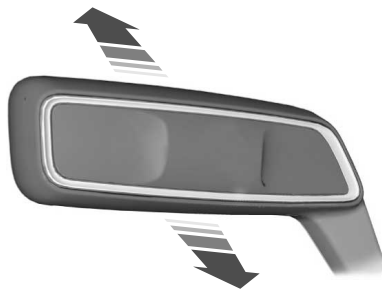

Push the lever away from you to switch the high beam on.

Push the lever forward again or pull the lever toward you to switch the high beams off.

Slightly pull the lever toward you and release it to flash the headlamps.

## SWITCHING HEADLAMP EXIT DELAY ON AND OFF

To switch headlamp exit delay on, pull the turn signal lever toward you after switching your vehicle off.

To switch headlamp exit delay off, pull the turn signal lever toward you again or switch your vehicle on.

**Note:** The headlamps turn off after three minutes with any door open or 30 seconds after the last door closes.

## HEADLAMP INDICATORS

### Lamps On



Illuminates when you switch the low beam headlamps or the parking lamps on.

### Headlamp High Beam



Illuminates when you switch the high beam headlamps on.

# Exterior Lighting

## HEADLAMPS – TROUBLESHOOTING

### HEADLAMPS – FREQUENTLY ASKED QUESTIONS

#### Why is there condensation in the headlamps?

Headlamps have vents to accommodate normal changes in air pressure. Condensation can be a natural by-product of this design. When moist air enters the lamp assembly through the vents, there is a possibility that condensation can occur when the temperature is cold. When normal condensation occurs, a fine mist can form on the interior of the lens. The fine mist eventually clears and exits through the vents during normal operation.

#### How much condensation is acceptable?

The presence of a fine mist, for example no streaks, drip marks or large droplets. A fine mist covers less than 50% of the lens.

#### How long may it take for the acceptable condensation to be cleared?

Clearing time may take as long as 48 hours under dry weather conditions.

#### How much condensation is unacceptable?

A water puddle inside the lamp. Streaks, drip marks or large droplets present on the interior of the lens.

#### What should I do if unacceptable condensation is present?

Have your vehicle checked as soon as possible.

#### Why do my headlamps turn off when I have them switched on when I switch my vehicle off?

The battery saver turns the headlamps off after a short period of time after you switch your vehicle off.

## AUTOLAMPS

### WHAT ARE AUTOLAMPS



**WARNING:** The system does not relieve you of your responsibility to drive with due care and attention. You may need to override the system if it does not turn the headlamps on in low visibility conditions, for example daytime fog.

Autolamps turn the headlamps on in low light situations or when the windshield wipers operate.

### AUTOLAMP SETTINGS

1. Using the instrument cluster controls on the steering wheel, select **Settings**.
2. Select **Vehicle**.
3. Select **Lighting**.
4. Select **Autolamp Delay**.
5. Select a setting and press the **OK** button.

# Exterior Lighting

## EXTERIOR LAMPS

### SWITCHING THE TURN SIGNAL LAMPS ON AND OFF

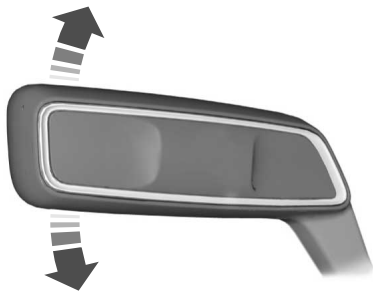

Push the lever up or down to switch the turn signal lamps on.

Set the lever to the middle position to switch the turn signal lamps off.

**Note:** Tap the lever up or down to make the turn signal lamps flash three times.

### SWITCHING THE DAYTIME RUNNING LAMPS ON AND OFF - VEHICLES WITH: CONFIGURABLE DAYTIME RUNNING LAMPS



**WARNING:** The daytime running lamps system does not activate the rear lamps and may not provide adequate lighting during low visibility driving conditions. Make sure you switch the headlamps on, as appropriate, during all low visibility conditions. Failure to do so may result in a crash.

1. Using the instrument cluster controls on the steering wheel, select **Settings**.
2. Select **Vehicle**.
3. Select **Lighting**.
4. Switch **Daytime Running Lights** on or off.

The daytime running lamps turn on when all of the following occur:

- You switch the system on.
- You switch your vehicle on.

- The transmission is not in park (P) for vehicles with automatic transmissions or you release the parking brake for vehicles with manual transmissions.
- The lighting control is in the autolamps position.
- The headlamps are off.

**Note:** Other lighting control positions do not turn on the daytime running lamps.

### SWITCHING THE DAYTIME RUNNING LAMPS ON AND OFF - VEHICLES WITH: DAYTIME RUNNING LAMPS (DRL)



**WARNING:** The daytime running lamps system does not activate the rear lamps and may not provide adequate lighting during low visibility driving conditions. Make sure you switch the headlamps on, as appropriate, during all low visibility conditions. Failure to do so may result in a crash.

# Exterior Lighting

Daytime running lamps are always on unless you switch on the headlamps or your vehicle is in park (P).

## SWITCHING THE FRONT FOG LAMPS ON AND OFF (If Equipped)

The front fog lamp button is on the lighting control.



Press the button to switch the front fog lamps on or off.

**Note:** Only switch the front fog lamps on during reduced visibility.

**Note:** The brightness of the daytime running lamps may decrease when the front fog lamps are switched on.

**Note:** When the lighting control is in the autolamps position, you cannot switch the fog lamps on unless the headlamps are on.

## SWITCHING WELCOME LIGHTING ON AND OFF

Welcome lighting slowly turns on the exterior lamps when you approach your vehicle with an authenticated device or unlock the doors.

1. Using the instrument cluster controls on the steering wheel, select **Settings**.
2. Select **Vehicle**.
3. Select **Lighting**.
4. Switch **Welcome Lighting** on or off.

## EXTERIOR LAMP INDICATORS

### Front Fog Lamp



It illuminates when you switch the front fog lamps on.

### Turn Signal Lamp



It flashes when you switch the turn signal lamps on.

**Note:** An increase in the rate of flashing warns of a failed turn signal lamp.

## EXTERIOR LAMP AUDIBLE WARNING

### Exterior Lamps On

Sounds when you open the driver door and the exterior lamps are on.

## AUTOMATIC HIGH BEAM CONTROL

### HOW DOES AUTOMATIC HIGH BEAM CONTROL WORK

Automatic high beam control turns the high beams on if it is dark enough and no other traffic is present. If it detects an approaching vehicle's headlamps or tail lamps, or street lighting ahead, the system turns the high beams off.

A camera sensor, centrally mounted behind the windshield of your vehicle, continuously monitors conditions to turn the high beams on and off.

# Exterior Lighting

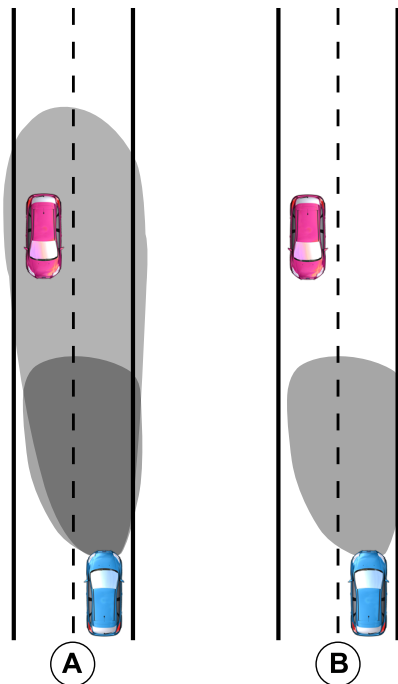



- A Without automatic high beam control.
- B With automatic high beam control.

## AUTOMATIC HIGH BEAM CONTROL PRECAUTIONS

 **WARNING:** The system does not relieve you of your responsibility to drive with due care and attention. You may need to override the system if it does not turn the high beams on or off.

 **WARNING:** The system may not switch the high beams off if the lights of oncoming vehicles are hidden by obstacles, for example guard rails.

 **WARNING:** Do not use the system in poor visibility, for example fog, heavy rain, spray or snow.

 **WARNING:** You may need to override the system when approaching other road users.

 **WARNING:** You may need to override the system during inclement weather.

## AUTOMATIC HIGH BEAM CONTROL REQUIREMENTS

The system turns the high beams on if all of the following occur:

- You switch the system on.
- You set the lighting control to the autolamps position.
- The ambient light level is low enough that you require high beams.
- There is no traffic in front of your vehicle.
- The vehicle speed is greater than approximately 32 mph (52 km/h).

# Exterior Lighting

## AUTOMATIC HIGH BEAM CONTROL LIMITATIONS

The system turns the high beams off if any of the following occur:

- You switch the system off.
- You set the lighting control to any position except autolamps.
- The ambient light level is high enough that you do not require high beams.
- The system detects an approaching vehicle's headlamps or a leading vehicle's tail lamps.
- The system detects severe rain, snow or fog.
- The system detects street lighting.
- The camera has reduced visibility.
- The vehicle speed falls below approximately 27 mph (44 km/h).

## SWITCHING AUTOMATIC HIGH BEAM CONTROL ON AND OFF

1. Using the instrument cluster controls on the steering wheel, select **Settings**.
2. Select **Vehicle**.
3. Select **Lighting**.
4. Switch **Auto High Beam** on or off.

## AUTOMATIC HIGH BEAM CONTROL INDICATORS



Illuminates to confirm when the system is ready to assist.

## OVERRIDING AUTOMATIC HIGH BEAM CONTROL

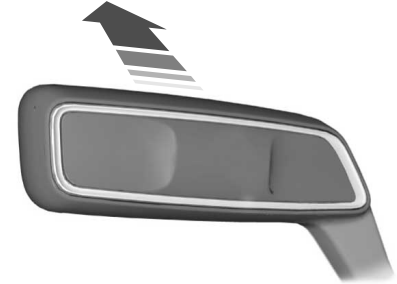

Push the lever away from you to switch the high beam on.

Push the lever away from you again to switch the high beams off.

Push the lever away from you for a third time to switch automatic high beam control back on.

# Exterior Lighting

---

## **AUTOMATIC HIGH BEAM CONTROL – TROUBLESHOOTING**

### **AUTOMATIC HIGH BEAM CONTROL – INFORMATION MESSAGES**

<b>Message</b>	<b>Description</b>
Front Camera Low Visibility Clean Screen	The camera has reduced visibility. Clean the windshield. If the message continues to appear, have your vehicle checked as soon as possible.
Front Camera Temporarily Not Available	The camera has malfunctioned. Wait a short period of time for the camera to cool down. If the message continues to appear, have your vehicle checked as soon as possible.
Front Camera Malfunction Service Required	The camera has malfunctioned. Have your vehicle checked as soon as possible.

## **ADAPTIVE FRONT LIGHTING**

### **HOW DOES ADAPTIVE FRONT LIGHTING WORK**

#### **Speed Dependent Lamps**

Adaptive front lighting provides additional light on the road depending on your vehicle speed and steering wheel input.

# Exterior Lighting

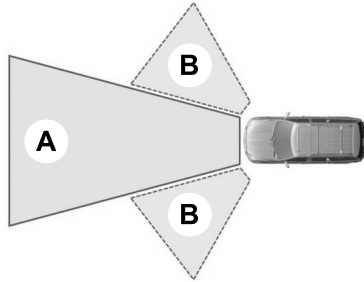

- A Standard low beam.
- B Additional lighting.

## Static Bending Lamps (If Equipped)

Adaptive front lighting adapts when you are steering around a curve or if the camera detects lane markings indicating a curve.

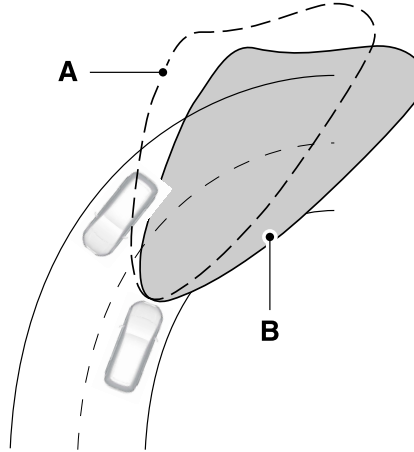

- A Without adaptive front lighting.
- B With adaptive front lighting.

## SWITCHING ADAPTIVE FRONT LIGHTING ON AND OFF

1. Using the instrument cluster controls on the steering wheel, select **Settings**.
  2. Select **Vehicle**.
  3. Select **Lighting**.
  4. Switch **Adaptive Headlamps** on or off.
- Set the lighting control to the autolamps position to use the adaptive front lighting.



# Interior Lighting

## SWITCHING ALL OF THE INTERIOR LAMPS ON AND OFF

The lamps turn on under the following conditions:

- You open any door.
- You press a button on the remote control.
- You press the all lamps on button on the overhead console.



Press to switch all interior lamps on or off.

## SWITCHING THE FRONT INTERIOR LAMPS ON AND OFF

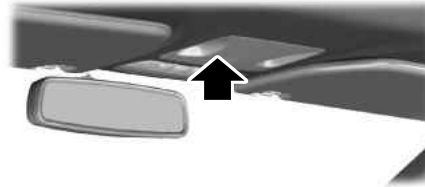

The front interior lamp switches are on the overhead console.

**Note:** *The position of each button on the overhead console depends on your vehicle.*

### Individual Map Lamps



Press to switch the left-hand individual dome lamp on and off.



Press to switch the right-hand individual dome lamp on and off.

## SWITCHING THE REAR INTERIOR LAMPS ON AND OFF



The rear interior lamps may be above the rear seat or above the rear windows.



Press to switch the lamps on or off.

**Note:** *If you switch the rear lamps on through the overhead console, you cannot switch them off with the rear lamp switch.*

# Interior Lighting

## INTERIOR LAMP FUNCTION

### WHAT IS THE INTERIOR LAMP FUNCTION

The interior lamp function switches the courtesy and door lamps on or off.

### SWITCHING THE INTERIOR LAMP FUNCTION ON AND OFF



Press to switch the interior lamp function on and off.

**Note:** *The indicator lamp illuminates amber when the door function is off.*

### ADJUSTING THE INSTRUMENT PANEL LIGHTING BRIGHTNESS

The instrument lighting dimmer buttons are on the lighting control.



Repeatedly press one of the buttons to adjust the brightness.

## AMBIENT LIGHTING (IF EQUIPPED)

### SWITCHING AMBIENT LIGHTING ON AND OFF

1. Press **Settings** on the touchscreen.
2. Press **Vehicle Settings**.
3. Press **Ambient Light**.
4. Press a color.

### ADJUSTING AMBIENT LIGHTING

Drag the selected color up or down.

## INTERIOR LIGHTING – TROUBLESHOOTING

### INTERIOR LIGHTING – FREQUENTLY ASKED QUESTIONS

**Why do my courtesy lamps or interior lamps turn off when I have them switched on when I switch my vehicle off?**

The battery saver turns the courtesy lamps and interior lamps off after a short period of time after you switch your vehicle off.

# Windows

## OPENING AND CLOSING THE WINDOWS



**WARNING:** Do not leave children unattended in your vehicle and do not let them play with the power windows. Failure to follow this instruction could result in personal injury.



**WARNING:** When closing the power windows, verify they are free of obstruction and make sure that children and pets are not in the proximity of the window openings.



Press the window control switch to open the window. Lift the window control switch to close the window.

**Note:** *The power windows operate with the ignition on, and for several minutes after you switch the ignition off or until you open a front door.*

To reduce wind noise or pulsing noise when one window is open, slightly open the opposite window.

### One-Touch Open (If Equipped)

Fully press the window control switch and release it. Press again or lift it to stop the window.

### One-Touch Close (If Equipped)

Fully lift the window control switch and release it. Press again or lift it to stop the window.

### Resetting One-Touch Close

Carry out all steps within 30 seconds of starting the sequence.

1. Close the window.
2. Press and hold the window control switch until the window is fully open. Keep the window control switch pressed for a few seconds.

3. Lift and hold the window control switch until the window is fully closed. Keep the window control switch held for a few seconds.
4. Press and hold the window control switch until the window is fully open. Keep the window control switch pressed for a few seconds.
5. Lift and hold the window control switch until the window is fully closed. Keep the window control switch held for a few seconds.

**Note:** *Repeat the procedure if the window does not close when you use one-touch.*

### Accessory Delay

The window switches remain operational for several minutes when you switch the ignition off or until you open either front door.

# Windows

## GLOBAL OPENING AND CLOSING

### WHAT IS GLOBAL OPENING AND CLOSING

You can use the remote control to open the windows with the ignition off.

### USING GLOBAL OPENING

1. Press and release the unlock button on the remote control.
2. Press and hold the unlock button on the remote control.
3. Release the button when the windows start to open.

Press the lock or the unlock button on the remote control to stop global opening.

**Note:** *You can use global opening for a short period of time when you unlock your vehicle using the remote control.*

### SWITCHING GLOBAL OPENING ON AND OFF

1. Press the menu button on the steering wheel to enter the information display main menu.
2. Select **Settings**.
3. Select **Vehicle**.
4. Select **Windows**.
5. Switch **Remote Open** on or off.

### USING GLOBAL CLOSING

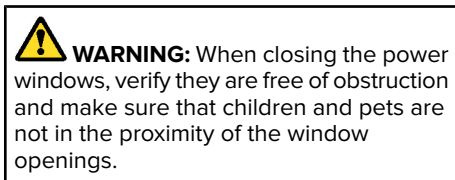

1. Press and hold the lock button on the remote control.
2. Release the button when the windows start to close.

Press the lock or the unlock button on the remote control to stop global closing.

**Note:** *Bounce-back is on during global closing. See **What Is Window Bounce-Back** (page 132).*

### SWITCHING GLOBAL CLOSING ON AND OFF

1. Press the menu button on the steering wheel to enter the information display main menu.
2. Select **Settings**.
3. Select **Vehicle**.
4. Select **Windows**.
5. Switch **Remote Close** on or off.

## WINDOW BOUNCE-BACK

### WHAT IS WINDOW BOUNCE-BACK

The window stops and reverses if it detects an obstruction when closing.

# Windows

---

## OVERRIDING WINDOW BOUNCE-BACK



**WARNING:** If you override bounce-back, the window does not reverse if it detects an obstacle. Take care when closing the windows to avoid personal injury or damage to your vehicle.

1. Close the window until it reaches the point of resistance and let it reverse.
2. Lift and hold the window control switch within two seconds to override bounce-back and close the window. Bounce-back is now disabled and you can close the window manually.

**Note:** *The window goes past the point of resistance and you can fully close it.*

**Note:** *If the window does not close, have your vehicle checked as soon as possible.*

## LOCKING THE REAR WINDOW CONTROLS



Press the window control switch to lock or unlock the rear window controls. It illuminates when you lock the rear window controls.

# Interior Mirror

---

## INTERIOR MIRROR PRECAUTIONS



**WARNING:** Do not adjust the mirrors when your vehicle is moving. This could result in the loss of control of your vehicle, serious personal injury or death.

**Note:** Do not clean the mirror housing or glass with harsh abrasives, fuel or other petroleum-based cleaning products.

## AUTO-DIMMING INTERIOR MIRROR

### WHAT IS THE AUTO-DIMMING INTERIOR MIRROR

The mirror dims to reduce the effect of bright light from behind. It returns to normal when the bright light from behind is no longer present or if you shift into reverse (R).

## AUTO-DIMMING INTERIOR MIRROR LIMITATIONS

Do not block the sensors on the front and back of the mirror.

**Note:** A rear center passenger or raised rear center head restraint could prevent light from reaching the sensor.

# Exterior Mirrors

## ADJUSTING THE EXTERIOR MIRRORS



**WARNING:** Do not adjust the mirrors when your vehicle is moving. This could result in the loss of control of your vehicle, serious personal injury or death.



- A Left-hand mirror.
- B Adjustment control.
- C Right-hand mirror.

To adjust your mirrors, switch your vehicle on, with the ignition in accessory mode or the engine running and then:

1. Select the mirror you want to adjust. The control light turns on.
2. Use the adjustment control to adjust the position of the mirror.
3. Press the mirror control again. The control light turns off.

## FOLDING THE EXTERIOR MIRRORS - VEHICLES WITH: MANUAL FOLDING MIRRORS

Push the mirror toward the door window glass.

Make sure that you fully engage the mirror in its support when returning it to its original position.

## FOLDING THE EXTERIOR MIRRORS - VEHICLES WITH: POWER FOLDING MIRRORS

With the auto-fold feature enabled, the exterior mirrors fold in toward the glass after you place the transmission into park (P), turn off the vehicle, open and close the driver side door and lock the vehicle. The exterior mirrors unfold and return to their driving position after you unlock the vehicle and open and close the driver side door.



For tight parking conditions, press the control to fold the mirrors.

Press the control again to unfold the mirrors.

If you press the control to fold in the mirrors with auto-fold on, the mirrors do not unfold when you unlock your vehicle.

**Note:** The power folding mirrors operate with the ignition on, and for several minutes after you switch the ignition off.

# Exterior Mirrors

---

**Note:** *If you fold and unfold the mirrors several times within one minute, the power fold function may turn off to protect the motors from overheating.*

## Switching Auto-fold On and Off

1. Press **Settings** on the touchscreen.
2. Press **Vehicle Settings**.
3. Press **Mirrors**.
4. Switch **Autofold** on or off.

## Loose Mirror

If you manually fold the power-folding mirrors, they may not work properly even after you re-position them. You need to reset them if:

- The mirrors vibrate when you drive.
- The mirrors feel loose.
- The mirrors do not stay in the folded or unfolded position.
- One of the mirrors is not in its normal driving position.

To reset the power-fold feature, use the power-folding mirror control to fold and unfold the mirrors. You may hear a loud noise as you reset the power-folding mirrors. This sound is normal. Repeat this process as needed each time you manually fold the mirrors.

## AUTO-DIMMING EXTERIOR MIRROR

### WHAT IS THE AUTO-DIMMING EXTERIOR MIRROR

The driver exterior mirror dims when the interior auto-dimming mirror turns on.

### Memory Mirrors (If Equipped)

You can save and recall the mirror positions through the memory function. See **Memory Function** (page 174).

### Heated Exterior Mirrors

See **Switching the Heated Mirrors On and Off** (page 157).

### Signal Indicator Mirrors (If Equipped)

The outer portion of the appropriate mirror housing blinks when you switch on the turn signal.

### Lincoln Welcome Mat

Projection lights, on the bottom of the mirror housings, project an image onto the ground a short distance from the vehicle.

### Blind Spot Monitor

See **What Is Blind Spot Information System** (page 277).



## Moonroof (If Equipped)

### OPENING AND CLOSING THE SUN SHADE



**WARNING:** Do not leave children unattended in your vehicle and do not let them play with the sun shades. Failure to follow this instruction could result in personal injury.

The controls are on the overhead console.

#### Opening the Sun Shade



Press and release the switch to activate the one-touch open feature. To stop movement, press the switch a second time. The sun shade also opens when you open the moonroof.

**Note:** *The sun shade stops short of its fully opened position for the comfort of rear passengers. To fully open the sun shade, press the switch again.*

#### Closing the Sun Shade



Press and release the switch to activate the one-touch close feature. To stop movement, press the switch a second time.

**Note:** *If fully open, the sunshade stops after covering the rear glass panel. Press and release again to fully close the sunshade.*

### OPENING AND CLOSING THE MOONROOF



**WARNING:** Do not leave children unattended in your vehicle and do not let them play with the moonroof. Failure to follow this instruction could result in personal injury.



**WARNING:** When closing the moonroof, verify that it is free of obstruction and make sure that children and pets are not in the proximity of the roof opening.

**Note:** *With the panoramic moonroof panel fully open and vehicle speed increasing to approximately 50 mph (80 km/h), the moonroof opening panel automatically closes approximately 8 in (20 cm) to reduce excessive wind noise at higher speeds. This feature only functions one time per key cycle, so you can open the glass further if desired.*

The moonroof controls are located on the overhead console and have a one-touch open and close feature. To stop its movement during one-touch operation, press the control a second time.

#### Opening the Moonroof



Press and release the switch to activate the one-touch open feature. To stop movement, press the switch a second time.

#### Closing the Moonroof



Press and release the switch to activate the one-touch close feature, from either the open or vent positions. To stop movement, press the switch a second time.

# Moonroof (If Equipped)

---

## VENTING THE MOONROOF



**WARNING:** Do not leave children unattended in your vehicle and do not let them play with the moonroof. Failure to follow this instruction could result in personal injury.

The moonroof controls are on the overhead console.



With the moonroof in the closed position, press and release the switch to vent the moonroof. To close the moonroof from the vent position, press and release the switch again.

## MOONROOF BOUNCE-BACK

### WHAT IS MOONROOF BOUNCE-BACK

The moonroof stops and reverses some distance if it detects an obstacle when closing.

## OVERRIDING MOONROOF BOUNCE-BACK

Press and hold the close button within two seconds after the moonroof comes to a stop.

# Instrument Cluster

## INSTRUMENT CLUSTER OVERVIEW

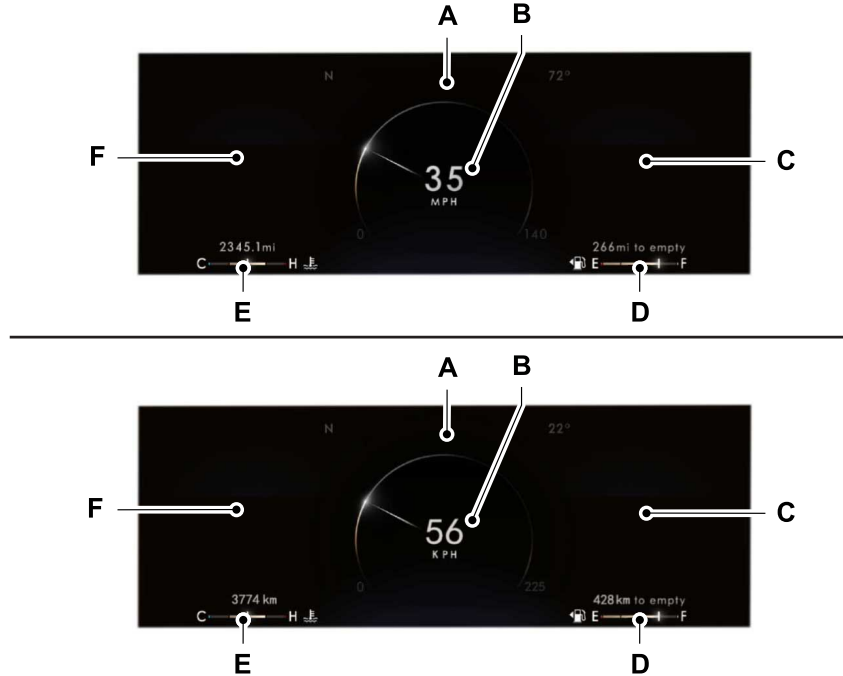

# Instrument Cluster

---

- A Status bar.
- B Speedometer.
- C Right information group.
- D Fuel gauge.
- E Engine coolant temperature gauge.
- F Left information group.

## TACHOMETER

Indicates the engine speed.

## SPEEDOMETER

Indicates the vehicle speed.

## FUEL GAUGE

### WHAT IS THE FUEL GAUGE

Indicates approximately how much fuel is in the fuel tank.

## FUEL GAUGE LIMITATIONS

The fuel gauge may not provide an accurate reading when your vehicle is on an incline.

## LOCATING THE FUEL FILLER DOOR

The arrow adjacent to the fuel pump symbol indicates on which side of your vehicle the fuel filler door is located.

## WHAT IS THE LOW FUEL REMINDER

A low fuel level reminder displays and sounds when the distance to empty reaches 75 mi (120 km) to empty for MyKey, and at 50 mi (80 km), 25 mi (40 km), 12 mi (20 km) and 0 mi (0 km) for all vehicle keys.

**Note:** *The low fuel reminder can appear at different fuel gauge positions depending on fuel economy conditions. This variation is normal.*

# Instrument Cluster

## WHAT IS DISTANCE TO EMPTY

Indicates the approximate distance your vehicle can travel on the fuel remaining in the tank. Changes in driving pattern can cause the value to not only decrease but also increase or stay constant for periods of time.

## ENGINE COOLANT TEMPERATURE GAUGE

Indicates the engine coolant temperature.

## ENGINE OIL PRESSURE GAUGE

Indicates the engine oil pressure.

**Note:** *This is a configurable gauge.*

## TRANSMISSION FLUID TEMPERATURE GAUGE

Indicates the transmission fluid temperature.

Special operating conditions can cause higher than normal operating temperatures. See **Special Operating Conditions Scheduled Maintenance** (page 471).

**Note:** *This is a configurable gauge.*

## 12V BATTERY GAUGE

Indicates the power of the 12-volt battery.

## WHAT ARE THE INSTRUMENT CLUSTER WARNING LAMPS

Warning lamps alert you to a vehicle condition that could become serious. Some lamps illuminate when you start your vehicle to make sure they work. If any lamps remain on after starting your vehicle, refer to the respective system warning lamp for further information.

## INSTRUMENT CLUSTER WARNING LAMPS

### Anti-Lock Brake System



If it illuminates when you are driving, this indicates that the system requires service. Your vehicle continues to have normal braking without the anti-lock brake system function. Have your vehicle checked as soon as possible.

### Battery



It illuminates when you switch the ignition on.

If it illuminates when the engine is running, this indicates your vehicle requires service. Have your vehicle checked as soon as possible.

# Instrument Cluster

## Brake System



It illuminates when you apply the parking brake and the ignition is on. If it illuminates when your



vehicle is moving, make sure the parking brake is released. If the parking brake is released, this

indicates low brake fluid level or the brake system requires service. Have your vehicle checked as soon as possible.

**Note:** *Indicators may vary depending on region.*

## Door Ajar



It illuminates when you switch the ignition on and remains on if any door is open.

## Electric Parking Brake



It illuminates or flashes when the electric parking brake requires service.

## Engine Coolant Temperature



If it illuminates, safely stop your vehicle and switch your vehicle off.

## Fasten Seatbelt



It illuminates and a tone sounds until you fasten the seatbelts.

## Hood Ajar



It illuminates when the ignition is on and the hood is not completely closed.

## Liftgate Ajar



It illuminates when the ignition is on and the liftgate is not completely closed.

## Low Beam Warning



It illuminates when the low beam headlamp requires service. Have the system checked as soon as possible.

## Low Fuel Level



It illuminates when the fuel level is low.

## Low Tire Pressure



It illuminates when your tire pressure is low. If illuminated, check your tire pressure as soon as possible. If it begins to flash at anytime, have the system checked as soon as possible.

## Low Washer Fluid Level



It illuminates when the washer fluid is low.

# Instrument Cluster

## Malfunction Indicator Lamp



It illuminates when the ignition is on and the engine is off, this is normal operation. If it illuminates when the engine is on this indicates that the emission control system requires service. If it flashes, have your vehicle checked immediately. See **Starting and Stopping the Engine – Warning Lamps** (page 195). See **Emission Law** (page 554).

## Oil Pressure



It illuminates when the engine oil pressure is low.

## Powertrain Fault



It illuminates when the powertrain requires service. Have your vehicle checked as soon as possible.

## WHAT ARE THE INSTRUMENT CLUSTER INDICATORS

Indicators notify you of various features that are active on your vehicle.

## INSTRUMENT CLUSTER INDICATORS

### Adaptive Cruise Control



See **Adaptive Cruise Control** (page 256).

### Adaptive Steering



See **Electric Power Steering** (page 234).

### Airbag



See **Airbags** (page 64).

## Auto Hold



See **Auto Hold** (page 228).



## Automatic High Beam



See **Automatic High Beam Control** (page 124).

## Auto Start-Stop



See **Auto-Start-Stop** (page 198).

## Blind Spot Information System



See **Blind Spot Information System** (page 277).

## Cruise Control (If Equipped)



See **Cruise Control** (page 254).

# Instrument Cluster

---

## Front Fog Lamp



See **Exterior Lamps** (page 123).

## Turn Signal



See **Exterior Lamps** (page 123).

## Headlamp High Beam



See **Headlamps** (page 121).

## Hill Start Assist



See **Hill Start Assist** (page 227).

## Parking Lamps



See **Exterior Lamps** (page 123).

## Stability and Traction Control



See **Stability Control** (page 231).  
See **Traction Control** (page 230).





# Instrument Cluster Display

## USING THE INSTRUMENT CLUSTER DISPLAY CONTROLS



**WARNING:** Driving while distracted can result in loss of vehicle control, crash and injury. We strongly recommend that you use extreme caution when using any device that may take your focus off the road. Your primary responsibility is the safe operation of your vehicle. We recommend against the use of any hand-held device while driving and encourage the use of voice-operated systems when possible. Make sure you are aware of all applicable local laws that may affect the use of electronic devices while driving.

**Note:** Some options may appear slightly different or not at all if the items are optional.

The controls are on the steering wheel. You can control various systems on your vehicle using the quick action menu (QAM) buttons.

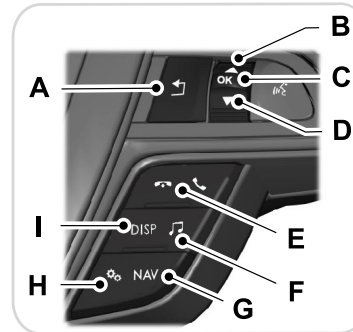

- A Return button.
- B Toggle up.
- C OK button

- D Toggle down.
- E Phone QAM buttons.
- F Audio QAM button.
- G Navigation QAM button.
- H Settings QAM button.
- I Display QAM button.

### Return Button

Press to go back or exit a menu.

### Toggle Buttons

Press the toggle button up or down to scroll through menu items.

### OK Button

Press to make a selection.

### Quick Action Menu Buttons

Press to open the correlating menu.

# Instrument Cluster Display

## Status Indicator



A check in the box indicates a feature is on, and unchecked indicates the feature is off.

## INSTRUMENT CLUSTER DISPLAY MAIN MENU

Depending on your vehicle options, some menu items can appear different or not at all.

**Note:** For your safety, some features are speed-dependent and could be unavailable when your vehicle is above a certain speed.

Settings
Drive Control
Adaptive Steering
Driver Assistance
Speedometer km/h
Speedometer MPH
Vehicle
MyKey

# Instrument Cluster Display

---

<b>Display</b>
Gauges
Info/Trip/Fuel
Display Setup

## TRIP COMPUTER

### ACCESSING THE TRIP COMPUTER

Using the instrument cluster controls, select the following to access the trip computer:

<b>Menu Item</b>	<b>Action</b>
Display	Press the <b>OK</b> button.
Info/Trip/Fuel	Press the <b>OK</b> button.

# Instrument Cluster Display

---

## RESETTING THE TRIP COMPUTER

Menu Item	Action
Display	Press the <b>OK</b> button.
Info/Trip/Fuel	Press the <b>OK</b> button. Press and hold the <b>OK</b> button until the system reset confirmation appears.

# Instrument Cluster Display

## RESETTING THE INDIVIDUAL TRIP VALUES

Using the instrument cluster controls, select the following to reset individual trip values:

Menu Item	Action
Display	Press the <b>OK</b> button.
Info/Trip/Fuel	Press the <b>OK</b> button.
Trip 1	Press and hold the <b>OK</b> button until the system reset confirmation appears.
Trip 2	Press and hold the <b>OK</b> button until the system reset confirmation appears.

## CUSTOMIZING THE INSTRUMENT CLUSTER DISPLAY

You can customize the gauge displays through the following:

Menu Item	Action
Display	Press the <b>OK</b> button.
Gauges	Press the <b>OK</b> button. Choose a gauge display.

# Instrument Cluster Display

---

## PERSONALIZED SETTINGS

### CHANGING THE INSTRUMENT CLUSTER DISPLAY LANGUAGE

Menu Item	Action
Display	Press the <b>OK</b> button.
Display Setup	Press the <b>OK</b> button.
Language	Press the <b>OK</b> button. Select a language.

**Note:** Available languages vary by region.

### CHANGING THE MEASUREMENT UNIT

Menu Item	Action
Display	Press the <b>OK</b> button.
Display Setup	Press the <b>OK</b> button.
Distance	Press the <b>OK</b> button. Select a measure unit.

# Instrument Cluster Display

---

## CHANGING THE TEMPERATURE UNIT

Menu Item	Action
Display	Press the <b>OK</b> button.
Display Setup	Press the <b>OK</b> button.
Temperature	Press the <b>OK</b> button. Select a temperature unit.

# Instrument Cluster Display

---

## CHANGING THE TIRE PRESSURE UNIT

Menu Item	Action
Display	Press the <b>OK</b> button.
Display Setup	Press the <b>OK</b> button.
Tire Pressure	Press the <b>OK</b> button. Select a pressure unit.



# Remote Start

## WHAT IS REMOTE START

The system allows you to remotely start your vehicle and to adjust the interior temperature according to the settings that you chose.

## REMOTE START PRECAUTIONS



**WARNING:** Do not start the engine in a closed garage or in other enclosed areas. Exhaust fumes are toxic. Always open the garage door before you start the engine. Failure to follow this instruction could result in personal injury or death.

## REMOTE START LIMITATIONS

Remote start does not work under the following conditions:

- The alarm horn is sounding.
- The hood is open.
- The transmission is not in park (P).

- The ignition is on.
- The battery voltage is below the minimum operating voltage.

**Note:** Do not use remote start if your fuel level is low.

**Note:** To use remote start with Lincoln Way or Phone as a Key, enable the modem. See **Connecting the Vehicle to a Wi-Fi Network** (page 423).

## ENABLING REMOTE START

1. Using the instrument cluster display controls on the steering wheel, select **Settings**.
2. Select **Vehicle**.
3. Select **Remote Start**.
4. Switch **System** on.

**Note:** To use remote start, make sure that the modem is enabled. See **Enabling and Disabling the Modem** (page 423).

## REMOTELY STARTING AND STOPPING THE VEHICLE

### Remotely Starting the Vehicle



Press the button on the remote control.



Within three seconds, press the button on the remote control.

Within three seconds, press the button again.

**Note:** You can also use the Lincoln Way App to start the vehicle.

**Note:** The direction indicators flash twice.

**Note:** The parking lamps turn on when the vehicle is running.

**Note:** The horn sounds if the system fails to start.

**Note:** All other vehicle systems remain off when you have remotely started the vehicle.

**Note:** The vehicle remains secured when you have remotely started the vehicle. A valid key must be inside your vehicle to switch the ignition on and drive your vehicle.

# Remote Start

## Remotely Stopping the Vehicle



Within three seconds, press the button on the remote control.

Within three seconds, press the button again.

## EXTENDING THE REMOTE START DURATION

To extend the remote start duration during remote start, do the following:



Press the button on the remote control.



Within three seconds, press the button on the remote control.

Within three seconds, press the button again.

If the duration is set to 15 minutes, the duration extends by another 15 minutes. This provides a total of 30 minutes.

**Note:** Remote start can only be extended once.

**Note:** A maximum of two remote starts, or one remote start with an extension, are allowed. To reset the restart procedure switch the vehicle to on, then to off.

## REMOTE START REMOTE CONTROL INDICATORS

### Remote Control Feedback (If Equipped)

An LED on the remote control provides status feedback of remote start or stop commands.

LED	Status
Solid green.	Remote start successful.
Solid red.	Remote stop successful.
Blinking red.	Request failed or status not received.
Blinking green.	Status incomplete.

## REMOTE START SETTINGS

### SWITCHING CLIMATE CONTROL LAST SETTINGS ON AND OFF

1. Using the instrument cluster display controls on the steering wheel, select **Settings**.
2. Select **Vehicle**.
3. Select **Remote Start Setup**.
4. Select **Climate Control**.
5. Select **Auto** or **Last settings**.

**Note:** If you switch the last settings on, the system remembers the last used settings.

### SWITCHING THE HEATED SEAT SETTINGS ON AND OFF

1. Using the instrument cluster display controls on the steering wheel, select **Settings**.
2. Select **Vehicle**.
3. Select **Remote Start**.
4. Select **Seats**.

# Remote Start

---

5. Select **Auto** or **Off**.

**Note:** *If you switch the heated seat settings on, the heated seats turn on during cold weather.*

**Note:** *You cannot adjust the heated seat settings when you have remotely started the engine.*

## SWITCHING THE HEATED STEERING WHEEL SETTINGS ON AND OFF

1. Using the instrument cluster display controls on the steering wheel, select **Settings**.
2. Select **Vehicle**.
3. Select **Remote Start**.
4. Select **Seats and Wheel**.
5. Select **Auto** or **Off**.

**Note:** *If you switch the heated steering wheel settings on, the heated steering wheel turns on during cold weather.*

**Note:** *You cannot adjust the heated steering wheel settings when you have remotely started the engine.*

## SETTING THE REMOTE START DURATION

You can set a duration for the engine to run.

**Note:** *Wait a few seconds before remotely starting the engine after the engine stops running.*

1. Using the instrument cluster display controls on the steering wheel, select **Settings**.
2. Select **Vehicle**.
3. Select **Remote Start**.
4. Select **Duration**.

# Climate Control

## IDENTIFYING THE CLIMATE CONTROL UNIT



Depending on your vehicle options, the controls could look different than what you see here.

## SWITCHING CLIMATE CONTROL ON AND OFF



Press the button.

## SWITCHING RECIRCULATED AIR ON AND OFF



Press the button to recirculate air currently in the passenger compartment.

**Note:** Recirculated air may turn off automatically, or prevent you from switching on in all air flow modes except MAX A/C to reduce the risk of fogging. Recirculation may also turn on and off automatically in various air distribution control combinations to improve heating or cooling efficiency.

## SWITCHING AIR CONDITIONING ON AND OFF



Press the button.

**Note:** Under certain conditions, the air conditioning compressor could continue to operate after you switch air conditioning off.

**Note:** To keep the system and its components fully functional, switch air conditioning on and let your vehicle idle at least once per month for a minimum of two minutes.

## SWITCHING MAXIMUM DEFROST ON AND OFF



Press the button.

**Note:** When you switch maximum defrost on, the heated windshield, heated rear window and air conditioning turn on. The blower motor is set to the highest speed.

**Note:** When you switch maximum defrost off, the heated windshield and heated rear window remain on.

## SWITCHING MAXIMUM COOLING ON AND OFF



Press the button.

# Climate Control

**Note:** When you switch maximum cooling off, air conditioning remains on.

## SWITCHING THE HEATED REAR WINDOW ON AND OFF



Press the button to clear the rear window of thin ice and fog. The heated rear window turns off after a short period of time.

**Note:** Do not use harsh chemicals, razor blades or other sharp objects to clean or remove decals from the inside of the heated rear window as this could cause damage to the heated rear window grid lines not covered by the vehicle warranty.

**Note:** Make sure the engine is on before operating the heated windows.

## SETTING THE BLOWER MOTOR SPEED



Turn the control to adjust the volume of air circulated in the vehicle.

## SWITCHING THE HEATED MIRRORS ON AND OFF

When you switch the heated rear window on, the heated exterior mirrors turn on.

**Note:** Do not remove ice from the mirrors with a scraper or adjust the mirror glass when it is frozen in place.

**Note:** Do not clean the mirror housing or glass with harsh abrasives, fuel or other petroleum-based cleaning products. The vehicle warranty may not cover damage caused to the mirror housing or glass.

## SETTING THE TEMPERATURE



Press the toggle button on the left-hand side of the climate control upward or downward to set the left-hand temperature.

**Note:** This control also adjusts the right-hand side temperature when you switch off dual zone mode.

Press the toggle button on the right-hand side of the climate control upward or downward to set the right-hand temperature.

## DIRECTING THE FLOW OF AIR

### Directing Air to the Windshield Air Vents



Press the button to activate the selection screen.



Press the button on the touchscreen.

### Directing Air to the Instrument Panel Air Vents



Press the button to activate the selection screen.



Press the button on the touchscreen.

# Climate Control

## Directing Air to the Footwell Air Vents



Press the button to activate the selection screen.



Press the button on the touchscreen.

## AUTO MODE

### SWITCHING AUTO MODE ON AND OFF



Press the button to switch auto mode on. Repeatedly press the button to adjust auto mode.

The system adjusts the blower motor speed, air distribution, air conditioning operation, and outside or recirculated air to reach and maintain the temperature you have set.

Adjust the blower motor control to switch auto mode off.

**Note:** *The system starts at the previous setting when you switch on auto mode.*

## AUTO MODE INDICATORS

The indicators are on the Auto Mode button.

Auto Mode Indicator Status	Description
One indicator illuminated.	The blower motor speed is reduced. Use this setting to minimize the amount of noise from the blower motor. This setting increases the time taken to cool the interior.
Two indicators illuminated.	The blower motor speed is moderate.
Three indicators illuminated.	The blower motor speed is increased. Use this setting to reduce the time taken to cool the interior. This setting increases the amount of noise from the blower motor.

# Climate Control

---

## **CLIMATE CONTROL – TROUBLESHOOTING**

### **CLIMATE CONTROL – FREQUENTLY ASKED QUESTIONS**

#### **Why is the volume of air to the rear passenger compartment limited ?**

Objects may obstruct the air direction to the rear passenger compartment. Make sure objects have not been placed under the front seats.

#### **Why is the volume of air from the air vents reduced?**

The air intake area at the base of the windshield could be obstructed. Make sure the air intake area is free from any snow, ice or leaves.

#### **What are the recommended settings for heating the interior?**

Auto mode on and instrument panel and side air vents fully open.

#### **How can I quickly heat the interior?**

Select the highest blower motor speed, highest temperature and direct the air to the footwell air vents.

#### **What are the recommended settings for cooling the interior?**

Auto mode on.

#### **How can I quickly cool the interior?**

Switch maximum cooling on, switch recirculated air on and drive with the windows open until you feel cold air through the air vents.

#### **How can I reduce the humidity build-up inside my vehicle?**

Do not drive with the system off or with recirculated air on.

#### **How can I defog the side windows?**

Switch maximum defrost on.

#### **How can I defog or clear the windshield of thin ice?**

Switch maximum defrost on.

#### **Why do I feel air from the footwell air vents regardless of the air distribution?**

This is normal operation. You may feel a small amount of air from the footwell air vents regardless of the air distribution.

#### **What happens if I switch auto mode on when the outside temperature and in-vehicle temperature is high?**

The system temporarily selects recirculated air to maximize cooling.

#### **What happens if I switch auto mode on when the outside temperature is low and the engine is cold?**

Air is directed to the windshield and the outer instrument panel air vents.

# Interior Air Quality

---

## WHAT IS THE CABIN AIR FILTER

The cabin air filter improves the quality of air in your vehicle by trapping dust, pollen and other particles.

## REPLACING THE CABIN AIR FILTER

Replace the filter at regular intervals. See **Scheduled Maintenance** (page 463).

The cabin air filter is behind the glove compartment.

To remove the lower glove compartment and access the filter:

1. Open the glove compartment.

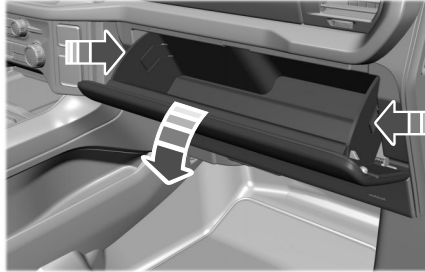

2. Press the tab on each side.
3. Fully lower the glove compartment.
4. Pull the glove compartment toward you.



# Front Seats

## FRONT SEAT PRECAUTIONS

**WARNING:** Sitting improperly, out of position or with the seatback reclined too far can take weight off the seat cushion and affect the decision of the passenger sensing system, resulting in serious injury or death in the event of a crash. Always sit upright against your seat back, with your feet on the floor.

**WARNING:** Do not recline the seat backrest too far as this can cause the occupant to slide under the seatbelt, resulting in personal injury in the event of a crash.

**WARNING:** Do not place objects higher than the top of the seat backrest. Failure to follow this instruction could result in personal injury or death in the event of a sudden stop or crash.

**WARNING:** Do not adjust the driver seat or seat backrest when your vehicle is moving. This may result in sudden seat movement, causing the loss of control of your vehicle.

## SITTING IN THE CORRECT POSITION

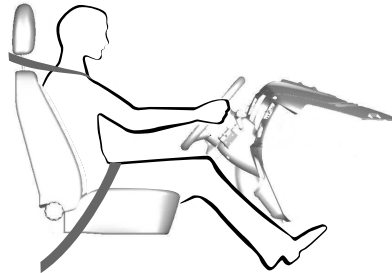

When you use them properly, the seat, head restraint, seatbelt and airbags will provide optimum protection in the event of a crash.

We recommend that you follow these guidelines:

- Sit in an upright position with the base of your spine as far back as possible.
- Do not recline the seat backrest so that your torso is more than 30 degrees from the upright position.
- Adjust the head restraint so that the top of it is level with the top of your head and as far forward as possible. Make sure that you remain comfortable.
- Keep sufficient distance between yourself and the steering wheel. We recommend a minimum of 10 in (25 cm) between your breastbone and the airbag cover.
- Hold the steering wheel with your arms slightly bent.

# Front Seats

- Bend your legs slightly so that you can press the pedals fully.
- Position the shoulder strap of the seatbelt over the center of your shoulder and position the lap strap tightly across your hips.

Make sure that your driving position is comfortable and that you can maintain full control of your vehicle.

## POWER SEATS

### HEAD RESTRAINT COMPONENTS

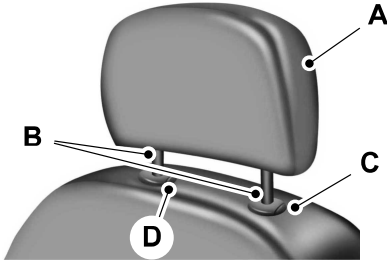



The head restraints consist of:

- A An energy absorbing head restraint.
- B Two steel stems.
- C Guide sleeve adjust and unlock button.
- D Guide sleeve unlock and remove button.

### ADJUSTING THE HEAD RESTRAINT

 **WARNING:** Fully adjust the head restraint before you sit in or operate your vehicle. This will help minimize the risk of neck injury in the event of a crash. Do not adjust the head restraint when your vehicle is moving.

 **WARNING:** The head restraint is a safety device. Whenever possible it should be installed and properly adjusted when the seat is occupied. Failure to adjust the head restraint properly could reduce its effectiveness during certain impacts.

 **WARNING:** Adjust the head restraints for all passengers before you drive your vehicle. This will help minimize the risk of neck injury in the event of a crash. Do not adjust the head restraints when your vehicle is moving.

**Note:** Adjust the seat backrest to an upright driving position before adjusting the head restraint. Adjust the head restraint so that the top of it is level with the top of your head and as far forward as possible. Make sure that you remain comfortable. If you are extremely tall, adjust the head restraint to its highest position.

Pull the head restraint up to raise it.

To lower the head restraint:

1. Press and hold the adjust and unlock button.
2. Push the head restraint down.

# Front Seats

## REMOVING THE HEAD RESTRAINT

1. Pull up the head restraint until it reaches its highest position.
2. Press and hold the adjust and unlock button, and the unlock and remove button.
3. Pull up the head restraint.

**Note:** You cannot remove front seat head restraints that have entertainment system video screens.

## INSTALLING THE HEAD RESTRAINT

Align the steel stems into the guide sleeves and push the head restraint down until it locks.

## Adjusting the Power Head Restraint (if Equipped)



## MOVING THE SEAT BACKWARD AND FORWARD

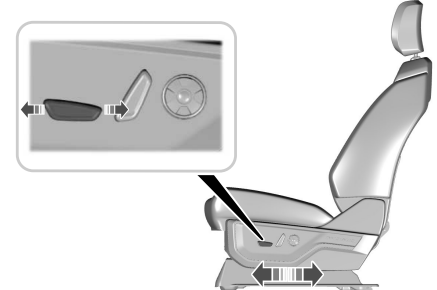

# Front Seats

## ADJUSTING THE SEAT CUSHION (If Equipped)

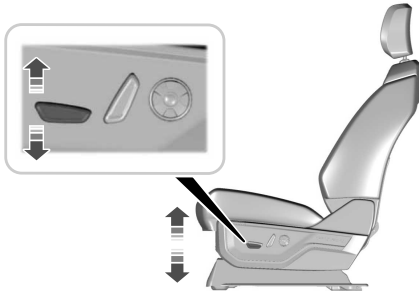

## Adjusting the Length of the Seat Cushion (If Equipped)

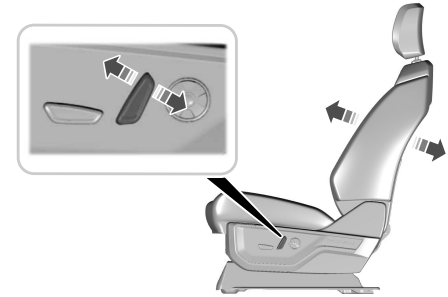

## Adjusting the Upper Seat Backrest and Head Restraint (If Equipped)

## ADJUSTING THE SEAT BACKREST

 **WARNING:** Do not place cargo or any objects behind the seatback before returning it to the original position.



# Front Seats

## ADJUSTING THE SEAT HEIGHT

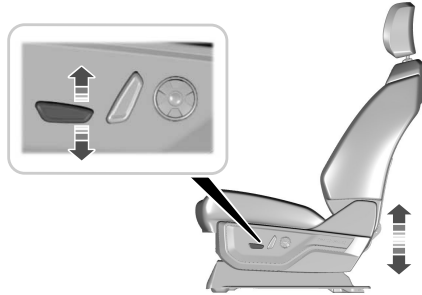

## ADJUSTING THE LUMBAR SUPPORT

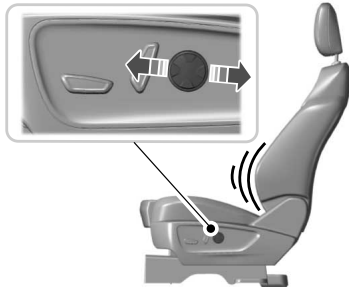

## MESSAGE SEATS

### MESSAGE SEAT LIMITATIONS

The engine must be running or the vehicle must be in accessory mode to activate the seats.

Allow a few seconds for any selection to activate. When the seat backrest and cushion are both active, the massage alternates between zones.

## ADJUSTING THE MESSAGE SEAT SETTINGS

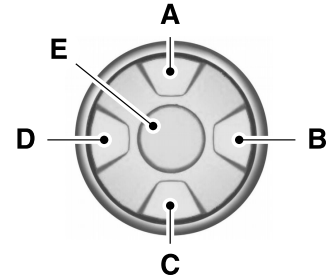

- A Select the previous massage pattern or lumbar area.
- B Decrease the massage or lumbar Intensity.
- C Select the next massage pattern or lumbar area.
- D Increase the massage or lumbar Intensity.
- E Select the massage or lumbar mode.

# Front Seats

You can also adjust this feature through the touchscreen.

## HEATED SEATS

### HEATED SEAT PRECAUTIONS

 **WARNING:** Use caution when using the heated seat if you are unable to feel pain to your skin because of advanced age, chronic illness, diabetes, spinal cord injury, medication, alcohol use, exhaustion or other physical conditions. The heated seat could cause burns even at low temperatures, especially if used for long periods of time. Failure to follow this instruction could result in personal injury.

 **WARNING:** Do not poke sharp objects into the seat cushion or seat backrest. This could damage the heated seat element and cause it to overheat. Failure to follow this instruction could result in personal injury.



**WARNING:** Do not place anything on the seat that blocks the heat, for example a seat cover or a cushion. This could cause the seat to overheat. Failure to follow this instruction could result in personal injury.

Do not:

- Place heavy objects on the seat.
- Operate the heated seat if water or any other liquid spills on the seat. Allow the seat to dry.

### SWITCHING THE HEATED SEATS ON AND OFF

The vehicle must be running to use this feature.



Press the heated seat symbol to cycle through the various heat settings and off. The more indicators that display, the warmer the temperature of the seat.

**Note:** *The heated seats may remain on after you remote start your vehicle, based on your remote start settings. The heated seats may also turn on when you start your vehicle if they were on when you switched your vehicle off.*

## VENTILATED SEATS

### SWITCHING THE VENTILATED SEATS ON AND OFF

The vehicle must be running to use this feature.



# Front Seats

---

Press this symbol to cycle through the various ventilation settings and off. More indicator lights indicate higher fan speeds.

If the engine falls below 350 RPM while the ventilated seats are on, the feature turns itself off. You need to reactivate it.

**Note:** *The ventilated seats may remain on after you remote start your vehicle, based on your remote start settings. The ventilated seats may also turn on when you start your vehicle if they were on when you switched your vehicle off.*

## **Automatic Climate Controlled Seats (if Equipped)**

When you switch the auto setting on, the climate controlled seats switch between the heated seats and ventilated seats to match your climate control setting.

# Rear Seats

## MANUAL SEATS

### HEAD RESTRAINT COMPONENTS

#### Rear Seat Outermost Head Restraints

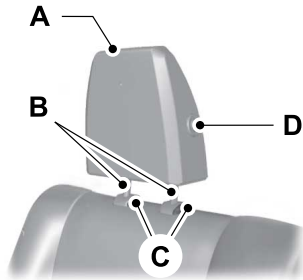

The head restraints consist of:

- A An energy absorbing head restraint.
- B Two steel stems.
- C Guide sleeve unlock and remove buttons.
- D Fold button.

#### Rear Seat Center Head Restraint

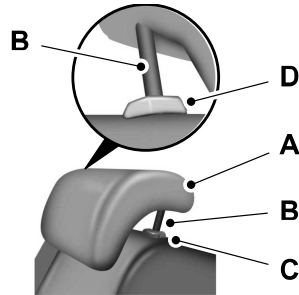

The head restraint consists of:

- A An energy absorbing head restraint.
- B Two steel stems.
- C Guide sleeve adjust and unlock button.
- D Guide sleeve unlock and remove button.

## ADJUSTING THE HEAD RESTRAINT

### Raising the Head Restraint

To raise the center head restraint, pull the head restraint up.

### Lowering the Head Restraint

To lower the center head restraint:

1. Press and hold the adjust and unlock button.
2. Push the head restraint down.

### Folding the Head Restraint

1. Press and hold the fold button.
2. Pull the head restraint back up to reset.

## REMOVING THE HEAD RESTRAINT

### Outermost Head Restraints

1. Press and hold the unlock and remove buttons.
2. Pull the head restraint up.



# Rear Seats

## Center Head Restraint

1. Pull the head restraint up until it reaches its highest position.
2. Press and hold the adjust and unlock button, and the unlock and remove button.
3. Pull the head restraint up.

## INSTALLING THE HEAD RESTRAINT

Align the steel stems into the guide sleeves and push the head restraint down until it locks.

## FOLDING THE SEAT BACKREST

**WARNING:** To prevent possible damage to the seat or seatbelts, make sure that the seatbelts are not fastened before folding the seatback.

**WARNING:** When folding or unfolding the seats, take care not to get your fingers caught between the seat backrest and seat frame. Failure to follow this warning could result in serious personal injury.

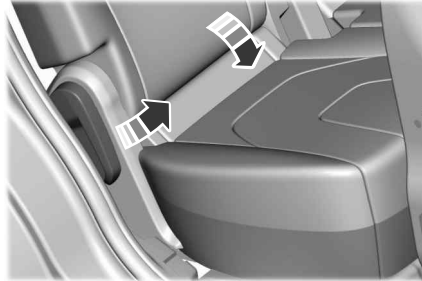

With the seat empty, pull the lever up to fold the seat backrest forward.

## UNFOLDING THE SEAT BACKREST

**WARNING:** When unfolding the seat backrests, make sure that the seatbelts are not trapped behind the seat.

**WARNING:** Make sure that the seats and the seat backrests are secure and fully locked in their catches.

Rotate the seat backrest up until it latches in the upright position. It clicks when you lock it into position.

## Reclining the Seat Backrest

With the seat occupied, pull the lever up to recline the seat backrest.

# Rear Seats

## POWER SEATS

### FOLDING THE SEAT BACKREST

 **WARNING:** Do not fold a seat if it is occupied. Failure to follow this instruction could result in personal injury.

This feature operates when the vehicle is in park (P) and the liftgate has been open for less than 10 minutes.

The controls are on the left-hand rear quarter trim panel and are accessible from the liftgate area.



Press and hold the left control to lower the left seat backrest.

Press and hold the right control to lower the right seat backrest.

### UNFOLDING THE SEAT BACKREST

Rotate the seat backrest up until it latches in the upright position. It clicks when you lock it into position.

## HEATED SEATS

### HEATED SEAT PRECAUTIONS

 **WARNING:** Use caution when using the heated seat if you are unable to feel pain to your skin because of advanced age, chronic illness, diabetes, spinal cord injury, medication, alcohol use, exhaustion or other physical conditions. The heated seat could cause burns even at low temperatures, especially if used for long periods of time. Failure to follow this instruction could result in personal injury.

 **WARNING:** Do not poke sharp objects into the seat cushion or seat backrest. This could damage the heated seat element and cause it to overheat. Failure to follow this instruction could result in personal injury.

 **WARNING:** Do not place anything on the seat that blocks the heat, for example a seat cover or a cushion. This could cause the seat to overheat. Failure to follow this instruction could result in personal injury.

Do not:

- Place heavy objects on the seat.
- Operate the heated seat if water or any other liquid spills on the seat. Allow the seat to dry.

### SWITCHING THE HEATED SEATS ON AND OFF

The vehicle must be running to use this feature.

## Rear Seats

---

The rear seat heat controls are on the rear of the center console.



Press the heated seat symbol to cycle through the various heat settings and off. More indicator lights indicate warmer settings.

The heated seats turn off when you switch off the vehicle.

# Rear Occupant Alert System (If Equipped)

## WHAT IS THE REAR OCCUPANT ALERT SYSTEM

The rear occupant alert system monitors vehicle conditions and notifies you to check for rear seat occupants when you switch the ignition off.

## HOW DOES THE REAR OCCUPANT ALERT SYSTEM WORK

The system monitors when rear doors have been opened and closed to indicate the potential presence of an occupant in the rear seat.

A message displays in the information and entertainment display screen and an audible warning sounds when you switch the ignition off after any of the following conditions have been met:

- A rear door is opened or closed while the ignition is on.
- You switch the ignition on within 15 minutes of a rear door opening and closing.
- You switch the ignition on within 15 minutes of the alert having displayed or sounded.

## REAR OCCUPANT ALERT SYSTEM PRECAUTIONS



**WARNING:** On hot days, the temperature inside the vehicle can rise very quickly. Exposure of people or animals to these high temperatures for even a short time can cause death or serious heat related injuries, including brain damage. Small children are particularly at risk.



**WARNING:** Do not leave children or pets unattended in your vehicle. Failure to follow this instruction could result in personal injury or death.

## REAR OCCUPANT ALERT SYSTEM LIMITATIONS

The system does not detect the presence of objects or passengers in the rear seat. It monitors when rear doors are opened and closed.

**Note:** *It is possible to receive an alert when there is no rear seat occupant, but alert conditions are met.*

**Note:** *It is possible to receive no alert when there is an occupant in the rear seat, if alert conditions are not met. For example, if a rear seat occupant does not enter the vehicle through a rear door.*

**Note:** *The audible warning does not sound when the front door is opened before you switch the ignition off.*

# Rear Occupant Alert System (If Equipped)

## SWITCHING REAR OCCUPANT ALERT SYSTEM ON AND OFF

1. Press **Settings** on the touchscreen.
2. Press **Vehicle**.
3. Switch **Rear Occupant Alert** on or off.

**Note:** The default setting is on.

**Note:** Performing a master reset causes the system to switch on again.

### Semiannual Reminder (If Equipped)

When you switch the system off, a message appears every six months as a reminder that the system is off. You can switch the system back on or leave it off.

## REAR OCCUPANT ALERT SYSTEM INDICATORS



<b>Message</b>
Check rear seats for occupants.

Displays when you switch your vehicle off after the alert conditions are met.

The message displays for a short period of time. Press **Close** to acknowledge and remove the message.

**Note:** Depending on your SYNC version, the graphic may look different from what you see here.

## REAR OCCUPANT ALERT SYSTEM AUDIBLE WARNINGS

Sounds when you switch your vehicle off after the alert conditions are met.

The warning sounds for a short period of time.

# Memory Function

## HOW DOES THE MEMORY FUNCTION WORK

The memory function recalls the position of these features:

- Driver seat.
- Power mirrors.
- Optional power steering column.

## MEMORY FUNCTION PRECAUTIONS



**WARNING:** Before activating the memory seat, make sure that the area immediately surrounding the seat is clear of obstructions and that all occupants are clear of moving parts.



**WARNING:** Do not use the memory function when your vehicle is moving.

## LOCATING THE MEMORY FUNCTION BUTTONS



The memory function buttons are on the driver door.

## SAVING A PRESET POSITION

1. Switch the ignition on.
2. Adjust the memory features to your preferred position.
3. Press and hold the preferred preset button until you hear a single tone.

A confirmation message appears in the information display.

You can save up to three preset memory positions at any time.

## RECALLING A PRESET POSITION

Press and release a preset button.

**Note:** You can only recall a preset memory position when the ignition is off, or when you place the transmission in park (P) or neutral (N) if the ignition is on and the vehicle is not moving.

**Note:** Pressing any of the memory feature controls during a memory recall cancels the operation.

You can also recall a preset memory position by:

- Pressing the unlock button on your remote control if you linked it to a preset position.
- Unlocking the intelligent driver door handle if a linked remote control is present.

# Memory Function

---

**Note:** *Using a linked remote control to recall your memory position when the ignition is off moves the seat and steering column to the easy entry position.*

## Garage Door Opener (If Equipped)

### WHAT IS THE GARAGE DOOR OPENER

#### HomeLink Wireless Control System



The universal garage door opener replaces the common hand-held garage door opener with a three-button transmitter integrated into the driver's sun visor.

### HOW DOES THE GARAGE DOOR OPENER WORK

The system includes two primary features, a garage door opener and a platform for remote activation of devices within the home. You can program garage doors as well as entry gate operators, security systems, entry door locks and home or office lighting.

Additional system information can be found online at [www.homelink.com](http://www.homelink.com) or by calling the toll-free help line at 1-800-355-3515.

**Note:** *You can program a maximum of three devices. To change or replace any of the three devices after it has been initially programmed, you must first erase the current settings. See **Clearing the Garage Door Opener** (page 179).*

### GARAGE DOOR OPENER PRECAUTIONS



**WARNING:** Do not use the system with any garage door opener that does not have the safety stop and reverse feature as required by U.S. Federal Safety Standards (this includes any garage door opener manufactured before April 1, 1982). A garage door opener which cannot detect an object, signaling the door to stop and reverse, does not meet current federal safety standards. Using a garage door opener without these features increases the risk of serious injury or death.

**Note:** *Make sure that the garage door and security device are free from obstruction when you are programming. Do not program the system with your vehicle in the garage.*

**Note:** *Make sure you keep the original remote control transmitter for use in other vehicles as well as for future system programming.*



## Garage Door Opener (If Equipped)

**Note:** We recommend that upon the sale or lease termination of your vehicle, you erase the programmed function buttons for security reasons. See **Clearing the Garage Door Opener** (page 179).

### GARAGE DOOR OPENER LIMITATIONS

Canadian radio-frequency laws require transmitter signals to time-out (or quit) after several seconds – which may not be long enough for HomeLink to pick up the signal.

U.S. gate operators time-out in the same manner.

**Note:** If programming a garage door opener or gate operator, it is advised to unplug the device during the “cycling” process to prevent possible overheating.

### PROGRAMMING THE GARAGE DOOR OPENER TO YOUR HAND-HELD TRANSMITTER

This process is to program your in-vehicle HomeLink function button with your hand-held transmitter.

**Note:** The programming steps below assume you will be programming HomeLink that was not previously programmed. If your HomeLink was previously programmed, you may need to erase your HomeLink buttons. See **Clearing the Garage Door Opener** (page 179).

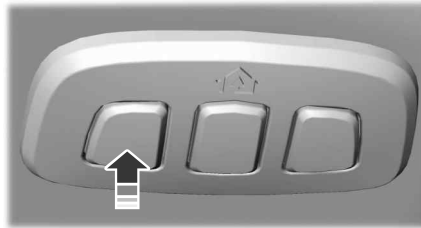

1. With your vehicle parked outside of the garage, switch your ignition to the on position, but do not start your vehicle.
2. Press and release one of the three HomeLink function buttons that you would like to program.
3. Hold your hand-held garage door transmitter 1–3 in (2–8 cm) away from the HomeLink button you want to program.
4. Press and hold the hand-held transmitter button you want to program while watching the indicator light on HomeLink. Continue to hold the hand-held button until the HomeLink indicator light flashes rapidly or is continuously on.

**Note:** You may need to use a different method if you live in Canada or have difficulties programming your gate operator or garage door opener. See **Programming the Garage Door Opener to Your Gate Opener Motor** (page 178).

5. Press and hold the HomeLink button you programmed for two seconds, then release. You may need to do this twice to activate the door.

## Garage Door Opener (If Equipped)

**Note:** If the indicator light stays on, the programming is complete.

**Note:** If the HomeLink indicator flashes rapidly, repeat step 5.

**Note:** If your device still does not operate, you must program your garage door. See **Programming the Garage Door Opener to Your Garage Door Opener Motor** (page 178).

6. To program additional buttons, repeat Steps 1 – 4.

### PROGRAMMING THE GARAGE DOOR OPENER TO YOUR GARAGE DOOR OPENER MOTOR



1. Press the learn button on the garage door opener motor, you have 30 seconds to complete the next two steps.
2. Return to your vehicle.

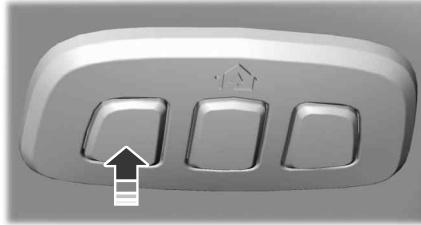

3. Press and hold one of the three HomeLink function buttons you want to program for two seconds, then release. Repeat this step. Depending on your brand of garage door opener, you may need to repeat this sequence a third time.

### PROGRAMMING THE GARAGE DOOR OPENER TO YOUR GATE OPENER MOTOR

#### Gate Operator / Canadian Programming

Canadian radio-frequency laws require transmitter signals to “time-out” (or quit) after several seconds of transmission – which may not be long enough for HomeLink to pick up the signal during programming. Similar to this Canadian law, some U.S. gate operators “time-out” in the same manner.

**Note:** If programming a garage door opener or gate operator, it is advised to unplug the device during the “cycling” process to prevent possible overheating.

1. Press and release, every two seconds, your hand-held transmitter until the HomeLink indicator light changes to a rapidly blinking or continuously on light.
2. Release the hand-held transmitter button.

## Garage Door Opener (If Equipped)

3. Press and hold the HomeLink function button you want to program for two seconds, then release. You may need to do this twice to activate the door.

**Note:** If the indicator light stays on, the programming is complete.

**Note:** If the HomeLink indicator flashes rapidly, repeat Step 3.

**Note:** If your device still does not operate, you must program your garage door. See **Programming the Garage Door Opener to Your Garage Door Opener Motor** (page 178).

4. To program additional buttons, repeat Steps 1 – 4.

### CLEARING THE GARAGE DOOR OPENER

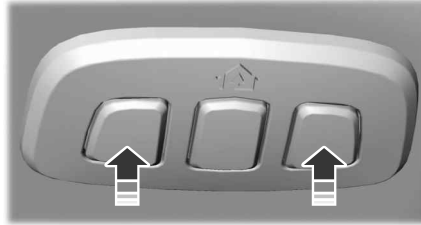

1. Press and hold the outer two function buttons simultaneously for approximately 10 seconds until the indicator light above the buttons flashes rapidly.
2. When the indicator light flashes, release the buttons.

**Note:** You cannot erase individual buttons.

### REPROGRAMMING THE GARAGE DOOR OPENER

To program a device to a previously trained button, follow these steps:

1. Press and hold the desired button. Do NOT release the button.
2. The indicator light begins to flash after 20 seconds. Without releasing the button, follow programming steps.

### GARAGE DOOR OPENER RADIO FREQUENCIES

#### FCC and RSS-210 Industry Canada Compliance



**WARNING:** Changes or modifications not expressly approved by the party responsible for compliance could void the user's authority to operate the equipment. The term "IC:" before the radio certification number only signifies that Industry Canada technical specifications were met.

## Garage Door Opener (If Equipped)

---

This device complies with Part 15 of the FCC Rules and with RSS-210 of Industry Canada. Operation is subject to the following two conditions: (1) this device may not cause harmful interference, and (2) this device must accept any interference received, including interference that could cause undesired operation.

This equipment complies with FCC radiation exposure limits set forth for an uncontrolled environment. End Users must follow the specific operating instructions for satisfying RF exposure compliance. This transmitter must be at least 8 in (20 cm) from the user and must not be co-located or operating in conjunction with any other antenna or transmitter.

# USB Ports

## LOCATING THE USB PORTS

### Data Transfer USB Ports



The USB ports could be in the following locations:

- On the lower instrument panel below the climate control.
- Inside the center console.

**Note:** *These USB ports can also charge devices.*

**Note:** *Not all USB ports in your vehicle have data transfer capabilities.*

**Note:** *We recommend using only USB-IF certified cables and adapters. Non-certified cables and adapters may not work.*

### Charge Only USB Ports



The USB ports could be in the following locations:

- On the lower instrument panel.
- On the upper instrument panel.
- Inside the media bin.
- Inside the center console.
- On the rear of the center console.
- In the cargo area.

## PLAYING MEDIA USING THE USB PORT



**WARNING:** Driving while distracted can result in loss of vehicle control, crash and injury. We strongly recommend that you use extreme caution when using any device that may take your focus off the road. Your primary responsibility is the safe operation of your vehicle. We recommend against the use of any hand-held device while driving and encourage the use of voice-operated systems when possible. Make sure you are aware of all applicable local laws that may affect the use of electronic devices while driving.

Connect your device to the USB port.



Press the audio button on the feature bar.

Select **Sources**.



Select the USB option.



Press the button to play a track. Press the button again to pause the track.



Press the button to skip to the next track.

Press and hold the button to fast forward through the track.



Press the button once to return to the beginning of a track. Repeatedly press the button to return to previous tracks.

Press and hold the button to fast rewind.

## CHARGING A DEVICE

Connect your device to the USB port.

# USB Ports

---

## Data Transfer USB Ports



You can charge your device through the data transfer USB port when SYNC is on.

## Charge Only USB Ports



You can charge your device through the charge only USB port when the vehicle is in accessory mode or when the vehicle is running.

# Power Outlet - Vehicles With: 110V Power Outlet

## WHAT IS THE POWER OUTLET

The power outlet is a socket that connects an electrical device to your vehicle's power supply.

## POWER OUTLET PRECAUTIONS



**WARNING:** Do not keep electrical devices plugged in the power point whenever the device is not in use. Do not use any extension cord with the 110 volt AC power point, since it will defeat the safety protection design. Doing so may cause the power point to overload due to powering multiple devices that can reach beyond the 150 watt load limit and could result in fire or serious injury.

**Note:** *The power point turns off when you switch off the ignition, when the vehicle is not in accessory mode, or when the battery voltage drops below 11 volts.*

## LOCATING THE POWER OUTLETS

The power outlet is on the instrument panel or the rear of the center console.



## POWER OUTLET INDICATORS

The power outlet indicator illuminates to let you know the status of the system.

Indicator Status	Description
On	When the indicator light is on, the outlet is providing power.
Off	When the indicator light is off, there is no power to the outlet.
Flashing	When the indicator light is flashing, the outlet is in a fault mode.

## Fault mode

The power outlet temporarily turns off power if the device exceeds the watt limit.

1. Unplug your device.
2. Switch your vehicle off to let the system cool and reset the fault mode.
3. Switch your vehicle back on, but do not plug your device back in.

## Power Outlet - Vehicles With: 110V Power Outlet

---

4. With your vehicle on, make sure the indicator light remains on.
5. Make sure your device does not exceed the power limits and then plug in your device.

**Note:** *If a fault occurs again, your device may exceed the capacity available from the power outlet.*



# Power Outlet - Vehicles With: 12V Power Outlet

---

## WHAT IS THE POWER OUTLET

The power outlet can power devices using a 12 V outlet adapter.

## POWER OUTLET PRECAUTIONS



**WARNING:** Do not plug optional electrical accessories into the cigar lighter socket. Incorrect use of the cigar lighter can cause damage not covered by the vehicle warranty, and can result in fire or serious injury.

When you switch the vehicle on, you can use the socket to power 12 V appliances with a maximum current rating of 20 A. Do not use the power point over the vehicle capacity of 12 V DC 240 W or a fuse could blow. Do not plug in any device that supplies power to the vehicle through the power points. This could result in damage to vehicle systems. Do not hang any accessory from the accessory plug. Always keep the power point caps closed when not in use. Do not insert objects other than an accessory plug into the power point.

To prevent the battery from running out of charge:

- Do not use the power point longer than necessary when the vehicle is off.
- Do not leave devices plugged in overnight or when you park your vehicle for extended periods.

## LOCATING THE POWER OUTLETS

Power outlets may be in the following locations:

- On the lower instrument panel.
- Inside the center console.
- On the front of the center console.
- On the rear of the center console.
- In the cargo area.
- On the passenger side floor panel.
- 3rd row on the quarter trim panels.

## Wireless Accessory Charger (If Equipped)

### WHAT IS THE WIRELESS ACCESSORY CHARGER

The wireless accessory charger allows you to charge one compatible Qi wireless charging device on the charging area.

### WIRELESS ACCESSORY CHARGER PRECAUTIONS



**WARNING:** Wireless charging devices can affect the operation of implanted medical devices, including cardiac pacemakers. If you have any implanted medical devices, we recommend that you consult with your physician.

Keep the charging area clean and remove foreign objects prior to charging a device.

Do not place items with a magnetic strip or radio-frequency identification chip, for example passports, parking tickets, transportation passes or credit cards, near the charging area when charging a device. Damage could occur to the magnetic strip or radio-frequency identification chip.

Do not place metal objects, for example remote controls, coins and candy wrappers, on or near the charging area when charging a device. Metal objects may heat up and degrade the charging performance, in addition to causing interruptions in charging.

Charging could be interrupted, degraded, or could stop if any of the following occur:

- The system detects a foreign object.
- The device is misaligned on the charging area.
- The device moves on the active charging area when the vehicle is in motion.
- The vehicle ambient temperature is too high.
- You attempt to charge a non-Qi compatible device on the wireless charger.

**Note:** During charging, the device and the charger could heat up, this is normal. If the battery gets hotter than usual, the device may stop charging.

### LOCATING THE WIRELESS ACCESSORY CHARGER



The charging area is on the center console or in the media bin below the instrument panel.

### CHARGING A WIRELESS DEVICE

Place the device on the center of the charging surface with the charging side down. The charging stops after your device reaches a full charge.

You can use the charger when the vehicle is in accessory mode, when the vehicle is running, or when SYNC is on.



Displays on the status bar when wireless charging is in progress.

## Wireless Accessory Charger (If Equipped)

---

**Note:** *The charging performance may be affected if your device is in a case. It may be necessary to remove the case to wirelessly charge your device.*

**Note:** *Software and firmware updates may affect device compatibility, including the use of unofficial software or firmware. You should verify charging functionality with your specific devices in-vehicle.*

# Storage

## CUP HOLDERS

### CUP HOLDER PRECAUTIONS



**WARNING:** Use caution when stowing items or hot drinks in the cup holders. Items could become loose or spill during hard braking, acceleration or crashes. Failure to follow this instruction could result in personal injury.

## UNDER FLOOR STORAGE

### LOCATING THE REAR UNDER FLOOR STORAGE

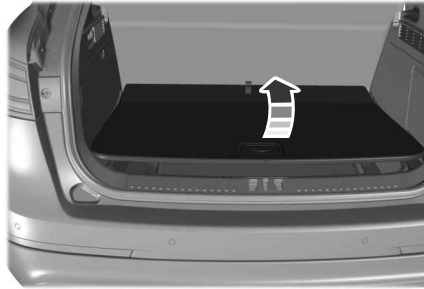

The system is in the floor of the cargo area. Lift the handle to open.



Your vehicle may have an additional cover that you can remove to access the spare tire or tire mobility kit.

# Storage

---

## In Floor Storage -Second Row

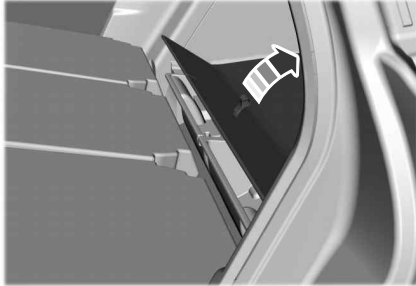

In-floor storage is behind the second row of seats in the cargo area. Lift the lid to open.

## GLASSES HOLDER

### LOCATING THE GLASSES HOLDER

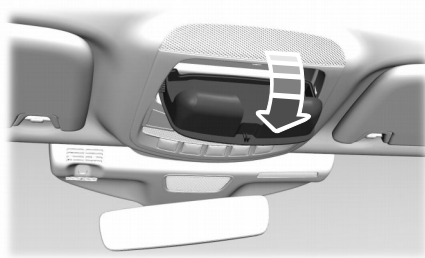



Press near the rear edge of the door on the overhead console to open the glasses holder.

# Starting and Stopping the Engine

## STARTING AND STOPPING THE ENGINE – PRECAUTIONS

 **WARNING:** Extended idling at high engine speeds can produce very high temperatures in the engine and exhaust system, creating the risk of fire or other damage.

 **WARNING:** Do not park, idle or drive your vehicle on dry grass or other dry ground cover. The emission system heats up the engine compartment and exhaust system, creating the risk of fire.

 **WARNING:** Do not start the engine in a closed garage or in other enclosed areas. Exhaust fumes are toxic. Always open the garage door before you start the engine. Failure to follow this instruction could result in personal injury or death.

 **WARNING:** Do not use starting fluid, for example ether, in the air intake system. Such fluid could cause immediate explosive damage to the engine and possible personal injury.

 **WARNING:** Exhaust leaks may result in entry of harmful and potentially lethal fumes into the passenger compartment. If you smell exhaust fumes inside your vehicle, have your vehicle inspected immediately. Do not drive if you smell exhaust fumes.

The powertrain control system meets all Canadian interference-causing equipment standard requirements regulating the impulse electrical field or radio noise.

If you stop your vehicle and leave the engine idling for long periods, we recommend that you do one of the following:

- Open the windows at least 1 in (2.5 cm).
- Set your climate control to outside air.

## PUSH BUTTON IGNITION SWITCH



### Switching the Ignition Off

When the ignition is on or in accessory mode, press the push button ignition switch once without your foot on the brake pedal.

### Switching the Ignition to Accessory Mode

When the ignition is off, press the push button ignition switch once without your foot on the brake pedal.

All electrical circuits and accessories are operational and the warning lamps and indicators illuminate.

# Starting and Stopping the Engine

**Note:** *Your vehicle has a battery saver feature that shuts your vehicle off when it detects a certain amount of battery drain, or after approximately 30 minutes of inactivity in accessory mode.*

## Starting the Engine

With the transmission in park (P), press the brake pedal and press the push button ignition switch. An indicator light on the button illuminates when the ignition is on and when the engine starts.

**Note:** *The system may not function if the passive key is close to metal objects or electronic devices, for example keys or a cell phone.*

**Note:** *A valid key must be inside your vehicle to switch the ignition on and start the engine.*

## STARTING THE ENGINE

### STARTING A GASOLINE ENGINE

Before starting your vehicle, check the following:

- Make sure that the headlamps and electrical accessories are off.
- Make sure that the parking brake is on.
- Make sure that the transmission is in park (P).

1. Fully press the brake pedal.

**Note:** *Do not touch the accelerator pedal.*



2. Press the push button ignition switch.

**Note:** *The engine may continue cranking for up to 15 seconds or until it starts.*

**Note:** *The engine takes longer to start at lower temperatures. It may crank for several seconds when very cold.*

## RESTARTING THE ENGINE AFTER STOPPING IT

The system allows you to start the engine within 10 seconds of switching it off, even if it does not detect a valid passive key.

Within 10 seconds of switching the engine off, fully press the brake pedal and press the push button ignition switch. After 10 seconds, you can no longer start the engine if the system does not detect a valid passive key.

When you start the engine, it remains running until you press the push button ignition switch, even if your vehicle does not detect a valid passive key. If you open and close a door when the engine is running, the system searches for a valid passive key.

# Starting and Stopping the Engine

## ENGINE BLOCK HEATER (IF EQUIPPED)

### ENGINE BLOCK HEATER PRECAUTIONS



**WARNING:** Failure to follow engine block heater instructions could result in property damage or serious personal injury.



**WARNING:** Do not use your heater with ungrounded electrical systems or two-pronged adapters. There is a risk of electrical shock.



**WARNING:** Do not fully close the hood, or allow it to drop under its own weight when using the engine block heater. This could damage the power cable and may cause an electrical short resulting in fire, injury and property damage.

We recommend that you do the following for a safe and correct operation:

- Use a 16-gauge outdoor extension cord that is product certified by Underwriter's Laboratory (UL) or Canadian Standards Association (CSA). This extension cord must be suitable for use outdoors, in cold temperatures, and be clearly marked Suitable for Use with Outdoor Appliances. Do not use an indoor extension cord outdoors. This could result in an electric shock or become a fire hazard.
- Use as short an extension cord as possible.
- Do not use multiple extension cords.
- Make sure that when in operation, the extension cord plug and engine block heater cord plug connections are free and clear of water. This could cause an electric shock or fire.
- If the engine block heater cord is under the hood, do not remove the wiring from its original location. Do not close the hood on the extension wiring.

- Park your vehicle in a clean area, clear of combustible materials.
- Firmly connect the engine block heater cord and the extension cord.
- Check the extension cord for heat anywhere when the system has been operating for approximately 30 minutes.
- Unplug and properly stow the system before starting and driving your vehicle. The protective cover seals the terminals of the engine block heater cord plug when not in use.
- Check the engine block heater system for proper operation before winter.

### HOW DOES THE ENGINE BLOCK HEATER WORK

The engine block heater warms the engine coolant. This allows the climate control system to quickly respond. The equipment includes a heater element installed in the engine block and a wire harness. You can connect the system to a grounded 220-240 volt AC electrical source.



# Starting and Stopping the Engine

**Note:** *The engine block heater is most effective when outdoor temperatures are below 0°F (-18°C).*

## USING THE ENGINE BLOCK HEATER

Make sure the receptacle terminals are clean and dry prior to use. Clean them with a dry cloth if necessary.

The heater uses 0.4 to 1.0 kilowatt-hours of energy per hour of use. The system does not have a thermostat. It achieves maximum temperature after approximately three hours of operation. Using the engine block heater longer than three hours does not improve system performance and unnecessarily uses electricity.

## STOPPING THE ENGINE

### STOPPING THE ENGINE WHEN YOUR VEHICLE IS STATIONARY

1. Shift into park (P).
2. Apply the parking brake.
3. Wait until the engine reaches idle speed.



4. Press the push button ignition switch.

### STOPPING THE ENGINE WHEN YOUR VEHICLE IS MOVING



**WARNING:** Switching off the engine when your vehicle is still moving results in a significant decrease in braking assistance. Higher effort is required to apply the brakes and to stop your vehicle. A significant decrease in steering assistance could also occur. The steering does not lock, but higher effort could be required to steer your vehicle. When you switch the ignition off, some electrical circuits, for example airbags, also turn off. If you unintentionally switch the ignition off, shift into neutral (N) and restart the engine.



1. Press and hold the push button ignition switch until the engine stops, or press it three times within two seconds.
2. Shift into neutral and use the brakes to bring your vehicle to a safe stop.
3. Shift into park (P).
4. Apply the parking brake.

## AUTOMATIC ENGINE STOP (IF EQUIPPED)

### WHAT IS AUTOMATIC ENGINE STOP

Automatic engine stop is a feature that switches the engine off if it has been idling for an extended period to help you save fuel.

# Starting and Stopping the Engine

## HOW DOES AUTOMATIC ENGINE STOP WORK

Automatic engine stop turns the engine off. The ignition also turns off in order to save battery power. Before the engine shuts down, a message appears in the information display showing a timer counting down. If you do not intervene within 30 seconds, the engine shuts down. Another message appears in the information display to inform you that the engine has shut down in order to save fuel. Start your vehicle as you normally do.

## SWITCHING AUTOMATIC ENGINE STOP ON AND OFF

1. Press the menu button on the steering wheel to enter the information display main menu.
2. Select **Settings**.
3. Switch **Auto Engine Off** on or off.

**Note:** You cannot permanently switch off the automatic shutdown. If you switch it off, it turns on each time you switch the ignition on.

## OVERRIDING AUTOMATIC ENGINE STOP

You can stop the engine shutdown, or reset the timer, at any point before the 30-second countdown has expired by doing any of the following:

- Pressing the brake pedal or accelerator pedal.
- Pressing the **OK** or **RESET** button during the countdown.

**Note:** You cannot permanently switch off the automatic engine shutdown feature. When you switch it off temporarily, it turns on at the next ignition cycle.

## ACCESSING THE PASSIVE KEY BACKUP POSITION

If you are unable to start the engine, do the following:

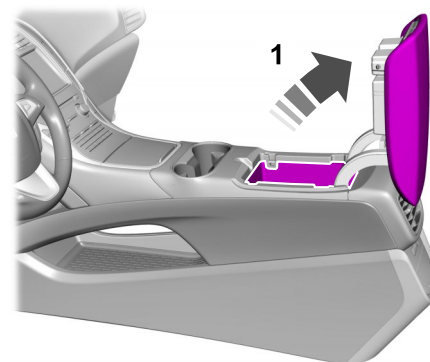

1. Open the floor console storage compartment lid.

# Starting and Stopping the Engine

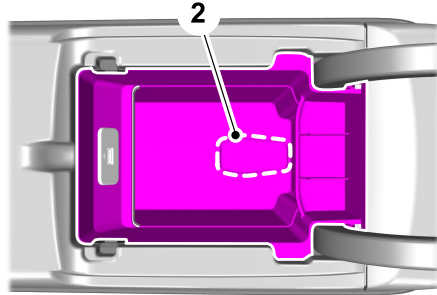

2. With the buttons facing upward and the unlock button facing the front of your vehicle, place the passive key into the backup slot.
3. With the key in this position, press the brake pedal then press the push button ignition switch to switch the ignition on and start your vehicle.

## STARTING AND STOPPING THE ENGINE – TROUBLESHOOTING

### STARTING AND STOPPING THE ENGINE – WARNING LAMPS

#### Malfunction Indicator Lamp



If it illuminates when the engine is running, the on-board diagnostics system is detecting a malfunction of the vehicle emission control system.

If it flashes, engine misfire could be occurring. Increased exhaust gas temperatures could damage the catalytic converter or other vehicle components. Avoid heavy acceleration and deceleration, and have your vehicle checked as soon as possible.

#### Powertrain Warning Lamp



If it illuminates when the engine is running, this indicates a powertrain or four-wheel drive fault. If it flashes when you are driving, immediately reduce the vehicle speed. Avoid heavy acceleration and deceleration, and have your vehicle checked as soon as possible.

If both lamps illuminate when the engine is running, stop your vehicle as soon as it is safe to do so. Continuing to drive your vehicle could cause reduced power or the engine to stop. Switch the ignition off and attempt to restart the engine. Have your vehicle checked as soon as possible.

# Starting and Stopping the Engine

---

## STARTING AND STOPPING THE ENGINE – INFORMATION MESSAGES

Message	Action
Cranking Time Exceeded	Displays if you exceed the starting time limit. You cannot attempt to start the engine for 15 minutes. If you cannot start the engine after 15 minutes passes, have your vehicle immediately checked.
Starting System Fault	Displays if you are unable to start your vehicle with a correctly coded key. The system has detected a fault that requires service. Have your vehicle checked as soon as possible.
No Key Detected	Displays if the system does not detect a valid passive key.

# Starting and Stopping the Engine

## STARTING AND STOPPING THE ENGINE – FREQUENTLY ASKED QUESTIONS

### Why is the engine idle speed high when I am starting the engine?

The speed at which the engine idles immediately after starting is optimized to minimize vehicle emissions and maximize cabin comfort and fuel economy.

### Why does the engine not crank?

You can only attempt to start the engine for a limited amount of time before the starting system temporarily disables. If you exceed the starting time limit, a message may appear and you cannot attempt to start the engine for at least 15 minutes.

### Why do I experience different driving characteristics?

If you disconnect the battery, your vehicle may exhibit some unusual driving characteristics for approximately 5 mi (8 km) after you reconnect it. This is because the engine management system must realign itself with the engine. You can disregard any unusual driving characteristics during this period.

### Why can I not start the engine?

If you cannot start the engine after 3 attempts, wait 10 seconds and do the following:

1. Fully press the brake pedal.

**Note:** Make sure that the parking brake is applied.

**Note:** Make sure that the transmission is in park (P) or neutral (N).

2. Fully press the accelerator pedal and hold it there.
3. Press the push button ignition switch.

**Note:** The engine cranks for a short period of time and then it stops.

4. Release the accelerator pedal.



5. Press the push button ignition switch.

### Why does the system not detect a passive key?

If the system does not detect a passive key and you are unable to start the engine, insert the passive key into the backup position and press the push button ignition switch to start the engine. See **Accessing the Passive Key Backup Position** (page 194).

# Auto-Start-Stop

## WHAT IS AUTO-START-STOP

The system is designed to help reduce fuel consumption and CO<sub>2</sub> emissions by stopping the engine when it is idling, for example at traffic lights.

## AUTO-START-STOP PRECAUTIONS

 **WARNING:** Apply the parking brake, shift into park (P), switch the ignition off and remove the key before you leave your vehicle. Failure to follow this instruction could result in personal injury or death.

 **WARNING:** Apply the parking brake, shift into park (P), switch the ignition off and remove the key before you open the hood or have any service or repair work completed. If you do not switch the ignition off, the engine could restart at any time. Failure to follow this instruction could result in personal injury or death.

## SWITCHING AUTO-START-STOP ON AND OFF

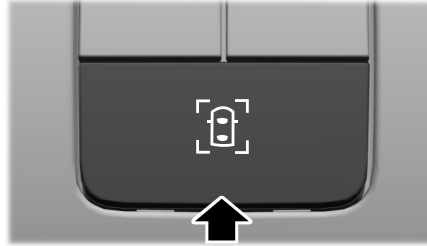

Press the driver assistance button on the instrument panel to access the Auto-Start-Stop feature on the touchscreen. Use the touchscreen to deactivate the feature. Deactivating the feature lasts only one key cycle. Use the touchscreen to restore Auto-Start-Stop function.

## STOPPING THE ENGINE

Stop your vehicle, keep your foot on the brake pedal and the transmission in drive (D).

**Note:** *Power assist steering turns off when the engine stops.*

## RESTARTING THE ENGINE

Release the brake pedal or press the accelerator pedal.

A message appears in the information display if the system requires you to take action.

## AUTO-START-STOP INDICATORS

 **WARNING:** The system may require the engine to automatically restart when the auto-start-stop indicator illuminates green or flashes amber. Failure to follow this instruction could result in personal injury.

# Auto-Start-Stop



The Auto-Start-Stop indicator illuminates green when the engine stops. It flashes amber and a message appears when you need to take action.



The Auto-Start-Stop indicator illuminates gray with a strikethrough when the system is not available.

**Note:** You can display the reason why the system is not available in the information display.

## AUTO-START-STOP – TROUBLESHOOTING

## AUTO-START-STOP – INFORMATION MESSAGES

A message appears in the information display if the system requires you to take action.

Message	Condition	Action
Auto StartStop Press Brake to Start Engine	The system needs to restart the engine but requires your confirmation.	Press the brake pedal to restart the engine.
Auto StartStop Press a Pedal to Start Engine	The system needs to restart the engine but requires your confirmation.	Press the brake pedal or the accelerator pedal to restart the engine.

# Auto-Start-Stop

---

## **AUTO-START-STOP – FREQUENTLY ASKED QUESTIONS**

### **Why does the engine not always stop when I expect it to?**

The system is designed to work in a way that complements other vehicle systems, allowing them to operate at optimum performance.

The system does not stop the engine if:

- The driver door is open.
- Your vehicle is at high altitude.
- The heated windshield is on.
- The engine is warming up.
- The outside temperature is too low or too high.
- The battery charge is low.
- The battery temperature is outside the optimal operating range.
- The engine is required to run to maintain interior climate and reduce fogging.

### **Why does the engine sometimes restart when I do not expect it to?**

The system is designed to work in a way that complements other vehicle systems, allowing them to operate at optimum performance.

The system restarts the engine if:

- You switch the heated windshield on.
- You switch maximum defrost on.
- Your vehicle starts to roll downhill in neutral.
- The engine is required to run to maintain adequate brake system assistance.
- The engine is required to run to maintain interior climate and reduce fogging.

### **Can I permanently switch the system off?**

No. The system plays an important role in reducing the fuel consumption and the CO<sub>2</sub> emissions.

### **Will the frequent engine starts cause parts to wear out?**

Your vehicle has an enhanced battery and starter motor that are designed for the increased number of engine starts.



# Fuel and Refueling

## FUEL AND REFUELING PRECAUTIONS



**WARNING:** Do not overfill the fuel tank. The pressure in an overfilled tank may cause leakage and lead to fuel spray and fire.



**WARNING:** The fuel system may be under pressure. If you hear a hissing sound near the fuel filler inlet, do not refuel until the sound stops. Otherwise, fuel may spray out, which could cause serious personal injury.



**WARNING:** Fuels can cause serious injury or death if misused or mishandled.



**WARNING:** Fuel may contain benzene, which is a cancer-causing agent.



**WARNING:** When refueling always shut the engine off and never allow sparks or open flames near the fuel tank filler valve. Never smoke or use a cell phone while refueling. Fuel vapor is extremely hazardous under certain conditions. Avoid inhaling excess fumes.



**WARNING:** Read and follow all the instructions on the pump island.

Follow these guidelines when refueling:

- Extinguish all smoking materials and any open flames before refueling your vehicle.
- Switch the engine off before refueling.
- Automotive fuels can be harmful or fatal if swallowed. Fuel is highly toxic and if swallowed can cause death or permanent injury. If fuel is swallowed immediately call a physician, even if no symptoms are immediately apparent. The toxic effects of fuel may not be apparent for hours.

- Avoid inhaling fuel vapors. Inhaling fuel vapor can lead to eye and respiratory tract irritation. In severe cases, excessive or prolonged breathing of fuel vapor can cause serious illness and permanent injury.
- Avoid getting fuel in your eyes. If you splash fuel in your eyes, immediately remove contact lenses, if worn, flush with water for 15 minutes and seek medical attention. Failure to seek proper medical attention could lead to permanent injury.
- Fuels can be harmful if absorbed through the skin. If you splash fuel on your skin, clothing or both, promptly remove contaminated clothing and thoroughly wash your skin with soap and water. Repeated or prolonged skin contact causes skin irritation.
- Be particularly careful if you are taking Antabuse or other forms of Disulfiram for the treatment of alcoholism. Breathing fuel vapors could cause an adverse reaction, serious personal injury or sickness. Immediately call a physician if you experience any adverse reactions.

# Fuel and Refueling

## FUEL QUALITY

### SELECTING THE CORRECT FUEL

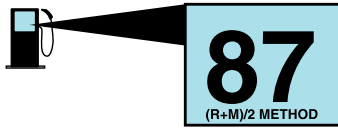

Your vehicle operates on regular unleaded gasoline with a minimum pump (R+M)/2 octane rating of 87.

Some fuel stations, particularly those in high altitude areas, offer fuels posted as regular unleaded gasoline with an octane rating below 87. The use of these fuels could result in engine damage that will not be covered by the vehicle Warranty.

For best overall vehicle and engine performance, premium fuel with an octane rating of 91 or higher is recommended. The performance gained by using premium fuel is most noticeable in hot weather as well as other conditions, for example when towing a trailer. See **Towing a Trailer** (page 304).

Do not be concerned if the engine sometimes knocks lightly. However, if the engine knocks heavily while using fuel with the recommended octane rating, contact an authorized dealer to prevent any engine damage.

We recommend Top Tier detergent gasolines, where available to help minimize engine deposits and maintain optimal vehicle and engine performance.

For additional information, visit [www.toptiergas.com](http://www.toptiergas.com).

**Note:** *Use of any fuel for which the vehicle was not designed can impair the emission control system, cause loss of vehicle performance, and cause damage to the engine which may not be covered by the vehicle Warranty.*

Do not use:

- Diesel fuel.
- Fuels containing kerosene or paraffin.
- Fuel containing more than 15% ethanol or E85 fuel.
- Fuels containing methanol.
- Fuels containing metallic-based additives, including manganese-based compounds.
- Fuels containing the octane booster additive, methylcyclopentadienyl manganese tricarbonyl (MMT).
- Leaded fuel, using leaded fuel is prohibited by law.

The use of fuels with metallic compounds such as methylcyclopentadienyl manganese tricarbonyl, which is a manganese-based fuel additive, will impair engine performance and affect the emission control system.

## LOCATING THE FUEL FILLER FUNNEL

The fuel filler funnel is under the luggage compartment floor covering.

# Fuel and Refueling

## RUNNING OUT OF FUEL

### FILLING A PORTABLE FUEL CONTAINER

 **WARNING:** Flow of fuel through a fuel pump nozzle can produce static electricity. This can cause a fire if you are filling an ungrounded fuel container.

Use the following guidelines to avoid electrostatic charge build-up, which can produce a spark, when filling an ungrounded fuel container:

- Only use an approved fuel container to transfer fuel to your vehicle. Place the container on the ground when filling it.
- Do not fill a fuel container when it is inside your vehicle (including the cargo area).
- Keep the fuel pump nozzle in contact with the fuel container when filling it.
- Do not use a device that holds the fuel pump nozzle lever in the fill position.

### ADDING FUEL FROM A PORTABLE FUEL CONTAINER

 **WARNING:** Do not insert the nozzle of a fuel container or an aftermarket funnel into the fuel filler neck. This may damage the fuel system filler neck or its seal and cause fuel to run onto the ground.

 **WARNING:** Do not pry open the fuel tank filler valve. This could damage the fuel system. Failure to follow this instruction could result in fire, personal injury or death.

 **WARNING:** Do not dispose of fuel in the household refuse or the public sewage system. Use an authorized waste disposal facility.

When refueling the vehicle fuel tank from a fuel container, use the fuel filler funnel included with your vehicle. See **Locating the Fuel Filler Funnel** (page 202).

**Note:** *Do not use aftermarket funnels as they may not work with the capless fuel system and can damage it.*

When refueling the vehicle fuel tank from a fuel container, do the following:

1. Fully open the fuel filler door.



2. Fully insert the fuel filler funnel into the fuel filler inlet.
3. Add fuel to your vehicle from the fuel container.
4. Remove the fuel filler funnel.
5. Fully close the fuel filler door.

# Fuel and Refueling

- Clean the fuel filler funnel and place it back in your vehicle or correctly dispose of it.

**Note:** If your vehicle runs out of fuel add a minimum of 1.3 gal (5 L) of fuel to restart the engine.

**Note:** You may need to switch the ignition from off to on several times after refueling to allow the fuel system to pump the fuel from the tank to the engine. When restarting, cranking time takes a few seconds longer than normal.

**Note:** Extra funnels can be purchased from an authorized dealer if you choose to dispose of the funnel.

## REFUELING

### REFUELING SYSTEM OVERVIEW

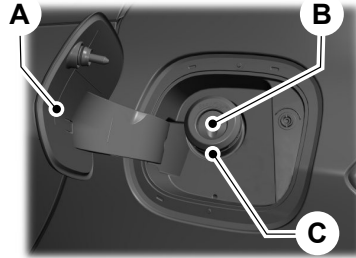

- A Fuel filler door.
- B Fuel filler inlet.
- C Fuel tank filler pipe.

## REFUELING YOUR VEHICLE

**WARNING:** When refueling always shut the engine off and never allow sparks or open flames near the fuel tank filler valve. Never smoke or use a cell phone while refueling. Fuel vapor is extremely hazardous under certain conditions. Avoid inhaling excess fumes.

**WARNING:** The fuel system may be under pressure. If you hear a hissing sound near the fuel filler inlet, do not refuel until the sound stops. Otherwise, fuel may spray out, which could cause serious personal injury.

**WARNING:** Do not pry open the fuel tank filler valve. This could damage the fuel system. Failure to follow this instruction could result in fire, personal injury or death.

**WARNING:** Do not remove the fuel pump nozzle from its fully inserted position when refueling.

# Fuel and Refueling

**⚠ WARNING:** Stop refueling when the fuel pump nozzle automatically shuts off for the first time. Failure to follow this will fill the expansion space in the fuel tank and could lead to fuel overflowing.

**⚠ WARNING:** Do not overfill the fuel tank. The pressure in an overfilled tank may cause leakage and lead to fuel spray and fire.

**⚠ WARNING:** Wait at least five seconds before removing the fuel pump nozzle to allow any residual fuel to drain into the fuel tank.

1. Fully open the fuel filler door.
2. Select the correct fuel pump nozzle for your vehicle.

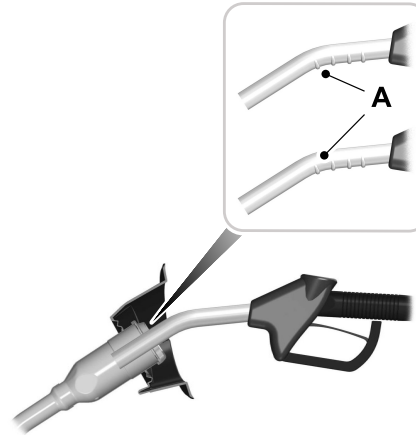

3. Insert the fuel pump nozzle up to the first notch. Keep the fuel pump nozzle resting on the fuel tank filler pipe.

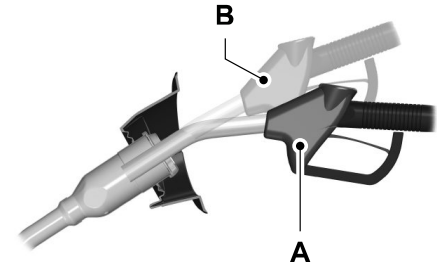

4. Hold the fuel pump nozzle in position A when refueling. Holding the fuel pump nozzle in position B can affect the flow of fuel and shut off the fuel pump nozzle before the fuel tank is full.

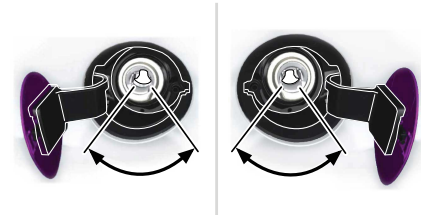

5. Operate the fuel pump nozzle within the area shown.

# Fuel and Refueling

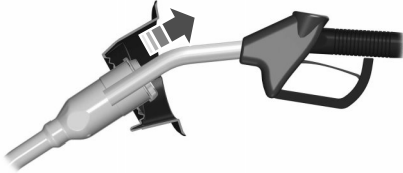

- When the pump shuts off, wait five seconds, then raise the fuel pump nozzle and slowly remove it.
- Fully close the fuel filler door.

**Note:** Do not attempt to start the engine if you have filled the fuel tank with incorrect fuel. Incorrect fuel use could cause damage not covered by the vehicle Warranty. Have your vehicle immediately checked.

## MANUALLY OPENING THE FUEL FILLER DOOR

Your vehicle does not have a fuel tank filler cap.

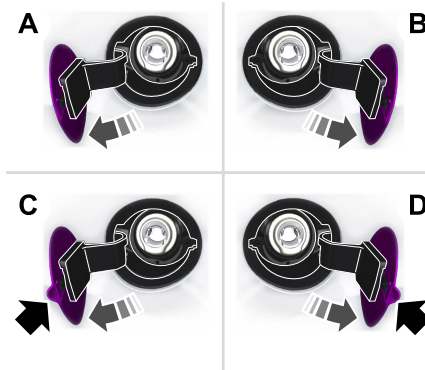

- A Left-hand side. To open the fuel filler door, press the center rear edge of the fuel filler door and then release.
- B Right-hand side. To open the fuel filler door, press the center rear edge of the fuel filler door and then release.

- C Left-hand side. Pull the rear of the fuel filler door to open it.
- D Right-hand side. Pull the rear of the fuel filler door to open it.

## FUEL TANK CAPACITY

### Advertised Capacity

The advertised capacity is the maximum amount of fuel that you can add to the fuel tank after running out of fuel. Included in the advertised capacity is an empty reserve. The empty reserve is an unspecified amount of fuel that remains in the fuel tank when the fuel gauge indicates empty.

**Note:** The amount of fuel in the empty reserve varies and should not be relied upon to increase driving range.

# Fuel and Refueling

## FUEL AND REFUELING – TROUBLESHOOTING

### FUEL AND REFUELING – WARNING LAMPS



If it illuminates when you are driving, refuel as soon as possible.

### FUEL AND REFUELING – INFORMATION MESSAGES

#### Refueling System Warning

If the fuel tank filler valve does not fully close, a message could appear in the information display.

Message
Check Fuel Fill Inlet

If the message appears, do the following:

1. Stop your vehicle as soon as it is safe to do so and switch the engine off.
2. Shift into park (P) or neutral (N).

3. Apply the parking brake.
4. Fully open the fuel filler door.
5. Check the fuel tank filler valve for any debris that may be restricting its movement.
6. Remove any debris from the fuel tank filler valve.
7. Fully insert a fuel pump nozzle or the fuel filler funnel provided with your vehicle into the fuel filler pipe. See **Locating the Fuel Filler Funnel** (page 202). This action should dislodge any debris that may be preventing the fuel tank filler valve from fully closing.
8. Remove the fuel pump nozzle or fuel filler funnel from the fuel filler pipe.
9. Fully close the fuel filler door.

**Note:** *The message may not immediately reset. If the message continues to appear and a warning lamp illuminates, have your vehicle checked as soon as possible.*

# Catalytic Converter

## WHAT IS THE CATALYTIC CONVERTER

The catalytic converter is part of your vehicle's emissions system and filters harmful pollutants from the exhaust gas.

## CATALYTIC CONVERTER PRECAUTIONS



**WARNING:** Do not park, idle or drive your vehicle on dry grass or other dry ground cover. The emission system heats up the engine compartment and exhaust system, creating the risk of fire.



**WARNING:** The normal operating temperature of the exhaust system is very high. Never work around or attempt to repair any part of the exhaust system until it has cooled. Use special care when working around the catalytic converter. The catalytic converter heats up to a very high temperature after only a short period of engine operation and stays hot after the engine is switched off.



**WARNING:** Exhaust leaks may result in entry of harmful and potentially lethal fumes into the passenger compartment. If you smell exhaust fumes inside your vehicle, have your vehicle inspected immediately. Do not drive if you smell exhaust fumes.

To avoid damaging the catalytic converter:

- Do not crank the engine for more than 10 seconds at a time.
- Do not run the engine with a spark plug lead disconnected.

- Do not push-start or tow-start your vehicle. Use booster cables. See **Jump Starting Precautions** (page 316).
- Use the correct fuel. See **Fuel and Refueling** (page 201).
- Do not switch the ignition off when your vehicle is moving.
- Avoid running out of fuel.
- Have the items listed in scheduled maintenance information performed according to the specified schedule.

**Note:** *Do not make any unauthorized changes to your vehicle or engine. By law, vehicle owners and anyone who manufactures, repairs, or services a fleet of vehicles are not permitted to intentionally remove an emission control device or prevent it from working.*



# Catalytic Converter

---

## CATALYTIC CONVERTER – TROUBLESHOOTING

### CATALYTIC CONVERTER – WARNING LAMPS

Your vehicle has an on-board diagnostics system that monitors the emission control system. If any of the following warning lamps illuminate, this may indicate that the on-board diagnostics system has detected an emission control system malfunction.



Continuing to drive your vehicle may cause reduced power or the engine to stop. Failure to respond to a warning lamp may cause damage that your vehicle Warranty may not cover. Have your vehicle checked as soon as possible.

# Automatic Transmission

## AUTOMATIC TRANSMISSION PRECAUTIONS



**WARNING:** Always fully apply the parking brake and make sure you shift into park (P). Failure to follow this instruction could result in personal injury or death.



**WARNING:** Do not apply the brake pedal and accelerator pedal simultaneously. Applying both pedals simultaneously for more than a few seconds will limit engine performance, which may result in difficulty maintaining speed in traffic and could lead to serious injury.



**WARNING:** When your vehicle is stationary, keep the brake pedal fully pressed when shifting gears. Failure to follow this instruction could result in personal injury, death or property damage.

**Note:** Do not use supplemental transmission fluid additives, treatments, or cleaning agents. Failure to follow this instruction could result in vehicle damage not covered by the vehicle warranty.

## AUTOMATIC TRANSMISSION POSITIONS

### PARK (P)



**WARNING:** Move the transmission selector lever to park (P) only when your vehicle is stationary.

This position locks the driveline. Come to a complete stop before shifting into and out of park (P).

The electric parking brake could apply when you shift to park (P) without the brake pedal fully pressed. The electric parking brake applies when you shift to park (P) on large slopes. The electric parking brake releases with the drive away release function. See **Electric Parking Brake** (page 223).

**Note:** A tone sounds if you attempt to exit your vehicle without the transmission in park (P).

**Note:** Your vehicle may not shift out of park (P) if the vehicle battery has run out of charge. See **Jump Starting the Vehicle** (page 316).

**Note:** Your vehicle may not shift out of park (P) if a fuse is blown. See **Fuses** (page 323).

**Note:** Your vehicle may not shift out of park (P) unless the key or remote control is inside your vehicle.

**Note:** Your vehicle shifts into park (P) if you attempt to exit your vehicle without the transmission in park (P). See **How Does Automatic Return to Park (P) Work** (page 213).

**Note:** If you shift into park (P) without fully pressing the brake, the parking brake could apply. If you shift into park (P) on a slope, the parking brake could apply. See **Automatically Releasing the Electric Parking Brake** (page 224).

**Note:** You can start your vehicle in this position.

# Automatic Transmission

**Note:** A tone could sound when you select park (P).

## REVERSE (R)



**WARNING:** Shift into reverse (R) only when your vehicle is stationary.

In reverse (R) power is transmitted to the driven wheels.

## NEUTRAL (N)



**WARNING:** In neutral (N) your vehicle is free to roll.

In neutral (N) power is not transmitted to the driven wheels.

## DRIVE (D)

In drive (D) power is transmitted to the driven wheels.

## SPORT (S)

Putting the vehicle in sport (S):

- Provides additional engine braking and extends lower gear operation to enhance performance for uphill climbs, hilly terrain or mountainous areas. This increases engine RPM during engine braking.
- Provides additional lower gear operation through the automatic transmission shift strategy.
- Provides gear selection more quickly and at higher engine speeds.

**Note:** You can shift into sport at any vehicle speed.

## SHIFTING YOUR VEHICLE INTO GEAR

The transmission selector is located near the middle of the instrument panel. Press a button to select a position.



- Park (P)
- Reverse (R)
- Neutral (N)
- Drive (D)
- Sport (S) (If equipped)

## AUTOMATIC TRANSMISSION POSITION INDICATORS

The instrument cluster displays the current position.



**Note:** The position could illuminate on the transmission selector.

# Automatic Transmission

## MANUALLY SHIFTING GEARS (IF EQUIPPED)

### SHIFTING USING THE PADDLE SHIFTERS

The instrument cluster displays the current gear. The current gear flashes when your vehicle cannot shift into the requested gear. Your vehicle will not shift if the requested gear raises or lowers the engine speed beyond the limit.

Your vehicle could shift when you fully press the accelerator or brake pedal.

**Note:** *Prolonged driving with high engine speed could cause vehicle damage not covered by vehicle warranty.*

**Note:** *Drive modes could affect when the vehicle shifts into the requested gear.*



### Manually Shifting in Drive (D)

Use this feature when overtaking another vehicle, or to temporarily change gear.

- Pull any paddle to switch the feature on.
- Pull the right (+) paddle to upshift.
- Pull the left (-) paddle to downshift.
- Hold the (+) paddle for a few seconds to switch the feature off.

**Note:** *The feature switches off after a short period of time if neither paddle is pulled.*

### Manually Shifting in Sport (S)

Use this feature for engine braking on hilly or mountainous roads, or to select a specific gear.

- Pull any paddle to switch the feature on.
- Pull the right (+) paddle to upshift.
- Pull the left (-) paddle to downshift.
- Hold the (+) paddle for a few seconds to switch the feature off.

## TEMPORARY NEUTRAL MODE

### WHAT IS TEMPORARY NEUTRAL MODE

This mode keeps your vehicle in neutral (N), for a limited time, when you exit your vehicle or switch your vehicle off.

**Note:** *Do not tow your vehicle in this mode.*

### TEMPORARY NEUTRAL MODE LIMITATIONS

Your vehicle could shift to park (P) after 30 minutes, or when the vehicle battery charge level is low. Prolonged use of this mode can cause the vehicle battery to run out of charge.

# Automatic Transmission

---

Do not tow your vehicle in this mode. Failure to follow these instructions could result in vehicle damage not covered by the vehicle warranty.

## ENTERING TEMPORARY NEUTRAL MODE

1. Power your vehicle on.
2. Bring your vehicle to a complete stop.
3. Press and hold the brake pedal.
4. Shift into neutral (N).

**Note:** *An instructional message appears.*

5. Press the neutral (N) button.

**Note:** *A confirmation message appears when your vehicle enters the mode.*

6. Release the brake pedal.

**Note:** *Your vehicle is free to roll.*

7. Switch your vehicle off.

**Note:** *Do not tow your vehicle in this mode.*

**Note:** *The neutral (N) indicator on the transmission selector may flash in this mode.*

## EXITING TEMPORARY NEUTRAL MODE

1. Press the brake pedal.
2. Shift into park (P), or power your vehicle on and shift into drive (D) or reverse (R).

## AUTOMATIC RETURN TO PARK (P)

### WHAT IS AUTOMATIC RETURN TO PARK (P)

Your vehicle shifts into park (P) if you attempt to exit your vehicle without the transmission in park (P).

## HOW DOES AUTOMATIC RETURN TO PARK (P) WORK

Your vehicle shifts into park (P) when your vehicle is stationary and any of the following occur:

- You switch the vehicle off.
- You open the driver door with your seatbelt unlatched.
- You unlatch the driver seatbelt when the driver door is open.

**Note:** *Do not use automatic return to park (P) when your vehicle is moving, except in an emergency. See **Stopping the Engine When Your Vehicle is Moving** (page 193).*

## AUTOMATIC RETURN TO PARK (P) LIMITATIONS

Automatic return to park may not work if the door ajar switch is malfunctioning.

See an authorized dealer if any of the following occur:

# Automatic Transmission

- Door ajar indicator does not illuminate with the driver door open.
- Door ajar indicator illuminates with the driver door closed.
- Transmission not in park message appears with the driver door closed, after you shift out of park (P).

## MANUAL PARK RELEASE

### WHAT IS MANUAL PARK RELEASE

Manual park release allows you to move your transmission out of the park (P) position in the event of an electrical malfunction or emergency.

### MANUAL PARK RELEASE PRECAUTIONS



**WARNING:** When doing this procedure, you need to take the transmission out of park (P) which means your vehicle can roll freely. To avoid unwanted vehicle movement, always fully apply the parking brake prior to doing this procedure. Use wheels chocks if appropriate.



**WARNING:** If the parking brake is fully released, but the brake warning lamp remains illuminated, the brakes may not be working properly. Have your vehicle checked as soon as possible.



**WARNING:** Do not drive your vehicle until you verify that the stoplamps are working.

### USING MANUAL PARK RELEASE

#### Activating the Manual Park Release Cable

1. Apply the parking brake. See **Electric Parking Brake** (page 223).

**Note:** *If vehicle battery has run out of charge, use an external power source to apply the parking brake.*

2. Remove the access cover. The cover is located under the dash below the steering wheel. Do not pull the tether.

# Automatic Transmission

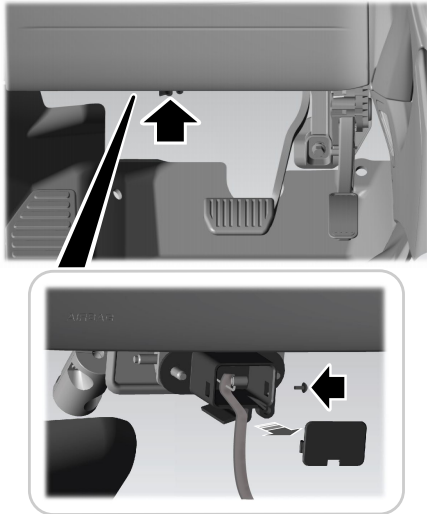

3. Sit in the drivers seat.
4. Switch the ignition on.

**Note:** Do not activate manual park release when the engine is started.

5. Press and hold the brake pedal. Do not release.

6. Pull the tether outward toward you. Move the tether to the lower right-hand corner and seat the metal bead in the pocket.

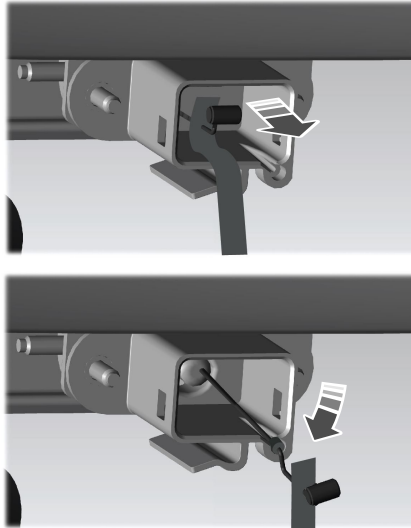

**Note:** A message appears in the information display when your vehicle is out of park (P). If you do not receive a message, release the tether and start the procedure again.

7. Release the parking brake. See **Electric Parking Brake** (page 223).

**Note:** Your vehicle is free to roll.

8. Switch the ignition off.
9. Disconnect the negative battery cable from the battery.

**Note:** If the vehicle detects wheel movement before the battery is disconnected, the electric parking brake could apply.

## Returning Your Vehicle to Normal Mode

1. Reconnect the negative battery cable to the battery.

2. Apply the parking brake.

**Note:** If the vehicle battery has run out of charge, use an external power source to apply the parking brake.

**Note:** If the vehicle detects wheel movement, the electric parking brake could apply.

3. Sit in the drivers seat.
4. Press and hold the brake pedal. Do not release.

# Automatic Transmission

5. Pull the tether outward toward you. Move tether left and into the stowed position.
6. Start your vehicle. Confirm the instrument cluster displays park (P).

**Note:** *If the instrument cluster does not display park (P) or if Park Not Available, Transmission Not In Park or Shift System Fault message appears in the information display, contact an authorized dealer for service. Switch the ignition off and apply the parking brake before you leave your vehicle.*

7. Reinstall the access cover.

## AUTOMATIC TRANSMISSION AUDIBLE WARNINGS

### Transmission Not In Park (P) Audible Warning

Sounds if you open the driver door before shifting into park (P).

### Park (P) Selection Audible Warning

Sounds when you shift into park (P).

## AUTOMATIC TRANSMISSION – TROUBLESHOOTING

## AUTOMATIC TRANSMISSION – INFORMATION MESSAGES

Shift to Park	You switched the engine off and shift select lever is in any position other than park (P).
Transmission Warming Up Please Wait	Transmission is too cold. Wait for it to warm up before you drive.
Transmission Over Temperature Stop Safely	The transmission is overheating and needs to cool. Stop in a safe place as soon as it's possible.
Transmission Service Required	Have system checked as soon as possible.

Transmission Too Hot Press Brake	The transmission is overheating and needs to cool. Stop in a safe place as soon as it's possible.
Transmission Limited Function See Manual	The transmission has limited functionality. Have system checked as soon as possible.
Transmission Not in Park	A reminder to shift into park. In addition, this message is typical after reconnecting or recharging the battery until you cycle the ignition to the on mode. See <b>Changing the 12V Battery</b> (page 353).



## Automatic Transmission

SHIFT SYS FAULT Confirm Park Brake Apply Before Exiting the Vehicle	Displays when the system requires service. Have your vehicle checked as soon as possible.
SHIFT SYS FAULT Service Required	Have system checked as soon as possible.
SHIFT SYS FAULT Vehicle is Shifting to Park	Displays when the system requires service. Have your vehicle checked as soon as possible.
SHIFT SYS FAULT Reverse Unavailable Service Required	Displays when the system requires service. Have your vehicle checked as soon as possible.
SHIFT SYS FAULT Drive Unavailable Select S for Drive Service Required	Have system checked as soon as possible.

SHIFT SYS FAULT Neutral Unavailable Service Required	Have system checked as soon as possible.
SHIFT SYS FAULT Sport Unavailable Service Required	Have system checked as soon as possible.
Invalid Gear Selection	Displays when an invalid gear has been selected.
Depress Brake to Shift from Park	Displays when the brake pedal needs to be depressed to enable the transmission to shift from park.
Stay in Neutral Mode Engaged	Displays when neutral hold is active.
To Stay in Neutral When Exiting Vehicle Select N Again	Displays when the neutral button N needs to be pressed again to enter neutral hold.

## All-Wheel Drive (If Equipped)

---

### HOW DOES ALL-WHEEL DRIVE WORK

All-wheel drive uses all four wheels to power the vehicle. This increases traction, enabling you to drive over terrain and road conditions that a conventional two-wheel drive vehicle cannot. The AWD system turns on when needed and does not require input from you.

There is further information on driving in unique driving conditions. See **Driving Hints** (page 310).

### ALL-WHEEL DRIVE PRECAUTIONS

 **WARNING:** Do not become overconfident in the ability of all-wheel drive vehicles. Although an all-wheel drive vehicle may accelerate better than a two-wheel drive vehicle in low traction situations, it won't stop any faster than two-wheel drive vehicles. Always drive at a safe speed.

### ALL-WHEEL DRIVE LIMITATIONS

Using different size tires other than the provided spare could cause system damage or disable the all-wheel drive system.

## All-Wheel Drive (If Equipped)

---

### ALL-WHEEL DRIVE – TROUBLESHOOTING

### ALL-WHEEL DRIVE – INFORMATION MESSAGES

<b>Message</b>	<b>Action</b>
AWD Temporarily Disabled	The all-wheel drive system temporarily turns off to protect itself from overheating.
AWD Restored	The all-wheel drive system will resume normal function and clear this message after driving a short distance with the road tire re-installed or after the system cools.
AWD OFF	The all-wheel drive system temporarily turns off to protect itself from overheating or if you are using the temporary spare tire.
AWD Malfunction Service Required	The all-wheel drive system is not operating properly. If the warning stays on or continues to come on, contact an authorized dealer.

# Brakes

## BRAKE PRECAUTIONS



**WARNING:** Driving your vehicle with the warning lamp on is dangerous. A significant decrease in braking performance may occur. It may take you longer to stop your vehicle. Have your vehicle checked as soon as possible. Driving extended distances with the parking brake engaged can cause brake failure and the risk of personal injury.

Wet brakes result in reduced braking efficiency. Gently press the brake pedal a few times when leaving a car wash or driving from standing water to dry the brakes.

**Note:** Depending on applicable laws and regulations in the country for which your vehicle was originally built, the stoplamps could flash during heavy braking. Following this the hazard warning flashers could also turn on when your vehicle comes to a stop.

## ANTI-LOCK BRAKING SYSTEM

### ANTI-LOCK BRAKING SYSTEM LIMITATIONS

The anti-lock braking system does not eliminate the risk of crash when:

- You drive too closely to the vehicle in front of you.
- Your vehicle is hydroplaning.
- You take corners too fast.
- The road surface is poor.

**Note:** If the system activates, the brake pedal could pulse and travel further. Maintain pressure on the brake pedal.

### BRAKE OVER ACCELERATOR

In the event the accelerator pedal becomes stuck or entrapped, apply steady and firm pressure to the brake pedal to slow the vehicle and reduce engine power. If you experience this condition, apply the brakes and bring your vehicle to a safe stop. Move

the transmission to park (P), switch the engine off and apply the parking brake. Inspect the accelerator pedal for any interference. If none are found and the condition persists, have your vehicle towed to the nearest authorized dealer.

## LOCATING THE BRAKE FLUID RESERVOIR

See **Under Hood Overview** (page 341).

## CHECKING THE BRAKE FLUID



**WARNING:** Do not use any fluid other than the recommended brake fluid as this will reduce brake efficiency. Use of incorrect fluid could result in the loss of vehicle control, serious personal injury or death.

# Brakes

 **WARNING:** Only use brake fluid from a sealed container. Contamination with dirt, water, petroleum products or other materials may result in brake system damage or failure. Failure to adhere to this warning could result in the loss of vehicle control, serious personal injury or death.

 **WARNING:** Do not allow the fluid to touch your skin or eyes. If this happens, rinse the affected areas immediately with plenty of water and contact your physician.

 **WARNING:** The brake system could be affected if the brake fluid level is below the **MIN** mark or above the **MAX** mark on the brake fluid reservoir.



1. Park your vehicle on a level surface.
2. Look at the brake fluid reservoir to see where the brake fluid level is relative to the **MIN** and the **MAX** marks on the reservoir.

**Note:** *To avoid fluid contamination, the reservoir cap must remain in place and fully tight, unless you are adding fluid.*

Only use fluid that meets our specifications. See **Capacities and Specifications** (page 404).

## BRAKE FLUID SPECIFICATION

See **Brake Fluid Specification** (page 420).

## BRAKES – TROUBLESHOOTING

### BRAKES – WARNING LAMPS



If the ABS indicator illuminates when you are driving, this indicates a malfunction. Your vehicle continues to have normal braking without the anti-lock braking system function. See an authorized dealer.

It also momentarily illuminates when you switch the ignition on to confirm the lamp is functional. If it does not illuminate when you switch the ignition on, or begins to flash at any time, have the system checked by an authorized dealer.

# Brakes

## BRAKE



The brake indicator momentarily illuminates when you switch the ignition on to confirm the lamp is functional. It may also illuminate when you apply the parking brake and the ignition is on. If it illuminates when your vehicle is moving, make sure the parking brake is disengaged. If the parking brake is disengaged, this indicates low brake fluid level or a brake system fault. See an authorized dealer.

## BRAKES – INFORMATION MESSAGES

Brake Fluid Level Low	The brake fluid level is low and the brake system should be inspected immediately. See <b>Checking the Brake Fluid</b> (page 220).
Check Brake System	The brake system needs servicing. Stop the vehicle in a safe place. Contact an authorized dealer.

## BRAKES – FREQUENTLY ASKED QUESTIONS

### Is brake dust on the wheels normal?

Brake dust could accumulate on the wheels, even under normal driving conditions. Some dust is inevitable as the brakes wear and does not contribute to brake noise. See **Cleaning Wheels** (page 364).

### Will wet driving conditions effect my braking abilities?

Wet brakes result in reduced braking efficiency. Gently press the brake pedal a few times when driving from a car wash or standing water to dry the brakes.

### Is brake noise considered normal?

Occasional brake noise is normal. If a metal-to-metal, continuous grinding or continuous squeal sound is present, the brake linings may be worn-out and an authorized dealer should check them. If the vehicle has continuous vibration or shudder in the steering wheel while braking, an authorized dealer should check your vehicle.

### When should you replace the brake fluid?

Brake fluid absorbs water over time which degrades the effectiveness of the brake fluid. Change the brake fluid at the specified intervals to prevent degraded braking performance. See **Normal Scheduled Maintenance** (page 467).

# Electric Parking Brake

## WHAT IS THE ELECTRIC PARKING BRAKE

The electric parking brake is used to hold your vehicle on slopes and flat roads.

## APPLYING THE ELECTRIC PARKING BRAKE



**WARNING:** Always fully apply the parking brake and make sure you shift into park (P). Failure to follow this instruction could result in personal injury or death.



**WARNING:** If you drive extended distances with the parking brake applied, you could cause damage to the brake system.



The switch is on the lower part of the instrument panel.

1. Pull the switch up.

The red warning lamp flashes during operation and illuminates when the parking brake is applied.

**Note:** You can apply the electric parking brake when the ignition is off.

**Note:** The electric parking brake could apply when the transmission selector is in park (P). See **Park (P)** (page 210).

## APPLYING THE ELECTRIC PARKING BRAKE IN AN EMERGENCY

You can use the electric parking brake to slow or stop your vehicle in an emergency.

1. Pull the switch up and hold it.

The electric parking brake continues to slow your vehicle down unless you release the switch.

The red warning lamp illuminates, a tone sounds and the stoplamps turn on when you use the electric parking brake in an emergency.

**Note:** Do not apply the electric parking brake when your vehicle is moving, except in an emergency. If you repeatedly use the electric parking brake to slow or stop your vehicle, you could cause damage to the brake system.

## MANUALLY RELEASING THE ELECTRIC PARKING BRAKE

1. Switch the ignition on.
2. Press and hold the brake pedal.
3. Push the switch down.

The red warning lamp turns off.

### Pulling Away on a Hill When Towing a Trailer

1. Press and hold the brake pedal.
2. Pull the switch upward and hold it.
3. Shift into gear.
4. Press the accelerator pedal until engine has developed sufficient torque to prevent your vehicle from rolling down the hill.

# Electric Parking Brake

5. Release the switch and pull away in a normal manner.

## AUTOMATICALLY RELEASING THE ELECTRIC PARKING BRAKE

1. Close the driver door.
2. Shift into gear.
3. Press the accelerator pedal and pull away in a normal manner.

## ELECTRIC PARKING BRAKE AUDIBLE WARNING

Sounds when the parking brake is on and your vehicle is moving. If the warning tone continues after you have released the parking brake, this indicates a malfunction. Have your vehicle checked as soon as possible.

## RELEASING THE ELECTRIC PARKING BRAKE IF THE VEHICLE BATTERY HAS RUN OUT OF CHARGE



**WARNING:** The electric parking brake does not operate if the vehicle battery has run out of charge.

Connect a booster battery to the vehicle battery to release the electric parking brake if the vehicle battery has run out of charge. See **Jump Starting the Vehicle** (page 317).

## ELECTRIC PARKING BRAKE – TROUBLESHOOTING

### ELECTRIC PARKING BRAKE – WARNING LAMPS

#### Brake System



It illuminates red when you apply the parking brake and your vehicle is on. If the lamp flashes when the parking brake has been released, this indicates the parking brake system requires service. Have your vehicle checked as soon as possible.

**Note:** *Lamps may vary depending on region.*

#### Electric Parking Brake



When the lamp illuminates yellow, it indicates a malfunction in the electric parking brake. Have your vehicle checked as soon as possible.



# Electric Parking Brake

## ELECTRIC PARKING BRAKE – INFORMATION MESSAGES

### Park Brake

Message	Action
Park Brake Engaged	The parking brake is set, the engine is running and you drive your vehicle more than 3 mph (5 km/h). If the warning stays on after the parking brake is released, contact an authorized dealer as soon as possible.
To Release: Press Brake and Switch	The electric parking brake is set and a manual release is attempted without the brake pedal being pressed.
Park Brake Use Switch to Release	The electric parking brake is set and an automatic release is attempted but cannot be performed. Perform a manual release.
Release Park Brake	The electric parking brake is set and your vehicle speed exceeds 3 mph (5 km/h). Release park brake before continued driving.
Park Brake Not Applied	The electric parking brake is not fully applied.
Park Brake Not Released	The electric parking brake is not fully released.
Park Brake Maintenance Mode	The electric parking brake system has been put into a special mode that is used to allow service of the rear brakes. Contact an authorized dealer.
Park Brake Limited Function Service Required	The electric park brake system has detected a condition that requires service. Some functionality may still be available. Contact your authorized dealer.
Park Brake Malfunction Service Now	The electric parking brake system has detected a condition that requires service. Contact your authorized dealer.

# Electric Parking Brake

---

<b>Message</b>	<b>Action</b>
Park Brake System Overheated	Numerous park brake applies have overheated the system. Wait 2 minutes before attempting to apply again.

# Hill Start Assist

## WHAT IS HILL START ASSIST

Hill Start Assist makes it easier for you to pull away when your vehicle is on a slope without using the parking brake.

## HOW DOES HILL START ASSIST WORK

When the system activates, your vehicle remains stationary for a few seconds after you release the brake pedal. This gives you time to move your foot from the brake pedal to the accelerator pedal. The brakes release when the engine has developed sufficient torque to prevent your vehicle from rolling down the slope.

## HILL START ASSIST PRECAUTIONS



**WARNING:** The system does not replace the parking brake. When you leave your vehicle, always apply the parking brake.



**WARNING:** You must remain in your vehicle when the system turns on. At all times, you are responsible for controlling your vehicle, supervising the system and intervening, if required. Failure to take care may result in the loss of control of your vehicle, serious personal injury or death.



**WARNING:** The system will turn off if a malfunction is apparent. Failure to take care may result in the loss of control of your vehicle, serious personal injury or death.

## HILL START ASSIST – TROUBLESHOOTING

## HILL START ASSIST – INFORMATION MESSAGES

Message	Action
Hill Start Assist Not Available	Displays when system is not available. Have your vehicle checked as soon as possible.

# Auto Hold

## HOW DOES AUTO HOLD WORK

Auto Hold applies the brakes to hold your vehicle after you stop it and release the brake pedal. This can help when waiting on a hill or in traffic.

## SWITCHING AUTO HOLD ON AND OFF



**WARNING:** The system does not replace the parking brake. When you leave your vehicle, always apply the parking brake.



**WARNING:** You must remain in your vehicle when the system turns on. At all times, you are responsible for controlling your vehicle, supervising the system and intervening, if required. Failure to take care may result in the loss of control of your vehicle, serious personal injury or death.



**WARNING:** The system will turn off if a malfunction is apparent. Failure to take care may result in the loss of control of your vehicle, serious personal injury or death.

Select the drive assist menu in the center display screen to switch auto hold on and off.

**Note:** You can only switch the system on after you close the driver door, fasten your seatbelt and start the engine.

**Note:** The system remembers the last setting when you start your vehicle.

Make sure you switch the system off before towing with your vehicle or before using an automatic car wash.

## USING AUTO HOLD

1. Bring your vehicle to a complete stop. The auto hold active indicator illuminates in the information display.

2. Release the brake pedal. The system holds your vehicle at a standstill. The auto hold active indicator remains illuminated in the information display.
3. Pull away in the normal manner. The system releases the brakes and the auto hold active indicator switches off.

**Note:** The system only activates if you apply enough brake pressure on the brake pedal.

**Note:** Under certain conditions, the system could apply the electric parking brake. The brake system warning lamp illuminates. The electric parking brake releases when you press the accelerator pedal. See **Automatically Releasing the Electric Parking Brake** (page 224).

**Note:** The system switches off if you shift into reverse (R) and press the brake pedal.

There could be actions that can cause the auto hold system not to work when the following occur:

- When you use active park assist.
- Your vehicle is in stay in neutral mode.
- The driver door is open.

# Auto Hold

---

- You have not fastened your seatbelt.
- You shift into reverse (R) before the system is active.

## AUTO HOLD INDICATORS



Illuminates when the system is active.



Illuminates when the system is on but cannot hold your vehicle at a standstill at this particular time.

# Traction Control

## HOW DOES TRACTION CONTROL WORK

If your vehicle begins to slide, the system applies the brakes to individual wheels and, when needed, reduces power at the same time. If the wheels spin when accelerating on slippery or loose surfaces, the system reduces power in order to increase traction.

## SWITCHING TRACTION CONTROL ON AND OFF



**WARNING:** Operating your vehicle with the traction control disabled could lead to an increased risk of loss of vehicle control, vehicle rollover, personal injury and death.

When you switch the system off or on, a message appears in the information display showing system status.

You can switch the system off with the traction control switch.

## Using a Switch

Use the traction control switch on the instrument panel to switch the system off or on.

## TRACTION CONTROL INDICATOR



## TRACTION CONTROL – TROUBLESHOOTING

## TRACTION CONTROL – WARNING LAMPS

### System Messages



The traction control light temporarily illuminates on start-up and flashes when activated by a driving condition.

The traction control off light temporarily illuminates on start-up and stays on:

- When you switch the traction control system off.
- When you select an alternative stability control mode.
- If a problem occurs in the system.

# Stability Control

## HOW DOES STABILITY CONTROL WORK



**WARNING:** Vehicle modifications involving braking system, aftermarket roof racks, suspension, steering system, tire construction and wheel and tire size may change the handling characteristics of your vehicle and may adversely affect the performance of the electronic stability control system. In addition, installing any stereo loudspeakers may interfere with and adversely affect the electronic stability control system. Install any aftermarket stereo loudspeaker as far as possible from the front center console, the tunnel, and the front seats in order to minimize the risk of interfering with the electronic stability control sensors. Reducing the effectiveness of the electronic stability control system could lead to an increased risk of loss of vehicle control, vehicle rollover, personal injury and death.



**WARNING:** Remember that even advanced technology cannot defy the laws of physics. It's always possible to lose control of a vehicle due to inappropriate driver input for the conditions. Aggressive driving on any road condition can cause you to lose control of your vehicle increasing the risk of personal injury or property damage. Activation of the electronic stability control system is an indication that at least some of the tires have exceeded their ability to grip the road; this could reduce the operator's ability to control the vehicle potentially resulting in a loss of vehicle control, vehicle rollover, personal injury and death. If your electronic stability control system activates, **SLOW DOWN.**

If a driving condition activates either the stability control or the traction control system you may experience the following conditions:

- The stability and traction control light flashes.
- Your vehicle slows down.
- Reduced engine power.

The stability control system has several features built into it to help you maintain control of your vehicle:

### Electronic Stability Control

Electronic stability control enhances your vehicle's ability to prevent skids or lateral slides by applying brakes to one or more of the wheels individually and, if necessary, reducing engine power.

### Roll Stability Control

Roll stability control enhances your vehicle's ability to prevent rollovers by detecting your vehicle's roll motion and the rate at which it changes by applying the brakes to one or more wheels individually.

# Stability Control

## Curve Control

Curve control enhances your vehicle's ability to follow the road when cornering severely or avoiding objects in the roadway. Curve control operates by reducing engine power and, if necessary, applying brakes to one or more of the wheels individually.

## Traction Control

Traction control enhances your vehicle's ability to maintain traction of the wheels by detecting and controlling wheel spin. See **How Does Traction Control Work** (page 230).

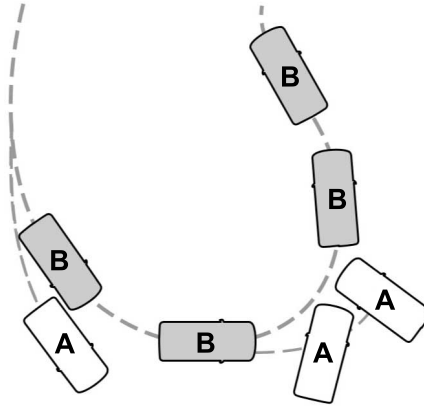

- A Vehicle without stability control skidding off its intended route.
- B Vehicle with stability control maintaining control on a slippery surface.

## SWITCHING STABILITY CONTROL ON AND OFF

The system turns on each time you switch the ignition on.

You can switch the electronic stability control system off by pressing and holding the ESC off button for over 15 seconds, or you can press the button again to switch the system on.



Shifting the transmission into reverse (R) disables the system.

You can switch the traction control system off or on independently. See **Switching Traction Control On and Off** (page 230).

## STABILITY CONTROL INDICATOR



If it does not illuminate when you switch the power on, or remains on, this indicates a malfunction.

Have your vehicle checked by an authorized dealer as soon as possible.



# Stability Control

---

## STABILITY CONTROL – TROUBLESHOOTING

### STABILITY CONTROL – INFORMATION MESSAGES

Service AdvanceTrac	Displayed when the system has detected a condition that requires service. Contact your authorized dealer as soon as possible.
AdvanceTrac Off On	The traction control has been disabled or enabled by the driver

# Steering

## ELECTRIC POWER STEERING

### ELECTRIC POWER STEERING PRECAUTIONS



**WARNING:** The electric power steering system has diagnostic checks that continuously monitor the system. If a fault is detected, a message displays in the information display. Stop your vehicle as soon as it is safe to do so. Switch the



**WARNING:** If the system detects an error, you may not feel a difference in the steering, however a serious condition may exist. Have your vehicle checked as soon as possible. Failure to do so may result in loss of steering control.

vehicle off. After at least 10 seconds, switch the vehicle on and watch the information display for a steering system warning message. If a steering system warning message returns, have the system checked as soon as possible.

Adapt your speed and driving behavior according to reduced steering assist.

Extreme continuous steering may increase the effort to steer. This occurs to prevent internal overheating and damage to the steering system. If this occurs, you will not lose the ability to steer your vehicle manually nor will it cause damage to the system. Normal steering and driving allows the system to cool down and steering assist returns to normal.

**Note:** *There is no fluid reservoir to check or fill.*

# Steering

---

## STEERING – TROUBLESHOOTING

### STEERING – INFORMATION MESSAGES

Message	Action
Steering Fault Service Now	The power steering system has detected a condition that requires service. Have your vehicle checked as soon as possible.
Steering Loss Stop Safely	The power steering system is not working. Stop your vehicle in a safe place. Have your vehicle checked as soon as possible.
Steering Assist Fault Service Required	The power steering system has detected a condition that requires service. Have your vehicle checked as soon as possible.

# Parking Aids

## PARKING AID PRECAUTIONS

 **WARNING:** To help avoid personal injury, always use caution when in reverse (R) and when using the sensing system.

 **WARNING:** The system may not detect objects with surfaces that absorb reflection. Always drive with due care and attention. Failure to take care may result in a crash.

 **WARNING:** Traffic control systems, fluorescent lamps, inclement weather, air brakes, external motors and fans may affect the correct operation of the sensing system. This may cause reduced performance or false alerts.

 **WARNING:** The system may not detect small or moving objects, particularly those close to the ground.

 **WARNING:** The parking aid system can only assist you to detect objects when your vehicle is moving at parking speeds. To help avoid personal injury you must take care when using the parking aid system.

 **WARNING:** The system may not function if the sensor is blocked.

 **WARNING:** In cold and severe weather conditions the system may not function. Rain, snow and spray can all limit sensor performance.

 **WARNING:** If damage occurs in the immediate area surrounding the sensor, have your vehicle checked as soon as possible.

**Note:** *If your vehicle sustains damage leaving the sensors misaligned, this will cause inaccurate measurements or false alerts.*

When you connect a trailer to your vehicle, the rear parking aid detects the trailer and provides an alert. Disable the parking aid when you connect a trailer to prevent the alert.

**Note:** *Certain add-on devices installed around the bumper or fascia may create false alerts, for example, large trailer hitches, bike or surfboard racks, license plate brackets, bumper covers or any other device that could block the normal detection zone of the parking aid system. Aftermarket spare tires or spare tire covers mounted to the rear tailgate could cause false alerts from the park aid system. Remove the add-on device to prevent false alerts.*

**Note:** *Keep the sensors free from snow, ice and large accumulations of dirt. If the sensors are covered, the system's accuracy can be affected.*

Do not clean the sensors with sharp objects.

**Note:** *When using a programmed MyKey, you cannot switch the parking aids off. See MyKey™ (page 85).*

# Parking Aids

## SWITCHING PARKING AID ON AND OFF



Press the parking aid button and use the menu to turn the system on and off.

The system can also be turned off using the pop-up message that appears when you are in reverse (R).

## REAR PARKING AID

### WHAT IS THE REAR PARKING AID

Rear parking sensors detect objects behind your vehicle when in reverse (R).

### REAR PARKING AID LIMITATIONS

There is a decreased coverage area at the outer corners.

When using a programmed MyKey, you cannot switch the rear parking aid off.

The rear parking aid sensors are active when your vehicle is in reverse (R) and the vehicle speed is less than 5 mph (8 km/h).

The sensor coverage area is up to 71 in (180 cm) from the rear bumper.

The rear parking aid detects large objects when you shift into reverse (R) and any of the following occur:

- Your vehicle is moving backward at a low speed.
- Your vehicle is stationary but an object is approaching the rear of your vehicle at a low speed.
- Your vehicle is moving backward at a low speed and an object is moving towards your vehicle, for example another vehicle at a low speed.

The system shall provide no audible warning for the object behind the vehicle when in neutral (N) gear.

## LOCATING THE REAR PARKING AID SENSORS



The rear parking aid sensors are in the rear bumper.

# Parking Aids

## REAR PARKING AID AUDIBLE WARNINGS

A warning tone sounds when your vehicle approaches an object. As your vehicle moves closer to an object, the rate of the tone increases. The warning tone continuously sounds when an object is 12 in (30 cm) or less from the rear bumper.

If your vehicle remains stationary for a few seconds, the audible warning turns off. If your vehicle moves backward the tone sounds again.

**Note:** *When the parking aid system sounds a tone, the audio system could reduce the set volume.*

## FRONT PARKING AID (IF EQUIPPED)

### WHAT IS THE FRONT PARKING AID

Front parking sensors detect objects in front of your vehicle.

## FRONT PARKING AID LIMITATIONS

The front parking aid sensors are active when your vehicle is in any position other than park (P) and the vehicle speed is less than 5 mph (8 km/h).

The sensor coverage area is up to 28 in (70 cm) from the bumper.

If your vehicle is in reverse (R), the front parking aid detects objects when your vehicle is moving at a low speed or an object is moving toward your vehicle and provides an audible warning, for example another vehicle at a low speed. If your vehicle remains stationary for a few seconds, the audible warning turns off. Visual indication is always active in reverse (R).

If your vehicle is in any forward gear, the front parking aid provides audible warnings and visual indication when your vehicle is moving at a speed of 5 mph (8 km/h) or below and the system detects an object within the detection zone. If your vehicle remains stationary for a few seconds, the visual indication and audible warning turns off.

If your vehicle is in neutral (N), the front and rear sensors provide visual indication only when your vehicle is moving below a speed of 5 mph (8 km/h) and obstacles are detected inside the detection areas. Once your vehicle stops, the visual indication and audible warning stops after a few seconds.

## LOCATING THE FRONT PARKING AID SENSORS



The front parking aid sensors are in the front bumper.

# Parking Aids

---

## FRONT PARKING AID AUDIBLE WARNINGS

A warning tone sounds when there is an object within 28 in (70 cm) from the front bumper. As your vehicle moves closer to an object, the rate of the tone increases.

The warning tone continuously sounds when an object is 12 in (30 cm) or less from the front bumper.

**Note:** *If the detected object is 12 in (30 cm) or less from your vehicle, visual indication remains on.*

## SIDE PARKING AID

### WHAT IS THE SIDE PARKING AID

The front and rear outermost parking aid sensors map objects that are near to the sides of your vehicle.

### SIDE PARKING AID LIMITATIONS

The sensor coverage is up to 24 in (60 cm) from the sides of your vehicle.

The side parking aid may not function if:

- Your vehicle remains stationary for over two minutes.
- The anti-lock brake system activates.
- The traction control system activates.
- Your vehicle is in park (P).
- The steering wheel angle information is not available. You must drive at least 492 ft (150 m) above 19 mph (30 km/h) to reset the steering wheel angle information.

**Note:** *If you switch traction control off, the side sensing system also turns off.*

To reinitialize the system, drive the length of your vehicle.

The side parking aid does not detect an object that is moving toward the side of your vehicle, for example another vehicle moving at a low speed, if it does not pass a front or rear parking aid sensor.

If the transmission is in reverse (R), the side sensing system provides audible warnings. When your vehicle is moving slowly, obstacles are detected within 24 in (60 cm) and are inside the driving path of your vehicle. If your vehicle remains stationary for a few seconds, the audible warning turns off. Visual indication is always present in reverse (R).

If your vehicle is in neutral (N), the side sensing system provides visual indication only when your vehicle is moving slowly and there is a front or rear parking aid obstacle detected, and the side obstacle is within 24 in (60 cm) from the side of your vehicle. If your vehicle remains stationary for a few seconds, the visual indication turns off.

If the transmission is in drive (D) or any other forward gear, the side sensing system provides audible and visual warnings. When your vehicle is moving slowly, obstacles are detected within 24 in (60 cm) and are inside the driving path of your vehicle. If your vehicle remains stationary for a few seconds, the visual indication and audible warning turns off.

# Parking Aids

## LOCATING THE SIDE PARKING AID SENSORS

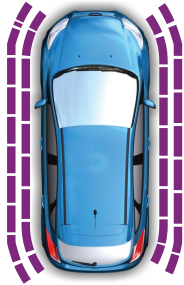

The side parking sensors are in the front and rear bumpers on both sides of the vehicle.

## SIDE PARKING AID AUDIBLE WARNINGS

When the side parking aid detects an object within the coverage area and the driving path of your vehicle, an audible warning sounds. As your vehicle moves closer to the object, the rate of the tone increases.

## PARKING AID INDICATORS

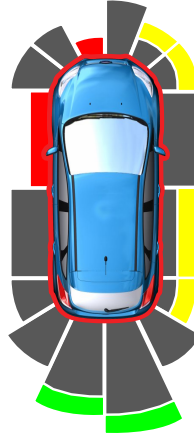

The system provides object distance indication through the information and entertainment display.

- As the distance to the object decreases, the indicator waves and the lines move toward the vehicle icon.
- If there is no object detected, the distance indicator lines are grey.

Visual indication remains on when your vehicle is in reverse (R). In any other gear, when you stop your vehicle, visual indication turns off after four seconds.

If the parking aids are not available, the side distance indicator lines do not display.

## PARKING AIDS – TROUBLESHOOTING

### PARKING AIDS – INFORMATION MESSAGES

If a fault is present in the parking aids, a warning message appears in the instrument cluster or the information and entertainment display.



# Parking Aids

---

<b>Message</b>	<b>Action</b>
Check Front Park Aid	The system detects a condition that requires service. Have your vehicle checked as soon as possible.
Check Rear Park Aid	The system detects a condition that requires service. Have your vehicle checked as soon as possible.
Front Park Aid On Off	Displays the park aid status.
Rear Park Aid On Off	Displays the park aid status.

# Rear View Camera

## WHAT IS THE REAR VIEW CAMERA

The rear view camera provides a video image of the area behind your vehicle when the transmission is in reverse (R).

## REAR VIEW CAMERA PRECAUTIONS



**WARNING:** The rear view camera system is a reverse aid supplement device that still requires the driver to use it in conjunction with the interior and exterior mirrors for maximum coverage.



**WARNING:** Objects that are close to either corner of the bumper or under the bumper, might not be seen on the screen due to the limited coverage of the camera system.



**WARNING:** Reverse your vehicle slowly. Failure to follow this instruction could result in the loss of control of your vehicle, personal injury or death.



**WARNING:** Use caution when the rear cargo door is ajar. If the rear cargo door is ajar, the camera will be out of position and the video image could be incorrect. All guide lines disappear when the rear cargo door is ajar. Failure to follow this instruction could result in personal injury.



**WARNING:** Use caution when turning camera features on or off when the transmission is not in park (P). Make sure your vehicle is not moving.

**Note:** *When towing, the camera only sees what you are towing. This might not provide adequate coverage and you might not see some objects. In some vehicles, the guide lines may disappear when you connect the trailer tow connector.*

## LOCATING THE REAR VIEW CAMERA

The rear view camera is located on the cargo door. It provides a video image of the area behind your vehicle.

## REAR VIEW CAMERA GUIDE LINES

**Note:** *Active guide lines and fixed guide lines are only available when the transmission is in reverse (R).*

**Note:** *The centerline is only available if the active or fixed guide lines are on.*

# Rear View Camera

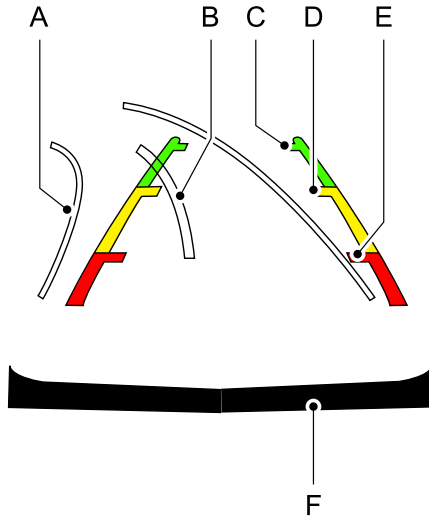

- A. Active guide lines.
- B. Centerline.
- C. Fixed guide line: Green zone.

- D. Fixed guide line: Yellow zone.
- E. Fixed guide line: Red zone.
- F. Rear bumper.

Active guide lines only show with fixed guide lines. To use active guide lines, turn the steering wheel to point the guide lines toward an intended path. If the steering wheel position changes while reversing, your vehicle might deviate from the intended path.

The fixed and active guide lines fade in and out depending on the steering wheel position. The active guide lines do not display when the steering wheel position is straight.

Use caution while reversing. Objects in the red zone are closest to your vehicle and objects in the green zone are farther away. Objects get closer to your vehicle as they move from the green zone to the yellow or red zones. Use the side view mirrors and rear view mirror to get better coverage on both sides and rear of your vehicle.

## REAR VIEW CAMERA OBJECT DISTANCE INDICATORS

The system provides an image of your vehicle and the sensor zones. The zones highlight green, yellow, and red when the parking aid sensors detect an object in the coverage area.

## REAR VIEW CAMERA SETTINGS

### ZOOMING THE REAR VIEW CAMERA IN AND OUT



**WARNING:** When manual zoom is on, the full area behind your vehicle may not show. Be aware of your surroundings when using the manual zoom feature.

Selectable settings for this feature are zoom in (+) and zoom out (-). Press the symbol on the camera screen to change the view. The default setting is zoom off.

# Rear View Camera

---

This allows you to get a closer view of an object behind your vehicle. The zoomed image keeps the bumper in the image to provide a reference. The zoom is only active while the transmission is in reverse (R).

**Note:** *Manual zoom is only available when the transmission is in reverse (R).*

**Note:** *Only the centerline shows when you enable manual zoom.*

## SWITCHING REAR VIEW CAMERA DELAY ON AND OFF

1. Press **Settings**.
2. Press **Vehicle Settings**.
3. Press **Rear View Camera**.
4. Switch **Rear View Camera Delay** on or off.

When shifting the transmission out of reverse (R) and into any gear other than park (P), the camera image remains in the display until:

- Your vehicle speed reaches approximately 5 mph (8 km/h).
- You shift your vehicle into park (P).

## 360 Degree Camera (If Equipped)

### WHAT IS THE 360 DEGREE CAMERA

The 360 degree camera system consists of front, side and rear cameras which provide visibility around your vehicle.

### HOW DOES THE 360 DEGREE CAMERA WORK

The 360 Degree Camera system:

- Allows you to see what is directly in front of or behind your vehicle.
- Provides a cross traffic view in front of and behind your vehicle.
- Allows you to see a top-down view of the area outside your vehicle, including the blind spots and obstacles near your vehicle.

### 360 DEGREE CAMERA PRECAUTIONS



**WARNING:** The 360 degree camera system still requires the driver to use it in conjunction with looking out of the windows, and checking the interior and exterior mirrors for maximum coverage.



**WARNING:** Objects that are close to either corner of the bumper or under the bumper, might not be seen on the screen due to the limited coverage of the camera system.



**WARNING:** Use caution when turning camera features on or off when the transmission is not in park (P). Make sure your vehicle is not moving.



**WARNING:** You are responsible for controlling your vehicle at all times. The system is designed to be an aid and does not relieve you of your responsibility to drive with due care and attention. Failure to follow this instruction could result in the loss of control of your vehicle, personal injury or death.



**WARNING:** Use caution when the rear cargo door is ajar. If the rear cargo door is ajar, the camera will be out of position and the video image could be incorrect. All guide lines disappear when the rear cargo door is ajar. Failure to follow this instruction could result in personal injury.



**WARNING:** When manual zoom is on, the full area behind your vehicle may not show. Be aware of your surroundings when using the manual zoom feature.

# 360 Degree Camera (If Equipped)

## 360 DEGREE CAMERA LIMITATIONS

**Note:** Use caution if a door is ajar. The 360 degree camera could be out of position and the image could be incorrect.

## LOCATING THE 360 DEGREE CAMERAS

### Rear View Camera

The rear view camera is on the liftgate. It provides a video image of the area behind your vehicle.

### Front View Camera

The front view camera is in the grille. It provides a video image of the area in front of your vehicle.

### Side View Camera

The side view camera is on the outside mirror. It provides a video image of the area on the sides of your vehicle to aid you when parking.

## 360 DEGREE CAMERA GUIDE LINES

**Note:** Active guide lines are only available when the transmission is in reverse (R).

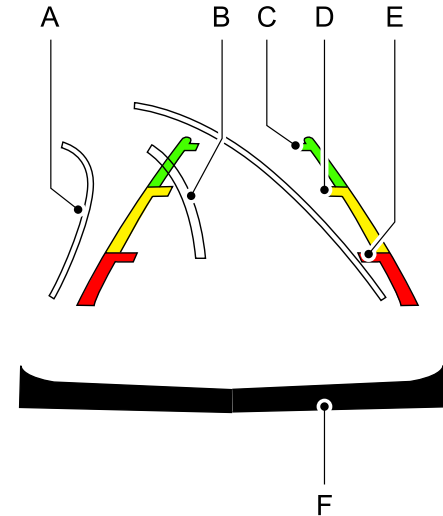

- A Active guide lines.
- B Centerline.
- C Fixed guide line: Green zone.

## 360 Degree Camera (If Equipped)

- D Fixed guide line: Yellow zone.
- E Fixed guide line: Red zone.
- F Rear bumper.

Active guide lines only show with fixed guide lines. Turn the steering wheel to point the guide lines toward an intended path. If the steering wheel position changes when reversing, your vehicle could deviate from the intended path.

The fixed and active guide lines fade in and out depending on the steering wheel position. The active guide lines do not display when the steering wheel position is straight.

Objects in the red zone are closest to your vehicle and objects in the green zone are farther away. Objects get closer to your vehicle as they move from the green zone to the yellow or red zones. Use the side view mirrors and rear view mirror to get better coverage on both sides and rear of your vehicle.

### Keep Out Zone

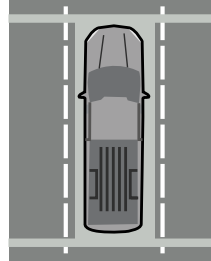

The keep out zone is represented by the yellow dotted lines running parallel to your vehicle.

### 360 DEGREE CAMERA SETTINGS

#### SWITCHING THE 360 DEGREE CAMERA ON AND OFF



The 360 degree camera system button is on the instrument panel and allows you to toggle through different camera views. The front and rear cameras have multiple screens which consist of:

- Normal view
- Normal view with 360
- Split view

When in park (P), neutral (N) or drive (D), only the front images display when you press the button. When in reverse (R), only the rear images display when you press the button.

**Note:** *The 360 degree camera system turns off when your vehicle is in motion at low speed, except when in reverse (R).*

# 360 Degree Camera (If Equipped)

---

## SWITCHING THE 360 DEGREE CAMERA VIEW



Press to access the different camera views.



**Normal + 360 view:** Contains the normal camera view next to a 360 degree camera view.



**Normal view:** Provides an image of what is directly in front of or behind your vehicle.



**Split view:** Provides an extended view of what is in front of or behind your vehicle.



Zooms in on the image.



# Active Park Assist (If Equipped)

## WHAT IS ACTIVE PARK ASSIST

Assists you with parking in and out of parking spaces.

## HOW DOES ACTIVE PARK ASSIST WORK

Active park assist uses sensors to detect parking spaces. Active park assist controls steering as required to maneuver into or out of a parking space when activate.

## ACTIVE PARK ASSIST PRECAUTIONS



**WARNING:** You must remain in your vehicle when the system turns on. At all times, you are responsible for controlling your vehicle, supervising the system and intervening, if required. Failure to take care may result in the loss of control of your vehicle, serious personal injury or death.



**WARNING:** The sensors may not detect objects in heavy rain or other conditions that cause interference.



**WARNING:** You are responsible for controlling your vehicle at all times. The system is designed to be an aid and does not relieve you of your responsibility to drive with due care and attention. Failure to follow this instruction could result in the loss of control of your vehicle, personal injury or death.



**WARNING:** Do not use the system with accessories that extend beyond the front or rear of your vehicle, for example a trailer hitch or bike rack. The system is not able to make corrections for the additional length of the accessories.

## SWITCHING ACTIVE PARK ASSIST ON AND OFF



Press the active park assist button to bring up full screen notifications.

Press the soft keys on the touchscreen to switch between parallel park in, perpendicular park in or parallel park out parking modes.

## Cancelling Active Park Assist

To cancel parking assistance at any time:

- Press the active park assist button during operation.
- Grab the steering wheel during operation.
- Drive above 22 mph (35 km/h) for a short period of time when searching for a parking space.
- Drive above 6 mph (9 km/h) during operation.
- Switch traction control off.

## ENTERING A PARALLEL PARKING SPACE

1. Press the active park assist button.
2. Select parallel park.

## Active Park Assist (If Equipped)

**Note:** The system detects other vehicles and curbs to find a parking space.

3. Use the turn signal lever to search for a parking space on the driver or passenger side of your vehicle.

**Note:** The system defaults to searching for a parking spot on the passenger side of your vehicle if you do not use the turn signal lever.

4. Drive your vehicle approximately 3 ft (1 m) away from and parallel to the other parked vehicles when searching for a parking space.

**Note:** A tone sounds and a message appears in the information and entertainment display when active park assist finds a parking space.

5. Press and hold the brake pedal.
6. Release the steering wheel and shift into reverse (R).
7. Use the accelerator and brake to control your vehicle's speed when parking. You are responsible for stopping your vehicle.

8. Active park assist is a multi-step process and requires you to shift the transmission multiple times. Follow the onscreen instructions until parking is complete.

**Note:** You can slow down your vehicle at any time by pressing the brake pedal.

**Note:** When parallel parking between objects, the system will park closer to the object in front of your vehicle to allow easier access to the luggage compartment.

### ENTERING A PERPENDICULAR PARKING SPACE

1. Press the active park assist button.
2. Select perpendicular parking.

**Note:** Active park assist does not recognize parking space lines and centers your vehicle between objects.

**Note:** Active park assist backs your vehicle into parking spaces.

3. Use the turn signal lever to search for a parking space on the driver or passenger side of your vehicle.

**Note:** The system defaults to searching for a parking spot on the passenger side of your vehicle if you do not use the turn signal lever.

4. Drive your vehicle approximately 3 ft (1 m) away from and perpendicular to the other parked vehicles when searching for a parking space.

**Note:** A tone sounds and a message appears in the information and entertainment display when active park assist finds a parking space.

5. Press and hold the brake pedal.
6. Release the steering wheel and shift into reverse (R).
7. Use the accelerator and brake to control your vehicle's speed when parking. You are responsible for stopping your vehicle.
8. Active park assist is a multi-step process and requires you to shift the transmission multiple times. Follow the onscreen instructions until parking is complete.

**Note:** Active park assist aligns the front-end of your vehicle with the lane side of the object next to it.

## Active Park Assist (If Equipped)

**Note:** When only one object is detected, the system allows enough distance to open the door on either side.

**Note:** You can slow down your vehicle at any time by pressing the brake pedal.

### EXITING A PARKING SPACE

Active park assist only assists leaving parallel parking spaces.

1. Press the active park assist button.
2. Select parallel park exit.
3. Use the turn signal to choose the direction to exit the parking space.
4. Press and hold the brake pedal.
5. Release the steering wheel and shift into the instructed gear.
6. Release the parking brake.
7. Use the accelerator and brake to control your vehicle's speed when exiting the parking space. You are responsible for stopping your vehicle.

8. Active park assist is multi-step process and requires you to shift the transmission multiple times. Follow the onscreen instructions until operation is complete.

**Note:** After active park assist drives your vehicle to a position where you can exit the parking space in a forward movement, a message appears instructing you to take full control of your vehicle.

9. Take control of your vehicle.

**Note:** You can slow down your vehicle at any time by pressing the brake pedal.

### ACTIVE PARK ASSIST – TROUBLESHOOTING

#### ACTIVE PARK ASSIST – INFORMATION MESSAGES

Message	Action
Active Park Fault	The system requires service. Have your vehicle checked as soon as possible.

#### ACTIVE PARK ASSIST – FREQUENTLY ASKED QUESTIONS

##### Why does active park assist not operate correctly?

The system is unable to detect a vehicle, curb or object to park next to or in between. The system needs boundary objects to operate correctly.

##### Why does active park assist not search for a parking space?

You have switched traction control off.

## Active Park Assist (If Equipped)

---

### **Why does active park assist not search for a parking space?**

The transmission is in reverse (R). Your vehicle must be moving forward to be able to detect a parking space.

### **Why does active park assist not offer a parking space?**

The sensors could be blocked. For example, snow, ice or large accumulations of dirt. Blocked sensors can affect how the system functions.

### **Why does active park assist not offer a parking space?**

The sensors in the front or rear bumper could be damaged.

### **Why does active park assist not offer a parking space?**

There is not enough room in the parking space for your vehicle to safely park.

### **Why does active park assist not offer a parking space?**

There is not enough space for the parking maneuver on the opposite side of the parking space.

### **Why does active park assist not offer a parking space?**

The parking space is more than 5 ft (1.5 m) or less than 2 ft (0.5 m) away from your vehicle.

### **Why does active park assist not offer a parking space?**

Your vehicle's speed is greater than 22 mph (35 km/h) for parallel parking or greater than 19 mph (30 km/h) for perpendicular parking.

### **Why does active park assist not offer a parking space?**

You recently disconnected or replaced the battery. After you reconnect the battery you must drive your vehicle on a straight road for a short period of time.

### **Why does active park assist not correctly position the vehicle into a parking space?**

An irregular curb along the parking space prevents the system from correctly aligning your vehicle.

### **Why does active park assist not correctly position the vehicle into a parking space?**

Vehicles or objects bordering the space could not be correctly parked.

### **Why does active park assist not correctly position the vehicle into a parking space?**

Your vehicle stopped too far past the parking space.

### **Why does active park assist not correctly position the vehicle into a parking space?**

The tires are not correctly installed or maintained. For example, using a spare tire, not inflated correctly, improper size, or of different sizes.

### **Why does active park assist not correctly position the vehicle into a parking space?**

A repair or alteration changed the detection capabilities.

### **Why does active park assist not correctly position the vehicle into a parking space?**

A parked vehicle has a high attachment. For example, a salt sprayer, snowplow or moving truck bed.

## Active Park Assist (If Equipped)

---

### **Why does active park assist not correctly position the vehicle into a parking space?**

The parking space length, or position of parked objects, changes after your vehicle passes the space.

### **Why does active park assist not correctly position the vehicle into a parking space?**

The temperature around your vehicle quickly changes. For example, driving from a heated garage into a cold outside temperature, or after leaving a car wash.

# Cruise Control (If Equipped)

## WHAT IS CRUISE CONTROL

Cruise control lets you maintain a set speed without keeping your foot on the accelerator pedal.

### Requirements

Use cruise control when the vehicle speed is greater than 20 mph (30 km/h).

## SWITCHING CRUISE CONTROL ON AND OFF



**WARNING:** Do not use cruise control on winding roads, in heavy traffic or when the road surface is slippery. This could result in loss of vehicle control, serious injury or death.

The cruise controls are on the steering wheel. See **What Is Cruise Control** (page 254).

### Switching Cruise Control On

Press the button.

### Switching Cruise Control Off

Press the button when the system is in standby mode.

The system also turns off when you switch the ignition off.

**Note:** *The set speed erases when you switch the system off.*

## SETTING THE CRUISE CONTROL SPEED



**WARNING:** When you are going downhill, your vehicle speed could increase above the set speed. The system does not apply the brakes.

Drive to the speed you prefer.

Press either button to set the current speed.

Take your foot off the accelerator pedal.

**Note:** *The indicator changes color in the information display.*

### Changing the Set Speed

Press and release the button to increase the set speed in small increments.

Press and hold the button to accelerate. Release the button when you reach your preferred speed.

Press and release the button to decrease the set speed in small increments.

Press and hold the button to decelerate. Release the button when you reach your preferred speed.

# Cruise Control (If Equipped)

---

**Note:** *If you accelerate by pressing the accelerator pedal, the set speed does not change. When you release the accelerator pedal, your vehicle returns to the speed that you previously set.*

## CANCELING THE SET SPEED

 Press the button, or tap the brake pedal to cancel the set speed.

**Note:** *The system remembers the set speed.*

**Note:** *The system cancels if the vehicle speed drops below 10 mph (16 km/h) under the set speed when driving uphill.*

## RESUMING THE SET SPEED

 Press the button.

## CRUISE CONTROL INDICATORS

 Illuminates when you switch the system on.

# Adaptive Cruise Control (If Equipped)

## HOW DOES ADAPTIVE CRUISE CONTROL WITH STOP AND GO WORK

Adaptive cruise control with stop and go uses radar and camera sensors to maintain a set gap between your vehicle and the vehicle in front of you while following it to a complete stop. Stop and go can also be set to follow a vehicle directly in front of you and adjust the set speed, while you are at a complete stop.

## ADAPTIVE CRUISE CONTROL PRECAUTIONS

 **WARNING:** You are responsible for controlling your vehicle at all times. The system is designed to be an aid and does not relieve you of your responsibility to drive with due care and attention. Failure to follow this instruction could result in the loss of control of your vehicle, personal injury or death.

 **WARNING:** Do not use adaptive cruise control on winding roads, in heavy traffic or when the road surface is slippery. This could result in loss of vehicle control, serious injury or death.

 **WARNING:** Pay close attention to changing road conditions such as entering or leaving a highway, on roads with intersections or roundabouts, roads without visible lanes of travel, roads that are unpaved, or steep slopes. Failure to follow this instruction could result in the loss of control of your vehicle, personal injury or death.

 **WARNING:** The system is not a crash warning or avoidance system.

 **WARNING:** Do not use the system when towing a trailer that has aftermarket electronic trailer brake controls. Failure to follow this instruction could result in the loss of control of your vehicle, personal injury or death.

 **WARNING:** Do not use tire sizes other than those recommended because this can affect the normal operation of the system. Failure to do so may result in a loss of vehicle control, which could result in serious injury.

 **WARNING:** Do not use the system with a snow plow blade installed.

 **WARNING:** Do not use the system in poor visibility, for example fog, heavy rain, spray or snow.

## When Following a Vehicle

 **WARNING:** When following a vehicle that is braking, your vehicle does not always decelerate quickly enough to avoid a crash without driver intervention. Apply the brakes when necessary. Failure to follow this instruction could result in personal injury or death.



# Adaptive Cruise Control (If Equipped)

## Hilly Condition Usage

Select a lower gear when the system is active in situations such as prolonged downhill driving on steep slopes, for example in mountainous areas.

## ADAPTIVE CRUISE CONTROL LIMITATIONS

### Sensor Limitations

**WARNING:** On rare occasions, detection issues can occur due to the road infrastructures, for example bridges, tunnels and safety barriers. In these cases, the system may brake late or unexpectedly. At all times, you are responsible for controlling your vehicle, supervising the system and intervening, if required.

**WARNING:** If the system malfunctions, have your vehicle checked as soon as possible.

**WARNING:** Large contrasts in outside lighting can limit sensor performance.

**WARNING:** The system only warns of vehicles detected by the radar sensor. In some cases there may be no warning or a delayed warning. Apply the brakes when necessary. Failure to follow this instruction could result in personal injury or death.

**WARNING:** The system may not detect stationary or slow moving vehicles below 6 mph (10 km/h).

**WARNING:** The system does not detect pedestrians or objects in the road.

**WARNING:** The system does not detect oncoming vehicles in the same lane.

**WARNING:** The system may not operate properly if the sensor is blocked. Keep the windshield free from obstruction.

**WARNING:** The sensor may incorrectly track lane markings as other structures or objects. This can result in a false or missed warning.



The camera is mounted on the windshield behind the interior mirror.

## Adaptive Cruise Control (If Equipped)

---

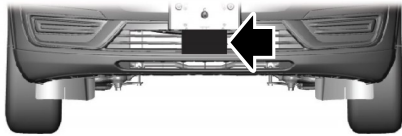

The radar sensor has a limited field of view. It may not detect vehicles at all or detect a vehicle later than expected in some situations. The lead vehicle image does not illuminate if the system does not detect a vehicle in front of you.

The radar sensor is in the lower grille.

**Note:** *You cannot see the sensor. It is behind a fascia panel.*

**Note:** *Keep the front of your vehicle free of dirt, metal badges or objects. Vehicle front protectors, aftermarket lights, additional paint or plastic coatings could also degrade sensor performance.*

A message displays if something obstructs the camera or the sensor. When something blocks the sensor, the system cannot detect a vehicle ahead and does not function. See

**Adaptive Cruise Control – Information Messages** (page 267).

# Adaptive Cruise Control (If Equipped)

## Detection issues can occur:

**A**

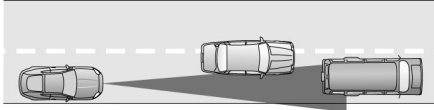

**B**

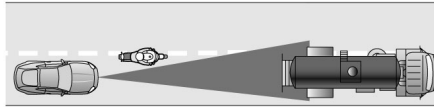

**C**

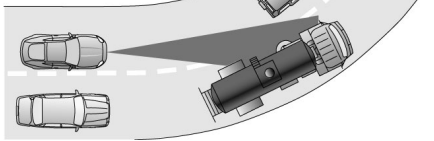

**A** When driving on a different line than the vehicle in front.

- B** With vehicles that edge into your lane. The system can only detect these vehicles once they move fully into your lane.
- C** There may be issues with the detection of vehicles in front when driving into and coming out of a bend or curve in the road.

In these cases, the system may brake late or unexpectedly.

If something hits the front end of your vehicle or damage occurs, the radar-sensing zone may change. This could cause missed or false vehicle detection.

Optimal system performance requires a clear view of the road by the windshield-mounted camera.

Optimal performance may not occur if:

- The camera is blocked.
- There is poor visibility or lighting conditions.
- There are bad weather conditions.

## SWITCHING ADAPTIVE CRUISE CONTROL ON AND OFF

The cruise controls are on the steering wheel.

### Switching Adaptive Cruise Control On



Press the button to set the system in standby mode.

The indicator, current gap setting and set speed appear in the information display.

### Switching Adaptive Cruise Control Off



Press the button when the system is in standby mode, or switch the ignition off.

**Note:** *You erase the set speed when you switch the system off.*

# Adaptive Cruise Control (If Equipped)

## ADAPTIVE CRUISE CONTROL AUTOMATIC CANCELLATION

The system may cancel if:

- The tires lose traction.
- You apply the parking brake.

The system may cancel and set the parking brake if:

- You unbuckle the seatbelt and open the driver door after you stop your vehicle.
- Your vehicle is at a stop continuously for more than three minutes.

The system may deactivate or prevent activating when requested if:

- The vehicle has a blocked sensor.
- The brake temperature is too high.
- There is a failure in the system or a related system.

## SETTING THE ADAPTIVE CRUISE CONTROL SPEED

Drive to the speed you prefer.

**RES+**

Press either button to set the current speed.

**SET-**

Take your foot off the accelerator pedal.

The indicator, current gap setting and set speed appear in the information display.



A vehicle image illuminates if there is a vehicle detected in front of you.

**Note:** When adaptive cruise control is active, the speedometer may vary slightly from the set speed displayed in the information display.

## Setting the Adaptive Cruise Speed from a Complete Stop

**RES+**

Press and release either button while keeping the brake pedal fully pressed.

**SET-**

The set speed adjusts to 20 mph (30 km/h).

The indicator, current gap setting and set speed appear in the information display.

**Note:** The system will activate from a complete stop only when it detects a lead vehicle in close proximity.

## Manually Changing the Set Speed

**RES+**

Press and release to increase the set speed in small increments.

Press and hold to increase the set speed in large increments. Release the button when you reach the speed you prefer.

**SET-**

Press and release to decrease the set speed in small increments.

# Adaptive Cruise Control (If Equipped)

Press and hold to decrease the set speed in large increments. Release the button when you reach the speed you prefer.

**SET-** You can also press the accelerator or brake pedal until you reach the speed you prefer. Press the button to select the current speed as the set speed.

The system may apply the brakes to slow the vehicle to the new set speed. The set speed continuously displays in the information display when the system is active.

## SETTING THE ADAPTIVE CRUISE CONTROL GAP

 Press the button to cycle through the four gap settings.



The selected gap appears in the instrument cluster display as shown by the bars in the image.

**Note:** *The gap setting is time dependent and therefore, the distance adjusts with your vehicle speed.*

**Note:** *It is your responsibility to select a gap appropriate to the driving conditions.*

## Adaptive Cruise Control Gap Settings

Graphic Display, Bars Indicated Between Vehicles	Gap Distance	Dynamic Behavior
1	Closest.	Sport.
2	Close.	Normal.
3	Medium.	Normal.
4	Far.	Comfort.

Each time you switch the system on, it selects the last chosen gap setting.

## Following a Vehicle

When a vehicle ahead of you enters the same lane or a slower vehicle is ahead in the same lane, the vehicle speed adjusts to maintain the gap setting.

# Adaptive Cruise Control (If Equipped)

**Note:** When you are following a vehicle and you switch on a turn signal lamp, adaptive cruise control may provide a small, temporary acceleration to help you pass.

Your vehicle maintains a consistent gap from the vehicle ahead until:

- The vehicle in front of you accelerates to a speed above the set speed.
- The vehicle in front of you moves out of the lane you are in.
- You set a new gap distance.

The system applies the brakes to slow down your vehicle to maintain a safe gap distance from the vehicle in front of you. The system only applies limited braking. You can override the system by applying the brakes.

**Note:** The brakes may emit noise when applied by the system.

If the system determines that its maximum braking level is not sufficient, an audible warning sounds, a message appears in the instrument cluster display and an indicator flashes when the system continues to brake. Take immediate action.

## CANCELING THE SET SPEED

**CAN** Press the button or tap the brake pedal.

The set speed does not erase.

## RESUMING THE SET SPEED

**RES** Press the button.

Your vehicle speed returns to the previously set speed and gap setting. The set speed displays continuously in the information display when the system is active.

**Note:** Only use resume if you are aware of the set speed and intend to return to it.

## Resuming the Set Speed from a Complete Stop

If your vehicle follows a vehicle to a complete stop and remains stationary for less than three seconds, your vehicle accelerates from a stationary position to follow the vehicle ahead.

**RES** If your vehicle follows a vehicle to a complete stop and remains stationary for more than three seconds, press and release the button or press the accelerator pedal to follow the vehicle ahead.

## OVERRIDING THE SET SPEED

 **WARNING:** If you override the system by pressing the accelerator pedal, it does not automatically apply the brakes to maintain a gap from any vehicle ahead.

When you press the accelerator pedal, you override the set speed and gap distance.

Use the accelerator pedal to intentionally exceed the set speed limit.

When you override the system, the green indicator illuminates and the vehicle icon does not appear in the instrument cluster display.

# Adaptive Cruise Control (If Equipped)

The system resumes operation when you release the accelerator pedal. The vehicle speed decreases to the set speed, or a lower speed if following a slower vehicle.

## ADAPTIVE CRUISE CONTROL INDICATORS



Illuminates when you switch adaptive cruise control on. The color of the indicator changes to indicate the system status.

White indicates the system is on but inactive.

Green indicates that you set the speed and the system is active.

## SWITCHING FROM ADAPTIVE CRUISE CONTROL TO CRUISE CONTROL



**WARNING:** Normal cruise control will not brake when your vehicle is approaching slower vehicles. Always be aware of which mode you have selected and apply the brakes when necessary.

You can change from adaptive cruise control to normal cruise control through the information display.



The cruise control indicator light replaces the adaptive cruise control indicator light if you select normal cruise control. The gap setting does not display, and the system does not respond to lead vehicles. Automatic braking remains active to maintain set speed.

## LANE CENTERING

### HOW DOES LANE CENTERING WORK

Adaptive cruise control with lane centering uses radar and camera sensors to help keep your vehicle in the middle of the lane by applying continuous assistance steering torque input toward the lane center on highways.

**Note:** *The adaptive cruise control gap setting operates normally.*

If you drive off-center within the lane, the system sets and maintains that preferred lane position. The system provides continuous assistance steering torque input toward the preferred position.

**Note:** *The system can only set preferred lane positions within the lane.*

**Note:** *If the system cancels, the preferred position erases. On the next activation, the system provides continuous assistance steering torque input toward the lane center.*

# Adaptive Cruise Control (If Equipped)

## LANE CENTERING PRECAUTIONS



**WARNING:** Do not use the system when towing a trailer. Failure to follow this instruction could result in the loss of control of your vehicle, personal injury or death.



**WARNING:** Do not use the system if any changes or modifications to the steering wheel have been made. Any changes or modifications to the steering wheel could affect the functionality or performance of the system. Failure to follow this instruction could result in the loss of control of your vehicle, personal injury or death.

Adaptive cruise control precautions apply to lane centering unless stated otherwise or contradicted by a lane centering precaution. See **Adaptive Cruise Control Precautions** (page 256).

## LANE CENTERING REQUIREMENTS

You must keep your hands on the steering wheel at all times.

The system only activates when all of the following occur:

- You have adaptive cruise control with stop and go on.
- You have your hands on the steering wheel.
- The system detects both lane markings.

**Note:** *If it does not detect valid lane markings, the system stays inactive until valid markings are available.*

**Note:** *You can override the system at any time by steering your vehicle.*

## LANE CENTERING LIMITATIONS

Adaptive cruise control limitations apply to lane centering unless stated otherwise or contradicted by a lane centering limitation. See **Adaptive Cruise Control Limitations** (page 257).

Lane Centering may not correctly operate in any of the following conditions:

- Your vehicle is not centered in the lane.
- The lane is too narrow or wide.
- The system does not detect at least one lane marking or when lanes merge or split.
- Limited steering torque input is applied.
- Areas under construction or new infrastructure.
- When modifications to the steering system have been made.
- When using a spare tire.
- In high wind conditions.

**Note:** *The driving assistance torque is limited and may not be sufficient for all driving situations such as driving through tight curves or driving through curves at high speeds.*

**Note:** *In exceptional conditions, the system may deviate from the center line.*



# Adaptive Cruise Control (If Equipped)

## SWITCHING LANE CENTERING ON AND OFF

You must keep your hands on the steering wheel at all times.

The controls are on the steering wheel.



Press the button.

The indicator appears in the information display. When the system is on, the color of the indicator changes to indicate the system status.

You can override the system at any time by steering your vehicle.

**Note:** *The correct requirements must be met before you can switch the system on. See [Lane Centering Requirements](#) (page 264).*

## LANE CENTERING ALERTS

When the system is active and detects no steering activity for a certain period of time, the system alerts you to put your hands on the steering wheel. If you do not react to the warnings the system cancels and slows your vehicle down to idle speeds while maintaining steering control.

The system also alerts you if your vehicle crosses lane markings without detected steering activity.

**Note:** *The system may detect a light grip or touch on the steering wheel as hands-off driving.*

## LANE CENTERING AUTOMATIC CANCELLATION

When an external condition cancels the system, for example, no lane markings available, a tone sounds and a message appears in the information display.

**RES**

If your vehicle starts to slow down, you must provide steering input to the wheel and press and release the button to regain full system performance.

Automatic cancellation can also occur if:

- The lane becomes too wide or too narrow.
- The system cannot detect valid lane markings.
- Lane markings cross over one another.

**Note:** *The system disables until the next key cycle if your vehicle slows down due to driver inactivity twice within a key cycle.*

## LANE CENTERING INDICATORS



Illuminates when you switch lane centering on. The color of the indicator changes to indicate the system status.

Gray indicates the system is on but inactive.

Green indicates the system is active and applying steering torque assistance input to keep your vehicle in the center of the lane.

# Adaptive Cruise Control (If Equipped)

Amber with an audible tone and then gray indicates a system automatic cancellation.

## ADAPTIVE CRUISE CONTROL – TROUBLESHOOTING

**Note:** *The system could abbreviate or shorten certain messages depending upon which cluster type you have.*

## ADAPTIVE CRUISE CONTROL – INFORMATION MESSAGES - VEHICLES WITH: LANE CENTERING

**Note:** *Depending on your vehicle options and instrument cluster type, not all messages display or are available.*

Message	Action
Keep Hands on Steering Wheel	Return your hands to the steering wheel and provide steering input.
Lane Centering Assist Not Available	Conditions exist that prevent the system from being available.
For Lane Centering Assist to work Turn On Adaptive Cruise	You need to switch on adaptive cruise control before you can switch on lane centering.

## Adaptive Cruise Control (If Equipped)

### ADAPTIVE CRUISE CONTROL – INFORMATION MESSAGES - VEHICLES WITH: STOP AND GO

**Note:** Depending on your vehicle options and instrument cluster type, not all messages display or are available.

**Note:** The system could abbreviate or shorten certain messages depending upon which cluster type you have.

Message	Action
Adaptive Cruise Malfunction	A malfunction is preventing the adaptive cruise from engaging.
Front Sensor Not Aligned	Contact an authorized dealer to have the radar checked for proper coverage and operation.
Adaptive Cruise Not Available	Conditions exist preventing the system from being available.
Adaptive Cruise Not Available Sensor Blocked See Manual	You have a blocked radar because of poor radar visibility due to inclement weather or ice, mud, or water in front of the radar. You can typically clean the sensor to resolve this. Due to the nature of radar technology, it is possible to get a blockage warning with no actual block. This happens, for example, when driving in sparse rural or desert environments. A false blocked condition either self clears, or clears after you restart your vehicle.
Normal Cruise Active Adaptive Braking Off	You have selected normal cruise control. The system does not brake or react to traffic.
Adaptive Cruise - Driver Resume Control	Displays when the adaptive cruise control is going to cancel and you must take control.
Adaptive Cruise Speed Too Low to Activate	Displays when the vehicle speed is too slow to activate the adaptive cruise control and there is no lead vehicle in range.

# Drive Mode Control

---

## WHAT IS DRIVE MODE CONTROL

Your vehicle has various drive modes that you can select for different driving conditions. Depending on the drive mode that you select, the system adjusts various vehicle settings.

## HOW DOES DRIVE MODE CONTROL WORK

Drive mode control adjusts your vehicle configuration for each mode you select.

Changing the drive mode changes the functionality of the steering system to adjust the steering effort and feel.

Active noise control utilizes your vehicle electronics to enhance the acoustic experience.

The stability and traction control assist your vehicle control in adverse conditions or high-performance driving.

Throttle control enhances the powertrain response, transmission controls become optimized with shift schedules, and four-wheel drive settings are optimized and tuned to each mode.

**Note:** *The system has diagnostic checks that continuously monitor the system for proper operation. If a mode is unavailable due to a system fault, the mode defaults to normal.*

## SELECTING A DRIVE MODE

You can configure which of the drive control modes are active when your vehicle is in drive (D) or in sport (S). The configuration remains active until modified from the main menu on the instrument cluster display. See **Instrument Cluster Display Main Menu** (page 146).

**Note:** *Not all settings may be available.*

**Note:** *Drive mode changes may not be available when the ignition is off.*

## DRIVE MODES

### COMFORT

Provides a more relaxed driving experience, maximizing comfort. Your steering effort decreases and the suspension movement is more fluid. Comfort mode is ideal when you desire enhanced traveling comfort.

### NORMAL

Delivers a balanced combination of a comfortable, controlled ride and confident handling. This mode provides an engaging driving experience and a direct connection to the road without sacrificing any of the composure demanded from a luxury vehicle.

### SPORT

Provides a sportier driving experience. The suspension stiffens, with an emphasis on handling and control. The engine responds more directly to your inputs and takes on a more powerful tone. This mode is ideal for use during more spirited driving.

# Lane Keeping System

## WHAT IS THE LANE KEEPING SYSTEM

The lane keeping system alerts you by providing temporary steering assistance or steering wheel vibration when it detects an unintended lane departure.

## HOW DOES THE LANE KEEPING SYSTEM WORK

The lane keeping system uses a forward looking camera mounted on the windshield to monitor vehicle movement within the travel lane.

When the camera detects a drift out of the travel lane, the lane keeping system alerts the driver by vibrating the steering wheel, or aids the driver by providing a small steering input to move the vehicle back into the travel lane.

The driver can select one of three modes:

- Alert (If Equipped)
- Aid
- Alert + Aid

## LANE KEEPING SYSTEM PRECAUTIONS

 **WARNING:** You are responsible for controlling your vehicle at all times. The system is designed to be an aid and does not relieve you of your responsibility to drive with due care and attention. Failure to follow this instruction could result in the loss of control of your vehicle, personal injury or death.

 **WARNING:** The system will not operate if the sensor cannot track the road lane markings.

 **WARNING:** The sensor may incorrectly track lane markings as other structures or objects. This can result in a false or missed warning.

 **WARNING:** In cold and severe weather conditions the system may not function. Rain, snow and spray can all limit sensor performance.

 **WARNING:** The system may not operate properly if the sensor is blocked. Keep the windshield free from obstruction.

 **WARNING:** If damage occurs in the immediate area surrounding the sensor, have your vehicle checked as soon as possible.

 **WARNING:** The system may not correctly operate if your vehicle is fitted with a suspension kit not approved by us.

 **WARNING:** Large contrasts in outside lighting can limit sensor performance.

# Lane Keeping System

## LANE KEEPING SYSTEM LIMITATIONS

The lane keeping system only operates when the vehicle speed is greater than 40 mph (64 km/h).

The system works when the camera can detect at least one lane marking.

The lane keeping system may not correctly operate in any of the following conditions:

- The lane keeping system does not detect at least one lane marking.
- You switch the turn signal on.
- You apply direct steering, accelerate fast or brake hard.
- The vehicle speed is less than 40 mph (64 km/h).
- The anti-lock brake, stability control or traction control system activates.
- The lane is too narrow.
- Something is obscuring the camera or it is unable to detect the lane markings due to environment, traffic or vehicle conditions.

The lane keeping system may not correct lane positioning in any of the following conditions:

- High winds.
- Uneven road surfaces.
- Heavy or uneven loads.
- Incorrect tire pressure.

## SWITCHING THE LANE KEEPING SYSTEM ON AND OFF



To activate the lane keeping system, press the button on the turn signal lever.

**Note:** *The system stores the on or off setting until manually changed, unless it detects a MyKey™. If the system detects a MyKey™, it defaults to on and the mode is set to alert.*

**Note:** *If the system detects a MyKey™, pressing the button does not affect the on or off status of the system. You can only change the mode and intensity settings.*

## SWITCHING THE LANE KEEPING SYSTEM MODE

The lane keeping system has different settings that you can view or adjust using the information display.

The system stores the last known selection for each of these settings. You do not need to readjust your settings each time you switch on the system.

To change the lane keeping system mode, use the instrument cluster display:

1. Using the instrument cluster display controls on the steering wheel, select **SETTINGS**.
2. Select **Driver assistance**.
3. Select **Lane keeping system**.
4. Select **Mode**.
5. Select a mode.

**Note:** *The system remembers the last setting when you start your vehicle. If the system detects a MyKey™, it defaults to the last setting for that MyKey™.*

# Lane Keeping System

## LANE KEEPING SYSTEM SETTINGS

To change the steering wheel vibration, use the instrument cluster display:

1. Using the instrument cluster display controls on the steering wheel, select **Driver Assist**.
2. Select **Lane Keeping Sys**.
3. Select **Alert Intensity**.
4. Select a setting.

## ALERT MODE

### WHAT IS ALERT MODE

Alert mode vibrates the steering wheel when it detects an unintended lane departure.

## HOW DOES ALERT MODE WORK

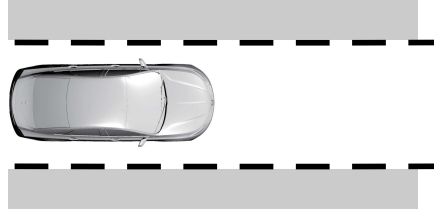

When in alert mode, the lane keeping system alerts you by vibrating the steering wheel. The intensity of the vibration is set through the lane keeping system menu.

## AID MODE

### WHAT IS AID MODE

Aid mode provides temporary steering assistance toward the center of the lane.

## HOW DOES AID MODE WORK

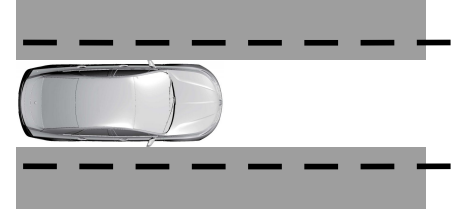

The lane keeping system aids you when an unintentional lane departure occurs. The system provides a small steering input to move the vehicle towards the center of the lane.

# Lane Keeping System

## ALERT AND AID MODE

### WHAT IS ALERT AND AID MODE

Alert and aid mode uses multiple features to keep you in your lane. The system first provides a small steering input to bring your vehicle back towards the center of the lane. If your vehicle moves too far out of the center of the lane the system alerts you with vibration in the steering wheel.

### HOW DOES ALERT AND AID MODE WORK

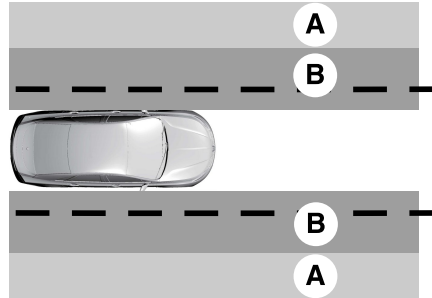

A Alert.

B Aid.

The lane keeping system detects a lane departure and provides aid when the vehicles enters **B** and applies the additional alert warning if **A** is entered.

## LANE KEEPING SYSTEM INDICATORS

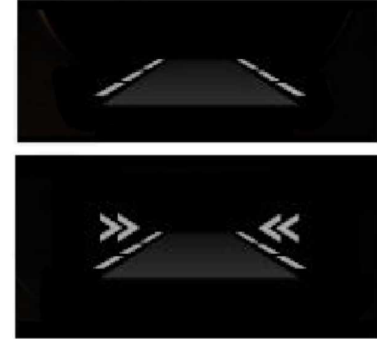

If you switch the lane keeping system on, a graphic with lane markings appears in the information display.

When you switch the system off, the lane marking graphics do not display.

**Note:** *The overhead vehicle graphic may still display if adaptive cruise control is enabled.*



# Lane Keeping System

---

While the lane keeping system is on, the color of the lane markings change to indicate the system status.

<b>Gray</b>	<b>Green</b>	<b>Yellow</b>	<b>Red</b>
Indicates that the system is temporarily unavailable to provide a warning or intervention on the indicated side.	Indicates that the system is available or ready to provide a warning or intervention on the indicated side.	Indicates that the system is providing or has just provided a lane keeping aid intervention.	Indicates that the system is providing or has just provided a lane keeping alert warning.

# Lane Keeping System

---

## LANE KEEPING SYSTEM – TROUBLESHOOTING

### LANE KEEPING SYSTEM – INFORMATION MESSAGES

Message	Action
Lane Keeping Sys. Malfunction Service Required	The system has malfunctioned. Have your vehicle checked as soon as possible.
Front Camera Temporarily Not Available	The system has detected a condition that has caused the system to be temporarily unavailable.
Front Camera Low Visibility Clean Screen	The system has detected a condition that requires you to clean the windshield in order for it to operate properly.
Front Camera Malfunction Service Required	The system has malfunctioned. Have your vehicle checked as soon as possible.
Keep Hands on Steering Wheel	The system requests that you keep your hands on the steering wheel.

# Lane Keeping System

## LANE KEEPING SYSTEM – FREQUENTLY ASKED QUESTIONS

<b>Why is the feature not available (lane markings are gray) when I can see the lane markings on the road?</b>
Your vehicle speed is less than 40 mph (65 km/h).
The sun is shining directly into the camera lens.
A quick intentional lane change has occurred.
Your vehicle stays too close to the lane markings for an extended interval of time.
Driving at high speeds in curves.
The last alert warning or aid intervention occurred a short time ago.
Ambiguous lane markings, for example, in construction zones.
Rapid transition from light to dark, or from dark to light.
Sudden offset in lane markings.
ABS or AdvanceTrac™ is active.
There is a camera blockage due to dirt, grime, fog, frost or water on the windshield.
You are driving too close to the vehicle in front of you.
Transitioning between no lane markings to lane markings, or vice versa.
There is standing water on the road.
Faint lane markings, for example, partial yellow lane markings on concrete roads.

# Lane Keeping System

---

<b>Why is the feature not available (lane markings are gray) when I can see the lane markings on the road?</b>
--

Lane width is too narrow or too wide.
---------------------------------------

You have not calibrated the camera after a windshield replacement.
--

Driving on tight or on uneven roads.
--------------------------------------

<b>Why does the vehicle not come back toward the middle of the lane, as expected, in the Aid, or Aid + Alert mode?</b>
--

High cross winds are present.
-------------------------------

There is a large road crown.
------------------------------

Rough roads, grooves or shoulder drop-offs.
---

Heavy, uneven loading of the vehicle or improper tire inflation pressure.
---

You changed the tires or modified the suspension.
---

# Blind Spot Information System

## WHAT IS BLIND SPOT INFORMATION SYSTEM

Blind spot information system detects vehicles that may have entered the blind spot zone.

## HOW DOES BLIND SPOT INFORMATION SYSTEM WORK

Blind spot information system uses sensors on both sides of your vehicle, detecting rearward from the exterior mirrors to approximately 13 ft (4 m) beyond the rear bumper. The detection area extends to approximately 59 ft (18 m) beyond the rear bumper when the vehicle speed is greater than 30 mph (48 km/h) to alert you of faster approaching vehicles.

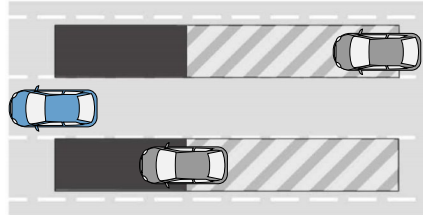

## BLIND SPOT INFORMATION SYSTEM PRECAUTIONS

**WARNING:** Do not use the blind spot information system as a replacement for using the interior and exterior mirrors or looking over your shoulder before changing lanes. The blind spot information system is not a replacement for careful driving.

**WARNING:** The system may not operate properly during severe weather conditions, for example snow, ice, heavy rain and spray. Always drive with due care and attention. Failure to take care may result in a crash.

**Note:** *Blind spot information system does not prevent contact with other vehicles. It does not detect parked vehicles, pedestrians, animals or other infrastructure.*

## BLIND SPOT INFORMATION SYSTEM LIMITATIONS

Blind spot information system does not operate in park (P) or reverse (R).

The system may not alert you if a vehicle quickly passes through the detection zone.

# Blind Spot Information System

**Note:** *The system may not correctly operate when towing a trailer. For vehicles with a trailer tow module and tow bar approved by us, the system turns off when you attach a trailer. For vehicles with an aftermarket trailer tow module or tow bar, we recommend that you switch the system off when you attach a trailer.*

## BLIND SPOT INFORMATION SYSTEM REQUIREMENTS

Blind spot information system turns on when all the following occur:

- You start your vehicle.
- You shift into drive (D).
- The vehicle speed is greater than 6 mph (10 km/h).

## SWITCHING BLIND SPOT INFORMATION SYSTEM ON AND OFF

To switch blind spot information system on or off, use the instrument cluster display:

1. Using the instrument cluster display controls on the steering wheel, select **SETTINGS**.
2. Select **Driver assistance**.
3. Switch **Blindspot** on or off.

When you switch blind spot information system off, a warning lamp illuminates and a message displays. When you switch the system on or off, the alert indicators flash twice.

**Note:** *The system remembers the last setting when you start your vehicle.*

To permanently switch the system off, contact an authorized dealer.

## LOCATING THE BLIND SPOT INFORMATION SYSTEM SENSORS

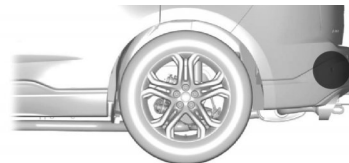

The sensors are behind the rear bumper on both sides of your vehicle.

**Note:** *Keep the sensors free from snow, ice and large accumulations of dirt.*

**Note:** *Do not cover the sensors with bumper stickers, repair compound or other objects.*

**Note:** *Blocked sensors may affect system accuracy.*

If the sensors become blocked, a message may appear in the information display. The alert indicators remain illuminated but the system does not alert you.

# Blind Spot Information System

## BLIND SPOT INFORMATION SYSTEM INDICATORS



When blind spot information system detects a vehicle, an alert indicator illuminates in the exterior mirror on the side the approaching vehicle is coming from. If you turn the turn signal on for that side of your vehicle, the alert indicator flashes.

## BLIND SPOT INFORMATION SYSTEM – TROUBLESHOOTING

## BLIND SPOT INFORMATION SYSTEM – INFORMATION MESSAGES

Message	Action
Blind Spot System Fault	A fault with the system has occurred. Have your vehicle checked as soon as possible.
Blind Spot Not Available Sensor Blocked See Manual	Something is blocking the sensors. Clean the sensors.
Blind Spot Alert Deactivated Trailer Attached	The system automatically turns off and displays this message when you connect a trailer to the vehicle that does not have a trailer blind spot system or when you switch the trailer blind spot system off through the touchscreen.

# Cross Traffic Alert

## WHAT IS CROSS TRAFFIC ALERT

The system alerts you of vehicles approaching from the sides behind your vehicle when you shift into reverse (R).

## HOW DOES CROSS TRAFFIC ALERT WORK

Cross traffic alert detects vehicles that approach at a speed between 4–37 mph (6–60 km/h). Coverage decreases when the sensors are partially, mostly or fully obstructed.

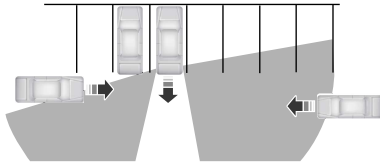

The sensor on the left-hand side is only partially obstructed and zone coverage on the right-hand side is maximized.

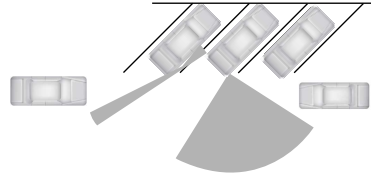

Zone coverage also decreases when parking at narrow angles. The sensor on the left-hand side is mostly obstructed and zone coverage on that side is severely reduced.

**Note:** *Slowly reversing helps increase the coverage area and effectiveness.*

## CROSS TRAFFIC ALERT PRECAUTIONS



**WARNING:** Do not use the cross traffic alert system as a replacement for using the interior and exterior mirrors or looking over your shoulder before reversing out of a parking space. The cross traffic alert system is not a replacement for careful driving.



**WARNING:** The system may not operate properly during severe weather conditions, for example snow, ice, heavy rain and spray. Always drive with due care and attention. Failure to take care may result in a crash.



# Cross Traffic Alert

## CROSS TRAFFIC ALERT LIMITATIONS

Cross traffic alert may not correctly operate when any of the following occur:

- Something is blocking the sensors.
- Adjacently parked vehicles or objects are obstructing the sensors.
- Vehicles approach at speeds less than 4 mph (6 km/h) or greater than 37 mph (60 km/h).
- Your vehicle speed is greater than 7 mph (12 km/h).
- You reverse out of an angled parking space.

## SWITCHING CROSS TRAFFIC ALERT ON AND OFF

To switch cross traffic alert on or off use the instrument cluster display:

1. Using the instrument cluster display controls on the steering wheel, select **SETTINGS**.

2. Select **Driver assistance**.
3. Switch **Cross traffic alert** on or off.

## LOCATING THE CROSS TRAFFIC ALERT SENSORS

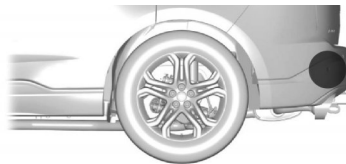

The sensors are behind the rear bumper on both sides of your vehicle.

**Note:** Keep the sensors free from snow, ice and large accumulations of dirt.

**Note:** Do not cover the sensors with bumper stickers, repair compound or other objects.

**Note:** Blocked sensors could affect system performance.

**Note:** Bike and cargo racks could cause false alerts due to obstruction of the sensor. We recommend switching the feature off when using a bike or cargo rack.

If the sensors are blocked, a message may appear in the information display when you shift into reverse (R).

## CROSS TRAFFIC ALERT INDICATORS



When the cross traffic alert detects an approaching vehicle, a tone sounds, a warning lamp illuminates in the relevant exterior mirror and arrows appear in the information display to show which side the vehicle is approaching from.

If the system malfunctions, a warning lamp illuminates in the instrument cluster and a message appears in the information display. Have your vehicle checked as soon as possible.

**Note:** If arrows do not display, a message appears in the information display.

# Cross Traffic Alert

---

**Note:** *In some conditions, the system could alert you, even when there is nothing in the detection zone, for example a vehicle passing further away from your vehicle.*

## CROSS TRAFFIC ALERT – TROUBLESHOOTING

### CROSS TRAFFIC ALERT – INFORMATION MESSAGES

Message	Action
Cross Traffic Alert	Displays instead of indication arrows when the system detects a vehicle. Check for approaching traffic.
Cross Traffic Not Available Sensor Blocked See Manual	Indicates blocked cross traffic alert system sensors. Clean the sensors. If the message continues to appear, have your vehicle checked as soon as possible.
Cross Traffic System Fault	The system has malfunctioned. Have your vehicle checked as soon as possible.
Cross Traffic Alert Deactivated Trailer Attached	Displays if you attach a trailer to your vehicle.

# Pre-Collision Assist

## WHAT IS PRE-COLLISION ASSIST

Pre-collision assist detects and warns of approaching hazards in the roadway. If your vehicle is rapidly approaching another stationary vehicle, a vehicle traveling in the same direction as yours, or a pedestrian within your driving path, the system provides multiple levels of assistance to help avoid a collision.

## HOW DOES PRE-COLLISION ASSIST WORK

The system warns the driver of potential hazards by providing three levels of assistance.



If your vehicle is rapidly approaching potential hazards, the system provides the following levels of functionality:

1. Alert.
2. Brake Support.

3. Automatic Emergency Braking.

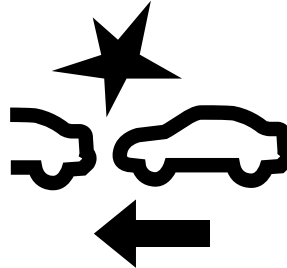

**Alert:** When active, a flashing visual warning appears and an audible warning tone sounds.

**Brake Support:** The system is designed to help reduce the impact speed by preparing the brakes for rapid braking. The system does not automatically apply the brakes. If you press the brake pedal, the system could apply additional braking up to maximum braking force, even if you lightly press the brake pedal.

**Automatic Emergency Braking:** Automatic emergency braking could activate if the system determines that a collision is imminent.

**Note:** *If you perceive pre-collision assist alerts as being too frequent or disturbing, then you could reduce the alert sensitivity. The manufacturer recommends using the highest sensitivity setting where possible. Setting a lower sensitivity would lead to fewer and later system warnings.*

Each system has various levels of detection capabilities. See **Pre-Collision Assist Limitations** (page 284).

# Pre-Collision Assist

## PRE-COLLISION ASSIST PRECAUTIONS

 **WARNING:** You are responsible for controlling your vehicle at all times. The system is designed to be an aid and does not relieve you of your responsibility to drive with due care and attention. Failure to follow this instruction could result in the loss of control of your vehicle, personal injury or death.

 **WARNING:** The system does not detect vehicles moving in a different direction or animals. Apply the brakes when necessary. Failure to follow this instruction could result in the loss of control of your vehicle, personal injury or death.

 **WARNING:** The system does not operate during hard acceleration or steering. Failure to take care may lead to a crash or personal injury.

 **WARNING:** The system may fail or operate with reduced function during cold and severe weather conditions. Snow, ice, rain, spray and fog can adversely affect the system. Keep the front camera and radar free of snow and ice. Failure to take care may result in the loss of control of your vehicle, serious personal injury or death.

 **WARNING:** Take additional care if your vehicle is heavily loaded or you are towing a trailer. These conditions could result in reduced performance of this system. Failure to follow this instruction could result in the loss of control of your vehicle, personal injury or death.

 **WARNING:** The system cannot help prevent all crashes. Do not rely on this system to replace driver judgment and the need to maintain a safe distance and speed.

 **WARNING:** In situations where the vehicle camera has limited detection capability, this may reduce system performance. These situations include but are not limited to direct or low sunlight, vehicles at night without tail lights, unconventional vehicle types, pedestrians with complex backgrounds, running pedestrians, partly obscured pedestrians, or pedestrians that the system cannot distinguish from a group. Failure to take care may result in the loss of control of your vehicle, serious personal injury or death.

## PRE-COLLISION ASSIST LIMITATIONS

Pre-collision assist depends on the detection ability of its camera and sensors. Any obstructions or damage to these areas can limit detection or prevent the system from functioning. See **Locating the Pre-Collision Assist Sensors** (page 285).

# Pre-Collision Assist

The system is active at speeds above 3 mph (5 km/h)

**Note:** The pre-collision assist system disables when you select four-wheel drive low or manually disable AdvanceTrac™.

**Note:** Brake support and automatic emergency braking are active at speeds up to 80 mph (130 km/h). If the vehicle has a radar sensor included with adaptive cruise control, then brake support and automatic emergency braking are active up to the maximum speed of the vehicle.

## Pedestrian Detection Limitations

Pedestrian detection is active at speeds up to 50 mph (80 km/h).

Pedestrian detection functions optimally when detected hazards are clearly identifiable. System performance may reduce in situations where pedestrians are running, partly obscured, have a complex background, or cannot be distinguished from a group.

## LOCATING THE PRE-COLLISION ASSIST SENSORS

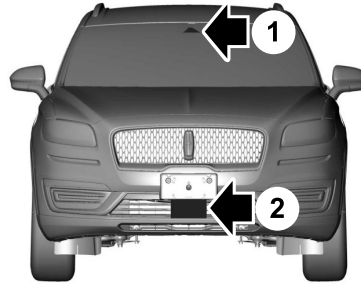

- 1 Camera.
- 2 Radar sensor (if equipped).

If a message regarding a blocked sensor or camera appears in the information display, something is obstructing the radar signals or camera images. The radar sensor is behind the fascia cover in the center of the lower grille. With a blocked sensor or camera, the system may not function, or performance may reduce. See **Pre-Collision Assist – Information Messages** (page 289).

**Note:** Proper system operation requires a clear view of the road by the camera. Have any windshield damage in the area of the camera's field of view repaired.

**Note:** If something hits the front end of your vehicle or damage occurs and your vehicle has a radar sensor, the radar sensing zone could change. This could cause missed or false vehicle detections. Have your vehicle serviced to have the radar checked for proper coverage and operation.

**Note:** If your vehicle detects excessive heat at the camera or a potential misalignment condition, a message could display in the information display indicating temporary sensor unavailability. When operational conditions are correct, the message deactivates. For example, when the ambient temperature around the sensor decreases or the sensor recalibrates successfully.

# Pre-Collision Assist

## DISTANCE INDICATION (IF EQUIPPED)

Distance indication displays the gap between your vehicle and the vehicle ahead of you.

**Note:** *The graphic does not display if you switch on cruise control or adaptive cruise control.*

## WHAT IS DISTANCE INDICATION

Vehicle Speed	System Sensitivity	Distance Indicator Color	Distance Gap	Time Gap
62 mph (100 km/h).	Normal.	Gray.	Greater than 82 ft (25 m).	Greater than 0.9 seconds.
		Yellow.	56–82 ft (17–25 m).	0.6-0.9 seconds.
		Red.	Less than 56 ft (17 m).	Less than 0.6 seconds.

# Pre-Collision Assist

## SWITCHING DISTANCE INDICATION ON AND OFF

To switch the system on or off, use the instrument cluster display:

1. Using the instrument cluster display controls on the steering wheel, select **SETTINGS**.
2. Select **Driver assistance**.
3. Select **Pre-collision**.
4. Switch **Distance Indication** on or off.

## DISTANCE INDICATION INDICATOR

The indicator displays the time gap between your vehicle and vehicles traveling in the same direction ahead of you.

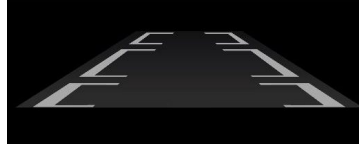

## DISTANCE ALERT (IF EQUIPPED)

### WHAT IS DISTANCE ALERT

The system alerts you with a warning lamp if the distance to the vehicle ahead is small.

**Note:** *The warning lamp does not illuminate if cruise control or adaptive cruise control is active.*

### ADJUSTING THE SENSITIVITY OF DISTANCE ALERT

To adjust the sensitivity of the system, use the instrument cluster display:

1. Using the instrument cluster display controls on the steering wheel, select **SETTINGS**.
2. Select **Driver assistance**.
3. Select **Pre-collision**.
4. Select **Alert sensitivity**.
5. Select a setting.

# Pre-Collision Assist

## AUTOMATIC EMERGENCY BRAKING

### WHAT IS AUTOMATIC EMERGENCY BRAKING

Automatic emergency braking may activate if the system determines that a collision is imminent. The system may help reduce impact damage to avoid the crash completely.

Automatic emergency braking is only available up to certain speeds. See **Pre-Collision Assist Limitations** (page 284).

### SWITCHING AUTOMATIC EMERGENCY BRAKING ON AND OFF

To switch the system on or off, use the instrument cluster display:

1. Using the instrument cluster display controls on the steering wheel, select **SETTINGS**.
2. Select **Driver assistance**.
3. Select **Pre-collision**.

4. Switch **Auto Emergency Braking** on or off.

**Note:** *Automatic emergency braking switches on every time you switch the ignition on.*

## EVASIVE STEERING ASSIST (IF EQUIPPED)

### WHAT IS EVASIVE STEERING ASSIST

If your vehicle is rapidly approaching a road user, evasive steering assist helps you steer around the road user.

After you turn the steering wheel in an attempt to avoid a crash with the road user, the system applies additional steering torque to help you steer around the road user. After you pass the road user, the system applies steering torque when you turn the steering wheel to steer back into the lane. The system deactivates after you fully pass the road user.

**Note:** *Road users are defined as another stationary vehicle in the same lane or a vehicle traveling in the same lane in the same direction as you. See **Pre-Collision Assist Precautions** (page 284).*

## EVASIVE STEERING ASSIST LIMITATIONS

Evasive steering assist only activates when all the following occur:

- Automatic emergency braking and evasive steering assist are on.
- The system detects a road user ahead and starts to apply the brakes.
- You significantly turn the steering wheel to steer around a road user.

**Note:** *Evasive steering assist does not automatically steer around a road user. If you do not turn the steering wheel, evasive steering assist does not activate.*

**Note:** *Evasive steering assist does not activate if the distance to the road user ahead is too small and the system cannot avoid a crash.*

**Note:** *Evasive steering does not activate with cyclists or pedestrians.*



# Pre-Collision Assist

## SWITCHING EVASIVE STEERING ASSIST ON AND OFF

To switch the system on or off, use the touchscreen:

1. Press **Features** on the touchscreen.
2. Press **Driver Assistance**.
3. Press **Pre-Collision Assist**.
4. Switch **Evasive Steering** on or off.

**Note:** *If you switch automatic emergency braking off, evasive steering assist turns off.*

**Note:** *Automatic emergency braking and evasive steering assist turn on every time you switch the ignition on.*

## PRE-COLLISION ASSIST – TROUBLESHOOTING

### PRE-COLLISION ASSIST – INFORMATION MESSAGES

Message	Action
Pre-Collision Assist Not Available Sensor Blocked	You have a blocked sensor due to bad weather, ice, mud or water in front of the radar sensor. You can typically clean the sensor to resolve.
Pre-Collision Assist Not Available	A fault with the system has occurred. Have your vehicle checked as soon as possible.

# Pre-Collision Assist

---

## PRE-COLLISION ASSIST – FREQUENTLY ASKED QUESTIONS

### Camera Troubleshooting

#### **The windshield in front of the camera is dirty or obstructed.**

Clean the outside of the windshield in front of the camera.

#### **The windshield in front of the camera is clean, but the message remains in the instrument cluster display.**

Wait a short time. It could take several minutes for the camera to detect that there is no obstruction.

### Radar Troubleshooting (if Equipped)

#### **The surface of the radar in the grille is dirty or obstructed.**

Clean the grille surface in front of the radar or remove the object causing the obstruction.

#### **The surface of the radar in the grille is clean, but the message remains in the instrument cluster display.**

Wait a short time. It could take several minutes for the radar to detect that there is no obstruction.

#### **Heavy rain, spray or fog is interfering with the radar signals.**

The pre-collision assist system is temporarily disabled. Pre-collision assist reactivates a short time after the weather conditions improve.

#### **Swirling water or snow or ice on the surface of the road could interfere with the radar signals.**

The pre-collision assist system is temporarily disabled. Pre-collision assist reactivates a short time after the weather conditions improve.

#### **Radar is out of alignment due to a front end impact.**

Have your vehicle serviced to have the radar checked for proper coverage and operation.

# Driver Alert

## WHAT IS DRIVER ALERT

Driver alert alerts you if it determines that you are becoming drowsy or if your driving deteriorates.

## HOW DOES DRIVER ALERT WORK

Driver Alert calculates your alertness level based on your driving behavior in relation to the lane markings and other factors through use of the front camera sensor behind the interior mirror.

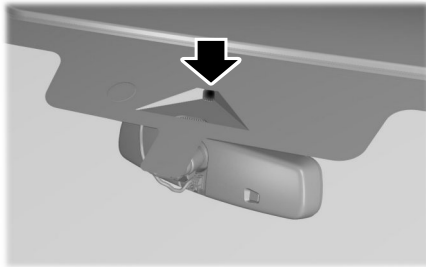



## DRIVER ALERT PRECAUTIONS

 **WARNING:** You are responsible for controlling your vehicle at all times. The system is designed to be an aid and does not relieve you of your responsibility to drive with due care and attention. Failure to follow this instruction could result in the loss of control of your vehicle, personal injury or death.

 **WARNING:** Take regular rest breaks if you feel tired. Do not wait for the system to warn you.

 **WARNING:** Certain driving styles may result in the system warning you even if you are not feeling tired.

 **WARNING:** In cold and severe weather conditions the system may not function. Rain, snow and spray can all limit sensor performance.

 **WARNING:** The system will not operate if the sensor cannot track the road lane markings.

 **WARNING:** If damage occurs in the immediate area surrounding the sensor, have your vehicle checked as soon as possible.

 **WARNING:** The system may not correctly operate if your vehicle is fitted with a suspension kit not approved by us.

 **WARNING:** The system may not operate properly if the sensor is blocked. Keep the windshield free from obstruction.

**Note:** *If something is blocking the camera or damaged the windshield, Driver Alert may not function.*

# Driver Alert

## DRIVER ALERT LIMITATIONS

Driver alert may not function correctly if:

- The sensor cannot track the road lane markings.
- Your vehicle's speed is less than approximately 40 mph (65 km/h).

## SWITCHING DRIVER ALERT ON AND OFF

1. Using the instrument cluster display controls on the steering wheel, select **SETTINGS**.
2. Select **Driver assistance**.
3. Switch **Driver alert** on or off.

**Note:** *The system remains on or off depending on how it was last set.*

## Resetting Driver Alert

You can reset the system by either:

- Switching the ignition off and on.
- Stopping the vehicle and then opening and closing the driver door.

## DRIVER ALERT – TROUBLESHOOTING

## DRIVER ALERT – INFORMATION MESSAGES

Message	Action
Driver Alert Warning Rest Now	Stop and rest as soon as it is safe to do so.
Driver Alert Warning Rest Suggested	Take a rest soon.

# Load Carrying

## LOAD CARRYING PRECAUTIONS

Keep your loaded vehicle weight within its design rating capability, with or without a trailer. Properly loading your vehicle provides maximum return of vehicle design performance. Before you load your vehicle, become familiar with the following terms for determining your vehicle's weight rating, with or without a trailer, from the vehicle's Tire and Loading Information label or Safety Compliance Certification label.



**WARNING:** The appropriate loading capacity of your vehicle can be limited either by volume capacity (how much space is available) or by payload capacity (how much weight the vehicle should carry). Once you have reached the maximum payload of your vehicle, do not add more cargo, even if there is space available. Overloading or improperly loading your vehicle can contribute to loss of vehicle control and vehicle rollover.



**WARNING:** Exceeding the Safety Compliance Certification label vehicle weight limits can adversely affect the performance and handling of your vehicle, cause vehicle damage and can result in the loss of control of your vehicle, serious personal injury or death.



**WARNING:** Do not use replacement tires with lower load carrying capacities than the original tires because they may lower your vehicle's GVWR and GAWR limitations. Replacement tires with a higher limit than the original tires do not increase the GVWR and GAWR limitations.



**WARNING:** Do not exceed the GVWR or the GAWR specified on the certification label.



**WARNING:** Exceeding any vehicle weight rating can adversely affect the performance and handling of your vehicle, cause vehicle damage and can result in the loss of control of your vehicle, serious personal injury or death.



**WARNING:** When loading the roof racks, we recommend you evenly distribute the load, as well as maintain a low center of gravity. Loaded vehicles, with higher centers of gravity, may handle differently than unloaded vehicles. Take extra precautions, such as slower speeds and increased stopping distance, when driving a heavily loaded vehicle.

The gross combined weight must never exceed the Gross Combined Weight Rating.

# Load Carrying

## LOCATING THE SAFETY COMPLIANCE CERTIFICATION LABELS

### Safety Compliance Certification Label Example:

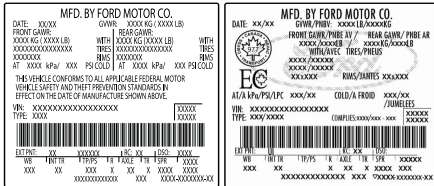

The Safety Compliance Certification label is located on the door hinge pillar, door-latch post, or the door edge that meets the door-latch post, next to the driver seating position.

## WHAT IS THE GROSS AXLE WEIGHT RATING

### GAWR (Gross Axle Weight Rating)

GAWR is the maximum allowable weight that a single axle (front or rear) can carry. These numbers are on the Safety Compliance Certification label.

## WHAT IS THE GROSS VEHICLE WEIGHT RATING

GVWR is the maximum allowable weight of the fully loaded vehicle. This includes all options, equipment, passengers and cargo. It appears on the Safety Compliance Certification label.

## WHAT IS THE MAXIMUM LOADED TRAILER WEIGHT

Maximum loaded trailer weight is the highest possible weight of a fully loaded trailer the vehicle can tow. Consult an authorized dealer (or the RV and Trailer Towing Guide available at an authorized dealer) for more detailed information. See **Towing a Trailer** (page 304).

## WHAT IS THE GROSS COMBINED WEIGHT RATING

Gross Combined Weight Rating (GCWR) is the maximum allowable weight of the vehicle and the loaded trailer, including all cargo and passengers, that the vehicle can handle without risking damage. (Important: The towing vehicle's braking system is rated for operation at Gross Vehicle Weight Rating, not at Gross Combined Weight

# Load Carrying

---

Rating.) Separate functional brakes should be used for safe control of towed vehicles and for trailers where the Gross Combined Weight of the towing vehicle

plus the trailer exceed the Gross Vehicle Weight Rating of the towing vehicle.

**Note:** For trailer towing information refer to the *RV and Trailer Towing Guide* available at an authorized dealer, or online at the website that follows.

<b>RV &amp; Trailer Towing Guide Online</b>	
Website	<a href="http://www.fleet.ford.com/towing-guides">www.fleet.ford.com/towing-guides</a>

# Load Carrying

## CALCULATING PAYLOAD

### Tire and Loading Label Information Example:



#### TIRE AND LOADING INFORMATION

SEATING CAPACITY TOTAL : 5 FRONT: 2 REAR: 3

The combined weight of occupants and cargo should never exceed **385 kg or 850 lbs.**

TIRE	SIZE	COLD TIRE PRESSURE	SEE OWNERS MANUAL FOR ADDITIONAL INFORMATION
FRONT	235/45R18 94V	235 KPA, 34 PSI	
REAR	235/45R18 94V	235 KPA, 34 PSI	
SPARE	NONE	NONE	



#### TIRE AND LOADING INFORMATION RENSEIGNEMENTS SUR LES PNEUS ET LE CHARGEMENT

SEATING CAPACITY TOTAL 5 FRONT 2 REAR 3  
NOMBRE DE PLACES AVANT ARRIERE 3

The combined weight of occupants and cargo should never exceed **396 kg or 875 lbs.**  
Le poids total des occupants et du chargement ne doit jamais dépasser **396 kg ou 875 lbs.**

TIRE PNEU	SIZE DIMENSIONS	COLD TIRE PRESSURE PRESSION DES PNEUS A FROID	SEE OWNER'S MANUAL FOR ADDITIONAL INFORMATION VOIR LE MANUEL DE L'USAGER POUR PLUS DE RENSEIGNEMENTS
FRONT AVANT	235/40R19 96V	255 KPA, 37 PSI	
REAR ARRIERE	235/40R19 96V	255 KPA, 37 PSI	
SPARE DE SECOURS	T125/80R16 97M	415 KPA, 60 PSI	

Payload is the combined weight of cargo and passengers that your vehicle is carrying. The maximum payload for your vehicle appears on the Tire and Loading label. The label is either on the B-pillar or the edge of the driver door. Vehicles exported outside the US and Canada may not have a tire and loading label. Look for "The combined weight of occupants and cargo should never exceed XXX kg or XXX lb" for maximum payload. The payload listed on the Tire and Loading Information label is the maximum payload for your vehicle as built by the assembly plant. If you install any additional equipment on your vehicle, you must determine the new payload. Subtract the weight of the equipment from the payload listed on the Tire and Loading label. When towing, trailer tongue weight or king pin weight is also part of payload.

## CALCULATING THE LOAD LIMIT

Steps for determining the correct load limit:

1. Locate the statement "The combined weight of occupants and cargo should never exceed XXX kg or XXX lb." on your vehicle's placard.
2. Determine the combined weight of the driver and passengers that will be riding in your vehicle.
3. Subtract the combined weight of the driver and passengers from XXX kg or XXX lb.
4. The resulting figure equals the available amount of cargo and luggage load capacity. For example, if the "XXX" amount equals 1,400 lb. and there will be five 150 lb. passengers in your vehicle, the amount of available cargo and luggage load capacity is 650 lb.  $(1400 - 750 (5 \times 150) = 650 \text{ lb.})$
5. Determine the combined weight of luggage and cargo being loaded on the vehicle. That weight may not safely exceed the available cargo and luggage load capacity calculated in Step 4.



# Load Carrying

6. If your vehicle will be towing a trailer, load from your trailer will be transferred to your vehicle. Consult this manual to determine how this reduces the available cargo and luggage load capacity of your vehicle.

## Helpful examples for calculating the available amount of cargo and luggage load capacity

Suppose your vehicle has a 1400-pound (635-kilogram) cargo and luggage capacity. You decide to go golfing. Is there enough load capacity to carry you, four of your friends and all the golf bags? You and four friends average 220 pounds (99 kilograms) each and the golf bags weigh approximately 30 pounds (13.5 kilograms) each. The calculation would be:  $1400 - (5 \times 220) - (5 \times 30) = 1400 - 1100 - 150 = 150$  pounds. Yes, you

have enough load capacity in your vehicle to transport four friends and your golf bags. In metric units, the calculation would be:  $635 \text{ kilograms} - (5 \times 99 \text{ kilograms}) - (5 \times 13.5 \text{ kilograms}) = 635 - 495 - 67.5 = 72.5$  kilograms.

Suppose your vehicle has a 1400-pound (635-kilogram) cargo and luggage capacity. You and one of your friends decide to pick up cement from the local home improvement store to finish that patio you have been planning for the past two years. Measuring the inside of the vehicle with the rear seat folded down, you have room for twelve 100-pound (45-kilogram) bags of cement. Do you have enough load capacity to transport the cement to your home? If you and your friend each weigh 220 pounds (99 kilograms), the calculation would be:  $1400 - (2 \times 220) - (12 \times 100) = 1400 - 440 - 1200 = -240$  pounds. No, you do not have enough cargo capacity to carry that much weight. In metric units, the calculation would be:  $635 \text{ kilograms} - (2 \times 99 \text{ kilograms}) - (12 \times 45 \text{ kilograms}) = 635 -$

$198 - 540 = -103$  kilograms. You will need to reduce the load weight by at least 240 pounds (104 kilograms). If you remove three 100-pound (45-kilogram) cement bags, then the load calculation would be:  $1400 - (2 \times 220) - (9 \times 100) = 1400 - 440 - 900 = 60$  pounds. Now you have the load capacity to transport the cement and your friend home. In metric units, the calculation would be:  $635 \text{ kilograms} - (2 \times 99 \text{ kilograms}) - (9 \times 45 \text{ kilograms}) = 635 - 198 - 405 = 32$  kilograms.

The above calculations also assume that the loads are positioned in your vehicle in a manner that does not overload the front or the rear gross axle weight rating specified for your vehicle on the Safety Compliance Certification label.

# Load Carrying

## ROOF RACK (IF EQUIPPED)

### ROOF RACK PRECAUTIONS



**WARNING:** Read and follow the manufacturer's instructions when you are fitting a roof rack.



**WARNING:** When loading the roof racks, we recommend you evenly distribute the load, as well as maintain a low center of gravity. Loaded vehicles, with higher centers of gravity, may handle differently than unloaded vehicles. Take extra precautions, such as slower speeds and increased stopping distance, when driving a heavily loaded vehicle.

**Note:** *If you use a roof rack, the fuel consumption of your vehicle will be higher and you may experience different driving characteristics.*

You must place loads directly on the crossbars fitted to the roof rack side rails. When using the roof rack system, we recommend that you use genuine Ford Motor Company accessory crossbars specifically designed for your vehicle.

Make sure that you securely fasten the load. Check the tightness of the load before driving and at each fuel stop.

### ROOF RACK LOAD CAPACITIES

Do not install crossbars if your vehicle has a moonroof. Do not place any load on your vehicle if it has a moonroof. Using crossbars or loading the vehicle roof may void your vehicle's warranty.

Description	Maximum Recommended Load
Vehicles with a moonroof	0 lb (0 kg)
Vehicles without a moonroof	100 lb (45 kg)

**Note:** *The maximum roof load is based on the load being evenly distributed on the crossbars.*

# Load Carrying

---

**Note:** *When using a roof rack system, you must subtract the weight of the roof rack system from the maximum recommended load to determine your actual maximum cargo load. See the roof rack system manufacturer for more information.*

# Luggage Compartment

## INSTALLING AND REMOVING THE LUGGAGE COMPARTMENT CARGO NET

 **WARNING:** This net is not designed to restrain objects during a collision or heavy braking.

Attach the net to the anchors. Repeat the attachment on both sides of the vehicle.

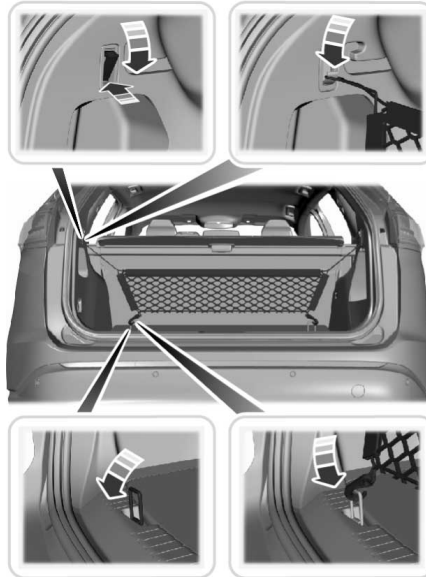

## INSTALLING AND REMOVING THE LUGGAGE COMPARTMENT COVER

(IF EQUIPPED)

 **WARNING:** Do not place objects on the luggage cover. Failure to follow this instruction could result in personal injury or death in the event of a sudden stop or crash.

Use the luggage cover to conceal items in the luggage compartment.

# Luggage Compartment

## Installing the Luggage Cover

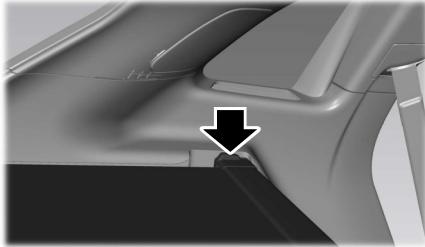

The luggage cover cassette attaches to the rear quarter trim panel.

1. Load the cassette into the rear quarter trim from the top down.
2. Push the cassette down, the click indicates the luggage cover is properly installed.

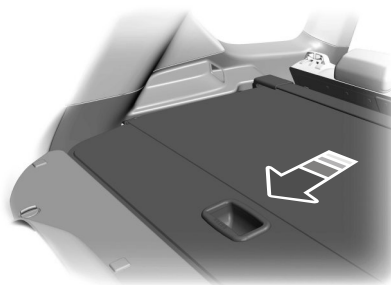

3. Pull the cover straight back until it locks.

## Removing the Luggage Cover

1. To release the cover, tap the center of the board by the pull handle.

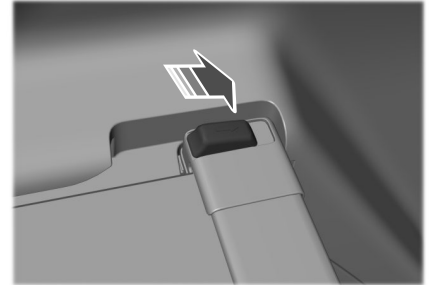

2. To release the cassette from the rear quarter trim panel, slide the button forward.
3. After sliding the button forward, lift the cassette up.

**Note:** *There are buttons on both sides of the cassette.*

# Connecting a Trailer

## CONNECTING A TRAILER PRECAUTIONS

Do not tow a trailer until you drive your vehicle at least 1,000 mi (1,600 km).

Consult your local motor vehicle laws for towing a trailer.

See the instructions included with towing accessories for the proper installation and adjustment specifications.

Service your vehicle more frequently if you tow a trailer. See **Normal Scheduled Maintenance** (page 467).

If you use a rental trailer, follow the instructions the rental agency gives you.

When attaching the trailer wiring connector to your vehicle, only use a proper fitting connector that works with the vehicle and trailer functions.

Account for the trailer coupler weight as part of your vehicle load when calculating the total vehicle weight.

Do not exceed the load limits. See **Calculating the Load Limit** (page 296).

## CONNECTING A TRAILER

### Trailer Towing Connector (If Equipped)

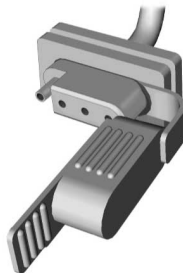

When attaching the trailer wiring connector to your vehicle, only use a proper fitting connector that works with the vehicle and trailer functions.

**Note:** *Install the waterproof protection cap back onto the trailer towing connector whenever it is not in use. This helps to prevent water damage and trailer towing connector malfunction.*

**Note:** *You cannot use a seven-pin trailer wiring connector for your vehicle and the trailer lighting equipment.*

### Trailer Lamps



**WARNING:** Never connect any trailer lamp wiring to the vehicle's tail lamp wiring; this may damage the electrical system resulting in fire. Contact your authorized dealer as soon as possible for assistance in proper trailer tow wiring installation. Additional electrical equipment may be required.

Trailer lamps are required on most towed vehicles. Make sure all running lights, brake lights, turn signals and hazard lights are working.

### Safety Chains

**Note:** *Do not attach safety chains to the bumper. Always connect the safety chains to the frame or hook retainers of your trailer hitch.*

## Connecting a Trailer

---

Install trailer safety chains to the trailer hitch as recommended by the manufacturer. Cross the chains under the trailer coupler and allow enough slack for turning tight corners. Do not allow the chains to drag on the ground.

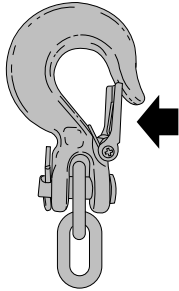



If the trailer safety chain hook has a latch, make sure the latch is fully closed.

# Towing a Trailer

## TOWING A TRAILER PRECAUTIONS

 **WARNING:** Do not exceed the GVWR or the GAWR specified on the certification label.

 **WARNING:** Towing trailers beyond the maximum recommended gross trailer weight exceeds the limit of your vehicle and could result in engine damage, transmission damage, structural damage, loss of vehicle control, vehicle rollover and personal injury.

 **WARNING:** Do not exceed the lowest rating capacity for your vehicle or trailer hitch. Overloading your vehicle or trailer hitch can impair your vehicle stability and handling. Failure to follow this instruction could result in the loss of control of your vehicle, personal injury or death.

 **WARNING:** Make sure that the vertical load on the tow ball is between the minimum and maximum recommended weight at all times. Failure to follow this instruction could result in the loss of control of your vehicle, personal injury or death.

 **WARNING:** Do not cut, drill, weld or modify the trailer hitch. Modifying the trailer hitch could reduce the hitch rating.

 **WARNING:** The anti-lock brake system does not control the trailer brakes.

## TRAILER BRAKE PRECAUTIONS

 **WARNING:** Do not connect a trailer's hydraulic brake system directly to your vehicle's brake system. Your vehicle may not have enough braking power and your chances of having a collision greatly increase.

 **WARNING:** Do not tow a trailer fitted with electric trailer brakes unless your vehicle is fitted with a compatible aftermarket electronic trailer brake controller. Failure to follow this instruction could result in the loss of control of your vehicle, personal injury or death. For additional information and assistance, we recommend that you contact an authorized dealer.

Electric brakes and manual, automatic or surge-type trailer brakes are safe if you install them properly and adjust them to the manufacturer's specifications. The trailer brakes must meet local and federal regulations.



# Towing a Trailer

---

The rating for the tow vehicle's braking system operation is at the gross vehicle weight rating, not the gross combined weight rating.

Certain states require functioning trailer brakes for trailers over a specified weight. Be sure to check state regulations for this specified weight.

Ford Motor Company recommends separate functioning brake systems for trailers weighing more than 1,500 lb (680 kg) when loaded.

## TOWING A TRAILER LIMITATIONS

The vehicle's load capacity designation is by weight, not by volume, so you cannot necessarily use all available space when loading a vehicle or trailer.

**Note:** *Your vehicle could have reduced performance when operating at high altitudes and when heavily loaded or towing a trailer. When driving at elevation, to match driving performance as perceived at sea level, reduce gross vehicle weight and gross combination weight by 2% per 1,000 ft (300 m) elevation.*

## LOADING YOUR TRAILER

To help minimize how trailer movement affects your vehicle when driving:

- Load the heaviest items closest to the trailer floor.
- Load the heaviest items centered between the left and right side trailer tires.

- Load the heaviest items above the trailer axles or just slightly forward toward the trailer tongue. Do not allow the final trailer tongue weight to go above or below 10-15% of the loaded trailer weight. The trailer tongue weight should never exceed 10% of the maximum towing capacity.
- Select a ball mount with the correct rise or drop. When both the loaded vehicle and trailer are connected, the trailer frame should be level, or slightly angled down toward your vehicle, when viewed from the side.

## TRAILER TOWING HINTS

Towing a trailer places an extra load on your vehicle's engine, transmission, axle, brakes, tires and suspension. Periodically inspect these components during and after any towing operation.

When driving with a trailer or payload, a slight takeoff vibration or shudder may be present due to the increased payload weight.

# Towing a Trailer

---

Your vehicle may have a temporary or conventional spare tire. A temporary spare tire is different in diameter or width, tread-type, or is from a different manufacturer than the road tires on your vehicle. Consult information on the tire label or Safety Compliance label for limitations when using.

When towing a trailer:

- Obey country specific regulations for towing a trailer.
- Do not drive faster than 70 mph (113 km/h) during the first 500 mi (800 km).
- Do not make full-throttle starts.
- Check your hitch, electrical connections and trailer wheel lug nuts thoroughly after you have traveled 50 mi (80 km).
- When stopped in congested or heavy traffic during hot weather, place the transmission in park (P) to aid engine and transmission cooling and to help A/C performance.
- Turn off the speed control with heavy loads or in hilly terrain. The speed control may turn off when you are towing on long, steep slopes.
- Shift to a lower gear when driving down a long or steep hill. Do not continuously apply the brakes, as they may overheat and become less effective.
- If your transmission has Grade Assist or Tow/Haul, use this feature when towing. This provides engine braking and helps eliminate excessive transmission shifting for optimum fuel economy and transmission cooling.
- Your vehicle has AdvanceTrac with roll stability control. When towing a trailer, additional loads could cause the AdvanceTrac system to engage during cornering maneuvers. Reduce cornering speeds to make sure that you can maintain control of the vehicle and trailer if the AdvanceTrac system engages.
- Allow more distance for stopping with a trailer attached. Anticipate stops and gradually brake.
- Avoid parking on a slope. However, if you must park on a slope, turn the steering wheel to point your vehicle tires away from traffic flow, set the parking brake, place the transmission in park (P) and place wheel chocks in front and back of the trailer wheels.

**Note:** *Chocks are not included with your vehicle.*

## LAUNCHING OR RETRIEVING A BOAT OR PERSONAL WATERCRAFT

When backing down a ramp during boat launching or retrieval:

- Do not allow the static water level to rise above the bottom edge of the rear bumper.
- Do not allow waves to break higher than 6 in (15 cm) above the bottom edge of the rear bumper.

# Towing a Trailer

Exceeding 6 in (15 cm) could allow water to enter vehicle components, causing internal damage to the components and affecting driveability, emissions and reliability.

**Note:** *Replace the rear axle lubricant anytime the rear axle has been submerged in water.*

**Note:** *Disconnect the trailer wiring connector before backing the trailer into the water.*

**Note:** *Reconnect the trailer wiring connector after removing the trailer from the water.*

## TOWING WEIGHTS AND DIMENSIONS

### RECOMMENDED TOWING WEIGHTS - 2.0L

Drivetrain	Maximum Trailer Weight	Maximum Trailer Frontal Area
FWD	1,500 lb (680 kg) <sup>1</sup>	20 ft <sup>2</sup> (1.86 m <sup>2</sup> )
AWD	1,500 lb (680 kg) <sup>1</sup>	20 ft <sup>2</sup> (1.86 m <sup>2</sup> )
FWD	3,500 lb (1,587 kg) <sup>2</sup>	30 ft <sup>2</sup> (2.79 m <sup>2</sup> )
AWD	3,500 lb (1,587 kg) <sup>2</sup>	30 ft <sup>2</sup> (2.79 m <sup>2</sup> )

<sup>1</sup> Vehicle without towing package.

<sup>2</sup> Vehicle with towing package.

**Note:** *All values calculated with SAE J2807 method.*

# Towing a Trailer

## RECOMMENDED TOWING WEIGHTS - 2.7L

Drivetrain	Maximum Trailer Weight	Maximum Trailer Frontal Area
AWD	2,000 lb (907 kg) <sup>1</sup>	20 ft <sup>2</sup> (1.86 m <sup>2</sup> )
AWD	3,500 lb (1,587 kg) <sup>2</sup>	30 ft <sup>2</sup> (2.79 m <sup>2</sup> )

<sup>1</sup> Vehicle without towing package.

<sup>2</sup> Vehicle with towing package.

**Note:** All values calculated with SAE J2807 method.

## WHAT IS THE MAXIMUM LOADED TRAILER WEIGHT

The maximum loaded trailer weight is the highest possible weight of a fully loaded trailer the vehicle can tow.

## CALCULATING THE MAXIMUM LOADED TRAILER WEIGHT FOR YOUR VEHICLE

1. Start with the gross combined weight rating for your vehicle model and axle ratio.
2. Subtract all of the following that apply to your vehicle:
  - Vehicle curb weight.
  - Hitch hardware weight, for example a draw bar, ball, locks or weight distributing hardware.
  - Driver weight.

- Passenger weight.
- Payload, cargo and luggage weight.
- Aftermarket equipment weight.

This equals the maximum loaded trailer weight for this combination.

**Note:** The trailer tongue load is considered part of the payload for your vehicle. Reduce the total payload by the final trailer tongue weight.

**Note:** Consult an authorized dealer to determine the maximum trailer weight allowed for your vehicle if you are not sure.

# Trailer Sway Control

## HOW DOES TRAILER SWAY CONTROL WORK

The system applies the brakes to the individual wheels and reduces engine torque to aid vehicle stability.

If the trailer begins to sway, the stability control lamp flashes and the message **Trailer Sway Reduce Speed** appears in the information display.

Stop your vehicle as soon as it is safe to do so. Check the vertical weight on the tow ball and trailer load distribution.

## TRAILER SWAY CONTROL PRECAUTIONS



**WARNING:** Turning off trailer sway control increases the risk of loss of vehicle control, serious injury or death. Ford does not recommend disabling this feature except in situations where speed reduction may be detrimental (such as hill climbing), the driver has significant trailer towing experience, and can control trailer sway and maintain safe operation.

**Note:** *This feature only activates when significant trailer sway occurs.*

**Note:** *This feature does not prevent trailer sway, but reduces it once it begins.*

**Note:** *This feature cannot stop all trailers from swaying.*

**Note:** *In some cases, if vehicle speed is too high, the system may activate multiple times, gradually reducing vehicle speed.*

## SWITCHING TRAILER SWAY CONTROL ON AND OFF

1. Press **Features** on the touchscreen.
2. Press **Towing**.
3. Switch **Trailer Sway Control** on or off.

The system turns on each time you start your vehicle.

# Driving Hints

## REDUCED ENGINE PERFORMANCE



**WARNING:** If you continue to drive your vehicle when the engine is overheating, the engine could stop without warning. Failure to follow this instruction could result in the loss of control of your vehicle.

If the engine coolant temperature gauge needle moves to the upper limit position, the engine is overheating. See **Engine Coolant Temperature Gauge** (page 141).

You must only drive your vehicle for a short distance if the engine overheats. The distance you can travel depends on ambient temperature, vehicle load and terrain. The engine continues to operate with limited power for a short period of time.

If the engine temperature continues to rise, the fuel supply to the engine reduces. The air conditioning switches off and the engine cooling fan operates continually.

1. Gradually reduce your speed and stop your vehicle as soon as it is safe to do so.
2. Immediately switch the engine off to prevent severe engine damage.
3. Wait for the engine to cool down.
4. Check the coolant level. See **Checking the Coolant** (page 347).
5. Have your vehicle checked as soon as possible.

## COLD WEATHER PRECAUTIONS

The functional operation of some components and systems can be affected at temperatures below approximately -13°F (-25°C).

## BREAKING-IN

You need to break in new tires for approximately 300 mi (480 km). During this time, your vehicle may exhibit some unusual driving characteristics.

## DRIVING ECONOMICALLY

The following helps to improve fuel consumption:

- Drive smoothly, accelerate gently and anticipate the road ahead to avoid heavy braking.
- Regularly check your tire pressures and make sure that they are inflated to the correct pressure.
- Follow the recommended maintenance schedule and carry out the recommended checks.
- Plan your journey and check the traffic before you set off. It is more efficient to combine errands into a single trip whenever possible.
- Avoid idling the engine in cold weather or for extended periods. Start the engine only when you are ready to set off.
- Do not carry unnecessary weight in your vehicle as extra weight wastes fuel.

# Driving Hints

---

- Do not add unnecessary accessories to the exterior of your vehicle, for example running boards. If you use a roof rack, remember to fold it down or remove it when not in use.
- Do not shift into neutral when you are braking or when your vehicle is slowing down.
- Shut all windows when driving at high speeds.
- Switch off all electric systems when not in use, for example air conditioning. Make sure that you unplug any accessories from the auxiliary power points when not in use.

## DRIVING IN SPECIAL CONDITIONS

### EMERGENCY MANEUVERS

In an unavoidable emergency where you must make a sudden sharp maneuver, turn the steering wheel only as rapidly and as far as required to avoid the emergency. Apply smooth pressure to the accelerator pedal or brake pedal as needed. Avoid abrupt

steering, acceleration and braking changes. Abrupt changes could increase the risk of vehicle roll over, loss of vehicle control and personal injury. If possible, use any available road surfaces to bring your vehicle under control.

### DRIVING THROUGH MUD AND WATER

#### Mud

Be cautious of sudden changes in vehicle speed or direction when you are driving in mud. Even all-wheel drive and four-wheel drive vehicles can lose traction in mud. If your vehicle slides, steer in the direction of the slide until you regain control of your vehicle. After driving through mud, clean off residue stuck to rotating driveshafts and tires. Excess residue can cause an imbalance that could damage drive components.

**Note:** *If your vehicle gets stuck in mud, it could be rocked out by shifting between forward and reverse gears, stopping between shifts in a steady pattern. Press lightly on the accelerator in each gear.*

**Note:** *Do not rock your vehicle if the engine is not at normal operating temperature, as damage to the transmission could occur.*

**Note:** *Do not rock your vehicle for more than a minute, as damage to the transmission and tires could occur or the engine could overheat.*

#### Water

If you must drive through deep water, drive slowly. The water could limit traction or brake capability. See **Driving Through Shallow Water** (page 313).

When driving through water, determine the depth and avoid water higher than the center of the wheel.

Once through water, always try the brakes. Wet brakes do not stop your vehicle as quickly as dry brakes. Apply light pressure to the brake pedal while slowly moving the vehicle to dry the brakes.

# Driving Hints

**Note:** *Driving through deep water could cause damage to the transmission. If the front or rear axle is submerged in water, have the axle lubricant and power transfer unit lubricant checked and changed if necessary.*

## DRIVING ON HILLY OR SLOPING TERRAIN



**WARNING:** Extreme care should be used when steering the vehicle in reverse down a slope so as not to cause the vehicle to swerve out of control.

Although natural obstacles could make it necessary to travel diagonally up or down a hill or steep incline, you should try to drive straight up or straight down.

**Note:** *Avoid turning on steep slopes or hills. A danger lies in losing traction, slipping sideways and possible vehicle roll over. Whenever driving on a hill, determine beforehand the route you can use. Do not drive over the crest of a hill without seeing what conditions are on the other side. Do not drive in reverse over a hill without the aid of an observer.*

Apply just enough power to the wheels to climb the hill. Too much power causes the tires to slip, spin or lose traction, and you could lose control of your vehicle. When descending a steep hill, do not descend the hill in neutral. Avoid sudden hard braking to keep the front wheels rolling and to maintain your vehicle's steering.

**Note:** *Your vehicle has anti-lock brakes, apply the brakes steadily. Do not pump the brakes.*

**Note:** *If your vehicle gets stuck driving on hilly or sloping terrain, it could be rocked out by shifting between forward and reverse gears, stopping between shifts in a steady pattern. Press lightly on the accelerator in each gear.*

**Note:** *Do not rock your vehicle if the engine is not at normal operating temperature, as damage to the transmission could occur.*

**Note:** *Do not rock your vehicle for more than a minute, as damage to the transmission and tires could occur or the engine could overheat.*

## DRIVING IN SAND

When driving over sand, try to keep all four wheels on the most solid area of the trail. Steadily drive through the terrain. Apply the accelerator slowly and avoid excessive wheel slip. Do not drive your vehicle in deep sand for an extended period of time. This could overheat the system. A message appears in the instrument cluster display.

**Note:** *If your vehicle gets stuck driving on hilly or sloping terrain, it could be rocked out by shifting between forward and reverse gears, stopping between shifts in a steady pattern. Press lightly on the accelerator in each gear.*



# Driving Hints

**Note:** Do not rock your vehicle if the engine is not at normal operating temperature, as damage to the transmission could occur.

**Note:** Do not rock your vehicle for more than a minute, as damage to the transmission and tires could occur or the engine could overheat

## DRIVING THROUGH SHALLOW WATER



**WARNING:** Do not attempt to cross a deep or flowing body of water. Failure to follow this instruction could result in the loss of control of your vehicle, personal injury or death.

**Note:** Driving through standing water can cause vehicle damage.

**Note:** Engine damage can occur if water enters the air filter.

Before driving through standing water, check the depth. Never drive through water that is higher than the bottom of the front rocker area of your vehicle.



When driving through standing water, drive very slowly and do not stop your vehicle. Your brake performance and traction could be limited. After driving through water and as soon as it is safe to do so:

- Lightly press the brake pedal to dry the brakes and to check that they work.
- Turn the steering wheel to check that the steering power assist works.

Check the function of the following:

- Horn
- Exterior lights

## FLOOR MATS



**WARNING:** Use a floor mat designed to fit the footwell of your vehicle that does not obstruct the pedal area. Failure to follow this instruction could result in the loss of control of your vehicle, personal injury or death.



**WARNING:** Pedals that cannot move freely can cause loss of vehicle control and increase the risk of serious personal injury.



**WARNING:** Secure the floor mat to both retention devices so that it cannot slip out of position and interfere with the pedals. Failure to follow this instruction could result in the loss of control of your vehicle, personal injury or death.

# Driving Hints

---

 **WARNING:** Do not place additional floor mats or any other covering on top of the original floor mats. This could result in the floor mat interfering with the operation of the pedals. Failure to follow this instruction could result in the loss of control of your vehicle, personal injury or death.

 **WARNING:** Always make sure that objects cannot fall into the driver foot well while your vehicle is moving. Objects that are loose can become trapped under the pedals causing a loss of vehicle control.

To install floor mats that have eyelets, position the floor mat eyelet over the retention post and press down to lock in position. Repeat for all eyelets on the floor mat.

To remove the floor mats, reverse the installation procedure.

**Note:** *Regularly check the floor mats to make sure they are secure.*



# Crash and Breakdown Information

---

## ROADSIDE ASSISTANCE

### Vehicles sold in the United States: Getting Roadside Assistance

To fully assist you should you have a vehicle concern, Lincoln offers a complimentary roadside assistance program. This program is separate from the New Vehicle Limited Warranty.

The service is available:

- Throughout the life of the vehicle for original owners.
- For six years or 70,000 mi (110,000 km), whichever comes first, for subsequent owners.

Roadside Assistance covers:

- A flat tire change with a good spare. For vehicles with an unusable tire inflation kit, we provide towing service.
- Battery jump start.
- Lock-out assistance - key replacement cost is the client's responsibility.

- Fuel delivery — independent service contractors, if not prohibited by state, local or municipal law shall deliver up to 2 gal (8 L) of gasoline fuel to a disabled vehicle. Roadside Assistance limits fuel delivery service to two no-charge occurrences within a 12-month period.
- Winch out — available within 100 ft (30 m) of a paved or county maintained road, no recoveries.

- Towing — independent service contractors, if not prohibited by state, local or municipal law shall tow Lincoln eligible vehicles to the client's selling or preferred dealer within 100 mi (160 km) of the disablement location or to the nearest Lincoln dealer. If a client requests a tow to a selling or preferred dealer that is more than 100 mi (160 km) from the disablement location, the client is responsible for any mileage costs in excess of 100 mi (160 km).
- Roadside Assistance includes up to \$200 for a towed trailer if the disabled eligible vehicle requires service at the nearest authorized dealer. If the towing vehicle is operational but the trailer is not, then the trailer does not qualify for any roadside services.

### Vehicles Sold in the United States: Using Roadside Assistance

United States clients who require roadside assistance, call 1-800-521-4140 or contact Roadside Assistance using the Lincoln Way mobile app.

# Crash and Breakdown Information

If you need to arrange roadside assistance for yourself, Lincoln reimburses a reasonable amount for towing to the nearest Lincoln dealership within 100 mi (160 km). To obtain reimbursement information, United States clients, call 1-800-521-4140. Clients need to submit their original receipts.

## Vehicles Sold in Canada: Getting Roadside Assistance

To fully assist you should you have a vehicle concern, Lincoln offers a complimentary roadside assistance program. This program is eligible within Canada or the continental United States.

The service is available 24 hours a day, seven days a week.

This program is separate from the New Vehicle Limited Warranty, beginning from the original warranty start date and lasts the life of the vehicle for the original owner. Subsequent owners receive coverage that is concurrent with the 6 years or 70,000 mi (110,000 km), whichever occurs first, powertrain warranty coverage period.

**Note:** *Canadian roadside coverage and benefits may differ from the U.S. coverage.*

For complete program coverage details, review your warranty guide, contact your dealer, call us in Canada at 1-844-665-2007, or visit our website at [www.lincolncanada.com](http://www.lincolncanada.com).

If you purchased your vehicle in Canada and require roadside assistance, please call 1-844-665-2007 or contact Roadside Assistance using the Lincoln Way mobile app.

**Note:** *For quick reference, complete the roadside assistance identification card found in the glove compartment of your vehicle and place it in your wallet.*

## SWITCHING THE HAZARD FLASHERS ON AND OFF



The hazard flasher button is on the instrument panel. Press the button to switch the hazard flashers on if your vehicle is creating a safety hazard for other road users.

When you switch the hazard flashers on, all front and rear direction indicators flash.

**Note:** *The hazard flashers operate when the ignition is in any position, or if the key is not in the ignition. The battery loses charge and could have insufficient power to restart your vehicle.*

Press the button again to switch them off.

## JUMP STARTING THE VEHICLE

### JUMP STARTING PRECAUTIONS



**WARNING:** Batteries normally produce explosive gases which can cause personal injury. Therefore, do not allow flames, sparks or lighted substances to come near the battery. When working near the battery, always shield your face and protect your eyes. Always provide correct ventilation.

# Crash and Breakdown Information

**WARNING:** Keep batteries out of reach of children. Batteries contain sulfuric acid. Avoid contact with skin, eyes or clothing. Shield your eyes when working near the battery to protect against possible splashing of acid solution. In case of acid contact with skin or eyes, flush immediately with water for a minimum of 15 minutes and get prompt medical attention. If acid is swallowed, call a physician immediately.

**WARNING:** Use only adequately sized cables with insulated clamps.

**WARNING:** Make sure that the cables are clear of any moving parts and fuel delivery system parts.

**WARNING:** Connect batteries with only the same nominal voltage.

**WARNING:** If the engine is running while the hood is open, stay clear of moving engine components. Failure to follow this warning could result in serious personal injury or death.

Do not attempt to push-start an automatic transmission vehicle. This could cause transmission damage.

Do not disconnect the battery of the disabled vehicle. This could damage your vehicle's electrical system.

## PREPARING THE VEHICLE

Use only a 12 volt supply to start your vehicle.

Park the booster vehicle close to the hood of the disabled vehicle, making sure the two vehicles do not touch.

## JUMP STARTING THE VEHICLE

### Connecting the Jumper Cables

**WARNING:** Do not connect the negative jumper cable to any other part of your vehicle. Use the ground point.

**Note:** If you are using a jump pack or booster box, follow the manufacturer's instructions.

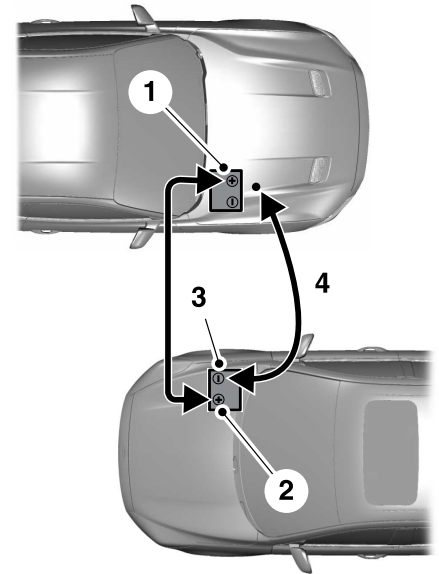

1. Pull the red rubber boot backward. Connect the positive (+) jumper cable to the positive (+) terminal of the discharged battery.

# Crash and Breakdown Information

2. Connect the other end of the positive (+) jumper cable to the positive (+) terminal of the booster vehicle battery.
3. Connect the negative (-) jumper cable to the negative (-) terminal of the booster vehicle battery.
4. Make the final connection of the negative (-) jumper cable to an exposed metal part of the disabled vehicle's engine, as shown in the following illustration, away from the battery and fuel injection system, or connect the negative (-) jumper cable to a ground connection point if available.

**Note:** Do not use the hood latch as a negative (-) connection point. This could cause springs in the latch to burn and prevent the hood from operating correctly.

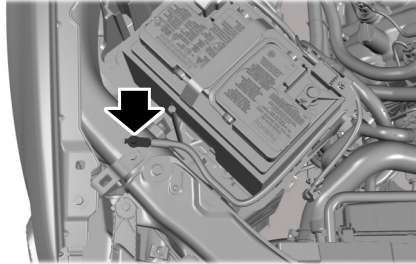

## Starting the Engine

1. Start the engine of the booster vehicle and moderately rev the engine, or gently press the accelerator to keep the engine speed between 2000 and 3000 RPM, as shown in your tachometer.
2. Start the engine of the disabled vehicle.
3. Once you start the disabled vehicle, run both vehicle engines for an additional three minutes before disconnecting the jumper cables.

## Removing the Jumper Cables

Remove the jumper cables in the reverse order that they were connected.

**Note:** Do not switch the headlamps on when disconnecting the cables. The peak voltage could blow the bulbs.

## POST-CRASH ALERT SYSTEM

### WHAT IS THE POST-CRASH ALERT SYSTEM

The system helps draw attention to your vehicle in the event of a serious impact.

### HOW DOES THE POST-CRASH ALERT SYSTEM WORK

The system is designed to turn the hazard flashers on and to intermittently sound the horn in the event of a serious impact that deploys an airbag or the seatbelt pretensioners.

# Crash and Breakdown Information

## POST-CRASH ALERT SYSTEM LIMITATIONS

Depending on applicable laws in the country your vehicle was built for, the horn does not sound in the event of a serious impact.

## SWITCHING THE POST-CRASH ALERT SYSTEM OFF

Press the hazard flasher switch or the unlock button on the remote control to switch the system off.

**Note:** *The alert turns off when the vehicle battery runs out of charge.*

## AUTOMATIC CRASH SHUTOFF

### WHAT IS AUTOMATIC CRASH SHUTOFF

The automatic crash shutoff is designed to stop the fuel going to the engine in the event of a moderate or severe crash.

**Note:** *Not every impact causes a shutoff.*

## AUTOMATIC CRASH SHUTOFF PRECAUTIONS



**WARNING:** If your vehicle has been involved in a crash, have the fuel system checked. Failure to follow this instruction could result in fire, personal injury or death.

## RE-ENABLING YOUR VEHICLE

1. Switch the ignition off.
2. Attempt to start your vehicle.
3. Switch the ignition off.
4. Attempt to start your vehicle.

**Note:** *If your vehicle does not start after the third attempt, have your vehicle checked as soon as possible.*

## TRANSPORTING THE VEHICLE

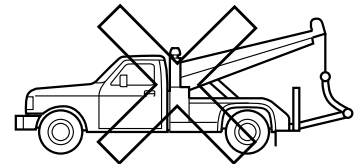
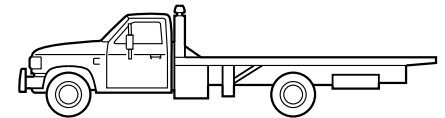
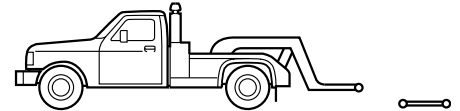

# Crash and Breakdown Information

---

If you need to tow your vehicle, contact a professional towing service or your roadside assistance service provider.

Your manufacturer produces a towing manual for all authorized tow truck operators. Have your tow truck operator refer to this manual for proper hook-up and towing procedures.

We recommend the use of a wheel lift and dollies or flatbed equipment to tow your vehicle. Vehicle damage could occur if towed incorrectly, or by any other means.

Front-wheel and rear-wheel drive vehicles must have their designated drive wheels off the ground regardless of towing direction. Use tow dollies to prevent damage to the transmission.

All-wheel or four-wheel drive vehicles require that all wheels be off the ground using a wheel lift and dollies or flatbed equipment. This prevents damage to the transmission and drive system.



# Towing Your Vehicle

## TOWING YOUR VEHICLE PRECAUTIONS

Use the following guidelines when towing your vehicle. Failure to follow this instruction could result in vehicle damage not covered by the vehicle warranty.

**Note:** *Make sure you properly secure your vehicle to the tow vehicle.*

**Note:** *If you are unsure of the vehicle's configuration, contact an authorized dealer.*

## RECREATIONALLY TOWING YOUR VEHICLE - 2.0L, AWD

You cannot recreational tow your vehicle with all wheels on the ground because vehicle or transmission damage could occur. You must recreational tow your vehicle with all four wheels off the ground, such as when using a car-hauling trailer. Otherwise, you cannot recreational tow your vehicle.

## RECREATIONALLY TOWING YOUR VEHICLE - 2.0L, FWD

You cannot recreational tow your vehicle with all wheels on the ground because vehicle or transmission damage could occur. Place the front wheels on a two-wheel tow dolly. If you are using a tow dolly, follow the instructions specified by the equipment provider.

**Note:** *Release the parking brake before towing your vehicle. See **Manually Releasing the Electric Parking Brake** (page 223).*

## RECREATIONALLY TOWING YOUR VEHICLE - 2.7L

**Note:** *Put your climate control system in recirculated air mode to prevent exhaust fumes from entering the vehicle. See **Climate Control** (page 156).*

Follow these guidelines if you have a need for recreational towing. An example of recreational towing would be towing your vehicle behind a motorhome. We designed these guidelines to prevent damage to your transmission.

You can recreational tow your vehicle with all four wheels on the ground using the Manual Park Release procedure, or with all four wheels off the ground using a vehicle transport trailer. If you are using a vehicle transport trailer, follow the instructions specified by the equipment provider.

If you recreational tow your vehicle with all four wheels on the ground:

- Only tow your vehicle in the forward direction.
- Use the manual park release procedure. See **Using Manual Park Release** (page 214). Failure to do so may result in damage to the transmission.
- Do not exceed 65 mph (105 km/h).

# Towing Your Vehicle

---

## EMERGENCY TOWING

If your vehicle becomes inoperable without access to wheel dollies or a vehicle transport trailer, it can be flat-towed with all wheels on the ground, regardless of the powertrain and transmission configuration, under the following conditions:

- Your vehicle is facing forward for towing in a forward direction.
- Use the manual park release procedure. See **Using Manual Park Release** (page 214). Failure to do so may result in damage to the transmission.
- Maximum speed is 35 mph (56 km/h).
- Maximum distance is 50 mi (80 km).

# Fuses

## FUSE PRECAUTIONS

**⚠ WARNING:** Always disconnect the battery before servicing high current fuses.

**⚠ WARNING:** To reduce risk of electrical shock, always replace the cover to the power distribution box before reconnecting the battery or refilling fluid reservoirs.

**⚠ WARNING:** Always replace a fuse with one that has the specified amperage rating. Using a fuse with a higher amperage rating can cause severe wire damage and could start a fire.

## UNDER HOOD FUSE BOX

### LOCATING THE UNDER HOOD FUSE BOX

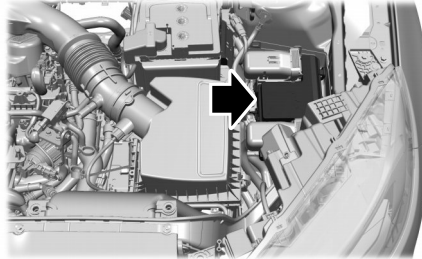

## ACCESSING THE UNDER HOOD FUSE BOX

### Accessing the Under Hood Fuse Box - Top

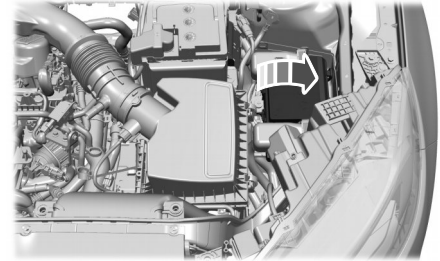

# Fuses

## Accessing the Under Hood Fuse Box - Bottom

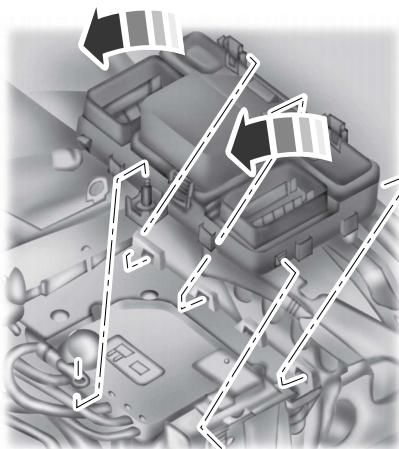

1. Release the latches on both sides of the fuse box.
2. Raise the inboard side of the fuse box from the cradle.
3. Move the fuse box toward the center of the engine compartment.
4. Pivot the outboard side of the fuse box to access the bottom side.

# Fuses

## IDENTIFYING THE FUSES IN THE UNDER HOOD FUSE BOX

### Under Hood Fuse Box - Top

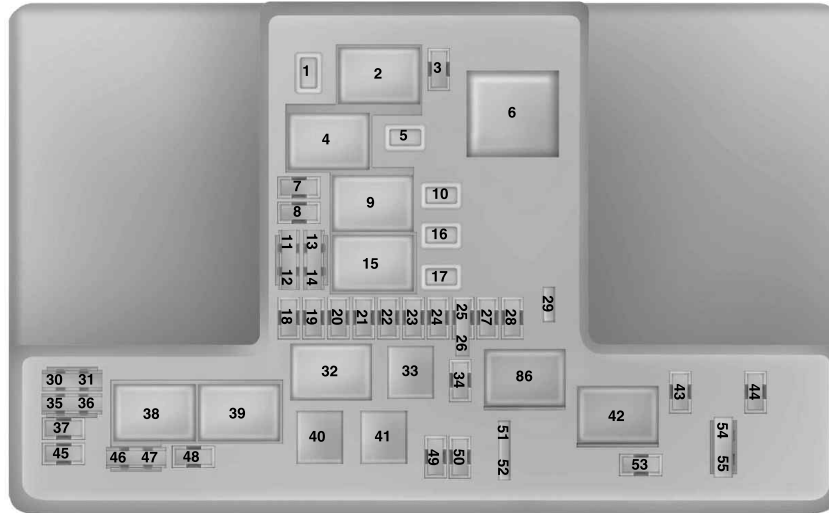

# Fuses

Fuse Number	Fuse Rating	Protected Component
1	30 A	Second row power seat.
2	—	Starter relay.
3	15 A	Rear window wiper. Rain sensor. Rear wash relay coil.
4	—	Blower motor relay.
5	—	Not used.
6	—	Not used.
7	20 A	Powertrain control module - vehicle power 1.
8	20 A	Powertrain control module - vehicle power 2. Canister vent. Vapor blocking valve. Heated oxygen post.
9	—	Powertrain control module relay.
10	20 A	Power outlet 5-main bin.
11	15 A	Powertrain control module - vehicle power 4.
12	15 A	Powertrain control module - vehicle power 3.

# Fuses

Fuse Number	Fuse Rating	Protected Component
13	—	Not used.
14	—	Not used.
15	—	Run-start relay.
16	20 A	Power outlet 2 - back of console.
17	20 A	Power outlet 4 - luggage compartment.
18	—	Not used.
19	10 A	Run-start electronic power assist steering.
20	10 A	Run/start lighting.
21	—	Not used.
22	10 A	Air conditioner clutch solenoid.
23	15 A	Front split view camera. Rear view camera. Forward looking radar. 360° camera module. Blind spot information system. Voltage quality module (start/stop).
24	10 A	Not used (spare).
25	10 A	Run-start anti-lock brake system.

# Fuses

Fuse Number	Fuse Rating	Protected Component
26	10 A	Run-start powertrain control module.
27	5 A	USB power outlet - back of console.
28	10 A	Rear window washer pump.
29	—	Not used.
30	—	Not used.
31	—	Not used.
32	—	Electronic fan 1 relay.
33	—	A/C clutch relay.
34	—	Not used.
35	—	Not used.
36	—	Not used.
37	—	Not used.
38	—	Electronic fan 2 relay.
39	—	Electronic fan 3 relay.
40	—	Horn relay.
41	—	Left-hand high beam and stoplamp relay.



## Fuses

Fuse Number	Fuse Rating	Protected Component
42	—	Fuel pump relay.
43	15 A	Right-hand high beam and stoplamp.
44	—	Not used.
45	—	Not used.
46	—	Not used.
47	—	Not used.
48	15 A	Left-hand high beam and stoplamp.
49	—	Not used.
50	20 A	Horn.
51	—	Not used.
52	—	Not used.
53	10 A	Massaging seats.
54	10 A	Brake on-off switch.
55	10 A	Alternator A-line.
86	—	Not used.

# Fuses

## Under Hood Fuse Box - Bottom

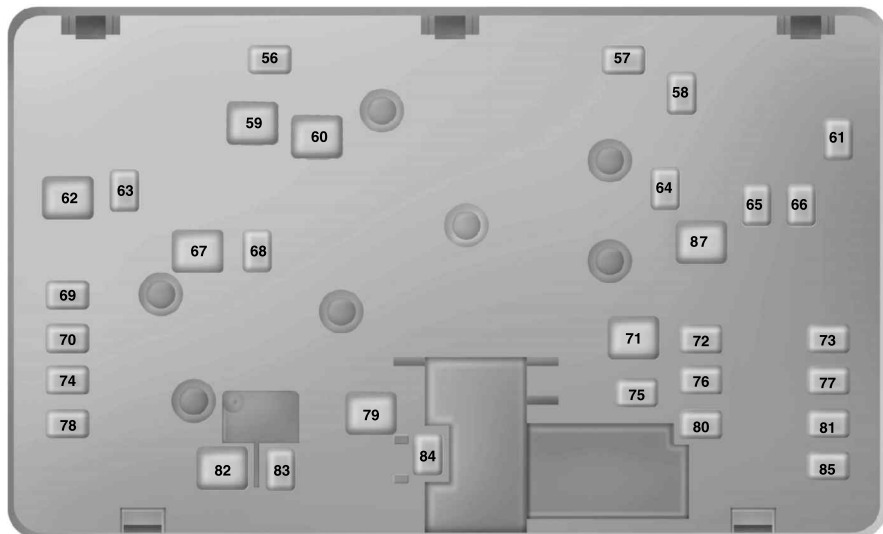

# Fuses

Fuse Number	Fuse Rating	Protected Component
56	—	Not used.
57	—	Not used.
58	30 A	Fuel pump feed.
59	40 A	Electronic fan 3.
60	40 A	Electronic fan 1.
61	—	Not used.
62	50 A	Body control module 1.
63	25 A	Electronic fan 2.
64	—	Not used.
65	20 A	Front heated seat.
66	15 A	Not used (spare).
67	50 A	Body control module 2.
68	40 A	Heated rear window.
69	30 A	Anti-lock brake system valves.
70	30 A	Passenger seat.

# Fuses

Fuse Number	Fuse Rating	Protected Component
71	–	Not used.
72	–	Not used.
73	20 A	Rear heated seats.
74	30 A	Driver seat module.
75	25 A	Windshield wiper motor.
76	30 A	Power liftgate module.
77	30 A	Climate controlled seat module.
78	40 A	Trailer tow.
79	40 A	Blower motor.
80	–	Not used.
81	40 A	110 V inverter.
82	–	Not used.
83	–	Not used.
84	30 A	Starter motor solenoid.
85	–	Not used.
87	60 A	Anti-lock brake system pump.

# Fuses

## BODY CONTROL MODULE FUSE BOX

### LOCATING THE BODY CONTROL MODULE FUSE BOX

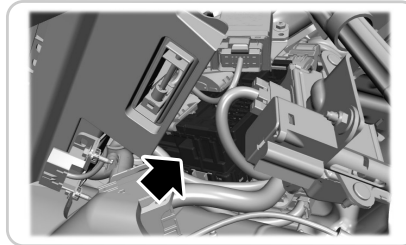

### ACCESSING THE BODY CONTROL MODULE FUSE BOX

To access the fuses in the body control module fuse box, contact an authorized dealer.

# Fuses

## IDENTIFYING THE FUSES IN THE BODY CONTROL MODULE FUSE BOX

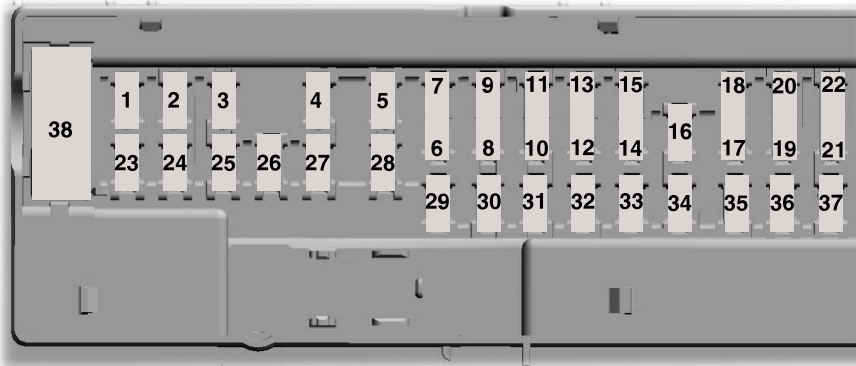

Fuse or Relay Number	Fuse Rating	Protected Components
1	–	Not used.
2	10 A	Delayed accessory - power inverter logic, moonroof logic and driver window switch power.
3	7.5 A	Memory seats.

# Fuses

Fuse or Relay Number	Fuse Rating	Protected Components
		Lumbar. Wireless accessory charging.
4	20 A	Subwoofer amplifier.
5	–	Not used.
6	10 A	Security horn relay.
7	10 A	Gearshift module.
8	5 A	Power liftgate module. Hands free liftgate module. Embedded modem.
9	5 A	Keypad. Combined sensing module.
10	–	Not used.
11	–	Not used.
12	7.5 A	Climate control module. Enhanced central gateway module.
13	7.5 A	Instrument cluster. Steering column control module.
14	15 A	Not used.

# Fuses

Fuse or Relay Number	Fuse Rating	Protected Components
15	15 A	SYNC module.
16	–	Not used.
17	7.5 A	Headlamp control module.
18	7.5 A	Not used (spare).
19	5 A	Headlamp switch. Bluetooth low energy module.
20	5 A	Push button ignition switch.
21	5 A	Not used (spare).
22	5 A	Not used (spare).
23	30 A	Driver door window and mirror. Driver door module. Driver door lock indicator. Driver lock switch illumination.
24	30 A	Moonroof.
25	20 A	Amplifier.
26	30 A	Front passenger door window and mirror. Front passenger door module. Front passenger lock indicator. Front passenger switch illumination.



# Fuses

Fuse or Relay Number	Fuse Rating	Protected Components
27	30 A	Left-hand rear door module.
28	30 A	Right-hand rear door module.
29	15 A	Enhanced central gateway power - OBD connector.
30	5 A	Not used (spare).
31	10 A	Radio transceiver module. Multi-function display. Integrated control panel.
32	20 A	Radio.
33	–	Not used.
34	30 A	Run-start bus (fuse 17, 18, 21, 22, 35, 36, 37, circuit breaker 38).
35	5 A	Passenger airbag deactivation indicator.
36	15 A	Rear heated seat module. Suspension module.
37	20 A	Heated steering wheel. Auto-dimming interior mirror. Automatic high beam and lane departure mirror module. Parking assist control module.
38	30 A	Circuit breaker.

# Fuses

## IDENTIFYING FUSE TYPES

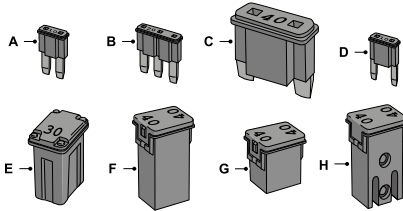

- A Micro 2.
- B Micro 3.
- C Maxi.
- D Mini.
- E M Case.
- F J Case.
- G J Case Low Profile.
- H Slotted M Case.

## FUSES – TROUBLESHOOTING

### FUSES – FREQUENTLY ASKED QUESTIONS

#### When do I need to check a fuse?

If electrical components in the vehicle are not working.

#### When do I need to replace a fuse?

If a fuse has blown.

#### How do I identify a blown fuse?

You can identify a blown fuse by a broken wire within the fuse.

# Maintenance

## MAINTENANCE PRECAUTIONS

Service your vehicle regularly to help maintain its roadworthiness and resale value. There is a large network of authorized dealers that are there to help you with their professional servicing expertise. We believe that their specially trained technicians are best qualified to service your vehicle properly and expertly. They are supported by a wide range of highly specialized tools developed specifically for servicing your vehicle.

If your vehicle requires professional service, an authorized dealer can provide the necessary parts and service. Check your warranty information to find out which parts and services are covered.

Use only recommended fuels, lubricants, fluids and service parts conforming to specifications. See **Capacities and Specifications** (page 404).

- Do not work on a hot engine.
- Make sure that nothing gets caught in moving parts.

- Do not work on a vehicle with the engine running in an enclosed space, unless you are sure you have enough ventilation.
- Keep all open flames and other burning material, such as cigarettes, away from the battery and all fuel related parts.
- Set the parking brake, shift the transmission to park (P) and block the wheels.

## OPENING AND CLOSING THE HOOD

### Opening the Hood



1. Inside the vehicle, pull the hood release handle located under the left-hand side of the instrument panel.

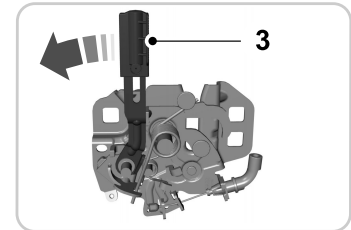
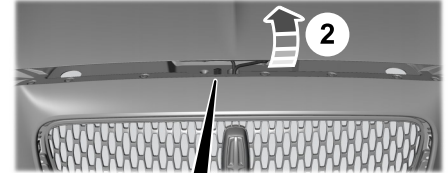

2. Slightly lift the hood.
3. Release the hood latch by pushing the secondary release lever to your left-hand side.

# Maintenance

---

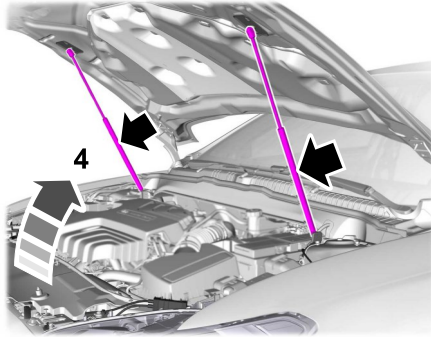

4. Open the hood. The hood struts automatically supports the hood.

## Closing the Hood

1. Lower the hood until it engages on to the secondary latch.
2. Firmly push down on the front of the hood to close it fully.

**Note:** *Make sure that the hood is correctly closed.*

# Maintenance

## UNDER HOOD OVERVIEW - 2.0L

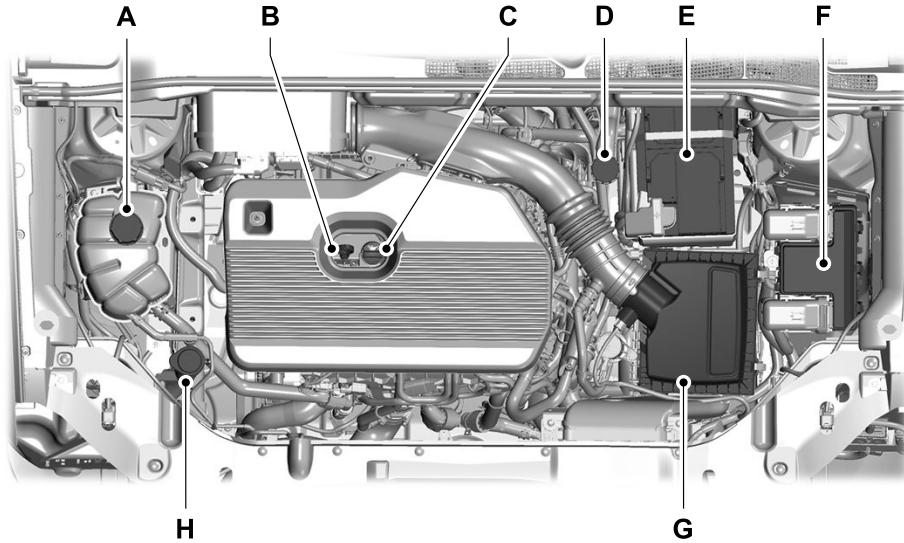

# Maintenance

---

- A Engine coolant reservoir. See **Checking the Coolant** (page 347).
- B Engine oil dipstick. See **Engine Oil Dipstick Overview** (page 345).
- C Engine oil filler cap. See **Adding Engine Oil** (page 346).
- D Brake fluid reservoir. See **Checking the Brake Fluid** (page 220).
- E Battery. See **Changing the 12V Battery** (page 353).
- F Power distribution box. See **Accessing the Under Hood Fuse Box** (page 323).
- G Air filter. See **Changing the Engine Air Filter** (page 351).
- H Windshield washer fluid reservoir. See **Adding Washer Fluid** (page 120).

# Maintenance

## UNDER HOOD OVERVIEW - 2.7L

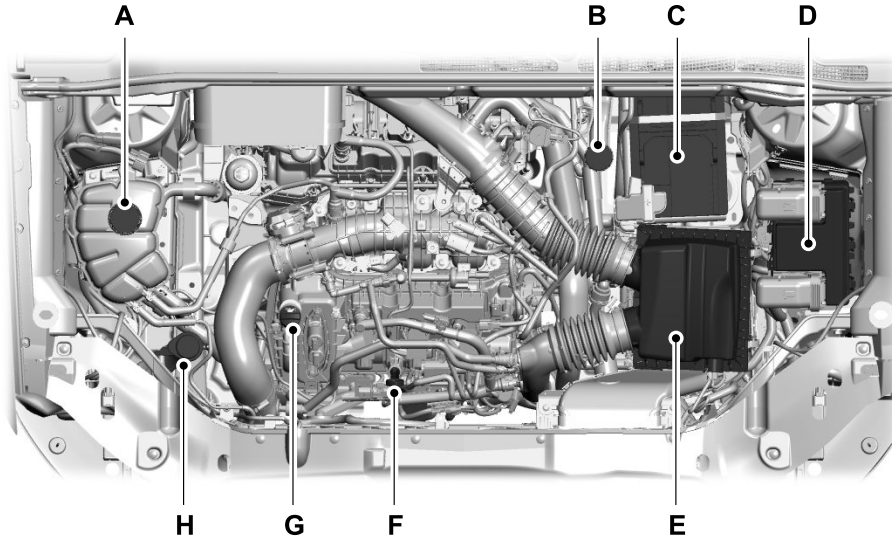

# Maintenance

---

- A Engine coolant reservoir. See **Checking the Coolant** (page 347).
- B Brake fluid reservoir. See **Checking the Brake Fluid** (page 220).
- C Battery. See **Changing the 12V Battery** (page 353).
- D Power distribution box. See **Accessing the Under Hood Fuse Box** (page 323).
- E Air filter assembly. See **Changing the Engine Air Filter** (page 351).
- F Engine oil dipstick. See **Engine Oil Dipstick Overview** (page 345).
- G Engine oil filler cap. See **Adding Engine Oil** (page 346).
- H Windshield washer fluid reservoir. See **Adding Washer Fluid** (page 120).



# Maintenance

## ENGINE OIL

### ENGINE OIL DIPSTICK OVERVIEW - 2.0L

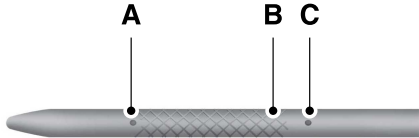

- A Minimum.
- B Nominal.
- C Maximum.

### ENGINE OIL DIPSTICK OVERVIEW - 2.7L

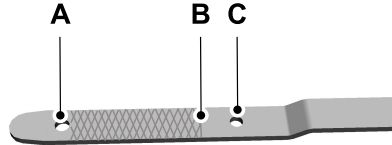

- A Minimum.
- B Nominal.
- C Maximum.

### CHECKING THE ENGINE OIL LEVEL

1. Make sure that your vehicle is on level ground.

2. Check the oil level before starting the engine, or switch the engine off after warming up and wait 10 minutes for the oil to drain into the oil pan.
3. Remove the dipstick and wipe it with a clean, lint-free cloth.
4. Reinstall the dipstick and make sure it is fully seated.
5. Remove the dipstick again to check the oil level.

**Note:** *If the oil level is between the maximum and minimum marks, the oil level is acceptable. Do not add oil.*

6. If the oil level is at the minimum mark, immediately add oil.
7. Reinstall the dipstick. Make sure it is fully seated.

**Note:** *The oil consumption of new engines reaches its normal level after approximately 3,000 mi (5,000 km).*

# Maintenance

## ADDING ENGINE OIL



**WARNING:** Do not remove the filler cap when the engine is running.



**WARNING:** Do not add engine oil when the engine is hot. Failure to follow this instruction could result in personal injury.

Do not use supplemental engine oil additives because they are unnecessary and could lead to engine damage that the vehicle warranty may not cover.

1. Clean the area surrounding the engine oil filler cap before you remove it.
2. Remove the engine oil filler cap.
3. Add engine oil that meets our specifications. See **Capacities and Specifications** (page 404).
4. Reinstall the engine oil filler cap. Turn it clockwise until you feel a strong resistance.

**Note:** Do not add oil further than the maximum mark. Oil levels above the maximum mark may cause engine damage.

**Note:** Immediately soak up any oil spillage with an absorbent cloth.

## RESETTING THE ENGINE OIL CHANGE REMINDER

Use the information display controls on the steering wheel to reset the oil change indicator.

**From the main menu scroll to:**

Message	Action and description
Settings	Press the right arrow button, then from this menu scroll to the following message.
Vehicle	Press the right arrow button, then from this menu scroll to the following message.
Oil Life	Press the right arrow button, then from this menu scroll to the following message.

Message	Action and description
Hold OK to Reset	Press and hold the <b>OK</b> button until the instrument cluster displays the following message.  Reset Successful
	When the oil change indicator resets the instrument cluster displays 100%.  Remaining Life {00}%
	If the instrument cluster displays one of the following messages, repeat the process.  Not Reset  Reset Cancelled

# Maintenance

## ENGINE OIL CAPACITY AND SPECIFICATION

For filling information, please refer to the Capacities and Specifications section of your owner's manual. See **Engine Oil Capacity and Specification** (page 410).

## CHECKING THE COOLANT

When the engine is cold, check the concentration and level of the coolant at the intervals listed in the scheduled maintenance information. See **Scheduled Maintenance** (page 463).

**Note:** Make sure that the coolant level is between the minimum and maximum marks on the coolant reservoir.

**Note:** Coolant expands when it is hot. The level may extend beyond the **MAX** mark.

If the coolant level is at or below the minimum mark, add prediluted coolant immediately.

Maintain coolant concentration within 48% to 50%, which equates to a freeze point between -29°F (-34°C) and -35°F (-37°C). Coolant concentration should be checked using a refractometer. We do not recommend the use of hydrometers or coolant test strips for measuring coolant concentration.

### Adding Coolant

 **WARNING:** Keep your hands and clothing clear of the cooling fan.

 **WARNING:** Do not remove the coolant reservoir cap when the engine is on or the cooling system is hot. Wait 10 minutes for the cooling system to cool down. Cover the coolant reservoir cap with a thick cloth to prevent the possibility of scalding and slowly remove the cap. Failure to follow this instruction could result in personal injury.

 **WARNING:** Do not add engine coolant when the engine is on or the cooling system is hot. Failure to follow this instruction could result in personal injury.

 **WARNING:** Do not add coolant further than the **MAX** mark.

 **WARNING:** Do not put coolant in the windshield washer reservoir. If sprayed on the windshield, coolant could make it difficult to see through the windshield.

 **WARNING:** Do not allow the fluid to touch your skin or eyes. If this happens, rinse the affected areas immediately with plenty of water and contact your physician.

**Note:** Do not use stop leak pellets, cooling system sealants, or non-specified additives as they can cause damage to the engine cooling or heating systems. Resulting component damage may not be covered by the vehicle Warranty.

**Note:** Automotive fluids are not interchangeable.

# Maintenance

---

It is very important to use prediluted coolant approved to the correct specification in order to avoid plugging the small passageways in the engine cooling system. See **Capacities and Specifications** (page 404). Do not mix different colors or types of coolant in your vehicle. Mixing of engine coolants or using an incorrect coolant may harm the engine or cooling system components and could void the vehicle Warranty.

**Note:** *If prediluted coolant is not available, use the approved concentrated coolant diluting it to 50/50 with deionized or distilled water. See **Capacities and Specifications** (page 404). Using water that has not been deionized may contribute to deposit formation, corrosion and plugging of the small cooling system passageways.*

To top up the coolant level do the following:

1. Unscrew the cap slowly. Any pressure escapes as you unscrew the cap.
2. Add enough prediluted coolant to reach the correct level.

**Note:** *We do not recommend the use of recycled coolant.*

3. Replace the coolant reservoir cap. Turn the cap clockwise until it contacts the hard stop.
4. Check the coolant level in the coolant reservoir the next few times you drive your vehicle. If necessary, repeat step 2.

If you have to add more than 1.1 qt (1 L) of engine coolant per month, have your vehicle checked as soon as possible. Operating an engine with a low level of coolant can result in engine overheating and possible engine damage.

In case of emergency, you can add a large amount of water without engine coolant in order to reach a vehicle service location. Service your vehicle as soon as possible.

Water alone, without engine coolant, can cause engine damage from corrosion, overheating or freezing.

Do not use the following as a coolant substitute, as they can cause engine damage from overheating or freezing:

- Alcohol.
- Methanol.

- Brine.
- Any coolant mixed with alcohol or methanol antifreeze.

Do not add extra inhibitors or additives to the coolant. These can be harmful and compromise the corrosion protection of the coolant.

## Severe Climates

If you drive in extremely cold climates, you may need to increase the coolant concentration above 50%.

**Note:** *A coolant concentration of 60% provides improved freeze point protection. Coolant concentrations above 60% decrease the overheat protection characteristics of the coolant and could cause engine damage.*

If you drive in extremely hot climates, you may need to decrease the coolant concentration to 40%.

# Maintenance

**Note:** A coolant concentration of 40% provides improved overheat protection. Coolant concentrations below 40% decrease the overheat and corrosion protection characteristics of the coolant and could cause engine damage.

## Coolant Change



**WARNING:** Do not dispose of coolant in the household refuse or the public sewage system. Use an authorized waste disposal facility.

Change the coolant at specific mileage intervals. Refer to the scheduled maintenance information. See **Normal Scheduled Maintenance** (page 467).

**Note:** Dispose of used coolant in the appropriate manner.

Follow your community's regulations and standards for recycling and disposing of automotive fluids.

## Fail-Safe Cooling

Fail-safe cooling allows you to temporarily drive your vehicle before any incremental component damage occurs. The fail-safe distance depends on ambient temperature, vehicle load and terrain.

### How Fail-Safe Cooling Works



If the engine begins to overheat, the coolant temperature gauge moves toward the red zone:



A warning lamp illuminates and a message may appear in the information display.

If the engine reaches a preset over-temperature condition, the engine automatically switches to alternating cylinder operation. Each disabled cylinder acts as an air pump and cools the engine.

When this occurs, your vehicle still operates, however:

- Engine power is limited.
- The air conditioning system turns off.

Continued operation increases the engine temperature, causing the engine to completely shut down. Your steering and braking effort increases in this situation.

When the engine temperature cools, you can re-start the engine. Have your vehicle checked as soon as possible to minimize engine damage.

### When Fail-Safe Mode Is Activated



**WARNING:** Fail-safe mode is for use during emergencies only. Operate your vehicle in fail-safe mode only as long as necessary to bring your vehicle to rest in a safe location and seek immediate repairs. When in fail-safe mode, your vehicle will have limited power, will not be able to maintain high-speed operation, and may completely shut down without warning, potentially losing engine power, power steering assist, and power brake assist, which may increase the possibility of a crash resulting in serious injury.

# Maintenance



**WARNING:** Do not remove the coolant reservoir cap when the engine is on or the cooling system is hot. Wait 10 minutes for the cooling system to cool down. Cover the coolant reservoir cap with a thick cloth to prevent the possibility of scalding and slowly remove the cap. Failure to follow this instruction could result in personal injury.

Your vehicle has limited engine power when in the fail-safe mode, drive your vehicle with caution. Your vehicle does not maintain high-speed operation and the engine could operate poorly.

Remember that the engine is capable of automatically shutting down to prevent engine damage. In this situation:

1. Pull off the road as soon as safely possible and switch the engine off.
2. If you are a member of a roadside assistance program, we recommend that you contact your roadside assistance service provider.

3. If this is not possible, wait for a short period of time for the engine to cool.
4. Check the coolant level. If the coolant level is at or below the minimum mark, add prediluted coolant immediately.
5. When the engine temperature cools, you can re-start the engine. Have your vehicle checked as soon as possible to minimize engine damage.

**Note:** *Driving your vehicle without repair increases the chance of engine damage.*

## Engine Coolant Temperature Management (If Equipped)



**WARNING:** To reduce the risk of crash and injury, be prepared that the vehicle speed may reduce and the vehicle may not be able to accelerate with full power until the coolant temperature reduces.

If you tow a trailer with your vehicle, the engine may temporarily reach a higher temperature during severe operating conditions, for example ascending a long or steep grade in high ambient temperatures.

At this time, you may notice the coolant temperature gauge moves toward the red zone and a message may appear in the information display.

You may notice a reduction in vehicle speed caused by reduced engine power in order to manage the engine coolant temperature. Your vehicle may enter this mode if certain high-temperature and high-load conditions take place. The amount of speed reduction depends on vehicle loading, grade and ambient temperature. If this occurs, there is no need to stop your vehicle. You can continue to drive.

The air conditioning may automatically turn on and off during severe operating conditions to protect the engine from overheating. When the coolant temperature decreases to the normal operating temperature, the air conditioning turns on.

# Maintenance

If the coolant temperature gauge moves fully into the red zone, or if the coolant temperature warning or service engine soon messages appear in your information display, do the following:

1. Stop your vehicle as soon as it is safe to do so. Fully apply the parking brake, shift into park (P) or neutral (N).
2. Leave the engine running until the coolant temperature gauge needle returns to the normal position. If the temperature does not drop after several minutes, follow the remaining steps.
3. Switch the engine off and wait for it to cool. Check the coolant level.
4. If the coolant level is at or below the minimum mark, add prediluted coolant immediately.
5. If the coolant level is normal, restart the engine and continue.

## CHANGING THE ENGINE AIR FILTER



**WARNING:** To reduce the risk of vehicle damage and personal burn injuries, do not start your engine with the air cleaner removed and do not remove it while the engine is running.

When changing the air filter element, use only the air filter element listed. See **Capacities and Specifications** (page 404).

For turbocharged equipped vehicles: When servicing the air cleaner, it is important that no foreign material enter the air induction system. The engine and turbocharger are susceptible to damage from even small particles.

Change the air filter element at the proper interval. See **Scheduled Maintenance** (page 463).

**Note:** Failure to use the correct air filter element may result in severe engine damage. The customer warranty may be void for any damage to the engine if the correct air filter element is not used.

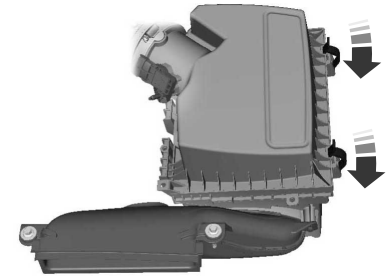

1. Release the clamps that secure the air filter housing cover.
2. Carefully lift the air filter housing cover.
3. Remove the air filter element from the air filter housing.
4. Wipe any dirt or debris from the air filter housing and cover to make sure no dirt gets in the engine and to make sure you have a good seal.

# Maintenance

5. Install a new air filter element. Be careful not to crimp the filter element edges between the air filter housing and cover. This could cause filter damage and allow unfiltered air to enter the engine if not properly seated.
6. Install the air filter housing cover.
7. Engage the clamps to secure the air filter housing cover to the air filter housing.

## CHANGING THE FUEL FILTER

Your vehicle has a lifetime fuel filter that integrates with the fuel tank. It does not need regular maintenance or replacement.

## DRIVE BELT ROUTING OVERVIEW - 2.0L

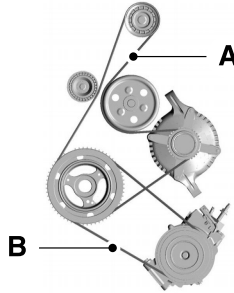

- A. The long drive belt is on the first pulley groove closest to the engine.
- B. The short drive belt is on the second pulley groove farthest from the engine.

## DRIVE BELT ROUTING OVERVIEW - 2.7L

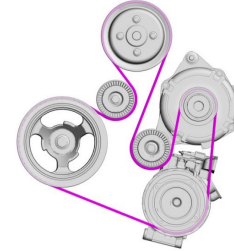



# Maintenance

## CHANGING THE 12V BATTERY



**WARNING:** Batteries normally produce explosive gases which can cause personal injury. Therefore, do not allow flames, sparks or lighted substances to come near the battery. When working near the battery, always shield your face and protect your eyes. Always provide correct ventilation.



**WARNING:** When lifting a plastic-cased battery, excessive pressure on the end walls could cause acid to flow through the vent caps, resulting in personal injury and damage to the vehicle or battery. Lift the battery with a battery carrier or with your hands on opposite corners.



**WARNING:** Keep batteries out of reach of children. Batteries contain sulfuric acid. Avoid contact with skin, eyes or clothing. Shield your eyes when working near the battery to protect against possible splashing of acid solution. In case of acid contact with skin or eyes, flush immediately with water for a minimum of 15 minutes and get prompt medical attention. If acid is swallowed, call a physician immediately.



**WARNING:** Battery posts, terminals and related accessories contain lead and lead compounds, chemicals known to the State of California to cause cancer and reproductive harm. **Wash your hands after handling.**



**WARNING:** This vehicle may have more than one battery. Removing the battery cables from only one battery does not disconnect your vehicle electrical system. Make sure you disconnect the battery cables from all batteries when disconnecting power. Failure to do so may cause serious personal injury or property damage.

The battery is in the engine compartment. See **Under Hood Overview** (page 341).

Your vehicle has a maintenance-free battery. It does not require additional water during service.

For longer, trouble-free operation, keep the top of the battery clean and dry and the battery cables tightly fastened to the battery terminals. If any corrosion is present on the battery or terminals, remove the cables from the terminals and clean with a wire brush. You can neutralize the acid with a solution of baking soda and water.

# Maintenance

---

We recommend that you disconnect the negative battery cable terminal from the battery if you plan to store your vehicle for an extended period.

**Note:** *If you only disconnect the negative battery cable terminal, make sure it is isolated or placed away from the battery terminal to avoid unintended connection or arcing.*

To maintain correct operation of the battery management system, if you add any electrical devices to your vehicle, do not connect the ground connection directly to the negative battery terminal. A connection at the negative battery terminal can cause inaccurate measurements of the battery condition and potential incorrect system operation.

**Note:** *If you add electrical accessories or components to your vehicle this may adversely affect battery performance, durability and the performance of other electrical systems on your vehicle.*

If you replace the battery make sure it matches the electrical requirements of your vehicle.

If you disconnect or replace the battery and your vehicle has an automatic transmission, it must relearn its adaptive strategy. Because of this, the transmission may shift firmly when first driven. This is normal operation while the transmission fully updates its operation to optimum shift feel.

## Remove and Reinstall the Battery

To disconnect or remove the battery, do the following:

1. Apply the parking brake and switch the ignition off.
2. Switch all electrical equipment off, for example lights and radio.
3. Wait a minimum of two minutes before disconnecting the battery.

**Note:** *The engine management system has a power hold function and remains powered for a period of time after you switch the ignition off. This is to allow diagnostic and adaptive tables to be stored. Disconnecting the battery without waiting can cause damage not covered by the vehicle Warranty.*

4. Disconnect the negative battery cable terminal.
5. Disconnect the positive battery cable terminal.
6. Remove the battery securing clamp.
7. Remove the battery.
8. To install, reverse the removal procedure.

**Note:** *Before reconnecting the battery, make sure the ignition remains switched off.*

**Note:** *Make sure the battery cable terminals are fully tightened.*

**Note:** *After cleaning or replacing the battery, make sure you reinstall the battery cover or shield.*

If you disconnect or replace the vehicle battery, you must reset the following features:

- Window bounce-back. See **Windows** (page 131).
- Clock Settings.
- Pre-set radio stations.
- Steering Angle Sensor.

# Maintenance

**Note:** To calibrate the steering angle sensor, drive the vehicle above 30 mph (50 km/h) for a minimum of 1.2 mi (2 km). Make sure to drive straight ahead for a minimum of 30 seconds. Several vehicle functions are disabled and a warning light could appear until the sensor is calibrated.

**Note:** The battery sensor must be reset when a new battery is installed. Install only a battery approved by Ford for use in the vehicle. Use the following procedure to perform the battery sensor reset:

1. Turn ignition to on and leave engine off. Steps 2 and 3 must be completed within 10 seconds.
2. Flash the high beams 5 times, ending with the high beams off.
3. Press and release the brake pedal 3 times.

The battery warning light on the cluster will flash 3 times to confirm that the reset was successful.

## Battery Management System

The battery management system monitors battery conditions and takes actions to extend battery life. If excessive battery drain is detected, the system temporarily disables some of the following features:

- Heated rear window.
- Heated seats.
- Climate control.
- Heated steering wheel.
- Audio unit.
- Navigation system.

A message may appear in the information display to alert you that battery protection actions are active.

After battery replacement, or in some cases after charging the battery with an external charger, the battery management system requires eight hours of vehicle sleep time to relearn the battery state of charge. During this time your vehicle must remain fully locked with the ignition off.

**Note:** If you add electrical accessories or components to the vehicle, it may adversely affect battery performance and durability. This may also affect the performance of other electrical systems in the vehicle.

## Battery Disposal



Make sure that you dispose of old batteries in an environmentally friendly way. Seek advice from your local authority about recycling old batteries.

## ADJUSTING THE HEADLAMPS

### Vertical Aim Adjustment

The headlamps on your vehicle are properly aimed at the assembly plant. If your vehicle has been involved in a crash, have the aim of the headlamp beam checked by an authorized dealer.

# Maintenance

## Headlamp Aiming Target

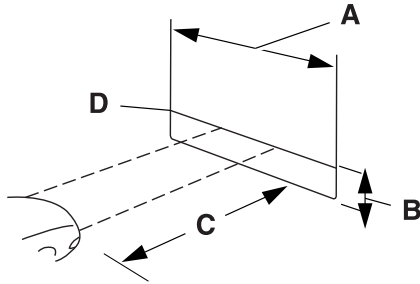

- A 8 ft (2.4 m).
- B Center height of lamp to ground.
- C 25 ft (7.6 m).
- D Horizontal reference line.

## Vertical Aim Adjustment Procedure

1. Park the vehicle directly in front of a wall or screen on a level surface, approximately 25 ft (7.6 m) away.

2. Measure the height of the headlamp bulb center from the ground and mark an 8 ft (2.4 m) horizontal reference line on the vertical wall or screen at this height.

**Note:** To see a clearer light pattern for adjusting, you may want to block the light from one headlamp while adjusting the other.

3. Turn on the low beam headlamps to illuminate the wall or screen and open the hood.

4. On the wall or screen you will observe a flat zone of high intensity light at the top of the right hand portion of the beam pattern. If the top edge of the high intensity light zone is not at the horizontal reference line, the headlamp needs to be adjusted.



# Maintenance

---

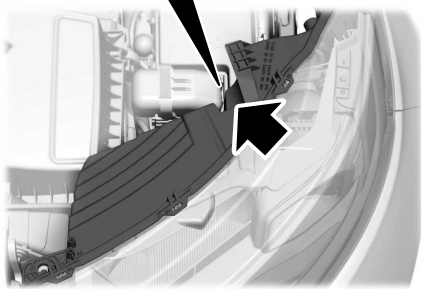

5. Locate the vertical adjuster on each headlamp. Using a Phillips #2 screwdriver, turn the adjuster either clockwise or counterclockwise in order to adjust the vertical aim of the headlamp. The horizontal edge of the brighter light should touch the horizontal reference line.
6. Close the hood and turn off the lamps.

# Maintenance

---

## EXTERIOR BULBS

### EXTERIOR BULB SPECIFICATION CHART

Lamp	Specification	Power (Watt)
Brake and rear lamp.	LED	LED
Central high mounted brake lamp.	LED	LED
Daytime running lamps.	H15/LED	PWM/LED
Front fog lamp.	LED	LED
Front turn signal lamp.	WY21W	21
Front side marker lamp.	LED	LED
Front signature lamp.	LED	LED
Headlamp high beam.	LED	LED
Headlamp low beam.	LED	LED
High-intensity discharge headlamps.	LED	LED
License plate lamp.	W5W	5
Rear turn signal lamp.	LED	LED
Rear side marker lamp.	LED	LED

# Maintenance

---

Lamp	Specification	Power (Watt)
Reversing lamps.	LED	LED
Side direction indicator.	LED	LED

**Note:** LED lamps are not serviceable. See an authorized dealer if they fail.

# Maintenance

## REMOVING A HEADLAMP ASSEMBLY

1. Open the hood. See **Opening and Closing the Hood** (page 339).

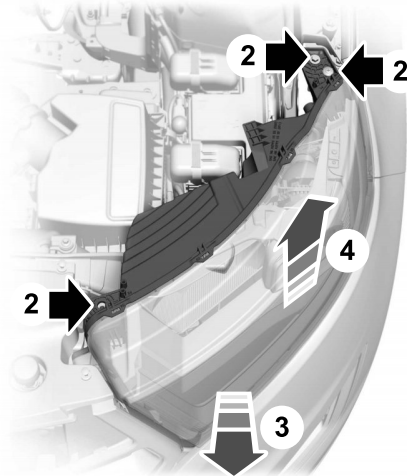

2. Remove the screws.
3. Pull the headlamp toward the front of the vehicle to disengage it from the lower fixing point.

4. Lift the headlamp up and remove it.

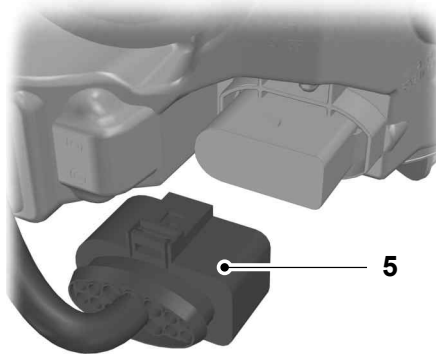

5. Disconnect the electrical connector.

## CHANGING A FRONT TURN SIGNAL LAMP BULB

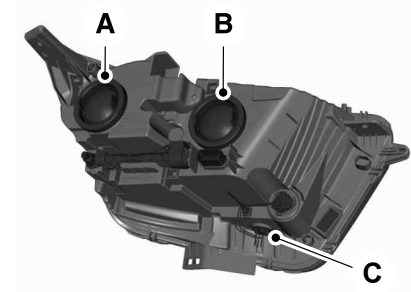

- A Headlamp low beam.  
Headlamp low and high beam - vehicles with high-intensity discharge headlamps.
- B Headlamp high beam.  
Daytime running lamp.
- C Front turn signal lamp.

1. Remove the headlamp assembly. See **Removing a Headlamp Assembly** (page 360).



# Maintenance

2. Turn the bulb holder counterclockwise and remove it.
3. Remove the bulb by pulling it straight out.

## CHANGING A LICENSE PLATE LAMP BULB

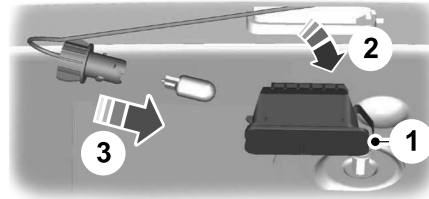

1. Use a suitable tool, for example a screwdriver, to carefully remove the lamp.
2. Remove the lamp.
3. Turn the bulb holder counterclockwise and remove it.
4. Remove the bulb by pulling it straight out.

## INTERIOR BULBS

### INTERIOR BULB SPECIFICATION CHART

Lamp	Specification	Power (Watt)
Interior lamp.	LED	LED
Luggage compartment lamp.	LED	LED

**Note:** LED lamps are not serviceable. See an authorized dealer if they fail.

# Vehicle Care

## CLEANING PRODUCTS

For best results, use the following products or products of equivalent quality:

For additional information and assistance, we recommend that you contact an authorized dealer.

### Materials

Name	Specification
Motorcraft® Bug and Tar Remover, ZC-42 (U.S. & Canada)	
Motorcraft® Custom Bright Metal Cleaner, ZC-15 (U.S. & Canada)	ESR-M5B194-B
Motorcraft® Detail Wash, ZC-3-A (U.S. & Canada)	ESR-M14P4-A
Motorcraft® Engine Shampoo and Degreaser, ZC-20 (U.S.)	ESR-M14P3-A
Motorcraft® Engine Shampoo, CXC-66-A (Canada)	
Motorcraft® Premium Leather and Vinyl Cleaner, ZC-56 (U.S. & Canada)	
Motorcraft® Multi-Purpose Cleaner, CXC-101 (Canada)	
Motorcraft® Premium Windshield Wash Concentrate with Bitterant, ZC-32-B2 (U.S.)	WSS-M14P19-A
Motorcraft® Premium Quality Windshield Washer Fluid, CXC-37-F/M (Canada)	WSS-M14P19-A
Motorcraft® Professional Strength Carpet & Upholstery Cleaner, ZC-54 (U.S. & Canada)	
Motorcraft® Premium Glass Cleaner, CXC-100 (Canada)	ESR-M14P5-A

# Vehicle Care

Name	Specification
Motorcraft® Spot and Stain Remover, ZC-14 (U.S.)	
Motorcraft® Ultra-Clear Spray Glass Cleaner, ZC-23 (U.S.)	ESR-M14P5-A
Motorcraft® Wheel and Tire Cleaner, ZC-37-A (U.S. & Canada)	

## CLEANING THE EXTERIOR

### CLEANING HEADLAMPS AND REAR LAMPS

We recommend that you only use cold or lukewarm water containing car shampoo to clean the headlamps and the rear lamps.

Do not scrape the lamps.

Do not wipe lamps when they are dry.

### CLEANING WINDOWS AND WIPER BLADES

To clean the windshield and wiper blades:

- Clean the windshield with a non-abrasive glass cleaner.

**Note:** *When cleaning the interior of the windshield, avoid getting any glass cleaner on the instrument panel or door panels. Wipe any glass cleaner off these surfaces immediately.*

- Clean the wiper blades with washer fluid or water applied with a soft sponge or cloth.

**Note:** *Do not use razor blades or other sharp objects to clean or remove decals from the inside of the heated rear window. This can cause damage not covered by the vehicle Warranty.*

## CLEANING CHROME, ALUMINIUM OR STAINLESS STEEL

We recommend that you only use a car shampoo, a soft cloth and water on bumpers and other chrome, aluminium or stainless steel parts.

**Note:** *For additional information and assistance, we recommend that you contact an authorized dealer.*

**Note:** *Rinse the area well after cleaning.*

**Note:** *Do not use abrasive materials, for example steel wool or plastic pads, as they can scratch these surfaces.*

**Note:** *Do not use chrome cleaner, metal cleaner or polish on wheels or wheel covers.*

# Vehicle Care

---

## CLEANING WHEELS

Only use a recommended wheel and tire cleaner to clean the wheels weekly. For additional information and assistance, we recommend that you contact an authorized dealer.

1. Use a sponge to remove heavy deposits of dirt and brake dust.
2. Rinse well after cleaning.

**Note:** *Do not apply a cleaning chemical to warm or hot wheel rims and covers.*

If you intend on parking your vehicle for an extended period after cleaning the wheels with a wheel cleaner, drive your vehicle for a few minutes before parking your vehicle. This reduces the risk of corrosion of the brake discs, brake pads and linings.

Do not clean the wheels when they are hot.

**Note:** *Some car washes could damage wheel rims and covers.*

**Note:** *Using non-recommended cleaners, harsh cleaning products, chrome wheel cleaners or abrasive materials could damage wheel rims and covers.*

## CLEANING THE ENGINE COMPARTMENT

Use a vacuum cleaner to remove debris from the screen area below windshield.

**Note:** *If you are not familiar with the parts around the engine do not wash the engine compartment. Avoid frequent engine washes.*

When washing the engine compartment:

- Never wash or rinse the engine while it is hot or running.
- Never wash or rinse any ignition coil, spark plug wire or spark plug well.
- Cover the battery, power distribution box, and air filter assembly to prevent water damage.

**Note:** *If your vehicle has an engine cover remove the cover before application of shampoo and degreaser.*

- Spray an approved engine shampoo and degreaser on all parts that require cleaning and rinse with water.

## CLEANING STRIPES OR GRAPHICS

It is recommended to wash your vehicle by hand however, pressure washing may be used under the following conditions:

- Use a spray with a 40° wide spray angle pattern.
- Keep the nozzle at a 12 in (305 mm) distance and 90° angle to your vehicle's surface.
- Do not use water pressure higher than 2,000 psi (14,000 kPa).
- Do not use water hotter than 179°F (82°C).

**Note:** *Holding the pressure washer nozzle at an angle to the vehicle's surface may damage graphics and cause the edges to peel away from the vehicle's surface.*

## CLEANING CAMERA LENSES AND SENSORS

We recommend that you only use lukewarm or cold water and a soft cloth to clean the camera lens and sensors.

# Vehicle Care

**Note:** Do not pressure wash camera lens and sensors.

## WAXING

Wax the high-gloss painted surface of your prewashed vehicle once or twice a year.

We recommend that you only use an approved quality wax that does not contain abrasives. For additional information and assistance, we recommend that you contact an authorized dealer.

When washing and waxing, park your vehicle in a shaded area out of direct sunlight.

**Note:** Avoid waxing unpainted or low-gloss black colored parts, they discolor over time.

## CLEANING THE INTERIOR

### CLEANING THE INSTRUMENT PANEL

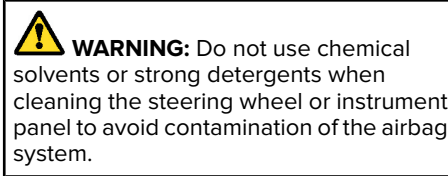

We recommend that you only clean the instrument panel and cluster lens with a damp soft cloth. Dry the area with a clean, soft cloth.

For additional information and assistance, we recommend that you contact an authorized dealer.

**Note:** Avoid cleaners or polishes that increase the gloss of the upper portion of the instrument panel. The dull finish in this area helps protect you from undesirable windshield reflection.

## CLEANING PLASTIC

We recommend that you only use a mild soap and water solution on a soft cloth. Dry the area with a clean, soft cloth.

## CLEANING DISPLAYS AND SCREENS

We recommend that you only use a microfiber cloth in a circular motion to clean off the fingerprint or dust.

If dirt or fingerprints are still on the screen, apply a small amount of alcohol to the cloth and try to clean it again.

**Note:** Do not pour or spray alcohol onto the touchscreen.

**Note:** Do not use detergent or any type of solvent to clean the touchscreen.

## CLEANING LEATHER AND VINYL

We recommend that you only clean the leather and vinyl surfaces in the following way:

1. Remove dust and loose dirt with a vacuum cleaner.

# Vehicle Care

2. Wipe the surface with a soft, damp cloth and a mild soap and water solution. Dry the area with a clean, soft cloth.
3. Make sure the leather is dry, then apply a small amount of conditioner to a clean, dry cloth.
4. Rub the conditioner into the leather until it disappears. Allow the conditioner to dry, then repeat the process for the entire interior. If a film appears, wipe it off with a dry, clean cloth.
5. For additional information and assistance, we recommend that you contact an authorized dealer.

## CLEANING FABRIC SEATS AND HEADLINERS



**WARNING:** On vehicles equipped with seat-mounted airbags, do not use chemical solvents or strong detergents. Such products could contaminate the side airbag system and affect performance of the side airbag in a crash.

We recommend that you only clean the fabric seats and headliners in the following way:

1. Remove dust and loose dirt with a vacuum cleaner.
2. Wipe the surface with a soft, damp cloth and a mild soap and water solution. Dry the area with a clean, soft cloth.
3. For additional information and assistance, we recommend that you contact an authorized dealer.

For heavy stains, spot clean the area. If a ring forms on the fabric, clean the entire area immediately, but do not oversaturate or the ring could set.

## CLEANING CARPETS AND FLOOR MATS

We recommend that you only clean your carpets in the following way:

1. Remove dust and loose dirt with a vacuum cleaner.
2. Wipe the surface with a soft, damp cloth and a mild soap and water solution. Dry the area with a clean, soft cloth.

3. For additional information and assistance, we recommend that you contact an authorized dealer.

For heavy stains, spot clean the area. If a ring forms on the fabric, clean the entire area immediately, but do not oversaturate or the ring could set.

We recommend that you only clean your floor mats in the following way:

1. Remove dust and loose dirt with a vacuum cleaner.
2. Wash rubber floor mats using mild soap and lukewarm or cold water.
3. Completely dry the floor mat before placing them back in your vehicle.

## CLEANING SEATBELTS



**WARNING:** Do not use cleaning solvents, bleach or dye on the vehicle's seatbelts, as these actions may weaken the belt webbing.

# Vehicle Care

---

1. Wipe the surface with a soft, damp cloth and a mild soap and water solution. Dry the area with a clean, soft cloth.

## **CLEANING STORAGE COMPARTMENTS**

1. Remove dust and loose dirt with a vacuum cleaner.
2. Wipe the surface with a soft, damp cloth and a mild soap and water solution. Dry the area with a clean, soft cloth.

## **CLEANING MOONROOF TRACKS**

1. Remove debris from the tracks with a vacuum cleaner.
2. Wipe the bulb seal and mating painted roof metal surface with a soft, damp cloth and a mild soap and water solution.

**Note:** *The moonroof rail tracks are greased to maintain proper functionality. Do not wipe off the grease.*

## **REPAIRING MINOR PAINT DAMAGE**

Authorized dealers have touch-up paint to match your vehicle's color. Your vehicle color code is printed on a sticker on the front, left-hand side door jamb. Take your color code to your authorized dealer to make sure you get the correct color.

Before repairing minor paint damage, use a cleaner to remove particles such as bird droppings, tree sap, insect deposits, tar spots, road salt and industrial fallout.

Read the instructions before using cleaning products.

# Body Styling Kits

---

## **BODY STYLING KIT PRECAUTIONS**

The distance between the underside of your vehicle and the ground is less than that of other models. Drive with extreme care to avoid damage to your vehicle.



# Storing Your Vehicle

---

## PREPARING YOUR VEHICLE FOR STORAGE

If you plan on storing your vehicle for 30 days or more, the following maintenance recommendations ensures your vehicle stays in good operating condition.

Under various conditions, long-term storage may lead to degraded engine performance or failure unless you use specific precautions to preserve your vehicle.

### General

- Store all vehicles in a dry, ventilated place.
- If vehicles are stored outside, they require regular maintenance to protect against rust and weather damage.
- Make sure all linkages, cables, levers and pins under your vehicle are covered with grease to prevent rust.

- Move vehicles at least 25 ft (7.5 m) every 15 days to lubricate working parts and prevent corrosion.
- Fill the fuel tank with high-quality fuel until the first automatic shutoff of the fuel pump nozzle.

### Engine

- Change the engine oil and filter prior to storage because used engine oil contains contaminants which may cause engine damage.
- Start the engine every 15 days for a minimum of 15 minutes. Run at fast idle with the climate controls set to defrost until the engine reaches normal operating temperature.
- With your foot on the brake, shift through all the gears while the engine is running.

### Body

- Wash your vehicle thoroughly to remove dirt, grease, oil, tar or mud from exterior surfaces, rear-wheel housings and the underside of front fenders.
- Periodically wash your vehicle if it is stored in exposed locations.
- Touch-up exposed or primed metal to prevent rust.
- Cover chrome and stainless steel parts with a thick coat of auto wax to prevent discoloration. Re-wax as necessary when you wash your vehicle.
- Lubricate all hood, door and luggage compartment hinges and latches with a light grade oil.
- Cover interior trim to prevent fading.
- Keep all rubber parts free from oil and solvents.

# Storing Your Vehicle

---

## Hybrid Battery Systems

We recommend the following actions for your vehicle:

- When storing your vehicle for greater than 30 days the state of charge should be approximately 50%. Additionally we recommend disconnecting the 12V battery which will reduce system loads on the HV battery.

## 12 Volt Battery

- Check and recharge as necessary. Keep connections clean.

**Note:** *It is necessary to reset memory features if you disconnect the battery cables.*

## Brakes

Make sure the brakes and parking brake release fully.

**Note:** *If you intend on parking your vehicle for an extended period after cleaning the wheels with a wheel cleaner, drive your vehicle for a few minutes before doing so to reduce the risk of increased corrosion of the brake discs, brake pads and linings.*

## Tires

- Maintain recommended air pressure.

**Note:** *If you intend on parking your vehicle for an extended period after cleaning the wheels with a wheel cleaner, drive your vehicle for a few minutes before doing so. This reduces the risk of corrosion of the brake discs, brake pads and linings.*

## REMOVING YOUR VEHICLE FROM STORAGE

When your vehicle is ready to come out of storage, do the following:

- We recommend that you change the engine oil before you use your vehicle again.
- Wash your vehicle to remove any dirt or grease film build-up on window surfaces.
- Check windshield wipers for any deterioration.
- Check under the hood for any foreign material that may have collected during storage such as mice or squirrel nests.

- Check the exhaust for any foreign material that may have collected during storage.
- Check tire pressures and set tire inflation per the Tire Label.
- Check brake pedal operation. Drive your vehicle 15 ft (4.5 m) back and forth to remove rust build-up.
- Check fluid levels (including coolant, oil and gas) to make sure there are no leaks, and fluids are at recommended levels.
- If you remove the battery, clean the battery cable ends and check for damage.

Contact an authorized dealer if you have any concerns or issues.

# Wheel and Tire Information

## LOCATING THE TIRE LABEL

The tire label or safety certification label is on the driver side B-pillar or the edge of the driver door. It contains information on the recommended front and rear tire inflation pressures. See **Locating the Safety Compliance Certification Labels** (page 294).

## DEPARTMENT OF TRANSPORTATION UNIFORM TIRE QUALITY GRADES



Tire Quality Grades apply to new pneumatic passenger car tires. The Quality grades can be found where applicable on the tire sidewall between tread shoulder and maximum section width. For example: **Treadwear 200 Traction AA Temperature A**.

These Tire Quality Grades are determined by standards that the United States Department of Transportation has set.

Tire Quality Grades apply to new pneumatic passenger car tires. They do not apply to deep tread, winter-type snow tires, space-saver or temporary use spare tires, light truck or LT type tires, tires with nominal rim diameters of 10 to 12 inches or limited production tires as defined in Title 49 Code of Federal Regulations Part 575.104 (c)(2).

**U.S. Department of Transportation Tire quality grades:** The U.S. Department of Transportation requires us to give you the following information about tire grades exactly as the government has written it.

## Treadwear

The treadwear grade is a comparative rating based on the wear rate of the tire when tested under controlled conditions on a specified government test course. For example, a tire graded 150 would wear 1½ times as well on the government course as a tire graded 100. The relative performance of tires depends upon the actual conditions of their use, however, and may depart significantly from the norm due to variations in driving habits, service practices, and differences in road characteristics and climate.

## Traction AA A B C



**WARNING:** The traction grade assigned to this tire is based on straight-ahead braking traction tests, and does not include acceleration, cornering, hydroplaning or peak traction characteristics.

# Wheel and Tire Information

The traction grades, from highest to lowest are AA, A, B, and C. The grades represent the tire's ability to stop on wet pavement as measured under controlled conditions on specified government test surfaces of asphalt and concrete. A tire marked C may have poor traction performance.

## Temperature A B C



**WARNING:** The temperature grade for this tire is established for a tire that is properly inflated and not overloaded. Excessive speed, underinflation, or excessive loading, either separately or in combination, can cause heat buildup and possible tire failure.

The temperature grades are A (the highest), B and C, representing the tire's resistance to the generation of heat and its ability to dissipate heat when tested under controlled conditions on a specified indoor laboratory test wheel. Sustained high temperature can cause

the material of the tire to degenerate and reduce tire life, and excessive temperature can lead to sudden tire failure. The grade C corresponds to a level of performance which all passenger car tires must meet under the Federal Motor Vehicle Safety Standard No. 139. Grades B and A represent higher levels of performance on the laboratory test wheel than the minimum required by law.

## INFORMATION ON THE TIRE SIDEWALL

Both United States and Canada Federal regulations require tire manufacturers to place standardized information on the sidewall of all tires. This information identifies and describes the fundamental characteristics of the tire and also provides a U.S. DOT Tire Identification Number for safety standard certification and in case of a recall.

## Information on P Type Tires

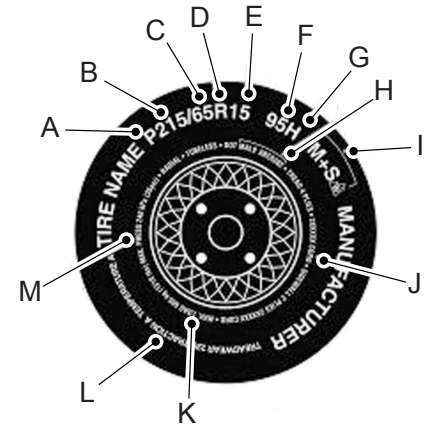

P215/65R15 95H is an example of a tire size, load index and speed rating. The definitions of these items are listed below. (Note that the tire size, load index and speed rating for your vehicle may be different from this example.)

# Wheel and Tire Information

A. **P:** Indicates a tire, designated by the Tire and Rim Association, that may be used for service on cars, sport utility vehicles, minivans and light trucks. **Note:** If your tire size does not begin with a letter this may mean it is designated by either the European Tire and Rim Technical Organization or the Japan Tire Manufacturing Association.

B. **215:** Indicates the nominal width of the tire in millimeters from sidewall edge to sidewall edge. In general, the larger the number, the wider the tire.

C. **65:** Indicates the aspect ratio which gives the tire's ratio of height to width.

D. **R:** Indicates a radial type tire.

E. **15:** Indicates the wheel or rim diameter in inches. If you change your wheel size, you will have to purchase new tires to match the new wheel diameter.

F. **95:** Indicates the tire's load index. It is an index that relates to how much weight a tire can carry. You may find this information in your owner's manual. If not, contact a local tire dealer.

**Note:** *You may not find this information on all tires because it is not required by federal law.*

G. **H:** Indicates the tire's speed rating. The speed rating denotes the speed at which a tire is designed to be driven for extended periods of time under a standard condition of load and inflation pressure. The tires on your vehicle may operate at different conditions for load and inflation pressure. These speed ratings may need to be adjusted for the difference in conditions. The ratings range from 81 mph (130 km/h) to 186 mph (299 km/h). These ratings are listed in the following chart.

**Note:** *You may not find this information on all tires because it is not required by federal law.*

Letter rating	Speed rating
M	81 mph (130 km/h)
N	87 mph (140 km/h)
Q	99 mph (159 km/h)
R	106 mph (171 km/h)
S	112 mph (180 km/h)
T	118 mph (190 km/h)
U	124 mph (200 km/h)
H	130 mph (210 km/h)
V	149 mph (240 km/h)

# Wheel and Tire Information

Letter rating	Speed rating
W	168 mph (270 km/h)
Y	186 mph (299 km/h)

**Note:** For tires with a maximum speed capability over 149 mph (240 km/h), tire manufacturers sometimes use the letters ZR. For those with a maximum speed capability over 186 mph (299 km/h), tire manufacturers always use the letters ZR.

**H. U.S. DOT Tire Identification Number (TIN):** This begins with the letters DOT and indicates that the tire meets all federal standards. The next two numbers or letters are the plant code designating where it was manufactured, the next two are the tire size code and the last four numbers represent the week and year the tire was built. For example, the numbers 317 mean the 31st week of 1997. After 2000, the numbers

go to four digits. For example, 2501 means the 25th week of 2001. The numbers in between are identification codes used for traceability. This information is used to contact customers if a tire defect requires a recall.

I. **M+S or M/S:** Mud and Snow, or

**AT:** All Terrain, or

**AS:** All Season.

J. **Tire Ply Composition and Material**

**Used:** Indicates the number of plies or the number of layers of rubber-coated fabric in the tire tread and sidewall. Tire manufacturers also must indicate the ply materials in the tire and the sidewall, which include steel, nylon, polyester, and others.

K. **Maximum Load:** Indicates the maximum load in kilograms and pounds that can be carried by the tire. See the Safety Compliance Certification Label (affixed to either the door hinge pillar, door-latch post, or the door edge that meets the door-latch post, next to the driver's seating position), for the correct tire pressure for your vehicle.

L. **Treadwear, Traction and Temperature Grades:**

\***Treadwear** The treadwear grade is a comparative rating based on the wear rate of the tire when tested under controlled conditions on a specified government test course. For example, a tire graded 150 would wear one and one-half times as well on the government course as a tire graded 100.

# Wheel and Tire Information

**\*Traction:** The traction grades, from highest to lowest are AA, A, B, and C. The grades represent the tire's ability to stop on wet pavement as measured under controlled conditions on specified government test surfaces of asphalt and concrete. A tire marked C may have poor traction performance.

**\*Temperature:** The temperature grades are A (the highest), B and C, representing the tire's resistance to the generation of heat and its ability to dissipate heat when tested under controlled conditions on a specified indoor laboratory test wheel.

### M. Maximum Inflation Pressure:

Indicates the tire manufacturers' maximum permissible pressure or the pressure at which the maximum load can be carried by the tire. This pressure is normally higher than the vehicle manufacturer's recommended cold inflation pressure which can be found on the Safety Compliance Certification Label (affixed to either the door hinge pillar, door-latch post, or the door edge that meets the door-latch post, next to

the driver's seating position), or Tire Label which is located on the B-Pillar or the edge of the driver's door. The cold inflation pressure should never be set lower than the recommended pressure on the vehicle label.

The tire suppliers may have additional markings, notes or warnings such as standard load or radial tubeless.

### Additional Information Contained on the Tire Sidewall for LT Type Tires

**Note:** *Tire Quality Grades do not apply to this type of tire.*

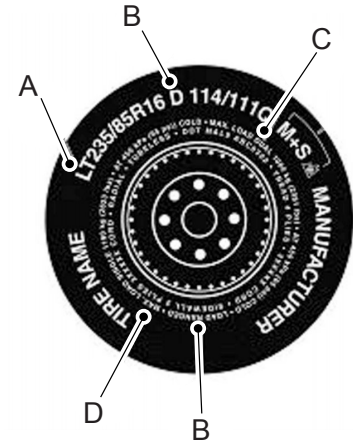

LT type tires have some additional information beyond those of P type tires; these differences are described below.

**A. LT:** Indicates a tire, designated by the Tire and Rim Association, that is intended for service on light trucks.

# Wheel and Tire Information

## B. Load Range and Load Inflation

**Limits:** Indicates the tire's load-carrying capabilities and its inflation limits.

## C. Maximum Load Dual lb (kg) at psi

**(kPa) cold:** Indicates the maximum load and tire pressure when the tire is used as a dual, defined as four tires on the rear axle (a total of six or more tires on the vehicle).

## D. Maximum Load Single lb (kg) at psi

**(kPa) cold:** Indicates the maximum load and tire pressure when the tire is used as a single, defined as two tires (total) on the rear axle.

## Information on T Type Tires

T145/80D16 is an example of a tire size.

**Note:** *The temporary tire size for your vehicle may be different from this example. Tire Quality Grades do not apply to this type of tire.*

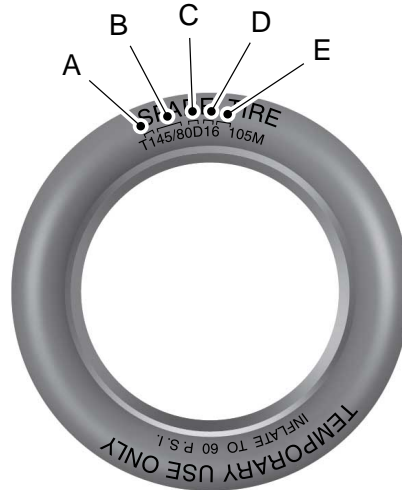

T type tires have some additional information beyond those of P type tires; these differences are described below:

A. **T:** Indicates a type of tire, designated by the Tire and Rim Association, that is intended for temporary service on cars, sport utility vehicles, minivans and light trucks.

B. **145:** Indicates the nominal width of the tire in millimeters from sidewall edge to sidewall edge. In general, the larger the number, the wider the tire.

C. **80:** Indicates the aspect ratio which gives the tire's ratio of height to width. Numbers of 70 or lower indicate a short sidewall.

D. **D:** Indicates a diagonal type tire.

**R:** Indicates a radial type tire.

E. **16:** Indicates the wheel or rim diameter in inches. If you change your wheel size, you will have to purchase new tires to match the new wheel diameter.



# Wheel and Tire Information

---

## GLOSSARY OF TIRE TERMINOLOGY

**\*Tire label:** A label showing the original equipment tire sizes, recommended inflation pressure and the maximum weight the vehicle can carry.

**\*Tire Identification Number (TIN):** A number on the sidewall of each tire providing information about the tire brand and manufacturing plant, tire size and date of manufacture. Also referred to as DOT code.

**\*Inflation pressure:** A measure of the amount of air in a tire.

**\*Standard load:** A class of P-metric or Metric tires designed to carry a maximum load at set pressure. For example: For P-metric tires 35 psi (2.4 bar) and for Metric tires 36 psi (2.5 bar). Increasing the inflation pressure beyond this pressure will not increase the tire's load carrying capability.

**\*Extra load:** A class of P-metric or Metric tires designed to carry a heavier maximum load at 42 psi (2.9 bar). Increasing the inflation pressure beyond this pressure will not increase the tire's load carrying capability.

**\*kPa:** Kilopascal, a metric unit of air pressure.

**\*PSI:** Pounds per square inch, a standard unit of air pressure.

**\*Cold tire pressure:** The tire pressure when the vehicle has been stationary and out of direct sunlight for an hour or more and prior to the vehicle being driven for 1 mi (1.6 km).

**\*Recommended inflation pressure:** The cold inflation pressure found on the Safety Compliance Certification Label (affixed to either the door hinge pillar, door-latch post, or the door edge that meets the door-latch post, next to the driver's seating position), or Tire Label located on the B-Pillar or the edge of the driver door.

**\* B-pillar:** The structural member at the side of the vehicle behind the front door.

**\*Bead area of the tire:** Area of the tire next to the rim.

**\* Sidewall of the tire:** Area between the bead area and the tread.

**\*Tread area of the tire:** Area of the perimeter of the tire that contacts the road when mounted on the vehicle.

**\*Rim:** The metal support (wheel) for a tire or a tire and tube assembly upon which the tire beads are seated.

## TIRE REPLACEMENT REQUIREMENTS

Your vehicle is equipped with tires designed to provide a safe ride and handling capability.

## Wheel and Tire Information



**WARNING:** Only use replacement tires and wheels that are the same size, load index, speed rating and type (such as P-metric versus LT-metric or all-season versus all-terrain) as those originally provided by Ford. The recommended tire and wheel size may be found on either the Safety Compliance Certification Label (affixed to either the door hinge pillar, door-latch post, or the door edge that meets the door-latch post, next to the driver's seating position), or the Tire Label which is located on the B-Pillar or edge of the driver's door. If this information is not found on these labels, then you should contact your authorized dealer as soon as possible. Use of any tire or wheel not recommended by Ford can affect the safety and performance of your vehicle, which could result in an increased risk of loss of vehicle control, vehicle rollover, personal injury and death.



**WARNING:** To reduce the risk of serious injury, when mounting replacement tires and wheels, you should not exceed the maximum pressure indicated on the sidewall of the tire to set the beads without additional precautions listed below. If the beads do not seat at the maximum pressure indicated, re-lubricate and try again.



**WARNING:** For a mounting pressure more than 20 psi (1.38 bar) greater than the maximum pressure, a Ford dealer or other tire service professional should do the mounting.



**WARNING:** Always inflate steel carcass tires with a remote air fill with the person inflating standing at a minimum of 12 ft (3.66 m) away from the wheel and tire assembly.



**WARNING:** When inflating the tire for mounting pressures up to 20 psi (1.38 bar) greater than the maximum pressure on the tire sidewall, the following precautions must be taken to protect the person mounting the tire:



**WARNING:** Use only the specified jacking points. If you use other locations, you could damage the body, steering, suspension, engine, braking system or the fuel lines.

- Make sure that you have the correct tire and wheel size.
- Lubricate the tire bead and wheel bead seat area again.
- Stand at a minimum of 12 ft (3.66 m) away from the wheel and tire assembly.
- Use both eye and ear protection.

**Important:** Remember to replace the wheel valve stems when the road tires are replaced on your vehicle.

# Wheel and Tire Information

It is recommended that the two front tires or two rear tires generally be replaced as a pair if the worn tires still have usable depth.

To avoid potential All-Wheel Drive (AWD) malfunction or (AWD) system damage, it is recommended to replace all four tires rather than mixing significantly worn tires with new tires.

The tire pressure sensors mounted in the wheels (originally installed on your vehicle) are not designed to be used in aftermarket wheels.

The use of wheels or tires not recommended may affect the operation of your tire pressure monitoring system.

If the tire pressure monitoring system indicator is flashing, your system is malfunctioning. Your replacement tire might be incompatible with your tire pressure monitoring system, or some component of the system may be damaged.

## Age



**WARNING:** Tires degrade over time depending on many factors such as weather, storage conditions, and conditions of use (load, speed, inflation pressure) the tires experience throughout their lives.

In general, tires should be replaced after six years regardless of tread wear. However, heat caused by hot climates or frequent high loading conditions can accelerate the aging process and may require tires to be replaced more frequently.

You should replace your spare tire when you replace the road tires or after six years due to aging even if it has not been used.

## U.S. DOT Tire Identification Number

Both United States and Canada Federal regulations require tire manufacturers to place standardized information on the sidewall of all tires. This information identifies and describes the fundamental characteristics of the tire and also provides a U.S. DOT Tire Identification Number for safety standard certification and in case of a recall.

This begins with the letters DOT and indicates that the tire meets all federal standards. The next two numbers or letters are the plant code designating where it was manufactured, the next two are the tire size code and the last four numbers represent the week and year the tire was built. For example, the numbers 317 mean the 31st week of 1997. After 2000, the numbers go to four digits. For example, 2501 means the 25th week of 2001. The numbers in between are identification codes used for traceability. This information is used to contact customers if a tire defect requires a recall.

# Wheel and Tire Information

## USING SNOW CHAINS

 **WARNING:** Do not exceed 30 mph (50 km/h). Failure to follow this instruction could result in the loss of control of your vehicle, personal injury or death.

 **WARNING:** Do not use snow chains on snow-free roads.

 **WARNING:** Only fit snow chains to specified tires.

 **WARNING:** If your vehicle is fitted with wheel trims, remove them before fitting snow chains.

 **WARNING:** Wheels and tires must be the same size, load index and speed rating as those originally fitted on the vehicle. Use of any other tire or wheel can affect the safety and performance of your vehicle. Additionally, the use of non-recommended tires and wheels can cause steering, suspension, axle, transfer case or power transfer unit failure. Follow

the recommended tire inflation pressures found on the Safety Compliance Certification label, or the Tire Label on the B-Pillar or the edge of the driver door. Failure to follow this instruction could result in loss of vehicle control, vehicle rollover, or personal injury or death.

 **WARNING:** If you are driving in slippery conditions that require tire chains or cables, then it is critical that you drive cautiously. Keep speeds down, allow for longer stopping distances and avoid aggressive steering to reduce the chances of a loss of vehicle control which can lead to serious injury or death. If the rear end of your vehicle slides while cornering, steer in the direction of the slide until you regain control of your vehicle.

Only use snow chains on the front wheels. Install snow chains in pairs. Do not use self-tensioning snow chains.

Only use snow chains on the following specified tire size:

- 235/60R18 all season tires.
- Only use ultra low profile snow chains that are 10 mm or less.

We recommend you use steel wheels of the same size and specification if snow chains are required because chains may chip aluminum wheels.

Follow these guidelines when using snow tires and traction devices:

- If possible, avoid fully loading your vehicle.
- Purchase snow chains from a manufacturer that clearly labels body to tire dimension restrictions.
- When driving with snow chains do not exceed 30 mph (50 km/h) or the maximum speed recommended by the chain manufacturer, whichever is less.
- Drive cautiously. If you hear the snow chains rub or bang against the vehicle, stop and tighten them. If this does not work, remove the snow chains to prevent vehicle damage.

# Wheel and Tire Information

---

- Remove the snow chains when they are no longer needed. Do not use snow chains on dry roads.
- If a temporary spare wheel is mounted on your vehicle, do not use snow chains on the axle with the temporary spare wheel.
- Use snow chains that fit against the sidewall of the tire to prevent the chains from touching the wheel rims or suspension.

If you have any questions regarding snow tires or snow chains, please contact your authorized dealer.

# Tire Care

## CHECKING THE TIRE PRESSURES

Safe operation of your vehicle requires that your tires are properly inflated. Every day before you drive, check your tires.

At least once a month and before long trips, inspect each tire and check the tire pressure with a tire gauge. Inflate all tires to the recommended inflation pressure. See **Inflating the Tires** (page 382).

## INFLATING THE TIRES

 **WARNING:** Under-inflation is the most common cause of tire failures and may result in severe tire cracking, tread separation or blowout, with unexpected loss of vehicle control and increased risk of injury. Under-inflation increases sidewall flexing and rolling resistance, resulting in heat buildup

and internal damage to the tire. It also may result in unnecessary tire stress, irregular wear, loss of vehicle control and accidents. A tire can lose up to half of its air pressure and not appear to be flat!



**WARNING:** Do not use the tire pressure displayed in the information display as a tire pressure gauge. Failure to follow this instruction could result in personal injury or death.

Use the recommended cold inflation pressure for optimum tire performance and wear. Under-inflation or over-inflation may cause uneven treadwear patterns.

Inflate your tires to the recommended inflation pressure even if it is less than the maximum inflation pressure information found on the tire. You can find the tire label with the recommended tire inflation pressure next to the tire size on the B-Pillar or the edge of the driver door.

The recommended tire inflation pressure is also found on the Safety Compliance Certification Label, affixed to either the door hinge pillar, door-latch post, or the door edge that meets the door-latch on the B-pillar, or on the edge of the driver door.

Failure to follow the tire pressure recommendations can cause uneven treadwear patterns and adversely affect the way your vehicle handles.

## INSPECTING THE TIRE FOR WEAR

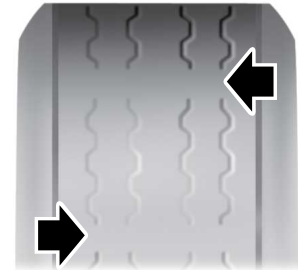

# Tire Care

When the tread is worn down to one sixteenth of an inch (2 mm), tires must be replaced to help prevent your vehicle from skidding and hydroplaning. Built-in treadwear indicators, or wear bars, which look like narrow strips of smooth rubber across the tread will appear on the tire when the tread is worn down to one sixteenth of an inch (2 mm).

When the tire tread wears down to the same height as these wear bars, the tire is worn out and must be replaced.

The tires should also be balanced periodically. An unbalanced tire and wheel assembly may result in irregular tire wear.

Periodically inspect the tire treads for uneven or excessive wear and remove objects such as stones, nails or glass that may be wedged in the tread grooves.

## INSPECTING THE TIRE FOR DAMAGE

Inspect the tire sidewalls for cracking, cuts, bruises and other signs of damage or excessive wear. If internal damage to the tire is suspected, have the tire dismounted and inspected in case it needs to be repaired or replaced. For your safety, tires that are damaged or show signs of excessive wear should not be used because they are more likely to blow out or fail.

Periodically inspect the tire treads and sidewalls for damage, such as bulges in the tread or sidewalls, cracks in the tread groove and separation in the tread or sidewall. If damage is observed or suspected, have the tire inspected by a tire professional.

## Safety Practices



**WARNING:** If your vehicle is stuck in snow, mud or sand, do not rapidly spin the tires; spinning the tires can tear the tire and cause an explosion. A tire can explode in as little as three to five seconds.



**WARNING:** Do not spin the wheels at over 34 mph (55 km/h). The tires may fail and injure a passenger or bystander.

## Highway Hazards

No matter how carefully you drive, there is always the possibility that you could eventually have a flat tire on the highway. Drive slowly to the closest safe area out of traffic. This could further damage the flat tire, but your safety is more important.

# Tire Care

If you feel a sudden vibration or ride disturbance while driving, or you suspect your tire or vehicle has been damaged, immediately reduce your speed. Drive with caution until you can safely pull off the road. Stop and inspect the tires for damage. If a tire is under-inflated or damaged, deflate it, remove the wheel and replace it with your spare tire and wheel. If you cannot detect a cause, have the vehicle towed to the nearest repair facility or tire dealer to have the vehicle inspected.

## Tire and Wheel Alignment

A bad jolt from hitting a curb or pothole can cause the front end of your vehicle to become misaligned or cause damage to your tires. If your vehicle seems to pull to one side when you are driving, the wheels could be out of alignment. Have an authorized dealer check the wheel alignment periodically.

Wheel misalignment in the front or the rear can cause uneven and rapid treadwear of your tires and should be corrected by an authorized dealer.

## INSPECTING THE WHEEL VALVE STEMS

Check the valve stems for holes, cracks, or cuts that could permit air leakage.

## TIRE ROTATION



**WARNING:** If the tire label shows different tire pressures for the front and rear tires and the vehicle has a tire pressure monitoring system, then you need to update the settings for the system sensors. Always perform the system reset procedure after tire rotation. If you do not reset the system, it may not provide a low tire pressure warning when necessary.

Rotating your tires at the recommended interval will help your tires wear more evenly, providing better tire performance and longer tire life.

**Note:** If your tires show any uneven wear have the alignment checked by an authorized dealer before rotating tires.

**Note:** If you have a dissimilar spare wheel and tire assembly, it is intended for temporary use only and should not be used in a tire rotation.

**Note:** After having your tires rotated, inflation pressure must be checked and adjusted to the vehicle requirements.

## Tire Rotation Diagram

Follow the diagram indicating the correct tire locations for rotating the tires.

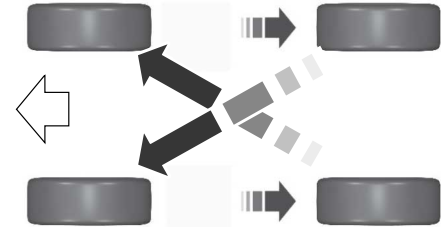



# Tire Sealant and Inflator Kit

## WHAT IS THE TIRE SEALANT AND INFLATOR KIT

The kit consists of an air compressor to re-inflate the tire and a canister of sealing compound that will effectively seal most punctures. This kit will provide a temporary tire repair allowing you to drive your vehicle up to 120 mi (200 km) at a maximum speed of 50 mph (80 km/h) to reach a tire service location.

**Note:** *The temporary mobility kit contains enough sealant compound in the canister for one tire repair only. See an authorized dealer for replacement sealant canisters.*

## TIRE SEALANT AND INFLATOR KIT PRECAUTIONS



**WARNING:** Failure to follow these guidelines could result in an increased risk of loss of vehicle control, injury or death.



**WARNING:** Do not run the engine when operating the air compressor unless the vehicle is outdoors or in a well-ventilated area.

**Note:** *Do not use the kit if a tire has become severely damaged. Only punctures located within the tire tread can be sealed with the kit.*

Do not attempt to repair punctures larger than 0.24 in (6 mm) or damage to the tire's sidewall. The tire may not completely seal.

- Drive carefully and avoid abrupt steering maneuvers.
- Periodically monitor tire inflation pressure in the affected tire; if the tire is losing pressure, have the vehicle towed.
- Read the information in the Tips for Use of the Kit section to make sure safe operation of the kit and your vehicle.

## LOCATING THE TIRE SEALANT AND INFLATOR KIT

The kit is located under the load floor in the rear of the vehicle.

# Tire Sealant and Inflator Kit

## TIRE SEALANT AND INFLATOR KIT COMPONENTS

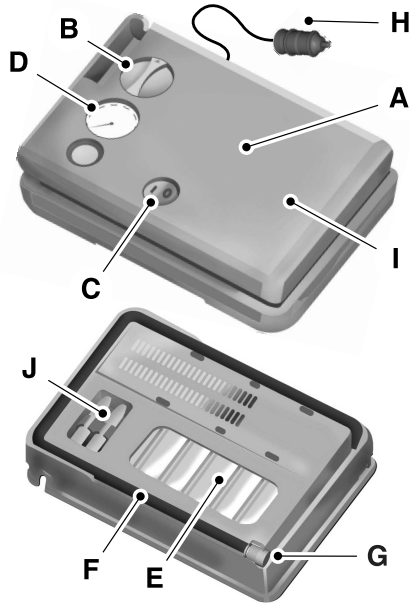

- A Air compressor (inside)
- B Selector switch
- C On and Off button
- D Air pressure gauge
- E Sealant bottle and canister
- F Dual purpose hose: air and repair
- G Tire valve connector
- H Accessory power plug
- I Casing/housing
- J Bike/raft/sports ball adapters

## USING THE TIRE SEALANT AND INFLATOR KIT

### Tips for use of the kit

To ensure safe operation of the kit:

- Before operating the kit, make sure your vehicle is safely off the road and away from moving traffic.
- Do not remove any foreign objects, such as nails or screws, from the tire.

- Do not allow the compressor to operate continuously for more than 15 minutes. This will help prevent the compressor from overheating.
- Only use the kit when the ambient temperature is between -22°F (-30°C) and 158°F (70°C).
- Only use the sealing compound before the use-by date. The use-by date is on a label on the sealant canister and can be seen through the rectangular viewing window on the bottom of the compressor. Check the use-by date regularly and replace the canister when the sealant expires.

**Note:** Sealant compound contains latex. Use appropriate precautions to avoid any allergic reactions.



When inflation only is required for a tire or other objects, the selector must be in the Air position.

### What to do when a tire is punctured

A tire puncture within the tire's tread area can be repaired in two stages with the kit.

# Tire Sealant and Inflator Kit

- In the first stage, the tire will be reinflated with a sealing compound and air. After the tire has been inflated, you will need to drive the vehicle a short distance approximately 4 mi (6 km) to distribute the sealant in the tire.
- In the second stage, you will need to check the tire pressure and adjust, if necessary, to the vehicle's specified tire inflation pressure.

## First Stage: Reinflating the Tire with sealing compound and air

**⚠ WARNING:** Do not stand directly over the kit while inflating the tire. If you notice any unusual bulges or deformations in the tire's sidewall during inflation, stop and call roadside assistance.

**⚠ WARNING:** If the tire does not inflate to the recommended tire pressure within 15 minutes, stop and call roadside assistance.

Park the vehicle in a safe, level and secure area, away from moving traffic.

Turn the hazard lights on. Apply the parking brake and power off the vehicle. Inspect the flat tire for visible damage.

If a puncture is located in the tire sidewall, stop and call roadside assistance.

1. Remove the valve cap from the tire valve.
2. Unwrap the dual purpose hose (black tube) from the back of the compressor housing.
3. Fasten the hose to the tire valve by turning the connector clockwise. Tighten the connection securely.

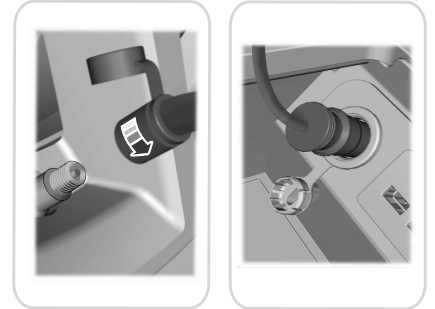

4. Plug the power cable into the 12-volt power point in the vehicle.

## Tire Sealant and Inflator Kit

- Remove the warning sticker found on the casing/housing and place it on the top of the instrument panel or the center of the dash.

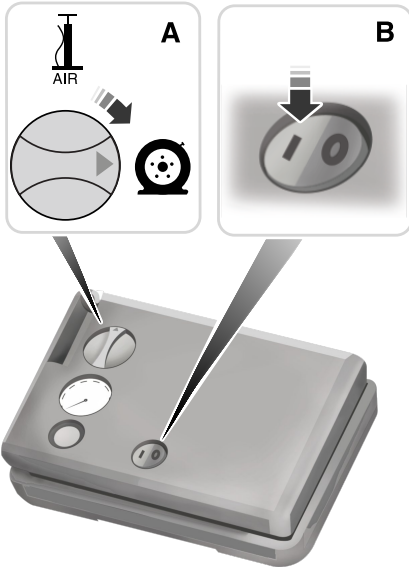

- Turn dial (A) clockwise to the sealant position. Turn the kit on by pressing the on/off button (B).
- Inflate the tire to the pressure listed on the tire label located on the driver door or the door jamb area. The final tire pressure should be checked with the compressor turned off in order to get an accurate pressure reading.

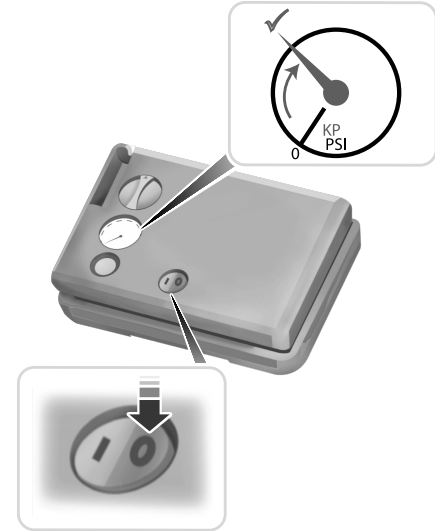

# Tire Sealant and Inflator Kit

- When the recommended tire pressure is reached, turn off the kit, unplug the power cable, and disconnect the hose from the tire valve. Re-install the valve cap on the tire valve and return the kit to the rear of the vehicle.
- Drive the vehicle 4 mi (6 km) to distribute the sealant evenly inside the tire.

**Note:** *If you experience any unusual vibration, ride disturbance or noise while driving, reduce your speed until you can safely pull off to the side of the road to call for roadside assistance. Do not proceed to the second stage of this operation.*

## Second Stage: Checking the tire pressure with the inflator kit



**WARNING:** If the tire does not inflate to the recommended tire pressure within 15 minutes, stop and call roadside assistance.



**WARNING:** The power plug may get hot after use and should be handled carefully when unplugging.

Check the air pressure of your tires as follows:



- Remove the valve cap from the tire valve.
- Firmly screw the air compressor hose onto the valve stem by turning clockwise.
- Push and turn the dial clockwise to the air position.
- If required, turn on the compressor and adjust the tire to the recommended inflation pressure.
- Unplug the hoses, re-install the valve cap on the tire and return the kit to the rear of the vehicle.

## What to do after the tire has been sealed

After using the kit to seal your tire, you will need to replace the sealant canister. Sealant canisters and spare parts can be obtained at an authorized dealer. Empty sealant canisters may be disposed of at home. However, canisters still containing liquid sealant should be disposed of in accordance with local waste disposal regulation.

## Removal of the sealant canister from the kit

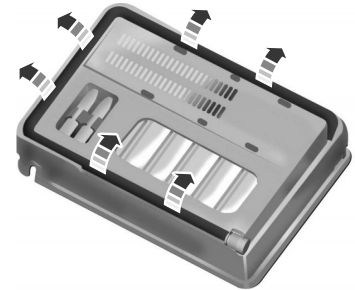

- Unwrap the dual purpose hose (black tube) from the compressor housing.

# Tire Sealant and Inflator Kit



2. Unwrap the power cord.



3. Remove the back cover.



4. Rotate the sealant canister up 90 degrees and pull away from casing/housing to remove.

## Installation of the sealant canister to the kit

1. With the canister held perpendicular to the housing, insert the canister nozzle into the connector and push until seated.
2. Rotate the canister 90 degrees down into the housing/casing.

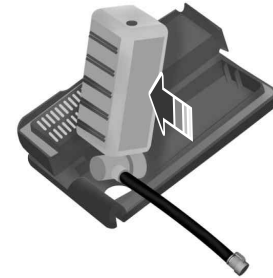

3. Snap the back cover back into place.

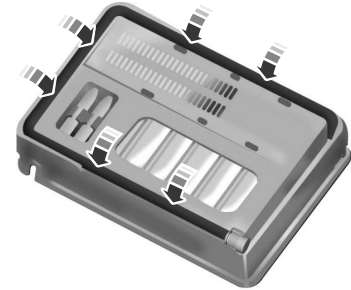

4. Wrap the dual purpose hose (black tube) around the channel on the bottom of the housing/casing.

## Tire Sealant and Inflator Kit

---



5. Wrap the power cord around the housing and stow the accessory power plug.

# Tire Pressure Monitoring System

## WHAT IS THE TIRE PRESSURE MONITORING SYSTEM



The tire pressure monitoring system measures the vehicle's tire pressures. A warning lamp illuminates if one or more tires are significantly underinflated or if there is a system malfunction.

## TIRE PRESSURE MONITORING SYSTEM OVERVIEW



**WARNING:** If the tire pressure monitor sensor becomes damaged it may not function.



**WARNING:** Under-inflation is the most common cause of tire failures and may result in severe tire cracking, tread separation or blowout, with unexpected loss of vehicle control and increased risk of injury. Under-inflation increases sidewall flexing and rolling resistance, resulting in

heat buildup and internal damage to the tire. It also may result in unnecessary tire stress, irregular wear, loss of vehicle control and accidents. A tire can lose up to half of its air pressure and not appear to be flat!



**WARNING:** To determine the required pressure(s) for your vehicle, see the Safety Compliance Certification Label (on the door hinge pillar, door-latch post or the door edge that meets the door-latch post, next to the driver seat) or the Tire Label on the B-Pillar or the edge of the driver door.

Each tire, including the spare (if provided), should be checked monthly when cold and inflated to the inflation pressure recommended by the vehicle manufacturer on the vehicle placard or tire inflation pressure label. (If your vehicle has tires of a different size than the size indicated on the vehicle placard or tire inflation pressure label, you should determine the proper tire inflation pressure for those tires).

As an added safety feature, your vehicle has been equipped with a Tire Pressure Monitoring System (TPMS) that illuminates a low tire pressure telltale when one or more of your tires is significantly under-inflated. Accordingly, when the low tire pressure telltale illuminates, you should stop and check your tires as soon as possible, and inflate them to the proper pressure. Driving on a significantly under-inflated tire causes the tire to overheat and can lead to tire failure. Under-inflation also reduces fuel efficiency and tire tread life, and may affect the vehicle's handling and stopping ability.

Please note that the TPMS is not a substitute for proper tire maintenance, and it is the driver's responsibility to maintain correct tire pressure, even if under-inflation has not reached the level to trigger illumination of the TPMS low tire pressure telltale.



# Tire Pressure Monitoring System

Your vehicle has also been equipped with a TPMS malfunction indicator to indicate when the system is not operating properly. The TPMS malfunction indicator is combined with the low tire pressure telltale. When the system detects a malfunction, the telltale will flash for approximately one minute and then remain continuously illuminated. This sequence will continue upon subsequent vehicle start-ups as long as the malfunction exists.

When the malfunction indicator is illuminated, the system may not be able to detect or signal low tire pressure as intended. TPMS malfunctions may occur for a variety of reasons, including the installation of replacement or alternate tires or wheels on the vehicle that prevent the TPMS from functioning properly. Always check the TPMS malfunction telltale after replacing one or more tires or wheels on your vehicle to ensure that the replacement or alternate tires and wheels allow the TPMS to continue to function properly.

 **WARNING:** Changes or modifications not expressly approved by the party responsible for compliance could void the user's authority to operate the equipment. The term "IC:" before the radio certification number only signifies that Industry Canada technical specifications were met.

This device complies with Part 15 of the FCC Rules and with License exempt RSS Standards of Industry Canada. Operation is subject to the following two conditions:

1. This device may not cause harmful interference, and
2. This device must accept any interference received, including interference that may cause undesired operation.

## TIRE PRESSURE MONITORING SYSTEM PRECAUTIONS

 **WARNING:** The tire pressure monitoring system is not a substitute for manually checking tire pressures. You should periodically check tire pressures using a pressure gauge. Failure to correctly maintain tire pressures could increase the risk of tire failure, loss of control, vehicle rollover and personal injury.

**Note:** *The use of tire sealants can damage the tire pressure monitoring system.*

## TIRE PRESSURE MONITORING SYSTEM LIMITATIONS

When the outside temperature drops significantly, the tire pressure could decrease and activate the low tire pressure warning lamp.

The warning lamp could also illuminate when you use a spare wheel, or tire sealant from the inflator kit.

# Tire Pressure Monitoring System

**Note:** Regularly checking the vehicle tire pressures can reduce the possibility for the warning lamp to illuminate due to outside air temperature changes.

**Note:** After you inflate the tires to the recommended pressure it could take up to two minutes of driving over 20 mph (32 km/h) for the warning indicator to turn off.

## VIEWING THE TIRE PRESSURES



To view the current tire pressures, use the information display or touchscreen.

## RESETTING TIRE PRESSURE MONITORING SYSTEM

### Changing Tires With a Tire Pressure Monitoring System



**Note:** Each road tire is equipped with a tire pressure sensor located inside the wheel and tire assembly cavity. The pressure sensor is attached to the valve stem. The pressure sensor is covered by the tire and is not visible unless the tire is removed. Take care when changing the tire to avoid damaging the sensor.

You should always have your tires serviced by an authorized dealer.

Check the tire pressure periodically (at least monthly) using an accurate tire gauge. See **When Inflating Your Tires** in this chapter.

### When Inflating Your Tires

When putting air into your tires (such as at a gas station or in your garage), the tire pressure monitoring system may not respond immediately to the air added to your tires.

It may take up to two minutes of driving over 20 mph (32 km/h) for the light to turn off after you have filled your tires to the recommended inflation pressure.

### When Your Temporary Spare Tire is Installed

When one of your road tires needs to be replaced with the temporary spare, the system will continue to identify an issue to remind you that the damaged road wheel and tire assembly needs to be repaired and put back on your vehicle.

# Tire Pressure Monitoring System

To restore the full function of the tire pressure monitoring system, have the damaged road wheel and tire assembly repaired and remounted on your vehicle.

## TIRE PRESSURE MONITORING SYSTEM – TROUBLESHOOTING

### TIRE PRESSURE MONITORING SYSTEM – WARNING LAMPS



The low tire pressure warning lamp has combined functions, as it warns you when your tires need air, and when the system is no longer capable of functioning as intended.

Warning Lamp	Possible Cause	Action Required
Solid warning lamp	One or more tires are significantly under inflated	After inflating your tires to the manufacturer's recommended pressure as shown on the tire label, on the edge of driver door or the B-pillar, drive your vehicle for at least two minutes over 20 mph (32 km/h) before the light turns off.
Solid warning lamp or flashing warning lamp	Temporary spare wheel in use	Repair the damaged road wheel and tire and refit it to your vehicle to restore operation of the system.
	Tire pressure monitoring system malfunction	If the tires are inflated to the recommended tire pressures and the temporary spare wheel is not in use, the system detected a fault that requires service. Have your vehicle checked as soon as possible.

# Tire Pressure Monitoring System

---

## TIRE PRESSURE MONITORING SYSTEM – INFORMATION MESSAGES

Message	Action
Tire Pressure Low	After inflating your tires to the manufacturer's recommended pressure as shown on the tire label, on the edge of the driver door or the B-pillar, drive your vehicle for at least two minutes over 20 mph (32 km/h) before the light turns off.
Tire Pressure Monitor Fault	The system has detected a fault that requires service. Have your vehicle checked as soon as possible.
Tire Pressure Sensor Fault	The system has detected a fault that requires service or a spare tire is in use. Have your vehicle checked as soon as possible.

# Changing a Road Wheel

## CHANGING A FLAT TIRE



**WARNING:** If the tire pressure monitor sensor becomes damaged it may not function.

If you get a flat tire while driving, do not apply the brake heavily. Instead, gradually decrease your speed. Hold the steering wheel firmly and slowly move to a safe place on the side of the road.

Have a flat serviced by an authorized dealer in order to prevent damage to the tire pressure monitoring system sensors. See **Tire Pressure Monitoring System Overview** (page 392). Replace the spare tire with a road tire as soon as possible. During repairing or replacing of the flat tire, have an authorized dealer inspect the tire pressure monitoring system sensor for damage.

**Note:** *The use of tire sealant could damage your tire pressure monitoring sensor and should only be used in roadside emergencies. If you must use a sealant, use the Tire Mobility Kit sealant. Replace the tire pressure monitoring system sensor and valve stem on the wheel by an authorized dealer after use of the sealant.*

**Note:** *The tire pressure monitoring system indicator light will illuminate when the spare tire is in use. To restore the full function of the monitoring system, all road wheels equipped with tire pressure monitoring sensors must be mounted on the vehicle.*

### Dissimilar Spare Wheel and Tire Assembly Information



**WARNING:** Failure to follow these guidelines could result in an increased risk of loss of vehicle control, injury or death.

If you have a dissimilar spare wheel and tire, then it is intended for temporary use only. This means that if you need to use it, you should replace it as soon as possible with a road wheel and tire assembly that is the same size and type as the road tires and wheels that were originally provided on your vehicle. If the dissimilar spare tire or wheel is damaged, replace it instead of repairing it.

A dissimilar spare wheel and tire assembly is defined as a spare wheel and tire assembly that is different in brand, size or appearance from the road tires and wheels and can be one of three types:

- 1. T-type mini-spares:** This spare tire begins with the letter T for tire size and could have Temporary Use Only molded in the sidewall.
- 2. Full-size dissimilar spare with label on wheel:** This spare tire has a label on the wheel that states: THIS WHEEL AND TIRE ASSEMBLY FOR TEMPORARY USE ONLY.

When driving with one of the dissimilar spare tires listed above, do not:

# Changing a Road Wheel

- Exceed 50 mph (80 km/h).
- Load the vehicle beyond maximum vehicle load rating listed on the Safety Compliance Label.
- Tow a trailer.
- Use snow chains on the end of the vehicle with the dissimilar spare tire.
- Use more than one dissimilar spare tire at a time.
- Use commercial car washing equipment.
- Try to repair the dissimilar spare tire.

Use of one of the dissimilar spare tires listed above at any one wheel location can lead to impairment of the following:

- Handling, stability and braking performance.
- Comfort and noise.
- Ground clearance and parking at curbs.
- Winter weather driving capability.
- Wet weather driving capability.
- All-wheel driving capability, if applicable.

### 3. Full-size dissimilar spare without label on wheel

When driving with the full-size dissimilar spare wheel and tire assembly, do not:

- Exceed 70 mph (113 km/h).
- Use more than one dissimilar spare wheel and tire assembly at a time.
- Use commercial car washing equipment.
- Use snow chains on the end of the vehicle with the dissimilar spare wheel and tire assembly.

The usage of a full-size dissimilar spare wheel and tire assembly can lead to impairment of the following:

- Handling, stability and braking performance.
- Comfort and noise.
- Ground clearance and parking at curbs.
- Winter weather driving capability.
- Wet weather driving capability.
- All-wheel driving capability.

When driving with the full-size dissimilar spare wheel and tire assembly additional caution should be given to:

- Towing a trailer.
- Driving vehicles equipped with a camper body.
- Driving vehicles with a load on the cargo rack.

Drive cautiously when using a full-size dissimilar spare wheel and tire assembly and seek service as soon as possible.

### Tire Change Procedure





**WARNING:** The jack supplied with this vehicle is only intended for changing a flat tire in an emergency. Do not attempt to do any other work on your vehicle when it is supported by the jack, as your vehicle could slip off the jack. Failure to follow this instruction could result in personal injury or death.

# Changing a Road Wheel

 **WARNING:** To help prevent your vehicle from moving when changing a wheel, shift the transmission into park (P), set the parking brake and use an appropriate block or wheel chock to secure the wheel diagonally opposite to the wheel being changed. For example, when changing the front left wheel, place an appropriate block or wheel chock on the right rear wheel.

 **WARNING:** Never place anything between the vehicle jack and your vehicle.

 **WARNING:** Never place anything between the vehicle jack and the ground.

 **WARNING:** Park your vehicle so that you do not obstruct the flow of traffic or place yourself in any danger and set up a warning triangle.

 **WARNING:** Do not get under a vehicle that is supported by a jack.

 **WARNING:** Do not attempt to change a tire on the side of the vehicle close to moving traffic. Pull far enough off the road to avoid the danger of being hit when operating the jack or changing the wheel.

 **WARNING:** Use only the specified jacking points. If you use other locations, you could damage the body, steering, suspension, engine, braking system or the fuel lines.

 **WARNING:** Always use the jack provided as original equipment with your vehicle. If using a jack other than the one provided, make sure the jack capacity is adequate for the vehicle weight, including any vehicle cargo or modifications. If you are unsure if the jack capacity is adequate, contact the authorized dealer.

 **WARNING:** The jack supplied with this vehicle is only intended for changing wheels. Do not use the vehicle jack other than when you are changing a wheel in an emergency.

 **WARNING:** Make sure there is no grease or oil on the threads or the surface between the wheel lugs and nuts. This can cause the lug nuts to loosen while driving.

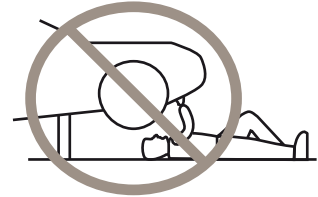

**Note:** *The jack does not require maintenance or additional lubrication over the service life of your vehicle.*

**Note:** *Passengers should not remain in your vehicle when the vehicle is being jacked.*

1. Park on a level surface, set the parking brake and activate the hazard flashers.
2. Place the transmission in park (P) and turn the engine off.

# Changing a Road Wheel

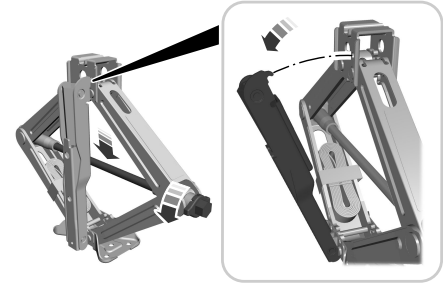
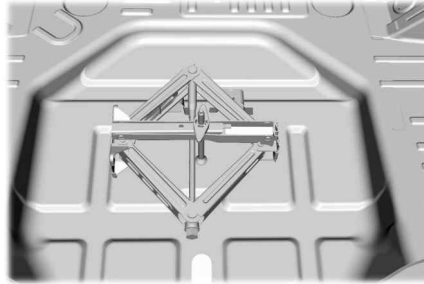
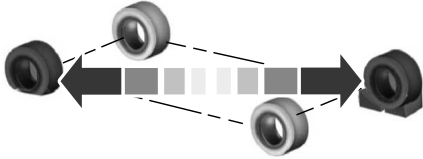

3. Block both the front and rear of the wheel diagonally opposite the flat tire. For example, if the left front tire is flat, block the right rear wheel.
4. Lift and remove the carpeted load floor panel to access the minispare and jack kit.
5. Remove the wing nut securing the spare tire by turning it counterclockwise.
6. Remove the spare tire and jack kit from the spare tire compartment.

7. Remove plastic wing nut and jack and lug wrench assembly.
8. Detach the lug wrench from the jack by turning the jack hex nut drive screw counterclockwise. This will lower the jack and loosen the mechanical lock.

9. Unfold the wrench for use.

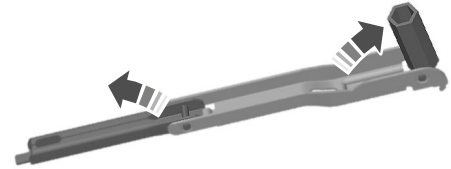

10. If your vehicle has wheel trim covering the lug nuts, use the tool provided with the jack assembly to remove the wheel trim.



# Changing a Road Wheel

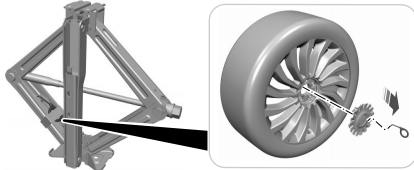

11. Loosen each wheel lug nut one-half turn counterclockwise, but do not remove them until the wheel is raised off the ground.
12. If your vehicle has a warning triangle and you are jacking the vehicle on the roadside shoulder, set the warning triangle upright on the shoulder of the road facing the direction of oncoming traffic.

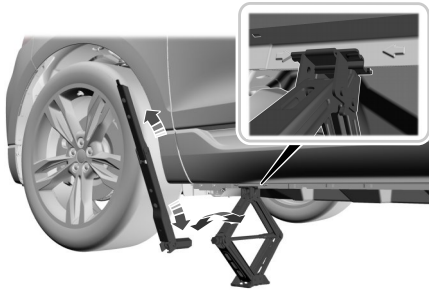

13. Arrows depict vehicle jacking points on the underside of the vehicle at the locations shown above. The warning label on the jack depicts the details.
14. Find the arrows embossed on the vehicle downward flange next to the tire you are changing.
15. Position the jack so that the vehicle downward flange rests in the jack saddle flange between the arrows, as shown above. Raise the vehicle by using the lug wrench to turn the jack nut clockwise. Once the flat tire is off the ground, remove the lug nuts with the lug wrench.

16. Replace the flat tire with the spare tire, making sure the valve stem is facing outward. Reinstall the lug nuts until the wheel is snug against the hub. Do not fully tighten the lug nuts until the wheel has been lowered.
17. Lower the wheel by turning the jack handle counterclockwise.
18. Remove the jack and fully tighten the lug nuts in the order shown. See **Wheel Nuts** (page 402).

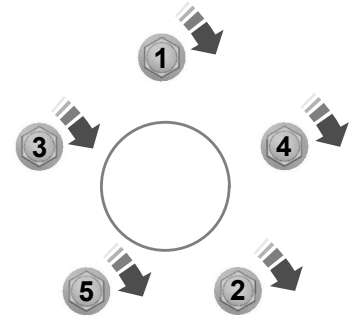

# Changing a Road Wheel

19. To store the jack kit, fold the jack wrench handle and engage it to the bracket of the jack base using the lug wrench pin. Swing the wrench upwards, adjust the jack height until the wrench hook engages to the hole on the jack. Turn the hex nut clockwise by hand until secure. Re-position the jack kit assembly into the original vehicle position and secure with the plastic wing nut. Make sure the jack is fastened securely before you drive.

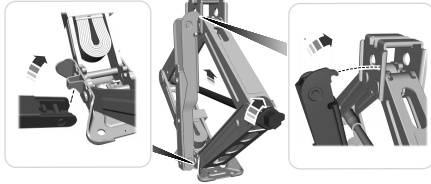

20. Unblock the wheel and retrieve the warning triangle.

## Stowing the flat tire

You cannot store the full-sized road wheel in the temporary spare tire well.

1. Find the flat tire retainer strap tucked inside the jack channel. Lower the carpeted load floor.
2. Stow the flat tire in the cargo area on the load floor with the wheel facing up. Secure the flat tire with the retainer strap by following the next steps.



3. Locate the rear left side and right side cargo tie-down rings. Push the loop end of the retainer strap through one cargo tie-down ring. Thread the non-loop end through the loop.
4. Weave the retainer strap through the wheel openings.

5. Locate the cargo tie-down in the opposite rear corner of the cargo area. Thread the retainer strap through the tie-down and pull tight.
6. Secure the flat tire by tying a 2-half hitch knot.

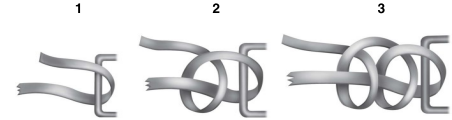

## WHEEL NUTS



**WARNING:** When you install a wheel, always remove any corrosion, dirt or foreign materials present on the mounting surfaces of the wheel or the surface of the wheel hub, brake drum or brake disc that contacts the wheel. Make sure to secure any fasteners that attach the rotor to the hub so they do not interfere with the mounting surfaces of the wheel. Installing

# Changing a Road Wheel

wheels without correct metal-to-metal contact at the wheel mounting surfaces can cause the wheel nuts to loosen and the wheel to come off while your vehicle is in motion, resulting in loss of vehicle control, personal injury or death.

Bolt Size	lb.ft (Nm) <sup>1</sup>
M14 x 1.5	162 lb.ft (220 Nm)

<sup>1</sup> Torque specifications are for nut and bolt threads free of dirt and rust. Use only our recommended replacement wheel nuts and or wheel bolts.

Retighten the wheel nuts to the specified torque within 100 mi (160 km) after any wheel disturbance, such as tire rotation, changing a flat tire or wheel removal.



A Hub pilot bore.

Inspect the wheel pilot hole and mounting surface prior to installation. Remove any visible corrosion or loose particles.

# Capacities and Specifications

---

## ENGINE SPECIFICATIONS - 2.0L

Engine	Specification
Compression ratio.	10.0:1
Displacement.	122 in <sup>3</sup> (2,000 cm <sup>3</sup> )
Firing order.	1-3-4-2
Ignition system.	Coil on plug
Required fuel.	Minimum 87 octane
Spark plug gap.	0.028 in (0.7 mm) - 0.031 in (0.8 mm)

# Capacities and Specifications

---

## ENGINE SPECIFICATIONS - 2.7L

<b>Engine</b>	<b>Specification</b>
Compression ratio.	10.0:1
Displacement.	165 in <sup>3</sup> (2,700 cm <sup>3</sup> )
Firing order.	1-4-2-5-3-6
Ignition system.	Coil on plug
Required fuel.	Minimum 87 octane
Spark plug gap.	0.028 in (0.7 mm) - 0.031 in (0.8 mm)

# Capacities and Specifications

## MOTORCRAFT PARTS - 2.0L

Component	Motorcraft Part Number
Air filter element.	FA-1912A
Battery.	BAGM-94RH7-800
Cabin air filter.	FP-71A
Cabin air filter.	FP-80 (odor)
Engine oil filter. <sup>1</sup>	FL-910-S
Spark plug.	SP-578
Windshield wiper blade.	WW-2350 (driver side) WW-1750 (passenger side) WW-1206 (rear window)

<sup>1</sup> If a Motorcraft oil filter is not available, use an oil filter that meets industry performance specification SAE/USCAR-36.

We recommend Motorcraft parts that are available at your authorized dealer or at [www.fordparts.com](http://www.fordparts.com). We engineer these parts for your vehicle to meet or exceed our specifications. Use of other parts could impact vehicle performance, emissions and durability. Your warranty could be void for any damage related to use of other parts.

# Capacities and Specifications

## MOTORCRAFT PARTS - 2.7L

Component	Motorcraft Part Number
Air filter element.	FA-1912A
Battery.	BAGM-94RH7-800
Cabin air filter.	FP-71A
Cabin air filter.	FP-80 (odor)
Engine oil filter. <sup>1</sup>	FL-2062A
Spark plug.	SP-578
Windshield wiper blade.	WW-2350 (driver side) WW-1750 (passenger side) WW-1206 (rear window)

<sup>1</sup>If a Motorcraft oil filter is not available, use an oil filter that meets industry performance specification SAE/USCAR-36.

We recommend Motorcraft parts that are available at your authorized dealer or at [www.fordparts.com](http://www.fordparts.com). We engineer these parts for your vehicle to meet or exceed our specifications. Use of other parts could impact vehicle performance, emissions and durability. Your warranty could be void for any damage related to use of other parts.

# Capacities and Specifications

## ENGINE OIL CAPACITY AND SPECIFICATION - 2.0L

Use oil that meets the defined specification and viscosity grade.

If you do not use oil that meets the defined specification and viscosity grade, it could result in:

- Component damage that your vehicle warranty does not cover.
- Longer engine cranking periods.
- Increased emission levels.

- Reduced vehicle performance.
- Reduced fuel economy.



An oil that displays this symbol conforms to current engine, emission system and fuel economy performance standards of ILSAC.

We recommend Motorcraft motor oil for your vehicle. If Motorcraft oil is not available, use motor oils of the recommended viscosity grade that display the API Certification Mark for gasoline engines.

Do not use supplemental engine oil additives because they are unnecessary and could lead to engine damage that your vehicle warranty does not cover.

## Capacities

Variant	Including the Oil Filter
All.	5.5 qt (5.2 L)



# Capacities and Specifications

---

## Materials

Name	Specification
Motorcraft® SAE 5W-30 Synthetic Blend Motor Oil(U.S.) Motorcraft® SAE 5W-30 Super Premium Motor Oil / Huile moteur de très haute qualité SAE 5W-30 Motorcraft®(Canada) XO-5W30-Q1SP(U.S.) CXO-5W30-LSP6(Canada)	WSS-M2C961-A1

## Alternative Engine Oil for Extremely Cold Climates

To improve engine cold start performance, use the following engine oil in climates where the ambient temperature reaches -22.0°F (-30°C) or below.

## Materials

Name	Specification
Engine Oil - SAE 0W-30 - Synthetic Blend	WSS-M2C963-A1

# Capacities and Specifications

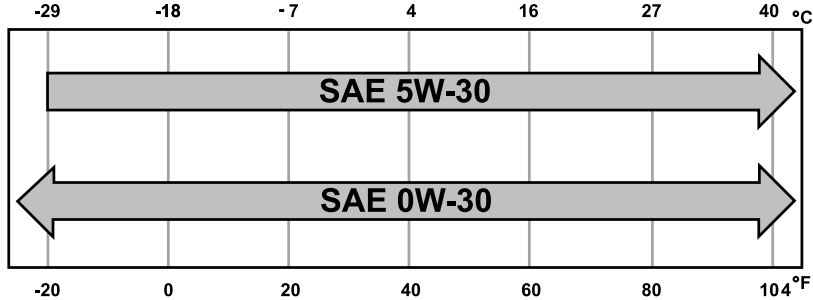

## ENGINE OIL CAPACITY AND SPECIFICATION - 2.7L

Use oil that meets the defined specification and viscosity grade.

If you do not use oil that meets the defined specification and viscosity grade, it could result in:

- Component damage that your vehicle warranty does not cover.
- Longer engine cranking periods.
- Increased emission levels.
- Reduced vehicle performance.
- Reduced fuel economy.



# Capacities and Specifications

An oil that displays this symbol conforms to current engine, emission system and fuel economy performance standards of ILSAC.

We recommend Motorcraft motor oil for your vehicle. If Motorcraft oil is not available, use motor oils of the recommended viscosity grade that meet API SP requirements and display the API Certification Mark for gasoline engines.

Do not use supplemental engine oil additives because they are unnecessary and could lead to engine damage that your vehicle warranty does not cover.

## Capacities

Variant	Including the Oil Filter
All.	6.0 qt (5.7 L)

## Materials

Name	Specification
Motorcraft® SAE 5W-30 Synthetic Blend Motor Oil(U.S.) Motorcraft® SAE 5W-30 Super Premium Motor Oil / Huile moteur de très haute qualité SAE 5W-30 Motorcraft®(Canada) XO-5W30-Q1SP(U.S.) CXO-5W30-LSP6(Canada)	WSS-M2C961-A1

# Capacities and Specifications

## Alternative Engine Oil for Extremely Cold Climates

use the following engine oil in climates where the ambient temperature reaches -22.0°F (-30°C) or below.

To improve engine cold start performance,

### Materials

Name	Specification
Engine Oil - SAE 0W-30 - Synthetic Blend	WSS-M2C963-A1

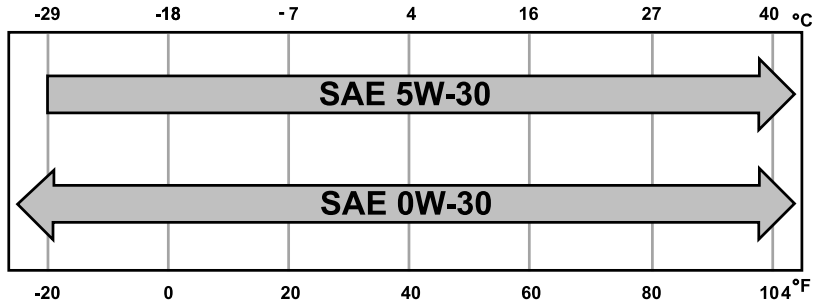

# Capacities and Specifications

## COOLING SYSTEM CAPACITY AND SPECIFICATION - 2.0L

Use coolant that meets the defined specification.

If you do not use coolant that meets the defined specification, it could result in:

- Component damage that your vehicle warranty does not cover.
- Reduced vehicle performance.

### Capacities

Variant	Quantity
All.	9.7 qt (9.2 L)

### Materials

Name	Specification
Motorcraft® Yellow Prediluted Antifreeze/Coolant(U.S.) Motorcraft® Yellow Prediluted Antifreeze/Coolant / Antigel/liquide de refroidissement prédilué jaune Motorcraft®(Canada) VC-13DL-G(U.S.) CVC-13DL-G(Canada)	WSS-M97B57-A2

# Capacities and Specifications

## COOLING SYSTEM CAPACITY AND SPECIFICATION - 2.7L

Use coolant that meets the defined specification.

If you do not use coolant that meets the defined specification, it could result in:

- Component damage that your vehicle warranty does not cover.
- Reduced vehicle performance.

### Capacities

Variant	Quantity
All.	12.5 qt (11.8 L)

### Materials

Name	Specification
Motorcraft® Yellow Prediluted Antifreeze/Coolant(U.S.) Motorcraft® Yellow Prediluted Antifreeze/Coolant / Antigel/liquide de refroidissement prédilué jaune Motorcraft®(Canada) VC-13DL-G(U.S.) CVC-13DL-G(Canada)	WSS-M97B57-A2

# Capacities and Specifications

---

## FUEL TANK CAPACITY

### Capacities

Variant	Quantity
Front-wheel drive.	18.4 gal (69.7 L)
All-wheel drive.	18.5 gal (70 L)

# Capacities and Specifications

## AIR CONDITIONING SYSTEM CAPACITY AND SPECIFICATION - 2.0L



**WARNING:** The air conditioning refrigerant system contains refrigerant

under high pressure. Only qualified personnel should service the air conditioning refrigerant system. Opening the air conditioning refrigerant system can cause personal injury.

Use refrigerant and oil that meets the defined specifications.

If you do not use refrigerant and oil that meets the defined specifications, it could result in:

- Component damage that your vehicle warranty does not cover.
- Reduced vehicle performance.

### Capacities

Variant	Refrigerant	Refrigerant Oil
All.	20.8 oz (0.59 kg)	3.2 fl oz (95 ml)



# Capacities and Specifications

---

## Materials

Name	Specification
R-1234yf Refrigerant(U.S.) R-1234yf Refrigerant / Frigorigène R-1234yf(Canada) YN-33-A(U.S.) HS7Z-19B519-BA(Canada)	WSS-M17B21-A
Motorcraft® R-1234yf Refrigerant PAG Oil(U.S.) Motorcraft® R-1234yf Refrigerant PAG Oil / Huile PAG pour frigorigène R-1234yf Motorcraft®(Canada) YN-35(U.S. & Canada)	WSS-M2C300-A2

# Capacities and Specifications

## AIR CONDITIONING SYSTEM CAPACITY AND SPECIFICATION - 2.7L



**WARNING:** The air conditioning refrigerant system contains refrigerant

under high pressure. Only qualified personnel should service the air conditioning refrigerant system. Opening the air conditioning refrigerant system can cause personal injury.

Use refrigerant and oil that meets the defined specifications.

If you do not use refrigerant and oil that meets the defined specifications, it could result in:

- Component damage that your vehicle warranty does not cover.
- Reduced vehicle performance.

### Capacities

Variant	Refrigerant	Refrigerant Oil
All.	20.8 oz (0.59 kg)	3.2 fl oz (95 ml)

# Capacities and Specifications

## Materials

Name	Specification
R-1234yf Refrigerant(U.S.) R-1234yf Refrigerant / Frigorigène R-1234yf(Canada) YN-33-A(U.S.) HS7Z-19B519-BA(Canada)	WSS-M17B21-A
Motorcraft® R-1234yf Refrigerant PAG Oil(U.S.) Motorcraft® R-1234yf Refrigerant PAG Oil / Huile PAG pour frigorigène R-1234yf Motorcraft®(Canada) YN-35(U.S. & Canada)	WSS-M2C300-A2

## WASHER FLUID SPECIFICATION

### Capacities

Variant	Quantity
All.	Fill as required.

# Capacities and Specifications

## Materials

Name	Specification
Motorcraft® Premium Windshield Wash Concentrate with Bitterant(U.S.) Motorcraft® Premium Quality Windshield Washer Fluid / Liquide lave-glace de haute qualité Motorcraft®(Canada) ZC-32-B2(U.S.) CXC-37-F/M(Canada)	WSS-M14P19-A

## BRAKE FLUID SPECIFICATION

Use fluid that meets the defined specification and viscosity grade.

If you do not use fluid that meets the defined specification and viscosity grade, it could result in:

- Component damage that your vehicle warranty does not cover.
- Reduced brake performance.

**Note:** We recommend you use Dot 4 Low Viscosity (LV) High Performance Brake Fluid meeting WSS-M6C65-A2 specifications or ISO 4925 Class 6 standards. If you use any fluid other than the recommended fluid, it could cause reduced brake performance and not meet our performance standards. Keep brake fluid clean and dry. Contamination with dirt, water, petroleum products or other materials could result in brake system damage and possible failure.

## Capacities

Variant	Quantity
All.	Fill as required.

# Capacities and Specifications

---

## Materials

Name	Specification
Motorcraft® DOT 4 LV High Performance Motor Vehicle Brake Fluid(U.S.) Motorcraft® DOT 4 LV High Performance Motor Vehicle Brake Fluid / Liquide de frein automobile haute performance DOT 4 LV Motorcraft®(Canada) PM-20(U.S. & Canada)	WSS-M6C65-A2

# Vehicle Identification

## VEHICLE IDENTIFICATION NUMBER

### LOCATING THE VEHICLE IDENTIFICATION NUMBER

The vehicle identification number is located on the left-hand side of the instrument panel.

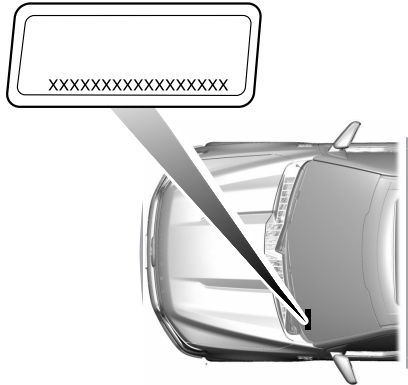

In the graphic, XXXX is representative of your vehicle identification number.

## VEHICLE IDENTIFICATION NUMBER OVERVIEW

The vehicle identification number contains the following information:

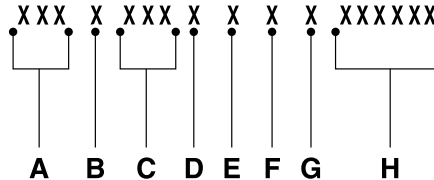

- A World manufacturer identifier.
- B Brake system, gross vehicle weight rating, restraint devices and their locations.
- C Make, vehicle line, series, body type.
- D Engine or motor type.
- E Check digit.

- F Model year.
- G Assembly plant.
- H Production sequence number.

# Connected Vehicle

## WHAT IS A CONNECTED VEHICLE

A connected vehicle has technology that allows your vehicle to connect to a mobile network and for you to access a range of features. When used in conjunction with the Lincoln Way app, it could allow you to monitor and control your vehicle further, for example checking the tire pressures, and the vehicle location. For additional information, refer to the local Lincoln website.

## CONNECTED VEHICLE REQUIREMENTS

Connected service and related feature functionality requires a compatible vehicle network.

Some remote features require a subscription. For additional information, see the Lincoln Way app. Some restrictions, third party terms and message or data rates may apply.

## CONNECTED VEHICLE LIMITATIONS

Evolving technology, cellular networks, or regulations could affect functionality and availability, or continued provision of some features. These changes could even stop some features from functioning.

## CONNECTING THE VEHICLE TO A MOBILE NETWORK

### WHAT IS THE MODEM



The modem allows access to a range of features built into your vehicle.

## ENABLING AND DISABLING THE MODEM

1. Press **Settings**.
2. Press **Lincoln Connect**.
3. Press **Connectivity Settings**.

4. Switch connectivity features on or off.

## CONNECTING LINCOLN WAY TO THE MODEM

1. Make sure that the modem is enabled using the vehicle settings menu.
2. Open the Lincoln Way app on your device and log in.
3. Add your vehicle or select your vehicle if already added.
4. Select the option for vehicle details.
5. Select the option to activate your vehicle.
6. Make sure that the name on the screen matches the name shown in your Lincoln Way account.
7. Confirm that your Lincoln Way account is connected to the modem.

## CONNECTING THE VEHICLE TO A WI-FI NETWORK

1. Press **Settings**.
2. Press **Wi-Fi**.

# Connected Vehicle

---

3. Switch **Wi-Fi** on.

5. Select an available Wi-Fi network.

**Note:** *Enter the network password to connect to a secure network.*

4. Press **View Available Networks**.

## CONNECTED VEHICLE – TROUBLESHOOTING

### CONNECTED VEHICLE – FREQUENTLY ASKED QUESTIONS - VEHICLES WITH: MODEM

Symptom	Possible Cause and Resolution
I cannot confirm the connection of my Lincoln Way account to the modem.	<ul style="list-style-type: none"><li>– Modem is not enabled.<ul style="list-style-type: none"><li>• Switch connectivity features on.</li></ul></li><li>– Weak network signal.<ul style="list-style-type: none"><li>• Move your vehicle closer to a place where the network signal is not obstructed.</li></ul></li></ul>



# Connected Vehicle

## CONNECTED VEHICLE – FREQUENTLY ASKED QUESTIONS

Symptom	Possible Cause and Resolution
I cannot connect to a Wi-Fi network.	<ul style="list-style-type: none"><li>– Password error.<ul style="list-style-type: none"><li>• Enter the correct network password.</li></ul></li><li>– Weak network signal.<ul style="list-style-type: none"><li>• Move your vehicle closer to the Wi-Fi hotspot or to a place where the network signal is not obstructed.</li></ul></li><li>– Multiple access points in range with the same SSID.<ul style="list-style-type: none"><li>• Use a unique name for your SSID. Do not use the default name unless it contains a unique identifier, for example as part of the MAC address.</li></ul></li></ul>
The Wi-Fi connection disconnects after successful connection.	<ul style="list-style-type: none"><li>– Weak network signal.<ul style="list-style-type: none"><li>• Move your vehicle closer to the Wi-Fi hotspot or to a place where the network signal is not obstructed.</li></ul></li></ul>
I am close to a Wi-Fi hotspot but the network signal strength is weak.	<ul style="list-style-type: none"><li>– Obstructed network signal.<ul style="list-style-type: none"><li>• If your vehicle has a heated windshield, position your vehicle so that the windshield is not facing the Wi-Fi hotspot.</li><li>• If your vehicle has metallic tinting on the windows but not on the windshield, position your vehicle so that the windshield is facing the Wi-Fi hotspot or open the windows that are facing the hotspot.</li><li>• If your vehicle has metallic tinting on the windows and the windshield, open the windows that are facing the hotspot.</li></ul></li></ul>

## Connected Vehicle

Symptom	Possible Cause and Resolution
	<ul style="list-style-type: none"> <li>• If your vehicle is in a garage and you have the garage door closed, open the garage door.</li> </ul>
I cannot see a network in the list of available networks that I expect to see.	<ul style="list-style-type: none"> <li>– Hidden network.               <ul style="list-style-type: none"> <li>• Make the network visible and try again.</li> </ul> </li> </ul>
I cannot see the Wi-Fi hotspot name when I search for Wi-Fi networks on my cell phone or other device.	<ul style="list-style-type: none"> <li>– System limitation.               <ul style="list-style-type: none"> <li>• Make sure Wi-Fi hotspot visibility is on.</li> <li>• The system does not provide a Wi-Fi hotspot at this time.</li> </ul> </li> </ul>
Software downloads take too long.	<ul style="list-style-type: none"> <li>– Weak network signal.               <ul style="list-style-type: none"> <li>• Move your vehicle closer to the Wi-Fi hotspot or to a place where the network signal is not obstructed.</li> </ul> </li> <li>– Wi-Fi hotspot in high demand or has a slow Internet connection.               <ul style="list-style-type: none"> <li>• Use a more reliable Wi-Fi hotspot.</li> </ul> </li> </ul>
The system seems to connect to a Wi-Fi network and the signal strength is excellent but the software does not update.	<ul style="list-style-type: none"> <li>– No software update available.</li> <li>– Wi-Fi network requires a subscription or acceptance of terms and conditions.               <ul style="list-style-type: none"> <li>• Test the connection using another device. If the network requires a subscription or acceptance of terms and conditions, contact the network service provider.</li> </ul> </li> </ul>

# Vehicle Wi-Fi Hotspot

## CREATING A VEHICLE WI-FI HOTSPOT

You can create a Wi-Fi hotspot in your vehicle and allow devices to connect to it for access to the Internet.



Select the settings option on the feature bar.

1. Select **Lincoln Way**.
2. Select **Vehicle Hotspot**.

**Note:** The vehicle hotspot default setting is on.

3. Select **Settings**.
4. Select **Wi-Fi Visibility**.

**Note:** The Wi-Fi Visibility default setting is on.

### Finding the Wi-Fi Hotspot Name and Password



Select the settings option on the feature bar.

1. Select **Lincoln Way**.

2. Select **Vehicle Hotspot**.
3. Select **Settings**.

**Note:** The SSID is the hotspot name.

4. Select **View Password**.

### Connecting a Device to the Wi-Fi Hotspot

1. On your device, switch Wi-Fi on and select the hotspot from the list of available Wi-Fi networks.
2. When prompted, enter the password.

### Purchasing a Data Plan

1. Connect a device to the hotspot.

**Note:** The vehicle network carrier's portal opens on your device.

2. If the portal does not open on your device, open a website and it redirects to the vehicle network carrier's portal.

**Note:** Secure websites do not redirect.

**Note:** If you have an active plan, the system does not redirect to the vehicle network carrier's portal when you connect a device. Visit the vehicle network carrier's website to purchase more data.

**Note:** If data usage information is available in the vehicle hotspot menu, it is approximate.

**Note:** If you carry out a master reset, the system does not remove your vehicle from your vehicle network carrier's account. To remove your vehicle from the account, contact your vehicle network carrier.

**Note:** The vehicle network carrier provides Vehicle Hotspot services, subject to your vehicle network carrier agreement, coverage and availability.

## CHANGING THE VEHICLE WI-FI HOTSPOT NAME OR PASSWORD



Select the settings option on the feature bar.

1. Select **Lincoln Way**.

# Vehicle Wi-Fi Hotspot

---

2. Select **Vehicle Hotspot**.

**Note:** *The vehicle hotspot default setting is on.*

3. Select **Settings**.
4. Select **Edit**.
5. Select Change SSID Name.
6. Enter your required SSID.
7. Select **Done**.
8. Select Change Password.
9. Enter your required password.
10. Select **Done**.

5. Under the option change frequency band.
6. Select 2.4 GHZ or 5.0 GHZ.

## Changing the Wi-Fi Hotspot Band

**Note:** *The Vehicle Hotspot frequency band is selectable as 2.4GHZ or 5.0 GHZ depending upon your device capabilities. To change the Vehicle Hotspot frequency band, you will need to perform the following steps.*

1. Select **Settings**.
2. Select **Vehicle Hotspot**.
3. Select **Settings**.
4. Select **Edit**.

# Audio System

## AUDIO SYSTEM PRECAUTIONS



**WARNING:** Driving while distracted can result in loss of vehicle control, crash and injury. We strongly recommend that you use extreme caution when using any device that may take your focus off the road. Your primary responsibility is the safe operation of your vehicle. We recommend against the use of any hand-held device while driving and encourage the use of voice-operated systems when possible. Make sure you are aware of all applicable local laws that may affect the use of electronic devices while driving.

Listening to loud audio for long periods of time could damage your hearing.

## IDENTIFYING THE AUDIO UNIT



Depending on your vehicle option package, the controls may look different from what you see here.

## SWITCHING THE AUDIO UNIT ON AND OFF



Press the button on the volume control.

## SELECTING THE AUDIO SOURCE

### Audio Unit



Press the button to open the media source menu.

You can press this multiple times to change to the audio source or scroll through the media sources.

### Touchscreen

Press **Sources** on the touchscreen to open the media source menu.

## PLAYING OR PAUSING THE AUDIO SOURCE

### Touchscreen



Press to pause playback. Press again to resume playback.

**Note:** *Not all sources can be paused.*

# Audio System

## ADJUSTING THE VOLUME

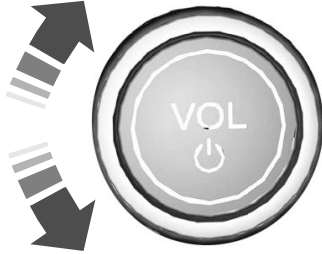

Turn to adjust the volume.

Some vehicles may be able to adjust the volume using buttons on the steering wheel.

## SWITCHING SHUFFLE MODE ON AND OFF



Press the button on the touchscreen to switch shuffle mode on or off.

**Note:** *Not all sources have shuffle mode.*

## SWITCHING REPEAT MODE ON AND OFF



Press the button on the touchscreen to switch repeat mode on or off.

**Note:** *Not all sources have repeat mode.*

## SETTING A MEMORY PRESET

1. Select a station or channel.
2. Press and hold a memory preset button on the touchscreen.

**Note:** *The audio mutes briefly while the system saves the preset and returns once it is stored.*

**Note:** *You can save presets from multiple sources to the memory preset bar.*

## MUTING THE AUDIO



Press the button on the steering wheel to mute the audio.



Press to mute the signal. Press again to restore the signal.

## ADJUSTING THE SOUND SETTINGS

### Balance and Fade (If Equipped)

1. Press **Settings** on the touchscreen.
2. Press **Sound Settings**.
3. Press **Balance / Fade**.
4. Press the arrows to adjust the settings.

### Tone Settings

1. Press **Settings** on the touchscreen.
2. Press **Sound Settings**.

# Audio System

---

3. Press **Tone Settings**.
4. Press the arrows or slider bar to adjust the settings.

## Speed Compensated Volume

1. Press **Settings** on the touchscreen.
2. Press **Sound Settings**.
3. Press **Speed Compensated Volume**.
4. Press a setting.

## Occupancy Mode (If Equipped)

1. Press **Settings** on the touchscreen.
2. Press **Sound Settings**.
3. Press **Occupancy Mode**.
4. Press a setting.

## Sound Mode (If Equipped)

1. Press **Settings** on the touchscreen.
2. Press **Sound Settings**.
3. Press **Sound Mode**.
4. Press a setting.

## SETTING THE CLOCK AND DATE

1. Press **Settings** on the touchscreen.
2. Press **Clock Settings**.
3. Set the time.

**Note:** The **AM** and **PM** options are not available if **24-hour mode** is on.

## Switching Automatic Time Updates On and Off

1. Press **Settings** on the touchscreen.
2. Press **Clock Settings**.
3. Switch **Automatic time zone update** on or off.

## AM/FM RADIO

### AM/FM RADIO LIMITATIONS

The further you travel from an AM or FM station, the weaker the signal and the weaker the reception.

Hills, mountains, tall buildings, bridges, tunnels, freeway overpasses, parking garages, dense tree foliage and thunderstorms can interfere with the reception.

When you pass a ground-based broadcast repeating tower, a stronger signal may overtake a weaker one and result in the audio system muting.

# Audio System

## SELECTING A RADIO STATION

### Manually Selecting a Radio Station

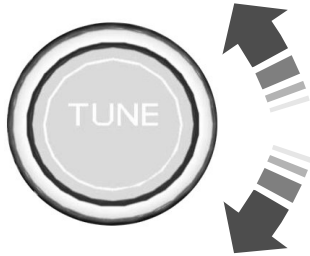

Turn to search through the radio frequency band.

### Using Direct Tune

1. Press **Direct Tune** to open the number pad.
2. Enter the station you prefer.

**Note:** *You can only enter a valid station for the audio source you are currently listening to.*

### Using Seek



Press either button. The system stops at the first station it finds in that direction.

### Using the Station List

1. Press **Browse**.

**Note:** *Available on FM radio only.*

2. Press a station.

## SWITCHING THE DISPLAY ON AND OFF

### Audio Unit



Press the button.

## Touchscreen

To switch the display off:

1. Press **Settings** on the touchscreen.
2. Press **Display Settings**.
3. Press **Display Off**.

**Note:** *The display defaults to on each time you switch your vehicle on.*

To switch the display on, press anywhere on the touchscreen.

## DIGITAL RADIO

### WHAT IS DIGITAL RADIO

HD Radio™ technology is the digital evolution of analog AM/FM radio.

For additional information, visit [www.HDRadio.com](http://www.HDRadio.com).



# Audio System

HD Radio Technology is manufactured under license from iBiquity Digital Corporation and foreign patents. HD Radio and the HD and HD Radio logos are proprietary trademarks of DTS. The vehicle manufacturer and DTS are not responsible for the content sent using HD Radio technology. Content may be changed, added or deleted at any time at the station owner's discretion.

## HOW DOES DIGITAL RADIO WORK

Your system has a special receiver that allows it to receive digital broadcasts in addition to analog broadcasts.

HD1 signifies the main programming status and is available in both analog and digital broadcasts. Other multicast stations are only available digitally and could contain new or different content.

**Note:** *When the system first receives an HD1 station, it plays the station in the analog version until it verifies the station is an HD Radio station. Then it shifts to the digital version.*

**Note:** *There is an audio mute delay when switching to an HD2 or HD3 station because the system has to reacquire and decode the digital signal.*

## DIGITAL RADIO LIMITATIONS

If you are outside the reception area, the system could not work.

If you are on the fringe of the reception area, the station could mute due to weak signal strength.

**Note:** *If you are listening to HD1, the system changes back to the analog broadcast until the digital broadcast is available again. If you are listening to any other multicast channels, the station mutes and stays muted unless it is able to connect to the digital signal again.*

Depending on the station quality, you could hear a slight sound change when the station changes between analog and digital audio.

You cannot access a saved HD station if your vehicle is outside the station's reception area.

## SWITCHING DIGITAL RADIO RECEPTION ON AND OFF

1. Press **Settings** on the touchscreen.
2. Press **Radio Settings**.
3. Switch **AM HD Radio** or **FM HD Radio** on or off.

## DIGITAL RADIO INDICATORS

### HD Radio Indicator

The indicator appears when HD Radio is on and you tune to a station broadcasting HD Radio technology.



The color of the indicator changes to indicate the system status.

# Audio System

Gray indicates the system is acquiring a digital station.

Orange indicates digital audio is playing.

## Multicast Indicator

The multicast indicator appears if the current station is broadcasting multiple digital broadcasts. The highlighted numbers indicate additional digital channels available.

**Note:** For stations that have more than one HD multicast, the HD indicator and radio text appears as a button. Press the button to cycle through all of the HD stations on that specific frequency.

## SATELLITE RADIO

### WHAT IS SATELLITE RADIO

Your factory-installed SiriusXM radio system includes a limited subscription term, which begins on the date of sale or lease of your vehicle. See an authorized dealer for availability.

For additional information about extended subscription terms, visit [www.SiriusXM.com](http://www.SiriusXM.com) in the United States, [www.SiriusXM.ca](http://www.SiriusXM.ca) in Canada, or call SiriusXM at 1-888-539-7474.

**Note:** *SiriusXM reserves the unrestricted right to change, rearrange, add or delete programming including canceling, moving or adding particular channels, and its prices, at any time, with or without notice to you. Neither SiriusXM and its affiliates nor Ford Motor Company and its affiliates will be liable to you or any third party for any such modification, suspension or termination.*

## SATELLITE RADIO LIMITATIONS

For optimal reception performance, keep the antenna clear of snow and ice build-up and keep luggage and other material as far away from the antenna as possible. Placing luggage over the antenna may reduce performance. Factory-installed and aftermarket vehicle structures including, but not limited to, roof racks and soft top roofs in a partially open position could reduce reception performance.

Hills, mountains, tall buildings, bridges, tunnels, freeway overpasses, parking garages, dense tree foliage and thunderstorms can interfere with your reception.

When you pass a ground-based broadcast-repeating tower, a stronger signal may overtake a weaker one and could result in the audio system muting. Your display could show an error message to indicate the interference.

## LOCATING THE SATELLITE RADIO IDENTIFICATION NUMBER

1. Select SiriusXM as the audio source.
2. Tune to channel 0.

## SELECTING A CHANNEL

### Manually Selecting a Channel

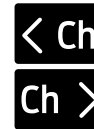

Press the button to find the previous or next available radio channel.

# Audio System

## Linear Tuner

The linear tuner is displayed when manually selecting a channel. You can swipe left or right on the linear tuner carousel to navigate through the channel list. Tap on a channel title to listen to it.

## Using Direct Tune

1. Press the channel up or down button to open the linear tuner screen.
2. Press **Direct Tune** to open the number pad.
3. Enter the channel you prefer.

## Using Seek



Press either button.



## Using the Channel List

1. Press **Browse**.
2. Select a channel.

## SATELLITE RADIO SETTINGS

### Subscription

Your subscription status is displayed. You can subscribe or manage your subscription directly from the touchscreen.

### Listener Add/Switch

You can create up to five listener profiles per SiriusXM account. Each listener profile can be personalized with a name and profile image.

**Note:** *Requires a trial or active subscription to use.*

**Note:** *A default profile is available when no listener profiles are created.*

### SiriusXM Favorites

SiriusXM Favorites are shown for the active listener profile. While you are listening to SiriusXM, you can save favorites by:

- Tapping the currently tuned channel or show logo on the SiriusXM audio screen. A favorite icon appears next to the logo when it is saved as a favorite.
- Tuning to a channel or show you want to save as a favorite. Navigate to the SiriusXM Favorites screen and press the Add Current button. The currently tuned channel or show is saved as a favorite.
- Saving a radio preset. This saves the currently tuned SiriusXM channel or show as a favorite.

**Note:** *Requires a trial or active subscription to use.*

### Listening History

Listening history is a list of recently listened to SiriusXM content and is shown for the active listener profile. You can view, manage and reset the listening history using the controls on the touchscreen.

**Note:** *Requires a trial or active subscription to use.*

# Audio System

---

## Listener Settings

Listener settings apply to the active listener profile.

**Note:** *Requires a trial or active subscription to use.*

**Note:** *A default profile is available when no listener profiles are created.*

## Help and Support

You can contact SiriusXM Customer Care directly from SYNC and view information required to manage your SiriusXM account.

## SETTING AN ALERT



Set a notification for the current song, artist, or sports team by pressing the icon. The system alerts you when it plays again on any channel. Selecting this button allows you to enable and edit alerts.

**Note:** *Notifications can be switched on or off and edited in the satellite radio settings.*

# Center Display Overview

## CENTER DISPLAY PRECAUTIONS



**WARNING:** Driving while distracted can result in loss of vehicle control, crash and injury. We strongly recommend that you use extreme caution when using any device that may take your focus off the road. Your primary responsibility is the safe operation of your vehicle. We recommend against the use of any hand-held device while driving and encourage the use of voice-operated systems when possible. Make sure you are aware of all applicable local laws that may affect the use of electronic devices while driving.

## CENTER DISPLAY LIMITATIONS

### Speed-restricted Features

For your safety, some features are not available while the vehicle is in motion at or above 5 mph (8 km/h). Settings that are not critical while driving your vehicle are shown as restricted on your display. Some of these settings include:

- System updates.
- Personal profiles setup.
- Valet mode setup.
- Driver assistance settings.

### Vehicle Settings

- MyKey setup.
- Door keypad code setup.
- Backup start passcode setup.

These restricted features become available when your vehicle is no longer in motion.

## STATUS BAR

The bar is on top of the display and indicates the status of your vehicle's features.

### Audio System



Audio system muted.

### Connected Device



Cell phone microphone muted.



Phone call in progress.



Media player connected.



Cell phone network signal strength.



Cell phone roaming.



Text message received.



Unread email message.



Automatic crash notification system off.



Cell phone battery status.

### Vehicle Data



Wi-Fi available.

# Center Display Overview



Wi-Fi connected.



Vehicle data sharing on.



Vehicle data sharing off.



Vehicle location sharing on.



Vehicle data and vehicle location sharing on.

## Vehicle System Update



Vehicle system update available.



Vehicle system update requires schedule.



Vehicle system update requires consent.



Vehicle system update requires Wi-Fi.



Vehicle system update schedule reminder.



Vehicle system update not successful.



Vehicle system update successful.

## Wireless Accessory Charger



Wireless accessory charger active.

## FEATURE BAR

The feature bar is located on the bottom of the display and allows you to access vehicle features.



Press to use the radio, a USB, a media player or a **Bluetooth**® device.



Press to make calls and access the phonebook on your cell phone.



Press to use the navigation system.



Press to replace this button with a shortcut to a feature or setting.



Press to search for and use compatible apps on your iOS or Android device.



Press to adjust system settings.

## INFORMATION ON DEMAND SCREEN

The information on demand screen displays cards on the side of the display and allows you to see information from different features.



Press the button to view the next card.



Press the button to view the previous card.

# Center Display Overview

---



Press the button to view available cards.

# Voice Interaction

## WHAT IS VOICE INTERACTION

Voice Interaction allows you to control vehicle features using conversational requests.

## SETTING THE WAKE WORD



Select the settings option on the feature bar.

1. Press **Lincoln Assistant**.
2. Switch **Listen for Wake Word** on.
3. Press **Preferred Wake Word**.
4. Select a wake word.

## BEGINNING A VOICE INTERACTION

Say the selected wake word.



Press the voice interaction button on the steering wheel.

## VOICE INTERACTION EXAMPLES

### General Examples

Command	Result
Start Over.	The system resets the current voice interaction.
Cancel.	The system ends the current voice interaction.
Next Page.	The system goes to the next page.
Previous Page.	The system goes to the previous page.
Help.	The system displays a list of available commands you can use on the current screen.

### Entertainment Examples

Command	Result
Play The Beatles.	The system plays the selected music.
Show music by The Beatles.	The system shows the selected music.
Tune to FM 101.9.	The system tunes the radio to 101.9 FM.
Set the station to Sirius Channel 2.	The system tunes the radio to Sirius Channel 2.



# Voice Interaction

## Climate Examples

Command	Result
Set the temperature to low.	The system sets the temperature to the minimum.
Set the temperature to 72°F (22°C).	The system sets the temperature to 72°F (22°C).

## Phone Examples

Command	Result
Call Henry.	The system calls Henry using your connected device.
Dial (phone number).	The system dials the selected phone number.
Send a text message to Henry.	The system begins a dictated text message.
Read my message	The system reads

Command	Result
from Henry.	you the most recent message from Henry.

## Apps Examples

Command	Result
Mobile Apps.	The system prompts you to say the name of an app to start it on the system.
List Mobile Apps.	The system will list all of the currently available Mobile Apps.
Find Mobile Apps	The system will search and connect to compatible apps running on your mobile device.

## Navigation Examples

Command	Result
Say the address that you're looking for, like '125 Main Street, New York'.	The system begins guided navigation to the address.
Where is ____	The system searches for the requested point of interest.
Show me directions to Oakwood Boulevard and Pelham Road.	The system shows directions to the selected intersection.
Cancel route.	The system ends guided navigation to the destination.

# Phone

## PHONE PRECAUTIONS



**WARNING:** Driving while distracted can result in loss of vehicle control, crash and injury. We strongly recommend that you use extreme caution when using any device that may take your focus off the road. Your primary responsibility is the safe operation of your vehicle. We recommend against the use of any hand-held device while driving and encourage the use of voice-operated systems when possible. Make sure you are aware of all applicable local laws that may affect the use of electronic devices while driving.

## CONNECTING YOUR PHONE

Go to the settings menu on your device and switch **Bluetooth**® on.



Press the phone option on the feature bar.

1. Press **Add Phone**.

**Note:** A prompt alerts you to search for your vehicle on your cell phone.

2. Select your vehicle on your cell phone.

**Note:** A number appears on your cell phone and on the touchscreen.

3. Confirm the number on your cell phone matches the number on the touchscreen.

**Note:** The touchscreen indicates that you have successfully paired your cell phone.

4. Download the phonebook from your cell phone when you are prompted.

**Note:** If you pair more than one cell phone, use the phone settings on the center display to specify the primary phone. You can change this setting at any time.

## PHONE MENU

This menu becomes available after pairing a phone.

### Recent Call List

Display and select an entry from a list of previous calls.

## Contacts

Display a smart search form to look up your contacts. Use the List button to alphabetically sort your contacts.

## Favorites

Display the list of favorite contacts that are set up on your phone.

## Messaging

Displays the list of text messages to read, listen to, or respond to.

## Email

Displays the list of emails to read, listen to, or respond to.

## Phone List

Display the list of paired or connected devices that you can select.

**Note:** Up to 12 devices can be stored.

# Phone

---

## ***Do Not Disturb***

Reject incoming calls and switch ring tones and alerts off.

## ***Phone Keypad***

Directly dial a number.

## **Voice Control**

Say a command to use the Google or Siri voice assistant available on your connected phone to access supported features.

**Note:** *Some features under the phone menu may not be available if the feature is not supported through the phone.*

# Phone

## MAKING AND RECEIVING A PHONE CALL

### Making Calls

To call a number in your contacts, select:

Menu Item	Action and Description
Contacts	You can then select the name of the contact you want to call. Any numbers stored for that contact display along with any stored contact photos. You can then select the number that you want to call. The system begins the call.

To call a number from your recent calls, select:

Menu Item	Action and Description
Recent Call List	You can then select an entry that you want to call. The system begins the call.

To call a number from your favorites, select:

Menu Item	Action and Description
Favorites	You can then select an entry that you want to call. The system begins the call.

To call a number that is not stored in your phone, select:

Menu Item	Action and Description
Phone Keypad	Select the digits of the number you wish to call.
Call	The system begins the call.

Pressing the backspace button deletes the last digit you typed.

### Receiving Calls

During an incoming call, an audible tone sounds. Caller information appears in the display if it is available.

To accept the call, select:

Menu Item
Accept

**Note:** You can also accept the call by pressing the phone button on the steering wheel.

To reject the call, select:

Menu Item
Reject

Ignore the call by doing nothing. The system logs it as a missed call.

### During a Phone Call

During a phone call, the contacts name and number display on the screen along with the call duration.

The phone status items are also visible:

- Signal Strength.
- Battery.

# Phone

---

You can select any of the following during an active phone call:

<b>Item</b>	
End Call	Immediately end a phone call. You can also press the button on the steering wheel.
Keypad	Press this to access the phone keypad.
Mute	You can switch the microphone off so the caller does not hear you.
Privacy	Transfer the call to the cell phone or back to the touch-screen.

# Phone

---

## SENDING AND RECEIVING A TEXT MESSAGE

Menu Item	Description
Hear It	Hear the text message.
View	View the text message.
Call	Call the sender.
Reply	Reply to the text message with a standard text message.

## **SWITCHING TEXT MESSAGE NOTIFICATION ON AND OFF**

The settings on your device must be enabled to receive text message notifications on the center display. Check your device settings to enable these features.

## CONNECTING A BLUETOOTH® DEVICE

1. Make sure **Bluetooth**® is enabled on your device.
2. Press **Settings** on the touchscreen.
3. Press **Connectivity**.
4. Press **Bluetooth**.
5. Press **Add a Bluetooth Device**.

**Note:** A prompt alerts you to search for your vehicle on your device.

6. Select your vehicle on your device.

**Note:** A number appears on your device and on the touchscreen.

7. Confirm that the number on your device matches the number on the touchscreen.

**Note:** The touchscreen indicates that you have successfully paired your device.

The **Bluetooth**® word mark and logos are registered trademarks owned by **Bluetooth SIG, Inc.** and any use of such marks by Ford Motor Company is under license. Other trademarks and trade names are those of their respective owners.

## PLAYING MEDIA USING BLUETOOTH®



**WARNING:** Driving while distracted can result in loss of vehicle control, crash and injury. We strongly recommend that you use extreme caution when using any device that may take your focus off the road. Your primary responsibility is the safe operation of your vehicle. We recommend against the use of any hand-held device while driving and encourage the use of voice-operated systems when possible. Make sure you are aware of all applicable local laws that may affect the use of electronic devices while driving.

Connect your device.



Press the audio button on the feature bar.



Press **Sources**.



Press the **Bluetooth**® option.



Press to play a track. Press again to pause the track.



Press to skip to the next track.

Press and hold to fast forward through the track.



Press once to return to the beginning of a track. Repeatedly press to return to previous tracks.

Press and hold to fast rewind through the track.



# Apps

## APP PRECAUTIONS



**WARNING:** Driving while distracted can result in loss of vehicle control, crash and injury. We strongly recommend that you use extreme caution when using any device that may take your focus off the road. Your primary responsibility is the safe operation of your vehicle. We recommend against the use of any hand-held device while driving and encourage the use of voice-operated systems when possible. Make sure you are aware of all applicable local laws that may affect the use of electronic devices while driving.

## APP REQUIREMENTS

When you start an app through the system for the first time, you could be asked to grant certain permissions. You can review and change the permissions that you have granted at any time when your vehicle is not moving. We recommend that you check your data plan before using your apps through

the system. Using them could result in additional charges. We also recommend that you check the app provider's terms and conditions and privacy policy before using their app. Make sure that you have an active account for apps that you want to use through the system. Some apps will work with no setup. Others require you to configure some personal settings before you can use them.

## ACCESSING APPS



Select the apps option on the feature bar.

## ENABLING APPS ON AN IOS DEVICE



Select the apps option on the feature bar.

1. Select Mobile Apps Help.
2. Follow the instructions to pair and connect your device via **Bluetooth**<sup>®</sup> or with a USB cable.

3. Start the apps on your device that you want to use.
4. Select the app that you want to use on the touchscreen.

**Note:** *Some apps may run through Apple CarPlay if it is enabled.*

**Note:** *Closing an app on your device will close it on the touchscreen.*

**Note:** *For troubleshooting assistance select Mobile Apps List under Mobile Apps Help.*

## ENABLING APPS ON AN ANDROID DEVICE



Select the apps option on the feature bar.

1. Select Mobile Apps Help.
2. Follow the instructions to pair and connect your device via **Bluetooth**<sup>®</sup> or with a USB cable.
3. Start the apps on your device that you want to use.
4. Select **Find Mobile Apps**.

# Apps

5. Select the app that you want to use on the touchscreen.

**Note:** *Some devices may lose the ability to play music over USB when Mobile Apps are enabled.*

**Note:** *Some apps may run through Android Auto if it is enabled.*

**Note:** *Closing an app on your device will close it on the touchscreen.*

**Note:** *For troubleshooting assistance select Mobile Apps List under Mobile Apps Help.*

## SWITCHING APPLE CARPLAY ON AND OFF

### Enabling Apple CarPlay with USB

1. Connect your device to a USB port.
2. Follow the instructions on your device and the touchscreen.

**Note:** *Selecting "Enable Wireless CarPlay" on your device prepares the device for wireless CarPlay when you re-enter the vehicle.*

### Enabling Apple CarPlay with Wireless

1. Pair your device to **Bluetooth**<sup>®</sup>.
2. Follow the instructions on your device and the touchscreen.

### Disabling Apple CarPlay



Select the settings option on the feature bar.

1. Press Phone List.
2. Select your device from the list.
3. Press Disable.

### Re-Enabling Apple CarPlay



Select the settings option on the feature bar.

1. Press Phone List.
2. Select your device from the list.
3. Press Connect to Apple CarPlay.

## SWITCHING ANDROID AUTO ON AND OFF

### Enabling Android Auto with USB (If

Equipped)

1. Connect your device to a USB port.
2. Follow the instructions on the touchscreen.

**Note:** *Certain features of the system are not available when you are using Android Auto.*

### Enabling Android Auto with Wireless

1. Pair your device to **Bluetooth**<sup>®</sup>.
2. Follow the instructions on your device and the touchscreen.

**Note:** *Certain Android Devices do not support Android Auto Wireless. Please check your Android OS version for compatibility.*

### Disabling Android Auto



Select the settings option on the feature bar.

1. Press Phone List.

2. Select your device from the list.
3. Press Disable.

## Re-Enabling Android Auto



Select the settings option on the feature bar.

1. Press Phone List.
2. Select your device from the list.
3. Press Connect to Android Auto.

# Personal Profiles

---

## HOW DO PERSONAL PROFILES WORK

This feature allows you to create multiple personal profiles enabling users to personalize vehicle's settings such as seats and mirrors, as well as non-positional settings like radio, navigation, driver assist system settings. Positional settings are saved by holding a memory seat button.

Non-positional settings are saved you change a setting while a profile is active. You can create one profile for each preset memory seat button along with a guest profile.

### Recalling and Changing a Profile

You can recall a profile using the touchscreen or the preset button you selected when you created your profile. You can also link a remote control and a mobile device to your profile, which are used to recall it.

## ENABLING OR DISABLING PERSONAL PROFILES

When you switch on the Personal Profiles feature:

- Unlocking a door with a remote control or mobile device that is not linked to a driver profile does not change the active profile, but remains in the last known profile. It does not change the positional settings.
- Pressing a memory seat button that is not linked to a driver profile or saved to a preset setting does not change the active profile, but remains in the last known profile. It does not change the positional settings.
- Pressing a memory seat button that is not linked to a driver profile but is saved to a preset setting does not change the active profile, but remains in the last known profile. It recalls the positional settings that you saved to that memory seat button.

When you switch off a Personal Profiles feature:

- Unlocking a door with a remote control or mobile device does not recall any non-positional settings but still recalls positional settings from the driver profile which the remote control or mobile device is linked to.
- Pressing a memory seat button that is not linked to a driver profile or saved to a preset setting does not change the positional or non-positional settings.
- Pressing a memory seat button that is linked to a driver profile or has saved to a preset setting recalls the positional settings that you saved to that memory seat button.

## CREATING A PERSONAL PROFILE

Use the touchscreen to create a personal profile.

1. Switch the vehicle on and leave the vehicle in park (P).
2. Select the Personal Profiles button under Settings.

# Personal Profiles

---

3. Follow the instructions on the display.

## LINKING OR UNLINKING A PERSONAL PROFILE TO A REMOTE CONTROL

You can save preset memory positions for up to three remote controls by assigning a remote control to a personal profile using the touchscreen.

Use the touchscreen to link a remote control to a personal profile.

1. Switch the vehicle on and leave the vehicle in park (P).
2. Select the Personal Profiles button under Settings.
3. Touch the arrow for the profile you wish to link to a remote control.
4. Select remote control.
5. Follow the instructions on the display.

**Note:** *If more than one linked remote control is in range, the memory function moves to the settings of the first key to initiate a memory recall.*

**Note:** *The guest profile consists of existing settings when there is no driver profile created. After you create a driver profile, the guest profile serves as an additional driver profile.*

**Note:** *You cannot link a remote control to a guest profile.*

## LINKING OR UNLINKING A PERSONAL PROFILE TO A DEVICE

Use the touchscreen to link a mobile device to a personal profile.

1. Switch the vehicle on and leave the vehicle in park (P).
2. Select the Personal Profiles button under Settings.
3. Touch the arrow for the profile you wish to link to a mobile device.
4. Select mobile device.
5. Follow the instructions on the display.

**Note:** *To successfully link a mobile device, the mobile device must be in your vehicle, and must have previously been setup as a remote control for your vehicle.*

**Note:** *The guest profile consists of existing settings when there is no driver profile created. After you create a driver profile, the guest profile serves as an additional driver profile.*

**Note:** *You cannot link a personalized name to a guest profile.*

# Navigation

---

## ACCESSING NAVIGATION



Press the button to access Navigation.

**Note:** *As the driver, be aware of all local traffic regulations and road attributes, and operate your vehicle in a safe and legal manner.*

## NAVIGATION MAP UPDATES

To update your Map data over Wi-Fi, your vehicle must be connected to a Wi-Fi access point. For USB updates and other details, contact dealers at 1-866-462-8837 in the United States and Canada, or 01-800-557-5539 in Mexico.

**Note:** *If you find map data errors, you may report them by going to [www.here.com/mapcreator](http://www.here.com/mapcreator).*

## ADJUSTING THE MAP

### ZOOMING THE MAP IN AND OUT

You can use pinch gestures to zoom in and out. Place two fingers on the screen and move them apart to zoom in. Place two fingers on the screen and bring them together to zoom out.

### CHANGING THE FORMAT OF THE MAP



Press the Menu button.

1. Press the Map Orientation tile.
2. Select a map orientation.

## LIVE TRAFFIC

### WHAT IS LIVE TRAFFIC

You can observe real-time road congestion when live traffic is on.

## SWITCHING LIVE TRAFFIC ON AND OFF



Press the Menu button.

1. Press the Traffic on Map tile.
2. Press Traffic on or Traffic Off.

## SETTING A DESTINATION

### SETTING A DESTINATION USING THE TEXT ENTRY SCREEN

1. Press the search bar at the top of the screen.
2. Enter your destination using the keyboard.
3. Press Search.
4. Select a destination from the list.
5. Press Start to begin navigation.

# Navigation

## SETTING A DESTINATION USING THE MAP SCREEN

Press and hold on the map to place a pin at that location. Information about the location of the pin appears on the screen.



Press the button to begin navigation to the pin.

## SETTING A DESTINATION USING A PREDICTIVE DESTINATION

Press the predicted destination card on the screen to navigate to it. These appear when the navigation system has learned your driving habits.

## SETTING A DESTINATION USING A RECENT DESTINATION

1. Press the Recents tile.
2. Select a destination from the list.

## SETTING A DESTINATION USING A SAVED DESTINATION

1. Press Saved Places.
2. Select a saved destination.

**Note:** Press the star icon next when viewing location details to save the location.

## SETTING A DESTINATION USING A POINT OF INTEREST

Press a point of interest icon on the map. Information about the location of the point of interest appears on the screen.



Press the button to begin navigation to the point of interest.

## WAYPOINTS

### ADDING A WAYPOINT



Press the Add Waypoint button when in an active navigation session.

1. Select a category or enter your waypoint on the keyboard and press Search.
2. Select a waypoint from the list.
3. Press Add to Trip.

## EDITING WAYPOINTS

1. Press the waypoint you would like to edit.
2. Select an option to reorder or delete the waypoint.

## ROUTE GUIDANCE

### ADJUSTING THE GUIDANCE PROMPT VOLUME

Turn the volume control when a guidance prompt plays to adjust the volume.

### CANCELING ROUTE GUIDANCE



Press the button to cancel route guidance to the selected location.

# Vehicle System Updates

## UPDATING THE VEHICLE SYSTEMS WIRELESSLY



System software updates allow you to update your vehicle system software wirelessly. To make sure you receive all updates, set a recurring schedule and connect to Wi-Fi. Updates may take longer if not connected to Wi-Fi, or may not download at all.

### System Update Requirements

Before updating, reference this list to make sure your vehicle is ready to be updated. If these requirements are not met during a scheduled update, the update will be canceled and you can reschedule.

- Your vehicle is not running.
- Your vehicle is stopped.
- Your vehicle is parked.
- The hazard indicators are switched off.
- The alarm is not sounding.
- The doors are closed.
- The parking lights are switched off.

- You are not pressing the brake pedal.
- An emergency call is not in progress.
- Your vehicle is not in limp mode.

### Scheduling an Update

Make sure Vehicle Connectivity and Automatic Updates are switched on.

### Using the Settings Menu



Press the settings option on the feature bar.

1. Press the **System Update** tile.
2. Press **Schedule Update**.
3. Use the controls to set the time and day of the update.
4. Save the schedule.

**Note:** *You can set the updates to occur every seven days.*

### Using the Status Bar Icon



When an update is available, tap the notification icon and follow the prompts on the screen.

## Applying a Vehicle System Software Update

You can schedule a convenient time for the update to complete. During scheduled updates you may not be able to use your vehicle.

**Note:** *Updates may take up to 30 minutes to complete.*

You can see the progress of the update on the touchscreen. An update cannot be canceled once it has been started.

During an update you will not be able to drive your vehicle, start the vehicle, use remote controls to lock and unlock the vehicle. The alarm, central locks, and door tones are disabled. The electronic door lock will not function during an update. You can open the doors using the mechanical latch if child locks are not on. Pull the handle until it stops to use the mechanical latch.

**Note:** *Double locking is switched off and central locking is switched on during and after an update.*



# Vehicle System Updates

---

**Note:** *If your vehicle is plugged in, charging will stop during an update and resume when the update is complete.*

## Viewing Update Details

If an update is successful, the touchscreen will provide additional details about the update. You can also access this information under the System Update tile.

If an update is not successful, follow the prompt that appears on the touchscreen.

## PERFORMING A MASTER RESET



Press the settings option on the feature bar.

1. Press the **Reset** tile.
2. Press **Master Reset**.
3. Follow the prompts on the screen to complete the reset.

# Accessories

For a complete listing of the accessories that are available for your vehicle, please contact your authorized dealer or visit the online store website:

<b>Web Address (United States)</b>
------------------------------------

<a href="https://accessories.lincoln.com/">https://accessories.lincoln.com/</a>
---

<b>Web Address (Canada)</b>
-----------------------------

<a href="http://www.lincolncanada.com">www.lincolncanada.com</a>
--

We will repair or replace any properly authorized dealer-installed Lincoln Original Accessory found to be defective in factory-supplied materials or workmanship during the warranty period, as well as any component damaged by the defective accessories.

We will warrant your Lincoln Original Accessory through the warranty that provides the greatest benefit:

- 24 months, unlimited mileage.
- The remainder of your new vehicle limited warranty.

## Lincoln Licensed Accessories

The accessory manufacturer designs, develops and therefore warrants Lincoln Licensed Accessories, and does not design or test these accessories to Lincoln engineering requirements. Contact an authorized Lincoln dealer for the accessory manufacturer's limited warranty details and request a copy of the Lincoln Licensed Accessories product limited warranty from the accessory manufacturer. See your warranty guide for more information.

For maximum vehicle performance, keep the following information in mind when adding accessories or equipment to your vehicle:

- When adding accessories, equipment, passengers and luggage to your vehicle, do not exceed the total weight capacity of the vehicle or of the front or rear axle (GVWR or GAWR as indicated on the Safety Compliance Certification label). Ask an authorized dealer for specific weight information.
- The Federal Communications Commission (FCC) and Canadian Radio Telecommunications Commission (CRTC) regulate the use of mobile communications systems that have radio transmitters, for example two-way radios, telephones and theft alarms. Any such equipment installed in your vehicle should comply with Federal Communications Commission (FCC) and Canadian Radio Telecommunications Commission (CRTC) regulations and should only be installed by an authorized dealer.

# Accessories

---

- Mobile communications systems may harm the operation of your vehicle, particularly if their manufacturer did not design them specifically for automotive use.
- If you or an authorized Lincoln dealer add any non-Lincoln electrical or electronic accessories or components to your vehicle, you may adversely affect battery performance and durability. In addition, you may also adversely affect the performance of other electrical systems in the vehicle.

# Lincoln Protect

---

## WHAT IS LINCOLN PROTECT

Protect yourself from the rising cost of vehicle repairs with the Lincoln Protect extended service plan.

### Lincoln Protect Extended Service Plans (United States Only)

Lincoln Protect means peace of mind. It is the extended service plan backed by Lincoln, and provides more protection beyond the New Vehicle Limited Warranty coverage. When you visit your Lincoln Dealer, insist on genuine Lincoln Protect extended service plans.

### Lincoln Protect Extended Service Plan Can Quickly Pay for Itself

One trip to the Service Center could easily exceed the price of your Lincoln Protect extended service plan. With Lincoln Protect, you minimize your risk for unexpected repair bills and rising repair costs.

## Up to 1000+ Covered Vehicle Components

There are four mechanical Lincoln Protect extended service plans with different levels of coverage. Ask your authorized dealer for details.

1. PremiumCARE - Our most comprehensive coverage. With over 1,000 covered components, this plan is so complete it is probably easier to list what is not covered.
2. ExtraCARE - Covers 113 components, and includes many high-tech items.
3. BaseCARE - Covers 84 components.
4. PowertrainCARE - Covers 29 critical components.

Lincoln Protect extended service plans are honored by all authorized Lincoln dealers in the United States, Canada and Mexico.

That means you get:

- Reliable, quality service at any Lincoln or Ford dealership.
- Repairs performed by factory trained technicians, using genuine parts.

## Rental Car Reimbursement

### *First Day Rental Benefit*

If you bring your car into your dealer for service, we will give you a rental vehicle to use for the day.

### *Extended Rental Benefits*

If your vehicle is kept overnight for covered repairs, you are eligible for rental car coverage, including bumper to bumper warranty repairs, and field service actions.

## Roadside Assistance

Exclusive 24/7 roadside assistance, including:

- Towing, flat-tire change and battery jump starts.
- Out of fuel and lock-out assistance.
- Travel expense reimbursement for lodging, meals and rental car.
- Assistance for taxi, shuttle, rental car coverage and other transportation.

# Lincoln Protect

---

## Transferable Coverage

If you sell your vehicle before your Lincoln Protect extended service plan coverage expires, you can transfer any remaining coverage to the new owner. This should give you and your potential buyer a little more peace of mind.

## Less Cost to Properly Maintain Your Vehicle

The Lincoln Protect extended service plan also offers a Premium Maintenance Plan that covers all scheduled maintenance, and selected wear items. The coverage is prepaid, so you never have to worry about the cost of your vehicle's maintenance.

Covered maintenance includes:

- Windshield wiper blades.
- Spark plugs.
- The clutch disc - if equipped.
- Brake pads and linings.
- Shock absorbers and struts.
- Engine cooling hoses, clamps and o-rings.

- Engine belts.
- Diesel exhaust fluid replenishment - if equipped.

## Interest Free Finance Options

Just a 5% down payment will provide you with an affordable, no interest, no fee payment program allowing you all the security and benefits Lincoln Protect extended service plan has to offer while paying over time. You are pre-approved with no credit check or hassles. To learn more, call our Lincoln Protect extended service plan specialists at 800-367-3377.

Complete the information below and mail to:

Lincoln Protect Extended Service Plan  
P.O. Box 321067  
Detroit, MI 48232

## Lincoln Protect (Canada Only)

You can get more protection for your vehicle by purchasing a Lincoln Protect extended service plan. The Lincoln Protect extended service plan is the only service contract backed by Lincoln, Limited. Depending on the plan you purchase, the Lincoln Protect extended service plan provides benefits such as:

- Rental reimbursement.
- Coverage for certain maintenance and wear items.
- Protection against repair costs after your New Vehicle Limited Warranty Coverage expires.
- Roadside Assistance benefits.

# Lincoln Protect

---

There are several Lincoln Protect extended service plans available in various time, distance and deductible combinations. Each plan is tailored to fit your own driving needs, including reimbursement for towing and rental. When you purchase a Lincoln Protect extended service plan, you receive added peace-of-mind protection throughout Canada, the United States and Mexico, provided by a network of participating authorized Lincoln dealers.

**Note:** *Repairs performed outside of Canada, the United States and Mexico are not eligible for Lincoln Protect extended service plan coverage.*

This information is subject to change. For more information, visit your local Lincoln of Canada dealer or [www.LincolnCanada.com](http://www.LincolnCanada.com) to find the Lincoln Protect extended service plan that is right for you.

# Scheduled Maintenance

---

## GENERAL MAINTENANCE INFORMATION

### Why Maintain Your Vehicle?

Carefully following the maintenance schedule helps protect against major repair expenses resulting from neglect or inadequate maintenance and may help to increase the value of your vehicle when you sell or trade it. Keep all receipts for completed maintenance with your vehicle.

It is important that you have your vehicle serviced at the proper times. These intervals serve two purposes: first is to maintain the reliability of your vehicle and the second is to keep the cost of owning your vehicle down.

It is your responsibility to have all scheduled maintenance performed and to make sure that the materials used meet the specifications identified in this owner's manual. See **Capacities and Specifications** (page 404).

Failure to perform scheduled maintenance and regularly inspect your vehicle may result in vehicle damage not covered by the vehicle Warranty.

### Why Maintain Your Vehicle at Your Dealership?

#### Our Genuine Replacement Parts

Dealerships stock our parts and our authorized branded re-manufactured replacement parts. These parts meet or exceed our specifications. Parts installed at your dealership carry a nationwide 24-month or unlimited mile (kilometer) parts and labor limited warranty.

If you do not use our authorized parts they may not meet our specifications and could affect emissions compliance.

### Protecting Your Investment

Maintenance is an investment that pays dividends in the form of improved reliability, durability and resale value. To maintain the proper performance of your vehicle and its emission control systems, make sure you have scheduled maintenance performed at the designated intervals.

Your vehicle comes with the Intelligent Oil-Life Monitor system, a message appears in the information display at the proper oil change interval. This interval may be up to one year or 10,000 mi (16,000 km), hybrid vehicles could exceed 10,000 mi (16,000 km).

When the oil change message appears in the information display, it is time for an oil change. Make sure you perform the oil change within two weeks or 500 mi (800 km) of the message appearing. Make sure to reset the Intelligent Oil-Life Monitor after each oil change. See **Resetting the Engine Oil Change Reminder** (page 346).

# Scheduled Maintenance

If your information display resets prematurely or becomes inoperative, you should perform the oil change interval at six months or 5,000 mi (8,000 km) from your last oil change. Never exceed one year or 10,000 mi (16,000 km) between oil change intervals.

You can drive high performance vehicles in such a way that may lead to higher oil consumption including extended time at high engine speeds, high loads, engine braking, hard cornering maneuvers, track and off-road usage. Under these conditions, oil consumption of approximately 1 quart per 500 miles (1 liter per 800 km) is possible. Check the engine oil level at every refueling and adjust to maintain proper levels to avoid engine damage.

It is important to rely upon your dealership to properly diagnose and repair your vehicle.

We strongly recommend only using our genuine or our authorized re-manufactured replacement parts engineered for your vehicle.

## Additives and Chemicals

We do not recommend using chemicals or additives not approved by us as part of your vehicle's normal maintenance. Please consult your warranty information.

## Oils, Fluids and Flushing

In many cases, fluid discoloration is a normal operating characteristic and, by itself, does not necessarily indicate a concern or that the fluid needs to be changed. Have discolored fluids that also show signs of overheating or foreign material contamination checked immediately.

Make sure to change the vehicle's oils and fluids at the specified intervals or in conjunction with a repair. Flushing is a viable way to change fluid for many vehicle sub-systems during scheduled maintenance. It is critical that systems are flushed only with new fluid that is the same as that required to fill and operate the system or using our approved flushing chemical.

## Owner Checks and Services

Make sure you perform the following basic maintenance checks and inspections.

Check Every Month
The air filter restriction gauge. <sup>1</sup>
The engine oil level.
Function of all interior and the exterior lights.



# Scheduled Maintenance

---

<b>Check Every Month</b>
The tires including the spare for wear and proper pressure.
The windshield washer fluid level.
The fuel and water separator. Drain if necessary or if indicated by the information display. <sup>1</sup>
The holes and slots in the tail pipe to make sure they are functional and clear of debris. <sup>1</sup>

<sup>1</sup> Diesel vehicles only.

<b>Check Every Six Months</b>
The battery connections. Clean if necessary.
The body and door drain holes for obstructions. Clean if necessary.
The cooling system fluid level and the coolant system strength.
The door weatherstrips for wear. Lubricate if necessary.
The hinges, latches and outside locks for proper operation. Lubricate if necessary.
The parking brake for proper operation.

# Scheduled Maintenance

Check Every Six Months
The seatbelts and seat latches for wear and function.
Safety warning lamps, brake, ABS, airbag and seatbelt for operation.
The washer spray and wiper operation. Clean or replace blades as necessary.

## Multi-Point Inspection

It is important to have the systems on your vehicle regularly checked. This can help identify potential issues and prevent major problems. We recommend having the following multi-point inspection performed at every scheduled maintenance interval to help make sure your vehicle keeps running great.

Multi-Point Inspection	
Accessory drive belt or belts	Hazard warning system operation
Battery performance	Horn operation
Engine air filter	Radiator, cooler, heater and air conditioning hoses
Exhaust system	Suspension components for leaks or damage

# Scheduled Maintenance

Multi-Point Inspection	
Exterior lamps operation	Steering and linkage
Fluid levels <sup>1</sup> ; fill if necessary	Tires including the spare for wear and proper pressure <sup>2</sup>
For oil and fluid leaks	Windshield for cracks, chips or pits
Half-shaft dust boots	Washer spray and wiper operation

<sup>1</sup> Brake, coolant recovery reservoir, automatic transmission and window washer.

<sup>2</sup> If your vehicle has a temporary mobility kit, check the tire sealant expiration Use By date on the canister. Replace as needed.

Be sure to ask your dealership service advisor or technician about the multi-point vehicle inspection. It is a comprehensive way to perform a thorough inspection of your vehicle. Your checklist gives you immediate feedback on the overall condition of your vehicle.

## NORMAL SCHEDULED MAINTENANCE

### Oil Change Reminder

Your vehicle comes with an oil change reminder that determines when you should change the engine oil based on how you use your vehicle.

Your vehicle lets you know when an oil change is due by displaying a message in the information display.

The following table provides examples of vehicle use and its impact on oil change intervals. It is a guideline only. Actual oil change intervals depend on several factors and generally decrease with severity of use.

# Scheduled Maintenance

When to expect the OIL CHANGE REQUIRED message	
Interval	Vehicle Use and Example
7,500–10,000 mi (12,000–16,000 km)	<b>Normal</b>
	Normal commuting with highway driving No, or moderate, load or towing Flat to moderately hilly roads No extended idling
5,000–7,500 mi (8,000–12,000 km)	<b>Severe</b>
	Moderate to heavy load or towing Mountainous or off-road conditions Extended idling Extended hot or cold operation
3,000–5,000 mi (5,000–8,000 km)	<b>Extreme</b>
	Maximum load or towing Extreme hot or cold operation

# Scheduled Maintenance

## Normal Maintenance Intervals

At Every Oil Change Interval as Indicated by the Information Display <sup>1</sup>
Change the engine oil and filter. <sup>2</sup>
Rotate the tires.
Perform a multi-point inspection, recommended.
Inspect the automatic transmission fluid level. Consult your dealer for requirements.
Inspect the brake pads, rotors, hoses and the parking brake.
Inspect the engine coolant level/strength and the hoses.
Inspect the exhaust system and the heat shields.
Inspect the rear axle and U-joints - all wheel drive only.
Inspect the half-shaft boots.
Inspect the steering linkage, ball joints, suspension, tire-rod ends, driveshaft and U-joints.
Inspect the tires, tire wear and measure the tread depth.
Inspect the wheels and related components for abnormal noise, wear, looseness or drag.

<sup>1</sup> Do not exceed one year or 10,000 mi (16,000 km) between service intervals.

<sup>2</sup> Reset the oil change reminder after engine oil and filter changes. See **Resetting the Engine Oil Change Reminder** (page 346).

# Scheduled Maintenance

Other Maintenance Items <sup>1</sup>	
Every 20,000 mi (32,000 km)	Replace the cabin air filter.
Every 30,000 mi (48,000 km)	Replace the engine air filter.
Every 100,000 mi (160,000 km)	Replace the spark plugs.
	Inspect the accessory drive belt or belts. <sup>2</sup>
Every 150,000 mi (240,000 km)	Change the automatic transmission fluid.
	Replace the accessory drive belt or belts. <sup>3</sup>
At 200,000 mi (320,000 km)	Change the engine coolant. <sup>4</sup>

<sup>1</sup> Perform these maintenance items within 3,000 mi (4,800 km) of the last engine oil and filter change. Do not exceed the designated distance for the interval.

<sup>2</sup> After initial inspection, inspect every other oil change until replaced.

<sup>3</sup> If not replaced within the last 100,000 mi (160,000 km).

<sup>4</sup> Initial replacement at 10 years or 200,000 mi (320,000 km), then every five years or 100,000 mi (160,000 km).

# Scheduled Maintenance

---

Brake Fluid Maintenance <sup>1</sup>	
Every 3 Years	Change the brake fluid. <sup>2</sup>

<sup>1</sup> Perform this maintenance item every 3 years. Do not exceed the designated time for the interval.

<sup>2</sup> Brake fluid servicing requires special equipment available at your authorized dealer.

## **SPECIAL OPERATING CONDITIONS SCHEDULED MAINTENANCE**

If you operate your vehicle **primarily** in any of the following conditions, you need to perform extra maintenance as indicated. If you operate your vehicle **occasionally** under any of these conditions, it is not necessary to perform the extra maintenance. For specific recommendations, see your dealership service advisor or technician.

# Scheduled Maintenance

---

<b>Towing a trailer or using a car-top carrier</b>	
As required	Change engine oil and filter as indicated by the information display and perform services listed in the Normal Scheduled Maintenance chart.
Inspect frequently, service as required	Inspect rear axle and U-joints (AWD only).
	Inspect half-shaft boots.
	See axle maintenance items under <b>Exceptions</b> .
Every 30,000 mi (48,000 km)	Change automatic transmission fluid.
Every 60,000 mi (96,000 km)	Replace spark plugs.



## Scheduled Maintenance

<b>Extensive idling or low-speed driving for long distances, as in heavy commercial use</b>	
As required	Change engine oil and filter as indicated by the information display and perform services listed in the Normal Scheduled Maintenance chart.
Inspect frequently, service as required	Replace cabin air filter.
	Replace engine air filter.
Every 30,000 mi (48,000 km)	Change automatic transmission fluid.
Every 60,000 mi (96,000 km)	Replace spark plugs.

<b>Extended Hot and Cold climate operation</b>	
Every 5,000 mi (8,000 km)	Change engine oil and filter.

Hot Climates only

# Scheduled Maintenance

Operating in off-road (unpaved, sandy, dusty) and Mountainous conditions	
Inspect frequently, service as required	Replace cabin air filter.
	Replace engine air filter.
Every 5,000 mi (8,000 km)	Inspect the wheels and related components for abnormal noise, wear, looseness or drag.
	Rotate tires, inspect tires for wear and measure tread depth.
Every 5,000 mi (8,000 km) or 6 months	Change engine oil and filter.
	Perform multi-point inspection.
Every 30,000 mi (48,000 km)	Change automatic transmission fluid.

Reset your Intelligent Oil-Life Monitor after engine oil and filter changes. See **Resetting the Engine Oil Change Reminder** (page 346).

## Exceptions

There are several exceptions to the Normal Schedule:

# Scheduled Maintenance

---

**Axle and PTU maintenance:** The Power Transfer Unit (PTU) and rear axle (AWD only) in your vehicle does not require any normal scheduled maintenance. The PTU lubricant may be more likely to require a fluid change if the vehicle has extended periods of extreme or severe duty cycle driving. Changing or checking the PTU lubricant is not necessary unless the unit has been submerged in water, shows sign of leakage. Contact your authorized dealer for service.

**California fuel filter replacement:** If you register your vehicle in California, the California Air Resources Board has determined that the failure to perform this maintenance item does not nullify the emission warranty or limit recall liability before the completion of your vehicle's useful life. We however, urge you to have all recommended maintenance services performed at the specified intervals and to record all vehicle service.

**Engine air filter and cabin air filter replacement:** The life of the engine air filter and cabin air filter is dependent on exposure to dusty and dirty conditions. Vehicles operated in these conditions require frequent inspection and replacement of the engine air filter and cabin air filter.

# Customer Information

## ROLLOVER WARNING



**WARNING:** Utility vehicles have a significantly higher rollover rate than other types of vehicles.



**WARNING:** Vehicles with a higher center of gravity (utility and four-wheel drive vehicles) handle differently than vehicles with a lower center of gravity (passenger cars). Avoid sharp turns, excessive speed and abrupt steering in these vehicles. Failure to drive cautiously increases the risk of losing control of your vehicle, vehicle rollover, personal injury and death.



**WARNING:** In a rollover crash, an unbelted person is significantly more likely to die than a person wearing a seatbelt.



**WARNING:** Do not become overconfident in the ability of four-wheel drive vehicles. Although a four-wheel drive vehicle may accelerate better than a two-wheel drive vehicle in low traction situations, it won't stop any faster than two-wheel drive vehicles. Always drive at a safe speed.

Utility vehicles and trucks handle differently than passenger cars in the various driving conditions that are encountered on streets, highways and off-road. Utility vehicles and trucks are not designed for cornering at speeds as high as passenger cars any more than low-slung sports cars are designed to perform satisfactorily under off-road conditions.

## THE BETTER BUSINESS BUREAU AUTO LINE PROGRAM

Your satisfaction is important to Ford Motor Company and to your dealer. If a warranty concern has not been resolved using the three-step procedure outlined earlier in this chapter in the Getting the Services you need section, you may be eligible to participate in the BBB AUTO LINE program.

The BBB AUTO LINE program consists of two parts – mediation and arbitration. During mediation, a representative of the BBB will contact both you and Ford Motor Company to explore options for settlement of the claim. If an agreement is not reached during mediation or you do not want to participate in mediation, and if your claim is eligible, you may participate in the arbitration process. An arbitration hearing will be scheduled so that you can present your case in an informal setting before an impartial person. The arbitrator considers the testimony provided and makes a decision after the hearing.

## Customer Information

---

Disputes submitted to the BBB AUTO LINE program are usually decided within 40 days after you file your claim with the BBB. You are not bound by the decision, and may reject the decision and proceed to court where all findings of the BBB Auto Line dispute, and decision, are admissible in the court action. Should you choose to accept the BBB AUTO LINE decision, Ford is then bound by the decision, and must comply with the decision within 30 days of receipt of your acceptance letter.

**BBB AUTO LINE Application:** Using the information that follows, please call or write to request a program application. You will be asked for your name and address, general information about your new vehicle, information about your warranty concerns, and any steps you have already taken to try to resolve them. A Customer Claim Form will be mailed that needs to be completed, signed and returned to the BBB along with proof of ownership. Upon receipt, the BBB reviews the claim for eligibility under the Program Summary Guidelines.

**You can get more information by calling BBB AUTO LINE at 1-800-955-5100, or writing to:**

**BBB AUTO LINE a Division of BBB National Programs, Inc.  
1676 International Drive, Suite 550  
McLean, VA 22102**

BBB AUTO LINE applications can also be requested by calling the Ford Motor Company Customer Relationship Center at 1-800-392-3673.

For additional information, refer to the Better Business Bureau website.

**Note:** *Ford Motor Company reserves the right to change eligibility limitations, modify procedures, or to discontinue this process at any time without notice and without obligation.*

## THE MEDIATION AND ARBITRATION PROGRAM

For vehicles delivered to authorized Canadian dealers. In those cases where you continue to feel that the efforts by Ford of Canada and the authorized dealer to resolve a factory-related vehicle service concern have been unsatisfactory, Ford of Canada participates in an impartial third party mediation/arbitration program administered by the Canadian Motor Vehicle Arbitration Plan (CAMVAP).

The CAMVAP program is a straightforward and relatively speedy alternative to resolve a disagreement when all other efforts to produce a settlement have failed. This procedure is without cost to you and is designed to eliminate the need for lengthy and expensive legal proceedings.

# Customer Information

---

In the CAMVAP program, impartial third-party arbitrators conduct hearings at mutually convenient times and places in an informal environment. These impartial arbitrators review the positions of the parties, make decisions and, when appropriate, render awards to resolve disputes. CAMVAP decisions are fast, fair, and final as the arbitrator's award is binding on both you and Ford of Canada.

CAMVAP services are available in all Canadian territories and provinces. For more information, without charge or obligation, call your CAMVAP Provincial Administrator directly at 1-800-207-0685 or visit [www.camvap.ca](http://www.camvap.ca).

## **ORDERING A CANADIAN FRENCH OWNER'S MANUAL**

You can obtain a French owner's manual from an authorized dealer or by contacting Helm, LLC at:

HELM, LLC  
47911 Halyard Drive, Suite 200  
Plymouth, Michigan 48170  
Attention: Customer Service  
Call toll free: 1-800-782-4356  
Monday-Friday 8:00 a.m. - 6:00 p.m. EST  
For additional information, visit  
[www.helminc.com](http://www.helminc.com).

## **REPORTING SAFETY DEFECTS IN THE UNITED STATES**

If you believe that your vehicle has a defect which could cause a crash or could cause injury or death, you should immediately inform the National Highway Traffic Safety Administration (NHTSA) in addition to notifying Ford Motor Company.

If NHTSA receives similar complaints, it may open an investigation, and if it finds that a safety defect exists in a group of vehicles, it may order a recall and remedy campaign. However, NHTSA cannot become involved in individual problems between you, your dealer, or Ford Motor Company.

To contact NHTSA, you may call the Vehicle Safety Hotline toll-free at 1-888-327-4236 (TTY: 1-800-424-9153); go to [www.safercar.gov](http://www.safercar.gov); or write to:

Administrator

1200 New Jersey Avenue, Southeast  
Washington, D.C. 20590

You can also obtain other information about motor vehicle safety from [www.safercar.gov](http://www.safercar.gov).

# Customer Information

---

## REPORTING SAFETY DEFECTS IN CANADA

If you believe that your vehicle has a defect

which could cause a crash or could cause injury or death, you should immediately inform Transport Canada and Ford of Canada.

Transport Canada Contact Information	
Website (English)	<a href="http://tc.canada.ca/recalls">http://tc.canada.ca/recalls</a>
Website (French)	<a href="http://tc.canada.ca/rappels">http://tc.canada.ca/rappels</a>
Phone	1-800-333-0510

Lincoln of Canada Contact Information	
Website	<a href="http://www.LincolnCanada.com">www.LincolnCanada.com</a>
Phone	1-800-387-9333

# Customer Information

## DECLARATION OF CONFORMITY

### Radio Frequency Statement

SYNC Version	FCC Identification Number	IC Identification Number
SYNC 4	KMH-SYNCG4	1422A-SYNCG4
SYNC 4 Low	KMH-SYNCG4L	1422A-SYNCG4L



**WARNING:** Changes or modifications not expressly approved by the party responsible for compliance could void the user's authority to operate the equipment. The term "IC:" before the radio certification number only signifies that Industry Canada technical specifications were met.

These devices comply with Part 15 of the FCC Rules and with RSS-210 of Industry Canada. Operation is subject to the following two conditions:

1. The device does not cause harmful interference.
2. The device accepts any interference received, including interference that could cause undesired operation.



# Customer Information

---

## RADIO FREQUENCY CERTIFICATION LABELS

## BLIND SPOT INFORMATION SYSTEM SENSORS

**Argentina**



**Belarus**



**Brazil**



**Canada**

Short Range Radar Sensor SRR3-B

IC ID: 4135A-SRR3B

# Customer Information

---

This device contains licence-exempt transmitter(s)/receiver(s) that comply with Innovation, Science and Economic Development Canada's licence-exempt RSS(s). Operation is subject to the following two conditions:

1. This device may not cause interference.
2. This device must accept any interference, including interference that may cause undesired operation of the device.

Radiofrequency radiation exposure information:

This equipment complies with radiation exposure limits set forth for an uncontrolled environment. This equipment should be installed and operated with minimum distance of 8 in (20 cm) between the radiator and the body of any persons, user or bystander.

L'émetteur/récepteur exempt de licence contenu dans le présent appareil est conforme aux CNR d'Innovation, Sciences et Développement économique Canada applicables aux appareils radio exempts de licence. L'exploitation est autorisée aux deux conditions suivantes:

1. L'appareil ne doit pas produire de brouillage;
2. L'appareil doit accepter tout brouillage radioélectrique subi, même si le brouillage est susceptible d'en compromettre le fonctionnement.

Cet équipement est conforme aux limites d'exposition aux rayonnements établies pour un environnement non contrôlé. Cet équipement doit être installé et utilisé avec un minimum de 8 in (20 cm) de distance entre la source de rayonnement et votre corps.

# Customer Information

---

## Djibouti

AGREE PAR LE MCPT (REPUBLIQUE DE DJIBOUTI)  
Numéro d'agrément : 240/MCPT/SG/16  
Date d'agrément : 23/05/2016

## Ghana

NCA PRODUCT IDENTIFIER: 3R8-8M-7DF-231

## Malaysia



## European Union EU

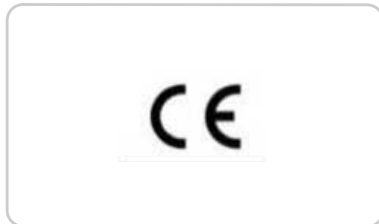

## Jamaica

This product has been Type Approved  
by Jamaica: SMA - SRR3-B.

RALM/24A/0715/S(15-2272)

# Customer Information

## Mauritania

AGREE PAR L'ANE MAURITANIE  
Numéro d'agrément : 0727/ARE/2018  
Date d'agrément : 10/12/2019

## Moldova



## Paraguay



## Mexico

IFETEL: RLVCSR15-0904

La operación de este equipo está sujeta a las siguientes dos condiciones:

- (1) es posible que este equipo o dispositivo no cause interferencia perjudicial y
- (2) este equipo o dispositivo debe aceptar cualquier interferencia, incluyendo la que pueda causar su operación no deseada.

## Pakistan



## Russia



# Customer Information

---

## Serbia



## South Africa



## Singapore

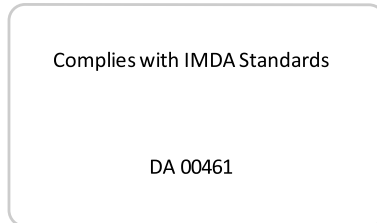

## South Korea



# Customer Information

---

## Taiwan, China

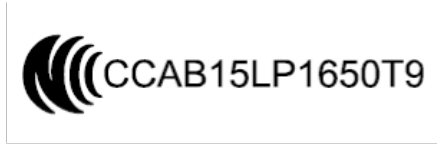

### 警語

經型式認證合格之低功率射頻電機，非經許可，公司、商號或使用者均不得擅自變更頻率、加大功率或變更原設計之特性及功能。

低功率射頻電機之使用不得影響飛航安全及干擾合法通信；經發現有干擾現象時，應立即停用，並改善至無干擾時方得繼續使用。

前項合法通信，指依電信法規定作業之無線電通信。低功率射頻電機須忍受合法通信或工業、科學及醫療用電波輻射性電機設備之干擾。

# Customer Information

---

## Ukraine



справжнім FIDC. Automotive Distance Control Systems GmbH заявляє, що тип радіобладнання SRR3 - В відповідає технічному регламенту радіобладнання;

повний текст декларації про відповідність доступний на веб-сайті за такою адресою :

<http://continental.automotive-approvals.com/>

# Customer Information

## United Arab Emirates (U.A.E.)

TRA  
REGISTERED No:  
ER62934

DEALER No:  
DA40068

This device complies with Part 15 of the FCC Rules. Operation is subject to the following two conditions:

1. This device may not cause harmful interference, and
2. This device must accept any interference received, including interference that may cause undesired operation.

### CAUTION TO USERS

Changes or modifications not expressly approved by the party responsible for compliance could void the user's authority to operate the equipment.

## Vietnam

Ford Viet Nam Limited  
A03846230815AF6AA2



## United Kingdom



## United States of America

FCC ID: OAYSRR3B

## Zambia





# Customer Information

## REMOTE FUNCTION ACTUATOR

### China

CMIIT ID: 2018DJ4563

### United States and Canada



**WARNING:** Changes or modifications not expressly approved by the party responsible for compliance could void the user's authority to operate the equipment. The term "IC:" before the radio certification number only signifies that Industry Canada technical specifications were met.

FCC ID: HYQS2NA0

IC: 1551A-S2NA0

This device complies with Part 15 of the FCC Rules and with Innovation, Science and Economic Development Canada's licence-exempt RSS(s). Operation is subject to the following two conditions:

1. This device may not cause harmful interference, and
2. This device must accept any interference received, including interference that may cause undesired operation.

## BODY CONTROL MODULE

### Argentina

**CNC** COMISIÓN NACIONAL  
DE COMUNICACIONES

CNC ID: H-20726

### Djibouti

AGREE PAR LE MCPT (REPUBLIQUE DE DJIBOUTI)  
Numéro d'agrément : 241/MCPT/SC/16  
Date d'agrément : 23/05/2016

### Ghana

NCA APPROVED: NCA/TA/16/23

# Customer Information

## Jamaica

This product has been Type Approved by  
Jamaica: SMA - M3NA2C738448.

## Mauritania

AGREE PAR L'ANE MAURITANIE  
Numéro d'agrément : 0262/ARE/2015  
Date d'agrément : 18/03/2015

## Morocco

AGREE PAR L'ANRT MAROC  
Numéro d'agrément: MR 8925 ANRT 2014  
Date d'agrément: 04/02/2014

## Paraguay



2018-08-I-000410

2013-08-I-0158

## Pakistan



# Customer Information

## South Africa



2013-07-03

## Syria

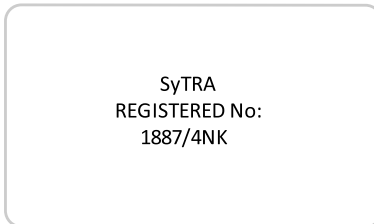

## Ukraine



## South Korea



## United States and Canada

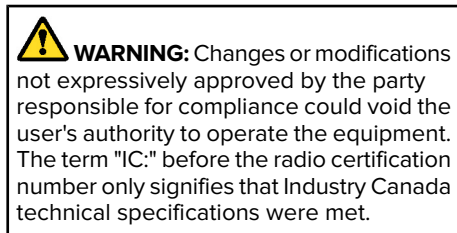

FCC ID: M3NA2C738448

IC: 7812A-A2C738448

# Customer Information

This device complies with Part 15 of the FCC Rules and with Innovation, Science and Economic Development Canada's licence-exempt RSS(s). Operation is subject to the following two conditions:

1. This device may not cause harmful interference, and
2. This device must accept any interference received, including interference that may cause undesired operation.

## Vietnam

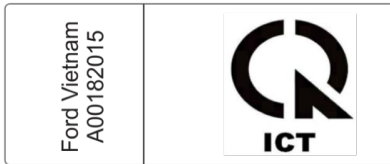

## Zambia



## CRUISE CONTROL MODULE (If Equipped)

## Argentina



## Brazil



# Customer Information

---

## Djibouti

AGREE PAR LE MCPT (REPUBLIQUE DE DJIBOUTI)  
Numéro d'agrément : 594/dpt/2017  
Date d'agrément : 09/04/2017

## Ghana

NCA PRODUCT IDENTIFIER: OR2-9H-7E1-x4D

## Indonesia

SERTIFIKAT NOMOR : 53104/SDPPI/2017  
PLG ID: 4927



## Jamaica

This product has been Type Approved  
by Jamaica: SMA - L2C0065TR.

## Malaysia



RALM/61A/0318/S(18-0852)

# Customer Information

## Mauritania

AGREE PAR L'ANE MAURITANIE  
Numéro d'agrément: 0409/ARE/2017  
Date d'agrément: 12/04/2017

## Morocco

AGREE PAR L'ANRT MAROC  
Numéro d'agrément: MR 13639 ARNT 2017  
Date d'agrément: 28/03/2017

## Paraguay



## Moldova



## Pakistan



## Serbia



# Customer Information

---

## Singapore

Complies with IMDA Standards  
DA105753

## South Korea



R-CMM-DLH-L2C0065TR

## Syria

SyTRA  
REGISTERED No:  
FR00085-17

## Taiwan, China

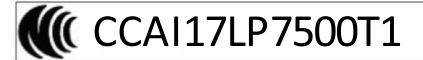

## South Africa



TA2017-1923

## Ukraine



# Customer Information

## United Arab Emirates



This device complies with Part 15 of the FCC Rules and with Innovation, Science and Economic Development Canada's licence-exempt RSS(s). Operation is subject to the following two conditions:

1. This device may not cause harmful interference, and
2. This device must accept any interference received, including interference that may cause undesired operation.

## Zambia

## United States and Canada

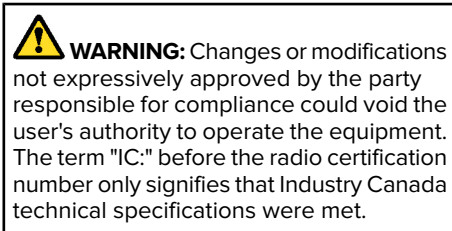

FCC ID: L2C0065TR

IC: 3432A-0065TR



## GARAGE DOOR OPENER

## United States and Canada

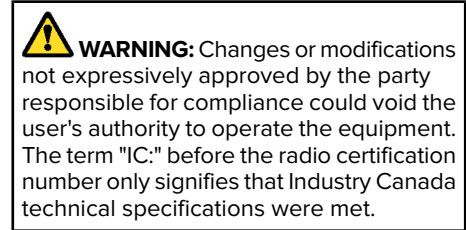

FCC ID: NZLSAHL5D

IC: 4112A-SAHL5D

This device complies with Part 15 of the FCC Rules and with Innovation, Science and Economic Development Canada's licence-exempt RSS(s). Operation is subject to the following two conditions:

1. This device may not cause harmful interference, and
2. This device must accept any interference received, including interference that may cause undesired operation.



# Customer Information

## KEYS AND REMOTE CONTROLS

### Argentina

**CNC: H-16366**

**CNC** COMISIÓN NACIONAL  
DE COMUNICACIONES

**CNC** COMISIÓN NACIONAL  
DE COMUNICACIONES

**CNC ID: H-22290**

### Brazil

 **ANATEL**  
Agência Nacional de Telecomunicações  
**02445-16-01821**

### Djibouti

AGREE PAR LE MCPT (REPUBLIQUE DE DJIBOUTI)  
Numéro d'agrément : 287/MCPT/SC/16  
Date d'agrément : 02/07/2016

### Ghana

NCA APPROVED: 2R9-8M-7E0-x94

### Jamaica

This product has been Type Approved by Jamaica: SMA – M3N-A2C931426

This product has been Type Approved  
by Jamaica: SMA – A2C97102000

# Customer Information

## Jordan

Type Approval No.: TRC/LPD/2016/143  
Equipment Type: Low Power Device (LPD)

## Moldova



## Paraguay



## Mauritania

AGREE PAR L'ANEMAURITANIE  
Numéro d'agrément : 0324/ARE/2016  
Date d'agrément : 07/03/2016

## Morocco

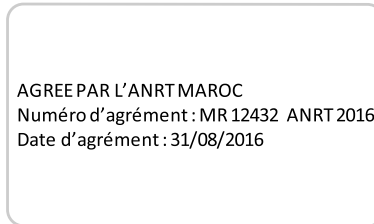

NR: 2016-9-I-000222

# Customer Information

---

## Serbia



## South Africa



MSIP-CRM-TAL-A2C97102000

## Ukraine



## Singapore

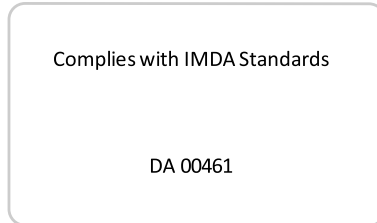

## South Korea



# Customer Information

## United Arab Emirates (U.A.E.)

TRA  
REGISTERED No: ER47690/16  
DEALER No: DA37380/15

This device complies with Part 15 of the FCC Rules and with Innovation, Science and Economic Development Canada's licence-exempt RSS(s). Operation is subject to the following two conditions:

1. This device may not cause harmful interference, and
2. This device must accept any interference received, including interference that may cause undesired operation.

## Zambia



## Vietnam

## United States and Canada

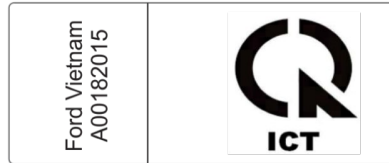
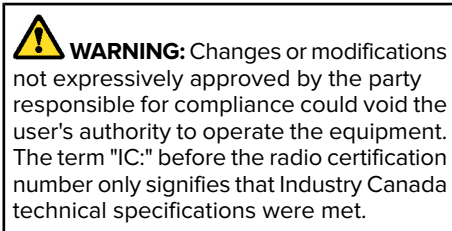

FCC ID: M3N-A2C931426

IC: 7812A-A2C931426

# Customer Information

## RADIO TRANSCEIVER MODULE

### Argentina



### Brazil



### Djibouti

AGREE PAR LE MCPT (REPUBLIQUE DE DJIBOUTI)  
Numéros d'agrément : 033/DDTIC/2020  
Date d'agrément : 07/06/2020

AGREE PAR LE MCPT (REPUBLIQUE DE DJIBOUTI)  
Numéros d'agrément : 034/DDTIC/2020  
Date d'agrément : 07/06/2020

### Ghana

NCA APPROVED: SRO-1M-7E4-108

NCA APPROVED: SRO-1M-7E4-114

### Mauritania

AGREE PAR L'ANE MAURITANIE  
Numéro d'agrément: 0803/ARE/2020  
Date d'agrément: 03/06/2020

AGREE PAR L'ANE MAURITANIE  
Numéro d'agrément : 0802/ARE/2020  
Date d'agrément : 03/06/2020

# Customer Information

## Moldova



## Pakistan



## South Africa



## Morocco

AGREE PAR L'ANE MAROC  
Numéro d'agrément : MR 24102 ANRT 2020  
Date d'agrément : 18/05/2020

## Serbia



## Taiwan, China

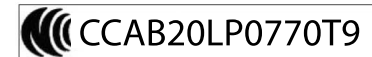

# Customer Information

## Ukraine



TRA  
REGISTERED No:  
ER81342/20

DEALER No:  
DA88113/20

This device complies with Part 15 of the FCC Rules and with Innovation, Science and Economic Development Canada's licence-exempt RSS(s). Operation is subject to the following two conditions:

1. This device may not cause harmful interference, and
2. This device must accept any interference received, including interference that may cause undesired operation.

## Zambia



## United Arab Emirates (U.A.E.)

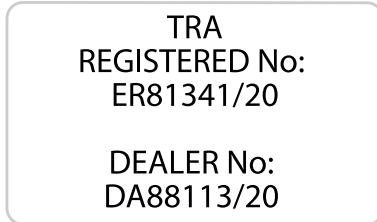

## United States and Canada

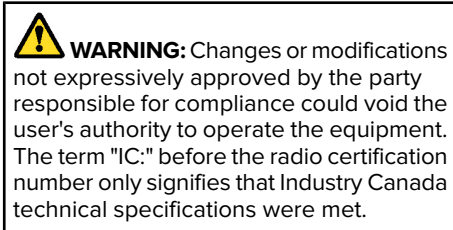

FCC ID: L2C0082R

FCC ID: L2C0083TR

IC: 342A-0083TR

# Customer Information

## SYNC

### Argentina

**CNC** COMISIÓN NACIONAL  
DE COMUNICACIONES

**CNC ID: C-24008**

**CNC** COMISIÓN NACIONAL  
DE COMUNICACIONES

**CNC ID: C-24009**

## Brazil



08657-19-01505

**Este equipamento não tem direito à proteção  
contra interferência prejudicial e não pode causar  
interferência em sistemas devidamente autorizados.**



08658-19-01505

**Este equipamento não tem direito à proteção  
contra interferência prejudicial e não pode causar  
interferência em sistemas devidamente autorizados.**

## Djibouti

AGREE PAR LE MCPT (REPUBLIQUE DE DJIBOUTI)

Numéro d'agrément : 124/DDTIC/2019

Date d'agrément : 07/08/2019

AGREE PAR LE MCPT (REPUBLIQUE DE DJIBOUTI)

Numéro d'agrément : 125/DDTIC/2019

Date d'agrément : 07/08/2019



# Customer Information

## European Union EU



## Ghana

NCA APPROVED: ZRO-1H-7E3-182

NCA APPROVED: ZRO-1H-7E3-180

## Jamaica

This product has been Type Approved by  
Jamaica: SMA – SYNC-G4.

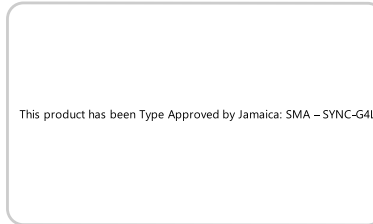

## Malaysia



SQASI/TA/19/4047

SQASI/TA/19/4046

## Mauritania

**AGREE PAR L'ANE MAURITANIE**  
**Numéro d'agrément : 0692/ARE/2018**  
**Date d'agrément : 08/08/2019**

# Customer Information

AGREE PAR L'ANEMAURITANIE  
Numéro d'agrément : 0691/ARE/2018  
Date d'agrément : 08/08/2019

## Morocco

AGREE PAR L'ANRT MAROC  
N° D'AGRÉMENT: MR 20608 ANRT 2019  
07 AOUT 2019

## Pakistan



## Moldova



AGREE PAR L'ANRT MAROC  
N° D'AGRÉMENT: MR 20606 ANRT 2019  
07 AOUT 2019

## Paraguay



# Customer Information

2020-03-I-00192

2020-03-I-00193

## Serbia



И005 20

## Singapore

Complies with IMDA Standards

DA 00461

## South Africa



## South Korea



MSIP-R-C-FDM-SYNCG4



MSIP-R-C-FDM-SYNCG4L



# Customer Information

## Taiwan



## Ukraine

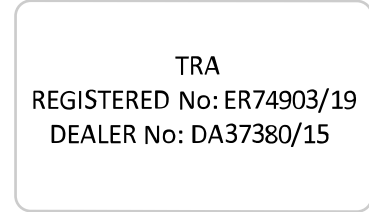

## United Arab Emirates (U.A.E.)

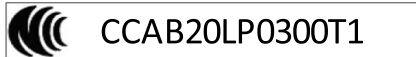

## United States and Canada

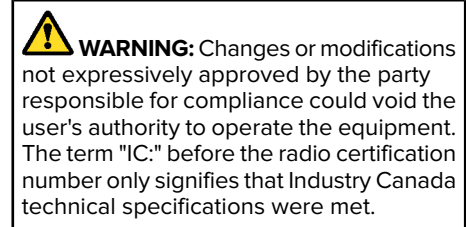

FCC ID: KMH-SYNCG4

FCC ID: KMH-SYNCG4L

IC: 1422A-SYNCG4

# Customer Information

IC: 1422A-SYNG4L

This device complies with Part 15 of the FCC Rules and with Innovation, Science and Economic Development Canada's licence-exempt RSS(s). Operation is subject to the following two conditions:

1. This device may not cause harmful interference, and
2. This device must accept any interference received, including interference that may cause undesired operation.

## Zambia



## TELEMATICS CONTROL UNIT

### Brazil



## Mexico



## United Arab Emirates (U.A.E.)

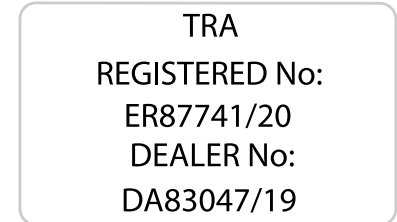

# Customer Information

## United Kingdom



## United States and Canada

 **WARNING:** Changes or modifications not expressly approved by the party responsible for compliance could void the user's authority to operate the equipment. The term "IC:" before the radio certification number only signifies that Industry Canada technical specifications were met.

FCC ID: KMH-14H074-NA1

IC: 1422A-14H074NA1

This device complies with Part 15 of the FCC Rules and with Innovation, Science and Economic Development Canada's licence-exempt RSS(s). Operation is subject to the following two conditions:

1. This device may not cause harmful interference, and
2. This device must accept any interference received, including interference that may cause undesired operation.

## South Africa



## TIRE PRESSURE MONITORING SYSTEM SENSORS - VEHICLES WITH: 315 MHZ SENSORS

## Argentina



# Customer Information

## Brazil



05160-16-08001

Este equipamento opera em caráter secundário, isto é, não tem direito a proteção contra interferência prejudicial, mesmo de estações do mesmo tipo, e não pode causar interferência a sistemas operando em caráter primário.



Agência Nacional de Telecomunicações

02109-14-08001

## Jamaica

This product has been Type Approved by Jamaica: SMA – FP3

This product has been Type Approved  
by Jamaica: SMA – AG2SZ3

## Mexico

IFT: RLVSCFP16-1400  
"La operación de este equipo está sujeta a las siguientes dos condiciones:  
(1) es posible que este  
equipo o dispositivo no cause interferencia perjudicial y  
(2) este equipo o dispositivo debe aceptar  
cualquier interferencia, incluyendo la que pueda causar  
su operación no deseada."

IFT: RLVSCFP15-1249

"La operación de este equipo está sujeta a las siguientes dos condiciones: (1) es posible que este equipo o dispositivo no cause interferencia perjudicial y (2) este equipo o dispositivo debe aceptar cualquier interferencia, incluyendo la que pueda causar su operación no deseada."

# Customer Information

## Paraguay



NR: 2014-07-1-000191

## Taiwan, China



CCAM14LP0460T0

本產品符合低功率電波輻射性電機管理辦法第十二條、第十四條等條文規定

1. 經型式認證合格之低功率射頻電機，非經許可，公司、商號或使用者均不得擅自變更頻率、加大功率或變更原設計之特性及功能。

2. 低功率射頻電機之使用不得影響飛航安全及干擾合法通信；經發現有干擾現象時，應立即停用，並改善至無干擾時方得繼續使用。

前項合法通信，指依電信法規定作業之無線電通信。

低功率射頻電機須忍受合法通信或工業、科學及醫療用電波輻射性電機設備之干擾。

## United States and Canada



**WARNING:** Changes or modifications not expressly approved by the party responsible for compliance could void the user's authority to operate the equipment. The term "IC:" before the radio certification number only signifies that Industry Canada technical specifications were met.

FCC ID: MRXFP3

FCC ID: MRXAG2SZ3

IC: 2546A-FP3

IC: 2546A-AG2SZ3

This device complies with Part 15 of the FCC Rules and with Innovation, Science and Economic Development Canada's licence-exempt RSS(s). Operation is subject to the following two conditions:

1. This device may not cause harmful interference, and
2. This device must accept any interference received, including interference that may cause undesired operation.



# Customer Information

## TIRE PRESSURE MONITORING SYSTEM SENSORS - VEHICLES WITH: 433 MHZ SENSORS

### Argentina

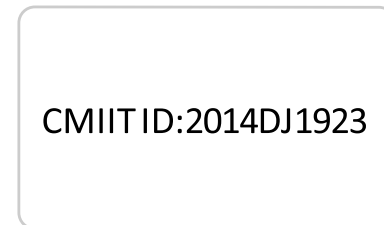

### China

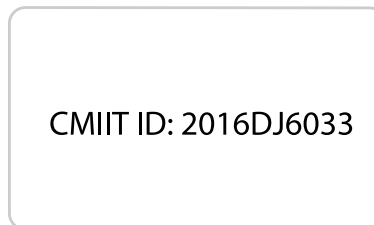

### Djibouti

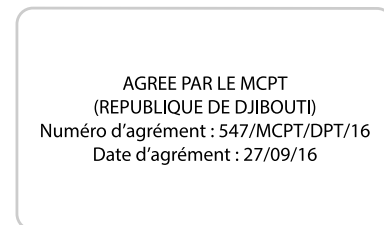

# Customer Information

## European Union (EU)

Hereby, Schrader Electronics Ltd declares that the radio equipment type AG2SZ4 is in compliance with Directive 2014/53/EU.  
The full text of the EU declaration of conformity is available at the following internet address:  
[http://www.schrader.com/ghana/documents/declaration\\_conformite](http://www.schrader.com/ghana/documents/declaration_conformite)  
F=433.92MHzP < 10mW (e.i.r.p)  
Schrader Electronics Ltd, 11 Technology Park, Belfast Road, Antrim BT41 1QS, Northern Ireland United Kingdom

NCA APPROVED: 3R88M14030

Kingdom of Jordan Type approval for tyre  
pressre sensor  
Model : AG2SZ4 Manufacturer: Schrader Electronics Ltd  
Type Approval Number:TRC/LPD/2014/56  
Equipment Type: Low Power Device (LPD)

## Ghana

NCA APPROVED: 2R9-8M-7E0-0BE

## Jordan

Model: FP4  
Manufacturer: Schrader Electronics Ltd  
Type Approval No: TRC/LPD/2017/360  
Equipment Type: Low Power Device (LPD)

## Malaysia



CIDF15000486

# Customer Information

## Mauritania

AGREE PAR L'ANE MAURITANIE  
Numéro d'agrément : 0358/ARE/2016  
Date d'agrément : 04/10/2016

AGREE PAR L'ANE MAURITANIE  
Numéro d'agrément : 0611/ARE/2019  
Date d'agrément : 11/01/2019

## Mexico

IFT: RLVSCMR15-1238  
"La operación de este equipo está sujeta a las siguientes dos condiciones:  
(1) es posible que este  
equipo o dispositivo no cause interferencia perjudicial y  
(2) este equipo o dispositivo debe aceptar  
cualquier interferencia, incluyendo la que pueda causar  
su operación no deseada."

## Moldova



## Morocco

AGREE PAR L'ANRT MAROC  
Numéro d'agrément: MR9098  
ANRT 2014  
Date d'agrément: 14/03/2014

# Customer Information

## Nigeria

Connection and use of this communications equipment is permitted by the Nigerian Communications Commission

## Pakistan

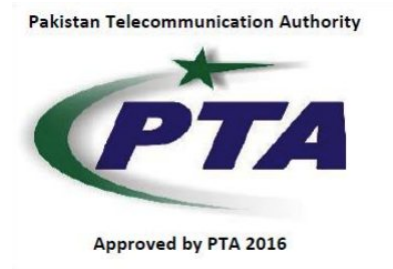

## Philippines



**NTC**

Type Approved

No:ESD-1408639C

## Oman

OMAN TRA  
TA-R/3591/16  
D080134

OMAN TRA  
TA-R/1752/14  
D090258

## Paraguay



## Russia



# Customer Information

---

## Serbia

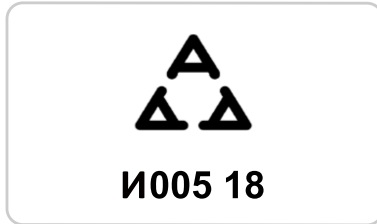

## Singapore

Complies with  
IMDA Standards  
DA 107968

Complies with  
IDA Standards  
DA 105282

## South Africa



TA-2014/064  
Approved

## South Korea



MSIP-CRM-SRD-FP4  
MSIP-CRM-SRD-AG2SZ4

# Customer Information

## Taiwan, China



TRA  
REGISTERED NO: ER0130238/14  
DEALER NO: DA0047074/10

## United Arab Emirates

## Ukraine



TRA  
REGISTERED No:  
ER48598/16

DEALER No.  
DA0047074

## United States and Canada

 **WARNING:** Changes or modifications not expressly approved by the party responsible for compliance could void the user's authority to operate the equipment. The term "IC:" before the radio certification number only signifies that Industry Canada technical specifications were met.

FCC ID: MRXAG2SZ4

IC: 2546A-AG2SZ4

# Customer Information

This device complies with Part 15 of the FCC Rules and with Innovation, Science and Economic Development Canada's licence-exempt RSS(s). Operation is subject to the following two conditions:

1. This device may not cause harmful interference, and
2. This device must accept any interference received, including interference that may cause undesired operation.

## WIRELESS ACCESSORY CHARGING MODULE (If Equipped)

### Argentina



### Brazil



### Djibouti



### European Union EU



### Ghana

NCA APPROVED: 1R3-1M-7E1-174

# Customer Information

## Jamaica

This product has been Type Approved  
by Jamaica: SMA - WACM.

## Jordan

Type Approval No: TRC/LPD/2017/418  
Equipment Type: Low Power Device (LPD)

## Malaysia



SQASI/TA/19/4129

## Mauritania

AGREE PAR L'ANE MAURITANIE  
Numéro d'agrément : 0474/ARE/2018  
Date d'agrément : 05/03/2018

## Moldova



## Morocco

AGREE PAR L'ANRT MAROC  
Numéro d'agrément : MR 15474 ANRT 2017  
Date d'agrément : 25/12/2017

## Paraguay





# Customer Information

2017-10-I-0000333

## Serbia



**W011 18**

## Singapore

Complies with IMDA Standards

DA 00461

## South Korea



R-RMM-DLH-WACM

## South Africa



## Taiwan, China



CCAH17LP1930T0

# Customer Information

## Ukraine



## United Arab Emirates (U.A.E.)

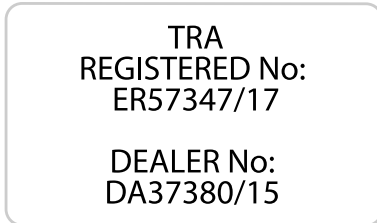

## United States and Canada

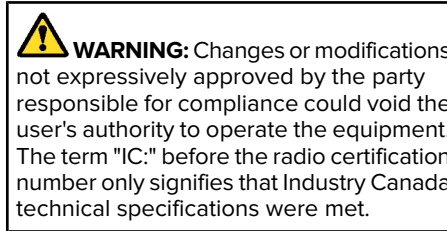

FCC ID: L2C0066T

This device complies with Part 15 of the FCC Rules and with Innovation, Science and Economic Development Canada's licence-exempt RSS(s). Operation is subject to the following two conditions:

1. This device may not cause harmful interference, and
2. This device must accept any interference received, including interference that may cause undesired operation.

## Vietnam



## Zambia



# Customer Information

---

## PERCHLORATE

Certain components in your vehicle such as airbag modules, seatbelt pretensioners and remote control batteries may contain perchlorate material. Special handling may apply for service or vehicle end of life disposal.

For more information visit:  
[www.dtsc.ca.gov/hazardouswaste/perchlorate](http://www.dtsc.ca.gov/hazardouswaste/perchlorate).

## REPLACEMENT PARTS RECOMMENDATION

We have built your vehicle to the highest standards using quality parts. We recommend that you demand the use of genuine Ford and Motorcraft parts whenever your vehicle requires scheduled maintenance or repair. You can clearly identify genuine Ford and Motorcraft parts by looking for the Ford, FoMoCo or Motorcraft branding on the parts or their packaging.

## Scheduled Maintenance and Mechanical Repairs

One of the best ways for you to make sure that your vehicle provides years of service is to have it maintained in line with our recommendations using parts that conform to the specifications detailed in this Owner's Manual.

Genuine Ford and Motorcraft parts meet or exceed these specifications.

## Collision Repairs

We hope that you never experience a collision, but accidents happen sometimes.

Genuine Ford replacement collision parts meet our stringent requirements for fit, finish, structural integrity, corrosion protection and dent resistance. During vehicle development we validate that these parts deliver the intended level of protection as a whole system. A great way to know for sure you are getting this level of protection is to use genuine Ford replacement collision parts.

## Warranty on Replacement Parts

Genuine Ford and Motorcraft replacement parts are the only replacement parts that benefit from a Ford Warranty.

The Ford Warranty may not cover damage caused to your vehicle as a result of failed non-Ford parts.

For additional information, refer to the terms and conditions of the Ford Warranty.

## MOBILE COMMUNICATIONS EQUIPMENT



**WARNING:** Driving while distracted can result in loss of vehicle control, crash and injury. We strongly recommend that you use extreme caution when using any device that may take your focus off the road. Your primary responsibility is the safe operation of your vehicle. We recommend

# Customer Information

against the use of any hand-held device while driving and encourage the use of voice-operated systems when possible. Make sure you are aware of all applicable local laws that may affect the use of electronic devices while driving.

Using mobile communications equipment is becoming increasingly important in the conduct of business and personal affairs. However, you must not compromise your own or others' safety when using such equipment. Mobile communications can enhance personal safety and security when appropriately used, particularly in emergency situations. Safety must be paramount when using mobile communications equipment to avoid negating these benefits. Mobile communication equipment includes, but is not limited to, cellular phones, pagers, portable email devices, text messaging devices and portable two-way radios.

## END USER LICENSE AGREEMENT

### VEHICLE SOFTWARE END USER LICENSE AGREEMENT (EULA)

- You ("You" or "Your" as applicable) have acquired a vehicle having several devices, including SYNC<sup>®</sup> and various control modules, ("DEVICES") that include software licensed or owned by Ford Motor Company and its affiliates ("FORD MOTOR COMPANY"). Those software products of FORD MOTOR COMPANY origin, as well as associated media, printed materials, and "online" or electronic documentation ("SOFTWARE") are protected by international intellectual property laws and treaties. The SOFTWARE is licensed, not sold. All rights reserved.
- The SOFTWARE may interface with and/or communicate with, or may be later upgraded to interface with and/or communicate with additional software and/or systems provided by FORD MOTOR COMPANY.

**IF YOU DO NOT AGREE TO THIS END USER LICENSE AGREEMENT ("EULA") DO NOT USE THE DEVICES OR COPY THE SOFTWARE. ANY USE OF THE SOFTWARE, INCLUDING BUT NOT LIMITED TO USE ON THE DEVICES, WILL CONSTITUTE YOUR AGREEMENT TO THIS EULA (OR RATIFICATION OF ANY PREVIOUS CONSENT).**

**GRANT OF SOFTWARE LICENSE:** This EULA grants you the following license:

- You may use the SOFTWARE as installed on the DEVICES and as otherwise interfacing with systems and/or services provide by or through FORD MOTOR COMPANY or its third party software and service providers.

### **Description of Other Rights and Limitations.**

- **Speech Recognition:** If the SOFTWARE includes speech recognition component(s), you should understand that speech recognition is an inherently statistical process and that recognition errors are inherent in the process. Neither FORD MOTOR COMPANY nor

## Customer Information

---

its suppliers shall be liable for any damages arising out of errors in the speech recognition process. It is your responsibility to monitor any speech recognition functions included in the system.

- **Limitations on Reverse Engineering, Decompilation and Disassembly:** You may not reverse engineer, decompile, translate, disassemble or attempt to discover any source code or underlying ideas or algorithms of the SOFTWARE nor permit others to reverse engineer, decompile or disassemble the SOFTWARE, except and only to the extent that such activity is expressly permitted by applicable law notwithstanding this limitation or to the extent as may be permitted by the licensing terms governing use of any open source components included with the SOFTWARE.
- **Limitations on Distributing, Copying, Modifying and Creating Derivative Works:** You may not distribute, copy, make modifications to or create derivative works based on the SOFTWARE, except and only to the extent that such activity is expressly permitted by applicable law notwithstanding this limitation or to the extent as may be permitted by the licensing terms governing use of any open source components included with the SOFTWARE.
- **Single EULA:** The end user documentation for the DEVICES and related systems and services may contain multiple EULAs, such as multiple translations and/or multiple media versions (e.g., in the user documentation and in the software). Even if you receive multiple EULAs, you are licensed to use only one (1) copy of the SOFTWARE.
- **SOFTWARE Transfer:** You may permanently transfer your rights under this EULA only as part of a sale or transfer of the DEVICES, provided you retain no copies, you transfer all of the SOFTWARE (including all component parts, the media and printed materials, any upgrades, and, if applicable, the Certificate(s) of Authenticity), and the recipient agrees to the terms of this EULA. If the SOFTWARE is an upgrade, any transfer must include all prior versions of the SOFTWARE.
- **Termination:** Without prejudice to any other rights, FORD MOTOR COMPANY may terminate this EULA if you fail to comply with the terms and conditions of this EULA.
- **Internet-Based Services Components:** The SOFTWARE may contain components that enable and facilitate the use of certain Internet-based services. You acknowledge and agree that FORD MOTOR COMPANY, third party software and service suppliers, its affiliates and/or its designated agent may

# Customer Information

---

automatically check the version of the SOFTWARE and/or its components that you are utilizing and may provide upgrades or supplements to the SOFTWARE that may be automatically downloaded to your DEVICES.

- **Additional Software/Services:** The SOFTWARE may permit FORD MOTOR COMPANY, third party software and service suppliers, its affiliates and/or its designated agent to provide or make available to you SOFTWARE updates, supplements, add-on components, or Internet-based services components of the SOFTWARE after the date you obtain your initial copy of the SOFTWARE ("Supplemental Components".) SOFTWARE updates may cause you to incur additional charges from your wireless service provider. If FORD MOTOR COMPANY or third party software and services suppliers provide or make available to you Supplemental Components and no other EULA terms are provided along with the Supplemental Components, then the terms of this EULA shall apply. FORD

MOTOR COMPANY, its affiliates and/or its designated agent reserve the right to discontinue without liability any Internet-based services provided to you or made available to you through the use of the SOFTWARE.

# Customer Information

---

- **Links to Third Party Sites:** The SOFTWARE may provide you with the ability to link to third party sites. The third party sites are not under the control of FORD MOTOR COMPANY, its affiliates and/or its designated agent. Neither FORD MOTOR COMPANY nor its affiliates nor its designated agent are responsible for (i) the contents of any third party sites, any links contained in third party sites, or any changes or updates to third party sites, or (ii) webcasting or any other form of transmission received from any third party sites. If the SOFTWARE provides links to third party sites, those links are provided to you only as a convenience, and the inclusion of any link does not imply an endorsement of the third party site by FORD MOTOR COMPANY, its affiliates and/or its designated agent.
- **Obligation to Drive Responsibly:** You recognize your obligation to drive responsibly and keep attention on the road. You will read and abide with the DEVICES operating instructions particularly as they pertain to safety and you agree to assume any risk associated

with the use of the DEVICES.

**UPGRADES AND RECOVERY MEDIA:** If the SOFTWARE is provided by FORD MOTOR COMPANY separate from the DEVICES on media such as a ROM chip, CD ROM disk(s) or via web download or other means, and is labeled "For Upgrade Purposes Only" or "For Recovery Purposes Only" you may install one (1) copy of such SOFTWARE onto the DEVICES as a replacement copy for the existing SOFTWARE, and use it in accordance with this EULA, including any additional EULA terms accompanying the upgrade SOFTWARE.

**INTELLECTUAL PROPERTY RIGHTS:** All title and intellectual property rights in and to the SOFTWARE (including but not limited to any images, photographs, animations, video, audio, music, text and "applets" incorporated into the SOFTWARE), the accompanying printed materials, and any copies of the SOFTWARE, are owned by FORD MOTOR COMPANY, or its affiliates or suppliers. The SOFTWARE is licensed, not sold. You may not copy the printed materials accompanying the SOFTWARE. All title and intellectual property rights in and to the content which

may be accessed through use of the SOFTWARE is the property of the respective content owner and may be protected by applicable copyright or other intellectual property laws and treaties. This EULA grants you no rights to use such content outside its intended use. All rights not specifically granted under this EULA are reserved by FORD MOTOR COMPANY, its affiliates, and third party software and service providers and suppliers. Use of any on-line services which may be accessed through the SOFTWARE may be governed by the respective terms of use relating to such services. If this SOFTWARE contains documentation that is provided only in electronic form, you may print one copy of such electronic documentation.

# Customer Information

---

**EXPORT RESTRICTIONS:** You acknowledge that the SOFTWARE is subject to U.S. and European Union export jurisdiction. You agree to comply with all applicable international and national laws that apply to the SOFTWARE, including the U.S. Export Administration Regulations, as well as end-user, end-use and destination restrictions issued by U.S. and other governments.

**TRADEMARKS:** This EULA does not grant you any rights in connection with any trademarks or service marks of FORD MOTOR COMPANY, its affiliates, and third party software and service providers.

**PRODUCT SUPPORT:** Please refer to FORD MOTOR COMPANY instructions provided in the documentation for the DEVICES product support, such as the vehicle owner guide.

Should you have any questions concerning this EULA, or if you desire to contact FORD MOTOR COMPANY for any other reason, please refer to the address provided in the documentation for the DEVICES.

**No Liability for Certain Damages:** EXCEPT AS PROHIBITED BY LAW, FORD MOTOR COMPANY, ANY THIRD PARTY SOFTWARE OR SERVICES SUPPLIERS, AND THEIR AFFILIATES SHALL HAVE NO LIABILITY FOR ANY INDIRECT, SPECIAL, CONSEQUENTIAL OR INCIDENTAL DAMAGES ARISING FROM OR IN CONNECTION WITH THE USE OR PERFORMANCE OF THE SOFTWARE. THIS LIMITATION SHALL APPLY EVEN IF ANY REMEDY FAILS OF ITS ESSENTIAL PURPOSE. THERE ARE NO WARRANTIES OTHER THAN THOSE THAT MAY BE EXPRESSLY PROVIDED FOR YOUR NEW VEHICLE.

**SYNC® Automotive Important Safety Information Read and follow instructions:**

- Before using your SYNC® system, read and follow all instructions and safety information provided in this end user manual ("Owner Guide.") Not following precautions found in the Owner Guide can lead to an accident or other serious injuries.

General Operation

- **Voice Command Control:** Certain functions within the SYNC® system may be accomplished using voice commands. Using voice commands while driving helps you to operate the system without removing your hands from the wheel or eyes from the road.
- **Prolonged Views of Screen:** Do not access any function requiring a prolonged view of the screen while you are driving. Pull over in a safe and legal manner before attempting to access a function of the system requiring prolonged attention.
- **Volume Setting:** Do not raise the volume excessively. Keep the volume at a level where you can still hear outside traffic and emergency signals while driving. Driving while unable to hear these sounds could cause an accident.



# Customer Information

---

- **Navigation Features:** Any navigation features included in the system are intended to provide turn by turn instructions to get you to a desired destination. Please make certain all persons using this system carefully read and follow instructions and safety information fully.
- **Distraction Hazard:** Any navigation features may require manual (non-verbal) setup. Attempting to perform such set-up or insert data while driving can distract your attention and could cause an accident or other serious injury. Stop the vehicle in a safe and legal manner before attempting these operations.
- **Let Your Judgment Prevail:** Any navigation features are provided only as an aid. Make your driving decisions based on your observations of local conditions and existing traffic regulations. Any such feature is not a substitute for your personal judgment. Any route suggestions made by this system should never replace any local traffic regulations or your personal judgment or knowledge of safe driving practices.
- **Route Safety:** Do not follow the route suggestions if doing so would result in an unsafe or illegal maneuver, if you would be placed in an unsafe situation, or if you would be directed into an area that you consider unsafe. The driver is ultimately responsible for the safe operation of the vehicle and therefore, must evaluate whether it is safe to follow the suggested directions.
- **Potential Map Inaccuracy:** Maps used by this system may be inaccurate because of changes in roads, traffic controls or driving conditions. Always use good judgment and common sense when following the suggested routes.
- **Emergency Services:** Do not rely on any navigation features included in the system to route you to emergency services. Ask local authorities or an emergency services operator for these locations. Not all emergency services such as police, fire stations, hospitals and clinics are likely to be contained in the map database for such navigation features.

# Customer Information

---

Your Responsibilities and Assumptions of  
Risk

## Customer Information

---

- You agree to each of the following:(a) Any use of the SOFTWARE while driving an automobile or other vehicle in violation of applicable law or otherwise driving in an unsafe manner presents a significant risk of distracted driving and should not be attempted under any circumstances;(b) Use of the SOFTWARE at excessive volume poses a significant risk of hearing damage and should not be attempted under any circumstances;(c) The SOFTWARE may not be compatible with new or different versions of an operating system, third party software, or third party services, and the SOFTWARE may potentially cause a critical failure of an operating system, third party software, or third party service.(d) Any third party service accessed by or third party software used with the SOFTWARE (l) may charge an additional fee for access, (ii) may not work correctly, on an uninterrupted basis, or error free, (iii) may change streaming formats or discontinue operation, (iv) may contain adult, profane or offensive content; and (v) may contain inaccurate, false or misleading traffic, weather,

financial or safety information or other content; and (e) Use of the SOFTWARE may cause you to incur additional charges from your wireless service provider (WSP) and any data or minute calculators that may be included in the software program are for reference only, are not warranted in any way and should not be relied upon in anyway.

- When using the SOFTWARE, you agree to be responsible for and assume the entire risk to the items set forth in Section (a) – (e) above.

### **Disclaimer of Warranty**

YOU EXPRESSLY ACKNOWLEDGE AND AGREE THAT USE OF THE DEVICES AND SOFTWARE IS AT YOUR SOLE RISK AND THAT THE ENTIRE RISK AS TO SATISFACTORY QUALITY, PERFORMANCE, COMPATIBILITY, ACCURACY AND EFFORT IS WITH YOU. TO THE MAXIMUM EXTENT PERMITTED BY APPLICABLE LAW, THE SOFTWARE AND ANY THIRD PARTY SOFTWARE OR THIRD-PARTY SERVICES ARE PROVIDED "AS IS" AND "AS AVAILABLE", WITH ALL FAULTS AND

WITHOUT WARRANTY OF ANY KIND, AND FORD MOTOR COMPANY HEREBY DISCLAIMS ALL WARRANTIES AND CONDITIONS WITH RESPECT TO THE SOFTWARE, THIRD PARTY SOFTWARE, AND THIRD-PARTY SERVICES, EITHER EXPRESS, IMPLIED OR STATUTORY, INCLUDING, BUT NOT LIMITED TO, THE IMPLIED WARRANTIES AND/OR CONDITIONS OF MERCHANTABILITY, OF SATISFACTORY QUALITY, OF FITNESS FOR AN ARTICULAR PURPOSE, OF ACCURACY, OF QUIET ENJOYMENT, AND NON-INFRINGEMENT OF THIRD-PARTY RIGHTS. FORD MOTOR COMPANY DOES NOT WARRANT (a) AGAINST INTERFERENCE WITH YOUR ENJOYMENT OF THE SOFTWARE, THIRD PARTY SOFTWARE, OR THIRD-PARTY SERVICES, (b) THAT THE SOFTWARE, THIRD PARTY SOFTWARE, OR THIRD-PARTY SERVICES WILL MEET YOUR REQUIREMENTS, (c) THAT THE OPERATION OF THE SOFTWARE, THIRD PARTY SOFTWARE, OR THIRD-PARTY SERVICES WILL BE UNINTERRUPTED OR ERROR-FREE, (d) OR THAT DEFECTS IN THE SOFTWARE, THIRD PARTY SOFTWARE, OR THIRD-PARTY SERVICES WILL BE CORRECTED. NO ORAL

# Customer Information

---

OR WRITTEN INFORMATION OR ADVICE GIVEN BY FORD MOTOR COMPANY OR ITS AUTHORIZED REPRESENTATIVE SHALL CREATE A WARRANTY. SHOULD THE SOFTWARE, THIRD PARTY SOFTWARE, OR THIRD-PARTY SERVICES PROVE DEFECTIVE, YOU ASSUME THE ENTIRE COST OF ALL NECESSARY SERVICING, REPAIR OR CORRECTION. SOME JURISDICTIONS DO NOT ALLOW THE DISCLAIMER OF IMPLIED WARRANTIES OR LIMITATIONS ON APPLICABLE STATUTORY RIGHTS OF A CONSUMER, SO THE ABOVE DISCLAIMER MAY NOT FULLY APPLY TO YOU. THE SOLE WARRANTY PROVIDED BY FORD MOTOR COMPANY SHALL BE FOUND IN THE WARRANTY INFORMATION INCLUDING WITH YOUR OWNER GUIDE. TO THE EXTENT THAT THERE IS ANY CONFLICT BETWEEN THE TERMS OF THIS SECTION AND THE WARRANTY BOOKLET, THE WARRANTY BOOKLET SHALL CONTROL.

## **Applicable Law, Venue, Jurisdiction**

- The laws of the State of Michigan govern this EULA and Your use of the SOFTWARE. Your use of the SOFTWARE may also be subject to other local, state, national, or international laws. Any litigation arising out of or related to this EULA shall be brought and maintained exclusively in a court of the State of Michigan located in Wayne County or in the United States District Court for the Eastern District of Michigan. You hereby consent to submit to the personal jurisdiction of a court in the State of Michigan located in Wayne County and the United States District Court for the Eastern District of Michigan for any dispute arising out of or relating to this EULA.

## **Binding Arbitration and Class Action Waiver**

**(a) Application.** This Section applies to any dispute EXCEPT IT DOES NOT INCLUDE A DISPUTE RELATING TO COPYRIGHT INFRINGEMENT, OR TO THE ENFORCEMENT OR VALIDITY OF YOUR, FORD MOTOR COMPANY, OR ANY OF

FORD MOTOR COMPANY'S LICENSORS' INTELLECTUAL PROPERTY RIGHTS. Dispute means any dispute, action, or other controversy between You and FORD MOTOR COMPANY, other than the exceptions listed above, concerning the SOFTWARE (including its price) or this EULA, whether in contract, warranty, tort, statute, regulation, ordinance, or any other legal or equitable basis.

**(b) Notice of Dispute.** In the event of a Dispute, You or FORD MOTOR COMPANY must give the other a "Notice of Dispute", which is a written statement of the name, address, and contact information of the party giving it, the facts giving rise to the dispute, and the relief requested. You and FORD MOTOR COMPANY will attempt to resolve any dispute through informal negotiation within 60 days from the date the Notice of Dispute is sent. After 60 days, You or FORD MOTOR COMPANY may commence arbitration.

## Customer Information

---

**(c) Small claims court.** You may also litigate any dispute in small claims court in your county of residence or FORD MOTOR COMPANY'S principal place of business, if the dispute meets all requirements to be heard in the small claims court. You may litigate in small claims court whether or not You negotiated informally first.

**(d) Binding arbitration.** If You and FORD MOTOR COMPANY, do not resolve any dispute by informal negotiation or in small claims court, any other effort to resolve the dispute will be conducted exclusively by binding arbitration. You are giving up the right to litigate (or participate in as a party or class member) all disputes in court before a judge or jury. Instead, all disputes will be resolved before a neutral arbitrator, whose decision will be final except for a limited right of appeal under the Federal Arbitration Act. Any court with jurisdiction over the parties may enforce the arbitrator's award.

**(e) Class action waiver.** Any proceedings to resolve or litigate any dispute in any forum will be conducted solely on an individual basis. Neither you nor FORD MOTOR COMPANY, will seek to have any dispute heard as a class action, as a private attorney general action, or in any other proceeding in which any party acts or proposes to act in a representative capacity. No arbitration or proceeding will be combined with another without the prior written consent of all parties to all affected arbitrations or proceedings.

**(f) Arbitration procedure.** Any arbitration will be conducted by the American Arbitration Association (the "AAA"), under its Commercial Arbitration Rules. If You are an individual and use the SOFTWARE for personal or vehicle use, or if the value of the dispute is \$75,000 or less whether or not You are an individual or how You use the SOFTWARE, the AAA Supplementary Procedures for Consumer-Related Disputes will also apply. To commence arbitration, submit a Commercial Arbitration Rules Demand for Arbitration form to the AAA. You may request a telephonic or in-person hearing by following the AAA rules. In a

dispute involving \$10,000 or less, any hearing will be telephonic unless the arbitrator finds good cause to hold an in-person hearing instead. For more information, see [adr.org](http://adr.org) or call 1-800-778-7879. You agree to commence arbitration only in your county of residence or FORD MOTOR COMPANY'S principal place of business. The arbitrator may award the same damages to you individually as a court could. The arbitrator may award declaratory or injunctive relief only to you individually, and only to the extent required to satisfy your individual claim.

**(g) Arbitration fees and incentives.**

- I. Disputes involving \$75,000 or less. FORD MOTOR COMPANY will promptly reimburse your filing fees and pay the AAA's and arbitrator's fees and expenses. If you reject FORD MOTOR COMPANY'S last written settlement offer made before the arbitrator was appointed ("last written offer"), your dispute goes all the way to an arbitrator's decision (called an "award"), and the arbitrator awards you more than the last written offer, FORD MOTOR COMPANY will give

# Customer Information

---

you three incentives: (1) pay the greater of the award or \$1,000; (2) pay twice your reasonable attorney's fees, if any; and (3) reimburse any expenses (including expert witness fees and costs) that your attorney reasonably accrues for investigating, preparing, and pursuing your claim in arbitration. The arbitrator will determine the amounts.

- ii. Disputes involving more than \$75,000. The AAA rules will govern payment of filing fees and the AAA's and arbitrator's fees and expenses.
- iii. Disputes involving any amount. In any arbitration you commence, FORD MOTOR COMPANY will seek its AAA or arbitrator's fees and expenses, or Your filing fees it reimbursed, only if the arbitrator finds the arbitration frivolous or brought for an improper purpose. In any arbitration FORD MOTOR COMPANY commences, it will pay all filing, AAA, and arbitrator's fees and expenses. It will not seek its attorney's fees or expenses from you in any arbitration. Fees and expenses are not counted in determining how much a dispute involves.

**(h) Claims or disputes must be filed within one year.** To the extent permitted by law, any claim or dispute under this EULA to which this Section applies must be filed within one year in small claims court (Section c) or in arbitration (Section d). The one-year period begins when the claim or dispute first could be filed. If such a claim or dispute is not filed within one year, it is permanently barred.

**(l) Severability.** If the class action waiver (Section e) is found to be illegal or unenforceable as to all or some parts of a dispute, then that portion of Section e will not apply to those parts. Instead, those parts will be severed and proceed in a court of law, with the remaining parts proceeding in arbitration. If any other provision of that portion Section e is found to be illegal or unenforceable, that provision will be severed with the remainder of Section e remaining in full force and effect.

## **Telenav Software End User License Agreement**

Please read these terms and conditions carefully before you use the TeleNav Software. Your use of the TeleNav Software indicates that you accept these terms and conditions. If you do not accept these terms and conditions, do not break the seal of the package, launch, or otherwise use the TeleNav Software. TeleNav may revise this Agreement and the privacy policy at any time, with or without notice to you. You agree to visit <http://www.telenav.com> from time to time to review the then current version of this Agreement and of the privacy policy.

### **1. Safe and Lawful Use**

You acknowledge that devoting attention to the TeleNav Software may pose a risk of injury or death to you and others in situations that otherwise require your undivided attention, and you therefore agree to comply with the following when using the TeleNav Software:

- (a) observe all traffic laws and otherwise drive safely;

# Customer Information

---

(b) use your own personal judgment while driving. If you feel that a route suggested by the TeleNav Software instructs you to perform an unsafe or illegal maneuver, places you in an unsafe situation, or directs you into an area that you consider to be unsafe, do not follow such instructions;

(c) do not input destinations, or otherwise manipulate the TeleNav Software, unless your vehicle is stationary and parked;

(d) do not use the TeleNav Software for any illegal, unauthorized, unintended, unsafe, hazardous, or unlawful purposes, or in any manner inconsistent with this Agreement;

(e) arrange all GPS and wireless devices and cables necessary for use of the TeleNav Software in a secure manner in your vehicle so that they will not interfere with your driving and will not prevent the operation of any safety device (such as an airbag).

You agree to indemnify and hold TeleNav harmless against all claims resulting from any dangerous or otherwise inappropriate use of the TeleNav Software in any moving vehicle, including as a result of your failure to comply with the directions above.

## 2. Account Information

You agree: (a) when registering the TeleNav Software, to provide TeleNav with true, accurate, current, and complete information about yourself, and (b) to inform TeleNav promptly of any changes to such information, and to keep it true, accurate, current and complete.

## 3. Software License

- Subject to your compliance with the terms of this Agreement, TeleNav hereby grants to you a personal, non-exclusive, non-transferable license (except as expressly permitted below in connection with your permanent transfer of the TeleNav Software license), without the right to sublicense, to use the TeleNav Software (in object code form only) in order to access and use the TeleNav Software. This license shall terminate upon any termination or expiration of this Agreement. You agree that you will use the TeleNav Software only for your personal business or leisure purposes, and not to provide commercial navigation services to other parties.

## 3.1 License Limitations

- **(a)** reverse engineer, decompile, disassemble, translate, modify, alter or otherwise change the TeleNav Software or any part thereof; **(b)** attempt to derive the source code, audio library or structure of the TeleNav Software without the prior express written consent of TeleNav; **(c)** remove from the TeleNav Software, or alter, any of TeleNav's or its suppliers' trademarks, trade names, logos, patent or copyright notices, or other notices or markings; **(d)** distribute, sublicense or otherwise transfer the TeleNav Software to others, except as part of your permanent transfer of the TeleNav Software; or **(e)** use the TeleNav Software in any manner that
  - i. infringes the intellectual property or proprietary rights, rights of publicity or privacy or other rights of any party,
  - ii. violates any law, statute, ordinance or regulation, including but not limited to laws and regulations related to spamming, privacy, consumer and child protection, obscenity or defamation, or

# Customer Information

---

iii. is harmful, threatening, abusive, harassing, tortuous, defamatory, vulgar, obscene, libelous, or otherwise objectionable; and (f) lease, rent out, or otherwise permit unauthorized access by third parties to the TeleNav Software without advanced written permission of TeleNav.

## 4. Disclaimers

- To the fullest extent permissible pursuant to applicable law, in no event will TeleNav, its licensors and suppliers, or agents or employees of any of the foregoing, be liable for any decision made or action taken by you or anyone else in reliance on the information provided by the TeleNav Software. TeleNav also does not warrant the accuracy of the map or other data used for the TeleNav Software. Such data may not always reflect reality due to, among other things, road closures, construction, weather, new roads and other changing conditions. You are responsible for the entire risk arising out of your use of the TeleNav Software. For example but without limitation, you agree not to rely

on the TeleNav Software for critical navigation in areas where the well-being or survival of you or others is dependent on the accuracy of navigation, as the maps or functionality of the TeleNav Software are not intended to support such high risk applications, especially in more remote geographical areas.

- TELENAV EXPRESSLY DISCLAIMS AND EXCLUDES ALL WARRANTIES IN CONNECTION WITH THE TELENAV SOFTWARE, WHETHER STATUTORY, EXPRESS OR IMPLIED, INCLUDING ALL WARRANTIES WHICH MAY ARISE FROM COURSE OF DEALING, CUSTOM OR TRADE AND INCLUDING, BUT NOT LIMITED TO, THE IMPLIED WARRANTIES OF MERCHANTABILITY, FITNESS FOR A PARTICULAR PURPOSE AND NON-INFRINGEMENT OF THIRD PARTY RIGHTS WITH RESPECT TO THE TELENAV SOFTWARE.
- Certain jurisdictions do not permit the disclaimer of certain warranties, so this limitation may not apply to you.

## 5. Limitation of Liability

- TO THE EXTENT PERMITTED UNDER APPLICABLE LAW, UNDER NO CIRCUMSTANCES SHALL TELENAV OR ITS LICENSORS AND SUPPLIERS BE LIABLE TO YOU OR TO ANY THIRD PARTY FOR ANY INDIRECT, INCIDENTAL, CONSEQUENTIAL, SPECIAL OR EXEMPLARY DAMAGES (INCLUDING IN EACH CASE, BUT NOT LIMITED TO, DAMAGES FOR THE INABILITY TO USE THE EQUIPMENT OR ACCESS DATA, LOSS OF DATA, LOSS OF BUSINESS, LOSS OF PROFITS, BUSINESS INTERRUPTION OR THE LIKE) ARISING OUT OF THE USE OF OR INABILITY TO USE THE TELENAV SOFTWARE, EVEN IF TELENAV HAS BEEN ADVISED OF THE POSSIBILITY OF SUCH DAMAGES. NOTWITHSTANDING ANY DAMAGES THAT YOU MIGHT INCUR FOR ANY REASON WHATSOEVER (INCLUDING, WITHOUT LIMITATION, ALL DAMAGES REFERENCED HEREIN AND ALL DIRECT OR GENERAL DAMAGES IN CONTRACT, TORT (INCLUDING NEGLIGENCE) OR



# Customer Information

---

OTHERWISE), THE ENTIRE LIABILITY OF TELENAV AND OF ALL OF TELENAV'S SUPPLIERS SHALL BE LIMITED TO THE AMOUNT ACTUALLY PAID BY YOU FOR THE TELENAV SOFTWARE. SOME STATES AND/OR JURISDICTIONS DO NOT ALLOW THE EXCLUSION OR LIMITATION OF INCIDENTAL OR CONSEQUENTIAL DAMAGES, SO THE ABOVE LIMITATIONS OR EXCLUSIONS MAY NOT APPLY TO YOU.

## **6. Arbitration and Governing Law**

- You agree that any dispute, claim or controversy arising out of or relating to this Agreement or the TeleNav Software shall be settled by independent arbitration involving a neutral arbitrator and administered by the American Arbitration Association in the County of Santa Clara, California. The arbitrator shall apply the Commercial Arbitration Rules of the American Arbitration Association, and the judgment upon the award rendered by the arbitrator may be entered by any court having jurisdiction. Note that there is no judge or jury in an

arbitration proceeding and the decision of the arbitrator shall be binding upon both parties. You expressly agree to waive your right to a jury trial. This Agreement and performance hereunder will be governed by and construed in accordance with the laws of the State of California, without giving effect to its conflict of law provisions. To the extent judicial action is necessary in connection with the binding arbitration, both TeleNav and you agree to submit to the exclusive jurisdiction of the courts of the County of Santa Clara, California. The United Nations Convention on Contracts for the International Sale of Goods shall not apply.

## **7. Assignment**

- You may not resell, assign, or transfer this Agreement or any of your rights or obligations, except in totality, in connection with your permanent transfer of the TeleNav Software, and expressly conditioned upon the new user of the TeleNav Software agreeing to be bound by the terms and conditions of this

Agreement. Any such sale, assignment or transfer that is not expressly permitted under this paragraph will result in immediate termination of this Agreement, without liability to TeleNav, in which case you and all other parties shall immediately cease all use of the TeleNav Software. Notwithstanding the foregoing, TeleNav may assign this Agreement to any other party at any time without notice, provided the assignee remains bound by this Agreement.

## **8. Miscellaneous**

### **8.1**

This Agreement constitutes the entire agreement between TeleNav and you with respect to the subject matter hereof.

### **8.2**

Except for the limited licenses expressly granted in this Agreement, TeleNav retains all right, title and interest in and to the TeleNav Software, including without limitation all related intellectual property rights. No licenses or other rights which are

# Customer Information

---

not expressly granted in this Agreement are intended to, or shall be, granted or conferred by implication, statute, inducement, estoppel or otherwise, and TeleNav and its suppliers and licensors hereby reserve all of their respective rights other than the licenses explicitly granted in this Agreement.

## **8.3**

By using the TeleNav Software, you consent to receive from TeleNav all communications, including notices, agreements, legally required disclosures or other information in connection with the TeleNav Software (collectively, "Notices") electronically. TeleNav may provide such Notices by posting them on TeleNav's Website or by downloading such Notices to your wireless device. If you desire to withdraw your consent to receive Notices electronically, you must discontinue your use of the TeleNav Software.

## **8.4**

TeleNav's or your failure to require performance of any provision shall not affect that party's right to require performance at any time thereafter, nor shall a waiver of any breach or default of this Agreement constitute a waiver of any subsequent breach or default or a waiver of the provision itself.

## **8.5**

If any provision herein is held unenforceable, then such provision will be modified to reflect the intention of the parties, and the remaining provisions of this Agreement will remain in full force and effect.

## **8.6**

The headings in this Agreement are for convenience of reference only, will not be deemed to be a part of this Agreement, and will not be referred to in connection with the construction or interpretation of this Agreement. As used in this Agreement, the words "include" and "including" and variations thereof, will not be deemed to be terms of limitation, but rather will be deemed to be followed by the words "without limitation".

## **9. Other Vendors Terms and Conditions**

- The Telenav Software utilizes map and other data licensed to Telenav by third party vendors for the benefit of you and other end users. This Agreement includes end-user terms applicable to these companies (included at the end of this Agreement), and thus your use of the Telenav Software is also subject to such terms. You agree to comply with the following additional terms and conditions, which are applicable to Telenav's third party vendor licensors.

# Customer Information

---

## **9.1 End User Terms Required by HERE North America, LLC**

The data (“Data”) is provided for your personal, internal use only and not for resale. It is protected by copyright, and is subject to the following terms and conditions which are agreed to by you, on the one hand, and Telenav (“Telenav”) and its licensors (including their licensors and suppliers) on the other hand.

© 2013 HERE. All rights reserved.

The Data for areas of Canada includes information taken with permission from Canadian authorities, including: © Her Majesty the Queen in Right of Canada, © Queen’s Printer for Ontario, © Canada Post Corporation, GeoBase®, © Department of Natural Resources Canada.

HERE holds a non-exclusive license from the United States Postal Service® to publish and sell ZIP+4® information.

©United States Postal Service® 2014. Prices are not established, controlled or approved by the United States Postal Service®. The following trademarks and registrations are owned by the USPS: United States Postal Service, USPS, and ZIP+4

The Data for Mexico includes certain data from Instituto Nacional de Estadística y Geografía.

## **9.2 End User Terms Required by NAV2 (Shanghai) Co., Ltd**

The data (“Data”) is provided for your personal, internal use only and not for resale. It is protected by copyright, and is subject to the following terms and conditions which are agreed to by you, on the one hand, and NAV2 (Shanghai) Co., Ltd (“NAV2”) and its licensors (including their licensors and suppliers) on the other hand. 20xx. All rights reserved

## **Terms and Conditions**

**Permitted Use.** You agree to use this Data together with the Telenav Software solely for the internal business and personal purposes for which you were licensed, and not for service bureau, time-sharing or other similar purposes. Accordingly, but subject to the restrictions set forth in the following paragraphs, you agree not to otherwise reproduce, copy, modify, decompile, disassemble, create any derivative works of, or reverse engineer any portion of this Data, and may not transfer or distribute it in any form, for any purpose, except to the extent permitted by mandatory laws.

**Restrictions.** Except where you have been specifically licensed to do so by Telenav, and without limiting the preceding paragraph, you may not use this Data (a) with any products, systems, or applications installed or otherwise connected to or in communication with vehicles, capable of vehicle navigation, positioning, dispatch, real time route guidance, fleet management or similar applications; or (b) with or in

# Customer Information

---

communication with any positioning devices or any mobile or wireless-connected electronic or computer devices, including without limitation cellular phones, palmtop and handheld computers, pagers, and personal digital assistants or PDAs.

**Warning.** The Data may contain inaccurate or incomplete information due to the passage of time, changing circumstances, sources used and the nature of collecting comprehensive geographic data, any of which may lead to incorrect results.

**No Warranty.** This Data is provided to you “as is,” and you agree to use it at your own risk. Telenav and its licensors (and their licensors and suppliers) make no guarantees, representations or warranties of any kind, express or implied, arising by law or otherwise, including but not limited to, content, quality, accuracy, completeness, effectiveness, reliability, fitness for a particular purpose, usefulness, use or results to be obtained from this Data, or that the Data or server will be uninterrupted or error-free.

**Disclaimer of Warranty:** TELENAV AND ITS LICENSORS (INCLUDING THEIR LICENSORS AND SUPPLIERS) DISCLAIM ANY WARRANTIES, EXPRESS OR IMPLIED, OF QUALITY, PERFORMANCE, MERCHANTABILITY, FITNESS FOR A PARTICULAR PURPOSE OR NON-INFRINGEMENT. Some States, Territories and Countries do not allow certain warranty exclusions, so to that extent the above exclusion may not apply to you.

**Disclaimer of Liability:** TELENAV AND ITS LICENSORS (INCLUDING THEIR LICENSORS AND SUPPLIERS) SHALL NOT BE LIABLE TO YOU: IN RESPECT OF ANY CLAIM, DEMAND OR ACTION, IRRESPECTIVE OF THE NATURE OF THE CAUSE OF THE CLAIM, DEMAND OR ACTION ALLEGING ANY LOSS, INJURY OR DAMAGES, DIRECT OR INDIRECT, WHICH MAY RESULT FROM THE USE OR POSSESSION OF THE INFORMATION; OR FOR ANY LOSS OF PROFIT, REVENUE, CONTRACTS OR SAVINGS, OR ANY OTHER DIRECT, INDIRECT, INCIDENTAL, SPECIAL OR CONSEQUENTIAL DAMAGES ARISING OUT OF YOUR USE OF OR INABILITY TO USE

THIS INFORMATION, ANY DEFECT IN THE INFORMATION, OR THE BREACH OF THESE TERMS OR CONDITIONS, WHETHER IN AN ACTION IN CONTRACT OR TORT OR BASED ON A WARRANTY, EVEN IF TELENAV OR ITS LICENSORS HAVE BEEN ADVISED OF THE POSSIBILITY OF SUCH DAMAGES. Some States, Territories and Countries do not allow certain liability exclusions or damages limitations, so to that extent the above may not apply to you.

**Export Control.** You shall not export from anywhere any part of the Data or any direct product thereof except in compliance with, and with all licenses and approvals required under, applicable export laws, rules and regulations, including but not limited to the laws, rules and regulations administered by the Office of Foreign Assets Control of the U.S. Department of Commerce and the Bureau of Industry and Security of the U.S. Department of Commerce. To the extent that any such export laws, rules or regulations prohibit HERE from complying with any of its obligations hereunder to deliver or distribute Data, such failure shall be excused and shall not constitute a breach of this Agreement.

# Customer Information

**Entire Agreement.** These terms and conditions constitute the entire agreement between Telenav (and its licensors, including their licensors and suppliers) and you pertaining to the subject matter hereof, and supersedes in their entirety any and all written or oral agreements previously existing between us with respect to such subject matter.

**Governing Law.** The above terms and conditions shall be governed by the laws of the State of Illinois [insert “Netherlands” where European HERE Data is used], without giving effect to (i) its conflict of laws provisions, or (ii) the United Nations Convention for Contracts for the International Sale of Goods, which is explicitly excluded. You agree to submit to the jurisdiction of the State of Illinois [insert “The Netherlands” where European HERE Data is used] for any and all disputes, claims and actions arising from or in connection with the Data provided to you hereunder.

**Government End Users.** If the Data is being acquired by or on behalf of the United States government or any other entity seeking or applying rights similar to those customarily claimed by the United States government, this Data is a “commercial item” as that term is defined at 48 C.F.R. (“FAR”) 2.101, is licensed in accordance with these End-User Terms, and each copy of Data delivered or otherwise furnished shall be marked and embedded as appropriate with the following “Notice of Use,” and shall be treated in accordance with such Notice:

NOTICE OF USE
CONTRACTOR (MANUFACTURER/ SUPPLIER) NAME: HERE
CONTRACTOR (MANUFACTURER/ SUPPLIER) ADDRESS: c/o Nokia, 425 West Randolph Street, Chicago, Illinois 60606
This Data is a commercial item as defined in FAR 2.101 and is subject to these End- User Terms under which this Data was provided.
© 1987 – 2014 HERE – All rights reserved.

If the Contracting Officer, federal government agency, or any federal official refuses to use the legend provided herein, the Contracting Officer, federal government agency, or any federal official must notify HERE prior to seeking additional or alternative rights in the Data.

## I. US/Canada Territory

A. United States Data. The End-User Terms for any Application containing Data for the United States shall contain the following notices:

“HERE holds a non-exclusive license from the United States Postal Service® to publish and sell ZIP+4® information.”

“©United States Postal Service® 20XX. Prices are not established, controlled or approved by the United States Postal Service®. The following trademarks and registrations are owned by the USPS: United States Postal Service, USPS, and ZIP+4.”

# Customer Information

---

B. Canada Data. The following provisions apply to the Data for Canada, which may include or reflect data from third party licensors (“Third Party Data”), including Her Majesty the Queen in Right of Canada (“Her Majesty”), Canada Post Corporation (“Canada Post”) and the Department of Natural Resources of Canada (“NRCan”):

1. Disclaimer and Limitation: Client agrees that its use of the Third Party Data is subject to the following provisions:

a. Disclaimer: The Third Party Data is licensed on an “as is” basis. The licensors of such data, including Her Majesty, Canada Post and NRCan, make no guarantees, representations or warranties respecting such data, either express or implied, arising by law or otherwise, including but not limited to, effectiveness, completeness, accuracy or fitness for a particular purpose.

b. Limitation on Liability: The Third Party Data licensors, including Her Majesty, Canada Post and NRCan, shall not be liable: (i) in respect of any claim, demand or action, irrespective of the nature of the cause of the claim, demand or action alleging any loss, injury or damages, direct or indirect, which may result from the use or possession of such Data; or (ii) in any way for loss of revenues or contracts, or any other consequential loss of any kind resulting from any defect in the Data.

2. Copyright Notice: In connection with each copy of all or any portion of the Data for the Territory of Canada, Client shall affix in a conspicuous manner the following copyright notice on at least one of: (i) the label for the storage media of the copy; (ii) the packaging for the copy; or (iii) other materials packaged with the copy, such as user manuals or end user license agreements: “This data includes information taken with permis-

sion from Canadian authorities, including © Her Majesty the Queen in Right of Canada, © Queen's Printer for Ontario, © Canada Post Corporation, GeoBase®, © The Department of Natural Resources Canada. All rights reserved.”

3. End-User Terms: Except as otherwise agreed by the parties, in connection with the provision of any portion of the Data for the Territory of Canada to End-Users as may be authorized under the Agreement, Client shall provide such End-Users, in a reasonably conspicuous manner, with terms (set forth with other end user terms required to be provided

## Customer Information

---

under the Agreement, or as otherwise may be provided, by Client) which shall include the following provisions on behalf of the Third Party Data licensors, including Her Majesty, Canada Post and NRCan:

The Data may include or reflect data of licensors, including Her Majesty the Queen in the Right of Canada (“Her Majesty”), Canada Post Corporation (“Canada Post”) and the Department of Natural Resources Canada (“NRCan”). Such data is licensed on an “as is” basis. The licensors, including Her Majesty, Canada Post and NRCan, make no guarantees, representations or warranties respecting such data, either express or implied, arising by law or otherwise, including but not limited to, effectiveness, completeness, accuracy or fitness for a particular purpose. The licensors, including Her Majesty, Canada Post and NRCan, shall not be liable in respect of any claim, demand or action, irrespective of the nature of the cause of the claim, demand or

action alleging any loss, injury or damages, direct or indirect, which may result from the use or possession of the data or the Data. The licensors, including Her Majesty, Canada Post and NRCan, shall not be liable in any way for loss of revenues or contracts, or any other consequential loss of any kind resulting from any defect in the data or the Data. End User shall indemnify and save harmless the licensors, including Her Majesty, Canada Post and NRCan, and their officers, employees and agents from and against any claim, demand or action, irrespective of the nature of

the cause of the claim, demand or action, alleging loss, costs, expenses, damages or injuries (including injuries resulting in death) arising out of the use or possession of the data or the Data.

4. Additional Provisions: The terms contained in this Section are in addition to all of the rights and obligations of the parties under the Agreement. To the extent that any of the provisions of this Section are inconsistent with, or conflict with, any other provisions of the Agreement, the provisions of this Section shall prevail.

# Customer Information

II. Mexico. The following provision applies to the Data for Mexico, which includes certain data from the Instituto Nacional de Estadística y Geografía (“INEGI”):

A. Any and all copies of the Data and/or packaging containing Data for Mexico shall contain the following notice: “Fuente: INEGI (Instituto Nacional de Estadística y Geografía)”

## III. Latin America Territory

A. Third Party Notices. Any and all copies of the Data and/or packaging relating thereto shall include the respective Third Party Notices set forth below and used as described below corresponding to the Territory (or portion thereof) included in such copy:

Territory Notice

Argentina IGN “INSTITUTO GEOGRAFICO NACIONAL ARGENTINO”

Ecuador “INSTITUTO GEOGRAFICO MILITAR DEL ECUADOR AUTORIZACION N° IGM-2011-01- PCO-01 DEL 25 DE ENERO DE 2011”  
“source: © IGN 2009 - BD TOPO ®”

Guadeloupe, French Guiana and Martinique Mexico “Fuente: INEGI (Instituto Nacional de Estadística y Geografía)”

## IV. Middle East Territory

A. Third Party Notices. Any and all copies of the Data and/or packaging relating thereto shall include the respective Third Party Notices set forth below and used as described below corresponding to the Territory (or portion thereof) included in such copy:

Country Notice

Jordan “© Royal Jordanian Geographic Centre”. The foregoing notice requirement for Jordan Data is a material term of the Agreement. If Client or any of its permitted sublicensees (if any) fail to meet such requirement, HERE shall have the right to terminate Client’s license with respect to the Jordan Data.

B. Jordan Data. Client and its permitted sublicensees (if any) are restricted from licensing and/or otherwise distributing HERE’s database for the country of Jordan (“Jordan Data”) for use in Enterprise Applications to (i) non-Jordanian entities for use of the Jordan Data solely in Jordan or (ii) Jordan-based customers. In addition, Client, its permitted sublicensees (if any) and End-Users are restricted from using the Jordan Data in Enterprise Applications if such party is (i) a non-Jordanian entity using the Jordan Data solely in Jordan or (ii) a Jordan-based customer. For purposes



# Customer Information

---

of the foregoing, “Enterprise Applications” shall mean Geomarketing applications, GIS applications, mobile business asset management applications, call center applications, telematics applications, public organization Internet applications or for providing geocoding services.

## V. Europe Territory

### A. Use of Certain Traffic Codes in Europe

1. General Restrictions Applicable to Traffic Codes. Client acknowledges and agrees that in certain countries of the Europe Territory, Client will need to obtain rights directly from third party RDS-TMC code providers to receive and use the Traffic Codes in the Data and to deliver to End-Users Transactions in any way derived from or based on such Traffic Codes. For such countries, HERE shall deliver the Data incorporating Traffic Codes to Client only after receiving certification from Client of its having obtained such rights.

2. Display of Third Party Rights Legends for Belgium. Client shall, for each Transaction that uses Traffic Codes for Belgium, provide the following notice to the End-User: “Traffic Codes for Belgium are provided by the Ministerie van de Vlaamse Gemeenschap and the Ministère de l'Équipement et des Transports.”

B. Paper Maps. With respect to any license granted to Client relating to making, selling or distributing paper maps (i.e., a map fixed on a paper or paper-like medium): (a) such license with respect to Data for the Territory of Great Britain is conditioned on Client's entering into and complying with a separate written agreement with the Ordnance Survey (“OS”) to create and sell paper maps, Client's paying to the OS any and all applicable paper map royalties, and Client's complying with the OS copyright notice requirements; (b) such license for selling or otherwise distributing for charge with respect to Data for the Territory of Czech Republic is conditioned on Client's obtaining prior written consent from

Kartografie a.s.; (c) such license for selling or distributing with respect to Data for the Territory of Switzerland is conditioned on Client's obtaining a permit from Bundesamt für Landestopografie of Switzerland; (d) Client is restricted from using Data for the Territory of France to create paper maps with a scale between 1:5,000 and 1:250,000; and (e) Client is restricted from using any Data to create, sell or distribute paper maps that are the same or substantially similar, in terms of data content and specific use of color, symbols and scale, to paper maps published by the European national mapping agencies, including without limitation, Landervermessungämter of Germany, Topografische Dienst of the Netherlands, Nationaal Geografisch Instituut of Belgium, Bundesamt für Landestopografie of Switzerland, Bundesamt für Eich-und Vermessungswesen of Austria, and the National Land Survey of Sweden.

# Customer Information

C. OS Enforcement. Without limiting Section IV(B) above, with respect to Data for the Territory of Great Britain, Client acknowledges and agrees that the Ordnance Survey (“OS”) may bring a direct action against Client to enforce compliance with the OS copyright notice (see Section IV(D) below) and paper map requirements (see Section IV(B) above) contained in this Agreement.

D. Third Party Notices. Any and all copies of the Data and/or packaging relating thereto shall include the respective Third Party Notices set forth below and used as described below corresponding to the Territory (or portion thereof) included in such copy:

Country(ies) Notice

Austria “© Bundesamt für Eich- und Vermessungswesen”

Croatia  
Cyprus,  
Estonia,  
Latvia,  
Lithuania, “© EuroGeographics”

Moldova,  
Poland,  
Slovenia  
and/or  
Ukraine

France “source: © IGN 2009 – BD TOPO ®”

Germany “Die Grundlagendaten wurden mit Genehmigung der zuständigen Behörden entnommen”

Great Britain “Contains Ordnance Survey data © Crown copyright and database right 2010  
Contains Royal Mail data © Royal Mail copyright and database right 2010”

Greece “Copyright Geomatics Ltd.”

Hungary “Copyright © 2003; Top-Map Ltd.”

Italy “La Banca Dati Italiana è stata prodotta usando quale riferimento anche cartografia numerica ed al tratto prodotta e fornita dalla Regione Toscana.”

Norway “Copyright © 2000; Norwegian Mapping Authority”

Portugal “Source: IgeoE – Portugal”

Spain “Información geográfica propiedad del CNIG”

Sweden “Based upon electronic data © National Land Survey Sweden.”

Switzerland “Topografische Grundlage: © Bundesamt für Landestopographie.

E. Respective Country Distribution. Client acknowledges that HERE has not received approvals to distribute map data for the following countries in such respective countries: Albania, Belarus, Kyrgyzstan, Moldova and Uzbekistan. HERE may

## Customer Information

---

update such list from time to time. The license rights granted to Client under this TL with respect to the Data for such countries are contingent upon Client's compliance with all applicable laws and regulations, including, without limitation, any required licenses or approvals to distribute the Application incorporating such Data in such respective countries.

### VI. Australia Territory

A. Third Party Notices. Any and all copies of the Data and/or packaging relating thereto shall include the respective Third Party Notices set forth below and used as described below corresponding to the Territory (or portion thereof) included in such copy:

Copyright. Based on data provided under license from PSMA Australia Limited ([www.pasma.com.au](http://www.pasma.com.au)).

Product incorporates data which is © 20XX Telstra Corporation Limited, GM Holden Limited, Intelomatics Australia Pty Ltd and Continental Pty Ltd.

B. Third Party Notices for Australia. In addition to the foregoing, the End-User Terms for any Application containing RDS-TMC Traffic Codes for Australia shall contain the following notice: "Product incorporates traffic location codes which is © 20XX Telstra Corporation Limited and its licensors."

#### **AT&T Vehicle Network Carrier Telematics Disclosure**

END USER FOR PURPOSES OF THIS SECTION MEANS YOU AND YOUR HEIRS, EXECUTORS, LEGAL PERSONAL REPRESENTATIVES AND PERMITTED ASSIGNS. FOR PURPOSES OF THIS SECTION "UNDERLYING WIRELESS SERVICE CARRIER" INCLUDES ITS AFFILIATES AND CONTRACTORS AND THEIR RESPECTIVE OFFICERS, DIRECTORS, EMPLOYEES, SUCCESSORS AND ASSIGNS. END USER HAS NO CONTRACTUAL RELATIONSHIP

WITH THE UNDERLYING WIRELESS SERVICE CARRIER AND END USER IS NOT A THIRD PARTY BENEFICIARY OF ANY AGREEMENT BETWEEN FORD AND UNDERLYING CARRIER. END USER UNDERSTANDS AND AGREES THAT THE UNDERLYING CARRIER HAS NO LEGAL, EQUITABLE, OR OTHER LIABILITY OF ANY KIND TO END USER. IN ANY EVENT, REGARDLESS OF THE FORM OF THE ACTION, WHETHER FOR BREACH OF CONTRACT, WARRANTY, NEGLIGENCE, STRICT LIABILITY IN TORT OR OTHERWISE, END USER'S EXCLUSIVE REMEDY FOR CLAIMS ARISING IN ANY WAY IN CONNECTION WITH THIS AGREEMENT, FOR ANY CAUSE WHATSOEVER, INCLUDING BUT NOT LIMITED TO ANY FAILURE OR DISRUPTION OF SERVICE PROVIDED HEREUNDER, IS LIMITED TO PAYMENT OF DAMAGES IN AN AMOUNT NOT TO EXCEED THE AMOUNT PAID BY END USER FOR THE SERVICES DURING THE TWO-MONTH PERIOD PRECEDING THE DATE THE CLAIM AROSE.

## Customer Information

---

(ii) END USER AGREES TO INDEMNIFY AND HOLD HARMLESS THE UNDERLYING WIRELESS SERVICE CARRIER AND ITS OFFICERS, EMPLOYEES, AND AGENTS AGAINST ANY AND ALL CLAIMS, INCLUDING WITHOUT LIMITATION CLAIMS FOR LIBEL, SLANDER, OR ANY PROPERTY DAMAGE, PERSONAL INJURY OR DEATH, ARISING IN ANY WAY, DIRECTLY OR INDIRECTLY, IN CONNECTION WITH THIS AGREEMENT OR THE USE, FAILURE TO USE, OR INABILITY TO USE THE DEVICE EXCEPT WHERE THE CLAIMS RESULT FROM THE UNDERLYING CARRIER'S GROSS NEGLIGENCE OR WILLFUL MISCONDUCT. THIS INDEMNITY WILL SURVIVE THE TERMINATION OF THE AGREEMENT.

(iii) END USER HAS NO PROPERTY RIGHT IN ANY NUMBER ASSIGNED TO THE DEVICE.

(iv) END USER UNDERSTANDS THAT FORD AND THE UNDERLYING CARRIER CANNOT GUARANTY THE SECURITY OF WIRELESS TRANSMISSIONS, AND WILL NOT BE LIABLE FOR ANY LACK OF SECURITY RELATING TO THE USE OF THE SERVICES

THE SERVICE IS FOR [END USER'S] USE ONLY AND END USER MAY NOT RESELL THE SERVICE TO ANY OTHER PARTY END USER UNDERSTANDS THAT THE UNDERLYING CARRIER DOES NOT GUARANTEE ANY END USER UNINTERRUPTED SERVICE OR COVERAGE. THE UNDERLYING CARRIER DOES NOT WARRANT THAT END USERS CAN OR WILL BE LOCATED USING THE SERVICE. THE UNDERLYING CARRIER MAKES NO WARRANTY, EXPRESS OR IMPLIED, OF MERCHANTABILITY OR FITNESS FOR A PARTICULAR PURPOSE, SUITABILITY, OR PERFORMANCE REGARDING ANY SERVICES OR GOODS, AND IN NO EVENT SHALL AT&T BE LIABLE, WHETHER OR NOT DUE TO ITS OWN NEGLIGENCE, FOR ANY: (A) ACT OR OMISSION OF A THIRD PARTY; (B) MISTAKES, OMISSIONS, INTERRUPTIONS, ERRORS, FAILURES TO TRANSMIT, DELAYS, OR DEFECTS IN THE SERVICE PROVIDED BY OR THROUGH THE UNDERLYING CARRIER; (C) DAMAGE OR INJURY CAUSED BY SUSPENSION OR TERMINATION BY THE UNDERLYING CARRIER; OR (D) DAMAGE OR INJURY CAUSED BY A FAILURE OR DELAY IN CONNECTING A CALL TO ANY ENTITY,

INCLUDING 911 OR ANY OTHER EMERGENCY SERVICE. TO THE FULL EXTENT ALLOWED BY LAW, THE END USER RELEASES, INDEMNIFIES AND HOLDS THE UNDERLYING CARRIER HARMLESS FROM AND AGAINST ANY AND ALL CLAIMS OF ANY PERSON OR ENTITY FOR DAMAGES OF ANY NATURE ARISING IN ANY WAY FROM OR RELATING TO, DIRECTLY OR INDIRECTLY, SERVICES PROVIDED BY THE UNDERLYING CARRIER OR ANY PERSON'S USE THEREOF, INCLUDING CLAIMS ARISING IN WHOLE OR IN PART FROM THE ALLEGED NEGLIGENCE OF THE UNDERLYING CARRIER.

### **VII. China Territory**

#### ***Personal Use Only***

You agree to use this Data together with [insert name of Client Application] for the solely personal, non-commercial purposes for which you were licensed, and not for service bureau, time-sharing or other similar purposes. Accordingly, but subject to the restrictions set forth in the following paragraphs, you may copy this Data only as necessary for your personal use to (i) view

## Customer Information

---

it, and (ii) save it, provided that you do not remove any copyright notices that appear and do not modify the Data in any way. You agree not to otherwise reproduce, copy, modify, decompile, disassemble or reverse engineer any portion of this Data, and may not transfer or distribute it in any form, for any purpose, except to the extent permitted by mandatory laws.

### **Restrictions**

Except where you have been specifically licensed to do so by NAV2, and without limiting the preceding paragraph, you may not (a) use this Data with any products, systems, or applications installed or otherwise connected to or in communication with vehicles, capable of vehicle navigation, positioning, dispatch, real time route guidance, fleet management or similar applications; or (b) with or in communication with any positioning devices or any mobile or wireless-connected electronic or computer

devices, including without limitation cellular phones, palmtop and handheld computers, pagers, and personal digital assistants or PDAs. You agree to cease using this Data if you fail to comply with these terms and conditions.

### **Limited Warranty**

NAV2 warrants that (a) the Data will perform substantially in accordance with the accompanying written materials for a period of ninety (90) days from the date of receipt, and (b) any support services provided by NAV2 shall be substantially as described in applicable written materials provided to you by NAV2, and NAV2's support engineers will make commercially reasonable efforts to solve any problem issues.

### **Customer Remedies**

NAV2 and its suppliers' entire liability and your exclusive remedy shall be, at NAV2's sole discretion, either (a) return of the price paid, if any, or (b) repair or replacement of the Data that do not meet NAV2's Limited Warranty and that are returned to NAV2 with a copy of your receipt. This Limited Warranty

is void if failure of the Data has resulted from accident, abuse, or misapplication. Any replacement Data will be warranted for the remainder of the original warranty period or thirty (30) days, whichever is longer. Neither these remedies nor any product support services offered by NAV2 are available without proof of purchase from an authorized international source.

### **No Other Warranty:**

EXCEPT FOR THE LIMITED WARRANTY SET FORTH ABOVE AND TO THE EXTENT PERMITTED BY APPLICABLE LAW, NAV2 AND ITS LICENSORS (INCLUDING THEIR LICENSORS AND SUPPLIERS) DISCLAIM ANY WARRANTIES, EXPRESS OR IMPLIED, OF QUALITY, PERFORMANCE, MERCHANTABILITY, FITNESS FOR A PARTICULAR PURPOSE, OWNERSHIP OR NON-INFRINGEMENT. Certain warranty exclusions may not be permitted under applicable law, so to that extent the above exclusion may not apply to you.

# Customer Information

---

## **Limited Liability:**

TO THE EXTENT PERMITTED BY APPLICABLE LAW, NAV2 AND ITS LICENSORS (INCLUDING THEIR LICENSORS AND SUPPLIERS) SHALL NOT BE LIABLE TO YOU: IN RESPECT OF ANY CLAIM, DEMAND OR ACTION, IRRESPECTIVE OF THE NATURE OF THE CAUSE OF THE CLAIM, DEMAND OR ACTION ALLEGING ANY LOSS, INJURY OR DAMAGES, DIRECT OR INDIRECT, WHICH MAY RESULT FROM THE USE OR POSSESSION OF THE INFORMATION; OR FOR ANY LOSS OF PROFIT, REVENUE, CONTRACTS OR SAVINGS, OR ANY OTHER DIRECT, INDIRECT, INCIDENTAL, SPECIAL OR CONSEQUENTIAL DAMAGES ARISING OUT OF YOUR USE OF OR INABILITY TO USE THIS INFORMATION, ANY DEFECT IN THE INFORMATION, OR THE BREACH OF THESE TERMS OR CONDITIONS, WHETHER IN AN ACTION IN CONTRACT OR TORT OR BASED ON A WARRANTY, EVEN IF NAV2 OR ITS LICENSORS HAVE BEEN ADVISED OF THE POSSIBILITY OF SUCH DAMAGES. UNDER

NO CIRCUMSTANCES SHALL NAV2'S OR ITS SUPPLIERS' LIABILITY HEREUNDER EXCEED THE PRICE PAID. Certain liability exclusions may not be permitted under applicable law, so to that extent the above exclusion may not apply to you.

## **Export Control**

You agree not to export to anywhere any part of the Data provided to you or any direct product thereof except in compliance with, and with all licenses and approvals required under, applicable export laws, rules and regulations.

## **IP Protection**

The Data are owned by NAV2 or its suppliers and are protected by applicable copyright and other intellectual property law and treaties. The Data are provided solely on the basis of a license to use, not sale.

## **Entire Agreement**

These terms and conditions constitute the entire agreement between NAV2 (and its licensors, including their licensors and suppliers) and you pertaining to the subject matter hereof, and supersedes in their entirety any and all written or oral agreements previously existing between us with respect to such subject matter.

## **Governing Law.**

The above terms and conditions shall be governed by the laws of the People's Republic of China, without giving effect to (i) its conflict of laws provisions, or (ii) the United Nations Convention for Contracts for the International Sale of Goods, which is explicitly excluded. Any dispute arising from or in connection with the Data provided to you hereunder shall be submitted to the Shanghai International Economic and Trade Arbitration Commission for arbitration.

## **Gracenote® Copyright**

CD and music-related data from Gracenote, Inc., copyright©

## Customer Information

---

2000-2007 Gracenote. Gracenote Software, copyright © 2000-2007 Gracenote. This product and service may practice one or more of the following U.S. Patents 5,987,525; 6,061,680; 6,154,773; 6,161,132; 6,230,192; 6,230,207; 6,240,459; 6,330,593 and other patents issued or pending. Some services supplied under license from Open Globe, Inc. for U.S. Patent 6,304,523.

Gracenote and CDDB are registered trademarks of Gracenote. The Gracenote logo and logotype, and the "Powered by Gracenote"™ logo are trademarks of Gracenote.

### **Gracenote® End User License Agreement (EULA)**

This device contains software from Gracenote, Inc. of 2000 Powell Street Emeryville, California 94608 ("Gracenote").

The software from Gracenote (the "Gracenote Software") enables this device to do disc and music file identification and obtain music-related information, including name, artist, track, and title information ("Gracenote Data") from online servers ("Gracenote Servers"), and to perform other

functions. You may use Gracenote Data only by means of the intended End User functions of this device. This device may contain content belonging to Gracenote's providers. If so, all of the restrictions set forth herein with respect to Gracenote Data shall also apply to such content and such content providers shall be entitled to all of the benefits and protections set forth herein that are available to Gracenote. You agree that you will use the content from Gracenote ("Gracenote Content"), Gracenote Data, the Gracenote Software, and Gracenote Servers for your own personal, non-commercial use only. You agree not to assign, copy, transfer or transmit the Gracenote Content, Gracenote Software or any Gracenote Data (except in a Tag associated with a music file) to any third party. **YOU AGREE NOT TO USE OR EXPLOIT GRACENOTE CONTENT, GRACENOTE DATA, THE GRACENOTE SOFTWARE, OR GRACENOTE SERVERS, EXCEPT AS EXPRESSLY PERMITTED HEREIN.**

You agree that your non-exclusive licenses to use the Gracenote Content, Gracenote Data, the Gracenote Software, and Gracenote Servers will terminate if you violate these restrictions. If your licenses terminate, you agree to cease any and all use of the Gracenote Content, Gracenote Data, the Gracenote Software, and Gracenote Servers.

Gracenote, respectively, reserve all rights in Gracenote Data, the Gracenote Software, and the Gracenote Servers and Gracenote Content, including all ownership rights. Under no circumstances will either Gracenote become liable for any payment to you for any information that you provide, including any copyrighted material or music file information. You agree that Gracenote may enforce its respective rights, collectively or separately, under this agreement against you, directly in each company's own name.

# Customer Information

---

Gracenote uses a unique identifier to track queries for statistical purposes. The purpose of a randomly assigned numeric identifier is to allow Gracenote to count queries without knowing anything about who you are. For more information, see the web page at [www.gracenote.com](http://www.gracenote.com) for the Gracenote Privacy Policy.

THE GRACENOTE SOFTWARE, EACH ITEM OF GRACENOTE DATA AND THE GRACENOTE CONTENT ARE LICENSED TO YOU "AS IS". NEITHER GRACENOTE MAKES ANY REPRESENTATIONS OR WARRANTIES, EXPRESS OR IMPLIED, REGARDING THE ACCURACY OF ANY GRACENOTE DATA FROM THE GRACENOTE SERVERS OR GRACENOTE CONTENT. GRACENOTE COLLECTIVELY AND SEPARATELY RESERVE THE RIGHT TO DELETE DATA AND/OR CONTENT FROM THE COMPANIES' RESPECTIVE SERVERS OR, IN THE CASE OF GRACENOTE, CHANGE DATA CATEGORIES FOR ANY CAUSE THAT GRACENOTE DEEMS SUFFICIENT. NO WARRANTY IS MADE THAT EITHER GRACENOTE CONTENT OR THE GRACENOTE SOFTWARE OR GRACENOTE SERVERS ARE

ERROR-FREE OR THAT THE FUNCTIONING OF THE GRACENOTE SOFTWARE OR GRACENOTE SERVERS WILL BE UNINTERRUPTED. GRACENOTE IS NOT OBLIGATED TO PROVIDE YOU WITH ANY ENHANCED OR ADDITIONAL DATA TYPES THAT GRACENOTE MAY CHOOSE TO PROVIDE IN THE FUTURE AND IS FREE TO DISCONTINUE ITS ONLINE SERVICES AT ANY TIME. GRACENOTE DISCLAIM ALL WARRANTIES EXPRESS OR IMPLIED, INCLUDING, BUT NOT LIMITED TO, IMPLIED WARRANTIES OF MERCHANTABILITY, FITNESS FOR A PARTICULAR PURPOSE, TITLE, AND NON-INFRINGEMENT. NEITHER GRACENOTE WARRANTS THE RESULTS THAT WILL BE OBTAINED BY YOUR USE OF THE GRACENOTE SOFTWARE OR ANY GRACENOTE SERVER. IN NO CASE WILL GRACENOTE BE LIABLE FOR ANY CONSEQUENTIAL OR INCIDENTAL DAMAGES OR FOR ANY LOST PROFITS OR LOST REVENUES FOR ANY REASON WHATSOEVER. © Gracenote 2007.

## ***Taiwan Territory***

Note: In accordance with the management approach of low-power radio wave radiation motors:

Article 12: For approved and certified low-power radiation motor models, companies, firms or users must not alter the frequency, increase the power or change the characteristics and functions of the original design without authorization.

Article 14: The usage of low-power radio-frequency motors must not affect aviation safety and interfere with legal telecommunications. Should interference be detected, immediately stop using the device and only resume usage after ensuring that there is no longer any interference. For the legal telecommunication and wireless telecommunication of the telco, the low-power radio frequency motor must be able to tolerate legal limits of interference from telecommunication, industrial, scientific and radio wave equipment.



# Customer Information

## SUNA TRAFFIC CHANNEL – TERMS AND CONDITIONS

By activating, using and/or accessing the SUNA Traffic Channel, SUNA Predictive or other content or material provided by Intelomatics (together, **SUNA Products and/or Services**), you must accept certain terms and conditions. The following is a brief summary of the terms and conditions that apply to you. To view the full terms and conditions relevant to your use of the SUNA Products and/or Services, please consult:

Website
<a href="http://www.sunattraffic.com.au/termsandconditions/">www.sunattraffic.com.au/termsandconditions/</a>

### 1. Acceptance

By using SUNA Products and/or Services, you will be deemed to have accepted and agreed to be bound by the terms and conditions fully detailed at:

Website
<a href="http://www.sunattraffic.com.au/termsandconditions/">www.sunattraffic.com.au/termsandconditions/</a>

### 2. Intellectual Property

SUNA Products and/or Services are for your personal use. You may not record, or retransmit the content, nor use the content in association with any other traffic information or route guidance service or device not approved by Intelomatics. You obtain no right of ownership in any Intellectual Property Rights (including copyright) in the data that is used to provide SUNA Products and/or Services.

### 3. Appropriate Use

SUNA Products and/or Services are intended as an aid to personal motoring and travel planning, and do not provide comprehensive or accurate information on all occasions. On occasions, you may experience additional delay as a result of using SUNA Products and/or Services. You acknowledge that it is not intended, or suitable, for use in applications where time of arrival or driving directions may impact the safety of the public or yourself.

### 4. Use of SUNA Products and Services while driving

You, and other authorized drivers of the vehicle in which SUNA Products and/or Services are available or installed and active, remain at all times responsible for observing all relevant laws and codes of safe driving. In particular, you agree to only actively operate SUNA Products and/or Services when the Vehicle is at a complete stop and it is safe to do so.

### 5. Service Continuity and Reception of the SUNA Traffic Channel

# Customer Information

We will use reasonable endeavors to provide the SUNA Traffic Channel 24 hours a day, 365 days a year. The SUNA Traffic Channel may occasionally be unavailable for technical reasons or for planned maintenance. We will try to perform maintenance at times when congestion is light. We reserve the right to withdraw SUNA Products and/or Services at any time.

Also, we cannot assure the uninterrupted reception of the SUNA Traffic Channel RDS-TMC signal at any particular location.

## 6. Limitation of Liability

Neither Intelematics (nor its suppliers or the manufacturer of your device (the “Suppliers”)) shall be liable to you or to any third party for any damages either direct, indirect, incidental, consequential or otherwise arising out of the use of or inability to use SUNA Products and/or Services even if Intelematics or a Supplier has been advised of the possibility of such damages. You also acknowledge that the neither Intelematics nor any Supplier guarantees nor make any warranties that relate to the availability, accuracy or completeness of SUNA Products

and/or Services, and to the extent which it is lawful to do so, both Intelematics and each Supplier excludes any warranties which might otherwise be implied by any State or Federal legislation in relation to SUNA Products and/or Services.

## 7. Please Note

Great care has been taken in preparing this manual. Constant product development may mean that some information is not entirely up-to-date. The information in this document is subject to change without notice.

## EMISSION LAW



**WARNING:** Do not remove or alter the original equipment floor covering or insulation between it and the metal floor of the vehicle. The floor covering and insulation protect occupants of the vehicle from the engine and exhaust system heat

and noise. On vehicles with no original equipment floor covering insulation, do not carry passengers in a manner that permits prolonged skin contact with the metal floor. Failure to follow these instructions may result in fire or personal injury.

U.S. federal laws and certain state laws prohibit removing or rendering inoperative emission control system components. Similar federal or provincial laws may apply in Canada. We do not approve of any vehicle modification without first determining applicable laws.



Tampering with emissions control systems including related sensors or the Diesel Exhaust Fluid system can result in reduced engine power and the illumination of the service engine soon light.

# Customer Information

---

## Tampering With a Noise Control System

Federal laws prohibit the following acts:

- Removal or rendering inoperative by any person other than for purposes of maintenance.
- Repair or replacement of any device or element of the design incorporated into a new vehicle for the purpose of noise control prior to its sale or delivery to the ultimate purchaser or while it is in use.
- The use of the vehicle after any person removes or renders inoperative any device or element of the design.

The U.S. Environmental Protection Agency may presume to constitute tampering as follows:

- Removal of hood blanket, fender apron absorbers, fender apron barriers, underbody noise shields or acoustically absorptive material.
- Tampering or rendering inoperative the engine speed governor, to allow engine speed to exceed manufacturer specifications.

If the engine does not start, runs rough, experiences a decrease in engine performance, experiences excess fuel consumption or produces excessive exhaust smoke, check for the following:

- A plugged or disconnected air inlet system hose.
- A plugged engine air filter element.
- Water in the fuel filter and water separator.
- A clogged fuel filter.
- Contaminated fuel.
- Air in the fuel system, due to loose connections.
- An open or pinched sensor hose.
- Incorrect engine oil level.
- Incorrect fuel for climatic conditions.
- Incorrect engine oil viscosity for climatic conditions.

**Note:** *Some vehicles have a lifetime fuel filter that is integrated with the fuel tank. Regular maintenance or replacement is not needed.*

**Note:** *If these checks do not help you correct the concern, have your vehicle checked as soon as possible.*

## Noise Emissions Warranty, Prohibited Tampering Acts and Maintenance

On January 1, 1978, Federal regulation became effective governing the noise emission on trucks over 10,000 lb (4,536 kg) Gross Vehicle Weight Rating (GVWR). The preceding statements concerning prohibited tampering acts and maintenance, and the noise warranty found in the Warranty Guide, are applicable to complete chassis cabs over 10,000 lb (4,536 kg) GVWR.

# Appendices

## ELECTROMAGNETIC COMPATIBILITY



**WARNING:** Do not place objects or mount equipment on or near the airbag cover, on the side of the front or rear seatbacks, or in areas that may come into contact with a deploying airbag. Failure to follow these instructions may increase the risk of personal injury in the event of a crash.



**WARNING:** Do not fasten antenna cables to vehicle wiring, fuel pipes and brake pipes.



**WARNING:** Keep antenna and power cables at least 4 in (10 cm) from any electronic modules and airbags.

**Note:** We test and certify your vehicle to meet electromagnetic compatibility legislation. It is your responsibility to make sure that any equipment an authorized dealer installs on your vehicle complies with applicable local legislation and other requirements. Installation of some aftermarket electronic devices could degrade the performance of vehicle functions, which use radio frequency signals such as broadcast radio receiver, tire pressure monitoring system, push button start, **Bluetooth**<sup>®</sup> connectivity or satellite navigation.

**Note:** Any radio frequency transmitter equipment in your vehicle (such as cellular telephones and amateur radio transmitters) must keep to the parameters in the following illustrations and table. We do not provide any other special provisions or conditions for installations or use.

# Appendices

---

## Car

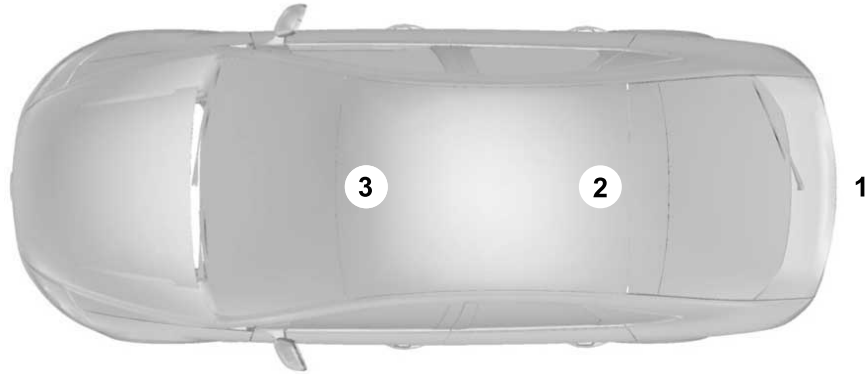

# Appendices

---

## Van



# Appendices

## Truck

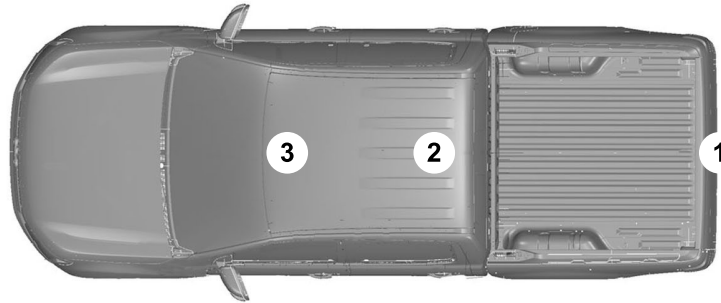

Frequency Band MHz	Maximum Output Power Watt (Peak RMS)	Antenna Positions
1-30	50	1
50-54	50	2, 3
68-88	50	2, 3

# Appendices

---

Frequency Band MHz	Maximum Output Power Watt (Peak RMS)	Antenna Positions
142-176	50	2, 3
380-512	50	2, 3
806-870	10	2, 3

**Note:** *After the installation of radio frequency transmitters, check for disturbances from and to all electrical equipment in your vehicle, both in the standby and transmit modes.*

Check all electrical equipment:

- With the ignition ON.
- With the vehicle running.
- During a road test at various speeds.

Check that electromagnetic fields generated inside your vehicle cabin by the transmitter installed do not exceed applicable human exposure requirements.



# Index

<b>1</b>		
12V Battery Gauge.....	141	
<b>3</b>		
360 Degree Camera.....	245	
360 Degree Camera Settings.....	247	
360 Degree Camera Guide Lines.....	246	
360 Degree Camera Limitations.....	246	
360 Degree Camera Precautions.....	245	
360 Degree Camera Settings.....	247	
Switching the 360 Degree Camera On and Off.....	247	
Switching the 360 Degree Camera View.....	248	
<b>9</b>		
911 Assist.....	74	
<b>A</b>		
A/C		
See: Climate Control.....	156	
About This Publication.....	17	
ABS		
See: Brakes.....	220	
Accessing Apps.....	449	
Accessing Navigation.....	454	
Accessing the Passive Key Backup Position.....	194	
Accessories.....	458	
Active Park Assist.....	249	
Active Park Assist – Troubleshooting.....	251	
Active Park Assist Precautions.....	249	
Active Park Assist – Troubleshooting.....	251	
Active Park Assist – Frequently Asked Questions.....	251	
Active Park Assist – Information Messages.....	251	
Adaptive Cruise Control.....	256	
Adaptive Cruise Control – Troubleshooting.....	266	
Lane Centering.....	263	
Adaptive Cruise Control Automatic Cancellation.....	260	
Adaptive Cruise Control Indicators.....	263	
Adaptive Cruise Control Limitations.....	257	
Adaptive Cruise Control Precautions.....	256	
Adaptive Cruise Control – Troubleshooting.....	266	
Adaptive Cruise Control – Information Messages.....	266	
Adaptive Front Lighting.....	127	
How Does Adaptive Front Lighting Work.....	127	
Switching Adaptive Front Lighting On and Off.....	128	
Adjusting the Exterior Mirrors.....	135	
Adjusting the Headlamps.....	355	
Adjusting the Instrument Panel Lighting Brightness.....	130	
Adjusting the Map.....	454	
Changing the Format of the Map.....	454	
Zooming the Map In and Out.....	454	
Adjusting the Seatbelt Height.....	57	
Adjusting the Seatbelts During Pregnancy.....	56	
Adjusting the Sound Settings.....	430	
Adjusting the Steering Wheel - Vehicles With: Manual Adjustable Steering Column.....	114	
Adjusting the Steering Wheel - Vehicles With: Power Adjustable Steering Column.....	114	
Adjusting the Volume.....	430	
Aid Mode.....	271	
How Does Aid Mode Work.....	271	
What Is Aid Mode.....	271	
Airbag Precautions.....	67	

# Index

Airbags.....64	Switching Ambient Lighting On and Off.....130	Auto-Dimming Exterior Mirror.....136
Front Passenger Sensing System.....68	Anti-Lock Braking System.....220	What Is the Auto-Dimming Exterior
Air Conditioning	Anti-Lock Braking System Limitations.....220	Mirror.....136
See: Climate Control.....156	Anti-Theft Alarm System.....110	Auto-Dimming Interior Mirror.....134
Air Conditioning System Capacity and	How Does the Anti-Theft Alarm System	Auto-Dimming Interior Mirror Limitations.....134
Specification - 2.0L.....416	Work.....110	What Is the Auto-Dimming Interior
Air Conditioning System Capacity and	What Are the Inclination Sensors.....110	Mirror.....134
Specification - 2.7L.....418	What Are the Interior Sensors.....110	Auto Hold.....228
Air Filter	What Is the Anti-Theft Alarm System.....110	Auto Hold Indicators.....229
See: Changing the Engine Air Filter.....351	What Is the Perimeter Alarm.....110	Autolamps.....122
Alert and Aid Mode.....272	Anti-Theft Alarm System Settings.....111	Autolamp Settings.....122
How Does Alert and Aid Mode Work.....272	Setting the Alarm Security Level.....111	What Are Autolamps.....122
What Is Alert and Aid Mode.....272	Switching Ask on Exit On and Off.....111	Autolock.....92
Alert Mode.....271	What are the Alarm Security Levels.....111	Autolock Requirements.....92
How Does Alert Mode Work.....271	What Is Ask on Exit.....111	What Is Autolock.....92
What Is Alert Mode.....271	Appendices.....556	Automatically Releasing the Electric
All-Wheel Drive.....218	Applying the Electric Parking Brake.....223	Parking Brake.....224
All-Wheel Drive – Troubleshooting.....219	Applying the Electric Parking Brake in an	Automatic Crash Shutoff.....319
All-Wheel Drive Limitations.....218	Emergency.....223	Automatic Crash Shutoff Precautions.....319
All-Wheel Drive Precautions.....218	App Precautions.....449	Re-Enabling Your Vehicle.....319
All-Wheel Drive – Troubleshooting.....219	App Requirements.....449	What Is Automatic Crash Shutoff.....319
All-Wheel Drive – Information	Apps.....449	Automatic Emergency Braking.....288
Messages.....219	Audio System.....429	Switching Automatic Emergency Braking On
AM/FM Radio.....431	AM/FM Radio.....431	and Off.....288
AM/FM Radio Limitations.....431	Digital Radio.....432	What Is Automatic Emergency Braking.....288
Selecting a Radio Station.....432	Satellite Radio.....434	Automatic Engine Stop.....193
Ambient Lighting.....130	Audio System Precautions.....429	How Does Automatic Engine Stop Work.....194
Adjusting Ambient Lighting.....130		Overriding Automatic Engine Stop.....194

# Index

Switching Automatic Engine Stop On and Off.....	194
What Is Automatic Engine Stop.....	193
Automatic High Beam Control.....	124
Automatic High Beam Control Indicators.....	126
Automatic High Beam Control Limitations.....	126
Automatic High Beam Control Precautions.....	125
Automatic High Beam Control Requirements.....	125
How Does Automatic High Beam Control Work.....	124
Overriding Automatic High Beam Control.....	126
Switching Automatic High Beam Control On and Off.....	126
Automatic High Beam Control – Troubleshooting.....	127
Automatic High Beam Control – Information Messages.....	127
Automatic Locking Mode.....	55
Disengaging Automatic Locking Mode.....	56
Engaging Automatic Locking Mode.....	56
What Is Automatic Locking Mode.....	55
Automatic Return to Park (P).....	213
Automatic Return to Park (P) Limitations.....	213
How Does Automatic Return to Park (P) Work.....	213
What Is Automatic Return to Park (P).....	213
Automatic Transmission Audible Warnings.....	216
Automatic Transmission.....	210
Automatic Return to Park (P).....	213
Automatic Transmission Positions.....	210
Automatic Transmission – Troubleshooting.....	216
Manually Shifting Gears.....	212
Manual Park Release.....	214
Temporary Neutral Mode.....	212
Automatic Transmission Position Indicators.....	211
Automatic Transmission Positions.....	210
Drive (D).....	211
Neutral (N).....	211
Park (P).....	210
Reverse (R).....	211
Sport (S).....	211
Automatic Transmission Precautions.....	210
Automatic Transmission – Troubleshooting.....	216
Automatic Transmission – Information Messages.....	216
Auto Mode.....	158
Auto Mode Indicators.....	158
Switching Auto Mode On and Off.....	158
Auto-Start-Stop.....	198
Auto-Start-Stop – Troubleshooting.....	199
Auto-Start-Stop Indicators.....	198
Auto-Start-Stop Precautions.....	198
Auto-Start-Stop – Troubleshooting.....	199
Auto-Start-Stop – Frequently Asked Questions.....	200
Auto-Start-Stop – Information Messages.....	199
Autounlock.....	91
Autounlock Requirements.....	91
Switching Autounlock On and Off.....	92
What Is Autounlock.....	91
Autowipers.....	116
Adjusting the Sensitivity of the Rain Sensor.....	117
Autowipers Settings.....	116
What Are Autowipers.....	116
AWD	
See: All-Wheel Drive.....	218
<b>B</b>	
Battery	
See: Changing the 12V Battery.....	353
Beginning a Voice Interaction.....	440

# Index

Blind Spot Information System.....277	Brake Fluid Specification.....221	Changing a Flat Tire.....397
Blind Spot Information System – Troubleshooting.....279	Brake Over Accelerator.....220	Changing a Road Wheel.....397
Blind Spot Information System Indicators.....279	Brake Precautions.....220	Changing the 12V Battery.....353
Blind Spot Information System Limitations.....277	Brakes.....220	Changing the Engine Air Filter.....351
Blind Spot Information System Precautions.....277	Anti-Lock Braking System.....220	Changing the Fuel Filter.....352
Blind Spot Information System Requirements.....278	Brakes – Troubleshooting.....221	Changing the Remote Control Battery.....77
Blind Spot Information System – Troubleshooting.....279	Brakes – Troubleshooting.....221	Changing the Vehicle Wi-Fi Hotspot Name or Password.....427
Blind Spot Information System – Information Messages.....279	Brakes – Frequently Asked Questions.....222	Charging a Device.....181
Bluetooth®.....448	Brakes – Information Messages.....222	Charging a Wireless Device.....186
Body Control Module Fuse Box.....333	Brakes – Warning Lamps.....221	Checking MyKey System Status.....88
Accessing the Body Control Module Fuse Box.....333	Breaking-In.....310	Checking the Brake Fluid.....220
Identifying the Fuses in the Body Control Module Fuse Box.....334	<b>C</b>	Checking the Coolant.....347
Locating the Body Control Module Fuse Box.....333	Calculating Payload.....296	Checking the Seatbelts.....61
Body Styling Kit Precautions.....368	Calculating the Load Limit.....296	Checking the Tire Pressures.....382
Body Styling Kits.....368	Canceling the Set Speed.....255	Checking the Wiper Blades.....118
Bonnet Lock	Capacities and Specifications.....404	Children and Airbags.....68
See: Opening and Closing the Hood.....339	Catalytic Converter.....208	Child Restraint Anchor Points.....40
Booster Seats.....49	Catalytic Converter – Troubleshooting.....209	Locating the Child Restraint Lower Anchor Points.....41
	Catalytic Converter Precautions.....208	Locating the Child Restraint Top Tether Anchor Points.....41
	Troubleshooting.....209	What Are the Child Restraint Anchor Points.....40
	Catalytic Converter – Warning Lamps.....209	Child Restraints.....41
	Center Console.....31	Child Restraint Position Information.....41
	Center Display Limitations.....437	Child Restraints Recommendation.....43
	Center Display Overview.....437	
	Center Display Precautions.....437	

# Index

Child Safety.....	39	Climate Control.....	156	Connecting a Trailer Precautions.....	302
Child Restraint Anchor Points.....	40	Auto Mode.....	158	Connecting the Vehicle to a Mobile	
Child Restraints.....	41	Climate Control – Troubleshooting.....	159	Network.....	423
Installing Child Restraints.....	44	Climate Control – Troubleshooting.....	159	Connecting Lincoln Way to the Modem.....	423
Child Safety Locks.....	52	Climate Control – Frequently Asked		Enabling and Disabling the Modem.....	423
Child Safety Precautions.....	39	Questions.....	159	What Is the Modem.....	423
Cleaning Products.....	362	Closing the Liftgate.....	105	Connecting the Vehicle to a Wi-Fi	
Cleaning the Exterior.....	363	Closing the Hands-Free Liftgate.....	106	Network.....	423
Cleaning Camera Lenses and Sensors.....	364	Closing the Liftgate From Inside Your		Connecting Your Phone.....	442
Cleaning Chrome, Aluminium or Stainless		Vehicle.....	105	Contacting Us.....	15
Steel.....	363	Closing the Liftgate From Outside Your		Cooling System Capacity and Specification	
Cleaning Headlamps and Rear Lamps.....	363	Vehicle.....	105	- 2.0L.....	413
Cleaning Stripes or Graphics.....	364	Closing the Liftgate Using the Remote		Cooling System Capacity and Specification	
Cleaning the Engine Compartment.....	364	Control.....	106	- 2.7L.....	414
Cleaning Wheels.....	364	Cold Weather Precautions.....	310	Crash and Breakdown Information.....	315
Cleaning Windows and Wiper Blades.....	363	Connected Vehicle.....	423	Automatic Crash Shutoff.....	319
Cleaning the Interior.....	365	Connected Vehicle – Troubleshooting.....	424	Jump Starting the Vehicle.....	316
Cleaning Carpets and Floor Mats.....	366	Connecting the Vehicle to a Mobile		Post-Crash Alert System.....	318
Cleaning Displays and Screens.....	365	Network.....	423	Crash Sensors and Airbag Indicator.....	72
Cleaning Fabric Seats and Headliners.....	366	Connected Vehicle Data.....	25	Creating a MyKey.....	86
Cleaning Leather and Vinyl.....	365	Connected Vehicle Limitations.....	423	Creating a Personal Profile.....	452
Cleaning Moonroof Tracks.....	367	Connected Vehicle Requirements.....	423	Creating a Vehicle Wi-Fi Hotspot.....	427
Cleaning Plastic.....	365	Connected Vehicle –		Cross Traffic Alert.....	280
Cleaning Seatbelts.....	366	Troubleshooting.....	424	Cross Traffic Alert – Troubleshooting.....	282
Cleaning Storage Compartments.....	367	Connected Vehicle – Frequently Asked		Cross Traffic Alert Indicators.....	281
Cleaning the Instrument Panel.....	365	Questions.....	424	Cross Traffic Alert Limitations.....	281
Clearing All MyKeys.....	87	Connecting a Bluetooth® Device.....	448	Cross Traffic Alert Precautions.....	280
Clearing the Garage Door Opener.....	179	Connecting a Trailer.....	302		

# Index

Cross Traffic Alert – Troubleshooting.....	282	Distance Alert.....	287	Drive Modes.....	268
Cross Traffic Alert – Information Messages.....	282	Adjusting the Sensitivity of Distance Alert.....	287	Comfort.....	268
Cruise Control.....	254	What Is Distance Alert.....	287	Normal.....	268
Cruise Control Indicators.....	255	Distance Indication.....	286	Sport.....	268
Cup Holders.....	188	Distance Indication Indicator.....	287	Driver Alert.....	291
Cup Holder Precautions.....	188	Switching Distance Indication On and Off.....	287	Driver Alert – Troubleshooting.....	292
Customer Information.....	476	What Is Distance Indication.....	286	Driver Alert Limitations.....	292
Radio Frequency Certification Labels.....	481	Doors and Locks Audible Warnings.....	92	Driver Alert Precautions.....	291
Customizing the Instrument Cluster Display.....	149	Doors and Locks.....	90	Driver Alert – Troubleshooting.....	292
<b>D</b>		Autolock.....	92	Driver Alert – Information Messages.....	292
Data Privacy.....	22	Autounlock.....	91	Driving Economically.....	310
Declaration of Conformity.....	480	Doors and Locks – Troubleshooting.....	93	Driving Hints.....	310
Department of Transportation Uniform Tire Quality Grades.....	371	Mislock.....	92	Driving in Special Conditions.....	311
Digital Radio.....	432	Operating the Doors From Inside Your Vehicle.....	91	Driving in Special Conditions.....	311
Digital Radio Indicators.....	433	Operating the Doors From Outside Your Vehicle.....	90	Driving In Sand.....	312
Digital Radio Limitations.....	433	Doors and Locks – Troubleshooting.....	93	Driving on Hilly or Sloping Terrain.....	312
How Does Digital Radio Work.....	433	Doors and Locks – Information Messages.....	93	Driving Through Mud and Water.....	311
Switching Digital Radio Reception On and Off.....	433	Doors and Locks – Warning Lamps.....	93	Emergency Maneuvers.....	311
What Is Digital Radio.....	432	Drive Belt Routing Overview - 2.0L.....	352	Driving Through Shallow Water.....	313
Directing the Flow of Air.....	157	Drive Belt Routing Overview - 2.7L.....	352	<b>E</b>	
Disposing of Airbags.....	73	Drive Mode Control.....	268	Easy Entry and Exit.....	101
		Drive Modes.....	268	Electric Parking Brake Audible Warning.....	224

# Index

Electric Parking Brake – Troubleshooting.....	224	Engine Oil Capacity and Specification - 2.0L.....	408	Changing a License Plate Lamp Bulb.....	361
Electric Parking Brake – Information Messages.....	225	Engine Oil Capacity and Specification - 2.7L.....	410	Exterior Bulb Specification Chart.....	358
Electric Parking Brake – Warning Lamps.....	224	Engine Oil.....	345	Removing a Headlamp Assembly.....	360
Electric Power Steering.....	234	Adding Engine Oil.....	346	Exterior Lamps.....	123
Electric Power Steering Precautions.....	234	Checking the Engine Oil Level.....	345	Exterior Lamp Audible Warning.....	124
Electromagnetic Compatibility.....	556	Engine Oil Capacity and Specification.....	347	Exterior Lamp Indicators.....	124
Emergency Call Limitations.....	75	Engine Oil Dipstick Overview.....	345	Switching the Daytime Running Lamps On and Off.....	123
Emergency Call Requirements.....	74	Resetting the Engine Oil Change Reminder.....	346	Switching the Front Fog Lamps On and Off.....	124
Emergency Call System Data.....	26	Engine Oil Pressure Gauge.....	141	Switching the Turn Signal Lamps On and Off.....	123
Emergency Towing.....	322	Engine Specifications - 2.0L.....	404	Switching Welcome Lighting On and Off.....	124
Emission Law.....	554	Engine Specifications - 2.7L.....	405	Exterior Lighting Control.....	121
Enabling Apps on an Android Device.....	449	Entering a Parallel Parking Space.....	249	Exterior Lighting.....	121
Enabling Apps on an iOS Device.....	449	Entering a Perpendicular Parking Space.....	250	Adaptive Front Lighting.....	127
Enabling or Disabling Personal Profiles.....	452	Evasive Steering Assist.....	288	Autolamps.....	122
Enabling Remote Start.....	153	Evasive Steering Assist Limitations.....	288	Automatic High Beam Control.....	124
End User License Agreement.....	524	Switching Evasive Steering Assist On and Off.....	289	Automatic High Beam Control – Troubleshooting.....	127
Engine Block Heater.....	192	What Is Evasive Steering Assist.....	288	Exterior Lamps.....	123
Engine Block Heater Precautions.....	192	Event Data.....	24	Headlamps.....	121
How Does the Engine Block Heater Work.....	192	Exiting a Parking Space.....	251	Headlamps – Troubleshooting.....	122
Using the Engine Block Heater.....	193	Extending the Remote Start Duration.....	154	Exterior Mirrors.....	135
Engine Coolant Temperature Gauge.....	141	Exterior Bulbs.....	358	Auto-Dimming Exterior Mirror.....	136
		Changing a Front Turn Signal Lamp Bulb.....	360		

# Index

## F

Fastening and Unfastening the Seatbelts.....	54
Feature Bar.....	438
Flat Tire See: Changing a Flat Tire.....	397
Floor Mats.....	313
Folding the Exterior Mirrors - Vehicles With: Manual Folding Mirrors.....	135
Folding the Exterior Mirrors - Vehicles With: Power Folding Mirrors.....	135
Front Exterior.....	35
Front Parking Aid.....	238
Front Parking Aid Audible Warnings.....	239
Front Parking Aid Limitations.....	238
Locating the Front Parking Aid Sensors.....	238
What is the Front Parking Aid.....	238
Front Passenger Sensing System.....	68
Front Passenger Sensing System Indicators.....	71
Front Passenger Sensing System Precautions.....	71
How Does the Front Passenger Sensing System Work.....	68
What Is the Front Passenger Sensing System.....	68
Front Seat Precautions.....	161

Front Seats.....	161
Heated Seats.....	166
Massage Seats.....	165
Power Seats.....	162
Ventilated Seats.....	166
Fuel and Refueling.....	201
Fuel and Refueling – Troubleshooting.....	207
Fuel Quality.....	202
Refueling.....	204
Running Out of Fuel.....	203
Fuel and Refueling Precautions.....	201
Fuel and Refueling – Troubleshooting.....	207
Fuel and Refueling – Information Messages.....	207
Fuel and Refueling – Warning Lamps.....	207
Fuel Gauge.....	140
Fuel Gauge Limitations.....	140
Locating the Fuel Filler Door.....	140
What Is Distance to Empty.....	141
What Is the Fuel Gauge.....	140
What Is the Low Fuel Reminder.....	140
Fuel Quality.....	202
Selecting the Correct Fuel.....	202
Fuel Tank Capacity.....	206
Fuse Precautions.....	323
Fuses.....	323
Body Control Module Fuse Box.....	333

Fuses – Troubleshooting.....	338
Under Hood Fuse Box.....	323
Fuses – Troubleshooting.....	338
Fuses – Frequently Asked Questions.....	338

## G

Garage Door Opener.....	176
Garage Door Opener Limitations.....	177
Garage Door Opener Precautions.....	176
Garage Door Opener Radio Frequencies.....	179
General Maintenance Information.....	463
Glasses Holder.....	189
Locating the Glasses Holder.....	189
Global Opening and Closing.....	132
Switching Global Closing On and Off.....	132
Switching Global Opening On and Off.....	132
Using Global Closing.....	132
Using Global Opening.....	132
What Is Global Opening and Closing.....	132
Glossary of Tire Terminology.....	377

## H

Headlamp Adjusting See: Adjusting the Headlamps.....	355
---	-----





# Index

Instrument Cluster Display.....145	Introduction.....17	Keyless Entry Settings.....94
Personalized Settings.....150	<b>J</b>	Keyless Entry – Troubleshooting.....96
Trip Computer.....147		Keyless Entry – Frequently Asked
Instrument Cluster Display Main		Questions.....96
Menu.....146	Jump Starting the Vehicle.....316	Keys and Remote Controls.....76
Instrument Cluster Indicators.....143	Jump Starting Precautions.....316	Keys and Remote Controls –
Instrument Cluster.....139	Jump Starting the Vehicle.....317	Troubleshooting.....80
Fuel Gauge.....140	Preparing the Vehicle.....317	Keys and Remote Controls –
Instrument Cluster Overview.....139	<b>K</b>	Troubleshooting.....80
Instrument Cluster Warning Lamps.....141		Keys and Remote Controls – Information
Instrument Panel.....29	Keyless Entry.....94	Messages.....80
Interior Air Quality.....160	Keyless Entry – Troubleshooting.....96	<b>L</b>
Interior Bulbs.....361	Locking and Unlocking the Doors Using	Lane Centering.....263
Interior Bulb Specification Chart.....361	Keyless Entry.....95	How Does Lane Centering Work.....263
Interior Lamp Function.....130	Keyless Entry Keypad.....97	Lane Centering Alerts.....265
Switching the Interior Lamp Function On and	Keyless Entry Keypad –	Lane Centering Automatic Cancellation.....265
Off.....130	Troubleshooting.....100	Lane Centering Indicators.....265
What Is the Interior Lamp Function.....130	Keyless Entry Keypad Limitations.....97	Lane Centering Limitations.....264
Interior Lighting.....129	Keyless Entry Keypad Master Access	Lane Centering Precautions.....264
Ambient Lighting.....130	Code.....97	Lane Centering Requirements.....264
Interior Lamp Function.....130	Keyless Entry Keypad Personal Access	Switching Lane Centering On and Off.....265
Interior Lighting – Troubleshooting.....130	Codes.....98	Lane Keeping System Indicators.....272
Interior Lighting – Troubleshooting.....130	Keyless Entry Keypad –	Lane Keeping System.....269
Interior Lighting – Frequently Asked	Troubleshooting.....100	Aid Mode.....271
Questions.....130	Keyless Entry Keypad – Frequently Asked	Alert and Aid Mode.....272
Interior Mirror.....134	Questions.....100	Alert Mode.....271
Auto-Dimming Interior Mirror.....134	Keyless Entry Limitations.....94	
Interior Mirror Precautions.....134		

# Index

Lane Keeping System – Troubleshooting.....	274	Live Traffic.....	454	Locating the Wireless Accessory Charger.....	186
Lane Keeping System Limitations.....	270	Switching Live Traffic On and Off.....	454	Locating Your Vehicle.....	77
Lane Keeping System Precautions.....	269	What Is Live Traffic.....	454	Locking and Unlocking the Doors Using Keyless Entry.....	95
Lane Keeping System Settings.....	271	Load Carrying.....	293	Unlocking the Doors.....	95
Lane Keeping System – Troubleshooting.....	274	Roof Rack.....	298	Locking the Rear Window Controls.....	133
Lane Keeping System – Frequently Asked Questions.....	275	Load Carrying Precautions.....	293	Luggage Compartment.....	300
Lane Keeping System – Information Messages.....	274	Loading Your Trailer.....	305		
Launching or Retrieving a Boat or Personal Watercraft.....	306	Locating the 360 Degree Cameras.....	246	<b>M</b>	
Liftgate.....	102	Locating the Blind Spot Information System Sensors.....	278	Maintenance.....	339
Closing the Liftgate.....	105	Locating the Brake Fluid Reservoir.....	220	Engine Oil.....	345
Liftgate – Troubleshooting.....	107	Locating the Cross Traffic Alert Sensors.....	281	Exterior Bulbs.....	358
Opening the Liftgate.....	102	Locating the Fuel Filler Funnel.....	202	Interior Bulbs.....	361
Liftgate Obstacle Detection.....	107	Locating the Keyless Entry Keypad.....	94	Maintenance Precautions.....	339
Liftgate Precautions.....	102	Locating the Memory Function Buttons.....	174	Making and Receiving a Phone Call.....	444
Liftgate – Troubleshooting.....	107	Locating the Power Outlets.....	183	Manually Releasing the Electric Parking Brake.....	223
Liftgate – Frequently Asked Questions.....	109	Locating the Pre-Collision Assist Sensors.....	285	Manually Shifting Gears.....	212
Liftgate – Information Messages.....	108	Locating the Rear View Camera.....	242	Shifting Using the Paddle Shifters.....	212
Liftgate – Warning Lamps.....	107	Locating the Safety Compliance Certification Labels.....	294	Manual Park Release.....	214
Lincoln Protect.....	460	Locating the Tire label.....	371	Manual Park Release Precautions.....	214
Linking or Unlinking a Personal Profile to a Device.....	453	Locating the Tire Sealant and Inflator Kit.....	385	Using Manual Park Release.....	214
Linking or Unlinking a Personal Profile to a Remote Control.....	453	Locating the USB Ports.....	181	What Is Manual Park Release.....	214
				Manual Seats.....	168
				Adjusting the Head Restraint.....	168
				Folding the Seat Backrest.....	169

# Index

Head Restraint Components.....	168
Installing the Head Restraint.....	169
Removing the Head Restraint.....	168
Unfolding the Seat Backrest.....	169
Massage Seats.....	165
Adjusting the Massage Seat Settings.....	165
Massage Seat Limitations.....	165
Memory Function.....	174
Memory Function Precautions.....	174
Mislock.....	92
Mislock Limitations.....	92
Switching Mislock On and Off.....	92
What Is Mislock.....	92
Mobile Communications Equipment.....	523
Mobile Device Data.....	25
Moonroof Bounce-Back.....	138
Overriding Moonroof Bounce-Back.....	138
What Is Moonroof Bounce-Back.....	138
Moonroof.....	137
Moonroof Bounce-Back.....	138
Motorcraft Parts - 2.0L.....	406
Motorcraft Parts - 2.7L.....	407
Muting the Audio.....	430
MyKey – Troubleshooting.....	88
MyKey™.....	85
Principle of Operation.....	85

## N

Navigation Map Updates.....	454
Navigation.....	454
Adjusting the Map.....	454
Live Traffic.....	454
Route Guidance.....	455
Setting a Destination.....	454
Waypoints.....	455
Normal Scheduled Maintenance.....	467

## O

Opening and Closing the Hood.....	339
Opening and Closing the Moonroof.....	137
Opening and Closing the Sun Shade.....	137
Opening and Closing the Windows.....	131
Opening the Liftgate.....	102
Opening the Hands-Free Liftgate.....	103
Opening the Liftgate From Inside Your Vehicle.....	102
Opening the Liftgate From Outside Your Vehicle.....	102
Opening the Liftgate Using the Remote Control.....	103

Operating the Doors From Inside Your Vehicle.....	91
Individually Unlocking and Locking the Doors Using the Locking Button.....	91
Opening the Doors From Inside Your Vehicle.....	91
Operating the Doors From Outside Your Vehicle.....	90
Individually Unlocking and Locking the Doors Using the Key Blade.....	90
Unlocking and Locking the Doors Using the Key Blade.....	90
Unlocking and Locking the Doors Using the Remote Control.....	90
Ordering a Canadian French Owner's Manual.....	478
Overriding the Set Speed.....	262

## P

Parking Aid Indicators.....	240
Parking Aid Precautions.....	236
Parking Aids.....	236
Front Parking Aid.....	238
Parking Aids – Troubleshooting.....	240
Rear Parking Aid.....	237
Side Parking Aid.....	239

# Index

Parking Aids – Troubleshooting.....	240
Parking Aids – Information Messages.....	240
Passive Anti-Theft System.....	110
How Does the Passive Anti-Theft System Work.....	110
What Is the Passive Anti-Theft System.....	110
Perchlorate.....	523
Performing a Master Reset.....	457
Personalized Settings.....	150
Changing the Instrument Cluster Display Language.....	150
Changing the Measurement Unit.....	150
Changing the Temperature Unit.....	151
Changing the Tire Pressure Unit.....	152
Personal Profiles.....	452
Personal Safety System Components.....	63
Personal Safety System™.....	63
Phone as a Key Limitations.....	81
Phone as a Key.....	81
Phone as a Key – Troubleshooting.....	83
Phone as a Key – Troubleshooting.....	83
Phone as a Key – Frequently Asked Questions.....	83
Phone Menu.....	442
Phone.....	442
Phone Precautions.....	442
Playing Media Using Bluetooth®.....	448
Playing Media Using the USB Port.....	181
Playing or Pausing the Audio Source.....	429
Post-Crash Alert System.....	318
How Does the Post-Crash Alert System Work.....	318
Post-Crash Alert System Limitations.....	319
Switching the Post-Crash Alert System Off.....	319
What Is the Post-Crash Alert System.....	318
Power Outlet Indicators.....	183
Power Outlet.....	183
Power Outlet Precautions.....	183
Power Seats.....	162
Adjusting the Head Restraint.....	162
Adjusting the Lumbar Support.....	165
Adjusting the Seat Backrest.....	164
Adjusting the Seat Cushion.....	164
Adjusting the Seat Height.....	165
Folding the Seat Backrest.....	170
Head Restraint Components.....	162
Installing the Head Restraint.....	163
Moving the Seat Backward and Forward.....	163
Removing the Head Restraint.....	163
Unfolding the Seat Backrest.....	170
Pre-Collision Assist Limitations.....	284
Pre-Collision Assist Precautions.....	284
Pre-Collision Assist.....	283
Automatic Emergency Braking.....	288
Distance Alert.....	287
Distance Indication.....	286
Evasive Steering Assist.....	288
Pre-Collision Assist – Troubleshooting.....	289
Pre-Collision Assist – Troubleshooting.....	289
Pre-Collision Assist – Frequently Asked Questions.....	290
Pre-Collision Assist – Information Messages.....	289
Preparing Your Vehicle for Storage.....	369
Programming the Garage Door Opener to Your Garage Door Opener Motor.....	178
Programming the Garage Door Opener to Your Gate Opener Motor.....	178
Programming the Garage Door Opener to Your Hand-Held Transmitter.....	177
Programming the Remote Control.....	78
Programming Your Phone.....	81
Properly Adjusting the Driver and Front Passenger Seats.....	68
Puncture	
See: Changing a Flat Tire.....	397
Push Button Ignition Switch.....	190

# Index

## R

Radio Frequency Certification		
Labels.....	481	
Blind Spot Information System Sensors.....	481	
Body Control Module.....	489	
Cruise Control Module.....	492	
Garage Door Opener.....	496	
Keys and Remote Controls.....	497	
Radio Transceiver Module.....	501	
Remote Function Actuator.....	489	
SYNC.....	504	
Telematics Control Unit.....	509	
Tire Pressure Monitoring System		
Sensors.....	510	
Wireless Accessory Charging Module.....	519	
Rear Exterior.....	37	
Rear Occupant Alert System Audible		
Warnings.....	173	
Rear Occupant Alert System		
Indicators.....	173	
Rear Occupant Alert System		
Limitations.....	172	
Rear Occupant Alert System		
Precautions.....	172	
Rear Occupant Alert System.....	172	
Rear Parking Aid.....	237	
Locating the Rear Parking Aid Sensors.....	237	
Rear Parking Aid Audible Warnings.....	238	
Rear Parking Aid Limitations.....	237	
What is the Rear Parking Aid.....	237	
Rear Seats.....	168	
Heated Seats.....	170	
Manual Seats.....	168	
Power Seats.....	170	
Rear View Camera Guide Lines.....	242	
Rear View Camera Object Distance		
Indicators.....	243	
Rear View Camera Precautions.....	242	
Rear View Camera.....	242	
Rear View Camera Settings.....	243	
Rear View Camera Settings.....	243	
Switching Rear View Camera Delay On and		
Off.....	244	
Zooming the Rear View Camera In and		
Out.....	243	
Recalling a Preset Position.....	174	
Recreationally Towing Your Vehicle - 2.0L,		
AWD.....	321	
Recreationally Towing Your Vehicle - 2.0L,		
FWD.....	321	
Recreationally Towing Your Vehicle -		
2.7L.....	321	
Reduced Engine Performance.....	310	
Refueling.....	204	
Manually Opening the Fuel Filler Door.....	206	
Refueling System Overview.....	204	
Refueling Your Vehicle.....	204	
Releasing the Electric Parking Brake if the		
Vehicle Battery Has Run Out of		
Charge.....	224	
Remote Control Limitations.....	76	
Remotely Starting and Stopping the		
Vehicle.....	153	
Remote Start Limitations.....	153	
Remote Start Precautions.....	153	
Remote Start Remote Control		
Indicators.....	154	
Remote Start.....	153	
Remote Start Settings.....	154	
Remote Start Settings.....	154	
Setting the Remote Start Duration.....	155	
Switching Climate Control Last Settings On		
and Off.....	154	
Switching the Heated Seat Settings On and		
Off.....	154	
Switching the Heated Steering Wheel Settings		
On and Off.....	155	
Removing Your Vehicle From		
Storage.....	370	
Repairing Minor Paint Damage.....	367	
Replacement Parts		
Recommendation.....	523	

# Index

Replacing a Lost Key or Remote Control.....	78	Canceling Route Guidance.....	455	Seatbelts.....	53
Replacing the Cabin Air Filter.....	160	Running-In		Automatic Locking Mode.....	55
Replacing the Front Wiper Blades.....	118	See: Breaking-In.....	310	Seatbelt Reminder.....	57
Replacing the Rear Wiper Blades.....	118	Running Out of Fuel.....	203	Sensitive Locking Mode.....	55
Reporting Safety Defects in Canada.....	479	Adding Fuel From a Portable Fuel Container.....	203	Security.....	110
Reporting Safety Defects in the United States.....	478	Filling a Portable Fuel Container.....	203	Anti-Theft Alarm System.....	110
Reprogramming the Garage Door Opener.....	179			Anti-Theft Alarm System Settings.....	111
Resetting the Stopping Position - Vehicles With: Power Adjustable Steering Column.....	115			Passive Anti-Theft System.....	110
Resetting Tire Pressure Monitoring System.....	394	<b>S</b>		Security – Troubleshooting.....	112
Restarting the Engine.....	198	Satellite Radio.....	434	Security – Troubleshooting.....	112
Resuming the Set Speed.....	255	Locating the Satellite Radio Identification Number.....	434	Security – Frequently Asked Questions.....	113
Reverse Wipe.....	117	Satellite Radio Limitations.....	434	Security – Information Messages.....	112
Reverse Wipe Settings.....	117	Satellite Radio Settings.....	435	Selecting a Drive Mode.....	268
What Is Reverse Wipe.....	117	Selecting a Channel.....	434	Selecting the Audio Source.....	429
Roadside Assistance.....	315	Setting an Alert.....	436	Sending and Receiving a Text Message.....	446
Rollover Warning.....	476	What Is Satellite Radio.....	434	Sensitive Locking Mode.....	55
Roof Rack.....	298	Saving a Preset Position.....	174	How Does Sensitive Locking Mode Work.....	55
Roof Rack Load Capacities.....	298	Scheduled Maintenance.....	463	What is Sensitive Locking Mode.....	55
Roof Rack Precautions.....	298	Seatbelt Extensions.....	61	Service Data.....	23
Route Guidance.....	455	Seatbelt Precautions.....	53	Setting a Destination.....	454
Adjusting the Guidance Prompt		Seatbelt Reminder.....	57	Setting a Destination Using a Point of Interest.....	455
Volume.....	455	How Does the Seatbelt Reminder Work.....	57	Setting a Destination Using a Predictive Destination.....	455
		Seatbelt Reminder Audible Warnings.....	60	Setting a Destination Using a Recent Destination.....	455
		Seatbelt Reminder Indicators.....	59		
		Switching the Seatbelt Reminder On and Off.....	60		

# Index

Setting a Destination Using a Saved Destination.....	455	Speed Control		Starting a Gasoline Engine.....	191
Setting a Destination Using the Map Screen.....	455	See: Cruise Control.....	254	Status Bar.....	437
Setting a Destination Using the Text Entry Screen.....	454	Speedometer.....	140	Steering.....	234
Setting a Memory Preset.....	430	Stability Control Indicator.....	232	Electric Power Steering.....	234
Settings Data.....	24	Stability Control.....	231	Steering – Troubleshooting.....	235
Setting the Adaptive Cruise Control Gap.....	261	Stability Control – Troubleshooting.....	233	Steering – Troubleshooting.....	235
Setting the Adaptive Cruise Control Speed.....	260	Stability Control – Troubleshooting.....	233	Steering – Information Messages.....	235
Setting the Blower Motor Speed.....	157	Stability Control – Information Messages.....	233	Steering Wheel.....	27
Setting the Clock and Date.....	431	Starting and Stopping the Engine – Precautions.....	190	Stopping the Engine.....	198
Setting the Cruise Control Speed.....	254	Starting and Stopping the Engine.....	190	Stopping the Engine When Your Vehicle is Moving.....	193
Setting the Liftgate Opening Height.....	104	Automatic Engine Stop.....	193	Stopping the Engine When Your Vehicle is Stationary.....	193
Setting the Temperature.....	157	Engine Block Heater.....	192	Stopping the Liftgate Movement.....	107
Setting the Wake Word.....	440	Starting and Stopping the Engine – Troubleshooting.....	195	Storage.....	188
Shifting Your Vehicle Into Gear.....	211	Starting the Engine.....	191	Cup Holders.....	188
Side Parking Aid.....	239	Stopping the Engine.....	193	Glasses Holder.....	189
Locating the Side Parking Aid Sensors.....	240	Starting and Stopping the Engine – Troubleshooting.....	195	Under Floor Storage.....	188
Side Parking Aid Audible Warnings.....	240	Starting and Stopping the Engine – Frequently Asked Questions.....	197	Storing Your Vehicle.....	369
Side Parking Aid Limitations.....	239	Starting and Stopping the Engine – Information Messages.....	196	Sunroof	
What is the Side Parking Aid.....	239	Starting and Stopping the Engine – Warning Lamps.....	195	See: Moonroof.....	137
Sitting in the Correct Position.....	161	Starting the Engine.....	191	Switching Active Park Assist On and Off.....	249
Sounding the Panic Alarm.....	77	Restarting the Engine After Stopping it.....	191	Switching Adaptive Cruise Control On and Off.....	259
Special Operating Conditions Scheduled Maintenance.....	471			Switching Air Conditioning On and Off.....	156



# Index

Switching All of the Interior Lamps On and Off.....	129
Switching Android Auto On and Off.....	450
Switching Apple CarPlay On and Off.....	450
Switching Auto Hold On and Off.....	228
Switching Auto-Start-Stop On and Off.....	198
Switching Blind Spot Information System On and Off.....	278
Switching Climate Control On and Off.....	156
Switching Cross Traffic Alert On and Off.....	281
Switching Cruise Control On and Off.....	254
Switching Driver Alert On and Off.....	292
Switching Easy Entry and Exit On and Off.....	101
Switching From Adaptive Cruise Control to Cruise Control.....	263
Switching Maximum Cooling On and Off.....	156
Switching Maximum Defrost On and Off.....	156
Switching Parking Aid On and Off.....	237
Switching Rear Occupant Alert System On and Off.....	173
Switching Recirculated Air On and Off.....	156
Switching Repeat Mode On and Off.....	430
Switching Shuffle Mode On and Off.....	430
Switching Stability Control On and Off.....	232
Switching Text Message Notification On and Off.....	447
Switching the Audio Unit On and Off.....	429
Switching the Display On and Off.....	432
Switching the Front Interior Lamps On and Off.....	129
Switching the Hazard Flashers On and Off.....	316
Switching the Heated Mirrors On and Off.....	157
Switching the Heated Rear Window On and Off.....	157
Switching the Heated Steering Wheel On and Off.....	115
Switching the Lane Keeping System Mode.....	270
Switching the Lane Keeping System On and Off.....	270
Switching the Rear Interior Lamps On and Off.....	129
Switching the Rear Window Wiper On and Off.....	117
Switching Traction Control On and Off.....	230
Switching Trailer Sway Control On and Off.....	309
Symbols Glossary.....	19
Symbols Used on Your Vehicle.....	19
<b>T</b>	
Tachometer.....	140
Technical Specifications See: Capacities and Specifications.....	404
Temporary Neutral Mode.....	212
Entering Temporary Neutral Mode.....	213
Exiting Temporary Neutral Mode.....	213
Temporary Neutral Mode Limitations.....	212
What Is Temporary Neutral Mode.....	212
The Better Business Bureau Auto Line Program.....	476
The Mediation and Arbitration Program.....	477
Tire Care.....	382
Tire Pressure Monitoring System Limitations.....	393
Tire Pressure Monitoring System Overview.....	392

# Index

Tire Pressure Monitoring System		
Precautions.....	393	
Tire Pressure Monitoring System.....	392	
Tire Pressure Monitoring System – Troubleshooting.....	395	
Tire Pressure Monitoring System – Troubleshooting.....	395	
Tire Pressure Monitoring System – Information Messages.....	396	
Tire Pressure Monitoring System – Warning Lamps.....	395	
Tire Replacement Requirements.....	377	
Tire Rotation.....	384	
Tire Sealant and Inflator Kit		
Components.....	386	
Tire Sealant and Inflator Kit		
Precautions.....	385	
Tire Sealant and Inflator Kit.....	385	
Towing a Trailer Limitations.....	305	
Towing a Trailer Precautions.....	304	
Towing a Trailer.....	304	
Towing Weights and Dimensions.....	307	
Towing Weights and Dimensions.....	307	
Calculating the Maximum Loaded Trailer Weight for Your Vehicle.....	308	
Recommended Towing Weights.....	307	
What Is the Maximum Loaded Trailer Weight.....	308	
Towing Your Vehicle Precautions.....	321	
Towing Your Vehicle.....	321	
Traction Control Indicator.....	230	
Traction Control.....	230	
Traction Control – Troubleshooting.....	230	
Traction Control – Troubleshooting.....	230	
Traction Control – Warning Lamps.....	230	
Trailer Brake Precautions.....	304	
Trailer Sway Control Precautions.....	309	
Trailer Sway Control.....	309	
Trailer Towing Hints.....	305	
Transmission Fluid Temperature Gauge.....	141	
Transporting the Vehicle.....	319	
Trip Computer.....	147	
Accessing the Trip Computer.....	147	
Resetting the Individual Trip Values.....	149	
Resetting the Trip Computer.....	148	
<b>U</b>		
Under Floor Storage.....	188	
Locating the Rear Under Floor Storage.....	188	
Under Hood Fuse Box.....	323	
Accessing the Under Hood Fuse Box.....	323	
Identifying the Fuses in the Under Hood Fuse Box.....	325	
Locating the Under Hood Fuse Box.....	323	
Under Hood Overview - 2.0L.....	341	
Under Hood Overview - 2.7L.....	343	
Updating the Vehicle Systems		
Wirelessly.....	456	
USB Ports.....	181	
Using Auto Hold.....	228	
Using Keyless Entry.....	94	
Using MyKey With Remote Start Systems.....	88	
Using Snow Chains.....	380	
Using the Backup Start Passcode.....	82	
Using the Instrument Cluster Display Controls.....	145	
Using the Keyless Entry Keypad.....	99	
Using the Remote Control.....	76	
Using the Tire Sealant and Inflator Kit.....	386	
Using the Valet Mode.....	82	
Using This Publication.....	18	
<b>V</b>		
Vehicle Care.....	362	
Cleaning the Exterior.....	363	
Cleaning the Interior.....	365	
Vehicle Identification Number.....	422	
Locating the Vehicle Identification Number.....	422	

# Index

Vehicle Identification Number Overview.....	422	Washer Precautions.....	119	What Is the Catalytic Converter.....	208
Vehicle Identification.....	422	Washers See: Wipers and Washers.....	116	What Is the Electric Parking Brake.....	223
Vehicle Identification Number.....	422	Waxing.....	365	What Is the Garage Door Opener.....	176
Vehicle Interior.....	33	Waypoints.....	455	What Is the Gross Axle Weight Rating.....	294
Vehicle System Updates.....	456	Adding a Waypoint.....	455	What Is the Gross Combined Weight Rating.....	294
Vehicle Wi-Fi Hotspot.....	427	Editing Waypoints.....	455	What Is the Gross Vehicle Weight Rating.....	294
Ventilated Seats.....	166	What Are the Instrument Cluster Indicators.....	143	What Is the Keyless Entry Keypad.....	97
Switching the Ventilated Seats On and Off.....	166	What Are the Instrument Cluster Warning Lamps.....	141	What Is the Lane Keeping System.....	269
Ventilation See: Climate Control.....	156	What Is 911 Assist.....	74	What Is the Maximum Loaded Trailer Weight.....	294
Venting the Moonroof.....	138	What Is a Connected Vehicle.....	423	What Is the Personal Safety System.....	63
Viewing the Tire Pressures.....	394	What Is Active Park Assist.....	249	What Is the Power Outlet.....	183
Visual Search.....	27	What Is Auto-Start-Stop.....	198	What Is the Rear Occupant Alert System.....	172
Voice Interaction Examples.....	440	What Is Blind Spot Information System.....	277	What Is the Rear View Camera.....	242
Voice Interaction.....	440	What Is Cross Traffic Alert.....	280	What Is the Tire Pressure Monitoring System.....	392
<b>W</b>		What Is Cruise Control.....	254	What Is the Tire Sealant and Inflator Kit.....	385
Washer Fluid Specification.....	419	What Is Drive Mode Control.....	268	What Is the Wireless Accessory Charger.....	186
Washers.....	119	What Is Driver Alert.....	291	What is Voice Interaction.....	440
Adding Washer Fluid.....	120	What Is Hill Start Assist.....	227	Wheel and Tire Information.....	371
Switching the Courtesy Wipe On and Off.....	119	What Is Lincoln Protect.....	460	Wheel Nuts.....	402
Using the Rear Window Washer.....	119	What Is Phone As a Key.....	81		
Using the Windshield Washer.....	119	What Is Pre-Collision Assist.....	283		
Washer Fluid Specification.....	120	What Is Remote Start.....	153		
		What Is the 360 Degree Camera.....	245		
		What Is the Cabin Air Filter.....	160		

# Index

---

Wi Fi	
See: Changing the Vehicle Wi-Fi Hotspot Name or Password.....	427
See: Connecting the Vehicle to a Wi-Fi Network.....	423
See: Creating a Vehicle Wi-Fi Hotspot.....	427
See: Vehicle Wi-Fi Hotspot.....	427
Window Bounce-Back.....	132
Overriding Window Bounce-Back.....	133
What Is Window Bounce-Back.....	132
Windows.....	131
Global Opening and Closing.....	132
Window Bounce-Back.....	132
Wipers and Washers – Troubleshooting.....	120
Wipers and Washers – Frequently Asked Questions.....	120
Wipers and Washers – Warning Lamps.....	120
Wipers and Washers.....	116
Autowipers.....	116
Reverse Wipe.....	117
Washers.....	119
Wipers.....	116
Wipers and Washers – Troubleshooting.....	120
Wipers.....	116
Switching Windshield Wipers On and Off.....	116
Wiper Precautions.....	116
Wireless Accessory Charger Precautions.....	186
Wireless Accessory Charger.....	186



, Edition date: 202108