

FORD **MUSTANG** Owner's Manual

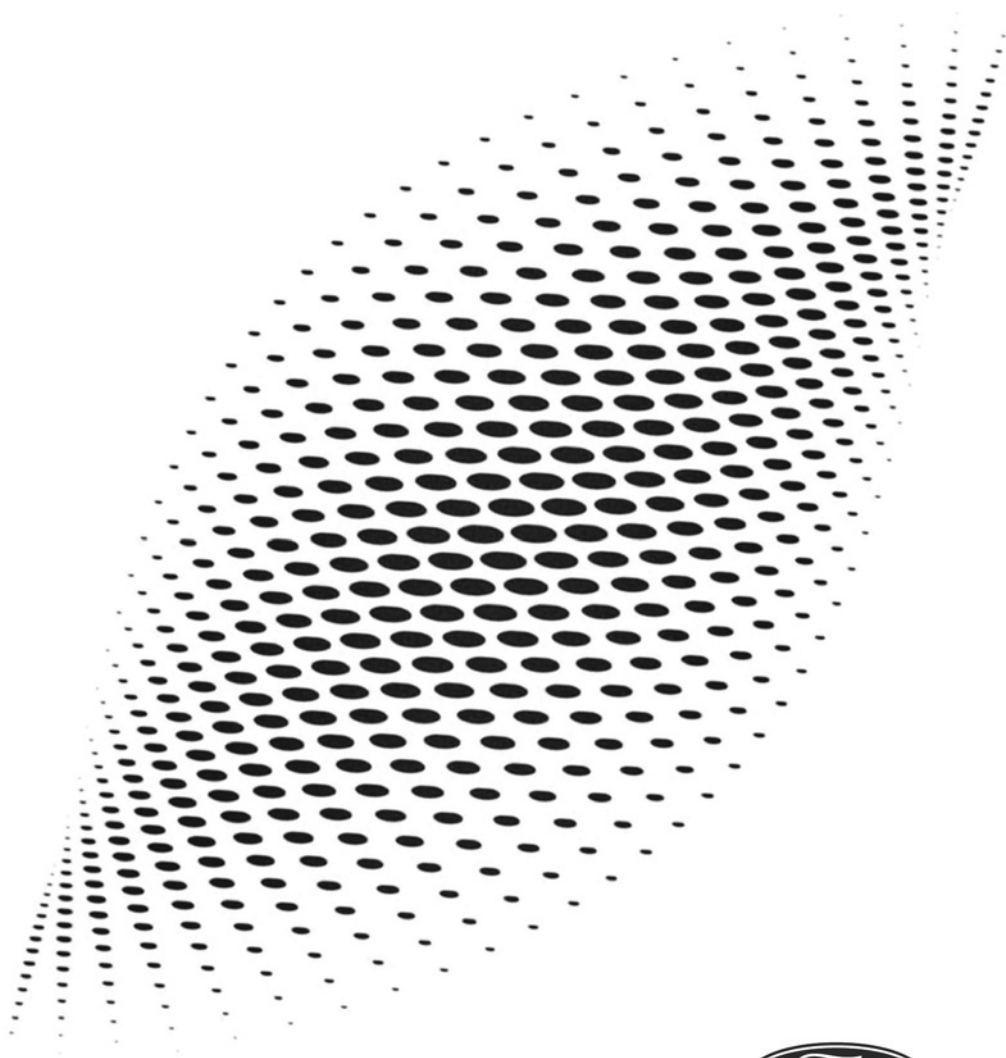

The information contained in this publication was correct at the time of release. In the interest of continuous development, we reserve the right to change specifications, design or equipment at any time without notice or obligation. No part of this publication may be reproduced, transmitted, stored in a retrieval system or translated into any language in any form by any means without our written permission. Errors and omissions excepted.

© Ford Motor Company 2024

All rights reserved.

Part Number: -202407-20240711145251

California Proposition 65



WARNING: Operating, servicing and maintaining a passenger vehicle or off-highway motor vehicle can expose you to chemicals including engine exhaust, carbon monoxide, phthalates, and lead, which are known to the State of California to cause cancer and birth defects or other reproductive harm. To minimize exposure, avoid breathing exhaust, do not idle the engine except as necessary, service your vehicle in a well-ventilated area and wear gloves or wash your hands frequently when servicing your vehicle. For more information go to www.P65Warnings.ca.gov/passenger-vehicle.



WARNING: Battery posts, terminals and related accessories contain lead and lead compounds, chemicals known to the State of California to cause cancer and reproductive harm.
Wash your hands after handling.

Table of Contents

Contacting Us

Contacting Us	15
---------------------	----

Introduction

About This Publication	17
Using This Publication	18

Symbols Glossary

Symbols Used on Your Vehicle	19
Symbols Used On Your Instrument Cluster	21

Data Privacy

Data Privacy	25
Service Data	26
Event Data	26
Settings Data	27
Connected Vehicle Data	27
Mobile Device Data	28
Emergency Call System Data	28

Environment

Protecting the Environment	29
----------------------------------	----

Visual Search

Interior Overview	30
Exterior Overview	31

Child Safety

Child Safety Precautions	32
Child Restraint Anchor Points	33
Child Restraints	34
Installing Child Restraints	35
Booster Seats	40

Seatbelts

Seatbelt Precautions	43
Fastening and Unfastening the Seatbelts	44
Sensitive Locking Mode	45

Automatic Locking Mode	46
Adjusting the Seatbelts During Pregnancy	47
Seatbelt Reminder	47
Checking the Seatbelts	49
Seatbelt Extensions	49

Personal Safety System™

What Is the Personal Safety System	50
How Does the Personal Safety System Work	50
Personal Safety System Components	50

Airbags

How Do the Front Airbags Work	51
How Do the Side Airbags Work	51
How Do the Knee Airbags Work	52
How Does the Safety Canopy™ Work - Coupe	53
Airbag Precautions	54
Properly Adjusting the Driver and Front Passenger Seats	54
Children and Airbags	55
Front Passenger Sensing System	55
Crash Sensors and Airbag Indicator	58
Disposing of Airbags	59

911 Assist

What Is 911 Assist	60
How Does 911 Assist Work	60
Emergency Call Requirements	60
Emergency Call Limitations	61

Keys and Remote Controls

Remote Control Limitations	62
Using the Remote Control	62
Removing the Key Blade	63
Sounding the Panic Alarm	63
Locating Your Vehicle	63

Table of Contents

Changing the Remote Control Battery	63
Replacing a Lost Key or Remote Control	65
Programming the Remote Control	65
Keys and Remote Controls Audible Warnings	66
Using the Valet Mode	66
Remote Rev	67
Keys and Remote Controls – Troubleshooting	68

Doors and Locks

Operating the Doors From Outside Your Vehicle	69
Operating the Doors From Inside Your Vehicle	70
Autounlock	70
Autolock	70
Mislock	70
Doors and Locks Audible Warnings	71
Doors and Locks – Troubleshooting	71

Keyless Entry

What Is Keyless Entry	73
Keyless Entry Limitations	73
Keyless Entry Settings	73
Using Keyless Entry	73

Easy Entry and Exit - Vehicles With: Driver Memory Seat

How Does Easy Entry and Exit Work	75
Switching Easy Entry and Exit On and Off	75

Security

Passive Anti-Theft System	76
Anti-Theft Alarm System	76
Anti-Theft Alarm System Settings	77
Security – Troubleshooting	78

Steering Wheel

Using the Controls on the Steering Wheel	80
Adjusting the Steering Wheel	80
Horn	81
Switching the Heated Steering Wheel On and Off - Vehicles With: Heated Steering Wheel	81

Wipers and Washers

Wipers	82
Autowipers	82
Checking the Wiper Blades	83
Replacing the Front Wiper Blades	83
Washers	84
Wipers and Washers Videos	85
Wipers and Washers – Troubleshooting	86

Exterior Lighting

Exterior Lighting Control	87
Headlamps	87
Headlamps – Troubleshooting	88
Autolamps	88
Exterior Lamps	89
Automatic High Beam Control	90
Automatic High Beam Control – Troubleshooting	92

Interior Lighting

Switching All of the Interior Lamps On and Off	93
Switching the Front Interior Lamps On and Off	93
Interior Lamp Function	93
Adjusting the Instrument Panel Lighting Brightness	93
Ambient Lighting	93
Interior Lighting – Troubleshooting	94

Table of Contents

Windows

Opening and Closing the Windows - Convertible	95
Opening and Closing the Windows - Coupe	96
Global Opening	96
Window Bounce-Back	97
Using Short Drop Windows	97

Interior Mirror

Interior Mirror Precautions	99
Auto-Dimming Interior Mirror	99

Exterior Mirrors

Adjusting the Exterior Mirrors	100
Folding the Exterior Mirrors	100
Auto-Dimming Exterior Mirror	100

Instrument Cluster

Instrument Cluster Overview	101
Tachometer	101
Speedometer	101
Fuel Gauge	102
Engine Coolant Temperature Gauge	102

Instrument Cluster Display

Using the Instrument Cluster Display Controls	103
Customizing the Instrument Cluster Display	103

Trip Computer

Accessing the Trip Computer	104
Resetting the Trip Computer	104
Configuring the Trip Computer	104

Remote Start

Using Remote Start - Vehicles With: Ford Mobile App	105
--	-----

Using Remote Start - Vehicles With:

Remote Control	105
Remote Start Settings	106

Climate Control

Identifying the Climate Control Unit	107
Switching Climate Control On and Off	107
Switching Recirculated Air On and Off	107
Switching Air Conditioning On and Off	107
Switching Defrost On and Off	107
Switching Maximum Defrost On and Off	107
Switching Maximum Cooling On and Off	108
Switching the Heated Rear Window On and Off	108
Setting the Blower Motor Speed	108
Switching the Heated Mirrors On and Off	108
Setting the Temperature	108
Directing the Flow of Air	109
Auto Mode	109
Climate Control Hints	110
Climate Control – Warning Lamps	111
Air Conditioning System Refrigerant	111

Interior Air Quality

What Is the Cabin Air Filter	112
Locating the Cabin Air Filter	112
Replacing the Cabin Air Filter	112

Front Seats

Front Seat Precautions	113
Sitting in the Correct Position	113
Manual Seats	114
Power Seats	116
Heated Seats	119

Table of Contents

Ventilated Seats	120
------------------------	-----

Rear Seats - Coupe

Manual Seats	121
--------------------	-----

Rear Occupant Alert System

What is the Rear Occupant Alert System	122
How Does the Rear Occupant Alert System Work	122
Rear Occupant Alert System Precautions	122
Rear Occupant Alert System Limitations	122
Switching Rear Occupant Alert System On and Off	122
Rear Occupant Alert System Indicators	123
Rear Occupant Alert System Audible Warnings	123

Memory Function

How Does the Memory Function Work	124
Memory Function Precautions	124
Locating the Memory Function Buttons	124
Saving a Preset Position	124
Recalling a Preset Position	124

Garage Door Opener

Garage Door Opener Introduction	125
Garage Door Opener Precautions and Frequencies	125
Programming the Garage Door Opener	126
Garage Door Opener Additional Assistance	128

USB Ports

Locating the USB Ports	129
------------------------------	-----

Playing Media Using the USB Port	129
Charging a Device	129

Power Outlet

What Is the Power Outlet	131
Power Outlet Precautions	131
Locating the Power Outlets	131

Wireless Accessory Charger

What Is the Wireless Accessory Charger	133
Wireless Accessory Charger Precautions	133
Locating the Wireless Accessory Charger	133
Charging a Wireless Device	133

Storage

Cup Holders	135
Glove Compartment	135
Center Console	135
Glasses Holder	136

Starting and Stopping the Engine

Starting and Stopping the Engine – Precautions	137
Push Button Ignition Switch	137
Starting the Engine	138
Engine Block Heater	138
Stopping the Engine	139
Automatic Engine Stop	140
Accessing the Passive Key Backup Position	141
Starting and Stopping the Engine – Troubleshooting	141

Auto-Start-Stop

What Is Auto-Start-Stop	145
Auto-Start-Stop Precautions - Manual Transmission	145

Table of Contents

Auto-Start-Stop Precautions - Automatic Transmission	145
Switching Auto-Start-Stop On and Off	145
Stopping the Engine - Automatic Transmission	145
Stopping the Engine - Manual Transmission	145
Restarting the Engine - Manual Transmission	146
Restarting the Engine - Automatic Transmission	147
Auto-Start-Stop Indicators	147
Auto-Start-Stop – Troubleshooting	147

Fuel and Refueling

Fuel and Refueling Precautions	150
Fuel Quality	150
Locating the Fuel Filler Funnel	151
Running Out of Fuel	151
Refueling	153
Fuel Tank Capacity	154
Fuel and Refueling – Troubleshooting	155

Catalytic Converter

What Is the Catalytic Converter	156
Catalytic Converter Precautions	156
Catalytic Converter – Troubleshooting	156

Manual Transmission

Manual Transmission Precautions	157
Shifting Into Reverse	157
Checking the Manual Transmission Fluid Level	157
Checking the Clutch Fluid Level	158
Manual Transmission Fluid Capacity and Specification - 6-Speed Manual Transmission – 3160	158

Manual Transmission Fluid Capacity and Specification - 6-Speed Manual Transmission – MT82	158
Clutch Fluid Capacity and Specification	158

Automatic Transmission

Automatic Transmission Positions	160
Manually Shifting Gears	162
Shifting Your Immobile Vehicle Out of Park (P)	162
Automatic Transmission Audible Warnings	164
Automatic Transmission Fluid Capacity and Specification - Vehicles Without: GT Performance Package	164
Automatic Transmission Fluid Capacity and Specification - Vehicles With: GT Performance Package	164

Rear Axle

Limited Slip Differential	166
Rear Axle Fluid Capacity and Specification	166

Brakes

Brake Precautions	167
Anti-Lock Braking System	167
Brake Over Accelerator	167
Locating the Brake Fluid Reservoir	167
Checking the Brake Fluid	167
Brake Fluid Specification	168
Brakes – Troubleshooting	169

Electric Parking Brake

What Is the Electric Parking Brake	172
Applying the Electric Parking Brake - Manual Transmission, Vehicles Without: EcoBoost™ Performance Package/GT Performance Package	172

Table of Contents

Applying the Electric Parking Brake - Manual Transmission, Vehicles With: EcoBoost™ Performance Package/GT Performance Package	172
Applying the Electric Parking Brake - Automatic Transmission, Vehicles With: EcoBoost™ Performance Package/GT Performance Package	173
Applying the Electric Parking Brake - Automatic Transmission, Vehicles Without: EcoBoost™ Performance Package/GT Performance Package	173
Applying the Electric Parking Brake in an Emergency - Vehicles Without: EcoBoost™ Performance Package/GT Performance Package	174
Applying the Electric Parking Brake in an Emergency - Vehicles With: EcoBoost™ Performance Package/GT Performance Package	174
Manually Releasing the Electric Parking Brake - Vehicles Without: EcoBoost™ Performance Package/GT Performance Package	174
Manually Releasing the Electric Parking Brake - Vehicles With: EcoBoost™ Performance Package/GT Performance Package	175
Automatically Releasing the Electric Parking Brake	175
Electric Parking Brake Audible Warning	175
Releasing the Electric Parking Brake if the Vehicle Battery Has Run Out of Charge	175
Electric Parking Brake – Troubleshooting	176
Hill Start Assist	
What Is Hill Start Assist	179
How Does Hill Start Assist Work	179
Hill Start Assist Precautions	179
Switching Hill Start Assist On and Off - Manual Transmission	179
Switching Hill Start Assist On and Off - Automatic Transmission	179
Hill Start Assist – Troubleshooting	179
Auto Hold	
How Does Auto Hold Work	180
Switching Auto Hold On and Off	180
Using Auto Hold	180
Auto Hold Indicators	180
Traction Control	
What Is Traction Control	182
How Does Traction Control Work	182
Switching Traction Control On and Off	182
Traction Control Indicator	182
Traction Control – Troubleshooting	182
Stability Control	
How Does Stability Control Work	183
Switching Stability Control On and Off	184
Stability Control Indicator	184
Stability Control – Troubleshooting	184
Steering	
Electric Power Steering	185
Steering – Troubleshooting	186
Parking Aids	
Parking Aid Precautions	187
Switching Parking Aid On and Off	187
Rear Parking Aid	188
Parking Aid Indicators	189
Parking Aids – Troubleshooting	189
Rear View Camera	
What Is the Rear View Camera	190
Rear View Camera Precautions	190
Locating the Rear View Camera	190

Table of Contents

Rear View Camera Guide Lines	190
Rear View Camera Settings	191

Cruise Control

What Is Cruise Control	193
Switching Cruise Control On and Off	193
Setting the Cruise Control Speed	193
Canceling the Set Speed	194
Resuming the Set Speed	194
Cruise Control Indicators	194

Adaptive Cruise Control

How Does Adaptive Cruise Control Work - Manual Transmission	195
How Does Adaptive Cruise Control With Stop and Go Work - Automatic Transmission	195
Adaptive Cruise Control Precautions	195
Adaptive Cruise Control Limitations	196
Switching Adaptive Cruise Control On and Off - Manual Transmission	197
Switching Adaptive Cruise Control On and Off - Automatic Transmission	198
Adaptive Cruise Control Automatic Cancellation	198
Setting the Adaptive Cruise Control Speed - Manual Transmission	198
Setting the Adaptive Cruise Control Speed - Automatic Transmission	199
Setting the Adaptive Cruise Control Gap	200
Canceling the Set Speed	201
Resuming the Set Speed - Manual Transmission	201
Resuming the Set Speed - Automatic Transmission	201
Overriding the Set Speed	202
Adaptive Cruise Control Indicators	203

Switching From Adaptive Cruise Control to Cruise Control	203
Lane Centering	203
Predictive Speed Assist	206
Predictive Speed Assist - Troubleshooting	208
Adaptive Cruise Control - Troubleshooting	208

Drive Mode Control

What Is Drive Mode Control	211
How Does Drive Mode Control Work	211
Selecting a Drive Mode	211
Drive Modes	212
Drive Mode Control - Troubleshooting	213

Speed Limiter

How Does the Speed Limiter Work	216
Speed Limiter Precautions	216
Switching the Speed Limiter On and Off	216
Setting the Speed Limit	216
Changing the Set Speed Limit	216
Canceling the Set Speed Limit	216
Resuming the Set Speed Limit	216
Intentionally Exceeding the Set Speed Limit	217
Speed Limiter Indicators	217
Speed Limiter Audible Warnings	217

Intelligent Speed Limiter

What Is the Intelligent Speed Limiter	218
How Does the Intelligent Speed Limiter Work	218
Intelligent Speed Limiter Precautions	218
Switching the Intelligent Speed Limiter On and Off	218
Setting the Speed Limit	218

Table of Contents

Changing the Set Speed Limit	218	Blind Spot Information System Limitations	228
Adjusting the Speed Limit Tolerance	219	Blind Spot Information System Requirements	228
Canceling the Set Speed Limit	219	Switching Blind Spot Information System On and Off	228
Resuming the Set Speed Limit	219	Locating the Blind Spot Information System Sensors	229
Intentionally Exceeding the Set Speed Limit	219	Blind Spot Information System Indicators	229
Intelligent Speed Limiter Indicators	219	Blind Spot Information System – Troubleshooting	230
Intelligent Speed Limiter Audible Warnings	219	Exit Warning	
Switching From Intelligent Speed Limiter to Speed Limiter	219	What is Exit Warning	231
Intelligent Speed Limiter – Troubleshooting	220	How Does Exit Warning Work	231
Lane Keeping System		Exit Warning Precautions	231
What Is the Lane Keeping System	221	Exit Warning Limitations	231
How Does the Lane Keeping System Work	221	Exit Warning Indicators	232
Lane Keeping System Precautions	221	Switching Exit Warning On and Off	232
Lane Keeping System Limitations	221	Locating the Exit Warning Sensors	232
Switching the Lane Keeping System On and Off	222	Exit Warning – Troubleshooting	233
Switching the Lane Keeping System Mode	222	Cross Traffic Alert	
Lane Keeping System Settings	222	What Is Cross Traffic Alert	234
Alert Mode	222	How Does Cross Traffic Alert Work	234
Aid Mode	223	Cross Traffic Alert Precautions	234
Alert and Aid Mode	223	Cross Traffic Alert Limitations	235
Lane Keeping System Indicators	223	Switching Cross Traffic Alert On and Off	236
Blind Spot Assist	224	Locating the Cross Traffic Alert Sensors	236
Lane Keeping System – Troubleshooting	226	Cross Traffic Alert Indicators	236
Blind Spot Information System		Cross Traffic Alert – Troubleshooting	237
What Is Blind Spot Information System	228	Pre-Collision Assist	
How Does Blind Spot Information System Work	228	What Is Pre-Collision Assist	238
Blind Spot Information System Precautions	228	How Does Pre-Collision Assist Work	238
		Pre-Collision Assist Precautions	238
		Pre-Collision Assist Limitations	239

Table of Contents

Switching Pre-Collision Assist On and Off	240
Locating the Pre-Collision Assist Sensors	241
Distance Indication	241
Forward Collision Warning	242
Distance Alert	242
Automatic Emergency Braking	243
Evasive Steering Assist	243
Pre-Collision Assist – Troubleshooting	244
Speed Sign Recognition	
What Is Speed Sign Recognition	246
How Does Speed Sign Recognition Work	246
Speed Sign Recognition Precautions	246
Speed Sign Recognition Limitations	246
Speed Sign Recognition Indicators	247
Speed Sign Recognition Settings	247
Speed Sign Recognition – Troubleshooting	247
Driver Alert	
What Is Driver Alert	249
How Does Driver Alert Work	249
Driver Alert Precautions	249
Driver Alert Limitations	249
Switching Driver Alert On and Off	250
Driver Alert Indicators	250
Driver Alert – Troubleshooting	250
Load Carrying	
Load Carrying Precautions	251
Locating the Safety Compliance Certification Labels	252
What Is the Gross Axle Weight Rating	252
What Is the Gross Vehicle Weight Rating	252
What Is the Gross Combined Weight Rating	252
Calculating Payload	253
Calculating the Load Limit	253
Luggage Compartment	
Luggage Compartment Precautions	256
Opening the Rear Luggage Compartment	256
Closing the Rear Luggage Compartment	258
Using the Rear Luggage Compartment Emergency Release	258
Luggage Compartment – Troubleshooting	258
Towing a Trailer	
Towing a Trailer Precautions – Base/GT	260
Towing a Trailer Precautions – Dark Horse	260
Loading Your Trailer	260
Towing Weights and Dimensions	261
Convertible Top	
Opening the Convertible Top	262
Closing the Convertible Top	263
Driving Hints	
Cold Weather Precautions	264
Driving on Snow and Ice	264
Breaking-In	264
Driving Economically	264
Driving Through Shallow Water – Base/GT	265
Driving Through Shallow Water – Dark Horse	265
Floor Mats	266

Table of Contents

Crash and Breakdown Information

Roadside Assistance	267
Switching the Hazard Flashers On and Off	268
Jump Starting the Vehicle	268
Post-Crash Alert System	271
Post-Collision Braking	271
Automatic Crash Shutoff	271
Recovery Towing	272
Transporting the Vehicle	272
Transporting the Vehicle - Dark Horse	273
Fail-Safe Cooling	277

Towing Your Vehicle

Towing Your Vehicle Precautions	279
Recreationally Towing Your Vehicle	279
Emergency Towing	279

Fuses

Fuse Precautions	280
Under Hood Fuse Box	280
Body Control Module Fuse Box	283
High Current Fuse Box	286
Identifying Fuse Types	286
Fuses – Troubleshooting	286

Maintenance

Maintenance Precautions	287
Opening and Closing the Hood	287
Under Hood Overview - 2.3L EcoBoost™	288
Under Hood Overview - 5.0L	289
Engine Oil	290
Engine Air Filter	294
Coolant	296
Changing the Fuel Filter	301

Drive Belt Routing Overview - 2.3L EcoBoost™	302
Drive Belt Routing Overview - 5.0L	303
12V Battery	303
12V Battery – Troubleshooting	305
Adjusting the Headlamps	307
Exterior Bulbs	308
Interior Bulbs	308

Vehicle Specifications

Engine Specifications - 2.3L	309
Engine Specifications - 5.0L	310
Suspension Specifications	311
Motorcraft Parts - 2.3L	311
Motorcraft Parts - 5.0L	312

Track Use

Track Use	313
Track Use - Dark Horse	315

Vehicle Care

Cleaning Products	320
Cleaning the Exterior	321
Cleaning the Interior	323
Repairing Minor Paint Damage	325
Waxing Your Vehicle	325

Body Styling Kits

Body Styling Kit Precautions	326
------------------------------------	-----

Storing Your Vehicle

Preparing Your Vehicle for Storage	327
Removing Your Vehicle From Storage	328

Wheel and Tire Information

Locating the Tire label	329
Department of Transportation Uniform Tire Quality Grades	329
Information on the Tire Sidewall	330

Table of Contents

Glossary of Tire Terminology	335
Tire Replacement Requirements	336
Using Summer Tires	338
Using Snow Chains	341

Tire Care

Checking the Tire Pressures	343
Inflating the Tires	343
Inspecting the Tire for Wear	344
Inspecting the Tire for Damage	345
Inspecting the Wheel Valve Stems	349
Tire Rotation	349

Tire Sealant and Inflator Kit

What Is the Tire Sealant and Inflator Kit	351
Tire Sealant and Inflator Kit Precautions	351
Locating the Tire Sealant and Inflator Kit	351
Tire Sealant and Inflator Kit Components	352
Using the Tire Sealant and Inflator Kit	353

Tire Pressure Monitoring System

What Is the Tire Pressure Monitoring System	363
Tire Pressure Monitoring System Overview	363
Tire Pressure Monitoring System Precautions	364
Tire Pressure Monitoring System Limitations	364
Viewing the Tire Pressures	365
Tire Pressure Monitoring System – Troubleshooting	365

Changing a Road Wheel

Changing a Flat Tire	367
Wheel Nuts	371

Vehicle Identification

Vehicle Identification Number	373
-------------------------------------	-----

Connected Vehicle

What Is a Connected Vehicle	374
Connected Vehicle Requirements	374
Connected Vehicle Limitations	374
Connecting the Vehicle to a Mobile Network	374
Connecting the Vehicle to a Wi-Fi Network	374
Connected Vehicle Settings	375
Connected Vehicle – Troubleshooting	375

Vehicle Hotspot

Setting Up a Vehicle Hotspot	377
Vehicle Hotspot Settings	377
Vehicle Hotspot – Troubleshooting	378

Audio System

Audio System Precautions	379
Switching the Audio Unit On and Off	379
Selecting the Audio Source	379
Media Control Buttons	379
Adjusting the Volume	380
Setting a Memory Preset	380
Muting the Audio	380
Adjusting the Sound Settings	380
Setting the Clock and Date	380
AM/FM Radio	380
Switching the Display On and Off	381
Digital Radio	381
Satellite Radio	382
Audio System – Troubleshooting	385

Center Display

Center Display Overview	389
Home Screen	389

Table of Contents

Favorite	389
Status Bar	390
Information On Demand Screen	391
Settings	391
Driver Assistance Menu	391
Rebooting the Center Display	391

My Mustang

My Mustang Overview	392
Track Apps	393
Auxiliary Gauges	399
Custom Drive Mode	399
Cluster Theme	400
My Color	400
Exhaust Mode	400

Voice Interaction

Ford Assistant	402
----------------------	-----

Alexa Built-In

What is Alexa Built-In	404
Alexa Built-In Requirements	404
Signing In to Your Account	404
Using Alexa Built-In	404
Alexa Built-In Settings	404

Phone

Phone Precautions	406
Connecting Your Phone	406
Phone Menu	406
Making and Receiving a Phone Call	408
Sending and Receiving a Text Message	409
Switching Text Message Notification On and Off	410
Enabling Apps on a Mobile Device	410
Switching Apple CarPlay On and Off	410
Switching Android Auto™ On and Off	411

Bluetooth®

Connecting a Bluetooth® Device	412
Playing Media Using Bluetooth®	412

Personal Profiles

How Do Personal Profiles Work	413
Enabling or Disabling Personal Profiles	413
Creating a Personal Profile	414
Linking or Unlinking a Personal Profile to a Remote Control	414

Navigation

Connected Navigation	415
Accessing Navigation	415
Navigation Map Updates	415
Adjusting the Map	415
Live Traffic	415
Setting a Destination	415
Waypoints	416
Route Guidance	416

Vehicle Software Updates

Vehicle Software Updates	417
Software Update Settings	417
Software Update Indicators	418

Vehicle System Reset

Performing a System Reset	419
---------------------------------	-----

Accessories

Accessories	420
-------------------	-----

Ford Protect

What Is Ford Protect	421
----------------------------	-----

Scheduled Maintenance

Scheduled Maintenance	423
General Maintenance Information	425

Table of Contents

Customer Information

The Better Business Bureau Auto Line Program	430
The Mediation and Arbitration Program	430
Reporting Safety Defects in the United States	431
Reporting Safety Defects in Canada	431
Third Party Software Copyright Acknowledgment	433
Radio Frequency Certification Labels	433
Perchlorate	492
Replacement Parts Recommendation	492
Mobile Communications Equipment	493
Federal Highway Administration Regulation	493
End User License Agreement	494
Emission Law	519
Export Unique Options	520
Warranty Information	520

Appendices

Electromagnetic Compatibility	523
-------------------------------------	-----

Contacting Us

If you require assistance or clarification on policies or procedures, please contact the customer relationship center.

United States

Ford Motor Company
Customer Relationship Center
PO Box 6248
Dearborn, MI 48126
1-800-392-3673 (FORD)
TDD for the hearing impaired:
7-1-1 (where offered by your telephone
service provider)
www.ford.com/help/contact/

Ford Credit - US Only

Ford Credit offers a full range of financing and lease plans to help you acquire your vehicle. If you have financed or leased your vehicle through Ford Credit, thank you for your business.

For assistance call 1-800-727-7000, or for more information about Ford Credit and access to an account manager, visit www.ford.com/finance.

Canada

Customer Relationship Centre
Ford Motor Company of Canada Limited
P.O. Box 2000
Oakville, Ontario L6J 5E4
1-800-565-3673 (FORD)
TDD for the hearing impaired:
7-1-1 (where offered by your telephone
service provider)
www.ford.ca

Australia

Ford Motor Company of Australia Pty Ltd.
Customer Relationship Centre
Private Mail Bag 5
Campbellfield, Victoria, 3061
Telephone: (13 FORD) 13 3673
E-mail: foacust1@ford.com

New Zealand

Ford Motor Company
Attention: Customer Relationship Centre
Private Bag 76912
Manukau City 2241
Telephone: 0800 367 369 (FORDNZ)
E-mail: fnzcust@ford.com

China - Imported Vehicle

Customer Relationship Center
Telephone: 400-690-1886
Website: <https://www.ford.com.cn/>

China - Chang'An Ford

Customer Relationship Center
Telephone: 800-810-8168
Mobile: 400-887-7766
Website: <https://www.ford.com.cn/>

Asia Pacific Direct Markets (APDM)

E-mail: apemcrc@ford.com

Caribbean, Central America and Israel

Ford Motor Company
Ford Export Operations
Attention: Owner Relations
1555 Fairlane Drive
Fairlane Business Park #3
Allen Park, MI 48101
Fax: (313) 390-0804
Telephone: (800) 841-3673
E-mail: atnclien@ford.com

U.S. Virgin Islands and Puerto Rico

Ford Motor Company
Ford Export Operations
Attention: Owner Relations
1555 Fairlane Drive
Fairlane Business Park #3
Allen Park, MI 48101
Telephone: (800) 841-3673
E-mail: atnclien@ford.com

Contacting Us

Argentina

Telephone: 0800-888-3673

Brazil

Website: www.ford.com.br
Telephone: 0800-703-3673
E-mail: central@ford.com

North Africa

E-mail: nafcrc@ford.com

South Africa

Telephone: 0860011022
Email: fordcrc2@ford.com

Sub-Saharan Africa

E-mail: ssacrc@ford.com

Puerto Rico

Ford International Business Development,
Inc.
P.O. Box 11957
Caparra Heights Station
San Juan, PR 00922-1957
1-800-392-3673 (FORD)
Fax: (313) 390-0804
E-mail: prcac@ford.com
www.ford.com.pr

Middle East

Ford Middle East Customer Relationship
Center
P.O. Box 21740
Dubai, United Arab Emirates
Telephone: 80004441066
Toll-free number for the Kingdom of Saudi
Arabia: 8008443673
Mobily and Zain cell phone users in Saudi
Arabia: 800850078
Kuwait: 22280384
Local telephone number for Kuwait: +965
1 898900
Fax: +971 4 3327266
E-mail: menacac@ford.com
www.me.ford.com

South Korea

Customer Relationship Center
Telephone: +82-02-1600-6003
E-mail: infokr1@ford.com
Emergency Dispatch Service call:
080-300-3673

Philippines

Telephone: 02-88669408
Email: emailus@ford.com

Taiwan

Telephone: 0800-032100
705 Zhonghua Rd., Sec. 1
Zhongli District, Taoyuan, Taiwan, 32068

Thailand

Telephone: 1383
E-mail: fordthai@ford.com

Vietnam

Telephone: 1800588888
E-mail: fordvn@ford.com

Introduction

ABOUT THIS PUBLICATION



WARNING: Driving while distracted can result in loss of vehicle control, crash and injury. We strongly recommend that you use extreme caution when using any device that may take your focus off the road. Your primary responsibility is the safe operation of your vehicle. We recommend against the use of any hand-held device while driving and encourage the use of voice-operated systems when possible. Make sure you are aware of all applicable local laws that may affect the use of electronic devices while driving.



WARNING: You risk death, fire, or serious injury to yourself and others if you do not follow the instruction highlighted by the warning symbol.

Thank you for choosing Ford. We recommend that you take some time to get to know your vehicle in order to benefit from greater safety and pleasure from driving it. Use this publication, whether in-vehicle center display screen, print, in Ford mobile app or online, to familiarize yourself with the features on your vehicle.

Note: Use and operate your vehicle in line with all applicable laws and regulations.

Note: Pass on all printed owner's information when selling this vehicle.

Features and Options

This publication describes product features and options available throughout the range of available models, sometimes even before they are generally available. It could describe options that are not available on the vehicle you have purchased.

Providing Feedback

If you would like to provide feedback to the Owner's Manual team, please email us at OWNERMANUALFEEDBACK@ford.com.

You will not receive a direct email response. Your submission will be investigated and necessary changes will be made to the Owner's Manual content.

To help investigate your submission, please include the following information:

- Your vehicle model
- The country in which your vehicle was purchased
- The Owner's Manual section needing investigation

Illustrations

Note: Some of the illustrations in this publication could show features as used in different models, so could appear different to you on your vehicle.

Location of Components

This manual may qualify the location of a component as left-hand side or right-hand side. The side is determined when facing forward in the seat.

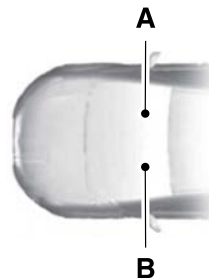

- A Right-hand side.
- B Left-hand side.

Introduction

Accessing the Digital Owner's Manual

The online version of the Owner's Manual may contain the very latest information, which may vary slightly from the in-vehicle digital Owner's Manual originally provided with your vehicle. We recommend updating the in-vehicle digital Owner's Manual when prompted using Over The Air updates.

Vehicles with a Portrait Center Display Screen

The Owner's Manual application is located in the Apps list.

Vehicles with a Landscape Center Display Screen

Depending on your vehicle, the Owner's Manual application is located in either the Apps list or the Features list.

Accessing the Online and Printed Owner's Manual

Online Owner's Manual

- Through your device's app store, you can download the Ford mobile app.
- You can visit the local Ford Website.

Note: To find the local Ford website, visit <https://corporate.ford.com/operations/locations/global-links.html>.

Note: We strongly recommend downloading a copy of the Owner's Manual and having it with you whenever you drive, and to view the information if you are unable to be inside the vehicle.

Printed Owner's Manual

In U.S. and Canada, visit www.helminc.com or see an authorized dealer.

In Europe, visit www.z-order.de or see an authorized dealer.

For all other Countries, see your authorized dealer.





USING THIS PUBLICATION

To quickly locate information about your vehicle, use the word search within the Owner's Manual application.

Symbols Glossary

SYMBOLS USED ON YOUR VEHICLE

These are some of the symbols you may see on your vehicle.

	Airbag		Child safety door lock or unlock
	Air conditioning system		Child seat lower anchor
	Air conditioning system lubricant type		Child seat tether anchor
	Anti-lock braking system		Cruise control
	Avoid smoking, flames or sparks		Do not open when hot
	Battery		Electric Parking brake
	Battery acid		Engine air filter
	Blower motor		Engine coolant
	Brake fluid - non petroleum based		Engine coolant temperature
	Brake system		Engine oil
	Brake system		Explosive gas
	Cabin air filter		Fan warning
	Check fuel cap		Fasten seatbelt
			Flammable
			Front fog lamps

Symbols Glossary



Fuel pump reset



Fuse compartment



Hazard flashers



Headlamp high beams



Headlamps on



Heated rear window



Hill descent control



Horn control



Interior luggage compartment release



Jack



Keep out of reach of children



Lighting control



Low fuel level



Low tire pressure warning



Maintain correct fluid level



Malfunction Indicator Lamp (MIL)



Note operating instructions



Panic alarm



Parking aid



Parking lamps



Passenger airbag activated



Passenger airbag deactivated



Power steering fluid



Power windows front/rear



Power window lockout



Requires registered technician



Safety alert



See Owner's Manual



See Service Manual



Side airbag

Symbols Glossary



Shield the eyes



Stability control



Stability control off



Trail control



Turn Signal



Windshield defrosting system



Windshield wiping system



Windshield wash and wipe

SYMBOLS USED ON YOUR INSTRUMENT CLUSTER

Depending on your vehicle options, market, and instrument cluster type, not all symbols shown are available.

Lighting and Signaling



High beams. See **Headlamp Indicators** (page 87).



Auto high beams. See **Automatic High Beam Control Indicators** (page 92).



Rear fog lamps.



Turn signal - right. See **Exterior Lamp Indicators** (page 90).



Turn signal - left. See **Exterior Lamp Indicators** (page 90).



Positioning/side lights. See **Headlamp Indicators** (page 87).



Exterior bulb failure. See **Exterior Bulb Specification Chart** (page 308).

Brakes



Brake failure. See **Brakes – Warning Lamps** (page 169). See **Electric Parking Brake – Warning Lamps** (page 176).



Brake failure. See **Brakes – Warning Lamps** (page 169). See **Electric Parking Brake – Warning Lamps** (page 176).



Electric parking brake fault. See **Electric Parking Brake – Warning Lamps** (page 176).



Anti-lock brake system malfunction. See **Brakes – Warning Lamps** (page 169). See **Anti-Lock Braking System Indicators** (page 167).



Automatic brake hold. See **Auto Hold Indicators** (page 180).



Automatic brake hold off or unavailable. See **Auto Hold Indicators** (page 180).



Performance park brake. See **Drift Brake** (page 398).

Visibility



Windshield washer fluid level. See **Wipers and Washers – Warning Lamps** (page 86).

Symbols Glossary

Engine



Check engine. See **Starting and Stopping the Engine – Warning Lamps** (page 141).

See **Catalytic Converter – Warning Lamps** (page 156). See **Coolant – Warning Lamps** (page 301). See **Emission Law** (page 519). See **Fail-Safe Cooling Indicators** (page 278).



Engine oil pressure. See **Starting and Stopping the Engine – Warning Lamps**

(page 141).



Engine coolant temperature. See **Catalytic Converter – Warning Lamps** (page 156).

See **Fail-Safe Cooling Indicators** (page 278). See **Coolant – Warning Lamps** (page 301).



Auto start/stop. See **Auto-Start-Stop Indicators** (page 147).



Auto start/stop off or unavailable. See **Auto-Start-Stop Indicators**

(page 147).

Fuel



Fuel. See **Fuel and Refueling – Warning Lamps** (page 155).

Transmission



Non-emission powertrain fault. See **Starting and Stopping the Engine – Warning Lamps**

(page 141).

Vehicle Handling



Selectable drive mode - normal. See **Normal** (page 213).



Selectable drive mode - sport. See **Sport** (page 213).



Selectable drive mode -track. See **Track** (page 213).



Selectable drive mode - slippery. See **Slippery** (page 213).



Selectable drive mode - drag strip. See **Drag Strip** (page 212).



Selectable drive mode - custom. See **Custom** (page 212).



Suspension mode - normal. See **Selecting a Drive Mode** (page 211).



Suspension mode - sport. See **Selecting a Drive Mode** (page 211).



Suspension mode - track. See **Selecting a Drive Mode** (page 211).



Suspension mode - drag. See **Selecting a Drive Mode** (page 211).



Steering mode - normal. See **Selecting a Drive Mode** (page 211).



Steering mode - sport. See **Selecting a Drive Mode** (page 211).



Steering mode - comfort. See **Selecting a Drive Mode** (page 211).



Exhaust mode - dual tip - normal. See **Selecting a Drive Mode** (page 211).



Exhaust mode - dual tip - sport. See **Selecting a Drive Mode** (page 211).

Symbols Glossary



Exhaust mode - dual tip - track. See **Selecting a Drive Mode** (page 211).



Exhaust mode - dual tip - quiet. See **Selecting a Drive Mode** (page 211).



Launch control - ready. See **Launch Control** (page 397).



Launch control - active. See **Launch Control** (page 397).



Launch control - off or unavailable. See **Launch Control** (page 397).



RPM hold - ready. See **Launch Control** (page 397).



RPM hold - active. See **Launch Control** (page 397).



RPM hold - off or unavailable. See **Launch Control** (page 397).

Driver Assistance



Cruise control. See **Cruise Control Indicators** (page 194). See **Switching From Adaptive**

Cruise Control to Cruise Control (page 203).



Adaptive cruise control. See **Adaptive Cruise Control Indicators** (page 203).



Lane keeping assist. See **Lane Keeping System Indicators** (page 223).



Lane centering assist. See **Lane Centering Indicators** (page 205).



Lane keeping assist off. See **Lane Keeping System Indicators** (page 223).

Safety



Seatbelt. See **Seatbelt Reminder Indicators** (page 47). See **Seatbelt Precautions** (page 43).



Airbag. See **How Does the Front Passenger Sensing System Work** (page 55). See

Crash Sensors and Airbag Indicator (page 58). See **Seatbelt Precautions** (page 43).



Stability control system active or not available. See **Traction Control – Warning Lamps** (page 182). See **Stability Control Indicator** (page 184).



Stability control system off. See **Traction Control Indicator** (page 182). See **Drive Mode Control – Warning Lamps** (page 213).



Tire failure/Low tire pressure. See **What Is the Tire Pressure Monitoring System** (page 363).

See **Tire Pressure Monitoring System – Warning Lamps** (page 365).



Forward collision warning system. See **How Does Pre-Collision Assist Work**

(page 238).



Blind spot information system off or unavailable. See **Blind Spot Information System Indicators** (page 229).



Forward collision warning system off or unavailable. See **Pre-Collision Assist – Warning Lamps** (page 244).

Symbols Glossary



Icy road conditions. See **Climate Control – Warning Lamps** (page 111).



Driver alert system off or unavailable. See **Driver Alert Indicators** (page 250).



Door(s) ajar. See **Doors and Locks – Warning Lamps** (page 71).

Security



Hood release/ajar. See **Opening and Closing the Hood** (page 287).



Trunk release/ajar. See **Luggage Compartment – Warning Lamps** (page 258).

Electrical Systems



Battery charge level. See **Catalytic Converter – Warning Lamps** (page 156).

See **12V Battery – Warning Lamps** (page 305).

Data Privacy



WARNING: Do not connect wireless plug-in devices to the data link connector. Unauthorized third parties could gain access to vehicle data and impair the performance of safety related systems. Only allow repair facilities that follow our service and repair instructions to connect their equipment to the data link connector.

We respect your privacy and are committed to protecting it. The information contained in this publication was correct at the time of release, but as technology rapidly changes, we recommend that you visit the local Ford website for the latest information.

Your vehicle has electronic control units that have data recording functionality and the ability to permanently or temporarily store data. This data could include information on the condition and status of your vehicle, vehicle maintenance requirements, events and malfunctions. The types of data that can be recorded are described in this section. Some of the data recorded is stored in event logs or error logs.

Note: *Error logs are reset following a service or repair.*

Note: *We may provide information in response to requests from law enforcement, other government authorities and third parties acting with lawful authority or through a legal process. Such information could be used by them in legal proceedings.*

Data recorded includes, for example:

- Operating states of system components, for example fuel level, tire pressure and battery charge level.
- Vehicle and component status, for example wheel speed, deceleration, lateral acceleration and seatbelt status.

- Events or errors in essential systems, for example headlamps and brakes.
- System responses to driving situations, for example airbag deployment and stability control.
- Environmental conditions, for example temperature.

Some of this data, when used in combination with other information, for example an accident report, damage to a vehicle or eyewitness statements, could be associated with a specific person.

Services That We Provide

If you use our services, we collect and use data, for example account information, vehicle location and driving characteristics, that could identify you. We transmit this data through a dedicated, protected connection. We only collect and use data to enable your use of our services to which you have subscribed, with your consent or where permitted by law. For additional information, see the terms and conditions of the services to which you have subscribed.

For additional information about our privacy policy, refer to the local Ford website.

Services That Third Parties Provide

We recommend that you review the terms and conditions and data privacy information for any services equipped with your vehicle or to which you subscribe. We take no responsibility for services that third parties provide.

Where equipped, SiriusXM with 360L could use the modem. To disable, turn off the SiriusXM with 360L or Vehicle Connectivity setting. See **Enabling and Disabling the Modem** (page 374).

Data Privacy

SERVICE DATA

Service data recorders in your vehicle are capable of collecting and storing diagnostic information about your vehicle. This potentially includes information about the performance or status of various systems and modules in the vehicle, such as engine, throttle, steering or brake systems. In order to properly diagnose and service your vehicle, Ford Motor Company (Ford of Canada in Canada), and service and repair facilities may access or share among them vehicle diagnostic information received through a direct connection to your vehicle when diagnosing or servicing your vehicle. Additionally, Ford Motor Company (Ford of Canada, in Canada) may, where permitted by law, use vehicle diagnostic information for vehicle improvement or with other information we may have about you, for example, your contact information, to offer you products or services that may interest you. Data may be provided to our service providers such as part suppliers that may help diagnose malfunctions, and who are similarly obligated to protect data. We retain this data only as long as necessary to perform these functions or to comply with law. We may provide information where required in response to official requests to law enforcement or other government authorities or third parties acting with lawful authority or court order, and such information may be used in legal proceedings. For U.S. only (if equipped), if you choose to use connected apps and services, you consent that certain diagnostic information may also be accessed electronically by Ford Motor Company and Ford authorized service facilities, and that the diagnostic information may be used to provide services to you, personalizing your experience, troubleshoot, and to improve products and services and offer you products and services that may interest

you, where permitted by law. For Canada only, for more information, please review the Ford of Canada privacy policy at www.ford.ca, including our U.S. data storage and use of service providers in other jurisdictions who may be subject to legal requirements in Canada, the United States and other countries applicable to them, for example, lawful requirements to disclose personal information to governmental authorities in those countries.

EVENT DATA

This vehicle is equipped with an event data recorder. The main purpose of an event data recorder is to record, in certain crash or near crash-like situations, such as an airbag deployment or hitting a road obstacle; this data will assist in understanding how a vehicle's systems performed. The event data recorder is designed to record data related to vehicle dynamics and safety systems for a short period of time, typically 30 seconds or less.

The event data recorder in this vehicle is designed to record such data as:

- How various systems in your vehicle were operating.
- Whether or not the driver and passenger seatbelts were buckled/fastened.
- How far (if at all) the driver was depressing the accelerator and/or the brake pedal.
- How fast the vehicle was traveling.
- Where the driver was positioning the steering wheel.

This data can help provide a better understanding of the circumstances in which crashes and injuries occur.

Data Privacy

Note: *Event data recorder data is recorded by your vehicle only if a non-trivial crash situation occurs; no data is recorded by the event data recorder under normal driving conditions and no personal data or information (for example name, gender, age, and crash location) is recorded. However, parties, such as law enforcement, could combine the event data recorder data with the type of personally identifying data routinely acquired during a crash investigation.*

To read data recorded by an event data recorder, special equipment is required, and access to the vehicle or the event data recorder is needed. In addition to the vehicle manufacturer, other parties, such as law enforcement, that have such special equipment, can read the information if they have access to the vehicle or the event data recorder.

SETTINGS DATA

Your vehicle has electronic control units that have the ability to store data based on your personalized settings. The data is stored locally in the vehicle or on devices that you connect to it, for example, a USB drive or digital music player. You can delete some of this data and also choose whether to share it through the services to which you subscribe.

Comfort and Convenience Data

Data recorded includes, for example:

- Seat and steering wheel position.
- Climate control settings.
- Radio presets.

Entertainment Data

Data recorded includes, for example:

- Music, videos or album art.
- Contacts and corresponding address book entries.
- Navigation destinations.

CONNECTED VEHICLE DATA



The modem has a SIM. The modem was enabled when your vehicle was built and periodically sends messages to stay connected to the cell phone network, receive automatic software updates and send vehicle-related information to us, for example diagnostic information. These messages could include information that identifies your vehicle, the SIM and the electronic serial number of the modem. Cell phone network service providers could have access to additional information, for example cell phone network tower identification. For additional information about our privacy policy, visit www.FordConnected.com or refer to your local Ford website.

Note: *The modem continues to send this information unless you disable the modem or stop the modem from sharing vehicle data by changing the modem settings. See **Connected Vehicle** (page 374).*

Note: *The service can be unavailable or interrupted for a number of reasons, for example environmental or topographical conditions and data plan coverage.*

Note: *To find out if your vehicle has a modem, visit www.FordConnected.com.*

Data Privacy

MOBILE DEVICE DATA

If you connect a mobile device to your vehicle, you can display data from your device on the touchscreen for example, music and album art. You can share your vehicle data with mobile apps on your device through the system. See **Enabling Apps on a Mobile Device** (page 410).

The mobile apps function operates by your connected device sending data to us in the United States. The data is encrypted and includes, for example, the vehicle identification number of your vehicle, the SYNC module serial number, odometer, enabled apps, usage statistics and debugging information. We retain it only as long as necessary to provide the service, to troubleshoot, for continuous improvement and to offer you products and services that may be of interest to you according to your preferences and where allowed by law.

If you connect a cell phone to the system, the system creates a profile that links to that cell phone. The cell phone profile enables more mobile features and efficient operation. The profile contains, for example data from your phonebook, read and unread text messages and call history, including history of calls when your cell phone was not connected to the system.

If you connect a media device, the system creates and retains a media device index of supported media content. The system also records a short diagnostic log of approximately 10 minutes of all recent system activity.

The cell phone profile, media device index and diagnostic log remain in your vehicle unless you delete them and are generally accessible only in your vehicle when you connect your cell phone or media device. If you no longer plan to use the system or your vehicle, we recommend you use the system reset function to erase the stored information. See **Performing a System Reset** (page 419).

System data cannot be accessed without special equipment and access to your vehicle's module.

For additional information about our privacy policy, refer to the local Ford website.

Note: *To find out if your vehicle has connectivity technology, visit www.FordConnected.com.*

EMERGENCY CALL SYSTEM DATA

When the emergency call system is active, it may disclose to emergency services that your vehicle has been in a crash involving the deployment of an airbag or activation of the fuel pump shut-off. Certain versions or updates to the emergency call system may also be capable of electronically or verbally disclosing to emergency services operators your vehicle location or other details about your vehicle or crash to assist emergency services operators to provide the most appropriate emergency services. If you do not want to disclose this information, do not activate the emergency call system.

Note: *You cannot deactivate emergency call systems that are required by law.*

Environment

PROTECTING THE ENVIRONMENT

Sustainability is a priority at Ford. We are constantly looking for ways to reduce our impact on the planet while providing customers with great products and delivering a strong business. You should play your part in protecting the environment. Correct vehicle usage and the authorized disposal of waste, cleaning and lubrication materials are significant steps toward this aim.

For additional information about our sustainability progress and initiatives, visit www.sustainability.ford.com.

Visual Search

INTERIOR OVERVIEW

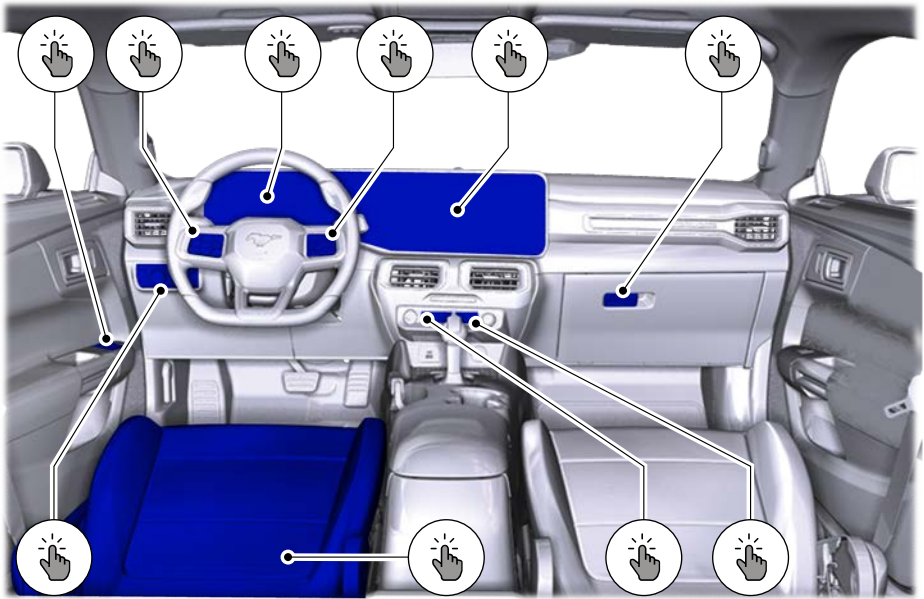

- A See **Adjusting the Exterior Mirrors** (page 100). See **Adjusting the Exterior Mirrors** (page 100).
- B See **Switching Cruise Control On and Off** (page 193). See **Switching Adaptive Cruise Control On and Off** (page 197). See **Switching Adaptive Cruise Control On and Off** (page 198).
- C See **Instrument Cluster Overview** (page 101).
- D See **Selecting a Drive Mode** (page 211). See **Selecting a Drive Mode** (page 211).
- E See **Center Display Overview** (page 389).
- F See **Opening the Glove Compartment** (page 135).
- G See **Favorite** (page 389).
- H See **My Mustang Overview** (page 392).

Visual Search

- I See **Sitting in the Correct Position** (page 113). See **Sitting in the Correct Position** (page 113).
- J See **Exterior Lighting Control** (page 87).

EXTERIOR OVERVIEW

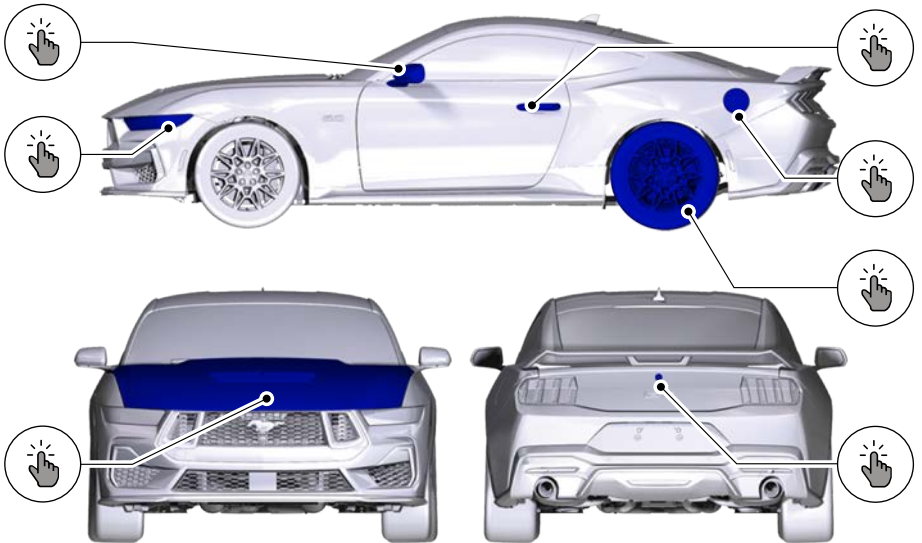

- A See **Folding the Exterior Mirrors** (page 100). See **Folding the Exterior Mirrors** (page 100).
- B See **Unlocking and Locking the Doors Using the Key Blade** (page 69).
- C See **Refueling Your Vehicle** (page 153).
- D See **Checking the Tire Pressures** (page 343).
- E See **Opening the Rear Luggage Compartment from Outside Your Vehicle** (page 257).
- F See **Opening and Closing the Hood** (page 287).
- G See **Using the High Beam Headlamps** (page 87).

Child Safety

CHILD SAFETY PRECAUTIONS



WARNING: Always make sure your child is secured properly in a device that is appropriate for their height, age and weight. Child safety restraints must be bought separately from your vehicle. Failure to follow these instructions and guidelines may result in an increased risk of serious injury or death to your child.



WARNING: All children are shaped differently. The National Highway Traffic Safety Administration and other safety organizations, base their recommendations for child restraints on probable child height, age and weight thresholds, or on the minimum requirements of the law. We recommend that you check with a NHTSA Certified Child Passenger Safety Technician (CPST) to make sure that you properly install the child restraint in your vehicle and that you consult your pediatrician to make sure you have a child restraint appropriate for your child. To locate a child restraint fitting station and CPST, contact NHTSA toll free at 1-888-327-4236 or go to www.nhtsa.dot.gov. In Canada, contact Transport Canada toll free at 1-800-333-0371 or go to www.tc.gc.ca to find a Child Car Seat Clinic in your area. Failure to properly restrain children in child restraints made especially for their height, age and weight, may result in an increased risk of serious injury or death to your child.



WARNING: On hot days, the temperature inside the vehicle can rise very quickly. Exposure of people or animals to these high temperatures for even a short time can cause death or serious heat related injuries, including brain damage. Small children are particularly at risk.



WARNING: Do not place a rearward facing child restraint in front of an active airbag. Failure to follow this instruction could result in personal injury or death.



WARNING: Properly secure children 12 years old and under in a rear seating position whenever possible. If you are unable to properly secure all children in a rear seating position, properly secure the largest child on the front seat. If you must use a forward facing child restraint on the front seat, move the seat as far back as possible. Failure to follow these instructions could result in personal injury or death.



WARNING: Always carefully follow the instructions and warnings provided by the manufacturer of any child restraint to determine if the restraint device is appropriate for your child's size, height, weight, or age. Follow the child restraint manufacturer's instructions and warnings provided for installation and use in conjunction with the instructions and warnings provided by your vehicle manufacturer. A safety seat that is improperly installed or utilized, is inappropriate for your child's height, age, or weight or does not properly fit the child may increase the risk of serious injury or death.

Child Safety

WARNING: Do not allow a passenger to hold a child on their lap when your vehicle is moving. Failure to follow this instruction could result in personal injury or death in the event of a sudden stop or crash.

WARNING: Do not use pillows, books or towels to boost your child's height. Failure to follow this instruction could result in personal injury or death.

WARNING: Properly secure child restraints or booster seats when they are not in use. They could become projectiles in a sudden stop or crash. Failure to follow this instruction could result in personal injury or death.

WARNING: Do not put the shoulder section of the seatbelt or allow the child to put the shoulder section of the seatbelt under their arm or behind their back. Failure to follow this instruction could reduce the effectiveness of the seatbelt and increase the risk of injury or death in a crash.

WARNING: Do not leave children or pets unattended in your vehicle. Failure to follow this instruction could result in personal injury or death.

When installing a child restraint with seatbelts:

- Place the vehicle seat in the upright position before you install the child restraint.
- Use the correct seatbelt buckle for that seating position.
- Insert the belt tongue into the buckle. Make sure the tongue is securely fastened in the buckle.

- Keep the buckle release button pointing up and away from the child restraint, with the tongue between the child restraint and the release button, to prevent accidental unbuckling.
- Put the seatbelt in the automatic locking mode.

CHILD RESTRAINT ANCHOR POINTS

WHAT ARE THE CHILD RESTRAINT ANCHOR POINTS

Anchor points are designed to allow you to quickly and safely install a child restraint.

LOCATING THE CHILD RESTRAINT LOWER ANCHOR POINTS

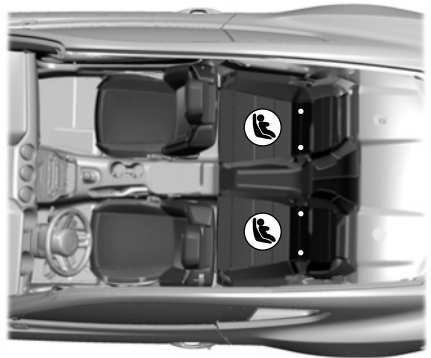

Child Safety

LOCATING THE CHILD RESTRAINT TOP TETHER ANCHOR POINTS

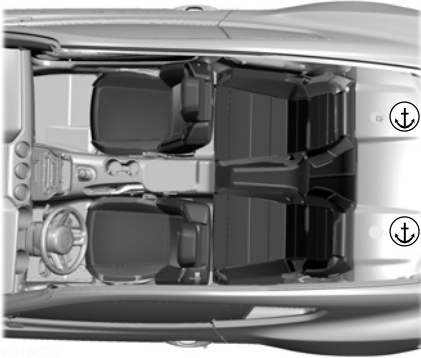

CHILD RESTRAINTS

CHILD RESTRAINT POSITION INFORMATION

Install the child restraint tightly against the vehicle seat. It may be necessary to lift or remove the head restraint.

Rear Facing Child Restraints

Combined Weight of Child and Child Restraint	LATCH (Lower Anchors Only)	Seatbelt Only
Up to 65 lb (29 kg)	X	X
Over 65 lb (29 kg)		X

Forward Facing Child Restraints

Combined Weight of Child and Child Restraint	LATCH (Lower Anchors and Top Tether Anchor)	Seatbelt and Top Tether Anchor	Seatbelt and LATCH (Lower Anchors and Top Tether Anchor)
Up to 65 lb (29 kg)	X	X	X
Over 65 lb (29 kg)		X	X

Child Safety

CHILD RESTRAINTS RECOMMENDATION

Child Size, Height, Weight, or Age	Recommended Restraint Type
Children weighing 40 lb (18 kg) or less (generally age four or younger).	Use a child restraint (sometimes called an infant carrier, convertible seat, or toddler seat).
Children who have outgrown or no longer properly fit in a child restraint (generally children who are less than 57 in (1.45 m) tall, are greater than age four and less than age 12, and between 40 lb (18 kg) and 80 lb (36 kg) and upward to 100 lb (45 kg) if recommended by your child restraint manufacturer).	Use a belt-positioning booster seat.
Children who have outgrown or no longer properly fit in a belt-positioning booster seat (generally children who are at least 57 in (1.45 m) tall or greater than 80 lb (36 kg) or 100 lb (45 kg) if recommended by child restraint manufacturer).	Use a vehicle seatbelt having the lap belt snug and low across the hips, shoulder belt centered across the shoulder and chest, and seat backrest upright.

You are required by law to properly use child restraints for infants and toddlers in the United States, Canada and Mexico.

Many states and provinces require that small children use approved booster seats until they reach age eight, a height of 57 in (1.45 m) tall, or 80 lb (36 kg). Check your local and state or provincial laws for specific requirements about the safety of children in your vehicle.

When possible, properly restrain children 12 years of age and under in a rear seating position of your vehicle. Accident statistics suggest that children are safer when properly restrained in the rear seating positions than in a front seating position.

When installing a rear facing child restraint, adjust the vehicle seats to avoid interference between the child restraint and the vehicle seat in front of the child restraint.

INSTALLING CHILD RESTRAINTS

USING SEATBELTS



WARNING: Depending on where you secure a child restraint, and depending on the child restraint design, you may block access to certain seatbelt buckle assemblies and LATCH lower anchors, rendering those features potentially unusable. To avoid risk of injury, make sure occupants only use seating positions where they are able to be properly restrained.

Note: *Although the child restraint illustrated is a forward-facing child restraint, the steps are the same for installing a rear-facing child restraint.*

Perform the following steps when installing a child restraint with seatbelts.

Child Safety

1. Position the child restraint in a seat with a seatbelt.



2. Pull down on the shoulder belt and then grasp it and the lap belt together.



3. While holding the shoulder and lap belt portions together, route the tongue through the child restraint according to the child restraint manufacturer's instructions. Make sure you did not twist the belt webbing.

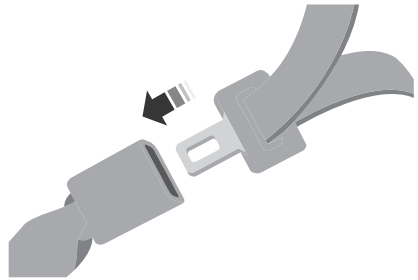

4. Insert the belt tongue into the proper buckle for that seating position until the latch engages. Make sure that you securely latch the tongue by pulling on it.



5. To put the retractor in the automatic locking mode, grasp the shoulder portion of the belt and pull downward until you pull all of the seatbelt out.

Note: *The automatic locking mode is available on the front passenger and rear seats. This vehicle does not require the use of a locking clip.*

6. Allow the belt to retract to remove slack. The seatbelt clicks as it retracts to indicate it is in the automatic locking mode.

Child Safety

- Pull the seatbelt out of the retractor to make sure the retractor is in the automatic locking mode. You should not be able to pull more belt out. If the retractor is not locked, unbuckle the belt and repeat Steps 5 and 6.

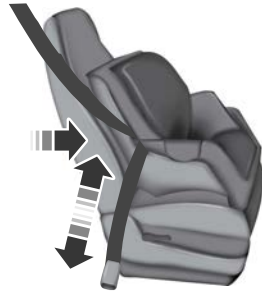

- Remove remaining slack from the belt. Force the seat down with extra weight, for example, by pressing down or kneeling on the child restraint while pulling up on the shoulder belt in order to force slack from the belt. This is necessary to remove the remaining slack that exists once you add the extra weight of the child to the child restraint. It also helps to achieve the proper snugness of the child restraint to your vehicle. Sometimes, a slight lean toward the buckle helps to remove remaining slack from the belt.
- If the child restraint has a tether strap, attach it.

- Before placing the child in the seat, forcibly move the seat forward and back to make sure the seat is securely held in place.

To check this, grab the seat at the belt path and attempt to move it side to side and forward and back. There should be no more than 1 in (2.5 cm) of movement.

We recommend checking with a NHTSA Certified Child Passenger Safety Technician to make certain the child restraint is properly installed. In Canada, check with Transport Canada for referral to a Child Car Seat Clinic.

USING LOWER ANCHORS AND TETHERS FOR CHILDREN



WARNING: Do not attach two child safety restraints to the same anchor. In a crash, one anchor may not be strong enough to hold two child safety restraint attachments and may break, causing serious injury or death.

Child Safety



WARNING: Depending on where you secure a child restraint, and depending on the child restraint design, you may block access to certain seatbelt buckle assemblies and LATCH lower anchors, rendering those features potentially unusable. To avoid risk of injury, make sure occupants only use seating positions where they are able to be properly restrained.



WARNING: The center of the rear seat is not designed as a seating position and does not have seatbelts. The LATCH anchors were not designed to be used with a child restraint in the center position and there is no tether anchor available at the center. Do not attempt to use the center as a seating position as this will increase the risk of injury or death in the event of a crash.

The Lower Anchors and Tethers for Children (LATCH) system has three vehicle anchor points:

- Two lower anchors where the vehicle seat backrest and seat cushion meet, called the seat bight.
- One top tether anchor behind that seating position.

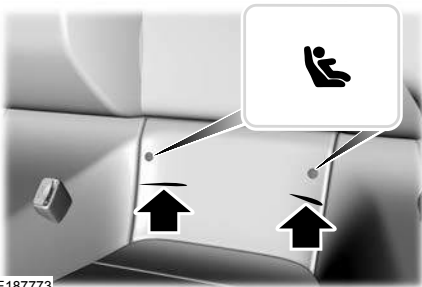

E187773

The lower anchors are at the rear section of the rear seat between the cushion and seat backrest.

LATCH compatible child restraints have two rigid or webbing mounted attachments. These attachments connect to the two lower anchors at the LATCH equipped seating positions in your vehicle. This type of attachment method eliminates the need to use seatbelts to attach the child restraint.

However, you can still use the seatbelt to attach the child restraint if the lower anchors are not used. For forward-facing child restraints, you must also attach the top tether strap to the proper top tether anchor if a top tether strap has been provided with your child restraint.

Follow the instructions later in this chapter on attaching child restraints with tether straps.

COMBINING THE SEATBELT AND LOWER ANCHORS FOR ATTACHING CHILD RESTRAINTS

When used in combination, you may attach either the seatbelt or the LATCH lower anchors first, provided a proper installation is achieved. Attach the tether strap afterward, if it is included with the child restraint.

USING TETHER STRAPS

Many forward-facing child restraints include a tether strap which extends from the back of the child restraint and hooks to an anchoring point called the top tether anchor. Tether straps are available as an accessory for many older child restraints.

Child Safety

Contact the manufacturer of your child restraint for information about ordering a tether strap, or to obtain a longer tether strap if the tether strap on your child restraint does not reach the appropriate top tether anchor in the vehicle.

Attach the tether strap only to the appropriate tether anchor. The tether strap may not work properly if attached somewhere other than the correct tether anchor.

If you install a child restraint with rigid LATCH attachments, do not tighten the tether strap enough to lift the child restraint off the vehicle seat cushion when the child is seated in it. Keep the tether strap snug without lifting the front of the child restraint. Keeping the child restraint just touching the vehicle seat gives the best protection in a severe crash.

Once you install the child restraint using either the seatbelt, the lower anchors of the LATCH system, or both, you can attach the tether strap.

For vehicles with a hard top:

1. Route the tether strap over the back of the seat.

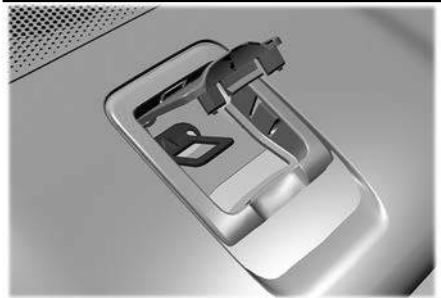

2. Locate the correct anchor for the selected seating position.
3. Open the tether anchor cover.
4. Clip the tether strap to the anchor.
5. Tighten the tether strap according to the manufacturer's instructions.

If your child restraint system has a tether strap, and the child restraint manufacturer recommends its use, we also recommend its use.

For vehicles with a convertible top:

Note: For easier access, attach the tether strap with the convertible top up.

1. Route the tether strap over the top of the seat backrest.

Child Safety

BOOSTER SEATS

Use a belt-positioning booster seat for children who have outgrown or no longer properly fit in a child restraint and meet the following criteria.

- Generally children who are less than 57 in (1.45 m) tall.
- Are greater than age four (4) and less than age twelve (12).
- Are between 40 lb (18 kg) and 80 lb (36 kg) and upward to 100 lb (45 kg).

Many state and provincial laws require that children use approved booster seats until they reach age eight, a height of 57 in (1.45 m) tall, or 80 lb (36 kg).

Booster seats should be used until you can answer yes to all of these questions when seated without a booster seat:

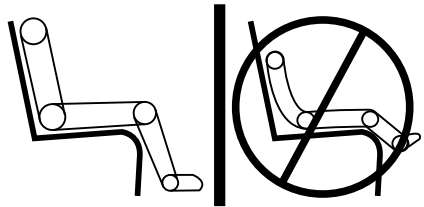

2. Locate the correct anchor for the selected seating position.
3. Remove the tether anchor cap.
4. Clip the tether strap to the anchor.
5. Tighten the tether strap according to the manufacturer's instructions.

If you do not properly anchor the child restraint, the risk of injury to a child greatly increases in a crash.

If your child restraint system has a tether strap, and the child restraint manufacturer recommends its use, we also recommend its use.

- Can the child sit all the way back against their vehicle seat backrest with knees bent comfortably at the edge of the seat cushion?
- Can the child sit without slouching?
- Does the lap belt rest low across the hips?
- Is the shoulder belt centered on the shoulder and chest?
- Can the child stay seated like this for the whole trip?

Child Safety

Always use booster seats in conjunction with your vehicle lap and shoulder belt.

Types of Booster Seats



- Backless booster seats

If your backless booster seat has a removable shield, remove the shield.

If a vehicle seating position has a low seat backrest or no head restraint, a backless booster seat may place your child's head, as measured at the tops of the ears, above the top of the seat. In this case, move the backless booster to another seating position with a higher seat backrest or head restraint and lap and shoulder belts, or consider using a high-back booster seat.



- High-back booster seats

If, with a backless booster seat, you cannot find a seating position that adequately supports your child's head, a high-back booster seat would be a better choice.

Children and booster seats vary in size and shape. Choose a booster that keeps the lap belt low and snug across the hips, never up across the stomach, and lets you adjust the shoulder belt to cross the chest and rest snugly near the center of the shoulder.

The following drawings compare the ideal fit to a shoulder belt uncomfortably close to the neck and a shoulder belt that could slip off the shoulder. The drawings also show how the lap belt should be low and snug across the child's hips.



Child Safety



If the booster seat slides on the vehicle seat upon which it is being used, placing a rubberized mesh sold as shelf or carpet liner under the booster seat may improve this condition. Do not use any item thicker than this under the booster seat. Check with the booster seat manufacturer's instructions.

Seatbelts

SEATBELT PRECAUTIONS



WARNING: Always drive and ride with your seatback upright and the lap belt snug and low across the hips.



WARNING: Children must always be properly restrained.



WARNING: Do not allow a passenger to hold a child on their lap when your vehicle is moving. Failure to follow this instruction could result in personal injury or death in the event of a sudden stop or crash.



WARNING: All occupants of your vehicle, including the driver, should always properly wear their seatbelts, even when an airbag supplemental restraint system is provided. Failure to properly wear your seatbelt could seriously increase the risk of injury or death.



WARNING: It is extremely dangerous to ride in a cargo area, inside or outside of a vehicle. In a crash, people riding in these areas are more likely to be seriously injured or killed. Do not allow people to ride in any area of your vehicle that is not equipped with seats and seatbelts. Make sure everyone in your vehicle is in a seat and properly using a seatbelt. Failure to follow this warning could result in serious personal injury or death.



WARNING: In a rollover crash, an unbelted person is significantly more likely to die than a person wearing a seatbelt.



WARNING: Each seating position in your vehicle has a specific seatbelt assembly made up of one buckle and one tongue designed to be used as a pair. Use the shoulder belt on the outside shoulder only. Never wear the shoulder belt under the arm. Never use a single seatbelt for more than one person.



WARNING: Even with advanced restraints systems, properly restrain children 12 and under in a rear seating position. Failure to follow this could seriously increase the risk of injury or death.



WARNING: Seatbelts and seats may be hot in a vehicle that is in the sunshine. The hot seatbelts or seats may burn a small child. Check seat covers and buckles before you place a child anywhere near them.



WARNING: The center of the rear seat is not designed as a seating position and does not have seatbelts. The LATCH anchors were not designed to be used with a child restraint in the center position and there is no tether anchor available at the center. Do not attempt to use the center as a seating position as this will increase the risk of injury or death in the event of a crash.



WARNING: If your vehicle is involved in a crash, have the seatbelts and associated components inspected as soon as possible. Failure to follow this instruction could result in personal injury or death.

All seating positions in this vehicle have lap and shoulder seatbelts. All occupants of the vehicle should properly wear their seatbelts, even when an airbag supplemental restraint system is provided.

Seatbelts

The seatbelt system consists of:

- Lap and shoulder seatbelts.
- Seatbelt pretensioners at the front and rear seating positions.
- Belt tension sensor at the front passenger seating position.



A seatbelt warning light and chime.



Crash sensors and monitoring system with a readiness indicator.

The seatbelt pretensioners are designed to tighten the seatbelts when activated. In frontal and near-frontal crashes, the seatbelt pretensioners may be activated alone or, if the crash is of sufficient severity, together with the front airbags. The pretensioners may also activate in side impacts and rollovers.

FASTENING AND UNFASTENING THE SEATBELTS



WARNING: Make sure that the seatbelts are securely stowed away when not in use and not outside your vehicle when closing the doors.



WARNING: Do not use accessory seat covers. The use of accessory seat covers may prevent the deployment of the airbags and the seatbelt from retracting correctly which could increase the risk of injuries in a crash.

A web guide is included on the outermost side of the front seats. Depending on occupant size and seating position, you may need to route the belt through the guide for a proper fit. If the seatbelt does not route across the middle of the shoulder, route the belt through the web guide.

Convertible



Coupe

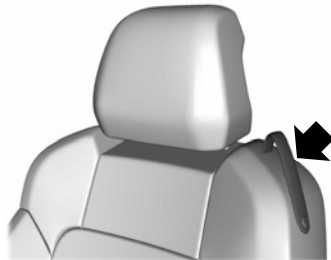

Seatbelts

Recaro

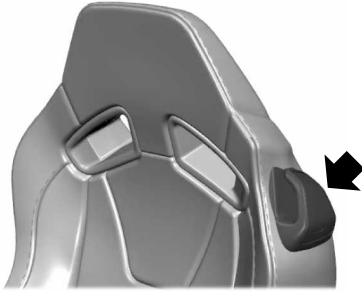

All seatbelts in your vehicle are three-point combination lap and shoulder seatbelts.

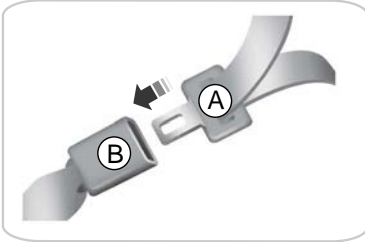

A Seatbelt tongue.

B Seatbelt buckle.

1. Pull the seatbelt out steadily.

Note: *It may lock if you pull it sharply or if the vehicle is on a slope.*

2. Insert the tongue into the buckle.
3. Pull the seatbelt tight to remove any slack.

Rear Seats

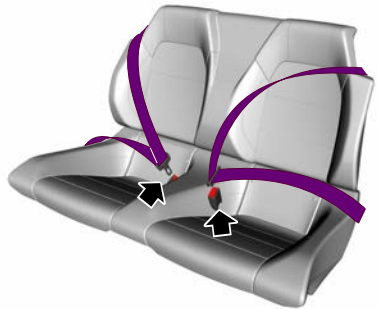

Unfastening the Seatbelts

1. Press the red button on the buckle to release the seatbelt.
2. Hold the seatbelt tongue and let it retract completely and smoothly to its stowed position.

SENSITIVE LOCKING MODE

WHAT IS SENSITIVE LOCKING MODE

Sensitive locking mode is a seatbelt retractor feature that allows shoulder belt length adjustment according to your movements and locking in response to vehicle movement.

HOW DOES SENSITIVE LOCKING MODE WORK

If the driver suddenly brakes, turns a corner sharply, or the vehicle receives an impact of about 5 mph (8 km/h) or more, the seatbelts lock to help reduce forward movement of the driver and passengers.

Seatbelts

In addition, the seatbelt retractor locks if you pull the seatbelt webbing out too quickly. If the retractor locks, slowly lower the height adjuster to allow the seatbelt to retract.

If the retractor does not unlock, pull the seatbelt out slowly then feed a small length of webbing back toward the stowed position.

AUTOMATIC LOCKING MODE

WHAT IS AUTOMATIC LOCKING MODE

This is a safety feature built into the seatbelt retractors that keeps the seatbelts pre-locked.

WHEN TO USE AUTOMATIC LOCKING MODE

Use this mode any time you install a child restraint in a front outermost passenger seating position or any rear seating position. Properly restrain children 12 years old and under in a rear seat whenever possible.

Note: *Automatic locking mode is not available on the driver seatbelt.*

ENGAGING AUTOMATIC LOCKING MODE



1. Fasten the combination lap and shoulder belt.
2. Grasp the shoulder portion and pull downward until you pull the entire belt out.
3. Allow the belt to retract. As the belt retracts, you will hear a clicking sound. This indicates the seatbelt is now in the automatic locking mode.

DISENGAGING AUTOMATIC LOCKING MODE

Unbuckle the combination lap and shoulder belt and allow it to retract completely to disengage the automatic locking mode and activate the vehicle sensitive locking mode.

Seatbelts

ADJUSTING THE SEATBELTS DURING PREGNANCY



WARNING: Always ride and drive with your seatback upright and properly fasten your seatbelt. Fit the lap portion of the seatbelt snugly and low across the hips. Position the shoulder portion of the seatbelt across your chest. Pregnant women must follow this practice. See the following figure.

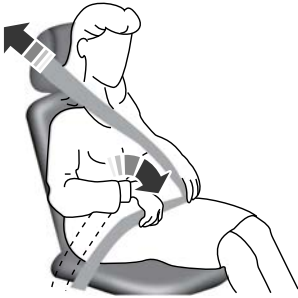

Pregnant women should always wear their seatbelt. Position the lap belt portion of a combination lap and shoulder belt low across the hips below the belly and worn as tight as comfort allows. Position the shoulder belt to cross the middle of the shoulder and the center of the chest.

SEATBELT REMINDER

HOW DOES THE SEATBELT REMINDER WORK



WARNING: The system will only provide protection when you use the seatbelt correctly.

This system monitors all seating positions and provides audio and graphic feedback.

SEATBELT REMINDER INDICATORS



This lamp illuminates if you do not fasten your seatbelt when you switch the power on. The lamp switches off when you fasten your seatbelt.

When the initial warning expires for the driver, the system provides more warnings for the driver and front passenger. This lamp illuminates if you or your front passenger do not fasten the seatbelt buckle and the vehicle speed exceeds 6 mph (9.7 km/h).

Note: To avoid inadvertent warnings, do not place large objects on the front passenger seat.



This warning displays if an occupant unfastens a seatbelt buckle or it becomes unfastened.

Note: If a rear seat is unoccupied, or an occupant never fastens the seatbelt buckle to begin with, the warning will not display.

Note: Front seating positions appear in this warning display. Warnings for unfastened front seatbelt buckles appear in the initial warning lamp.

Seatbelts

Checking Seatbelt Status

To view the seatbelt status, use the touchscreen.

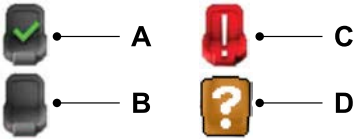

- A Seatbelt fastened.
- B Seatbelt not fastened.
- C Seatbelt recently unfastened or for your seat and seats with occupant presence detection not fastened when you start your vehicle.
- D Fault.

SEATBELT REMINDER AUDIBLE WARNINGS

A warning tone sounds if you do not fasten your seatbelt when you switch the power on. The tone switches off when you fasten your seatbelt or about one minute elapses.

When the initial warning expires for the driver, more warnings are provided for the driver and front passenger. This warning tone sounds if you or your front passenger do not fasten the seatbelt buckle and the vehicle speed exceeds 6 mph (9.7 km/h).

This tone also sounds if an occupant unfastens the rear seatbelt buckle or it becomes unfastened.

SWITCHING THE SEATBELT REMINDER ON AND OFF



WARNING: While the system allows you to deactivate it, this system is designed to improve your chances of being safely belted and surviving an accident. We recommend you leave the system activated for yourself and others who may use the vehicle.

Note: *The driver and front passenger warnings switch off independently. When you perform this procedure for one seating position and the other seat is occupied, fasten the other seat.*

Read Steps 1-4 before proceeding with the programming procedure.

Make sure that:

- You set the parking brake.
 - The transmission is in park (P).
 - The ignition is off.
 - You close all vehicle doors.
 - You unfasten the driver and front passenger seatbelts.
1. Start the engine.
 2. Wait a short period of time until the seatbelt warning light switches off. After Step 2, wait an additional five seconds before proceeding with Step 3. Once you start Step 3, complete the procedure within 30 seconds.

Seatbelts

3. For the seating position you are switching off, fasten then unfasten the seatbelt four times at a moderate speed, ending in the unfastened state. After each unfasten, the seatbelt warning light switches on and off with each fasten.
4. The seatbelt warning light flashes for confirmation.

This switches the feature off for that seating position if it is currently on.

This switches the feature on for that seating position if it is currently off.

CHECKING THE SEATBELTS

Check the seatbelts and child restraints periodically to make sure they work properly and are not damaged. Make sure there are no nicks, tears or cuts. Replace if necessary.

Check all of the following seatbelt assemblies after a crash.

- Retractors.
- Buckles.
- Front seatbelt buckle assemblies.
- Shoulder belt guide on seat backrest.
- Child restraint anchors and top tethers.
- Attaching hardware.

Read the child restraint manufacturer's instructions for additional inspection and maintenance information specific to the child restraint.

We recommend that all seatbelt assemblies in use in vehicles involved in a crash be replaced. However, if the crash was minor and an authorized dealer finds that the belts do not show damage and continue to operate properly, they do not need to be replaced. Seatbelt assemblies not in use during a crash should also be checked and replaced if either damage or improper operation is noted.

Properly care for seatbelts. See **Vehicle Care** (page 320).

SEATBELT EXTENSIONS



WARNING: Persons who fit into the vehicle's seatbelt should not use an extension. Unnecessary use could result in serious personal injury in the event of a crash.



WARNING: Only use extensions provided free of charge by our dealers. The dealer will provide an extension designed specifically for this vehicle, model year and seating position. The use of an extension intended for another vehicle, model year or seating position may not offer you the full protection of your vehicle's seatbelt restraint system.



WARNING: Never use seatbelt extensions to install child restraints.



WARNING: Do not use extensions to change the way the seatbelt fits across the torso, over the lap or to make the seatbelt buckle easier to reach.

If, because of body size or driving position, it is not possible to properly fasten the seatbelt over your lap and shoulder, an extension that is compatible with the seatbelts is available free of charge from our dealers. Only use our seatbelt extensions made by the original equipment seatbelt manufacturer with our seatbelts. Ask your authorized dealer if your extension is compatible with your vehicle restraint system.

Personal Safety System™

WHAT IS THE PERSONAL SAFETY SYSTEM

An advanced safety system that protects occupants in frontal crashes.

HOW DOES THE PERSONAL SAFETY SYSTEM WORK

This system provides an improved level of frontal crash protection to front seat occupants and is designed to reduce the risk of airbag-related injuries. The system analyzes occupant conditions and crash severity before activating the appropriate safety devices. During a crash, the restraints control module may deploy the seatbelt pretensioners, and one or both stages of the dual-stage airbags based on crash severity and occupant conditions.

PERSONAL SAFETY SYSTEM COMPONENTS

- Driver and passenger dual-stage airbag supplemental restraints.
- Front seat outermost seatbelts with pretensioners, energy management retractors and seatbelt usage sensors.
- Front passenger sensing system.
- Passenger airbag off and on indicators.
- Front crash severity sensors.
- Restraints control module with impact and safing sensors.
- Restraint system warning light and tone.
- The electrical wiring for the airbags, crash sensors, seatbelt pretensioners, front seatbelt usage sensors, front passenger sensing system and indicator lights.

Airbags

HOW DO THE FRONT AIRBAGS WORK

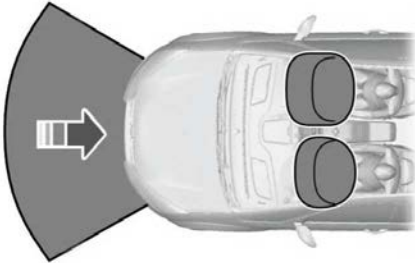

The driver and front passenger airbags deploy during significant frontal and near frontal crashes.

The driver and passenger front airbag system consists of:

- Driver and passenger airbag modules.
- Front passenger sensing system.
- Crash sensors and monitoring system with readiness indicator. See **Crash Sensors and Airbag Indicator** (page 58).

The airbags are a supplemental restraint system and are designed to work with the seatbelts to help protect the driver and right front passenger from certain upper body injuries. Airbags do not inflate slowly; there is a risk of injury from a deploying airbag.

Note: *You will hear a loud bang and see a cloud of harmless powdery residue if an airbag deploys. This is normal.*

The airbags inflate and deflate rapidly upon activation. After airbag deployment, it is normal to notice a smoke-like, powdery residue or smell the burnt propellant. This may consist of cornstarch, talcum powder (to lubricate the bag) or sodium

compounds (for example, baking soda) that result from the combustion process that inflates the airbag. Small amounts of sodium hydroxide may be present which may irritate the skin and eyes, but none of the residue is toxic.

Contact with a deploying airbag may cause abrasions or swelling. Temporary hearing loss is also a possibility as a result of the noise associated with a deploying airbag.

Because airbags must inflate rapidly and with considerable force, there is the risk of death or serious injuries such as fractures, facial and eye injuries or internal injuries, particularly to occupants who are not properly restrained or are otherwise out of position at the time of airbag deployment. Thus, it is extremely important that occupants be properly restrained as far away from the airbag module as possible.

Routine maintenance of the airbags is not required.

HOW DO THE SIDE AIRBAGS WORK

 **WARNING:** Do not place objects or mount equipment on or near the airbag cover, on the side of the front seat backrests, or in areas that may come into contact with a deploying airbag. Failure to follow this instruction could result in personal injury or death.

 **WARNING:** Do not use accessory seat covers. The use of accessory seat covers may prevent the deployment of the airbags and the seatbelt from retracting correctly which could increase the risk of injuries in a crash.

Airbags



WARNING: Do not lean your head on the door. The side airbag could injure you as it deploys from the side of the seatback.

The side airbags are on the outermost side of the front seat backrests. In certain sideways crashes or rollovers, the airbags inflate. The airbag was designed to inflate between the door panel and occupant to further enhance the protection provided occupants in side impact crashes.

Coupe



Convertible



E174777

The system consists of:

- A label or embossed side panel indicating that your vehicle has side airbags.
- Side airbags inside the driver and front passenger seat backrests.
- Crash sensors and monitoring system with a readiness indicator. See **Crash Sensors and Airbag Indicator** (page 58).

Note: For some models, the passenger sensing system deactivates the passenger seat-mounted side airbag if it detects an empty passenger seat.

HOW DO THE KNEE AIRBAGS WORK



WARNING: To reduce risk of injury, do not obstruct or place objects in the deployment path of the airbag.



WARNING: Close the glove box door when your vehicle is moving. Failure to follow this instruction could reduce the effectiveness of the passenger knee airbag and increase the risk of injury in a crash.

A driver knee airbag is under or within the instrument panel. A passenger knee airbag is within or under the glove compartment.

During a crash, the restraints control module may activate the driver and passenger knee airbags based on crash severity and occupant conditions. Under certain crash and occupant conditions, the driver and passenger knee airbag may deploy but the driver front airbag may not activate.

Airbags

As with front and side airbags, it is important to be properly seated and restrained to reduce the risk of death or serious injury.



Make sure the knee airbag is operating properly. See **Crash Sensors and Airbag Indicator**

(page 58).

HOW DOES THE SAFETY CANOPY™ WORK - COUPE



WARNING: Do not place objects or mount equipment on or near the headliner at the siderail that may come into contact with a deploying curtain airbag. Failure to follow these instructions may increase the risk of personal injury in the event of a crash.



WARNING: Do not lean your head on the door. The curtain airbag could injure you as it deploys from the headliner.



WARNING: All occupants of your vehicle, including the driver, should always properly wear their seatbelts, even when an airbag supplemental restraint system is provided. Failure to properly wear your seatbelt could seriously increase the risk of injury or death.

The Safety Canopy deploys during significant side crashes or when a certain likelihood of a rollover event is detected by the rollover sensor. The Safety Canopy is mounted to the roof side rail sheet metal, behind the headliner, above each row of seats.

In certain sideways crashes or rollover events, the Safety Canopy activates, regardless of which seats are occupied. The Safety Canopy is designed to inflate between the side window area and occupants to further enhance protection provided in side impact crashes and rollover events.

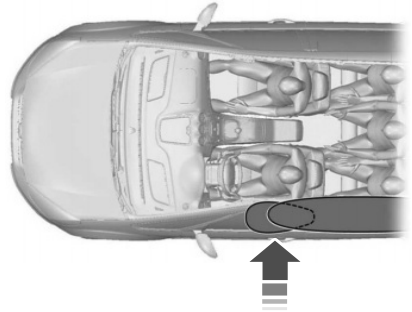

The system consists of:

- Safety Canopy curtain airbags above the trim panels over the front and rear side windows. They are identified by a label or wording on the headliner or roof pillar trim.
- A flexible headliner which opens above the side doors to allow air curtain deployment
- Crash sensors and monitoring system with a readiness indicator. See **Crash Sensors and Airbag Indicator** (page 58).

Properly restrain children 12 years old and under in the rear seats. The Safety Canopy airbags will not interfere with children restrained using a properly installed child or booster seat because it is designed to inflate downward from the headliner above the doors along the side window opening.

Airbags

AIRBAG PRECAUTIONS



WARNING: Airbags do not inflate slowly or gently, and the risk of injury from a deploying airbag is the greatest close to the trim covering the airbag module.



WARNING: All occupants of your vehicle, including the driver, should always properly wear their seatbelts, even when an airbag supplemental restraint system is provided. Failure to properly wear your seatbelt could seriously increase the risk of injury or death.



WARNING: Properly secure children 12 years old and under in a rear seating position whenever possible. If you are unable to properly secure all children in a rear seating position, properly secure the largest child on the front seat. If you must use a forward facing child restraint on the front seat, move the seat as far back as possible. Failure to follow these instructions could result in personal injury or death.



WARNING: Do not place your arms on the airbag cover or through the steering wheel. Failure to follow this instruction could result in personal injury.



WARNING: Keep the areas in front of the airbags free from obstruction. Do not affix anything to or over the airbag covers. Objects could become projectiles during airbag deployment. Failure to follow this instruction could result in personal injury or death.



WARNING: To reduce risk of injury, do not obstruct or place objects in the deployment path of the airbag.



WARNING: Do not place a rearward facing child restraint in front of an active airbag. Failure to follow this instruction could result in personal injury or death.



WARNING: Do not attempt to service, repair, or modify the supplementary restraint system or associated components. Failure to follow this instruction could result in personal injury or death.



WARNING: Several airbag system components get hot after inflation. To reduce the risk of injury, do not touch them after inflation.



WARNING: If a supplementary restraint system component has deployed, it will not function again. Have the system and associated components inspected as soon as possible. Failure to follow this instruction could result in personal injury or death.

PROPERLY ADJUSTING THE DRIVER AND FRONT PASSENGER SEATS



WARNING: National Highway Traffic Safety Administration (NHTSA) recommends a minimum distance of at least 10 in (25 cm) between an occupant's chest and the driver airbag module.

Airbags

To properly position yourself away from the airbag:

- Move your seat to the rear as far as you can while still reaching the pedals comfortably.
- Recline the seat slightly one or two degrees from the upright position.

After all occupants have adjusted their seats and put on seatbelts, it is very important that they continue to sit properly. Properly seated occupants sit upright, lean against the seat backrest, and center themselves on the seat cushion, with their feet comfortably extended on the floor. Sitting improperly can increase the chance of injury in a crash event. For example, if an occupant slouches, lies down, turns sideways, sits forward, leans forward or sideways, or puts one or both feet up, the chance of injury during a crash greatly increases.

CHILDREN AND AIRBAGS



WARNING: Do not place a rearward facing child restraint in front of an active airbag. Failure to follow this instruction could result in personal injury or death.



Children must always be properly restrained. Accident statistics suggest that children are safer when properly restrained in the rear seating positions than in the front seating position. Failure to follow these instructions may increase the risk of injury in a crash.

FRONT PASSENGER SENSING SYSTEM

WHAT IS THE FRONT PASSENGER SENSING SYSTEM

This system detects a properly seated occupant and determines if the front passenger airbag should be enabled.

HOW DOES THE FRONT PASSENGER SENSING SYSTEM WORK

The system uses a passenger airbag status indicator which illuminates indicating that the front passenger frontal airbag is either enabled or disabled.

Note: When you first switch the power on, the passenger airbag status indicator off and on lamps illuminate for a short period to confirm they are functional.



The indicators are in the center of the instrument panel.

Airbags

The front passenger sensing system is designed to disable the front passenger frontal airbag under these conditions:

- The front passenger seat is unoccupied.
- The system determines an infant is present in a child restraint.
- A passenger takes their weight off of the seat for a period of time.
- If there is a problem with the airbag system or the passenger sensing system.

Note: *Even with this technology, parents are strongly encouraged to always properly restrain children in the rear seat.*

- When the front passenger sensing system disables the front passenger frontal airbag, the passenger airbag status indicator illuminates the off lamp.
- If you have installed the child restraint and the passenger airbag status indicator illuminates the on lamp, switch your vehicle off, remove the child restraint from your vehicle and reinstall the restraint following the child restraint manufacturer's instructions.

The front passenger sensing system works with sensors that are part of the front passenger seat and seatbelt. The sensors are designed to detect the presence of a properly seated occupant and determine if the front passenger frontal airbag should be enabled.

- When the front passenger sensing system enables the front passenger frontal airbag, the passenger airbag status indicator illuminates the on lamp.

If a person of adult size is sitting in the front passenger seat, but the passenger airbag status indicator off lamp is illuminated, it is possible that the person is not sitting properly in the seat. If this happens:

- Switch your vehicle off and ask the person to place the seat backrest in an upright position.
- Have the person sit upright in the seat, centered on the seat cushion, with the person's legs comfortably extended.
- Restart your vehicle and have the person remain in this position for about two minutes. This allows the system to detect that person and enable the passenger frontal airbag.
- If the indicator off lamp remains illuminated even after this, you should advise the person to ride in the rear seat.

After all occupants have adjusted their seats and put on seatbelts, it is very important that they continue to sit upright, leaning against the seat backrest, and centered on the seat cushion, with their feet comfortably extended on the floor.

Sitting improperly can increase the chance of injury in a crash event. For example, if an occupant slouches, lies down, turns sideways, sits forward, leans forward or sideways, or puts one or both feet up, the chance of injury during a crash greatly increases.

If you think that the state of the passenger airbag status indicator lamp is incorrect, check for the following:

- Objects lodged underneath the seat.
- Objects between the seat cushion and the center console.
- Objects hanging off the seat backrest.
- Objects stowed in the seat backrest map pocket.
- Objects placed on the occupant's lap.

Airbags

- Cargo interference with the seat
- Other passengers pushing or pulling on the seat.
- Rear passenger feet and knees resting or pushing on the seat.

The listed conditions could cause the weight of a properly seated occupant to be incorrectly interpreted by the front passenger sensing system. The person in the front passenger seat could appear heavier or lighter due to the conditions listed.



Make sure the front passenger sensing system is operating properly. See **Crash Sensors and Airbag Indicator** (page 58).

If the airbag readiness light is on, do the following:

- Pull your vehicle over.
- Switch your vehicle off.
- Check for any objects lodged underneath the front passenger seat or cargo interfering with the seat.
- Remove the obstruction if found.
- Restart your vehicle.
- Wait at least two minutes and verify that the airbag readiness light in the instrument cluster is no longer illuminated.
- If the airbag readiness light in the instrument cluster remains illuminated, there may be a problem due to the front passenger sensing system.

Do not attempt to repair or service the system. Take your vehicle in for service immediately.

If it is necessary to modify an advanced front airbag system to accommodate a person with disabilities, contact your Customer Relationship Center.

FRONT PASSENGER SENSING SYSTEM PRECAUTIONS



WARNING: Sitting improperly, out of position or with the seatback reclined too far can take weight off the seat cushion and affect the decision of the passenger sensing system, resulting in serious injury or death in the event of a crash. Always sit upright against your seat back, with your feet on the floor.



WARNING: Any alteration or modification to the front passenger seat may affect the performance of the front passenger sensing system. This could seriously increase the risk of injury or death.



WARNING: Do not place objects under the front passenger seat or between the seat and the center console. Failure to follow this instruction may interfere with the front passenger seat sensing system and increase the risk of injury or death in a crash.



WARNING: Check the passenger airbag indicator lamp for proper airbag status. Failure to follow this instruction could result in personal injury or death.

Airbags

FRONT PASSENGER SENSING SYSTEM INDICATORS

Occupant	Passenger Airbag Status Indicator	Passenger Airbag
Empty	OFF: Illuminated	Disabled
	ON: Not Illuminated	
Child	OFF: Illuminated	Disabled
	ON: Not Illuminated	
Adult	OFF: Not Illuminated	Enabled
	ON: Illuminated	

CRASH SENSORS AND AIRBAG INDICATOR



WARNING: Modifying or adding equipment to the front of your vehicle could affect the performance of the airbag system, increasing the risk of injury. This includes the hood, bumper system, frame, front body structure, tow hooks, hood pins, push bar and snowplows.

Your vehicle has a collection of crash and occupant sensors. These sensors provide information to the restraints control module which activates the following:

- Front seatbelt pretensioners.
- Driver airbag.
- Passenger airbag.
- Knee airbag(s).
- Seat mounted side airbags.
- Adaptive steering column.
- Safety Canopy airbags.

Based on the type of crash, the restraints control module deploys the appropriate safety devices.

The restraints control module also monitors the readiness of the above safety devices plus the crash and occupant sensors. The safety system displays an indicator in the instrument cluster when it is ready. The system sends out a tone as a backup if it is not working. The airbag does not require routine maintenance.

One or more of the following may indicate a system issue:



The readiness light does not immediately illuminate after you switch the power on.

- The readiness light either flashes or stays on.
- You hear a series of five tones. The tone pattern periodically repeats until the problem, the light or both are repaired.

If any of these things happen, even intermittently, have the supplemental restraint system immediately serviced. Unless serviced, the system may not properly function in the event of a crash.

Airbags

The fact that the seatbelt pretensioners or front airbags did not activate for both front seat occupants in a crash does not mean that something is wrong with the system. Rather, it means the restraints control module determined the accident conditions (crash severity, seatbelt usage) were not appropriate to activate these safety devices.

- The front airbags activate only in frontal and near-frontal crashes. The front airbags may activate in rollovers, side impacts or rear impacts if the crash causes sufficient frontal deceleration.
- The seatbelt pretensioners activate in frontal, near-frontal and side crashes, and in rollovers.
- The knee airbag deploys based on crash severity and occupant conditions.
- The side airbags inflate in certain side impact crashes or rollover events. Side airbags may activate in other types of crashes if the vehicle experiences sufficient sideways motion or deformation.
- The Safety Canopy inflates in certain side impact crashes or rollover events. The Safety Canopy may activate in other types of crashes if the vehicle experiences sufficient sideways motion or deformation, or a certain likelihood of rollover.

DISPOSING OF AIRBAGS

Contact your authorized dealer as soon as possible. Airbags must be disposed of by qualified personnel.

911 Assist (If Equipped)

WHAT IS 911 ASSIST

911 Assist is a SYNC system feature that can call for help.

For more information, visit www.owner.ford.com.

HOW DOES 911 ASSIST WORK

If a crash deploys an airbag, excluding knee airbags and rear inflatable seatbelts, or activates the fuel pump shut-off, your vehicle may be able to contact emergency services by dialing 911 through a paired and connected **Bluetooth**® enabled phone.

Not all crashes deploy an airbag or activate the fuel pump shut-off. If a connected cell phone sustains damage or loses its connection to SYNC during a crash, SYNC searches for and tries to connect to a previously paired cell phone. SYNC then attempts to call the emergency services.

Before making the call:

- SYNC provides about 10 seconds to cancel the call. If you fail to cancel the call, SYNC attempts to dial 911.
- SYNC says the following, or a similar message: SYNC will attempt to call 911, to cancel the call, press Cancel on your screen or press and hold the phone button on your steering wheel.

If you do not cancel the call and SYNC makes a successful call a pre-recorded message plays for the 911 operator. The occupants in your vehicle are able to talk with the operator. Be prepared to provide your name, phone number and location immediately because not all 911 systems are capable of receiving this information electronically.

During an emergency call the system transmits vehicle data to the emergency service.

EMERGENCY CALL REQUIREMENTS



WARNING: Do not wait for 911 Assist to make an emergency call if you can do it yourself. Dial emergency services immediately to avoid delayed response time which could increase the risk of serious injury or death after a crash. If you do not hear 911 Assist within five seconds of the crash, the system or phone may be damaged or non-functional.



WARNING: Always place your phone in a secure location in your vehicle so it does not become a projectile or get damaged in a crash. Failure to do so may cause serious injury to someone or damage the phone which could prevent 911 Assist from working properly.



WARNING: Unless the 911 Assist setting is set on before a crash, the system will not dial for help which could delay response time, potentially increasing the risk of serious injury or death after a crash.

- SYNC is powered and working properly at the time of the incident and throughout feature activation and use.
- The 911 Assist feature must be set on before the incident.
- You must pair and connect a **Bluetooth**® enabled and compatible cell phone to SYNC.
- A connected **Bluetooth**® enabled phone must have the ability to make and maintain an outgoing call at the time of the incident.

911 Assist (If Equipped)

- A connected **Bluetooth**® enabled phone must have adequate network coverage, battery power and signal strength.
- The vehicle must have battery power and be located in the U.S., Canada or in a territory in which 911 is the emergency number.

Note: *If any user sets 911 Assist to on or off, that setting applies for all paired phones. If 911 Assist is off and the phone connected to SYNC, an icon displays on the status bar.*

Note: *Every phone operates differently. While SYNC 911 Assist works with most cellular phones, some may have trouble using this feature.*

EMERGENCY CALL LIMITATIONS

The SYNC 911 Assist feature only operates in the U.S., Canada or in a territory in which 911 is the emergency number. The following are limitations of this feature:

- Your cellular phone or 911 Assist hardware sustains damage in a crash.
- The vehicle's battery or the SYNC system has no power.
- The phone(s) thrown from your vehicle are the ones paired and connected to the system.

Keys and Remote Controls

REMOTE CONTROL LIMITATIONS



WARNING: Changes or modifications not expressly approved by the party responsible for compliance could void the user's authority to operate the equipment. The term "IC:" before the radio certification number only signifies that Industry Canada technical specifications were met.

This device complies with Part 15 of the FCC Rules and with Industry Canada license-exempt RSS standard(s). Operation is subject to the following two conditions: (1) This device may not cause harmful interference, and (2) This device must accept any interference received, including interference that may cause undesired operation.

Make sure a valid remote control is within 3 ft (1 m) from the front door handles and rear of vehicle.

The system may not function if:

- The remote control remains stationary for about a minute.
- The vehicle battery has no charge.
- The remote control battery has no charge.
- There is interference causing issues with the remote control frequencies.
- The remote control is too close to metal objects or electronic devices, for example keys or a cell phone.

USING THE REMOTE CONTROL



WARNING: Do not leave a key or remote control unattended in the vehicle. Children or pets could operate the power windows, moonroof or other controls. Failure to follow this instruction could result in personal injury or death.

Use your remote control to access various vehicle systems.

Note: *The buttons on your remote may vary depending on the vehicle region or options.*

One-Stage Unlocking



Press the button to unlock all doors. See **Unlocking and Locking the Doors Using the Remote Control** (page 69).

Two-Stage Unlocking (If Equipped)



Press the button to unlock the driver's door. Press the button again within three seconds to unlock all doors. See **Unlocking and Locking the Doors Using the Remote Control** (page 69).

Lock



Press the button to lock all doors. See **Unlocking and Locking the Doors Using the Remote Control** (page 69).

Panic Alarm (If Equipped)



Press the button to sound the panic alarm. See **Sounding the Panic Alarm** (page 63).

Keys and Remote Controls

Remote Start (If Equipped)



Press the button to remote start. See **Using Remote Start** (page 105).

Luggage Compartment



Press the button twice to open the luggage compartment.

REMOVING THE KEY BLADE



Push the release button on your passive key and pull the key blade out.

SOUNDING THE PANIC ALARM



Press the button to sound the panic alarm. Press the button again or switch the vehicle on to turn it off.

Note: *The panic alarm only operates when the vehicle is off.*

LOCATING YOUR VEHICLE



Press the lock button twice within three seconds. The turn signal lamps flash. We recommend you use this method to locate your vehicle.

CHANGING THE REMOTE CONTROL BATTERY



WARNING: Keep batteries away from children to prevent ingestion. Failure to follow this instruction could result in personal injury or death. If ingested, immediately seek medical attention.



WARNING: If the battery compartment does not securely close, stop using the remote control and replace it as soon as possible. In the meantime, keep the remote control away from children. Failure to follow this instruction could result in personal injury or death.

The remote control uses one coin-type 3-volt lithium battery, CR2450, or equivalent.

Keys and Remote Controls



1. Push the release button and pull the key blade out.

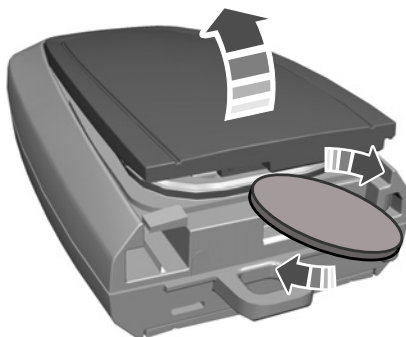
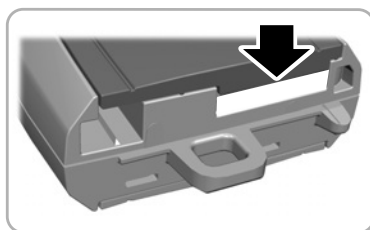

2. Twist a thin coin under the tab hidden behind the key blade head to remove the battery cover.

Keys and Remote Controls

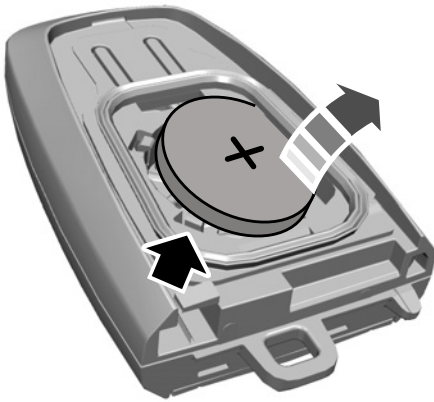

3. Insert a screwdriver in the position shown and carefully remove the battery.
4. Insert a new battery with the + facing upward.
5. Reinstall the battery cover onto the remote control and install the key blade.



Note: Refer to local regulations before you dispose of the remote control batteries.

Note: Do not wipe off any grease on the battery terminals or on the back surface of the circuit board.

Note: Replacing the remote control battery does not erase the programmed key from your vehicle. The remote control operates as normal.

Note: A message appears in the information display when the remote control battery is low.

REPLACING A LOST KEY OR REMOTE CONTROL

You can purchase replacement keys or remote controls from an authorized dealer. Authorized dealers can program remote controls for your vehicle.

PROGRAMMING THE REMOTE CONTROL

General Information

Make sure you are ready with the following before programming the remote control.

- You must have two previously programmed remote controls inside your vehicle. Contact an authorized dealer to have the spare remote control programmed if two previously programmed remotes are not available.
- The new unprogrammed remote controls must be readily accessible.
- Make sure that your vehicle is off.
- Make sure that you close all the doors and that they remain closed throughout the procedure.

Perform all steps within 30 seconds of starting the sequence. Stop and wait for at least one minute before starting again if you perform any steps out of sequence.

Read and understand the entire procedure before you begin.

Note: You can program a maximum of four remote controls to your vehicle.

Keys and Remote Controls

Note: If your programmed remote controls are lost or stolen and you do not have an extra coded remote, you need to have your vehicle towed to an authorized dealer. Store an extra programmed remote away from your vehicle in a safe place to help prevent any inconvenience. Contact an authorized dealer to purchase additional spare or replacement remotes.

Steps for Programming Your Spare Remote Control



1. Access the backup slot.
2. Place the first programmed remote in the backup slot in the center console with the buttons facing up. With your foot off the brake pedal, press and release the push button ignition switch.
3. Wait five seconds and then press and release the push button ignition switch again.
4. Remove the remote control.

5. Within 10 seconds, place a second programmed remote control in the backup slot. Press and release the push button ignition switch.
6. Wait five seconds and then press and release the push button ignition switch again. Keep the ignition on for at least three seconds, but no more than 10 seconds.
7. Remove the remote control.
8. Place the unprogrammed remote control in the backup slot and press and release the push button ignition switch.

Programming is now complete. With your foot on the brake pedal, press the push button ignition switch to verify the remote control functions operate and your vehicle starts with the new remote control.

If programming was not successful, wait 10 seconds and repeat steps 1 through 7. If you are still unsuccessful, take your vehicle to an authorized dealer.

KEYS AND REMOTE CONTROLS AUDIBLE WARNINGS

Key In Reminder

Sounds when the following conditions are met:

- Vehicle is out of park (P).
- You switch the vehicle off.
- You open the driver's door.
- You have left the key inside the vehicle.

USING THE VALET MODE

What is Valet Mode

The valet mode allows you to limit the access of these features:

Keys and Remote Controls

- Audio system.
- Voice interaction.
- Phone.
- Navigation.
- Memory function (if equipped).

Valet Mode Limitations

Make sure your vehicle is on and the remote control is inside the vehicle.

The system does not function if any of the following occur:

- The vehicle speed is greater than 8km/h.
- The vehicle is not in park (P) for automatic transmission or in neutral (N) for manual transmission.

Enabling Classic Valet Mode

Make sure the remote control is in your vehicle.

1. From the settings menu, press Valet Mode.
2. Enter a four digit code to lock the touchscreen.
3. Re-enter the same four digit code to complete enabling valet mode.

Disabling Classic Valet Mode

1. Press Exit Valet Mode.
2. Enter your four digit code to disable valet mode and unlock the touchscreen.

REMOTE REV (IF EQUIPPED)

WHAT IS REMOTE REV

Allows you to remotely command engine speed using your remote control to enjoy the engine sound from outside of the vehicle.

REMOTE REV LIMITATIONS

The system does not function, or deactivates, in the following conditions:

- The engine is off.
- The remote control is not working.
- The remote control is out of range.
- The transmission is not in park (P).
- The accelerator or brake pedal is pressed.
- The engine oil temperature is too high or too low.
- The engine coolant temperature is too high or too low.
- The catalytic converter temperature is too high or too low.
- The engine speed is not at stable idle condition.
- The automatic engine shutdown is activated.
- Any system fault is detected.

USING REMOTE REV





WARNING: Do not start the engine in a closed garage or in other enclosed areas. Exhaust fumes are toxic. Always open the garage door before you start the engine. Failure to follow this instruction could result in personal injury or death.

1. Start the engine.

Keys and Remote Controls

Note: Remote Rev is not available until system reaches optimal temperature after a cold start. For ambient temperatures of 41°F (5°C) and above, it may take up to one minute to reach the appropriate system temperatures to enable the feature. For ambient temperatures lower than 41°F (5°C) the system takes longer to reach the appropriate temperature, depending on the ambient temperature.

2.  Press the unlock button on the remote control.

3.  Within three seconds, press the lock button on the remote control.

Note: Engine RPM quickly increases to confirm that the feature is enabled.

4.  With remote rev enabled, press the unlock button on the remote control.

5.  Within three seconds, press the lock button on the remote control.

Note: The engine accelerates strongly.

Note: You can still lock or unlock your vehicle when using the feature.

Note: If your vehicle has active exhaust, it automatically switches to track position to enhance engine sound and feature experience. It returns to the initial position once the feature is disabled.

KEYS AND REMOTE CONTROLS – TROUBLESHOOTING

KEYS AND REMOTE CONTROLS – INFORMATION MESSAGES

Message	Action
Key Battery Low Replace Soon	Replace remote control battery.

Doors and Locks

OPERATING THE DOORS FROM OUTSIDE YOUR VEHICLE

UNLOCKING AND LOCKING THE DOORS USING THE REMOTE CONTROL

You can only use the remote control when your vehicle is stationary.

Unlocking the Doors



Press the button to unlock all doors. One long flash of the turn signal lamps confirms that your vehicle has unlocked.

One-Stage Unlocking



Press the button to unlock all doors.

Two-Stage Unlocking (If Equipped)



Press the button to unlock the driver's door. Press the button again within three seconds to unlock all doors.

Locking the Doors



Press the button to lock all doors. One short flash of the turn signal lamps confirms your vehicle is locked.

A tone sounds when you press the lock button twice within three seconds on the remote control to confirm your vehicle is locked.

Note: You can also lock and unlock your vehicle without using the remote control. See **Keyless Entry** (page 73).

UNLOCKING AND LOCKING THE DOORS USING THE KEY BLADE

If there is a power door lock fault you can use the key blade to lock and unlock the doors.

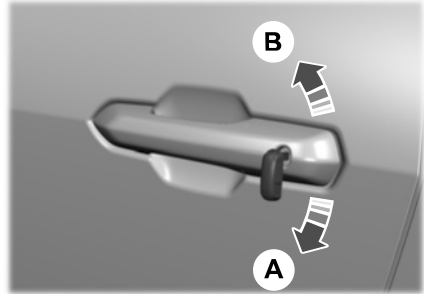

- A Lock.
- B Unlock.

DOUBLE LOCKING THE DOORS USING THE REMOTE CONTROL (If Equipped)



WARNING: Do not use double locking when passengers or animals are inside your vehicle. The doors cannot be unlocked or opened from the inside when double locked.

Double locking is a theft protection feature that prevents someone from opening the doors from the inside. You can only double lock the doors if all the doors are closed.



Press the button twice within three seconds. Three short flashes of the direction indicators confirm that your vehicle has double locked.

Doors and Locks

OPERATING THE DOORS FROM INSIDE YOUR VEHICLE

UNLOCKING AND LOCKING THE DOORS USING THE CENTRAL LOCKING

The power door lock control is on the front doors.



Press the button to unlock all doors.



Press the button to lock all doors.

Note: The central locking only operates if the front doors are fully closed.

OPENING THE DOORS FROM INSIDE YOUR VEHICLE

Pull the interior door handle to unlock and open a door.

AUTOUNLOCK

WHAT IS AUTOUNLOCK

Autounlock is a feature that centrally unlocks the vehicle doors when your vehicle comes to a stop and you open the driver door.

AUTOUNLOCK REQUIREMENTS

Autounlock unlocks all the doors after:

1. The vehicle speed exceeds 12 mph (20 km/h).
2. Your vehicle comes to a stop.
3. You open the driver door.

Note: Autounlock operates for only 10 minutes after the ignition is switched off.

SWITCHING AUTOUNLOCK ON AND OFF

1. From the settings menu, press Vehicle.
2. Press Locks.
3. Switch Autounlock on or off.

AUTOLOCK

WHAT IS AUTOLOCK

Autolock is a locking feature that centrally locks your vehicle doors when driving.

AUTOLOCK REQUIREMENTS

Autolock locks all the doors after:

1. All doors are closed and the ignition is on.
2. Your vehicle speed exceeds 12 mph (20 km/h).

Autolock repeats if:

1. Your vehicle is stopped.
2. Any door is opened and closed again.
3. Your vehicle speed exceeds 12 mph (20 km/h).

MISLOCK

WHAT IS MISLOCK

Mislock is a locking feature that warns you if your vehicle has not locked.

MISLOCK LIMITATIONS

The turn signals will not flash when you press the lock button once and the hood or any door is open.

If you switch mislock off, the horn does not sound if you press the lock button on the remote control when a door is open.

Doors and Locks

SWITCHING MISLOCK ON AND OFF

1. From the settings menu, press Vehicle.
2. Press Locks.
3. Switch Mislock on or off.

DOORS AND LOCKS AUDIBLE WARNINGS

Door Ajar Audible Warning

Sounds when any front door is not fully closed and your vehicle is moving.

DOORS AND LOCKS – TROUBLESHOOTING

DOORS AND LOCKS – WARNING LAMPS

Door Ajar Warning Lamp



Illuminates when you switch the vehicle on and remains on if any door, the hood or the liftgate is

open.

DOORS AND LOCKS – INFORMATION MESSAGES

Message	Details
Driver Door Ajar	Displays if a door is open. Fully close the door.
Passenger Door Ajar	
Rear Left Door Ajar	
Rear Right Door Ajar	
Hood Ajar	Displays if a hood is open. Fully close the hood.

Doors and Locks

DOORS AND LOCKS – FREQUENTLY ASKED QUESTIONS

Can accessories such as steps or handles be used with the latch assembly?

- Do not use the door latch assembly to attach any accessory, such as handles or steps, as this can cause damage to your vehicle.

Keyless Entry

WHAT IS KEYLESS ENTRY

The system allows you to lock and unlock your vehicle without taking the passive key out of your pocket or purse.

KEYLESS ENTRY LIMITATIONS

Make sure your remote control is within 3 ft (1 m) from the front door handles and the luggage compartment.

The system could not function if:

- The remote control remains stationary for about a minute.
- The vehicle battery has no charge.
- The remote control battery has no charge.
- There is interference causing issues with the remote control frequencies.
- The remote control is too close to metal objects or electronic devices, for example keys or a cell phone.

KEYLESS ENTRY SETTINGS

Reprogramming the Unlocking Function (If Equipped)

You can enable the two-stage unlocking function allowing you to unlock only the driver door when you touch the unlock sensor.

Press and hold both the lock and unlock buttons on the remote control for four seconds to disable or enable two-stage unlocking.

If you program the unlocking function so that only the driver door unlocks, you can unlock all of the other doors from inside your vehicle using the power door lock control. You can unlock individual doors by pulling the interior door handles on those doors.

Key Detection Alert

Displays a message in the instrument cluster if no valid key is detected, when you exit your vehicle with a key, after the last front door is closed and your keyless vehicle is in run, indicating your vehicle is still on. An audible alert sounds if you have driven the vehicle and reached a speed of 16 mph (25 km/h) and the above mentioned conditions are met.

You can switch the audible alert on or off.

1. From the settings menu, press Vehicle.
2. Switch Key Detection Alert On or Off.

USING KEYLESS ENTRY

Unlocking the Doors

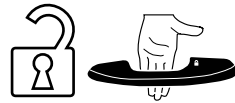

With your passive key or authorized phone within 3 ft (1 m) of your vehicle, gently press the touchpad on the door window trim to unlock and open the door.

Keyless Entry

Opening the Luggage Compartment with Passive Key (If Equipped)

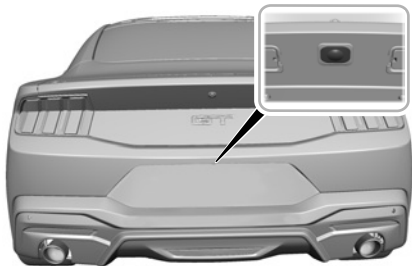

Double Locking

With your remote control or authorized phone within 3 ft (1 m) of your vehicle, touch the lock icon twice within three seconds to double lock your vehicle.

Press the exterior luggage compartment release button of the luggage compartment handle. The luggage compartment unlocks and opens. See **Opening the Rear Luggage Compartment from Outside Your Vehicle** (page 257).

Locking the Doors



With your remote control or authorized phone within 3 ft (1 m) of your vehicle, touch the lock icon on the door window trim to lock the door. The keyless entry system requires a brief delay to authenticate your device.

Note: *The door activation switch flashes once to indicate the vehicle locks.*

Note: *Do not use the outside door handle as a roof cargo strap.*

Easy Entry and Exit - Vehicles With: Driver Memory Seat

HOW DOES EASY ENTRY AND EXIT WORK

This feature moves the driver seat rearward up to 2 in (5 cm) when you switch the ignition off. The driver seat returns to its previous position when you switch the ignition on.

SWITCHING EASY ENTRY AND EXIT ON AND OFF

1. Press **Settings** on the touchscreen.
2. Press **Vehicle**.
3. Press **Easy Entry/Exit**.

If you press any adjustment or memory button when in easy exit mode, the system cancels the operation.

Security

PASSIVE ANTI-THEFT SYSTEM

WHAT IS THE PASSIVE ANTI-THEFT SYSTEM

The passive anti-theft system prevents someone from starting your vehicle with an incorrectly coded key.

Note: *Do not leave a duplicate coded key in your vehicle. Always take the keys and lock all the doors when leaving your vehicle.*

HOW DOES THE PASSIVE ANTI-THEFT SYSTEM WORK

The passive anti-theft system arms when you switch your vehicle off.

It disarms when you switch your vehicle on with a correctly coded key.

Note: *The system is not compatible with non-Ford aftermarket remote start systems.*

Note: *Do not leave a duplicate coded key in your vehicle. Always take the keys and lock all doors when leaving your vehicle.*

ANTI-THEFT ALARM SYSTEM

WHAT IS THE ANTI-THEFT ALARM SYSTEM

The anti-theft alarm system warns you of an unauthorized entry to your vehicle.

HOW DOES THE ANTI-THEFT ALARM SYSTEM WORK

When armed, the anti-theft alarm is triggered in any of the following ways:

- If someone opens a door, the liftgate or the hood without a correctly coded key or remote control.
- If you turn the power on without a correctly coded key.
- If the interior sensors detect movement inside your vehicle.
- If the inclination sensors detect an attempt to raise your vehicle.
- If someone disconnects your vehicle's 12V battery or the battery backup alarm.

If the anti-theft alarm is triggered, the alarm horn sounds for 30 seconds and the turn signals flash for 5 minutes.

Any further attempts to carry out one of the above sounds the alarm again.

WHAT IS THE PERIMETER ALARM

The perimeter alarm is designed to detect unauthorized access to your vehicle.

WHAT ARE THE INTERIOR SENSORS (If Equipped)

The interior sensors are designed to detect any movement inside your vehicle.

The interior sensors are in the overhead console.

Note: *Do not cover the interior sensors.*

Security

WHAT ARE THE INCLINATION SENSORS (If Equipped)

The inclination sensor is designed to detect an attempt to raise your vehicle, for example to remove a wheel or to tow it away.

ARMING THE ANTI-THEFT ALARM SYSTEM

The alarm is ready to arm when you switch your vehicle off.

Lock your vehicle with your remote control to arm the alarm.

DISARMING THE ANTI-THEFT ALARM SYSTEM

Disarm the alarm by performing any of the following actions:

- Unlock the doors or luggage compartment with the remote control.
- Switch your vehicle on or start your vehicle.

ANTI-THEFT ALARM SYSTEM SETTINGS (IF EQUIPPED)

WHAT ARE THE ALARM SECURITY LEVELS

You can select two levels of alarm security, all sensors and perimeter sensing.

All Sensors

All sensors is the standard setting.

In all sensors, all equipped sensors are on when you arm the alarm.

Note: *Do not arm the alarm with all sensors if passengers, animals or other moving objects are inside your vehicle.*

Perimeter Sensing

In perimeter sensing, the interior sensors are off when you arm the alarm.

All the other equipped sensors activate when you arm the alarm in this mode.

SETTING THE ALARM SECURITY LEVEL

1. Press **Settings** on the touchscreen.
2. Press **Vehicle**.
3. Press **Alarm System**.
4. Press **Motion Sensors**.
5. Press a setting.

WHAT IS ASK ON EXIT

You can choose which level of security you require after you switch your vehicle off.

Note: *If you do not choose a setting, the system defaults to all sensors.*

SWITCHING ASK ON EXIT ON AND OFF

1. Press **Settings** on the touchscreen.
2. Press **Vehicle**.
3. Press **Alarm System**.
4. Switch **Ask on Exit** on or off.

Security

SECURITY – TROUBLESHOOTING

SECURITY – INFORMATION MESSAGES

Message	Details
No Key Detected	The system has not detected a correctly coded key.
Starting System Fault	The system has malfunctioned. Have your vehicle checked as soon as possible.
Vehicle Alarm To Stop Alarm, Start Vehicle.	Displays when the alarm has been triggered due to unauthorized entry.
Alarm	

Security

SECURITY – FREQUENTLY ASKED QUESTIONS

What should I do if there is a potential alarm problem with my vehicle?

- Take all remote controls to an authorized dealer if there is a potential alarm problem with your vehicle.

What should I do if my vehicle is unable to start with a correctly coded key?

- Have your vehicle checked as soon as possible.

Steering Wheel

USING THE CONTROLS ON THE STEERING WHEEL



See **Cruise Control** (page 193).



See **Adaptive Cruise Control** (page 195).



See **Adaptive Cruise Control** (page 195).



See **Cruise Control** (page 193).
See **Adaptive Cruise Control** (page 195). See **Intelligent Speed Limiter** (page 218).



See **Cruise Control** (page 193).
See **Adaptive Cruise Control** (page 195). See **Intelligent Speed Limiter** (page 218).



See **Cruise Control** (page 193).
See **Adaptive Cruise Control** (page 195). See **Intelligent Speed Limiter** (page 218).



See **Lane Centering** (page 203).
See **Lane Keeping System** (page 221).



See **Intelligent Speed Limiter** (page 218).



See **Horn** (page 81).



See **Ford Assistant** (page 402).



See **Adjusting the Volume** (page 380).



See **Adjusting the Volume** (page 380).



See **Audio System** (page 379).



See **Audio System** (page 379).



See **Instrument Cluster Display** (page 103).



See **Instrument Cluster Display** (page 103).



See **Instrument Cluster Display** (page 103).



See **Drive Mode Control** (page 211).



See **Drive Mode Control** (page 211).



See **Drive Mode Control** (page 211).

ADJUSTING THE STEERING WHEEL



WARNING: Do not adjust the steering wheel when your vehicle is moving.

Note: Make sure that you are sitting in the correct position. See **Sitting in the Correct Position** (page 113).

Steering Wheel

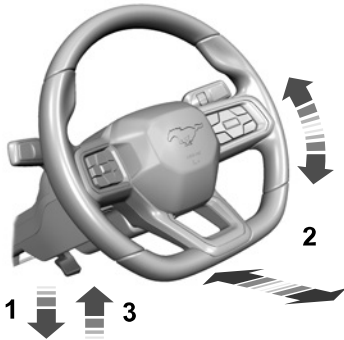

1. Unlock the steering column.
2. Adjust the steering wheel to the position you prefer.
3. Lock the steering column.

HORN



Press on the center of the steering wheel near the horn icon to activate the horn.

SWITCHING THE HEATED STEERING WHEEL ON AND OFF - VEHICLES WITH: HEATED STEERING WHEEL



WARNING: Use caution when using the heated steering wheel if you are unable to feel pain to your skin because of advanced age, chronic illness, diabetes, spinal cord injury, medication, exhaustion or other physical conditions. Failure to follow this instruction could result in personal injury, especially if the heated steering wheel is used for long periods of time.



To activate the heated steering wheel, press the button on the touchscreen. An indicator illuminates when the heated steering wheel is on. To turn it off, press the heated steering wheel button again.

Note: The engine must be running to use the heated steering wheel.

Note: A sensor regulates the temperature of the steering wheel.

Note: The heated steering wheel may remain on after remote starting your vehicle, depending on the remote start settings. It may also turn on when you start your vehicle if it was on the last time the engine was switched off.

Note: In warm temperatures, the steering wheel quickly reaches its maximum temperature and the system reduces the current to the heating element. This could cause you to think that the system has stopped working but it has not. This is normal.

Wipers and Washers

WIPERS

WIPER PRECAUTIONS

Do not operate the wipers on a dry windshield. This could scratch the glass or damage the wiper blades. Use the windshield washers before wiping a dry windshield.

Fully defrost the windshield before you switch the windshield wipers on.

Switch the windshield wipers off before entering a car wash.

SWITCHING WINDSHIELD WIPERS ON AND OFF

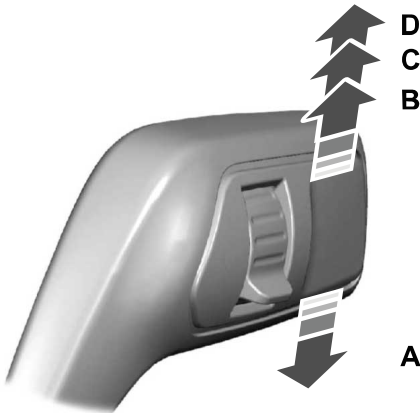

- A Single wipe.
- B Intermittent wipe/Auto wipe.
- C Normal wipe.
- D High-speed wipe.



Push the lever up or down to operate the windshield wipers.

AUTOWIPERS

WHAT ARE AUTOWIPERS

Autowipers turns on and controls the speed and frequency of the windshield wipers.

AUTOWIPERS SETTINGS

1. From the settings menu, press Vehicle.
2. Press Wipers.
3. Switch Rain sensing on or off.

Note: When you switch the feature off, the wipers do not operate based on the rain sensor. When you switch on the windshield wipers to the intermittent wipe position with the feature off, the wipers use the wipe speed set by the rotary control.

Wipers and Washers

ADJUSTING THE SENSITIVITY OF THE RAIN SENSOR

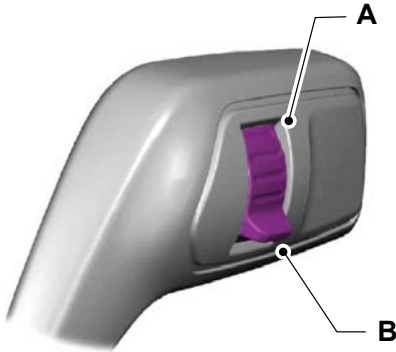

- A High sensitivity.
- B Low sensitivity.

Use the rotary control to set the rain sensor sensitivity.

When you select high sensitivity, the wipers operate when the sensor detects a small amount of water on the windshield.

When you select low sensitivity, the wipers operate when the sensor detects a large amount of water on the windshield.

CHECKING THE WIPER BLADES



Run the tip of your fingers over the edge of the blade to check for roughness.

REPLACING THE FRONT WIPER BLADES

Make sure your vehicle is off before beginning this procedure.

Note: Do not manually move the wiper arms when the vehicle is on or in accessory mode, this could damage the wiper motor.

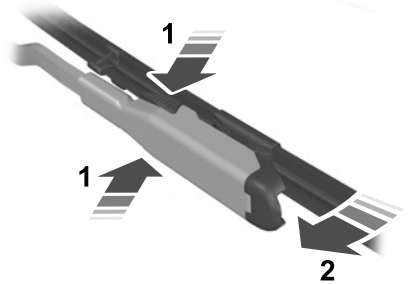

1. Lift the wiper arm and then press the wiper blade locking buttons together.

Note: Do not hold the wiper blade to lift the wiper arm.

Note: Make sure that the wiper arm does not spring back against the glass when the wiper blade is not attached.

Wipers and Washers

2. Slightly rotate the wiper blade.
3. Remove the wiper blade.
4. To install, reverse the removal procedure.

Note: Make sure that the wiper blade locks into place.

WASHERS

WASHER PRECAUTIONS



WARNING: If you operate your vehicle in temperatures below 41°F (5°C), use washer fluid with antifreeze protection. Failure to use washer fluid with antifreeze protection in cold weather could result in impaired windshield vision and increase the risk of injury or accident.

Do not operate the washers when the washer reservoir is empty. This could cause the washer pump to overheat.

Keep the outside of the windshield clean. The rain sensor is very sensitive and the wipers may operate if dirt, mist or insects hit the windshield.

USING THE WINDSHIELD WASHER



Pull the lever toward you to operate the windshield washer.

Note: A courtesy wipe occurs a short time after the wipers stop to clear any remaining washer fluid when switched on. See **Switching the Courtesy Wipe On and Off** (page 84).

SWITCHING THE COURTESY WIPE ON AND OFF

1. From the settings menu, press Vehicle.
2. Press Wipers.
3. Switch Courtesy Wipe on or off.

Note: When you switch the feature on, the wipers make an additional single wipe at the end of the washer request. When you switch it off, the wipers finish the current washer request.

Wipers and Washers

ADDING WASHER FLUID

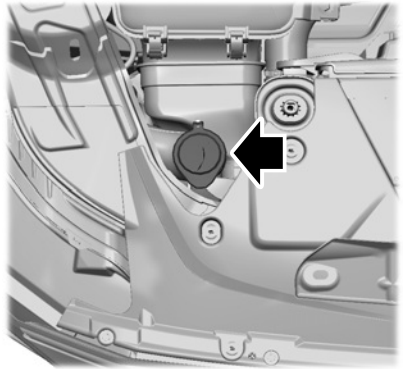

WASHER FLUID SPECIFICATION

Capacities

Variant	Quantity
All.	Fill as required.

Materials

Name	Specification
Motorcraft® Premium Windshield Wash Concentrate with Bitterant (U.S.) Motorcraft® Premium Quality Windshield Washer Fluid -35 °C / Liquide lave-glace de haute qualité -35 °C Motorcraft® (Canada) ZC-32-B2 (U.S.) CXC-37-M (Canada)	WSS-M14P19-A

WIPERS AND WASHERS VIDEOS

[Improving Your Windshield Wiper Performance Video Link](#)

[Courtesy Wipe Video Link](#)

Wipers and Washers

WIPERS AND WASHERS – TROUBLESHOOTING

WIPERS AND WASHERS – WARNING LAMPS



Illuminates when the windshield washer fluid is low.

WIPERS AND WASHERS – FREQUENTLY ASKED QUESTIONS

Why are there streaks and smears on the windshield?

- The wiper blades could be dirty, worn or damaged. Check the wiper blades. See **Checking the Wiper Blades** (page 83). If the wiper blades are dirty, clean them with washer fluid or water applied with a soft sponge or cloth. If the wiper blades are worn or damaged, install new ones. See **Replacing the Front Wiper Blades** (page 83).

Exterior Lighting

EXTERIOR LIGHTING CONTROL

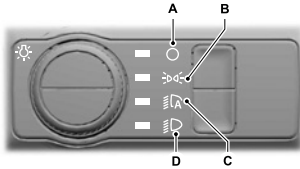

- A Lamps off.
- B Parking lamps on.
- C Autolamps on.
- D Headlamps on.

Rotate the control to make a selection.

Note: The lighting control defaults to autolamps every time you switch your vehicle on.

HEADLAMPS

USING THE HIGH BEAM HEADLAMPS



Push the lever away from you to switch the high beams on.

Push the lever forward again or pull the lever toward you to switch the high beams off.

Slightly pull the lever toward you and release it to flash the headlamps.

Note: Continuous activation only with headlamps on.

SWITCHING HEADLAMP EXIT DELAY ON AND OFF

To switch headlamp exit delay on, pull the turn signal lever toward you when the headlamps are off and the ignition is off. A short tone sounds when the system is on.

To switch headlamp exit delay off, pull the turn signal lever toward you again or switch your vehicle on.

Note: The headlamps turn off after three minutes with any door open or 30 seconds after the last door closes.

HEADLAMP INDICATORS

Lamps On



Illuminates when you switch the low beam headlamps or the parking lamps on.

Headlamp High Beam



Illuminates when you switch the high beam headlamps on.

Exterior Lighting

HEADLAMPS – TROUBLESHOOTING

HEADLAMPS – FREQUENTLY ASKED QUESTIONS

Why is there condensation in the headlamps?

- Headlamps have vents to accommodate normal changes in air pressure. Condensation can be a natural by-product of this design. When moist air enters the lamp assembly through the vents, there is a possibility that condensation can occur when the temperature is cold. When normal condensation occurs, a fine mist can form on the interior of the lens. The fine mist eventually clears and exits through the vents during normal operation.

How much condensation is acceptable?

- The presence of a fine mist, for example no streaks, drip marks or large droplets. A fine mist covers less than 50% of the lens.

How long does it take for the acceptable condensation to clear?

- Clearing time can take as long as 48 hours under dry weather conditions.

How much condensation is unacceptable?

- A water puddle inside the lamp. Streaks, drip marks or large droplets present on the interior of the lens.

What should I do if unacceptable condensation is present?

- Have your vehicle checked as soon as possible.

Why do my headlamps turn off when I have them switched on when I switch my vehicle off?

- The battery saver turns the headlamps off after a short period of time after you switch your vehicle off.

AUTOLAMPS

WHAT ARE AUTOLAMPS



WARNING: The system does not relieve you of your responsibility to drive with due care and attention. You may need to override the system if it does not turn the headlamps on in low visibility conditions, for example daytime fog.

Autolamps turn the headlamps on in low light situations or when the windshield wipers operate.

AUTOLAMP SETTINGS

Autolamp Exit Delay

You can adjust the amount of time the autolamps remain on after you switch off your vehicle. Use the touchscreen to choose a delay setting.

1. From the settings menu, press Vehicle.
2. Press Lighting.
3. Press Autolamp Delay.
4. Select a setting.

Note: *If the setting is off, the external lamps switch off immediately when you shut down your vehicle.*

Note: *You can pull the turn signal toward you to manually switch off the autolamp exit delay.*

Exterior Lighting

EXTERIOR LAMPS

USING THE TURN SIGNAL LAMPS



Push the lever up or down to switch the turn signal lamps on.

Set the lever to the middle position to switch the turn signal lamps off.

Note: Tap the lever up or down to make the turn signal lamps flash three times.

Turn Signal Lamp Indicator



It flashes when you switch the turn signal lamps on.

Note: An increase in the rate of flashing warns of a failed turn signal lamp.

SWITCHING THE DAYTIME RUNNING LAMPS ON AND OFF - VEHICLES WITH: CONFIGURABLE DAYTIME RUNNING LAMPS



WARNING: The daytime running lamps system may not activate the rear lamps and may not provide adequate lighting during low visibility driving conditions. Make sure you switch the headlamps on, as appropriate, during all low visibility conditions. Failure to do so may result in a crash.

1. Press **Settings** on the touchscreen.
2. Press **Vehicle Settings**.
3. Press **Lighting**.
4. Switch **Daytime Running Lights** on or off.

The daytime running lamps turn on when all of the following occur:

- You switch the system on.
- You switch your vehicle on.
- The transmission is not in park (P) for vehicles with automatic transmissions or you release the parking brake for vehicles with manual transmissions.
- The lighting control is in the autolamps position.
- The headlamps are off.

Note: Other lighting control positions do not turn on the daytime running lamps.

Exterior Lighting

SWITCHING THE DAYTIME RUNNING LAMPS ON AND OFF - VEHICLES WITH: DAYTIME RUNNING LAMPS (DRL)



WARNING: The daytime running lamps system may not activate the rear lamps and may not provide adequate lighting during low visibility driving conditions. Make sure you switch the headlamps on, as appropriate, during all low visibility conditions. Failure to do so may result in a crash.

Daytime running lamps are always on unless you switch on the headlamps or your vehicle is in park (P).

SWITCHING WELCOME LIGHTING ON AND OFF

Welcome lighting turns on the exterior lamps when you approach your vehicle with an authenticated device.

1. Press **Settings** on the touchscreen.
2. Press **Vehicle**.
3. Press **Lighting**.
4. Switch **Welcome Lighting** on or off.

Note: *Welcome lighting still displays when you use your remote control to unlock your vehicle.*

EXTERIOR LAMP INDICATORS

Turn Signal Lamp



It flashes when you switch the turn signal lamps on.

Note: *An increase in the rate of flashing warns of a failed turn signal lamp.*

EXTERIOR LAMPS ON AUDIBLE WARNING

Sounds when you open the driver door and the exterior lamps are on.

AUTOMATIC HIGH BEAM CONTROL

HOW DOES AUTOMATIC HIGH BEAM CONTROL WORK

Automatic high beam control turns the high beams on if it is dark enough and no other traffic is present. If it detects an approaching vehicle's headlamps or tail lamps, or street lighting ahead, the system turns the high beams off.

A camera sensor, centrally mounted behind the windshield of your vehicle, continuously monitors conditions to turn the high beams on and off.

Exterior Lighting

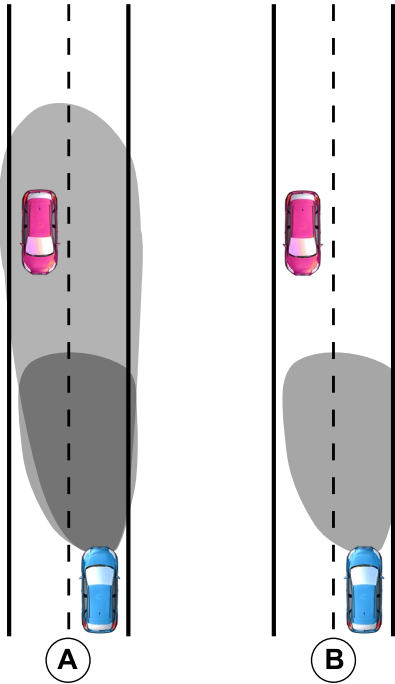

- A Without automatic high beam control.
- B With automatic high beam control.

AUTOMATIC HIGH BEAM CONTROL PRECAUTIONS

WARNING: The system does not relieve you of your responsibility to drive with due care and attention. You may need to override the system if it does not turn the high beams on or off.

- WARNING:** The system may not switch the high beams off if the lights of oncoming vehicles are hidden by obstacles, for example guard rails.
- WARNING:** You may need to override the system when approaching other road users.
- WARNING:** In situations with poor visibility, such as fog, heavy rain or other inclement weather, you may need to override or completely switch off the system.

AUTOMATIC HIGH BEAM CONTROL REQUIREMENTS

The system turns the high beams on if all of the following occur:

- You switch the system on.
- You set the lighting control to the autolamps position.
- The ambient light level is low enough that you require high beams.
- There is no traffic in front of your vehicle.
- The vehicle speed is greater than approximately 25 mph (40 km/h).

AUTOMATIC HIGH BEAM CONTROL LIMITATIONS

The system turns the high beams off if any of the following occur:

- You switch the system off.
- You set the lighting control to any position except autolamps.
- The ambient light level is high enough that you do not require high beams.
- The system detects an approaching vehicle's headlamps or a leading vehicle's tail lamps.

Exterior Lighting

- The system detects severe rain, snow or fog.
- The system detects street lighting.
- The camera has reduced visibility.
- The vehicle speed falls below approximately 19 mph (30 km/h).

Note: *The deactivation speed may be lower on curves.*

SWITCHING AUTOMATIC HIGH BEAM CONTROL ON AND OFF

1. From the Settings menu, press Vehicle.
2. Press Lighting.
3. Switch auto high beam on or off.

AUTOMATIC HIGH BEAM CONTROL INDICATORS



Illuminates to confirm when the system is ready to assist.

OVERRIDING AUTOMATIC HIGH BEAM CONTROL



Push the lever away from you to switch the high beams on.

Push the lever away from you again to switch the high beams off.

Push the lever away from you for a third time to switch automatic high beam control back on.

AUTOMATIC HIGH BEAM CONTROL – TROUBLESHOOTING

AUTOMATIC HIGH BEAM CONTROL – INFORMATION MESSAGES

Message	Details
Front Camera Low Visibility Clean Screen	The camera has reduced visibility. Clean the windshield. If the message continues to appear, have your vehicle checked as soon as possible.
Front Camera Temporarily Not Available	The camera has malfunctioned. Wait a short period of time for the camera to cool down. If the message continues to appear, have your vehicle checked as soon as possible.
Front Camera Malfunction Service Required	The camera has malfunctioned. Have your vehicle checked as soon as possible.

Interior Lighting

SWITCHING ALL OF THE INTERIOR LAMPS ON AND OFF

Switching All of the Interior Lamps On



Press the button on the overhead console toward the icon.

Switching All of the Interior Lamps Off



Press the button on the overhead console toward the icon.

SWITCHING THE FRONT INTERIOR LAMPS ON AND OFF



Press the edge of the lamp lens.

INTERIOR LAMP FUNCTION

WHAT IS THE INTERIOR LAMP FUNCTION

The interior lamp function switches the courtesy and door lamps on or off.

SWITCHING THE INTERIOR LAMP FUNCTION ON AND OFF

The switch is on the overhead console.

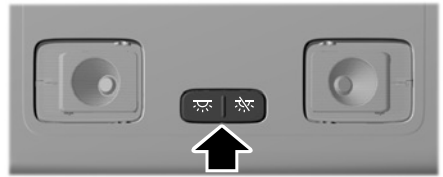

Set the switch to the middle position.

When you switch the interior lamp function on, the interior lamps turn on if:

- You open a door.
- You press the unlock button on the remote control.
- You switch the ignition off.

ADJUSTING THE INSTRUMENT PANEL LIGHTING BRIGHTNESS

The instrument lighting dimmer buttons are on the lighting control.



Repeatedly press one of the buttons to adjust the brightness.



AMBIENT LIGHTING (IF EQUIPPED)

SWITCHING AMBIENT LIGHTING ON AND OFF

1. From the My Mustang menu, press **MyColor**. See **My Mustang Overview** (page 392).
2. Press **Ambient Lighting**.
3. Use the arrows to select a color and brightness.

Interior Lighting

Note: *Setting the brightness to zero turns off the ambient lighting.*

INTERIOR LIGHTING – TROUBLESHOOTING

INTERIOR LIGHTING – FREQUENTLY ASKED QUESTIONS

Why do my courtesy lamps or interior lamps turn off when I have them switched on when I switch my vehicle off?

- The battery saver turns the courtesy lamps and interior lamps off after a short period of time after you switch your vehicle off.

Windows

OPENING AND CLOSING THE WINDOWS - CONVERTIBLE



WARNING: Do not leave children or pets unattended in your vehicle and do not let children play with the power windows. Failure to follow this instruction could result in personal injury or death.



WARNING: When closing the power windows, verify that they are free of obstructions and make sure children and pets are not in the proximity of the window openings. Failure to follow this instruction could result in personal injury or death.



WARNING: If an obstruction is detected, release the switch and reverse the window immediately. Failure to follow this instruction could result in personal injury or death.



WARNING: Do not leave a key or remote control unattended in the vehicle. Children or pets could operate the power windows and could become trapped in a closing window. Failure to follow this instruction could result in personal injury or death.



E180087

Press the window control switch to open the window. Lift the window control switch to close the window.

Note: *The power windows operate with the ignition on, and for several minutes after you switch the ignition off or until you open a front door.*

Note: *Use the single control to open and close both rear windows.*

To reduce wind noise or pulsing noise when one window is open, slightly open the opposite window.

One-Touch Open

Fully press the window control switch and release it. Press again or lift it to stop the window.

One-Touch Close

Fully lift the window control switch and release it. Press again or lift it to stop the window.

Resetting One-Touch Close

Carry out all steps within 30 seconds of starting the sequence.

1. Close the door.
2. Press and hold the window control switch until the window is fully open.
3. Lift and hold the window control switch until the window is fully closed. The glass auto retracts.
4. Once auto retract is completed, lift and hold the window control switch until the window is fully closed. Hold the window control switch for a few seconds.

Note: *Repeat the procedure if the window does not close when you use one-touch or window does not function with the door open.*

Windows

OPENING AND CLOSING THE WINDOWS - COUPE



WARNING: Do not leave children or pets unattended in your vehicle and do not let children play with the power windows. Failure to follow this instruction could result in personal injury or death.



WARNING: When closing the power windows, verify that they are free of obstructions and make sure children and pets are not in the proximity of the window openings. Failure to follow this instruction could result in personal injury or death.



WARNING: If an obstruction is detected, release the switch and reverse the window immediately. Failure to follow this instruction could result in personal injury or death.



WARNING: Do not leave a key or remote control unattended in the vehicle. Children or pets could operate the power windows and could become trapped in a closing window. Failure to follow this instruction could result in personal injury or death.



Press the window control switch to open the window. Lift the window control switch to close the window.

Note: *The power windows operate with the ignition on, and for several minutes after you switch the ignition off or until you open a front door.*

To reduce wind noise or pulsing noise when one window is open, slightly open the opposite window.

One-Touch Open

Fully press the window control switch and release it. Press again or lift it to stop the window.

One-Touch Close

Fully lift the window control switch and release it. Press again or lift it to stop the window.

Resetting One-Touch Close

Carry out all steps within 30 seconds of starting the sequence.

1. Close the door.
2. Press and hold the window control switch until the window is fully open.
3. Lift and hold the window control switch until the window is fully closed. The glass auto retracts.
4. Once auto retract is completed, lift and hold the window control switch until the window is fully closed. Hold the window control switch for a few seconds.

Note: *Repeat the procedure if the window does not close when you use one-touch or window does not function with the door open.*

GLOBAL OPENING

WHAT IS GLOBAL OPENING

You can use the remote control to open the windows with the ignition off.

USING GLOBAL OPENING

1. Press and release the unlock button on the remote control.
2. Press and hold the unlock button on the remote control.

Windows

3. Release the button when the windows start to open.

Press the lock or the unlock button on the remote control to stop global opening.

Note: *You can use global opening for a short period of time when you unlock your vehicle using the remote control.*

SWITCHING GLOBAL OPENING ON AND OFF

1. From the settings menu, press Vehicle.
2. Press Windows.
3. Switch Remote Open on or off.

WINDOW BOUNCE-BACK

WHAT IS WINDOW BOUNCE-BACK

The window stops and reverses if it detects an obstruction when closing.

OVERRIDING WINDOW BOUNCE-BACK



WARNING: If you override bounce-back, the window does not reverse if it detects an obstacle. Take care when closing the windows to avoid personal injury or damage to your vehicle.

1. Close the window until it reaches the point of resistance and let it reverse.
2. Lift and hold the window control switch within two seconds to override bounce-back and close the window. Bounce-back is now disabled and you can close the window manually.

Note: *The window goes past the point of resistance and you can fully close it.*

Note: *If the window does not close, have your vehicle checked as soon as possible.*

USING SHORT DROP WINDOWS

This feature lowers the window by a short distance to move the window out of the seal so you can open the door. It also raises the window a short distance, then back to the fully closed position as soon as you close the door.

Short drop windows requirements

Short drop windows only activate when all of the following occur:

- You open and close the door from the outside and inside of your vehicle.
- The vehicle speed falls below approximately 12.4 mph (20 km/h) from the external trigger and approximately 1.9 mph (3 km/h) from the internal trigger.
- During abnormal operation such as anti-pinch or over temperature conditions, short drop windows open when you interact with the trigger element.
- It allows the window to only move down if the current window position is greater than the short drop position.
- This feature allows the window to move up from the short drop position, when more than 30 seconds have elapsed with no door opened.

Note: *Use the door handle with the unlock button from your interior trim switch to use the short drop window feature.*

Note: *Short drop windows do not work if the vehicle speed exceeds 12.4 mph (20 km/h) from the external trigger and 1.9 mph (3 km/h) from the internal trigger.*

Windows

Note: *The short drop windows do not work in dry and wet conditions between -4.0°F (-20°C) and -39.9°F (-40°C) so that you can clear the ice from the windows and seals or activate the remote start to heat the chamber.*

Note: *The short drop window feature works for all doors.*

Resetting Short Drop Windows

Carry out all steps within 30 seconds of starting the sequence.

1. Close the door.
2. Press and hold the window control switch until the window is fully open.
3. Lift and hold the window control switch until the window is fully closed. The glass auto retracts.
4. Once auto retract is completed, lift and hold the window control switch until the window is fully closed. Hold the window control switch for a few seconds.

Note: *Repeat the procedure if the short drop windows do not work.*

Interior Mirror

INTERIOR MIRROR PRECAUTIONS



WARNING: Do not adjust the mirrors when your vehicle is moving. This could result in the loss of control of your vehicle, serious personal injury or death.

Note: Do not clean the mirror housing or glass with harsh abrasives, fuel or other petroleum-based cleaning products.

Note: In certain situations, very tall drivers may experience difficulty in reaching a satisfactory interior rear view mirror angle with the driver seat positioned all the way back. If this occurs, we recommend adjusting the interior rear view mirror toward the driver, up and then adjusting it to the desired position as needed. In extreme cases, the driver's face may reflect back in the mirror.

AUTO-DIMMING INTERIOR MIRROR (IF EQUIPPED)

WHAT IS THE AUTO-DIMMING INTERIOR MIRROR

The mirror dims to reduce the effect of bright light from behind. It returns to normal when the bright light from behind is no longer present or if you shift into reverse (R).

AUTO-DIMMING INTERIOR MIRROR LIMITATIONS

Do not block the sensors on the front and back of the mirror.

Note: A rear center passenger or raised rear center head restraint could prevent light from reaching the sensor.

Exterior Mirrors

ADJUSTING THE EXTERIOR MIRRORS



WARNING: Do not adjust the mirrors when your vehicle is moving. This could result in the loss of control of your vehicle, serious personal injury or death.

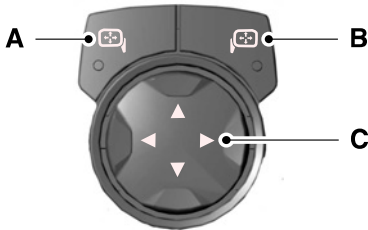

- A Left-hand mirror.
- B Right-hand mirror.
- C Adjustment control.

To adjust the mirrors, switch your vehicle on, with the push button start in accessory mode or your vehicle running.

1. Select the mirror you want to adjust. The control light turns on.
2. Use the adjustment control to adjust the position of the mirror.
3. Press the mirror control again. The control light turns off.

FOLDING THE EXTERIOR MIRRORS



WARNING: Objects in the mirror are closer than they appear.

Push the mirror toward the door window glass. Make sure that you fully engage the mirror in its support when returning it to its original position.

Directional Indicator Mirrors

When your vehicle is running, the forward-facing portion of the appropriate mirror housing blinks when you switch on the turn signal.

Puddle Lamps

The puddle lamps turn on when you approach your vehicle with a remote control or phone. If your vehicle has auto-folding mirrors, the puddle lamps are only on if the mirrors are unfolded and turn off when the mirrors fold.

AUTO-DIMMING EXTERIOR MIRROR (IF EQUIPPED)

WHAT IS THE AUTO-DIMMING EXTERIOR MIRROR

The driver exterior mirror dims when the interior auto-dimming mirror turns on.

Instrument Cluster

INSTRUMENT CLUSTER OVERVIEW

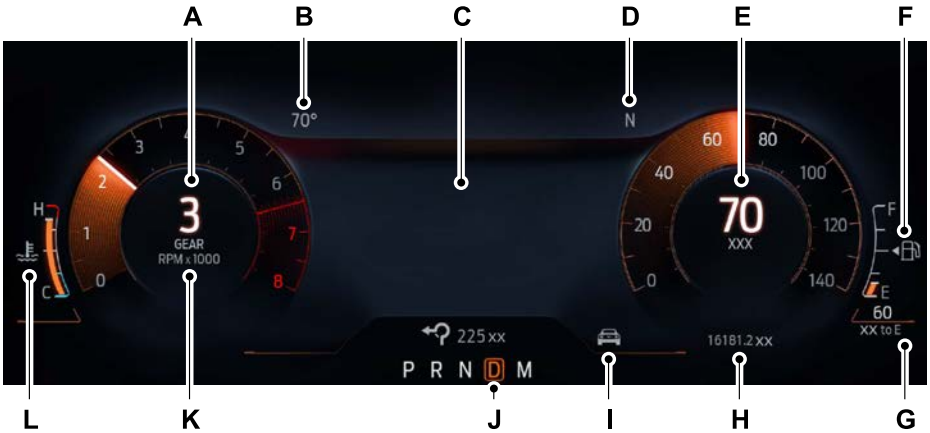

- A Gear indicator.
- B Outside air temperature.
- C Information on demand area.
- D Compass.
- E Speedometer.
- F Fuel gauge.
- G Distance to empty.
- H Odometer.
- I Drive mode indicator.
- J Transmission position indicator.
- K Tachometer.
- L Engine coolant temperature.

TACHOMETER

Indicates the engine speed.

SPEEDOMETER

Indicates the vehicle speed.

Instrument Cluster

Secondary Speedometer (If Equipped)

You can switch on a secondary speedometer that displays other measurement units. See **Home Screen** (page 389).

FUEL GAUGE

WHAT IS THE FUEL GAUGE

Indicates approximately how much fuel is in the fuel tank.

FUEL GAUGE LIMITATIONS

The fuel gauge may not provide an accurate reading when your vehicle is on an incline.

LOCATING THE FUEL FILLER DOOR

The arrow adjacent to the fuel pump symbol indicates on which side of your vehicle the fuel filler door is located.

WHAT IS THE LOW FUEL REMINDER

A low fuel level reminder displays and sounds when the distance to empty reaches 50 mi (80 km), 25 mi (40 km), 10 mi (20 km) and 0 mi (0 km).

Note: *The low fuel reminder can appear at different fuel gauge positions depending on fuel economy conditions. This variation is normal.*

WHAT IS DISTANCE TO EMPTY

Indicates the approximate distance your vehicle can travel on the fuel remaining in the tank. Changes in driving pattern can cause the value to not only decrease but also increase or stay constant for periods of time.

ENGINE COOLANT TEMPERATURE GAUGE

Indicates the engine coolant temperature.

Instrument Cluster Display

USING THE INSTRUMENT CLUSTER DISPLAY CONTROLS



WARNING: Driving while distracted can result in loss of vehicle control, crash and injury. We strongly recommend that you use extreme caution when using any device that may take your focus off the road. Your primary responsibility is the safe operation of your vehicle. We recommend against the use of any hand-held device while driving and encourage the use of voice-operated systems when possible. Make sure you are aware of all applicable local laws that may affect the use of electronic devices while driving.

The controls are on the steering wheel.



OK Button

Press to make a selection.

Scroll Buttons

Press the up or down buttons to scroll through information on demand screens or pop-up menu options.

CUSTOMIZING THE INSTRUMENT CLUSTER DISPLAY

Adding and Removing Screens

1. Press **Settings** on the touchscreen.
2. Press **Instrument Cluster**.
3. Press **Choose Screens**.
4. Select the screens you prefer.

Trip Computer

ACCESSING THE TRIP COMPUTER

The trip computer is available as a configurable screen in your instrument cluster. See **Customizing the Instrument Cluster Display** (page 103).

Once the screens have been added, use the instrument cluster display controls on the steering wheel to view each trip screen.

RESETTING THE TRIP COMPUTER

1. Press **Settings** on the touchscreen.
2. Press **Instrument Cluster**.
3. Press **Trip 1** or **Trip 2**.
4. Press **Reset Values**.
5. Select which values to reset.

CONFIGURING THE TRIP COMPUTER

1. Press **Settings** on the touchscreen.
2. Press **Instrument Cluster**.
3. Press **Trip 1** or **Trip 2**.
4. Press **Configure View**.
5. Select the views you prefer.

Note: *There is a minimum of one and a maximum of 4 items that can be selected at one time.*

Remote Start (If Equipped)

USING REMOTE START - VEHICLES WITH: FORD MOBILE APP



WARNING: Do not start the engine in a closed garage or in other enclosed areas. Exhaust fumes are toxic. Always open the garage door before you start the engine. Failure to follow this instruction could result in personal injury or death.



WARNING: Do not keep electrical devices plugged in the power outlet whenever the device is not in use. Power outlets power up during remote start.

The system allows you to remotely start your vehicle to heat or cool the interior to a preset temperature.

Follow the instructions in the vehicle app to start and stop your vehicle.

Note: *The vehicle app must be paired with your vehicle to remotely start using the app.*

Note: *Depending on your vehicle app, you may need to be within a certain range for the vehicle to successfully remote start.*

When you successfully remote start your vehicle:

- The vehicle doors lock.
- The turn signal lamps flash twice.
- The parking lamps turn on when the vehicle is running.
- The vehicle remains secured when you have remotely started the vehicle. A valid key must be inside your vehicle to switch your vehicle on and drive your vehicle.
- All other vehicle systems remain off when you have remotely started the vehicle.

The horn sounds if the system fails to start.

Note: *You cannot adjust any comfort settings until you switch your vehicle on from inside your vehicle.*

Remote start does not work under the following conditions:

- Remote start is not enabled.
- The alarm horn is sounding.
- The hood is open.
- The transmission is not in park (P).
- Your vehicle is already on.

Note: *Do not use remote start if your fuel level is low.*

Note: *A maximum of two remote starts are allowed. After that you have to switch your vehicle on and off before you can use remote start again.*

USING REMOTE START - VEHICLES WITH: REMOTE CONTROL



WARNING: Do not start the engine in a closed garage or in other enclosed areas. Exhaust fumes are toxic. Always open the garage door before you start the engine. Failure to follow this instruction could result in personal injury or death.



WARNING: Do not keep electrical devices plugged in the power outlet whenever the device is not in use. Power outlets power up during remote start.

The system allows you to remotely start your vehicle to heat or cool the interior to a preset temperature.

1.



Press the button on the remote control.

Remote Start (If Equipped)

2.  Press the button twice within a few seconds.

When you successfully remote start your vehicle:

- The vehicle doors lock.
- The turn signal lamps flash twice.
- The parking lamps turn on when the vehicle is running.
- The vehicle remains secured when you have remotely started the vehicle. A valid key must be inside your vehicle to switch your vehicle on and drive your vehicle.
- All other vehicle systems remain off when you have remotely started the vehicle.

The horn sounds if the system fails to start.

Note: *You cannot adjust any comfort settings until you switch your vehicle on from inside your vehicle.*

Remote start does not work under the following conditions:

- Remote start is not enabled.
- The alarm horn is sounding.
- The hood is open.
- The transmission is not in park (P).
- Your vehicle is already on.

Note: *Do not use remote start if your fuel level is low.*

Note: *A maximum of two remote starts are allowed. After that you have to switch your vehicle on and off before you can use remote start again.*



To remotely stop your vehicle, press the button.

REMOTE START SETTINGS

1. From the settings menu, press Vehicle.
2. Press Remote Start Setup.

You can adjust the following in the remote start settings menu:

- Enable or disable remote start.
- Climate control settings.
- Heated seat settings.
- Heated steering wheel settings.
- Remote start duration.

Climate Control

IDENTIFYING THE CLIMATE CONTROL UNIT



Note: Depending on your vehicle options, the controls may look different from what you see here.

SWITCHING CLIMATE CONTROL ON AND OFF



Press the button to activate the selection screen.



Press the button.

SWITCHING RECIRCULATED AIR ON AND OFF



Press the button to activate the selection screen.



Press the button to recirculate air currently in the passenger compartment.

Note: Recirculated air may turn off automatically, or prevent you from switching on in all air flow modes except MAX A/C to reduce the risk of fogging. Recirculation may also turn on and off automatically in various air distribution control combinations to improve heating or cooling efficiency.

SWITCHING AIR CONDITIONING ON AND OFF



Press the button.

Note: Under certain conditions, the air conditioning compressor could continue to operate after you switch air conditioning off.

Note: To keep the system and its components fully functional, switch air conditioning on and let your vehicle idle at least once per month for a minimum of two minutes.

SWITCHING DEFROST ON AND OFF



Press the button to activate the selection screen.



Press the button on the touchscreen to switch the windshield air vents on.



Make sure that the instrument panel air vents are switched off.



Make sure that the footwell air vents are switched off.

SWITCHING MAXIMUM DEFROST ON AND OFF



Press the button on the touchscreen.

Air flows through the windshield air vents, and the blower motor adjusts to the highest speed.

You can also use this setting to defog and clear the windshield of a thin covering of ice.

Climate Control

Note: You can also press the button on the instrument panel to switch the maximum defrost on or off.

Note: To prevent window fogging, you cannot select recirculated air when maximum defrost is on.

Note: The heated rear window and air conditioning also turn on when you select maximum defrost.

SWITCHING MAXIMUM COOLING ON AND OFF



Press the button to activate the selection screen.



Press the button.

Note: When you switch maximum cooling off, air conditioning remains on.

Note: In certain conditions, for example, cold weather, maximum cooling may not activate or could run slow when switched on. This helps reduce power consumption from the battery.

SWITCHING THE HEATED REAR WINDOW ON AND OFF



Press the button to clear the rear window of thin ice and fog. The heated rear window turns off after a short period of time.

Note: Do not use harsh chemicals, razor blades or other sharp objects to clean or remove decals from the inside of the heated rear window as this could cause damage to the heated rear window grid lines not covered by the vehicle Warranty.

Note: The engine must be running or your vehicle must be ready to drive to switch the system on.

SETTING THE BLOWER MOTOR SPEED



Press the button on the touchscreen to set the blower motor speed.

Slide the control to set the blower motor speed.

Note: You can press + or - to set the blower motor speed.

SWITCHING THE HEATED MIRRORS ON AND OFF (IF

EQUIPPED)

When you switch the heated rear window on, the heated exterior mirrors turn on. See **Switching the Heated Rear Window On and Off** (page 108).

Note: Do not remove ice from the mirrors with a scraper or adjust the mirror glass when it is frozen in place.

Note: Do not clean the mirror housing or glass with harsh abrasives, fuel or other petroleum-based cleaning products. The vehicle warranty may not cover damage caused to the mirror housing or glass.

Note: The engine must be running or your vehicle must be ready to drive to switch the system on.

SETTING THE TEMPERATURE

Press the temperature controls on either side of the climate control to set the temperature for that side.



Slide the control to set the temperature.

Note: You can press + or - to set the temperature.

Climate Control

DIRECTING THE FLOW OF AIR

Directing Air to the Windshield Air Vents



Press the button to activate the selection screen.



Press the button on the touchscreen.

Directing Air to the Instrument Panel Air Vents



Press the button to activate the selection screen.



Press the button on the touchscreen.

Directing Air to the Footwell Air Vents



Press the button to activate the selection screen.



Press the button on the touchscreen.

AUTO MODE

SWITCHING AUTO MODE ON AND OFF



Press the button to switch auto mode on. Repeatedly press the button to adjust auto mode.

Adjust the blower motor control or air distribution control to switch auto mode off.

AUTO MODE INDICATORS

The indicators are on the Auto Mode button.

Auto Mode Indicator Status	Description
One indicator illuminated.	The blower motor speed is reduced. Use this setting to minimize the amount of noise from the blower motor. This setting increases the time taken to cool the interior.
Two indicators illuminated.	The blower motor speed is moderate.
Three indicators illuminated.	The blower motor speed is increased. Use this setting to reduce the time taken to cool the interior. This setting increases the amount of noise from the blower motor.

Climate Control

SWITCHING DUAL MODE ON AND OFF



Press the button to activate the selection screen.



Press the button.

Note: When dual mode is off, setting the temperature using the driver side controls, sets the temperature for both sides.

Note: Setting the temperature using the passenger side controls, sets the passenger temperature and switches dual mode on.

CLIMATE CONTROL HINTS

General Hints

- Prolonged use of recirculated air may cause the windows to fog up.
- You may feel a small amount of air from the footwell air vents regardless of the air distribution setting.
- To reduce humidity build-up inside your vehicle, do not drive with the system switched off or with recirculated air always switched on.
- Do not place objects under the front seats as this may interfere with the airflow to the rear seats.
- Remove any snow, ice or leaves from the air intake area at the base of the windshield.
- To improve the time to reach a comfortable temperature in hot weather, drive with the windows open until you feel cold air through the air vents.

Automatic Climate Control

- Adjusting the settings when your vehicle interior is extremely hot or cold is not necessary. Automatic mode is best recommended to maintain set temperature.
- The system adjusts to heat or cool the interior to the temperature you select as quickly as possible.
- For the system to function efficiently, the instrument panel and side air vents should be fully open.
- If you press **AUTO** during cold outside temperatures, the system directs air flow to the windshield and side window air vents. In addition, the blower motor may run at a slower speed until the engine warms up.
- If you press **AUTO** during hot temperatures and the inside of the vehicle is hot, the system uses recirculated air to maximize interior cooling. Blower motor speed may also reduce until the air cools.

Quickly Heating the Interior

1. Press **AUTO**.
2. Adjust the temperature function to the setting you prefer.

Recommended Settings for Heating

1. Press **AUTO**.
2. Adjust the temperature function to the setting you prefer. Use 72°F (22°C) as a starting point, then adjust the setting as necessary.

Quickly Cooling the Interior

1. Press **MAX A/C**.
2. Drive with the windows open for a short period of time.

Climate Control

Recommended Settings for Cooling

1. Press **AUTO**.
2. Adjust the temperature function to the setting you prefer. Use 72°F (22°C) as a starting point, then adjust the setting as necessary.

Defogging the Side Windows in Cold Weather

1. Press and release defrost or maximum defrost.
2. Adjust the temperature control to the setting you prefer. Use 72°F (22°C) as a starting point, then adjust the setting as necessary.

CLIMATE CONTROL – WARNING LAMPS



WARNING: Even if the temperature rises to above 39°F (4°C) there is no guarantee that the road is free of hazards caused by inclement weather.



Illuminates when the outside air temperature is between 39.2°F (4°C) and 32.0°F (0°C).

AIR CONDITIONING SYSTEM REFRIGERANT



WARNING: The air conditioning refrigerant system contains refrigerant under high pressure. Only qualified personnel should service the air conditioning refrigerant system. Opening the air conditioning refrigerant system can cause personal injury.

Your vehicle has an under hood label that identifies the refrigerant used by the air conditioning system.

Note: Only allow a trained and certified technician service the refrigerant system to ensure proper and safe operation, per the society of automotive engineers J2845.

Note: Never repair or replace the air conditioning evaporator with one from a salvage vehicle. Only replace it with a new evaporator to ensure proper and safe operation.

The meaning of each symbol on the under hood label are as follows:



Caution



Air conditioning system.



System lubricant type.



See vehicle service manual for service information.



Requires registered technician to service.



Flammable refrigerant.



Replace safety system components. Do not repair, reuse or try to salvage.

Interior Air Quality

WHAT IS THE CABIN AIR FILTER

The cabin air filter improves the quality of air in your vehicle by trapping dust, pollen and other particles.

LOCATING THE CABIN AIR FILTER

The cabin air filter is behind the glovebox.

Note: *The filter access door is above the passenger footwell under the instrument panel.*

REPLACING THE CABIN AIR FILTER

Replace the filter at regular intervals. See **Scheduled Maintenance** (page 423).

Note: *Make sure you have a cabin air filter installed at all times. This prevents foreign objects from entering the system. Running the system without a filter in place could result in degradation or damage to the system.*

Note: *Using an aftermarket cabin air filter could reduce cabin air filtration and climate control performance.*

Front Seats

FRONT SEAT PRECAUTIONS



WARNING: Sitting improperly, out of position or with the seatback reclined too far can take weight off the seat cushion and affect the decision of the passenger sensing system, resulting in serious injury or death in the event of a crash. Always sit upright against your seat back, with your feet on the floor.



WARNING: Do not recline the seat backrest too far as this can cause the occupant to slide under the seatbelt, resulting in personal injury in the event of a crash.



WARNING: Do not place objects higher than the top of the seat backrest. Failure to follow this instruction could result in personal injury or death in the event of a sudden stop or crash.



WARNING: Do not adjust the driver seat or seat backrest when your vehicle is moving. This may result in sudden seat movement, causing the loss of control of your vehicle.

SITTING IN THE CORRECT POSITION

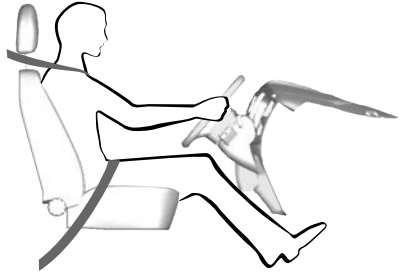

When you use them properly, the seat, head restraint, seatbelt and airbags will provide optimum protection in the event of a crash.

We recommend that you follow these guidelines:

- Sit in an upright position with the base of your spine as far back as possible.
- Do not recline the seat backrest so that your torso is more than 30 degrees from the upright position.
- Adjust the head restraint so that the top of it is level with the top of your head and as far forward as possible. Make sure that you remain comfortable.
- Keep sufficient distance between yourself and the steering wheel. We recommend a minimum of 10 in (25 cm) between your breastbone and the airbag cover.
- Hold the steering wheel with your arms slightly bent.

Front Seats

- Bend your legs slightly so that you can press the pedals fully.
- Position the shoulder strap of the seatbelt over the center of your shoulder and position the lap strap tightly across your hips.

Make sure that your driving position is comfortable and that you can maintain full control of your vehicle.

MANUAL SEATS (IF EQUIPPED)

HEADRESTRAINT COMPONENTS

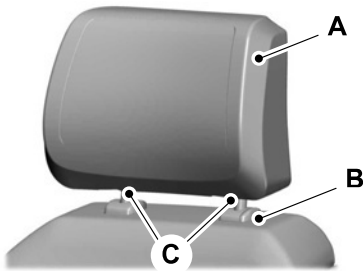

The head restraints consist of:

- A An energy absorbing head restraint.
- B Guide sleeve adjust and release button.
- C Two steel stems.

ADJUSTING THE HEAD RESTRAINT

WARNING: Fully adjust the head restraint before you sit in or operate your vehicle. This will help minimize the risk of neck injury in the event of a crash. Do not adjust the head restraint when your vehicle is moving.

WARNING: The head restraint is a safety device. Whenever possible it should be installed and properly adjusted when the seat is occupied. Failure to adjust the head restraint properly could reduce its effectiveness during certain impacts.

WARNING: Adjust the head restraints for all passengers before you drive your vehicle. This will help minimize the risk of neck injury in the event of a crash. Do not adjust the head restraints when your vehicle is moving.

Note: *Adjust the seat backrest to an upright driving position before adjusting the head restraint. Adjust the head restraint so that the top of it is level with the top of your head and as far forward as possible. Make sure that you remain comfortable. If you are extremely tall, adjust the head restraint to its highest position.*

Pull the head restraint up to raise it.

To lower the head restraint:

1. Press and hold the adjust and release button.
2. Push the head restraint down.

Front Seats



For vehicles with tilting head restraints:

1. Adjust the seat backrest to an upright driving or riding position.
2. Pivot the head restraint forward toward your head to the preferred position.

After the head restraint reaches the forward-most tilt position, pivot it forward again to release it to the rearward, untilted position.

Note: Do not attempt to force the head restraint backward after it is tilted. Instead, continue tilting it forward until the head restraint releases to the upright position.

REMOVING THE HEAD RESTRAINT

1. Pull up the head restraint until it reaches its highest position.
2. Press and hold the adjust and release button.
3. Pull up the head restraint.

INSTALLING THE HEAD RESTRAINT

Align the steel stems into the guide sleeves and push the head restraint down until it locks.

MOVING THE SEAT BACKWARD AND FORWARD

 **WARNING:** Make sure the seat fully locks into place by rocking it backward and forward. Not securing the seat into the locked position can be dangerous in a crash and could cause serious personal injury or death.



ADJUSTING THE SEAT BACKREST

 **WARNING:** Do not place cargo or any objects behind the seatback before returning it to the original position.

 **WARNING:** Reclining the seatback can cause an occupant to slide under the seat's seatbelt, resulting in severe personal injuries in the event of a crash.

Front Seats



ADJUSTING THE SEAT HEIGHT



ACCESSING THE REAR SEATS



E207088

Pull the release handle and fold the front seat backrest to access the rear seats. The seat backrest has memory and locks in the original position.

POWER SEATS (IF EQUIPPED)

HEADRESTRAINT COMPONENTS

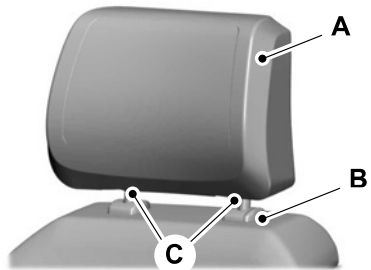

The head restraints consist of:

- A An energy absorbing head restraint.
- B Guide sleeve adjust and release button.
- C Two steel stems.

Front Seats

ADJUSTING THE HEAD RESTRAINT - VEHICLES WITH: FRONT 4-WAY HEADRESTRAINTS



WARNING: Fully adjust the head restraint before you sit in or operate your vehicle. This will help minimize the risk of neck injury in the event of a crash. Do not adjust the head restraint when your vehicle is moving.



WARNING: The head restraint is a safety device. Whenever possible it should be installed and properly adjusted when the seat is occupied. Failure to adjust the head restraint properly could reduce its effectiveness during certain impacts.



WARNING: Adjust the head restraints for all passengers before you drive your vehicle. This will help minimize the risk of neck injury in the event of a crash. Do not adjust the head restraints when your vehicle is moving.

To raise the head restraint, pull the head restraint up.

To lower the head restraint:

1. Press and hold the adjust and release button.
2. Push the head restraint down.

To tilt the head restraint:



1. Adjust the seat backrest to an upright driving or riding position.
2. Pivot the head restraint forward toward your head to the preferred position.

After the head restraint reaches the forward-most tilt position, pivot it forward again to release it to the rearward, untilted position.

Note: Do not attempt to force the head restraint backward after it is tilted. Instead, continue tilting it forward until the head restraint releases to the upright position.

ADJUSTING THE HEAD RESTRAINT - VEHICLES WITH: FRONT FIXED HEADRESTRAINTS



Front Seats

The non-adjustable head restraints consist of a trimmed foam covering over the upper structure of the seat backrest.

Properly adjust the seat backrest to an upright driving or riding position, so that the head restraint is positioned as close as possible to the back of your head.

REMOVING THE HEAD RESTRAINT

1. Pull up the head restraint until it reaches its highest position.
2. Press and hold the adjust and unlock button.
3. Pull up the head restraint.

INSTALLING THE HEAD RESTRAINT

Align the steel stems into the guide sleeves and push the head restraint down until it locks.

MOVING THE SEAT BACKWARD AND FORWARD



ADJUSTING THE SEAT BACKREST



WARNING: Do not place cargo or any objects behind the seatback before returning it to the original position.

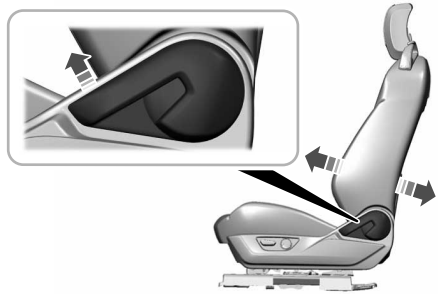

ADJUSTING THE SEAT HEIGHT

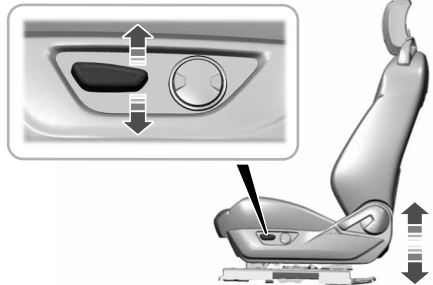

Front Seats

ADJUSTING THE LUMBAR SUPPORT

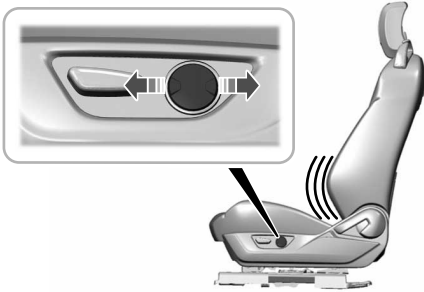

HEATED SEATS (IF EQUIPPED)

HEATED SEAT PRECAUTIONS



WARNING: Use caution when using the heated seat if you are unable to feel pain to your skin because of advanced age, chronic illness, diabetes, spinal cord injury, medication, alcohol use, exhaustion or other physical conditions. The heated seat could cause burns even at low temperatures, especially if used for long periods of time. Failure to follow this instruction could result in personal injury.



WARNING: Do not poke sharp objects into the seat cushion or seat backrest. This could damage the heated seat element and cause it to overheat. Failure to follow this instruction could result in personal injury.



WARNING: Do not place anything on the seat that blocks the heat, for example a seat cover or a cushion. This could cause the seat to overheat. Failure to follow this instruction could result in personal injury.

Do not:

- Place heavy objects on the seat.
- Operate the heated seat if water or any other liquid spills on the seat. Allow the seat to dry.

SWITCHING THE HEATED SEATS ON AND OFF

The vehicle must be running to use this feature.



Press this symbol on the touchscreen to switch on the heated seats.

Select your preferred heat level or off. You can also slide the menu bar up to control the heat intensity.

More indicator lights indicate the warmer temperature of the seat.

Note: *The heated seats turn on during a remote start if they are enabled.*

Note: *The heated seats may turn on when you start your vehicle if they were on when you previously switched your vehicle off.*

Note: *When you switch on the auto setting, the heated seats turn on to match your climate control setting.*

Front Seats

VENTILATED SEATS (IF EQUIPPED)

VENTILATED SEAT PRECAUTIONS

Do not:

- Spill liquid on the front seats. This may cause the air vent holes to become blocked and not work properly.
- Place cargo or objects under the seats. They may block the air intake causing the air vents to not work properly.

SWITCHING THE VENTILATED SEATS ON AND OFF

The vehicle must be running to use this feature.



Press this symbol on the touchscreen to switch on the ventilated seats.

Select your preferred fan speed or off. You can also slide the menu bar up to control the fan speed.

More indicator lights indicate higher fan speeds.

Note: *The ventilated seats turn on during a remote start if they were on when you previously switched your vehicle off.*

Note: *The ventilated seats may turn on when you start your vehicle if they were on when you previously switched your vehicle off.*

Note: *When you switch on the auto setting, the ventilated seats turn on to match your climate control setting.*

Rear Seats - Coupe

MANUAL SEATS

FOLDING THE SEAT BACKREST



WARNING: When folding the seat backrest down, take care not to get your fingers caught in the mechanism.



WARNING: Make sure that the seats and the seat backrests are secure and fully locked in their catches.

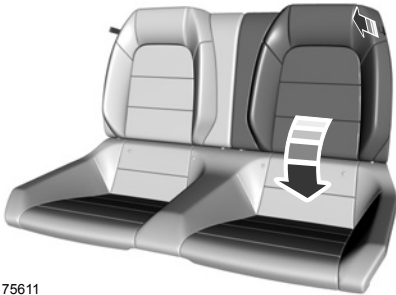

E175611

1. Pull the strap to release the seat backrest.
2. Fold the seat backrest down.

UNFOLDING THE SEAT BACKREST

Push the top of the seat backrest rearward and make sure it latches into place. Pull down on the backrest to make sure that it has locked into position.

Rear Occupant Alert System

WHAT IS THE REAR OCCUPANT ALERT SYSTEM

The rear occupant alert system monitors the vehicle conditions and notifies you to check for rear seat occupants when you switch the ignition off. The notifications are in the form of warnings inside the vehicle.

HOW DOES THE REAR OCCUPANT ALERT SYSTEM WORK

The system monitors the activity of turning the ignition on and off to indicate the potential presence of an occupant in the rear seat.

A message displays in the touchscreen and an audible warning sounds when you switch the ignition off.

REAR OCCUPANT ALERT SYSTEM PRECAUTIONS



WARNING: On hot days, the temperature inside the vehicle can rise very quickly. Exposure of people or animals to these high temperatures for even a short time can cause death or serious heat related injuries, including brain damage. Small children are particularly at risk.



WARNING: Do not leave children or pets unattended in your vehicle. Failure to follow this instruction could result in personal injury or death.

REAR OCCUPANT ALERT SYSTEM LIMITATIONS

The system does not detect the presence of objects or passengers in the rear seat. It monitors the activity of turning the ignition on and off.

Note: *It is possible to receive an alert when there is no rear seat occupant, but alert conditions are met.*

SWITCHING REAR OCCUPANT ALERT SYSTEM ON AND OFF

1. From the settings menu, press Vehicle
2. Switch Rear Occupant Alert on or off.

Note: *The default setting is on.*

Note: *Performing a system reset causes the system to switch on again.*

Semiannual Reminder

When you switch the system off, a message appears every six months as a reminder that the system is off. You can switch the system back on or leave it off.

Rear Occupant Alert System

REAR OCCUPANT ALERT SYSTEM INDICATORS



Message
Check rear seats for occupants.

Displays when you switch your vehicle off after the alert conditions are met.

The message displays for a short period of time. Press **Close** to acknowledge and remove the message.

Note: *The graphic may be different for your vehicle.*

REAR OCCUPANT ALERT SYSTEM AUDIBLE WARNINGS

The audible warning is an alert tone within the vehicle, which sounds when you switch your vehicle off. The warning sounds for a short period of time.

Memory Function (If Equipped)

HOW DOES THE MEMORY FUNCTION WORK

The memory function recalls the position of these features:

- Driver seat.
- Power mirrors.

MEMORY FUNCTION PRECAUTIONS



WARNING: Before activating the memory seat, make sure that the area immediately surrounding the seat is clear of obstructions and that all occupants are clear of moving parts.



WARNING: Do not use the memory function when your vehicle is moving.

LOCATING THE MEMORY FUNCTION BUTTONS



The memory function buttons are on the driver door.

SAVING A PRESET POSITION

1. Switch the ignition on.
2. Adjust the memory features to your preferred position.
3. Press and hold the preferred preset button until you hear a single tone.

A confirmation message appears in the information cluster display.

You can save up to three preset memory positions at any time.

RECALLING A PRESET POSITION

Press and release a preset button.

Note: You can recall a preset memory position when the ignition is off, or when you place the transmission in park (P) or neutral (N) if the ignition is on and the vehicle is not moving.

Note: Pressing any of the preset buttons or any memory feature control during a memory recall cancels the operation.

You can also recall a preset memory position by:

- Pressing the unlock button on your remote control if you linked it to a preset position.
- Unlocking the intelligent driver door handle if a linked remote control is present.

Using a linked remote control to recall your memory position when the ignition is off moves the seat and steering column to the easy entry position.

Linking a Preset Position to Your Remote Control or Passive Key

See **Linking or Unlinking a Personal Profile to a Remote Control** (page 414).

Garage Door Opener (If Equipped)

GARAGE DOOR OPENER INTRODUCTION

HomeLink Wireless Control System

The universal garage door opener replaces the common handheld garage door opener with a three-button transmitter integrated into the driver-side sun visor.



How Does The Garage Door Opener Work

The system includes two primary features, a garage door opener and a platform for remote activation of devices within the home. You can program garage doors as well as entry gate operators, security systems, entry door locks and home or office lighting.

Garage Door Opener Limitations

Canadian radio-frequency laws require transmitter signals to time out, or quit, after several seconds – which may not be long enough for HomeLink to pick up the signal. U.S. gate operators time-out in the same manner.

GARAGE DOOR OPENER PRECAUTIONS AND FREQUENCIES

Garage Door Opener Precautions

WARNING: Do not use the system with any garage door opener that does not have the safety stop and reverse feature as required by U.S. Federal Safety Standards (this includes any garage door opener manufactured before April 1, 1982). A garage door opener which cannot detect an object, signaling the door to stop and reverse, does not meet current federal safety standards. Using a garage door opener without these features increases the risk of serious injury or death.

FCC and RSS-210 Industry Canada Compliance

WARNING: Changes or modifications not expressly approved by the party responsible for compliance could void the user's authority to operate the equipment. The term "IC:" before the radio certification number only signifies that Industry Canada technical specifications were met.

This device complies with Part 15 of the FCC Rules and with RSS-210 of Industry Canada. Operation is subject to the following two conditions: (1) this device may not cause harmful interference, and (2) this device must accept any interference received, including interference that may cause undesired operation.

Garage Door Opener (If Equipped)

This equipment complies with FCC radiation exposure limits set forth for an uncontrolled environment. End Users must follow the specific operating instructions for satisfying RF exposure compliance. This transmitter must be at least 8 in (20 cm) from the user and must not be co-located or operating in conjunction with any other antenna or transmitter.

PROGRAMMING THE GARAGE DOOR OPENER

To clear all stored codes in the garage door opener in your vehicle, use the **clear** function. To override one button, use the **reprogram** function.

Note: Make sure that the garage door and security device are free from obstruction when you are programming. Do not program the system with the vehicle in the garage.

Clearing the Garage Door Opener

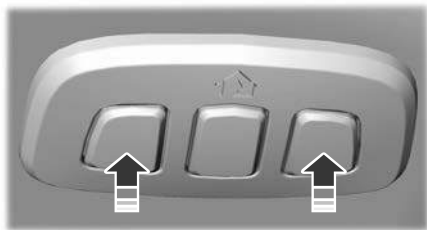

To clear all stored codes in the garage door opener in the vehicle:

1. Press and hold the outer two function buttons simultaneously for approximately 10 seconds until the indicator above the buttons flashes rapidly.
2. When the indicator flashes, release the buttons.

Note: This clears all stored codes. You cannot erase individual buttons.

Note: You can program a maximum of three devices. To change or replace any of the three devices after they have been initially programmed, you must either clear all codes, or reprogram each individual button.

Note: We recommend that upon the sale or lease termination of your vehicle, you erase the programmed function buttons for security reasons.

Reprogramming the Garage Door Opener

If a button on your garage door opener has already been programmed, you can override it. To program a device to a previously trained button:

1. Press and hold the desired button for approximately 20 seconds until the indicator begins to flash.
2. Without releasing the button, proceed to Step 3 of **Programming the Garage Door Opener to your Handheld Transmitter**.

Programming the Garage Door Opener to your Handheld Transmitter

Note: The programming steps below assume you are programming a HomeLink that was not previously programmed. If your HomeLink was previously programmed, you may need to **clear** or **reprogram** your HomeLink buttons.

Note: Put a new battery in the handheld transmitter. This allows for quicker training and accurate transmission of the radio-frequency signal.

Note: Make sure that the garage door and security device are free from obstruction when you are programming. Do not program the system with the vehicle in the garage.

Garage Door Opener (If Equipped)

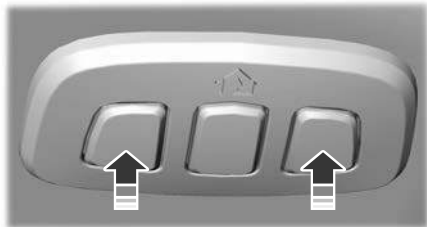

To program your in-vehicle HomeLink function button with your handheld transmitter:

1. With your vehicle parked outside of the garage, switch your vehicle on, but do not start your vehicle.
2. Press and release one of the three HomeLink function buttons that you would like to program.

Note: The indicator should begin to flash. If the indicator does not flash, press and hold the function button for 20 seconds until the indicator begins to flash.

3. Hold your handheld garage door transmitter 1–3 in (2–8 cm) away from the HomeLink button you want to program.
4. Press and hold the handheld transmitter button you want to program while watching the indicator on HomeLink. Continue to hold the handheld button until the HomeLink indicator flashes rapidly or is continuously on.

Note: You may need to use a different method if you live in Canada or have difficulties programming your gate operator or garage door opener.

5. Press and hold the HomeLink button you programmed for two seconds, then release. You may need to do this twice to activate the door.

Note: If the indicator stays on, the programming is complete.

Note: If the HomeLink indicator flashes rapidly, repeat Step 5.

Note: If your device still does not operate, you must program your garage door.

6. To program additional buttons, repeat Steps 1–4.

Note: Make sure you keep the original remote control transmitter for use in other vehicles as well as for future system programming.

Programming the Garage Door Opener to your Garage Door Opener Motor

Note: Make sure that the garage door and security device are free from obstruction when you are programming. Do not program the system with the vehicle in the garage.



1. Press the learn button on the garage door opener motor and then you have 30 seconds to complete the next two steps.
2. Return to your vehicle.

Garage Door Opener (If Equipped)

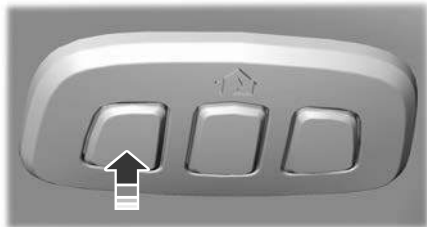

3. Press and hold one of the three HomeLink function buttons you want to program for two seconds, then release.
4. Repeat Step 3. Depending on your brand of garage door opener, you may need to repeat this sequence a third time.

Programming the Garage Door Opener to your Gate Opener Motor

Gate Operator / Canadian Programming

Canadian radio-frequency laws require transmitter signals to time-out (or quit) after several seconds of transmission – which may not be long enough for HomeLink to pick up the signal during programming. Similar to this Canadian law, some U.S. gate operators are designed to time-out in the same manner.

Note: *If programming a garage door opener or gate operator, it is advised that you unplug the device during the **cycling** process to prevent possible overheating.*

1. Press and release your handheld transmitter, **every two seconds**, until the HomeLink indicator flashes rapidly or is continuously on.
2. Release the handheld transmitter button.

3. Press and hold the HomeLink function button you want to program for two seconds, then release. You may need to do this twice to activate the door.

Note: *If the indicator stays on, the programming is complete.*

Note: *If the HomeLink indicator flashes rapidly, repeat Step 3.*

4. To program additional buttons, repeat Steps 1–4.

GARAGE DOOR OPENER ADDITIONAL ASSISTANCE

Video Setup Instructions

[Universal Garage Door Opener: HomeLink](#)

[Universal Garage Door Opener: HomeLink for Genie Intellicode 2](#)

[Universal Garage Door Opener Homelink for Genie Intellicode](#)

Additional assistance can be found online at www.homelink.com/Ford or by calling the toll-free help line at 1-800-355-3515.

USB Ports

LOCATING THE USB PORTS

Data Transfer USB Ports



The USB ports could be in the following locations:

- On the lower instrument panel.
- Inside the center console.

Note: These USB ports can also charge devices.

Note: Not all USB ports in your vehicle have data transfer capabilities.

Note: We recommend using only USB-IF certified cables and adapters. Non-certified cables and adapters may not work.

Charge Only USB Ports



The USB ports could be in the following locations:

- On the lower instrument panel.
- Inside the center console.
- On the windshield, behind the rear view mirror.

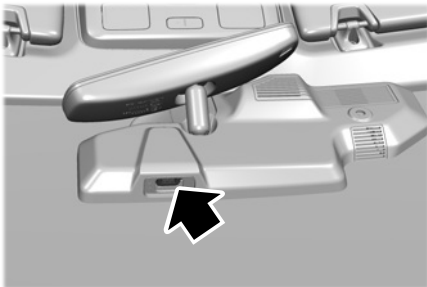

PLAYING MEDIA USING THE USB PORT

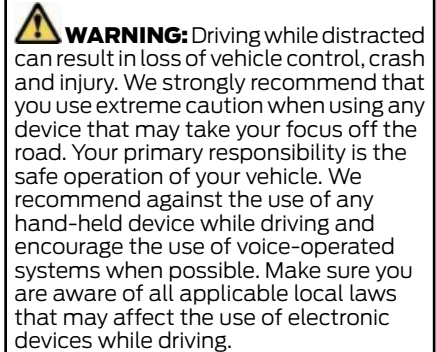

Connect your device to a data transfer USB port.



Press the audio button on the home screen.

Select **Sources**.



Select the USB option.



Press to play a track. Press again to pause the track.



Press to skip to the next track. Press and hold to fast forward through the track.



Press once to return to the beginning of a track. Repeatedly press to return to previous tracks.

Press and hold to fast rewind.

CHARGING A DEVICE

Connect your device to the USB port.

USB Ports

Data Transfer USB Ports



You can charge your device through the data transfer USB port when SYNC is on.

Charge Only USB Ports



You can charge your device through the charge only USB port when the vehicle is in accessory mode or when the vehicle is running.

Power Outlet

WHAT IS THE POWER OUTLET

The power outlet can power devices using a 12 V outlet adapter.

POWER OUTLET PRECAUTIONS

 **WARNING:** Do not plug electrical devices into the power outlets that exceed the maximum power rating. Incorrect use of the power outlets can cause damage not covered by the vehicle warranty, and can result in fire or personal injury.

When you switch the vehicle on, you can use the power outlets to power 12 V appliances with a maximum current rating of 15 A.

To prevent damage to the vehicle's battery:

- Do not use the power outlets over the vehicle capacity of 12 V DC 180 W or a fuse could blow.
- Do not plug in any device that supplies power to the vehicle through the power outlets. This could result in damage to vehicle systems.
- Do not hang any accessory from the accessory plug. Always keep the power outlets caps closed when not in use.
- Do not insert objects other than an accessory plug into the power outlets.

To prevent the battery from running out of charge:

- Do not use the power outlets longer than necessary when the vehicle is off.
- Do not leave devices plugged in overnight or when you park your vehicle for extended periods.
- Using devices for extended periods may require starting and running the engine to recharge the battery.

LOCATING THE POWER OUTLETS

The power outlets may be located in the media bin below the instrument panel and inside the center console bin.

Below the Instrument Panel

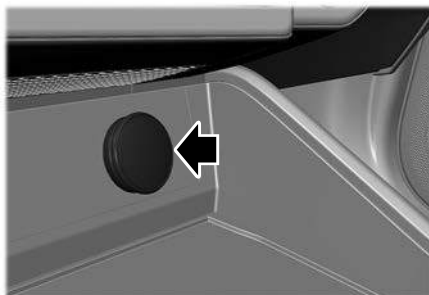

Power Outlet

Inside the Center Console

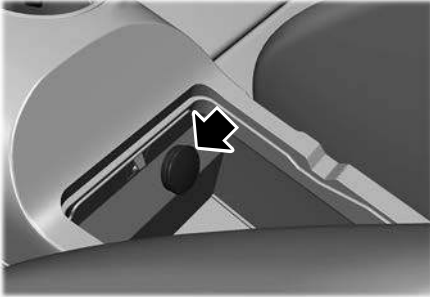

Wireless Accessory Charger (If Equipped)

WHAT IS THE WIRELESS ACCESSORY CHARGER

The wireless accessory charger allows you to charge one compatible Qi wireless charging device on the charging area.

WIRELESS ACCESSORY CHARGER PRECAUTIONS



WARNING: Wireless charging devices can affect the operation of implanted medical devices, including cardiac pacemakers. If you have any implanted medical devices, we recommend that you consult with your physician.



WARNING: Remove all metal objects like coins and keys from the charging surface and remove any metal objects attached to your mobile phone before placing the device on the charging surface. Some mobile devices or cases may attract metal objects. Metal objects on the charging surface or attached to the phone may become hot while charging is active. If an object is left on or near the charging surface or attached to the phone while the device is charging, let the objects cool before removing to prevent personal injury.

Keep the charging area clean and remove foreign objects prior to charging a device.

Do not place items with a magnetic strip or radio-frequency identification chip, for example passports, parking tickets, transportation passes or credit cards, near the charging area when charging a device. Damage could occur to the magnetic strip or radio-frequency identification chip.

Do not place metal objects, for example remote controls, coins and candy wrappers, on or near the charging area when charging a device. Metal objects may heat up and degrade the charging performance, in addition to causing interruptions in charging.

Charging could be interrupted, degraded, or could stop if any of the following occur:

- The system detects a foreign object.
- The device is misaligned on the charging area.
- The device moves on the active charging area when the vehicle is in motion.
- The vehicle ambient temperature is too high.
- You attempt to charge a non-Qi compatible device on the wireless charger.

Note: During charging, the device and the charger could heat up, this is normal. If the battery gets hotter than usual, the device may stop charging.

LOCATING THE WIRELESS ACCESSORY CHARGER



The charging area is in the center console media bin below the instrument panel.

CHARGING A WIRELESS DEVICE

Place the device on the center of the charging surface with the charging side down. The charging stops after your device reaches a full charge.

You can use the charger when the vehicle is in accessory mode, when the vehicle is running or when the touchscreen is on.

Wireless Accessory Charger (If Equipped)



Displays on the status bar when wireless charging is in progress.



Displays on the status bar when wireless charging has been interrupted.

Note: *The charging performance may be affected if your device is in a case. It may be necessary to remove the case to wirelessly charge your device.*

Note: *Software and firmware updates may affect device compatibility, including the use of unofficial software or firmware. You should verify charging functionality with your specific devices in-vehicle.*

Storage

CUP HOLDERS

CUP HOLDER PRECAUTIONS



WARNING: Use caution when stowing items or hot drinks in the cup holders. Items could become loose or spill during hard braking, acceleration or crashes. Failure to follow this instruction could result in personal injury.

GLOVE COMPARTMENT

OPENING THE GLOVE COMPARTMENT



Pull the latch to the left to open the glove compartment.

CENTER CONSOLE

OPENING THE CENTER CONSOLE

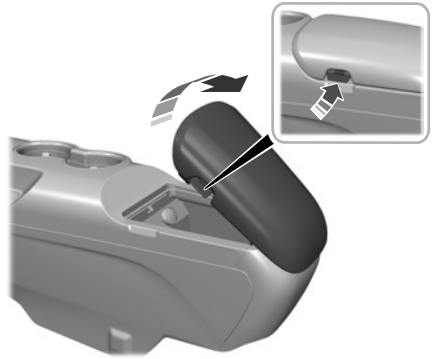

Lift the latch to open the center console.

LOCKING THE CENTER CONSOLE

(If Equipped)



The center console locks when you electronically lock the doors. The center console unlocks when you use the remote control to unlock the driver door.

Storage

Note: You cannot lock the center console when the vehicle is on.

GLASSES HOLDER

LOCATING THE GLASSES HOLDER - CONVERTIBLE

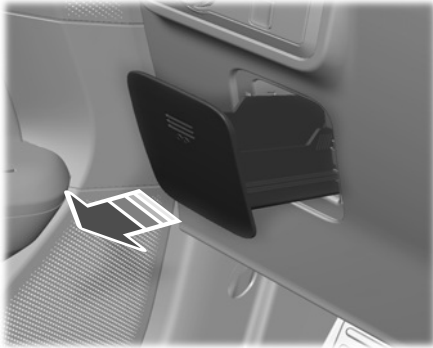

Press near the center of the door to release the glasses holder, then pull the tray all the way out.

LOCATING THE GLASSES HOLDER - COUPE

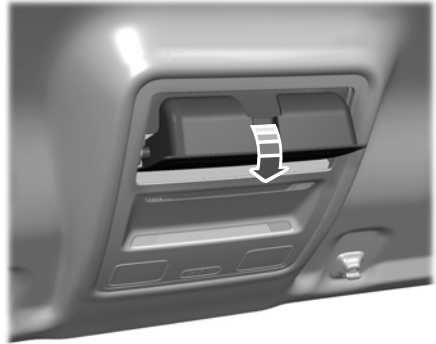

The glasses holder is in the overhead console.

Press near the rear edge of the door to open it.

Starting and Stopping the Engine

STARTING AND STOPPING THE ENGINE – PRECAUTIONS



WARNING: Extended idling at high engine speeds can produce very high temperatures in the engine and exhaust system, creating the risk of fire or other damage.



WARNING: Do not park, idle or drive your vehicle on dry grass or other dry ground cover. The emission system heats up the engine compartment and exhaust system, creating the risk of fire.



WARNING: Do not start the engine in a closed garage or in other enclosed areas. Exhaust fumes are toxic. Always open the garage door before you start the engine. Failure to follow this instruction could result in personal injury or death.



WARNING: Do not use starting fluid, for example ether, in the air intake system. Such fluid could cause immediate explosive damage to the engine and possible personal injury.



WARNING: Exhaust leaks may result in entry of harmful and potentially lethal fumes into the passenger compartment. If you smell exhaust fumes inside your vehicle, have your vehicle inspected immediately. Do not drive if you smell exhaust fumes.

The powertrain control system meets all Canadian interference-causing equipment standard requirements regulating the impulse electrical field or radio noise.

If you stop your vehicle and leave the engine idling for long periods, we recommend that you do one of the following:

- Open the windows at least 1 in (2.5 cm).
- Set your climate control to outside air.

PUSH BUTTON IGNITION SWITCH



Switching the Ignition Off

When the ignition is on or in accessory mode, press the push button ignition switch once without your foot on the brake pedal.

Switching the Ignition to Accessory Mode

When the ignition is off, press the push button ignition switch once without your foot on the brake pedal.

All electrical circuits and accessories are operational and the warning lamps and indicators illuminate.

Note: *Your vehicle has a battery saver feature that shuts your vehicle off when it detects a certain amount of battery drain, or after about 30 minutes of inactivity in accessory mode.*

Starting and Stopping the Engine

Note: The system may not function if the passive key is close to metal objects or electronic devices, for example keys or a cell phone.

Note: You need a valid passive key inside your vehicle to switch the ignition on and start the engine.

STARTING THE ENGINE

STARTING A GASOLINE ENGINE

Before starting your vehicle, check the following:

- Make sure that the parking brake is on.
 - Make sure that the transmission is in park (P) for automatic transmissions or neutral (N) for manual transmissions.
1. Fully press the brake pedal for automatic transmissions or clutch pedal for manual transmissions.

Note: Do not touch the accelerator pedal.

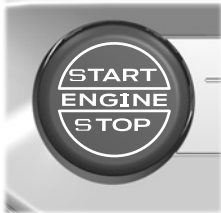

2. Press the push button ignition switch.

Note: The engine may continue cranking for up to 15 seconds or until it starts.

Note: The engine takes longer to start at lower temperatures. It may crank for several seconds when very cold.

RESTARTING THE ENGINE AFTER STOPPING IT

The system allows you to start the engine within 20 seconds of switching it off, even if it does not detect a valid passive key.

Within 20 seconds of switching the engine off, fully press the brake or clutch pedal and press the push button ignition switch. After 20 seconds, you can no longer start the engine if the system does not detect a valid passive key.

When you start the engine, it remains running until you press the push button ignition switch, even if your vehicle does not detect a valid passive key. If you open and close a door when the engine is running, the system searches for a valid passive key.

ENGINE BLOCK HEATER (IF EQUIPPED)

ENGINE BLOCK HEATER PRECAUTIONS

 **WARNING:** Failure to follow engine block heater instructions could result in property damage or serious personal injury.

 **WARNING:** Do not use your heater with ungrounded electrical systems or two-pronged adapters. There is a risk of electrical shock.

 **WARNING:** Do not fully close the hood, or allow it to drop under its own weight when using the engine block heater. This could damage the power cable and may cause an electrical short resulting in fire, injury and property damage.

Starting and Stopping the Engine

We recommend that you do the following for a safe and correct operation:

- Use a 16-gauge outdoor extension cord that is product certified by Underwriter's Laboratory (UL) or Canadian Standards Association (CSA). This extension cord must be suitable for use outdoors, in cold temperatures, and be clearly marked Suitable for Use with Outdoor Appliances. Do not use an indoor extension cord outdoors. This could result in an electric shock or become a fire hazard.
- Use as short an extension cord as possible.
- Do not use multiple extension cords.
- Make sure that when in operation, the extension cord plug and heater cord plug connections are free and clear of water. This could cause an electric shock or fire.
- If the block heater cord is under the hood, do not remove the wiring from its original location. Do not close the hood on the extension wiring.
- Make sure your vehicle is parked in a clean area, clear of combustibles.
- Make sure the heater, heater cord and extension cord are firmly connected.
- Check for heat anywhere in the electrical hookup once the system has been operating for about 30 minutes.
- Make sure the system is unplugged and properly stowed before starting and driving your vehicle. Make sure the protective cover seals the prongs of the block heater cord plug when not in use.
- Make sure the heater system is checked for proper operation before winter.

HOW DOES THE ENGINE BLOCK HEATER WORK

The engine block heater warms the engine coolant. This allows the climate control system to quickly respond. The equipment includes a heater element installed in the engine block and a wire harness. You can connect the system to a grounded 110 volt AC electrical source.

Note: *The engine block heater is most effective when outdoor temperatures are below 0°F (-18°C). We recommend the use of engine block heater to improve engine cold start performance.*

USING THE ENGINE BLOCK HEATER

Make sure the receptacle terminals are clean and dry prior to use. Clean them with a dry cloth if necessary.

The heater uses 0.4 to 1.0 kilowatt-hours of energy per hour of use. The system does not have a thermostat. It achieves maximum temperature after approximately three hours of operation. Using the heater longer than three hours does not improve system performance and unnecessarily uses electricity.

STOPPING THE ENGINE

STOPPING THE ENGINE WHEN YOUR VEHICLE IS STATIONARY

1. Make sure that the transmission is in park (P) for automatic transmissions or neutral (N) for manual transmissions.
2. Apply the parking brake.
3. Wait until the engine reaches idle speed.

Starting and Stopping the Engine



4. Press the push button ignition switch.

STOPPING THE ENGINE WHEN YOUR VEHICLE IS MOVING



WARNING: Switching off the engine when your vehicle is still moving results in a significant decrease in braking assistance. Higher effort is required to apply the brakes and to stop your vehicle. A significant decrease in steering assistance could also occur. The steering does not lock, but higher effort could be required to steer your vehicle. When you switch the ignition off, some electrical circuits, for example airbags, also turn off. If you unintentionally switch the ignition off, shift into neutral (N) and restart the engine.

Only in case of emergency, do the following:



1. Press and hold the push button ignition switch until the engine stops, or press it three times within two seconds.

2. Shift into neutral (N) and use the brakes to safely bring your vehicle to a complete stop.
3. Make sure that the transmission is in park (P) for automatic transmissions or neutral (N) for manual transmissions.
4. Apply the parking brake.

AUTOMATIC ENGINE STOP

WHAT IS AUTOMATIC ENGINE STOP

Automatic engine stop switches the engine off if it has been idling for an extended period to help you save fuel.

HOW DOES AUTOMATIC ENGINE STOP WORK

Automatic engine stop turns the engine off. The ignition also turns off to save battery power. Before the engine shuts down, a message appears in the instrument cluster display showing a timer counting down. If you do not intervene within 30 seconds, the engine shuts down. Another message appears in the instrument cluster display to inform you that the engine has shut down to save fuel. Start your vehicle as you normally do.

SWITCHING AUTOMATIC ENGINE STOP ON AND OFF

1. From the settings menu, press Vehicle.
2. Switch 30min Max Idle on or off.

Note: You cannot permanently switch off the automatic shutdown. If you switch it off, it turns on each time you switch the ignition on.

Starting and Stopping the Engine

OVERRIDING AUTOMATIC ENGINE STOP

Note: You cannot permanently switch off the automatic engine stop feature. When you switch it off temporarily, it turns on at the next ignition cycle.

You can stop the engine shutdown, or reset the timer, at any point before the 30-second countdown has expired by doing any of the following:

- Pressing the brake pedal or accelerator pedal.
- Pressing the **OK** or **RESET** button during the countdown.

ACCESSING THE PASSIVE KEY BACKUP POSITION

If you are unable to start the engine, do the following:



1. Open the center console storage compartment lid.
2. Remove the plastic mat from the console floor.
3. With the buttons facing upward and the unlock button facing the front of your vehicle, place the passive key into the backup slot.
4. With the key in this position, press the brake pedal then press the push button ignition switch to switch the ignition on and start your vehicle.

STARTING AND STOPPING THE ENGINE – TROUBLESHOOTING

STARTING AND STOPPING THE ENGINE – WARNING LAMPS

Malfunction Indicator Lamp



If it illuminates when the engine is running, the on-board diagnostics system is detecting a malfunction of the vehicle emission control system.

If it flashes, engine misfire could be occurring. Increased exhaust gas temperatures could damage the catalytic converter or other vehicle components. Avoid heavy acceleration and deceleration, and have your vehicle checked as soon as possible.

Powertrain Warning Lamp



If it illuminates when the engine is running, this indicates a powertrain or four-wheel drive fault. If it flashes when you are driving, immediately reduce the vehicle speed. Avoid heavy acceleration and deceleration, and have your vehicle checked as soon as possible.

Starting and Stopping the Engine

If both lamps illuminate when the engine is running, stop your vehicle as soon as it is safe to do so. Continuing to drive your vehicle could cause reduced power or the engine to stop. Switch the ignition off and attempt to restart the engine. Have your vehicle checked as soon as possible.

Oil Pressure Warning Lamp



It illuminates when you switch the ignition on. If it illuminates when the engine is running, this indicates a malfunction. Stop your vehicle and switch the engine off. Check the engine oil level. If the oil level is sufficient, this indicates a system malfunction. Have your vehicle checked as soon as possible.

STARTING AND STOPPING THE ENGINE – INFORMATION MESSAGES

Message	Action
Cranking Time Exceeded	Displays if you exceed the starting time limit. You cannot attempt to start the engine for 15 minutes. If you cannot start the engine after 15 minutes passes, have your vehicle immediately checked.
Starting System Fault	Displays if you are unable to start your vehicle with a correctly coded key. The system has detected a fault that requires service. Have your vehicle checked as soon as possible.
No Key Detected	Displays if the system does not detect a valid passive key.

Starting and Stopping the Engine

STARTING AND STOPPING THE ENGINE – FREQUENTLY ASKED QUESTIONS

Why is the engine idle speed high when I start the engine?

- The speed the engine idles immediately after starting is optimized to minimize vehicle emissions and maximize cabin comfort and fuel economy.

Why is the engine not cranking?

The engine will not crank if:

- The system does not detect a valid passive key.
- The passive key battery has no charge.
- The vehicle battery does not have sufficient charge.
- The brake pedal is not pressed for automatic transmissions or the clutch pedal is not pressed for manual transmissions.
- The transmission is not in the park (P) or neutral (N) for automatic transmissions.
- The starting system has been disabled after multiple attempts of starting the engine.

What should I do if the starting system is disabled?

- You can only attempt to start the engine for a set number of times before the starting system temporarily disables. If you exceed the limit, a message may appear and you need to wait at least 15 minutes to start the engine again.

What should I do if the engine does not start?

- If you cannot start the engine after three attempts, wait 10 seconds and do the following:
 1. Fully press the brake pedal for automatic transmissions or clutch pedal for manual transmissions.

Note: Make sure that the parking brake is applied.

Note: Make sure that the transmission is in park (P) or neutral (N) for automatic transmissions.

2. Fully press and hold the accelerator pedal.
3. Press the push button ignition switch. See **Push Button Ignition Switch** (page 137).

Note: The engine cranks for a short period of time and then stops.

4. Release the accelerator pedal.
5. Press the push button ignition switch. See **Push Button Ignition Switch** (page 137).

Why do I experience different driving characteristics?

- If you disconnect the battery, your vehicle may exhibit some unusual driving characteristics for about 5 mi (8 km) after you reconnect it. This is because the engine management system must realign itself with the engine. You can disregard any unusual driving characteristics during this period.

Starting and Stopping the Engine

Why does the system not detect a passive key?

- If the system does not detect a passive key and you are unable to start the engine, insert the passive key into the backup position and press the push button ignition switch to start the engine. See **Accessing the Passive Key Backup Position** (page 141).

Auto-Start-Stop (If Equipped)

WHAT IS AUTO-START-STOP

The system is designed to help reduce fuel consumption and CO₂ emissions by stopping the engine when it is idling, for example at traffic lights.

AUTO-START-STOP PRECAUTIONS - MANUAL TRANSMISSION



WARNING: Apply the parking brake, shift into neutral, switch the ignition off and remove the key before you leave your vehicle. Failure to follow this instruction could result in personal injury or death.



WARNING: Apply the parking brake, shift into neutral, switch the ignition off and remove the key before you open the hood or have any service or repair work completed. If you do not switch the ignition off, the engine could restart at any time. Failure to follow this instruction could result in personal injury or death.

AUTO-START-STOP PRECAUTIONS - AUTOMATIC TRANSMISSION



WARNING: Apply the parking brake, shift into park (P), switch the ignition off and remove the key before you leave your vehicle. Failure to follow this instruction could result in personal injury or death.



WARNING: Apply the parking brake, shift into park (P), switch the ignition off and remove the key before you open the hood or have any service or repair work completed. If you do not switch the ignition off, the engine could restart at any time. Failure to follow this instruction could result in personal injury or death.

SWITCHING AUTO-START- STOP ON AND OFF

The system turns on when you switch the ignition on.



Press the button to switch the system off.

Note: *OFF* illuminates in the switch.

Note: *Deactivating the system using the button lasts only one key cycle.*

Press the button again to switch the system back on.

Note: *The system turns off if it detects a malfunction. If the system malfunctions, have your vehicle checked as soon as possible.*

STOPPING THE ENGINE - AUTOMATIC TRANSMISSION

Stop your vehicle, keep your foot on the brake pedal and the transmission in drive (D).

STOPPING THE ENGINE - MANUAL TRANSMISSION

1. Stop your vehicle.
2. Shift into neutral.

Auto-Start-Stop (If Equipped)

3. Release the clutch pedal and the accelerator pedal.

Note: *To obtain maximum benefit from the system, shift into neutral and release the clutch pedal whenever you stop your vehicle for more than three seconds.*

RESTARTING THE ENGINE - MANUAL TRANSMISSION

Press the clutch pedal.

A message appears in the instrument cluster display if the system requires you to take action.

Message	Condition	Action
Auto StartStop Press a Pedal to Start Engine	The system needs to restart the engine but requires your confirmation.	Press the accelerator pedal, brake pedal or clutch pedal to restart the engine.
Auto StartStop Select Neutral To Start Engine	The system needs to restart the engine but cannot because the transmission is in gear.	Shift into neutral to restart the engine.

Auto-Start-Stop (If Equipped)

RESTARTING THE ENGINE - AUTOMATIC TRANSMISSION

Release the brake pedal or press the accelerator pedal.

A message appears in the instrument cluster display if the system requires you to take action.



The auto-start-stop indicator illuminates green when the engine stops. It flashes amber and a message appears when you need to take action.



The auto-start-stop indicator illuminates gray with a strikethrough when the system is not available.

AUTO-START-STOP INDICATORS



WARNING: The system may require the engine to automatically restart when the auto-start-stop indicator illuminates green or flashes amber. Failure to follow this instruction could result in personal injury.

AUTO-START-STOP – TROUBLESHOOTING

AUTO-START-STOP – INFORMATION MESSAGES - MANUAL TRANSMISSION

Message	Condition	Action
Auto StartStop Manual Restart Required	The system is not functioning.	Restart the engine yourself.

Auto-Start-Stop (If Equipped)

AUTO-START-STOP – INFORMATION MESSAGES - AUTOMATIC TRANSMISSION

A message appears in the instrument cluster display if the system requires you to take action.

Message	Condition	Action
Auto StartStop Press Brake to Start Engine	The system needs to restart the engine but requires your confirmation.	Press the brake pedal to restart the engine.
Auto StartStop Press a Pedal to Start Engine	The system needs to restart the engine but requires your confirmation.	Press the brake pedal or the accelerator pedal to restart the engine.

Auto-Start-Stop (If Equipped)

AUTO-START-STOP – FREQUENTLY ASKED QUESTIONS

Why does the engine not always stop when I expect it to?

The system is designed to work in a way that complements other vehicle systems, allowing them to operate at optimum performance.

The system does not stop the engine if:

- The driver door is open.
- Your vehicle is at high altitude.
- The heated windshield is on.
- The engine is warming up.
- The outside temperature is too low or too high.
- The battery charge is low.
- The battery temperature is outside the optimal operating range.
- The engine is required to run to maintain interior climate and reduce fogging.

Why does the engine sometimes restart when I do not expect it to?

The system is designed to work in a way that complements other vehicle systems, allowing them to operate at optimum performance.

The system restarts the engine if:

- You switch the heated windshield on.
- You switch maximum defrost on.
- Your vehicle starts to roll downhill in neutral.
- The engine is required to run to maintain adequate brake system assistance.
- The engine is required to run to maintain interior climate and reduce fogging.

Can I permanently switch the system off?

No. The system plays an important role in reducing the fuel consumption and the CO₂ emissions.

Will the frequent engine starts cause parts to wear out?

Your vehicle has an enhanced battery and starter motor that are designed for the increased number of engine starts.

Fuel and Refueling

FUEL AND REFUELING PRECAUTIONS



WARNING: Fuels can cause serious injury or death if misused or mishandled.



WARNING: Fuel may contain benzene, which is a cancer-causing agent.



WARNING: Read and follow all the instructions on the pump island.



WARNING: When refueling always shut the engine off and never allow sparks or open flames near the fuel tank filler valve. Never smoke or use a cell phone while refueling. Fuel vapor is extremely hazardous under certain conditions. Avoid inhaling excess fumes.

Follow these guidelines when refueling:

- Extinguish all smoking materials and any open flames before refueling your vehicle.
- Switch the engine off before refueling.
- Automotive fuels can be harmful or fatal if swallowed. Fuel is highly toxic and if swallowed can cause death or permanent injury. If fuel is swallowed immediately call a physician, even if no symptoms are immediately apparent. The toxic effects of fuel may not be apparent for hours.
- Avoid inhaling fuel vapors. Inhaling fuel vapor can lead to eye and respiratory tract irritation. In severe cases, excessive or prolonged breathing of fuel vapor can cause serious illness and permanent injury.

- Avoid getting fuel in your eyes. If you splash fuel in your eyes, immediately remove contact lenses, if worn, flush with water for 15 minutes and seek medical attention. Failure to seek proper medical attention could lead to permanent injury.
- Fuels can be harmful if absorbed through the skin. If you splash fuel on your skin, clothing or both, promptly remove contaminated clothing and thoroughly wash your skin with soap and water. Repeated or prolonged skin contact causes skin irritation.
- Be particularly careful if you are taking Antabuse or other forms of Disulfiram for the treatment of alcoholism. Breathing fuel vapors could cause an adverse reaction, serious personal injury or sickness. Immediately call a physician if you experience any adverse reactions.

FUEL QUALITY

SELECTING THE CORRECT FUEL

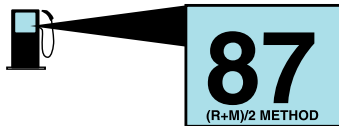

Your vehicle operates on regular unleaded gasoline with a minimum pump (R+M)/2 octane rating of 87.

Some fuel stations, particularly those in high altitude areas, offer fuels posted as regular unleaded gasoline with an octane rating below 87. The use of these fuels could result in engine damage that will not be covered by the vehicle Warranty.

Fuel and Refueling

For best overall vehicle and engine performance, premium fuel with an octane rating of 91 or higher is recommended. The performance gained by using premium fuel is most noticeable in hot weather as well as other conditions, for example when towing a trailer. See **Towing a Trailer** (page 260).

Do not be concerned if the engine sometimes knocks lightly. However, if the engine knocks heavily while using fuel with the recommended octane rating, contact an authorized dealer to prevent any engine damage.

We recommend Top Tier detergent gasolines, where available to help minimize engine deposits and maintain optimal vehicle and engine performance.

For additional information, visit www.toptiergas.com.

Note: *Use of any fuel for which the vehicle was not designed can impair the emission control system, cause loss of vehicle performance, and cause damage to the engine which may not be covered by the vehicle Warranty.*

Do not use:

- Diesel fuel.
- Fuels containing kerosene or paraffin.
- Fuel containing more than 15% ethanol (E15) or E85 fuel.
- Fuels containing methanol.
- Fuels containing metallic-based additives, including manganese-based compounds.
- Fuels containing the octane booster additive, methylcyclopentadienyl manganese tricarbonyl (MMT).
- Leaded fuel, using leaded fuel is prohibited by law.

The use of fuels with metallic compounds such as methylcyclopentadienyl manganese tricarbonyl, which is a manganese-based fuel additive, will impair engine performance and affect the emission control system.

LOCATING THE FUEL FILLER FUNNEL

The fuel filler funnel is under the luggage compartment floor covering.

RUNNING OUT OF FUEL

FILLING A PORTABLE FUEL CONTAINER

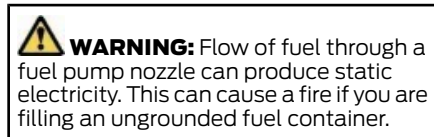

Use the following guidelines to avoid electrostatic charge build-up, which can produce a spark, when filling an ungrounded fuel container:

- Only use an approved fuel container to transfer fuel to your vehicle. Place the container on the ground when filling it.
- Do not fill a fuel container when it is inside your vehicle (including the cargo area).
- Keep the fuel pump nozzle in contact with the fuel container when filling it.
- Do not use a device that holds the fuel pump nozzle lever in the fill position.

Fuel and Refueling

ADDING FUEL FROM A PORTABLE FUEL CONTAINER



WARNING: Do not insert the nozzle of a fuel container or an aftermarket funnel into the fuel filler neck. This may damage the fuel system filler neck or its seal and cause fuel to run onto the ground.



WARNING: Do not pry open the fuel tank filler valve. This could damage the fuel system. Failure to follow this instruction could result in fire, personal injury or death.



WARNING: Do not dispose of fuel in the household refuse or the public sewage system. Use an authorized waste disposal facility.

When refueling the vehicle fuel tank from a fuel container, use the fuel filler funnel included with your vehicle. See **Locating the Fuel Filler Funnel** (page 151).

Note: Do not use aftermarket funnels as they may not work with the capless fuel system and can damage it.

When refueling the vehicle fuel tank from a fuel container, do the following:

1. Fully open the fuel filler door.



2. Fully insert the fuel filler funnel into the fuel filler inlet.
3. Add fuel to your vehicle from the fuel container.
4. Remove the fuel filler funnel.
5. Fully close the fuel filler door.
6. Clean the fuel filler funnel and place it back in your vehicle or correctly dispose of it.

Note: If your vehicle runs out of fuel add a minimum of 1.3 gal (5 L) of fuel to restart the engine.

Note: You may need to switch the ignition from off to on several times after refueling to allow the fuel system to pump the fuel from the tank to the engine. When restarting, cranking time takes a few seconds longer than normal.

Note: Extra funnels can be purchased from an authorized dealer if you choose to dispose of the funnel.

Fuel and Refueling

REFUELING

REFUELING SYSTEM OVERVIEW

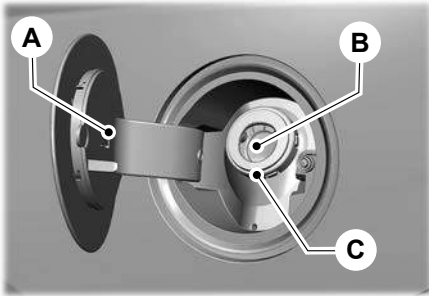

- A Fuel filler door.
- B Fuel filler inlet.
- C Fuel tank filler pipe.

REFUELING YOUR VEHICLE

WARNING: When refueling always shut the engine off and never allow sparks or open flames near the fuel tank filler valve. Never smoke or use a cell phone while refueling. Fuel vapor is extremely hazardous under certain conditions. Avoid inhaling excess fumes.

WARNING: Fuel vapor burns violently and a fuel fire can cause severe injuries.

WARNING: The fuel system may be under pressure. If you hear a hissing sound near the fuel filler inlet, do not refuel until the sound stops. Otherwise, fuel may spray out, which could cause serious personal injury.

WARNING: Keep children away from the fuel pump. Never let children pump fuel.

WARNING: Do not pry open the fuel tank filler valve. This could damage the fuel system. Failure to follow this instruction could result in fire, personal injury or death.

WARNING: Stay outside your vehicle and do not leave the fuel pump unattended when refueling your vehicle.

WARNING: Do not remove the fuel pump nozzle from its fully inserted position when refueling.

WARNING: Stop refueling when the fuel pump nozzle automatically shuts off for the first time. Failure to follow this will fill the expansion space in the fuel tank and could lead to fuel overflowing.

WARNING: Do not overfill the fuel tank. The pressure in an overfilled tank may cause leakage and lead to fuel spray and fire.

WARNING: Wait at least five seconds before removing the fuel pump nozzle to allow any residual fuel to drain into the fuel tank.

1. Fully open the fuel filler door.
2. Select the correct fuel pump nozzle for your vehicle.

Fuel and Refueling

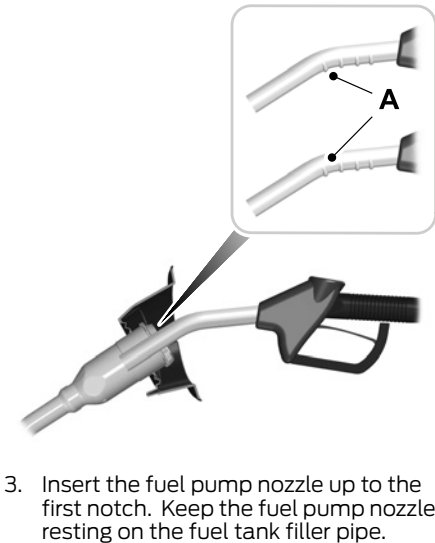

4. Hold the fuel pump nozzle in position A when refueling. Holding the fuel pump nozzle in position B can affect the flow of fuel and shut off the fuel pump nozzle before the fuel tank is full.

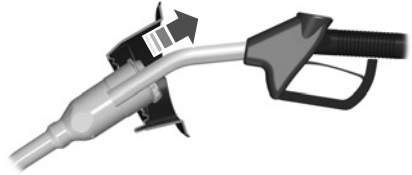

5. When the pump shuts off, wait five seconds, then raise the fuel pump nozzle and slowly remove it.
6. Fully close the fuel filler door.

Note: Do not attempt to start the engine if you have filled the fuel tank with incorrect fuel. Incorrect fuel use could cause damage not covered by the vehicle Warranty. Have your vehicle immediately checked.

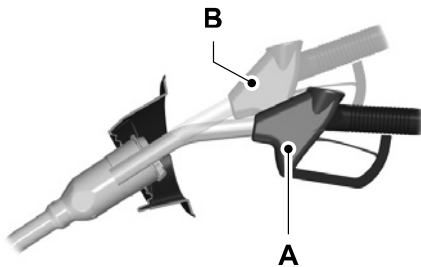

FUEL TANK CAPACITY

Capacities

Variant	Quantity
All	16 gal (60.5 L)

Fuel and Refueling

Advertised Capacity

The advertised capacity is the maximum amount of fuel that you can add to the fuel tank when the fuel gauge indicates empty.

In addition, the fuel tank contains an empty reserve. The empty reserve is an unspecified amount of fuel that remains in the fuel tank when the fuel gauge indicates empty.

Note: *When refueling your vehicle after the fuel gauge indicates empty, you might not be able to refuel the full amount of the advertised capacity due to the empty reserve still present in the fuel tank.*

FUEL AND REFUELING – TROUBLESHOOTING

FUEL AND REFUELING – WARNING LAMPS



If it illuminates when you are driving, refuel as soon as possible.

FUEL AND REFUELING – INFORMATION MESSAGES

Refueling System Warning

If the fuel tank filler valve does not fully close, a message could appear in the instrument cluster display.

Message
Check Fuel Fill Inlet

If the message appears, do the following:

1. Stop your vehicle as soon as it is safe to do so and switch the engine off.
2. Shift into park (P) or neutral (N).
3. Apply the parking brake.

4. Fully open the fuel filler door.
5. Check the fuel tank filler valve for any debris that may be restricting its movement.
6. Remove any debris from the fuel tank filler valve.
7. Fully insert a fuel pump nozzle or the fuel filler funnel provided with your vehicle into the fuel filler pipe. See **Locating the Fuel Filler Funnel** (page 151). This action should dislodge any debris that may be preventing the fuel tank filler valve from fully closing.
8. Remove the fuel pump nozzle or fuel filler funnel from the fuel filler pipe.
9. Fully close the fuel filler door.

Note: *The message may not immediately reset. If the message continues to appear and a warning lamp illuminates, have your vehicle checked as soon as possible.*

Catalytic Converter

WHAT IS THE CATALYTIC CONVERTER

The catalytic converter is part of your vehicle's emissions system and filters harmful pollutants from the exhaust gas.

CATALYTIC CONVERTER PRECAUTIONS



WARNING: Do not park, idle or drive your vehicle on dry grass or other dry ground cover. The emission system heats up the engine compartment and exhaust system, creating the risk of fire.



WARNING: The normal operating temperature of the exhaust system is very high. Never work around or attempt to repair any part of the exhaust system until it has cooled. Use special care when working around the catalytic converter. The catalytic converter heats up to a very high temperature after only a short period of engine operation and stays hot after the engine is switched off.



WARNING: Exhaust leaks may result in entry of harmful and potentially lethal fumes into the passenger compartment. If you smell exhaust fumes inside your vehicle, have your vehicle inspected immediately. Do not drive if you smell exhaust fumes.

To avoid damaging the catalytic converter:

- Do not crank the engine for more than 10 seconds at a time.
- Do not run the engine with a spark plug lead disconnected.
- Do not push-start or tow-start your vehicle. Use booster cables. See **Jump Starting the Vehicle** (page 269).

- Use the correct fuel. See **Fuel Quality** (page 150).
- Do not switch the ignition off when your vehicle is moving.
- Avoid running out of fuel.
- Have the items listed in scheduled maintenance information performed according to the specified schedule.

Note: Do not make any unauthorized changes to your vehicle or engine. By law, vehicle owners and anyone who manufactures, repairs, or services a fleet of vehicles are not permitted to intentionally remove an emission control device or prevent it from working.

CATALYTIC CONVERTER – TROUBLESHOOTING

CATALYTIC CONVERTER – WARNING LAMPS

Your vehicle has an on-board diagnostics system that monitors the emission control system. If any of the following warning lamps illuminate, this may indicate that the on-board diagnostics system has detected an emission control system malfunction.



Continuing to drive your vehicle may cause reduced power or the engine to stop. Failure to respond to a warning lamp may cause damage that your vehicle Warranty may not cover. Have your vehicle checked as soon as possible.

Manual Transmission (If Equipped)

MANUAL TRANSMISSION PRECAUTIONS



WARNING: Always set the parking brake fully and make sure you shift the gearshift lever to first gear. Switch the ignition off and remove the key whenever you leave your vehicle.

Do not rest your hand on the gearshift lever or use the gearshift lever to hang and support objects. This could cause damage to the transmission not covered by the vehicle warranty.

Do not rest your foot on the clutch pedal or use the clutch pedal to keep your vehicle stationary when waiting on a hill. This could cause damage to the clutch not covered by the vehicle warranty.

Failure to fully press the clutch pedal could cause increased shift efforts, or premature transmission wear to components or damage to the transmission.

If any gear is not fully engaged, fully press the clutch pedal and shift into neutral. Release the clutch pedal for a moment, fully press the clutch pedal again and shift into desired gear.

SHIFTING INTO REVERSE

Do not shift into reverse when your vehicle is moving. This could cause damage to the transmission not covered by the vehicle warranty.

1. Fully press the brake pedal.
2. Fully press the clutch pedal and shift into neutral.

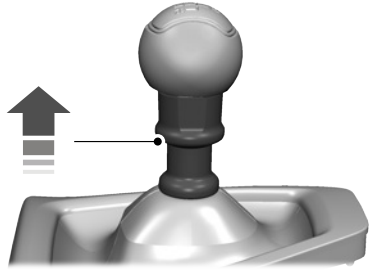

3. Raise the collar and shift into reverse.

CHECKING THE MANUAL TRANSMISSION FLUID LEVEL

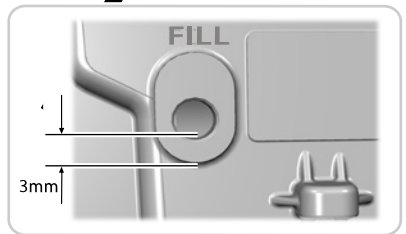
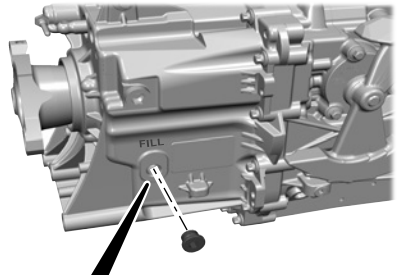

Transmission fluid fill level is 0.12 in (3 mm) from the oil fill plug.

Manual Transmission (If Equipped)

CHECKING THE CLUTCH FLUID LEVEL

The clutch and brake systems share the same fluid reservoir. See **Checking the Brake Fluid** (page 167).

MANUAL TRANSMISSION FLUID CAPACITY AND SPECIFICATION - 6-SPEED MANUAL TRANSMISSION – 3160

Materials

Name	Specification
Motorcraft® MERCON® LV Automatic Transmission Fluid (U.S.) Motorcraft® MERCON® LV Automatic Transmission Fluid / Huile pour boîte automatique MERCON® LV Motorcraft® (Canada) XT-10-QLVC (U.S.) CXT-10-LV6 (Canada)	WSS-M2C938-A

Note: Only use transmission fluid that conforms to the defined specification. Use of other fluids could result in vehicle damage not covered by the vehicle warranty.

MANUAL TRANSMISSION FLUID CAPACITY AND SPECIFICATION - 6-SPEED MANUAL TRANSMISSION – MT82

Materials

Name	Specification
Motorcraft® Dual Clutch Transmission Fluid (U.S.) Motorcraft® Dual Clutch Transmission Fluid / Huile pour boîtes embrayage double Motorcraft® (Canada) XT-11-QDC (U.S. & Canada)	WSS-M2C200-D2

Note: Only use transmission fluid that conforms to the defined specification. Use of other fluids could result in vehicle damage not covered by the vehicle warranty.

CLUTCH FLUID CAPACITY AND SPECIFICATION

Only use fluid that meets Ford specifications.

Manual Transmission (If Equipped)

Materials

Name	Specification
Motorcraft® DOT 4 LV High Performance Motor Vehicle Brake Fluid(U.S.) Motorcraft® DOT 4 LV High Performance Motor Vehicle Brake Fluid / Liquide de frein automobile haute performance DOT 4 LV Motorcraft®(Canada) PM-20(U.S. & Canada)	WSS-M6C65-A2

Automatic Transmission

AUTOMATIC TRANSMISSION POSITIONS

AUTOMATIC TRANSMISSION PRECAUTIONS



WARNING: Apply the parking brake, shift into park (P), switch the vehicle off and remove the key or remote control before you leave your vehicle. Failure to follow this instruction could result in personal injury or death.



WARNING: When your vehicle is stationary, keep the brake pedal fully pressed when shifting gears. Failure to follow this instruction could result in personal injury, death or property damage.



WARNING: Do not apply the brake pedal and accelerator pedal simultaneously. Applying both pedals simultaneously for more than a few seconds limits vehicle performance, which may result in difficulty maintaining speed in traffic and could lead to serious injury.

SHIFTING YOUR VEHICLE INTO GEAR

The transmission selector lever is on the center console.



1. Press and hold the brake pedal.
2. Press and hold the button on the selector lever to move to a selected position.

PARK (P)



WARNING: Shift into park (P) only when your vehicle is stationary.

In park (P) power is not transmitted to the driven wheels.

Note: A tone sounds if you attempt to exit your vehicle without the vehicle in park (P).

Note: Your vehicle may not shift out of park (P) if the 12 V battery has run out of charge.

Note: Your vehicle may not shift out of park (P) if a fuse is blown.

Note: Your vehicle may not shift out of park (P) unless the key or remote control is inside your vehicle.

Note: The electronic parking brake could apply when you power your vehicle on with the selector in park (P).

Note: The electronic parking brake could apply if you shift to park (P) without fully pressing the brake pedal.

Note: The electronic parking brake could apply if you shift to park (P) on a slope.

Automatic Transmission

Note: Do not manually release the parking brake when the selector is in park (P). See **Automatically Releasing the Electric Parking Brake** (page 175).

REVERSE (R)



In reverse (R) power is transmitted to the driven wheels.

NEUTRAL (N)

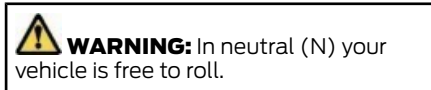

In neutral (N) power is not transmitted to the driven wheels.

DRIVE (D)

In drive (D) power is transmitted to the driven wheels.

LOW (L) - VEHICLES WITHOUT: PADDLE SHIFTERS

In low (L) your vehicle holds low gears.

Note: We recommend using this mode for driving on hilly or mountainous roads or when towing a trailer. See **Towing a Trailer** (page 260).

MANUAL (M) - VEHICLES WITH: PADDLE SHIFTERS

In manual (M) you can select a specific gear. See **Manually Shifting Gears** (page 162).

Note: We recommend using this mode for driving on hilly or mountainous roads or when towing a trailer. See **Towing a Trailer** (page 260).

AUTOMATIC TRANSMISSION POSITION INDICATORS - VEHICLES WITHOUT: PADDLE SHIFTERS

The instrument cluster displays the current position.



Note: The position could illuminate on the transmission selector.

AUTOMATIC TRANSMISSION POSITION INDICATORS - VEHICLES WITH: PADDLE SHIFTERS

The instrument cluster displays the current position.



Note: The position could illuminate on the transmission selector.

Automatic Transmission

MANUALLY SHIFTING GEARS

Shifting Using the Paddle Shifters

(If Equipped)

The instrument cluster displays the current gear. The current gear flashes when your vehicle cannot shift into the requested gear. Your vehicle does not shift if the requested gear raises or lowers the engine speed beyond the limit.

Your vehicle could shift when you fully press the accelerator or brake pedal.

Note: Prolonged driving with high engine speed could cause vehicle damage not covered by the vehicle warranty.

Note: Drive modes could affect when the vehicle shifts into the requested gear.



Manually Shifting Gears in Drive (D)

Use this feature to temporarily change gears.

Note: We recommend using this feature for engine braking or driving on hilly or mountainous roads.

- Pull either paddle to switch the feature on.
- Pull the right (+) paddle to upshift.
- Pull the left (-) paddle to downshift.
- Hold the right (+) paddle for a few seconds to switch the feature off.

Note: The feature switches off after a short period of time if neither paddle is pulled.

Manually Shifting Gears in Manual (M)

Use this feature to select a specific gear.

Note: We recommend using this feature for engine braking, driving on hilly or mountainous roads, or when towing a trailer. See **Towing a Trailer** (page 260).

- Shift to manual (M) or with the selector in drive (D) press the manual (M) button to switch the feature on.
- Pull the right (+) paddle to upshift.
- Pull the left (-) paddle to downshift.
- Shift to drive (D) or press the manual (M) button again to switch the feature off.

SHIFTING YOUR IMMOBILE VEHICLE OUT OF PARK (P)



WARNING: When doing this procedure, you need to take your vehicle out of park (P) which means your vehicle can roll freely. To avoid unwanted vehicle movement, apply the parking brake prior to doing this procedure. Use wheel chocks if appropriate.



WARNING: If the parking brake is fully released, but the brake warning lamp remains illuminated, the brakes may not be working properly. Have your vehicle checked as soon as possible.



WARNING: Do not drive your vehicle until you verify that the stoplamps are working.

Use this procedure to shift your vehicle out of park (P) in the event of an electrical malfunction or emergency.

Shifting Your Vehicle Out of Park

1. Apply the parking brake.

Automatic Transmission

Note: If the 12V battery has run out of charge, use an external power source to apply the parking brake.

2. Remove the selector cover using a plastic wedge or pry tool.

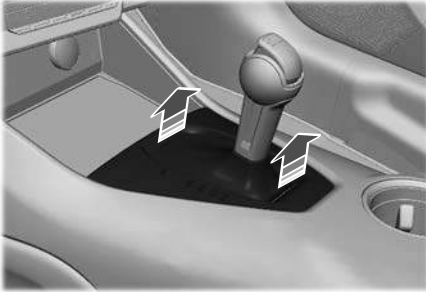

3. Sit in the driver seat.
4. Press and hold the brake pedal.
5. Locate the selector override lever.
6. Using the screwdriver push the lever towards the front of your vehicle and hold.

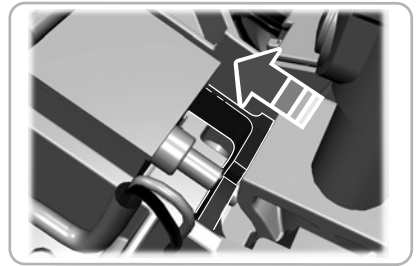
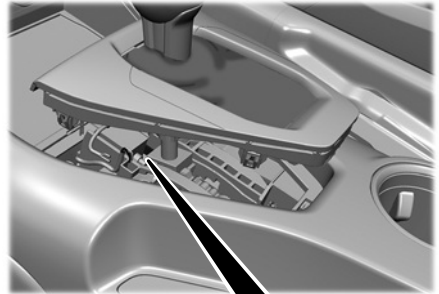

7. Shift into neutral (N).
8. Release the selector override lever.
9. Install the selector cover.
10. Release the parking brake.
11. Release the brake pedal.

Note: Your vehicle is free to roll.

Returning Your Vehicle to Normal Mode

1. Press the brake pedal.
2. Shift into park (P).

Automatic Transmission

AUTOMATIC TRANSMISSION AUDIBLE WARNINGS

Transmission Not in Park (P) Audible Warning

Sounds if any of the following occur:

- You switch your vehicle off before shifting into park (P).
- You open the driver door before shifting into park (P).

AUTOMATIC TRANSMISSION FLUID CAPACITY AND SPECIFICATION - VEHICLES WITHOUT: GT PERFORMANCE PACKAGE

Note: Only use transmission fluid that conforms to the defined specification. Use of other fluids could result in vehicle damage not covered by the vehicle warranty.

Variant	Quantity
All	13.10 qt (12.4 L)

Materials

Name	Specification
Motorcraft® MERCON® ULV Automatic Transmission Fluid(U.S.) Motorcraft® MERCON® ULV Automatic Transmission Fluid / MERCON® ULV huile pour boîtes automatique Motorcraft®(Canada) XT-12-QULV(U.S. & Canada)	WSS-M2C949-A,

AUTOMATIC TRANSMISSION FLUID CAPACITY AND SPECIFICATION - VEHICLES WITH: GT PERFORMANCE PACKAGE

Note: Only use transmission fluid that conforms to the defined specification. Use of other fluids could result in vehicle damage not covered by the vehicle warranty.

Automatic Transmission

Variant	Quantity
All	14.05 qt (13.3 L)

Materials

Name	Specification
Motorcraft® MERCON® ULV Automatic Transmission Fluid(U.S.) Motorcraft® MERCON® ULV Automatic Transmission Fluid / MERCON® ULV huile pour boîtes automatique Motorcraft®(Canada) XT-12-QULV(U.S. & Canada)	WSS-M2C949-A,

Rear Axle

LIMITED SLIP DIFFERENTIAL

Traction-Lok™ and TORSEN™ Axles

These axles provide improved traction on slippery and loose surfaces, particularly when one wheel is on a poor traction surface. Under normal conditions, these axles function like a standard rear axle.

Extended use of tire sizes other than the manufacturer's specified tire size on these axles could result in a permanent reduction in effectiveness. This loss does not affect your normal driving and should not be noticeable.

Capacities

Variant	Quantity
All.	1.6 qt (1.5 L) ¹

¹ For complete refill of our limited slip axles, add 3.28 fl oz (97 ml) of Additive Friction Modifier XL-3 or equivalent meeting specification EST-M2C118-A. Include this friction modifier in the total fluid capacity. Our rear axles contain a synthetic lubricant that does not require changing unless you submerge the axle in water.

Materials

Name	Specification
Motorcraft® SAE 75W-85 Premium Synthetic Hypoid Gear Lubricant(U.S.) Motorcraft® SAE 75W-85 Premium Synthetic Hypoid Gear Lubricant / Huile synthétique de haute qualité pour engrenages hypoides SAE 75W-85 Motorcraft®(Canada) XY-75W85-QL(U.S. & Canada)	WSS-M2C942-A
Motorcraft® Additive Friction Modifier(U.S.) Motorcraft® Additive Friction Modifier / Additif modificateur de friction Motorcraft®(Canada) XL-3(U.S. & Canada)	EST-M2C118-A

Brakes

BRAKE PRECAUTIONS

Wet brakes result in reduced braking efficiency. Gently press the brake pedal a few times when leaving a car wash or driving from standing water to dry the brakes.

Note: *Depending on applicable laws and regulations in the country for which your vehicle was originally built, your brake lamps may flash during heavy braking. Following this, your hazard lights may also flash when your vehicle comes to a stop.*

ANTI-LOCK BRAKING SYSTEM

ANTI-LOCK BRAKING SYSTEM LIMITATIONS

The anti-lock braking system does not eliminate the risk of crash when:

- You drive too closely to the vehicle in front of you.
- Your vehicle is hydroplaning.
- You take corners too fast.
- The road surface is poor.

Note: *If the system activates, the brake pedal could pulse and travel further. Maintain pressure on the brake pedal.*

ANTI-LOCK BRAKING SYSTEM INDICATORS

This system helps you maintain steering control during emergency stops by keeping the brakes from locking.



If the warning lamp illuminates when you are driving, this indicates a malfunction. Your vehicle continues to have normal braking without the anti-lock brake system function. Have your vehicle checked as soon as possible.

The warning lamp also momentarily illuminates when you switch the ignition on to confirm the lamp is functional. If it does not illuminate when you switch the ignition on, or begins to flash at any time, have the system checked by an authorized dealer.

BRAKE OVER ACCELERATOR

In the event the accelerator pedal becomes stuck or entrapped, apply steady and firm pressure to the brake pedal to slow the vehicle and reduce engine power. If you experience this condition, apply the brakes and bring your vehicle to a safe stop. Move the transmission to park (P), switch the engine off and apply the parking brake. Inspect the accelerator pedal for any interference. If none are found and the condition persists, have your vehicle towed to the nearest authorized dealer.

Note: *Brake over accelerator will not function in Drag and Track modes.*

LOCATING THE BRAKE FLUID RESERVOIR

See **Under Hood Overview** (page 288).

CHECKING THE BRAKE FLUID



WARNING: Do not use any fluid other than the recommended brake fluid as this will reduce brake efficiency. Use of incorrect fluid could result in the loss of vehicle control, serious personal injury or death.

Brakes



WARNING: Only use brake fluid from a sealed container. Contamination with dirt, water, petroleum products or other materials may result in brake system damage or failure. Failure to adhere to this warning could result in the loss of vehicle control, serious personal injury or death.



WARNING: Do not allow the fluid to touch your skin or eyes. If this happens, rinse the affected areas immediately with plenty of water and contact your physician.



WARNING: The brake system could be affected if the brake fluid level is below the **MIN** mark or above the **MAX** mark on the brake fluid reservoir.

1. Park your vehicle on a level surface.



2. Look at the brake fluid reservoir to see where the brake fluid level is relative to the **MIN** and the **MAX** marks on the reservoir.

Note: To avoid fluid contamination, the reservoir cap must remain in place and fully tight, unless you are adding fluid.

Only use fluid that meets our specifications. See **Brake Fluid Specification** (page 168).

BRAKE FLUID SPECIFICATION

Use fluid that meets the defined specification and viscosity grade.

If you do not use fluid that meets the defined specification and viscosity grade, it could result in:

- Component damage that your vehicle warranty does not cover.
- Reduced brake performance.

Note: We recommend you to use Dot 4 Low Viscosity (LV) High Performance Brake Fluid meeting WSS-M6C65-A2 specifications or ISO 4925 Class 6 standards. If you use any fluid other than the recommended fluid, it could cause reduced brake performance and not meet our performance standards. Keep brake fluid clean and dry. Contamination with dirt, water, petroleum products or other materials could result in brake system damage and possible failure.

Brakes

Capacities

Variant	Quantity
All.	Fill as required.

Materials

Name	Specification
Motorcraft® DOT 4 LV High Performance Motor Vehicle Brake Fluid(U.S.) Motorcraft® DOT 4 LV High Performance Motor Vehicle Brake Fluid / Liquide de frein automobile haute performance DOT 4 LV Motorcraft®(Canada) PM-20(U.S. & Canada)	WSS-M6C65-A2

BRAKES – TROUBLESHOOTING

BRAKES – WARNING LAMPS



WARNING: Driving your vehicle with the warning lamp on is dangerous. A significant decrease in braking performance may occur. It may take you longer to stop your vehicle. Have your vehicle checked as soon as possible. Driving extended distances with the parking brake engaged can cause brake failure and the risk of personal injury.



If the ABS indicator illuminates when you are driving, this indicates a malfunction. Your vehicle continues to have normal braking without the anti-lock braking system function. See an authorized dealer.

It also momentarily illuminates when you switch the ignition on to confirm the lamp is functional. If it does not illuminate when you switch the ignition on, or begins to flash at any time, have the system checked by an authorized dealer.

BRAKE



The brake indicator momentarily illuminates when you switch the ignition on to confirm the lamp is functional. It may also illuminate when you apply the parking brake and the ignition is on. If it illuminates when your vehicle is moving, make sure the parking brake is disengaged. If the parking brake is disengaged, this indicates low brake fluid level or a brake system fault. See an authorized dealer.

Note: Lamps may vary depending on region.

Brakes

BRAKES – INFORMATION MESSAGES

Message	Details
Check Brake System	The system has detected a fault that requires service. Have your vehicle checked as soon as possible.

BRAKES – FREQUENTLY ASKED QUESTIONS

Is it normal for my brakes to make noise?

Occasional brake noise is normal. If a metal-to-metal, continuous grinding, or squeal sound is present, the brake lining could be worn. Have the system checked.

There is an electrical motor sound when I press on the brake pedal or activate the park brake switch. Is this normal?

Yes, those sounds are the electronic brake booster or the electronic park brake operating.

Note: *Brake dust could accumulate on the wheels, even under normal driving conditions. Some dust is normal as the brakes wear and does not contribute to brake noise. See **Cleaning Wheels** (page 321).*

Electric Parking Brake

WHAT IS THE ELECTRIC PARKING BRAKE

The electric parking brake is used to hold your vehicle on slopes and flat roads.

APPLYING THE ELECTRIC PARKING BRAKE - MANUAL TRANSMISSION, VEHICLES WITHOUT: ECOBOOST™ PERFORMANCE PACKAGE/GT PERFORMANCE PACKAGE



WARNING: Apply the parking brake, shift into first gear, switch the ignition off and remove the keys or remote control before you leave your vehicle. Failure to follow this instruction could result in personal injury or death.



WARNING: If you drive extended distances with the parking brake applied, you could cause damage to the brake system.



WARNING: The electric parking brake does not operate if the vehicle battery has run out of charge.



WARNING: If the parking brake is fully released, but the brake warning lamp remains illuminated, the brakes may not be working properly. Have your vehicle checked as soon as possible.



The switch is on the center console.

1. Pull the switch up.

The red warning lamp flashes during operation and illuminates when the parking brake is applied.

Note: You can apply the electric parking brake when the ignition is off.

Note: If you park your vehicle on a hill and facing uphill, select first gear and turn the steering wheel away from the curb.

Note: If you park your vehicle on a hill and facing downhill, select reverse gear and turn the steering wheel toward the curb.

APPLYING THE ELECTRIC PARKING BRAKE - MANUAL TRANSMISSION, VEHICLES WITH: ECOBOOST™ PERFORMANCE PACKAGE/GT PERFORMANCE PACKAGE



WARNING: Apply the parking brake, shift into first gear, switch the ignition off and remove the keys or remote control before you leave your vehicle. Failure to follow this instruction could result in personal injury or death.



WARNING: If you drive extended distances with the parking brake applied, you could cause damage to the brake system.



WARNING: The electric parking brake does not operate if the vehicle battery has run out of charge.



WARNING: If the parking brake is fully released, but the brake warning lamp remains illuminated, the brakes may not be working properly. Have your vehicle checked as soon as possible.



The electric parking brake handle is on the center console.

1. Pull the handle up.

Electric Parking Brake

The red warning lamp flashes during operation and illuminates when the parking brake is applied.

Note: You can apply the electric parking brake when the ignition is off.

Note: If you park your vehicle on a hill and facing uphill, select first gear and turn the steering wheel away from the curb.

Note: If you park your vehicle on a hill and facing downhill, select reverse gear and turn the steering wheel toward the curb.

APPLYING THE ELECTRIC PARKING BRAKE - AUTOMATIC TRANSMISSION, VEHICLES WITH: ECOBOOST™ PERFORMANCE PACKAGE/GT PERFORMANCE PACKAGE



WARNING: Apply the parking brake and make sure your vehicle is in park (P). Power the vehicle off and remove the keys or remote control whenever you leave your vehicle. Failure to follow this instruction could result in personal injury or death.



WARNING: If you drive extended distances with the parking brake applied, you could cause damage to the brake system.



WARNING: The electric parking brake does not operate if the vehicle battery has run out of charge.



WARNING: If the parking brake is fully released, but the brake warning lamp remains illuminated, the brakes may not be working properly. Have your vehicle checked as soon as possible.



The electric parking brake handle is on the center console.

1. Pull the handle up.

The red warning lamp flashes during operation and illuminates when the parking brake is applied.

Note: You can apply the electric parking brake when the power is off.

Note: The electric parking brake could apply when you shift into park (P). See **Park (P)** (page 160).

APPLYING THE ELECTRIC PARKING BRAKE - AUTOMATIC TRANSMISSION, VEHICLES WITHOUT: ECOBOOST™ PERFORMANCE PACKAGE/GT PERFORMANCE PACKAGE



WARNING: Apply the parking brake, shift into park (P), switch the ignition off and remove the key before you leave your vehicle. Failure to follow this instruction could result in personal injury or death.



WARNING: If you drive extended distances with the parking brake applied, you could cause damage to the brake system.



WARNING: The electric parking brake does not operate if the vehicle battery has run out of charge.



The electric parking brake switch is on the center console.

1. Pull the switch up.

Electric Parking Brake

The red warning lamp flashes during operation and illuminates when the parking brake is applied.

Note: You can apply the electric parking brake when the ignition is off.

Note: The electric parking brake could apply when park (P) is selected. See **Park (P)** (page 160).

APPLYING THE ELECTRIC PARKING BRAKE IN AN EMERGENCY - VEHICLES WITHOUT: ECOBOOST™ PERFORMANCE PACKAGE/GT PERFORMANCE PACKAGE

You can use the electric parking brake to slow or stop your vehicle in an emergency.

Pull the switch up and hold it.

The red warning lamp illuminates, a tone sounds and the stoplamps turn on when you use the electric parking brake in an emergency.

The electric parking brake continues to slow your vehicle down unless you release the switch.

Note: Do not apply the electric parking brake when your vehicle is moving, except in an emergency. If you repeatedly use the electric parking brake to slow or stop your vehicle, you could cause damage to the brake system.

APPLYING THE ELECTRIC PARKING BRAKE IN AN EMERGENCY - VEHICLES WITH: ECOBOOST™ PERFORMANCE PACKAGE/GT PERFORMANCE PACKAGE

You can use the electric parking brake to slow or stop your vehicle in an emergency.

Pull the electric parking brake handle up and hold it.

The red warning lamp illuminates, a tone sounds and the stoplamps turn on when you use the electric parking brake in an emergency.

The electric parking brake continues to slow your vehicle down unless you release the handle.

Note: Do not apply the electric parking brake when your vehicle is moving, except in an emergency. If you repeatedly use the electric parking brake to slow or stop your vehicle, you could cause damage to the brake system.

MANUALLY RELEASING THE ELECTRIC PARKING BRAKE - VEHICLES WITHOUT: ECOBOOST™ PERFORMANCE PACKAGE/GT PERFORMANCE PACKAGE

1. Switch the ignition on.
2. Press and hold the brake pedal.
3. Push the switch down.

The red warning lamp turns off.

Pulling Away When Towing a Trailer Uphill

1. Press and hold the brake pedal.

Electric Parking Brake

2. Pull the switch upward and hold it.
 3. Shift into gear.
 4. Press the accelerator pedal until engine has developed sufficient torque to prevent your vehicle from rolling down the hill.
 5. Release the switch and pull away in a normal manner.
3. Press the accelerator pedal and pull away in a normal manner.

MANUALLY RELEASING THE ELECTRIC PARKING BRAKE - VEHICLES WITH: ECOBOOST™ PERFORMANCE PACKAGE/GT PERFORMANCE PACKAGE

1. Switch the ignition on.
2. Press and hold the brake pedal.
3. Push the electric parking brake handle down.

The red warning lamp turns off.

Pulling Away on a Hill When Towing a Trailer

1. Press and hold the brake pedal.
2. Pull the electric parking brake handle upward and hold it.
3. Shift into gear.
4. Press the accelerator pedal until engine has developed sufficient torque to prevent your vehicle from rolling down the hill.
5. Release the handle and pull away in a normal manner.

AUTOMATICALLY RELEASING THE ELECTRIC PARKING BRAKE

1. Close the driver door.
2. Shift into gear.

ELECTRIC PARKING BRAKE AUDIBLE WARNING

Sounds when the parking brake is on and your vehicle is moving. If the warning tone continues after you have released the parking brake, this indicates a malfunction. Have your vehicle checked as soon as possible.

RELEASING THE ELECTRIC PARKING BRAKE IF THE VEHICLE BATTERY HAS RUN OUT OF CHARGE



WARNING: The electric parking brake does not operate if the vehicle battery has run out of charge.

Connect a booster battery to the vehicle battery to release the electric parking brake if the vehicle battery has run out of charge. See **Jump Starting the Vehicle** (page 269).

Electric Parking Brake

ELECTRIC PARKING BRAKE – TROUBLESHOOTING

ELECTRIC PARKING BRAKE – WARNING LAMPS

Brake System



It illuminates red when you apply the parking brake and your vehicle is on. If the lamp flashes when the parking brake has been released, this indicates the parking brake system requires



service. Have your vehicle checked as soon as possible.

Note: Lamps may vary depending on region.

Electric Parking Brake



When the lamp illuminates yellow, it indicates a malfunction in the electric parking brake.

Have your vehicle checked as soon as possible.

Note: Lamps may vary depending on region.

ELECTRIC PARKING BRAKE – INFORMATION MESSAGES - VEHICLES WITHOUT: ECOBOOST™ PERFORMANCE PACKAGE/GT PERFORMANCE PACKAGE

Message	Details
Park Brake Malfunction Service Now	The electric parking brake has malfunctioned. Have your vehicle checked as soon as possible.
Park Brake Not Released	The electric parking brake has not released. Manually release the electric parking brake. If the message continues to appear, have your vehicle checked as soon as possible.
Park Brake Not Applied	The electric parking brake has not applied. Apply the electric parking brake. If the message continues to appear, have your vehicle checked as soon as possible.
Park Brake Use Switch to Release	The electric parking brake has not automatically released. Manually release the electric parking brake.
To Release: Press Brake and Switch	You have not pressed the brake pedal. Press the brake pedal to release the parking brake.
Park Brake Limited Function Service Required	The electric parking brake has malfunctioned. Have your vehicle checked as soon as possible.
Park Brake Maintenance Mode	The electric parking brake system has been put into a special mode that is used to allow service of the brakes. Have your vehicle checked as soon as possible.
Park Brake System Overheated	The electric parking brake has overheated. Wait for the electric parking brake to cool down.

Electric Parking Brake

Message	Details
Park Brake Released	The electric parking brake is released.
Release Park Brake	The electric parking brake has not released. Manually release the electric parking brake. If the message continues to appear, have your vehicle checked as soon as possible.
Park Brake Applied	The electric parking brake is applied.

Electric Parking Brake

ELECTRIC PARKING BRAKE – INFORMATION MESSAGES - VEHICLES WITH: ECOBOOST™ PERFORMANCE PACKAGE/GT PERFORMANCE PACKAGE

Message	Action
Park Brake Malfunction Service Now	The electric parking brake has malfunctioned. Have your vehicle checked as soon as possible.
Park Brake Not Released	The electric parking brake has not released. Manually release the electric parking brake. If the message continues to appear, have your vehicle checked as soon as possible.
Park Brake Not Applied	The electric parking brake has not applied. Apply the electric parking brake. If the message continues to appear, have your vehicle checked as soon as possible.
Park brake handle fault Drive to release park brake	The electric parking brake handle has malfunctioned. Drive to release the electric parking brake.
Press brake pedal Push handle down to release park brake	You have not pressed the brake pedal. Press the brake pedal and push the handle down to release the parking brake.
Park Brake Limited Function Service Required	The electric parking brake has malfunctioned. Have your vehicle checked as soon as possible.
Brake maintenance mode	The electric parking brake system has been put into a special mode that is used to allow service of the brakes. Have your vehicle checked as soon as possible.
Park Brake System Overheated	The electric parking brake has overheated. Wait for the electric parking brake to cool down.
Park Brake Off	The electric parking brake is released.
Release Park Brake	The electric parking brake has not released. Manually release the electric parking brake. If the message continues to appear, have your vehicle checked as soon as possible.
Park Brake On	The electric parking brake is applied.
Drift brake not available Service required	The drift brake has malfunctioned. Have your vehicle checked as soon as possible.

Hill Start Assist

WHAT IS HILL START ASSIST

Hill Start Assist applies the brakes to hold your vehicle after you bring it to a stop on a slope. This makes it easier for you to pull away without using the parking brake.

HOW DOES HILL START ASSIST WORK

When the system activates, your vehicle remains stationary for a few seconds after you release the brake pedal. This gives you time to move your foot from the brake pedal to the accelerator pedal. The brakes release when you apply the accelerator pedal and the vehicle begins to move forward, or the system exceeds the time allowed for automatically applying the brakes.

The system activates when your vehicle is in any forward gear and facing uphill, or when your vehicle is in reverse (R) and facing downhill.

HILL START ASSIST PRECAUTIONS



WARNING: The system does not replace the parking brake. When you leave your vehicle, always apply the parking brake.



WARNING: You must remain in your vehicle when the system turns on. At all times you are responsible for controlling your vehicle, supervising the system, and intervening if required. Failure to follow this instruction could result in the loss of control of your vehicle, personal injury or death.



WARNING: The system turns off if there is a malfunction.

SWITCHING HILL START ASSIST ON AND OFF - MANUAL TRANSMISSION

You can switch hill start assist on and off on the touchscreen:

1. From the driver assistance menu, press Hill Start Assist. See **Driver Assistance Menu** (page 391).
2. Switch the feature on or off.

Note: *The system remembers the last setting when you start your vehicle.*

SWITCHING HILL START ASSIST ON AND OFF - AUTOMATIC TRANSMISSION

Hill start assist is active when you switch the ignition on. You cannot switch the system on or off.

HILL START ASSIST – TROUBLESHOOTING

HILL START ASSIST – INFORMATION MESSAGES

Message	Details
Hill Start Assist Not Available	Displays when system is not available. Have your vehicle checked as soon as possible.

Auto Hold (If Equipped)

HOW DOES AUTO HOLD WORK

Auto hold applies the brakes to hold your vehicle after you bring the vehicle to a stop. This can help when waiting on a hill or in traffic.

SWITCHING AUTO HOLD ON AND OFF



WARNING: The system does not replace the parking brake. When you leave your vehicle, always apply the parking brake.



WARNING: You must remain in your vehicle when the system turns on. At all times you are responsible for controlling your vehicle, supervising the system, and intervening if required. Failure to follow this instruction could result in the loss of control of your vehicle, personal injury or death.

You can switch the system on or off by accessing the menu on the touchscreen.

1. Press Features on the touchscreen.
2. Press Driver Assistance.

Note: You can only switch the system on after you close the driver door and fasten your seatbelt.

Note: The system remembers the last setting when you start your vehicle.

Note: When using an automatic car wash, make sure to switch auto hold off, or shift into neutral (N) with the brake pedal applied to make sure auto hold is not active.

USING AUTO HOLD

1. Bring your vehicle to a complete stop. The auto hold active indicator illuminates in the information display.
2. Release the brake pedal. The system holds your vehicle at a standstill. The auto hold active indicator remains illuminated in the information display.
3. Apply the accelerator and drive off in a normal manner. The system releases the brakes and the auto hold active indicator switches off.

Note: The system only activates if you apply enough brake pressure on the brake pedal to bring the vehicle to a standstill.

Note: Under certain conditions, the system could apply the electric parking brake. The brake system warning lamp illuminates. The electric parking brake releases when you press the accelerator pedal. See **Automatically Releasing the Electric Parking Brake** (page 175).

Note: The system switches off if you shift into reverse (R) or neutral (N) while pressing the brake pedal.

There could be actions that can cause the auto hold system not to work when the following occur:

- Your vehicle is in stay in temporary neutral mode.
- The driver door is open or the driver seatbelt is unbuckled.
- You shift into reverse (R) or neutral (N) before the system is active.

AUTO HOLD INDICATORS



Illuminates when the system is active.

Auto Hold (If Equipped)



Illuminates when the system is on but cannot hold your vehicle at a standstill at this particular time.

Traction Control

WHAT IS TRACTION CONTROL

The traction control system helps to avoid drive wheel spin and loss of traction.

HOW DOES TRACTION CONTROL WORK

If your vehicle begins to slide, the system applies the brakes to individual wheels and, when needed, reduces power at the same time. If the wheels spin when accelerating on slippery or loose surfaces, the system reduces power in order to increase traction.

SWITCHING TRACTION CONTROL ON AND OFF



WARNING: Operating your vehicle with the traction control disabled could lead to an increased risk of loss of vehicle control, vehicle rollover, personal injury and death.



The traction control system turns on each time you switch the ignition on.

The button for the stability and traction control system is on the instrument panel.

Press and release the button to switch traction control off. The stability control system remains fully active, to switch it off, press and hold the button for a few seconds, then release.

When you switch traction control off, a message and an illuminated icon appear on the instrument cluster.

Press the switch again to turn the traction control system back on to normal operation.

If your vehicle is stuck in mud or snow, switching traction control off may be beneficial as this allows the wheels to spin.

TRACTION CONTROL INDICATOR

System Indicator Lights



The traction control off indicator illuminates when you switch the traction control system off.

TRACTION CONTROL – TROUBLESHOOTING

TRACTION CONTROL – WARNING LAMPS

System Messages



The traction control light temporarily illuminates on start-up and flashes when activated by a driving condition. The light stays on if a problem occurs in the system.



The traction control off light temporarily illuminates on start-up and stays on:

- When you switch the traction control system off.
- When you select an alternative stability control mode.

Stability Control

HOW DOES STABILITY CONTROL WORK



WARNING: Vehicle modifications involving braking system, aftermarket roof racks, suspension, steering system, tire construction and wheel and tire size may change the handling characteristics of your vehicle and may adversely affect the performance of the electronic stability control system. In addition, installing any stereo speakers may interfere with and adversely affect the electronic stability control system. Reducing the effectiveness of the electronic stability control system could lead to an increased risk of loss of vehicle control, vehicle rollover, personal injury and death.



WARNING: Remember that even advanced technology cannot defy the laws of physics. It's always possible to lose control of a vehicle due to inappropriate driver input for the conditions. Aggressive driving on any road condition can cause you to lose control of your vehicle increasing the risk of personal injury or property damage. Activation of the electronic stability control system is an indication that at least some of the tires have exceeded their ability to grip the road; this could reduce the operator's ability to control the vehicle potentially resulting in a loss of vehicle control, vehicle rollover, personal injury and death.



WARNING: You are responsible for controlling your vehicle at all times. The system is designed to be an aid and does not relieve you of your responsibility to drive with due care and attention. Failure to follow this instruction could result in the loss of control of your vehicle, personal injury or death.

If a driving condition activates either the stability control or the traction control system you may experience the following conditions:

- The stability and traction control light flashes.
- Your vehicle slows down.
- Reduced power.

The stability control system has several features built into it to help you maintain control of your vehicle:

Electronic Stability Control

Electronic stability control enhances your vehicle's ability to prevent skids or lateral slides by applying brakes to one or more of the wheels individually and, if necessary, reducing power.

Curve Control

Curve control enhances your vehicle's ability to follow the road when cornering severely or avoiding objects in the roadway. Curve control operates by reducing power and, if necessary, applying brakes to one or more of the wheels individually.

Traction Control

Traction control enhances your vehicle's ability to maintain traction of the wheels by detecting and controlling wheel spin. See **What Is Traction Control** (page 182).

Stability Control

SWITCHING STABILITY CONTROL ON AND OFF



The system turns on each time you switch the power on.

Press and hold the stability and traction control button for a few seconds and then release to switch the system off.

Shifting into reverse (R) will disable the system.

You can switch the traction control system off or on independently. See **Switching Traction Control On and Off** (page 182).

STABILITY CONTROL INDICATOR



If it does not illuminate when you switch the power on, or remains on, this indicates a malfunction.

Have your vehicle checked by an authorized dealer as soon as possible.

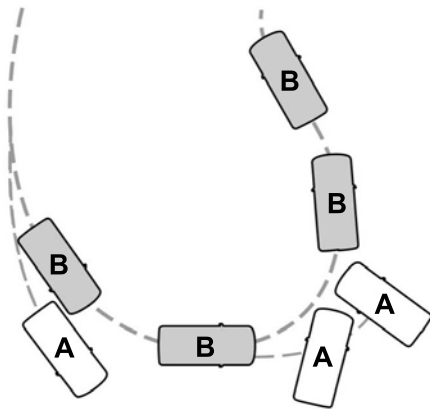

- A Vehicle without stability control skidding off its intended route.
- B Vehicle with stability control maintaining control on a slippery surface.

STABILITY CONTROL – TROUBLESHOOTING

STABILITY CONTROL – INFORMATION MESSAGES

Message	Action
Service AdvanceTrac	Displays when the system detects a condition that requires service. Have the system serviced as soon as possible.
AdvanceTrac Off	The status of the system when you disable it.
AdvanceTrac On	The status of the system when you enable it.
AdvanceTrac SPORT MODE	The system is in sport mode.

Steering

ELECTRIC POWER STEERING

HOW DOES ELECTRIC POWER STEERING WORK

The electric power steering system uses an electric motor to provide assistance when turning the steering wheel to steer your vehicle. If your vehicle detects a steering concern when you are driving, a warning message appears and the system reduces steering assistance. If your vehicle loses electrical power, the steering system still operates and you can manually steer your vehicle. Manually steering your vehicle requires more effort.

Note: *When the battery is disconnected or a new battery is installed, you must drive your vehicle a short distance before the system relearns the strategy and reactivates all systems.*

Steering Tips

If the steering wanders or pulls, check for:

- An improperly inflated tire.
- Uneven tire wear.
- Loose or worn suspension components.
- Improper vehicle alignment.

Note: *A high crown in the road or high crosswinds could also make the steering wander or pull.*

ELECTRIC POWER STEERING PRECAUTIONS



WARNING: The electric power steering system has diagnostic checks that continuously monitor the system. If a fault is detected, a message displays in the information display. Stop your vehicle as soon as it is safe to do so.

Switch the vehicle off. After at least 10 seconds, switch the vehicle on and watch the information display for a steering system warning message. If a steering system warning message returns, have the system checked as soon as possible.



WARNING: If the system detects an error, you may not feel a difference in the steering, however a serious condition may exist. Have your vehicle checked as soon as possible. Failure to do so may result in loss of steering control.

Adapt your speed and driving behavior according to reduced steering assist.

Extreme continuous steering may increase the effort to steer. This occurs to prevent internal overheating and damage to the steering system. If this occurs, you will not lose the ability to steer your vehicle manually nor will it cause damage to the system. Normal steering and driving allows the system to cool down and steering assist returns to normal.

Note: *There is no fluid reservoir to check or fill.*

When your vehicle is still moving, a significant decrease in steering assistance or a loss of steering assistance could occur if:

- You switch your vehicle off.
- Your vehicle loses electrical power.
- Your vehicle detects a concern.

When your vehicle is off and your vehicle begins moving, there is no steering assistance.

Steering

STEERING – TROUBLESHOOTING

STEERING – INFORMATION MESSAGES

Message	Action
Steering Fault Service Now	The power steering system has detected a condition that requires service. Have your vehicle checked as soon as possible.
Steering Loss Stop Safely	The power steering system is not working. Stop your vehicle in a safe place. Have your vehicle checked as soon as possible.
Steering Assist Fault Service Required	The power steering system has detected a condition that requires service. Have your vehicle checked as soon as possible.
Steering Lock Malfunction Service Now	The steering system has detected a condition that could prevent you from starting your vehicle. Have your vehicle checked as soon as possible.

Parking Aids

PARKING AID PRECAUTIONS



WARNING: To help avoid personal injury, always use caution when in reverse (R) and when using the sensing system.



WARNING: The system may not detect objects with surfaces that absorb reflection. Always drive with due care and attention. Failure to take care may result in a crash.



WARNING: Traffic control systems, fluorescent lamps, inclement weather, air brakes, external motors and fans may affect the correct operation of the sensing system. This may cause reduced performance or false alerts.



WARNING: The system may not detect small or moving objects, particularly those close to the ground.



WARNING: The parking aid system can only assist you to detect objects when your vehicle is moving at parking speeds. To help avoid personal injury you must take care when using the parking aid system.



WARNING: The system may not function if the sensor is blocked.



WARNING: In cold and severe weather conditions the system may not function. Rain, snow and spray can all limit sensor performance.



WARNING: If damage occurs in the immediate area surrounding the sensor, have your vehicle checked as soon as possible.

Note: If your vehicle sustains damage leaving the sensors misaligned, this will cause inaccurate measurements or false alerts.

When you connect a trailer to your vehicle, the rear parking aid detects the trailer and provides an alert. Disable the parking aid when you connect a trailer to prevent the alert.

Note: Connected trailers might be detected by the vehicle and parking aid turns off automatically in those instances.

Note: Certain add-on devices installed around the bumper or fascia may create false alerts. For example, large trailer hitches, bike or surfboard racks, license plate brackets, bumper covers or any other device could block the normal detection zone of the parking aid system. Aftermarket spare tires or spare tire covers mounted to the rear tailgate could cause false alerts from the park aid system. Remove the add-on device to prevent false alerts.

Note: Keep the sensors free from snow, ice and large accumulations of dirt. If the sensors are covered, the system's accuracy can be affected.

Do not clean the sensors with sharp objects.

SWITCHING PARKING AID ON AND OFF

You can only switch the audible tone on and off. The parking aid system remains on at all times.

Muting the Audible Tone



Shift into reverse (R) and press the button on the rear view camera display screen to switch the system's audible tone on and off.

Parking Aids

REAR PARKING AID

WHAT IS THE REAR PARKING AID

Rear parking sensors detect objects behind your vehicle when in reverse (R).

REAR PARKING AID LIMITATIONS

There is a decreased coverage area at the outer corners.

The rear parking aid sensors are active when your vehicle is in reverse (R) and the vehicle speed is less than 5 mph (8 km/h).

The sensor coverage area is up to 71 in (180 cm) from the rear bumper.

The rear parking aid detects large objects when you shift into reverse (R) and any of the following occur:

- Your vehicle is moving backward at a low speed.
- Your vehicle is stationary but an object is approaching the rear of your vehicle at a low speed.
- Your vehicle is moving backward at a low speed and an object is moving towards your vehicle, for example another vehicle at a low speed.

The system shall provide no audible warning for the object behind the vehicle when in neutral (N) gear.

LOCATING THE REAR PARKING AID SENSORS



The rear parking aid sensors are in the rear bumper.

REAR PARKING AID AUDIBLE WARNINGS

A warning tone sounds when your vehicle approaches an object. As your vehicle moves closer to an object, the rate of the tone increases. The warning tone continuously sounds when an object is 12 in (30 cm) or less from the rear bumper.

If your vehicle remains stationary for a few seconds, the audible warning turns off. If your vehicle moves backward the tone sounds again.

Note: *When the parking aid system sounds a tone, the audio system may reduce the set volume.*

Parking Aids

PARKING AID INDICATORS

Parking Aid Indicators Shown When 360 Degree Camera Views are not Available



The system provides object distance indication through the touchscreen.

- As the distance to an object decreases, the indicators change color. The indicators for closer objects appear closer to the vehicle icon.
- The indicators are green when the object is at the farthest detection point. As the object gets closer, the indicators turn amber. When the object is at the closest detection point, the indicators turn red.
- If there is no object detected, the distance indicators are not activated.

The activated visual indicators continue displaying when your vehicle is stopped in reverse (R). If stopped in drive (D) or neutral (N), the activated visual indicators disappear after four seconds.

Note: *If stopped in drive (D) or neutral (N) with rear camera delay mode showing the rear camera view, the activated visual indicators continue displaying.*

Parking aids are not available in the following situations:

- The system is switched off.
- A trailer is connected.
- Sensors are blocked.
- A system fault occurs.

Note: *If the parking aids are not available, the distance indicators do not display. See **Parking Aids – Troubleshooting** (page 189).*

Note: *Front park aid indicators are not available.*

PARKING AIDS – TROUBLESHOOTING

PARKING AIDS – INFORMATION MESSAGES

If a fault is present in the parking aids, a warning message appears in the instrument cluster or the touchscreen.

Message	Action
Park Aid Fault	The system detects a condition that requires service. Have your vehicle checked as soon as possible.
Parking Sensors Blocked	Inclement weather, ice, mud, or water is blocking the sensor, causing the system to become unavailable. You can typically clean the sensor to resolve.

Rear View Camera

WHAT IS THE REAR VIEW CAMERA

The rear view camera provides a video image of the area behind your vehicle when the transmission is in reverse (R).

REAR VIEW CAMERA PRECAUTIONS



WARNING: The rear view camera system is a reverse aid supplement device that still requires the driver to use it in conjunction with the interior and exterior mirrors for maximum coverage.



WARNING: Objects that are close to either corner of the bumper or under the bumper, might not be seen on the screen due to the limited coverage of the camera system.



WARNING: Reverse your vehicle slowly. Failure to follow this instruction could result in the loss of control of your vehicle, personal injury or death.



WARNING: Use caution when the liftgate is ajar. If the liftgate is ajar, the camera is out of position and the video image could be incorrect. All guide lines disappear when the liftgate is ajar. Failure to follow this instruction could result in personal injury.



WARNING: Use caution when turning camera features on or off when the transmission is not in park (P). Make sure your vehicle is not moving.

Note: If the view comes on while the vehicle is not in reverse (R) and you have not recently shifted out of reverse (R), have the system inspected by your authorized dealer.

LOCATING THE REAR VIEW CAMERA

The rear view camera is on the liftgate or tailgate. It provides a view of the area behind your vehicle.

REAR VIEW CAMERA GUIDE LINES

Note: Active guide lines and fixed guide lines are only available when the transmission is in reverse (R).

Note: The centerline is only available if the active or fixed guide lines are on.

Note: When the battery is disconnected, the fixed guidelines may not function until you restart your vehicle. Make sure the center display shuts down in between ignition cycles.

Note: When the battery is disconnected, the active guidelines may not function until you drive your vehicle a short distance and exceed 12.4 mph (20 km/h).

Rear View Camera

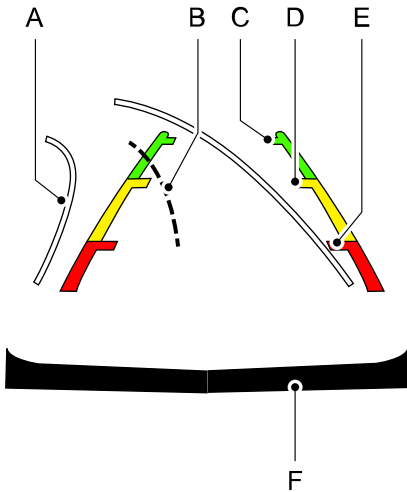

- A. Active guide lines.
- B. Centerline.
- C. Fixed guide line: Green zone.
- D. Fixed guide line: Yellow zone.
- E. Fixed guide line: Red zone.
- F. Rear bumper.

Active guide lines only show with fixed guide lines. To use active guide lines, turn the steering wheel to point the guide lines toward an intended path. If the steering wheel position changes while reversing, your vehicle might deviate from the intended path.

The fixed and active guide lines fade in and out depending on the steering wheel position. The active guide lines do not display when the steering wheel position is straight.

Use caution while reversing. Objects in the red zone are closest to your vehicle and objects in the green zone are farther away. Objects get closer to your vehicle as they move from the green zone to the yellow or red zones. Use the side view mirrors and rear view mirror to get better coverage on both sides and rear of your vehicle.

REAR VIEW CAMERA SETTINGS

ZOOMING THE REAR VIEW CAMERA IN AND OUT



WARNING: When manual zoom is on, the full area behind your vehicle may not show. Be aware of your surroundings when using the manual zoom feature.

Selectable settings for this feature are zoom in (+) and zoom out (-). Press the symbol on the camera screen to change the view. The default setting is zoom off.

This allows you to get a closer view of an object behind your vehicle. The zoomed image keeps the bumper in the image to provide a reference.

Note: Manual zoom is only available when the transmission is in reverse (R).

Note: Only the centerline shows when you enable manual zoom.

SWITCHING REAR VIEW CAMERA DELAY ON AND OFF

1. Press Features on the touchscreen.
2. Press Driver Assistance.
3. Press Rear View Camera.
4. Switch rear view camera delay on or off.

Rear View Camera

When shifting the transmission out of reverse (R) and into any gear other than park (P), the camera image remains in the display until:

- Your vehicle speed reaches approximately 5 mph (8 km/h).
- You shift your vehicle into park (P).

Cruise Control

WHAT IS CRUISE CONTROL

Cruise control lets you maintain a set speed without keeping your foot on the accelerator pedal.

Requirements

Use cruise control when the vehicle speed is greater than 20 km/h in metric units or 15 mph in imperial units.

SWITCHING CRUISE CONTROL ON AND OFF



WARNING: Do not use cruise control on winding roads, in heavy traffic or when the road surface is slippery. This could result in loss of vehicle control, serious injury or death.

The cruise controls are on the steering wheel.

Switching Cruise Control On



Press the button to activate the system. When the system activates, the set speed is equal to the current vehicle speed or 20 km/h (15 mph), whichever is greater. If the speed is too low, or other conditions are not correct for cruise control activation, the system enters standby mode.

Switching Cruise Control Off



Press the button when the system is active or switch the ignition off.

Note: When you switch cruise control off, the set speed clears.

SETTING THE CRUISE CONTROL SPEED



WARNING: When you are going downhill, your vehicle speed could increase above the set speed. The system does not apply the brakes.

Drive to the speed you prefer.

SET+

Press either button to set the current speed.

SET-

Take your foot off the accelerator pedal.

Note: The indicator changes color in the instrument cluster display.

Changing the Set Speed

SET+

Press and release the button to increase the set speed in small increments.

Press and hold the button to accelerate. Release the button when you reach your preferred speed.

SET-

Press and release the button to decrease the set speed in small increments.

Press and hold the button to decelerate. Release the button when you reach your preferred speed.

Note: If you accelerate by pressing the accelerator pedal, the set speed does not change. When you release the accelerator pedal, your vehicle returns to the speed that you previously set.

Cruise Control

CANCELING THE SET SPEED



Press the button, or tap the brake pedal to cancel the set speed.

Note: *The system remembers the set speed.*

Note: *The system cancels if the vehicle speed drops below 10 mph (16 km/h) under the set speed when driving uphill.*

RESUMING THE SET SPEED



Press the button.

CRUISE CONTROL INDICATORS



Illuminates when you switch the system on.

Adaptive Cruise Control (If Equipped)

HOW DOES ADAPTIVE CRUISE CONTROL WORK - MANUAL TRANSMISSION

Adaptive cruise control uses a radar sensor to adjust your vehicle speed to maintain a set gap between you and the vehicle in front of you in the same lane.

HOW DOES ADAPTIVE CRUISE CONTROL WITH STOP AND GO WORK - AUTOMATIC TRANSMISSION

Adaptive cruise control with stop and go uses radar and camera sensors to maintain a set gap between your vehicle and the vehicle in front of you while following it to a complete stop. Stop and go can also be set to follow a vehicle directly in front of you and adjust the set speed, while you are at a complete stop.

ADAPTIVE CRUISE CONTROL PRECAUTIONS



WARNING: You are responsible for controlling your vehicle at all times. The system is designed to be an aid and does not relieve you of your responsibility to drive with due care and attention. Failure to follow this instruction could result in the loss of control of your vehicle, personal injury or death.



WARNING: Do not use adaptive cruise control on winding roads, in heavy traffic or when the road surface is slippery. This could result in loss of vehicle control, serious injury or death.



WARNING: Pay close attention to changing road conditions such as entering or leaving a highway, on roads with intersections or roundabouts, roads without visible lanes of travel, roads that are winding, slippery, unpaved, or steep slopes.



WARNING: The system is not a crash warning or avoidance system.



WARNING: Do not use tire sizes other than those recommended because this can affect the normal operation of the system. Failure to do so may result in a loss of vehicle control, which could result in serious injury.



WARNING: Do not use the system in poor visibility, for example fog, heavy rain, spray or snow.

When Following a Vehicle



WARNING: When following a vehicle that is braking, your vehicle does not always decelerate quickly enough to avoid a crash without driver intervention. Apply the brakes when necessary. Failure to follow this instruction could result in personal injury or death.

Hilly Condition Usage

You should select a lower gear when the system is active in situations such as prolonged downhill driving on steep slopes, for example in mountainous areas.

Adaptive Cruise Control (If Equipped)

ADAPTIVE CRUISE CONTROL LIMITATIONS

Sensor Limitations

 **WARNING:** On rare occasions, detection issues can occur due to the road infrastructures, for example bridges, tunnels and safety barriers. In these cases, the system may brake late or unexpectedly. At all times, you are responsible for controlling your vehicle, supervising the system and intervening, if required.

 **WARNING:** If the system malfunctions, have your vehicle checked as soon as possible.

 **WARNING:** Large contrasts in outside lighting can limit sensor performance.

 **WARNING:** The system only warns of vehicles detected by the radar sensor. In some cases there may be no warning or a delayed warning. Apply the brakes when necessary. Failure to follow this instruction could result in personal injury or death.

 **WARNING:** The system may not detect stationary or slow moving vehicles below 6 mph (10 km/h).

 **WARNING:** The system does not detect pedestrians or objects in the road.

 **WARNING:** The system does not detect oncoming vehicles in the same lane.

 **WARNING:** The system may not operate properly if the sensor is blocked. Keep the windshield free from obstruction.

 **WARNING:** The sensor may incorrectly track lane markings as other structures or objects. This can result in a false or missed warning.

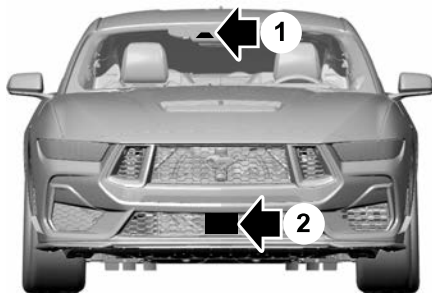

1. Camera.
2. Radar sensor.

The camera is on the windshield behind the interior mirror.

The radar sensor is in the lower grille.

Note: You cannot see the sensor. It is behind a fascia panel.

Note: Keep the front of your vehicle free of dirt, metal badges or objects. Vehicle front protectors, aftermarket lights, additional paint or plastic coatings could also degrade sensor performance.

A message displays if something obstructs the camera or the sensor. When something blocks the sensor, the system cannot detect a vehicle ahead and does not function. See **Adaptive Cruise Control – Information Messages** (page 209).

Adaptive Cruise Control (If Equipped)

The radar sensor has a limited field of view. It may not detect vehicles at all or detect a vehicle later than expected in some situations. The lead vehicle image does not illuminate if the system does not detect a vehicle in front of you.

Detection issues can occur:

A

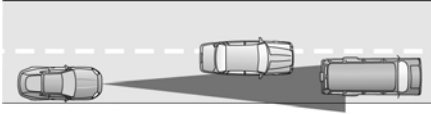

B

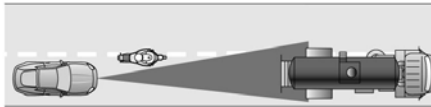

C

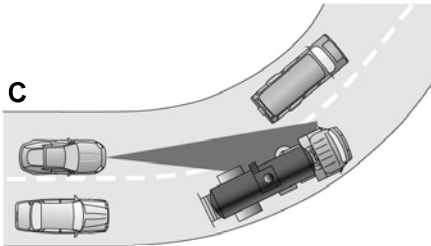

- A When driving on a different line than the vehicle in front.
- B With vehicles that edge into your lane. The system can only detect these vehicles once they move fully into your lane.
- C There may be issues with the detection of vehicles in front when driving into and coming out of a bend or curve in the road.

In these cases, the system may brake late or unexpectedly.

If something hits the front end of your vehicle or damage occurs, the radar-sensing zone may change. This could cause missed or false vehicle detection.

Optimal system performance requires a clear view of the road by the windshield-mounted camera.

Optimal performance may not occur if:

- The camera is blocked.
- There is poor visibility or lighting conditions.
- There are bad weather conditions.

SWITCHING ADAPTIVE CRUISE CONTROL ON AND OFF - MANUAL TRANSMISSION

The cruise controls are on the steering wheel. See **Cruise Control** (page 193).

Switching Adaptive Cruise Control On



Press the button to activate the system. When the system activates, the set speed is equal to whichever is greater, the current vehicle speed, or 20 km/h when in metric units or 15 mph when in imperial units. If the speed is too low, or other conditions are not correct for adaptive cruise control activation, the system enters standby mode.

The indicator, current gap setting and set speed appear in the instrument cluster display.

Switching Adaptive Cruise Control Off



Press the button when the system is in standby mode or switch the ignition off.

Adaptive Cruise Control (If Equipped)

Note: When you switch the system off, the set speed clears.

SWITCHING ADAPTIVE CRUISE CONTROL ON AND OFF - AUTOMATIC TRANSMISSION

The cruise controls are on the steering wheel. See **Cruise Control** (page 193).

Switching Adaptive Cruise Control On



Press the button to activate the system. When the system activates, the set speed is equal to whichever is greater, the current vehicle speed, or 20 km/h when in metric units or 15 mph when in imperial units. If the speed is too low, or other conditions are not correct for adaptive cruise control activation, the system enters standby mode. When you are below 20 km/h when in metric units or 15 mph when in imperial units, adaptive cruise control does not activate unless you are following another vehicle.

The indicator, current gap setting and set speed appear in the instrument cluster display.

Switching Adaptive Cruise Control Off



Press the button when the system is in standby mode or switch the ignition off.

Note: When you switch the system off, the set speed clears.

ADAPTIVE CRUISE CONTROL AUTOMATIC CANCELLATION

The system may cancel if:

- The tires lose traction.
- You apply the parking brake.

The system may cancel and set the parking brake if:

- You unbuckle the seatbelt and open the driver door after adaptive cruise control stops your vehicle.
- Adaptive cruise control holds your vehicle at a stop continuously for more than three minutes.

The system may deactivate or prevent activating when requested if:

- The vehicle has a blocked sensor.
- The brake temperature is too high.
- There is a failure in the system or a related system.

SETTING THE ADAPTIVE CRUISE CONTROL SPEED - MANUAL TRANSMISSION

Drive to the speed you prefer.



Press the SET+ or SET- buttons to set the current speed.



Take your foot off the accelerator pedal.

The indicator, current gap setting and set speed appear in the instrument cluster display.

Adaptive Cruise Control (If Equipped)



A vehicle image illuminates if there is a vehicle detected in front of you.

Note: When adaptive cruise control is active, the speedometer may vary slightly from the set speed displayed in the instrument cluster display.

Manually Changing the Set Speed

SET+ Press the SET+ button to increase the set speed in small increments. Press and hold the SET+ button to increase set speed in large increments. Release the button when the indicated set speed reaches the preferred speed.

SET- Press the SET- button to decrease the set speed in small increments. Press and hold the SET- button to decrease the set speed in large increments. Release the button when the indicated set speed reaches the preferred speed.

You can also press the accelerator or brake pedal until you reach the speed you prefer. Press the SET+ or SET- button to select the current speed as the set speed.

The system may apply the brakes to slow the vehicle to the new set speed. The set speed continuously displays in the instrument cluster display when the system is active.

SETTING THE ADAPTIVE CRUISE CONTROL SPEED - AUTOMATIC TRANSMISSION

Drive to the speed you prefer.

SET+ Press the SET+ or SET- buttons to set the current speed.

SET-

Take your foot off the accelerator pedal.

The indicator, current gap setting and set speed appear in the instrument cluster display.

A vehicle image illuminates if there is a vehicle detected in front of you.



Note: When adaptive cruise control is active, the speedometer may vary slightly from the set speed displayed in the instrument cluster display.

Setting the Adaptive Cruise Speed from a Complete Stop

SET+ Press the SET+ or SET- buttons while keeping the brake pedal fully pressed.

SET-

Adaptive Cruise Control (If Equipped)

The set speed adjusts to 20 km/h when in metric units or 15 mph when in imperial units.

The indicator, current gap setting and set speed appear in the instrument cluster display.

Note: *The system activates from a complete stop only when it detects a lead vehicle in close proximity.*

Manually Changing the Set Speed

SET+

Press the SET+ button to increase the set speed in small increments. Press and hold the SET+ button to increase set speed in large increments. Release the button when the indicated set speed reaches the preferred speed.

SET-

Press the SET- button to decrease the set speed in small increments. Press and hold the SET- button to decrease the set speed in large increments. Release the button when the indicated set speed reaches the preferred speed.

You can also press the accelerator or brake pedal until you reach the speed you prefer. Press the SET+ or SET- button to select the current speed as the set speed.

The system may apply the brakes to slow the vehicle to the new set speed. The set speed continuously displays in the instrument cluster display when the system is active.

SETTING THE ADAPTIVE CRUISE CONTROL GAP



Press the button to cycle through the four gap settings.



The selected gap appears in the instrument cluster display as shown by the bars in the image.

Note: *The gap setting is time dependent and therefore, the distance adjusts with your vehicle speed.*

Note: *It is your responsibility to select a gap appropriate to the driving conditions.*

Adaptive Cruise Control Gap Settings

Graphic Display, Bars Indicated Between Vehicles	Gap Distance	Dynamic Behavior
1	Closest.	Sport.
2	Close.	Normal.
3	Medium.	Normal.
4	Far.	Comfort.

Each time you switch the system on, it selects the last chosen gap setting.

Following a Vehicle

When a vehicle ahead of you enters the same lane or a slower vehicle is ahead in the same lane, the vehicle speed adjusts to maintain the gap setting.

Adaptive Cruise Control (If Equipped)

Note: When you are following a vehicle and you switch on a turn signal lamp, adaptive cruise control may provide a small, temporary acceleration to help you pass.

Your vehicle maintains a consistent gap from the vehicle ahead until:

- The vehicle in front of you accelerates to a speed above the set speed.
- The vehicle in front of you moves out of the lane you are in.
- You set a new gap distance.

The system applies the brakes to slow down your vehicle to maintain a safe gap distance from the vehicle in front of you. The system only applies limited braking. You can override the system by applying the brakes.

Note: The brakes may emit noise when applied by the system.

If the system determines that its maximum braking level is not sufficient, an audible warning sounds, a message appears in the instrument cluster display and an indicator flashes when the system continues to brake. Take immediate action.

CANCELING THE SET SPEED



Press the button or tap the brake pedal.

The set speed does not erase.

RESUMING THE SET SPEED - MANUAL TRANSMISSION



Press the button.

Your vehicle speed returns to the previously set speed and gap setting. The set speed displays continuously in the information display when the system is active.

Note: Only use resume if you are aware of the set speed and intend to return to it.

RESUMING THE SET SPEED - AUTOMATIC TRANSMISSION



Press the button.

Your vehicle speed returns to the previously set speed and gap setting. The set speed displays continuously in the instrument cluster display when the system is active.

Note: Only use resume if you are aware of the set speed and intend to return to it.

Resuming the Set Speed from a Complete Stop (If Equipped)

If your vehicle follows a vehicle to a complete stop and remains stationary for less than a few seconds, your vehicle accelerates from a stationary position to follow the vehicle ahead.

If your vehicle follows a vehicle to a complete stop and remains stationary for more than a few seconds, an indicator and message displays.

Adaptive Cruise Control (If Equipped)



Message	Action
Stopped	Cruise control does not resume automatically when this display is active.
Press button to resume	If the lead vehicle begins to move, you are prompted to press the resume button. Press and release the button or use the accelerator pedal to resume following the lead vehicle.
Auto-Resume	Displays when on a limited access highway after following a vehicle to a complete stop. In this situation, the vehicle resumes following the lead vehicle without a button press or pressing the accelerator pedal. The system can remain in auto-resume state for approximately 30 seconds, after which it no longer automatically resumes.

OVERRIDING THE SET SPEED

 **WARNING:** If you override the system by pressing the accelerator pedal, it does not automatically apply the brakes to maintain a gap from any vehicle ahead.

When you press the accelerator pedal, you override the set speed and gap distance.

Use the accelerator pedal to intentionally exceed the set speed limit.

When you override the system, the indicator remains blue, the set speed is dimmed and the lead vehicle icon does not appear in the instrument cluster display.

Adaptive Cruise Control (If Equipped)

The system resumes operation when you release the accelerator pedal. The vehicle speed decreases to the set speed, or a lower speed if following a slower vehicle.

ADAPTIVE CRUISE CONTROL INDICATORS



Illuminates when you switch adaptive cruise control on. The color of the indicator changes to indicate the system status.

White indicates the system is on but inactive.

Blue indicates that you set the speed and the system is active.

SWITCHING FROM ADAPTIVE CRUISE CONTROL TO CRUISE CONTROL



WARNING: Normal cruise control will not brake when your vehicle is approaching slower vehicles. Always be aware of which mode you have selected and apply the brakes when necessary.

1. Press Features on the touchscreen.
2. Press Driver Assistance.
3. Press Cruise Control.
4. Press Normal Cruise Control.



The cruise control indicator replaces the adaptive cruise control indicator if you select normal cruise control. The gap setting does not display, and the system does not respond to lead vehicles. Automatic braking remains active to maintain set speed. The system remembers the last setting when you start your vehicle.

LANE CENTERING (IF EQUIPPED)

HOW DOES LANE CENTERING WORK

Adaptive cruise control with lane centering uses the vehicle's front radar sensor and front windshield camera sensor, together with the steering sensor to operate.

Using these sensors, the system applies continuous steering assistance towards driving in the middle of the lane.

Note: *The gap setting for adaptive cruise control with lane centering, operates in the same way as normal adaptive cruise control.*

LANE CENTERING PRECAUTIONS



WARNING: Do not use the system if any changes or modifications to the steering wheel have been made. Any changes or modifications to the steering wheel could affect the functionality or performance of the system. Failure to follow this instruction could result in the loss of control of your vehicle, personal injury or death.

Adaptive cruise control precautions apply to lane centering unless stated otherwise or contradicted by a lane centering precaution. See **Adaptive Cruise Control Precautions** (page 195).

LANE CENTERING REQUIREMENTS

You must keep your hands on the steering wheel at all times.

Adaptive Cruise Control (If Equipped)

Lane centering only activates when all of the following occur:

- Adaptive cruise control with lane centering is enabled in the touchscreen. See **Switching Lane Centering On and Off** (page 204).
- You have adaptive cruise control with stop and go enabled and set.
- The steering system detects your hands on the steering wheel.
- The system detects both lane markings when driving on a straight road.
- Your vehicle is initially centered in the lane between two visible line markings.

Note: *If the system does not detect valid lane line markings, the system remains in standby until valid line markings are available.*

Note: *If the system does not detect your hands on the steering wheel, apply a slight force to the steering wheel.*

LANE CENTERING LIMITATIONS

Adaptive cruise control limitations apply to lane centering unless stated otherwise or contradicted by a lane centering limitation. See **Adaptive Cruise Control Limitations** (page 196).

Lane centering may not correctly operate in any of the following conditions:

- The lane width is too narrow or wide.
- The curve in the road is too tight.
- The system does not detect the minimum required lane markings or when lanes merge or split.
- When the required steering effort to maintain lane center exceeds the lane centering system limit.
- When driving in areas that are under construction or when road work is in progress.

- If the front windshield camera and/or the front radar are blocked.
- When using a spare tire.
- Inclement weather conditions including, but not limited to, high wind, heavy rain, and fog.
- Driving into direct sunlight.
- When modification to the steering system has been made, including alterations to the steering wheel.
- When towing a trailer.

See **Lane Centering Precautions** (page 203).

Note: *The system steering assistance is limited and may not have sufficient effort for all driving situations and/or conditions, such as driving through tight curves or driving through curves at high speeds.*

Note: *In exceptional conditions, the system may deviate from the lane center.*

SWITCHING LANE CENTERING ON AND OFF

Keep your hands on the steering wheel at all times.

The controls are on the steering wheel.



Press the button.

The indicator appears in the instrument cluster display. When the system is on, the color of the indicator changes to indicate the system status. See **Lane Centering Indicators** (page 205).

You can override the system at any time by steering your vehicle.

Note: *The correct requirements must be met before you can switch the system on. See **Lane Centering Requirements** (page 203).*

Adaptive Cruise Control (If Equipped)

Enabling and Disabling Lane Centering

1. Press Features on the touchscreen.
2. Press Driver Assistance.
3. Press Cruise Control.
4. Press Lane Centering.

LANE CENTERING ALERTS

You must keep your hands on the steering wheel at all times.

When the system is active and detects no steering activity for a period of time, the system alerts you to put your hands on the steering wheel. If you do not react appropriately to the warnings the adaptive cruise control with lane centering system cancels and slows your vehicle down to idle speeds while maintaining steering control. See **Lane Centering Automatic Cancellation** (page 205).

The system also alerts you if your vehicle crosses lane line markings without detected steering activity.

Note: *The system could detect a light grip or light touch on the steering wheel as hands-off driving.*

LANE CENTERING AUTOMATIC CANCELLATION

When an external condition cancels the system, and your hands are on the steering wheel, a tone sounds and a message appears in the instrument cluster display.

When an external condition cancels the system, and your hands are not on the steering wheel, the system immediately alerts you to take control of the vehicle. If this alert is ignored, the system slows the vehicle while maintaining steering assistance when lane markings are available. When no lane markings are available, the vehicle comes to a stop.



If your vehicle starts to slow down after system cancellation, you must take full control of the vehicle. To re-enable adaptive cruise control with lane centering after cancellation, press and release the resume button.

Automatic cancellation can also occur if:

- The lane becomes too wide or narrow.
- The system cannot detect valid lane markings.
- Lane markings cross over one another.
- The curve of the road is too sharp.

Note: *If your vehicle slows down due to your inactivity twice within a key cycle, the system disables. To reset the system, when the vehicle is stationary, return the gear selector to park (P) and turn the vehicle off. Then, restart the vehicle with your foot on the brake pedal.*

LANE CENTERING MANUAL CANCELLATION

When you perform the following actions, adaptive cruise control with lane centering will cancel:

- The brake pedal is pressed.
- Adaptive cruise control button on the steering wheel is switched off.

The lane centering system is momentarily suppressed when either of the following actions are performed:

- Turn signal indicator is latched or tapped.
- You steer the vehicle out of lane.

LANE CENTERING INDICATORS



Illuminates when you switch lane centering on. The color of the indicator changes to indicate the system status.

Adaptive Cruise Control (If Equipped)

Gray indicates the system is on but in standby mode.

Blue indicates the system is enabled and applying steering assistance to keep the vehicle in the center of the lane.

White with an audible tone, that then changes to gray, indicates a system automatic cancellation.

PREDICTIVE SPEED ASSIST

HOW DOES PREDICTIVE SPEED ASSIST WORK

Predictive Speed Assist works with adaptive cruise control and adjusts the vehicle speed to the road geometry and to the speed limit detected by the speed sign recognition system. As the system identifies curves and highway exits, the vehicle speed temporarily decreases ahead of and during the changing road geometry. When passing new speed signs, the set speed updates. See **Predictive Speed Assist Precautions** (page 206).

There are limitations that affect the accuracy of the speed sign recognition system and its ability to determine the current speed limit. Predictive speed assist and its ability to determine the current speed limit shares these limitations. See **Speed Sign Recognition** (page 246).

Note: *The adaptive cruise control gap setting operates normally when the feature is enabled.*

PREDICTIVE SPEED ASSIST PRECAUTIONS



WARNING: You are responsible for controlling your vehicle at all times. The system is designed to be an aid and does not relieve you of your responsibility to drive with due care and attention. Failure to follow this instruction could result in the loss of control of your vehicle, personal injury or death.



WARNING: Pay close attention to changing road conditions. You may need to override the system by pressing the brake or accelerator pedal if the adjusted speed becomes higher or lower than necessary.



WARNING: The system only provides limited braking. Your vehicle may not always decelerate quickly enough to avoid a crash without driver intervention. Apply the brakes when necessary.



WARNING: The system does not activate the turn signal.

Adaptive cruise control precautions apply to predictive speed assist unless stated otherwise or contradicted by a predictive speed assist precaution. See **Adaptive Cruise Control Precautions** (page 195).

The system only applies limited braking. You can override the system with the accelerator pedal or cancel the system by applying the brakes.

The system may adapt to various factors such as time of day, lane width. This could influence speed adjustments and accelerations.

Adaptive Cruise Control (If Equipped)

The system may adapt to various drive modes. See **Drive Mode Control** (page 211). This could influence speed adjustments and accelerations.

Note: *The system does not activate the turn signal automatically.*

PREDICTIVE SPEED ASSIST LIMITATIONS



WARNING: The system may not always adjust vehicle speed in certain road or weather conditions such as crossing traffic, yield or stop signs, right of way, traffic lights, speed bumps, rain, snow, fog. You must always apply the brake or accelerator pedal when necessary.

The road geometry and speed limit information provided by the navigation map data could be inaccurate or out of date.

The system may not detect and read speed limit signs with conditional information, for example, when a sign is flashing, during specific time ranges, or when children are present.

Note: *The system does not set the vehicle speed to speed limits shown with a supplementary traffic sign.*

Under certain conditions, the system may not adjust the vehicle speed until after your vehicle passes the speed limit.

Detection of road geometry operates only where related information is available. Road geometry information may not be available in some areas.

SWITCHING PREDICTIVE SPEED ASSIST MODE ON AND OFF

1. Press **Features** on the touchscreen.

2. Press **Driver Assistance**.
3. Press **Cruise Control**.
4. Press **Adaptive Cruise Control**.
5. Switch **Predictive Speed Assist** on or off.

ADJUSTING THE SET SPEED TOLERANCE

1. Press Features on the touchscreen.
2. Press Drive Assistance.
3. Press Cruise Control.
4. Press Adaptive Cruise Control.
5. Switch Predictive Speed Assist on.
6. Press Tolerance.
7. Adjust the slider to set the tolerance.

Note: *You can set tolerance for vehicle speed adjustment based on speed sign recognition only.*

PREDICTIVE SPEED ASSIST ALERTS

If the speed sign recognition system detects a speed limit below the minimum adaptive cruise control set speed, a tone sounds and the system returns to standby mode.

PREDICTIVE SPEED ASSIST INDICATORS

A blue marker around the speed sign and a blue arrow next to the set speed indicates that the system is active.

Speed Sign Indicator

When the system detects a new speed sign, a gray indicator appears above the set speed while the system adjusts the vehicle speed to the speed limit. When the speed limit is reached, the set speed updates and the gray indicator disappears.

Adaptive Cruise Control (If Equipped)

Road Geometry Indicator

When the system detects a curve or highway exit, the vehicle starts to decelerate, and the indicator appears and changes color.

Road Geometry Indicator Symbols



Left curve.



Right curve.

PREDICTIVE SPEED ASSIST – TROUBLESHOOTING

PREDICTIVE SPEED ASSIST – INFORMATION MESSAGES

Message	Details
Adaptive Cruise Control Speed Sign Recognition Not Available	Navigation system based speed limit information is not available. If the message continues to appear, have your vehicle checked as soon as possible.
Driver Resume Control	The system is going to cancel and you must take control.

ADAPTIVE CRUISE CONTROL – TROUBLESHOOTING

ADAPTIVE CRUISE CONTROL – INFORMATION MESSAGES - VEHICLES WITH: LANE CENTERING

Note: Depending on your vehicle options and instrument cluster type, some messages can appear different or not at all.

Adaptive Cruise Control (If Equipped)

Message	Action
Keep Hands on Steering Wheel	You must return your hands to the steering wheel and provide steering input to cancel the message.
Lane Centering Assist Not Available	Lane centering is currently not available, due to conditions that prevent the system from becoming active. To reset the system, when the vehicle is stationary, return the gear selector to park (P) and turn the vehicle off. Then, restart the vehicle with your foot on the brake pedal.
Resume Control	Adaptive cruise control with lane centering is about to cancel. You must immediately take full control of the vehicle.
Press Accelerator Pedal to Resume	Adaptive cruise control with lane centering is in standby mode. When safe to do so, you can resume adaptive cruise control with lane centering by applying pressure on the accelerator pedal. Alternatively, you can also re-enable adaptive cruise control with lane centering by pressing the resume button on the steering wheel.

ADAPTIVE CRUISE CONTROL – INFORMATION MESSAGES - VEHICLES WITH: STOP AND GO

Note: Depending on your vehicle options and instrument cluster type, not all messages display or are available.

Note: The system could abbreviate or shorten certain messages depending upon which cluster type you have.

Message	Details
Front Sensor Not Aligned	Contact an authorized dealer to have the radar checked for proper coverage and operation.
Cruise Control Not Available	Conditions exist preventing the system from being available.
Adaptive Cruise Control Not Available Sensor Blocked See Manual	You have a blocked radar because of poor radar visibility due to inclement weather or ice, mud, or water in front of the sensor. You can typically clean the sensor to resolve this issue.

Adaptive Cruise Control (If Equipped)

Message	Details
	Due to the nature of sensor technology, it is possible to get a blockage warning with no actual block. This happens, for example, when driving in sparse rural or desert environments. A false blocked condition either self clears, or clears after you restart your vehicle.
Normal Cruise Active Adaptive Braking Off	You have selected normal cruise control. The system does not brake or react to traffic.
Adaptive Cruise - Driver Resume Control	Displays when the adaptive cruise control is going to cancel and you must take control.
Cruise Control Speed Too Low to Activate	Displays when the vehicle speed is too slow to activate the adaptive cruise control and there is no lead vehicle in range.

Drive Mode Control

WHAT IS DRIVE MODE CONTROL

This feature connects multiple vehicle systems through a single interface, providing you with enhanced vehicle control and driving dynamics for different driving scenarios, terrains, weather, or various road conditions.

HOW DOES DRIVE MODE CONTROL WORK

Drive mode control adjusts your vehicle configuration for each mode you select.

Changing the drive mode adjusts the steering effort and feel of the steering system.

The stability and traction control assist your vehicle control in adverse conditions or high-performance driving.

Throttle control enhances the powertrain response, transmission controls become optimized with shift schedules.

Note: The system has diagnostic checks that continuously monitor the system for proper operation. If a mode is unavailable due to a system fault, the drive mode system defaults to normal. When the system defaults to normal, the driveline settings remain the same as prior to the system fault.

SELECTING A DRIVE MODE



Press the mode buttons on the steering wheel to scroll through the available modes.

Note: Button icons vary depending on your vehicles options.

Note: If you disconnect or remove the battery, the steering system defaults to normal.

Selecting a Steering Mode



To change the steering mode, press the button on the steering wheel. See **Custom Drive**

Mode (page 399). The first press of the steering wheel displays a pop-up message in the instrument cluster display for the selected mode and subsequent presses changes the selected mode.

The steering selections available are dependent on the current drive mode.

After selecting the desired setting, you may feel a soft feedback bump in the steering wheel when the changeover occurs.

Note: Steering options from custom mode may appear different from what is displayed on the instrument cluster display.

Drive Mode Control

Steering Modes



Normal - Developed to complement vehicle response during daily driving.



Sport – Slightly less assist and damping for improved steering feel during spirited driving.



Comfort – Slightly more assist for driver preference and daily driving ease.

Selecting a Suspension Mode (if

Equipped)



The different available suspension settings can be set for different drive modes in the custom drive mode menu. See **Custom Drive Mode** (page 399).

Suspension Modes



Normal - Default factory setting.



Sport – Slightly stiffer suspension with emphasis on handling and control.



Track – Maximum emphasis on handling and control.



Drag – Maximizes shock performance for drag strip environments.

Selecting an Exhaust Mode (if

Equipped)



The different available exhaust settings can be set for different drive modes. See **Custom Drive Mode** (page 399). Or See **Exhaust Mode** (page 400).

Exhaust Modes



Normal – Default setting provides a balance of comfort and feedback.



Sport – Slightly louder than normal for spirited driving.



Track – Loudest setting for track use only. Maximum exhaust noise under all driving conditions.



Quiet – Quietest setting for maximum comfort under all driving conditions.

DRIVE MODES

CUSTOM



Allows you to create your own drive mode experience. Choose a drive mode to use as a starting point and then mix and match settings to tailor the experience to your preferences. Custom drive mode must be active in order to see real time updates. See **Selecting a Drive Mode** (page 211).

Note: *Some settings or combinations of settings may not be available.*

DRAG STRIP



For high-performance drag strip driving. This mode adjusts the transmissions shift schedule for aggressive shifting and higher engine speeds, optimizing performance at maximum throttle. Accelerator pedal responsiveness increases, and steering is set to its sport setting for enhanced driver connectivity and feedback. Adaptive

Drive Mode Control

dampers are optimized for straight line maximum acceleration and active exhaust is set to its loudest setting for a more powerful tone. Use this mode for driving on closed circuit drag strips where optimal straight line performance is needed.

Note: *This mode is for track use only and is not intended for public roads.*

NORMAL



For everyday driving. This mode is the perfect balance of excitement, comfort, and convenience. This is the default mode after each ignition cycle and all systems altered by drive mode control are adjusted to their base settings.

SLIPPERY



For less than ideal road conditions such as snow or ice covered roads. Use this mode for crossing terrain where loose or slippery materials cover a firm surface. Slippery mode lowers throttle response and optimizes shifting for slippery surfaces.

Note: *Using slippery mode on dry, hard surfaces could produce some vibration, driveline bind up, and excessive tire wear.*

SPORT



For sporty driving with improved performance handling and response. This mode increases accelerator pedal responsiveness, holds the transmission in lower gears longer, and changes steering feel to have more torque buildup enhancing driver connectivity and feedback. Chassis controls are switched to their sport settings. The adjustable

suspension is modified to provide firmer and more responsive dynamics. Additionally, exhaust sound is changed to its sport setting for a louder and more aggressive tone. Use this mode for a fun and engaging driving experience.

TRACK



For high-performance track driving. This mode increases throttle response and adjusts the transmissions shift schedule to both hold lower gears longer for faster acceleration and downshift more aggressively under braking. Traction and Stability Control intervention is reduced and tuned specifically for track usage. If equipped, the adaptive dampers are optimized for transient handling maneuvers and active exhaust is opened to take on a more powerful tone. Additionally, steering is switched to its Sport setting for enhanced connectivity and driver feedback. Use this mode for on-road courses, auto-cross style events, and on-road closed circuit track driving.

Note: *This mode is for track use only and is not intended for public roads. Automatic Emergency Braking and Brake Over Accelerator systems are disabled.*

DRIVE MODE CONTROL – TROUBLESHOOTING

DRIVE MODE CONTROL – WARNING LAMPS



Some drive modes reduce traction and stability control performance and the indicator illuminates in the instrument cluster.

Drive Mode Control

Note: *The system has diagnostic checks that continuously monitor the system for proper operation. If a mode is unavailable due to a system fault, the drive mode system defaults to normal. When the system defaults to normal, the driveline settings remain the same as prior to the system fault.*

DRIVE MODE CONTROL – INFORMATION MESSAGES

Message	Details
Drive Mode Not Available	The system is not available. If it is still not available the next time you switch the ignition on, the system has malfunctioned. Have your vehicle checked as soon as possible.

Drive Mode Control

DRIVE MODE CONTROL – FREQUENTLY ASKED QUESTIONS

Why did the system default to normal mode?

- If a mode is unavailable due to a system fault, it defaults to normal mode and the driveline settings remain the same as prior to the system fault.

Can I switch drive modes while I am driving?

- In most instances, you can switch drive modes while you are driving (if you maintain attention on the road), or while the vehicle is stationary. However, you should not switch the vehicle into a drive mode intended for off-road or track use while driving on paved, public roads. For example, while driving on a paved highway, it would be acceptable to switch from normal mode to eco mode, but not to off-road mode.

How long does it take for the vehicle to switch modes after I make a selection?

- After switching modes, the new drive mode will activate within several seconds, if all the appropriate pre-conditions are met.

How should I decide which drive mode to use?

- Selecting a drive mode usually depends on the driving experience you would like to have, and the driving conditions. For example, if you want to have a more exciting on-road driving experience, you could switch into sport mode. If you find yourself driving on slick roads, you could switch into slippery mode.

Will drive modes impact my vehicle's fuel consumption?

- Drive modes can have an impact on your vehicle's fuel consumption. In addition to the active mode, your driving style will also affect the fuel consumption.

Speed Limiter

HOW DOES THE SPEED LIMITER WORK

The system allows you to set a speed to which your vehicle becomes limited. The set speed sets the effective maximum speed of your vehicle. You can temporarily exceed the set speed if required, for example to overtake.

The controls are on the steering wheel.

SPEED LIMITER PRECAUTIONS



WARNING: When you are going downhill, your vehicle speed may increase above the set speed. The system will not apply the brakes but a warning displays. Failure to follow this warning could result in serious personal injury or death.



WARNING: You are responsible for controlling your vehicle at all times. The system is designed to be an aid and does not relieve you of your responsibility to drive with due care and attention. Failure to follow this instruction could result in the loss of control of your vehicle, personal injury or death.

SWITCHING THE SPEED LIMITER ON AND OFF

LIM

Press to switch the system on.

The system activates with the current vehicle speed as the set speed. Press again to switch the system off.

SETTING THE SPEED LIMIT

SET+

Press with the limiter in standby mode to set the limiter to the current vehicle speed. Speed limitation activates and the symbol in the instrument cluster appears green.

SET-

CHANGING THE SET SPEED LIMIT

SET+

You can adjust the set speed in small or large increments. Press the toggle button upward or downward once to adjust the set speed in small increments. Press and hold the toggle button upward or downward to adjust the set speed in large increments.

SET-

CANCELING THE SET SPEED LIMIT



Press to cancel the limiter and place it in standby mode. The symbol in the instrument cluster appears grey.

RESUMING THE SET SPEED LIMIT



Press again to resume the limiter. The symbol in the instrument cluster appears green.

Speed Limiter

INTENTIONALLY EXCEEDING THE SET SPEED LIMIT

Firmly press the accelerator to temporarily turn the system off. The system reactivates once your vehicle speed drops below the set speed.

SPEED LIMITER INDICATORS



It illuminates in the instrument cluster when the system is standby or active.

SPEED LIMITER AUDIBLE WARNINGS

If you accidentally exceed the set speed, the set speed indicator flashes and an audible warning tone sounds.

If you intentionally exceed the set speed, only the set speed indicator flashes.

Intelligent Speed Limiter

WHAT IS THE INTELLIGENT SPEED LIMITER

The system allows you to limit the vehicle speed to the maximum speed limit detected by the traffic sign recognition system.

HOW DOES THE INTELLIGENT SPEED LIMITER WORK

Intelligent speed limiter uses data from the traffic sign recognition system to set a maximum speed. For example, if the traffic sign recognition system detects a 50 mph (80 km/h) speed limit, the vehicle speed is limited to 50 mph (80 km/h).

INTELLIGENT SPEED LIMITER PRECAUTIONS



WARNING: When you are going downhill, your vehicle speed may increase above the set speed. The system will not apply the brakes but a warning displays. Failure to follow this warning could result in serious personal injury or death.



WARNING: You are responsible for controlling your vehicle at all times. The system is designed to be an aid and does not relieve you of your responsibility to drive with due care and attention. Failure to follow this instruction could result in the loss of control of your vehicle, personal injury or death.

Note: *The system does not limit your vehicle's speed to speed limits shown with a supplementary traffic sign.*

SWITCHING THE INTELLIGENT SPEED LIMITER ON AND OFF



Press to switch the system on.

The system activates with the detected speed limit or, if no speed limit is detected the current speed of your vehicle is set. Press again to switch the system off.

SETTING THE SPEED LIMIT



Press the toggle button upward or downward with the system in standby mode to set the speed limiter to the current vehicle speed. The set speed is stored and displayed in the instrument



cluster.

Note: *The set speed limiter adjusts when the system detects a different maximum speed limit.*

Note: *If the system cannot detect a maximum speed limit, the system returns to standby mode.*

CHANGING THE SET SPEED LIMIT



You can adjust the set speed in small or large increments. Press the toggle button upward or downward once to adjust the set speed in small increments. Press and hold the toggle button upward or downward to adjust the set speed in large increments.



Intelligent Speed Limiter

ADJUSTING THE SPEED LIMIT TOLERANCE

You can set a permanent speed tolerance that is in addition to the detected speed limit.

1. Press **Features** on the touchscreen.
2. Press **Driver Assistance**.
3. Press **Speed Limiter**.
4. Press **Intelligent Speed Limiter**.
5. Press **Tolerance**.
6. Select a setting.

CANCELING THE SET SPEED LIMIT



Press to cancel the limiter and place it in standby mode. The symbol in instrument cluster display appears grey.

RESUMING THE SET SPEED LIMIT



Press to resume the limiter. The system sets the speed limit to the detected maximum speed limit when it resumes. The symbol in the instrument cluster display appears green.

INTENTIONALLY EXCEEDING THE SET SPEED LIMIT

Firmly press the accelerator pedal to temporarily turn the system off. The system reactivates once your vehicle speed drops below the set speed.

INTELLIGENT SPEED LIMITER INDICATORS



It illuminates in the instrument cluster when the system is in standby or active.

INTELLIGENT SPEED LIMITER AUDIBLE WARNINGS

A warning appears in the instrument cluster and a tone sounds if any of the following occur:

- Your vehicle's speed exceeds the current set speed.
- The system detects a maximum speed limit that is lower than your vehicle's current speed.
- You intentionally exceed the set speed.

If the traffic sign recognition system detects a speed limit outside the operational speed range, 12–112 mph (20–180 km/h), a single warning tone sounds and the system switches to standby mode.

SWITCHING FROM INTELLIGENT SPEED LIMITER TO SPEED LIMITER

1. From the settings menu, press Driver Assistance.
2. Press Speed Limit Assist.
3. Switch Intelligent Speed Limiter off.

Note: *If you switch intelligent speed limiter off, the system defaults to manual speed limiter. You can manually set the speed limiter using the controls on the steering wheel.*

Intelligent Speed Limiter

INTELLIGENT SPEED LIMITER – TROUBLESHOOTING

INTELLIGENT SPEED LIMITER – FREQUENTLY ASKED QUESTIONS

Why does a warning appear in the instrument cluster display?

- The vehicle speed exceeds the current set speed.
- The system detects a maximum speed limit that is lower than the current vehicle speed.
- You intentionally exceed the set speed.

Lane Keeping System

WHAT IS THE LANE KEEPING SYSTEM

The lane keeping system alerts you by providing temporary steering assistance or steering wheel vibration when it detects an unintended lane departure.

HOW DOES THE LANE KEEPING SYSTEM WORK

The lane keeping system uses a forward looking camera mounted on the windshield to monitor vehicle movement within the lane of travel.

When the camera detects a drift out of the lane of travel, the lane keeping system alerts the driver by vibrating the steering wheel, or aids the driver by providing a small steering input to move the vehicle back into the lane of travel.

The driver can select one of three modes:

- Alert (if equipped)
- Aid
- Alert + Aid

LANE KEEPING SYSTEM PRECAUTIONS



WARNING: You are responsible for controlling your vehicle at all times. The system is designed to be an aid and does not relieve you of your responsibility to drive with due care and attention. Failure to follow this instruction could result in the loss of control of your vehicle, personal injury or death.



WARNING: The system will not operate if the sensor cannot track the road lane markings.



WARNING: The sensor may incorrectly track lane markings as other structures or objects. This can result in a false or missed warning.



WARNING: In cold and severe weather conditions the system may not function. Rain, snow and spray can all limit sensor performance.



WARNING: The system may not operate properly if the sensor is blocked. Keep the windshield free from obstruction.



WARNING: If damage occurs in the immediate area surrounding the sensor, have your vehicle checked as soon as possible.



WARNING: The system may not correctly operate if your vehicle is fitted with a suspension kit not approved by us.



WARNING: Large contrasts in outside lighting can limit sensor performance.

LANE KEEPING SYSTEM LIMITATIONS

The lane keeping system only operates when the vehicle speed is greater than 40 mph (64 km/h).

The system works when the camera can detect at least one lane marking or the edge of the road.

The lane keeping system may not correctly operate in any of the following conditions:

- The lane keeping system does not detect at least one lane marking.
- You switch the turn signal on.

Lane Keeping System

- You apply direct steering, accelerate fast or brake hard.
- The vehicle speed is less than 40 mph (64 km/h).
- The anti-lock brake, stability control or traction control system activates.
- The lane is too narrow.
- Something is obscuring the camera or it is unable to detect the lane markings due to environment, traffic or vehicle conditions.

The lane keeping system may not correct lane positioning in any of the following conditions:

- High winds.
- Uneven road surfaces.
- Heavy or uneven loads.
- Incorrect tire pressure.

SWITCHING THE LANE KEEPING SYSTEM ON AND OFF



To activate the lane keeping system, press the button on the steering wheel.

To deactivate the lane keeping system, press the button again.

Note: When switching the system on or off a message appears in the instrument cluster display to show the status.

Note: The system stores the on or off setting until manually changed. For some markets, the system defaults to the ON setting at every Ignition cycle.

SWITCHING THE LANE KEEPING SYSTEM MODE

1. From the settings menu, press Driver Assistance.
2. Press Lane-Keeping System.
3. Press Lane-Keeping Mode.
4. Select a mode.

Note: The system remembers the last setting when you start your vehicle.

LANE KEEPING SYSTEM SETTINGS

Adjusting the Steering Wheel Vibration Intensity

1. From the settings menu, press Driver Assistance.
2. Press Lane Keeping System.
3. Press Lane Keeping Intensity.
4. Select a setting.

Note: This setting is not available in all modes.

ALERT MODE

WHAT IS ALERT MODE

Alert mode vibrates the steering wheel when it detects an unintended lane departure.

HOW DOES ALERT MODE WORK

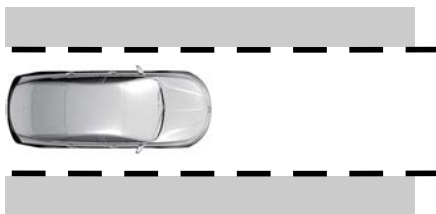

Lane Keeping System

When in alert mode, the lane keeping system alerts you by vibrating the steering wheel. The intensity of the vibration is set through the lane keeping system menu.

AID MODE

WHAT IS AID MODE

Aid mode provides temporary steering assistance toward the center of the lane.

HOW DOES AID MODE WORK

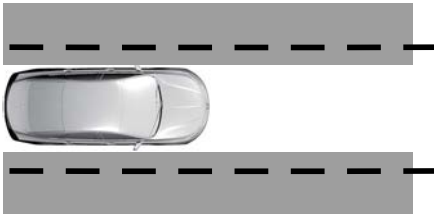

The lane keeping system aids you when an unintentional lane departure occurs. The system provides a small steering input to move the vehicle towards the center of the lane.

ALERT AND AID MODE

WHAT IS ALERT AND AID MODE

Alert and aid mode uses multiple features to keep you in your lane. The system first provides a small steering input to bring your vehicle back towards the center of the lane. If your vehicle moves too far from the center of the lane the system alerts you with vibration in the steering wheel.

HOW DOES ALERT AND AID MODE WORK

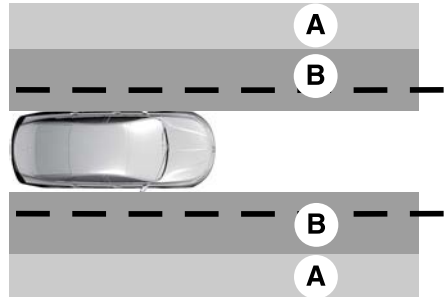

- A Alert.
- B Aid.

The lane keeping system detects a lane departure and provides aid when the vehicle enters **B** and applies the additional alert warning if **A** is entered.

LANE KEEPING SYSTEM INDICATORS

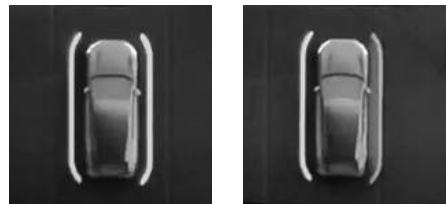

If you switch the lane keeping system on, a graphic with lane markings and an activation icon appear in the instrument cluster display.

Lane Keeping System

If you switch the system off, the lane marking graphics do not display and a deactivation icon appears in the instrument cluster display.

Note: *The overhead vehicle graphic may still display if adaptive cruise control is enabled.*

While the lane keeping system is on, the color of the lane markings change to indicate the system status.

Gray	Green	Yellow	Red
Indicates that the system is temporarily unavailable to provide a warning or intervention on the indicated side.	Indicates that the system is available or ready to provide a warning or intervention on the indicated side.	Indicates that the system is providing or has just provided a lane keeping aid intervention.	Indicates that the system is providing or has just provided a lane keeping alert warning.

BLIND SPOT ASSIST

WHAT IS BLIND SPOT ASSIST

Blind spot assist is an extension of the lane keeping system.

It may help you identify adjacent vehicles during a lane change.

Blind spot assist provides a blind spot warning and steering assistance to help you become aware of and steer away from vehicles in your blind spot during lane changes.

HOW DOES BLIND SPOT ASSIST WORK



Activate and deactivate the system using the lane keeping system button on the steering wheel.

During lane changes, the design of the blind spot assist feature detects vehicles in, or approaching, your blind spot and provides a warning, plus steering assistance to direct your vehicle back into your lane.

When active, this system functions with or without the use of turn signals and hazard flashers.

You must keep your hands on the steering wheel at all times.

BLIND SPOT ASSIST LIMITATIONS

All system limitations present in the basic lane keeping system also apply to blind spot assist.

Blind spot assist does not function under the following conditions:

- No lane markings are detected.
- One or both rear radar sensors become blocked or faulty.
- Attaching bike or cargo racks could cause false alerts due to obstruction of the sensor.

Blind spot assist may have difficulty detecting hazards under the following conditions:

- If a vehicle is approaching in an adjacent lane at a speed higher than your vehicle.
- Bad weather obstructing the sensors.

Lane Keeping System

BLIND SPOT ASSIST INDICATORS

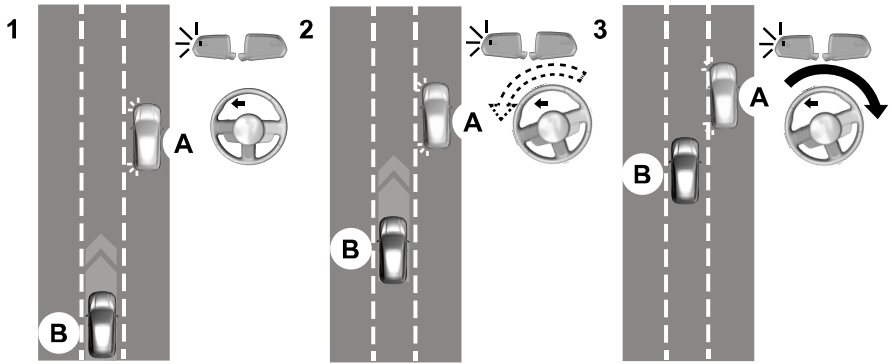

Diagram 1: Vehicle A uses its left turn signal preparing to change from the right lane to the middle lane. Vehicle B is already in the middle lane and just entered Vehicle A's blind spot causing the blind spot information system alert indicator to flash on the exterior mirror.

Diagram 2: The driver of Vehicle A begins to steer into the center lane not aware of Vehicle B.

Diagram 3: Blind spot assist counter steers to help alert the driver of Vehicle A to direct their vehicle back into the right lane to help avoid a possible collision with Vehicle B.

The lane keeping aid warning lamp or yellow lane marking in your instrument cluster display indicate blind spot assist activation. In addition, the blind spot information system alert indicator flashes on the exterior mirror on the same side as the detection. See **Blind Spot Information System** (page 228).

Blind Spot Assist Information Messages

Message	Action
Blind Spot Assist Not Available Trailer Attached	Displays if you attach a trailer to your vehicle.
Blind Spot Assist Not Available Side Sensor Blocked	Displays if your blind spot information system sensors are blocked.
Blind Spot Assist System fault	The system has detected a fault that requires service. Have your vehicle checked as soon as possible.

Lane Keeping System

Message	Action
Trailer Brake Module Fault	Lost communication with the trailer module. Blind spot assist is suppressed until the failure is fixed.
Trailer Lighting Module Fault See Manual	Lost communication with the trailer module. Blind spot assist is suppressed until the failure is fixed.
Front Camera Fault Service Required	Front camera fault. Blind spot assist is disabled until the failure is fixed.

LANE KEEPING SYSTEM – TROUBLESHOOTING

LANE KEEPING SYSTEM – INFORMATION MESSAGES

Message	Action
Lane Keeping Sys. Malfunction Service Required	The system has malfunctioned. Have your vehicle checked as soon as possible.
Front Camera Temporarily Not Available	The system has detected a condition that has caused the system to be temporarily unavailable.
Front Camera Low Visibility Clean Screen	The system has detected a condition that requires you to clean the windshield in order for it to operate properly.
Front Camera Malfunction Service Required	The system has malfunctioned. Have your vehicle checked as soon as possible.
Keep Hands on Steering Wheel	The system requests that you keep your hands on the steering wheel.

Lane Keeping System

LANE KEEPING SYSTEM – FREQUENTLY ASKED QUESTIONS

Why is the feature not available (lane markings are gray) when I can see the lane markings on the road?

- Your vehicle speed is less than 40 mph (65 km/h).
- The sun is shining directly into the camera lens.
- A quick intentional lane change has occurred.
- You are driving your vehicle too close to the lane markings for an extended interval of time.
- Driving at high speeds in curves.
- The last alert warning or aid intervention occurred a short time ago.
- Ambiguous lane markings, for example, in construction zones.
- Rapid transition from light to dark, or from dark to light.
- Sudden offset in lane markings.
- ABS or AdvanceTrac™ is active.
- There is a camera blockage due to dirt, grime, fog, frost or water on the windshield.
- You are driving too close to the vehicle in front of you.
- Transitioning between no lane markings to lane markings, or vice versa.
- There is standing water on the road.
- Faint lane markings, for example, partial yellow lane markings on concrete roads.
- Lane width is too narrow or too wide.
- You have not calibrated the camera after a windshield replacement.

- Driving on roads with tight curves or uneven surfaces.

Why does the vehicle not come back toward the middle of the lane, as expected, in the Aid, or Aid + Alert mode?

- High cross winds are present.
- There is a large road crown.
- Rough roads, grooves or shoulder drop-offs.
- Heavy, uneven loading of the vehicle or improper tire inflation pressure.
- You changed the tires or modified the suspension.

Blind Spot Information System

WHAT IS BLIND SPOT INFORMATION SYSTEM

Blind spot information system detects vehicles that may have entered the blind spot zone.

HOW DOES BLIND SPOT INFORMATION SYSTEM WORK

Blind spot information system uses sensors on both sides of your vehicle, detecting rearward from the exterior mirrors to approximately 13 ft (4 m) beyond the rear bumper. The detection area extends to approximately 59 ft (18 m) beyond the rear bumper when the vehicle speed is greater than 30 mph (48 km/h) to alert you of faster approaching vehicles.

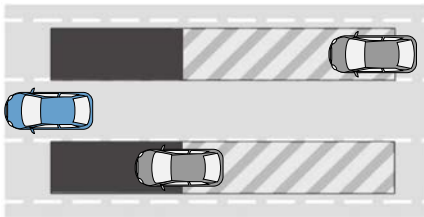

BLIND SPOT INFORMATION SYSTEM PRECAUTIONS



WARNING: Do not use the blind spot information system as a replacement for using the interior and exterior mirrors or looking over your shoulder before changing lanes. The blind spot information system is not a replacement for careful driving.



WARNING: The system may not operate properly during severe weather conditions, for example snow, ice, heavy rain and spray. Always drive with due care and attention. Failure to take care may result in a crash.

Note: *Blind spot information system does not prevent contact with other vehicles. It does not detect parked vehicles, pedestrians, animals or other infrastructure.*

BLIND SPOT INFORMATION SYSTEM LIMITATIONS

Blind spot information system does not operate in park (P) or reverse (R).

The system may not alert you if a vehicle quickly passes through the detection zone while overtaking.

Note: *For vehicles without the trailer coverage feature, we recommend that you switch the blind spot information system off when you attach a trailer.*

BLIND SPOT INFORMATION SYSTEM REQUIREMENTS

Blind spot information system turns on when all the following occur:

- You start your vehicle.
- You shift into drive (D).
- The vehicle speed is greater than 6 mph (10 km/h).

SWITCHING BLIND SPOT INFORMATION SYSTEM ON AND OFF

1. From the settings menu, press Driver Assistance.

Blind Spot Information System

2. Switch Blind Spot Information System on or off.

When you switch blind spot information system off, a warning lamp illuminates. When you switch the system on or off, the alert indicators flash twice. A telltale remains illuminated in the instrument cluster when the blind spot information system is switched off in the settings menu.

Note: The system remembers the last setting when you start your vehicle.

LOCATING THE BLIND SPOT INFORMATION SYSTEM SENSORS



The sensors are behind the rear bumper on both sides of your vehicle.

Note: Keep the sensors free from snow, ice and large accumulations of dirt.

Note: Blocked sensors may affect system accuracy.

Note: Do not cover the sensors with bumper stickers, repair compound or other objects.

Note: Bike and cargo racks could cause false alerts due to obstruction of the sensor. We recommend switching the feature off when using a bike or cargo rack.

Note: The system may not correctly operate when towing a trailer. For vehicles with a trailer tow module and tow bar approved by us, the system turns off when you attach a trailer. For vehicles with an aftermarket trailer tow module or tow bar, we recommend that you switch the system off when you attach a trailer.



If the sensors become blocked, a message and indicator may appear in the instrument cluster display. See **Blind Spot Information System – Information Messages** (page 230). The alert indicators remain illuminated, but the system does not alert you.

BLIND SPOT INFORMATION SYSTEM INDICATORS



When blind spot information system detects a vehicle, an alert indicator illuminates in the exterior mirror on the side from which the vehicle is approaching. If you turn the turn signal on for that side of your vehicle, the alert indicator flashes.

Blind Spot Information System

BLIND SPOT INFORMATION SYSTEM – TROUBLESHOOTING

BLIND SPOT INFORMATION SYSTEM – INFORMATION MESSAGES

Message	Action
Blind Spot System Fault	A fault with the system has occurred. Have your vehicle checked as soon as possible.
Blind Spot Not Available Sensor Blocked See Manual	Something is blocking the sensors. Clean the sensors.

Exit Warning

WHAT IS EXIT WARNING

Exit warning is designed to provide a visual and audible alert when a vehicle occupant opens a door into approaching traffic. It uses radar sensors to alert you to traffic objects approaching your open door.

HOW DOES EXIT WARNING WORK

Exit warning detects traffic objects such as vehicles, cyclists, scooters and motorcycles that approach your vehicle from the rear and cross into the exit warning zone. The exit warning zones are along the left and right sides of your vehicle and extend slightly past a fully open door. The exit warning system becomes active once you have started your vehicle and the vehicle is not moving. Exit warning operates in any gear position.

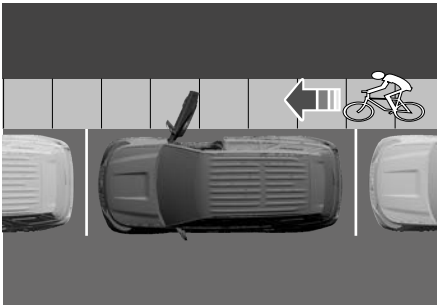

Note: *The system cannot detect animals, slow moving pedestrians or any type of stationary object.*

EXIT WARNING PRECAUTIONS



WARNING: The system is not a crash warning or avoidance system.



WARNING: Always pay attention to the traffic situation and the area around the vehicle.



WARNING: In cold and severe weather conditions the system may not function. Rain, snow and spray can all limit sensor performance.



WARNING: If damage occurs in the immediate area surrounding the sensor, have your vehicle checked as soon as possible.



WARNING: You are responsible for controlling your vehicle at all times. The system is designed to be an aid and does not relieve you of your responsibility to drive, stop and park with due care and attention. Failure to follow this instruction could result in the loss of control of your vehicle, personal injury or death.



WARNING: Exit Warning may not detect objects with surfaces that absorb reflection. Always open doors with due care and attention. Failure to follow this instruction may result in personal injury or property damage.

EXIT WARNING LIMITATIONS

The exit warning system is operational in any gear position once you start your vehicle and anytime the vehicle is not moving. The exit warning system remains on for about 3 minutes after turning your vehicle off. The system immediately turns off when locking the doors. Exit warning informs you when it turns off.

Note: *Do not use exit warning as a replacement for paying attention when exiting your vehicle.*

Exit Warning

Note: The system does not prevent contact with other vehicles by automatically closing the doors.

Note: The system may not inform and/or alert you if a traffic object is approaching too quickly or if the parking position prevents detection.

Exit Warning Alert

Note: Exit warning is designed to provide a visual alert during an exit when an occupant opens any door and a traffic object is approaching on the same side.

EXIT WARNING INDICATORS



When exit warning detects an approaching traffic object on one side, the corresponding alert indicator in the exterior mirror is illuminated. If exit warning alert or the optional exit warning prevention are active, the same alert indicator flashes. See **Blind Spot Information System Indicators** (page 229).

In addition to the mirror indicator there is also visual indicator in the information display noting what side a traffic object has been detected on.

SWITCHING EXIT WARNING ON AND OFF

You can switch off the exit warning system using the touchscreen.

Note: The system remembers the last setting when you start your vehicle.

LOCATING THE EXIT WARNING SENSORS



The sensors for the exit warning are mounted behind the rear bumper on both sides of your vehicle.

Note: Keep the sensors free from snow, ice and large accumulations of dirt.

Note: Do not cover the sensors with bumper stickers, repair compound or other objects.

Note: Blocked sensors may affect system accuracy.

Note: The system may not correctly operate when towing a trailer or bike rack.

Exit Warning

EXIT WARNING – TROUBLESHOOTING

EXIT WARNING – INFORMATION MESSAGES

Message	Reason
Left/Right Side Check surroundings before exiting	Left/Right exit warning alert or exit warning prevention is active.
Exit Warning turning off. Exit safely	Displays when the exit warning system turns off or shuts down.
Exit Warning System Fault	Displays when the exit warning system detects any system error.

If exit warning detects a fault, the system deactivates and a **System Fault** message appears in the instrument cluster display.

Cross Traffic Alert

WHAT IS CROSS TRAFFIC ALERT

The system is designed to alert you of road users and traffic objects approaching from the rear sides and from behind your vehicle when you shift into reverse (R).

If you continue to reverse after the system alerts you, the system is designed to apply the brakes if it still detects approaching road users or traffic objects. If the system applies the brakes, a message appears in the instrument cluster display.

Note: *There could be instances when unexpected or unwanted braking occurs. You can override this by firmly pressing the accelerator pedal.*

HOW DOES CROSS TRAFFIC ALERT WORK

Cross Traffic Alert is designed to detect road users or traffic objects approaching above a minimum speed of 5 mph (8 km/h). Coverage can decrease when the sensors are partially, mostly or fully obstructed.

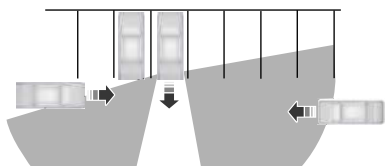

The sensor on the left-hand side is only partially obstructed and zone coverage on the right-hand side is maximized.

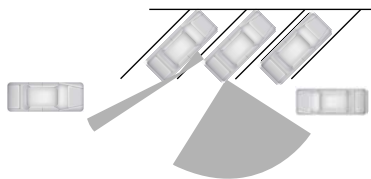

Zone coverage also decreases when parking at narrow angles. The sensor on the left-hand side is mostly obstructed and zone coverage on that side is severely reduced.

Note: *Slowly reversing helps increase the coverage area and effectiveness.*

The system only applies the brakes for a short period of time when an event occurs. Take action as soon as you notice the system applying the brakes in order to remain in control of your vehicle, the system does not do this for you.

CROSS TRAFFIC ALERT PRECAUTIONS



WARNING: You are responsible for controlling your vehicle at all times. The system is designed to be an aid and does not relieve you of your responsibility to drive with due care and attention. Failure to follow this instruction could result in the loss of control of your vehicle, personal injury or death.



WARNING: If damage occurs in the immediate area surrounding the sensor, have your vehicle checked as soon as possible.

Cross Traffic Alert



WARNING: To help avoid personal injury, always use caution when in reverse (R) and when using the sensing system.



WARNING: The system may not operate properly during severe weather conditions, for example snow, ice, heavy rain and spray. Always drive with due care and attention. Failure to take care may result in a crash.



WARNING: The system may not detect objects with surfaces that absorb reflection. Always drive with due care and attention. Failure to take care may result in a crash.



WARNING: Traffic control systems, fluorescent lamps, inclement weather, air brakes, external motors and fans may affect the correct operation of the sensing system. This may cause reduced performance or false alerts.



WARNING: Some situations and objects prevent hazard detection, for example, inclement weather, unconventional vehicle types and pedestrians. Apply the brakes when necessary. Failure to follow this instruction could result in the loss of control of your vehicle, personal injury or death.



WARNING: Do not use the system with accessories that extend beyond the front or rear of your vehicle, for example a trailer hitch or bike rack. The system is not able to make corrections for the additional length of the accessories.



WARNING: Do not use the cross traffic alert system as a replacement for using the interior and exterior mirrors or looking over your shoulder before reversing out of a parking space. The cross traffic alert system is not a replacement for careful driving.

Note: *Certain add-on devices around the bumper or fascia may cause unexpected system behavior. For example, large trailer hitches, bicycle or surfboard racks, license plate brackets, fuel containers, bumper covers or any other device may block the normal detection zone of the system. Remove the add-on device to prevent unexpected system behavior.*

Note: *If your vehicle sustains damage to the bumper or fascia leaving it misaligned or bent, it could alter the sensing zone causing inaccurate measurement of obstacles or false alerts.*

Note: *Vehicle loading and suspension changes can impact the angle of the sensors and may change the normal detection zone of the system resulting in inaccurate measurement of obstacles or false alerts.*

Note: *You may experience reduced system performance on road surfaces that limit deceleration. For example, roads with ice, loose gravel, mud or sand.*

CROSS TRAFFIC ALERT LIMITATIONS

The system may not correctly operate when any of the following occur:

- Something is blocking the sensors.
- Adjacently parked vehicles or objects are obstructing the sensors.
- Traffic objects approach at speeds less than 5 mph (8 km/h) or greater than 37 mph (60 km/h).

Cross Traffic Alert

- Your vehicle speed is greater than 7 mph (12 km/h).
- You reverse out of an angled parking space.
- If you switch the traction system off, cross traffic alert does not apply the brakes.

Note: The system does not alert for small stationary and moving objects.

Cross Traffic Alert Limitations with a Trailer Attached

The system remains on when you attach a trailer to vehicles with blind spot information system with trailer coverage under the following conditions:

- You connect a bike rack or cargo rack with a maximum length of 3 ft (1 m).
- You set the trailer length to 3 ft (1 m) in the touchscreen.

Note: The system may not correctly operate when towing a trailer. For vehicles with an approved trailer tow module and tow bar, the system turns off when you attach a trailer greater than 3 ft (1 m). For vehicles with an aftermarket trailer tow module or tow bar, we recommend that you switch the system off when you attach a trailer.

SWITCHING CROSS TRAFFIC ALERT ON AND OFF

1. From the settings menu, press Driver Assistance.
2. Press Cross Traffic Alert.
3. Switch the feature on or off.

When you switch the system on or off, the alert indicators flash twice.

Note: The system switches on every time you switch the ignition on.

LOCATING THE CROSS TRAFFIC ALERT SENSORS



The sensors are behind the rear bumper on both sides of your vehicle.

Note: Keep the sensors free from snow, ice and large accumulations of dirt.

Note: Do not cover the sensors with bumper stickers, repair compound or other objects.

Note: Blocked sensors may affect system accuracy.

Note: Bike and cargo racks could cause false alerts due to obstruction of the sensor. We recommend switching the feature off when using a bike or cargo rack.

If something is blocking the sensors, a message may appear in the information display when you shift into reverse (R).

CROSS TRAFFIC ALERT INDICATORS



When the system detects an approaching vehicle, a tone sounds, an alert indicator illuminates in the relevant exterior mirror and arrows appear in the touchscreen to show from which side the vehicle is approaching.

Cross Traffic Alert

If the system malfunctions, a message appears. Have your vehicle checked as soon as possible.

Note: *In exceptional conditions, the system could alert you or apply the brakes, even when there is nothing in the detection zone, for example a vehicle passing further away from your vehicle.*

CROSS TRAFFIC ALERT – TROUBLESHOOTING

CROSS TRAFFIC ALERT – INFORMATION MESSAGES

Message	Details
Cross Traffic Alert	Displays when the system detects a vehicle. Check for approaching traffic.
Cross Traffic Not Available Sensor Blocked See Manual	Displays if the cross traffic alert system sensors are blocked. Clean the sensors. If the message continues to appear, have your vehicle checked as soon as possible.
Cross Traffic System Fault	The system has malfunctioned. Have your vehicle checked as soon as possible.
Cross Traffic Alert Deactivated Trailer Attached	Displays if you attach a trailer to your vehicle.
Cross Traffic Alert Applying Brakes	Displays if the system applies the brakes. Check for approaching traffic.

Pre-Collision Assist

WHAT IS PRE-COLLISION ASSIST

Pre-collision assist detects and warns of approaching hazards in the roadway. The system provides multiple levels of assistance to help avoid a collision if your vehicle is rapidly approaching another stationary vehicle, a vehicle traveling in the same direction as yours, or a pedestrian or cyclist within your driving path.

HOW DOES PRE-COLLISION ASSIST WORK

The system warns the driver of potential hazards by providing three levels of assistance.



If your vehicle is rapidly approaching potential hazards the system provides the following levels of functionality:

1. Alert.
2. Brake support.
3. Automatic emergency braking.



Alert: When active, a flashing visual warning appears and an audible warning tone sounds.

Brake Support: The system helps reduce the impact speed by preparing the brakes for rapid braking. The system does not automatically apply the brakes. If you press the brake pedal, the system may apply additional braking up to maximum braking force, even if you lightly press the brake pedal.

Automatic Emergency Braking: Automatic emergency braking may activate if the system determines that a collision is imminent.

Note: If the pre-collision assist alerts are too frequent or disturbing, you can reduce the alert sensitivity. Setting the low sensitivity results in fewer and later warnings of a potential forward collision. The manufacturer recommends using the high sensitivity setting where possible.

Note: Automatic emergency braking performance is not affected by the sensitivity setting.

Each system has various levels of detection capabilities. See **Pre-Collision Assist Limitations** (page 239).

PRE-COLLISION ASSIST PRECAUTIONS



WARNING: You are responsible for controlling your vehicle at all times. The system is designed to be an aid and does not relieve you of your responsibility to drive with due care and attention. Failure to follow this instruction could result in the loss of control of your vehicle, personal injury or death.



WARNING: The system only provides limited braking. Your vehicle may not always decelerate quickly enough to avoid a crash without driver intervention. Apply the brakes when necessary.



WARNING: The system does not operate during hard acceleration or steering. Failure to take care may lead to a crash or personal injury.

Pre-Collision Assist



WARNING: The system may operate with reduced function during cold and inclement weather conditions. Snow, ice, rain, spray and fog can adversely affect the system. Keep the front camera and radar free of snow and ice. Failure to follow this instruction may result in the loss of control of your vehicle, serious personal injury or death.



WARNING: The system may not function properly if your vehicle is fitted with a replacement windshield not approved by us.



WARNING: Do not perform windshield repairs around the rear-view mirror. Failure to follow this instruction could limit sensor performance.



WARNING: System performance could be reduced in situations where the vehicle camera has limited detection capability. These situations include but are not limited to direct or low sunlight, vehicles at night without tail lights, unconventional vehicle types, pedestrians or cyclists with complex backgrounds, running pedestrians or fast moving cyclists, partly obscured pedestrians or cyclists, pedestrians or cyclists that the system cannot distinguish from a group. Failure to take care may result in the loss of control of your vehicle, personal injury or death.



WARNING: The system cannot help prevent all crashes. Do not rely on this system to replace driver judgment and the need to maintain a safe distance and speed.



WARNING: Take additional care if your vehicle is heavily loaded or you are towing a trailer. These conditions could result in reduced performance of this system. Failure to follow this instruction could result in the loss of control of your vehicle, personal injury or death.

Note: *Automatic emergency braking may activate when a collision is imminent. The system cannot prevent all crashes, but may reduce crash severity. Do not test automatic emergency braking or forward collision warning. Testing this system must only be conducted by authorized test facilities using specialized equipment. Do not use automatic emergency braking to replace normal braking for any reason. Relying on automatic emergency braking to stop your vehicle may cause an unexpected accident which could lead to serious injury or death.*

Note: *The system does not detect animals.*

PRE-COLLISION ASSIST LIMITATIONS

Pre-collision assist depends on the detection ability of its camera and sensors. Any obstructions or damage to these areas can limit detection or prevent the system from functioning. See **Locating the Pre-Collision Assist Sensors** (page 241).

The system is active at 3 mph (5 km/h) and above.

Note: *Brake support and automatic emergency braking are active up to the maximum speed of the vehicle.*

Note: *The pre-collision assist system automatically disables when you manually disable AdvanceTrac™ or put the vehicle in Track Mode (if available)*

Pre-Collision Assist

Pedestrian Detection Limitations

Pedestrian detection is active at speeds up to 50 mph (80 km/h).

Pedestrian detection functions optimally when detected hazards are clearly identifiable. System performance may reduce in situations where pedestrians are running, partly obscured, have a complex background, or cannot be distinguished from a group.

Cyclist Detection Limitations

Cyclist detection is active at speeds up to 50 mph (80 km/h).

Cyclist detection functions optimally when detected hazards are clearly identifiable. The system's detection level may be less in situations where cyclists are moving fast, partly hidden, have a complex background, or the system cannot distinguish the cyclist from a group.

Intersection Assist

The pre-collision assist system may operate in a scenario where you are turning across the path of an oncoming vehicle, or with crossing pedestrians and cyclists. Detection of vehicles driving in an oncoming direction is active if your vehicle is driving at speeds up to 50 mph (80 km/h). Detection of crossing pedestrians and cyclists at an intersection is active if your vehicle is driving at speeds up to 19 mph (30 km/h).

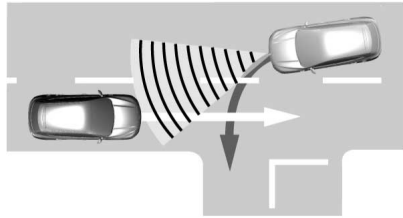

SWITCHING PRE-COLLISION ASSIST ON AND OFF

You cannot switch the system off.

Adjusting the Pre-Collision Assist Settings

You can adjust the following settings by using the touchscreen controls in the pre-collision assist menu:

- Change alert sensitivity to one of three possible settings.
- If required, switch automatic emergency braking on or off.
- If required, switch evasive steering assist on or off.

Note: *Automatic emergency braking and evasive steering assist automatically turn on every time you start your vehicle.*

Note: *If you switch automatic emergency braking off, evasive steering assist switches off.*

Pre-Collision Assist

LOCATING THE PRE-COLLISION ASSIST SENSORS

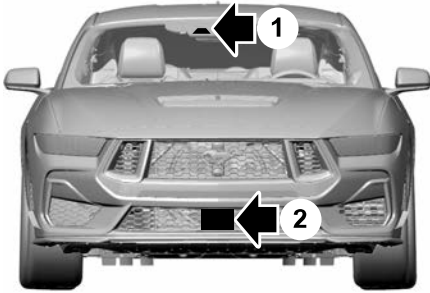

1. Camera.
2. Radar sensor (if equipped).

If a message regarding a blocked sensor or camera appears in the instrument cluster display, something is obstructing the radar signals or camera images. The radar sensor is behind the fascia cover in the center of the lower grille. With a blocked sensor or camera, the system may not function, or performance may reduce. See **Pre-Collision Assist – Information Messages** (page 244).

Note: Proper system operation requires a clear view of the road by the camera. Repair any windshield damage in the area of the camera's field of view.

Note: If something hits the front end of your vehicle or damage occurs and your vehicle has a radar sensor, the radar sensing zone could change. This could cause missed or false vehicle detections. Have your vehicle serviced to have the radar checked for proper coverage and operation.

Note: If your vehicle detects excessive heat at the camera or a potential misalignment condition, a message could display in the information display indicating temporary sensor unavailability. When operational conditions are correct, the message deactivates. For example, when the ambient temperature around the sensor decreases or the sensor recalibrates successfully.

DISTANCE INDICATION (IF EQUIPPED)

WHAT IS DISTANCE INDICATION

Distance indication displays the gap between your vehicle and the vehicle ahead of you.

Note: The graphic does not display if you switch on cruise control or adaptive cruise control.

Vehicle Speed	System Sensitivity	Distance Indicator Color	Distance Gap	Time Gap
62 mph (100 km/h).	Normal.	Blue.	Greater than 82 ft (25 m).	Greater than 0.9 seconds.
		Yellow.	56–82 ft (17–25 m).	0.6–0.9 seconds.
		Red.	Less than 56 ft (17 m).	Less than 0.6 seconds.

Pre-Collision Assist

SWITCHING DISTANCE INDICATION ON AND OFF

1. From the settings menu, press Driver Assistance.
2. Press Pre-Collision Assist.
3. Press Distance Indication.
4. Switch the feature on or off.

DISTANCE INDICATION INDICATOR

The indicator displays the time gap between your vehicle and vehicles traveling in the same direction ahead of you.



FORWARD COLLISION WARNING

WHAT IS FORWARD COLLISION WARNING

A warning flashes and an audible warning sounds if your vehicle rapidly approaches another vehicle to warn you of the risk of a crash with the vehicle in front of you.

ADJUSTING THE SENSITIVITY OF FORWARD COLLISION WARNING

1. From the settings menu, press Driver Assistance.
2. Press Pre-Collision Assist.
3. Press Alert Sensitivity.
4. Select a setting.

DISTANCE ALERT (IF EQUIPPED)

WHAT IS DISTANCE ALERT

The system alerts you with a warning lamp if the distance to the vehicle ahead is small.

Note: *The warning lamp does not illuminate if cruise control or adaptive cruise control is active.*

ADJUSTING THE SENSITIVITY OF DISTANCE ALERT

To adjust the sensitivity of the system, use the touchscreen:

1. Press **Features** on the touchscreen.
2. Press **Driver Assistance**.
3. Press **Pre-Collision Assist**.
4. Press **Alert Sensitivity**.
5. Select a setting.

Pre-Collision Assist

AUTOMATIC EMERGENCY BRAKING

WHAT IS AUTOMATIC EMERGENCY BRAKING

Automatic emergency braking may activate if the system determines that a collision is imminent. The system may help to reduce impact damage or completely avoid the crash.

SWITCHING AUTOMATIC EMERGENCY BRAKING ON AND OFF

1. From the settings menu, press Driver Assistance.
2. Press Pre-Collision Assist.
3. Press Auto Emergency Braking.
4. Switch the feature on or off.

Note: A telltale remains illuminated in the instrument cluster when automatic emergency braking is switched off using the settings menu.

EVASIVE STEERING ASSIST (IF EQUIPPED)

WHAT IS EVASIVE STEERING ASSIST

If your vehicle is rapidly approaching a road user, evasive steering assist helps you steer around the road user.

After you turn the steering wheel in an attempt to avoid a crash with the road user, the system applies additional steering torque to help you steer around the road user. After you pass the road user, the system applies steering torque when you turn the steering wheel to steer back into the lane. The system deactivates after you fully pass the road user.

Note: Road users are defined as pedestrians or bicyclists in your vehicle's path or another stationary vehicle in the same lane or a vehicle traveling in the same lane in the same direction as you. See **Pre-Collision Assist Precautions** (page 238).

EVASIVE STEERING ASSIST LIMITATIONS

Evasive steering assist only activates when all the following occur:

- Automatic emergency braking and evasive steering assist are on.
- The system detects a road user ahead and starts to apply the brakes.
- You significantly turn the steering wheel to steer around a road user.

Note: Evasive steering assist does not automatically steer around a road user. If you do not turn the steering wheel, evasive steering assist does not activate.

Note: Evasive steering assist does not activate if the distance to the road user ahead is too small and the system cannot avoid a crash.

SWITCHING EVASIVE STEERING ASSIST ON AND OFF

1. From the settings menu, press Driver Assistance.
2. Press Pre-Collision Assist.
3. Press Evasive Steering Assist.

Pre-Collision Assist

4. Switch the feature on or off.

Note: If you switch automatic emergency braking off, evasive steering assist turns off.

Note: Automatic emergency braking and evasive steering assist turn on every time you start your vehicle.

Note: If the telltale illuminates without a corresponding information message, make sure the setting for automatic emergency braking is switched on. See **Switching Automatic Emergency Braking On and Off** (page 243). No action is needed unless an information message appears. See **Pre-Collision Assist Precautions** (page 238).

PRE-COLLISION ASSIST – TROUBLESHOOTING

PRE-COLLISION ASSIST – WARNING LAMPS



A telltale illuminates in the instrument cluster display to indicate if the system is disabled, unavailable, or temporarily degraded due to external environmental conditions.

PRE-COLLISION ASSIST – INFORMATION MESSAGES

Message	Action
Pre-Collision Assist Not Available Sensor Blocked	You have a blocked sensor due to bad weather, ice, mud or water in front of the radar sensor. You can typically clean the sensor to resolve.
Pre-Collision Assist Not Available	A fault with the system has occurred. Have your vehicle checked as soon as possible.

Pre-Collision Assist

PRE-COLLISION ASSIST – FREQUENTLY ASKED QUESTIONS

Camera Troubleshooting

What should I do if the windshield in front of the camera is dirty or obstructed?

- Clean the outside of the windshield in front of the camera.

What if the windshield in front of the camera is clean, but the message remains in the instrument cluster display?

- Wait a short time. It could take several minutes for the camera to detect that there is no obstruction.

Radar Troubleshooting (If Equipped)

What should I do if the surface of the radar in the grille is dirty or obstructed?

- Clean the grille surface in front of the radar or remove the object causing the obstruction.

What if the surface of the radar in the grille is clean, but the message remains in the instrument cluster display?

- Wait a short time. It could take several minutes for the radar to detect that there is no obstruction.

Can weather or road conditions interfere with the radar signals?

- Yes, weather such as heavy rain, spray or fog as well as water, snow or ice on the surface of the road can interfere with the radar signals. In these situations, the system temporarily disables this feature. Pre-collision assist reactivates a short time after the weather conditions improve.

What if the radar is out of alignment due to a front end impact?

- Have your vehicle serviced to have the radar checked for proper coverage and operation.

Speed Sign Recognition (If Equipped)

WHAT IS SPEED SIGN RECOGNITION

Speed sign recognition detects speed limit signs to inform you of the current speed limit. Detected speed signs appear in the instrument cluster display.

HOW DOES SPEED SIGN RECOGNITION WORK

Speed sign recognition uses a sensor behind the interior mirror to detect speed signs.

If your vehicle has speed sign recognition with Map Data, stored speed sign data may influence the indicated speed limit value.

SPEED SIGN RECOGNITION PRECAUTIONS

 **WARNING:** You are responsible for controlling your vehicle at all times. The system is designed to be an aid and does not relieve you of your responsibility to drive with due care and attention. Failure to follow this instruction could result in the loss of control of your vehicle, personal injury or death.

 **WARNING:** In cold and severe weather conditions the system may not function. Rain, snow and spray can all limit sensor performance.

 **WARNING:** The system may not operate properly if the sensor is blocked. Keep the windshield free from obstruction.

 **WARNING:** Do not perform windshield repairs around the rear-view mirror. Failure to follow this instruction could limit sensor performance.

 **WARNING:** The system may not correctly operate if your vehicle is fitted with a suspension kit not approved by Ford.

 **WARNING:** Not all traffic signs can be recognized by the system and displayed correctly.

Note: Always fit our original parts when replacing headlamp bulbs. Other bulbs may reduce system performance.

SPEED SIGN RECOGNITION LIMITATIONS

Speed sign recognition may not detect the correct speed due to:

- Construction zones.
- Outdated map data.
- Incorrect recognition of speed limits by the sensor of signs on parallel roads or exit ramps.
- Missed recognition of faded, dirty, or distorted signs.

Note: The system may not detect all speed signs and may incorrectly read signs.

Speed Sign Recognition (If Equipped)

SPEED SIGN RECOGNITION INDICATORS



When the system detects a speed limit sign, it appears in the instrument cluster display.

Note: Sign indicator image may vary based on your vehicle's display type.

SPEED SIGN RECOGNITION SETTINGS

1. From the settings menu, press driver assistance. See **Center Display** (page 389).

2. Press Speed Limit Assist.

You can adjust the following settings:

- Switch the speed warning on or off.
- Set the speed limit tolerance (if equipped).



If you see this icon next to a menu option, press it for more information.

SPEED SIGN RECOGNITION – TROUBLESHOOTING

SPEED SIGN RECOGNITION – INFORMATION MESSAGES

Message	Details
Traffic Sign Reduced Performance See Manual	The traffic sign data provided by the Map Data is unavailable due to weak or no signal. Wait for a short period of time for the signal to improve. If the message continues to appear, have the system checked as soon as possible.

Speed Sign Recognition (If Equipped)

SPEED SIGN RECOGNITION – FREQUENTLY ASKED QUESTIONS

Why does the speed limit change without any sign on the road?

- The speed limit changes due to the speed limit data stored in the map data.

Why does speed sign recognition show a wrong speed limit?

- The system shows a wrong speed limit due to incorrect and outdated map data or due to incorrect recognition of the speed limits by the camera.

Driver Alert

WHAT IS DRIVER ALERT

Driver alert alerts you if it determines that you are becoming drowsy or if your driving deteriorates.

HOW DOES DRIVER ALERT WORK

Driver alert determines your alertness level based on your driving behavior in relation to the lane markings and other factors using the front windshield camera.

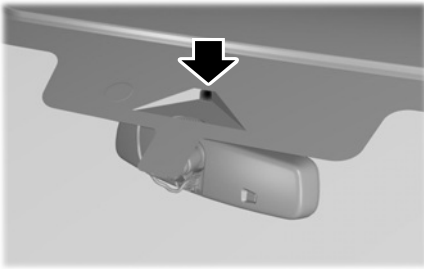

DRIVER ALERT PRECAUTIONS

WARNING: You are responsible for controlling your vehicle at all times. The system is designed to be an aid and does not relieve you of your responsibility to drive with due care and attention. Failure to follow this instruction could result in the loss of control of your vehicle, personal injury or death.

WARNING: Take regular rest breaks if you feel tired. Do not wait for the system to warn you.

WARNING: Certain driving styles may result in the system warning you even if you are not feeling tired.

WARNING: In cold and severe weather conditions the system may not function. Rain, snow and spray can all limit sensor performance.

WARNING: The system will not operate if the sensor cannot track the road lane markings.

WARNING: If damage occurs in the immediate area surrounding the sensor, have your vehicle checked as soon as possible.

WARNING: The system may not correctly operate if your vehicle is fitted with a suspension kit not approved by us.

WARNING: The system may not operate properly if the sensor is blocked. Keep the windshield free from obstruction.

Note: If something is blocking the camera or damaged the windshield, Driver Alert may not function.

DRIVER ALERT LIMITATIONS

Driver alert may not function correctly if:

- The sensor cannot track the road lane markings.
- Your vehicle's speed is less than approximately 40 mph (65 km/h).

Driver Alert

SWITCHING DRIVER ALERT ON AND OFF

1. From the settings menu, press Driver Assistance.
2. Press Driver Alert.
3. Switch the feature on or off.

DRIVER ALERT INDICATORS



When the system detects an issue, for example, the camera is blocked or misaligned, an off symbol appears in the instrument cluster display. If the symbol continues to appear, have your vehicle checked as soon as possible.

System Warnings

The warning system has two stages:

1. A temporary warning is issued to advise you to take a rest. This message only appears for a short time.
2. If you do not rest and the system continues to detect that your driving deteriorates, it issues a further warning. This remains in the instrument cluster display until you cancel it.

Note: *The system does not warn you if the vehicle speed falls below approximately 40 mph (65 km/h).*

DRIVER ALERT – TROUBLESHOOTING

DRIVER ALERT – INFORMATION MESSAGES

Message	Action
Driver Alert Warning Rest Now	Stop and rest as soon as it is safe to do so.
Driver Alert Warning Rest Suggested	Take a rest soon.

Load Carrying

LOAD CARRYING PRECAUTIONS

Keep your loaded vehicle weight within its design rating capability, with or without a trailer. Properly loading your vehicle provides maximum return of vehicle design performance. Before you load your vehicle, become familiar with the following terms for determining your vehicle's weight rating, with or without a trailer, from the vehicle's Tire and Loading Information label or Safety Compliance Certification label.



WARNING: The appropriate loading capacity of your vehicle can be limited either by volume capacity (how much space is available) or by payload capacity (how much weight the vehicle should carry). Once you have reached the maximum payload of your vehicle, do not add more cargo, even if there is space available. Overloading or improperly loading your vehicle can contribute to loss of vehicle control and vehicle rollover.



WARNING: Exceeding the Safety Compliance Certification label vehicle weight limits can adversely affect the performance and handling of your vehicle, cause vehicle damage and can result in the loss of control of your vehicle, serious personal injury or death.



WARNING: Do not use replacement tires with lower load carrying capacities than the original tires because they may lower your vehicle's GVWR and GAWR limitations. Replacement tires with a higher limit than the original tires do not increase the GVWR and GAWR limitations.



WARNING: Do not exceed the GVWR or the GAWR specified on the certification label.



WARNING: Exceeding any vehicle weight rating can adversely affect the performance and handling of your vehicle, cause vehicle damage and can result in the loss of control of your vehicle, serious personal injury or death.



WARNING: When loading the roof racks, we recommend you evenly distribute the load, as well as maintain a low center of gravity. Loaded vehicles, with higher centers of gravity, may

Load Carrying

handle differently than unloaded vehicles. Take extra precautions, such as slower speeds and increased stopping distance, when driving a heavily loaded vehicle.

The gross combined weight must never exceed the Gross Combined Weight Rating.

LOCATING THE SAFETY COMPLIANCE CERTIFICATION LABELS

Safety Compliance Certification Label Example:

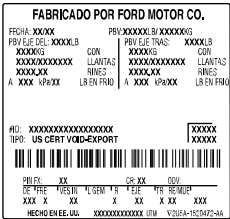
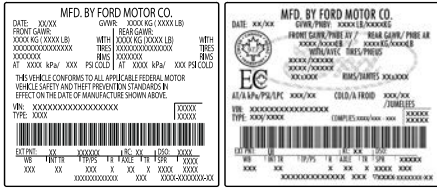

The Safety Compliance Certification label is located on the door pillar, door latch post, or the door edge that meets the door latch post, next to the driver seat.

WHAT IS THE GROSS AXLE WEIGHT RATING

GAWR (Gross Axle Weight Rating)

GAWR is the maximum allowable weight that a single axle (front or rear) can carry. These numbers are on the Safety Compliance Certification label.

WHAT IS THE GROSS VEHICLE WEIGHT RATING

GVWR is the maximum allowable weight of the fully loaded vehicle. This includes all options, equipment, passengers and cargo. It appears on the Safety Compliance Certification label.

WHAT IS THE GROSS COMBINED WEIGHT RATING

Gross Combined Weight Rating (GCWR) is the maximum allowable weight of the vehicle and the loaded trailer, including all cargo and passengers, that the vehicle can handle without risking damage. (Important: The towing vehicle's braking system is rated for operation at Gross Vehicle Weight Rating, not at Gross Combined Weight Rating.)

Note: *Your vehicle is not designed for trailer towing. Never tow a trailer with your vehicle.*

Load Carrying

CALCULATING PAYLOAD

Tire and Loading Label Information

Example:



TIRE AND LOADING INFORMATION

SEATING CAPACITY TOTAL: 5 FRONT: 2 REAR: 3

The combined weight of occupants, and cargo should never exceed: **385 kg or 850 lbs.**

TIRE	SIZE	COLD TIRE PRESSURE	SEE OWNERS MANUAL FOR ADDITIONAL INFORMATION
FRONT	235/45R18 94V	235 KPA, 34 PSI	
REAR	235/45R18 94V	235 KPA, 34 PSI	
SPARE	NONE	NONE	

is the maximum payload for your vehicle as built by the assembly plant. If you install any additional equipment on your vehicle, you must determine the new payload. Subtract the weight of the equipment from the payload listed on the Tire and Loading label.

Note: *Your vehicle is not designed for trailer towing. Never tow a trailer with your vehicle.*

CALCULATING THE LOAD LIMIT

Steps for determining the correct load limit:

1. Locate the statement "The combined weight of occupants and cargo should never exceed XXX kg or XXX lb." on your vehicle's placard.
2. Determine the combined weight of the driver and passengers that will be riding in your vehicle.
3. Subtract the combined weight of the driver and passengers from XXX kg or XXX lb.
4. The resulting figure equals the available amount of cargo and luggage load capacity. For example, if the "XXX" amount equals 1,400 lb. and there will be five 150 lb. passengers in your vehicle, the amount of available cargo and luggage load capacity is 650 lb. (1400-750 (5 x 150) = 650 lb.)



TIRE AND LOADING INFORMATION
RENSEIGNEMENTS SUR LES PNEUS ET LE CHARGEMENT

SEATING CAPACITY / NOMBRE DE PLACES TOTAL: 5 FRONT: 2 REAR: 3

The combined weight of occupants and cargo should never exceed: **396 kg or 875 lbs.**
Le poids total des occupants et du chargement ne doit jamais dépasser

TIRE PNEU	SIZE DIMENSIONS	COLD TIRE PRESSURE / PRESSION DES PNEUS A FROID	SEE OWNER'S MANUAL FOR ADDITIONAL INFORMATION VOIR LE MANUEL DE L'USAGER POUR PLUS DE RENSEIGNEMENTS
FRONT AVANT	235/40R19 96V	255 KPA, 37 PSI	
REAR ARRIERE	235/40R19 96V	255 KPA, 37 PSI	
SPARE DE SECOURS	T125/80R16 97M	415 KPA, 60 PSI	

Payload is the combined weight of cargo and passengers that your vehicle is carrying. The maximum payload for your vehicle appears on the Tire and Loading label. The label is either on the B-pillar or the edge of the driver door. Vehicles exported outside the US and Canada may not have a tire and loading label. Look for "The combined weight of occupants and cargo should never exceed XXX kg OR XXX lb" for maximum payload. The payload listed on the Tire and Loading Information label

Load Carrying

- Determine the combined weight of luggage and cargo being loaded on the vehicle. That weight may not safely exceed the available cargo and luggage load capacity calculated in Step 4.
- If your vehicle will be towing a trailer, load from your trailer will be transferred to your vehicle. Consult this manual to determine how this reduces the available cargo and luggage load capacity of your vehicle.

Helpful examples for calculating the available amount of cargo and luggage load capacity

Suppose your vehicle has a 1400-pound (635-kilogram) cargo and luggage capacity. You decide to go golfing. Is there enough load capacity to carry you, four of your friends and all the golf bags? You and four friends average 220 pounds (99 kilograms) each and the golf bags weigh approximately 30 pounds (13.5 kilograms) each. The calculation would be: $1400 - (5 \times 220) - (5 \times 30) = 1400 - 1100 - 150 = 150$ pounds. Yes, you have enough load capacity in your vehicle to transport four friends and your golf bags. In metric units, the calculation would be: $635 \text{ kilograms} - (5 \times 99 \text{ kilograms}) - (5 \times 13.5 \text{ kilograms}) = 635 - 495 - 67.5 = 72.5$ kilograms.

Suppose your vehicle has a 1400-pound (635-kilogram) cargo and luggage capacity. You and one of your friends decide to pick up cement from the local home improvement store to finish that patio you have been planning for the past two years. Measuring the inside of the vehicle with the rear seat folded down, you have room for twelve 100-pound (45-kilogram) bags of cement. Do you have enough load capacity to transport the cement to your home? If you and your friend each weigh 220 pounds (99 kilograms), the calculation would be: $1400 - (2 \times 220) - (12 \times 100) = 1400 - 440 - 1200 = -240$ pounds. No, you do not have enough cargo capacity to carry that much weight. In metric units, the calculation would be: $635 \text{ kilograms} - (2 \times 99 \text{ kilograms}) - (12 \times 45 \text{ kilograms}) = 635 - 198 - 540 = -103$ kilograms. You will need to reduce the load weight by at least 240 pounds (104 kilograms). If you remove three 100-pound (45-kilogram) cement bags, then the load calculation would be: $1400 - (2 \times 220) - (9 \times 100) = 1400 - 440 - 900 = 60$ pounds. Now you have the load capacity to transport the cement and your friend home. In metric units, the calculation would be: $635 \text{ kilograms} - (2 \times 99 \text{ kilograms}) - (9 \times 45 \text{ kilograms}) = 635 - 198 - 405 = 32$ kilograms.

Load Carrying

The above calculations also assume that the loads are positioned in your vehicle in a manner that does not overload the front or the rear gross axle weight rating specified for your vehicle on the Safety Compliance Certification label.

Luggage Compartment

LUGGAGE COMPARTMENT PRECAUTIONS

WARNING: Keep vehicle doors and luggage compartment locked and keep keys and remote transmitters out of a child's reach. Unsupervised children could lock themselves in the luggage compartment and risk injury. Children should be taught not to play in vehicles.

WARNING: People should never climb inside the luggage compartment. Never shut the luggage compartment when a person is inside.

WARNING: The appropriate loading capacity of your vehicle can be limited either by volume capacity (how much space is available) or by payload capacity (how much weight the vehicle should carry). Once you have reached the maximum payload of your vehicle, do not add more cargo, even if there is space available. Overloading or improperly loading your vehicle can contribute to loss of vehicle control and vehicle rollover.

WARNING: Do not load any objects on the shelf that may obstruct your vision or strike occupants of the vehicle in the case of a sudden stop or collision.

OPENING THE REAR LUGGAGE COMPARTMENT

OPENING THE REAR LUGGAGE COMPARTMENT FROM INSIDE YOUR VEHICLE - CONVERTIBLE

Using the Instrument Panel Button



Press the button on the instrument panel to open the luggage compartment.

Luggage Compartment

Unlocking the Rear Luggage Compartment

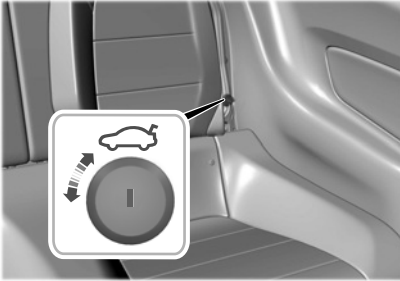

If the decklid does not open because of a discharged battery, pull the rear left-hand side seatback cushion aside, insert the mechanical key blade into the key slot and turn the key to release the decklid latch.

OPENING THE REAR LUGGAGE COMPARTMENT FROM INSIDE YOUR VEHICLE - COUPE



Press the button on the instrument panel to open the luggage compartment.

OPENING THE REAR LUGGAGE COMPARTMENT FROM OUTSIDE YOUR VEHICLE

Note: Be careful when opening the luggage compartment in a garage or other enclosed area to avoid damaging the decklid.

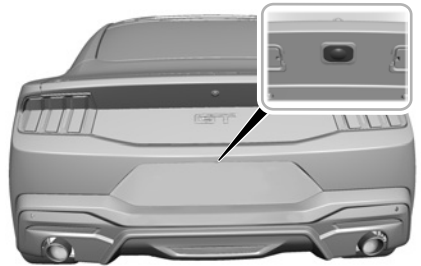

Press the exterior release button hidden above the license plate. You need to have your vehicle unlocked or have an intelligent access key within 3.3 ft (1 m) of the luggage compartment.

OPENING THE REAR LUGGAGE COMPARTMENT USING THE REMOTE CONTROL



Press the button twice within three seconds.

Note: Be careful when opening the luggage compartment in a garage or other enclosed area to avoid damaging the decklid.

Luggage Compartment

CLOSING THE REAR LUGGAGE COMPARTMENT

CLOSING THE REAR LUGGAGE COMPARTMENT FROM OUTSIDE YOUR VEHICLE

Lower the decklid and apply light pressure as it drops to manually close the luggage compartment.

Note: Before driving off, check the instrument cluster for a trunk ajar message or warning indicator. Failure to do so could result in unintentionally leaving the luggage compartment open while driving. An unlatched decklid may block your rear view.

USING THE REAR LUGGAGE COMPARTMENT EMERGENCY RELEASE

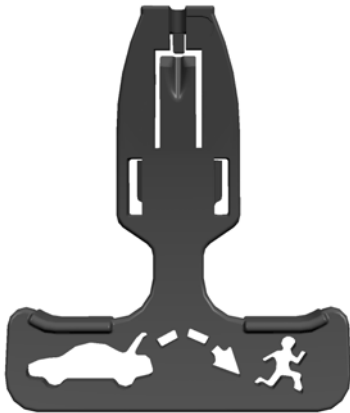

Your vehicle is equipped with a release handle that provides a means of escape if you become locked inside the luggage compartment. The handle is located inside the luggage compartment on the decklid. The material around the handle glows after a brief exposure to ambient light.

Pull the handle and push up on the decklid to open from within the luggage compartment.

LUGGAGE COMPARTMENT – TROUBLESHOOTING

LUGGAGE COMPARTMENT – WARNING LAMPS



Illuminates when the the ignition is on and the luggage compartment is not completely closed.

Luggage Compartment

LUGGAGE COMPARTMENT – INFORMATION MESSAGES

Message	Action
Trunk Ajar	Displays to remind you that the luggage compartment is not completely closed.

Towing a Trailer

TOWING A TRAILER PRECAUTIONS - BASE/GT



WARNING: Do not exceed the GVWR or the GAWR specified on the certification label.



WARNING: Towing trailers beyond the maximum recommended gross trailer weight exceeds the limit of your vehicle and could result in engine damage, transmission damage, structural damage, loss of vehicle control, vehicle rollover and personal injury.

TOWING A TRAILER PRECAUTIONS - DARK HORSE



WARNING: Your vehicle is not approved for trailer towing. Never tow a trailer with your vehicle.

LOADING YOUR TRAILER

To help minimize how trailer movement affects your vehicle when driving:

- Load the heaviest items closest to the trailer floor.
- Load the heaviest items centered between the left and right side trailer tires.
- Load the heaviest items above the trailer axles or just slightly forward toward the trailer tongue. Do not allow the final trailer tongue weight to go above or below 10-15% of the loaded trailer weight. The trailer tongue weight should never exceed 10% of the maximum towing capacity.
- Select a ball mount with the correct rise or drop. When both the loaded vehicle and trailer are connected, the trailer frame should be level, or slightly angled down toward your vehicle, when viewed from the side.

Towing a Trailer

TOWING WEIGHTS AND DIMENSIONS

RECOMMENDED TOWING WEIGHTS

Market	Website
United States of America	https://www.fordpro.com/en-us/fleet-vehicles/manuals-and-guides/
Canada (English)	https://www.fordpro.ca/en-ca/fleet-vehicles/manuals-and-guides/
Canada (French)	https://www.fordpro.ca/fr-ca/fleet-vehicles/manuals-and-guides/

Convertible Top (If Equipped)

OPENING THE CONVERTIBLE TOP

When you use the top, you must first unlatch it from the windshield and then use the convertible top control.

Note: *The convertible top does not operate unless the vehicle is stationary or traveling under 3 mph (5 km/h). A tone sounds and a warning message appears in the instrument panel. When you slow down, the top operates.*

Note: *When you latch or unlatch the convertible top, the audio system briefly mutes. This allows the vehicle to optimize the cabin's sound quality depending on the position of the convertible top.*

To unlatch the convertible top:

1. Bring the vehicle to a complete stop. The ignition must be on. We recommend that the vehicle remains running when you open the top to prevent draining the battery.
2. Check the convertible top stowage compartment behind the rear seat to be sure it is empty. Make sure the convertible top outer surface is free of debris.
3. Move the latch handle, above the interior mirror, down toward the windshield and rotate the handle clockwise to release the convertible top.

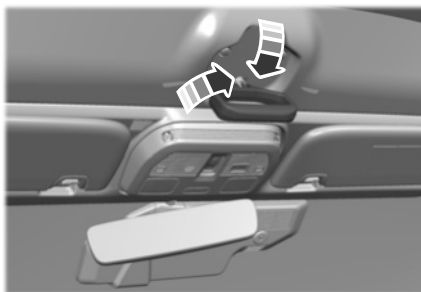

The windows automatically open when you press the convertible top control.

To open the convertible top:

1. Press and hold the convertible top control on the overhead console until the windows are completely down and the top stores completely.
2. Release the convertible top control.

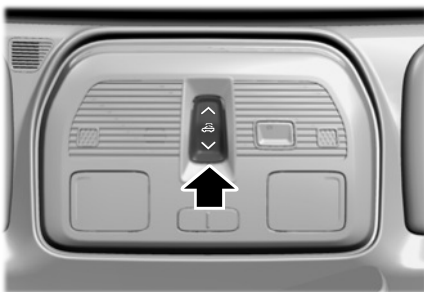

Note: *Do not store articles behind the rear seat. Articles in the convertible top stowage compartment may break the rear glass window when you open the top.*

Note: *Opening the convertible top when the top material is wet may cause mold or mildew.*

Convertible Top (If Equipped)

CLOSING THE CONVERTIBLE TOP

Closing the Convertible Top

1. Bring your vehicle to a complete stop and make sure to leave the ignition on. We recommend that your vehicle remains running when you close the top to prevent draining the battery.

Note: The convertible top does not operate unless your vehicle is stationary or traveling under 3 mph (5 km/h). A tone sounds and a warning message appears in the instrument panel. When you slow down, the top operates.

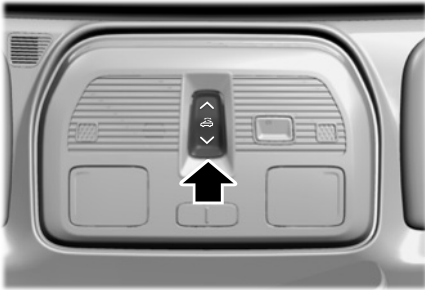

2. Press and hold the convertible top control. When the convertible latch handle is within reach, make sure it is down and that you rotate it clockwise so the latch is in the fully opened position. Continue pressing the convertible top control until the windows completely lower, and the top unfolds and moves forward toward the windshield header.
3. When the top lines up evenly with the windshield header, release the convertible top control.

Latching the Convertible Top

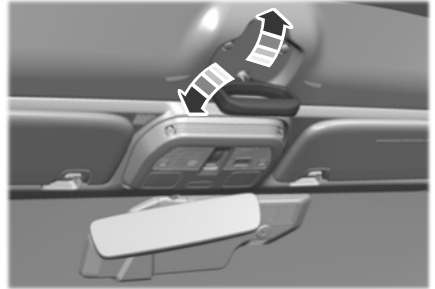

1. Pull down on the latch handle and rotate it counterclockwise to secure the convertible top.
2. After fully securing the convertible top, push the latch handle up into the stowed position to secure the latch.

Note: When you latch or unlatch the convertible top, the audio system briefly mutes. This allows the vehicle to optimize the cabin's sound quality depending on the position of the convertible top.

Note: If you keep the top open for an extended period of time or if the temperature is low, the top material may shrink slightly. If this happens, pull on the latch handle to secure the top.

Driving Hints

COLD WEATHER PRECAUTIONS

The functional operation of some components and systems can be affected at temperatures below approximately -13°F (-25°C).

DRIVING ON SNOW AND ICE



WARNING: If you are driving in slippery conditions that require tire chains or cables, then it is critical that you drive cautiously. Keep speeds down, allow for longer stopping distances and avoid aggressive steering to reduce the chances of a loss of vehicle control which can lead to serious injury or death. If the rear end of your vehicle slides while cornering, steer in the direction of the slide until you regain control of your vehicle.

On ice and snow, you should drive more slowly than usual. Your vehicle has an anti-lock braking system, apply the brake pedal steadily. Do not pump the brake pedal. See **Anti-Lock Braking System Limitations** (page 167).

BREAKING-IN

Your vehicle requires a break-in period. For the first 1,000 mi (1,600 km), avoid driving at high speeds, heavy braking, aggressive shifting or using your vehicle to tow. During this time, your vehicle may exhibit some unusual driving characteristics.

Ground Clearance

Since ground clearance is reduced, use caution when approaching curbs or curb stops from the front and rear as vehicle damage may occur. Additionally, when crossing speed bumps or driveway curbs, you should approach at a 45 degree angle to reduce the risk of vehicle damage.

DRIVING ECONOMICALLY

The following helps to improve fuel consumption:

- Drive smoothly, accelerate gently and anticipate the road ahead to avoid heavy braking.
- Regularly check your tire pressures and make sure that they are inflated to the correct pressure.
- Follow the recommended maintenance schedule and carry out the recommended checks.
- Plan your journey and check the traffic before you set off. It is more efficient to combine errands into a single trip whenever possible.
- Avoid idling the engine in cold weather or for extended periods. Start the engine only when you are ready to set off.
- Do not carry unnecessary weight in your vehicle as extra weight wastes fuel.
- Do not add unnecessary accessories to the exterior of your vehicle, for example running boards. If you use a roof rack, remember to fold it down or remove it when not in use.
- Do not shift into neutral when you are braking or when your vehicle is slowing down.

Driving Hints

- Shut all windows when driving at high speeds.
- Switch off all electric systems when not in use, for example air conditioning. Make sure that you unplug any accessories from the auxiliary power points when not in use.

DRIVING THROUGH SHALLOW WATER - BASE/GT



WARNING: Do not attempt to cross a deep or flowing body of water. Failure to follow this instruction could result in the loss of control of your vehicle, personal injury or death.

Note: *Driving through standing water can cause vehicle damage.*

Note: *Engine damage can occur if water enters the air filter.*

Before driving through standing water, check the depth. Never drive through water that is higher than the bottom of the front rocker area of your vehicle.



When driving through standing water, drive very slowly and do not stop your vehicle. Your brake performance and traction could be limited. After driving through water and as soon as it is safe to do so:

- Lightly press the brake pedal to dry the brakes and to check that they work.
- Turn the steering wheel to check that the steering power assist works.

Check the function of the following:

- Horn
- Exterior lights

DRIVING THROUGH SHALLOW WATER - DARK HORSE



WARNING: Do not attempt to cross a deep or flowing body of water. Failure to follow this instruction could result in the loss of control of your vehicle, personal injury or death.

Note: *Driving through standing water can cause vehicle damage.*

Note: *Engine damage can occur if water enters the air filter.*

Your vehicle has aerodynamic devices attached to the underbody designed to help control airflow for superior performance. Therefore, the driver must be especially careful to avoid driving through deep or standing water. If driving through deep or standing water is unavoidable, do not exceed 10 mph (16 km/h).

Never drive through water that is higher than the bottom of the wheel rims. Water may enter through the air intake due to the vacuum generated in the engine. Your vehicle warranty does not cover damage caused by the intake of water into the engine.

Before driving through standing water, check the depth.

Driving Hints

When driving through standing water, drive very slowly and do not stop your vehicle. Your brake performance and traction could be limited. After driving through water and as soon as it is safe to do so:

- Lightly press the brake pedal to dry the brakes and to check that they work.
- Turn the steering wheel to check that the steering power assist works.

Check the function of the following:

- Horn
- Exterior lights

FLOOR MATS



WARNING: Use a floor mat designed to fit the footwell of your vehicle that does not obstruct the pedal area. Failure to follow this instruction could result in the loss of control of your vehicle, personal injury or death.



WARNING: Pedals that cannot move freely can cause loss of vehicle control and increase the risk of serious personal injury.



WARNING: Secure the floor mat to both retention devices so that it cannot slip out of position and interfere with the pedals. Failure to follow this instruction could result in the loss of control of your vehicle, personal injury or death.



WARNING: Do not place additional floor mats or any other covering on top of the original floor mats. This could result in the floor mat interfering with the operation of the pedals. Failure to follow this instruction could result in the loss of control of your vehicle, personal injury or death.



WARNING: Always make sure that objects cannot fall into the driver foot well while your vehicle is moving. Objects that are loose can become trapped under the pedals causing a loss of vehicle control.



To install floor mats that have eyelets, position the floor mat eyelet over the retention post and press down to lock in position. Repeat for all eyelets on the floor mat.

To remove the floor mats, reverse the installation procedure.

Note: *Regularly check the floor mats to make sure they are secure.*

Crash and Breakdown Information

ROADSIDE ASSISTANCE

Vehicles Sold in the United States: Getting Roadside Assistance

If you have a vehicle concern, Ford Motor Company offers a complimentary roadside assistance program. This program is separate from the New Vehicle Limited Warranty.

The service is available:

- 24 hours a day, seven days a week.
- For the coverage period supplied with your vehicle.

Knowing your vehicle's VIN, mileage and your specific location allows help to get to you faster.

Roadside Assistance covers:

- A flat tire change with a good spare (except vehicles supplied with a tire inflation kit).
- Battery jump start.
- Lock-out assistance (key replacement cost is the customer's responsibility).
- Fuel delivery — independent service contractors, if not prohibited by state, local or municipal law, shall deliver up to 2 gal (8 L) of gasoline or 5 gal (20 L) of diesel fuel to a disabled vehicle. Roadside assistance limits fuel delivery service to two no-charge occurrences within a 12-month period.
- Winch out — available within 100 ft (30 m) of a paved or county maintained road, no recoveries.

- Towing — independent service contractors, if not prohibited by state, local or municipal law, shall tow Ford eligible vehicles to an authorized dealer within 50 mi (80 km) of the disablement location or to the nearest authorized dealer. If a member requests a tow to an authorized dealer that is more than 50 mi (80 km) from the disablement location, the member shall be responsible for any mileage costs in excess of 50 mi (80 km). Warranty towing, non-warranty towing and collision towing are available.
- Roadside Assistance includes up to \$200 for a towed trailer if the disabled eligible vehicle requires service at the nearest authorized dealer. If the towing vehicle is operational but the trailer is not, then the trailer does not qualify for any roadside services.

Vehicles Sold in the United States: Using Roadside Assistance

United States vehicle customers who require Roadside Assistance, call 1-800-241-3673.

If you need to arrange roadside assistance on your own, Ford Motor Company reimburses a reasonable amount for towing to the nearest dealership within 50 mi (80 km). To obtain reimbursement information, United States vehicle customers call 1-800-241-3673. Customers need to submit their original receipts.

Vehicles Sold in Canada: Getting Roadside Assistance

If you have a vehicle concern, Ford Motor Company of Canada, Limited offers a complimentary roadside assistance program. This program is eligible within Canada or the continental United States.

The service is available 24 hours a day, seven days a week.

Crash and Breakdown Information

This program is separate from the New Vehicle Limited Warranty, but the coverage is concurrent with the powertrain coverage period of your vehicle. Canadian roadside coverage and benefits may differ from the U.S. coverage. For complete details, see your Warranty Guide at www.ford.com/support/warranty/.

Download the Sykes4Ford Roadside Assistance App for access to your roadside assistance services. For more information, scan here:



If you require more information, please call us in Canada at 1-800-665-2006, or visit our website at www.ford.ca.

Ford Motor Company reserves the right to modify or discontinue Roadside Assistance at any time. Certain restrictions apply to Roadside Assistance benefits.

For further details, call
1-800-665-2006 (Canada)
1-800-241-3673 (United States)

SWITCHING THE HAZARD FLASHERS ON AND OFF



The hazard flasher button is on the instrument panel. Press the button to switch the hazard flashers on if your vehicle is creating a safety hazard for other road users.

When you switch the hazard flashers on, all front and rear direction indicators flash.

Note: *The hazard flashers operate when the ignition is in any position, or if the key is not in the ignition. The battery loses charge and could have insufficient power to restart your vehicle.*

Press the button again to switch them off.

JUMP STARTING THE VEHICLE

JUMP STARTING PRECAUTIONS



WARNING: Batteries normally produce explosive gases which can cause personal injury. Therefore, do not allow flames, sparks or lighted substances to come near the battery. When working near the battery, always shield your face and protect your eyes. Always provide correct ventilation.



WARNING: Keep batteries out of reach of children. Batteries contain sulfuric acid. Avoid contact with skin, eyes or clothing. Shield your eyes when working near the battery to protect against possible splashing of acid solution. In case of acid contact with skin or eyes, flush immediately with water for a minimum of 15 minutes and get prompt medical attention. If acid is swallowed, call a physician immediately.



WARNING: Use only adequately sized cables with insulated clamps.





WARNING: Make sure that the cables are clear of any moving parts and fuel delivery system parts.





WARNING: Connect batteries with only the same nominal voltage.

Crash and Breakdown Information

 **WARNING:** Using the jump leads incorrectly or completing the jump start procedure incorrectly can cause the battery to explode, which can lead to severe injuries.

 **WARNING:** All work on the vehicle battery and the electrical system can cause serious chemical burns, fire or electric shocks. Always read the warnings and safety information before carrying out any kind of work on the battery.

 **WARNING:** Never charge a 12-volt vehicle battery once it has been frozen. Discharged 12-volt vehicle batteries can even freeze at temperatures of approximately 0°C (+32°F).

 **WARNING:** The battery should be replaced if it is or has ever been frozen.

 **WARNING:** A highly explosive mixture of gases is given off when the vehicle battery is jump started. Always keep fire, sparks, naked flames and lit cigarettes away from the vehicle battery. Never use a mobile telephone when the jump leads are being connected or disconnected.

 **WARNING:** Only charge the battery in a well-ventilated space as the battery emits a highly explosive mixture of gases when the vehicle is being jump started.

 **WARNING:** Never confuse the negative and positive terminals or connect the jump leads incorrectly.

 **WARNING:** Observe the jump lead manufacturer's instructions.

 **WARNING:** If the engine is running while the hood is open, stay clear of moving engine components. Failure to follow this warning could result in serious personal injury or death.

Do not attempt to push-start an automatic transmission vehicle. This could cause transmission damage.

Do not disconnect the battery of the disabled vehicle. This could damage your vehicle's electrical system.

PREPARING THE VEHICLE

Use only a 12 volt supply to start your vehicle.

Park the booster vehicle close to the hood of the disabled vehicle, making sure the two vehicles do not touch.

JUMP STARTING THE VEHICLE

Connecting the Jumper Cables

 **WARNING:** Do not connect the negative jumper cable to any other part of your vehicle. Use the ground point.

Note: If you are using a jump pack or booster box, follow the manufacturer's instructions.

Note: In the illustration that follows, the bottom vehicle represents the booster vehicle.

Crash and Breakdown Information

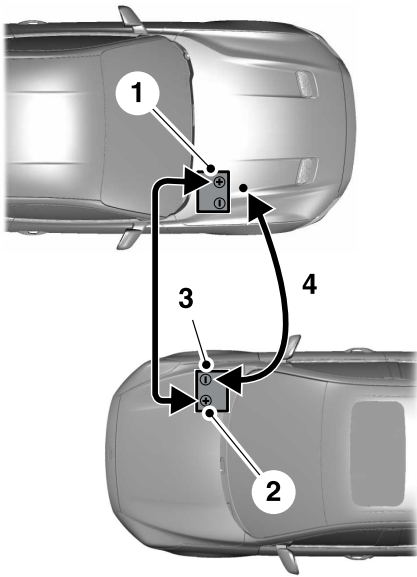

3. Connect the negative (-) jumper cable to the negative (-) terminal of the booster vehicle battery.
4. Make the final connection of the negative (-) jumper cable to the jump start stud, as shown in the following illustration.

Note: Do not use the hood latch as a negative (-) connection point. This could cause springs in the latch to burn and prevent the hood from operating correctly.

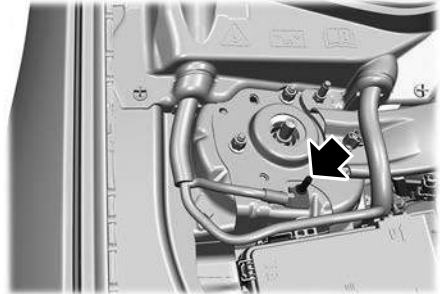

Starting the Engine

1. Start the engine of the booster vehicle and moderately rev the engine, or gently press the accelerator to keep the engine speed between 2000 RPM and 3000 RPM, as shown in your tachometer.
2. Start the engine of the disabled vehicle.
3. Once you start the disabled vehicle, run both vehicle engines for an additional three minutes before disconnecting the jumper cables.

Removing the Jumper Cables

Remove the jumper cables in the reverse order that they were connected.

Note: Do not switch the headlamps on when disconnecting the cables. The peak voltage could blow the bulbs.

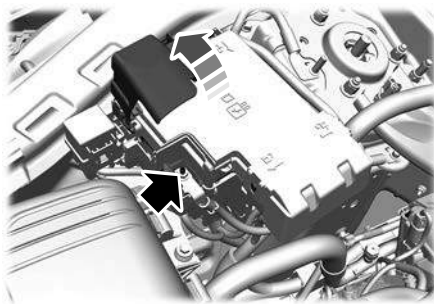

1. Lift the red cap. Connect the positive (+) jumper cable to the positive (+) terminal of the discharged battery.
2. Connect the other end of the positive (+) jumper cable to the positive (+) terminal of the booster vehicle battery.

Crash and Breakdown Information

POST-CRASH ALERT SYSTEM

WHAT IS THE POST-CRASH ALERT SYSTEM

The system helps draw attention to your vehicle in the event of a serious impact.

HOW DOES THE POST-CRASH ALERT SYSTEM WORK

The system is designed to turn the hazard flashers on, turn the courtesy lamps on, intermittently sound the horn and unlock all doors in the event of a serious impact that deploys an airbag or the seatbelt pretensioners.

POST-CRASH ALERT SYSTEM LIMITATIONS

Depending on applicable laws in the country your vehicle was built for, the horn does not sound in the event of a serious impact.

SWITCHING THE POST-CRASH ALERT SYSTEM OFF

Press the hazard flasher switch, the unlock button on the remote control, the panic button on the remote control or cycle the ignition to switch the system off.

Note: *The alert turns off when the vehicle battery runs out of charge.*

POST-COLLISION BRAKING

How Does Post-Collision Braking Work

In the event of a moderate to severe crash, the braking system reduces the vehicle's speed to prevent or reduce the impact of a potential secondary crash.

Post-Collision Braking Limitations

Post-collision braking does not activate if any of the following occur:

- The anti-lock braking system is damaged during the collision.
- Electronic stability control is disabled.

Overriding Post-Collision Braking

You can override post-collision braking by pressing the brake or accelerator pedal.

Post-Collision Braking Indicators



It flashes when a post-collision braking event is occurring.

AUTOMATIC CRASH SHUTOFF

WHAT IS AUTOMATIC CRASH SHUTOFF

The automatic crash shutoff is designed to stop the fuel going to the engine in the event of a moderate or severe crash.

Note: *Not every impact causes a shutoff.*

AUTOMATIC CRASH SHUTOFF PRECAUTIONS



WARNING: If your vehicle has been involved in a crash, have the fuel system checked. Failure to follow this instruction could result in fire, personal injury or death.

RE-ENABLING YOUR VEHICLE

1. Switch the ignition off.
2. Attempt to start your vehicle.
3. Switch the ignition off.

Crash and Breakdown Information

4. Attempt to start your vehicle.

Note: If your vehicle does not start after the third attempt, have your vehicle checked as soon as possible.

RECOVERY TOWING

ACCESSING THE FRONT TOWING POINT - VEHICLES WITH: ECOBOOST™ PERFORMANCE PACKAGE/GT PERFORMANCE PACKAGE

There is an installation point for the recovery hook behind the fascia.

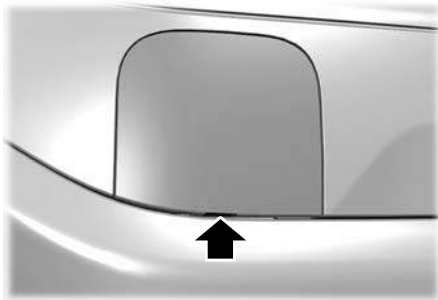

1. Insert a suitable tool into the hole on the underside of the cover.
2. Carefully pry off the cover.

LOCATING THE TOWING EYE

If your vehicle is equipped with a screw-in recovery hook, it is with the spare tire kit.

INSTALLING THE TOWING EYE

Insert the recovery hook into the installation point and turn it counterclockwise. Make sure that you fully tighten the recovery hook.

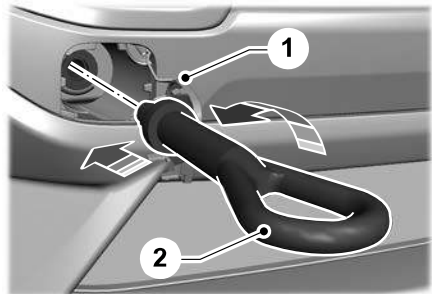

Note: The screw-in recovery hook has a left-hand thread.

TRANSPORTING THE VEHICLE

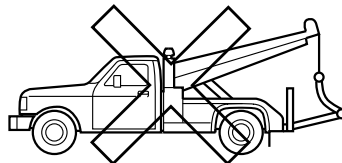
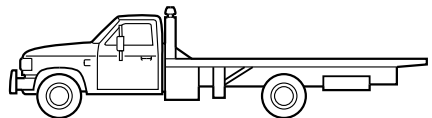
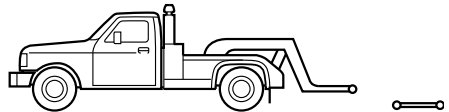

Crash and Breakdown Information

If you need to tow your vehicle, contact a professional towing service or your roadside assistance service provider.

Your manufacturer produces a towing manual for all authorized tow truck operators. Have your tow truck operator refer to this manual for proper hook-up and towing procedures.

We recommend the use of a wheel lift and dollies or flatbed equipment to tow your vehicle. Vehicle damage could occur if towed incorrectly, or by any other means.

Front-wheel and rear-wheel drive vehicles must have their designated drive wheels off the ground regardless of towing direction. Use tow dollies to prevent damage to the transmission.

The front wheels must be on tow dollies when towing your vehicle from the rear using wheel lift equipment. This prevents damage to the front fascia.

TRANSPORTING THE VEHICLE - DARK HORSE

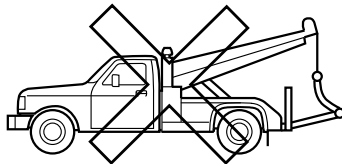
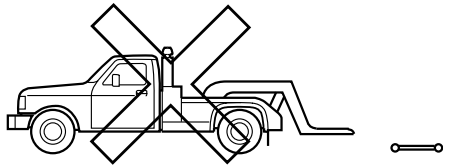
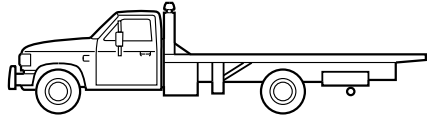

If you need to have your vehicle towed, contact your roadside assistance center or a professional towing service.

We recommend towing your vehicle with flatbed equipment only. When towing with a flatbed, race ramps or wood ramps must be used when loading or unloading your vehicle. Tire slings are required when flatbed towing.

Note: Do not tow with a sling belt or wheel lift equipment.

Note: If your vehicle is towed incorrectly or by any other means, vehicle damage may occur.

Crash and Breakdown Information

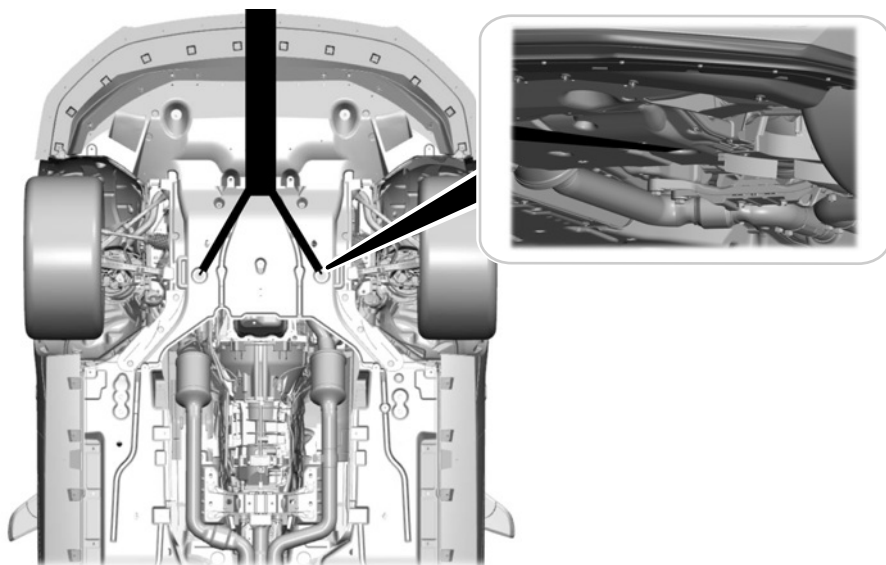

Use two mini J hooks when having your vehicle towed. Attach the hooks to the holes as shown to winch the vehicle onto the flatbed. Only use tire slings to tie the vehicle down to the flatbed. Other methods may damage the vehicle.

Crash and Breakdown Information

Preferred Flatbed Method

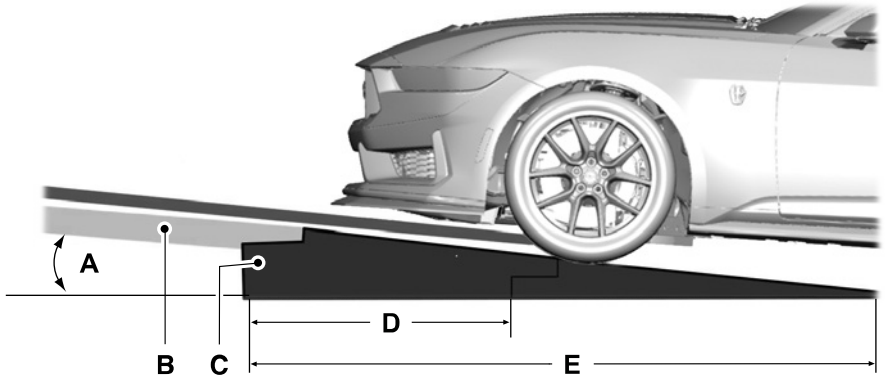

- A Seven degrees maximum.
- B Tow vehicle ramp.
- C Race ramps.
- D 30 in (76 cm) minimum.
- E 70 in (178 cm) minimum.

Use race ramps to load the vehicle.

The diagram illustrates the maximum ramp angle allowable to load your vehicle on a flatbed. Vehicle damage may occur with greater angles.

Ramps must be used to achieve appropriate undercarriage clearances.

Crash and Breakdown Information

Alternate Flatbed Method

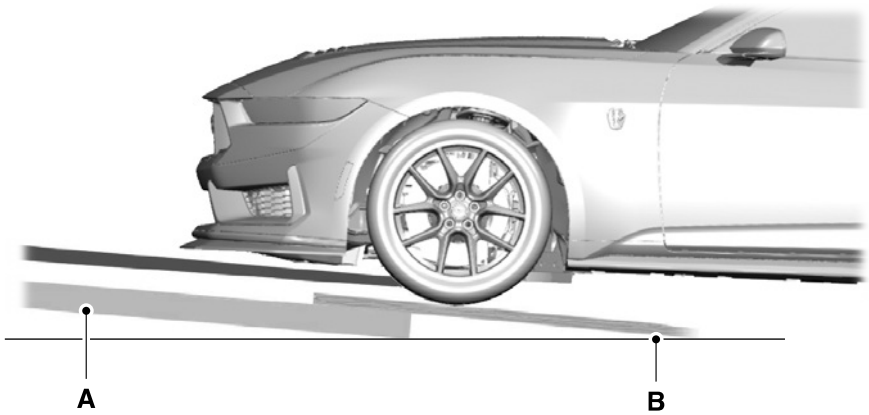

- A Tow vehicle ramp.
- B Wooden ramp.

Use 2 in (5 cm) by 8 in (20 cm) by 8 ft (2.5 m) wooden ramps to load the vehicle.

The diagram illustrates the maximum ramp angle allowable to load your vehicle on a flatbed. Vehicle damage may occur with greater angles.

Ramps must be used to achieve appropriate undercarriage clearances.

Transporting or Trailering - Dark Horse Handling Package (If Equipped)

Due to low ground clearance, your vehicle is transported from the assembly plant to the dealer with front suspension spacers installed. These are removed by the dealer prior to customer delivery and are provided with the vehicle. If you plan to transport or trailer your vehicle and need additional clearance, the spacers may be reinstalled for additional underbody clearance.

Note: Suspension spacers must be removed before driving your vehicle. Failure to remove the spacers may cause damage to suspension components and degrade vehicle performance.

Note: It is only possible for you to install or remove the suspension spacers while the vehicle is raised in the air.

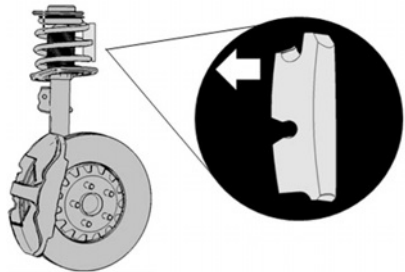

Crash and Breakdown Information

Front Suspension

Insert the top of the spring spacer onto the spring first, then snap the bottom of the spacer into place.

FAIL-SAFE COOLING

WHAT IS FAIL-SAFE COOLING

Fail-safe cooling allows you to temporarily drive your vehicle before any incremental component damage occurs due to overheating.

The fail-safe distance depends on outside temperature, vehicle load and terrain.

HOW DOES FAIL-SAFE COOLING WORK

If the engine reaches a preset over-temperature condition, the engine automatically switches to alternating cylinder operation. Each disabled cylinder acts as an air pump and cools the engine.

When this occurs, your vehicle still operates, however:

- Engine power is limited.
- The air conditioning system turns off.

Continued operation increases the engine temperature, causing the engine to completely shut down. Your steering and braking effort increases in this situation.

When the engine temperature cools, you can re-start the engine.

Note: *Have your vehicle checked as soon as possible to minimize engine damage.*

DRIVING WHEN FAIL-SAFE MODE IS ACTIVATED



WARNING: Fail-safe mode is for use during emergencies only. Operate your vehicle in fail-safe mode only as long as necessary to bring your vehicle to rest in a safe location and seek immediate repairs. When in fail-safe mode, your vehicle will have limited power, will not be able to maintain high-speed operation, and may completely shut down without warning, potentially losing engine power, power steering assist, and power brake assist, which may increase the possibility of a crash resulting in serious injury.



WARNING: Do not remove the coolant reservoir cap when the engine is on or the cooling system is hot. Wait 10 minutes for the cooling system to cool down. Cover the coolant reservoir cap with a thick cloth to prevent the possibility of scalding and slowly remove the cap. Failure to follow this instruction could result in personal injury.

Continued operation increases the engine temperature, causing the engine to completely shut down. Your steering and braking effort increases in this situation.

When the engine temperature cools, you can re-start the engine. Have your vehicle checked as soon as possible to minimize engine damage.

Your vehicle has limited engine power when in the fail-safe mode, drive your vehicle with caution. Your vehicle does not maintain high-speed operation and the engine may operate poorly.

Remember that the engine is capable of automatically shutting down to prevent engine damage. In this situation:

Crash and Breakdown Information

1. Pull off the road as soon as safely possible and switch the engine off.
2. If you are a member of a roadside assistance program, we recommend that you contact your roadside assistance service provider.
3. If this is not possible, wait for a short period of time for the engine to cool.
4. Check the coolant level. If the coolant level is at or below the minimum mark, add prediluted coolant immediately.
5. When the engine temperature cools, you can re-start the engine. Have your vehicle checked as soon as possible to minimize engine damage.

Note: *Driving your vehicle without repair increases the chance of engine damage.*

FAIL-SAFE COOLING INDICATORS



If the engine begins to overheat, the coolant temperature gauge moves toward the red zone.



A warning lamp illuminates and a message may appear in the instrument cluster display.

Towing Your Vehicle

TOWING YOUR VEHICLE PRECAUTIONS

Use the following guidelines when towing your vehicle. Failure to follow this instruction could result in vehicle damage not covered by the vehicle warranty.

Note: *Make sure you properly secure your vehicle to the tow vehicle.*

Note: *If you are unsure of the vehicle's configuration, contact an authorized dealer.*

RECREATIONALLY TOWING YOUR VEHICLE

You cannot recreational tow your vehicle with all wheels on the ground because vehicle or transmission damage could occur. You must recreational tow your vehicle with all four wheels off the ground, such as when using a car-hauling trailer. Otherwise, you cannot recreational tow your vehicle.

EMERGENCY TOWING

If your vehicle becomes inoperable without access to wheel dollies or a vehicle transport trailer, it can be flat-towed with all wheels on the ground, regardless of the powertrain and transmission configuration, under the following conditions:

- Your vehicle is facing forward for towing in a forward direction.
- Place the transmission in neutral (N). If you cannot move the transmission into neutral (N), you may need to override it. See **Shifting Your Immobile Vehicle Out of Park (P)** (page 162).
- Maximum speed is 35 mph (56 km/h).
- Maximum distance is 50 mi (80 km).

Fuses

FUSE PRECAUTIONS



WARNING: Always disconnect the battery before servicing high current fuses.



WARNING: To reduce risk of electrical shock, always replace the cover to the power distribution box before reconnecting the battery or refilling fluid reservoirs.



WARNING: Always replace a fuse with one that has the specified amperage rating. Using a fuse with a higher amperage rating can cause severe wire damage and could start a fire.

UNDER HOOD FUSE BOX

LOCATING THE UNDER HOOD FUSE BOX

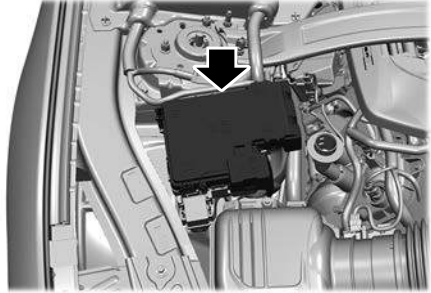

ACCESSING THE UNDER HOOD FUSE BOX

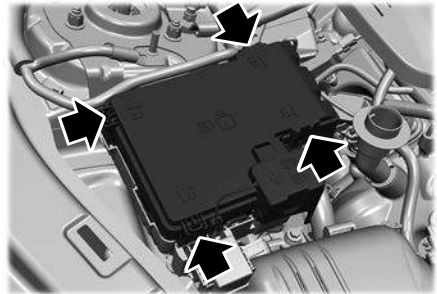

Fuses

IDENTIFYING THE FUSES IN THE UNDER HOOD FUSE BOX

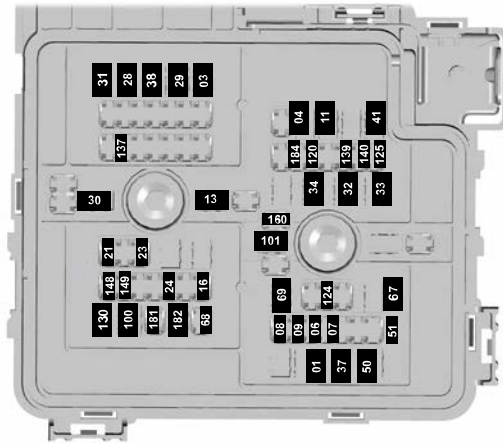

Item	Rating	Protected Component
1	40 A	Body control module 1.
3	30 A	Body control module 2.
4	40 A	Fuel pump.
6	15 A	Vehicle power 1.
7	30 A	Vehicle power 2.
8	15 A	Vehicle power 3.
9	20 A	Vehicle power 4.
11	30 A	Starter motor.
13	40 A	Blower motor.
16	10 A	Decklid release.
21	10 A	Not used (spare).
23	10 A	Automatic brake system module.
24	10 A	Powertrain control module.

Fuses

Item	Rating	Protected Component
		Electronic power assist steering.
28	40 A	Automatic brake system valve.
29	60 A	Automatic brake system pump.
30	40 A	Driver power seat. Driver seat module.
31	30 A	Passenger power seat.
32	20 A	Power point 1.
33	20 A	Power point 2.
34	20 A	Not used (spare).
35	30 A	Not used (spare).
37	20 A	Convertible top motor - left-hand side.
38	30 A	Climate controlled seat.
41	20 A	Convertible top motor - right-hand side.
50	40 A	Heated rear window.
51	10 A	Heated exterior mirror.
67	20 A	Transmission fluid pump.
68	20 A	Electronic steering column lock.
69	30 A	Wiper motor.
100	15 A	Left-hand headlamps.
101	15 A	Right-hand headlamps.
120	15 A	Fuel injectors.
124	5 A	Rain sensor.
125	5 A	Not used (spare).
130	20 A	Differential pump.

Fuses

Item	Rating	Protected Component
137	10 A	Advanced driver assistance module.
139	5 A	USB charge port 2.
140	10 A	Not used (spare).
148	10 A	Left-hand tail lamp.
149	5 A	Right-hand tail lamp.
160	10 A	On-board diagnostic connector. Gateway module.
181	5 A	Headlamp control module.
182	30 A	Body control module.
184	7.5 A	Wireless accessory charging module.

BODY CONTROL MODULE FUSE BOX

LOCATING THE BODY CONTROL MODULE FUSE BOX

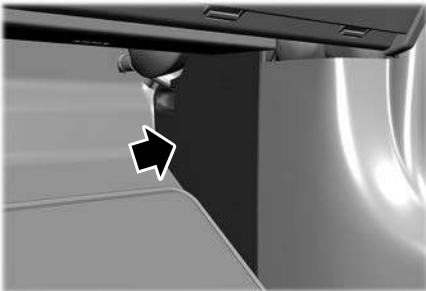

ACCESSING THE BODY CONTROL MODULE FUSE BOX

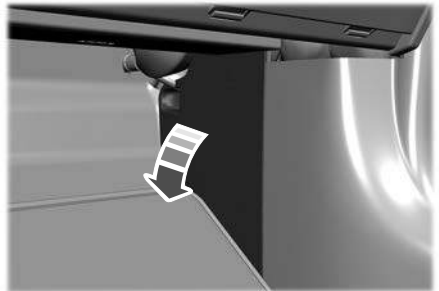

Fuses

IDENTIFYING THE FUSES IN THE BODY CONTROL MODULE FUSE BOX

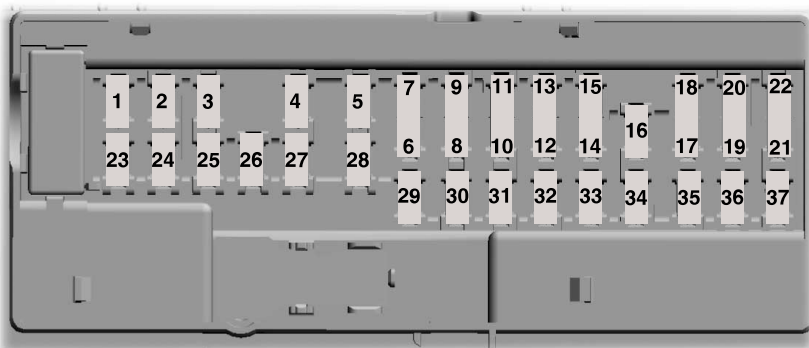

Item	Rating	Protected Component
1	—	Not used.
2	10 A	Power windows.
3	7.5 A	Not used (spare).
4	20 A	Amplifier.
5	—	Not used.
6	10 A	Not used (spare).
7	10 A	Auxiliary body module.
8	5 A	Telematics control unit module.
9	5 A	Intrusion sensor module. Performance electric parking brake.
10	—	Not used.
11	—	Not used.
12	7.5 A	Climate control module.

Fuses

Item	Rating	Protected Component
13	7.5 A	Steering column control module. Instrument cluster display.
14	15 A	Not used (spare).
15	15 A	SYNC.
16	—	Not used.
17	7.5 A	Not used (spare).
18	7.5 A	Not used (spare).
19	5 A	Headlamp switch.
20	5 A	Push button ignition switch.
21	5 A	Not used (spare).
22	5 A	Vehicle dynamics module.
23	30 A	Driver door module. Driver door window.
24	30 A	Vehicle dynamics module.
25	20 A	Amplifier.
26	30 A	Passenger door module. Passenger door window.
27	30 A	Left-hand rear window power (convertible).
28	30 A	Right-hand rear window power (convertible).
29	15 A	Instrument cluster module.
30	5 A	Not used (spare).
31	10 A	SYNC display screen. Integrated control panel. Gateway module. Remote keyless entry.
32	20 A	Audio unit.
33	—	Not used.
34	30 A	Run/start relay.

Fuses

Item	Rating	Protected Component
35	5 A	Auxiliary body module.
36	15 A	Not used (spare).
37	20 A	Auto-dimming interior mirror. Heated steering wheel.

HIGH CURRENT FUSE BOX

LOCATING THE HIGH CURRENT FUSE BOX

To locate the fuses in the high current fuse box, contact an authorized dealer.

ACCESSING THE HIGH CURRENT FUSE BOX

To access the fuses in the high current fuse box, contact an authorized dealer.

IDENTIFYING THE FUSES IN THE HIGH CURRENT FUSE BOX

To identify the fuses in the high current fuse box, contact an authorized dealer.

IDENTIFYING FUSE TYPES

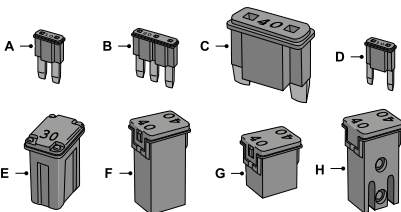

- A Micro 2.
- B Micro 3.

- C Maxi.
- D Mini.
- E M Case.
- F J Case.
- G J Case Low Profile.
- H Slotted M Case.

FUSES – TROUBLESHOOTING

FUSES – FREQUENTLY ASKED QUESTIONS

When do I need to check a fuse?

- If electrical components in the vehicle are not working.

When do I need to replace a fuse?

- If a fuse has blown.

How do I identify a blown fuse?

- You can identify a blown fuse by a broken wire within the fuse.

Maintenance

MAINTENANCE PRECAUTIONS

Service your vehicle regularly to help maintain its roadworthiness and resale value. There is a large network of authorized dealers that are there to help you with their professional servicing expertise. We believe that their specially trained technicians are best qualified to service your vehicle properly and expertly. They are supported by a wide range of highly specialized tools developed specifically for servicing your vehicle.

If your vehicle requires professional service, an authorized dealer can provide the necessary parts and service. Check your warranty information to find out which parts and services are covered.

Use only recommended fuels, lubricants, fluids and service parts conforming to specifications.

- Do not work on a hot engine.
- Make sure that nothing gets caught in moving parts.
- Do not work on a vehicle with the engine running in an enclosed space, unless you are sure you have enough ventilation.
- Keep all open flames and other burning material, such as cigarettes, away from the battery and all fuel related parts.
- Set the parking brake, shift the transmission to park (P) and block the wheels.

OPENING AND CLOSING THE HOOD

Opening the Hood



1. Inside the vehicle, pull the hood release handle located under the left-hand side of the instrument panel.
2. Slightly lift the hood.

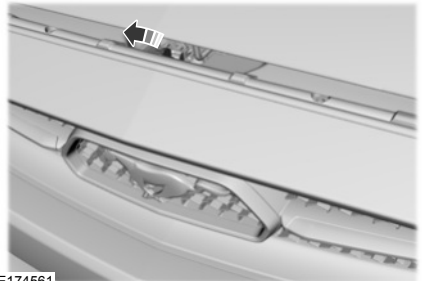

E174561

3. Release the hood latch by pushing the secondary release lever to your left-hand side.
4. Open the hood. The hood struts automatically support the hood.

Closing the Hood

Lower the hood and make sure it fully latches.

Maintenance

Note: Make sure that the hood is correctly closed.

Warning Lamps and Indicators

Hood Ajar



It illuminates when the ignition is on and the hood is not completely closed.

UNDER HOOD OVERVIEW - 2.3L ECOBOOST™

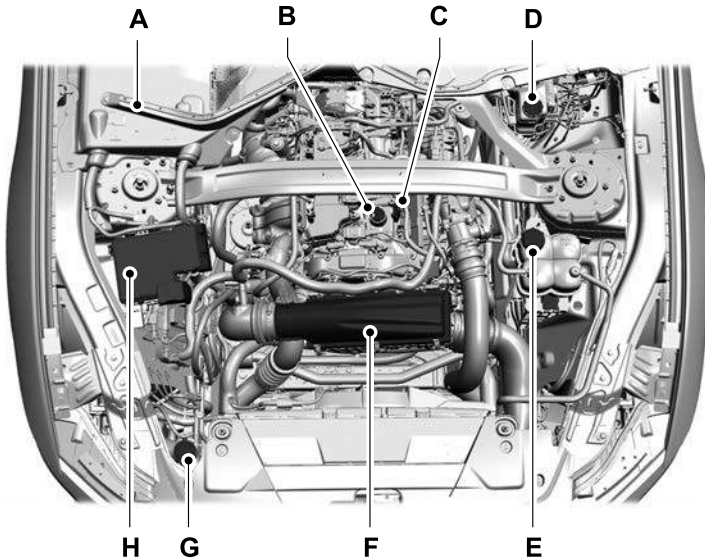

- A Battery (out of view). See **Changing the 12V Battery** (page 304).
- B Engine oil filler cap. See **Checking the Engine Oil Level** (page 290).
- C Engine oil dipstick. See **Engine Oil Dipstick Overview** (page 290).
- D Brake fluid reservoir. See **Checking the Brake Fluid** (page 167).
- E Engine coolant reservoir. See **Checking the Coolant Level** (page 296).
- F Air filter assembly. See **Changing the Engine Air Filter** (page 295).

Maintenance

- G Windshield washer fluid reservoir. See **Adding Washer Fluid** (page 85).
- H Power distribution box. See **Fuses** (page 280).

UNDER HOOD OVERVIEW - 5.0L

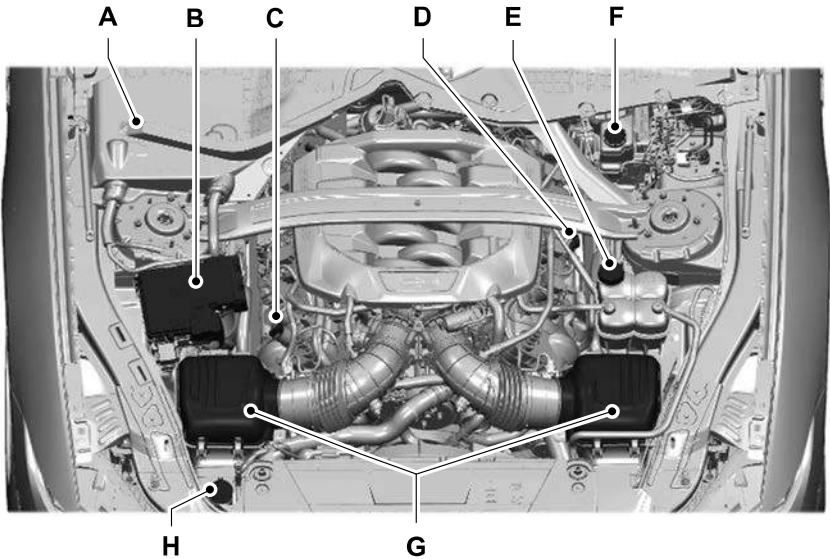

- A. Battery (out of view). See **Changing the 12V Battery** (page 304).
- B. Engine compartment fuse box. See **Fuses** (page 280).
- C. Engine oil filler cap. See **Adding Engine Oil** (page 290).
- D. Engine oil dipstick. See **Checking the Engine Oil Level** (page 290).
- E. Engine coolant reservoir. See **Checking the Coolant Level** (page 296).
- F. Brake fluid reservoir. See **Checking the Brake Fluid** (page 167).
- G. Air filter. See **Changing the Engine Air Filter** (page 295).
- H. Washer system fluid reservoir. See **Adding Washer Fluid** (page 85).

Maintenance

ENGINE OIL

ENGINE OIL DIPSTICK OVERVIEW

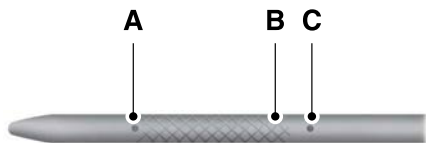

- A Minimum.
- B Nominal.
- C Maximum.

CHECKING THE ENGINE OIL LEVEL

1. Make sure that your vehicle is on level ground.
2. Check the oil level before starting the engine, or switch the engine off after warm up and wait 15 minutes for the oil to drain into the oil pan.

Note: *Checking the oil level too soon could result in an inaccurate reading.*

3. Remove the dipstick and wipe it with a clean, lint-free cloth.
4. Reinstall the dipstick and make sure it is fully seated.
5. Remove the dipstick again to check the oil level.

Note: *Read both sides of the dipstick and use the lowest oil level as the correct reading.*

Note: *If the oil level is between the maximum and minimum marks, the oil level is acceptable. Do not add oil.*

6. If the oil level is at the minimum mark, immediately add oil.
7. Reinstall the dipstick. Make sure it is fully seated.

Note: *The oil consumption of new engines reaches its normal level after approximately 3,000 mi (5,000 km).*

Note: *Increases in oil level can occur from frequent short trips that do not allow the engine to get to operating temperature, as well as frequent idling or low speed driving for long periods of time.*

Note: *If oil levels are continuously noted above the maximum mark, have your vehicle checked as soon as possible.*

ADDING ENGINE OIL



WARNING: Do not remove the filler cap when the engine is running.



WARNING: Do not add engine oil when the engine is hot. Failure to follow this instruction could result in personal injury.

Do not use supplemental engine oil additives because they are unnecessary and could lead to engine damage that the vehicle warranty may not cover.

1. Clean the area surrounding the engine oil filler cap before you remove it.
2. Remove the engine oil filler cap.
3. Add engine oil that meets our specifications. See **Engine Oil** (page 291).
4. Reinstall the engine oil filler cap. Turn it clockwise until you feel a strong resistance.

Maintenance

Note: Do not add oil further than the maximum mark. Oil levels above the maximum mark may cause engine damage.

Note: Immediately soak up any oil spillage with an absorbent cloth.

INTELLIGENT OIL LIFE MONITOR

Under certain conditions the vehicle's intelligent oil life monitor may determine your oil requires replacement prior to your general service. Should this occur it is recommended you replace your oil within two weeks or 500 mi (800 km) of being alerted.

Your authorized dealer will be able to advise you whether only an engine oil and filter change is recommended or whether you should complete your general service inclusive of oil and oil filter.

RESETTING THE INTELLIGENT OIL LIFE MONITOR

1. Press **Settings** on the touchscreen.
2. Press **Vehicle Settings**.
3. Select **Oil Life**.
4. Press and hold the **OK** button until the system reset confirmation appears.

ENGINE OIL CAPACITY AND SPECIFICATION - 2.3L

Use oil that meets the defined specification and viscosity grade.

Capacities

Variant	Including the Oil Filter
All.	5.7 qt (5.4 L)

When tracking your vehicle, oil change information and intervals are in the Track Use chapter. See **Track Use** (page 313).

If you do not use oil that meets the defined specification and viscosity grade, it could result in:

- Component damage that your vehicle warranty does not cover.
- Longer engine cranking periods.
- Increased emission levels.
- Reduced vehicle performance.
- Reduced fuel economy.



An oil that displays this symbol conforms to current engine, emission system and fuel economy performance standards of ILSAC.

We recommend Motorcraft® motor oil for your vehicle. If Motorcraft® oil is not available, use motor oils of the recommended viscosity grade that display the API Certification Mark for gasoline engines.

Do not use supplemental engine oil additives because they are unnecessary and could lead to engine damage that your vehicle warranty does not cover.

Maintenance

Materials

Name	Specification
Motorcraft® SAE 5W-30 Motor Oil (U.S.) Motorcraft® SAE 5W-30 Motor Oil / Huile moteur SAE 5W-30 Motorcraft® (Canada) XO-5W30-Q1SP, XO-5W30-Q1FS (U.S.) CXO-5W30-LSP6, CXO-5W30-LFS6 (Canada)	WSS-M2C961-A1

Alternative Engine Oil for Extremely Cold Climates

To improve engine cold start performance, we recommend that you use the following alternative engine oil in extremely cold climates, where the ambient temperature reaches -22.0°F (-30°C) or below.

Materials

Name	Specification
Engine Oil - SAE 0W-30	WSS-M2C963-A1

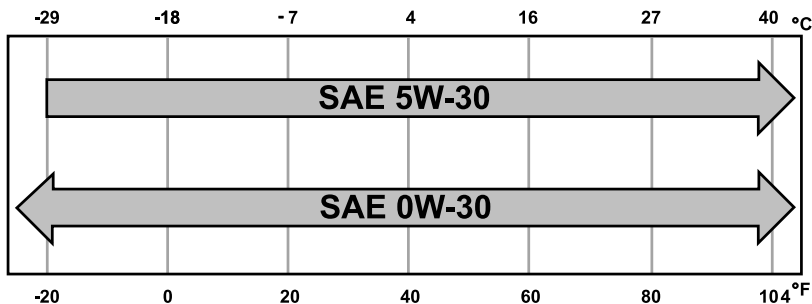

Note: If you use your vehicle regularly above the altitude of 5,000 ft (1,524 m) and under the temperature of -4.0°F (-20°C), it is recommended to use the alternative engine oil.

Maintenance

ENGINE OIL CAPACITY AND SPECIFICATION - 5.0L

Use oil that meets the defined specification and viscosity grade.

If you do not use oil that meets the defined specification and viscosity grade, it could result in:

- Component damage that your vehicle warranty does not cover.
- Longer engine cranking periods.
- Increased emission levels.
- Reduced vehicle performance.
- Reduced fuel economy.



An oil that displays this symbol conforms to current engine, emission system and fuel economy performance standards of ILSAC.

We recommend Motorcraft® motor oil for your vehicle. If Motorcraft® oil is not available, use motor oils of the recommended viscosity grade that display the API Certification Mark for gasoline engines.

Do not use supplemental engine oil additives because they are unnecessary and could lead to engine damage that your vehicle warranty does not cover.

Capacities

Variant	Including the Oil Filter
5.0L	9.5 qt (9 L)

Materials

Name	Specification
Motorcraft® SAE 5W-30 Motor Oil(U.S.) Motorcraft® SAE 5W-30 Motor Oil / Huile moteur SAE 5W-30 Motorcraft®(Canada) XO-5W30-Q1SP, XO-5W30-Q1FS(U.S.) CXO-5W30-LSP6, CXO-5W30-LFS6(Canada)	WSS-M2C961-A1

Maintenance

Alternative Engine Oil for Extremely Cold Climates

To improve engine cold start performance,

use the following engine oil in climates where the ambient temperature reaches -22.0°F (-30°C) or below.

Materials

Name	Specification
Engine Oil - SAE 0W-30	WSS-M2C963-A1

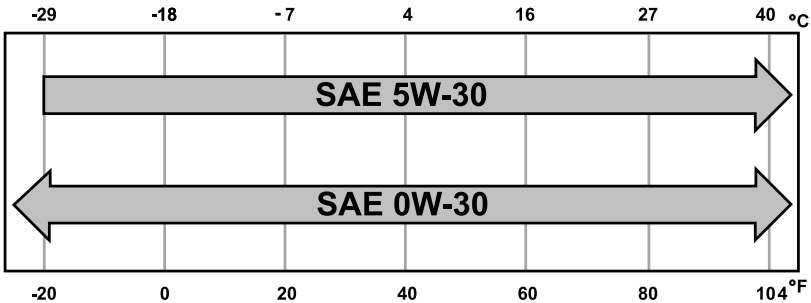

Note: If you use your vehicle regularly above the altitude of 5,000 ft (1,524 m) and under the temperature of -4.0°F (-20°C), it is recommended to use the alternative engine oil.

ENGINE AIR FILTER

CHANGING THE ENGINE AIR FILTER - 2.3L ECOBOOST™



WARNING: To reduce the risk of vehicle damage and personal burn injuries, do not start your engine with the air cleaner removed and do not remove it while the engine is running.

Change the air filter element at the proper intervals. See **Scheduled Maintenance** (page 423).

When changing the air filter element, use only the air filter element listed. See **Motorcraft Parts** (page 311).

Note: Failure to use the correct air filter element could result in severe engine damage that the vehicle warranty may not cover.

Note: When servicing the air cleaner, do not allow foreign material to enter the air induction system. The engine is susceptible to damage from even small particles.

Maintenance

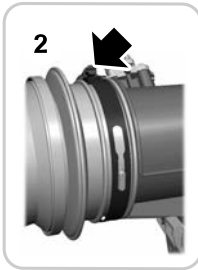

1. Remove the clips that secure the air filter housing cover.
2. Using a screwdriver, loosen the clamp of the air filter housing cover.
3. Gently pull the boot back away from the air filter housing cover.
4. Carefully lift the air filter housing cover from the air filter housing assembly.
5. Remove the air filter element from the air filter housing.
6. Wipe any dirt or debris from the air filter housing and cover to make sure no dirt gets in the engine and that you have a good seal.

7. Install a new air filter element. Be careful not to crimp the filter element edges between the air filter housing and cover. This could cause filter damage and allow unfiltered air to enter the engine if it is not properly seated.
8. Install the air filter housing cover.
9. Engage the clips to secure the air filter housing cover to the air filter housing.
10. Reconnect the boot on the air filter housing cover and torque to 3.54 lb.ft (4.8 Nm).

CHANGING THE ENGINE AIR FILTER - 5.0L



WARNING: To reduce the risk of vehicle damage and personal burn injuries, do not start your engine with the air cleaner removed and do not remove it while the engine is running.

Change the air filter element at the proper intervals. See **Scheduled Maintenance** (page 423).

When changing the air filter element, use only the air filter element listed. See **Vehicle Specifications** (page 309).

Note: *Failure to use the correct air filter element could result in severe engine damage that the vehicle Warranty may not cover.*

Note: *When servicing the air cleaner, do not allow foreign material to enter the air induction system. The engine is susceptible to damage from even small particles.*

Maintenance

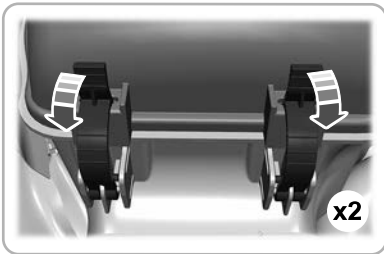

1. Release the clips that secure the air filter cover to the housing.
2. Carefully lift the air filter housing cover.

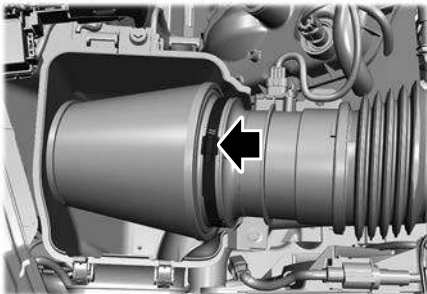

3. Loosen the clamp that secures the air filter to the air duct.
4. Remove the air filter element from the air filter housing.

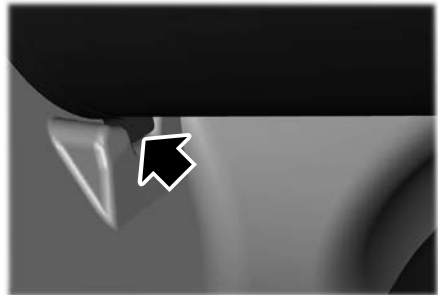

5. To install, reverse the removal procedure.

Note: Ensure that the tab on the bottom of the filter is properly seated to the notch in the housing.

6. Repeat the procedure with the second air filter assembly.

COOLANT

CHECKING THE COOLANT LEVEL



WARNING: Do not remove the coolant reservoir cap when the engine is on or the cooling system is hot. Wait 10 minutes for the cooling system to cool down. Cover the coolant reservoir cap with a thick cloth to prevent the possibility of scalding and slowly remove the cap. Failure to follow this instruction could result in personal injury.



WARNING: To reduce the risk of personal injury, make sure the engine is cool before unscrewing the coolant pressure relief cap. The cooling system is under pressure. Steam and hot liquid can come out forcefully when you loosen the cap slightly.

Maintenance

When the engine is cold, check the concentration and level of the coolant at the intervals listed in the scheduled maintenance information. See **Scheduled Maintenance** (page 423).

Note: Make sure that the coolant level is between the **MIN** and the **MAX** marks on the coolant reservoir.

Note: Coolant expands when it is hot. The level may extend beyond the **MAX** mark. This is normal.

Maintain coolant concentration within 48% to 50%, which equates to a freeze point between -29°F (-34°C) and -35°F (-37°C). Coolant concentration should be checked using a refractometer. We do not recommend the use of hydrometers or coolant test strips for measuring coolant concentration.

ADDING COOLANT



WARNING: Do not add coolant when the vehicle is on or the cooling system is hot. Failure to follow this instruction could result in personal injury.



WARNING: Do not remove the coolant reservoir cap when the engine is on or the cooling system is hot. Wait 10 minutes for the cooling system to cool down. Cover the coolant reservoir cap with a thick cloth to prevent the possibility of scalding and slowly remove the cap. Failure to follow this instruction could result in personal injury.



WARNING: Do not allow the fluid to touch your skin or eyes. If this happens, rinse the affected areas immediately with plenty of water and contact your physician.



WARNING: Do not put coolant in the windshield washer reservoir. If sprayed on the windshield, coolant could make it difficult to see through the windshield.



WARNING: Do not add coolant further than the **MAX** mark.

Note: Do not use stop leak pellets, cooling system sealants, or non-specified additives as they can cause damage to the engine cooling or heating systems. Resulting component damage may not be covered by the vehicle Warranty.

Note: Automotive fluids are not interchangeable.

It is very important to use prediluted coolant approved to the correct specification in order to avoid plugging the small passageways in the engine cooling system. See **Coolant** (page 300). Do not mix different colors or types of coolant in your vehicle. Mixing of engine coolants or using an incorrect coolant may harm the engine or cooling system components and may not be covered by the vehicle Warranty.

Note: If prediluted coolant is not available, use the approved concentrated coolant diluting it to 50/50 with deionised or distilled water. See **Coolant** (page 300). Using water that has not been deionised may contribute to deposit formation, corrosion and plugging of the small cooling system passageways.

Note: Coolants marketed for all makes and models may not be approved to our specifications and may cause damage to the cooling system. Resulting component damage may not be covered by the vehicle Warranty.

Maintenance

If the coolant level is at or below the minimum mark, add prediluted coolant immediately.

To top up the coolant level do the following:

1. Unscrew the cap slowly. Any pressure escapes as you unscrew the cap.
2. Add prediluted coolant approved to the correct specification. See **Coolant** (page 300).
3. Add enough prediluted coolant to reach the correct level.
4. Replace the coolant reservoir cap. Turn the cap clockwise until it contacts the hard stop.
5. Check the coolant level in the coolant reservoir the next few times you drive your vehicle. If necessary, add enough prediluted engine coolant to bring the coolant level to the correct level.

If you have to add more than 1.1 qt (1 L) of engine coolant per month, have your vehicle checked as soon as possible. Operating an engine with a low level of coolant can result in engine overheating and possible engine damage.

In case of emergency, you can add a large amount of water without engine coolant in order to reach a vehicle service location.

Water alone, without engine coolant, can cause engine damage from corrosion, overheating or freezing.

Do not use the following as a coolant substitute:

- Alcohol.
- Methanol.
- Brine.
- Any coolant mixed with alcohol or methanol antifreeze.

Alcohol and other liquids can cause engine damage from overheating or freezing.

Do not add extra inhibitors or additives to the coolant. These can be harmful and compromise the corrosion protection of the coolant.

CHANGING THE COOLANT

For coolant change, see your authorized dealer.

Changing the coolant is necessary at specific mileage intervals listed in the scheduled maintenance information. See **Scheduled Maintenance** (page 423).

MANAGING THE COOLANT TEMPERATURE

If you tow a trailer with your vehicle, the engine may temporarily reach a higher temperature during severe operating conditions, for example ascending a long or steep grade in high ambient temperatures.

At this time, you may notice the coolant temperature gauge moves toward the red zone and a message may appear in the information display.



WARNING: To reduce the risk of crash and injury, be prepared that the vehicle speed may reduce and the vehicle may not be able to accelerate with full power until the coolant temperature reduces.



WARNING: If you continue to drive your vehicle when the engine is overheating, the engine could stop without warning. Failure to follow this instruction could result in the loss of control of your vehicle.

Maintenance

You may notice a reduction in vehicle speed caused by reduced engine power in order to manage the engine coolant temperature. Your vehicle may enter this mode if certain high-temperature and high-load conditions take place. The amount of speed reduction depends on vehicle loading, grade and outside temperature. If this occurs, there is no need to stop your vehicle. You can continue to drive. See **Fail-Safe Cooling** (page 277).

The air conditioning may automatically turn on and off during severe operating conditions to protect the engine from overheating. When the coolant temperature decreases to the normal operating temperature, the air conditioning turns on.

If the coolant temperature gauge moves fully into the red zone, or if the coolant temperature warning or service engine soon messages appear in your information display, do the following:

1. Stop your vehicle as soon as it is safe to do so. Fully apply the parking brake, shift into park (P) or neutral (N).

2. Leave the engine running until the coolant temperature gauge needle returns to the normal position. If the temperature does not drop after several minutes, follow the remaining steps.
3. Switch the engine off and wait for it to cool. Check the coolant level.
4. If the coolant level is at or below the minimum mark, add prediluted coolant immediately.
5. If the coolant level is normal, restart the engine and continue.

COOLING SYSTEM CAPACITY AND SPECIFICATION - 2.3L

Use coolant that meets the defined specification.

If you do not use coolant that meets the defined specification, it could result in:

- Component damage that your vehicle warranty does not cover.
- Reduced vehicle performance.

Capacities

Variant	Quantity
Base vehicle.	10.46 qt (9.9 L)
Performance vehicle.	10.99 qt (10.4 L)

Maintenance

Materials

Name	Specification
Motorcraft® Yellow Prediluted Antifreeze/ Coolant(U.S.) Motorcraft® Yellow Prediluted Antifreeze/Coolant / Antigel/liquide de refroidissement prédilué jaune Motorcraft®(Canada) VC-13DL-G(U.S.) CVC-13DL-G(Canada)	WSS-M97B57-A2

COOLING SYSTEM CAPACITY AND SPECIFICATION - 5.0L

Use coolant that meets the defined specification.

If you do not use coolant that meets the defined specification, it could result in:

- Component damage that your vehicle warranty does not cover.
- Reduced vehicle performance.

Capacities

Variant	Quantity
Base vehicle with automatic transmission.	12.3 qt (11.6 L)
Performance vehicle with automatic transmission.	12.8 qt (12.1 L)
Manual transmission.	11.7 qt (11.1 L)

Materials

Name	Specification
Motorcraft® Yellow Prediluted Antifreeze/ Coolant(U.S.) Motorcraft® Yellow Prediluted Antifreeze/Coolant / Antigel/liquide de refroidissement prédilué jaune Motorcraft®(Canada) VC-13DL-G(U.S.) CVC-13DL-G(Canada)	WSS-M97B57-A2

Maintenance

COOLANT – WARNING LAMPS



If the engine begins to overheat, the coolant temperature gauge

moves toward the red zone.



A warning lamp illuminates and a message may appear in the information display.

COOLANT – INFORMATION MESSAGES

Message	Description and Action
High engine temperature Stop safely	Displays when the engine temperature is too high. Stop your vehicle as soon as it is safe to do so, switch the engine off and allow it to cool. If the problem persists, have your vehicle checked as soon as possible. See Checking the Coolant Level (page 296).

CHANGING THE FUEL FILTER

Your vehicle has a lifetime fuel filter that integrates with the fuel tank. It does not need regular maintenance or replacement.

Maintenance

DRIVE BELT ROUTING OVERVIEW - 2.3L ECOBOOST™

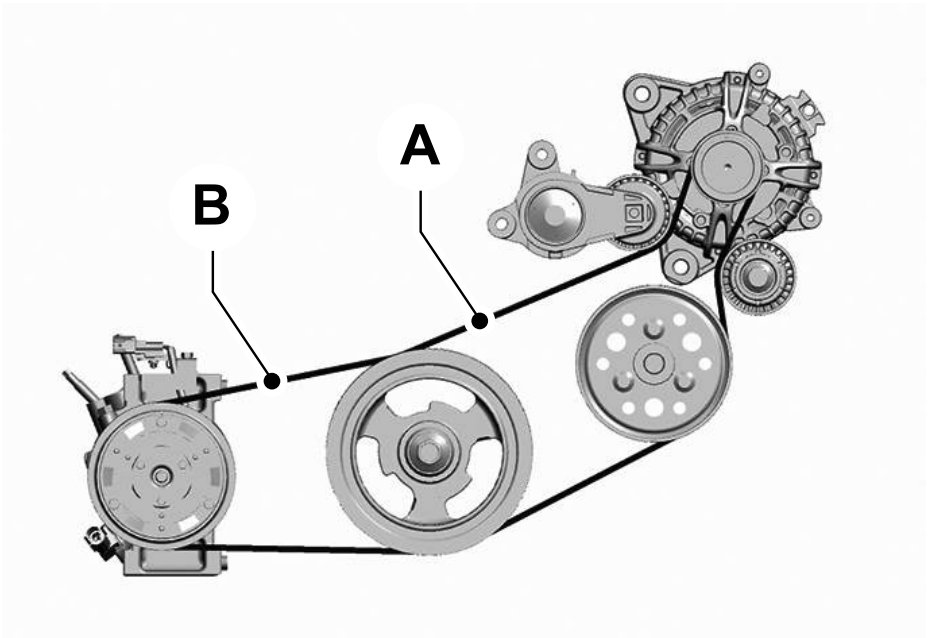

- A. Long drive belt is closest to the engine.
- B. Short drive belt is furthest from the engine.

Maintenance

DRIVE BELT ROUTING OVERVIEW - 5.0L

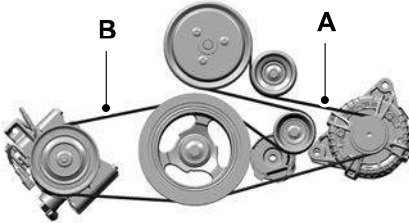

- A. Short drive belt is closest to the engine.
- B. Long drive belt is furthest from the engine.

12V BATTERY

12V BATTERY PRECAUTIONS

WARNING: Batteries normally produce explosive gases which can cause personal injury. Therefore, do not allow flames, sparks or lighted substances to come near the battery. When working near the battery, always shield your face and protect your eyes. Always provide correct ventilation.

WARNING: When lifting a plastic-cased battery, excessive pressure on the end walls could cause acid to flow through the vent caps, resulting in personal injury and damage to the vehicle or battery. Lift the battery with a battery carrier or with your hands on opposite corners.

WARNING: Keep batteries out of reach of children. Batteries contain sulfuric acid. Avoid contact with skin, eyes or clothing. Shield your eyes when working near the battery to protect against possible splashing of acid solution. In case of acid contact with skin or eyes, flush immediately with water for a minimum of 15 minutes and get prompt medical attention. If acid is swallowed, call a physician immediately.

WARNING: Battery posts, terminals and related accessories contain lead and lead compounds, chemicals known to the State of California to cause cancer and reproductive harm. **Wash your hands after handling.**

WARNING: This vehicle may have more than one battery. Removing the battery cables from only one battery does not disconnect your vehicle electrical system. Make sure you disconnect the battery cables from all batteries when disconnecting power. Failure to do so may cause serious personal injury or property damage.

WARNING: For vehicles with Auto-Start-Stop the battery requirement is different. You must replace the battery with one of exactly the same specification.

WHAT IS THE BATTERY MANAGEMENT SYSTEM

The battery management system monitors battery conditions and takes actions to extend battery life.

Maintenance

HOW DOES THE BATTERY MANAGEMENT SYSTEM WORK

If excessive battery drain is detected, the system temporarily disables some electrical systems to protect the battery.

Systems included are:

- Heated rear window.
- Heated seats.
- Climate control.
- Heated steering wheel.
- Audio unit.
- Navigation system.

A message could appear in the information display to alert you that battery protection actions are active. This message is only for notification that an action is taking place, and not intended to indicate an electrical problem or that the battery requires replacement.

BATTERY MANAGEMENT SYSTEM LIMITATIONS

After battery replacement, or in some cases after charging the battery with an external charger, the battery management system requires eight hours of vehicle sleep time to relearn the battery state of charge. During this time, your vehicle must remain fully locked with the ignition switched off.

Note: Prior to relearning the battery state of charge, the battery management system could temporarily disable some electrical systems.

Electrical Accessory Installation

To make sure the battery management system works correctly, do not connect an electrical device ground connection directly to the battery negative post. This can cause inaccurate measurements of the battery condition and potential incorrect system operation.

Note: If you add electrical accessories or components to the vehicle, it could adversely affect battery performance and durability. This could also affect the performance of other electrical systems in the vehicle.

CHANGING THE 12V BATTERY

The battery is in the engine compartment. See **Maintenance** (page 287).

Your vehicle has a maintenance-free battery. It does not require additional water during service.

If the vehicle battery has a cover, make sure you correctly install it after cleaning or replacing the battery.

For longer, trouble-free operation, keep the top of the battery clean and dry and the battery cables tightly fastened to the battery terminals. If any corrosion is present on the battery or terminals, remove the cables from the terminals and clean with a wire brush. You can neutralize the acid with a solution of baking soda and water.

We recommend that you disconnect the negative battery cable terminal from the battery if you plan to store your vehicle for an extended period.

Note: If you only disconnect the negative battery cable terminal, make sure it is isolated or placed away from the battery terminal to avoid unintended connection or arcing.

If you disconnect or replace the battery and your vehicle has an automatic transmission, it must relearn its adaptive strategy. Because of this, the transmission may shift firmly when first driven. This is normal operation while the transmission fully updates its operation to optimum shift feel.

Maintenance

Removing the Battery

1. Apply the parking brake and switch the ignition off.
2. Switch all electrical equipment off, for example lights and radio.
3. Wait a minimum of two minutes before disconnecting the battery.

Note: *The engine management system has a power hold function and remains powered for a period of time after you switch the ignition off. This is to allow diagnostic and adaptive tables to be stored. Disconnecting the battery without waiting can cause damage not covered by the vehicle Warranty.*

4. Disconnect and isolate the negative battery cable terminal.
5. Disconnect and isolate the positive battery cable terminal.
6. Remove the battery securing clamp.
7. Remove the battery.

If you disconnect or replace the vehicle battery, you must reset the following features:

- Window bounce-back. See **Window Bounce-Back** (page 97).
- Clock Settings.
- Pre-set radio stations.

Replacing the Battery

Note: *Before reconnecting the battery, make sure the ignition remains switched off.*

You must replace the battery with one of exactly the same specification.

To install, reverse the removal procedure.

Note: *Make sure that you correctly install the battery terminal covers, battery cover and battery cable terminals.*

RESETTING THE BATTERY SENSOR

When you install a new battery, reset the battery sensor by doing the following:

1. Switch the ignition on, and leave the engine off.

Note: *Complete Steps 2 and 3 within 10 seconds.*

2. Flash the high beam headlamps five times, ending with the high beams off.
3. Press and release the brake pedal three times.

The battery warning lamp flashes three times to confirm that the reset is successful.

RECYCLING AND DISPOSING OF THE 12V BATTERY



Make sure that you dispose of old batteries in an environmentally friendly way. Seek advice from your local authority about recycling old batteries.

12V BATTERY – TROUBLESHOOTING

12V BATTERY – WARNING LAMPS



If it illuminates while driving, it indicates a charging system error. Switch off all unnecessary electrical equipment and have your vehicle immediately checked.

Maintenance

12V BATTERY – INFORMATION MESSAGES

Message	Details
Charging System Service Soon	The charging system needs servicing. If the warning stays on or continues to come on, have your vehicle checked as soon as possible. ¹
Charging System Service Now	The charging system needs servicing. Have your vehicle immediately checked. ¹
Turn Power Off To Save Battery	The battery management system determines that the battery is at a low state of charge. Turn the ignition off as soon as possible to protect the battery. The system clears this message once you start your vehicle and the battery state of charge recovers. Turning off unnecessary electrical loads allows for a faster battery state-of-charge recovery.
Electrical Power Saver Active Some Features Turned Off See Manual	Displays when the battery management system detects an extended low-voltage condition. The system disables various vehicle features to help preserve the battery. Turn off as many of the electrical loads as soon as possible to improve system voltage. If the system voltage recovers, the disabled features will operate again as normal. ¹
12V battery State of charge low	The battery management system determines that the 12V battery is at a low state of charge. Start the engine to charge the battery or charge the battery using an aftermarket battery charger. Always use the vehicle ground point when connecting the negative cable of the external battery charger. See Jump Starting the Vehicle (page 269). This message clears once you restart your vehicle and the battery state of charge has recovered. Do not switch on the ignition when a battery charger is in use to charge the battery. To resolve the issue after the battery reset, start and stop the vehicle three times. See Starting and Stopping the Engine (page 137). ²

¹Check Brake System message may also display.

²Check Brake System message may also display. Start and stop the vehicle three times or charge the battery to clear the message. If the message still appears, have the system checked as soon as possible.

Maintenance

ADJUSTING THE HEADLAMPS

Vertical Aim Adjustment

The headlamps on your vehicle are properly aimed at the assembly plant. If your vehicle has been in an accident, have the alignment of your headlamps checked by an authorized dealer.

Headlamp Aiming Target

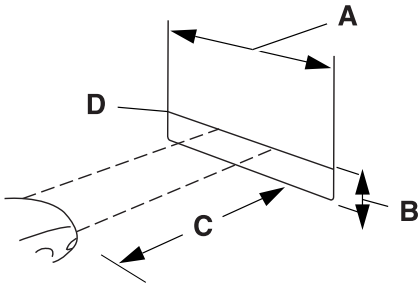

- A 8 ft (2.4 m).
- B Center height of lamp to ground (measurement B is relative to vehicle height).
- C 25 ft (7.6 m).
- D Horizontal reference line.

Vertical Aim Adjustment

1. Park the vehicle directly in front of a wall or screen on a level surface, approximately 25 ft (7.6 m) away.
2. Measure the height from the center of your headlamp indicated by a 3 mm circle on the lens to the ground and mark an 8 ft (2.4 m) horizontal reference line on the vertical wall or screen at this height, a piece of masking tape works well.

Note: To see a clearer light pattern for adjusting, you may want to block the light from one headlamp while adjusting the other.

3. Turn on the low beam headlamps to illuminate the wall or screen and open the hood. Cover one of the headlamps so no light hits the wall.



4. On the wall or screen you will observe a flat zone of high intensity light at the top of the right-hand portion of the beam pattern. If the top edge of the high intensity light zone is not at the horizontal reference line, the headlamp needs to be adjusted.

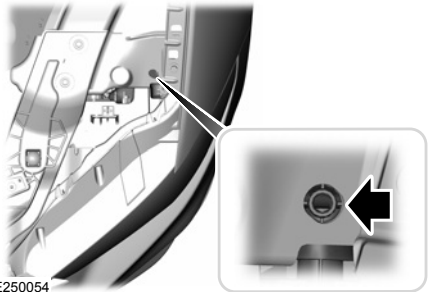

E250054

Maintenance

5. Locate the vertical adjuster on each headlamp. Use a Phillips #2 screwdriver to turn the adjuster either clockwise or counterclockwise to adjust the vertical aim of the headlamp.
6. Repeat Steps 3 through 7 to adjust the other headlamp.
7. Close the hood and turn off the lamps.

Horizontal Aim Adjustment

The headlamps are not equipped with horizontal adjusters.

EXTERIOR BULBS

EXTERIOR BULB SPECIFICATION CHART

Your vehicle has LED lamps. These are not serviceable items. See an authorized dealer if they fail.

Warning Lamps and Indicators

Exterior Bulb Failure



It illuminates when the ignition is on and there is an exterior bulb failure.

INTERIOR BULBS

INTERIOR BULB SPECIFICATION CHART

Your vehicle has LED lamps. These are not serviceable items. See an authorized dealer if they fail.

Vehicle Specifications

ENGINE SPECIFICATIONS - 2.3L

Measurement	Specification
Engine Displacement.	138 in ³ (2,261 cm ³)
Firing order.	1-3-4-2
Ignition system.	Coil on plug
Spark plug gap.	0.026 in (0.65 mm) - 0.030 in (0.75 mm)
Compression ratio.	10.634:1

Vehicle Specifications

ENGINE SPECIFICATIONS - 5.0L

Measurement	Specification
Engine displacement.	307 in ³ (5,038 cm ³)
Firing order.	1-5-4-8-6-3-7-2
Ignition system.	Coil on plug
Spark plug gap.	0.049 in (1.25 mm) - 0.053 in (1.35 mm)
Compression ratio.	12.0:1

Vehicle Specifications

SUSPENSION SPECIFICATIONS

For wheel alignment specifications, always

consult with a dealer service department for the latest specifications and technical bulletins before any adjustments or repairs are made.

MOTORCRAFT PARTS - 2.3L

Component	Part Number
Air filter element.	FA-2067
Battery. ¹	See note below. ²
Cabin air filter.	FP-78
Oil filter. ³	FL-2127
Spark plugs.	SP-597-X
Windshield wiper blade.	WW-1964-A (passenger side) WW-2160-A (driver side)

¹ Configure your vehicle's battery management system to match the replacement battery. Failure to use an appropriate configuration for your battery management system could result in shortened battery life, features not working correctly, or your vehicle not starting. Consult your local dealer or service provider for further details.

² See your dealer for the most current part number.

³ If a Motorcraft oil filter is not available, use an oil filter that aligns to SAE/USCAR – 36 Performance Specifications. Filter Type B.

We recommend Motorcraft parts that are available at your authorized dealer or at www.fordparts.com. We engineer these parts for your vehicle to meet or exceed our specifications. Use of other parts could impact vehicle performance, emissions and durability. Your warranty could be void for any damage related to use of other parts.

Vehicle Specifications

MOTORCRAFT PARTS - 5.0L

Component	Part Number
Air filter element.	FA-2066
Battery. ¹	See note below. ²
Cabin air filter.	FP-78
Oil filter. ³	FL-500-S
Spark plugs.	SP-589
Windshield wiper blade.	WW-1964-A (passenger side) WW-2160-A (driver side)

¹ Configure your vehicle's battery management system to match the replacement battery. Failure to use an appropriate configuration for your battery management system could result in shortened battery life, features not working correctly, or your vehicle not starting. Consult your local dealer or service provider for further details.

² See your dealer for the most current part number.

³ If a Motorcraft oil filter is not available, use an oil filter that aligns to SAE/USCAR – 36 Performance Specifications. Filter Type C.

We recommend Motorcraft parts that are available at your authorized dealer or at www.fordparts.com. We engineer these parts for your vehicle to meet or exceed our specifications. Use of other parts could impact vehicle performance, emissions and durability. Your warranty could be void for any damage related to use of other parts.

Track Use

Appropriately change the engine oil for track events. Before and after track events, drain the engine oil and replace the engine oil filter.

- 2.3L: See **Engine Oil Capacity and Specification** (page 291).
- 5.0L: See **Engine Oil Capacity and Specification** (page 293).

Regularly check the engine oil level during the event. Maintain the engine oil level at or near the max mark on the engine oil dipstick. See **Checking the Engine Oil Level** (page 290).

Operating at High Speeds and Track Days



WARNING: Before driving at high speeds, adjust the tire pressures to the recommended tire inflation pressures which are on the tire information label on the driver side B-pillar. Failure to follow this instruction could result in the loss of control of your vehicle, personal injury or death.

Before operating your vehicle at high speeds:

- Verify your tires have the correct pressures.
- Inspect wheels and tires for wear and damage. Replace any damaged wheels and tires.
- Check and set lug nut torque. See **Wheel Nuts** (page 371).
- Verify fluid levels for oil, coolant, brake and hydraulic fluid.
- Change the oil and filter prior to use on the track.

After operating your vehicle at high speeds or track day driving, do the following:

- Set the tire pressure to the proper specification.
- Check and set the lug nut torque. See **Wheel Nuts** (page 371).
- Check all fluid levels.
- Check the front and rear wheel bearings for abnormal wear.
- Inspect brake caliper dust boots for abnormal wear.

Drive Modes and Track Apps

If you are operating your vehicle on a drag strip, use the drag strip selectable drive mode in addition to using line lock and launch control to provide a specific setup tuned for the quickest straight line elapsed times.

If you are operating your vehicle on a road course, use the sport or track selectable drive mode to provide a specific setup tuned for optimal shift and suspension setup that is tuned towards handling prowess on closed course surfaces. See **Drive Modes** (page 212). See **Track Apps** (page 393).

Recovery Towing

If needed, your vehicle has an installation point for a recovery hook behind the fascia. See **Recovery Towing** (page 272).

Track Use Maintenance Intervals

Follow these maintenance intervals for when you use your vehicle on a track or in a high speed event.

Track Use

Interval	Vehicle Use and Example
One track weekend or approximately 4 hours of track use.	Change the engine oil and filter.
Every 500 mi (800 km). ¹	Change the rear axle fluid.

¹Change the fluid every 500 mi (800 km) or when a message appears in the instrument cluster display stating that the axle fluid is over temperature.

Timing Chain

If you use your vehicle extensively at a race track or at high rpm, it is possible to exceed the service life of the engine timing chain. A wrench indicator illuminates when it is time for you to replace your chain. Have your vehicle checked as soon as possible.

Catch Can

If you plan to track your vehicle and it did not come with an oil catch can, we recommend that you purchase the catch can kit through your authorized dealer or Ford Performance Parts Catalog.

Installation instructions are included with the catch can.

The catch can has a self-draining feature and does not require any maintenance.

Brake Burnishing

Properly burnish the brakes prior to heavy track use. Excessive brake noise may occur after the track burnish or track use. Perform this procedure in a safe manner on dry pavement, and in compliance with all local and state ordinances and laws regarding motor vehicle operation.

How to Burnish the Brakes

Initial low temperature bedding:

- If your brakes already have 200 mi (322 km) or more of city driving, skip this step and go directly to the high temperature bedding cycle procedure. Otherwise, perform at least 30 stops from 50 mph (80 km/h) at 1/3 g deceleration with 1 mi (1.2 km) spacing between stops. A deceleration gauge can be accessed through the Track Apps menu in your touchscreen.

High temperature bedding cycle:

- Beginning with cool brakes, perform 15 consecutive stops back to back, accelerating at 3/4 throttle to 80 mph (128 km/h) and braking to 20 mph (32 km/h) at 1.0 g deceleration. The brakes may emit an odor or smoke during this part of the procedure.

Cool down:

- Cool the brakes down by driving one or two laps, 5 mi (8 km), at 60 mph (96 km/h) with minimal to no brake usage.

Recovery low temperature bedding:

- Perform at least 30 stops from 50 mph (80 km/h) at 1/3 g deceleration with 0.7 mi (1.2 km) spacing between stops. A deceleration gauge can be accessed through the Track Apps menu in your touchscreen.

Track Use

TRACK USE - DARK HORSE

Appropriately change the engine oil for track events. Before and after track events, drain the engine oil and replace the engine oil filter. See **Engine Oil Capacity and Specification** (page 293).

Regularly check the engine oil level during the event. Maintain the engine oil level at or near the max mark on the engine oil dipstick. See **Checking the Engine Oil Level** (page 290).

Operating at High Speeds and Track Days



WARNING: Before driving at high speeds, adjust the tire pressures to the recommended tire inflation pressures which are on the tire information label on the driver side B-pillar. Failure to follow this instruction could result in the loss of control of your vehicle, personal injury or death.

Before operating your vehicle at high speeds:

- Verify your tires have the correct pressures.
- Inspect wheels and tires for wear and damage. Replace any damaged wheels and tires.
- Check and set lug nut torque. See **Wheel Nuts** (page 371).
- Verify fluid levels for oil, coolant, brake and hydraulic fluid.
- Change the oil and filter prior to use on the track.

After operating your vehicle at high speeds or track day driving, do the following:

- Set the tire pressure to the proper specification.
- Check and set the lug nut torque. See **Wheel Nuts** (page 371).
- Check all fluid levels.
- Check the front and rear wheel bearings for abnormal wear.
- Inspect brake caliper dust boots for abnormal wear.

Drive Modes and Track Apps

If you are operating your vehicle on a drag strip, use the drag strip selectable drive mode in addition to using line lock and launch control to provide a specific setup tuned for the quickest straight line elapsed times.

If you are operating your vehicle on a road course, use the sport or track selectable drive mode to provide a specific setup tuned for optimal shift and suspension setup that is tuned towards handling prowess on closed course surfaces. See **Drive Modes** (page 212). See **Track Apps** (page 393).

Recovery Towing

If needed, your vehicle has an installation point for a recovery hook behind the fascia. See **Recovery Towing** (page 272).

Track Use Maintenance Intervals

Follow these maintenance intervals for when you use your vehicle on a track or in a high speed event.

Track Use

Interval	Vehicle Use and Example
One track weekend or approximately 4 hours of track use.	Change the engine oil and filter.
Every 500 mi (800 km). ¹	Change the rear axle fluid.

¹Change the fluid every 500 mi (800 km) or when a message appears in the instrument cluster display stating that the axle fluid is over temperature.

Road Course Alignment Recommendations

If you plan to participate in road course track days, we recommend the following chassis settings for optimal tire wear and handling performance:

All settings are at curb loading condition full of fuel.

Note: After your track day is complete, return your car to the street alignment and tire pressures.

Note: Using these wheel alignment settings could cause excessive tire wear. Only use these settings for racing or competitive driving. The vehicle warranty does not cover excessive tire wear.

Dark Horse

Front	Track	Street
Camber	-1.5°	-1.03°
Toe - Total	0°	0°

Rear	Track	Street
Camber	-1.5°	-1.5°
Toe - Total	0.24°	0.24°

Dark Horse with Handling Package

Front	Track	Street
Camber	-2.25°	-1.21°
Toe - Total	0.1°	0.1°

Track Use

Rear	Track	Street
Camber	-1.5°	-1.14°
Toe - Total	0.3°	0.3°

Track Tire Pressures

Cold Tire Pressures

Tire Pressure	Front	Rear
Dark Horse	30 psi (2.07 bar)	30 psi (2.07 bar)
Dark Horse with Handling Package	28 psi (1.93 bar)	28 psi (1.93 bar)

Hot Tire Pressures

Tire Pressure	Front	Rear
Dark Horse	Less than 38 psi (2.62 bar)	Less than 38 psi (2.62 bar)
Dark Horse with Handling Package	Less than 36 psi (2.48 bar)	Less than 36 psi (2.48 bar)

Timing Chain

If you use your vehicle extensively at a race track or at high rpm, it is possible to exceed the service life of the engine timing chain. A wrench indicator illuminates when it is time for you to replace your chain. Have your vehicle checked as soon as possible.

Adjustable Camber Front Strut Top Mounts (If Equipped)

Your vehicle has adjustable strut mounts which you can use to adjust the camber of your vehicle before and after a track event to the specifications listed in the Road Course Alignment Recommendations table previously shown.

Note: After your track day is complete, return your car to the street alignment and tire pressures.

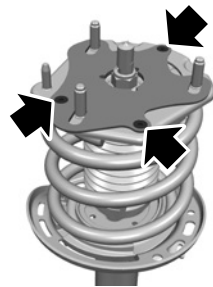

Track Use

Note: The adjustable camber front strut mounts are fitted with three set screws that must be removed before camber can be adjusted. If you cannot adjust the camber, please see your authorized dealer or call 800-367-3788 for more details to remove the set screws.

Aerodynamics (If Equipped)

Rear Gurney Flap

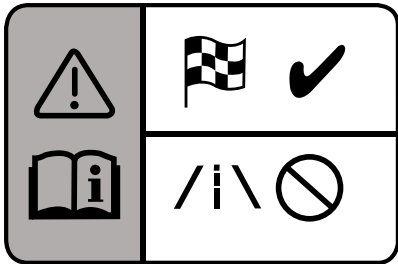

The rear Gurney flap must be removed for on-road driving.

Your vehicle may include a removable Gurney flap in the luggage compartment. The Gurney flap greatly enhances high speed stability and performance on the track. It is recommended that you use the Gurney flap at all tracks featuring high speed corners and can be used at any track regardless of cornering speeds.

You could benefit from the removal Gurney flap to improve low speed balance on smaller tracks with maximum cornering speeds below 70 mph (112 km/h). We recommend that you attach the Gurney flap for all track events and carefully assess both the vehicle's condition and your capability before removal.



Note: The Gurney flap comes with longer size bolts to install it onto the rear spoiler. **Do not use the longer size bolts without the Gurney flap attached or damage to the spoiler may occur.**

Catch Can

If you plan to track your vehicle and it did not come with an oil catch can, we recommend that you purchase the catch can kit through your authorized dealer or Ford Performance Parts Catalog.

Installation instructions are included with the catch can.

The catch can has a self-draining feature and does not require any maintenance.

Brake Burnishing

Properly burnish the brakes prior to heavy track use. Excessive brake noise may occur after the track burnish or track use.

Perform this procedure in a safe manner on dry pavement, and in compliance with all local and state ordinances and laws regarding motor vehicle operation.

Track Use

How to Burnish the Brakes

Initial low temperature bedding:

- If your brakes already have 200 mi (322 km) or more of city driving, skip this step and go directly to the high temperature bedding cycle procedure. Otherwise, perform at least 30 stops from 50 mph (80 km/h) at 1/3 g deceleration with 1 mi (1.2 km) spacing between stops. A deceleration gauge can be accessed through the Track Apps menu in your touchscreen.

High temperature bedding cycle:

- Beginning with cool brakes, perform 15 consecutive stops back to back, accelerating at 3/4 throttle to 80 mph (128 km/h) and braking to 20 mph (32 km/h) at 1.0 g deceleration. The brakes may emit an odor or smoke during this part of the procedure.

Cool down:

- Cool the brakes down by driving one or two laps, 5 mi (8 km), at 60 mph (96 km/h) with minimal to no brake usage.

Recovery low temperature bedding:

- Perform at least 30 stops from 50 mph (80 km/h) at 1/3 g deceleration with 0.7 mi (1.2 km) spacing between stops. A deceleration gauge can be accessed through the Track Apps menu in your touchscreen.

Vehicle Care

CLEANING PRODUCTS

For best results, use the following products or products of equivalent quality:

Materials

Name	Specification
Motorcraft® Bug and Tar Remover, ZC-42 (U.S. & Canada)	-
Motorcraft® Custom Bright Metal Cleaner, ZC-15 (U.S. & Canada)	ESR-M5B194-B
Motorcraft® Detail Wash, ZC-3-A (U.S. & Canada)	ESR-M14P4-A
Motorcraft® Engine Shampoo and Degreaser, ZC-20 (U.S.)	ESR-M14P3-A
Motorcraft® Engine Shampoo, CXC-66-A (Canada)	-
Motorcraft® Premium Leather and Vinyl Cleaner, ZC-56 (U.S. & Canada)	-
Motorcraft® Multi-Purpose Cleaner, CXC-101 (Canada)	-
Motorcraft® Premium Windshield Wash Concentrate with Bitterant, ZC-32-B2 (U.S.)	WSS-M14P19-A
Motorcraft® Premium Quality Windshield Washer Fluid, CXC-37-F/M (Canada)	WSS-M14P19-A
Motorcraft® Professional Strength Carpet & Upholstery Cleaner, ZC-54 (U.S. & Canada)	-
Motorcraft® Premium Glass Cleaner, CXC-100 (Canada)	ESR-M14P5-A
Motorcraft® Spot and Stain Remover, ZC-14 (U.S.)	-
Motorcraft® Ultra-Clear Spray Glass Cleaner, ZC-23 (U.S.)	ESR-M14P5-A
Motorcraft® Wheel and Tire Cleaner, ZC-37-A (U.S. & Canada)	-

Vehicle Care

CLEANING THE EXTERIOR

CLEANING THE EXTERIOR PRECAUTIONS

Immediately remove fuel spillages, additive residuals, bird droppings, insect deposits and road tar. These may damage your vehicle's paintwork or trim over time. Remove any exterior accessories, for example antennas, before entering a car wash.

Note: *If you intend to park your vehicle for an extended period after cleaning, drive it for few minutes before parking. This reduces the risk of corrosion of the brake discs, brake pads and linings.*

CLEANING HEADLAMPS AND REAR LAMPS

We recommend that you only use cold or lukewarm water containing car shampoo to clean the headlamps and the rear lamps.

Do not scrape the lamps.

Do not wipe lamps when they are dry.

CLEANING WINDOWS AND WIPER BLADES

To clean the windshield and wiper blades:

- Clean the windshield with a non-abrasive glass cleaner.

Note: *When cleaning the interior of the windshield, avoid getting any glass cleaner on the instrument panel or door panels. Wipe any glass cleaner off these surfaces immediately.*

- Clean the wiper blades with washer fluid or water applied with a soft sponge or cloth.

Note: *Do not use razor blades or other sharp objects to clean or remove decals from the inside of the heated rear window. This can cause damage not covered by the vehicle Warranty.*

CLEANING CHROME, ALUMINIUM OR STAINLESS STEEL

We recommend that you only use a car shampoo, a soft cloth and water on bumpers and other chrome, aluminium or stainless steel parts.

Note: *For additional information and assistance, we recommend that you contact an authorized dealer.*

Note: *Rinse the area well after cleaning.*

Note: *Do not use abrasive materials, for example steel wool or plastic pads, as they can scratch these surfaces.*

Note: *Do not use chrome cleaner, metal cleaner or polish on wheels or wheel covers.*

CLEANING WHEELS

Only use a recommended wheel and tire cleaner to clean the wheels. For additional information and assistance, we recommend that you contact an authorized dealer.

1. Use a sponge to remove heavy deposits of dirt and brake dust.
2. Rinse well after cleaning.

Note: *Do not apply a cleaning chemical to warm or hot wheel rims and covers.*

If you intend to park your vehicle for an extended period after cleaning the wheels, drive it for few minutes before parking. This reduces the risk of corrosion of the brake discs, brake pads and linings.

Do not clean the wheels when they are hot.

Note: *Some car washes could damage wheel rims and covers.*

Vehicle Care

Note: Using non-recommended cleaners, harsh cleaning products, chrome wheel cleaners or abrasive materials could damage wheel rims and covers.

CLEANING THE ENGINE COMPARTMENT

Use a vacuum cleaner to remove debris from the screen area below the windshield.

Note: If you are not familiar with the parts around the engine do not wash the engine compartment. Avoid frequent engine washes.

When washing the engine compartment:

- Never wash or rinse the engine while it is hot or running.
- Never wash or rinse any ignition coil, spark plug wire or spark plug well.
- Cover the battery, power distribution box, and air filter assembly to prevent water damage.

Note: If your vehicle has an engine cover remove the cover before application of shampoo and degreaser.

- Spray an approved engine shampoo and degreaser on all parts that require cleaning and rinse with water.

Note: Follow the manufacturer's instructions for using engine shampoo and degreaser.

CLEANING THE CONVERTIBLE TOP (If Equipped)

Remove lint with a lint roller or vacuum with a soft bristle brush.

Wash with an approved high quality convertible top cleaner and protectant.

Note: Do not use stiff bristle brushes, abrasive materials or household cleaning products.

Note: High pressure water may cause water leaks and possible seal damage to the convertible top.

CLEANING STRIPES OR GRAPHICS

It is recommended to wash your vehicle by hand however, pressure washing may be used under the following conditions:

- Use a spray with a minimum of 40° wide spray angle pattern.
- Keep the nozzle 12 in (30 cm) and at a 90° angle to your vehicle.
- Do not use water pressure higher than 1,000 psi (6,895 kPa).
- Do not use water hotter than 73°F (23°C).

Note: Holding the pressure washer nozzle at an angle to the vehicle's surface may damage graphics and cause the edges to peel away.

CLEANING CAMERA LENSES AND SENSORS

We recommend that you only use lukewarm or cold water and a soft cloth to clean the camera lens and sensors.

Note: Do not pressure wash camera lens and sensors.

CLEANING THE UNDERBODY

Flush the complete underside of your vehicle frequently. Keep body and door drain holes free from packed dirt.

Vehicle Care

Rear suspension components may require regular cleaning with a power washer or a thorough rinse with a strong stream of water if the vehicle is operated in dusty or muddy environments. Rear leaf springs or other suspension components may emit squeaking or popping noises while operating the vehicle if particles, such as dirt, rocks, or other debris, are present in the components.

CLEANING THE INTERIOR

CLEANING THE INSTRUMENT PANEL



WARNING: Do not use chemical solvents or strong detergents when cleaning the steering wheel or instrument panel to avoid contamination of the airbag system.

We recommend that you only clean the instrument panel and cluster lens with a damp soft cloth. Dry the area with a clean, soft cloth.

For additional information and assistance, we recommend that you contact an authorized dealer.

Note: *Avoid cleaners or polishes that increase the gloss of the upper portion of the instrument panel. The dull finish in this area helps protect you from undesirable windshield reflection.*

CLEANING PLASTIC

We recommend that you only use a mild soap and water solution on a soft cloth. Dry the area with a clean, soft cloth.

CLEANING DISPLAYS AND SCREENS

We recommend that you only use a microfiber cloth in a circular motion to clean off the fingerprint or dust.

Note: *Do not pour or spray alcohol onto the touchscreen.*

Note: *Do not use detergent or any type of solvent to clean the touchscreen.*

CLEANING FABRIC



WARNING: On vehicles equipped with seat-mounted airbags, do not use chemical solvents or strong detergents. Such products could contaminate the side airbag system and affect performance of the side airbag in a crash.

We recommend that you only clean fabric in the following way:

1. Remove dust and loose dirt with a vacuum cleaner.
2. Wipe the surface with a soft, damp cloth and a mild soap and water solution. Dry the area with a clean, soft cloth.
3. For additional information and assistance, we recommend that you contact an authorized dealer.

For heavy stains, spot clean the area. If a ring forms on the fabric, clean the entire area immediately, but do not oversaturate or the ring could set.

Vehicle Care

CLEANING LEATHER



WARNING: On vehicles equipped with seat-mounted airbags, do not use chemical solvents or strong detergents. Such products could contaminate the side airbag system and affect performance of the side airbag in a crash.

We recommend that you only clean the leather surfaces in the following way:

1. Remove dust and loose dirt with a vacuum cleaner.
2. Wipe the surface with a soft, damp cloth and a mild soap and water solution. Dry the area with a clean, soft cloth.
3. Make sure the leather is dry, then apply a small amount of conditioner to a clean, dry cloth.
4. Rub the conditioner into the leather until it disappears. Allow the conditioner to dry, then repeat the process for the entire interior. If a film appears, wipe it off with a dry, clean cloth.
5. For additional information and assistance, we recommend that you contact an authorized dealer.

CLEANING VINYL



WARNING: On vehicles equipped with seat-mounted airbags, do not use chemical solvents or strong detergents. Such products could contaminate the side airbag system and affect performance of the side airbag in a crash.

We recommend that you only clean vinyl surfaces in the following way:

1. Remove dust and loose dirt with a vacuum cleaner.
2. Wipe the surface with a soft, damp cloth and a mild soap and water solution. Dry the area with a clean, soft cloth.
3. For additional information and assistance, we recommend that you contact an authorized dealer.

CLEANING CARPETS AND FLOOR MATS

We recommend that you only clean your carpets in the following way:

1. Remove dust and loose dirt with a vacuum cleaner.
2. Wipe the surface with a soft, damp cloth and a mild soap and water solution. Dry the area with a clean, soft cloth.
3. For additional information and assistance, we recommend that you contact an authorized dealer.

For heavy stains, spot clean the area. If a ring forms on the fabric, clean the entire area immediately, but do not oversaturate or the ring could set.

We recommend that you only clean your floor mats in the following way:

1. Remove dust and loose dirt with a vacuum cleaner.
2. Wash rubber floor mats using mild soap and lukewarm or cold water.
3. Completely dry the floor mat before placing them back in your vehicle.

Vehicle Care

CLEANING SEATBELTS



WARNING: Do not use cleaning solvents, bleach or dye on the vehicle's seatbelts, as these actions may weaken the belt webbing.

1. Wipe the surface with a soft, damp cloth and a mild soap and water solution. Dry the area with a clean, soft cloth.

CLEANING STORAGE COMPARTMENTS

1. Remove dust and loose dirt with a vacuum cleaner.
2. Wipe the surface with a soft, damp cloth and a mild soap and water solution. Dry the area with a clean, soft cloth.

REPAIRING MINOR PAINT DAMAGE

We recommend that you contact an authorized dealer to identify your vehicle color code. Authorized dealers have touch-up paint to match your vehicle's color.

Before repairing minor paint damage, use a cleaner to remove particles such as bird droppings, tree sap, insect deposits, tar spots, road salt and industrial fallout.

Read the instructions before using cleaning products.

WAXING YOUR VEHICLE

Wax the high-gloss painted surface of your prewashed vehicle once or twice a year.

We recommend that you only use an approved quality wax that does not contain abrasives. Follow the manufacturer's instructions to apply and remove the wax. For additional information and assistance, we recommend that you contact an authorized dealer.

When washing and waxing, park your vehicle in a shaded area out of direct sunlight.

Note: Avoid waxing unpainted or low-gloss black colored parts, they discolor over time.

Body Styling Kits

BODY STYLING KIT PRECAUTIONS

The distance between the underside of your vehicle and the ground is less than that of other models. Drive with extreme care to avoid damage to your vehicle.

Storing Your Vehicle

PREPARING YOUR VEHICLE FOR STORAGE

If you plan on storing your vehicle for 30 days or more, the following maintenance recommendations makes sure your vehicle stays in good operating condition.

Under various conditions, long-term storage may lead to degraded engine performance or failure unless you use specific precautions to preserve your vehicle.

General

- Store all vehicles in a dry, ventilated place.
- If vehicles are stored outside, they require regular maintenance to protect against rust and weather damage.
- Make sure all linkages, cables, levers and pins under your vehicle are covered with grease to prevent rust.
- Move vehicles at least 25 ft (7.5 m) every 15 days to lubricate working parts and prevent corrosion.
- Fill the fuel tank with high-quality fuel until the first automatic shutoff of the fuel pump nozzle.

Engine

- Change the engine oil and filter prior to storage because used engine oil contains contaminants which may cause engine damage.
- Start the engine every 15 days for a minimum of 15 minutes. Run at fast idle with the climate controls set to defrost until the engine reaches normal operating temperature.
- With your foot on the brake, shift through all the gears while the engine is running.

Body

- Wash your vehicle thoroughly to remove dirt, grease, oil, tar or mud from exterior surfaces, rear wheel housings and the underside of front fenders.
- Periodically wash your vehicle if it is stored in exposed locations.
- Touch-up exposed or primed metal to prevent rust.
- Cover chrome and stainless steel parts with a thick coat of auto wax to prevent discoloration. Rewax as necessary when you wash your vehicle.
- Lubricate all hood, door and luggage compartment hinges and latches with a light grade oil.
- Cover interior trim to prevent fading.
- Keep all rubber parts free from oil and solvents.

12 Volt Battery

- When storing your vehicle for longer than 30 days the battery state of charge should be approximately 50%. Additionally, we recommend to disconnect the 12v battery to reduce system loads on the battery, or you can use a trickle charger for longer storage periods.
- Check and recharge as necessary. Keep connections clean.

Note: *It is necessary to reset memory features if you disconnect the battery cables.*

Storing Your Vehicle

Tires

- Maintain recommended air pressure.
- To minimize flat spots on the tires, inflate all four tires to the recommended cold pressures listed on the Safety Compliance Certification Label or Tire Label affixed to your vehicle. When the vehicle is taken out of storage, reset the tire pressures as necessary to the recommended levels listed on the Safety Compliance Certification Label or Tire Label affixed to your vehicle.

Note: *If you store your vehicle in a location with low ambient temperatures, follow the instructions for care of summer tires. See **Using Summer Tires** (page 338).*

Brakes

Make sure the brakes and parking brake fully release.

Note: *If you intend to park your vehicle for an extended period after cleaning, drive it for few minutes before parking. This reduces the risk of corrosion of the brake discs, brake pads and linings.*

- Check the exhaust for any foreign materials.
- Check tire pressures and set tire inflation per the Tire Label.
- Check brake pedal operation. Corroded brake rotors could cause brake noise. Drive your vehicle and gently apply and release the brakes repeatedly over a 10-minute drive to reduce the corrosion from the brakes.
- Check fluid levels (including coolant, oil and gas) to make sure there are no leaks, and fluids are at recommended levels.
- If you remove the battery, clean the battery cable ends and check for damage.

Contact an authorized dealer if you have any concerns or issues.

REMOVING YOUR VEHICLE FROM STORAGE

When your vehicle is ready to come out of storage, do the following:

- We recommend that you change the engine oil before you use your vehicle again.
- Wash your vehicle to remove any dirt or grease film build-up on window surfaces.
- Check windshield wipers for any deterioration.
- Check the underhood for any foreign materials such as mice or squirrel nests.

Wheel and Tire Information

LOCATING THE TIRE LABEL

The tire label or safety certification label is on the driver side B-pillar or the edge of the driver door. It contains information on the recommended front and rear tire inflation pressures. See **Locating the Safety Compliance Certification Labels** (page 252).

DEPARTMENT OF TRANSPORTATION UNIFORM TIRE QUALITY GRADES



Tire Quality Grades apply to new pneumatic passenger car tires. The Quality grades can be found where applicable on the tire sidewall between tread shoulder and maximum section width. For example: **Treadwear 200 Traction AA Temperature A.**

These Tire Quality Grades are determined by standards that the United States Department of Transportation has set.

Tire Quality Grades apply to new pneumatic passenger car tires. They do not apply to deep tread, winter-type snow tires, space-saver or temporary use spare tires, light truck or LT type tires, tires with nominal rim diameters of 10 to 12 inches or limited production tires as defined in Title 49 Code of Federal Regulations Part 575.104 (c)(2).

U.S. Department of Transportation Tire quality grades: The U.S. Department of Transportation requires us to give you the following information about tire grades exactly as the government has written it.

Treadwear

The treadwear grade is a comparative rating based on the wear rate of the tire when tested under controlled conditions on a specified government test course. For example, a tire graded 150 would wear 1½ times as well on the government course as a tire graded 100. The relative performance of tires depends upon the actual conditions of their use, however, and may depart significantly from the norm due to variations in driving habits, service practices, and differences in road characteristics and climate.

Wheel and Tire Information

Traction AA A B C



WARNING: The traction grade assigned to this tire is based on straight-ahead braking traction tests, and does not include acceleration, cornering, hydroplaning or peak traction characteristics.

The traction grades, from highest to lowest are AA, A, B, and C. The grades represent the tire's ability to stop on wet pavement as measured under controlled conditions on specified government test surfaces of asphalt and concrete. A tire marked C may have poor traction performance.

Temperature A B C



WARNING: The temperature grade for this tire is established for a tire that is properly inflated and not overloaded. Excessive speed, underinflation, or excessive loading, either separately or in combination, can cause heat buildup and possible tire failure.

The temperature grades are A (the highest), B and C, representing the tire's resistance to the generation of heat and its ability to dissipate heat when tested under controlled conditions on a specified indoor laboratory

test wheel. Sustained high temperature can cause the material of the tire to degenerate and reduce tire life, and excessive temperature can lead to sudden tire failure. The grade C corresponds to a level of performance which all passenger car tires must meet under the Federal Motor Vehicle Safety Standard No. 139. Grades B and A represent higher levels of performance on the laboratory test wheel than the minimum required by law.

INFORMATION ON THE TIRE SIDEWALL

Both United States and Canada Federal regulations require tire manufacturers to place standardized information on the sidewall of all tires. This information identifies and describes the fundamental characteristics of the tire and also provides a U.S. DOT Tire Identification Number for safety standard certification and in case of a recall.

Wheel and Tire Information

Information on P Type Tires

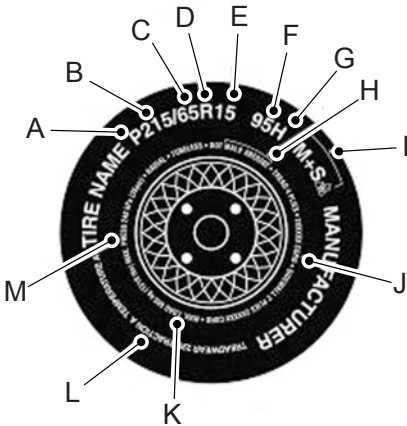

P215/65R15 95H is an example of a tire size, load index and speed rating. The definitions of these items are listed below. (Note that the tire size, load index and speed rating for your vehicle may be different from this example.)

A. P: Indicates a tire, designated by the Tire and Rim Association, that may be used for service on cars, sport utility vehicles, minivans and light trucks. **Note:** If your tire size does not begin with a letter this may mean it is designated by either the European Tire and Rim Technical Organization or the Japan Tire Manufacturing Association.

B. 215: Indicates the nominal width of the tire in millimeters from sidewall edge to sidewall edge. In general, the larger the number, the wider the tire.

C. 65: Indicates the aspect ratio which gives the tire's ratio of height to width.

D. R: Indicates a radial type tire.

E. 15: Indicates the wheel or rim diameter in inches. If you change your wheel size, you will have to purchase new tires to match the new wheel diameter.

F. 95: Indicates the tire's load index. It is an index that relates to how much weight a tire can carry. You may find this information in your owner's manual. If not, contact a local tire dealer.

Note: You may not find this information on all tires because it is not required by federal law.

G. H: Indicates the tire's speed rating. The speed rating denotes the speed at which a tire is designed to be driven for extended periods of time under a standard condition of load and inflation pressure. The tires on your vehicle may operate at different conditions for load and inflation pressure. These speed ratings may need to be adjusted for the difference in conditions. The ratings range from 81 mph (130 km/h) to 186 mph (300 km/h). These ratings are listed in the following chart.

Wheel and Tire Information

Note: You may not find this information on all tires because it is not required by federal law.

Letter rating	Speed rating
M	81 mph (130 km/h)
N	87 mph (140 km/h)
Q	99 mph (160 km/h)
R	106 mph (170 km/h)
S	112 mph (180 km/h)
T	118 mph (190 km/h)
U	124 mph (200 km/h)
H	130 mph (210 km/h)
V	149 mph (240 km/h)
W	168 mph (270 km/h)
Y	186 mph (300 km/h)

Note: For tires with a maximum speed capability over 149 mph (240 km/h), tire manufacturers sometimes use the letters ZR. For those with a maximum speed capability over 186 mph (299 km/h), tire manufacturers always use the letters ZR.

H. U.S. DOT Tire Identification Number (TIN): This begins with the letters DOT and indicates that the tire meets all federal standards. The next two numbers or letters are the plant code designating where it was manufactured, the next two are

the tire size code and the last four numbers represent the week and year the tire was built. For example, the numbers 317 mean the 31st week of 1997. After 2000, the numbers go to four digits. For example, 2501 means the 25th week of 2001. The numbers in between are identification codes used for traceability. This information is used to contact customers if a tire defect requires a recall.

I. M+S or M/S: Mud and Snow, or

AT: All Terrain, or

AS: All Season.

J. Tire Ply Composition and Material Used: Indicates the number of plies or the number of layers of rubber-coated fabric in the tire tread and sidewall. Tire manufacturers also must indicate the ply materials in the tire and the sidewall, which include steel, nylon, polyester, and others.

K. Maximum Load: Indicates the maximum load in kilograms and pounds that can be carried by the tire. See the Safety Compliance Certification Label (affixed to either the door hinge pillar, door-latch post, or the door edge that meets the door-latch post, next to the driver's seating position), for the correct tire pressure for your vehicle.

L. Treadwear, Traction and Temperature Grades:

Wheel and Tire Information

***Treadwear** The treadwear grade is a comparative rating based on the wear rate of the tire when tested under controlled conditions on a specified government test course. For example, a tire graded 150 would wear one and one-half times as well on the government course as a tire graded 100.

***Traction:** The traction grades, from highest to lowest are AA, A, B, and C. The grades represent the tire's ability to stop on wet pavement as measured under controlled conditions on specified government test surfaces of asphalt and concrete. A tire marked C may have poor traction performance.

***Temperature:** The temperature grades are A (the highest), B and C, representing the tire's resistance to the generation of heat and its ability to dissipate heat when tested under controlled conditions on a specified indoor laboratory test wheel.

M. Maximum Inflation

Pressure: Indicates the tire manufacturers' maximum permissible pressure or the pressure at which the maximum load can be carried by the tire. This pressure is normally higher than the vehicle manufacturer's recommended cold inflation pressure which can be found on the Safety Compliance Certification Label (affixed to either the door hinge pillar, door-latch post, or the door edge

that meets the door-latch post, next to the driver's seating position), or Tire Label which is located on the B-Pillar or the edge of the driver's door. The cold inflation pressure should never be set lower than the recommended pressure on the vehicle label.

The tire suppliers may have additional markings, notes or warnings such as standard load or radial tubeless.

Additional Information Contained on the Tire Sidewall for LT Type Tires

Note: *Tire Quality Grades do not apply to this type of tire.*

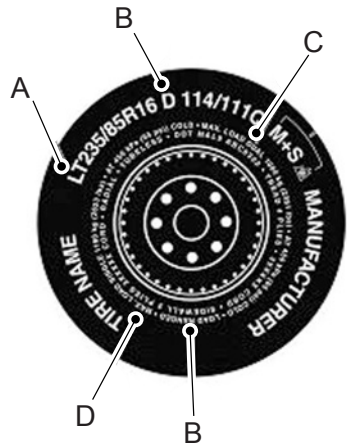

LT type tires have some additional information beyond those of P type tires; these differences are described below.

Wheel and Tire Information

A. **LT:** Indicates a tire, designated by the Tire and Rim Association, that is intended for service on light trucks.

B. **Load Range and Load Inflation Limits:** Indicates the tire's load-carrying capabilities and its inflation limits.

C. **Maximum Load Dual lb (kg) at psi (kPa) cold:** Indicates the maximum load and tire pressure when the tire is used as a dual, defined as four tires on the rear axle (a total of six or more tires on the vehicle).

D. **Maximum Load Single lb (kg) at psi (kPa) cold:** Indicates the maximum load and tire pressure when the tire is used as a single, defined as two tires (total) on the rear axle.

Information on T Type Tires

T145/80D16 is an example of a tire size.

Note: *The temporary tire size for your vehicle may be different from this example. Tire Quality Grades do not apply to this type of tire.*

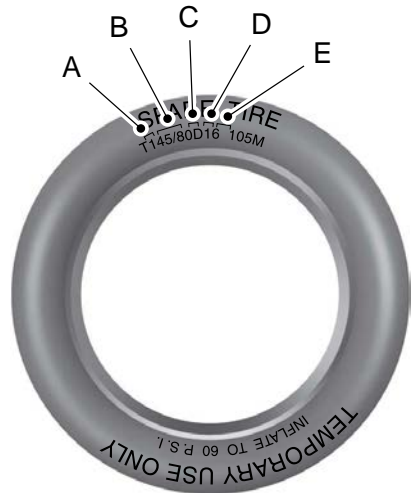

T type tires have some additional information beyond those of P type tires; these differences are described below:

A. **T:** Indicates a type of tire, designated by the Tire and Rim Association, that is intended for temporary service on cars, sport utility vehicles, minivans and light trucks.

B. **145:** Indicates the nominal width of the tire in millimeters from sidewall edge to sidewall edge. In general, the larger the number, the wider the tire.

Wheel and Tire Information

C. **80:** Indicates the aspect ratio which gives the tire's ratio of height to width. Numbers of 70 or lower indicate a short sidewall.

D. **D:** Indicates a diagonal type tire.

R: Indicates a radial type tire.

E. **16:** Indicates the wheel or rim diameter in inches. If you change your wheel size, you will have to purchase new tires to match the new wheel diameter.

GLOSSARY OF TIRE TERMINOLOGY

***Tire label:** A label showing the original equipment tire sizes, recommended inflation pressure and the maximum weight the vehicle can carry.

***Tire Identification Number (TIN):** A number on the sidewall of each tire providing information about the tire brand and manufacturing plant, tire size and date of manufacture. Also referred to as DOT code.

***Inflation pressure:** A measure of the amount of air in a tire.

***Standard load:** A class of P-metric or Metric tires designed to carry a maximum load at set pressure. For example: For P-metric tires 35 psi (2.4 bar) and for Metric tires 36 psi (2.5 bar). Increasing the inflation pressure beyond this pressure will not increase the tire's load carrying capability.

***Extra load:** A class of P-metric or Metric tires designed to carry a heavier maximum load at 42 psi (2.9 bar). Increasing the inflation pressure beyond this pressure will not increase the tire's load carrying capability.

***kPa:** Kilopascal, a metric unit of air pressure.

***PSI:** Pounds per square inch, a standard unit of air pressure.

***Cold tire pressure:** The tire pressure when the vehicle has been stationary and out of direct sunlight for an hour or more and prior to the vehicle being driven for 1 mi (1.6 km).

***Recommended inflation pressure:** The cold inflation pressure found on the Safety Compliance Certification Label (affixed to either the door hinge pillar, door-latch post, or the door edge that meets the door-latch post, next to the driver's seating position), or Tire Label located on the B-Pillar or the edge of the driver door.

* **B-pillar:** The structural member at the side of the vehicle behind the front door.

***Bead area of the tire:** Area of the tire next to the rim.

* **Sidewall of the tire:** Area between the bead area and the tread.

Wheel and Tire Information

***Tread area of the tire:** Area of the perimeter of the tire that contacts the road when mounted on the vehicle.

***Rim:** The metal support (wheel) for a tire or a tire and tube assembly upon which the tire beads are seated.

TIRE REPLACEMENT REQUIREMENTS

Your vehicle is equipped with tires designed to provide a safe ride and handling capability.



WARNING: Only use replacement tires and wheels that are the same size, load index, speed rating, and type as those originally provided for your vehicle. The recommended tire and wheel sizes can be found on the Tire Label on the driver side door frame or the edge of the driver door. If this information is not found in those locations, or for additional options, contact your authorized dealer. Use of any tire or wheel not recommended, could affect the safety and performance of your vehicle, which could result in an increased risk of loss of vehicle control, vehicle rollover, personal injury and death.



WARNING: To reduce the risk of serious injury, when mounting replacement tires and wheels, you should not exceed the maximum pressure indicated on the sidewall of the tire to set the beads without additional precautions listed below. If the beads do not seat at the maximum pressure indicated, re-lubricate and try again.



WARNING: For a mounting pressure more than 20 psi (1.38 bar) greater than the maximum pressure, a Ford dealer or other tire service professional should do the mounting.



WARNING: Always inflate steel carcass tires with a remote air fill with the person inflating standing at a minimum of 12 ft (3.66 m) away from the wheel and tire assembly.



WARNING: Only use the specified jacking points. If you use any other locations you could damage vehicle components, such as brake lines.

Wheel and Tire Information



WARNING: When inflating the tire for mounting pressures up to 20 psi (1.38 bar) greater than the maximum pressure on the tire sidewall, the following precautions must be taken to protect the person mounting the tire:

- Make sure that you have the correct tire and wheel size.
- Lubricate the tire bead and wheel bead seat area again.
- Stand at a minimum of 12 ft (3.66 m) away from the wheel and tire assembly.
- Use both eye and ear protection.

Note: *If your vehicle has 265/35R20 tires, replace them with original equipment tires provided by us. Using other tire sizes could damage your vehicle.*

Important: Remember to replace the wheel valve stems when the road tires are replaced on your vehicle.

It is recommended that the two front tires or two rear tires generally be replaced as a pair if the worn tires still have usable depth.

The tire pressure sensors mounted in the wheels (originally installed on your vehicle) are not designed to be used in aftermarket wheels.

The use of wheels or tires not recommended may affect the operation of your tire pressure monitoring system.

If the tire pressure monitoring system indicator is flashing, your system is malfunctioning. Your replacement tire might be incompatible with your tire pressure monitoring system, or some component of the system may be damaged.

Age



WARNING: Tires degrade over time depending on many factors such as weather, storage conditions, and conditions of use (load, speed, inflation pressure) the tires experience throughout their lives.

In general, tires should be replaced after six years regardless of tread wear. However, heat caused by hot climates or frequent high loading conditions can accelerate the aging process and may require tires to be replaced more frequently.

You should replace your spare tire when you replace the road tires or after six years due to aging even if it has not been used.

Wheel and Tire Information

U.S. DOT Tire Identification Number

Both United States and Canada Federal regulations require tire manufacturers to place standardized information on the sidewall of all tires. This information identifies and describes the fundamental characteristics of the tire and also provides a U.S. DOT Tire Identification Number for safety standard certification and in case of a recall.

This begins with the letters DOT and indicates that the tire meets all federal standards. The next two numbers or letters are the plant code designating where it was manufactured, the next two are the tire size code and the last four numbers represent the week and year the tire was built. For example, the numbers 317 mean the 31st week of 1997. After 2000, the numbers go to four digits. For example, 2501 means the 25th week of 2001. The numbers in between are identification codes used for traceability. This information is used to contact customers if a tire defect requires a recall.

USING SUMMER TIRES

Summer tires provide superior performance on wet and dry roads. Summer tires do not have the Mud and Snow (M+S or M/S) tire traction rating on the tire side wall. Since summer tires do not have the same traction performance as All-season or Snow tires, we do not recommend using summer tires when temperatures drop to about 45°F (7°C) or below, depending on tire wear and environmental conditions, or in snow and ice conditions. Like any tire, summer tire performance is affected by tire wear and environmental conditions. If you must drive in those conditions, we recommend using Mud and Snow (M+S, M/S), All-season or Snow tires.

Always store your summer tires indoors at temperatures above 19°F (-7°C). The rubber compounds used in these tires lose flexibility and may develop surface cracks in the tread area at temperatures below 19°F (-7°C). If the tires have been subjected to 19°F (-7°C) or less, warm them in a heated space to at least 41°F (5°C) for at least 24 hours before installing them on a vehicle, or moving the vehicle with the tires installed, or checking tire inflation. Always inspect the tires after storage periods and before use.

Dark Horse Handling Package

Wheels

Your vehicle has unique wheels matched to the tires. These wheels are more susceptible to damage due to their diameter, width, and low profile tires.

To avoid damage to your wheels:

- Maintain proper tire pressure
- When installing wheels, always torque lug nuts to specification with a torque wrench.

Wheel and Tire Information

- Inspect your wheels for damage on a regular basis. If a wheel is damaged, replace it immediately.
- In the event that you encounter an abnormally harsh impact, inspect the outer diameter of your wheels, both inside and out, for damage.

Tires

Your vehicle has low profile, high performance tires that are designed to optimize the driving dynamics you expect in a Ford vehicle. These tires are not optimized for off-road or winter (snow or cold weather) performance, and their ride, noise and wear characteristics are different than non-performance tires. Also, because of their lower profile, the tires are more susceptible to damage due to potholes and rough roads.

Variant		Tires	Wheels (inches)
GT	Front	255/40R19	19 x 9
	Rear	275/40R19	19 x 9.5
Dark Horse	Front	255/40R19	19 x 9.5
	Rear	275/40R19	19 x 10
Dark Horse with handling package	Front	305/30R19	19 x 10.5
	Rear	315/30R19	19 x 11

Note: As outlined in the previous table, there are different sized tires and wheels on the front and rear positions. In order to identify that wheels are in their correct position, check the valve hole location as indicated in the following chart:

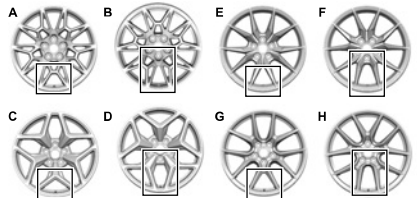

- A 19 in. x 9 in. front wheel, with the valve hole in a smaller window.
- B 19 in. x 9.5 in. rear wheel, with the valve hole in a larger window.
- C 19 in. x 9 in. front wheel, with the valve hole in a smaller window.
- D 19 in. x 9.5 in. rear wheel, with the valve hole in a larger window.

Wheel and Tire Information

- E 19 in. x 9.5 in. rear wheel, with the valve hole in a larger window.
- F 19 in. x 10 in. rear wheel, with the valve hole in a larger window.
- G 19 in. x 10.5 in. rear wheel, with the valve hole in a larger window.
- H 19 in. x 11 in. rear wheel, with the valve hole in a larger window.

To make sure that your tires perform as intended, it is important that you properly maintain your tires:

- Your original equipment tires are optimized for performance in both wet and dry conditions. We do not recommend using the original equipment tires when temperatures drop to about 45°F (7°C) or below (depending on tire wear and environmental conditions) or in snow and ice conditions.
- The tires were designed for track use and may exhibit significantly reduced tread life and increased tire noise compared to the standard equipment tires under normal driving conditions. Increasing the front camber settings beyond the factory settings may further accelerate tread wear and induce tire noise.
- For tire pressures, see the placard located on the B-pillar inside the driver door.
- Always maintain your tire pressures according to the tire information placard on the driver door jamb, using an accurate gauge.
- Tire pressures are specified cold and should be checked after the vehicle has been parked for at least three hours. Do not reduce the pressure of warm tires.
- Check your tire pressure often to maintain it properly. Tire pressure can diminish over time and fluctuate with temperature.
- Do not overload your vehicle. Maximum vehicle and axle weights are listed on the tire information placard.
- Extra caution should be taken when operating the vehicle near its maximum load, including assuring proper tire pressure and reducing speeds.
- Extra caution should be taken when operating on rough roads to avoid impacts that could cause tire damage.
- In the event that you encounter an abnormally harsh impact, inspect your tires for damage.
- Inspect your tires for damage on a regular basis. If a tire is damaged, immediately replace it.
- Proper suspension alignment is critical for maximum performance and optimal tire wear. If you notice uneven tire wear, have your alignment checked.
- Rotate tires as recommended in the tire rotation information. See Tire Care, in the Wheels and Tires Chapter of the Owner's Manual.
- Follow the rotation pattern for "Vehicles equipped with different size tires on the front and rear axle".
- When replacing tires, the only way to maintain original performance is to use the original equipment tire. If a different tire is used, it should be the same size, speed rating and load rating and be replaced as a set of four. Never mix tire brands.

Wheel and Tire Information

USING SNOW CHAINS



WARNING: Do not exceed 30 mph (50 km/h). Failure to follow this instruction could result in the loss of control of your vehicle, personal injury or death.



WARNING: Do not use snow chains on snow-free roads.



WARNING: Only fit snow chains to specified tires.



WARNING: If your vehicle is fitted with wheel trims, remove them before fitting snow chains.



WARNING: Remember that even advanced technology cannot defy the laws of physics. It's always possible to lose control of a vehicle due to inappropriate driver input for the conditions. Aggressive driving on any road condition can cause you to lose control of your vehicle increasing the risk of personal injury or property damage. Activation of the electronic stability control system is an indication that at least some of the tires have exceeded their ability to grip the road; this could reduce the operator's ability to control the vehicle potentially resulting in a loss of vehicle control, vehicle rollover, personal injury and death.



WARNING: Wheels and tires must be the same size, load index and speed rating as those originally fitted on the vehicle. Use of any other tire or wheel can affect the safety and performance of your vehicle. Additionally, the use of non-recommended tires and wheels can cause steering, suspension, axle, transfer case or power transfer unit failure. Follow the recommended tire inflation

pressures found on the Safety Compliance Certification label, or the Tire Label on the B-Pillar or the edge of the driver door. Failure to follow this instruction could result in loss of vehicle control, vehicle rollover, or personal injury or death.

The tires on your vehicle could have all-weather treads to provide traction in rain and snow. In some climates you need to use snow tires and chains on your vehicle in emergency situations or if required by law.

Note: *The suspension insulation and bumpers help prevent vehicle damage. Do not remove these components from your vehicle when using snow tires and chains.*

Note: *Driving too fast for road conditions creates the possibility of losing control of the vehicle. Driving at very high speeds for extended periods of time may result in damage to vehicle components.*

Note: *Snow chains could damage aluminum wheels.*

Follow these guidelines when using snow tires and chains:

- Use ultra low profile cables, 10 mm or less in dimension as measured on the sidewall of your tire, with 235/55R17, 235/50R18, 255/45R18 and 255/40R19 on the rear axle only.
- Do not use snow chains or cables with 275/40R19, 305/30R19, 315/30R19, and 265/35R20.
- Not all S-class snow chains or cables meet the same restrictions. Chains of this size restriction include a tensioning device.
- Purchase chains or cables from a manufacturer that clearly labels body to tire dimension restrictions. Mount the snow chains or cables in pairs on the rear tires only.

Wheel and Tire Information

- When driving with snow chains do not exceed 30 mph (50 km/h) or the maximum speed recommended by the chain manufacturer, whichever is less.
- Install cables securely, verifying that the cables do not touch any wiring or brake lines.
- Drive cautiously. If you hear the cables rub or bang against the vehicle, stop and retighten them. If this does not work, remove the cables to prevent vehicle damage.
- Remove the tire chains when they are no longer needed. Do not use tire chains on dry roads.

If you have any questions regarding snow chains or cables, contact your authorized dealer.

Tire Care

CHECKING THE TIRE PRESSURES

Safe operation of your vehicle requires that your tires are properly inflated. Every day before you drive, check your tires.

At least once a month and before long trips, inspect each tire and check the tire pressure with a tire gauge. Inflate all tires to the recommended inflation pressure. See **Inflating the Tires** (page 343).

INFLATING THE TIRES



WARNING: Under-inflation is the most common cause of tire failures and may result in severe tire cracking, tread separation or blowout, with unexpected loss of vehicle control and increased risk of injury. Under-inflation increases sidewall flexing and rolling resistance, resulting in heat buildup and internal damage to the tire. It also may result in unnecessary tire stress, irregular wear, loss of vehicle control and accidents. A tire can lose up to half of its air pressure and not appear to be flat!



WARNING: Do not use the tire pressure displayed in the information display as a tire pressure gauge. Failure to follow this instruction could result in personal injury or death.

Use the recommended cold inflation pressure for optimum tire performance and wear. Under-inflation or over-inflation may cause uneven treadwear patterns.

Inflate your tires to the recommended inflation pressure even if it is less than the maximum inflation pressure information found on the tire. You can find the tire label with the recommended tire inflation pressure next to the tire size on the B-Pillar or the edge of the driver door.

The recommended tire inflation pressure is also found on the Safety Compliance Certification Label, affixed to either the door hinge pillar, door-latch post, or the door edge that meets the door-latch on the B-pillar, or on the edge of the driver door.

Failure to follow the tire pressure recommendations can cause uneven treadwear patterns and adversely affect the way your vehicle handles.

Tire Care

Checking Pressure when tires are hot:

If pressures are checked after tires have been driven for more than three minutes or more than 1 mile, (2 km) the tires become hot and the pressures will increase by approximately 4 psi (27.6 kPa). Therefore when the tire pressure is adjusted under these conditions, it should be increased to a gauge reading of 4 psi (27.6 kPa) greater than the recommended cold inflation pressure.

After inflating the tires while hot, make sure to recheck tire pressure later once the tires are cold.

For Example Only

Gauge reading of hot tire	33 psi (230 kPa)
If recommended, cold inflation pressure is	32 psi (220 kPa)
The hot tire pressure is only 1 psi (10 kPa) greater than the recommended cold inflation pressure. Therefore, add 3 psi (20 kPa) more to increase the hot pressure to 4 psi (30 kPa) over the recommended cold inflation pressure.	

New hot pressure	36 psi (250 kPa)
------------------	------------------

INSPECTING THE TIRE FOR WEAR

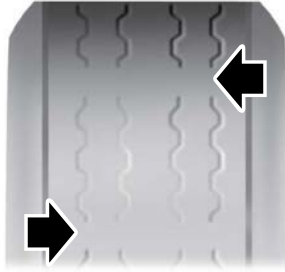

When the tread is worn down to 2/32 inch (1.6 mm), tires must be replaced to help prevent your vehicle from skidding and hydroplaning. Built-in treadwear indicators, or wear bars, which look like narrow strips of smooth rubber across the tread will appear on the tire when the tread is worn down to 2/32 inch (1.6 mm).

When the tire tread wears down to the same height as these wear bars, the tire is worn out and must be replaced.

The tires should also be balanced periodically. An unbalanced tire and wheel assembly may result in irregular tire wear.

Tire Care

Periodically inspect the tire treads for uneven or excessive wear and remove objects such as stones, nails or glass that may be wedged in the tread grooves.

INSPECTING THE TIRE FOR DAMAGE

Inspect the tire sidewalls for cracking, cuts, bruises and other signs of damage or excessive wear. If internal damage to the tire is suspected, have the tire dismantled and inspected in case it needs to be repaired or replaced. For your safety, tires that are damaged or show signs of excessive wear should not be used because they are more likely to blow out or fail.

Periodically inspect the tire treads and sidewalls for damage, such as bulges in the tread or sidewalls, cracks in the tread groove and separation in the tread or sidewall. If damage is observed or suspected, have the tire inspected by a tire professional.

Safety Practices



WARNING: If your vehicle is stuck in snow, mud or sand, do not rapidly spin the tires; spinning the tires can tear the tire and cause an explosion. A tire can explode in as little as three to five seconds.



WARNING: Do not spin the wheels at over 34 mph (55 km/h). The tires may fail and injure a passenger or bystander.

HIGH SPEED DRIVING CAN BE DANGEROUS

Correct inflation pressure is especially important. However, at high speeds, even with the correct inflation pressure, a road hazard for example is more difficult to avoid and if contact is made, has a greater chance of causing tire damage than at a lower speed. Moreover, driving at high speed reduces the reaction time available to avoid accidents and bring your vehicle to a safe stop.

If you see any damage to a tire or wheel, replace it with the spare at once and visit a participating Tire Retailer.

Exceeding the maximum speeds shown on the following page for each type of tire will cause the tire to build up excessive heat which can cause tire damage that could result in sudden tire destruction and rapid air loss. Failure to control a vehicle when one or more tires experience a sudden air loss can lead to an accident.

In any case, you should not exceed reasonable speeds as indicated by the legal limits and driving conditions.

Tire Care

DO NOT OVERLOAD: DRIVING ON ANY OVERLOADED TIRE IS DANGEROUS

The maximum load rating of your tires is molded on the tire sidewall. Do not exceed this rating. Follow the loading instructions of the manufacturer of your vehicle and this will ensure that your tires are not overloaded. Tires which are loaded beyond their maximum allowable loads for the particular application will build up excessive heat that may result in sudden tire destruction. Do not exceed the gross axle weight rating for any axle on your vehicle.

TIRE ALTERATIONS

Do not make or allow to be made any alterations on your tires. Alterations may prevent proper performance, leading to tire damage which can result in an accident. Tires which become unserviceable due to alterations such as truing, whitewall inlays, addition of balancing or sealant liquids, or the use of tire dressing containing petroleum distillates are excluded from warranty coverage.

REPAIRS - WHEREVER POSSIBLE, SEE YOUR TIRE RETAILER AT ONCE

If any tire sustains a puncture, have the tire demounted and thoroughly inspected by a tire retailer for possible damage that may have occurred. A tread area puncture in any passenger or light truck tire can be repaired provided that the puncture hole is not more than 1/4" in diameter, not more than one radial cable per casing ply is damaged, and the tire has not been damaged further by the puncturing object or by running underinflated. Tire punctures consistent with these guidelines should only be repaired by following the US Tire Manufacturers Association (USTMA) recommended repair procedures. Plug-only repairs done on-the-wheel are considered improper and therefore, not recommended. Such repairs are not reliable and may cause further damage to the tire.

STORAGE

Tires contain waxes and emollients to protect their outer surfaces from ozone and weather checking. As the tire rolls and flexes, the waxes and emollients continually migrate to the surface, replenishing this protection throughout the normal use of the tire. Consequently, when tires sit unused for long periods of time (a month or more) their surfaces

Tire Care

become dry and more susceptible to ozone and weather checking and the casing becomes susceptible to flat spotting. **For this reason, tires should always be stored in a cool, dry, clean, indoor environment. If storage is for one month or more, eliminate the weight from the tires by raising the vehicle or by removing the tires from the vehicle. Failure to store tires in accordance with these instructions could result in damage to your tires or premature aging of the tires and sudden tire failure.**

When tires are stored, be sure they are placed away from sources of heat and ozone such as direct sunlight, hot pipes and electric generators. Be sure that surfaces on which tires are stored are clean and free from grease, gasoline or other substances, which could deteriorate the rubber. Failure to store tires in accordance with these instructions could result in damage to your tires or premature aging of the tires and sudden tire failure.

FOLLOW THESE MOUNTING RECOMMENDATIONS

Tire changing can be dangerous and must be done by professionally trained persons using proper tools and procedures as specified by the US Tire Manufacturers Association (USTMA). Single or dual assemblies must be completely deflated before demounting.

Your tires should be mounted on wheels of correct size and type and which are in good, clean condition. Wheels that are bent, chipped, rusted (steel wheels) or corroded (alloy wheels) may cause tire damage. The inside of the tire must be free from foreign material. Have your retailer check the wheels before mounting new tires. Mismatched tires and rims can explode during mounting. Also, mismatched tires and rims can result in dangerous tire failure on the road. If a tire is mounted by error on the wrong-sized rim, do not remount it on the proper rim - scrap it. It may have been damaged internally (which is not externally visible) by having been dangerously stretched and could fail on the highway.

Tire Care

Old valves may leak. When new tubeless tires are mounted, have new valves of the correct type installed. Tubeless tires must only be mounted on wheels designed for tubeless tires i.e., wheels which have safety humps or ledges.

It is recommended that you have your tires and wheels balanced. Tires and wheels, which are not balanced, may cause steering difficulties, a bumpy ride, and irregular tire wear.

Be sure that all your valves have suitable valve caps. The valve cap is the primary seal against air loss.

TEMPORARY SPARE TIRES

When using any temporary spare tire, be sure to follow the vehicle manufacturer's instructions.

REMEMBER... TO AVOID DAMAGE TO YOUR TIRES AND POSSIBLE ACCIDENT:

- CHECK TIRE PRESSURE AT LEAST ONCE EACH MONTH WHEN TIRES ARE COLD AND BEFORE LONG TRIPS.
- DO NOT UNDERINFLATE/OVERINFLATE.
- DO NOT OVERLOAD.
- DRIVE AT MODERATE SPEEDS, OBSERVE LEGAL LIMITS.

- AVOID DRIVING OVER POTHOLES, OBSTACLES, CURBS OR EDGES OF PAVEMENT.
- AVOID EXCESSIVE WHEEL SPINNING.
- IF YOU SEE ANY DAMAGE TO A TIRE, REPLACE WITH THE SPARE AND VISIT ANY AUTHORIZED RETAILER AT ONCE.
- IF YOU HAVE ANY QUESTIONS, CONTACT YOUR AUTHORIZED RETAILER.

Highway Hazards

No matter how carefully you drive, there is always the possibility that you could eventually have a flat tire on the highway. Drive slowly to the closest safe area out of traffic. This could further damage the flat tire, but your safety is more important.

If you feel a sudden vibration or ride disturbance while driving, or you suspect your tire or vehicle has been damaged, immediately reduce your speed. Drive with caution until you can safely pull off the road. Stop and inspect the tires for damage. If a tire is under-inflated or damaged, deflate it, remove the wheel and replace it with your spare tire and wheel. If you cannot detect a cause, have the vehicle towed to the nearest repair facility or tire dealer to have the vehicle inspected.

Tire Care

Tire and Wheel Alignment

A bad jolt from hitting a curb or pothole can cause the front end of your vehicle to become misaligned or cause damage to your tires. If your vehicle seems to pull to one side when you are driving, the wheels could be out of alignment. Have an authorized dealer check the wheel alignment periodically.

Wheel misalignment in the front or the rear can cause uneven and rapid treadwear of your tires and should be corrected by an authorized dealer.

INSPECTING THE WHEEL VALVE STEMS

Check the valve stems for holes, cracks, or cuts that could permit air leakage.

TIRE ROTATION



WARNING: If the tire label shows different tire pressures for the front and rear tires and the vehicle has a tire pressure monitoring system, then you need to update the settings for the system sensors. Always

perform the system reset procedure after tire rotation. If you do not reset the system, it may not provide a low tire pressure warning when necessary.

Rotating your tires at the recommended interval helps your tires wear more evenly, providing better tire performance and longer tire life.

Note: *If your tires show any uneven wear have the alignment checked by an authorized dealer before rotating tires.*

Note: *If you have a dissimilar spare wheel and tire assembly, it is intended for temporary use only and should not be used in a tire rotation.*

Note: *After having your tires rotated check and adjust inflation pressure to the vehicle requirements.*

Tire Rotation Diagram

Follow the diagram indicating the correct tire locations for rotating the tires.

Rear-wheel drive vehicles (front tires on the left side of the diagram).

Non-directional tires

Tire Care

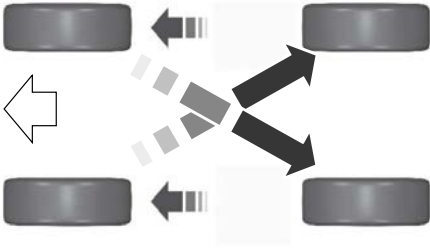

Vehicles equipped with different size tires on the front and rear axle

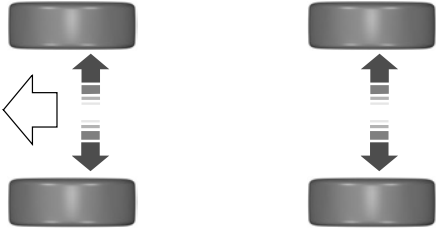

Tire Sealant and Inflator Kit (If Equipped)

WHAT IS THE TIRE SEALANT AND INFLATOR KIT

The kit consists of an air compressor to re-inflate the tire and a canister of sealing compound that effectively seals most punctures. This kit provides a temporary tire repair allowing you to drive your vehicle up to 120 mi (200 km) at a maximum speed of 50 mph (80 km/h) to reach a tire service location.

Note: *The temporary mobility kit contains enough sealant compound in the canister for one tire repair only. See an authorized dealer for replacement sealant canisters.*

TIRE SEALANT AND INFLATOR KIT PRECAUTIONS



WARNING: Depending on the type and extent of tire damage, some tires can only be partially sealed or not sealed at all. Loss of tire pressure can affect vehicle handling, leading to loss of vehicle control.



WARNING: Do not use the kit on a previously damaged tire, for example when it has been driven under inflated. This could cause loss of vehicle control, personal injury or death.



WARNING: Do not run the engine when operating the air compressor unless the vehicle is outdoors or in a well-ventilated area.

Do not attempt to repair punctures larger than 0.24 in (6 mm) or damage to the tire's sidewall.

Only punctures located within the tire tread can be sealed with the kit.

Only use the kit supplied with your vehicle.

The temporary mobility kit contains enough sealant compound in the canister for one tire repair only.

After using the sealant, an authorized dealer needs to replace the tire pressure monitoring system sensor and valve stem on the wheel.

LOCATING THE TIRE SEALANT AND INFLATOR KIT

The kit is located under the load floor in the rear of the vehicle.

Tire Sealant and Inflator Kit (If Equipped)

TIRE SEALANT AND INFLATOR KIT COMPONENTS

Tire Sealant and Inflator Kit Solution 1

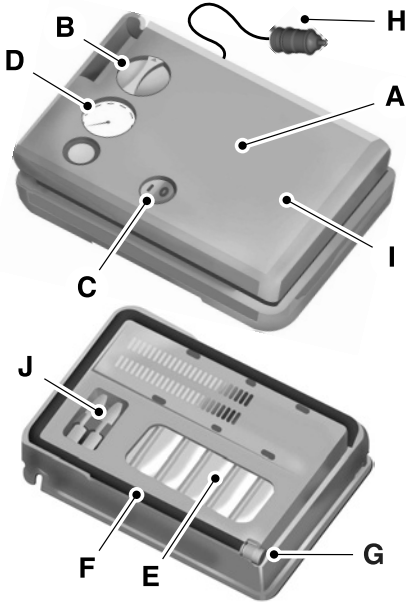

- A Air compressor (inside)
- B Selector switch
- C On and Off button
- D Air pressure gauge
- E Sealant bottle and canister
- F Dual purpose hose: air and repair
- G Tire valve connector
- H Accessory power plug
- I Casing/housing
- J Bike/raft/sports ball adapters

Tire Sealant and Inflator Kit Solution 2

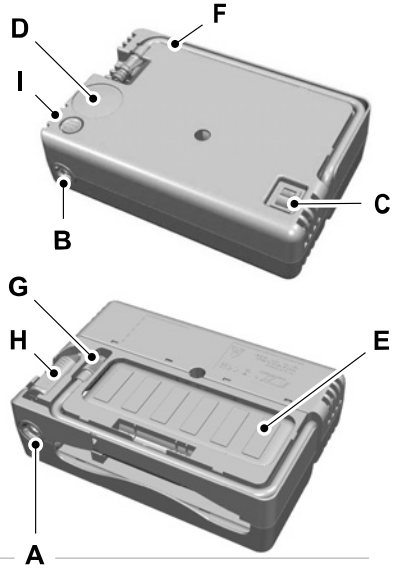

- A Air compressor (inside)
- B Air Hose port (1 of 2)
- C On and Off button
- D Air pressure gauge
- E Sealant bottle and canister
- F Dual purpose hose: air and repair
- G Tire valve connector
- H Accessory power plug
- I Casing/housing

Tire Sealant and Inflator Kit (If Equipped)

USING THE TIRE SEALANT AND INFLATOR KIT

Tips for use of the Tire Sealant and Inflator Kit Solution 1

To make sure the kit operates safely and properly, observe the following:

- Before operating the kit, make sure your vehicle is safely off the road and away from moving traffic.
- Do not remove any foreign objects, such as nails or screws, from the tire.
- Do not allow the compressor to operate continuously for more than 15 minutes. This prevents the compressor from overheating.
- Only use the kit when the ambient temperature is between -22°F (-30°C) and 158°F (70°C).
- Only use the sealing compound before the use by date. The use by date is on the sealant canister label and can be seen through the rectangular viewing window on the bottom of the compressor. Check the use by date regularly and replace the canister when the sealant expires.

Note: Sealant compound contains latex. Use appropriate precautions to avoid any allergic reactions.



When inflation only is required for a tire or other objects, the selector must be in the Air position.

What to do when a tire is punctured

A tire puncture within the tire's tread area can be repaired in two stages with the kit.

- In the first stage, the tire is reinflated with a sealing compound and air. After the tire has been inflated, drive the vehicle 4 mi (6 km) to distribute the sealant in the tire.
- In the second stage, check the tire pressure and adjust, if necessary, to the vehicle's specified tire inflation pressure.

First Stage: Reinflating the Tire with sealing compound and air



WARNING: Do not stand directly over the kit while inflating the tire. If you notice any unusual bulges or deformations in the tire's sidewall during inflation, stop and call roadside assistance.



WARNING: If the tire does not inflate to the recommended tire pressure within 15 minutes, stop and call roadside assistance.

Park the vehicle in a safe, level and secure area, away from moving traffic.

Turn the hazard lights on. Apply the parking brake and power off the vehicle. Inspect the flat tire for visible damage.

If a puncture is located in the tire sidewall, stop and call roadside assistance.

1. Remove the valve cap from the tire valve.
2. Unwrap the dual purpose hose (black tube) from the back of the compressor housing.
3. Fasten the hose to the tire valve by turning the connector clockwise. Tighten the connection securely.

Tire Sealant and Inflator Kit (If Equipped)

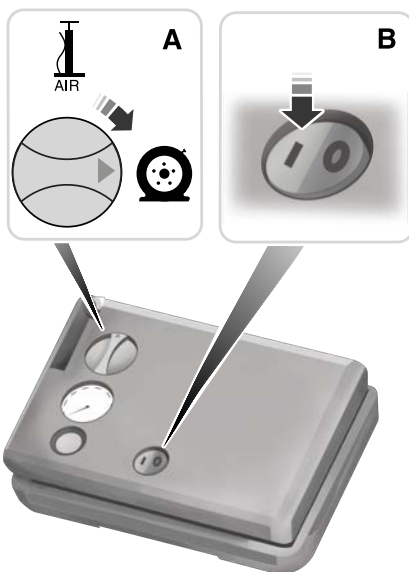
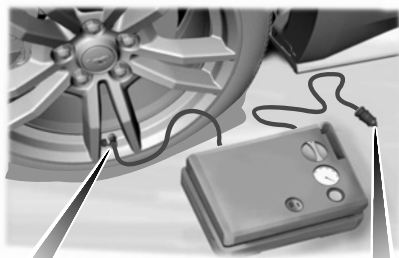

4. Plug the power cable into the 12-volt power point in the vehicle.
5. Remove the warning sticker found on the casing/housing and place it on top of the instrument panel or the center of the dash.
6. Turn dial (A) clockwise to the sealant position. Turn the kit on by pressing the on/off button (B).
7. Inflate the tire to the pressure listed on the tire label located on the driver door or the door jamb area. Check the final tire pressure with the compressor turned off to get an accurate pressure reading.

Tire Sealant and Inflator Kit (If Equipped)

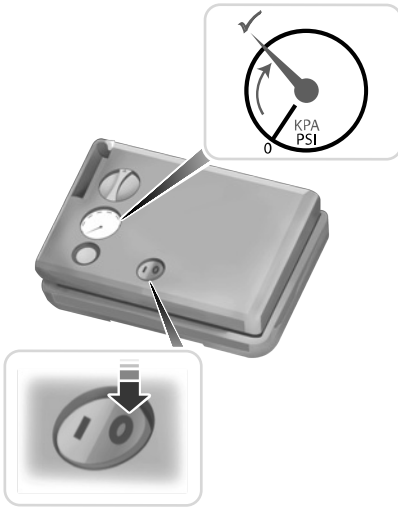

- When the recommended tire pressure is reached, turn off the kit, unplug the power cable, and disconnect the hose from the tire valve. Re-install the valve cap on the tire valve and return the kit to the rear of the vehicle.
- Drive the vehicle 4 mi (6 km) to evenly distribute the sealant inside the tire.

Note: If you experience any unusual vibration, ride disturbance or noise while driving, reduce your speed until you can safely pull off to the side of the road to call for roadside assistance. Do not proceed to the second stage of this operation.

Second Stage: Checking the tire pressure with the inflator kit



WARNING: If the tire does not inflate to the recommended tire pressure within 15 minutes, stop and call roadside assistance.



WARNING: The power plug may get hot after use and should be handled carefully when unplugging.

Check the air pressure of your tires as follows:



- Remove the valve cap from the tire valve.
- Attach the air compressor hose onto the valve stem by turning clockwise.
- Push and turn the dial clockwise to the air position.
- If required, turn on the compressor and adjust the tire to the recommended inflation pressure.
- Remove the hoses, re-install the tire valve cap on the tire and return the kit to the rear of the vehicle.

What to do after the tire has been sealed

After using the kit to seal your tire, replace the sealant canister. Sealant canisters and spare parts can be obtained at an authorized dealer. Empty sealant canisters may be disposed of at home. However, canisters still containing liquid sealant should be disposed of in accordance with local waste disposal regulation.

Tire Sealant and Inflator Kit (If Equipped)

Removal of the sealant canister from the kit

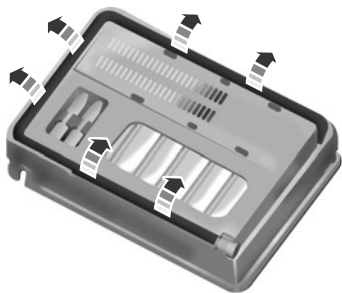

1. Unwrap the dual purpose hose (black tube) from the compressor housing.



2. Unwrap the power cord.



3. Remove the back cover.



4. Rotate the sealant canister up 90 degrees and pull away from casing/housing to remove.

Installation of the sealant canister to the kit

1. With the canister held perpendicular to the housing, insert the canister nozzle into the connector and push until seated.
2. Rotate the canister 90 degrees down into the housing/casing.



3. Snap the back cover back into place.

Tire Sealant and Inflator Kit (If Equipped)



4. Wrap the dual purpose hose (black tube) around the channel on the bottom of the housing/casing.

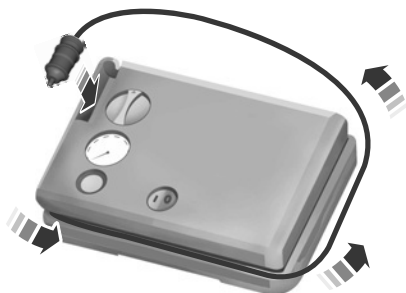

5. Wrap the power cord around the housing and stow the accessory power plug.

Tips for use of the Tire Sealant and Inflator Kit Solution 2

To make sure the kit operates safely and properly, observe the following:

- Before operating the kit, make sure your vehicle is safely off the road and away from moving traffic.
- Do not remove any foreign objects, such as nails or screws, from the tire.

- Do not allow the compressor to operate continuously for more than 15 minutes. This prevents the compressor from overheating.
- Only use the kit when the ambient temperature is between -22°F (-30°C) and 158°F (70°C).
- Only use the sealing compound before the use by date. The use by date is on the sealant canister label and can be seen through the rectangular viewing window on the bottom of the compressor. Check the use by date regularly and replace the canister when the sealant expires.

Note: Sealant compound contains latex. Use appropriate precautions to avoid any allergic reactions.



The tire sealant and inflator kit can be for regular tire pressure maintenance and inflating other objects by plugging the air supply hose into the port identified by a tire pump icon as indicated by the gray portion of the instruction label.

What to do when a tire is punctured

A tire puncture within the tire's tread area can be repaired in two stages with the kit:

- In the first stage, the tire is reinflated with a sealing compound and air. After the tire has been inflated, drive the vehicle 4 mi (6 km) to distribute the sealant in the tire.
- In the second stage, check the tire pressure and adjust, if necessary, to the vehicle's specified tire inflation pressure.

Tire Sealant and Inflator Kit (If Equipped)

First Stage: Reinflating the Tire with sealing compound and air



WARNING: Do not stand directly over the kit while inflating the tire. If you notice any unusual bulges or deformations in the tire's sidewall during inflation, stop and call roadside assistance.



WARNING: If the tire does not inflate to the recommended tire pressure within 15 minutes, stop and call roadside assistance.

Park the vehicle in a safe, level and secure area, away from moving traffic.

Turn the hazard lights on. Apply the parking brake and power off the vehicle. Inspect the flat tire for visible damage.

If a puncture is located in the tire sidewall, stop and call roadside assistance.

1. The dual-purpose hose (black tube) for air and sealant is pressed into a groove on the compressor housing. Remove the dual-purpose hose from the compressor housing.
2. Insert the air supply hose into the port as identified by the punctured tire icon and indicated by the blue portion of the instruction label for temporary repair of a tire puncture.

Note: Note the winged twist connector on the instruction label side of the housing.

3. Follow the arrow on the blue, puncture repair portion of the label to find the port for the winged twist connector on the side of the compressor housing. It is labeled "A" with a printed icon of a punctured tire.

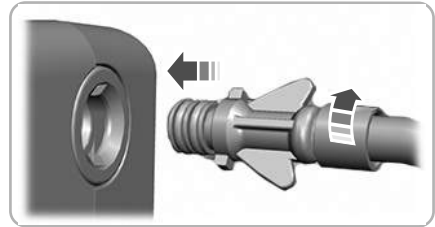
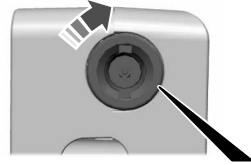
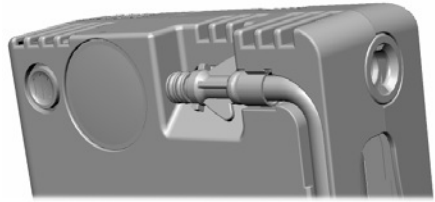

4. Insert the connector and twist it clockwise until the connector wing aligns with the marking on the compressor housing and it is locked in position.
5. Remove the valve cap from the tire valve.

Tire Sealant and Inflator Kit (If Equipped)

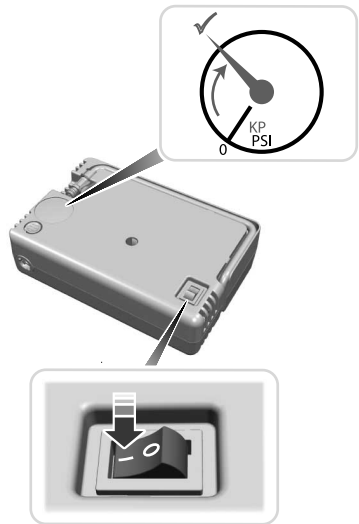
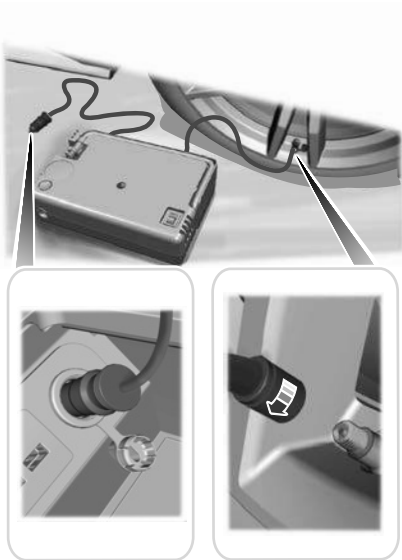

6. Fasten the hose to the tire valve by turning the threaded connector clockwise. Tighten the connection securely.
7. Plug the power cable into the 12-volt power point in the vehicle.
8. Turn the tire inflator kit on by pressing the on/off button.
9. Inflate the tire to the pressure listed on the tire label located on the driver door or the door jamb area. Check the final tire pressure with the compressor turned off to get an accurate pressure reading.

Tire Sealant and Inflator Kit (If Equipped)

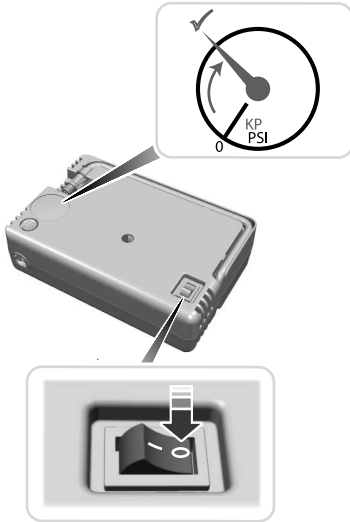

Note: If you experience any unusual vibration, ride disturbance or noise while driving, reduce your speed until you can safely pull off to the side of the road to call for roadside assistance. Do not proceed to the second stage of this operation.

Second Stage: Checking the tire pressure with the inflator kit

WARNING: If the tire does not inflate to the recommended tire pressure within 15 minutes, stop and call roadside assistance.

WARNING: The power plug may get hot after use and should be handled carefully when unplugging.

Check the air pressure of your tires as follows:



- When the recommended tire pressure is reached, turn off the kit, unplug the power cable, and disconnect the hose from the tire valve. Re-install the valve cap on the tire valve and return the kit to the rear of the vehicle.
- Remove the red warning sticker found on the casing/housing and place it on top of the instrument panel or the center of the dash.
- Drive the vehicle 4 mi (6 km) to evenly distribute the sealant inside the tire. Do not exceed 50 mph (80 km/h).
- After 4 mi (6 km), stop and check the tire pressure. See Second Stage: Checking Tire Pressure.

- Remove the valve cap from the tire valve.
- Attach the air compressor hose onto the valve stem by turning clockwise.
- Push and turn the dial clockwise to the air position.
- If required, turn on the compressor and adjust the tire to the recommended inflation pressure.

Tire Sealant and Inflator Kit (If Equipped)

5. Remove the hoses, re-install the valve cap on the tire valve and return the kit to the rear of the vehicle.

What to do after the tire has been sealed

After using the kit to seal your tire, replace the sealant canister. Sealant canisters and spare parts can be obtained at an authorized dealer. Empty sealant canisters may be disposed of at home. However, canisters still containing liquid sealant should be disposed of in accordance with local waste disposal regulation.

Removal of the sealant canister from the kit



1. Unwrap the dual purpose hose (black tube) from the compressor housing and discard.
2. Unwrap the power cord.

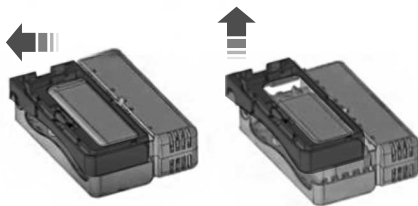

3. Unlatch the sealant bottle cover by sliding it outward, then lift and remove the cover.

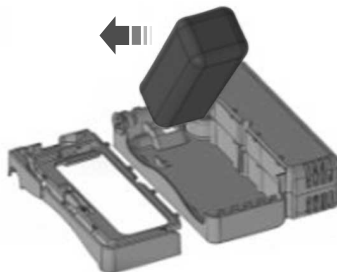

4. Rotate the sealant canister up 60 degrees and slide it outward from the case/housing to remove.

Tire Sealant and Inflator Kit (If Equipped)

Installation of the sealant canister to the kit

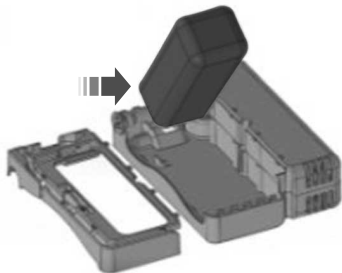

1. With the canister held at an angle to the housing, insert the canister nozzle into the connector and push until seated.
2. Rotate the canister 90 degrees down into the housing/case.
3. Slide the back cover over the cannister until it snaps back into place.
4. Wrap the new dual-purpose hose (black tube) into the channel around the housing/case.
5. Stow the power cord in the side compartment of the housing and stow the accessory power cord into its storage slot on the back cover.

Note: *If you experience any difficulties with the removal or installation of the sealant canister, contact your authorized dealer for assistance. Make sure the sealant compound use by date is on the sealant canister label and can be seen through the rectangular viewing window on the bottom of the kit. Replace the sealant canister after four years of non-use.*

Tire Pressure Monitoring System

WHAT IS THE TIRE PRESSURE MONITORING SYSTEM



The tire pressure monitoring system measures the vehicle's tire pressures. A warning lamp illuminates if one or more tires are significantly underinflated or if there is a system malfunction.

TIRE PRESSURE MONITORING SYSTEM OVERVIEW



WARNING: Under-inflation is the most common cause of tire failures and may result in severe tire cracking, tread separation or blowout, with unexpected loss of vehicle control and increased risk of injury. Under-inflation increases sidewall flexing and rolling resistance, resulting in heat buildup and internal damage to the tire. It also may result in unnecessary tire stress, irregular wear, loss of vehicle control and accidents. A tire can lose up to half of its air pressure and not appear to be flat!



WARNING: To determine the required pressure(s) for your vehicle, see the Safety Compliance Certification Label (on the door hinge pillar, door-latch post or the door edge that meets the door-latch post, next to the driver seat) or the Tire Label on the B-Pillar or the edge of the driver door.

Each tire, including the spare (if provided), should be checked monthly when cold and inflated to the inflation pressure recommended by the vehicle manufacturer on the vehicle placard or tire inflation pressure label. (If your vehicle has tires of a different size than the size indicated on the vehicle placard or tire inflation pressure label, you should determine the proper tire inflation pressure for those tires).

As an added safety feature, your vehicle has been equipped with a Tire Pressure Monitoring System (TPMS) that illuminates a low tire pressure telltale when one or more of your tires is significantly under-inflated. Accordingly, when the low tire pressure telltale illuminates, you should stop and check your tires as soon as possible, and inflate them to the proper pressure. Driving on a significantly under-inflated tire causes the tire to overheat and can lead to tire failure. Under-inflation also reduces fuel efficiency and tire tread life, and may affect the vehicle's handling and stopping ability.

Please note that the TPMS is not a substitute for proper tire maintenance, and it is the driver's responsibility to maintain correct tire pressure, even if under-inflation has not reached the level to trigger illumination of the TPMS low tire pressure telltale.

Your vehicle has also been equipped with a TPMS malfunction indicator to indicate when the system is not operating properly. The TPMS malfunction indicator is combined with the low tire pressure telltale. When the system detects a malfunction, the telltale will flash for approximately one minute and then remain continuously illuminated. This sequence will continue upon subsequent vehicle start-ups as long as the malfunction exists.

Tire Pressure Monitoring System

When the malfunction indicator is illuminated, the system may not be able to detect or signal low tire pressure as intended. TPMS malfunctions may occur for a variety of reasons, including the installation of replacement or alternate tires or wheels on the vehicle that prevent the TPMS from functioning properly. Always check the TPMS malfunction telltale after replacing one or more tires or wheels on your vehicle to ensure that the replacement or alternate tires and wheels allow the TPMS to continue to function properly.



WARNING: Changes or modifications not expressly approved by the party responsible for compliance could void the user's authority to operate the equipment. The term "IC:" before the radio certification number only signifies that Industry Canada technical specifications were met.

This device complies with Part 15 of the FCC Rules and with License exempt RSS Standards of Industry Canada. Operation is subject to the following two conditions:

1. This device may not cause harmful interference, and
2. This device must accept any interference received, including interference that may cause undesired operation.

TIRE PRESSURE MONITORING SYSTEM PRECAUTIONS



WARNING: The tire pressure monitoring system is not a substitute for manually checking tire pressures. You should periodically check tire pressures using a pressure gauge. Failure to correctly maintain tire pressures could increase the risk of tire failure, loss of control, vehicle rollover and personal injury.



WARNING: Do not use the tire pressure displayed in the information display as a tire pressure gauge. Failure to follow this instruction could result in personal injury or death.

Note: *The use of tire sealants can damage the tire pressure monitoring system.*

Note: *If the tire pressure monitor sensor becomes damaged it may not function.*

TIRE PRESSURE MONITORING SYSTEM LIMITATIONS

When the outside temperature drops significantly, the tire pressure could decrease and activate the low tire pressure warning lamp.

The warning lamp could also illuminate when you use a spare wheel, or tire sealant from the inflator kit.

Note: *Regularly checking the vehicle tire pressures can reduce the possibility for the warning lamp to illuminate due to outside air temperature changes.*

Note: *After you inflate the tires to the recommended pressure it could take up to two minutes of driving over 20 mph (32 km/h) for the warning indicator to turn off.*

Tire Pressure Monitoring System

VIEWING THE TIRE PRESSURES



To view the current tire pressures, use the information display or touchscreen.

TIRE PRESSURE MONITORING SYSTEM – TROUBLESHOOTING

TIRE PRESSURE MONITORING SYSTEM – WARNING LAMPS



The low tire pressure warning lamp has combined functions, as it warns you when your tires need air, and when the system is no longer capable of functioning as intended.

Warning Lamp	Possible Cause	Action Required
Solid warning lamp	One or more tires are significantly under inflated	After inflating your tires to the manufacturer's recommended pressure as shown on the tire label, on the edge of driver door or the B-pillar, drive your vehicle for at least two minutes over 20 mph (32 km/h) before the light turns off.
Solid warning lamp or flashing warning lamp	Temporary spare wheel in use	Repair the damaged road wheel and tire and refit it to your vehicle to restore operation of the system.
	Tire pressure monitoring system malfunction	If the tires are inflated to the recommended tire pressures and the temporary spare wheel is not in use, the system detected a fault that requires service. Have your vehicle checked as soon as possible.

Tire Pressure Monitoring System

TIRE PRESSURE MONITORING SYSTEM – INFORMATION MESSAGES

Message	Action
Tire Pressure Low	After inflating your tires to the manufacturer's recommended pressure as shown on the tire label, on the edge of the driver door or the B-pillar, drive your vehicle for at least two minutes over 20 mph (32 km/h) before the light turns off.
Tire Pressure Monitor Fault	The system has detected a fault that requires service. Have your vehicle checked as soon as possible.
Tire Pressure Sensor Fault	The system has detected a fault that requires service or a spare tire is in use. Have your vehicle checked as soon as possible.

Changing a Road Wheel

CHANGING A FLAT TIRE (IF EQUIPPED)

If you get a flat tire while driving, do not apply the brake heavily. Gradually decrease your speed and hold the steering wheel firmly and slowly move to a safe place on the side of the road.

Have a flat serviced by an authorized dealer to prevent damage to the tire pressure monitoring system sensors. See **Tire Pressure Monitoring System Overview** (page 363). Replace the spare tire with a road tire as soon as possible. During repairing or replacing the flat tire, have an authorized dealer inspect the tire pressure monitoring system sensor for damage.

Note: *Only use tire sealants in roadside emergencies as they may damage the tire pressure monitoring system sensor. If you use a sealant, use the Tire Mobility Kit sealant. Replace the tire pressure monitoring system sensor and valve stem on the wheel by an authorized dealer after use of the sealant.*

Note: *The tire pressure monitoring system indicator illuminates when the spare tire is in use. To restore the full functionality of the monitoring system, all road wheels with tire pressure monitoring sensors must be mounted on the vehicle.*

Dissimilar Spare Wheel and Tire Assembly Information



WARNING: Failure to follow these guidelines could result in an increased risk of loss of vehicle control, injury or death.

If you have a dissimilar spare wheel and tire, then it is intended for temporary use only. This means that if you need to use it, replace it as soon as possible with a road wheel and tire assembly that is the same size and type as the road tires and wheels that were originally provided on your vehicle. If the dissimilar spare tire or wheel is damaged, replace it instead of repairing it.

A dissimilar spare wheel and tire assembly is defined as a spare wheel and tire assembly that is different in brand, size or appearance from the road tires and wheels and can be one of three types:

1. **T-type mini-spares:** This spare tire begins with the letter T for tire size and could have Temporary Use Only molded in the sidewall.
2. **Full-size dissimilar spare with label on wheel:** This spare tire has a label on the wheel that states: THIS WHEEL AND TIRE ASSEMBLY FOR TEMPORARY USE ONLY.

When driving with one of the dissimilar spare tires listed above, do not:

- Exceed 50 mph (80 km/h).
- Load the vehicle beyond the maximum vehicle load rating listed on the Safety Compliance Label.
- Tow a trailer.
- Use snow chains on the end of the vehicle with the dissimilar spare tire.
- Use more than one dissimilar spare tire at a time.
- Use commercial car washing equipment.
- Try to repair the dissimilar spare tire.

Changing a Road Wheel

Using a dissimilar spare wheel and tire assembly can compromise the effectiveness of the following:

- Handling, stability and braking performance.
- Comfort and noise.
- Ground clearance and parking at curbs.
- Winter weather driving capability.
- Wet weather driving capability.
- All-wheel driving capability, if applicable.

3. Full-size dissimilar spare without label on wheel

When driving with the full-size dissimilar spare wheel and tire assembly, do not:

- Exceed 70 mph (113 km/h).
- Use more than one dissimilar spare wheel and tire assembly at a time.
- Use commercial car washing equipment.
- Use snow chains on the end of the vehicle with the dissimilar spare wheel and tire assembly.

Using a full-size dissimilar spare wheel and tire assembly can compromise the effectiveness of the following:

- Handling, stability and braking performance.
- Comfort and noise.
- Ground clearance and parking at curbs.
- Winter weather driving capability.
- Wet weather driving capability.
- All-wheel driving capability.

When driving with the full-size dissimilar spare wheel and tire assembly additional caution should be given to:

- Towing a trailer.
- Driving vehicles equipped with a camper body.
- Driving vehicles with a load on the cargo rack.

Drive cautiously when using a full-size dissimilar spare wheel and tire assembly and seek service as soon as possible.

Tire Change Procedure



WARNING: The jack supplied with this vehicle is only intended for changing a flat tire in an emergency. Do not attempt to do any other work on your vehicle when it is supported by the jack, as your vehicle could slip off the jack. Failure to follow this instruction could result in personal injury or death.



WARNING: To help prevent your vehicle from moving when changing a wheel, shift the transmission into park (P), set the parking brake and use an appropriate block or wheel chock to secure the wheel diagonally opposite to the wheel being changed. For example, when changing the front left wheel, place an appropriate block or wheel chock on the right rear wheel.



WARNING: Never place anything between the vehicle jack and your vehicle.





WARNING: Never place anything between the vehicle jack and the ground.

Changing a Road Wheel

 **WARNING:** Do not attempt to change a tire on the side of the vehicle close to moving traffic. Pull far enough off the road to not obstruct the flow of traffic and avoid the danger of being hit when operating the jack or changing the wheel.

 **WARNING:** Do not get under a vehicle that is supported by a jack.

 **WARNING:** Only use the specified jacking points. If you use any other locations you could damage vehicle components, such as brake lines.

 **WARNING:** Only use the jack provided as original equipment with your vehicle.

 **WARNING:** It is recommended that the wheels of the vehicle be chocked, and that no person should remain in a vehicle that is being jacked.

 **WARNING:** Make sure there is no grease or oil on the threads or the surface between the wheel studs and the wheel nuts. This can cause the wheel nuts to loosen while driving.

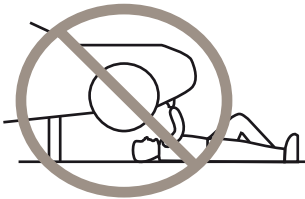

Note: The jack does not require maintenance or additional lubrication over the service life of your vehicle.

Note: Passengers should not remain in your vehicle when the vehicle is being jacked.

1. Park on a level surface, set the parking brake and activate the hazard flashers.
2. Place the transmission in park (P) and turn the engine off. For vehicles with a manual transmission, place the transmission in reverse (R) after the engine is turned off.

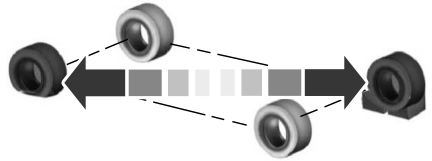

3. Block the wheels diagonally opposite the flat tire. For example, if the left front tire is flat, block the right rear wheel.

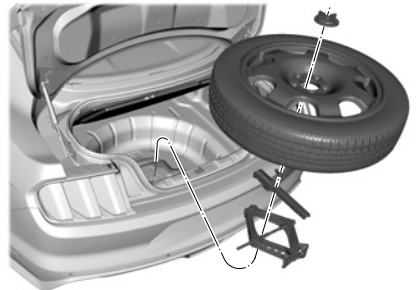

4. Open the luggage compartment and lift the access panel
5. Remove the lug wrench, spare tire and jack.
6. Remove the center ornament from the wheel if required to access the lug nuts.

Changing a Road Wheel

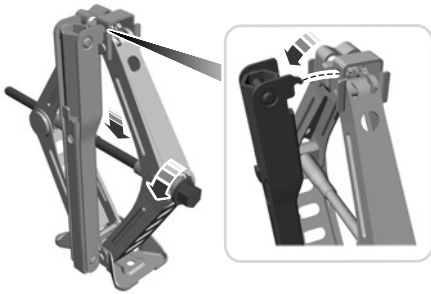

7. To remove the wrench from the jack, turn the hex nut on the jack counterclockwise. This lowers the jack and loosens the mechanical lock.
8. Unfold the wrench.



9. Loosen each wheel nut one-half turn counterclockwise but do not remove them until the wheel is raised off the ground.

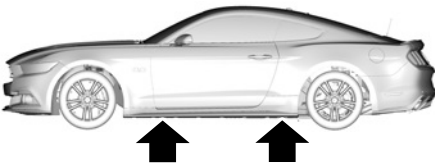

E176084

Note: Jack at the specified locations to avoid damage to the vehicle.

10. The vehicle jacking points are shown here, and can be identified by the triangle markings on the vehicle. Details are depicted on the warning label on the jack.



11. Place the jack at the jacking point next to the tire you are changing. Turn the jack handle clockwise until the wheel is completely off the ground.
12. Remove the wheel nuts with the lug wrench.
13. Replace the flat tire with the spare tire, making sure the valve stem is facing outward.
14. Reinstall wheel nuts until the wheel is snug against the hub. Do not fully tighten the wheel nuts until the wheel has been lowered.
15. Lower the wheel by turning the jack handle counterclockwise.

Changing a Road Wheel

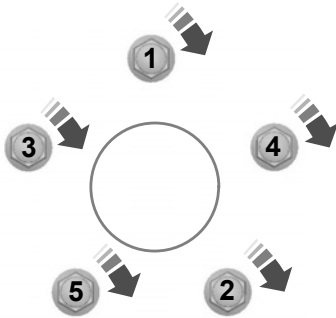

16. Remove the jack and fully tighten the wheel nuts in the order shown. See **Wheel Nuts** (page 371).
17. To store the folded wrench on the jack, engage the bracket of the jack base on the wrench feature as shown. Swing the wrench upwards and adjust the height of the jack until the pin engages the hole. Tighten the hex nut clockwise by hand until secure.

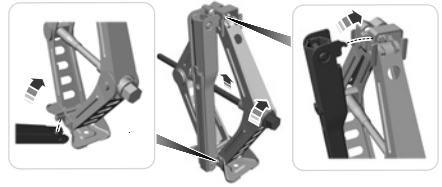

18. Put the flat tire, wheel ornament, jack and lug wrench away. Make sure the jack is fastened so it does not rattle when you drive.
19. Unblock the wheel.

WHEEL NUTS

 **WARNING:** When you install a wheel, remove any corrosion, dirt or foreign materials present on the mounting surfaces of the wheel or the surface of the wheel hub, brake drum or brake disc that contacts the wheel. Make sure to secure any fasteners that attach the rotor to the hub so they do not interfere with the mounting surfaces of the wheel. Installing wheels without following these steps can cause the wheel nuts to loosen and the wheel to come off while your vehicle is in motion, resulting in loss of vehicle control, personal injury or death.

Bolt Size	lb.ft (Nm) ¹
M14 x 1.5	150 lb.ft (204 Nm)

¹ Torque specifications are for nut and bolt threads free of dirt and rust. Use only our recommended replacement fasteners.

Retighten the lug nuts to the specified torque within 100 mi (160 km) after any wheel disturbance, such as tire rotation, changing a flat tire or wheel removal.

Changing a Road Wheel



A Hub pilot bore.

Inspect the wheel pilot hole and mounting surface prior to installation. Remove any visible corrosion or loose particles.

Vehicle Identification

VEHICLE IDENTIFICATION NUMBER

LOCATING THE VEHICLE IDENTIFICATION NUMBER

The vehicle identification number is on the left-hand side of the instrument panel.

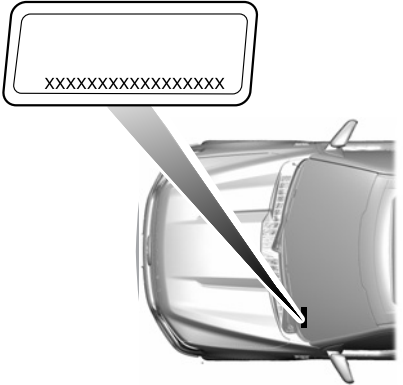

Note: In the illustration, XXXX is representative of your vehicle identification number.

VEHICLE IDENTIFICATION NUMBER OVERVIEW

The vehicle identification number contains the following information:

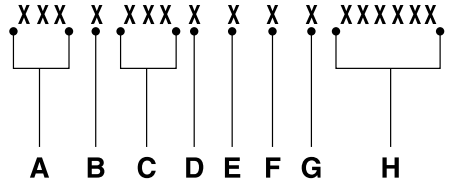

- A World manufacturer identifier.
- B Brake system, gross vehicle weight rating, restraint devices and their locations.
- C Make, vehicle line, series, body type.
- D Engine or motor type.
- E Check digit.
- F Model year.
- G Assembly plant.
- H Production sequence number.

Connected Vehicle

WHAT IS A CONNECTED VEHICLE

A connected vehicle has technology that allows your vehicle to connect to a mobile network and for you to access a range of features. When used in conjunction with the Ford mobile app, it could allow you to monitor and control your vehicle further, for example checking the tire pressures, the fuel level and the vehicle location. For additional information, refer to the local Ford website.

CONNECTED VEHICLE REQUIREMENTS

Connected service and related feature functionality requires a compatible vehicle network.

Some remote features require additional service activation. Log in to your Ford account for details. Some restrictions, third party terms and message or data rates may apply.

CONNECTED VEHICLE LIMITATIONS

Evolving technology, cellular networks, or regulations could affect functionality and availability, or continued provision of some features. These changes could even stop some features from functioning.

CONNECTING THE VEHICLE TO A MOBILE NETWORK

WHAT IS THE MODEM



The modem allows access to a range of features built into your vehicle.

ENABLING AND DISABLING THE MODEM

1. From the settings menu, press Connectivity.
2. Press Connected Vehicle Features.
3. Switch vehicle connectivity on or off.

CONNECTING FORDPASS TO THE MODEM

1. Make sure that the modem is enabled using the vehicle settings menu.
2. Open the FordPass app on your device and log in.
3. Add your vehicle or select your vehicle if already added.
4. Select the option to activate your vehicle.
5. Make sure that the name on the screen matches the name shown in your FordPass account.
6. Confirm that FordPass account is connected to the modem.

CONNECTING THE VEHICLE TO A WI-FI NETWORK

1. From the settings menu, press Connectivity.
2. Press Wi-Fi.
3. Switch Wi-Fi on.
4. Press View Available Networks.
5. Select an available Wi-Fi network.

Note: Enter the network password to connect to a secure network.

Connected Vehicle

CONNECTED VEHICLE SETTINGS

You can adjust several settings on the touchscreen under the connected vehicle features menu, such as:

- Vehicle connectivity.
- Share vehicle data.
- Share vehicle location.
- Share driving data.

Note: Depending on your vehicle, different options may be available.

Note: Editing connectivity settings could result in some features not operating correctly or at all. When you edit connectivity settings, pop-up messages may appear to notify you that services will not work without that setting. If you switch a feature on, pop-up messages could appear informing you of the settings that will be turned on. Some features, for example driver assistance features, use map data. We recommend having all connected vehicle settings enabled to allow the map content to be updated to the latest version.



Press the button next to a menu option for more information.

CONNECTED VEHICLE – TROUBLESHOOTING

CONNECTED VEHICLE – FREQUENTLY ASKED QUESTIONS

Why is my Ford mobile app not connecting to my vehicle?

- The modem is not enabled. Switch vehicle connectivity on.
- The network signal is weak. Move your vehicle closer to a place where the network signal is not obstructed.

Why can I not connect to a Wi-Fi network?

- You entered the wrong network password. Enter the correct password.
- The network signal is weak. Move your vehicle closer to the Wi-Fi router or to a place where the network signal is not obstructed.
- There are multiple access points in range with the same network name. Choose a unique name for your network. Do not use the default name unless it contains a unique identifier, for example as part of the MAC address.

Why does the Wi-Fi connection disconnect after successful connection?

- The network signal is weak. Move your vehicle closer to the Wi-Fi router or to a place where the network signal is not obstructed.

What can I do if I am close to a Wi-Fi router but the network signal strength is weak?

- If your vehicle has a heated windshield, position your vehicle so that the windshield is not facing the Wi-Fi router.
- If your vehicle has metallic tinting on the windows but not on the windshield, position your vehicle so that the windshield is facing the Wi-Fi router or open the windows that are facing the router.
- If your vehicle has metallic tinting on the windows and the windshield, open the windows that are facing the router.
- If your vehicle is in a garage and you have the garage door closed, open the garage door as it could block the signal.

Connected Vehicle

Why can I not see a network I expect to see in the list of available networks?

- The network is hidden. Make the network visible and try again, or manually add a network in the Wi-Fi settings menu.
- Some network security types are not supported, for example WEP.

Why do software downloads take too long?

- The network signal is weak. Move your vehicle closer to the Wi-Fi router or to a place where the network signal is not obstructed.
- Wi-Fi network is in high demand or has a slow Internet connection. Use a more reliable Wi-Fi network.

Why does the software not update when the system seems to connect to a Wi-Fi network and the signal strength is excellent?

- No software update is available at this time.
- Select automatic updates option in the settings menu to enable automatic software update or contact an authorized dealer.
- There could be a connection problem. Test the network using another device.

Vehicle Hotspot

SETTING UP A VEHICLE HOTSPOT

With a data plan, your hotspot can provide devices in and around your vehicle with Wi-Fi data.

Note: *A mobile device is required to complete hotspot setup.*

1. From the settings menu, press Vehicle Hotspot. See **Center Display** (page 389).
2. Press Settings.
3. Press Show Password.
4. Connect your device to the vehicle hotspot by selecting the hotspot from the list of Wi-Fi Networks.
5. When prompted, enter the password.

Activating a Trial or Purchasing a Data Plan

1. Connect a device to your vehicle hotspot. The vehicle network carrier's service activation website opens on your device.

Note: *If the website does not open, open a new website and it redirects to the vehicle network carrier's website.*

2. Follow the instructions on the carrier portal to purchase a plan or start a trial.

Note: *Visit the vehicle network carrier's website to purchase more data.*

Note: *Hotspot services are subject to your vehicle network carrier agreement, coverage and availability.*

VEHICLE HOTSPOT SETTINGS

You can change the following in the vehicle hotspot settings menu:

- Vehicle hotspot name or password.
- Vehicle hotspot frequency.

Changing the Vehicle Hotspot Name or Password

The hotspot information can only be updated once you activate the hotspot.

1. From the settings menu, press Vehicle Hotspot. See **Center Display** (page 389).
2. Press Settings.
3. Press Edit.
4. Press Change Network Name.
5. Enter your required network name.
6. Press enter to save the network name.
7. Press Change Password.
8. Enter your required password.
9. Press enter to save the password.

Changing the Vehicle Hotspot Frequency

The vehicle hotspot frequency band is selectable depending upon your device capabilities. You cannot connect your device to the vehicle hotspot if it does not support the selected frequency band.

1. From the settings menu, press Vehicle Hotspot. See **Center Display** (page 389).
2. Press Settings.
3. Press Edit.
4. Press Change Frequency Band.
5. Select a frequency.

Vehicle Hotspot

VEHICLE HOTSPOT – TROUBLESHOOTING

VEHICLE HOTSPOT – FREQUENTLY ASKED QUESTIONS

Why can I not see the vehicle hotspot name when I search for Wi-Fi networks on my cell phone or other device?

- Make sure the vehicle hotspot visibility is on.
- Check what frequency the hotspot is transmitting in the vehicle hotspot settings menu. If the frequency is 5 GHz and your device cannot see the network, change the frequency to 2.4 GHz.
- The system does not provide a vehicle hotspot at this time.

How do I remove the vehicle from the vehicle network carrier's account?

- Contact your vehicle network carrier.

Audio System

AUDIO SYSTEM PRECAUTIONS



WARNING: Driving while distracted can result in loss of vehicle control, crash and injury. We strongly recommend that you use extreme caution when using any device that may take your focus off the road. Your primary responsibility is the safe operation of your vehicle. We recommend against the use of any hand-held device while driving and encourage the use of voice-operated systems when possible. Make sure you are aware of all applicable local laws that may affect the use of electronic devices while driving.

Listening to loud audio for long periods of time could damage your hearing.

SWITCHING THE AUDIO UNIT ON AND OFF



Press the button on the volume control.

SELECTING THE AUDIO SOURCE

Audio Unit



Press to open the media source menu.

You can press this multiple times to change the audio source or scroll through the media sources.

Touchscreen

Press **Sources** on the touchscreen to open the media source menu.

MEDIA CONTROL BUTTONS



Press to play a track. Press again to pause the track.

Note: *Not all sources can be paused.*



Press the button to skip to the next track.

Press and hold the button to fast forward through the track.



Press the button once to return to the beginning of a track. Repeatedly press the button to return to previous tracks.

Press and hold the button to fast rewind through the track.



Press the button on the touchscreen to switch shuffle mode on or off.

Note: *Not all sources have shuffle mode.*



Press the button on the touchscreen to change repeat mode.

Note: *Not all sources have repeat mode.*

Audio System

ADJUSTING THE VOLUME

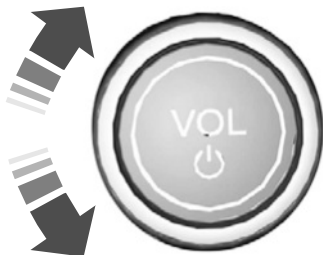

Turn to adjust the volume.

Some vehicles may be able to adjust the volume using buttons on the steering wheel.

SETTING A MEMORY PRESET

1. Select a station or channel.
2. Press and hold a memory preset button on the touchscreen.

Note: *The audio mutes briefly while the system saves the preset and returns once it is stored.*

Note: *You can save presets from multiple sources to the memory preset bar.*

MUTING THE AUDIO



Press to mute the signal. Press again to restore the signal.

ADJUSTING THE SOUND SETTINGS

1.  Press the settings icon on the touchscreen.
2. Press **Sound Settings**.
3. Select the desired menu point and adjust the settings.

SETTING THE CLOCK AND DATE

1. From the settings menu, press Clock. See **Center Display** (page 389).
2. Set the time.

Note: *The AM and PM options are not available if 24-hour mode is on.*

Switching Automatic Time Updates On and Off

1. From the settings menu, press Clock. See **Center Display** (page 389).
2. Switch Auto Time Update on or off

AM/FM RADIO

AM/FM RADIO LIMITATIONS

The further you travel from an AM or FM station, the weaker the signal and the weaker the reception.

Hills, mountains, tall buildings, bridges, tunnels, freeway overpasses, parking garages, dense tree foliage and thunderstorms can interfere with the reception.

When you pass a ground-based broadcast repeating tower, a stronger signal may overtake a weaker one and result in the audio system muting.

Audio System

SELECTING AN AM/FM RADIO STATION

Manually Selecting a Radio Station



Press the button on the radio tuner to go up the frequency band.



Press the button on the radio tuner to go down the frequency band.

Using Seek



Press to seek the next station up the frequency band.

Press and hold to quickly seek up the frequency band.



Press to seek the next station down the frequency band.

Press and hold to quickly seek down the frequency band.

Using the Station List

1. Press the search button on the radio screen.
2. Press a radio station from the list.

SWITCHING THE DISPLAY ON AND OFF

Audio Unit



Press the button.

Touchscreen

To switch the display off:

1. From the settings menu, press Display.
2. Press Display Off.

Note: The display defaults to on each time you switch your vehicle on.

To switch the display on, press anywhere on the touchscreen.

DIGITAL RADIO

WHAT IS DIGITAL RADIO

HD Radio™ technology is the digital evolution of analog FM radio.

For additional information, visit www.HDRadio.com.

HD Radio Technology is manufactured under license from iBiquity Digital Corporation and foreign patents. HD Radio and the HD and HD Radio logos are proprietary trademarks of XPERI. The vehicle manufacturer and XPERI are not responsible for the content sent using HD Radio technology. Content may be changed, added or deleted at any time at the station owner's discretion.

HOW DOES DIGITAL RADIO WORK

Your system has a special receiver that allows it to receive digital broadcasts in addition to analog broadcasts.

HD1 signifies the main programming status and is available in both analog and digital broadcasts. Other multicast stations are only available digitally and could contain new or different content.

Note: When the system first receives an HD1 station, it plays the station in the analog version until it verifies the station is an HD Radio station. Then it shifts to the digital version.

Note: There is an audio mute delay when switching to an HD2 or HD3 station because the system has to reacquire and decode the digital signal.

Audio System

DIGITAL RADIO LIMITATIONS

If you are outside the reception area, the system could not work.

If you are on the fringe of the reception area, the station could mute due to weak signal strength.

Note: *If you are listening to HD1, the system changes back to the analog broadcast until the digital broadcast is available again. If you are listening to any other multicast channels, the station mutes and stays muted unless it is able to connect to the digital signal again.*

Depending on the station quality, you could hear a slight sound change when the station changes between analog and digital audio.

You cannot access a saved HD station if your vehicle is outside the station's reception area.

SWITCHING DIGITAL RADIO RECEPTION ON AND OFF

1. From the settings menu, press Radio.
2. Switch HD Radio on or off.

DIGITAL RADIO INDICATORS

HD Radio Indicator

The indicator appears when HD Radio is on and you tune to a station broadcasting HD Radio technology.



The color of the indicator changes to indicate the system status.

Gray indicates the system is acquiring a digital station.

Orange indicates digital audio is playing.

Multicast Indicator

The multicast indicator appears if the current station is broadcasting multiple digital broadcasts. The highlighted numbers indicate additional digital channels available.

Note: *For stations that have more than one HD multicast, the HD indicator and radio text appears as a button. Press the button to cycle through all of the HD stations on that specific frequency.*

SATELLITE RADIO

WHAT IS SATELLITE RADIO

Your factory-installed SiriusXM radio system includes a limited subscription term, which begins on the date of sale or lease of your vehicle. See an authorized dealer for availability.

For additional information about extended subscription terms, visit www.SiriusXM.com in the United States, www.SiriusXM.ca in Canada, or call SiriusXM at 1-888-539-7474.

Note: *SiriusXM reserves the unrestricted right to change, rearrange, add or delete programming including canceling, moving or adding particular channels, and its prices, at any time, with or without notice to you. Neither SiriusXM and its affiliates nor Ford Motor Company and its affiliates will be liable to you or any third party for any such modification, suspension or termination.*

Audio System

SATELLITE RADIO LIMITATIONS

For optimal reception performance, keep the antenna clear of snow and ice build-up and keep luggage and other material as far away from the antenna as possible. Placing luggage over the antenna may reduce performance. Factory-installed and aftermarket vehicle structures including, but not limited to, roof racks and soft top roofs in a partially open position could reduce reception performance.

Hills, mountains, tall buildings, bridges, tunnels, freeway overpasses, parking garages, dense tree foliage and thunderstorms can interfere with your reception.

When you pass a ground-based broadcast-repeating tower, a stronger signal may overtake a weaker one and could result in the audio system muting. Your display could show an error message to indicate the interference.

LOCATING THE SATELLITE RADIO IDENTIFICATION NUMBER

1. Select SiriusXM as the audio source.
2. Tune to channel 0.

SELECTING A CHANNEL

Manually Selecting a Channel



Press the button to find the previous or next available radio channel.



Linear Tuner

The linear tuner is displayed when manually selecting a channel. You can swipe left or right on the linear tuner carousel to navigate through the channel list. Tap on a channel title to listen to it.

Using Direct Tune

1. Press the channel up or down button to open the linear tuner screen.
2. Press **Direct Tune** to open the number pad.
3. Enter the channel you prefer.

Using Browse

1. Press **Browse**.
2. Select a channel.

SATELLITE RADIO SETTINGS

Subscription

Your subscription status is displayed. You can subscribe or manage your subscription directly from the touchscreen.

SiriusXM Favorites

While you are listening to SiriusXM, you can save favorites by:

- Tapping the currently tuned channel or show logo on the SiriusXM audio screen.
- Tuning to a channel or show you want to save as a favorite. Navigate to the SiriusXM Favorites screen and press the Add Current button. The currently tuned channel or show is saved as a favorite.
- Saving a radio preset. This saves the currently tuned SiriusXM channel or show as a favorite.

Note: Requires a trial or active subscription to use.

Audio System

Listening History

Listening history is a list of recently listened to SiriusXM content. You can view, manage and reset the listening history using the controls on the touchscreen.

Note: *Requires a trial or active subscription to use.*

Help and Support

You can contact SiriusXM Customer Care directly from the operating system and view information required to manage your SiriusXM account.

Audio System

AUDIO SYSTEM – TROUBLESHOOTING

AUDIO SYSTEM – INFORMATION MESSAGES

Satellite Radio Troubleshooting

Error Message	Potential Effects	Recommended Action
Connectivity Disabled	Internet streaming and On Demand shows are unavailable and some SiriusXM features are disabled.	Internet connectivity is turned off. See Connected Vehicle (page 374).
No Internet	Audio system may mute. Switch to Satellite button may be displayed on the SiriusXM audio screen if the channel is also available via satellite.	SYNC attempts to connect. See Satellite Radio Limitations (page 383). Switch to a satellite connection for the current channel if the option is available.
No Satellite Signal	Audio system may mute. Switch to Internet button may be displayed on the SiriusXM audio screen if the channel is also available via streaming.	Antenna may be obstructed or satellite reception is weak in your location. See Satellite Radio Limitations (page 383). Switch to an internet connection for the current channel if the option is available.
Slow Network Connection	Audio system may mute while the audio attempts to load.	Allow some time for the audio to load or tune to a different channel.
Channel Unavailable	Audio system may mute. Radio may tune to a different channel.	A temporary update may be in progress. Allow some time before retrying to tune to the channel. If the issue continues, the channel may no longer be available.
Episode Unavailable	Audio system may mute. Radio may tune to a different channel.	A temporary update may be in progress. Allow some time before retrying to play the episode. If the issue continues, the episode may no longer be available.

Audio System

Error Message	Potential Effects	Recommended Action
Something went wrong	Audio system may mute. Radio may tune to a different channel.	Allow some time and retry the action.
Subscribe to Listen	Cannot listen to selected content. Content may appear grayed out and some features may be disabled.	<p>Your subscription has expired or you have not yet subscribed for access to the listed content. Navigate to Subscription under the Satellite Radio Settings menu. If you have an active subscription which includes the listed channel or content and you see this error, you may need to refresh your radio. To refresh your SiriusXM radio, visit www.siriusxm.com/refresh in the US, or www.siriusxm.ca/refresh in Canada.</p> <p>You may need to provide your SiriusXM Radio identification number. See Locating the Satellite Radio Identification Number (page 383).</p>

Audio System

Error Message	Potential Effects	Recommended Action
Upgrade to Listen	Cannot listen to selected content. Content may appear grayed out and some features may be disabled.	Your subscription does not include access to the listed content. You may need to upgrade your subscription. Navigate to Subscription under the Satellite Radio Settings menu. If you have an active subscription which includes the listed channel or content and you see this error, you may need to refresh your radio. To refresh your SiriusXM radio, visit www.siriusxm.com/refresh in the US, or www.siriusxm.ca/refresh in Canada. You may need to provide your SiriusXM Radio identification number. See Locating the Satellite Radio Identification Number (page 383).
Location Restricted Content	Audio may mute. Not available in your location or Unable to determine your location may be displayed.	Content is not available in your location or SiriusXM is unable to determine your location. Tuning to a different channel may resolve the issue.
Channel Blocked	Audio may mute. Radio may tune to a different channel.	The Block Explicit Content filter is turned on. Navigate to Listener Settings under the Satellite Radio Settings menu to access the Block Explicit Content filter. Navigate to Listener Settings. See Satellite Radio Settings (page 383).
Antenna Problem or Hardware Problem	Audio may mute. Access to SiriusXM features may be unavailable.	If issue persists, you may need to visit an authorized dealer for service.

Audio System

Error Message	Potential Effects	Recommended Action
SiriusXM Updating...	Audio may mute.	Allow SiriusXM some time to complete updating.
Loading...	Audio may mute. Content may be temporarily unavailable while loading.	No action necessary. If loading time is longer than usual, See Satellite Radio Settings (page 383).
SiriusXM Loading...	Audio may mute. Content and controls may be temporarily unavailable.	No action necessary. Allow SiriusXM some time to finish loading.

Center Display

CENTER DISPLAY OVERVIEW

 **WARNING:** Driving while distracted can result in loss of vehicle control, crash and injury. We strongly recommend that you use extreme caution when using any device that may take your focus off the road. Your primary responsibility is the safe operation of your vehicle. We recommend against the use of any hand-held device while driving and encourage the use of voice-operated systems when possible. Make sure you are aware of all applicable local laws that may affect the use of electronic devices while driving.

For your safety, features that are not critical while driving are not available when the vehicle is moving at or above 5 mph (8 km/h).

Note: Illustrations are provided for conceptual understanding only and may appear differently on your vehicle.

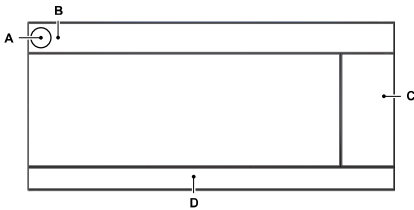

- A Home screen button. See **Home Screen** (page 389).
- B Status bar. See **Status Bar** (page 390).
- C Information on demand screen. See **Information On Demand Screen** (page 391).
- D Climate control. See **Climate Control** (page 107).

HOME SCREEN



Press to open the home screen.

Features, such as navigation, audio and phone, are located in the main portion of the display. The icons located on the side of the display allow you to access other vehicle features and settings.



Press to access the settings menu.

You can change the display language and other measurement units under the General menu.



Press to view features.

Note: The icon may be different depending on your vehicle.



Press to see a list of apps. To open an app, select the app.



If you see this icon next to a menu option, press it for more information.

FAVORITE



Press the button on the instrument panel to turn a feature on or off.

Assigning a Feature

If there is no feature assigned:

1.  Press the button on the instrument panel.
2. Follow the prompts on the touchscreen.

To change the assigned feature:

Center Display

1. Press **Features** on the touchscreen.
2. Press **Edit Favorite**.

Note: If you assign an exhaust mode to the favorite button, pressing the button activates the exhaust mode, and pressing it again restores the previous exhaust mode.

STATUS BAR

The status bar appears at the top of the display. The following buttons and icons can appear in the status bar.

Note: Some buttons and icons may not apply to your vehicle or may not appear exactly as shown.

Alexa Built-In



Press to set up Alexa. See **Alexa Built-In** (page 404).

Wireless Charging



Wireless charging active.



Device connected and not charging.

Traffic Announcements



Traffic announcements are turned on but are not supported by the selected station.



Traffic announcements are turned on and supported by the selected station but are not active.



Traffic announcements are active.

Note: If no traffic announcement icons are displayed, traffic announcements are turned off.

Vehicle Data



Wi-Fi available.



Wi-Fi connected.



Vehicle data sharing on.



Vehicle data sharing off.



Vehicle location sharing on.



Vehicle data and vehicle location sharing on.

Outside Air Temperature



Outside air temperature is active.

Audio System



Audio system muted.

Connected Device



Cell phone microphone muted.



Phone call in progress.



Media player connected using **Bluetooth®**.



Cell phone network signal strength.



Cell phone roaming.

Center Display



Text message received.



Unread email message.



Automatic crash notification system off.



Cell phone battery status.

Software Updates



Press to see details about software updates. See **Vehicle Software Updates** (page 417).

Back Button



Some screens have a back button in the top corner. Press the button to return to the previous screen.

INFORMATION ON DEMAND SCREEN

The information on demand screen displays cards on the side of the display and allows you to see information from different features.

You can swipe up or down to view a different card.

Note: *On some screens, you can swipe a card toward the center of the screen to move the content into the main screen.*

SETTINGS

Display Settings

From the display menu you can do the following:

- Switch the calm screen on.
- Manually adjust the screen brightness.
- Set the display mode.

Touchscreen Brightness

To manually adjust the screen brightness, use the plus or minus buttons.

Note: *The display brightness is limited if the settings of the instrument panel lighting brightness are set to the highest or lowest setting.*

DRIVER ASSISTANCE MENU

To access the driver assistance menu:

1.  Press to open the home screen.
2.  Press to view features.

Note: *The icon may be different depending on your vehicle.*

3. Press Driver Assistance.

REBOOTING THE CENTER DISPLAY

You can reboot the center display using the controls on the steering wheel.

1. Simultaneously press and hold the seek forward and audio system power button for 10 seconds.

My Mustang

MY MUSTANG OVERVIEW



Press the button on the instrument panel.

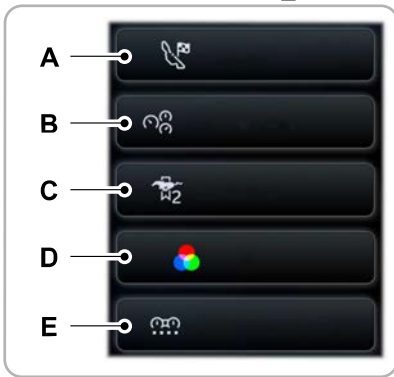
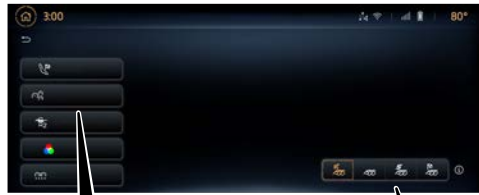

- A Track apps.
- B Auxiliary gauges.
- C Custom mode.
- D My color.
- E Cluster theme.
- F Exhaust mode. See **Selecting a Drive Mode** (page 211).

My Mustang

TRACK APPS

TRACK APPS PRECAUTIONS



WARNING: Track Apps™ is for track use only. Remember that even advanced technology cannot defy the laws of physics. It is always possible to lose control of a vehicle due to inappropriate driver input for the conditions. Aggressive driving on any road condition can cause you to lose

control of your vehicle increasing the risk of personal injury or property damage.

Note: Track apps are for track use only. Do not use them under any other driving conditions.

Note: The pre-collision assist system turns off when using Track apps or when you switch off your stability control system.

TRACK APPS OVERVIEW

From the My Mustang menu, press Track Apps.

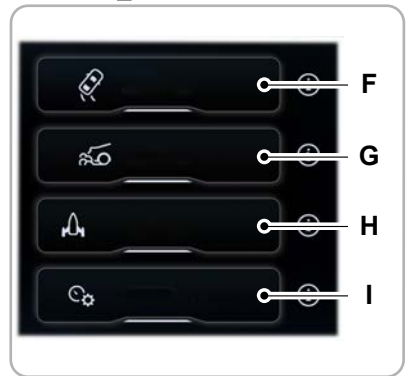
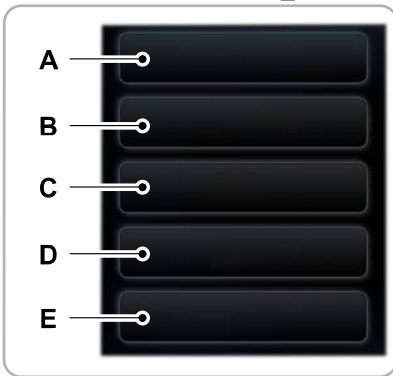

- A Acceleration timer.
- B Brake performance.
- C Lap timer.
- D Launch settings.

My Mustang

- E Performance shift indicator.
- F Drift brake.
- G Line lock.
- H Launch control.
- I Rev matching.

ACCELERATION TIMER

Displays your vehicle's rate of acceleration for a given speed or distance range.

Note: *Test events vary depending on the measurement unit conventions selected.*

Using Acceleration Timer

1. From the Track Apps menu, press **Acceleration Timer**.
2. Select a drive type.
3. Select a start type.
4. Press **Start**.

Note: *The start button is not available until a drive type and start type are selected.*

5. Press the OK button on the steering wheel to start the timer.

When finished, press OK for more options.

Results

To view your timer results:

1. From the acceleration timer menu, press **Results**.

To clear results without clearing all-time best:

1. Press **Clear**.
2. Press **Yes**.

To clear all results.

1. Press **Clear All**.
2. Press **Yes**.

BRAKE PERFORMANCE

Displays your vehicle's rate of deceleration for a given speed range.

Note: *Test events vary depending on the measurement unit conventions selected.*

Using Brake Performance

1. From the Track Apps menu, press **Brake Performance**.
2. Select a speed range.
3. Press **Start**.
4. Press the OK button on the steering wheel.

When finished, press OK for more options.

Results

To view your results:

1. From the brake performance menu, press **Results**.

To clear results without clearing all-time best:

1. Press **Clear**.
2. Press **Yes**.

To clear all results.

1. Press **Clear All**.
2. Press **Yes**.

MANUAL LAP TIMER

Gives you the ability to record lap times at three separate tracks.

My Mustang

Note: If you do not see your last lap timer result, make sure that the measurement unit setting is set to the same unit as the speedometer. See **HomeScreen** (page 389). See **Speedometer** (page 101).

Using Lap Timer

1. From the Track Apps menu, press **Lap Timer**.
2. Select a track.

Note: You can edit the track names.

3. Press **Start**.
4. Press the OK button on the steering wheel.

Note: You can interrupt a session at any time by holding the OK button on the steering wheel.

When finished, press OK for more options.

Results

To view your results:

1. From the lap timer menu, press **Results**.

Note: If there are no saved results, the button is grayed out.

To clear results without clearing all-time best:

1. Press **Clear**.
2. Press **Yes**.

To clear all results.

1. Press **Clear All**.
2. Press **Yes**.

PERFORMANCE SHIFT INDICATOR (If Equipped)

The performance shift indicator allows you to set the point at which you want to be alerted to shift gears, through audible and visual alerts. You can choose different graphic themes that represent the engine's rotation.

1. From the Track Apps menu, press **Performance Shift Indicator** to reach the menu.

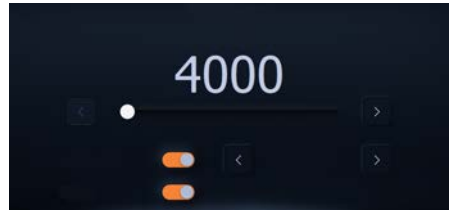

2. From the menu, you can:
 - Set the light mode between off, tach, track and drag.
 - Set a shift point within the allowable RPM range in increments of 100.
 - Enable or disable the shift tone, based on the set shift point.

Note: To enable or disable the feature, you must choose a light mode.

LINE LOCK

Line lock maintains brake force at the front wheels, allowing the rear wheels to spin with minimal vehicle movement. It is intended to condition the rear tires to maximize traction prior to track use.

My Mustang

Note: Line lock is a feature intended for use at tracks only and should not be used on public roadways.

Note: Use of this feature could result in significantly increased rear tire wear.

There are three line lock stages:

- Initiated.
- Engaged.
- Off.

Initiating Line Lock

The initiation stage verifies that the vehicle is ready for line lock function, and confirms driver intent.

1. From the track apps menu, press **Line Lock**.
2. Press and hold the OK button on the steering wheel.

The following conditions must be met to initialize line lock:

- The vehicle is on a level surface.
- The engine is running.
- The vehicle is traveling less than 25 mph (40 km/h).
- Selectable drive mode is not in wet mode (if equipped).
- There are no electronic stability control faults.
- A spare tire is not installed.
- The parking brake is not applied.
- Auto hold is turned off.
- Adaptive cruise control is not active.
- Both doors are closed.

If you want to cancel line lock once it is initialized, press the OK button on the steering wheel. Once initiated, line lock is prepared for activation and remains initiated up to 25 mph (40 km/h). If vehicle speed exceeds 25 mph (40 km/h), line lock automatically cancels.

Engaging Line Lock

Follow the prompts in the instrument cluster display to engage line lock after it is initialized. To engage, firmly apply the brakes. Then press the OK button. Once engaged, release the brake pedal. The front brakes remain applied and the rear brakes release. At this point, the engagement timer is initiated and shown on the instrument cluster display.

The following conditions must be met to engage line lock:

- The vehicle is on a level surface.
- The engine is running.
- The vehicle is stopped.
- The parking brake is not applied.
- Both doors are closed.
- The transmission is in a forward gear.
- There are no electronic stability control faults.
- The steering wheel is in the straight ahead position.
- A spare tire is not installed.
- Auto hold is turned off.
- Adaptive cruise control is not active.

Releasing Line Lock

While line lock is engaged, you can exit (release) the feature using the OK button. When you press the OK button, line lock immediately releases and normal vehicle function resumes. When line lock engages, a countdown timer shows the remaining time before line lock is automatically released. If the timer expires, or another vehicle condition requires line lock to release, the system safely disengages and normal vehicle function resumes.

Note: If you apply the brake pedal or parking brake while line lock is engaged, line lock automatically cancels and normal brake function resumes.

My Mustang

REV MATCHING (If Equipped)

This feature provides a smoother driving experience, particularly during a downshift event. Rev Matching commands a quick engine RPM match to the selected gear during a clutch pressed gear shift. You can switch this feature on and off through the touchscreen.

LAUNCH CONTROL (If Equipped)

Temporarily holds the engine RPM at a set point and maximizes traction to the wheels for a more aggressive start.

Enabling or Disabling Launch Control

1. From the Track Apps menu, press **Launch Control**.

To set the RPM hold point:

1. From the Track Apps menu, press **Launch Settings**.

Note: You can also enable or disable the feature from this screen.

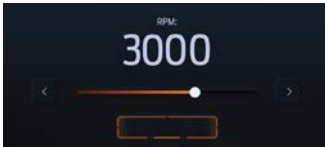

2. Use the slider bar or arrows to set the RPM value.

Using Launch Control

1. Make sure launch control is enabled.
2. Bring your vehicle to a complete stop.
3. The indicator illuminates white in the instrument cluster when launch control is ready.
4. Fully press and hold the clutch pedal.
5. Shift the transmission into first gear.

6. Fully press the accelerator pedal and keep it pressed. Allow the tachometer to settle at the RPM that you selected and wait for the indicator to turn green.
7. Release the clutch pedal.

Improving Your Launch

If launch control is not available when you come to a stop:

- Wait for the engine to come to operating temperature. If the engine is too hot or cold, launch control is not available.
- Make sure the drive mode is not set to Slippery.

If the vehicle did not launch effectively:

- Adjust the RPM and practice releasing the clutch. It may take practice to get a feel for how quickly to release the clutch.
- Switch traction control on, this can reduce excessive wheel spin.

Keep in mind that weather, road surface, and tire conditions can also affect your launch.

Launch Control Indicators

With Traction Control Off



Not ready.



Ready to use.



Active and ready to launch.

With Traction Control On



Not ready.

My Mustang

Ready to use.



Active and ready to launch.

DRIFT BRAKE (If Equipped)



Allows you to lock up the rear tires to enable drift maneuvers.

Before drifting, make sure you are on a track, and have the necessary safety equipment including a certified helmet and approved neck restraint device. Work up to your limit while drifting, do not expect to be an expert right away.

Note: *Drift brake is for track use only. Do not use it under any other driving conditions.*

Note: *Using this feature may result in significantly increased rear tire wear.*

Switching Drift Brake On or Off

1. From the Track Apps menu, press **Drift Brake**.
2. Confirm the selection. This enables track mode.

Note: *If track mode is already enabled, there is no confirmation message.*

Note: *Switching drift brake on automatically enables track mode. If you change to a different drive mode, drift brake disables.*

3. Press **Drift Brake** again to switch it off.

Note: *When you switch drift brake off, track mode remains on.*

Note: *When the feature is on, the brake handle applies braking to the rear wheels only and locks up the rear wheels. When the feature is off, the brake handle works like the foot brake and applies braking to all four wheels.*

Note: *The system may exit track mode if it reaches certain threshold limits. If this happens, Drive Mode Not Available or Service AdvanceTrac messages display in the instrument cluster display screen. You can reset the system by switching your vehicle off and back on, driving normally up to 15 minutes and reaching 45 mph (73 km/h). After the system is re-calibrated, drive modes will be available through the button on the steering wheel.*

Drift Brake Driving Hints - Vehicles with: Automatic Transmission

Two important things to note when driving a vehicle with an automatic transmission:

- Keep the RPM high when drifting to prevent unintentional engine stall. The engine RPM drops rapidly when locking the rear wheels, so it is best to be on the throttle prior to and after pulling the handle to prevent stalling.
- Using the paddle shifters or manual shift mode enhances your ability to keep the vehicle in the power band. This way when you release the drift brake you can quickly get back on the throttle and maintain your drift.

As your drifting skills develop, it may be beneficial to turn off other vehicle control systems such as traction control and electronic stability control. See **Traction Control** (page 182). See **Stability Control** (page 183). Before returning to public roads, re-enable both systems.

Drift Brake Driving Hints - Vehicles with: Manual Transmission

Drifting in a manual transmission gives you more control over the chosen gear, which allows you to make sure you have correct application of power to maintain the drift.

My Mustang

Two things to note while drifting in a manual transmission vehicle:

- Make sure to disengage the clutch immediately prior to pulling the drift brake. This prevents fighting engine torque and prevents unintended stalls.
- After releasing the drift brake, rapidly engage the clutch and get back on the throttle to maintain your drift.

As your drifting skills develop, it may be beneficial to turn off other vehicle control systems such as traction control and electronic stability control. See **Traction Control** (page 182). See **Stability Control** (page 183). Before returning to public roads, re-enable both systems.

AUXILIARY GAUGES



Auxiliary gauges are available in the touchscreen.

From the My Mustang menu, press **Auxiliary Gauges**.



Press the button to switch between three or five-gauge view.



To edit the gauges:

1.



Press the button.

2. Use the arrows on the screen to select the gauges you prefer.

Auxiliary gauges:

- Cylinder head temperature.
- Engine oil temperature.
- Transmission oil temperature.
- Axle temperature.
- Engine oil pressure.
- Inlet air temperature.
- Manifold charge temperature.
- Intercooler coolant temperature.
- Vacuum or vacuum/boost.
- Voltage.

Note: *Depending on your vehicle configuration, not all gauges are available.*

CUSTOM DRIVE MODE

Allows you to create your own drive mode experience. Choose a drive mode to use as a starting point and then mix and match settings to tailor the experience to your preferences. You can create up to six custom modes.



You can set one of the six custom modes as the active mode. The active mode appears as an available mode when selecting a drive mode. See **Selecting a Drive Mode** (page 211).

My Mustang

Creating a Drive Mode

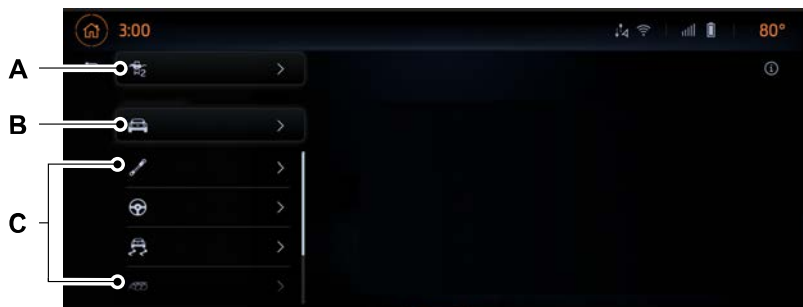

- A Profile selection.
- B Base drive mode.
- C Adjustable settings.

1. From the My Mustang menu, press **Custom Drive Mode**.
2. Press the profile button to select a profile to edit.
Note: *Selecting a profile also sets it as the active mode.*
3. Select the base drive mode you prefer.
4. Press each option and select the setting you prefer.

CLUSTER THEME



You can change the style of the display behind the steering wheel.

1. From the My Mustang menu, press **Cluster Theme**.
2. Select a theme.

Note: *If you choose **Match Drive Mode**, the instrument cluster style changes according to the drive mode you select.*

MY COLOR



Allows you to customize the colors of the instrument cluster and touchscreen.

You can also adjust the ambient lighting. See **Ambient Lighting** (page 93).

1. From the My Mustang menu, press **MyColor**.
2. Adjust the primary and secondary colors to the setting you prefer.

EXHAUST MODE (IF EQUIPPED)

Allows you to change how loud your exhaust is. You can choose from one of four settings.

Quiet Mode



Lowers the noise of the exhaust.

My Mustang

Quiet Start

Minimizes exhaust noise when you start the vehicle. You can set a schedule for when you want quiet start to be on.

To access the quiet start menu:

1. Press **Settings** on the touchscreen.
2. Press **Vehicle**.
3. Press **Quiet Start**.

From the menu, you can do the following:

- Switch quiet start on or off.
- Set the schedule.

Normal Mode



Default factory setting.

Sport Mode



Raises the noise of the exhaust.

Track Mode



Loudest level of exhaust noise.

Note: *The track exhaust mode setting is only for use at tracks and not for use on public roadways. Use of this setting results in increased exterior noise, which may not meet state and local laws and regulations. It is the obligation of the driver to operate the vehicle in a manner that complies with state and local requirements. Only use the track exhaust mode setting at a competition track or an off-road course where increased exterior vehicle noise is acceptable.*

Voice Interaction

FORD ASSISTANT

USING FORD ASSISTANT

The digital assistant allows you to control vehicle features using conversational requests.

To begin a voice interaction using the wake word, say the selected wake word, then say your command.



Press the voice interaction button on the steering wheel. A tone sounds before you can say your command.

Note: You may need to enable your vehicle's modem to use certain voice commands. See **Enabling and Disabling the Modem** (page 374).

Voice Command Examples

To see examples of what voice commands you can use with different features:



Press the button on the touchscreen.

1. Press **Ford Assistant**.
2. Press **Voice Command Help**.
3. Select a feature.

FORD ASSISTANT SETTINGS

To access the settings menu:



Press the button on the touchscreen.

1. Press **Ford Assistant**.

From the settings menu you can do the following:

- Switch listen for wake word on or off.
- Set the preferred wake word.
- Switch advanced mode on or off.

- Switch phone confirmation on or off.
- Switch the commands list on or off.
- View the commands help menu.



Press the button next to a menu option for more information.

FORD ASSISTANT – FREQUENTLY ASKED QUESTIONS

Why does the system not understand what I am saying?

- You are speaking too soon. When using the button of the steering wheel, wait for the tone before you speak.

Why does the system not understand the name of a track or artist?

- **Bluetooth®** does not support voice commands. Connect your device to a USB port.
- You are not saying the name exactly as it appears on your device. Say the name of the track or artist exactly as it appears on your device. Spell out any abbreviations in the name.
- The system does not recognize some special characters contained in the name of a song or artist, for example *, - or +. Rename the files on your device or use the touchscreen to select and play the track.

Voice Interaction

Why does the system not understand the name of a contact in the phonebook on my device and calls the wrong contact?

- You are not saying the name exactly as it appears on your device. Say the first and last name of the contact exactly as it appears on your device. Spell out any abbreviations in the name.
- The name contains special characters, for example *, - or +. Rename the contact on your device or use the touchscreen to select and call the contact.

Why does the system not understand foreign names of contacts in the phonebook on my device?

- The system applies phonetic pronunciation rules of the selected language to the names of contacts in the phonebook on your device. Select the name of the contact on the touchscreen and use the Hear it option to get an idea of how the system expects you to pronounce it.

Why do the system voice prompts and the pronunciation of some words not seem accurate?

- The system uses text-to-speech technology and a synthetically generated voice rather than a pre-recorded human voice.

Alexa Built-In (If Equipped)

WHAT IS ALEXA BUILT-IN

Alexa Built-In allows you to use Alexa in your vehicle for auto-specific use cases on the road and gives you access to an ever-evolving number of skills that help to make your life more productive, entertaining, and connected while using your vehicle.

ALEXA BUILT-IN REQUIREMENTS

To use Alexa, all of the following must occur:

- Your vehicle modem is enabled.
- You are signed in to an existing Amazon account.
- Vehicle location services are enabled.
- Vehicle connectivity and vehicle data sharing is enabled.

Note: *Support and functionality may vary based on the country in which your FordPass account is registered.*

SIGNING IN TO YOUR ACCOUNT



Press the button in the status bar and follow the on-screen prompts.

To sign in using the settings menu:

1. Press **Settings** on the touchscreen.
2. Press **Amazon Alexa**.
3. Press **Get Started**.
4. Sign in to your account by either scanning the QR code or entering the on-screen code into the Amazon website.
5. Once signed in, follow the on-screen prompts.

6. When complete, the vehicle informs you that Alexa is ready to be used in the vehicle.

Signing Out of Your Account

1. Press **Settings** on the touchscreen.
2. Press **Amazon Alexa**.
3. Press **Sign Out**.

USING ALEXA BUILT-IN

To use Alexa, say “Alexa” or press the voice interaction button on the steering wheel and then say “Alexa” to invoke Alexa to start listening.

Note: *If the wake word is not enabled, you can only use the voice interaction button.*

You can use Alexa for the following and more:

- Entertainment.
- Hands-free calling.
- Traffic and navigation.
- Vehicle controls.
- Smart home device control.
- Weather and news information.

ALEXA BUILT-IN SETTINGS

Enabling the Wake Word

1. Press **Settings** on the touchscreen.
2. Press **Amazon Alexa**.
3. Switch **Listen for Wake Word** on or off.

Note: *If the wake word is not enabled, you can only use the voice interaction button.*

Contact List

Displays a list of connected phones and contact sharing status for each phone.

To change the contact sharing status:

Alexa Built-In (If Equipped)

1. Press **Settings** on the touchscreen.
2. Press **Amazon Alexa**.
3. Press **Contact List**.
4. Enable or disable sharing for each phone.

Note: *You can share contacts from more than one phone at a time.*

Things to Try

Learn more about what you can do with Alexa by browsing the things to try.

1. Press **Settings** on the touchscreen.
2. Press **Amazon Alexa**.
3. Press **Things to Try**.

Phone

PHONE PRECAUTIONS



WARNING: Driving while distracted can result in loss of vehicle control, crash and injury. We strongly recommend that you use extreme caution when using any device that may take your focus off the road. Your primary responsibility is the safe operation of your vehicle. We recommend against the use of any hand-held device while driving and encourage the use of voice-operated systems when possible. Make sure you are aware of all applicable local laws that may affect the use of electronic devices while driving.

CONNECTING YOUR PHONE

Go to the settings menu on your device and switch **Bluetooth®** on.



Press the phone option on the home screen.

1. Press **Add Phone**.

Note: A prompt alerts you to search for your vehicle on your cell phone.

2. Select your vehicle on your cell phone.

Note: A number appears on your cell phone and on the touchscreen.

3. Confirm the number on your cell phone matches the number on the touchscreen.

Note: The touchscreen indicates that you have successfully paired your cell phone.

4. Download the phonebook from your cell phone when you are prompted.

Note: If you pair more than one cell phone, use the phone settings on the center display to specify the primary phone. You can change this setting at any time.

PHONE MENU

This menu becomes available after pairing a phone.

Recent Call List

Display and select an entry from a list of previous calls.

Contacts

Display a smart search form to look up your contacts. Use the List button to alphabetically sort your contacts.

Favorites

Display the list of favorite contacts that are set up on your phone.

Messaging

Displays the list of text messages to read, listen to, or respond to.

Email

Displays the list of emails to read, listen to, or respond to.

Phone List

Display the list of paired or connected devices that you can select.

Note: Up to 12 devices can be stored.

Do Not Disturb

Reject incoming calls and switch ring tones and alerts off.

Phone Keypad

Directly dial a number.

Phone

Voice Control

Press the button and say a command to use the Google or Siri voice assistant available on your connected phone to access supported features.

Note: *Some features under the phone menu may not be available if the feature is not supported through the phone.*

Phone

MAKING AND RECEIVING A PHONE CALL

Making Calls

To call a number in your contacts, select:

Menu Item	Action and Description
Contacts	You can then select the name of the contact you want to call. Any numbers stored for that contact display along with any stored contact photos. You can then select the number that you want to call. The system begins the call.

To call a number from your recent calls, select:

Menu Item	Action and Description
Recent Call List	You can then select an entry that you want to call. The system begins the call.

To call a number from your favorites, select:

Menu Item	Action and Description
Favorites	You can then select an entry that you want to call. The system begins the call.

To call a number that is not stored in your phone, select:

Menu Item	Action and Description
Phone Keypad	Select the digits of the number you wish to call.
Call	The system begins the call.

Pressing the backspace button deletes the last digit you typed.

Receiving Calls

During an incoming call, an audible tone sounds. Caller information appears in the display if it is available.

To accept the call, select:

Menu Item
Accept

Note: You can also accept the call by pressing the phone button on the steering wheel.

To reject the call, select:

Menu Item
Reject

Ignore the call by doing nothing. The system logs it as a missed call.

During a Phone Call

During a phone call, the contacts name and number display on the screen along with the call duration.

The phone status items are also visible:

- Signal Strength.
- Battery.

You can select any of the following during an active phone call:

Phone

Item	
End Call	Immediately end a phone call. You can also press the button on the steering wheel.
Keypad	Press this to access the phone keypad.

Item	
Mute	You can switch the microphone off so the caller does not hear you.
Privacy	Transfer the phone call audio to the cell phone or back to the touchscreen.

SENDING AND RECEIVING A TEXT MESSAGE

Menu Item	Description
Hear It	Hear the text message.
View	View the text message.
Call	Call the sender.
Reply	Reply to the text message with a standard text message.

Phone

SWITCHING TEXT MESSAGE NOTIFICATION ON AND OFF

The settings on your device must be enabled to receive text message notifications on the center display. Check your device settings to enable these features.

ENABLING APPS ON A MOBILE DEVICE

When you start an app through the system for the first time, you could be asked to grant certain permissions. You can review and change the permissions that you have granted at any time when your vehicle is not moving. We recommend that you check your data plan before using your apps through the system. Using them could result in additional charges. We also recommend that you check the app provider's terms and conditions and privacy policy before using their app. Make sure that you have an active account for apps that you want to use through the system. Some apps work with no setup. Others require you to configure some personal settings before you can use them.

Enabling Apps on an iOS Device



Select the apps option on the feature bar.

1. Select Mobile Apps Help.
2. Follow the instructions to pair and connect your device via **Bluetooth**® or with a USB cable.
3. Start the apps on your device that you want to use.
4. Select the app that you want to use on the touchscreen.

Note: Some apps may run through Apple CarPlay if it is enabled.

Note: Closing an app on your device closes it on the touchscreen.

Note: For troubleshooting assistance select Mobile Apps List under Mobile Apps Help.

Enabling Apps on an Android Device



Select the apps option on the feature bar.

1. Select Mobile Apps Help.
2. Follow the instructions to pair and connect your device via **Bluetooth**® or with a USB cable.
3. Start the apps on your device that you want to use.
4. Select **Find Mobile Apps**.
5. Select the app that you want to use on the touchscreen.

Note: Some devices may lose the ability to play music over USB when Mobile Apps are enabled.

Note: Some apps may run through Android Auto if it is enabled.

Note: Closing an app on your device closes it on the touchscreen.

Note: For troubleshooting assistance select Mobile Apps List under Mobile Apps Help.

SWITCHING APPLE CARPLAY ON AND OFF

Enabling Apple CarPlay with USB

1. Connect your device to a USB port.
2. Follow the instructions on your device and the touchscreen.

Note: Selecting Enable Wireless CarPlay on your device prepares the device for wireless CarPlay when you reenter the vehicle.

Phone

Enabling Apple CarPlay with Wireless

1. Pair your device to **Bluetooth®**.
2. Follow the instructions on your device and the touchscreen.

Disabling Apple CarPlay



Select the settings option on the feature bar.

1. Press Phone List.
2. Select your device from the list.
3. Press Disable.

Re-Enabling Apple CarPlay



Select the settings option on the feature bar.

1. Press Phone List.
2. Select your device from the list.
3. Press Connect to Apple CarPlay.

SWITCHING ANDROID AUTO™ ON AND OFF

Enabling Android Auto with USB

(If Equipped)

1. Connect your device to a USB port.
2. Follow the instructions on the touchscreen.

Note: *Certain features of the system are not available when you are using Android Auto.*

Enabling Android Auto with Wireless

1. Pair your device to **Bluetooth®**.
2. Follow the instructions on your device and the touchscreen.

Note: *Certain Android™ devices do not support Android Auto Wireless. Check your Android OS version for compatibility.*

Disabling Android Auto



Select the settings option on the feature bar.

1. Press Phone List.
2. Select your device from the list.
3. Press Disable.

Re-Enabling Android Auto



Select the settings option on the feature bar.

1. Press Phone List.
2. Select your device from the list.
3. Press Connect to Android Auto.

Bluetooth®

CONNECTING A BLUETOOTH® DEVICE

1. Make sure **Bluetooth®** is enabled on your device.
2. Press **Settings** on the touchscreen.
3. Press **Connectivity**.
4. Press **Bluetooth**.
5. Press **Add a Bluetooth Device**.

Note: A prompt alerts you to search for your vehicle on your device.

6. Select your vehicle on your device.

Note: A number appears on your device and on the touchscreen.

7. Confirm that the number on your device matches the number on the touchscreen.

Note: The touchscreen indicates that you have successfully paired your device.

The **Bluetooth®** word mark and logos are registered trademarks owned by **Bluetooth SIG, Inc.** and any use of such marks by Ford Motor Company is under license. Other trademarks and trade names are those of their respective owners.

PLAYING MEDIA USING BLUETOOTH®



WARNING: Driving while distracted can result in loss of vehicle control, crash and injury. We strongly recommend that you use extreme caution when using any device that may take your focus off the road. Your primary responsibility is the safe operation of your vehicle. We recommend against the use of any

hand-held device while driving and encourage the use of voice-operated systems when possible. Make sure you are aware of all applicable local laws that may affect the use of electronic devices while driving.

Connect your device.



Press the audio button on the home screen.



Press **Sources**.



Press the **Bluetooth®** option.



Press to play a track. Press again to pause the track.



Press to skip to the next track. Press and hold to fast forward through the track.



Press once to return to the beginning of a track. Repeatedly press to return to previous tracks.

Press and hold to fast rewind through the track.

Personal Profiles

HOW DO PERSONAL PROFILES WORK

This feature allows you to create multiple personal profiles enabling users to personalize vehicle's settings such as seats and mirrors, as well as non-positional settings like radio, navigation and driver assist. Positional settings are saved by holding a memory seat button.

Non-positional settings are saved when you change a setting while a profile is active. You can create one profile for each preset memory seat button along with a guest profile.

Recalling and Changing a Profile

You can recall a profile using the touchscreen or the preset button you selected when you created your profile. You can also link a remote control and a mobile device to your profile, to recall the profile.

ENABLING OR DISABLING PERSONAL PROFILES

When you switch on the Personal Profiles feature:

- Unlocking a door with a remote control or mobile device that is not linked to a driver profile does not change the active profile, but remains in the last known profile. It does not change the positional settings.
- Pressing a memory seat button that is not linked to a driver profile or saved to a preset setting does not change the active profile, but remains in the last known profile. It does not change the positional settings.
- Pressing a memory seat button that is not linked to a driver profile but is saved to a preset setting does not change the active profile, but remains in the last known profile. It recalls the positional settings that you saved to that memory seat button.

When you switch off a Personal Profiles feature:

- Unlocking a door with a remote control or mobile device does not recall any non-positional settings but still recalls positional settings from the driver profile which the remote control or mobile device is linked to.
- Pressing a memory seat button that is not linked to a driver profile or saved to a preset setting does not change the positional or non-positional settings.
- Pressing a memory seat button that is linked to a driver profile or has saved to a preset setting recalls the positional settings that you saved to that memory seat button.

Personal Profiles

CREATING A PERSONAL PROFILE

Use the touchscreen to create a personal profile.

1. Switch the vehicle on and leave the vehicle in park (P).
2. Select the Personal Profiles button under Settings.
3. Follow the instructions on the display.

LINKING OR UNLINKING A PERSONAL PROFILE TO A REMOTE CONTROL

You can save Personal Profiles, including preset memory positions, for up to three remote controls by assigning a remote control to a personal profile using the touchscreen.

Use the touchscreen to link a remote control to a personal profile.

1. Switch the vehicle on and leave the vehicle in park (P).
2. Select Personal Profiles under Settings.
3. Touch the arrow for the profile you want to link to a remote control.
4. Select remote control.
5. Follow the instructions on the display.

Note: *If more than one linked remote control is in range, the memory function moves to the settings of the first key to initiate a memory recall.*

Note: *The guest profile consists of existing settings when there is no driver profile created. After you create a driver profile, the guest profile serves as an additional driver profile.*

Note: *You cannot link a remote control to a guest profile.*

Navigation (If Equipped)

CONNECTED NAVIGATION (IF EQUIPPED)

Your vehicle may have connected navigation as a free trial after purchase. You require a subscription after the trial expires. For additional information, visit ford.com/connectedservices.

Note: *If you do not sign up or renew your subscription, you can still use navigation through a connected device.*

ACCESSING NAVIGATION



Press the button to access Navigation.

Note: *As the driver, be aware of all local traffic regulations and road attributes, and operate your vehicle in a safe and legal manner.*

NAVIGATION MAP UPDATES

To update your map data over Wi-Fi, your vehicle must be connected to a Wi-Fi access point. For USB updates and other details, contact dealers at 1-866-462-8837 in the United States and Canada, or 800-557-5539 in Mexico.

Note: *If you find map data errors, you may report them by going to www.here.com/mapcreator.*

ADJUSTING THE MAP

ZOOMING THE MAP IN AND OUT

You can use pinch gestures to zoom in and out. Place two fingers on the screen and move them apart to zoom in. Place two fingers on the screen and bring them together to zoom out.

CHANGING THE FORMAT OF THE MAP



Press the Menu button.

1. Press the Map Orientation tile.
2. Select a map orientation.

LIVE TRAFFIC

WHAT IS LIVE TRAFFIC

You can observe real-time road congestion when live traffic is on.

SWITCHING LIVE TRAFFIC ON AND OFF



Press the Menu button.

1. Press the Traffic on Map tile.
2. Press Traffic on or Traffic Off.

SETTING A DESTINATION

SETTING A DESTINATION USING THE TEXT ENTRY SCREEN

1. Press the search bar at the top of the screen.
2. Enter your destination using the keyboard.
3. Press Search.
4. Select a destination from the list.
5. Press Start to begin navigation.

Navigation (If Equipped)

SETTING A DESTINATION USING THE MAP SCREEN

Press and hold on the map to place a pin at that location. Information about the location of the pin appears on the screen.



Press the button to begin navigation to the pin.

SETTING A DESTINATION USING A PREDICTIVE DESTINATION

Press the predicted destination card on the screen to navigate to it. These appear when the navigation system has learned your driving habits.

SETTING A DESTINATION USING A RECENT DESTINATION

1. Press the Recents tile.
2. Select a destination from the list.

SETTING A DESTINATION USING A SAVED DESTINATION

1. Press Saved Places.
2. Select a saved destination.

Note: Press the star icon next when viewing location details to save the location.

SETTING A DESTINATION USING A POINT OF INTEREST

Press a point of interest icon on the map. Information about the location of the point of interest appears on the screen.



Press the button to begin navigation to the point of interest.

WAYPOINTS

ADDING A WAYPOINT



Press the Add Waypoint button when in an active navigation session.

1. Select a category or enter your waypoint on the keyboard and press Search.
2. Select a waypoint from the list.
3. Press Add to Trip.

EDITING WAYPOINTS

1. Press the waypoint you would like to edit.
2. Select an option to reorder or delete the waypoint.

ROUTE GUIDANCE

ADJUSTING THE GUIDANCE PROMPT VOLUME

Turn the volume control when a guidance prompt plays to adjust the volume.

CANCELING ROUTE GUIDANCE



Press the button to cancel route guidance to the selected location.

Vehicle Software Updates

These software updates introduce new features or provide updates to vehicle software systems. To receive updates, we recommend you switch Automatic Updates on, set a recurring update schedule and connect your vehicle to Wi-Fi. Updates could take longer when not connected to Wi-Fi or could not download at all. See **Connecting the Vehicle to a Wi-Fi Network** (page 374).

Your vehicle may be able to receive drivable software updates, non-drivable software updates or both. Drivable software updates happen during normal vehicle usage. If Automatic Updates is switched on, updates happen without any input from you. If Automatic Updates is switched off, a software update icon displays on the touchscreen and customer acceptance is required.

Non-drivable software updates require you to input a scheduled start time. You are notified on your touchscreen and connected device prior to a non-drivable update.

Most updates complete in less than 30 minutes, although some updates could take up to a few hours.

You are notified of the software updates status on the top left part of the touchscreen and on your connected device. See **Software Update Indicators** (page 418).

Note: *Some updates may be delivered when automatic updates is on, while other updates are downloaded and you need to schedule or press update now.*

Vehicle Software Update Requirements

Non-drivable software updates do not install if any of the following occur:

- Your vehicle is running.
- Your vehicle is switched on.

- Your vehicle is not parked.
- The 12 V battery charge is too low.
- The hazard indicators are switched on.
- The alarm is sounding.
- The doors are open.
- The parking lamps are switched on.
- You are pressing the brake pedal.
- An emergency call is in process.
- Your vehicle is in limp home mode.

Vehicle Software Update Limitations

Once you begin a non-drivable software update, you cannot:

- Cancel the update.
- Enter your vehicle unless you have a key blade.
 - You can open the doors using the mechanical latch if child locks are not on.
- Use the remote control to lock, unlock or start your vehicle.
- Drive your vehicle.

SOFTWARE UPDATE SETTINGS

To access the Software Updates menu:

1. Press Settings.
2. Press Software Updates.

You can do the following in the Software Updates menu:

- Switch Automatic Updates on and off.
- Schedule and install software updates.
- View software update details.



Press the button next to a menu option for more information.

Vehicle Software Updates

Switching Automatic Updates On and Off

Your vehicle may come with Automatic Updates switched on. Where Automatic Updates is set to On, you agree that software updates may be automatically delivered without any further notice or additional consent from you.

Note: *Software updates require approval to download or install with Automatic Updates switched off.*

Scheduling and Installing Software Updates

Scheduling Software Updates

From the Software Updates menu:

1. Press Schedule Updates.
2. Select the days and time for updates.
3. Press Save.

The more days that updates are scheduled, the more frequently your vehicle installs new updates. We recommend selecting a time you normally do not need your vehicle.

Note: *The schedule you set is recurring. If Automatic Updates is on, every time a non-drivable update is available, it installs on this schedule unless you change it. You are notified on your touchscreen and connected device prior to a non-drivable update, with an option to reschedule it.*

Installing Software Updates

Using the Status Bar

1. Press a Software Update indicator on your touchscreen when it appears.
2. Follow the instructions on the touchscreen.

Using the Touchscreen

From the Software Updates menu:

1. Press Update Details.
2. Press Update Now.

Viewing Software Update Details

From the Software Updates menu, press Update Details.

SOFTWARE UPDATE INDICATORS

You can press the indicators in the status bar when they appear for more information.



Vehicle software update reminder, schedule required, confirmation of default schedule required, or consent required.



Vehicle software update canceled, update not successful, or precondition not met.



Vehicle software update successful.

Vehicle System Reset

PERFORMING A SYSTEM RESET

1. Press **Settings** on the touchscreen.
2. Press **General**.
3. Press **Reset**.

You can perform multiple resets from this menu.



Press the button next to a menu option for more information.

Accessories

For a complete listing of the accessories that are available for your vehicle, please contact your authorized dealer or visit the online store web site:

Web Address (United States)

www.Accessories.Ford.com
--

Web Address (Canada)

www.Accessories.Ford.ca
--

We will repair or replace any properly authorized dealer-installed Ford Original Accessory found to be defective in factory-supplied materials or workmanship during the warranty period, as well as any component damaged by the defective accessories.

We will warrant your Ford Original Accessory through the warranty that provides the greatest benefit:

- 24 months, unlimited mileage.
- The remainder of your new vehicle limited warranty.

Contact an authorized dealer for details and a copy of the warranty.

Ford Licensed Accessories are the accessory manufacturer's designs. The manufacturer develops and therefore warrants Ford Licensed Accessories, and does not design or test these accessories to Ford Motor Company engineering requirements. Contact an authorized Ford dealer for the manufacturer's limited warranty details, and request a copy of the Ford Licensed Accessories product limited warranty from the accessory manufacturer.

For maximum vehicle performance, keep the following information in mind when adding accessories or equipment to your vehicle:

- When adding accessories, equipment, passengers and luggage to your vehicle, do not exceed the total weight capacity of the vehicle or of the front or rear axle (GVWR or GAWR as indicated on the Safety Compliance Certification label). Ask an authorized dealer for specific weight information.
- The Federal Communications Commission (FCC) and Canadian Radio Telecommunications Commission (CRTC) regulate the use of mobile communications systems that are equipped with radio transmitters, for example two-way radios, telephones and theft alarms. Any such equipment installed in your vehicle should comply with Federal Communications Commission (FCC) and Canadian Radio Telecommunications Commission (CRTC) regulations and should be installed only by an authorized dealer.
- An authorized dealer needs to install mobile communications systems. Improper installation may harm the operation of your vehicle, particularly if the manufacturer did not design the mobile communication system specifically for automotive use.
- If you or an authorized Ford dealer add any non-Ford electrical or electronic accessories or components to your vehicle, you may adversely affect battery performance and durability. In addition, you may also adversely affect the performance of other electrical systems in the vehicle.

Ford Protect

WHAT IS FORD PROTECT

Protect yourself from the rising cost of vehicle repairs with a Ford Protect extended service plan.

Ford Protect Extended Service Plans - United States Only

Ford Protect extended service plans mean peace of mind. Extended service plans are backed by Ford Motor Company, and provide more protection beyond the New Vehicle Limited Warranty coverage. When you visit your Ford Dealer, insist on the Ford Protect extended service plan.

Ford Protect Can Quickly Pay for Itself

One trip to the service center could easily exceed the price of your Ford Protect extended service plan. With the Ford Protect extended service plan, you minimize your risk for unexpected repair bills and rising repair costs.

Up to 1,000+ Covered Vehicle Components

There are four mechanical Ford Protect extended service plans with different levels of coverage. Ask your authorized dealer for details.

1. PremiumCARE - Our most comprehensive coverage. With over 1,000 covered components, this plan is so complete it is probably easier to list what is not covered.
2. ExtraCARE - Covers 113 components, and includes many high-tech items.
3. BaseCARE - Covers 84 components.
4. PowertrainCARE - Covers 29 critical components.

Ford Protect extended service plans are honored by all authorized Ford dealers in the United States, Canada and Mexico.

That means you get:

- Reliable, quality service at any Ford or Lincoln dealership.
- Repairs performed by factory trained technicians, using genuine parts.

Rental Car Reimbursement

First Day Rental Benefit

If you bring your car into your dealer for service, we will give you a rental vehicle to use for the day.

Extended Rental Benefits

If your vehicle is kept overnight for covered repairs, you are eligible for rental car coverage, warranty repairs, and field service actions.

Roadside Assistance

Exclusive 24/7 roadside assistance, including:

- Towing, flat-tire change and battery jump starts.
- Lock-out assistance.
- Travel expense reimbursement for lodging, meals and rental car.
- Assistance for taxi, shuttle, rental car coverage or other transportation.

Transferable Coverage

If you sell your vehicle before your Ford Protect extended service plan coverage expires, you can transfer any remaining coverage to the new owner. This should give you and your potential buyer peace of mind.

Ford Protect

Less Cost to Properly Maintain Your Vehicle

The Ford Protect extended service plan also offers a Premium Maintenance Plan that covers all scheduled maintenance, and selected wear items. The coverage is prepaid, so you never have to worry about the cost of your vehicle's maintenance.

Covered maintenance includes:

- Windshield wiper blades.
- The clutch disc (if equipped).
- Brake pads and linings.
- Shock absorbers.
- Struts.
- Cabin air filter replacement every 20,000 mi (32,000 km).

Interest Free Finance Options

Just a 5% down payment provides you with an affordable, no interest, no fee payment program allowing you all the security and benefits Ford Protect extended service plan has to offer while paying over time. You are pre-approved with no credit check or hassles. To learn more, call our Ford Protect extended service plan specialists at 800-367-3377.

Ford Protect Extended Service Plan
P.O. Box 321067
Detroit, MI 48232

Ford Protect Extended Service Plan (Canada Only)

You can get more protection for your vehicle by purchasing a Ford Protect extended service plan. Ford Protect extended service plan is the only service contract backed by Ford Motor Company of Canada, Limited. Depending on the plan you purchase, Ford Protect extended service plan provides benefits such as:

- Rental reimbursement.
- Coverage for certain maintenance and wear items.
- Protection against repair costs after your New Vehicle Limited Warranty Coverage expires.
- Roadside Assistance benefits.

There are several Ford Protect extended service plans available in various time, distance and deductible combinations. Each plan is tailored to fit your own driving needs, including reimbursement for towing and rental. When you purchase Ford Protect extended service plan, you receive added peace-of-mind protection throughout Canada, the United States and Mexico, provided by a network of participating authorized Ford Motor Company dealers.

Note: *Repairs performed outside of Canada and the United States are not eligible for Ford Protect extended service plan coverage.*

This information is subject to change. Visit your local Ford of Canada dealer or www.ford.ca to find the Ford Protect extended service plan that is right for you.

Scheduled Maintenance

Intelligent Oil-Life Monitor™

Your vehicle has an Intelligent Oil-Life Monitor that determines when you should change the engine oil based on how you use your vehicle. By using several important factors in its calculations, the monitor helps reduce the cost of owning your vehicle and reduces environmental waste at the same time.

This means you do not have to remember to change the oil on a mileage-based schedule. Your vehicle lets you know when an oil change is due by displaying a message in the information display.

The following table provides examples of vehicle use and its impact on oil change intervals. It is a guideline only. Actual oil change intervals depend on several factors and generally decrease with severity of use.

Maintenance Intervals

At every oil change interval as indicated by the information display¹
Change the engine oil and filter. ²
Rotate tires, inspect tire wear and measure the tread depth.
Perform a multi-point inspection, recommended.
Inspect the automatic transmission fluid level if your vehicle has a dipstick. Consult your dealer for requirements.
Inspect the brake pads, rotors, hoses and the parking brake.
Inspect the engine cooling system strength and hoses.
Inspect the exhaust system and heat shields.
Inspect rear axle and U-joints. Lubricate if your vehicle has grease fittings.
Inspect the half-shaft boots.
Inspect the steering linkage, ball joints, suspension, tie-rod ends, driveshaft and U-joints. Lubricate any areas with grease fittings.
Inspect the wheels and related components for abnormal noise, wear, looseness or drag.
Inspect cabin air filter if equipped, service as required.
Inspect engine air filter, service as required.

¹ Do not exceed one year or 10,000 mi (16,000 km) between service intervals.

² Reset the Intelligent Oil-Life Monitor after engine oil and filter changes.

Scheduled Maintenance

Brake Fluid Maintenance¹	
Every three years.	Change the brake fluid. ²

¹ Perform this maintenance item every three years. Do not exceed the designated time for the interval.

² Brake fluid servicing requires special equipment available at your authorized dealer.

Other Maintenance Items¹	
Every 20,000 mi (32,000 km)	Replace the cabin air filter.
Every 30,000 mi (48,000 km)	Replace the engine air filter.
Every 50,000 mi (80,000 km)	For severe service, change the manual transmission fluid.
Every 60,000 mi (96,000 km)	For severe service, replace the spark plugs.
Every 100,000 mi (160,000 km)	Replace the spark plugs.
	Inspect the accessory drive belts. ²
Every 150,000 mi (240,000 km)	Change the automatic transmission fluid and filter.
	Change the manual transmission fluid.
	Replace the accessory drive belts.
	Change the rear axle fluid.
At 200,000 mi (320,000 km)	Change the engine coolant. ³

¹ Perform these maintenance items within 3,000 mi (4,800 km) of the last engine oil and filter change. Do not exceed the designated distance for the interval.

² After initial inspection, inspect every other oil change until replaced.

³ Initial replacement at 10 years or 200,000 mi (320,000 km), then every 5 years or 100,000 mi (160,000 km).

Exceptions

There are several exceptions to the schedule:

Scheduled Maintenance

Axle Maintenance

Change the axle fluid anytime an axle is submerged in water. If you receive an axle overtemperature warning message in the instrument cluster display and a wrench warning indicator appears, you should change the rear axle fluid at the next convenient time. The wrench warning indicator turns off when you switch off your vehicle.

Timing Chain

If you use your vehicle extensively at a racetrack or at high rpm, it is possible to exceed the service life of the engine timing chain. A wrench indicator light will illuminate when it is time for you to replace your chain. See an authorized dealer.

California Fuel Filter Replacement

If you register your vehicle in California, the California Air Resources Board has determined that the failure to perform this maintenance item does not nullify the emission warranty or limit recall liability before the completion of your vehicle's useful life. Ford Motor Company, however, urges you to have all recommended maintenance services performed at the specified intervals and to record all vehicle service.

Hot Climate Oil Change Intervals

Vehicles operating in the Middle East, North Africa, Sub-Saharan Africa or locations with similar climates using an American Petroleum Institute (API) Certified for Gasoline Engines (Certification mark) oil of SM or SN quality, the oil change interval is 3,000 mi (4,800 km).

If the available API SM or SN oils are not available, then the oil change interval is 2,000 mi (2,900 km).

Engine Air Filter and Cabin Air Filter Replacement

The life of the engine air filter and cabin air filter is dependent on exposure to dusty and dirty conditions. Vehicles operated in these conditions require frequent inspection and replacement of the engine air filter and cabin air filter.

What Are Considered Severe Driving Conditions

A vehicle that is driven for short trips of less than 5–10 mi (8–16 km), driving in temperatures well below or above average, driving in any dusty conditions, idling more than recommended such as in traffic, and driving with a heavy load or while towing a load are considered severe driving conditions. If the vehicle is driven in any of these conditions, follow the severe service maintenance items listed in the scheduled maintenance chart.

GENERAL MAINTENANCE INFORMATION

Why Maintain Your Vehicle?

Carefully following the maintenance schedule helps protect against major repair expenses resulting from neglect or inadequate maintenance and may help to increase the value of your vehicle when you sell or trade it. Keep all receipts for completed maintenance with your vehicle.

We have established regular maintenance intervals for your vehicle based upon rigorous testing. It is important that you have your vehicle serviced at the proper times. These intervals serve two purposes; one is to maintain the reliability of your vehicle and the second is to keep your cost of owning your vehicle down.

Scheduled Maintenance

It is your responsibility to have all scheduled maintenance performed and to make sure that the materials used meet the specifications identified in this owner's manual.

Failure to perform scheduled maintenance invalidates warranty coverage on parts affected by the lack of maintenance.

Why Maintain Your Vehicle at Your Dealership?

Factory-Trained Technicians

Service technicians participate in extensive factory-sponsored certification training to help them become experts on the operation of your vehicle. Ask your dealership about the training and certification their technicians have received.

Genuine Ford and Motorcraft® Replacement Parts

Dealerships stock Ford, Motorcraft and Ford-authorized branded re-manufactured replacement parts. These parts meet or exceed our specifications. Parts installed at your dealership carry a nationwide 24-month or unlimited mile (kilometer) parts and labor limited warranty.

If you do not use Ford authorized parts they may not meet our specifications and depending on the part, it could affect emissions compliance.

Convenience

Many dealerships have extended evening and Saturday hours to make your service visit more convenient and they offer one stop shopping. They can perform any services that are required on your vehicle, from general maintenance to collision repairs.

Note: *Not all dealers have extended hours or body shops. Please contact your dealer for details.*

Protecting Your Investment

Maintenance is an investment that pays dividends in the form of improved reliability, durability and resale value. To maintain the proper performance of your vehicle and its emission control systems, make sure you have scheduled maintenance performed at the designated intervals.

Your vehicle has an intelligent oil-life monitor that determines oil life based on engine operating conditions.

- Under normal operating conditions, a message appears in the instrument cluster display to indicate the regular oil change interval.
- Under severe operating conditions, the oil change interval may reduce, and the message interval may adjust.

High performance vehicles can be driven in such a way that may lead to higher oil consumption (this includes extended time at high engine speeds, high loads, engine braking, hard cornering maneuvers, and track use). Under these conditions, oil consumption of approximately 1 quart per 500 miles (1 liter per 800 km) is possible. As a result, you need to check the engine oil level at every refueling and adjust to maintain the proper level, and to avoid engine damage.

Note: *Oil level should not exceed the maximum mark on the indicator. See **Checking the Engine Oil Level** (page 290).*

Your vehicle can be driven in such a way that dilutes and increases the level of oil by short trips that do not allow the engine to get to operating temperature, extended idling, and low speed driving for long periods of time.

Scheduled Maintenance

When the oil change message appears in the instrument cluster display, it is time for an oil change. Make sure you perform the oil change within two weeks or 500 mi (800 km) of the message appearing. Make sure you reset the Intelligent Oil-Life Monitor after each oil change.

If your instrument cluster display resets prematurely or becomes inoperative, you should perform the oil change interval at six months or 5,000 mi (8,000 km) from your last oil change. Never exceed one year or 10,000 mi (16,000 km) between oil change intervals.

Your vehicle is very sophisticated and built with multiple, complex, performance systems. Every manufacturer develops these systems using different specifications and performance features. That is why it is important to rely upon your dealership to properly diagnose and repair your vehicle.

Ford Motor Company has recommended maintenance intervals for various parts and component systems based upon engineering testing. Ford Motor Company relies upon this testing to determine the most appropriate mileage for replacement of oils and fluids to protect your vehicle at the lowest overall cost to you and recommends against maintenance schedules that deviate from the scheduled maintenance information.

We strongly recommend the use of only genuine Ford, Motorcraft or Ford-authorized re-manufactured replacement parts engineered for your vehicle.

Additives and Chemicals

This owner's manual and the Ford Workshop Manual list the recommended additives and chemicals for your vehicle. We do not recommend using chemicals or additives not approved by us as part of your vehicle's normal maintenance. Please consult your warranty information.

Oils, Fluids and Flushing

In many cases, fluid discoloration is a normal operating characteristic and, by itself, does not necessarily indicate a concern or that the fluid needs to be changed. However, a qualified expert, such as the factory-trained technicians at your dealership, should immediately inspect discolored fluids that also show signs of overheating or foreign material contamination.

Make sure to change your vehicle's oils and fluids at the specified intervals or in conjunction with a repair. Flushing is a viable way to change fluid for many vehicle sub-systems during scheduled maintenance. It is critical that systems are flushed only with new fluid that is the same as that required to fill and operate the system or using a Ford-approved flushing chemical.

Scheduled Maintenance Service Intervals

For your scheduled maintenance service intervals, visit <https://www.ford.com/support/maintenance-schedule>.

Owner Checks and Services

Make sure you perform the following basic maintenance checks and inspections every month or at six-month intervals.

Scheduled Maintenance

Check every month
Engine oil level.
For severe use, high engine speed and engine loads, engine braking and track use, check engine oil level every fuel fill-up.
Function of all interior and exterior lights.
Tires, including spare, for wear and proper pressure.
Windshield washer fluid level.

Check every six months
Battery connections. Clean if necessary.
Body and door drain holes for obstructions. Clean if necessary.
Cooling system fluid level and coolant strength.
Door weatherstrips for wear. Lubricate if necessary.
Hinges, latches and outside locks for proper operation. Lubricate if necessary.
Parking brake for proper operation.
Seatbelts and seat latches for wear and function.
Safety warning lamps operation for brake, ABS, airbag and seatbelt.
Washer spray and wiper operation. Clean or replace blades as necessary.

Multi-Point Inspection

In order to keep your vehicle running right, it is important to have the systems on your vehicle regularly checked. This can help identify potential issues and prevent major problems. We recommend having the following multi-point inspection performed at every scheduled maintenance interval to help make sure your vehicle keeps running great.

Scheduled Maintenance

Multi-Point inspection	
Accessory drive belts.	Hazard warning system operation.
Battery performance.	Horn operation.
Engine air filter.	Radiator, cooler, heater and air conditioning hoses.
Exhaust system.	Suspension components for leaks or damage.
Exterior lamps operation.	Steering and linkage.
Fluid levels; fill if necessary. ¹	Tires, including spare, for wear and proper pressure. ²
For oil and fluid leaks.	Windshield for cracks, chips or pits.
Half-shaft dust boots.	Washer spray and wiper operation.

¹ Brake, coolant recovery reservoir, automatic transmission and window washer.

² If your vehicle is equipped with a temporary mobility kit, check the tire sealant expiration Use By date on the canister. Replace as needed.

Make sure to ask your dealership service advisor or technician about the multi-point vehicle inspection. It is a comprehensive way to perform a thorough inspection of your vehicle. Your checklist gives you immediate feedback on the overall condition of your vehicle.

Severe Driving Conditions

A vehicle that is driven for short trips of less than 5–10 mi (8–16 km), driving in temperatures greatly below or above average, driving in any dusty conditions, idling more than recommended such as in traffic, and driving with a heavy load or while towing a load are considered severe driving conditions. If you drive your vehicle in any of these conditions, follow the severe service maintenance items listed in the scheduled maintenance chart.

Customer Information

THE BETTER BUSINESS BUREAU AUTO LINE PROGRAM

Your satisfaction is important to Ford Motor Company and to your dealer. If a warranty concern has not been resolved using the three-step procedure outlined earlier in this chapter in the Getting the Services you need section, you may be eligible to participate in the BBB AUTO LINE program.

The BBB AUTO LINE program consists of two parts – mediation and arbitration. During mediation, a representative of the BBB will contact both you and Ford Motor Company to explore options for settlement of the claim. If an agreement is not reached during mediation or you do not want to participate in mediation, and if your claim is eligible, you may participate in the arbitration process. An arbitration hearing will be scheduled so that you can present your case in an informal setting before an impartial person. The arbitrator considers the testimony provided and makes a decision after the hearing.

Disputes submitted to the BBB AUTO LINE program are usually decided within 40 days after you file your claim with the BBB. You are not bound by the decision, and may reject the decision and proceed to court where all findings of the BBB Auto Line dispute, and decision, are admissible in the court action. Should you choose to accept the BBB AUTO LINE decision, Ford is then bound by the decision, and must comply with the decision within 30 days of receipt of your acceptance letter.

BBB AUTO LINE Application: Using the information that follows, call or write to request a program application. You will be asked for your name and address, general information about your new vehicle, information about your warranty concerns, and any steps you have already taken to

try to resolve them. A Customer Claim Form will be mailed that needs to be completed, signed and returned to the BBB along with proof of ownership. Upon receipt, the BBB reviews the claim for eligibility under the Program Summary Guidelines.

You can get more information by calling BBB AUTO LINE at 1-800-955-5100, or writing to:

**BBB AUTO LINE a Division of BBB National Programs, Inc.
1676 International Drive, Suite 550
McLean, VA 22102**

BBB AUTO LINE applications can also be requested by calling the Ford Motor Company Customer Relationship Center at 1-800-392-3673.

For additional information, refer to the Better Business Bureau website.

Note: *Ford Motor Company reserves the right to change eligibility limitations, modify procedures, or to discontinue this process at any time without notice and without obligation.*

THE MEDIATION AND ARBITRATION PROGRAM

For vehicles delivered to authorized Canadian dealers. In those cases where you continue to feel that the efforts by Ford of Canada and the authorized dealer to resolve a factory-related vehicle service concern have been unsatisfactory, Ford of Canada participates in an impartial third party mediation/arbitration program administered by the Canadian Motor Vehicle Arbitration Plan (CAMVAP).

Customer Information

The CAMVAP program is a straightforward and relatively speedy alternative to resolve a disagreement when all other efforts to produce a settlement have failed. This procedure is without cost to you and is designed to eliminate the need for lengthy and expensive legal proceedings.

In the CAMVAP program, impartial third-party arbitrators conduct hearings at mutually convenient times and places in an informal environment. These impartial arbitrators review the positions of the parties, make decisions and, when appropriate, render awards to resolve disputes. CAMVAP decisions are fast, fair, and final as the arbitrator's award is binding on both you and Ford of Canada.

CAMVAP services are available in all Canadian territories and provinces. For more information, without charge or obligation, call your CAMVAP Provincial Administrator directly at 1-800-207-0685 or visit www.camvap.ca.

REPORTING SAFETY DEFECTS IN THE UNITED STATES

If you believe that your vehicle has a defect which could cause a crash or could cause injury or death, you should immediately inform the National Highway Traffic Safety Administration (NHTSA) in addition to notifying Ford Motor Company.

If NHTSA receives similar complaints, it may open an investigation, and if it finds that a safety defect exists in a group of vehicles, it may order a recall and remedy campaign. However, NHTSA cannot become involved in individual problems between you, your dealer, or Ford Motor Company.

To contact NHTSA, you may call the Vehicle Safety Hotline toll-free at 1-888-327-4236 (TTY: 1-800-424-9153); go to www.safercar.gov; or write to:

Administrator
1200 New Jersey Avenue,
Southeast
Washington, D.C. 20590

You can also obtain other information about motor vehicle safety from www.safercar.gov.

REPORTING SAFETY DEFECTS IN CANADA

If you believe that your vehicle has a defect which could cause a crash or could cause injury or death, you should immediately inform Transport Canada and Ford of Canada.

Transport Canada Contact Information

Website (English)	http://tc.canada.ca/recalls
Website (French)	http://tc.canada.ca/rappels
Phone	1-800-333-0510

Customer Information

Ford of Canada Contact Information	
Website	www.ford.ca
Phone	1-800-565-3673

Customer Information

THIRD PARTY SOFTWARE COPYRIGHT ACKNOWLEDGMENT

Your vehicle could have components that use open source software. For additional information, visit <http://corporate.ford.com/ford-open-source.html>.

RADIO FREQUENCY CERTIFICATION LABELS

ANTENNAS

European Union EU

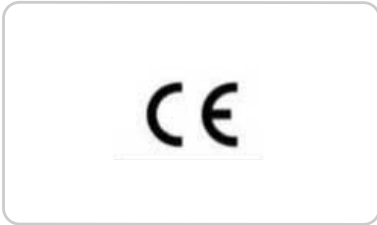

Ukraine



United Kingdom



BLIND SPOT INFORMATION SYSTEM SENSORS

Device	Supplier	Type Designation
SRR5 BLIS Corner Radar (RRU2)	Aptiv	2F5TR

Customer Information

Argentina

15375-23-12270



H-28070

Brazil



China

CMIIT ID: 2023LJ10407

Djibouti

AGREE PAR LE MCPT (REPUBLIQUE DE DJIBOUTI)

Numéro d'agrément:

040/DDTIC/2024

Date d'agrément:

16/04/2024

Europe Union EU

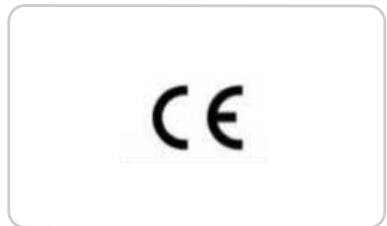

Customer Information

Ghana

NCA APPROVED: 7E6-M0-XDF-TME

Indonesia

Sertifikat Nomor: 98785/SDPPI/2024
PLG ID: 13493



Mexico

IFT: ROAP2F23-27117

Morocco

AGREE PAR L'ANRT MAROC

Numéro d'agrément:

MR00036523ANRT2023

Date d'agrément:

30/01/23

Jamaica

This product has been Type Approved by
Jamaica: SMA - 2F5TR.

Mauritania

AGREE PAR L'ANE MAURITANIE

Numéro d'agrément:

1222/ARE/2023

Date d'agrément:

06/02/2023

Paraguay



NR: 2022-04-I-0255

South Africa



Customer Information

South Korea



R-C-1Ap-2F5TR

Taiwan



CCA123LP0640T2

United Arab Emirates (U.A.E.)

The logo for TDR (Telecommunications Regulatory Authority) features the letters 'TDR' in blue and 'A' in gold, with a horizontal line underneath.

ER10085/22
United Arab Emirates



United Kingdom



United States and Canada

FCC ID: L2C2F5TR

IC: 3432A-2F5TR

Customer Information

This equipment generates, uses, and can radiate radio frequency energy and may cause harmful interference to radio communications. There is no guarantee that interference will not occur in a particular installation. If this equipment does cause harmful interference to radio or television reception, please consult the dealer.

This product is not end-user serviceable.

RF Radiation Exposure Statement: This equipment complies with FCC RF Radiation exposure limits set forth for an uncontrolled environment. This device and its antenna must not be co-located or operating in conjunction with any other antenna or transmitter. This equipment should be installed and operated with a minimum distance of 20cm between the radiator and your body.

This device complies with Part 15 of the FCC Rules and with Innovation, Science and Economic Development Canada's licence-exempt RSS(s). Operation is subject to the following two conditions:

1. This device may not cause harmful interference, and
2. This device must accept any interference received, including interference that may cause undesired operation.

Le présent appareil est conforme aux CNR d'Industrie Canada applicables aux appareils radio exempts de licence. L'exploitation est autorisée aux deux conditions suivantes:

- 1. L'appareil ne doit pas produire de brouillage;*
- 2. L'appareil doit accepter tout brouillage radioélectrique subi, même si le brouillage est susceptible d'en compromettre le fonctionnement.*

BLIND SPOT INFORMATION SYSTEM SENSORS

Device	Supplier	Type Designation
SRR5 BLIS Corner Radar	Aptiv	F5TR

Argentina



Brazil



Customer Information

China

CMIIT ID: 2022LP14250

Djibouti

AGREE PAR LE MCPT (REPUBLIQUE DE DJIBOUTI)
Numéro d'agrément: 195/MCPT/DDTIC
Date d'agrément: 06/09/2021

Ghana

NCA APPROVED: SRO-1M-7E4-X0E

Indonesia

Sertifikat Nomor: 90715/SDPPI/2023
PLG ID: 13493



Europe Union EU



Jamaica

This product has been Type Approved by Jamaica: SMA – F5TR.

Customer Information

Mauritania

AGREE PAR L'ANEMAURITANIE
Numéro d'agrément : 0985/ARE/2021
Date d'agrément : 24/08/2021

Paraguay



Mexico

IFETEL: RCPAPF520-0480

NR: 2020-10-I-0753

Singapore

Morocco

AGREE PAR L'ANRT MAROC
Numéro d'agrément : MR00030033ANRT2021
Date d'agrément : 16/09/2021

Complies with IMDA Standards

DA 00461

South Africa



Customer Information

South Korea



R-C-1Ap-F5TR

Thailand

- (1) เครื่องใช้โทรคมนาคมและอุปกรณ์นี้ มีความสอดคล้องตามข้อกำหนดของ กทท.
- (2) เครื่องใช้โทรคมนาคมและอุปกรณ์นี้ได้รับการแต่งตั้งให้ใช้ที่สอดคล้องขงกรมการโทรคมนาคมที่ออกโดยต่อศุภภาพของกรมชื้อทางการใช้ หรือรัฐโทรคมนาคมที่คณะกรรมการกิจการโทรคมนาคมแห่งชาติประกาศกำหนด

Taiwan

CCAI 20LP1990T7

Ukraine



United Arab Emirates (U.A.E.)



ER19231/23
United Arab Emirates



Customer Information

United Kingdom



United States and Canada

FCC ID: L2CF5TR

IC: 3432A-F5TR

This device complies with Part 15 of the FCC Rules and with Innovation, Science and Economic Development Canada's licence-exempt RSS(s). Operation is subject to the following two conditions:

1. This device may not cause harmful interference, and
2. This device must accept any interference received, including interference that may cause undesired operation.

L'émetteur/récepteur exempt de licence contenu dans le présent appareil est conforme aux CNR d'Innovation, Sciences et Développement économique Canada applicables aux appareils radio exempts de licence. L'exploitation est autorisée aux deux conditions suivantes:

1. L'appareil ne doit pas produire de brouillage;
2. L'appareil doit accepter tout brouillage radioélectrique subi, même si le brouillage est susceptible d'en compromettre le fonctionnement.

Note: Changes or modifications not expressly approved by the party responsible for compliance could void the user's authority to operate the equipment.

Nota: Tout changement apporté au dispositif sans l'approbation expresse des autorités compétentes pourrait révoquer le droit de l'utilisateur d'en faire usage.

Vietnam



Customer Information

BODY CONTROL MODULE

Device	Supplier	Type Designation
BCM GENIM	Continental	M3NA2C766336

Argentina



Ghana

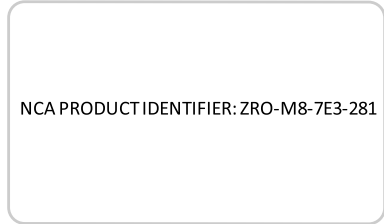

Brazil



Jamaica

This product has been Type Approved by Jamaica: SMA - M3NA2C766336.

Customer Information

Moldova



Serbia



И011 20

Morocco

AGREE PAR L'ANRT MAROC
Numéro d'agrément: MR 20148 ANRT 2019
Date d'agrément: 19/06/2019

Singapore

Complies with IMDA Standards

DA 00461

Paraguay



2019-01-I-000076

South Africa



Customer Information

Ukraine



United Arab Emirates (U.A.E.)



United Kingdom



United States and Canada

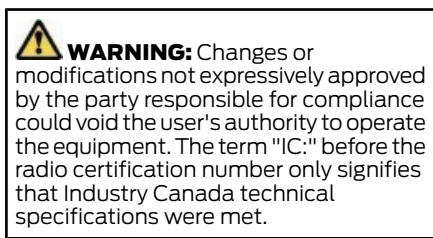

FCC ID: M3NA2C766336

IC: 7812A-A2C766336

Customer Information

This device complies with Part 15 of the FCC Rules and with Innovation, Science and Economic Development Canada's licence-exempt RSS(s). Operation is subject to the following two conditions:

1. This device may not cause harmful interference, and
2. This device must accept any interference received, including interference that may cause undesired operation.

Zambia



Vietnam

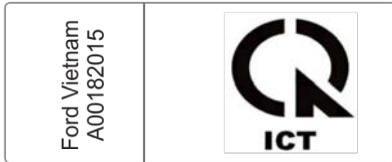

CRUISE CONTROL MODULE

Device	Supplier	Type Designation
MRR3 Medium Range Radar	Aptiv	F3TR

Customer Information

Argentina



EAC Marking - Russia, Belarus, Kazakhstan



Europe Union EU

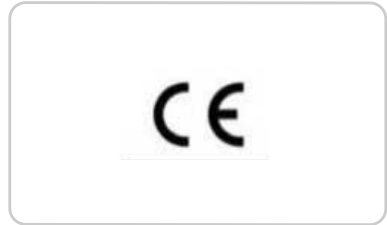

Brazil



Ghana

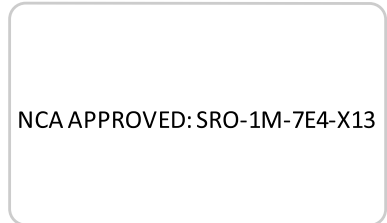

Djibouti

AGRÉÉ PAR LE MCPT (REPUBLIQUE DE DJIBOUTI)
Numéro d'agrément : 059/DDTIC/2020
Date d'agrément : 01/10/2020

Customer Information

Independent State Of Samoa



Jamaica

This product has been Type Approved by Jamaica: SMA – F3TR.

Indonesia

Sertifikat Nomor: 90714/SDPPI/2023
PLG ID: 13493



Malaysia



HIDF16000009

Israel

1. מספר אישור התאמה סטטוס משרד התקשורת: 51-82320
2. חל אישור לכניע פעולות במכשיר שיש בהן כדי לשנות את תכונותיו האלחוטיות של המכשיר, ובכלל זה שינוי תכונה, החלפת אנטנה מקורית או הוספת אפשרות לחיבור לאנטנה חיצונית, בלא קבלת אישור משרד התקשורת, כשל החשש להפרצת אלוטיות.

Mauritania

AGREE PAR L'ANE MAURITANIE
Numéro d'agrément : 0835/ARE/2020
Date d'agrément : 31/08/2020

Customer Information

Mexico

IFT: RCPAPF320-0479

Moldova



Morocco

AGREE PAR L'ANRT MAROC

Numéro d'agrément:
MR00030034ANRT2021

Date d'agrément: 16/09/2021

Pakistan



Paraguay



NR: 2020-10-I-0752

Sierra Leone



Customer Information

TAN: 2021-002-0028

Singapore

Complies with IMDA Standards

DA 00461

R-C-1Ap-F3TR

Taiwan



South Africa



Thailand

- (1) เพื่อแจ้งทราบหน่วยงานและบุคลากรในนี้ มีหัวรถเลื่อนห้องโดยสารของการบินไทย
 - (2) เพื่อแจ้งข้อมูลและรายละเอียดการดำเนินงานเพื่อให้สอดคล้องกับข้อกำหนดทางเทคนิคของหน่วยงานที่เกี่ยวข้องเพื่อความปลอดภัยของประชาชน
- หากการแจ้งนี้ สืบเนื่องมาจากข้อบกพร่องในการดำเนินงานของหน่วยงานแห่งชาติประเทไทย

South Korea



Ukraine



Customer Information

Unites Arab Emirates (U.A.E.)

TDR A

ER19344/23
United Arab Emirates



United Kingdom

UK
CA

United States and Canada

FCC ID: L2CF3TR

IC: 3432A-F3TR

This device complies with Part 15 of the FCC Rules and with Innovation, Science and Economic Development Canada's licence-exempt RSS(s). Operation is subject to the following two conditions:

1. This device may not cause harmful interference, and
2. This device must accept any interference received, including interference that may cause undesired operation.

L'émetteur/récepteur exempt de licence contenu dans le présent appareil est conforme aux CNR d'Innovation, Sciences et Développement économique Canada applicables aux appareils radio exempts de licence. L'exploitation est autorisée aux deux conditions suivantes:

1. L'appareil ne doit pas produire de brouillage;
2. L'appareil doit accepter tout brouillage radioélectrique subi, même si le brouillage est susceptible d'en compromettre le fonctionnement.

Note: Changes or modifications not expressly approved by the party responsible for compliance could void the user's authority to operate the equipment.

Nota: Tout changement apporté au dispositif sans l'approbation expresse des autorités compétentes pourrait révoquer le droit de l'utilisateur d'en faire usage.

Customer Information

Zambia



PASSIVE KEY

Device	Supplier	Type Designation
Passive Key	Continental	A2C93142100

Argentina

H-16355



Customer Information

H-16355

European Union EU



Ghana

NCA APPROVED: 2R9-1H-7E0-01A

Indonesia

Sertifikat Nomor: 90461/SDPPI/2023
PLG ID: 13493



Israel

Democratic Republic of Congo

Agréé par l'ARPTC

N° d'homologation:

HIR - 0053/2016

Date d'homologation:

20/05/2016

1. מספר אישור התאמה מסעם משרד התקשורת: 51-95978
2. חל אישור לכצע פעולות מכשירי שיש בהן כדי לשנות את תכונות האלחוטיות של המכשיר, ובכלל זה שינוי תכנה, החלפת אנטנה מקורית או הוספת אישורת לרזיבי לאנטנה חיצונית, בלא קבלת אישור משרד התקשורת, בעל החשב לאיפגעת אלחוטיות.

Djibouti

AGREE PAR LE MCPT (REPUBLIQUE DE
DJIBOUTI)

Numéro d'agrément:

074/DDTIC/MCPT

Date d'agrément:

20/05/2021

Customer Information

Jamaica

This product has been Type Approved by
Jamaica: SMA – A2C93142100

Malaysia



HIDF16000009

Mauritania

AGREE PAR L'ANE MAURITANIE

Numéro d'agrément:

0919/ARE/2021

Date d'agrément:

18/02/2021

Mexico



IFT: RLVCOA220-2687

Moldova



Morocco

AGREE PAR L'ANRT MAROC

Numéro d'agrément:

MR 12433 ANRT 2016

Date d'agrément:

31/08/2016

Customer Information

Pakistan

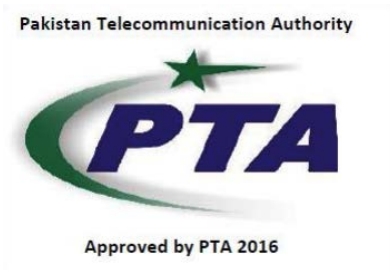

NR: 2016-9-I-000220

NR: 2021-60-I-0358

Serbia



Paraguay



Singapore

Complies with IMDA Standards

DA 00461

South Africa



Customer Information

Thailand

- (1) เครื่องมือประเมินและสรุปประเด็น มีความสอดคล้องตามข้อกำหนดของ กทท.
- (2) เครื่องมือประเมินและสรุปประเด็นดังกล่าวมีแนวโน้มประสิทธิภาพที่สอดคล้องตามมาตรฐานความปลอดภัยข้อมูลของศูนย์รักษาข้อมูลซึ่งอยู่ภายใต้คณะกรรมการกำกับดูแลความมั่นคงทางไซเบอร์ของประเทศไทย

Ukraine



United Arab Emirates (U.A.E)



United Kingdom



Vietnam



Customer Information

Zambia



PASSIVE KEY

Device	Supplier	Type Designation
Passive Key	Continental	A2C97102000

Argentina

H-22290

Ghana

NCA APPROVED: 2R9-8M-7E0-x94

Jamaica

This product has been Type Approved by Jamaica: SMA – A2C97102000

Paraguay



Customer Information

NR: 2016-9-I-000222

South Korea



MSIP-CRM-TAL-A2C97102000

Ukraine



United Kingdom



Vietnam



PASSIVE KEY

Device	Supplier	Type Designation
Passive Key Transmitter	Continental	A2C931423

Customer Information

Argentina

02444-16-01821



Jamaica

This product has been Type Approved by Jamaica: SMA – M3N-A2C931423

Paraguay



H-24101



NR: 2016-9-I-000223

Taiwan

Four-button



Three-button



United States and Canada

FCC ID: M3N-A2C931423

IC: 7812A-A2C931423

H-24101

Brazil



Customer Information

This device complies with Part 15 of the FCC Rules and with Innovation, Science and Economic Development Canada's licence-exempt RSS(s). Operation is subject to the following two conditions:

1. This device may not cause harmful interference, and
2. This device must accept any interference received, including interference that may cause undesired operation.

L'émetteur/récepteur exempt de licence contenu dans le présent appareil est conforme aux CNR d'Innovation, Sciences et Développement économique Canada applicables aux appareils radio exempts de licence. L'exploitation est autorisée aux deux conditions suivantes:

1. L'appareil ne doit pas produire de brouillage;
2. L'appareil doit accepter tout brouillage radioélectrique subi, même si le brouillage est susceptible d'en compromettre le fonctionnement.

Note: Changes or modifications not expressly approved by the party responsible for compliance could void the user's authority to operate the equipment.

Note: Tout changement apporté au dispositif sans l'approbation expresse des autorités compétentes pourrait révoquer le droit de l'utilisateur d'en faire usage.

RADIO TRANSCEIVER MODULE

Device	Supplier	Type Designation
Radio Transceiver Module (RTM)	Aptiv	FO2-RX433UDA

Democratic Republic of Congo

Agréé par l'ARPTC

N° d'homologation:

HER - 0151/Septembre/2022

Date d'homologation:

22/09/2022

Djibouti

AGREE PAR LE MCPT (REPUBLIQUE DE DJIBOUTI)

Numéro d'agrément:

033/DDTIC/2020

Date d'agrément:

07/06/2020

Customer Information

Europe Union EU

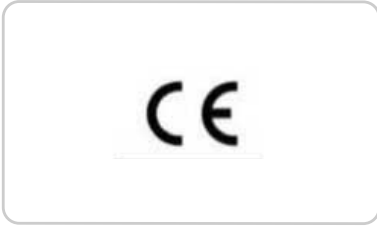

Israel

1. מספר אישור התאמה מטעם משרד התקשורת: 56-03001
2. חל אישור לבצע פעולות במכשיר שיש בהן כדי לשנות את תכונותיו האלחוטיות של המכשיר, ובכלל זה שינוי תוכנה, החלפת אנטנה מקורית או הוספת אפשרות לחיבור לאנטנה חיצונית, כלא קבלת אישור משרד התקשורת, כשל החשש להפרעת אלחוטיות.

Ghana

NCA PRODUCT IDENTIFIERS: SRO-1M-7E4-108

1. מספר אישור התאמה מטעם משרד התקשורת: 56-03001
2. חל אישור לבצע פעולות במכשיר שיש בהן כדי לשנות את תכונותיו האלחוטיות של המכשיר, ובכלל זה שינוי תוכנה, החלפת אנטנה מקורית או הוספת אפשרות לחיבור לאנטנה חיצונית, כלא קבלת אישור משרד התקשורת, כשל החשש להפרעת אלחוטיות.

Jamaica

This product has been Type Approved by Jamaica: SMA – FO2-RX433UDA

Malaysia

Independent State of Samoa



HIDF16000009

Customer Information

Mauritania

AGREE PAR L'ANE MAURITANIE

Numéro d'agrément:

0803/ARE/2020

Date d'agrément:

03/06/2020

Morocco

AGREE PAR L'ANE MAROC
Numéro d'agrément : MR 24102 ANRT 2020
Date d'agrément : 18/05/2020

Mexico



IFT: RCPAPFO21-0004

Pakistan



Moldova



Serbia



Customer Information

South Africa



Ukraine



Taiwan



CCAB22LP1370T1

Thailand

United Kingdom



เครื่องหมายการค้าและสัญลักษณ์นี้ มีความสอดคล้องตามข้อกำหนดของ ICAO.

United Arab Emirates (U.A.E.)



Customer Information

Zambia



SYNC

Device	Supplier	Type Designation
SYNC	Ford	SYNC-G4 SYNC-G4L

Argentina



Customer Information

Brazil



08657-19-01505

Este equipamento não tem direito à proteção
contra interferência prejudicial e não pode causar
interferência em sistemas devidamente autorizados.



08658-19-01505

Este equipamento não tem direito à proteção
contra interferência prejudicial e não pode causar
interferência em sistemas devidamente autorizados.

Djibouti

AGREE PAR LE MCPT (REPUBLIQUE DE DJIBOUTI)

Numéro d'agrément : 124/DDTIC/2019

Date d'agrément : 07/08/2019

AGREE PAR LE MCPT (REPUBLIQUE DE DJIBOUTI)

Numéro d'agrément : 125/DDTIC/2019

Date d'agrément : 07/08/2019

European Union EU



Ghana

NCA APPROVED: ZRO-1H-7E3-182

NCA APPROVED: ZRO-1H-7E3-180

Customer Information

Indonesia

Model: SYNC-G4
Sertifikat Nomor: 80700/SDPPI/2022
PLG ID: 13493



This product has been Type Approved by Jamaica: SMA – SYNC-G4L

Malaysia

Model: SYNC-G4L
Sertifikat Nomor: 81116/SDPPI/2022
PLG ID: 13493



Jamaica

This product has been Type Approved by
Jamaica: SMA – SYNC-G4.

HIDF16000009

Mauritania

AGREE PAR L'ANE MAURITANIE
Numéro d'agrément : 0692/ARE/2018
Date d'agrément : 08/08/2019

Customer Information

AGREE PAR L'ANEMAURITANIE
Numéro d'agrément : 0691/ARE/2018
Date d'agrément : 08/08/2019

AGREE PAR L'ANRT MAROC
N° D'AGRÉMENT: MR 20606 ANRT 2019
07 AOUT 2019

Moldova



Pakistan



Morocco

AGREE PAR L'ANRT MAROC
N° D'AGRÉMENT: MR 20608 ANRT 2019
07 AOUT 2019

Paraguay



2020-03-I-00192

2020-03-I-00193

Customer Information

Serbia

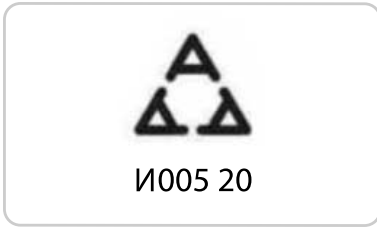

Singapore



South Korea



South Africa



Taiwan

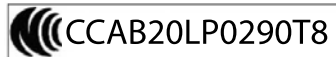

Customer Information

Ukraine

 CCAB20LP0300T1



United Arab Emirates (U.A.E.)

 <p>ER74903/19 United Arab Emirates</p>	
--	---

 <p>ER74902/19 United Arab Emirates</p>	
---	--

Customer Information

United Kingdom



This device complies with Part 15 of the FCC Rules and with Innovation, Science and Economic Development Canada's licence-exempt RSS(s). Operation is subject to the following two conditions:

1. This device may not cause harmful interference, and
2. This device must accept any interference received, including interference that may cause undesired operation.

United States and Canada

 **WARNING:** Changes or modifications not expressly approved by the party responsible for compliance could void the user's authority to operate the equipment. The term "IC:" before the radio certification number only signifies that Industry Canada technical specifications were met.

FCC ID: KMH-SYNCG4

FCC ID: KMH-SYNCG4L

IC: 1422A-SYNCG4

IC: 1422A-SYNCG4L

Zambia



TELEMATICS CONTROL UNIT

Device	Supplier	Type Designation
Telematics Control Unit	Ford	FB5-TCU

Customer Information

Argentina



C-28150

Malaysia



HIDF16000009

Brazil



Europe Union EU

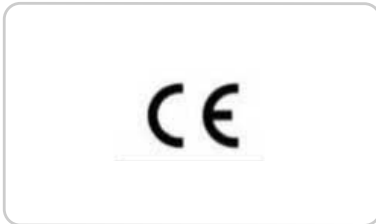

Mexico



Customer Information

South Africa



Taiwan

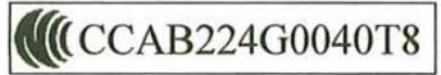

We recommend that the distance between the antenna of the telematics control unit and the user be greater than 14 in (35 cm) when using the telematics control unit.

United Arab Emirates (U.A.E.)



United Kingdom



United States and Canada

FCC ID: KMH-14H074-NA1
IC: 1422A-14H074NA1

Customer Information

This device complies with Part 15 of the FCC Rules and with Innovation, Science and Economic Development Canada's licence-exempt RSS(s). Operation is subject to the following two conditions:

1. This device may not cause harmful interference, and
2. This device must accept any interference received, including interference that may cause undesired operation.

L'émetteur/récepteur exempt de licence contenu dans le présent appareil est conforme aux CNR d'Innovation, Sciences et Développement économique Canada applicables aux appareils radio exempts de licence. L'exploitation est autorisée aux deux conditions suivantes:

1. L'appareil ne doit pas produire de brouillage;
2. L'appareil doit accepter tout brouillage radioélectrique subi, même si le brouillage est susceptible d'en compromettre le fonctionnement.

Note: Changes or modifications not expressly approved by the party responsible for compliance could void the user's authority to operate the equipment.

Nota: Tout changement apporté au dispositif sans l'approbation expresse des autorités compétentes pourrait révoquer le droit de l'utilisateur d'en faire usage.

Vietnam



TIRE PRESSURE MONITORING SYSTEM SENSORS

Device	Supplier	Type Designation
434 Faraday TPMS Sensor	Schrader/Sensata	AG2SZ4

Customer Information

Argentina



Democratic Republic of Congo

Agréé par l'ARPTC

N° d'homologation: HIR -0051/4/2014

Date d'homologation: 16/4/2014

Djibouti

AGREE PAR LE MCPT (REPUBLIQUE DE DJIBOUTI)

Numéro d'agrément : 198/MCPT/DDTCC

Date d'agrément : 7/9/2021

Brazil



18962-22-08001

China

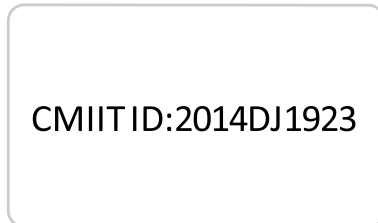

European Union (EU)



Customer Information

The RED 2014/53/EU (replacing R&TTE Directive 1999/5/EC on 13 June 2016) explicitly states that instructions for intentional radiators include reference to "(a) frequency band(s) in which the radio equipment operates; and (b) maximum radio-frequency power transmitted in the frequency band(s) in which the radio equipment operates," in addition to carrying over the general operational instruction and Declaration of Conformity inclusion requirements from the R&TTE Directive.

Hereby, Schrader Electronics Ltd. declares that the radio equipment type AG2SZ4 is in compliance with Directive 2014/53/EU. The full text of the EU declaration of conformity is available at the following internet address:

<https://www.schradertpms.com/en-gb/downloads>

f=433.92MHz

P<10mW (e.i.r.p)

Schrader Electronics Ltd. 11 Technology Park, Belfast Road, Antrim BT41 1QS, Northern Ireland United Kingdom.

Ghana



Independent State of Samoa



Indonesia

Sertifikat Nomor: 90379/SDPPI/2023
PLG ID: 13493



Customer Information

Israel

1. מספר אישור התאמה מסוג משרד התקשורת 51-88688
2. תל אישור לבצע פעולות בביטוי שיש בהן כדי לשמור את חובותיו האזרחיות של המכשיר, ובכלל זה שינוי תוכנו, החלפת אנטנה סקרית או הוספת אפשרות לחיבור לאנטנה חיצונית, בלא קבלת אישור משרד התקשורת, בעל החשב להפרעות אלוויות.

Mauritania

AGREE PAR L'ANEMAURITANIE
Numéro d'agrément : 0842/ARE/2020
Date d'agrément : 21/09/2020

Jamaica

This product has been Type Approved by
Jamaica: SMA - AG2SZ4

Malaysia



HIDF16000009

Mexico

IFT: RLVSCMR15-1238

Moldova



Morocco

AGREE PAR L'ANRT MAROC
Numéro d'agrément: MR9098
ANRT 2014
Date d'agrément: 14/03/2014

Customer Information

Nigeria

NR: 2022-01-I-0032

Connection and use of this communications equipment is permitted by the Nigerian Communications Commission

Pakistan



Oman

OMAN TRA
TA-R/1752/14
D090258

Russia



Paraguay



Sierra Leone



Customer Information

TAN: 2017-002-0035

Serbia

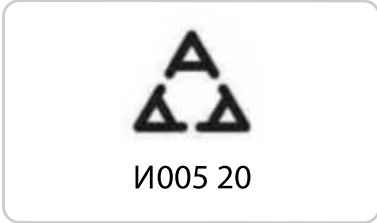

South Korea



MSIP-CRM-SRD-AG2SZ4

Singapore

Complies with IMDA Standards
DA 00461

Taiwan

South Africa



TA-2014/064
Approved



CCAM14LP0090T3

Thailand

- (1) เพื่อใช้ทรงกลมและอุปกรณ์นี้ มีความสอดคล้องตามข้อกำหนดของ กทช.
- (2) เพื่อไว้ใช้คุณสมบัติการเดินคลื่นบนแผงโซลิดที่สอดคล้องตามมาตรฐานความถี่ของชุดอุปกรณ์ของประเทศไทย การแก้ไข หรือปรับเปลี่ยนที่คณะกรรมการกิจการโทรคมนาคมแห่งชาติ จะประกาศ

Customer Information

Ukraine



United Arab Emirates (U.A.E)



United Kingdom



United States and Canada

FCC ID: MRXAG2SZ4

IC: 2546A-AG2SZ4

Customer Information

This device complies with Part 15 of the FCC Rules and with Innovation, Science and Economic Development Canada's licence-exempt RSS(s). Operation is subject to the following two conditions:

1. This device may not cause harmful interference, and
2. This device must accept any interference received, including interference that may cause undesired operation.

L'émetteur/récepteur exempt de licence contenu dans le présent appareil est conforme aux CNR d'Innovation, Sciences et Développement économique Canada applicables aux appareils radio exempts de licence. L'exploitation est autorisée aux deux conditions suivantes:

1. L'appareil ne doit pas produire de brouillage;
2. L'appareil doit accepter tout brouillage radioélectrique subi, même si le brouillage est susceptible d'en compromettre le fonctionnement.

Note: Changes or modifications not expressly approved by the party responsible for compliance could void the user's authority to operate the equipment.

Nota: Tout changement apporté au dispositif sans l'approbation expresse des autorités compétentes pourrait révoquer le droit de l'utilisateur d'en faire usage.

Vietnam



Zambia



TIRE PRESSURE MONITORING SYSTEM SENSORS

Device	Supplier	Type Designation
Burnell TPM Sensor	Schrader/Sensata	BG2BP4

Customer Information

Argentina

13309-22-08001



CNC ID: H-28035

European Union EU



Brazil



The RED 2014/53/EU (replacing R&TTE Directive 1999/5/EC on 13 June 2016) explicitly states that instructions for intentional radiators include reference to "(a) frequency band(s) in which the radio equipment operates; and (b) maximum radio-frequency power transmitted in the frequency band(s) in which the radio equipment operates," in addition to carrying over the general operational instruction and Declaration of Conformity inclusion requirements from the R&TTE Directive.

Hereby, Schrader Electronics Ltd. declares that the radio equipment type BG2BP4 is in compliance with Directive 2014/53/EU. The full text of the EU declaration of conformity is available at the following internet address:

<https://www.schradertpms.com/en-gb/downloads>

Customer Information

f=433.92MHz

P<10mW (e.i.r.p)

Schrader Electronics Ltd. 11 Technology Park, Belfast Road, Antrim BT41 1QS, Northern Ireland United Kingdom.

Israel

1. מספר אישור התאמה מסעם משרד התקשורת: 51-86230
2. תל אישור לבצע פעולות במשך שיש בהן כדי לשנות את תכונותיו האלחוטיות של המכשיר, ובכלל זה שינוי חובנה, החלפת אנטנה סקורית או חוספת אפשרות לחיבור לאנטנה חיצונית, בלא קבלת אישור משרד התקשורת, כשל החשש להפרעות אלחוטיות.

Jamaica

This product has been Type Approved by Jamaica: SMA - BG2BP4.

Malaysia



HIDF16000009

Mexico

IFT: RLVSCBG22-2502

Moldova



Morocco

AGREE PAR L'ANRT MAROC

Numéro d'agrément:
MR00034968ANRT2022

Date d'agrément: 21/12/2022

Paraguay



Customer Information

NR: 2022-05-I-0000331

South Korea

Serbia



MSIP-R-C-SRD-BG2BP4

Singapore

Complies with IMDA Standards
DA 00461

Taiwan



CCAB22LP0730T0

Thailand

South Africa



- (1) เพื่อให้ทราบสถานะและอุปกรณ์นี้มีความสอดคล้องตามข้อกำหนดของ กทท.
- (2) เครื่องมือและวัสดุที่เกี่ยวข้องกับการนำคลื่นแม่เหล็กไฟฟ้าที่สอดคล้องของมาตรฐานควรปฏิบัติตามข้อกำหนดของหน่วยงานที่เกี่ยวข้อง เพื่อให้ทราบถึงสถานะการปฏิบัติงานที่สอดคล้องตามข้อกำหนดของ กทท.

Customer Information

Ukraine



United Arab Emirates (U.A.E.)



United Kingdom



United States and Canada

FCC ID: MRXBG2BP4

IC: 2546A-BG2BP4

Customer Information

This device complies with Part 15 of the FCC Rules and with Innovation, Science and Economic Development Canada's licence-exempt RSS(s). Operation is subject to the following two conditions:

1. This device may not cause harmful interference, and
2. This device must accept any interference received, including interference that may cause undesired operation.

L'émetteur/récepteur exempt de licence contenu dans le présent appareil est conforme aux CNR d'Innovation, Sciences et Développement économique Canada applicables aux appareils radio exempts de licence. L'exploitation est autorisée aux deux conditions suivantes:

1. L'appareil ne doit pas produire de brouillage;
2. L'appareil doit accepter tout brouillage radioélectrique subi, même si le brouillage est susceptible d'en compromettre le fonctionnement.

Note: Changes or modifications not expressly approved by the party responsible for compliance could void the user's authority to operate the equipment.

Nota: Tout changement apporté au dispositif sans l'approbation expresse des autorités compétentes pourrait révoquer le droit de l'utilisateur d'en faire usage.

WIRELESS ACCESSORY CHARGING MODULE

Device	Supplier	Type Designation
Wireless Charger (WCM)	LG/BH EVS	WCFDM00N2A1 WCFDM00N2A3 WCFDM00N2A5

Argentina



Customer Information

European Union

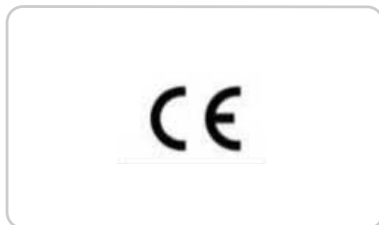

Brazil



Ghana

NCA APPROVED: 7ES-7M-XB1-RDR

Democratic Republic of Congo

Agréé par l'ARPTC

Nº d'homologation: HER-062/Avril/2023

Date d'homologation: 28/4/2023

Indonesia

Model: WCFDM00N2A1
Sertifikat Nomor: 80110/SDPPI/2022
PLG ID: 13493



Customer Information

Model: WCFDM00N2A3
Sertifikat Nomor: 80111/SDPPI/2022
PLG ID: 13493



1. מספר אישור התאמה מטעם משרד התקשורת: 51-80015
2. חל אישור לבצע פעולות במכשיר שיש בהן כדי לשנות את תכונותיו האלחוטיות של המכשיר, ובכלל זה שינוי תכונה, החלפת אנטנה מקורית או הוספת אפשרות לחיבור לאנטנה חיצונית, בלא קבלת אישור משרד התקשורת, בשל החשש להפרות אלחוטיות

Model: WCFDM00N2A5
Sertifikat Nomor: 80112/SDPPI/2022
PLG ID: 13493



1. מספר אישור התאמה מטעם משרד התקשורת: 51-80013
2. חל אישור לבצע פעולות במכשיר שיש בהן כדי לשנות את תכונותיו האלחוטיות של המכשיר, ובכלל זה שינוי תכונה, החלפת אנטנה מקורית או הוספת אפשרות לחיבור לאנטנה חיצונית, בלא קבלת אישור משרד התקשורת, בשל החשש להפרות אלחוטיות

Jamaica

This product has been Type Approved by Jamaica:
SMA - WCFDM00N2A.

Israel

1. מספר אישור התאמה מטעם משרד התקשורת: 51-80014
2. חל אישור לבצע פעולות במכשיר שיש בהן כדי לשנות את תכונותיו האלחוטיות של המכשיר, ובכלל זה שינוי תכונה, החלפת אנטנה מקורית או הוספת אפשרות לחיבור לאנטנה חיצונית, בלא קבלת אישור משרד התקשורת, בשל החשש להפרות אלחוטיות

Malaysia



Customer Information

HIDF16000009

Mauritania

AGREE PAR L'ANE MAURITANIE
Numéro d'agrément : 0935/ARE/2021
Date d'agrément : 23/03/2021

AGREE PAR L'ANE MAURITANIE
Numéro d'agrément : 0934/ARE/2021
Date d'agrément : 23/03/2021

AGREE PAR L'ANE MAURITANIE
Numéro d'agrément : 0933/ARE/2021
Date d'agrément : 23/03/2021

Moldova



Morocco

AGREE PAR L'ANRT MAROC
Numéro d'agrément : MR 00027924ANRT 2021
Date d'agrément : 25/03/2021

AGREE PAR L'ANRT MAROC
Numéro d'agrément : MR 00027925ANRT 2021
Date d'agrément : 25/03/2021

Customer Information

Serbia

AGREE PAR L'ANRT MAROC
Nu m ero d'agr ement : MR 00027923ANRT 2021
Date d'agr ement : 25/03/2021



V005 21

Paraguay



www.conatel.gov.py

NR: 2021-04-I-0202

NR: 2021-04-I-0203

NR: 2021-04-I-0204

Russia



Sierra Leone



TAN: 2021-002-0099

Singapore

Complies with IMDA Standards

DA 00461

Customer Information

South Africa



South Korea



R-R-LGE-WCFDM00N2A1

Taiwan



品名 (Product name): 無線充電座

型號 (Type Designation): WCFDM00N2A1, WCFDM00N2A3, WCFDM00N2A5 **產地 (Origin):** 馬來西亞

額定電壓 (Input rating): 12V

製造日期 (Approval date): 2021.04.21



申請廠商名稱 (Approval name): 福特六和汽車股份有限公司

申請廠商地址 (Approval address): 桃園市中壢區中華路一段705號

Customer Information

Ukraine



United Kingdom



United Arab Emirates (U.A.E.)



Customer Information

TDRA

ER00421/21
United Arab Emirates



United States and Canada

IC: 2703H-WCFDMOON2A

FCC ID: BEJWCFDMOON2A

This equipment generates, uses, and can radiate radio frequency energy and may cause harmful interference to radio communications. There is no guarantee that interference will not occur in a particular installation. If this equipment does cause harmful interference to radio or television reception, please consult the dealer.

This product is not end-user serviceable.

RF Radiation Exposure Statement: This equipment complies with FCC RF Radiation exposure limits set forth for an uncontrolled environment. This device and its antenna must not be co-located or operating in conjunction with any other antenna or transmitter. This equipment should be installed and operated with a minimum distance of 20cm between the radiator and your body.

This device complies with Part 15 of the FCC Rules and with Innovation, Science and Economic Development Canada's licence-exempt RSS(s). Operation is subject to the following two conditions:

1. This device may not cause harmful interference, and
2. This device must accept any interference received, including interference that may cause undesired operation.

Le présent appareil est conforme aux CNR d'Industrie Canada applicables aux appareils radio exempts de licence. L'exploitation est autorisée aux deux conditions suivantes:

1. *L'appareil ne doit pas produire de brouillage;*
2. *L'appareil doit accepter tout brouillage radioélectrique subi, même si le brouillage est susceptible d'en compromettre le fonctionnement.*

Customer Information

Vietnam



REPLACEMENT PARTS RECOMMENDATION

We have built your vehicle to the highest standards using quality parts. We recommend that you demand the use of genuine Ford and Motorcraft parts whenever your vehicle requires scheduled maintenance or repair. You can clearly identify genuine Ford and Motorcraft parts by looking for the Ford, FoMoCo or Motorcraft branding on the parts or their packaging.

Zambia



Scheduled Maintenance and Mechanical Repairs

One of the best ways for you to make sure that your vehicle provides years of service is to have it maintained in line with our recommendations using parts that conform to the specifications detailed in this Owner's Manual.

Genuine Ford and Motorcraft parts meet or exceed these specifications.

Collision Repairs

We hope that you never experience a collision, but accidents happen sometimes.

Genuine Ford replacement collision parts meet our stringent requirements for fit, finish, structural integrity, corrosion protection and dent resistance. During vehicle development we validate that these parts deliver the intended level of protection as a whole system. A great way to know for sure you are getting this level of protection is to use genuine Ford replacement collision parts.

PERCHLORATE

Certain components in your vehicle such as airbag modules, seatbelt pretensioners and remote control batteries may contain perchlorate material. Special handling may apply for service or vehicle end of life disposal.

For more information visit:
www.dtsc.ca.gov/hazardouswaste/perchlorate.

Warranty on Replacement Parts

Genuine Ford and Motorcraft replacement parts are the only replacement parts that benefit from a Ford Warranty.

Customer Information

The Ford Warranty may not cover damage caused to your vehicle as a result of failed non-Ford parts.

For additional information, refer to the terms and conditions of the Ford Warranty.

MOBILE COMMUNICATIONS EQUIPMENT



WARNING: Driving while distracted can result in loss of vehicle control, crash and injury. We strongly recommend that you use extreme caution when using any device that may take your focus off the road. Your primary responsibility is the safe operation of your vehicle. We recommend against the use of any hand-held device while driving and encourage the use of voice-operated systems when possible. Make sure you are aware of all applicable local laws that may affect the use of electronic devices while driving.

Using mobile communications equipment is becoming increasingly important in the conduct of business and personal affairs. However, you must not compromise your own or others' safety when using such equipment. Mobile communications can enhance personal safety and security when appropriately used, particularly in emergency situations. Safety must be paramount when using mobile communications equipment to avoid negating these benefits. Mobile communication equipment includes, but is not limited to, cellular phones, pagers, portable email devices, text messaging devices and portable two-way radios.

FEDERAL HIGHWAY ADMINISTRATION REGULATION

Regulations such as those issued by the Federal Highway Administration or issued pursuant to the Occupational Safety and Health Act (OSHA), and state and local laws and regulations may require additional equipment for the way you intend to use your vehicle. It is the responsibility of the registered owner to determine the applicability of such laws and regulations to your intended use for the vehicle, and to arrange for the installation of required equipment. The dealer has information about the availability of equipment which can be ordered for your vehicle.

Customer Information

END USER LICENSE AGREEMENT

VEHICLE SOFTWARE END USER LICENSE AGREEMENT (EULA)

- You ("You" or "Your" as applicable) have acquired a vehicle having several devices, including SYNC ® and various control modules, ("DEVICES") that include software licensed or owned by Ford Motor Company and its affiliates ("FORD MOTOR COMPANY"). Those software products of FORD MOTOR COMPANY origin, as well as associated media, printed materials, and "online" or electronic documentation ("SOFTWARE") are protected by international intellectual property laws and treaties. The SOFTWARE is licensed, not sold. All rights reserved.
- The SOFTWARE may interface with and/or communicate with, or may be later upgraded to interface with and/or communicate with additional software and/or systems provided by FORD MOTOR COMPANY.

IF YOU DO NOT AGREE TO THIS END USER LICENSE AGREEMENT ("EULA") DO NOT USE THE DEVICES OR COPY THE SOFTWARE. ANY USE OF THE SOFTWARE, INCLUDING BUT NOT LIMITED TO USE ON THE DEVICES, WILL CONSTITUTE YOUR AGREEMENT TO THIS EULA (OR RATIFICATION OF ANY PREVIOUS CONSENT).

GRANT OF SOFTWARE LICENSE: This EULA grants you the following license:

- You may use the SOFTWARE as installed on the DEVICES and as otherwise interfacing with systems and/or services provide by or through FORD MOTOR COMPANY or its third party software and service providers.

Description of Other Rights and Limitations.

- **Speech Recognition:** If the SOFTWARE includes speech recognition component(s), you should understand that speech recognition is an inherently statistical process and that recognition errors are inherent in the process. Neither FORD MOTOR COMPANY nor its suppliers shall be liable for any damages arising out of errors in the speech recognition process. It is your responsibility to monitor any speech recognition functions included in the system.
- **Limitations on Reverse Engineering, Decompilation and Disassembly:** You may not reverse engineer, decompile, translate, disassemble or attempt to discover any source code or underlying ideas or algorithms of the SOFTWARE nor permit others to reverse engineer, decompile or disassemble the SOFTWARE, except and only to the extent that such activity is expressly permitted by applicable law notwithstanding this limitation or to the extent as may be permitted by the licensing terms governing use of any open source components included with the SOFTWARE.
- **Limitations on Distributing, Copying, Modifying and Creating Derivative Works:** You may not distribute, copy, make modifications to or create derivative works based on the SOFTWARE, except and only to the extent that such activity is expressly permitted by applicable law notwithstanding this limitation or to the extent as may be permitted by the licensing terms governing use of any open source components included with the SOFTWARE.

Customer Information

- **Single EULA:** The end user documentation for the DEVICES and related systems and services may contain multiple EULAs, such as multiple translations and/or multiple media versions (e.g., in the user documentation and in the software). Even if you receive multiple EULAs, you are licensed to use only one (1) copy of the SOFTWARE.
- **SOFTWARE Transfer:** You may permanently transfer your rights under this EULA only as part of a sale or transfer of the DEVICES, provided you retain no copies, you transfer all of the SOFTWARE (including all component parts, the media and printed materials, any upgrades, and, if applicable, the Certificate(s) of Authenticity), and the recipient agrees to the terms of this EULA. If the SOFTWARE is an upgrade, any transfer must include all prior versions of the SOFTWARE.
- **Termination:** Without prejudice to any other rights, FORD MOTOR COMPANY may terminate this EULA if you fail to comply with the terms and conditions of this EULA.
- **Internet-Based Services Components:** The SOFTWARE may contain components that enable and facilitate the use of certain Internet-based services. You acknowledge and agree that FORD MOTOR COMPANY, third party software and service suppliers, its affiliates and/or its designated agent may automatically check the version of the SOFTWARE and/or its components that you are utilizing and may provide upgrades or supplements to the SOFTWARE that may be automatically downloaded to your DEVICES.
- **Additional Software/Services:** The SOFTWARE may permit FORD MOTOR COMPANY, third party software and service suppliers, its affiliates and/or its designated agent to provide or make available to you SOFTWARE updates, supplements, add-on components, or Internet-based services components of the SOFTWARE after the date you obtain your initial copy of the SOFTWARE ("Supplemental Components".) SOFTWARE updates may cause you to incur additional charges from your wireless service provider. If FORD MOTOR COMPANY or third party software and services suppliers provide or make available to you Supplemental Components and no other EULA terms are provided along with the Supplemental Components, then the terms of this EULA shall apply. FORD MOTOR COMPANY, its affiliates and/or its designated agent reserve the right to discontinue without liability any Internet-based services provided to you or made available to you through the use of the SOFTWARE.

Customer Information

- **Links to Third Party Sites:** The SOFTWARE may provide you with the ability to link to third party sites. The third party sites are not under the control of FORD MOTOR COMPANY, its affiliates and/or its designated agent. Neither FORD MOTOR COMPANY nor its affiliates nor its designated agent are responsible for (i) the contents of any third party sites, any links contained in third party sites, or any changes or updates to third party sites, or (ii) webcasting or any other form of transmission received from any third party sites. If the SOFTWARE provides links to third party sites, those links are provided to you only as a convenience, and the inclusion of any link does not imply an endorsement of the third party site by FORD MOTOR COMPANY, its affiliates and/or its designated agent.
- **Obligation to Drive Responsibly:** You recognize your obligation to drive responsibly and keep attention on the road. You will read and abide with the DEVICES operating instructions particularly as they pertain to safety and you agree to assume any risk associated with the use of the DEVICES.

UPGRADES AND RECOVERY MEDIA:

If the SOFTWARE is provided by FORD MOTOR COMPANY separate from the DEVICES on media such as a ROM chip, CD ROM disk(s) or via web download or other means, and is labeled "For Upgrade Purposes Only" or "For Recovery Purposes Only" you may install one (1) copy of such SOFTWARE onto the DEVICES as a replacement copy for the existing SOFTWARE, and use it in accordance with this EULA, including any additional EULA terms accompanying the upgrade SOFTWARE.

INTELLECTUAL PROPERTY RIGHTS:

All title and intellectual property rights in and to the SOFTWARE (including but not limited to any images, photographs, animations, video, audio, music, text and "applets" incorporated into the SOFTWARE), the accompanying printed materials, and any copies of the SOFTWARE, are owned by FORD MOTOR COMPANY, or its affiliates or suppliers. The SOFTWARE is licensed, not sold. You may not copy the printed materials accompanying the SOFTWARE. All title and intellectual property rights in and to the content which may be accessed through use of the SOFTWARE is the property of the respective content owner and may be protected by applicable copyright or other intellectual property laws and treaties. This EULA grants you no rights to use such content outside its intended use. All rights not specifically granted under this EULA are reserved by FORD MOTOR COMPANY, its affiliates, and third party software and service providers and suppliers. Use of any on-line services which may be accessed through the SOFTWARE may be governed by the respective terms of use relating to such services. If this SOFTWARE contains documentation that is provided only in electronic form, you may print one copy of such electronic documentation.

EXPORT RESTRICTIONS: You acknowledge that the SOFTWARE is subject to U.S. and European Union export jurisdiction. You agree to comply with all applicable international and national laws that apply to the SOFTWARE, including the U.S. Export Administration Regulations, as well as end-user, end-use and destination restrictions issued by U.S. and other governments.

Customer Information

TRADEMARKS: This EULA does not grant you any rights in connection with any trademarks or service marks of FORD MOTOR COMPANY, its affiliates, and third party software and service providers.

PRODUCT SUPPORT: Please refer to FORD MOTOR COMPANY instructions provided in the documentation for the DEVICES product support, such as the vehicle owner guide.

Should you have any questions concerning this EULA, or if you desire to contact FORD MOTOR COMPANY for any other reason, please refer to the address provided in the documentation for the DEVICES.

No Liability for Certain Damages: EXCEPT AS PROHIBITED BY LAW, FORD MOTOR COMPANY, ANY THIRD PARTY SOFTWARE OR SERVICES SUPPLIERS, AND THEIR AFFILIATES SHALL HAVE NO LIABILITY FOR ANY INDIRECT, SPECIAL, CONSEQUENTIAL OR INCIDENTAL DAMAGES ARISING FROM OR IN CONNECTION WITH THE USE OR PERFORMANCE OF THE SOFTWARE. THIS LIMITATION SHALL APPLY EVEN IF ANY REMEDY FAILS OF ITS ESSENTIAL PURPOSE. THERE ARE NO WARRANTIES OTHER THAN THOSE THAT MAY BE EXPRESSLY PROVIDED FOR YOUR NEW VEHICLE.

SYNC® Automotive Important Safety Information Read and follow instructions:

- Before using your SYNC® system, read and follow all instructions and safety information provided in this end user manual ("Owner Guide".) Not following precautions found in the Owner Guide can lead to an accident or other serious injuries.

General Operation

- **Voice Command Control:** Certain functions within the SYNC® system may be accomplished using voice commands. Using voice commands while driving helps you to operate the system without removing your hands from the wheel or eyes from the road.
- **Prolonged Views of Screen:** Do not access any function requiring a prolonged view of the screen while you are driving. Pull over in a safe and legal manner before attempting to access a function of the system requiring prolonged attention.
- **Volume Setting:** Do not raise the volume excessively. Keep the volume at a level where you can still hear outside traffic and emergency signals while driving. Driving while unable to hear these sounds could cause an accident.
- **Navigation Features:** Any navigation features included in the system are intended to provide turn by turn instructions to get you to a desired destination. Please make certain all persons using this system carefully read and follow instructions and safety information fully.
- **Distraction Hazard:** Any navigation features may require manual (non-verbal) setup. Attempting to perform such set-up or insert data while driving can distract your attention and could cause an accident or other serious injury. Stop the vehicle in a safe and legal manner before attempting these operations.
- **Let Your Judgment Prevail:** Any navigation features are provided only as an aid. Make your driving decisions based on your observations of local conditions and existing traffic regulations. Any such feature is not a

Customer Information

substitute for your personal judgment. Any route suggestions made by this system should never replace any local traffic regulations or your personal judgment or knowledge of safe driving practices.

- **Route Safety:** Do not follow the route suggestions if doing so would result in an unsafe or illegal maneuver, if you would be placed in an unsafe situation, or if you would be directed into an area that you consider unsafe. The driver is ultimately responsible for the safe operation of the vehicle and therefore, must evaluate whether it is safe to follow the suggested directions.
- **Potential Map Inaccuracy:** Maps used by this system may be inaccurate because of changes in roads, traffic controls or driving conditions. Always use good judgment and common sense when following the suggested routes.
- **Emergency Services:** Do not rely on any navigation features included in the system to route you to emergency services. Ask local authorities or an emergency services operator for these locations. Not all emergency services such as police, fire stations, hospitals and clinics are likely to be contained in the map database for such navigation features.

Your Responsibilities and Assumptions of Risk

- You agree to each of the following:(a) Any use of the SOFTWARE while driving an automobile or other vehicle in violation of applicable law or otherwise driving in an unsafe manner presents a significant risk of distracted driving and should not be attempted under any circumstances;(b) Use of the SOFTWARE at excessive volume poses a significant risk of hearing damage and should not be attempted under any circumstances;(c) The SOFTWARE may not be compatible with new or different versions of an operating system, third party software, or third party services, and the SOFTWARE may potentially cause a critical failure of an operating system, third party software, or third party service.(d) Any third party service accessed by or third party software used with the SOFTWARE (i) may charge an additional fee for access, (ii) may not work correctly, on an uninterrupted basis, or error free, (iii) may change streaming formats or discontinue operation, (iv) may contain adult, profane or offensive content; and (v) may contain inaccurate, false or misleading traffic, weather, financial or safety information or other content; and (e) Use of the SOFTWARE may cause you to incur additional charges from your wireless service provider (WSP) and any data or minute calculators that may be included in the software program are for reference only, are not warranted in any way and should not be relied upon in anyway.
- When using the SOFTWARE, you agree to be responsible for and assume the entire risk to the items set forth in Section (a) – (e) above.

Customer Information

Disclaimer of Warranty

YOU EXPRESSLY ACKNOWLEDGE AND AGREE THAT USE OF THE DEVICES AND SOFTWARE IS AT YOUR SOLE RISK AND THAT THE ENTIRE RISK AS TO SATISFACTORY QUALITY, PERFORMANCE, COMPATIBILITY, ACCURACY AND EFFORT IS WITH YOU. TO THE MAXIMUM EXTENT PERMITTED BY APPLICABLE LAW, THE SOFTWARE AND ANY THIRD PARTY SOFTWARE OR THIRD-PARTY SERVICES ARE PROVIDED "AS IS" AND "AS AVAILABLE", WITH ALL FAULTS AND WITHOUT WARRANTY OF ANY KIND, AND FORD MOTOR COMPANY HEREBY DISCLAIMS ALL WARRANTIES AND CONDITIONS WITH RESPECT TO THE SOFTWARE, THIRD PARTY SOFTWARE, AND THIRD-PARTY SERVICES, EITHER EXPRESS, IMPLIED OR STATUTORY, INCLUDING, BUT NOT LIMITED TO, THE IMPLIED WARRANTIES AND/OR CONDITIONS OF MERCHANTABILITY, OF SATISFACTORY QUALITY, OF FITNESS FOR AN PARTICULAR PURPOSE, OF ACCURACY, OF QUIET ENJOYMENT, AND NON-INFRINGEMENT OF THIRD-PARTY RIGHTS. FORD MOTOR COMPANY DOES NOT WARRANT (a) AGAINST INTERFERENCE WITH YOUR ENJOYMENT OF THE SOFTWARE, THIRD PARTY SOFTWARE, OR THIRD-PARTY SERVICES, (b) THAT THE SOFTWARE, THIRD PARTY SOFTWARE, OR THIRD-PARTY SERVICES WILL MEET YOUR REQUIREMENTS, (c) THAT THE OPERATION OF THE SOFTWARE, THIRD PARTY SOFTWARE, OR THIRD-PARTY SERVICES WILL BE UNINTERRUPTED OR ERROR-FREE, (d) OR THAT DEFECTS IN THE SOFTWARE, THIRD PARTY SOFTWARE, OR THIRD-PARTY SERVICES WILL BE CORRECTED. NO ORAL OR WRITTEN INFORMATION OR ADVICE GIVEN BY FORD MOTOR COMPANY OR ITS AUTHORIZED REPRESENTATIVE SHALL

CREATE A WARRANTY. SHOULD THE SOFTWARE, THIRD PARTY SOFTWARE, OR THIRD-PARTY SERVICES PROVE DEFECTIVE, YOU ASSUME THE ENTIRE COST OF ALL NECESSARY SERVICING, REPAIR OR CORRECTION. SOME JURISDICTIONS DO NOT ALLOW THE DISCLAIMER OF IMPLIED WARRANTIES OR LIMITATIONS ON APPLICABLE STATUTORY RIGHTS OF A CONSUMER, SO THE ABOVE DISCLAIMER MAY NOT FULLY APPLY TO YOU. THE SOLE WARRANTY PROVIDED BY FORD MOTOR COMPANY SHALL BE FOUND IN THE WARRANTY INFORMATION INCLUDING WITH YOUR OWNER GUIDE. TO THE EXTENT THAT THERE IS ANY CONFLICT BETWEEN THE TERMS OF THIS SECTION AND THE WARRANTY BOOKLET, THE WARRANTY BOOKLET SHALL CONTROL.

Applicable Law, Venue, Jurisdiction

- The laws of the State of Michigan govern this EULA and Your use of the SOFTWARE. Your use of the SOFTWARE may also be subject to other local, state, national, or international laws. Any litigation arising out of or related to this EULA shall be brought and maintained exclusively in a court of the State of Michigan located in Wayne County or in the United States District Court for the Eastern District of Michigan. You hereby consent to submit to the personal jurisdiction of a court in the State of Michigan located in Wayne County and the United States District Court for the Eastern District of Michigan for any dispute arising out of or relating to this EULA.

Customer Information

Binding Arbitration and Class Action Waiver

(a) Application. This Section applies to any dispute EXCEPT IT DOES NOT INCLUDE A DISPUTE RELATING TO COPYRIGHT INFRINGEMENT, OR TO THE ENFORCEMENT OR VALIDITY OF YOUR, FORD MOTOR COMPANY, OR ANY OF FORD MOTOR COMPANY'S LICENSORS' INTELLECTUAL PROPERTY RIGHTS. Dispute means any dispute, action, or other controversy between You and FORD MOTOR COMPANY, other than the exceptions listed above, concerning the SOFTWARE (including its price) or this EULA, whether in contract, warranty, tort, statute, regulation, ordinance, or any other legal or equitable basis.

(b) Notice of Dispute. In the event of a Dispute, You or FORD MOTOR COMPANY must give the other a "Notice of Dispute", which is a written statement of the name, address, and contact information of the party giving it, the facts giving rise to the dispute, and the relief requested. You and FORD MOTOR COMPANY will attempt to resolve any dispute through informal negotiation within 60 days from the date the Notice of Dispute is sent. After 60 days, You or FORD MOTOR COMPANY may commence arbitration.

(c) Small claims court. You may also litigate any dispute in small claims court in your county of residence or FORD MOTOR COMPANY'S principal place of business, if the dispute meets all requirements to be heard in the small claims court. You may litigate in small claims court whether or not You negotiated informally first.

(d) Binding arbitration. If You and FORD MOTOR COMPANY, do not resolve any dispute by informal negotiation or in small claims court, any other effort to resolve the dispute will be conducted exclusively by binding arbitration. You are giving up

the right to litigate (or participate in as a party or class member) all disputes in court before a judge or jury. Instead, all disputes will be resolved before a neutral arbitrator, whose decision will be final except for a limited right of appeal under the Federal Arbitration Act. Any court with jurisdiction over the parties may enforce the arbitrator's award.

(e) Class action waiver. Any proceedings to resolve or litigate any dispute in any forum will be conducted solely on an individual basis. Neither you nor FORD MOTOR COMPANY, will seek to have any dispute heard as a class action, as a private attorney general action, or in any other proceeding in which any party acts or proposes to act in a representative capacity. No arbitration or proceeding will be combined with another without the prior written consent of all parties to all affected arbitrations or proceedings.

(f) Arbitration procedure. Any arbitration will be conducted by the American Arbitration Association (the "AAA"), under its Commercial Arbitration Rules. If You are an individual and use the SOFTWARE for personal or vehicle use, or if the value of the dispute is \$75,000 or less whether or not You are an individual or how You use the SOFTWARE, the AAA Supplementary Procedures for Consumer-Related Disputes will also apply. To commence arbitration, submit a Commercial Arbitration Rules Demand for Arbitration form to the AAA. You may request a telephonic or in-person hearing by following the AAA rules. In a dispute involving \$10,000 or less, any hearing will be telephonic unless the arbitrator finds good cause to hold an in-person hearing instead. For more information, see adr.org or call 1-800-778-7879. You agree to commence arbitration only in your county of residence or FORD MOTOR COMPANY'S principal place of business. The arbitrator

Customer Information

may award the same damages to you individually as a court could. The arbitrator may award declaratory or injunctive relief only to you individually, and only to the extent required to satisfy your individual claim.

(g) Arbitration fees and incentives.

- I. Disputes involving \$75,000 or less. FORD MOTOR COMPANY will promptly reimburse your filing fees and pay the AAA's and arbitrator's fees and expenses. If you reject FORD MOTOR COMPANY'S last written settlement offer made before the arbitrator was appointed ("last written offer"), your dispute goes all the way to an arbitrator's decision (called an "award"), and the arbitrator awards you more than the last written offer, FORD MOTOR COMPANY will give you three incentives: (1) pay the greater of the award or \$1,000; (2) pay twice your reasonable attorney's fees, if any; and (3) reimburse any expenses (including expert witness fees and costs) that your attorney reasonably accrues for investigating, preparing, and pursuing your claim in arbitration. The arbitrator will determine the amounts.
- ii. Disputes involving more than \$75,000. The AAA rules will govern payment of filing fees and the AAA's and arbitrator's fees and expenses.
- iii. Disputes involving any amount. In any arbitration you commence, FORD MOTOR COMPANY will seek its AAA or arbitrator's fees and expenses, or Your filing fees it reimbursed, only if the arbitrator finds the arbitration frivolous or brought for an improper purpose. In any arbitration FORD MOTOR COMPANY commences, it will pay all

filing, AAA, and arbitrator's fees and expenses. It will not seek its attorney's fees or expenses from you in any arbitration. Fees and expenses are not counted in determining how much a dispute involves.

(h) Claims or disputes must be filed within one year. To the extent permitted by law, any claim or dispute under this EULA to which this Section applies must be filed within one year in small claims court (Section c) or in arbitration (Section d). The one-year period begins when the claim or dispute first could be filed. If such a claim or dispute is not filed within one year, it is permanently barred.

(i) Severability. If the class action waiver (Section e) is found to be illegal or unenforceable as to all or some parts of a dispute, then that portion of Section e will not apply to those parts. Instead, those parts will be severed and proceed in a court of law, with the remaining parts proceeding in arbitration. If any other provision of that portion Section e is found to be illegal or unenforceable, that provision will be severed with the remainder of Section e remaining in full force and effect.

Telenav Software End User License Agreement

Please read these terms and conditions carefully before you use the TeleNav Software. Your use of the TeleNav Software indicates that you accept these terms and conditions. If you do not accept these terms and conditions, do not break the seal of the package, launch, or otherwise use the TeleNav Software. TeleNav may revise this Agreement and the privacy policy at any time, with or without notice to you. You agree to visit <http://www.telenav.com> from time to time to review the then current version of this Agreement and of the privacy policy.

Customer Information

1. Safe and Lawful Use

You acknowledge that devoting attention to the TeleNav Software may pose a risk of injury or death to you and others in situations that otherwise require your undivided attention, and you therefore agree to comply with the following when using the TeleNav Software:

- (a) observe all traffic laws and otherwise drive safely;
- (b) use your own personal judgment while driving. If you feel that a route suggested by the TeleNav Software instructs you to perform an unsafe or illegal maneuver, places you in an unsafe situation, or directs you into an area that you consider to be unsafe, do not follow such instructions;
- (c) do not input destinations, or otherwise manipulate the TeleNav Software, unless your vehicle is stationary and parked;
- (d) do not use the TeleNav Software for any illegal, unauthorized, unintended, unsafe, hazardous, or unlawful purposes, or in any manner inconsistent with this Agreement;
- (e) arrange all GPS and wireless devices and cables necessary for use of the TeleNav Software in a secure manner in your vehicle so that they will not interfere with your driving and will not prevent the operation of any safety device (such as an airbag).

You agree to indemnify and hold TeleNav harmless against all claims resulting from any dangerous or otherwise inappropriate use of the TeleNav Software in any moving vehicle, including as a result of your failure to comply with the directions above.

2. Account Information

You agree: (a) when registering the TeleNav Software, to provide TeleNav with true, accurate, current, and complete information about yourself, and (b) to inform TeleNav promptly of any changes to such information, and to keep it true, accurate, current and complete.

3. Software License

- Subject to your compliance with the terms of this Agreement, TeleNav hereby grants to you a personal, non-exclusive, non-transferable license (except as expressly permitted below in connection with your permanent transfer of the TeleNav Software license), without the right to sublicense, to use the TeleNav Software (in object code form only) in order to access and use the TeleNav Software. This license shall terminate upon any termination or expiration of this Agreement. You agree that you will use the TeleNav Software only for your personal business or leisure purposes, and not to provide commercial navigation services to other parties.

3.1 License Limitations

- **(a)** reverse engineer, decompile, disassemble, translate, modify, alter or otherwise change the TeleNav Software or any part thereof; **(b)** attempt to derive the source code, audio library or structure of the TeleNav Software without the prior express written consent of TeleNav; **(c)** remove from the TeleNav Software, or alter, any of TeleNav's or its suppliers' trademarks, trade names, logos, patent or copyright notices, or other notices or markings; **(d)**

Customer Information

distribute, sublicense or otherwise transfer the TeleNav Software to others, except as part of your permanent transfer of the TeleNav Software; or **(e)** use the TeleNav Software in any manner that

- i. infringes the intellectual property or proprietary rights, rights of publicity or privacy or other rights of any party,
- ii. violates any law, statute, ordinance or regulation, including but not limited to laws and regulations related to spamming, privacy, consumer and child protection, obscenity or defamation, or
- iii. is harmful, threatening, abusive, harassing, tortuous, defamatory, vulgar, obscene, libelous, or otherwise objectionable; and (f) lease, rent out, or otherwise permit unauthorized access by third parties to the TeleNav Software without advanced written permission of TeleNav.

4. Disclaimers

- To the fullest extent permissible pursuant to applicable law, in no event will TeleNav, its licensors and suppliers, or agents or employees of any of the foregoing, be liable for any decision made or action taken by you or anyone else in reliance on the information provided by the TeleNav Software. TeleNav also does not warrant the accuracy of the map or other data used for the TeleNav Software. Such data may not always reflect reality due to, among other things, road closures, construction, weather, new roads and other changing conditions. You are responsible for the entire risk arising out of your use of the TeleNav Software. For example but without limitation, you agree not to rely on the TeleNav Software for critical navigation in areas where the well-being or survival of you or others

is dependent on the accuracy of navigation, as the maps or functionality of the TeleNav Software are not intended to support such high risk applications, especially in more remote geographical areas.

- TELENAV EXPRESSLY DISCLAIMS AND EXCLUDES ALL WARRANTIES IN CONNECTION WITH THE TELENAV SOFTWARE, WHETHER STATUTORY, EXPRESS OR IMPLIED, INCLUDING ALL WARRANTIES WHICH MAY ARISE FROM COURSE OF DEALING, CUSTOM OR TRADE AND INCLUDING, BUT NOT LIMITED TO, THE IMPLIED WARRANTIES OF MERCHANTABILITY, FITNESS FOR A PARTICULAR PURPOSE AND NON-INFRINGEMENT OF THIRD PARTY RIGHTS WITH RESPECT TO THE TELENAV SOFTWARE.
- Certain jurisdictions do not permit the disclaimer of certain warranties, so this limitation may not apply to you.

5. Limitation of Liability

- TO THE EXTENT PERMITTED UNDER APPLICABLE LAW, UNDER NO CIRCUMSTANCES SHALL TELENAV OR ITS LICENSORS AND SUPPLIERS BE LIABLE TO YOU OR TO ANY THIRD PARTY FOR ANY INDIRECT, INCIDENTAL, CONSEQUENTIAL, SPECIAL OR EXEMPLARY DAMAGES (INCLUDING IN EACH CASE, BUT NOT LIMITED TO, DAMAGES FOR THE INABILITY TO USE THE EQUIPMENT OR ACCESS DATA, LOSS OF DATA, LOSS OF BUSINESS, LOSS OF PROFITS, BUSINESS INTERRUPTION OR THE LIKE) ARISING OUT OF THE USE OF OR INABILITY TO USE THE TELENAV SOFTWARE, EVEN IF TELENAV HAS BEEN ADVISED OF THE POSSIBILITY OF SUCH DAMAGES. NOTWITHSTANDING ANY DAMAGES THAT YOU MIGHT INCUR FOR ANY

Customer Information

REASON WHATSOEVER (INCLUDING, WITHOUT LIMITATION, ALL DAMAGES REFERENCED HEREIN AND ALL DIRECT OR GENERAL DAMAGES IN CONTRACT, TORT (INCLUDING NEGLIGENCE) OR OTHERWISE), THE ENTIRE LIABILITY OF TELENAV AND OF ALL OF TELENAV'S SUPPLIERS SHALL BE LIMITED TO THE AMOUNT ACTUALLY PAID BY YOU FOR THE TELENAV SOFTWARE. SOME STATES AND/OR JURISDICTIONS DO NOT ALLOW THE EXCLUSION OR LIMITATION OF INCIDENTAL OR CONSEQUENTIAL DAMAGES, SO THE ABOVE LIMITATIONS OR EXCLUSIONS MAY NOT APPLY TO YOU.

6. Arbitration and Governing Law

- You agree that any dispute, claim or controversy arising out of or relating to this Agreement or the TeleNav Software shall be settled by independent arbitration involving a neutral arbitrator and administered by the American Arbitration Association in the County of Santa Clara, California. The arbitrator shall apply the Commercial Arbitration Rules of the American Arbitration Association, and the judgment upon the award rendered by the arbitrator may be entered by any court having jurisdiction. Note that there is no judge or jury in an arbitration proceeding and the decision of the arbitrator shall be binding upon both parties. You expressly agree to waive your right to a jury trial. This Agreement and performance hereunder will be governed by and construed in accordance with the laws of the State of California, without giving effect to its conflict of law provisions. To the extent judicial action is necessary in connection with the binding arbitration, both TeleNav and you agree to submit

to the exclusive jurisdiction of the courts of the County of Santa Clara, California. The United Nations Convention on Contracts for the International Sale of Goods shall not apply.

7. Assignment

- You may not resell, assign, or transfer this Agreement or any of your rights or obligations, except in totality, in connection with your permanent transfer of the TeleNav Software, and expressly conditioned upon the new user of the TeleNav Software agreeing to be bound by the terms and conditions of this Agreement. Any such sale, assignment or transfer that is not expressly permitted under this paragraph will result in immediate termination of this Agreement, without liability to TeleNav, in which case you and all other parties shall immediately cease all use of the TeleNav Software. Notwithstanding the foregoing, TeleNav may assign this Agreement to any other party at any time without notice, provided the assignee remains bound by this Agreement.

8. Miscellaneous

8.1

This Agreement constitutes the entire agreement between TeleNav and you with respect to the subject matter hereof.

8.2

Except for the limited licenses expressly granted in this Agreement, TeleNav retains all right, title and interest in and to the TeleNav Software, including without limitation all related intellectual property rights. No licenses or other rights which are not expressly granted in this Agreement are intended to, or shall be, granted or

Customer Information

conferred by implication, statute, inducement, estoppel or otherwise, and TeleNav and its suppliers and licensors hereby reserve all of their respective rights other than the licenses explicitly granted in this Agreement.

8.3

By using the TeleNav Software, you consent to receive from TeleNav all communications, including notices, agreements, legally required disclosures or other information in connection with the TeleNav Software (collectively, "Notices") electronically. TeleNav may provide such Notices by posting them on TeleNav's Website or by downloading such Notices to your wireless device. If you desire to withdraw your consent to receive Notices electronically, you must discontinue your use of the TeleNav Software.

8.4

TeleNav's or your failure to require performance of any provision shall not affect that party's right to require performance at any time thereafter, nor shall a waiver of any breach or default of this Agreement constitute a waiver of any subsequent breach or default or a waiver of the provision itself.

8.5

If any provision herein is held unenforceable, then such provision will be modified to reflect the intention of the parties, and the remaining provisions of this Agreement will remain in full force and effect.

8.6

The headings in this Agreement are for convenience of reference only, will not be deemed to be a part of this Agreement, and will not be referred to in connection with the construction or interpretation of this Agreement. As used in this Agreement, the words "include" and "including" and variations thereof, will not be deemed to be terms of limitation, but rather will be deemed to be followed by the words "without limitation".

9. Other Vendors Terms and Conditions

- The Telenav Software utilizes map and other data licensed to Telenav by third party vendors for the benefit of you and other end users. This Agreement includes end-user terms applicable to these companies (included at the end of this Agreement), and thus your use of the Telenav Software is also subject to such terms. You agree to comply with the following additional terms and conditions, which are applicable to Telenav's third party vendor licensors.

9.1 End User Terms Required by HERE North America, LLC

The data ("Data") is provided for your personal, internal use only and not for resale. It is protected by copyright, and is subject to the following terms and conditions which are agreed to by you, on the one hand, and Telenav ("Telenav") and its licensors (including their licensors and suppliers) on the other hand.

© 2013 HERE. All rights reserved.

The Data for areas of Canada includes information taken with permission from Canadian authorities, including: © Her Majesty the Queen in Right of Canada, © Queen's Printer for Ontario, © Canada Post Corporation, GeoBase®, © Department of Natural Resources Canada.

Customer Information

HERE holds a non-exclusive license from the United States Postal Service® to publish and sell ZIP+4® information.

©United States Postal Service® 2014. Prices are not established, controlled or approved by the United States Postal Service®. The following trademarks and registrations are owned by the USPS: United States Postal Service, USPS, and ZIP+4

The Data for Mexico includes certain data from Instituto Nacional de Estadística y Geografía.

9.2 End User Terms Required by NAV2 (Shanghai) Co., Ltd

The data (“Data”) is provided for your personal, internal use only and not for resale. It is protected by copyright, and is subject to the following terms and conditions which are agreed to by you, on the one hand, and NAV2 (Shanghai) Co., Ltd (“NAV2”) and its licensors (including their licensors and suppliers) on the other hand. 20xx. All rights reserved

Terms and Conditions

Permitted Use. You agree to use this Data together with the Telenav Software solely for the internal business and personal purposes for which you were licensed, and not for service bureau, time-sharing or other similar purposes. Accordingly, but subject to the restrictions set forth in the following paragraphs, you agree not to otherwise reproduce, copy, modify, decompile, disassemble, create any derivative works of, or reverse engineer any portion of this Data, and may not transfer or distribute it in any form, for any purpose, except to the extent permitted by mandatory laws.

Restrictions. Except where you have been specifically licensed to do so by Telenav, and without limiting the preceding paragraph, you may not use this Data (a) with any products, systems, or applications installed or otherwise connected to or in communication with vehicles, capable of vehicle navigation, positioning, dispatch, real time route guidance, fleet management or similar applications; or (b) with or in communication with any positioning devices or any mobile or wireless-connected electronic or computer devices, including without limitation cellular phones, palmtop and handheld computers, pagers, and personal digital assistants or PDAs.

Warning. The Data may contain inaccurate or incomplete information due to the passage of time, changing circumstances, sources used and the nature of collecting comprehensive geographic data, any of which may lead to incorrect results.

No Warranty. This Data is provided to you “as is,” and you agree to use it at your own risk. Telenav and its licensors (and their licensors and suppliers) make no guarantees, representations or warranties of any kind, express or implied, arising by law or otherwise, including but not limited to, content, quality, accuracy, completeness, effectiveness, reliability, fitness for a particular purpose, usefulness, use or results to be obtained from this Data, or that the Data or server will be uninterrupted or error-free.

Disclaimer of Warranty: TELENAV AND ITS LICENSORS (INCLUDING THEIR LICENSORS AND SUPPLIERS) DISCLAIM ANY WARRANTIES, EXPRESS OR IMPLIED, OF QUALITY, PERFORMANCE, MERCHANTABILITY, FITNESS FOR A

Customer Information

PARTICULAR PURPOSE OR NON-INFRINGEMENT. Some States, Territories and Countries do not allow certain warranty exclusions, so to that extent the above exclusion may not apply to you.

Disclaimer of Liability: TELENAV AND ITS LICENSORS (INCLUDING THEIR LICENSORS AND SUPPLIERS) SHALL NOT BE LIABLE TO YOU: IN RESPECT OF ANY CLAIM, DEMAND OR ACTION, IRRESPECTIVE OF THE NATURE OF THE CAUSE OF THE CLAIM, DEMAND OR ACTION ALLEGING ANY LOSS, INJURY OR DAMAGES, DIRECT OR INDIRECT, WHICH MAY RESULT FROM THE USE OR POSSESSION OF THE INFORMATION; OR FOR ANY LOSS OF PROFIT, REVENUE, CONTRACTS OR SAVINGS, OR ANY OTHER DIRECT, INDIRECT, INCIDENTAL, SPECIAL OR CONSEQUENTIAL DAMAGES ARISING OUT OF YOUR USE OF OR INABILITY TO USE THIS INFORMATION, ANY DEFECT IN THE INFORMATION, OR THE BREACH OF THESE TERMS OR CONDITIONS, WHETHER IN AN ACTION IN CONTRACT OR TORT OR BASED ON A WARRANTY, EVEN IF TELENAV OR ITS LICENSORS HAVE BEEN ADVISED OF THE POSSIBILITY OF SUCH DAMAGES. Some States, Territories and Countries do not allow certain liability exclusions or damages limitations, so to that extent the above may not apply to you.

Export Control. You shall not export from anywhere any part of the Data or any direct product thereof except in compliance with, and with all licenses and approvals required under, applicable export laws, rules and regulations, including but not limited to the laws, rules and regulations administered by the Office of Foreign Assets Control of the U.S. Department of Commerce and the Bureau of Industry and Security of the U.S. Department of Commerce. To the extent that any such

export laws, rules or regulations prohibit HERE from complying with any of its obligations hereunder to deliver or distribute Data, such failure shall be excused and shall not constitute a breach of this Agreement.

Entire Agreement. These terms and conditions constitute the entire agreement between Telenav (and its licensors, including their licensors and suppliers) and you pertaining to the subject matter hereof, and supersedes in their entirety any and all written or oral agreements previously existing between us with respect to such subject matter.

Governing Law. The above terms and conditions shall be governed by the laws of the State of Illinois [insert "Netherlands" where European HERE Data is used], without giving effect to (i) its conflict of laws provisions, or (ii) the United Nations Convention for Contracts for the International Sale of Goods, which is explicitly excluded. You agree to submit to the jurisdiction of the State of Illinois [insert "The Netherlands" where European HERE Data is used] for any and all disputes, claims and actions arising from or in connection with the Data provided to you hereunder.

Government End Users. If the Data is being acquired by or on behalf of the United States government or any other entity seeking or applying rights similar to those customarily claimed by the United States government, this Data is a "commercial item" as that term is defined at 48 C.F.R. ("FAR") 2.101, is licensed in accordance with these End-User Terms, and each copy of Data delivered or otherwise furnished shall be marked and embedded as appropriate with the following "Notice of Use," and shall be treated in accordance with such Notice:

Customer Information

NOTICE OF USE

CONTRACTOR (MANUFACTURER/
SUPPLIER) NAME: HERE

CONTRACTOR (MANUFACTURER/
SUPPLIER) ADDRESS: c/o Nokia, 425
West Randolph Street, Chicago, Illinois
60606

This Data is a commercial item as
defined in FAR 2.101 and is subject to
these End-User Terms under which this
Data was provided.

© 1987 – 2014 HERE – All rights reserved.

If the Contracting Officer, federal government agency, or any federal official refuses to use the legend provided herein, the Contracting Officer, federal government agency, or any federal official must notify HERE prior to seeking additional or alternative rights in the Data.

I. US/Canada Territory

A. United States Data. The End-User Terms for any Application containing Data for the United States shall contain the following notices:

“HERE holds a non-exclusive license from the United States Postal Service® to publish and sell ZIP+4® information.”

“©United States Postal Service® 20XX. Prices are not established, controlled or approved by the United States Postal Service®. The following trademarks and registrations are owned by the USPS: United States Postal Service, USPS, and ZIP+4.”

B. Canada Data. The following provisions apply to the Data for Canada, which may include or reflect data from third party licensors (“Third Party Data”), including Her Majesty the Queen in Right of Canada (“Her Majesty”), Canada Post Corporation (“Canada Post”) and the Department of Natural Resources of Canada (“NRCan”):

1. Disclaimer and Limitation: Client agrees that its use of the Third Party Data is subject to the following provisions:

a. Disclaimer: The Third Party Data is licensed on an “as is” basis. The licensors of such data, including Her Majesty, Canada Post and NRCan, make no guarantees, representations or warranties respecting such data, either express or implied, arising by law or otherwise, including but not limited to, effectiveness, completeness, accuracy or fitness for a particular purpose.

b. Limitation on Liability: The Third Party Data licensors, including Her Majesty, Canada Post and NRCan, shall not be liable: (i) in respect of any claim, demand or action, irrespective of the nature of the cause of the claim, demand or action alleging any loss, injury or damages, direct or indirect, which may result from the use or possession of such Data; or (ii) in any way for loss of revenues or contracts, or any other consequential loss of any kind resulting from any defect in the Data.

Customer Information

2. Copyright Notice: In connection with each copy of all or any portion of the Data for the Territory of Canada, Client shall affix in a conspicuous manner the following copyright notice on at least one of: (i) the label for the storage media of the copy; (ii) the packaging for the copy; or (iii) other materials packaged with the copy, such as user manuals or end user license agreements: "This data includes information taken with permission from Canadian authorities, including © Her Majesty the Queen in Right of Canada, © Queen's Printer for Ontario, © Canada Post Corporation, GeoBase®, © The Department of Natural Resources Canada. All rights reserved!"

3. End-User Terms: Except as otherwise agreed by the parties, in connection with the provision of any portion of the Data for the Territory of Canada to End-Users as may be authorized under the Agreement, Client shall provide such End-Users, in a reasonably conspicuous manner, with terms (set forth with other end user terms required to be provided under the Agreement, or as otherwise may be provided, by Client) which shall include the following provisions on behalf of the Third Party Data licensors, including Her Majesty, Canada Post and NRCan:

The Data may include or reflect data of licensors, including Her Majesty the Queen in the Right of Canada ("Her Majesty"), Canada Post Corporation ("Canada Post") and the Department of Natural Resources Canada ("NRCan"). Such data is licensed on an "as is" basis. The licensors, including Her Majesty, Canada Post and NRCan, make no guarantees, representations or warranties respecting such data,

either express or implied, arising by law or otherwise, including but not limited to, effectiveness, completeness, accuracy or fitness for a particular purpose. The licensors, including Her Majesty, Canada Post and NRCan, shall not be liable in respect of any claim, demand or action, irrespective of the nature of the cause of the claim, demand or action alleging any loss, injury or damages, direct or indirect, which may result from the use or possession of the data or the Data. The licensors, including Her Majesty, Canada Post and NRCan, shall not be liable in any way for loss of revenues or contracts, or any other consequential loss of any kind resulting from any defect in the data or the Data.

End User shall indemnify and save harmless the licensors, including Her Majesty, Canada Post and NRCan, and their officers, employees and agents from and against any claim, demand or action, irrespective of the nature of the cause of the claim, demand or action, alleging loss, costs, expenses, damages or injuries (including injuries resulting in death) arising out of the use or possession of the data or the Data.

4. Additional Provisions: The terms contained in this Section are in addition to all of the rights and obligations of the parties under the Agreement. To the extent that any of the provisions of this Section are inconsistent with, or conflict with, any other provisions of the Agreement, the provisions of this Section shall prevail.

Customer Information

II. Mexico. The following provision applies to the Data for Mexico, which includes certain data from the Instituto Nacional de Estadística y Geografía (“INEGI”):

A. Any and all copies of the Data and/or packaging containing Data for Mexico shall contain the following notice: “Fuente: INEGI (Instituto Nacional de Estadística y Geografía)”

III. Latin America Territory

A. Third Party Notices. Any and all copies of the Data and/or packaging relating thereto shall include the respective Third Party Notices set forth below and used as described below corresponding to the Territory (or portion thereof) included in such copy:

Territory Notice

Argentina IGN “INSTITUTO GEOGRAFICO NACIONAL ARGENTINO”

Ecuador “INSTITUTO GEOGRAFICO MILITAR DEL ECUADOR AUTORIZACION N° IGM-2011-01- PCO-01 DEL 25 DE ENERO DE 2011”
“source: © IGN 2009 - BD TOPO ®”

Guadeloupe, French Guiana and Martinique Mexico “Fuente: INEGI (Instituto Nacional de Estadística y Geografía)”

IV. Middle East Territory

A. Third Party Notices. Any and all copies of the Data and/or packaging relating thereto shall include the respective Third Party Notices set forth below and used as described below corresponding to the Territory (or portion thereof) included in such copy:

Country Notice

Jordan “© Royal Jordanian Geographic Centre”. The foregoing notice requirement for Jordan Data is a material term of the Agreement. If Client or any of its permitted sublicensees (if any) fail to meet such requirement, HERE shall have the right to terminate Client’s license with respect to the Jordan Data.

B. Jordan Data. Client and its permitted sublicensees (if any) are restricted from licensing and/or otherwise distributing HERE’s database for the country of Jordan (“Jordan Data”) for use in Enterprise Applications to (i) non-Jordanian entities for use of the Jordan Data solely in Jordan or (ii) Jordan-based customers. In addition, Client, its permitted sublicensees (if any) and End-Users are restricted from using the Jordan Data in Enterprise Applications if such party is (i) a non-Jordanian entity using the Jordan Data solely in Jordan or (ii) a Jordan-based customer. For purposes of the foregoing, “Enterprise Applications” shall mean Geomarketing applications, GIS applications, mobile business asset management applications, call center applications, telematics applications, public organization Internet applications or for providing geocoding services.

Customer Information

V. Europe Territory

A. Use of Certain Traffic Codes in Europe

1. General Restrictions Applicable to Traffic Codes. Client acknowledges and agrees that in certain countries of the Europe Territory, Client will need to obtain rights directly from third party RDS-TMC code providers to receive and use the Traffic Codes in the Data and to deliver to End-Users Transactions in any way derived from or based on such Traffic Codes. For such countries, HERE shall deliver the Data incorporating Traffic Codes to Client only after receiving certification from Client of its having obtained such rights.

2. Display of Third Party Rights Legends for Belgium. Client shall, for each Transaction that uses Traffic Codes for Belgium, provide the following notice to the End-User: "Traffic Codes for Belgium are provided by the Ministerie van de Vlaamse Gemeenschap and the Ministère de l'Équipement et des Transports."

B. Paper Maps. With respect to any license granted to Client relating to making, selling or distributing paper maps (i.e., a map fixed on a paper or paper-like medium): (a) such license with respect to Data for the Territory of Great Britain is conditioned on Client's entering into and complying with a separate written agreement with the Ordnance Survey ("OS") to create and sell paper maps, Client's paying to the OS any and all applicable paper map royalties, and Client's complying with the OS copyright notice requirements; (b) such license for selling or otherwise distributing for charge with respect to Data for the Territory of Czech Republic

is conditioned on Client's obtaining prior written consent from Kartografie a.s.; (c) such license for selling or distributing with respect to Data for the Territory of Switzerland is conditioned on Client's obtaining a permit from Bundesamt für Landestopografie of Switzerland; (d) Client is restricted from using Data for the Territory of France to create paper maps with a scale between 1:5,000 and 1:250,000; and (e) Client is restricted from using any Data to create, sell or distribute paper maps that are the same or substantially similar, in terms of data content and specific use of color, symbols and scale, to paper maps published by the European national mapping agencies, including without limitation, Landvermessungämter of Germany, Topografische Dienst of the Netherlands, Nationaal Geografisch Instituut of Belgium, Bundesamt für Landestopografie of Switzerland, Bundesamt für Eich-und Vermessungswesen of Austria, and the National Land Survey of Sweden.

C. OS Enforcement. Without limiting Section IV(B) above, with respect to Data for the Territory of Great Britain, Client acknowledges and agrees that the Ordnance Survey ("OS") may bring a direct action against Client to enforce compliance with the OS copyright notice (see Section IV(D) below) and paper map requirements (see Section IV(B) above) contained in this Agreement.

D. Third Party Notices. Any and all copies of the Data and/or packaging relating thereto shall include the respective Third Party Notices set forth below and used as described below corresponding to the Territory (or portion thereof) included in such copy:

Country(ies) Notice

Customer Information

Austria “© Bundesamt für Eich- und Vermessungswesen”

Croatia
Cyprus,
Estonia,
Latvia,
Lithuania,
Moldova,
Poland,
Slovenia
and/or
Ukraine

“© EuroGeographics”

France “source: © IGN 2009 – BD TOPO ®”

Germany “Die Grundlagendaten wurden mit Genehmigung der zuständigen Behörden entnommen”

Great Britain “Contains Ordnance Survey data © Crown copyright and database right 2010 Contains Royal Mail data © Royal Mail copyright and database right 2010”

Greece “Copyright Geomatics Ltd.”

Hungary “Copyright © 2003; Top-Map Ltd.”

Italy “La Banca Dati Italiana è stata prodotta usando quale riferimento anche cartografia numerica ed al tratto prodotta e fornita dalla Regione Toscana.”

Norway “Copyright © 2000; Norwegian Mapping Authority”

Portugal “Source: IgeoE – Portugal”

Spain “Información geográfica propiedad del CNIG”

Sweden “Based upon electronic data © National Land Survey Sweden.”

Switzerland “Topografische Grundlage: © Bundesamt für Landestopographie.

E. Respective Country Distribution. Client acknowledges that HERE has not received approvals to distribute map data for the following countries in such respective countries: Albania, Belarus, Kyrgyzstan, Moldova and Uzbekistan. HERE may update such list from time to time. The license rights granted to Client under this TL with respect to the Data for such countries are contingent upon Client’s compliance with all applicable laws and regulations, including, without limitation, any required licenses or approvals to distribute the Application incorporating such Data in such respective countries.

VI. Australia Territory

A. Third Party Notices. Any and all copies of the Data and/or packaging relating thereto shall include the respective Third Party Notices set forth below and used as described below corresponding to the Territory (or portion thereof) included in such copy:

Copyright. Based on data provided under license from PSMA Australia Limited (www.pasma.com.au).

Customer Information

Product incorporates data which is © 20XX Telstra Corporation Limited, GM Holden Limited, Intelomatics Australia Pty Ltd and Continental Pty Ltd.

B. Third Party Notices for Australia. In addition to the foregoing, the End-User Terms for any Application containing RDS-TMC Traffic Codes for Australia shall contain the following notice: “Product incorporates traffic location codes which is © 20XX Telstra Corporation Limited and its licensors.”

AT&T Vehicle Network Carrier Telematics Disclosure

END USER FOR PURPOSES OF THIS SECTION MEANS YOU AND YOUR HEIRS, EXECUTORS, LEGAL PERSONAL REPRESENTATIVES AND PERMITTED ASSIGNS. FOR PURPOSES OF THIS SECTION “UNDERLYING WIRELESS SERVICE CARRIER” INCLUDES ITS AFFILIATES AND CONTRACTORS AND THEIR RESPECTIVE OFFICERS, DIRECTORS, EMPLOYEES, SUCCESSORS AND ASSIGNS. END USER HAS NO CONTRACTUAL RELATIONSHIP WITH THE UNDERLYING WIRELESS SERVICE CARRIER AND END USER IS NOT A THIRD PARTY BENEFICIARY OF ANY AGREEMENT BETWEEN FORD AND UNDERLYING CARRIER. END USER UNDERSTANDS AND AGREES THAT THE UNDERLYING CARRIER HAS NO LEGAL, EQUITABLE, OR OTHER LIABILITY OF ANY KIND TO END USER. IN ANY EVENT, REGARDLESS OF THE FORM OF THE ACTION, WHETHER FOR BREACH OF CONTRACT, WARRANTY, NEGLIGENCE, STRICT LIABILITY IN TORT OR OTHERWISE, END USER'S EXCLUSIVE REMEDY FOR CLAIMS ARISING IN ANY WAY IN CONNECTION WITH THIS AGREEMENT, FOR ANY CAUSE WHATSOEVER, INCLUDING BUT NOT LIMITED TO ANY FAILURE OR

DISRUPTION OF SERVICE PROVIDED HEREUNDER, IS LIMITED TO PAYMENT OF DAMAGES IN AN AMOUNT NOT TO EXCEED THE AMOUNT PAID BY END USER FOR THE SERVICES DURING THE TWO-MONTH PERIOD PRECEDING THE DATE THE CLAIM AROSE.

(ii) END USER AGREES TO INDEMNIFY AND HOLD HARMLESS THE UNDERLYING WIRELESS SERVICE CARRIER AND ITS OFFICERS, EMPLOYEES, AND AGENTS AGAINST ANY AND ALL CLAIMS, INCLUDING WITHOUT LIMITATION CLAIMS FOR LIBEL, SLANDER, OR ANY PROPERTY DAMAGE, PERSONAL INJURY OR DEATH, ARISING IN ANY WAY, DIRECTLY OR INDIRECTLY, IN CONNECTION WITH THIS AGREEMENT OR THE USE, FAILURE TO USE, OR INABILITY TO USE THE DEVICE EXCEPT WHERE THE CLAIMS RESULT FROM THE UNDERLYING CARRIER'S GROSS NEGLIGENCE OR WILLFUL MISCONDUCT. THIS INDEMNITY WILL SURVIVE THE TERMINATION OF THE AGREEMENT.

(iii) END USER HAS NO PROPERTY RIGHT IN ANY NUMBER ASSIGNED TO THE DEVICE.

(iv) END USER UNDERSTANDS THAT FORD AND THE UNDERLYING CARRIER CANNOT GUARANTY THE SECURITY OF WIRELESS TRANSMISSIONS, AND WILL NOT BE LIABLE FOR ANY LACK OF SECURITY RELATING TO THE USE OF THE SERVICES

THE SERVICE IS FOR [END USER'S] USE ONLY AND END USER MAY NOT RESELL THE SERVICE TO ANY OTHER PARTY END USER UNDERSTANDS THAT THE UNDERLYING CARRIER DOES NOT GUARANTEE ANY END USER UNINTERRUPTED SERVICE OR COVERAGE. THE UNDERLYING CARRIER DOES NOT WARRANT THAT END USERS CAN OR WILL BE LOCATED USING THE SERVICE. THE UNDERLYING CARRIER

Customer Information

MAKES NO WARRANTY, EXPRESS OR IMPLIED, OF MERCHANTABILITY OR FITNESS FOR A PARTICULAR PURPOSE, SUITABILITY, OR PERFORMANCE REGARDING ANY SERVICES OR GOODS, AND IN NO EVENT SHALL AT&T BE LIABLE, WHETHER OR NOT DUE TO ITS OWN NEGLIGENCE, FOR ANY: (A) ACT OR OMISSION OF A THIRD PARTY; (B) MISTAKES, OMISSIONS, INTERRUPTIONS, ERRORS, FAILURES TO TRANSMIT, DELAYS, OR DEFECTS IN THE SERVICE PROVIDED BY OR THROUGH THE UNDERLYING CARRIER; (C) DAMAGE OR INJURY CAUSED BY SUSPENSION OR TERMINATION BY THE UNDERLYING CARRIER; OR (D) DAMAGE OR INJURY CAUSED BY A FAILURE OR DELAY IN CONNECTING A CALL TO ANY ENTITY, INCLUDING 911 OR ANY OTHER EMERGENCY SERVICE. TO THE FULL EXTENT ALLOWED BY LAW, THE END USER RELEASES, INDEMNIFIES AND HOLDS THE UNDERLYING CARRIER HARMLESS FROM AND AGAINST ANY AND ALL CLAIMS OF ANY PERSON OR ENTITY FOR DAMAGES OF ANY NATURE ARISING IN ANY WAY FROM OR RELATING TO, DIRECTLY OR INDIRECTLY, SERVICES PROVIDED BY THE UNDERLYING CARRIER OR ANY PERSON'S USE THEREOF, INCLUDING CLAIMS ARISING IN WHOLE OR IN PART FROM THE ALLEGED NEGLIGENCE OF THE UNDERLYING CARRIER.

VII. China Territory

Personal Use Only

You agree to use this Data together with [insert name of Client Application] for the solely personal, non-commercial purposes for which you were licensed, and not for service bureau, time-sharing or other similar purposes. Accordingly, but subject to the restrictions set forth in the following paragraphs, you may copy this Data only as necessary for your personal use to (i)

view it, and (ii) save it, provided that you do not remove any copyright notices that appear and do not modify the Data in any way. You agree not to otherwise reproduce, copy, modify, decompile, disassemble or reverse engineer any portion of this Data, and may not transfer or distribute it in any form, for any purpose, except to the extent permitted by mandatory laws.

Restrictions

Except where you have been specifically licensed to do so by NAV2, and without limiting the preceding paragraph, you may not (a) use this Data with any products, systems, or applications installed or otherwise connected to or in communication with vehicles, capable of vehicle navigation, positioning, dispatch, real time route guidance, fleet management or similar applications; or (b) with or in communication with any positioning devices or any mobile or wireless-connected electronic or computer devices, including without limitation cellular phones, palmtop and handheld computers, pagers, and personal digital assistants or PDAs. You agree to cease using this Data if you fail to comply with these terms and conditions.

Limited Warranty

NAV2 warrants that (a) the Data will perform substantially in accordance with the accompanying written materials for a period of ninety (90) days from the date of receipt, and (b) any support services provided by NAV2 shall be substantially as described in applicable written materials provided to you by NAV2, and NAV2's support engineers will make commercially reasonable efforts to solve any problem issues.

Customer Information

Customer Remedies

NAV2 and its suppliers' entire liability and your exclusive remedy shall be, at NAV2's sole discretion, either (a) return of the price paid, if any, or (b) repair or replacement of the Data that do not meet NAV2's Limited Warranty and that are returned to NAV2 with a copy of your receipt. This Limited Warranty is void if failure of the Data has resulted from accident, abuse, or misapplication. Any replacement Data will be warranted for the remainder of the original warranty period or thirty (30) days, whichever is longer. Neither these remedies nor any product support services offered by NAV2 are available without proof of purchase from an authorized international source.

No Other Warranty:

EXCEPT FOR THE LIMITED WARRANTY SET FORTH ABOVE AND TO THE EXTENT PERMITTED BY APPLICABLE LAW, NAV2 AND ITS LICENSORS (INCLUDING THEIR LICENSORS AND SUPPLIERS) DISCLAIM ANY WARRANTIES, EXPRESS OR IMPLIED, OF QUALITY, PERFORMANCE, MERCHANTABILITY, FITNESS FOR A PARTICULAR PURPOSE, OWNERSHIP OR NON-INFRINGEMENT. Certain warranty exclusions may not be permitted under applicable law, so to that extent the above exclusion may not apply to you.

Limited Liability:

TO THE EXTENT PERMITTED BY APPLICABLE LAW, NAV2 AND ITS LICENSORS (INCLUDING THEIR LICENSORS AND SUPPLIERS) SHALL NOT BE LIABLE TO YOU: IN RESPECT OF ANY CLAIM, DEMAND OR ACTION, IRRESPECTIVE OF THE NATURE OF THE CAUSE OF THE CLAIM, DEMAND OR ACTION ALLEGING ANY LOSS, INJURY OR DAMAGES, DIRECT OR INDIRECT, WHICH MAY RESULT FROM THE USE OR POSSESSION OF THE INFORMATION; OR

FOR ANY LOSS OF PROFIT, REVENUE, CONTRACTS OR SAVINGS, OR ANY OTHER DIRECT, INDIRECT, INCIDENTAL, SPECIAL OR CONSEQUENTIAL DAMAGES ARISING OUT OF YOUR USE OF OR INABILITY TO USE THIS INFORMATION, ANY DEFECT IN THE INFORMATION, OR THE BREACH OF THESE TERMS OR CONDITIONS, WHETHER IN AN ACTION IN CONTRACT OR TORT OR BASED ON A WARRANTY, EVEN IF NAV2 OR ITS LICENSORS HAVE BEEN ADVISED OF THE POSSIBILITY OF SUCH DAMAGES. UNDER NO CIRCUMSTANCES SHALL NAV2'S OR ITS SUPPLIERS' LIABILITY HEREUNDER EXCEED THE PRICE PAID. Certain liability exclusions may not be permitted under applicable law, so to that extent the above exclusion may not apply to you.

Export Control

You agree not to export to anywhere any part of the Data provided to you or any direct product thereof except in compliance with, and with all licenses and approvals required under, applicable export laws, rules and regulations.

IP Protection

The Data are owned by NAV2 or its suppliers and are protected by applicable copyright and other intellectual property law and treaties. The Data are provided solely on the basis of a license to use, not sale.

Entire Agreement

These terms and conditions constitute the entire agreement between NAV2 (and its licensors, including their licensors and suppliers) and you pertaining to the subject matter hereof, and supersedes in their entirety any and all written or oral agreements previously existing between us with respect to such subject matter.

Customer Information

Governing Law.

The above terms and conditions shall be governed by the laws of the People's Republic of China, without giving effect to (i) its conflict of laws provisions, or (ii) the United Nations Convention for Contracts for the International Sale of Goods, which is explicitly excluded. Any dispute arising from or in connection with the Data provided to you hereunder shall be submitted to the Shanghai International Economic and Trade Arbitration Commission for arbitration.

Gracenote® Copyright

CD and music-related data from Gracenote, Inc., copyright©

2000-2007 Gracenote. Gracenote Software, copyright © 2000-2007 Gracenote. This product and service may practice one or more of the following U.S. Patents 5,987,525; 6,061,680; 6,154,773; 6,161,132; 6,230,192; 6,230,207; 6,240,459; 6,330,593 and other patents issued or pending. Some services supplied under license from Open Globe, Inc. for U.S. Patent 6,304,523.

Gracenote and CDDB are registered trademarks of Gracenote. The Gracenote logo and logotype, and the "Powered by Gracenote™" logo are trademarks of Gracenote.

Gracenote® End User License Agreement (EULA)

This device contains software from Gracenote, Inc. of 2000 Powell Street Emeryville, California 94608 ("Gracenote").

The software from Gracenote (the "Gracenote Software") enables this device to do disc and music file identification and obtain music-related information, including name, artist, track, and title information ("Gracenote Data") from online servers

("Gracenote Servers"), and to perform other functions. You may use Gracenote Data only by means of the intended End User functions of this device. This device may contain content belonging to Gracenote's providers. If so, all of the restrictions set forth herein with respect to Gracenote Data shall also apply to such content and such content providers shall be entitled to all of the benefits and protections set forth herein that are available to Gracenote. You agree that you will use the content from Gracenote ("Gracenote Content"), Gracenote Data, the Gracenote Software, and Gracenote Servers for your own personal, non-commercial use only. You agree not to assign, copy, transfer or transmit the Gracenote Content, Gracenote Software or any Gracenote Data (except in a Tag associated with a music file) to any third party. YOU AGREE NOT TO USE OR EXPLOIT GRACENOTE CONTENT, GRACENOTE DATA, THE GRACENOTE SOFTWARE, OR GRACENOTE SERVERS, EXCEPT AS EXPRESSLY PERMITTED HEREIN.

You agree that your non-exclusive licenses to use the Gracenote Content, Gracenote Data, the Gracenote Software, and Gracenote Servers will terminate if you violate these restrictions. If your licenses terminate, you agree to cease any and all use of the Gracenote Content, Gracenote Data, the Gracenote Software, and Gracenote Servers.

Gracenote, respectively, reserve all rights in Gracenote Data, the Gracenote Software, and the Gracenote Servers and Gracenote Content, including all ownership rights. Under no circumstances will either Gracenote become liable for any payment to you for any information that you provide,

Customer Information

including any copyrighted material or music file information. You agree that Gracenote may enforce its respective rights, collectively or separately, under this agreement against you, directly in each company's own name.

Gracenote uses a unique identifier to track queries for statistical purposes. The purpose of a randomly assigned numeric identifier is to allow Gracenote to count queries without knowing anything about who you are. For more information, see the web page at www.gracenote.com for the Gracenote Privacy Policy.

THE GRACENOTE SOFTWARE, EACH ITEM OF GRACENOTE DATA AND THE GRACENOTE CONTENT ARE LICENSED TO YOU "AS IS". NEITHER GRACENOTE MAKES ANY REPRESENTATIONS OR WARRANTIES, EXPRESS OR IMPLIED, REGARDING THE ACCURACY OF ANY GRACENOTE DATA FROM THE GRACENOTE SERVERS OR GRACENOTE CONTENT. GRACENOTE COLLECTIVELY AND SEPARATELY RESERVE THE RIGHT TO DELETE DATA AND/OR CONTENT FROM THE COMPANIES' RESPECTIVE SERVERS OR, IN THE CASE OF GRACENOTE, CHANGE DATA CATEGORIES FOR ANY CAUSE THAT GRACENOTE DEEMS SUFFICIENT. NO WARRANTY IS MADE THAT EITHER GRACENOTE CONTENT OR THE GRACENOTE SOFTWARE OR GRACENOTE SERVERS ARE ERROR-FREE OR THAT THE FUNCTIONING OF THE GRACENOTE SOFTWARE OR GRACENOTE SERVERS WILL BE UNINTERRUPTED. GRACENOTE IS NOT OBLIGATED TO PROVIDE YOU WITH ANY ENHANCED OR ADDITIONAL DATA TYPES THAT GRACENOTE MAY CHOOSE TO PROVIDE IN THE FUTURE AND IS FREE TO DISCONTINUE ITS ONLINE SERVICES AT ANY TIME. GRACENOTE DISCLAIMS ALL WARRANTIES EXPRESS OR IMPLIED, INCLUDING, BUT NOT LIMITED TO,

IMPLIED WARRANTIES OF MERCHANTABILITY, FITNESS FOR A PARTICULAR PURPOSE, TITLE, AND NON-INFRINGEMENT. NEITHER GRACENOTE WARRANTS THE RESULTS THAT WILL BE OBTAINED BY YOUR USE OF THE GRACENOTE SOFTWARE OR ANY GRACENOTE SERVER. IN NO CASE WILL GRACENOTE BE LIABLE FOR ANY CONSEQUENTIAL OR INCIDENTAL DAMAGES OR FOR ANY LOST PROFITS OR LOST REVENUES FOR ANY REASON WHATSOEVER. © Gracenote 2007.

Taiwan Territory

According to the "Technical Specifications for Low Power Radio Frequency Equipment" formulated by the National Communications and Communication Committee of the Executive Yuan: 3.8.2. For the low-power radio frequency equipment that has obtained the verification certificate, the company, firm or user shall not change the frequency, increase the power or change the characteristics and functions of the original design without authorization.

The use of low-power radio frequency equipment must not affect flight safety and interfere with legal communications: when the system detects interference, immediately stop using it until there is no interference.

The aforementioned legal communication refers to the wireless communication operated in accordance with the provisions of the Telecommunications Management Law. Low-power radio frequency equipment needs to endure the interference of legal communication or industrial, scientific and medical radio wave radiation electrical equipment.

Customer Information

SUNA TRAFFIC CHANNEL – TERMS AND CONDITIONS

By activating, using and/or accessing the SUNA Traffic Channel, SUNA Predictive or other content or material provided by Intelematics (together, **SUNA Products and/or Services**), you must accept certain terms and conditions. The following is a brief summary of the terms and conditions that apply to you. To view the full terms and conditions relevant to your use of the SUNA Products and/or Services, please consult:

Website
www.sunattraffic.com.au/termsandconditions/

1. Acceptance

By using SUNA Products and/or Services, you will be deemed to have accepted and agreed to be bound by the terms and conditions fully detailed at:

Website
www.sunattraffic.com.au/termsandconditions/

2. Intellectual Property

SUNA Products and/or Services are for your personal use. You may not record, or retransmit the content, nor use the content in association with any other traffic information or route guidance service or device not approved by Intelematics. You obtain no right of ownership in any Intellectual Property Rights (including copyright) in the data that is used to provide SUNA Products and/or Services.

3. Appropriate Use

SUNA Products and/or Services are intended as an aid to personal motoring and travel planning, and do not provide comprehensive or accurate information on all occasions. On occasions, you may experience additional delay as a result of using SUNA Products and/or Services. You acknowledge that it is not intended, or suitable, for use in applications where time of arrival or driving directions may impact the safety of the public or yourself.

4. Use of SUNA Products and Services while driving

You, and other authorized drivers of the vehicle in which SUNA Products and/or Services are available or installed and active, remain at all times responsible for observing all relevant laws and codes of safe driving. In particular, you agree to only actively operate SUNA Products and/or Services when the Vehicle is at a complete stop and it is safe to do so.

5. Service Continuity and Reception of the SUNA Traffic Channel

We will use reasonable endeavors to provide the SUNA Traffic Channel 24 hours a day, 365 days a year. The SUNA Traffic Channel may occasionally be unavailable for technical reasons or for planned maintenance. We will try to perform maintenance at times when congestion is light. We reserve the right to withdraw SUNA Products and/or Services at any time.

Also, we cannot assure the uninterrupted reception of the SUNA Traffic Channel RDS-TMC signal at any particular location.

6. Limitation of Liability

Neither Intelematics (nor its suppliers or the manufacturer of your device (the **“Suppliers”**)) shall be liable to you or to any third party for any damages either direct, indirect, incidental, consequential or otherwise arising out of the use of or inability to use SUNA Products and/or

Customer Information

Services even if Intelematics or a Supplier has been advised of the possibility of such damages. You also acknowledge that neither Intelematics nor any Supplier guarantees nor make any warranties that relate to the availability, accuracy or completeness of SUNA Products and/or Services, and to the extent which it is lawful to do so, both Intelematics and each Supplier excludes any warranties which might otherwise be implied by any State or Federal legislation in relation to SUNA Products and/or Services.

7. Please Note

Great care has been taken in preparing this manual. Constant product development may mean that some information is not entirely up-to-date. The information in this document is subject to change without notice.

EMISSION LAW



WARNING: Do not remove or alter the original equipment floor covering or insulation between it and the metal floor of the vehicle. The floor covering and insulation protect occupants of the vehicle from the engine and exhaust system heat and noise. On vehicles with no original equipment floor covering insulation, do not carry passengers in a manner that permits prolonged skin contact with the metal floor. Failure to follow these instructions may result in fire or personal injury.

U.S. federal laws and certain state laws prohibit removing or rendering inoperative emission control system components. Similar federal or provincial laws may apply in Canada. We do not approve of any vehicle modification without first determining applicable laws.



Tampering with emissions control systems including related sensors or the Diesel Exhaust Fluid system can result in reduced engine power and the illumination of the service engine soon light.

Tampering With a Noise Control System

Federal laws prohibit the following acts:

- Removal or rendering inoperative by any person other than for purposes of maintenance.
- Repair or replacement of any device or element of the design incorporated into a new vehicle for the purpose of noise control prior to its sale or delivery to the ultimate purchaser or while it is in use.
- The use of the vehicle after any person removes or renders inoperative any device or element of the design.

The U.S. Environmental Protection Agency may presume to constitute tampering as follows:

- Removal of hood blanket, fender apron absorbers, fender apron barriers, underbody noise shields or acoustically absorptive material.
- Tampering or rendering inoperative the engine speed governor, to allow engine speed to exceed manufacturer specifications.

If the engine does not start, runs rough, experiences a decrease in engine performance, experiences excess fuel consumption or produces excessive exhaust smoke, check for the following:

- A plugged or disconnected air inlet system hose.
- A plugged engine air filter element.
- Water in the fuel filter and water separator.

Customer Information

- A clogged fuel filter.
- Contaminated fuel.
- Air in the fuel system, due to loose connections.
- An open or pinched sensor hose.
- Incorrect engine oil level.
- Incorrect fuel for climatic conditions.
- Incorrect engine oil viscosity for climactic conditions.

Note: *Some vehicles have a lifetime fuel filter that is integrated with the fuel tank. Regular maintenance or replacement is not needed.*

Note: *If these checks do not help you correct the concern, have your vehicle checked as soon as possible.*

Noise Emissions Warranty, Prohibited Tampering Acts and Maintenance

On January 1, 1978, Federal regulation became effective governing the noise emission on trucks over 10,000 lb (4,536 kg) Gross Vehicle Weight Rating (GVWR). The preceding statements concerning prohibited tampering acts and maintenance, and the noise warranty found in the Warranty Guide, are applicable to complete chassis cabs over 10,000 lb (4,536 kg) GVWR.

EXPORT UNIQUE OPTIONS

For your particular global region, your vehicle may be equipped with features and options that are different from the features and options that are described in this Owner's Manual. A market unique supplement may be supplied that complements this book. By referring to the market unique supplement, if provided, you can properly identify those features, recommendations and specifications that are unique to your vehicle. This Owner's

Manual is written primarily for the U.S. and Canadian markets. Features or equipment listed as standard may be different on units built for export. **Refer to this Owner's Manual for all other required information and warnings.**

WARRANTY INFORMATION

The following warranties may apply to your vehicle:

- New vehicle limited warranties.
- Emissions warranties, if applicable. (Note: Fully-electric vehicles are not eligible for emissions warranties.)
- Other warranties, if applicable.

Detailed warranty information specific to your vehicle can be found in the Warranty Guide at www.owner.ford.com.

The following California Warranty Statement, required by California regulations, applies to vehicles certified to California emissions standards and registered in a state that requires California emissions warranty. If applicable, additional California Emissions Warranties can be found in the Warranty Guide at www.owner.ford.com.

CALIFORNIA EMISSION CONTROL WARRANTY STATEMENT

YOUR WARRANTY RIGHTS AND OBLIGATIONS

The California Air Resources Board and Ford Motor Company are pleased to explain the emission control system warranty on your (year) vehicle. In California, new motor vehicles must be designated, built and equipped to meet

Customer Information

the State's stringent anti-smog standards. Ford Motor Company must warrant the emission control system on your vehicle for the periods of time listed below provided there has been no abuse, neglect or improper maintenance of your vehicle.

Your emission control system may include parts such as the carburetor or fuel-injection system, the ignition system, catalytic converter and engine computer. Also included may be hoses, belts, connectors and other emission-related assemblies. Where a warrantable condition exists, Ford Motor Company will repair your vehicle at no cost to you including diagnosis, parts and labor.

MANUFACTURER'S WARRANTY COVERAGE:

(For 1990 and subsequent model passenger cars, light-duty trucks, and medium-duty vehicles.)

- For 3 years or 50,000 miles (whichever occurs first);

1) If your vehicle fails a Smog Check inspection, all necessary repairs and adjustments will be made by Ford Motor Company to ensure that your emission control system **PERFORMANCE WARRANTY**.

2) If any emission-related part on your vehicle is defective, the part will be repaired or replaced by Ford Motor Company. This is your short-term emission control system **DEFECTS WARRANTY**.

- For 7 years or 70,000 miles (whichever occurs first);

1) If an emission-related part listed in this warranty booklet specially noted with coverage for 7 years or 70,000 miles is defective, the part will be repaired or replaced by Ford Motor Company. This is your long-term emission control system **DEFECTS WARRANTY**.

OWNER'S WARRANTY RESPONSIBILITIES:

- As the vehicle owner, you are responsible for the performance of the required maintenance listed in your owner's manual. Ford Motor Company recommends that you retain all receipts covering maintenance on your vehicle, but Ford Motor Company cannot deny warranty solely for the lack of receipts or for your failure to ensure the performance of all scheduled maintenance.

- You are responsible for presenting your vehicle to a Ford or Lincoln dealer as soon as a problem exists. The warranty repairs should be completed in a reasonable amount of time, not to exceed 30 days.

- As the vehicle owner, you should also be aware that Ford Motor Company may deny you warranty coverage if your vehicle or a part has failed due to abuse, neglect, improper maintenance or unapproved modifications.

If you have any questions regarding your warranty rights and responsibilities, you should contact Ford Customer Service at 1-800-392-3673 or the California Air Resource Board at 4001 Iowa Avenue, Riverside, CA 92507.

New Vehicle Limited Warranty

Your vehicle comes with a New Vehicle Limited Warranty. The express warranties of the New Vehicle Limited Warranty are in substitution for and exclude all other liabilities of any kind whether arising under statute, in tort, by implication of law or otherwise including, to the full extent as may be allowed by law, liability for any other representations respecting the vehicle, statutory warranties or implied warranties or conditions as to its merchantability or fitness.

Customer Information

Download a free electronic copy or order one free printed copy of the most up-to-date Warranty Guide by visiting the Owner Manuals section of owner.ford.com (United States).

For Canada, visit ford.ca/warranty.

For Limo/Livery/Hearse vehicles: View and download your Warranty Guide by visiting the Warranty Information section of the Fleet website, fleet.ford.com/limo (United States only).

Appendices

ELECTROMAGNETIC COMPATIBILITY



WARNING: Do not place objects or mount equipment on or near the airbag cover, on the side of the front or rear seatbacks, or in areas that may come into contact with a deploying airbag. Failure to follow these instructions may increase the risk of personal injury in the event of a crash.



WARNING: Keep antenna and power cables at least 4 in (10 cm) from any electronic modules and airbags.

Note: We test and certify your vehicle to meet electromagnetic compatibility legislation. It is your responsibility to make sure that any equipment an authorized dealer installs on your vehicle complies with applicable local legislation and other requirements. Installation of some aftermarket electronic devices could degrade the performance of vehicle functions, which use radio frequency signals such as broadcast radio receiver, tire pressure monitoring system, push button start, **Bluetooth®** connectivity or satellite navigation.

Note: Any radio frequency transmitter equipment in your vehicle, such as, cellular telephones and amateur radio transmitters, must keep to the parameters in the following illustrations and table. We do not provide any other special provisions or conditions for installations or use.

Car

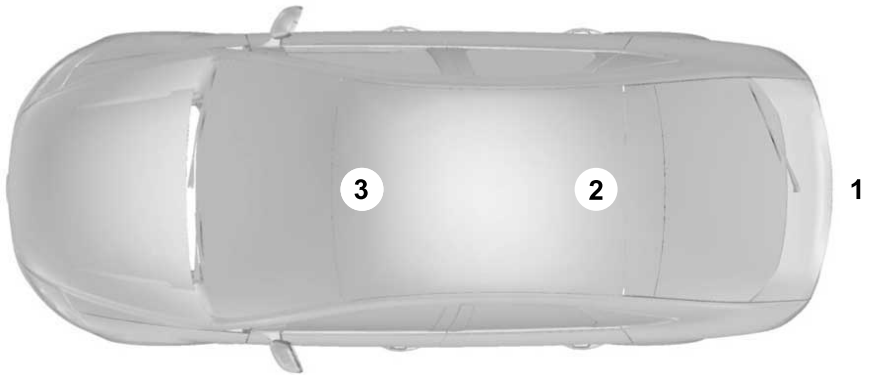

Appendices

Van



Truck

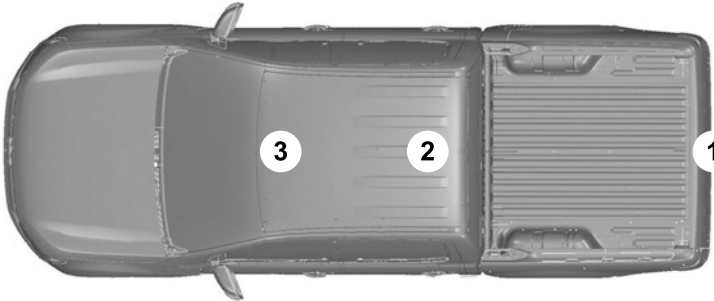

Appendices

Frequency Band MHz	Maximum Output Power Watt (Peak RMS)	Antenna Positions
1-30	50	1
50-54	50	2, 3
68-88	50	2, 3
142-176	50	2, 3
380-512	50	2, 3
806-870	10	2, 3

Index

1

12V Battery.....	303
12V Battery Precautions.....	303
Battery Management System	
Limitations.....	304
Changing the 12V Battery.....	304
How Does the Battery Management	
System Work.....	304
Recycling and Disposing of the 12V	
Battery.....	305
Resetting the Battery Sensor.....	305
What Is the Battery Management	
System.....	303
12V Battery – Troubleshooting.....	305
12V Battery – Information Messages.....	306
12V Battery – Warning Lamps.....	305

9

911 Assist.....	60
-----------------	----

A

A/C

See: Climate Control.....	107
---------------------------	-----

About This Publication.....	17
-----------------------------	----

ABS

See: Brakes.....	167
------------------	-----

Accessing Navigation.....	415
---------------------------	-----

Accessing the Passive Key Backup

Position.....	141
---------------	-----

Accessing the Trip Computer.....	104
----------------------------------	-----

Accessories.....	420
------------------	-----

Adaptive Cruise Control.....	195
------------------------------	-----

Adaptive Cruise Control –

Troubleshooting.....	208
----------------------	-----

Lane Centering.....	203
---------------------	-----

Predictive Speed Assist.....	206
------------------------------	-----

Predictive Speed Assist –	
---------------------------	--

Troubleshooting.....	208
----------------------	-----

Adaptive Cruise Control Automatic

Cancellation.....	198
-------------------	-----

Adaptive Cruise Control Indicators.....	203
---	-----

Adaptive Cruise Control

Limitations.....	196
------------------	-----

Adaptive Cruise Control

Precautions.....	195
------------------	-----

Adaptive Cruise Control –

Troubleshooting.....	208
----------------------	-----

Adaptive Cruise Control – Information

Messages.....	208
---------------	-----

Adjusting the Exterior Mirrors.....	100
-------------------------------------	-----

Adjusting the Headlamps.....	307
------------------------------	-----

Adjusting the Instrument Panel Lighting

Brightness.....	93
-----------------	----

Adjusting the Map.....	415
------------------------	-----

Changing the Format of the Map.....	415
-------------------------------------	-----

Zooming the Map In and Out.....	415
---------------------------------	-----

Adjusting the Seatbelts During

Pregnancy.....	47
----------------	----

Adjusting the Sound Settings.....	380
-----------------------------------	-----

Adjusting the Speed Limit

Tolerance.....	219
----------------	-----

Adjusting the Steering Wheel.....	80
-----------------------------------	----

Adjusting the Volume.....	380
---------------------------	-----

Aid Mode.....	223
---------------	-----

How Does Aid Mode Work.....	223
-----------------------------	-----

What Is Aid Mode.....	223
-----------------------	-----

Airbag Precautions.....	54
-------------------------	----

Airbags.....	51
--------------	----

Front Passenger Sensing System.....	55
-------------------------------------	----

Air Conditioning

See: Climate Control.....	107
---------------------------	-----

Air Conditioning System Refrigerant.....	111
--	-----

Alert and Aid Mode.....	223
-------------------------	-----

How Does Alert and Aid Mode Work.....	223
---------------------------------------	-----

What Is Alert and Aid Mode.....	223
---------------------------------	-----

Alert Mode.....	222
-----------------	-----

How Does Alert Mode Work.....	222
-------------------------------	-----

What Is Alert Mode.....	222
-------------------------	-----

Alexa Built-In.....	404
---------------------	-----

Alexa Built-In Requirements.....	404
----------------------------------	-----

Alexa Built-In Settings.....	404
------------------------------	-----

AM/FM Radio.....	380
------------------	-----

AM/FM Radio Limitations.....	380
------------------------------	-----

Selecting an AM/FM Radio Station.....	381
---------------------------------------	-----

Ambient Lighting.....	93
-----------------------	----

Switching Ambient Lighting On and

Off.....	93
----------	----

Anti-Lock Braking System.....	167
-------------------------------	-----

Anti-Lock Braking System Indicators.....	167
--	-----

Anti-Lock Braking System

Limitations.....	167
------------------	-----

Anti-Theft Alarm System.....	76
------------------------------	----

Arming the Anti-Theft Alarm System.....	77
---	----

Index

Disarming the Anti-Theft Alarm System.....	77
How Does the Anti-Theft Alarm System Work.....	76
What Are the Inclination Sensors.....	77
What Are the Interior Sensors.....	76
What Is the Anti-Theft Alarm System.....	76
What Is the Perimeter Alarm.....	76
Anti-Theft Alarm System Settings.....	77
Setting the Alarm Security Level.....	77
Switching Ask on Exit On and Off.....	77
What are the Alarm Security Levels.....	77
What Is Ask on Exit.....	77
Appendices.....	523
Applying the Electric Parking Brake - Automatic Transmission, Vehicles With: EcoBoost™ Performance Package/GT Performance Package.....	173
Applying the Electric Parking Brake - Automatic Transmission, Vehicles Without: EcoBoost™ Performance Package/GT Performance Package.....	173
Applying the Electric Parking Brake in an Emergency - Vehicles With: EcoBoost™ Performance Package/GT Performance Package.....	174
Applying the Electric Parking Brake in an Emergency - Vehicles Without: EcoBoost™ Performance Package/GT Performance Package.....	174
Applying the Electric Parking Brake - Manual Transmission, Vehicles With: EcoBoost™ Performance Package/GT Performance Package.....	172
Applying the Electric Parking Brake - Manual Transmission, Vehicles Without: EcoBoost™ Performance Package/GT Performance Package.....	172
Approach Detection See: Switching Welcome Lighting On and Off.....	90
Audio System.....	379
AM/FM Radio.....	380
Audio System – Troubleshooting.....	385
Digital Radio.....	381
Satellite Radio.....	382
Audio System Precautions.....	379
Audio System – Troubleshooting.....	385
Audio System – Information Messages.....	385
Auto-Dimming Exterior Mirror.....	100
What Is the Auto-Dimming Exterior Mirror.....	100
Auto-Dimming Interior Mirror.....	99
Auto-Dimming Interior Mirror Limitations.....	99
What Is the Auto-Dimming Interior Mirror.....	99
Auto Hold.....	180
Auto Hold Indicators.....	180
Autolamps.....	88
Autolamp Settings.....	88
What Are Autolamps.....	88
Autolock.....	70
Autolock Requirements.....	70
What Is Autolock.....	70
Automatically Releasing the Electric Parking Brake.....	175
Automatic Crash Shutoff.....	271
Automatic Crash Shutoff Precautions.....	271
Re-Enabling Your Vehicle.....	271
What Is Automatic Crash Shutoff.....	271
Automatic Emergency Braking.....	243
Switching Automatic Emergency Braking On and Off.....	243
What Is Automatic Emergency Braking.....	243
Automatic Engine Stop.....	140
How Does Automatic Engine Stop Work.....	140
Overriding Automatic Engine Stop.....	141
Switching Automatic Engine Stop On and Off.....	140
What Is Automatic Engine Stop.....	140
Automatic High Beam Control.....	90
Automatic High Beam Control Indicators.....	92
Automatic High Beam Control Limitations.....	91
Automatic High Beam Control Precautions.....	91

Index

Automatic High Beam Control Requirements.....	91
How Does Automatic High Beam Control Work.....	90
Overriding Automatic High Beam Control.....	92
Switching Automatic High Beam Control On and Off.....	92
Automatic High Beam Control – Troubleshooting.....	92
Automatic High Beam Control – Information Messages.....	92
Automatic Locking Mode.....	46
Disengaging Automatic Locking Mode.....	46
Engaging Automatic Locking Mode.....	46
What Is Automatic Locking Mode.....	46
When to Use Automatic Locking Mode.....	46
Automatic Transmission Audible Warnings.....	164
Automatic Transmission.....	160
Automatic Transmission Positions.....	160
Automatic Transmission Fluid Capacity and Specification - Vehicles With: GT Performance Package.....	164
Automatic Transmission Fluid Capacity and Specification - Vehicles Without: GT Performance Package.....	164
Automatic Transmission Positions.....	160
Automatic Transmission Position Indicators.....	161
Automatic Transmission Precautions.....	160
Drive (D).....	161
Low (L).....	161
Manual (M).....	161
Neutral (N).....	161
Park (P).....	160
Reverse (R).....	161
Shifting Your Vehicle Into Gear.....	160
Auto Mode.....	109
Auto Mode Indicators.....	109
Switching Auto Mode On and Off.....	109
Switching Dual Mode On and Off.....	110
Auto-Start-Stop.....	145
Auto-Start-Stop – Troubleshooting.....	147
Auto-Start-Stop Indicators.....	147
Auto-Start-Stop Precautions - Automatic Transmission.....	145
Auto-Start-Stop Precautions - Manual Transmission.....	145
Auto-Start-Stop – Troubleshooting.....	147
Auto-Start-Stop – Frequently Asked Questions.....	149
Auto-Start-Stop – Information Messages.....	147
Autounlock.....	70
Autounlock Requirements.....	70
Switching Autounlock On and Off.....	70
What Is Autounlock.....	70
Autowipers.....	82
Adjusting the Sensitivity of the Rain Sensor.....	83
Autowipers Settings.....	82
What Are Autowipers.....	82
Auxiliary Gauges.....	399

B

Blind Spot Assist.....	224
Blind Spot Assist Indicators.....	225
Blind Spot Assist Limitations.....	224
How Does Blind Spot Assist Work.....	224
What Is Blind Spot Assist.....	224
Blind Spot Information System.....	228
Blind Spot Information System – Troubleshooting.....	230
Blind Spot Information System Indicators.....	229
Blind Spot Information System Limitations.....	228
Blind Spot Information System Precautions.....	228
Blind Spot Information System Requirements.....	228
Blind Spot Information System – Troubleshooting.....	230
Blind Spot Information System – Information Messages.....	230
Bluetooth®.....	412
Body Control Module Fuse Box.....	283
Accessing the Body Control Module Fuse Box.....	283

Index

Identifying the Fuses in the Body Control Module Fuse Box.....	284
Locating the Body Control Module Fuse Box.....	283
Body Styling Kit Precautions.....	326
Body Styling Kits.....	326
Bonnet Lock See: Opening and Closing the Hood.....	287
Booster Seats.....	40
Brake Fluid Specification.....	168
Brake Over Accelerator.....	167
Brake Precautions.....	167
Brakes.....	167
Anti-Lock Braking System.....	167
Brakes – Troubleshooting.....	169
Brakes – Troubleshooting.....	169
Brakes – Frequently Asked Questions.....	171
Brakes – Information Messages.....	170
Brakes – Warning Lamps.....	169
Breaking-In.....	264
C	
Calculating Payload.....	253
Calculating the Load Limit.....	253
Canceling the Set Speed.....	194
Canceling the Set Speed Limit.....	216
Catalytic Converter.....	156
Catalytic Converter – Troubleshooting.....	156
Catalytic Converter Precautions.....	156
Catalytic Converter – Troubleshooting.....	156
Catalytic Converter – Warning Lamps.....	156
Center Console.....	135
Locking the Center Console.....	135
Opening the Center Console.....	135
Center Display.....	389
Center Display Overview.....	389
Changing a Flat Tire.....	367
Changing a Road Wheel.....	367
Changing the Fuel Filter.....	301
Changing the Remote Control Battery.....	63
Changing the Set Speed Limit.....	216
Charging a Device.....	129
Charging a Wireless Device.....	133
Checking the Brake Fluid.....	167
Checking the Clutch Fluid Level.....	158
Checking the Manual Transmission Fluid Level.....	157
Checking the Seatbelts.....	49
Checking the Tire Pressures.....	343
Checking the Wiper Blades.....	83
Children and Airbags.....	55
Child Restraint Anchor Points.....	33
Locating the Child Restraint Lower Anchor Points.....	33
Locating the Child Restraint Top Tether Anchor Points.....	34
What Are the Child Restraint Anchor Points.....	33
Child Restraints.....	34
Child Restraint Position Information.....	34
Child Restraints Recommendation.....	35
Child Safety.....	32
Child Restraint Anchor Points.....	33
Child Restraints.....	34
Installing Child Restraints.....	35
Child Safety Precautions.....	32
Cleaning Products.....	320
Cleaning the Exterior.....	321
Cleaning Camera Lenses and Sensors.....	322
Cleaning Chrome, Aluminium or Stainless Steel.....	321
Cleaning Headlamps and Rear Lamps.....	321
Cleaning Stripes or Graphics.....	322
Cleaning the Convertible Top.....	322
Cleaning the Engine Compartment.....	322
Cleaning the Exterior Precautions.....	321
Cleaning the Underbody.....	322
Cleaning Wheels.....	321
Cleaning Windows and Wiper Blades.....	321
Cleaning the Interior.....	323
Cleaning Carpets and Floor Mats.....	324
Cleaning Displays and Screens.....	323
Cleaning Fabric.....	323
Cleaning Leather.....	324
Cleaning Plastic.....	323
Cleaning Seatbelts.....	325
Cleaning Storage Compartments.....	325
Cleaning the Instrument Panel.....	323
Cleaning Vinyl.....	324

Index

Climate Control.....107	Crash and Breakdown Information.....267
Auto Mode.....109	Automatic Crash Shutoff.....271
Climate Control Hints.....110	Fail-Safe Cooling.....277
Climate Control – Warning Lamps.....111	Jump Starting the Vehicle.....268
Closing the Convertible Top.....263	Post-Crash Alert System.....271
Closing the Rear Luggage	Recovery Towing.....272
Compartment.....258	Crash Sensors and Airbag Indicator.....58
Closing the Rear Luggage Compartment	Creating a Personal Profile.....414
from Outside Your Vehicle.....258	Cross Traffic Alert.....234
Cluster Theme.....400	Cross Traffic Alert –
Clutch Fluid Capacity and	Troubleshooting.....237
Specification.....158	Cross Traffic Alert Indicators.....236
Cold Weather Precautions.....264	Cross Traffic Alert Limitations.....235
Configuring the Trip Computer.....104	Cross Traffic Alert Precautions.....234
Connected Navigation.....415	Cross Traffic Alert –
Connected Vehicle.....374	Troubleshooting.....237
Connected Vehicle –	Cross Traffic Alert – Information
Troubleshooting.....375	Messages.....237
Connecting the Vehicle to a Mobile	Cruise Control.....193
Network.....374	Cruise Control Indicators.....194
Connected Vehicle Data.....27	Cup Holders.....135
Connected Vehicle Limitations.....374	Cup Holder Precautions.....135
Connected Vehicle Requirements.....374	Custom Drive Mode.....399
Connected Vehicle Settings.....375	Customer Information.....430
Connected Vehicle –	Radio Frequency Certification
Troubleshooting.....375	Labels.....433
Connected Vehicle – Frequently Asked	Customizing the Instrument Cluster
Questions.....375	Display.....103
Connecting a Bluetooth® Device.....412	D
Connecting the Vehicle to a Mobile	Data Privacy.....25
Network.....374	Department of Transportation Uniform
Connecting FordPass to the Modem.....374	Tire Quality Grades.....329
Enabling and Disabling the Modem.....374	Digital Radio.....381
What Is the Modem.....374	Digital Radio Indicators.....382
Connecting the Vehicle to a Wi-Fi	Digital Radio Limitations.....382
Network.....374	How Does Digital Radio Work.....381
Connecting Your Phone.....406	Switching Digital Radio Reception On and
Contacting Us.....15	Off.....382
Convertible Top.....262	What Is Digital Radio.....381
Coolant.....296	Dinghy Tow
Adding Coolant.....297	See: Recreationally Towing Your
Changing the Coolant.....298	Vehicle.....279
Checking the Coolant Level.....296	Directing the Flow of Air.....109
Coolant – Information Messages.....301	Disposing of Airbags.....59
Coolant – Warning Lamps.....301	
Cooling System Capacity and	
Specification.....299	
Managing the Coolant Temperature.....298	

Index

Distance Alert.....	242	Driver Alert.....	249
Adjusting the Sensitivity of Distance		Driver Alert – Troubleshooting.....	250
Alert.....	242	Driver Alert Indicators.....	250
What Is Distance Alert.....	242	Driver Alert Limitations.....	249
Distance Indication.....	241	Driver Alert Precautions.....	249
Distance Indication Indicator.....	242	Driver Alert – Troubleshooting.....	250
Switching Distance Indication On and		Driver Alert – Information Messages.....	250
Off.....	242	Driver Assistance Menu.....	391
What Is Distance Indication.....	241	Driving Economically.....	264
Doors and Locks Audible Warnings.....	71	Driving Hints.....	264
Doors and Locks.....	69	Driving on Snow and Ice.....	264
Autolock.....	70	Driving Through Shallow Water - Base/ GT.....	265
Autounlock.....	70	Driving Through Shallow Water - Dark Horse.....	265
Doors and Locks – Troubleshooting.....	71	Drowsiness Monitor	
Mislock.....	70	See: Driver Alert.....	249
Operating the Doors From Inside Your Vehicle.....	70		
Operating the Doors From Outside Your Vehicle.....	69		
Doors and Locks – Troubleshooting.....	71	E	
Doors and Locks – Frequently Asked		Easy Entry and Exit.....	75
Questions.....	72	Electric Parking Brake Audible	
Doors and Locks – Information		Warning.....	175
Messages.....	71	Electric Parking Brake.....	172
Doors and Locks – Warning Lamps.....	71	Electric Parking Brake –	
Drive Belt Routing Overview - 2.3L		Troubleshooting.....	176
EcoBoost™.....	302	Electric Parking Brake –	
Drive Belt Routing Overview - 5.0L.....	303	Troubleshooting.....	176
Drive Mode Control.....	211	Electric Parking Brake – Information	
Drive Mode Control –		Messages.....	176
Troubleshooting.....	213	Electric Parking Brake – Warning	
Drive Modes.....	212	Lamps.....	176
Drive Mode Control –		Electric Power Steering.....	185
Troubleshooting.....	213	Electric Power Steering Precautions.....	185
Drive Mode Control – Frequently Asked		How Does Electric Power Steering	
Questions.....	215	Work.....	185
Drive Mode Control – Information		Electromagnetic Compatibility.....	523
Messages.....	214	Emergency Call Limitations.....	61
Drive Mode Control – Warning		Emergency Call Requirements.....	60
Lamps.....	213	Emergency Call System Data.....	28
Drive Modes.....	212	Emergency Towing.....	279
Custom.....	212	Emission Law.....	519
Drag Strip.....	212	Enabling Apps on a Mobile Device.....	410
Normal.....	213	Enabling or Disabling Personal	
Slippery.....	213	Profiles.....	413
Sport.....	213	End User License Agreement.....	494
Track.....	213	Engine Air Filter.....	294
		Changing the Engine Air Filter.....	294

Index

Engine Block Heater.....	138	Automatic High Beam Control.....	90
Engine Block Heater Precautions.....	138	Automatic High Beam Control –	
How Does the Engine Block Heater		Troubleshooting.....	92
Work.....	139	Exterior Lamps.....	89
Using the Engine Block Heater.....	139	Headlamps.....	87
Engine Coolant Temperature		Headlamps – Troubleshooting.....	88
Gauge.....	102	Exterior Mirrors.....	100
Engine Oil.....	290	Auto-Dimming Exterior Mirror.....	100
Adding Engine Oil.....	290	Exterior Overview.....	31
Checking the Engine Oil Level.....	290		
Engine Oil Capacity and		F	
Specification.....	291	Fail-Safe Cooling.....	277
Engine Oil Dipstick Overview.....	290	Driving When Fail-Safe Mode Is	
Intelligent Oil Life Monitor.....	291	Activated.....	277
Resetting the Intelligent Oil Life		Fail-Safe Cooling Indicators.....	278
Monitor.....	291	How Does Fail-Safe Cooling Work.....	277
Engine Specifications - 2.3L.....	309	What Is Fail-Safe Cooling.....	277
Engine Specifications - 5.0L.....	310	Fastening and Unfastening the	
Environment.....	29	Seatbelts.....	44
Evasive Steering Assist.....	243	Favorite.....	389
Evasive Steering Assist Limitations.....	243	Federal Highway Administration	
Switching Evasive Steering Assist On and		Regulation.....	493
Off.....	243	Flat Tire	
What Is Evasive Steering Assist.....	243	See: Changing a Flat Tire.....	367
Event Data.....	26	Flat Tow	
Exhaust Mode.....	400	See: Recreationally Towing Your	
Exit Warning.....	231	Vehicle.....	279
Exit Warning – Troubleshooting.....	233	Floor Mats.....	266
Exit Warning Indicators.....	232	Folding the Exterior Mirrors.....	100
Exit Warning Limitations.....	231	Ford Assistant.....	402
Exit Warning Precautions.....	231	Ford Assistant – Frequently Asked	
Exit Warning – Troubleshooting.....	233	Questions.....	402
Exit Warning – Information		Ford Assistant Settings.....	402
Messages.....	233	Using Ford Assistant.....	402
Export Unique Options.....	520	Ford Protect.....	421
Exterior Bulbs.....	308	Forward Collision Warning.....	242
Exterior Bulb Specification Chart.....	308	Adjusting the Sensitivity of Forward	
Exterior Lamps.....	89	Collision Warning.....	242
Exterior Lamp Indicators.....	90	What Is Forward Collision Warning.....	242
Exterior Lamps On Audible Warning.....	90	Four Wheels Down Tow	
Switching the Daytime Running Lamps On		See: Recreationally Towing Your	
and Off.....	89	Vehicle.....	279
Switching Welcome Lighting On and		Front Passenger Sensing System.....	55
Off.....	90	Front Passenger Sensing System	
Using the Turn Signal Lamps.....	89	Indicators.....	58
Exterior Lighting Control.....	87	Front Passenger Sensing System	
Exterior Lighting.....	87	Precautions.....	57
Autolamps.....	88		

Index

How Does the Front Passenger Sensing System Work.....	55
What Is the Front Passenger Sensing System.....	55
Front Seat Precautions.....	113
Front Seats.....	113
Heated Seats.....	119
Manual Seats.....	114
Power Seats.....	116
Ventilated Seats.....	120
Fuel and Refueling.....	150
Fuel and Refueling – Troubleshooting.....	155
Fuel Quality.....	150
Refueling.....	153
Running Out of Fuel.....	151
Fuel and Refueling Precautions.....	150
Fuel and Refueling – Troubleshooting.....	155
Fuel and Refueling – Information Messages.....	155
Fuel and Refueling – Warning Lamps.....	155
Fuel Gauge.....	102
Fuel Gauge Limitations.....	102
Locating the Fuel Filler Door.....	102
What Is Distance to Empty.....	102
What Is the Fuel Gauge.....	102
What Is the Low Fuel Reminder.....	102
Fuel Quality.....	150
Selecting the Correct Fuel.....	150
Fuel Tank Capacity.....	154
Fuse Precautions.....	280
Fuses.....	280
Body Control Module Fuse Box.....	283
Fuses – Troubleshooting.....	286
High Current Fuse Box.....	286
Under Hood Fuse Box.....	280
Fuses – Troubleshooting.....	286
Fuses – Frequently Asked Questions.....	286
G	
Garage Door Opener Additional Assistance.....	128
Garage Door Opener.....	125
Garage Door Opener Introduction.....	125
Garage Door Opener Precautions and Frequencies.....	125
General Maintenance Information.....	425
Glasses Holder.....	136
Locating the Glasses Holder.....	136
Global Opening.....	96
Switching Global Opening On and Off.....	97
Using Global Opening.....	96
What Is Global Opening.....	96
Glossary of Tire Terminology.....	335
Glove Compartment.....	135
Opening the Glove Compartment.....	135
H	
Headlamp Adjusting	
See: Adjusting the Headlamps.....	307
Headlamps.....	87
Headlamp Indicators.....	87
Switching Headlamp Exit Delay On and Off.....	87
Using the High Beam Headlamps.....	87
Headlamps – Troubleshooting.....	88
Headlamps – Frequently Asked Questions.....	88
Heated Seats.....	119
Heated Seat Precautions.....	119
Switching the Heated Seats On and Off.....	119
Heating	
See: Climate Control.....	107
High Current Fuse Box.....	286
Accessing the High Current Fuse Box.....	286
Identifying the Fuses in the High Current Fuse Box.....	286
Locating the High Current Fuse Box.....	286
Hill Start Assist.....	179
Hill Start Assist – Troubleshooting.....	179
Hill Start Assist Precautions.....	179
Hill Start Assist – Troubleshooting.....	179
Hill Start Assist – Information Messages.....	179
Home Screen.....	389
Hood Lock	
See: Opening and Closing the Hood.....	287
Horn.....	81
How Does 911 Assist Work.....	60
How Does Adaptive Cruise Control With Stop and Go Work – Automatic Transmission.....	195

Index

How Does Adaptive Cruise Control Work	
- Manual Transmission.....	195
How Does Auto Hold Work.....	180
How Does Blind Spot Information System Work.....	228
How Does Cross Traffic Alert Work.....	234
How Does Drive Mode Control Work.....	211
How Does Driver Alert Work.....	249
How Does Easy Entry and Exit Work.....	75
How Does Exit Warning Work.....	231
How Does Hill Start Assist Work.....	179
How Does Pre-Collision Assist Work.....	238
How Does Speed Sign Recognition Work.....	246
How Does Stability Control Work.....	183
How Does the Intelligent Speed Limiter Work.....	218
How Does the Lane Keeping System Work.....	221
How Does the Memory Function Work.....	124
How Does the Personal Safety System Work.....	50
How Does the Rear Occupant Alert System Work.....	122
How Does the Safety Canopy™ Work - Coupe.....	53
How Does the Speed Limiter Work.....	216
How Does Traction Control Work.....	182
How Do Personal Profiles Work.....	413
How Do the Front Airbags Work.....	51
How Do the Knee Airbags Work.....	52
How Do the Side Airbags Work.....	51
I	
Icon Glossary	
See: Symbols Glossary.....	19
Icons	
See: Symbols Glossary.....	19
Identifying Fuse Types.....	286
Identifying the Climate Control Unit.....	107
Inflating the Tires.....	343
Information On Demand Screen.....	391
Information on the Tire Sidewall.....	330
Inspecting the Tire for Damage.....	345
Inspecting the Tire for Wear.....	344
Inspecting the Wheel Valve Stems.....	349
Installing Child Restraints.....	35
Combining the Seatbelt and Lower Anchors for Attaching Child Restraints.....	38
Using Lower Anchors and Tethers for Children.....	37
Using Seatbelts.....	35
Using Tether Straps.....	38
Instrument Cluster Display.....	103
Instrument Cluster.....	101
Fuel Gauge.....	102
Instrument Cluster Overview.....	101
Intelligent Speed Limiter Audible Warnings.....	219
Intelligent Speed Limiter Indicators.....	219
Intelligent Speed Limiter.....	218
Intelligent Speed Limiter – Troubleshooting.....	220
Intelligent Speed Limiter Precautions.....	218
Intelligent Speed Limiter – Troubleshooting.....	220
Intelligent Speed Limiter – Frequently Asked Questions.....	220
Intentionally Exceeding the Set Speed Limit.....	217
Interior Air Quality.....	112
Interior Bulbs.....	308
Interior Bulb Specification Chart.....	308
Interior Lamp Function.....	93
Switching the Interior Lamp Function On and Off.....	93
What Is the Interior Lamp Function.....	93
Interior Lighting.....	93
Ambient Lighting.....	93
Interior Lamp Function.....	93
Interior Lighting – Troubleshooting.....	94
Interior Lighting – Troubleshooting.....	94
Interior Lighting – Frequently Asked Questions.....	94
Interior Mirror.....	99
Auto-Dimming Interior Mirror.....	99
Interior Mirror Precautions.....	99

Index

Interior Overview.....	30
Introduction.....	17

J

Jump Starting the Vehicle.....	268
Jump Starting Precautions.....	268
Jump Starting the Vehicle.....	269
Preparing the Vehicle.....	269

K

Keyless Entry.....	73
Keyless Entry Limitations.....	73
Keyless Entry Settings.....	73
Keys and Remote Controls Audible Warnings.....	66
Keys and Remote Controls.....	62
Keys and Remote Controls – Troubleshooting.....	68
Remote Rev.....	67
Keys and Remote Controls – Troubleshooting.....	68
Keys and Remote Controls – Information Messages.....	68

L

Lane Centering.....	203
How Does Lane Centering Work.....	203
Lane Centering Alerts.....	205
Lane Centering Automatic Cancellation.....	205
Lane Centering Indicators.....	205
Lane Centering Limitations.....	204
Lane Centering Manual Cancellation.....	205
Lane Centering Precautions.....	203
Lane Centering Requirements.....	203
Switching Lane Centering On and Off.....	204
Lane Keeping System Indicators.....	223
Lane Keeping System.....	221
Aid Mode.....	223
Alert and Aid Mode.....	223
Alert Mode.....	222
Blind Spot Assist.....	224
Lane Keeping System – Troubleshooting.....	226

Lane Keeping System Limitations.....	221
Lane Keeping System Precautions.....	221
Lane Keeping System Settings.....	222
Lane Keeping System – Troubleshooting.....	226
Lane Keeping System – Frequently Asked Questions.....	227
Lane Keeping System – Information Messages.....	226
Limited Slip Differential.....	166
Linking or Unlinking a Personal Profile to a Remote Control.....	414
Live Traffic.....	415
Switching Live Traffic On and Off.....	415
What Is Live Traffic.....	415
Load Carrying.....	251
Load Carrying Precautions.....	251
Loading Your Trailer.....	260
Locating the Blind Spot Information System Sensors.....	229
Locating the Brake Fluid Reservoir.....	167
Locating the Cabin Air Filter.....	112
Locating the Cross Traffic Alert Sensors.....	236
Locating the Exit Warning Sensors.....	232
Locating the Fuel Filler Funnel.....	151
Locating the Memory Function Buttons.....	124
Locating the Power Outlets.....	131
Locating the Pre-Collision Assist Sensors.....	241
Locating the Rear View Camera.....	190
Locating the Safety Compliance Certification Labels.....	252
Locating the Tire label.....	329
Locating the Tire Sealant and Inflator Kit.....	351
Locating the USB Ports.....	129
Locating the Wireless Accessory Charger.....	133
Locating Your Vehicle.....	63
Luggage Compartment.....	256
Closing the Rear Luggage Compartment.....	258
Luggage Compartment – Troubleshooting.....	258
Opening the Rear Luggage Compartment.....	256

Index

Luggage Compartment	
Precautions.....	256
Luggage Compartment –	
Troubleshooting.....	258
Luggage Compartment – Information	
Messages.....	259
Luggage Compartment – Warning	
Lamps.....	258
M	
Maintenance.....	287
12V Battery.....	303
12V Battery – Troubleshooting.....	305
Coolant.....	296
Engine Air Filter.....	294
Engine Oil.....	290
Exterior Bulbs.....	308
Interior Bulbs.....	308
Maintenance Precautions.....	287
Making and Receiving a Phone	
Call.....	408
Manually Releasing the Electric Parking	
Brake - Vehicles With: EcoBoost™	
Performance Package/GT	
Performance Package.....	175
Manually Releasing the Electric Parking	
Brake - Vehicles Without: EcoBoost™	
Performance Package/GT	
Performance Package.....	174
Manually Shifting Gears.....	162
Manual Seats.....	114
Accessing the Rear Seats.....	116
Adjusting the Head Restraint.....	114
Adjusting the Seat Backrest.....	115
Adjusting the Seat Height.....	116
Folding the Seat Backrest.....	121
Head Restraint Components.....	114
Installing the Head Restraint.....	115
Moving the Seat Backward and	
Forward.....	115
Removing the Head Restraint.....	115
Unfolding the Seat Backrest.....	121
Manual Transmission Fluid Capacity and	
Specification - 6-Speed Manual	
Transmission – 3160.....	158
Manual Transmission Fluid Capacity and	
Specification - 6-Speed Manual	
Transmission – MT82.....	158
Manual Transmission.....	157
Manual Transmission Precautions.....	157
Media Control Buttons.....	379
Memory Function.....	124
Memory Function Precautions.....	124
Mislock.....	70
Mislock Limitations.....	70
Switching Mislock On and Off.....	71
What Is Mislock.....	70
Mobile Communications	
Equipment.....	493
Mobile Device Data.....	28
Motorcraft Parts - 2.3L.....	311
Motorcraft Parts - 5.0L.....	312
Muting the Audio.....	380
My Color.....	400
My Mustang.....	392
Track Apps.....	393
My Mustang Overview.....	392
N	
Navigation Map Updates.....	415
Navigation.....	415
Adjusting the Map.....	415
Live Traffic.....	415
Route Guidance.....	416
Setting a Destination.....	415
Waypoints.....	416
Neutral Towing	
See: Recreationally Towing Your	
Vehicle.....	279
Neutral Tow	
See: Recreationally Towing Your	
Vehicle.....	279
O	
Opening and Closing the Hood.....	287
Opening and Closing the Windows -	
Convertible.....	95
Opening and Closing the Windows -	
Coupe.....	96
Opening the Convertible Top.....	262

Index

Opening the Rear Luggage Compartment.....	256	Perchlorate.....	492
Opening the Rear Luggage Compartment from Inside Your Vehicle.....	256	Performing a System Reset.....	419
Opening the Rear Luggage Compartment from Outside Your Vehicle.....	257	Personal Profiles.....	413
Opening the Rear Luggage Compartment Using the Remote Control.....	257	Personal Safety System Components.....	50
Operating the Doors From Inside Your Vehicle.....	70	Personal Safety System™.....	50
Opening the Doors From Inside Your Vehicle.....	70	Phone Menu.....	406
Unlocking and Locking the Doors Using the Central Locking.....	70	Phone.....	406
Operating the Doors From Outside Your Vehicle.....	69	Phone Precautions.....	406
Double Locking the Doors Using the Remote Control.....	69	Playing Media Using Bluetooth®.....	412
Unlocking and Locking the Doors Using the Key Blade.....	69	Playing Media Using the USB Port.....	129
Unlocking and Locking the Doors Using the Remote Control.....	69	Post-Collision Braking.....	271
OTA		Post-Crash Alert System.....	271
See: Software Update Settings.....	417	How Does the Post-Crash Alert System Work.....	271
See: Vehicle Software Updates.....	417	Post-Crash Alert System Limitations.....	271
Overriding the Set Speed.....	202	Switching the Post-Crash Alert System Off.....	271
Over the air		What Is the Post-Crash Alert System.....	271
See: Software Update Settings.....	417	Power Outlet.....	131
Over-the-air		Power Outlet Precautions.....	131
See: Software Update Settings.....	417	Power Seats.....	116
See: Vehicle Software Updates.....	417	Adjusting the Head Restraint.....	117
See: Vehicle Software Updates.....	417	Adjusting the Lumbar Support.....	119
		Adjusting the Seat Backrest.....	118
P		Adjusting the Seat Height.....	118
Parking Aid Indicators.....	189	Head Restraint Components.....	116
Parking Aid Precautions.....	187	Installing the Head Restraint.....	118
Parking Aids.....	187	Moving the Seat Backward and Forward.....	118
Parking Aids – Troubleshooting.....	189	Removing the Head Restraint.....	118
Rear Parking Aid.....	188	Power-Up	
Parking Aids – Troubleshooting.....	189	See: Software Update Settings.....	417
Parking Aids – Information Messages.....	189	See: Vehicle Software Updates.....	417
Passive Anti-Theft System.....	76	Pre-Collision Assist Limitations.....	239
How Does the Passive Anti-Theft System Work.....	76	Pre-Collision Assist Precautions.....	238
What Is the Passive Anti-Theft System.....	76	Pre-Collision Assist.....	238
		Automatic Emergency Braking.....	243
		Distance Alert.....	242
		Distance Indication.....	241
		Evasive Steering Assist.....	243
		Forward Collision Warning.....	242
		Pre-Collision Assist – Troubleshooting.....	244
		Pre-Collision Assist – Troubleshooting.....	244
		Pre-Collision Assist – Frequently Asked Questions.....	245

Index

Pre-Collision Assist – Information Messages.....	244
Pre-Collision Assist – Warning Lamps.....	244
Predictive Speed Assist.....	206
Adjusting the Set Speed Tolerance.....	207
How Does Predictive Speed Assist Work.....	206
Predictive Speed Assist Alerts.....	207
Predictive Speed Assist Indicators.....	207
Predictive Speed Assist Limitations.....	207
Predictive Speed Assist Precautions.....	206
Switching Predictive Speed Assist Mode On and Off.....	207
Predictive Speed Assist – Troubleshooting.....	208
Predictive Speed Assist – Information Messages.....	208
Preparing Your Vehicle for Storage.....	327
Programming the Garage Door Opener.....	126
Programming the Remote Control.....	65
Properly Adjusting the Driver and Front Passenger Seats.....	54
Protecting the Environment.....	29
Puncture	
See: Changing a Flat Tire.....	367
Push Button Ignition Switch.....	137
R	
Radio Frequency Certification Labels.....	433
Antennas.....	433
Blind Spot Information System Sensors.....	433
Body Control Module.....	442
Cruise Control Module.....	445
Passive Key.....	451
Radio Transceiver Module.....	459
SYNC.....	463
Telematics Control Unit.....	469
Tire Pressure Monitoring System Sensors.....	472
Wireless Accessory Charging Module.....	484
Rear Axle Fluid Capacity and Specification.....	166
Rear Axle.....	166
Rear Occupant Alert System Audible Warnings.....	123
Rear Occupant Alert System Indicators.....	123
Rear Occupant Alert System Limitations.....	122
Rear Occupant Alert System Precautions.....	122
Rear Occupant Alert System.....	122
Rear Parking Aid.....	188
Locating the Rear Parking Aid Sensors.....	188
Rear Parking Aid Audible Warnings.....	188
Rear Parking Aid Limitations.....	188
What is the Rear Parking Aid.....	188
Rear Seats.....	121
Manual Seats.....	121
Rear View Camera Guide Lines.....	190
Rear View Camera Precautions.....	190
Rear View Camera.....	190
Rear View Camera Settings.....	191
Rear View Camera Settings.....	191
Switching Rear View Camera Delay On and Off.....	191
Zooming the Rear View Camera In and Out.....	191
Rebooting the Center Display.....	391
Recalling a Preset Position.....	124
Recovery Towing.....	272
Accessing the Front Towing Point.....	272
Installing the Towing Eye.....	272
Locating the Towing Eye.....	272
Recreationally Towing Your Vehicle.....	279
Refueling.....	153
Refueling System Overview.....	153
Refueling Your Vehicle.....	153
Releasing the Electric Parking Brake if the Vehicle Battery Has Run Out of Charge.....	175
Remote Control Limitations.....	62
Remote Rev.....	67
Remote Rev Limitations.....	67
Using Remote Rev.....	67
What is Remote Rev.....	67
Remote Start.....	105
Remote Start Settings.....	106

Index

Removing the Key Blade.....	63	Seatbelt Extensions.....	49
Removing Your Vehicle From Storage.....	328	Seatbelt Precautions.....	43
Repairing Minor Paint Damage.....	325	Seatbelt Reminder.....	47
Replacement Parts		How Does the Seatbelt Reminder Work.....	47
Recommendation.....	492	Seatbelt Reminder Audible Warnings.....	48
Replacing a Lost Key or Remote Control.....	65	Seatbelt Reminder Indicators.....	47
Replacing the Cabin Air Filter.....	112	Switching the Seatbelt Reminder On and Off.....	48
Replacing the Front Wiper Blades.....	83	Seatbelts.....	43
Reporting Safety Defects in Canada.....	431	Automatic Locking Mode.....	46
Reporting Safety Defects in the United States.....	431	Seatbelt Reminder.....	47
Resetting the Trip Computer.....	104	Sensitive Locking Mode.....	45
Restarting the Engine - Automatic Transmission.....	147	Security.....	76
Restarting the Engine - Manual Transmission.....	146	Anti-Theft Alarm System.....	76
Resuming the Set Speed - Automatic Transmission.....	201	Anti-Theft Alarm System Settings.....	77
Resuming the Set Speed Limit.....	216	Passive Anti-Theft System.....	76
Resuming the Set Speed - Manual Transmission.....	201	Security – Troubleshooting.....	78
Resuming the Set Speed.....	194	Security – Troubleshooting.....	78
Roadside Assistance.....	267	Security – Frequently Asked Questions.....	79
Route Guidance.....	416	Security – Information Messages.....	78
Adjusting the Guidance Prompt Volume.....	416	Selecting a Drive Mode.....	211
Canceling Route Guidance.....	416	Selecting the Audio Source.....	379
Running-In		Sending and Receiving a Text Message.....	409
See: Breaking-In.....	264	Sensitive Locking Mode.....	45
Running Out of Fuel.....	151	How Does Sensitive Locking Mode Work.....	45
Adding Fuel From a Portable Fuel Container.....	152	What is Sensitive Locking Mode.....	45
Filling a Portable Fuel Container.....	151	Service Data.....	26
S		Setting a Destination.....	415
Satellite Radio.....	382	Setting a Destination Using a Point of Interest.....	416
Locating the Satellite Radio Identification Number.....	383	Setting a Destination Using a Predictive Destination.....	416
Satellite Radio Limitations.....	383	Setting a Destination Using a Recent Destination.....	416
Satellite Radio Settings.....	383	Setting a Destination Using a Saved Destination.....	416
Selecting a Channel.....	383	Setting a Destination Using the Map Screen.....	416
What Is Satellite Radio.....	382	Setting a Destination Using the Text Entry Screen.....	415
Saving a Preset Position.....	124	Setting a Memory Preset.....	380
Scheduled Maintenance.....	423	Settings Data.....	27
		Settings.....	391

Index

Setting the Adaptive Cruise Control Gap.....	200
Setting the Adaptive Cruise Control Speed - Automatic Transmission.....	199
Setting the Adaptive Cruise Control Speed - Manual Transmission.....	198
Setting the Blower Motor Speed.....	108
Setting the Clock and Date.....	380
Setting the Cruise Control Speed.....	193
Setting the Speed Limit.....	216
Setting the Temperature.....	108
Setting Up a Vehicle Hotspot.....	377
Shifting Into Reverse.....	157
Shifting Your Immobile Vehicle Out of Park (P).....	162
Signing In to Your Account.....	404
Sitting in the Correct Position.....	113
Software Update Indicators.....	418
Software Update Settings.....	417
Software Update See: Software Update Settings.....	417
See: Vehicle Software Updates.....	417
Sounding the Panic Alarm.....	63
Speed Control See: Cruise Control.....	193
Speed Limiter Audible Warnings.....	217
Speed Limiter Indicators.....	217
Speed Limiter Precautions.....	216
Speed Limiter.....	216
Speedometer.....	101
Speed Sign Recognition Indicators.....	247
Speed Sign Recognition Limitations.....	246
Speed Sign Recognition Precautions.....	246
Speed Sign Recognition Settings.....	247
Speed Sign Recognition Speed Sign Recognition – Troubleshooting.....	247
Speed Sign Recognition – Troubleshooting.....	247
Speed Sign Recognition – Frequently Asked Questions.....	248
Speed Sign Recognition – Information Messages.....	247
Stability Control Indicator.....	184
Stability Control.....	183
Stability Control – Troubleshooting.....	184
Stability Control – Troubleshooting.....	184
Stability Control – Information Messages.....	184
Starting and Stopping the Engine – Precautions.....	137
Starting and Stopping the Engine.....	137
Automatic Engine Stop.....	140
Engine Block Heater.....	138
Starting and Stopping the Engine – Troubleshooting.....	141
Starting the Engine.....	138
Stopping the Engine.....	139
Starting and Stopping the Engine – Troubleshooting.....	141
Starting and Stopping the Engine – Frequently Asked Questions.....	143
Starting and Stopping the Engine – Information Messages.....	142
Starting and Stopping the Engine – Warning Lamps.....	141
Starting the Engine.....	138
Restarting the Engine After Stopping It.....	138
Starting a Gasoline Engine.....	138
Status Bar.....	390
Steering.....	185
Electric Power Steering.....	185
Steering – Troubleshooting.....	186
Steering – Troubleshooting.....	186
Steering – Information Messages.....	186
Steering Wheel.....	80
Stopping the Engine - Automatic Transmission.....	145
Stopping the Engine - Manual Transmission.....	145
Stopping the Engine.....	139
Stopping the Engine When Your Vehicle is Moving.....	140
Stopping the Engine When Your Vehicle is Stationary.....	139
Storage.....	135
Center Console.....	135
Cup Holders.....	135
Glasses Holder.....	136
Glove Compartment.....	135
Storing Your Vehicle.....	327
Suspension Specifications.....	311

Index

Switching Adaptive Cruise Control On and Off - Automatic Transmission.....	198
Switching Adaptive Cruise Control On and Off - Manual Transmission.....	197
Switching Air Conditioning On and Off.....	107
Switching All of the Interior Lamps On and Off.....	93
Switching Android Auto™ On and Off.....	411
Switching Apple CarPlay On and Off.....	410
Switching Auto Hold On and Off.....	180
Switching Auto-Start-Stop On and Off.....	145
Switching Blind Spot Information System On and Off.....	228
Switching Climate Control On and Off.....	107
Switching Cross Traffic Alert On and Off.....	236
Switching Cruise Control On and Off.....	193
Switching Defrost On and Off.....	107
Switching Driver Alert On and Off.....	250
Switching Easy Entry and Exit On and Off.....	75
Switching Exit Warning On and Off.....	232
Switching From Adaptive Cruise Control to Cruise Control.....	203
Switching From Intelligent Speed Limiter to Speed Limiter.....	219
Switching Hill Start Assist On and Off - Automatic Transmission.....	179
Switching Hill Start Assist On and Off - Manual Transmission.....	179
Switching Maximum Cooling On and Off.....	108
Switching Maximum Defrost On and Off.....	107
Switching Parking Aid On and Off.....	187
Switching Pre-Collision Assist On and Off.....	240
Switching Rear Occupant Alert System On and Off.....	122
Switching Recirculated Air On and Off.....	107
Switching Stability Control On and Off.....	184
Switching Text Message Notification On and Off.....	410
Switching the Audio Unit On and Off.....	379
Switching the Display On and Off.....	381
Switching the Front Interior Lamps On and Off.....	93
Switching the Hazard Flashers On and Off.....	268
Switching the Heated Mirrors On and Off.....	108
Switching the Heated Rear Window On and Off.....	108
Switching the Heated Steering Wheel On and Off - Vehicles With: Heated Steering Wheel.....	81
Switching the Intelligent Speed Limiter On and Off.....	218
Switching the Lane Keeping System Mode.....	222
Switching the Lane Keeping System On and Off.....	222
Switching the Speed Limiter On and Off.....	216
Switching Traction Control On and Off.....	182
Symbols Glossary.....	19
Symbols Used On Your Instrument Cluster.....	21
Symbols Used on Your Vehicle.....	19
System Update See: Software Update Settings.....	417
See: Vehicle Software Updates.....	417
T	
Tachometer.....	101
The Better Business Bureau Auto Line Program.....	430
The Mediation and Arbitration Program.....	430
Third Party Software Copyright Acknowledgment.....	433
Tire Care.....	343

Index

Tire Pressure Monitoring System	
Limitations.....	364
Tire Pressure Monitoring System	
Overview.....	363
Tire Pressure Monitoring System	
Precautions.....	364
Tire Pressure Monitoring System.....	363
Tire Pressure Monitoring System –	
Troubleshooting.....	365
Tire Pressure Monitoring System –	
Troubleshooting.....	365
Tire Pressure Monitoring System –	
Information Messages.....	366
Tire Pressure Monitoring System – Warning	
Lamps.....	365
Tire Replacement Requirements.....	336
Tire Rotation.....	349
Tire Sealant and Inflator Kit	
Components.....	352
Tire Sealant and Inflator Kit	
Precautions.....	351
Tire Sealant and Inflator Kit.....	351
Towing a Trailer Precautions - Base/ GT.....	260
Towing a Trailer Precautions - Dark Horse.....	260
Towing a Trailer.....	260
Towing Weights and Dimensions.....	261
Towing Weights and Dimensions.....	261
Recommended Towing Weights.....	261
Towing Your Vehicle Precautions.....	279
Towing Your Vehicle.....	279
Track Apps.....	393
Acceleration Timer.....	394
Brake Performance.....	394
Drift Brake.....	398
Launch Control.....	397
Line Lock.....	395
Manual Lap Timer.....	394
Performance Shift Indicator.....	395
Rev Matching.....	397
Track Apps Overview.....	393
Track Apps Precautions.....	393
Track Use - Dark Horse.....	315
Track Use.....	313
Traction Control Indicator.....	182
Traction Control.....	182
Traction Control – Troubleshooting.....	182
Traction Control –	
Troubleshooting.....	182
Traction Control – Warning Lamps.....	182
Transporting the Vehicle - Dark Horse.....	273
Transporting the Vehicle.....	272
Trip Computer.....	104
U	
Under Hood Fuse Box.....	280
Accessing the Under Hood Fuse Box.....	280
Identifying the Fuses in the Under Hood	
Fuse Box.....	281
Locating the Under Hood Fuse Box.....	280
Under Hood Overview - 2.3L	
EcoBoost™.....	288
Under Hood Overview - 5.0L.....	289
USB Ports.....	129
Using Alexa Built-In.....	404
Using Auto Hold.....	180
Using Keyless Entry.....	73
Using Remote Start - Vehicles With: Ford Mobile App.....	105
Using Remote Start - Vehicles With: Remote Control.....	105
Using Short Drop Windows.....	97
Using Snow Chains.....	341
Using Summer Tires.....	338
Using the Controls on the Steering	
Wheel.....	80
Using the Instrument Cluster Display	
Controls.....	103
Using the Rear Luggage Compartment	
Emergency Release.....	258
Using the Remote Control.....	62
Using the Tire Sealant and Inflator Kit.....	353
Using the Valet Mode.....	66
Using This Publication.....	18
V	
Vehicle Care.....	320
Cleaning the Exterior.....	321
Cleaning the Interior.....	323
Vehicle Hotspot Settings.....	377

Index

Vehicle Hotspot – Troubleshooting.....	378
Vehicle Hotspot – Frequently Asked Questions.....	378
Vehicle Hotspot.....	377
Vehicle Hotspot – Troubleshooting.....	378
Vehicle Identification Number.....	373
Locating the Vehicle Identification Number.....	373
Vehicle Identification Number Overview.....	373
Vehicle Identification.....	373
Vehicle Identification Number.....	373
Vehicle Software Updates.....	417
Vehicle Specifications.....	309
Vehicle System Reset.....	419
Ventilated Seats.....	120
Switching the Ventilated Seats On and Off.....	120
Ventilated Seat Precautions.....	120
Ventilation	
See: Climate Control.....	107
Viewing the Tire Pressures.....	365
Visual Search.....	30
Voice Interaction.....	402
Ford Assistant.....	402
W	
Warranty Information.....	520
Washers.....	84
Adding Washer Fluid.....	85
Switching the Courtesy Wipe On and Off.....	84
Using the Windshield Washer.....	84
Washer Fluid Specification.....	85
Washer Precautions.....	84
Washers	
See: Wipers and Washers.....	82
Waxing Your Vehicle.....	325
Waypoints.....	416
Adding a Waypoint.....	416
Editing Waypoints.....	416
What Is 911 Assist.....	60
What Is a Connected Vehicle.....	374
What is Alexa Built-In.....	404
What Is Auto-Start-Stop.....	145
What Is Blind Spot Information System.....	228
What Is Cross Traffic Alert.....	234
What Is Cruise Control.....	193
What Is Drive Mode Control.....	211
What Is Driver Alert.....	249
What Is Exit Warning.....	231
What Is Ford Protect.....	421
What Is Hill Start Assist.....	179
What Is Keyless Entry.....	73
What Is Pre-Collision Assist.....	238
What Is Speed Sign Recognition.....	246
What Is the Cabin Air Filter.....	112
What Is the Catalytic Converter.....	156
What Is the Electric Parking Brake.....	172
What Is the Gross Axle Weight Rating.....	252
What Is the Gross Combined Weight Rating.....	252
What Is the Gross Vehicle Weight Rating.....	252
What Is the Intelligent Speed Limiter.....	218
What Is the Lane Keeping System.....	221
What Is the Personal Safety System.....	50
What Is the Power Outlet.....	131
What is the Rear Occupant Alert System.....	122
What Is the Rear View Camera.....	190
What Is the Tire Pressure Monitoring System.....	363
What Is the Tire Sealant and Inflator Kit.....	351
What Is the Wireless Accessory Charger.....	133
What Is Traction Control.....	182
Wheel and Tire Information.....	329
Wheel Nuts.....	371
Wi-Fi	
See: Connecting the Vehicle to a Wi-Fi Network.....	374
Window Bounce-Back.....	97
Overriding Window Bounce-Back.....	97
What Is Window Bounce-Back.....	97
Windows.....	95
Global Opening.....	96
Window Bounce-Back.....	97

Index

Wipers and Washers – Troubleshooting.....	86
Wipers and Washers – Frequently Asked Questions.....	86
Wipers and Washers – Warning Lamps.....	86
Wipers and Washers Videos.....	85
Wipers and Washers.....	82
Autowipers.....	82
Washers.....	84
Wipers.....	82
Wipers and Washers – Troubleshooting.....	86
Wipers.....	82
Switching Windshield Wipers On and Off.....	82
Wiper Precautions.....	82
Wireless Accessory Charger Precautions.....	133
Wireless Accessory Charger.....	133

