



# 2022 DODGE DURANGO OWNER'S MANUAL



This Owner's Manual illustrates and describes the operation of features and equipment that are either standard or optional on this vehicle. This manual may also include a description of features and equipment that are no longer available or were not ordered on this vehicle. Please disregard any features and equipment described in this manual that are not on this vehicle. FCA US LLC reserves the right to make changes in design and specifications, and/or make additions to or improvements to its products without imposing any obligation upon itself to install them on products previously manufactured.

With respect to any vehicles sold in Canada, the name FCA US LLC shall be deemed to be deleted and the name FCA Canada Inc. used in substitution therefore.

This Owner's Manual is intended to familiarize you with the important features of your vehicle. Your most up-to-date Owner's Manual, Navigation/Uconnect manuals and Warranty Booklet can be found by visiting the website on the back cover.

**U.S. Residents:** If you are the first registered retail owner of your vehicle, you may obtain a complimentary printed copy of the Warranty Booklet by calling **1-800-423-6343** or by contacting your dealer. Replacement kits can be purchased by visiting **[www.techauthority.com](http://www.techauthority.com)**.

**Canadian Residents:** If you are the first registered retail owner of your vehicle, you may obtain a complimentary printed copy of the Warranty Booklet or purchase a replacement kit by calling **1-800-387-1143** or by contacting your dealer.

 **WARNING:** Operating, servicing and maintaining a passenger vehicle or off-highway motor vehicle can expose you to chemicals including engine exhaust, carbon monoxide, phthalates, and lead, which are known to the State of California to cause cancer and birth defects or other reproductive harm. To minimize exposure, avoid breathing exhaust, do not idle the engine except as necessary, service your vehicle in a well-ventilated area and wear gloves or wash your hands frequently when servicing your vehicle. For more information go to **[www.P65Warnings.ca.gov/passenger-vehicle](http://www.P65Warnings.ca.gov/passenger-vehicle)**.



# TABLE OF CONTENTS

1	INTRODUCTION.....	8
2	GETTING TO KNOW YOUR VEHICLE .....	14
3	GETTING TO KNOW YOUR INSTRUMENT PANEL .....	81
4	STARTING AND OPERATING .....	99
5	MULTIMEDIA .....	154
6	SAFETY .....	187
7	IN CASE OF EMERGENCY .....	237
8	SERVICING AND MAINTENANCE .....	256
9	TECHNICAL SPECIFICATIONS .....	305
10	CUSTOMER ASSISTANCE .....	311
11	INDEX.....	315

1

2

3

4

5

6

7

8

9

10

11

## INTRODUCTION

<b>SYMBOLS KEY</b> .....	9
<b>ROLLOVER WARNING</b> .....	9
<b>VEHICLE MODIFICATIONS/ALTERATIONS</b> .....	10
<b>SYMBOL GLOSSARY</b> .....	10

## GETTING TO KNOW YOUR VEHICLE

<b>KEYS</b> .....	14
Key Fob .....	14
<b>SENTRY KEY</b> .....	16
<b>IGNITION SWITCH</b> .....	17
Keyless Enter 'n Go™ Ignition .....	17
<b>REMOTE START — IF EQUIPPED</b> .....	18
How To Use Remote Start.....	19
To Exit Remote Start Mode.....	19
Remote Start Front Defrost Activation — If Equipped.....	20
Remote Start Comfort Systems — If Equipped.....	20
Remote Start Windshield Wiper De-Icer Activation — If Equipped .....	20
Remote Start Cancel Message — If Equipped.....	20

<b>VEHICLE SECURITY SYSTEM — IF EQUIPPED</b> .....	21
To Arm The System .....	21
To Disarm The System .....	21
Rearming Of The System .....	22
Security System Manual Override.....	22
Tamper Alert .....	22
<b>DOORS</b> .....	22
Manual Door Locks .....	22
Power Door Locks .....	23
Keyless Enter 'n Go™ — Passive Entry .....	23
Automatic Unlock On Exit Feature — If Equipped.....	25
Automatic Door Locks — If Equipped .....	25
Child-Protection Door Lock System — Rear Doors .....	25
<b>STEERING WHEEL</b> .....	26
Manual Tilt/Telescoping Steering Column — If Equipped .....	26
Power Tilt/Telescoping Steering Column — If Equipped.....	26
Heated Steering Wheel — If Equipped .....	27
<b>DRIVER MEMORY SETTINGS — IF EQUIPPED</b> .....	27
Programming The Memory Feature .....	28
Linking And Unlinking The Remote Keyless Entry Key Fob To Memory.....	28
Memory Position Recall .....	28

<b>SEATS</b> .....	29
Manual Adjustment (Front Seats) — If Equipped .....	29
Manual Adjustment (Rear Seats).....	30
Power Adjustment (Front Seats) — If Equipped .....	34
Power Passenger Seat Adjustment — If Equipped .....	36
Heated Seats — If Equipped .....	36
Front Ventilated Seats — If Equipped .....	37
Head Restraints .....	38
<b>UCONNECT VOICE RECOGNITION</b> .....	40
Introducing Voice Recognition .....	40
Basic Voice Commands .....	40
Get Started .....	41
Additional Information .....	41
<b>MIRRORS</b> .....	42
Inside Rearview Mirror.....	42
Illuminated Vanity Mirrors .....	42
Outside Mirrors .....	42
Outside Automatic Dimming Mirror— If Equipped .....	43
Power Mirrors .....	43
Heated Mirrors — If Equipped .....	43
Tilt Side Mirrors In Reverse — If Equipped .....	43



**UNIVERSAL GARAGE DOOR OPENER**

<b>(HOMELINK®) </b> .....	<b>44</b>
Before You Begin Programming .....	
HomeLink® .....	44
Erasing All The HomeLink® Channels .....	44
Identifying Whether You Have A Rolling Code Or Non-Rolling Code Device .....	44
Programming HomeLink® To A Garage Door Opener .....	45
Programming HomeLink® To A Miscellaneous Device .....	46
Reprogramming A Single HomeLink® Button .....	46
Canadian/Gate Operator Programming .....	46
Security .....	47
Troubleshooting Tips .....	47
<b>EXTERIOR LIGHTS</b> .....	<b>48</b>
Multifunction Lever .....	48
Headlight Switch .....	48
Daytime Running Lights (DRLs) .....	49
High/Low Beam Switch .....	49
Automatic High Beam — If Equipped .....	49
Flash-To-Pass .....	50
Automatic Headlights .....	50

Parking Lights And Panel Lights .....	50
Automatic Headlights With Wipers .....	50
Headlight Delay .....	50
Lights-On Reminder .....	50
Fog Lights — If Equipped .....	51
Turn Signals .....	51
Lane Change Assist — If Equipped .....	51
Automatic Headlight Leveling — If Equipped .....	51
Battery Saver .....	51
<b>INTERIOR LIGHTS</b> .....	<b>51</b>
Courtesy Lights .....	52
<b>WINDSHIELD WIPERS AND WASHERS</b> .....	<b>53</b>
Windshield Wiper Operation .....	53
Rain Sensing Wipers — If Equipped .....	54
Rear Window Wiper/Washer .....	55
<b>CLIMATE CONTROLS</b> .....	<b>55</b>
Automatic Climate Control Descriptions And Functions .....	55
Automatic Temperature Control (ATC) .....	61
Climate Voice Recognition .....	62
Operating Tips .....	62

<b>INTERIOR STORAGE AND EQUIPMENT</b> .....	<b>63</b>
Storage .....	63
USB/AUX Control .....	65
Lighted Cupholders — If Equipped .....	67
Electrical Power Outlets .....	67
Power Inverter — If Equipped .....	69
Wireless Charging Pad — If Equipped .....	70
<b>WINDOWS</b> .....	<b>70</b>
Power Windows .....	70
Wind Buffeting .....	72
<b>POWER SUNROOF — IF EQUIPPED</b> .....	<b>72</b>
Opening And Closing The Sunroof .....	72
Sunshade Operation .....	73
Pinch Protect Feature .....	73
Sunroof Maintenance .....	73
Ignition Off Operation .....	73
<b>HOOD</b> .....	<b>73</b>
Opening The Hood .....	73
Closing The Hood .....	74
<b>LIFTGATE</b> .....	<b>74</b>
Power Liftgate — If Equipped .....	74
Cargo Area Features .....	75
<b>ROOF LUGGAGE RACK — IF EQUIPPED</b> .....	<b>76</b>
Deploying The Crossbars .....	77
Stowing The Crossbars .....	78

## GETTING TO KNOW YOUR INSTRUMENT PANEL

<b>INSTRUMENT CLUSTER</b> .....	<b>81</b>
Instrument Cluster Descriptions .....	82
<b>INSTRUMENT CLUSTER DISPLAY</b> .....	<b>82</b>
Location And Controls .....	83
Engine Oil Life Reset .....	84
Display And Messages .....	85
Instrument Cluster Display Menu Items .....	86
Battery Saver On/Battery Saver Mode Message – Electrical Load Reduction Actions – If Equipped .....	88
<b>WARNING LIGHTS AND MESSAGES</b> .....	<b>89</b>
Red Warning Lights .....	90
Yellow Warning Lights .....	92
Yellow Indicator Lights .....	95
Green Indicator Lights .....	95
White Indicator Lights .....	96
Blue Indicator Lights .....	96
<b>ONBOARD DIAGNOSTIC SYSTEM – OBD II</b> .....	<b>97</b>
Onboard Diagnostic System (OBD II) Cybersecurity .....	97
<b>EMISSIONS INSPECTION AND MAINTENANCE PROGRAMS</b> .....	<b>97</b>

## STARTING AND OPERATING

<b>STARTING THE ENGINE</b> .....	<b>99</b>
Automatic Transmission .....	99
Normal Starting .....	99
AutoPark .....	100
Extended Park Starting .....	101
If Engine Fails To Start .....	102
Cold Weather Operation (Below -22° F Or -30° C) .....	102
After Starting .....	102
<b>ENGINE BREAK-IN RECOMMENDATIONS</b> .....	<b>102</b>
<b>PARKING BRAKE</b> .....	<b>103</b>
<b>AUTOMATIC TRANSMISSION</b> .....	<b>104</b>
Ignition Park Interlock .....	105
Brake Transmission Shift Interlock (BTSI) System .....	105
Fuel Economy (ECO) Mode .....	105
8-Speed Automatic Transmission .....	105
<b>SPORT MODE – IF EQUIPPED</b> .....	<b>110</b>
<b>ALL-WHEEL DRIVE OPERATION</b> .....	<b>110</b>
Single-Speed Operating Instructions/Precautions – If Equipped .....	110
Electronically Shifted Transfer Case – If Equipped .....	110
Shifting Procedure .....	112
<b>TOW N GO – IF EQUIPPED</b> .....	<b>113</b>
Guidelines For Track Use .....	113

## FUEL SAVER TECHNOLOGY 5.7L ONLY –

<b>IF EQUIPPED</b> .....	<b>114</b>
<b>POWER STEERING</b> .....	<b>114</b>
<b>STOP/START SYSTEM – IF EQUIPPED</b> .....	<b>115</b>
Autostop Mode .....	115
Possible Reasons The Engine Does Not Autostop .....	115
To Start The Engine While In Autostop Mode .....	116
To Manually Turn Off The Stop/Start System .....	116
To Manually Turn On The Stop/Start System .....	116
System Malfunction .....	116
<b>CRUISE CONTROL SYSTEMS – IF EQUIPPED</b> .....	<b>116</b>
Cruise Control .....	117
Adaptive Cruise Control (ACC) .....	118
<b>PARKSENSE FRONT/REAR PARK ASSIST SYSTEM – IF EQUIPPED</b> .....	<b>126</b>
ParkSense Sensors .....	127
ParkSense Display .....	127
ParkSense Warning Display .....	130
Enabling And Disabling ParkSense Operation With A Trailer .....	130
Service The ParkSense Park Assist System .....	131
Cleaning The ParkSense System .....	131
ParkSense System Usage Precautions .....	131

<b>LANESENSE — IF EQUIPPED</b> .....	<b>132</b>	<b>DRIVING TIPS</b> .....	<b>151</b>	<b>SAFETY</b>	
LaneSense Operation .....	132	On-Road Driving Tips.....	151	<b>SAFETY FEATURES</b> .....	<b>187</b>
Turning LaneSense On Or Off.....	133	Off-Road Driving Tips .....	151	Anti-Lock Brake System (ABS) .....	187
LaneSense Warning Message.....	133			Rear Seat Reminder Alert (RSRA).....	188
Changing LaneSense Status .....	135	<b>MULTIMEDIA</b>		Electronic Brake Control (EBC) System .....	188
<b>PARKVIEW REAR BACK UP CAMERA</b> .....	<b>135</b>	<b>UCONNECT SYSTEMS</b> .....	<b>154</b>	<b>AUXILIARY DRIVING SYSTEMS</b> .....	<b>193</b>
<b>REFUELING THE VEHICLE</b> .....	<b>136</b>	<b>CYBERSECURITY</b> .....	<b>154</b>	Blind Spot Monitoring (BSM) —	
<b>VEHICLE LOADING</b> .....	<b>137</b>	<b>UCONNECT SETTINGS</b> .....	<b>155</b>	If Equipped .....	193
Certification Label .....	137	Customer Programmable Features.....	155	Forward Collision Warning (FCW) With	
<b>TRAILER TOWING</b> .....	<b>138</b>	<b>STEERING WHEEL AUDIO CONTROLS</b> .....	<b>177</b>	Mitigation.....	196
Common Towing Definitions.....	138	Radio Operation .....	177	Tire Pressure Monitoring System (TPMS)....	198
Trailer Hitch Classification.....	140	Media Mode.....	177	<b>OCCUPANT RESTRAINT SYSTEMS</b> .....	<b>201</b>
Trailer Towing Weights (Maximum Trailer		<b>UCONNECT REAR SEAT ENTERTAINMENT</b>		Occupant Restraint Systems Features .....	201
Weight Ratings) .....	141	<b>(RSE) SYSTEM — IF EQUIPPED</b> .....	<b>177</b>	Important Safety Precautions .....	201
Trailer Hitch Receiver Cover Removal —		Getting Started .....	177	Seat Belt Systems .....	202
If Equipped.....	141	Video Screen .....	178	Supplemental Restraint Systems (SRS) .....	209
Trailer And Tongue Weight .....	142	Play A Blu-ray™ Disc.....	179	Child Restraints.....	220
Towing Requirements .....	142	Play Video Games .....	180	<b>SAFETY TIPS</b> .....	<b>233</b>
Towing Tips .....	146	Important Notes For The Video Screen		Transporting Passengers.....	233
<b>RECREATIONAL TOWING (BEHIND</b>		System .....	181	Transporting Pets.....	234
<b>MOTORHOME)</b> .....	<b>147</b>	Blu-ray™ Disc Player Remote Control .....	181	Safety Checks You Should Make Inside	
Towing This Vehicle Behind Another		Headphones Operation.....	182	The Vehicle .....	234
Vehicle.....	147	Controls.....	182	Periodic Safety Checks You Should Make	
Recreational Towing — Rear-Wheel Drive		Replacing The Headphone Batteries .....	183	Outside The Vehicle .....	235
Models .....	148	Accessibility — If Equipped .....	183	Exhaust Gas .....	236
Recreational Towing — All-Wheel Drive		Stereo Headphone Lifetime Limited		Carbon Monoxide Warnings .....	236
Models (Single-Speed Transfer Case).....	148	Warranty .....	183		
Recreational Towing — All-Wheel Drive		<b>RADIO OPERATION AND MOBILE PHONES</b> .....	<b>186</b>		
Models (Two-Speed Transfer Case) .....	148	Regulatory And Safety Information .....	186		

## IN CASE OF EMERGENCY

<b>HAZARD WARNING FLASHERS</b> .....	<b>237</b>
<b>ASSIST AND SOS MIRROR — IF EQUIPPED</b> .....	<b>237</b>
<b>JACKING AND TIRE CHANGING</b> .....	<b>240</b>
Preparations For Jacking .....	240
Jack Location .....	241
Spare Tire Stowage .....	242
Spare Tire Removal .....	242
Jacking Instructions .....	243
<b>JUMP STARTING</b> .....	<b>247</b>
Preparations For Jump Start.....	248
Jump Starting Procedure .....	248
<b>REFUELING IN EMERGENCY – IF EQUIPPED</b> ...	<b>249</b>
<b>IF YOUR ENGINE OVERHEATS</b> .....	<b>251</b>
<b>MANUAL PARK RELEASE</b> .....	<b>251</b>
<b>FREEING A STUCK VEHICLE</b> .....	<b>253</b>
<b>TOWING A DISABLED VEHICLE</b> .....	<b>253</b>
Rear Wheel Drive Models .....	255
All Wheel Drive Models .....	255
<b>ENHANCED ACCIDENT RESPONSE SYSTEM</b>	
<b>(EARS)</b> .....	<b>255</b>
<b>EVENT DATA RECORDER (EDR)</b> .....	<b>255</b>

## SERVICING AND MAINTENANCE

<b>SCHEDULED SERVICING</b> .....	<b>256</b>
Maintenance Plan .....	256
<b>ENGINE COMPARTMENT</b> .....	<b>259</b>
3.6L Engine .....	259
5.7L Engine .....	260
Checking Oil Level.....	261
Adding Washer Fluid .....	261
Maintenance-Free Battery .....	261
Pressure Washing.....	262
<b>VEHICLE MAINTENANCE</b> .....	<b>262</b>
Engine Oil .....	262
Engine Oil Filter .....	263
Engine Air Cleaner Filter .....	263
Air Conditioner Maintenance.....	264
Accessory Drive Belt Inspection .....	266
Body Lubrication .....	267
Windshield Wiper Blades.....	267
Exhaust System .....	270
Cooling System .....	271
Brake System .....	273
Automatic Transmission .....	274
Front/Rear Axle Fluid .....	275
Transfer Case .....	275
Fuses.....	275
Bulb Replacement.....	283

<b>TIRES</b> .....	<b>285</b>
Tire Safety Information .....	285
Tires – General Information .....	292
Tire Types.....	295
Spare Tires – If Equipped.....	296
Wheel And Wheel Trim Care.....	298
Snow Traction Devices.....	299
Tire Rotation Recommendations .....	300
<b>DEPARTMENT OF TRANSPORTATION</b>	
<b>UNIFORM TIRE QUALITY GRADES</b> .....	<b>301</b>
Treadwear.....	301
Traction Grades.....	301
Temperature Grades.....	301
<b>STORING THE VEHICLE</b> .....	<b>302</b>
<b>BODYWORK</b> .....	<b>302</b>
Protection From Atmospheric Agents .....	302
Body And Underbody Maintenance .....	302
Preserving The Bodywork .....	302
<b>INTERIORS</b> .....	<b>303</b>
Seats And Fabric Parts .....	303
Plastic And Coated Parts .....	303
Leather Surfaces.....	304
Glass Surfaces .....	304

## TECHNICAL SPECIFICATIONS

<b>VEHICLE IDENTIFICATION NUMBER (VIN)</b> .....	<b>305</b>
<b>BRAKE SYSTEM</b> .....	<b>305</b>
<b>WHEEL AND TIRE TORQUE SPECIFICATIONS</b> ..	<b>305</b>
Torque Specifications .....	305
<b>FUEL REQUIREMENTS</b> .....	<b>306</b>
3.6L Engine.....	306
5.7L Engine.....	306
Reformulated Gasoline .....	306
Materials Added To Fuel .....	307
Gasoline/Oxygenate Blends .....	307
Do Not Use E-85 In Non-Flex Fuel Vehicles.....	307
CNG And LP Fuel System Modifications .....	308
Methylcyclopentadienyl Manganese Tricarbonyl (MMT) In Gasoline.....	308
Fuel System Cautions .....	308
<b>FLUID CAPACITIES</b> .....	<b>309</b>
<b>ENGINE FLUIDS AND LUBRICANTS</b> .....	<b>309</b>
<b>CHASSIS FLUIDS AND LUBRICANTS</b> .....	<b>310</b>

## CUSTOMER ASSISTANCE

<b>SUGGESTIONS FOR OBTAINING SERVICE FOR YOUR VEHICLE</b> .....	<b>311</b>
Prepare For The Appointment .....	311
Prepare A List .....	311
Be Reasonable With Requests.....	311
<b>IF YOU NEED ASSISTANCE</b> .....	<b>311</b>
FCA US LLC Customer Center.....	311
FCA Canada Inc. Customer Center.....	311
Mexico.....	311
Puerto Rico And US Virgin Islands.....	312
Customer Assistance For The Hearing Or Speech Impaired (TDD/TTY).....	312
Service Contract .....	312

<b>WARRANTY INFORMATION</b> .....	<b>312</b>
<b>MOPAR® PARTS</b> .....	<b>312</b>
<b>REPORTING SAFETY DEFECTS</b> .....	<b>313</b>
In The 50 United States And Washington, D.C.....	313
In Canada .....	313
<b>PUBLICATION ORDER FORMS</b> .....	<b>313</b>
<b>GENERAL INFORMATION</b> .....	<b>314</b>

# INTRODUCTION

Dear Customer,

Congratulations on the purchase of your new Dodge vehicle. Be assured that it represents precision workmanship, distinctive styling, and high quality.



This is a specialized utility vehicle. It can go places and perform tasks that are not intended for conventional passenger vehicles. It handles and maneuvers differently from many passenger vehicles both on-road and off-road, so take time to become familiar with your vehicle. If equipped, the two-wheel drive version of this vehicle was designed for on-road use only. It is not intended for off-road driving or use in other severe conditions suited for a four-wheel drive vehicle. Before you start to drive this vehicle, read the Owner's Manual. Be sure you are familiar with all vehicle controls, particularly those used for braking, steering, transmission, and transfer case shifting. Learn how your vehicle handles on different road surfaces. Your driving skills will improve with experience. When driving off-road, or working the vehicle, don't overload the vehicle or expect the vehicle to overcome the natural laws of physics. Always observe federal, state, provincial and local laws wherever you drive. As with other vehicles of this type, failure to operate this vehicle correctly may result in loss of control or a collision ↗ page 151.

This Owner's Manual has been prepared with the assistance of service and engineering specialists to acquaint you with the operation and maintenance of your vehicle. It is supplemented by customer-oriented documents. Within this information, you will find a description of the services that FCA US LLC offers to its customers as well as the details of the terms and conditions for maintaining its validity. Please take the time to read all of these publications carefully before driving your vehicle for the first time. Following the instructions, recommendations, tips, and important warnings in this manual will help ensure safe and enjoyable operation of your vehicle.

This Owner's Manual describes all versions of this vehicle. Options and equipment dedicated to specific markets or versions are not expressly indicated in the text. Therefore, you should only consider the information that is related to the trim level, engine, and version that you have purchased. Any content introduced throughout the Owner's Information, which may or may not be applicable to your vehicle, will be identified with the wording "If Equipped". All data contained in this publication are intended to help you use your vehicle in the best possible way. FCA US LLC aims at a constant improvement of the vehicles produced. For this reason, it reserves the right to make changes to the model described for technical and/or commercial reasons. For further information, contact an authorized dealer.

When it comes to service remember that authorized dealers know your Dodge best, have factory-trained technicians, genuine Mopar® parts, and care about your satisfaction.

## SYMBOLS KEY

<b>WARNING!</b>	These statements are against operating procedures that could result in a collision, bodily injury and/or death.
<b>CAUTION!</b>	These statements are against procedures that could result in damage to your vehicle.
<b>NOTE:</b>	A suggestion which will improve installation, operation, and reliability. If not followed, may result in damage.
<b>TIP:</b>	General ideas/solutions/suggestions on easier use of the product or functionality.
<b>PAGE REFERENCE ARROW</b> 	Follow this reference for additional information on a particular feature.
<b>FOOTNOTE</b> 	Supplementary and relevant information pertaining to the topic.

If you do not read this entire Owner's Manual, you may miss important information. Observe all Cautions and Warnings.

## ROLLOVER WARNING

Utility vehicles have a significantly higher rollover rate than other types of vehicles. This vehicle has a higher ground clearance and a higher center of

gravity than many passenger vehicles. It is capable of performing better in a wide variety of off-road applications. Driven in an unsafe manner, all vehicles can go out of control. Because of the higher center of gravity, if this vehicle is out of control, it may roll over while some other vehicles may not.

Do not attempt sharp turns, abrupt maneuvers, or other unsafe driving actions that can cause loss of vehicle control. Failure to operate this vehicle safely may result in a collision, rollover of the vehicle, and severe or fatal injury. Drive carefully.

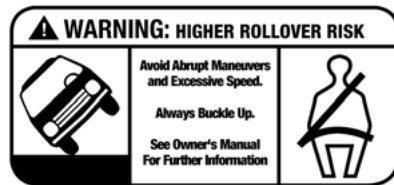

80bfe0f0

**Rollover Warning Label**

Failure to use the driver and passenger seat belts provided is a major cause of severe or fatal injury. In fact, the US government notes that the universal use of existing seat belts could cut the highway death toll by 10,000 or more each year and could reduce disabling injuries by two million annually. In a rollover crash, an unbelted person is significantly more likely to die than a person wearing a seat belt. Always buckle up.

## VEHICLE MODIFICATIONS/ALTERATIONS

### WARNING!



Any modifications or alterations to this vehicle could seriously affect its roadworthiness and safety and may lead to a collision resulting in serious injury or death.









## SYMBOL GLOSSARY

Some car components have colored labels with symbols indicating precautions to be observed when using this component. It is important to follow all warnings when operating your vehicle. See below for the definition of each symbol ↪ page 89.





### NOTE:



Warning and Indicator lights are different based upon equipment options and current vehicle status. Some telltales are optional and may not appear.









Red Warning Lights	
	Seat Belt Reminder Warning Light ↪ page 90
	Air Bag Warning Light ↪ page 90
<b>BRAKE</b>	Brake Warning Light ↪ page 90



Red Warning Lights	
	Battery Charge Warning Light ↪ page 91
	Door Open Warning Light ↪ page 91
	Electric Power Steering (EPS) Fault Warning Light ↪ page 91
	Electronic Throttle Control (ETC) Warning Light ↪ page 91
	Engine Coolant Temperature Warning Light ↪ page 91
	Hood Open Warning Light ↪ page 91
	Liftgate Open Warning Light ↪ page 92
	Oil Pressure Warning Light ↪ page 92













Red Warning Lights	
	Oil Temperature Warning Light ↪ page 92
	Trailer Brake Disconnected Warning Light ↪ page 92
	Transmission Temperature Warning Light ↪ page 92
	Vehicle Security Warning Light ↪ page 92

Yellow Warning Lights	
	Engine Check/Malfunction Indicator Warning Light (MIL) ↪ page 93
	Electronic Stability Control (ESC) Active Warning Light ↪ page 93
	Electronic Stability Control (ESC) OFF Warning Light ↪ page 93

Yellow Warning Lights	
	Low Washer Fluid Warning Light ↪ page 93
	Tire Pressure Monitoring System (TPMS) Warning Light ↪ page 94
	Low Fuel Warning Light ↪ page 93
	Anti-Lock Brake System (ABS) Warning Light ↪ page 92
	Service Forward Collision Warning (FCW) Light ↪ page 94
	Service Adaptive Cruise Control (ACC) Warning Light ↪ page 94
	Service AWD Warning Light ↪ page 94
	Service Stop/Start System Warning Light ↪ page 94

<b>Yellow Warning Lights</b>	
	LaneSense Warning Light ↪ page 93
	Service LaneSense Warning Light ↪ page 93
	Cruise Control Fault Warning Light ↪ page 94

<b>Yellow Indicator Lights</b>	
	Forward Collision Warning (FCW) OFF Indicator Light ↪ page 95
	All Wheel Drive (AWD) Low Indicator Light ↪ page 95
	NEUTRAL Indicator Light ↪ page 95

<b>Green Indicator Lights</b>	
	Adaptive Cruise Control (ACC) Set With Target Light ↪ page 95
	Adaptive Cruise Control (ACC) Set Without Target Light ↪ page 95
	Cruise Control Set Indicator Light ↪ page 95
	Front Fog Indicator Light ↪ page 96
	LaneSense Indicator Light ↪ page 96
	Parking/Headlights On Indicator Light ↪ page 96
	Sport Mode Indicator Light ↪ page 96
	Stop/Start Active Indicator Light ↪ page 96

**Green Indicator Lights**

Turn Signal Indicator Lights  
⇨ page 96

**Blue Indicator Lights**

High Beam Indicator Light  
⇨ page 96

1

**White Indicator Lights**

Adaptive Cruise Control (ACC) Ready Light  
⇨ page 96



Cruise Control Ready Indicator Light  
⇨ page 96



LaneSense Indicator Light  
⇨ page 96

# GETTING TO KNOW YOUR VEHICLE

## KEYS

### KEY FOB

Your vehicle is equipped with a key fob which supports Passive Entry, Remote Keyless Entry (RKE), Keyless Enter 'n Go™ (if equipped), Remote Start (if equipped), and remote power liftgate operation. The key fob allows you to lock or unlock the doors and liftgate from distances up to approximately 66 ft (20 m). The key fob does not need to be pointed at the vehicle to activate the system. The key fob also contains an emergency key, which is stored in the rear of the key fob.

#### NOTE:

- The key fob's wireless signal may be blocked if the key fob is located next to a mobile phone, laptop, or other electronic device. This may result in poor performance.
- With ignition in the ON position and the vehicle moving at 2 mph (4 km/h), all RKE commands are disabled.

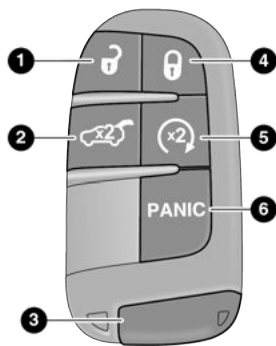

Key Fob

A0204000070US

- 1 – Unlock
- 2 – Liftgate
- 3 – Emergency Key
- 4 – Lock
- 5 – Remote Start
- 6 – PANIC

In case the ignition switch does not change with the push of a button, the key fob may have a low or fully depleted battery. A low key fob battery can be

verified by referring to the instrument cluster, which will display directions to follow page 314.

### To Lock/Unlock The Doors And Liftgate

Push and release the unlock button on the key fob once to unlock the driver's door, or twice within five seconds to unlock all the doors and the liftgate. To lock all the doors and the liftgate, push the lock button once.

When the doors are unlocked, the turn signals will flash and the illuminated entry system will be activated. When the doors are locked, the turn signals will flash and the horn will chirp.

#### NOTE:

- If the vehicle is unlocked with the key fob, and no door is opened within 60 seconds, the vehicle will relock and the security system will arm (if equipped).
- If one or more doors are open, or the liftgate is open, the doors will lock. The doors will unlock again automatically if the key is left inside the passenger compartment, otherwise the doors will stay locked.

All doors can be programmed to unlock on the first push of the unlock button within Uconnect Settings page 155.

## Key Left Vehicle Feature

If a valid key fob is no longer detected inside the vehicle while the vehicle's ignition system is in the ON/RUN or START position, the message "Key Left Vehicle" will be shown in the instrument cluster display along with an interior chime. An exterior audible and visual alert will also be activated to warn the driver.

The vehicle's horn will rapidly chirp three times along with a single flash of the vehicle's exterior lights.

### NOTE:

- The doors have to be open and then closed in order for the vehicle to check for the presence of a key fob; the Key Left Vehicle feature will not activate until all of the doors are closed.
- These alerts will not be activated in situations where the vehicle's engine is left running with the key fob inside.

## Replacing The Battery In The Key Fob

The recommended replacement battery is one CR2032 battery.

### NOTE:

- Customers are recommended to use a battery obtained from Mopar®. Aftermarket coin battery dimensions may not meet the original OEM coin battery dimensions.

- Perchlorate Material — special handling may apply. See [www.dtsc.ca.gov/hazardouswaste/perchlorate](http://www.dtsc.ca.gov/hazardouswaste/perchlorate) for further information.
  - Do not touch the battery terminals that are on the back housing or the printed circuit board.
1. Remove the emergency key (2) by sliding the emergency key release (1) on the back of the key fob and pulling the emergency key out with your other hand.

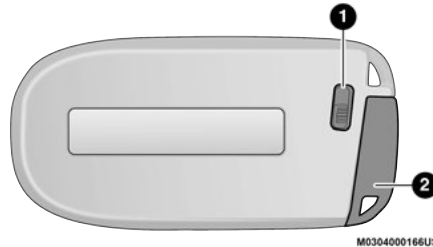

Emergency Key Removal

- 1 — Emergency Key Release
- 2 — Emergency Key

2. Separate the key fob halves using a #2 flat blade screwdriver or a coin, and gently pry the two halves of the key fob apart. Make sure not to damage the seal during removal.

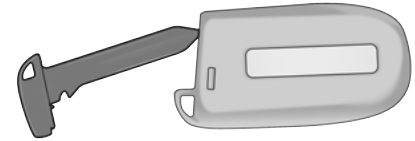

A0204000053US

Emergency Key Removal

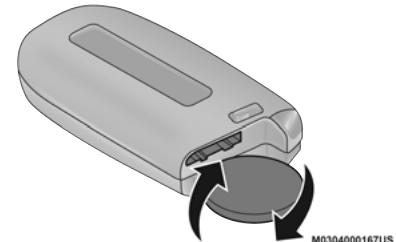

Separating Case With A Coin



### Key Fob Battery Replacement

- Remove the back cover to access and replace the battery. When replacing the battery, match the (+) sign on the battery to the (+) sign on the inside of the battery clip, located on the back cover. Avoid touching the new battery with your fingers. Skin oils may cause battery deterioration. If you touch a battery, clean it with rubbing alcohol.
- To assemble the key fob case, snap the two halves together.

#### WARNING!

- The integrated key fob contains a coin cell battery. Do not ingest the battery; there is a chemical burn hazard. If the coin cell battery is swallowed, it can cause severe internal burns in just two hours and can lead to death.

(Continued)

#### WARNING!

- If you think a battery may have been swallowed or placed inside any part of the body, seek immediate medical attention.
- Keep new and used batteries away from children. If the battery compartment does not close securely, stop using the product and keep it away from children.

### Programming And Requesting Additional Key Fobs

Programming the key fob may be performed by an authorized dealer.

#### NOTE:

- Once a key fob is programmed to a vehicle, it cannot be repurposed and reprogrammed to another vehicle.
- Only key fobs that are programmed to the vehicle electronics can be used to start and operate the vehicle. Once a key fob is programmed to a vehicle, it cannot be programmed to any other vehicle.

#### WARNING!

- Always remove the key fobs from the vehicle and lock all doors when leaving the vehicle unattended.
- Always remember to place the Keyless Enter 'n Go™ ignition in the OFF position.

Duplication of key fobs may be performed at an authorized dealer. This procedure consists of programming a blank key fob to the vehicle electronics. A blank key fob is one that has never been programmed.

#### NOTE:

- When having the Sentry Key Immobilizer system serviced, bring all vehicle keys with you to an authorized dealer.
- Keys must be ordered to the correct key cut to match the vehicle locks.

### SENTRY KEY

The Sentry Key Immobilizer system prevents unauthorized vehicle operation by disabling the engine. The system does not need to be armed or activated. Operation is automatic, regardless of whether the vehicle is locked or unlocked.

The system uses a key fob, keyless push button ignition and a Radio Frequency (RF) receiver to

prevent unauthorized vehicle operation. Therefore, only key fobs that are programmed to the vehicle can be used to start and operate the vehicle. The system will shut the engine off in two seconds if an incorrect key fob is used to start the engine.

After placing the ignition in the ON/RUN position, the Vehicle Security Light will turn on for three seconds for a bulb check. If the light remains on after the bulb check, it indicates that there is a problem with the electronics. In addition, if the light begins to flash after the bulb check, it indicates that someone used an invalid key fob to start the engine. Either of these conditions will result in the engine being shut off after two seconds.

If the Vehicle Security Light turns on during normal vehicle operation (vehicle running for longer than 10 seconds), it indicates that there is a fault in the electronics. Should this occur, have the vehicle serviced as soon as possible by an authorized dealer.

### CAUTION!

The Sentry Key Immobilizer system is not compatible with some aftermarket remote starting systems. Use of these systems may result in vehicle starting problems and loss of security protection.

All of the key fobs provided with your new vehicle have been programmed to the vehicle electronics  
 ☞ page 314.

## IGNITION SWITCH

### KEYLESS ENTER 'N GO™ IGNITION

This feature allows the driver to operate the ignition switch with the push of a button as long as the key fob is in the passenger compartment.

The START/STOP ignition button has several operating modes that are labeled and will illuminate when in position. These modes are OFF, ACC, ON/RUN, and START.

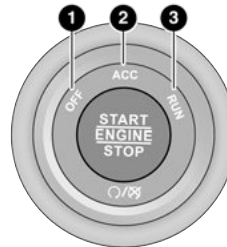

START/STOP Ignition Button

A020500001SUS

- 1 — OFF
- 2 — ACC
- 3 — ON/RUN

The push button ignition can be placed in the following modes:

#### OFF

- The engine is stopped
- Some electrical devices (e.g. power locks, alarm, etc.) are still available

#### ACC

- Engine is not started
- Some electrical devices are available (e.g. power windows, etc.)

#### ON/RUN

- Driving position
- All electrical devices are available (e.g. climate controls, etc.)

#### START

- The engine will start (when foot is on the brake pedal)

#### NOTE:

If the ignition position does not change with a push of the ignition button, and the instrument cluster display message "Key Fob Not Detected" is being displayed, the key fob may have a low or depleted battery. In this situation, a back up method can be used to operate the ignition switch. Put the nose side of the key fob (side opposite of the emergency key) against the START/STOP ignition button and push to operate the ignition switch.

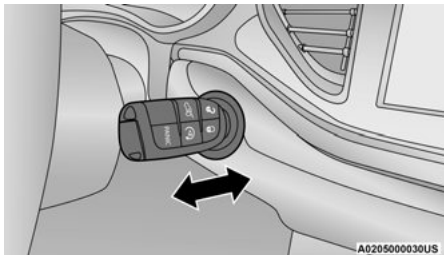

Depleted Key Fob Battery Procedure

**WARNING!**

- Before exiting a vehicle, always shift the automatic transmission into PARK and apply the parking brake. Always make sure the keyless ignition is in the OFF position, remove the key fob from the vehicle and lock the vehicle.
- Never leave children alone in a vehicle, or with access to an unlocked vehicle.
- Allowing children to be in a vehicle unattended is dangerous for a number of reasons. A child or others could be seriously or fatally injured. Children should be warned not to touch the parking brake, brake pedal or the gear selector.

*(Continued)***WARNING!**

- Do not leave the key fob in or near the vehicle, or in a location accessible to children, and do not leave the ignition of a vehicle equipped with Keyless Enter 'n Go™ in the ACC or ON/RUN position. A child could operate power windows, other controls, or move the vehicle.
- Do not leave children or animals inside parked vehicles in hot weather. Interior heat buildup may cause serious injury or death.

**CAUTION!**

An unlocked vehicle is an invitation. Always remove the key fobs from vehicle, place the ignition in the OFF position and lock all doors when leaving the vehicle unattended.

**NOTE:**

- For more information on normal starting procedures, see ↗ page 99.
- When opening the driver's door with the ignition in ON/RUN (engine not running), a chime will sound to remind you to place the ignition in the OFF position. In addition to the chime, the message will display "Ignition Or Accessory On" in the cluster.

**REMOTE START — IF EQUIPPED**

This system uses the key fob to start the engine conveniently from outside the vehicle while still maintaining security. The system has a range of 328 ft (100 m).

Remote Start is used to defrost windows in cold weather, and to reach a comfortable climate in all ambient conditions before the driver enters the vehicle.

**NOTE:**

Obstructions between the vehicle and key fob may reduce this range ↗ page 314.

**WARNING!**

- Do not start or run an engine in a closed garage or confined area. Exhaust gas contains Carbon Monoxide (CO) which is odorless and colorless. Carbon Monoxide is poisonous and can cause serious injury or death when inhaled.
- Keep key fobs away from children. Operation of the Remote Start system, windows, door locks or other controls could cause serious injury or death.



## HOW TO USE REMOTE START

Push and release the Remote Start button on the key fob twice within five seconds. The vehicle doors will lock, the parking lights will flash, and the horn will chirp twice (if programmed). Then, the engine will start, and the vehicle will remain in the Remote Start mode for a 15 minute cycle. Pushing the Remote Start button a third time shuts the engine off.

To drive the vehicle, push the unlock button, and with a valid Keyless Enter 'n Go™ key fob in the vehicle, place the ignition in the ON/RUN position.

### NOTE:

- With Remote Start, the engine will only run for 15 minutes.
- Remote Start can only be used twice.
- If an engine fault is present or fuel level is low, the vehicle will start and then shut down in 10 seconds.
- The parking lights will turn on and remain on during Remote Start mode.
- For security, power window and sunroof (if equipped) operation is disabled when the vehicle is in the Remote Start mode.
- The ignition must be placed in the ON/RUN position before the Remote Start sequence can be repeated for a third cycle.

All of the following conditions must be met before the engine will remote start:

- Gear selector in PARK
- Doors closed
- Hood closed
- Liftgate closed
- Hazard switch off
- Brake pedal not pressed
- Battery at an acceptable charge level
- PANIC button not pressed
- System not disabled from previous remote start event
- Vehicle Security system indicator flashing
- Ignition in OFF position
- Fuel level meets minimum requirement
- Vehicle Security system is not signaling an intrusion
- Malfunction Indicator Light (MIL) is not illuminated

### WARNING!

- Do not start or run an engine in a closed garage or confined area. Exhaust gas contains Carbon Monoxide (CO) which is odorless and colorless. Carbon Monoxide is poisonous and can cause serious injury or death when inhaled.
- Keep key fobs away from children. Operation of the Remote Start system, windows, door locks or other controls could cause serious injury or death.

2

## TO EXIT REMOTE START MODE

To drive the vehicle after starting the Remote Start system, either push and release the unlock button on the key fob to unlock the doors, or unlock the vehicle using Keyless Enter 'n Go™ — Passive Entry via the door handles, and disarm the Vehicle Security system (if equipped). Then, prior to the end of the 15 minute cycle, push and release the START/STOP ignition button.

The Remote Start system will turn the engine off if the Remote Start button on the key fob is pushed again, or if the engine is allowed to run for the entire 15 minute cycle. Once the ignition is placed in the ON/RUN position, the climate controls will resume the previously set operations (temperature, blower control, etc.).

**NOTE:**

- To avoid unintentional shutdowns, the system will disable for two seconds after receiving a valid Remote Start request.
- For vehicles equipped with the Keyless Enter 'n Go™ — Passive Entry feature, the message “Remote Start Active — Push Start Button” will display in the instrument cluster display until you push the START/STOP ignition button.

### REMOTE START FRONT DEFROST ACTIVATION — IF EQUIPPED

When Remote Start is active, and the outside ambient temperature is 40°F (4.5°C) or below, the system will automatically activate front defrost for 15 minutes or less. The time is dependent on the ambient temperature. Once the timer expires, the system will automatically adjust the settings depending on ambient conditions. See “Remote Start Comfort Systems — If Equipped” in the next section for detailed operation.

### REMOTE START COMFORT SYSTEMS — IF EQUIPPED

When Remote Start is activated, the front and rear defrost will automatically turn on in cold weather. The heated steering wheel and driver heated seat feature will turn on if selected in the comfort menu

screen within Uconnect Settings ↪ page 155. In warm weather, the driver vented seat feature will automatically turn on when Remote Start is activated, if programmed in the comfort menu screen. The vehicle will adjust the climate control settings depending on the outside ambient temperature.

#### Automatic Temperature Control (ATC) — If Equipped

The climate controls will automatically adjust to the optimal temperature and mode settings depending on the outside ambient temperature. This will occur until the ignition is placed in the ON/RUN position, where the climate controls will resume their previous settings.

#### Manual Temperature Control (MTC) — If Equipped

- In ambient temperatures at 40°F (4.5°C) or below, the climate settings will default to maximum heat, with fresh air entering the cabin. If the front defrost timer expires, the vehicle will enter Mix Mode.
- In ambient temperatures from 40°F (4.5°C) to 78°F (26°C), the climate settings will be based on the last settings selected by the driver.
- In ambient temperatures at 78°F (26°C) or above, the climate settings will default to MAX A/C, Bi-Level Mode, and Recirculation on.

For more information on ATC, MTC, and climate control settings, see ↪ page 55.

**NOTE:**

These features will stay on through the duration of Remote Start until the ignition is placed in the ON/RUN position. The climate control settings will change if manually adjusted by the driver while the vehicle is in Remote Start mode, and exit automatic override. This includes the OFF button on the climate controls, which will turn the system off.

### REMOTE START WINDSHIELD WIPER DE-ICER ACTIVATION — IF EQUIPPED

When Remote Start is active and the outside ambient temperature is less than 33°F (0.6°C), the Windshield Wiper De-Icer will activate. Exiting Remote Start will resume its previous operation. If the Windshield Wiper De-Icer was active, the timer and operation will continue.

### REMOTE START CANCEL MESSAGE — IF EQUIPPED

The following messages will display in the instrument cluster display if the vehicle fails to remote start or exits Remote Start prematurely:

- Remote Start Cancelled — Door Open
- Remote Start Cancelled — Hood Open
- Remote Start Cancelled — Fuel Low
- Remote Start Cancelled — Liftgate Open

- Remote Start Cancelled — Timer Expired
- Remote Start Disabled — Start Vehicle To Reset

The instrument cluster display message stays active until the ignition is placed in the ON/RUN position.

## VEHICLE SECURITY SYSTEM — IF EQUIPPED

The Vehicle Security system monitors the vehicle doors for unauthorized entry and the Keyless Enter 'n Go™ Ignition for unauthorized operation. While the Vehicle Security system is armed, interior switches for door locks and liftgate release are disabled. If something triggers the alarm, the Vehicle Security system will provide the following audible and visible signals:

- The horn will pulse
- The parking lights and/or turn signals will flash
- The Vehicle Security Light in the instrument cluster will flash

### TO ARM THE SYSTEM

Follow these steps to arm the Vehicle Security system:

1. Make sure the vehicle's ignition is placed in the OFF position.
  - For vehicles equipped with Keyless Entry, make sure the vehicle's keyless ignition system is OFF.

2. Perform one of the following methods to lock the vehicle:
  - Push lock on the interior power door lock switch with the driver and/or passenger door open.
  - Push the lock button on the exterior Passive Entry door handle with a valid key fob available in the same exterior zone ↪ page 23.
  - Push the lock button on the key fob.
3. If any doors are open, close them.

### TO DISARM THE SYSTEM

The Vehicle Security system can be disarmed using any of the following methods:

- Push the unlock button on the key fob.
- Grab the Passive Entry unlock door handle (if equipped) ↪ page 23.
- Cycle the vehicle ignition system out of the OFF position.

#### NOTE:

- The driver's door key cylinder cannot arm or disarm the Vehicle Security system. Use of the door key cylinder when the alarm is armed will sound the alarm when the door is opened.
- The Vehicle Security system remains armed when the power liftgate is opened using the liftgate button on the key fob. If someone enters

the vehicle through the liftgate and opens any door from the inside, the alarm will sound.

- If Passive Entry (if equipped) is used to unlock the liftgate, the Vehicle Security system is disarmed and the rest of the vehicle doors will remain locked unless all doors are set to unlock on first press within Uconnect Settings.
- When the Vehicle Security system is armed, the interior power door lock switches will not unlock the doors.

The Vehicle Security system is designed to protect your vehicle. However, you can create conditions where the system will give you a false alarm. If one of the previously described arming sequences has occurred, the Vehicle Security system will arm regardless of whether you are in the vehicle or not. If you remain in the vehicle and open a door, the alarm will sound. If this occurs, disarm the Vehicle Security system.

If the Vehicle Security system is armed and the battery becomes disconnected, the Vehicle Security system will remain armed when the battery is reconnected; the exterior lights will flash, and the horn will sound. If this occurs, disarm the Vehicle Security system.

## REARMING OF THE SYSTEM

If something triggers the alarm and no action is taken to disarm it, the Vehicle Security system will turn the horn off after a 29 second cycle (with five seconds between cycles and up to eight cycles if the trigger remains active) and then rearm itself.

## SECURITY SYSTEM MANUAL OVERRIDE

The Vehicle Security system will not arm if you lock the doors using the manual door lock.

## TAMPER ALERT

If something has triggered the Vehicle Security system in your absence, the horn will sound three times and the exterior lights will blink three times when you disarm the Vehicle Security system.

## DOORS

### MANUAL DOOR LOCKS

The power door locks can be manually locked from inside the vehicle by using the door lock knob. To lock each door, push the door lock knob on each door trim panel downward. To unlock the front doors, pull the inside door handle to the first detent. To unlock the rear doors, pull the door lock

knob on the door trim panel upward. If the lock knob is down when the door is closed, the door will lock. Make sure the key is not inside the vehicle before closing the door.

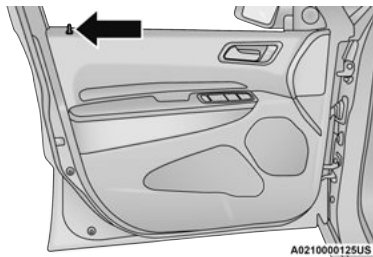

Manual Door Lock Knob

### WARNING!

- For personal security and safety in the event of a collision, lock the vehicle doors as you drive as well as when you park and leave the vehicle.
- Never leave children alone in a vehicle, or with access to an unlocked vehicle.

(Continued)

### WARNING!

- Allowing children to be in a vehicle unattended is dangerous for a number of reasons. A child or others could be seriously or fatally injured. Children should be warned not to touch the parking brake, brake pedal or the gear selector.
- Do not leave the key fob in or near the vehicle, or in a location accessible to children, and do not leave the ignition of a vehicle equipped with Keyless Enter 'n Go™ in the ACC or ON/RUN position. A child could operate power windows, other controls, or move the vehicle.
- When leaving the vehicle, always make sure the keyless ignition node is in the OFF position, remove the key fob from the vehicle and lock the vehicle. Unsupervised use of the vehicle equipment may cause severe person injuries and death.

## POWER DOOR LOCKS

The power door lock switches are located on each front door panel. Push the switch to lock or unlock the doors and liftgate.

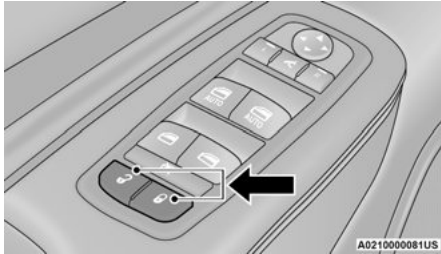

**Power Door Lock Switches**

If the lock knob is down when the door is closed, the door will lock. Make sure the key fob is not inside the vehicle before closing the door.

### NOTE:

If the key fob is located next to a mobile phone, laptop, or other electronic device, the wireless signal may get blocked, and the driver's door may not unlock automatically.

If the door lock switch is pushed while the ignition is in the ACC or ON/RUN position, and the driver's door is open, the doors will not lock.

If a rear door is locked, it cannot be opened from inside the vehicle without first unlocking the door. The door may be unlocked manually by raising the lock knob.

## KEYLESS ENTER 'N GO™ — PASSIVE ENTRY

The Passive Entry system is an enhancement to the vehicle's Remote Keyless Entry (RKE) system and a feature of Keyless Enter 'n Go™ — Passive Entry. This feature allows you to lock and unlock the vehicle's door(s) without having to push the key fob lock or unlock buttons.

### NOTE:

- Passive Entry may be programmed on/off within Uconnect Settings  page 155.
- The key fob may not be detected by the vehicle Passive Entry system if it is located next to a mobile phone, laptop or other electronic device; these devices may block the key fob's wireless signal and prevent the passive entry handle from locking/unlocking the vehicle.
- Passive Entry Unlock initiates illuminated approach (low beams, license plate lamp, position lamps) for whichever time duration is set between 0, 30, 60 or 90 seconds. Passive Entry Unlock also initiates two flashes of the turn signal lamps.

- If wearing gloves, or if it has been raining/snowing on the Passive Entry door handle, the unlock sensitivity can be affected, resulting in a slower response time.
- If the vehicle is unlocked by Passive Entry and no door is opened within 60 seconds, the vehicle will relock and will arm the Vehicle Security system (if equipped).

### To Unlock From The Driver Or Passenger Side:

With a valid Passive Entry key fob within 5 ft (1.5 m) of the door handle, grab the handle to unlock the vehicle. Grabbing the driver's door handle will unlock the driver door automatically. Grabbing the passenger door handle will unlock all doors and the liftgate automatically. The interior door panel lock knob will raise when the door is unlocked.

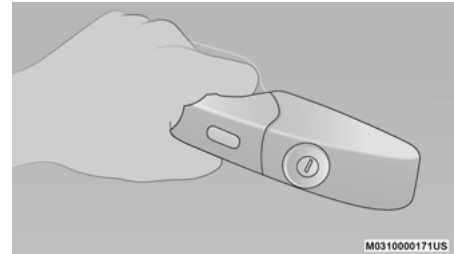

**Grab The Door Handle To Unlock**

**NOTE:**

Either the driver door only or all doors will unlock when you grab hold of the front driver's door handle, depending on the selected setting in the Uconnect system → page 155.

**Preventing Inadvertent Locking Of Passive Entry Key Fob In Vehicle**

To minimize the possibility of unintentionally locking a Passive Entry key fob inside your vehicle, the Passive Entry system is equipped with an automatic door unlock feature, which will function if the ignition is in the OFF position.

If one of the vehicle doors is open, and the door panel switch is used to lock the vehicle, once all open doors have been closed, the vehicle checks the inside and outside of the vehicle for any valid Passive Entry key fob. If one of the vehicle's Passive Entry key fobs is detected inside the vehicle, and no other valid Passive Entry key fobs are detected outside the vehicle, the Passive Entry system automatically unlocks all vehicle doors and chirps the horn three times (on the third attempt, ALL doors will lock, and the Passive Entry key fob can be locked in the vehicle).

**To Unlock/Enter The Liftgate**

The liftgate Passive Entry unlock feature is built into the electronic liftgate handle. With a valid Passive Entry key fob within 5 ft (1.5 m) of the liftgate, pull the electronic liftgate handle for a power open on vehicles equipped with a power

liftgate. Pull the electronic liftgate handle and lift for manual liftgate vehicles.

**NOTE:**

- If the vehicle is unlocked, the liftgate will open with the handle and no key fob is required.
- The liftgate will either unlock along with the vehicle doors, or it will need to be unlocked by pushing the electronic liftgate release, depending on the selected setting in the Uconnect system → page 155.
- The liftgate (and vehicle doors if unlocked) must be locked using the lock button on the key fob, the Passive Entry lock button, or the lock buttons on the interior front door panels.

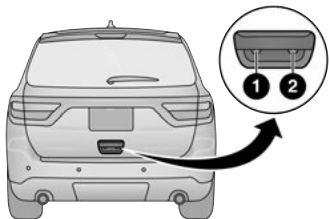

A0210000047US

**Electronic Liftgate Handle**

- 1 – Electronic Release Switch  
2 – Lock Button Location

**To Lock The Liftgate**

With a valid Passive Entry key fob within 5 ft (1.5 m) of the liftgate, push the Passive Entry lock button located to the right of electronic liftgate handle.

**NOTE:**

When you push the button on the liftgate, either only the liftgate will unlock or all doors and the liftgate will unlock, depending on the selected setting in the Uconnect system → page 155.

**To Lock The Vehicle's Doors And Liftgate**

With one of the vehicle's Passive Entry key fobs within 5 ft (1.5 m) of the driver or passenger front door handle, push the door handle lock button to lock all four doors and liftgate.

**NOTE:**

This feature will cause the horn to chirp when the doors are locked with the door handle lock button. This feature can be turned on or off within Uconnect Settings → page 155.

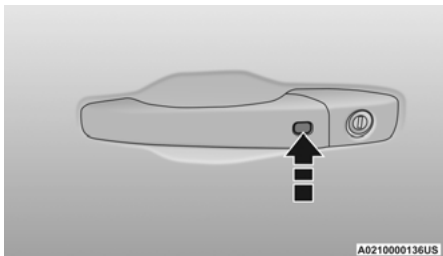

**Push The Door Handle Button To Lock**

**NOTE:**

Do NOT grab the door handle when pushing the door handle button. This could unlock the door(s).

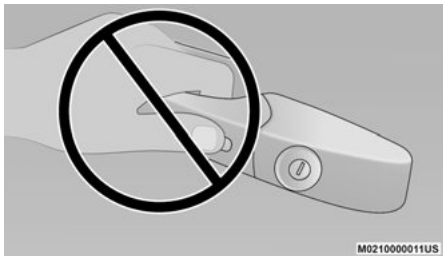

**Do NOT Grab The Door Handle When Locking**

**NOTE:**

- After pushing the door handle button, you must wait two seconds before you can lock or unlock the doors, using either Passive Entry door handle or door handle button. This is done to allow you to check if the vehicle is locked by pulling the door handle without the vehicle unlocking.
- The Passive Entry system will not operate if the key fob battery is depleted.
- Close proximity to mobile devices can affect the Passive Entry system.

The vehicle doors can also be locked by using the key fob lock button or the lock button located on the vehicle's interior door panel ⇨ page 314.

**AUTOMATIC UNLOCK ON EXIT  
FEATURE — IF EQUIPPED**

If Auto Unlock is enabled within Uconnect Settings ⇨ page 155, this feature will unlock all the doors when any door is opened if the vehicle is in PARK.

**AUTOMATIC DOOR LOCKS —  
IF EQUIPPED**

When enabled, the door locks will lock automatically when the vehicle's speed exceeds 15 mph (24 km/h). Auto door lock feature is enabled/disabled within Uconnect Settings ⇨ page 155.

**CHILD-PROTECTION DOOR LOCK  
SYSTEM — REAR DOORS**

To provide a safer environment for small children riding in the rear seats, the rear doors are equipped with Child-Protection Door Lock system.

**To Engage Or Disengage The Child Protection Door Lock System**

1. Open the rear door.
2. Insert the tip of the emergency key into the lock and rotate to the lock or unlock position.
3. Repeat steps 1 and 2 for the opposite rear door.



**Child-Protection Door Lock Function**

**WARNING!**

Avoid trapping anyone in a vehicle in a collision. Remember that the rear doors can only be opened from the outside with the Child-Protection locks are engaged (locked).

**NOTE:**

For emergency exit with the system engaged, move the lock knob up (unlocked position), roll down the window, and open the door with the outside door handle.

**STEERING WHEEL****MANUAL TILT/TELESCOPING STEERING COLUMN — IF EQUIPPED**

This feature allows you to tilt the steering column upward or downward. It also allows you to lengthen or shorten the steering column. The tilt/telescoping lever is located below the steering wheel at the end of the steering column.

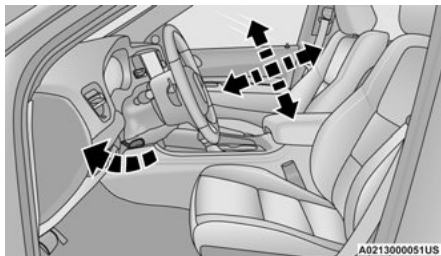
**Manual Tilt/Telescoping Steering Column Handle**

To unlock the steering column, push the lever downward (toward the floor). To tilt the steering column, move the steering wheel upward or downward as desired. To lengthen or shorten the steering column, pull the steering wheel outward or push it inward as desired. To lock the steering column in position, push the lever upward until fully engaged.

**WARNING!**

Do not adjust the steering column while driving. Adjusting the steering column while driving or driving with the steering column unlocked, could cause the driver to lose control of the vehicle. Failure to follow this warning may result in serious injury or death.

**POWER TILT/TELESCOPING STEERING COLUMN — IF EQUIPPED**

This feature allows you to tilt the steering column upward or downward. It also allows you to lengthen or shorten the steering column. The power tilt/telescoping steering column control is located below the multifunction lever on the steering column.

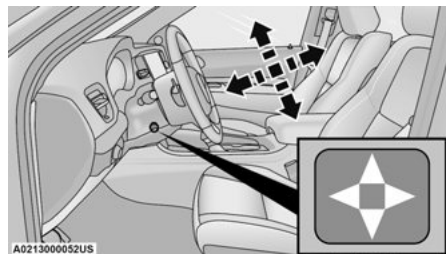
**Power Tilt/Telescoping Steering Control Location**

Use the four-way control to adjust the steering column.

**NOTE:**

For vehicles equipped with Driver Memory Settings ⇨ page 27, you can use your key fob or the memory switch on the driver's door trim panel to return the tilt/telescoping steering column to saved positions.



**WARNING!**

Do not adjust the steering column while driving. Adjusting the steering column while driving or driving with the steering column unlocked, could cause the driver to lose control of the vehicle. Failure to follow this warning may result in serious injury or death.

## HEATED STEERING WHEEL — IF EQUIPPED



The steering wheel contains a heating element that helps warm your hands in cold weather. The heated steering wheel has only one temperature setting. Once the heated steering wheel has been turned on, it will stay on until the operator turns it off. The heated steering wheel may not turn on when it is already warm.

The heated steering wheel control button is located on the center stack below the radio screen, or within the Uconnect system.

- Push the heated steering wheel button once to turn the heating element on.
- Push the heated steering wheel button a second time to turn the heating element off.

**NOTE:**

The engine must be running for the heated steering wheel to operate.

For information on use with the Remote Start system, see → page 20.

**WARNING!**

- Persons who are unable to feel pain to the skin because of advanced age, chronic illness, diabetes, spinal cord injury, medication, alcohol use, exhaustion, or other physical conditions must exercise care when using the steering wheel heater. It may cause burns even at low temperatures, especially if used for long periods.
- Do not place anything on the steering wheel that insulates against heat, such as a blanket or steering wheel covers of any type and material. This may cause the steering wheel heater to overheat.

## DRIVER MEMORY SETTINGS — IF EQUIPPED

This feature allows the driver to save up to two different memory profiles for easy recall through a memory switch. Each memory profile saves desired position settings for the following features:

- Driver seat
- Easy Entry/Exit seat (if equipped)

- Side mirrors
- Power tilt and telescopic steering column (if equipped)

- A set of desired radio station presets

**NOTE:**

- Your vehicle is equipped with two key fobs, each can be linked to either memory position 1 or 2.
- Be sure to program the radio presets prior to programming the memory settings.

The memory setting switch is located on the driver's door trim panel. The switch consists of three buttons:

- The set (S) button, which is used to activate the memory save function.
- The (1) and (2) buttons which are used to recall either of two saved memory profiles.

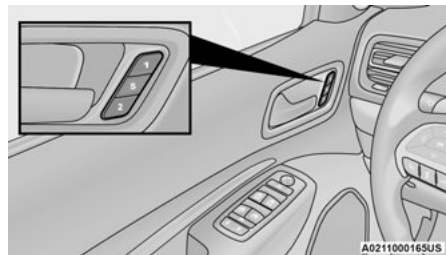

**Memory Setting Buttons**

## PROGRAMMING THE MEMORY FEATURE

To create a new memory profile, perform the following:

### NOTE:

Saving a new memory profile will erase the selected profile from memory.

1. Place the vehicle's ignition in the ON/RUN position (do not start the engine).
2. Adjust all memory profile settings to desired preferences (i.e., seat, side mirror, power tilt and telescopic steering column [if equipped], and radio station presets).
3. Push the set (S) button on the memory switch, and then push the desired memory button (1 or 2) within five seconds. The instrument cluster display will display which memory position has been set.

### NOTE:

Memory profiles can be set without the vehicle in PARK, but the vehicle must be in PARK to recall a memory profile.

## LINKING AND UNLINKING THE REMOTE KEYLESS ENTRY KEY FOB TO MEMORY

Your key fobs can be programmed to recall one of two saved memory profiles.

### NOTE:

Before programming your key fobs you must select the "Personal Settings Linked To Fob" feature through the Uconnect Settings ↗ page 155.

To program your key fobs, perform the following:

1. Place the vehicle's ignition in the OFF position.
2. Select a desired memory profile, 1 or 2.
3. Once the profile has been recalled, push and release the set (S) button on the memory switch. Then, within five seconds, push and release button (1) or (2) accordingly. "Memory Profile Set" (1 or 2) will display in the instrument cluster display.
4. Push and release the lock button on the key fob within 10 seconds.

### NOTE:

Your key fobs can be unlinked from your memory settings by pushing the set (S) button, and within 10 seconds, followed by pushing the unlock button on the key fob.

## MEMORY POSITION RECALL

### NOTE:

If a recall is attempted when the vehicle is not in PARK, a message will be displayed in the instrument cluster display.

To recall the memory settings for driver one or two, push the desired memory button (1 or 2) or the unlock button on the key fob linked to the desired memory position.

A recall can be canceled by pushing any of the memory buttons during a recall (S, 1, or 2), or by pushing any of the seat adjustment switches. When a recall is canceled, the driver's seat and telescopic steering column (if equipped) will stop moving. A delay of one second will occur before another recall can be selected.

## SEATS

Seats are a part of the Occupant Restraint system of the vehicle.

### WARNING!

- It is dangerous to ride in a cargo area, inside or outside of a vehicle. In a collision, people riding in these areas are more likely to be seriously injured or killed.
- Do not allow people to ride in any area of your vehicle that is not equipped with seats and seat belts. In a collision, people riding in these areas are more likely to be seriously injured or killed.
- Be sure everyone in your vehicle is in a seat and using a seat belt properly.

## MANUAL ADJUSTMENT (FRONT SEATS) — IF EQUIPPED

### WARNING!

- Adjusting a seat while the vehicle is moving is dangerous. The sudden movement of the seat could cause you to lose control. The seat belt might not be adjusted properly and you could be injured. Adjust the seat only while the vehicle is parked.
- Do not ride with the seatback reclined so that the shoulder belt is no longer resting against your chest. In a collision you could slide under the seat belt and be seriously or even fatally injured. Use the recliner only when the vehicle is parked.

### Manual Front Passenger Seat Forward/Rearward Adjustment

Some models may be equipped with a manual front passenger seat. The passenger seat can be adjusted forward or rearward by using a bar located by the front of the seat cushion, near the floor.

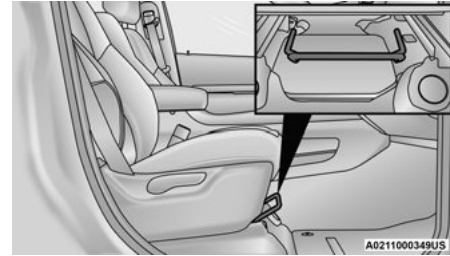

**Adjustment Bar**

While sitting in the seat, lift up on the bar located under the seat cushion and move the seat forward or rearward. Release the bar once you have reached the desired position. Then, using body pressure, move forward and rearward on the seat to be sure that the seat adjusters have latched.

### WARNING!

- Adjusting a seat while driving may be dangerous. Moving a seat while driving could result in loss of control which could cause a collision and serious injury or death.
- Seats should be adjusted before fastening the seat belts and while the vehicle is parked. Serious injury or death could result from a poorly adjusted seat belt.

### Manual Front Passenger Seatback Adjustment – Recline

To adjust the seatback, lift the lever located on the outboard side of the seat, lean back to the desired position and release the lever. To return the seatback, lift the lever, lean forward and release the lever.

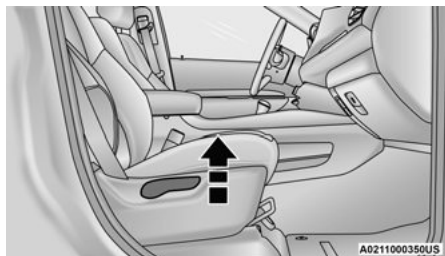

Recline Lever

#### WARNING!

Do not ride with the seatback reclined so that the shoulder belt is no longer resting against your chest. In a collision you could slide under the seat belt, which could result in serious injury or death.

### Front Passenger Seat Fold-Flat Feature – If Equipped

To fold the seatback to the flat load-floor position, lift the recline lever and push the seatback forward. To return to the seating position, raise the seatback and lock it into place.

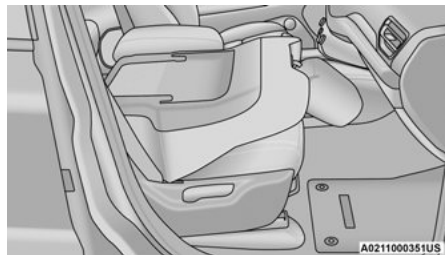

Fold-Flat Passenger Seat

#### WARNING!

- Adjusting a seat while the vehicle is moving is dangerous. The sudden movement of the seat could cause you to lose control. The seat belt might not be properly adjusted, and you could be severely injured or killed. Only adjust a seat while the vehicle is parked.

(Continued)

#### WARNING!

- Do not ride with the seatback reclined so that the seat belt is no longer resting against your chest. In a collision, you could slide under the seat belt and be severely injured or killed. Use the recliner only when the vehicle is parked.

#### CAUTION!

Do not place any article under a power seat or impede its ability to move as it may cause damage to the seat controls. Seat travel may become limited if movement is stopped by an obstruction in the seat's path.

### MANUAL ADJUSTMENT (REAR SEATS)

#### WARNING!

Do not pile luggage or cargo higher than the top of the seatback. This could impair visibility or become a dangerous projectile in a sudden stop or collision.

## 60/40 Split Rear Seat

### SECOND ROW FOLD-FLAT SEATS

The second row seats can be folded flat to carry cargo.

Pull upward on the release lever located on the outboard side of the seat.

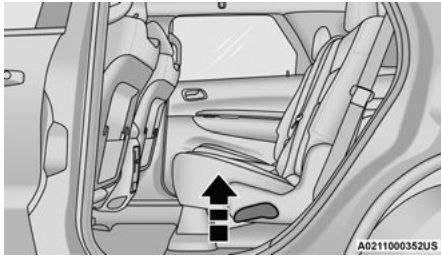

Release Lever



Fold-Flat Second Row Seats

#### NOTE:

You may experience deformation in the seat cushion from the seat belt buckles if the seats are left folded for an extended period of time. This is normal and by simply unfolding the seats to the open position, over time the seat cushion will return to its normal shape.

### EASY ACCESS FOR THIRD ROW

Either side of the rear seat can be tumbled forward to allow passengers to easily access the third row seats.

1. Pull upward on the release lever to release the seat.

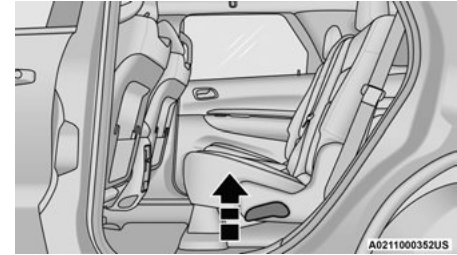

Release Lever

## 32 GETTING TO KNOW YOUR VEHICLE

2. Tumble the seat forward using the pull strap located behind the seatback.

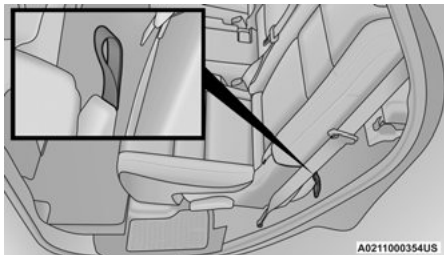

**Tumble Pull Strap**

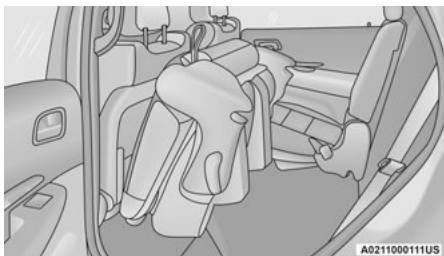

**Tumbled Second Row**

### **WARNING!**

Do not drive the vehicle with the second row seats in the tumbled position. The second row seats are only intended to be tumbled for entry and exit to the third row seat. Failure to follow these instructions could result in personal injury.

### **TO RAISE REAR SEAT**

Fold the seat rearward to its original position, and lock it into place. Then lift the head restraint until it locks into place.

### **WARNING!**

Be certain that the seatback is securely locked into position. If the seatback is not securely locked into position the seat will not provide the proper stability for child seats and/or passengers. An improperly latched seat could cause serious injury.

### **Rear Captain's Chairs — If Equipped**

#### **SECOND ROW CAPTAIN'S CHAIRS FOLD-FLAT SEATS**

The second row seats can be folded flat to carry cargo.

Pull upward on the release lever located on the outboard side of the seat.

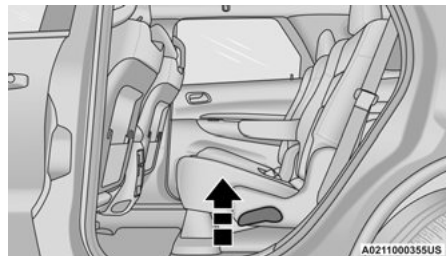

**Release Lever**



**Fold-Flat Second Row Seats**

### **NOTE:**

You may experience deformation in the seat cushion from the seat belt buckles if the seats are left folded for an extended period of time. This is normal and by simply unfolding the seats to the open position, over time the seat cushion will return to its normal shape.

## EASY ACCESS FOR THIRD ROW

Either side of the rear seat can be tumbled forward to allow passengers to easily access the third row seats.

1. Pull upward on the release lever to release the seat.

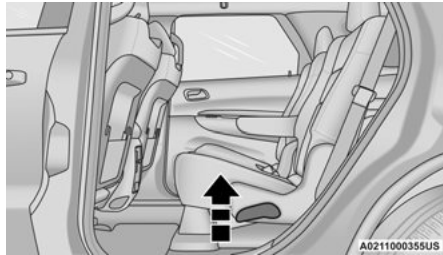

**Release Lever**

2. Tumble the seat forward using the pull strap located behind the seatback.



**Tumble Strap**

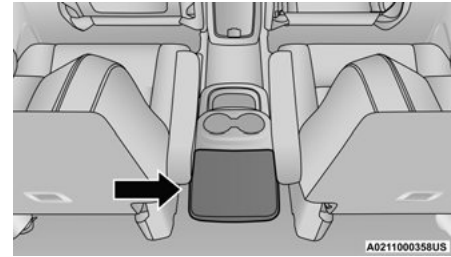

**Mini Console Stepping Pad**

### WARNING!

Do not drive the vehicle with the second row seats in the tumbled position. The second row seats are only intended to be tumbled for entry and exit to the third row seat. Failure to follow these instructions could result in personal injury.

3. If your vehicle is equipped with a mini console, there is a stepping pad to allow passengers to easily access the third row seats.

### TO RAISE REAR SEAT

Fold the seat rearward to its original position, and lock it into place. Then lift the head restraint until it locks into place.

### WARNING!

Be certain that the seatback is securely locked into position. If the seatback is not securely locked into position the seat will not provide the proper stability for child seats and/or passengers. An improperly latched seat could cause serious injury.

### Folding Third Row

Both third row seats can be folded forward to increase the cargo area. To lower either seat, pull on the release handle located on the back of the seat and lower the seat using the pull strap located next to the release handle.

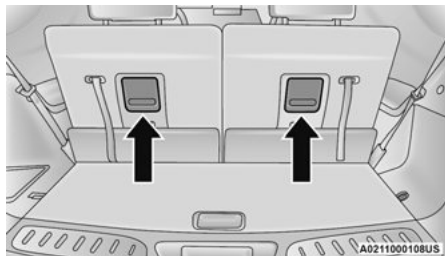

Release Handles

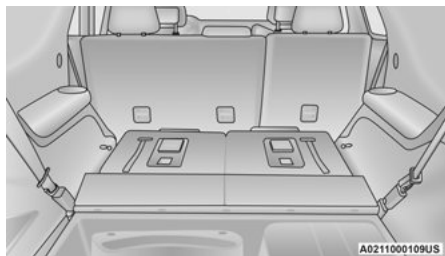

Third Row Folded

#### NOTE:

The second row seats must be in their full upright position, folded flat or tumbled when folding the third row seats.

To raise the seat, pull the seat toward you using the strap located on the back of the seat. Then lift the head restraint until it locks into place.

#### NOTE:

You may experience deformation in the seat cushion from the seat belt buckles if the seats are left folded for an extended period of time. This is normal and by simply unfolding the seats to the open position, over time the seat cushion will return to its normal shape.

#### WARNING!

Be certain that the seatback is securely locked into position. If the seatback is not securely locked into position the seat will not provide the proper stability for child seats and/or passengers. An improperly latched seat could cause serious injury.

### POWER ADJUSTMENT (FRONT SEATS) — IF EQUIPPED

Some models may be equipped with eight-way power driver and front passenger seats. The power seat switches are located on the outboard side of

the seat. There are two switches that control the movement of the seat cushion and the seatback.

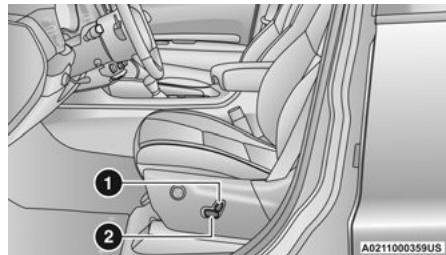

Power Seat Switches

- 1 — Seatback Switch
- 2 — Seat Switch

### Adjusting The Seat Forward Or Rearward

The seat can be adjusted both forward and rearward by using the seat switch. The seat will move in the direction of the switch. Release the switch when the desired position has been reached.

### Adjusting The Seat Up Or Down

The height of the seats can be adjusted up or down. Pull upward or push downward on the rear of the seat switch, the seat will move in the direction of the switch. Release the switch when the desired position has been reached.



## Tilting The Seat Up Or Down

The angle of the seat cushion can be adjusted in two directions. Pull upward or push downward on the front of the seat switch, the front of the seat cushion will move in the direction of the switch. Release the switch when the desired position has been reached.

## Reclining The Seatback

The angle of the seatback can be adjusted forward or rearward. Push the seatback switch forward or rearward, the seat will move in the direction of the switch. Release the switch when the desired position is reached.

### WARNING!

- Adjusting a seat while driving may be dangerous. Moving a seat while driving could result in loss of control which could cause a collision and serious injury or death.
- Seats should be adjusted before fastening the seat belts and while the vehicle is parked. Serious injury or death could result from a poorly adjusted seat belt.
- Do not ride with the seatback reclined so that the shoulder belt is no longer resting against your chest. In a collision you could slide under the seat belt, which could result in serious injury or death.

### CAUTION!

Do not place any article under a power seat or impede its ability to move as it may cause damage to the seat controls. Seat travel may become limited if movement is stopped by an obstruction in the seat's path.

## Power Lumbar — If Equipped

Vehicles equipped with power driver or passenger seats may also be equipped with power lumbar. The power lumbar switch is located on the outboard side of the power seat. Push the switch forward to increase the lumbar support. Push the switch rearward to decrease the lumbar support. Pushing upward or downward on the switch will raise and lower the position of the support.

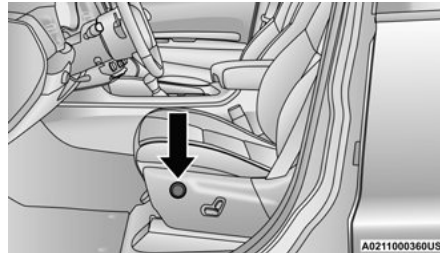

Power Lumbar Switch

## Easy Entry/Exit Seat — If Equipped

This feature provides automatic driver seat positioning to enhance driver mobility when entering and exiting the vehicle.

The distance the driver seat moves depends on where you have the driver seat positioned when you place the vehicle's ignition in the OFF position.

- When you place the vehicle's ignition in the OFF position, the driver seat will move about 2.4 inches (60 mm) rearward if the driver seat position is greater than or equal to 2.7 inches (67.7 mm) forward of the rear stop. The seat will return to its previously set position when you place the vehicle's ignition in the ACC or RUN position.
- The Easy Entry/Exit feature is not available when the driver seat position is less than 0.9 of an inch (22.7 mm) forward of the rear stop. At this position, there is no benefit to the driver by moving the seat for Easy Exit or Easy Entry.

When enabled in Uconnect Settings, Easy Entry and Easy Exit positions are stored in each Driver Memory Setting profile ↗ page 27.

### NOTE:

The Easy Entry/Exit feature is enabled (or disabled) through the programmable features in the Uconnect system ↗ page 155.

## POWER PASSENGER SEAT ADJUSTMENT — IF EQUIPPED

Some models are equipped with a six-way power passenger seat. The power seat switch is located on the outboard side of the seat. The switch is used to control the movement of the seat and seat cushion.

### Adjusting The Seat Forward Or Rearward

The seat can be adjusted both forward and rearward by using the seat switch. The seat will move in the direction of the switch. Release the switch when the desired position has been reached.

### Adjusting The Seat Up Or Down

The height of the seats can be adjusted up or down. Pull upward or push downward on the rear of seat switch, the seat will move in the direction of the switch. Release the switch when the desired position has been reached.

### Tilting The Seat Up Or Down

The angle of the seat cushion can be adjusted in two directions. Pull upward or push downward on the front of the seat switch, the front of the seat cushion will move in the direction of the switch. Release the switch when the desired position has been reached.

## Reclining The Seatback

The angle of the seatback can be adjusted forward or rearward. Push the seatback switch forward or rearward, the seat will move in the direction of the switch. Release the switch when the desired position is reached.

### WARNING!

- Adjusting a seat while driving may be dangerous. Moving a seat while driving could result in loss of control which could cause a collision and serious injury or death.
- Seats should be adjusted before fastening the seat belts and while the vehicle is parked. Serious injury or death could result from a poorly adjusted seat belt.
- Do not ride with the seatback reclined so that the shoulder belt is no longer resting against your chest. In a collision you could slide under the seat belt, which could result in serious injury or death.

### CAUTION!

Do not place any article under a power seat or impede its ability to move as it may cause damage to the seat controls. Seat travel may become limited if movement is stopped by an obstruction in the seat's path.

## Power Lumbar — If Equipped

The power lumbar switch is located on the outboard side of the power seat. Push the switch forward to increase the lumbar support. Push the switch rearward to decrease the lumbar support. Pushing upward or downward on the switch will raise and lower the position of the support.

## HEATED SEATS — IF EQUIPPED

### WARNING!

- Persons who are unable to feel pain to the skin because of advanced age, chronic illness, diabetes, spinal cord injury, medication, alcohol use, exhaustion or other physical condition must exercise care when using the seat heater. It may cause burns even at low temperatures, especially if used for long periods of time.
- Do not place anything on the seat or seatback that insulates against heat, such as a blanket or cushion. This may cause the seat heater to overheat. Sitting in a seat that has been overheated could cause serious burns due to the increased surface temperature of the seat.

## Front Heated Seats — If Equipped



The front heated seats control buttons are located on the center stack below the radio screen, or within the Uconnect system.

- Push the heated seat switch once to turn the HI setting on.
- Push the heated seat switch a second time to turn the MED setting on.
- Push the heated seat switch a third time to turn the LO setting on.
- Push the heated seat switch a fourth time to turn the heating elements off.

### NOTE:

- Once a heat setting is selected, heat will be felt within two to five minutes.
- The engine must be running for the heated seats to operate.
- The level of heat selected will stay on until the operator changes it.

For information on use with the Remote Start system, see ⇨ page 20.

## Rear Heated Seats — If Equipped



The two second row outboard seats may be equipped with heated seats. There are two heated seat switches that allow the rear passengers to operate the seats independently. The heated seat switches for each heater are located on the rear of the center console.

You can choose from HI, LO, or off heat settings. Amber indicator lights in each switch indicate the level of heat in use. Two indicator lights will illuminate for HI, one for LO and none for off.

- Push the switch once to turn the HI setting on.
- Push the switch a second time to turn the LO setting on.
- Push the switch a third time to turn the heating elements off.

The level of heat selected will stay on until the operator changes it.

### NOTE:

The engine must be running for the heated seats to operate.

## FRONT VENTILATED SEATS — IF EQUIPPED



The ventilated seats control buttons are located on the center stack below the radio screen, or within the Uconnect system. The fans operate at three speeds: HI, MED, and LO.

- Press the ventilated seat switch once to choose HI.
- Press the ventilated seat switch a second time to choose MED.
- Press the ventilated seat switch a third time to choose LO.
- Press the ventilated seat switch a fourth time to turn the ventilation off.

### NOTE:

The engine must be running for the ventilated seats to operate.

For information on use with the Remote Start system, see ⇨ page 20.

## HEAD RESTRAINTS

Head restraints are designed to reduce the risk of injury by restricting head movement in the event of a rear impact. Head restraints should be adjusted so that the top of the head restraint is located above the top of your ear.

### WARNING!

- All occupants, including the driver, should not operate a vehicle or sit in a vehicle's seat until the head restraints are placed in their proper positions in order to minimize the risk of neck injury in the event of a crash.
- Head restraints should never be adjusted while the vehicle is in motion. Driving a vehicle with the head restraints improperly adjusted or removed could cause serious injury or death in the event of a collision.

### Front Head Restraints

Your vehicle is equipped with front four-way driver and passenger head restraints.

To raise the head restraint, pull upward on the head restraint. To lower the head restraint, push the adjustment button, located at the base of the head restraint, and push downward on the head restraint.

### NOTE:

The head restraints should only be removed by qualified technicians, for service purposes only. If either of the head restraints require removal, see an authorized dealer.

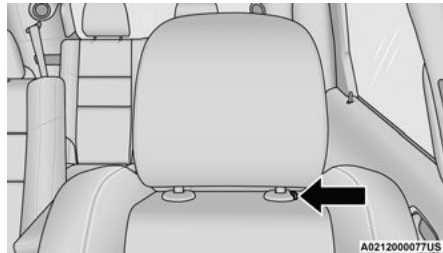

Head Restraint Adjustment Button Location

To adjust the head restraint forward, pull the top of the head restraint toward the front of the vehicle as desired and release. To adjust the head restraint rearward, pull the top of the head restraint to the forward most position and release. The head restraint will return to the rear most position.

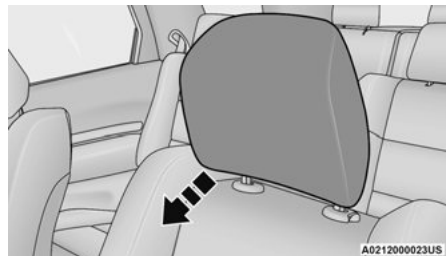

Forward Adjustment

### WARNING!

- All occupants, including the driver, should not operate a vehicle or sit in a vehicle's seat until the head restraints are placed in their proper positions in order to minimize the risk of neck injury in the event of a crash.
- Head restraints should never be adjusted while the vehicle is in motion. Driving a vehicle with the head restraints improperly adjusted or removed could cause serious injury or death in the event of a collision.

## Head Restraints — Rear Seats

The head restraints on the outboard seats are not adjustable. They automatically fold forward when the rear seat is folded to a load floor position, but do not return to their normal position when the rear seat is raised. After returning either seat to its upright position, raise the head restraint until it locks in place. The outboard head restraints are not removable.

The center head restraint has limited adjustment. Lift upward on the head restraint to raise it or push downward on the head restraint to lower it.



Rear Head Restraint

### WARNING!

Sitting in a seat with the head restraint in its lowered position could result in serious injury or death in a collision. Always make sure the outboard head restraints are in their upright positions when the seat is to be occupied.

### NOTE:

For proper routing of a Child Seat Tether, see [page 201](#).

## Head Restraint Removal — Rear Seats

The center head restraint can be adjusted when occupied, or removed for Child Seat Tethering. To remove the head restraint, raise it as far as it can go by pulling upward. Then, push the release button at the base of the post while pulling the head restraint upward. To reinstall the head restraint, put the head restraint posts into the holes and push downward. Then, adjust the head restraint to the appropriate height.

### WARNING!

- ALL the head restraints MUST be reinstalled in the vehicle to properly protect the occupants. Follow the reinstallation instructions above prior to operating the vehicle or occupying a seat.
- Sitting in a seat with the head restraint in its lowered position could result in serious injury or death in a collision. Always make sure the outboard head restraints are in their upright positions when the seat is to be occupied.

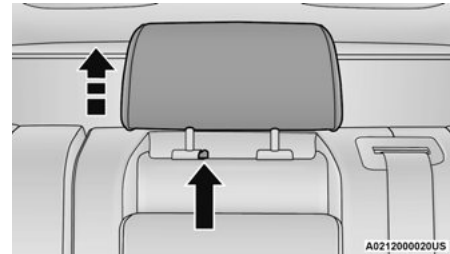

Center Head Restraint Release Button

**NOTE:**

For proper routing of a Child Seat Tether, see  page 201.

**WARNING!**

- A loose head restraint thrown forward in a collision or hard stop could cause serious injury or death to occupants of the vehicle. Always securely stow removed head restraints in a location outside the occupant compartment.
- ALL the head restraints MUST be reinstalled in the vehicle to properly protect the occupants. Follow the reinstallation instructions above prior to operating the vehicle or occupying a seat.

**Power Folding Third Row Head Restraints**

For improved visibility when in REVERSE, the third row head restraints can be folded using the Uconnect system.

Press the “Controls” button located on the bottom of the Uconnect display.



Press the Headrest Fold button to power fold the third row head restraints.

**NOTE:**

- The head restraints can only be folded downward using the Headrest Fold button. The head restraints must be raised manually when occupying the third row.
- Do not fold if there are passengers seated in the third row seats.

**UCONNECT VOICE RECOGNITION****INTRODUCING VOICE RECOGNITION**

Start using Uconnect Voice Recognition (VR) with these helpful quick tips. It provides the key Voice Commands and tips you need to know to control your Uconnect system.

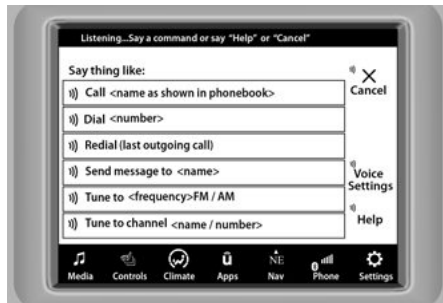
**Voice Recognition****BASIC VOICE COMMANDS**

The basic Voice Commands below can be given at any point while using your Uconnect system.

Push the VR button  or for the Uconnect 5 NAV With 10.1-inch Display, say the vehicle’s Wake Up word, “Hey Uconnect”. After the beep, say:

- “**Cancel**” to stop a current voice session
- “**Help**” to hear a list of suggested Voice Commands
- “**Repeat**” to listen to the system prompts again

Notice the visual cues that inform you of your voice recognition system’s status. Cues appear on the touchscreen.

**NOTE:**

On Uconnect 5 systems, the factory default Wake Up word is set to “Hey Uconnect” and can be reprogrammed through the Uconnect Settings.

## GET STARTED

All you need to control your Uconnect system with your voice are the buttons on your steering wheel.

Helpful hints for using Voice Recognition:

- Reduce background noise. Wind and passenger conversations are examples of noise that may impact recognition.
- Speak clearly at a normal pace and volume while facing straight ahead.
- Each time you give a Voice Command, first push the VR button, wait until after the beep, then say your Voice Command. You can also say the vehicle Wake Up word and state your command. Some examples of Wake Up words include “Hey Uconnect” or “Hey Dodge”.
- A passenger can press the VR button shortcut on the radio status bar to also issue a command.
- You can interrupt the help message or system prompts by pushing the VR button and saying a Voice Command from the current category.

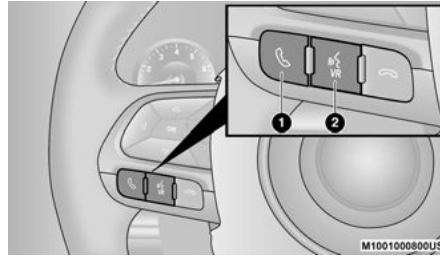

**Uconnect Voice Command Buttons**

- 1 – Push To Answer An Incoming Phone Call
- 2 – For The Uconnect 4C/4C NAV With 8.4-inch Display: Push The Voice Recognition Button To Start A Phone Call, Begin Radio, Media, Navigation (If Equipped) And Climate Functions, Or Send Or Receive A Text
- 2 – For The Uconnect 5/5 NAV System Vehicles Equipped With Navigation: Push The Voice Recognition Button To Begin Radio, Media, Navigation, Climate, Start Or Answer A Phone Call, And Send Or Receive A Text
- 2 – For The Uconnect 5/5 NAV System Vehicles Not Equipped With Navigation: Push The Phone Button To Answer An Incoming Phone Call

## ADDITIONAL INFORMATION

© 2021 FCA US LLC. All rights reserved. Mopar and Uconnect are registered trademarks and Mopar Owner Connect is a trademark of FCA US LLC. SiriusXM® and all related marks and logos are trademarks of SiriusXM® Radio Inc. ↪ page 314.

Uconnect System Support:

- US residents visit [www.DriveUconnect.com](http://www.DriveUconnect.com) or call: 1-877-855-8400 (24 hours a day 7 days a week)
- Canadian residents visit [www.DriveUconnect.ca](http://www.DriveUconnect.ca) or call: 1-800-465-2001 (English) or 1-800-387-9983 (French)

SiriusXM Guardian™ services support:

- US residents visit [www.driveuconnect.com/sirius-xm-guardian](http://www.driveuconnect.com/sirius-xm-guardian) or call: 1-844-796-4827
- Canadian residents visit <https://www.driveuconnect.ca/en/sirius-xm-guardian> or call: 1-877-324-9091

## MIRRORS

### INSIDE REARVIEW MIRROR

#### Automatic Dimming Mirror — If Equipped

The rearview mirror can be adjusted up, down, left, and right. The mirror should be adjusted to center on the view through the rear window.

This mirror automatically adjusts for headlight glare from vehicles behind you.

#### NOTE:

The Automatic Dimming Mirror feature is disabled when the vehicle is in REVERSE to improve rear view viewing.

You can turn the feature on or off by pushing the button at the base of the mirror. A light in the button will illuminate to indicate when the dimming feature is activated. Some vehicles may be equipped with an auto dimming mirror with no on/off button in the mirror. If that is the case, the mirror will default to auto dimming on and the feature can be disabled in the radio through a soft button in the radio.



Automatic Dimming Mirror

### ILLUMINATED VANITY MIRRORS

To access an illuminated vanity mirror, flip down one of the visors and lift the cover.

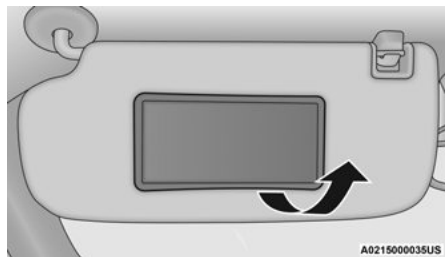

Illuminated Vanity Mirror

### Sun Visor “Slide-On-Rod” Feature — If Equipped

The sun visor “Slide-On-Rod” feature allows for additional flexibility in positioning the sun visor to block out the sun.

1. Fold down the sun visor.
2. Unclip the visor from the corner clip.
3. Pivot the sun visor toward the side window.
4. Extend the sun visor blade for additional sun blockage.

#### NOTE:

The sun visor blade can also be extended while the sun visor is against the windshield for additional sun blockage through the front of the vehicle.

### OUTSIDE MIRRORS

The outside mirror(s) can be adjusted to the center of the adjacent lane of traffic to achieve the optimal view.

#### WARNING!

Vehicles and other objects seen in an outside convex mirror will look smaller and farther away than they really are. Relying too much on side convex mirrors could cause you to collide with another vehicle or other object. Use your inside mirror when judging the size or distance of a vehicle seen in a side convex mirror.



## Outside Mirrors Folding Feature

All outside mirrors are hinged and may be moved either forward or rearward to resist damage. The hinges have three detent positions:

- Full forward position
- Full rearward position
- Normal position

## OUTSIDE AUTOMATIC DIMMING MIRROR— IF EQUIPPED

The driver's side outside mirror will automatically adjust for glare from vehicles behind you. This feature is controlled by the inside automatic dimming mirror. The mirror will automatically adjust for headlight glare when the inside mirror adjusts.

## POWER MIRRORS

The power mirror switch is located on the driver's side door trim panel.

The power mirror controls consist of mirror select buttons and a four-way mirror control switch. To adjust a mirror, push the mirror select button for the mirror that you want to adjust. Using the mirror control switch, push on any of the four arrows for the direction that you want the mirror to move.

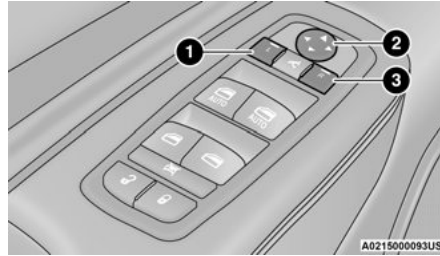

Power Mirror Switch

- 1 — Left Mirror Selection
- 2 — Mirror Direction Control
- 3 — Right Mirror Selection

Power mirror positions can be saved to a Driver Memory Settings profile (if equipped) ↪ page 27.

## HEATED MIRRORS — IF EQUIPPED



These mirrors are heated to melt frost or ice. This feature will be activated whenever you turn on the rear window defroster (if equipped) ↪ page 55.

## TILT SIDE MIRRORS IN REVERSE — IF EQUIPPED

This feature provides automatic outside mirror positioning which will assist the driver's ground visibility. Outside mirrors will move slightly downward from the present position when the vehicle is shifted into REVERSE. Outside mirrors will then return to the original position when the vehicle is shifted out of REVERSE position. If the vehicle is equipped with Driver Memory Settings, this feature will be linked to the programmable settings.

### NOTE:

The Tilt Side Mirrors In Reverse feature can be turned on and off using the Uconnect system ↪ page 155.

## UNIVERSAL GARAGE DOOR OPENER (HOMELINK®)

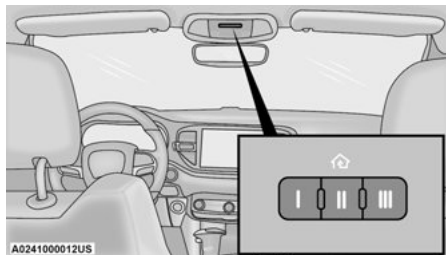

HomeLink® Buttons And Indicator Light

Use this QR code to access your digital experience.

- HomeLink® replaces up to three hand-held transmitters that operate devices such as garage door openers, motorized gates, lighting or home security systems. The HomeLink® unit is powered by your vehicle's 12 Volt battery.
- The HomeLink® buttons that are located in the overhead console or sunvisor designate the three different HomeLink® channels.



- To operate HomeLink®, push and release any of the programmed HomeLink® buttons. These buttons will activate the devices they are programmed to with each press of the corresponding HomeLink® button.
- The HomeLink® indicator light is located above the center button.

### NOTE:

HomeLink® is disabled when the Vehicle Security system is active ↪ page 314.

## BEFORE YOU BEGIN PROGRAMMING HOMELINK®

For efficient programming and accurate transmission of the Radio Frequency (RF) signal, it is recommended that a new battery be placed in the hand-held transmitter of the device that is being programmed to the HomeLink® system. Make sure your hand-held transmitter is programmed to activate the device you are trying to program your HomeLink® button to.

Ensure that your vehicle is parked outside of the garage before you begin programming.

It is recommended that you erase all the channels of your HomeLink® before you use it for the first time.

## ERASING ALL THE HOMELINK® CHANNELS

To erase the channels, follow this procedure:

1. Place the ignition switch into the ON/RUN position.
2. Push and hold the two outside HomeLink® buttons (I and III) for up to 20 seconds, or until the HomeLink® indicator light flashes.

### NOTE:

Erasing all channels should only be performed when programming HomeLink® for the first time. Do not erase channels when programming additional buttons.

## IDENTIFYING WHETHER YOU HAVE A ROLLING CODE OR NON-ROLLING CODE DEVICE

Before programming a device to one of your HomeLink® buttons, you must determine whether the device has a rolling code or non-rolling code.

### Rolling Code Devices

To determine if your device has a rolling code, a good indicator is its manufacturing date. Typically, devices manufactured after 1995 have rolling codes. A device with a rolling code will also have a "LEARN" or "TRAIN" button located where the antenna is attached to the device. The button may

not be immediately visible when looking at the device. The name and color of the button may vary slightly by manufacturer.

**NOTE:**

The “LEARN” or “TRAIN” button is not the button you normally use to operate the device.

**Non-rolling Code Devices**

Most devices manufactured before 1995 will not have a rolling code. These devices will also not have a “LEARN” or “TRAIN” button.

**PROGRAMMING HOMELINK® TO A GARAGE DOOR OPENER**

To program any of the HomeLink® buttons to activate your garage door opener motor, follow the steps below:

**NOTE:**

All HomeLink® buttons are programmed using this procedure. You do not need to erase all channels when programming additional buttons.

1. Place the ignition switch into the ON/RUN position.
2. Place the garage door opener transmitter 1 to 3 inches (3 to 8 cm) away from the HomeLink® button you wish to program, while keeping the HomeLink® indicator light in view.
3. Push and hold the HomeLink® button you want to program while you push and hold the

garage door opener transmitter button you are trying to replicate.

4. Continue to hold both buttons and observe the HomeLink® indicator light. The HomeLink® indicator light will flash slowly and then rapidly. Once this happens, release both buttons.

**NOTE:**

Make sure the garage door opener motor is plugged in before moving on to the rolling code/non-rolling code final steps.

**Rolling Code Garage Door Opener Final Steps**

**NOTE:**

You have 30 seconds in which to initiate rolling code final step 2, after completing rolling code final step 1.

1. At the garage door opener motor (in the garage), locate the “LEARN” or “TRAIN” button. This can usually be found where the hanging antenna wire is attached to the garage door opener motor. Firmly push and release the “LEARN” or “TRAIN” button.
2. Return to the vehicle and push the programmed HomeLink® button three times (holding the button for two seconds each time). If the garage door opener motor operates, programming is complete.
3. Push the programmed HomeLink® button to confirm that the garage door opener motor

operates. If the garage door opener motor does not operate, repeat the final steps for the rolling code procedure.

**Non-Rolling Code Garage Door Opener Final Steps**

1. Push and hold the programmed HomeLink® button and observe the HomeLink® indicator light. If the HomeLink® indicator light stays on constantly, programming is complete.
2. Push the programmed HomeLink® button to confirm that the garage door opener motor operates. If the garage door opener motor does not operate, repeat the steps from the beginning.

2

**WARNING!**

- Your motorized door or gate will open and close while you are programming the universal transceiver. Do not program the transceiver if people or pets are in the path of the door or gate.
- Do not run your vehicle in a closed garage or confined area while programming the transceiver. Exhaust gas from your vehicle contains Carbon Monoxide (CO) which is odorless and colorless. Carbon Monoxide is poisonous when inhaled and can cause you and others to be severely injured or killed.

## PROGRAMMING HOMELINK® TO A MISCELLANEOUS DEVICE

The procedure on how to program HomeLink® to a miscellaneous device follows the same procedure as programming to a garage door opener

➤ page 45. Be sure to determine if the device has a rolling code, or non-rolling code before beginning the programming process.

### NOTE:

Canadian Radio Frequency (RF) laws require transmitter signals to time-out (or quit) after several seconds of transmission, which may not be long enough for HomeLink® to pick up the signal during programming. Similar to this Canadian law, some U.S. gate operators are designed to time-out in the same manner. The procedure may need to be performed multiple times to successfully pair the device to your HomeLink® buttons.

## REPROGRAMMING A SINGLE HOMELINK® BUTTON

To reprogram a single HomeLink® button that has been previously trained, without erasing all the channels, follow the procedure below. Be sure to determine whether the new device you want to program the HomeLink® button to has a rolling code, or non-rolling code.

1. Place the ignition to the ON/RUN position, without starting the engine.
2. Push and hold the desired HomeLink® button until the HomeLink® indicator light begins to flash after 20 seconds. **Do not release the button.**
3. **Without releasing the button**, proceed with Step 2 in “Programming HomeLink® To A Garage Door Opener” and follow all remaining steps.

## CANADIAN/GATE OPERATOR PROGRAMMING

For programming transmitters in Canada/United States that require the transmitter signals to “time-out” after several seconds of transmission:

Canadian Radio Frequency (RF) laws require transmitter signals to time-out (or quit) after several seconds of transmission, which may not be long enough for HomeLink® to pick up the signal during programming. Similar to this Canadian law, some U.S. gate operators are designed to time-out in the same manner.

It may be helpful to unplug the device during the cycling process to prevent possible overheating of the garage door or gate motor.

1. Place the ignition in the ON/RUN position.

### NOTE:

For vehicles equipped with Keyless Enter ‘n Go™, place the ignition in the RUN position with the engine on. Make sure while programming HomeLink® with the engine on that your vehicle is outside of your garage, or that the garage door remains open at all times.

2. Place the hand-held transmitter 1 to 3 inches (3 to 8 cm) away from the HomeLink® button you wish to program while keeping the HomeLink® indicator light in view.
3. Continue to push and hold the HomeLink® button while you push and release (cycle) your hand-held transmitter every two seconds until HomeLink® has successfully accepted the frequency signal. The indicator light will flash slowly and then rapidly when fully trained.
4. Watch for the HomeLink® indicator to change flash rates. When it changes, it is programmed. It may take up to 30 seconds or longer in rare cases. The garage door may open and close while you are programming.
5. Push and hold the programmed HomeLink® button and observe the indicator light.

**NOTE:**

- If the indicator light stays on constantly, programming is complete and the garage door/device should activate when the HomeLink® button is pushed.
- To program the two remaining HomeLink® buttons, repeat each step for each remaining button. DO NOT erase the channels.

If you unplugged the garage door opener/device for programming, plug it back in at this time.

### Reprogramming A Single HomeLink® Button (Canadian/Gate Operator)

To reprogram a channel that has been previously trained, follow these steps:

1. Place the ignition in the ON/RUN position.
2. Press and hold the desired HomeLink® button until the indicator light begins to flash after 20 seconds. Do not release the button.
3. Without releasing the button, proceed with “Canadian/Gate Operator Programming” Step 2 and follow all remaining steps.

**SECURITY**

It is advised to erase all channels before you sell or turn in your vehicle.

To do this, push and hold the two outside buttons for 20 seconds until the indicator flashes.

**NOTE:**

All channels will be erased. Individual channels cannot be erased.

The HomeLink® Universal Transceiver is disabled when the Vehicle Security system is active.

**TROUBLESHOOTING TIPS**

If you are having trouble programming HomeLink®, here are some of the most common solutions:

- Replace the battery in the garage door opener hand-held transmitter.
- Push the LEARN button on the garage door opener to complete the training for a rolling code.
- Did you unplug the device for programming and remember to plug it back in?

If you have any problems, or require assistance, please call toll-free 1-800-355-3515 or, on the Internet at HomeLink.com for information or assistance.

**WARNING!**

- Vehicle exhaust contains carbon monoxide, a dangerous gas. Do not run your vehicle in the garage while programming the transceiver. Exhaust gas can cause serious injury or death.
- Your motorized door or gate will open and close while you are programming the universal transceiver. Do not program the transceiver if people, pets or other objects are in the path of the door or gate. Only use this transceiver with a garage door opener that has a “stop and reverse” feature as required by Federal safety standards. This includes most garage door opener models manufactured after 1982. Do not use a garage door opener without these safety features.

## EXTERIOR LIGHTS

### MULTIFUNCTION LEVER

The multifunction lever is located on the left side of the steering column.



A0216000205US

**Multifunction Lever**

### HEADLIGHT SWITCH

The headlight switch is located on the left side of the instrument panel, next to the steering wheel. The headlight switch controls the operation of the headlights, parking lights, instrument panel lights, cargo lights and fog lights (if equipped).

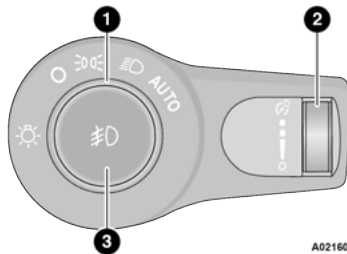

A0216000161US

**Headlight Switch**

- 1 – Rotate Headlight Switch
- 2 – Dimmer Control
- 3 – Fog Light Switch

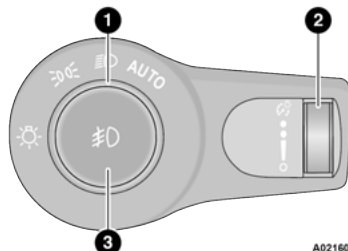

A0216000203US

**Headlight Switch (Vehicles Sold In Canada)**

- 1 – Rotate Headlight Switch
- 2 – Dimmer Control
- 3 – Fog Light Switch

#### NOTE:

Vehicles sold in Canada are equipped with a headlight switch with an AUTO and ON detent but without an OFF detent. Headlights will be deactivated when the headlight switch is placed in the parking lights position. However, the Daytime Running Lights (DRLs) will be activated along with the front and rear marker lights. The DRLs may be deactivated when the parking brake is engaged.

To turn on the headlights, rotate the headlight switch clockwise. When the headlight switch is on, the parking lights, taillights, license plate light and instrument panel lights are also turned on. To turn off the headlights, rotate the headlight switch back to the O (off) position.

**NOTE:**

For vehicles sold in Canada, rotate the headlight switch clockwise from the parking lights and instrument panel lights position to the first detent to turn on headlights, parking lights, and instrument panel lights. Rotate the headlight switch to the second detent for the AUTO position.

**NOTE:**

- Your vehicle is equipped with plastic headlight and fog light (if equipped) lenses that are lighter and less susceptible to stone breakage than glass lights. Plastic is not as scratch resistant as glass and therefore different lens cleaning procedures must be followed.
- To minimize the possibility of scratching the lenses and reducing light output, avoid wiping with a dry cloth. To remove road dirt, wash with a mild soap solution followed by rinsing.

**CAUTION!**

Do not use abrasive cleaning components, solvents, steel wool or other abrasive materials to clean the lenses.

## DAYTIME RUNNING LIGHTS (DRLs)

The Daytime Running Lights (DRLs) come on whenever the engine is running. The lights will remain on until the ignition is placed in the OFF position, or the parking brake is engaged. The headlight switch must be used during normal nighttime driving.

**NOTE:**

- For vehicles sold in Canada, the Daytime Running Lights will automatically deactivate when the front fog lights are turned on.
- If allowed by law in the country in which the vehicle was purchased, the Daytime Running Lights can be turned on and off using the Uconnect system ↗ page 155.
- On some vehicles, the Daytime Running Lights may deactivate or reduce intensity on one side of the vehicle (when a turn signal is activated on that side), or on both sides of the vehicle (when the hazard warning lights are activated).

## HIGH/LOW BEAM SWITCH

Push the multifunction lever toward the instrument panel to switch the headlights to high beams. Pulling the multifunction back will turn the low beams on.

## AUTOMATIC HIGH BEAM — IF EQUIPPED

The Automatic High Beam Headlamp Control system provides increased forward lighting at night by automatically controlling the high beams through the use of a camera mounted on the inside rearview mirror. This camera detects vehicle specific light and automatically switches from high beams to low beams until the approaching vehicle is out of view.

**NOTE:**

- The Automatic High Beam Headlamp Control can be turned on or off by selecting or deselecting “Auto Dim High Beams” within your Uconnect Settings ↗ page 155, as well as turning the headlight switch to the AUTO position.
- Broken, muddy, or obstructed headlights and taillights of vehicles in the field of view will cause headlights to remain on longer (closer to the vehicle). Also, dirt, film, and other obstructions on the windshield or camera lens will cause the system to function improperly.
- If the windshield or Automatic High Beam Headlamp Control mirror is replaced, the mirror must be re-aimed to ensure proper performance. See a local authorized dealer.
- To opt out of the Advanced Auto High-Beam Sensitivity Control (default) and enter Reduced High-Beam Sensitivity Control (not recom-

mended), toggle high beam lever six full on/off cycles within 10 seconds of ignition ON. System will return to default setting upon ignition off.

## FLASH-TO-PASS

You can signal another vehicle with your headlights by lightly pulling the multifunction lever toward you. This will cause the high beam headlights to turn on, and remain on, until the lever is released.

## AUTOMATIC HEADLIGHTS

This system automatically turns the headlights on or off according to ambient light levels. To turn the system on, rotate the headlight switch counterclockwise to the AUTO position. When the system is on, the headlight time delay feature is also on. This means the headlights will stay on for up to 90 seconds after you place the ignition into the OFF position. The headlight time delay can be programmed 0/30/60/90 seconds within Uconnect Settings ↗ page 155.

To turn the automatic system off, move the headlight switch out of the AUTO position.

### NOTE:

The engine must be running before the headlights will come on in the automatic mode.

## PARKING LIGHTS AND PANEL LIGHTS

To turn on the parking lights and instrument panel lights, rotate the headlight switch clockwise. To turn off the parking lights, rotate the headlight switch back to the 0 (off) position.

### NOTE:

Vehicles sold in Canada are equipped with a headlight switch with an AUTO and ON detent but without an OFF detent. Headlights will be deactivated when the headlight switch is placed in the parking lights position. However, the Daytime Running Lights (DRLs) will be activated along with the front and rear marker lights. The DRLs may be deactivated when the parking brake is engaged.

## AUTOMATIC HEADLIGHTS WITH WIPERS

If your vehicle is equipped with Automatic Headlights, it also has this customer-programmable feature. When your headlights are in the automatic mode and the engine is running, they will automatically turn on when the wiper system is on. This feature is programmable through the Uconnect system ↗ page 155.

### NOTE:

When your headlights come on during the daytime, the vehicle will monitor outside brightness and decide if the instrument panel needs to be dimmed or not ↗ page 52.

## HEADLIGHT DELAY

To assist when exiting the vehicle, the headlight delay feature will leave the headlights on for up to 90 seconds. This delay is initiated when the ignition is placed in the OFF position while the headlight switch is on, and then the headlight switch is cycled off. Headlight delay can be canceled by either turning the headlight switch on then off, or by placing the ignition in the ON position.

### NOTE:

The headlight delay time is programmable through the Uconnect system ↗ page 155.

## LIGHTS-ON REMINDER

If the headlights, parking lights, or cargo lights are left on after the ignition is placed in the OFF position, the vehicle will chime when the driver's door is opened.



## FOG LIGHTS — IF EQUIPPED

The fog lights are turned on by pushing fog light button on the headlight switch.

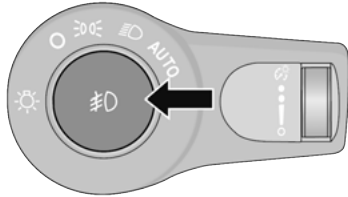

A0216000074US

Fog Light Operation

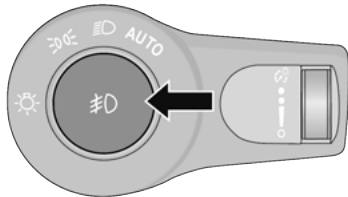

A02160000204US

Fog Light Operation (Vehicles Sold In Canada)

The fog lights will operate only when the parking lights are on or when the vehicle headlights are on low beam. An indicator light located in the instrument cluster display will illuminate when the fog lights are on. The fog lights will turn off when the switch is pushed a second time, when the headlight switch is rotated to the off position, or the high beam is selected.

## TURN SIGNALS

Move the multifunction lever up or down to activate the turn signals. The arrows on each side of the instrument cluster flash to show proper operation.

### NOTE:

If either light remains on and does not flash, or there is a very fast flash rate, check for a defective outside light bulb.

## LANE CHANGE ASSIST — IF EQUIPPED

Lightly push the multifunction lever up or down, without moving beyond the detent, and the turn signal will flash three times then automatically turn off.

## AUTOMATIC HEADLIGHT LEVELING — IF EQUIPPED

This feature prevents the headlights from interfering with the vision of oncoming drivers. Headlight leveling automatically adjusts the height

of the headlight beam in reaction to changes in vehicle pitch.

## BATTERY SAVER

Timers are set to both the interior and exterior lights to protect the life of your vehicle's battery.

After 10 minutes, if the ignition is OFF and any door is left open or the dimmer control is rotated all the way up to the dome light on position, the interior lights will automatically turn off.

### NOTE:

Battery saver mode is canceled if the ignition is ON. If the headlights remain on while the ignition is placed in the OFF position, the exterior lights will automatically turn off after eight minutes. If the headlights are turned on and left on for eight minutes while the ignition is OFF, the exterior lights will automatically turn off.

## INTERIOR LIGHTS

Courtesy and dome lights are turned on when the front doors are opened or when the dimmer control is rotated to its upward most position. If your vehicle is equipped with a key fob and the unlock button is pushed, the courtesy and dome lights will turn on. When a door is open and the interior lights are on, rotating the dimmer control all the way down, to the O (off) position, will cause all the

interior lights to go out. This allows the doors to stay open for extended periods of time without discharging the vehicle's battery.

### COURTESY LIGHTS

The courtesy lights can be turned on by pushing the top corner of the lens. To turn the lights off, push the lens a second time.

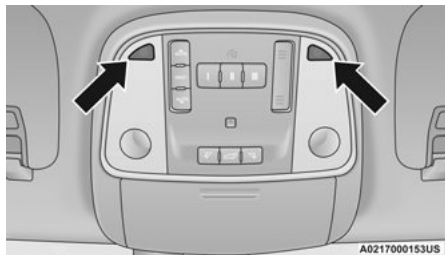

Courtesy Lights

### Front Map/Reading Lights — If Equipped

Lights are mounted in the overhead console. Each light can be turned on by pushing the switch on either side of the console. These buttons are backlit for nighttime visibility.

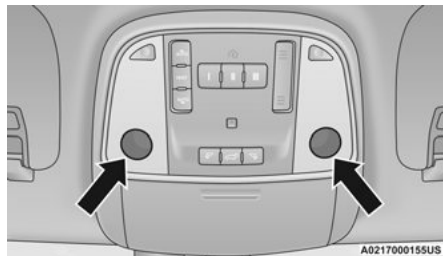

Front Map/Reading Lights

To turn the lights off, push the switch a second time. The lights also turn on when a door is opened. The lights will also turn on when the unlock button on the key fob is pushed.

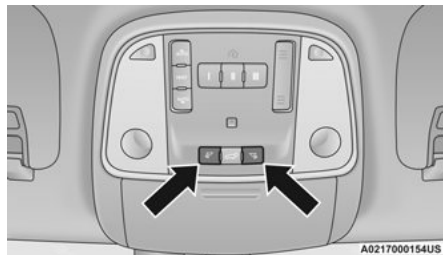

Front Map/Reading Light Switches

### Ambient Light — If Equipped

The overhead console is equipped with an ambient light feature. This light illuminates for improved visibility of the floor and center console area.

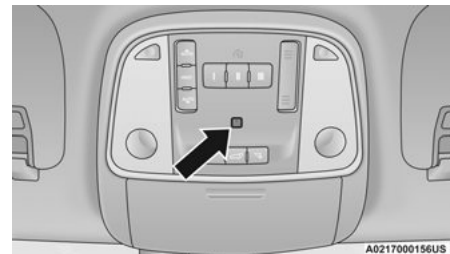

Ambient Light

### Dimmer Control

The brightness of the instrument panel lighting can be regulated by rotating the dimmer control up (brighter) or down (dimmer). When the headlights are on you can supplement the brightness of the odometer, trip odometer, radio and overhead console by rotating the control to its upward most position until you hear a click. This is useful when headlights are required during the day.

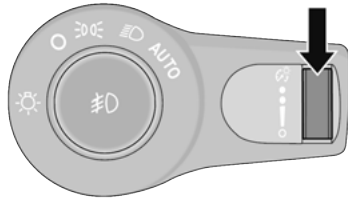

A021700068US

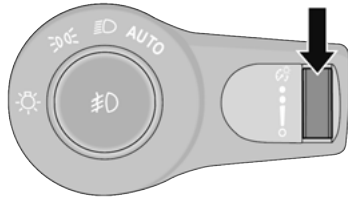
**Dimmer Control**

A0217000170US

**Dimmer Control (Vehicles Sold In Canada)**

### Illuminated Entry

When programmed with the Uconnect system, the headlights and courtesy lights will turn on when you use the key fob to unlock the doors or open any door → page 155.

The time the lights stay on is programmable up to 90 seconds. The lights will fade to off after the programmed time, or they will immediately fade to off once the ignition switch is placed in the ON/RUN position from the OFF position.

The front courtesy overhead console and door courtesy lights will not turn off if the instrument panel dimmer switch is rotated to the upward most position, past the detent. The overhead and door courtesy lights will turn off after 10 minutes when the ignition is placed in the OFF position to protect the battery.

The illuminated entry system will not operate if the instrument panel dimmer switch is rotated all the way downward to the O (off) position.

## WINDSHIELD WIPERS AND WASHERS

The windshield wiper/washer controls are located on the multifunction lever on the left side of the steering column. The front wipers are operated by rotating a switch, located on the end of the lever.

### WINDSHIELD WIPER OPERATION

Rotate the end of the lever to one of the first four detent positions for intermittent settings, the fifth detent for low wiper operation and the sixth detent for high wiper operation.

#### CAUTION!

Always remove any buildup of snow that prevents the windshield wiper blades from returning to the “park” position. If the windshield wiper switch is turned off, and the blades cannot return to the “park” position, damage to the wiper motor may occur.

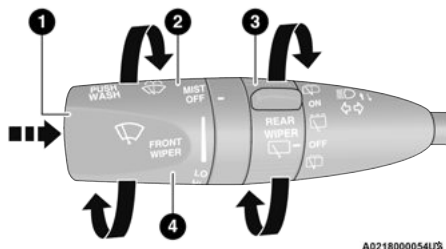

**Windshield Wiper Operation**

- 1 — Push End Of Lever And Hold For Front Washer
- 2 — Rotate Downward For Mist
- 3 — Rotate For Rear Wiper/Washer Operation
- 4 — Rotate For Front Wiper Operation

### Intermittent Wipers

Use one of the four intermittent wiper settings when weather conditions make a single wiping cycle, with a variable delay between cycles, desirable. At driving speeds above 10 mph (16 km/h), the delay can be regulated from a maximum of approximately 18 seconds between cycles (first detent), to a cycle every one second (fourth detent). If the vehicle is moving less than 10 mph (16 km/h), delay times will be doubled.

### Windshield Washers

To use the washer, push on the end of the lever (toward the steering wheel) and hold. If the lever is pushed while in the intermittent setting, the wipers will turn on and operate for several cycles after the end of the lever is released, and then resume the intermittent interval previously selected.

If the end of the lever is pushed while the wipers are in the off position, the wipers will operate for several cycles, then turn off.

#### NOTE:

As a protective measure, the washer will stop if the switch is held for more than 20 seconds. Once the switch is released the washer will resume normal operation.

#### WARNING!

Sudden loss of visibility through the windshield could lead to a collision. You might not see other vehicles or other obstacles. To avoid sudden icing of the windshield during freezing weather, warm the windshield with the defroster before and during windshield washer use.

### Mist

Rotate the end of the lever downward to the MIST position and release for a single wiping cycle.

#### NOTE:

The Mist feature does not activate the washer pump; therefore, no washer fluid will be sprayed on the windshield. The wash function must be used in order to spray the windshield with washer fluid. For information on wiper care and replacement, see [page 267](#).

### RAIN SENSING WIPERS — IF EQUIPPED

This feature senses rain or snowfall on the windshield and automatically activates the wipers. Rotate the end of the multifunction lever to one of four detent positions to activate this feature.

The sensitivity of the system can be adjusted with the multifunction lever. Wiper delay position one is the least sensitive, and wiper delay position four is the most sensitive.

Setting three is preferred by the average driver during normal rain conditions.

#### NOTE:

- The Rain Sensing feature will not operate when the wiper switch is in the low or high-speed position.
- The Rain Sensing feature may not function properly when ice, or dried salt water is present on the windshield.

- Use of Rain-X or products containing wax or silicone may reduce Rain Sensing performance.
- The Rain Sensing feature can be turned on and off using the Uconnect system ↪ page 155.

The Rain Sensing system has protection features for the wiper blades and arms, and will not operate under the following conditions:

- **Low Ambient Temperature** – When the ignition is first placed in the ON position, the Rain Sensing system will not operate until the wiper switch is moved, vehicle speed is greater than 3 mph (5 km/h), or the outside temperature is greater than 32°F (0°C).
- **Transmission In NEUTRAL Position** – When the ignition is in the ON position, and the gear selector is in NEUTRAL, the Rain Sensing system will not operate until the wiper switch is moved, vehicle speed is greater than 3 mph (5 km/h), or the gear selector is moved out of NEUTRAL.

## REAR WINDOW WIPER/WASHER

The rear wiper/washer controls are located on the multifunction lever on the left side of the steering column. The rear wiper/washer is operated by rotating a switch, located at the middle of the lever.



Rotate the center portion of the lever upward to the first detent for intermittent operation and to the second detent for continuous rear wiper operation.



Rotate the center portion of the lever upward to the third detent to activate the washer. The washer will continue to operate as long as the switch is held.

Rotate the center portion downward from the OFF position to activate the rear washer. The washer will continue to operate as long as the switch is held.

### NOTE:

As a protective measure, the pump will stop if the switch is held for more than 20 seconds. Once the switch is released the pump will resume normal operation.

If the rear wiper is operating when the ignition is placed in the OFF position, the wiper will automatically return to the “park” position.

## CLIMATE CONTROLS

The Climate Control system allows you to regulate the temperature, air flow, and direction of air circulating throughout the vehicle. The controls are located on the touchscreen and on the instrument panel below the radio.

## AUTOMATIC CLIMATE CONTROL DESCRIPTIONS AND FUNCTIONS



Uconnect 5/5 NAV With 10.1-inch Display Temperature Controls



Uconnect 4 With 8.4-inch Display Temperature Controls

## Max A/C Button



Press and release the MAX A/C button on the touchscreen to change the current setting to the coldest output of air. The MAX A/C indicator illuminates when MAX A/C is ON. Performing this function again will cause the MAX A/C operation to switch into manual mode and the MAX A/C indicator will turn off.

In MAX A/C, the blower level and mode position can be adjusted to desired user settings. Pressing other settings will cause the MAX A/C to exit.

### NOTE:

The MAX A/C button is only available on the touchscreen.

## A/C Button



Press and release this button on the touchscreen to change the current setting. The A/C indicator illuminates when A/C is on.

The Air Conditioning (A/C) button allows the operator to manually activate or deactivate the air conditioning system. When the air conditioning system is turned on, cool dehumidified air will flow through the outlets into the cabin.

### NOTE:

If fog or mist appears on the windshield or side glass, select Defrost mode and increase blower speed if needed. If your air conditioning performance seems lower than expected, check the front of the A/C condenser (located in front of the radiator), for an accumulation of dirt or insects. Clean with a gentle water spray from the front of the radiator and through the condenser.

## Recirculation Button



Press and release this button to change the system between recirculation mode and outside air mode. The Recirculation indicator and the A/C indicator illuminate when the Recirculation button is pressed.

Recirculation can be used when outside conditions such as smoke, odors, dust, or high humidity are present. Recirculation can be used in all modes. Recirculation may be unavailable (button on the touchscreen greyed out) if conditions exist that could create fogging on the inside of the windshield. The A/C can be deselected manually without disturbing the mode control selection. Continuous use of Recirculation mode may make the inside air stuffy and window fogging may occur. Extended use of this mode is not recommended. Recirculation mode may automatically adjust to optimize customer experience for warming, cooling, dehumidification, etc.

## AUTO Button



Press and release this button on the touchscreen, or push the button on the faceplate, to change the current setting.

The AUTO button automatically controls the interior cabin temperature by adjusting distribution and amount of airflow. Air Conditioning (A/C) may be active during AUTO operation to improve performance. Performing this function will cause the system to switch between manual mode and automatic modes. AUTO mode is highly recommended for efficiency ↪ page 61.

## Front Defrost Button



Press and release the touchscreen button, or push and release the button on the faceplate, to change the current airflow setting to Defrost mode. The Front Defrost indicator illuminates when the Front Defrost is on. Air comes from the windshield and side window demist outlets. When the defrost button is selected, the blower level may increase. Use Defrost mode with maximum temperature settings for best windshield and side window defrosting and defogging. When toggling the Front Defrost mode button, the climate system will return to the previous setting.

## Rear Defrost Button



Press and release the button on the touchscreen, or push and release the button on the faceplate, to turn on the rear window defroster and the heated outside mirrors (if equipped). The Rear Defrost indicator illuminates when the rear window defroster is on. The rear window defroster automatically turns off after 10 minutes.

### CAUTION!

Failure to follow these cautions can cause damage to the heating elements:

- Use care when washing the inside of the rear window. Do not use abrasive window cleaners on the interior surface of the window. Use a soft cloth and a mild washing solution, wiping parallel to the heating elements. Labels can be peeled off after soaking with warm water.
- Do not use scrapers, sharp instruments, or abrasive window cleaners on the interior surface of the window.
- Keep all objects a safe distance from the window.

## Driver And Passenger Temperature Buttons

These buttons provide the driver and passenger with independent temperature control.



Push the Up button on the faceplate or press and slide the temperature bar towards the red arrow button on the touchscreen for warmer temperature settings.



Push the Down button on the faceplate or press and slide the temperature bar towards the blue arrow button on the touchscreen for cooler temperature settings.

## SYNC Button



Press the SYNC button on the touchscreen to toggle the SYNC feature on/off. The SYNC indicator illuminates when SYNC is on. SYNC is used to synchronize the front passenger temperature and rear passenger temperature, mode, and blower settings with the driver temperature, mode, and blower settings. Changing the front passenger temperature or rear passenger temperature, mode, and blower settings while in SYNC will automatically exit this feature.

### NOTE:

The SYNC setting is only available on the touchscreen.

## Blower Control



Blower Control is used to regulate the amount of air forced through the Climate Control system. There are seven blower speeds available. Adjusting the blower will cause automatic mode to switch to manual operation. The speeds can be selected using either the blower control knob on the faceplate or the buttons on the touchscreen.

- **Faceplate:** The blower speed increases as you turn the blower control knob clockwise from the lowest blower setting. The blower speed decreases as you turn the blower control knob counterclockwise.
- **Touchscreen:** Use the small blower icon to reduce the blower setting and the large blower icon to increase the blower setting. Blower speed can also be selected by pressing the blower bar area between the icons.

## Mode Control



Select Mode by pressing the Mode button on the faceplate, or one of the Mode buttons on the touchscreen to change the airflow distribution mode.

The airflow distribution mode can be adjusted so air comes from the instrument panel outlets, floor outlets, defrost outlets and demist outlets.

## Panel Mode



Air comes from the outlets in the instrument panel. Each of these outlets can be individually adjusted to direct the flow of air. The air vanes of the center outlets and outboard outlets can be moved up and down or side to side to regulate airflow direction. There is a shut-off wheel located below the air vanes to shut off or adjust the amount of airflow from these outlets.

## Bi-Level Mode



Air comes from the instrument panel outlets and floor outlets. A slight amount of air is directed through the defrost and side window demister outlets.

### NOTE:

Bi-Level mode is designed under comfort conditions to provide cooler air out of the panel outlets and warmer air from the floor outlets.

## Floor Mode



Air comes from the floor outlets. A slight amount of air is directed through the defrost and side window demister outlets.

## Mix Mode



Air is directed through the floor, defrost, and side window demister outlets. This setting works best in cold or snowy conditions that require extra heat to the windshield. This setting is good for maintaining comfort while reducing moisture on the windshield.

## Climate Control OFF Button



Press and release this button to turn the Climate Control ON/OFF.

## Controlling The Rear Climate Controls From The Front ATC Panel

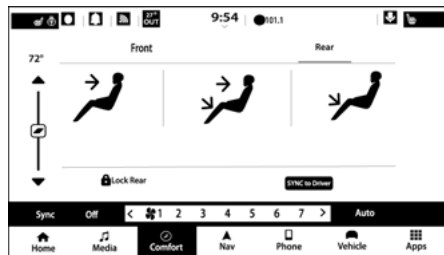

Front ATC Panel Uconnect 5/5 NAV With 10.1-inch Display Rear Controls

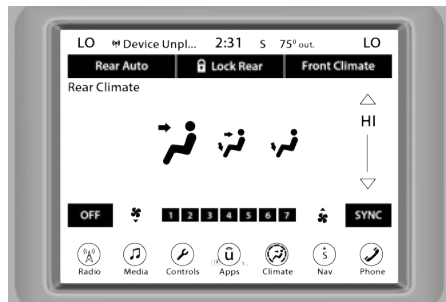

Front ATC Panel Uconnect 4 With 8.4-inch Display Rear Controls

The Three-Zone ATC system allows for adjustment of the rear climate controls from the front ATC panel.

### To change the rear system settings:

- Press the "Rear Climate" button on the touchscreen to display the rear climate controls. The control functions now operate the rear system.
- Press the "Front Climate" button on the touchscreen to return to the front climate controls.



## REAR CLIMATE CONTROL BUTTON



Press and release this button to access the rear climate controls. The Rear Climate indicator will illuminate when the rear climate controls are ON.

## REAR AUTO BUTTON



Press and release this button on the touchscreen to change the current setting. The REAR AUTO indicator will illuminate when REAR AUTO is on. This feature automatically controls the rear interior cabin temperature by adjusting airflow distribution and amount. Toggling this function will cause the rear system to switch between manual mode and automatic modes → page 61.

## REAR LOCK BUTTON



Press and release this button to lock out the rear manual temperature controls from adjusting the rear temperature and blower settings. The LOCK REAR indicator will illuminate when LOCK REAR is on. Press and release this button again to exit the feature.

## FRONT CLIMATE BUTTON



Press and release to return to the Front Climate Control Screen.

## SYNC BUTTON



Press the SYNC (or SYNC To Driver) button on the touchscreen to toggle the SYNC feature on/off. The SYNC indicator will illuminate when SYNC is on. SYNC is used to synchronize the front passenger temperature and rear passenger temperature, mode, and blower settings with the driver temperature, mode, and blower settings. Changing the front passenger temperature or rear passenger temperature, mode, or blower settings while in SYNC will automatically exit this feature.

### NOTE:

The SYNC setting is only available on the touchscreen.

## REAR BLOWER CONTROL



Rear Blower Control is used to regulate the amount of air forced through the rear climate system. There are seven blower speeds available. The speeds can be selected using the buttons on the touchscreen. Use the small blower icon (or blower icon with the downward arrow) to reduce the blower setting, and the large blower icon (or blower icon with the upward arrow) to increase the blower setting. Blower can also be selected by pressing the blower bar area between the icons.

## REAR MODE CONTROL



Select Mode by pressing one of the Mode buttons on the touchscreen to change the airflow distribution mode. The rear airflow distribution mode can be adjusted so air comes from the headliner outlets, the floor outlets or both.

## HEADLINER MODE



Air comes from the outlets in the headliner. Each of these outlets can be individually adjusted to direct the flow of air. Moving the air vanes of the outlets to one side shuts off the airflow.

## BI-LEVEL MODE



Press this button on the touchscreen to change the air distribution mode to Bi-Level Mode. In Bi-Level Mode, air comes from both the headliner outlets and the floor outlets.

### NOTE:

In many temperature positions, the Bi-Level mode is designed to provide cooler air out of the headliner outlets and warmer air from the floor outlets.

**FLOOR MODE**

Press this button on the touchscreen to change the air distribution mode to Floor Mode. In Floor Mode, air comes from the floor outlets.

**REAR CLIMATE CONTROL OFF BUTTON**

To manually set the rear blower controls to off, press the Rear Climate Control/Blower Off button.

**Rear Automatic Temperature Control**

The rear system temperature control buttons are located on the headliner on the passenger side of the vehicle.

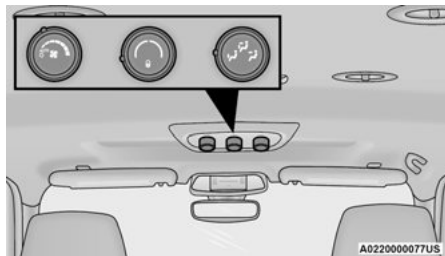

**Rear Automatic Climate Controls**

The rear ATC system has floor air outlets at the rear right side of the third row seats and overhead outlets at each outboard rear seating position. The system provides heated air through the floor outlets or cool, dehumidified air through the headliner outlets.

**AUTO BUTTON**

Turn the blower knob to the AUTO setting. This feature automatically controls the rear interior cabin temperature by adjusting airflow distribution and amount. Changing the blower knob to any other blower setting will cause the rear system to switch to manual mode → page 61.

**REAR TEMPERATURE CONTROL**

Turn the rear temperature knob to adjust the temperature.



Turn the knob to the right (clockwise) to raise the temperature.



Turn the knob to the left (counterclockwise) to lower the temperature.

The rear temperature setting is displayed in the control head.

**REAR BLOWER CONTROL**

Turn the rear blower knob to regulate the amount of air forced through the system in any mode you select. The blower speed increases as you move the knob clockwise from the off position. The rear blower setting is displayed in the control head.

**REAR MODE CONTROL**

Turn the rear mode knob to adjust airflow distribution. The rear mode settings are displayed in the control head. The rear airflow distribution mode can be adjusted so air comes from the headliner outlets, the floor outlets, or both.

**HEADLINER MODE**

Air comes from the outlets in the headliner. Each of these outlets can be individually adjusted to direct the flow of air. Moving the air vanes of the outlets to one side will shut off the airflow.

**BI-LEVEL MODE**

Air comes from both the headliner outlets and the floor outlets.

**NOTE:**

In many temperature positions, the Bi-Level mode is designed to provide cooler air out of the headliner outlets and warmer air from the floor outlets.

**FLOOR MODE**

Air comes from the floor outlets.

**REAR TEMPERATURE LOCK**

The Rear Temperature Lock symbol on the control head is illuminated when the rear controls are locked by the front system.

**Rear Lock**

Pressing the Rear Temperature Lock button on the Uconnect touchscreen, illuminates a lock symbol in the rear display. The rear temperature and air source are controlled from the front Uconnect system.

Rear second row occupants can only adjust the rear ATC control when the Rear Temperature Lock button is turned off.

The rear ATC is located in the headliner, near the center of the vehicle.

- Press the Rear Temperature Lock button on the Uconnect touchscreen. This turns off the Rear Temperature Lock icon in the rear temperature knob.

- Rotate the Rear Blower, Rear Temperature and the Rear Mode Control knobs to suit your comfort needs.
- ATC is selected by adjusting the rear blower knob counterclockwise to AUTO.

Once the desired temperature is displayed, the ATC System will automatically achieve and maintain that comfort level. When the system is set up for your comfort level, it is not necessary to change the settings. You will experience the greatest efficiency by simply allowing the system to function automatically.

**AUTOMATIC TEMPERATURE CONTROL (ATC)****Automatic Operation**

1. Push the AUTO button on the front Automatic Temperature Control (ATC) Panel and the word "AUTO" will illuminate in the front ATC display, along with two temperatures for the driver and front passenger. The system will then automatically regulate the amount of airflow.
2. Adjust the temperature you would like the system to maintain, by adjusting the driver, passenger, and rear temperatures. Once the desired temperature is displayed, the system will achieve and automatically maintain that comfort level.

3. When the system is set up for your comfort level, it is not necessary to change the settings. You will experience the greatest efficiency by simply allowing the system to function automatically.

**NOTE:**

It is not necessary to move the temperature settings. The system automatically adjusts the temperature, mode and fan speed to provide comfort as quickly as possible.

To provide you with maximum comfort in the automatic mode, during cold start-ups, the blower fan will remain on low until the engine warms up. The fan will engage immediately if the Defrost mode is selected, or by changing the front blower knob setting.

**Manual Operation Override**

This system offers a full complement of manual override features. The AUTO symbol in the front ATC display will be turned off when the system is being used in the manual mode.

**NOTE:**

The system will not automatically sense the presence of fog, mist or ice on the windshield. Defrost mode must be manually selected to clear the windshield and side glass.

## CLIMATE VOICE RECOGNITION

Adjust vehicle temperatures hands-free and keep everyone comfortable while you keep moving ahead.

Push the VR button on the steering wheel. After the beep, say one of the following commands:

- “Set driver temperature to 70 degrees”
- “Set passenger temperature to 70 degrees”

**Did you know:** Voice Command for Climate may only be used to adjust the interior temperature of your vehicle. Voice Command will not work to adjust the heated seats or steering wheel if equipped.

## OPERATING TIPS

### CAUTION!

Interior air enters the Rear Automatic Temperature Control system through an intake grille, located in the right side trim panel behind the third row seats. The heater outlets are located in the right side trim panel, just behind the passenger second row door. Do not block or place objects directly in front of the inlet grille or heater outlets. The electrical system could overload causing damage to the blower motor.

Refer to the chart at the end of this section for suggested control settings for various weather conditions.

### Summer Operation

The engine cooling system must be protected with a high-quality antifreeze coolant to provide proper corrosion protection and to protect against engine overheating. A solution of 50% OAT (Organic Additive Technology) coolant that meets the requirements of FCA Material Standard MS.90032 and 50% water is recommended → page 309.

### Winter Operation

To ensure the best possible heater and defroster performance, make sure the engine cooling system is functioning properly and the proper amount, type, and concentration of coolant is used. Use of the Air Recirculation mode during Winter months is not recommended, because it may cause window fogging.

### Vacation/Storage

For information on maintaining the Climate Control system when the vehicle is being stored for an extended period of time, see → page 302.

### Window Fogging

Interior fogging on the windshield can be quickly removed by turning the mode selector to Defrost. The Defrost/Floor mode can be used to maintain a clear windshield and provide sufficient heating. If

side window fogging becomes objectionable, increase blower speed to improve airflow and clearing of the side windows. Vehicle windows tend to fog on the inside in mild but rainy or humid weather.

### NOTE:

- Recirculate without A/C should not be used for long periods, as fogging may occur.
- Automatic Temperature Controls (ATC) will automatically adjust the climate control settings to reduce or eliminate window fogging on the front windshield. When this occurs, recirculation will be unavailable.

### Outside Air Intake

Make sure the air intake, located directly in front of the windshield, is free of obstructions, such as leaves. Leaves collected in the air intake may reduce airflow, and if they enter the air distribution box, they could plug the water drains. In Winter months, make sure the air intake is clear of ice, slush, and snow.









### Cabin Air Filter

The Climate Control system filters out dust and pollen from the air. Contact an authorized dealer to service your cabin air filter, and to have it replaced when needed → page 262.

## Stop/Start System — If Equipped

While in an Autostop, the Climate Control system may automatically adjust airflow to maintain cabin comfort. Customer settings will be maintained upon return to an engine running condition.

## Operating Tips Chart

WEATHER	CONTROL SETTINGS
Hot Weather And Vehicle Interior Is Very Hot	Set the mode control to  (Panel Mode),  (A/C) on, and blower on high. Roll down the windows for a minute to flush out the hot air. Adjust the controls as needed to achieve comfort.
Warm Weather	Turn  (A/C) on and set the mode control to  (Panel Mode).
Cool Sunny	Operate in  (Bi-Level Mode).
Cool & Humid Conditions	Set the mode control to  (Floor Mode) and turn  (A/C) on to keep windows clear.
Cold Weather	Set the mode control to  (Floor Mode). If windshield fogging starts to occur, move the control to  (Mix Mode).

## INTERIOR STORAGE AND EQUIPMENT

### STORAGE

#### Glove Compartment

The glove compartment is located on the passenger side of the instrument panel.

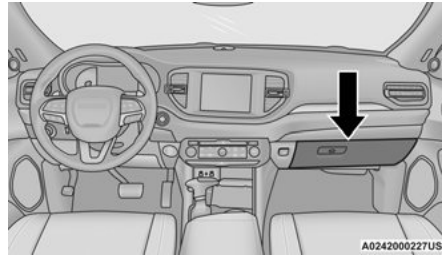

Glove Compartment

To open the glove compartment, pull the release handle.

#### Front Center Console

The front center console contains both an upper and a lower storage area.

To open the upper storage compartment, pull upward on the small latch located on the lid.



Storage Compartment Latches

- 1 — Upper Storage Compartment Latch
- 2 — Lower Storage Compartment Latch

Lift upward on the larger of the latches to access the lower storage compartment.

#### Sunglasses Bin Door

At the front of the console a compartment is provided for the storage of a pair of sunglasses. The storage compartment access is a “push/push” design. Push the push cover on the door to open. Push the push cover on the door to close.

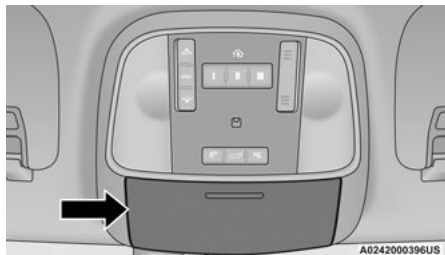

Sunglasses Bin Door

### Rear Full Center Console – If Equipped

The rear full center console contains both an upper and a lower storage area.

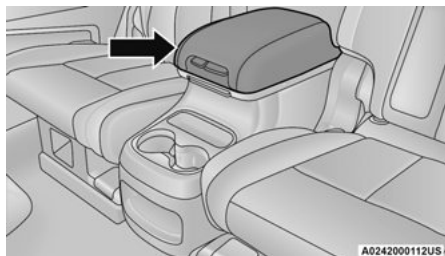

Storage Compartment

To open the upper storage compartment, pull upward on the small latch located on the front of the lid.

Lift upward on the larger of the latches to access the lower storage compartment.

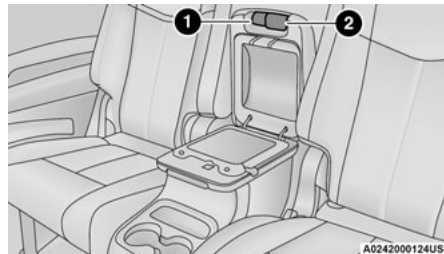

Storage Compartment Latches

- 1 – Upper Storage Compartment Latch
- 2 – Lower Storage Compartment Latch

### NOTE:

Lower storage compartment light is always on with ignition in the ON/RUN position.

The upper storage compartment may also be lifted forward. Push in the release button located on the back of the lid.

### CAUTION!

Remove any items stored in the console cupholders or devices with cords routing through upper storage area. Damage may occur to upper console lid and device cables when upper storage compartment is lifted forward.

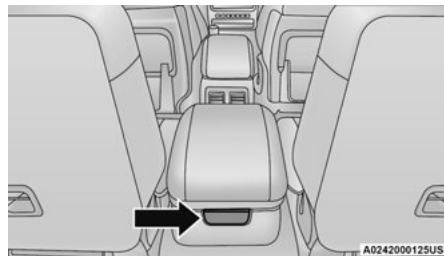

Storage Compartment Rear Push Button

When lifted forward there is access to the lower storage compartment.

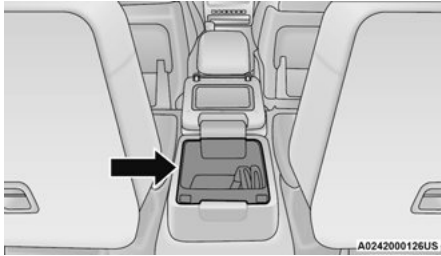

**Lower Storage Compartment**

**NOTE:**

When the lower storage compartment is accessed, it allows the armrest to flip forward for “Fold-Flat mode”. Fold-Flat mode allows the console armrest to be lowered below the Fold-Flat seat plane and protects the armrest vinyl from damage when using the vehicle to haul cargo.

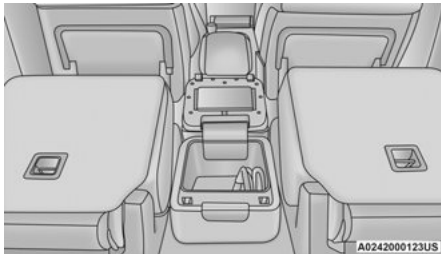

**Fold-Flat Mode**

Open storage areas, or cubby bins with removable liners, are located rearward of the cupholders and in the lower front of the console.

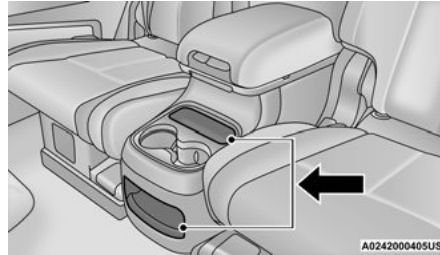

**Console Cubby Bins**

**Rear Mini Center Console – If Equipped**

An open storage area, or cubby bin with removable liner, is located in the front of the console.

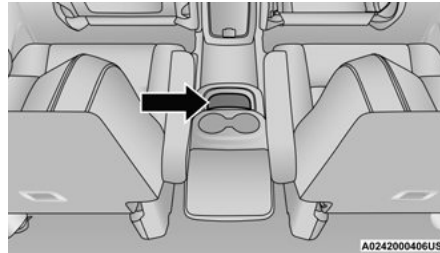

**Console Cubby Bin**

**USB/AUX CONTROL**

This feature allows an external USB device to be plugged into the USB port.

Plugging in a smartphone device to a USB port may activate Android Auto™ or Apple CarPlay® features, if equipped. For further information, refer to “Android Auto™” or “Apple CarPlay®” in the Owner’s Manual Supplement.

**Connecting The AUX Audio Input Or External USB Device**

Use the connection cable to connect an external USB device to the vehicle’s USB/AUX connector port which is located in the center console.

The USB ports on the media hub are equipped with a Smart Electronic Voltage Regulator (Smart Charge) feature. This feature allows a device to charge for up to one hour after the vehicle is powered off.

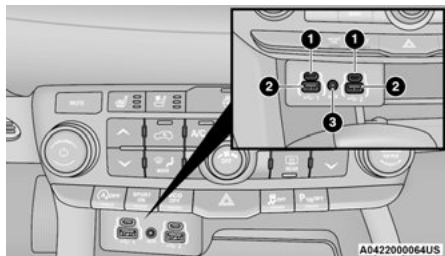

### Integrated Center Console USB/AUX Media HUB

- 1 — Mini-USB Type C Port
- 2 — Standard USB Type A Port
- 3 — AUX Port

Once the audio device is connected and synchronized to the vehicle's USB control system (an external USB device may take a few minutes to connect), the audio device starts charging and is ready for use.

Once a device is connected to the USB port, it will begin charging and is ready for use with the system. Type C and Type A charge-only USB ports can be used at the same time but cannot be used simultaneously while playing media. When both Type C and Type A charge-only USB ports are in use they will be charged at a reduced rate.

### NOTE:

If the audio device battery is completely discharged, it may not communicate with the USB control system until a minimum charge is attained. Leaving the audio device connected to the USB control system may charge it to the required level.

### Using This Feature

By using an external USB device to connect to the USB port:

- The audio device can be played on the vehicle's sound system, providing metadata (artist, track title, album, etc.) information on the radio display.

### NOTE:

Depending on track configuration, track information may not be present on the radio display.

- The audio device can be controlled using the radio buttons to Play, Browse, and List the contents.
- The audio device battery charges when plugged into the USB/AUX connector (if supported by the specific audio device).

### NOTE:

For further information, refer to the Uconnect Owner's Manual Supplement.

### Second Row USB Charging Port

Second Row USB Charging ports can be used for charging purposes only. Use the connection cable

to connect an external USB device to the vehicle's USB charging ports which are located either on the rear of the front center console and/or in the second row center console.

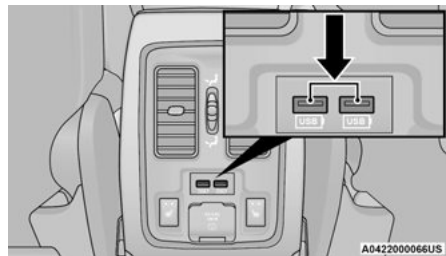

### Rear Center Console USB Ports

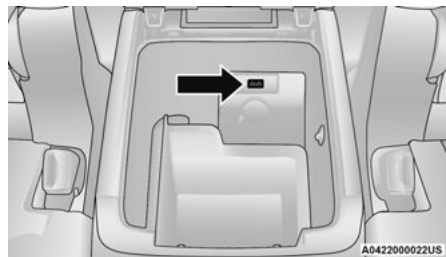

### Second Row Center Console USB Port



**NOTE:**

Charge unsupported devices with the Charge Only USB ports. If an unsupported device is plugged into a Media USB port, a message will display on the touchscreen that the device is not supported by the system.

**LIGHTED CUPHOLDERS — IF EQUIPPED**

On some vehicles, the front cupholders are equipped with a light ring that illuminates the cupholders for the front passengers.

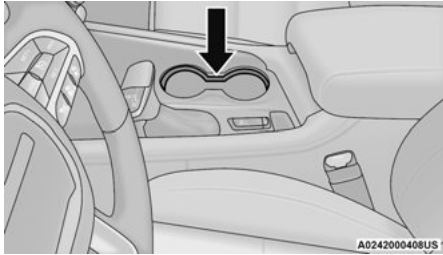

**Light Ring In Front Cupholder**

The rear cupholders may also be equipped with a light ring that illuminates the cupholders for the rear passengers. The light ring is controlled by the Dimmer Control → page 52.

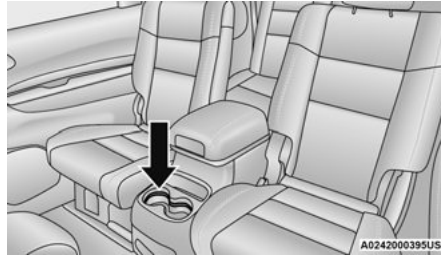

**Light Ring In Rear Cupholder**

**ELECTRICAL POWER OUTLETS**

Your vehicle is equipped with 12 Volt (13 Amp) power outlets that can be used to power cellular phones, small electronics and other low powered electrical accessories. The power outlets are labeled with either a “key” or a “battery” symbol to indicate how the outlet is powered. Power outlets labeled with a key symbol are powered when the ignition switch is in the ON or ACC position, while the outlets labeled with a battery symbol are connected directly to the battery, and are powered at all times.

**NOTE:**

- All accessories connected to the battery powered outlets should be removed or turned off when the vehicle is not in use to protect the battery against discharge.
- Do not exceed the maximum power of 160 Watts (13 Amps) at 12 Volts. If the 160 Watt (13 Amp) power rating is exceeded the fuse protecting the system needs to be replaced.
- Power outlets are designed for accessory plugs only. Do not insert any other object in the power outlets as this will damage the outlet and blow the fuse. Improper use of the power outlet can cause damage not covered by your New Vehicle Limited Warranty.

The front power outlet is located to the right of the climate controls.

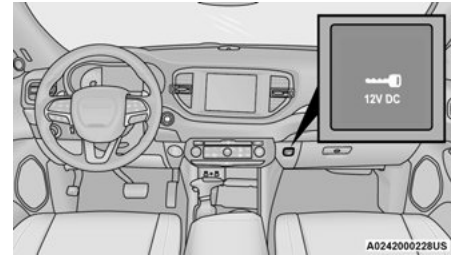

**Front Power Outlet**

In addition to the front power outlet, there is also a power outlet located in the storage area of the center console.

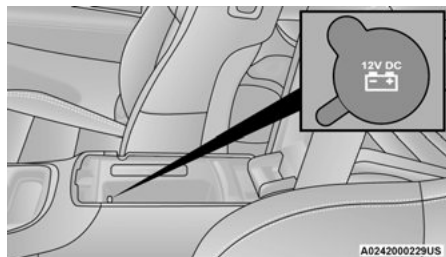

**Front Center Console Outlet**

If your vehicle is equipped with a rear full center console, there is also a power outlet located in the lower storage area of the rear full center console.



**Rear Full Center Console Outlet**

The rear cargo power outlet is located in the right rear cargo area.

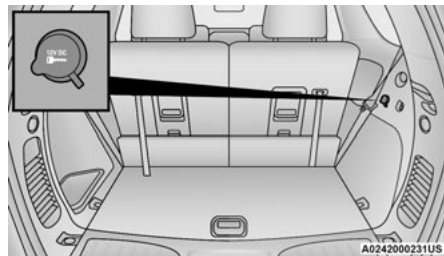

**Rear Cargo Power Outlet**

**NOTE:**

The rear cargo power outlet can be changed to “battery” powered at all times by switching the power outlet right rear quarter panel fuse in the fuse panel from fuse location F90 to F91.

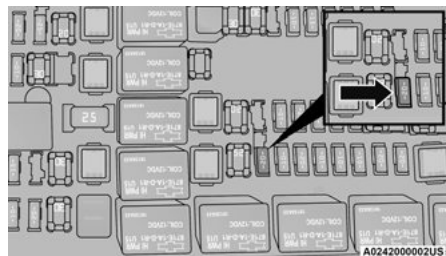

**Rear Cargo Power Outlet Fuse**

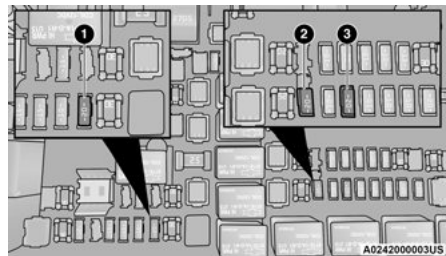

**Power Outlet Fuse Locations**

- 1 — F104 Fuse 20 A Yellow Power Outlet Console Bin
- 2 — F90–F91 Fuse 20 A Yellow Power Outlet Right Rear Quarter Panel
- 3 — F93 Fuse 20 A Yellow Cigar Lighter Instrument Panel

**WARNING!**

To avoid serious injury or death:

- Only devices designed for use in this type of outlet should be inserted into any 12 Volt outlet.
- Do not touch with wet hands.
- Close the lid when not in use and while driving the vehicle.
- If this outlet is mishandled, it may cause an electric shock and failure.

**CAUTION!**

- Many accessories that can be plugged in draw power from the vehicle's battery, even when not in use (i.e., cellular phones, etc.). Eventually, if plugged in long enough, the vehicle's battery will discharge sufficiently to degrade battery life and/or prevent the engine from starting.
- Accessories that draw higher power (i.e., coolers, vacuum cleaners, lights, etc.) will degrade the battery even more quickly. Only use these intermittently and with greater caution.

(Continued)

**CAUTION!**

- After the use of high power draw accessories, or long periods of the vehicle not being started (with accessories still plugged in), the vehicle must be driven a sufficient length of time to allow the generator to recharge the vehicle's battery.

**POWER INVERTER — IF EQUIPPED**

There is a 115 Volt, 150 Watt inverter outlet located on the back of the center console to convert DC current to AC current. This outlet can power cellular phones, electronics and other low power devices requiring power up to 150 Watts. Certain video game consoles exceed this power limit, as will most power tools.

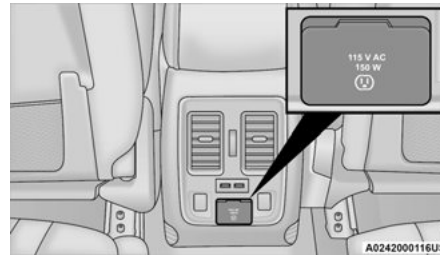

Power Inverter

The power inverter is designed with built-in overload protection. If the power rating of 150 Watts is exceeded, the power inverter automatically shuts down. Once the electrical device has been removed from the outlet the inverter should automatically reset. To avoid overloading the circuit, check the power ratings on electrical devices prior to using the inverter.

**WARNING!**

To avoid serious injury or death:

- Do not insert any objects into the receptacles.
- Do not touch with wet hands.
- Close the lid when not in use.
- If this outlet is mishandled, it may cause an electric shock and failure.

## WIRELESS CHARGING PAD — IF EQUIPPED

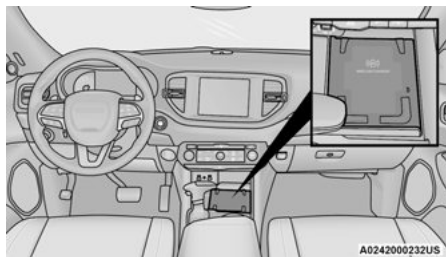

Wireless Charging Pad

Your vehicle may be equipped with a 15W 3A Qi wireless charging pad located below the center stack by the cupholders. This charging pad is designed to wirelessly charge your Qi enabled mobile phone. Qi is a standard that allows wireless charging of your mobile phone.

Your mobile phone must be designed for Qi wireless charging. If the phone is not equipped with Qi wireless charging functionality, an aftermarket sleeve or a specialized back plate can be purchased from your mobile phone provider or a local electronics retailer. Please see your phone's owner's manual for further information.

The wireless charging pad is equipped with an anti-slip mat to hold your mobile phone in place, and an LED indicator.

### LED Indicator Status:

- No Light: Charging pad is idle or searching for a device.
- Blue Light: Device is detected, and is charging.
- Red Light/Flashing: Internal error, or foreign object is detected.

### NOTE:

- The wireless charging pad will not work if any of the four doors or the liftgate are open, even if the engine is running.
- Using a phone case may interfere with wireless charging.

### CAUTION!

The key fob should not be placed on the charging pad or within 6 inches (15 cm) of it. Doing so can cause excessive heat buildup and damage to the fob. Placing the fob in close proximity of the charging pad blocks the fob from being detected by the vehicle and prevents the vehicle from starting.

## WINDOWS

### POWER WINDOWS

The power window controls are located on the driver's door trim panel.

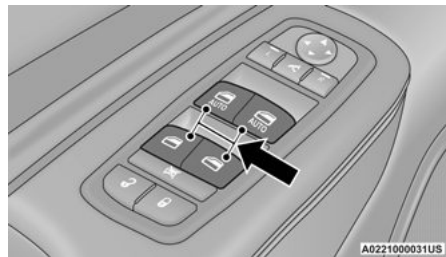

Power Window Switches

The passenger door windows can also be operated by using the single window controls on the passenger door trim panel. The window controls will operate only when the ignition is in the ON/RUN or ACC position.

To open the window part way (manually), push the switch to the first detent and release it when you want the window to stop.

The power window controls remain active for up to 10 minutes after the ignition has been placed in the OFF position. Opening a vehicle front door will cancel this feature.

#### WARNING!

Never leave children unattended in a vehicle, and do not let children play with power windows. Do not leave the key fob in or near the vehicle, or in a location accessible to children, and do not leave the ignition of a vehicle equipped with Keyless Enter 'n Go™ in the ACC or ON/RUN position. Occupants, particularly unattended children, can become entrapped by the windows while operating the power window switches. Such entrapment may result in serious injury or death.

## Automatic Window Features

### Auto-Down Feature

Both the driver and front passenger window switches have an Auto-Down feature. Push the window switch past the first detent, release, and the window will go down automatically.

To cancel the Auto-Down movement, operate the switch in either the up or down direction and release the switch.

### Auto-Up Feature With Anti-Pinch Protection — Driver And Front Passenger Door Only

Lift the window switch fully upward to the second detent, release, and the window will go up automatically.

To stop the window from going all the way up during the Auto-Up operation, push down on the switch briefly.

If the window runs into any obstacle during Auto-Up, it will reverse direction and then go back down. Remove the obstacle and use the window switch again to close the window.

#### NOTE:

Any impact due to rough road conditions may trigger the auto reverse function unexpectedly during Auto-Up. If this happens, pull the switch lightly to the first detent and hold it to close the window manually.

#### WARNING!

There is no anti-pinch protection when the window is almost closed. To avoid personal injury be sure to clear your arms, hands, fingers and all objects from the window path before closing.

## Reset Auto-Up

Should the Auto-Up feature stop working, the window may need to be reset. To reset Auto-Up:

1. Make sure the door is fully closed.
2. Pull the window switch up to close the window completely and continue to hold the switch up for an additional two seconds after the window is closed.
3. Push the window switch down firmly to the second detent to open the window completely and continue to hold the switch down for an additional two seconds after the window is fully open.

## Window Lockout Switch

The window lockout switch on the driver's door trim panel allows you to disable the window controls on the rear passenger doors. To disable the window controls, push and release the window lockout button. To enable the window controls, push and release the window lockout button again.

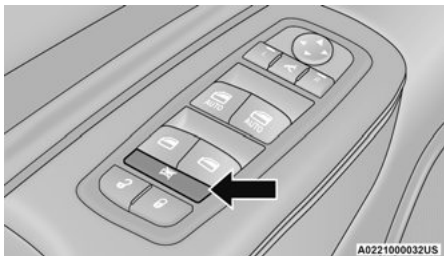

Power Window Lockout Switch

## WIND BUFFETING

Wind buffeting can be described as the perception of pressure on the ears or a helicopter-type sound in the ears. Your vehicle may exhibit wind buffeting with the windows down, or the sunroof (if equipped) in certain open or partially open positions. This is a normal occurrence and can be minimized. If the buffeting occurs with the rear windows open, open the front and rear windows together to minimize the buffeting. If the buffeting occurs with the sunroof open, adjust the sunroof opening to minimize the buffeting or open any window.

## POWER SUNROOF — IF EQUIPPED

The power sunroof switch is located between the sun visors on the overhead console.

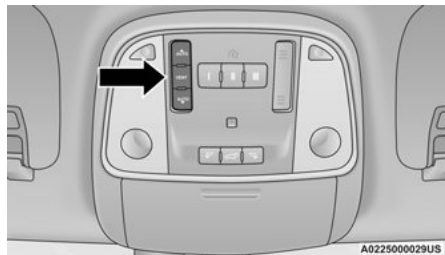

Power Sunroof Switch

### WARNING!

- Never leave children unattended in a vehicle, or with access to an unlocked vehicle. Never leave the key fob in or near the vehicle, or in a location accessible to children. Do not leave the ignition of a vehicle equipped with Keyless Enter 'n Go™ in the ACC or ON/RUN position. Occupants, particularly unattended children, can become entrapped by the power sunroof while operating the power sunroof switch. Such entrapment may result in serious injury or death.

(Continued)

### WARNING!

- In a collision, there is a greater risk of being thrown from a vehicle with an open sunroof. You could also be seriously injured or killed. Always fasten your seat belt properly and make sure all passengers are also properly secured.
- Do not allow small children to operate the sunroof. Never allow your fingers, other body parts, or any object, to project through the sunroof opening. Injury may result.

## OPENING AND CLOSING THE SUNROOF

### Express Open/Close

Push the switch rearward and release it within one-half second; the sunroof and sunshade will open automatically and stop at full open position.

Push the switch forward and release it within one-half second and the sunroof will close automatically from any position.

During Express Open or Express Close operation, any movement of the sunshade switch will stop the shade.

### Manual Open/Close

Push and hold the switch rearward; the sunroof and sunshade will open and automatically stop at full open position.

Push and hold the switch forward and the sunroof will close from any position and stop at a full closed position.

Any release of the switch during open or close operation will stop the sunroof movement. The sunroof will remain in a partially opened position until the switch is operated and held again.

### Venting The Sunroof

Push and release the "Vent" button within one-half second and the sunroof will open to the vent position. This is called "Express Vent", and it will occur regardless of sunroof position. During Express Vent operation, any movement of the switch will stop the sunroof.

### SUNSHADE OPERATION

The sunshade can be opened manually. However, the sunshade will open automatically as the sunroof opens.

#### NOTE:

The sunshade cannot be closed if the sunroof is open.

### PINCH PROTECT FEATURE

This feature will detect an obstruction in the closing of the sunroof during the Express Close operation. If an obstruction in the path of the sunroof is detected, the sunroof will automatically retract. Remove the obstruction if this occurs.

#### WARNING!

There is no anti-pinch protection when the sunroof is almost closed. To avoid personal injury be sure to clear your arms, hands, fingers and all objects from the top's path before closing.

#### NOTE:

If three consecutive sunroof close attempts result in Pinch Protect reversals, Pinch Protect will disable and the sunroof must be closed in Manual Mode.

### SUNROOF MAINTENANCE

Use only a non-abrasive cleaner and a soft cloth to clean the glass panel. Periodically check for and clear out any debris that may have collected in the tracks.

### IGNITION OFF OPERATION

#### NOTE:

- The power sunroof switch can remain active in Accessory Delay for up to approximately 10 minutes after the vehicle's ignition is placed to the OFF position. Opening either front door will cancel this feature.
- This feature is programmable using the Uconnect system → page 155.

### HOOD

#### OPENING THE HOOD

To open the hood, two latches must be released.

1. Pull the release lever located underneath the driver's side of the instrument panel.

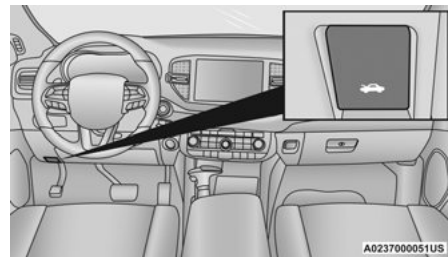

Hood Release

- Reach under the hood from outside the vehicle, move the safety latch to the left and lift the hood.

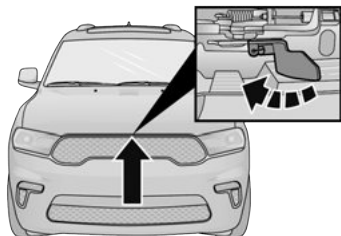

A0237000025US

Safety Latch Location

## CLOSING THE HOOD

In one continuous motion, pull down on the front edge of the hood with moderate force until the angle is below the crossover point (where the gas props are no longer resisting) and let the hood continue to fall closed from its own inertia.

### WARNING!

Be sure the hood is fully latched before driving your vehicle. If the hood is not fully latched, it could open when the vehicle is in motion and block your vision. Failure to follow this warning could result in serious injury or death.

## LIFTGATE

### POWER LIFTGATE — IF EQUIPPED



The power liftgate may be opened by pushing the liftgate release handle  page 23 or by pushing the liftgate button on the key fob twice within five seconds to open or close the power liftgate.

#### NOTE:

- When using the liftgate button on the key fob to open the liftgate while the vehicle is locked, only the liftgate will unlock leaving the other doors to remain locked. Closing the liftgate will not relock the liftgate. The lock button on the key fob, or the Passive Entry lock button must be pushed to relock.
- If the electronic liftgate handle is used to open the liftgate and all the doors unlock, the liftgate and vehicle doors must be locked again. Use the key fob, Passive Entry lock button, or the power door lock switches on the front door panels.

The power liftgate may also be opened or closed by pushing the liftgate button located on the front overhead console. If the liftgate is fully open, it can be closed by pushing the liftgate button located on the left rear trim panel. If the liftgate is in motion, pushing the button again will reverse the liftgate.

When the liftgate button on the key fob is pushed two times, the turn signals will flash to signal that the liftgate is opening or closing (if Flash Lamps with Lock is enabled in the Uconnect settings), and the liftgate chime will be audible. The chime can be turned on or off through the Uconnect Settings  page 155.

#### NOTE:

- In the event of a power malfunction to the liftgate, an emergency liftgate latch release can be used to open the liftgate. The emergency liftgate latch release can be accessed through a snap-in cover located on the liftgate trim panel.
- If liftgate is left open for an extended period of time, the liftgate may need to be closed manually to reset power liftgate functionality.

### WARNING!

During power operation, personal injury or cargo damage may occur. Ensure the liftgate travel path is clear. Make sure the liftgate is closed and latched before driving away.

#### NOTE:

- The power liftgate buttons will not operate if the vehicle is in gear or the vehicle speed is above 0 mph (0 km/h).
- The power liftgate will not operate in temperatures below  $-22^{\circ}\text{F}$  ( $-30^{\circ}\text{C}$ ) or temperatures



above 150°F (65°C). Be sure to remove any buildup of snow or ice from the liftgate before pushing any of the power liftgate switches.

- If anything obstructs the power liftgate while it is closing or opening, the liftgate will automatically reverse to the closed or open position. After multiple obstructions in the same cycle, the liftgate will automatically stop and must be opened or closed manually.
- There are also pinch sensors attached to the side of the liftgate. Light pressure anywhere along these strips will cause the liftgate to return to the open position.
- If the liftgate is only partially open, push the liftgate button on the key fob twice to operate the liftgate.
- If the liftgate release handle is pushed while the power liftgate is opening, the liftgate motor will disengage to allow manual operation.

#### WARNING!

- Driving with the liftgate open can allow poisonous exhaust gases into your vehicle. You and your passengers could be injured by these fumes. Keep the liftgate closed when you are operating the vehicle.

(Continued)

#### WARNING!

- If you are required to drive with the liftgate open, make sure that all windows are closed, and the climate control blower switch is set at high speed. Do not use the recirculation mode.

## CARGO AREA FEATURES

### Cargo Storage

There is a removable storage bin located on the left side of the rear cargo area.

Additional storage can be found in the load floor. To access the lower storage, lift the handle and raise the storage lid.

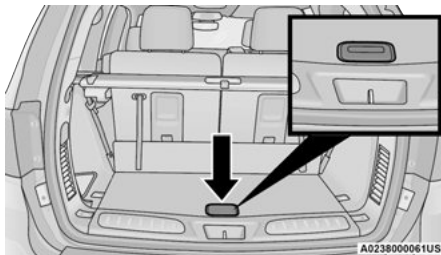

Load Floor Handle

## Retractable Cargo Area Cover — If Equipped

The purpose of this cover is for privacy, not to secure loads. It will not prevent cargo from shifting or protect passengers from loose cargo.

To cover the cargo area:

1. Grab the cover at the center handle, and pull it over the cargo area.
2. Insert the pins on the ends of the cover into the slots in the pillar trim cover.
3. The liftgate may be opened with the cargo cover in place.

#### WARNING!

In a collision, a loose cargo cover in the vehicle could cause injury. It could fly around in a sudden stop and strike someone in the vehicle. Do not store the cargo cover on the cargo floor or in the passenger compartment. Remove the cover from the vehicle when taken from its mounting. Do not store it in the vehicle.

## Cargo Tie-Down Hooks

The cargo tie-downs, located on the cargo area floor, should be used to safely secure loads when the vehicle is moving.

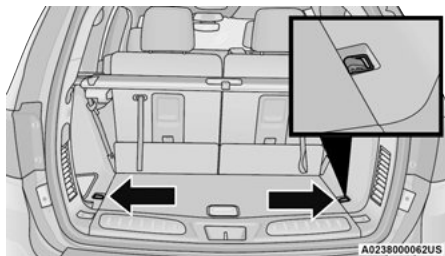

**Tie-Down Hooks**

### WARNING!

- Cargo tie-downs are not safe anchors for a child seat tether strap. In a sudden stop or accident, a tie-down could pull loose and allow the child seat to come loose. A child could be badly injured. Use only the anchors provided for child seat tethers.

(Continued)

### WARNING!

- To help protect against personal injury, passengers should not be seated in the rear cargo area. The rear cargo space is intended for load carrying purposes only, not for passengers, who should sit in seats and use seat belts.

The weight and position of cargo and passengers can change the vehicle center of gravity and vehicle handling. To avoid loss of control resulting in personal injury, follow these guidelines for loading your vehicle:

- Do not carry loads that exceed the load limits described on the label attached to the left door or left door center pillar.
- Always place cargo evenly on the cargo floor. Put heavier objects as low and as far forward as possible.
- Place as much cargo as possible in front of the rear axle. Too much weight or improperly placed weight over or behind the rear axle can cause the vehicle to sway.
- Do not pile luggage or cargo higher than the top of the seatback. This could impair visibility or become a dangerous projectile in a sudden stop or accident.

## ROOF LUGGAGE RACK — IF EQUIPPED

The crossbars and side rails are designed to carry weight on vehicles equipped with a luggage rack. **The load must not exceed 150 lb (68 kg), and should be uniformly distributed over the luggage rack crossbars.**

The crossbars on your vehicle are delivered stowed within the roof rack side rails. Crossbars should always be used whenever cargo is placed on the roof rack. Check the straps frequently to be sure that the load remains securely attached.

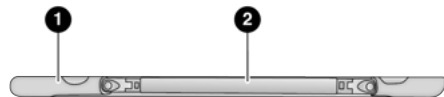

**Roof Rack**

- 1 — Side Rail
- 2 — Crossbar

The roof rack does not increase the total load carrying capacity of the vehicle. Be sure the total load of cargo inside the vehicle plus that on the external rack does not exceed the maximum vehicle load capacity.

## DEPLOYING THE CROSSBARS

1. Starting with one crossbar, completely loosen the thumb screws at both ends of the crossbar.

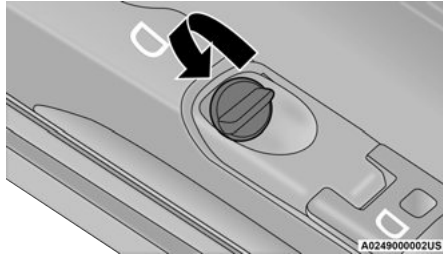

**Thumb Screw**

**NOTE:**  
The thumb screws cannot be fully removed.

2. Remove the crossbar from the stowed position by sliding the crossbar towards the center of the roof. Repeat with the crossbar on the opposite side.

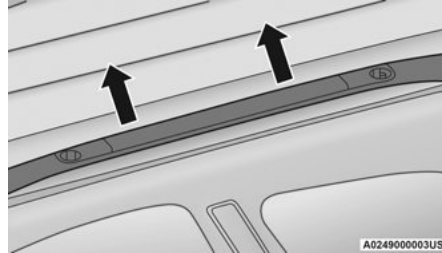

**Removing Crossbars**

### CAUTION!

Use care when removing and handling the crossbars to prevent damage to the vehicle.

3. Starting with one crossbar, bend down the pivot supports at each end.

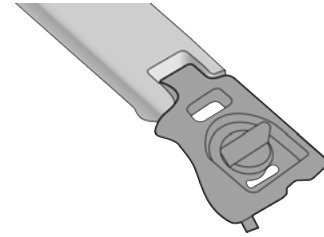

**Bending Pivot**

4. Position the crossbars across the roof making sure the letters on the crossbars align with the matching letters on the side rail.

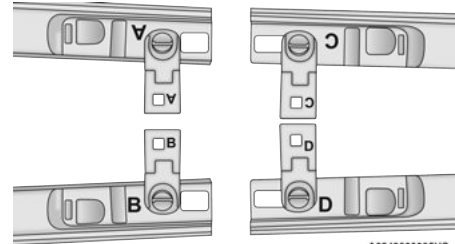

**Positioning Crossbars**

- Slide the crossbar into the deploy position by moving it towards the matching letter in the side rail. Be sure the crossbar is fully deployed with the crossbar pushed as far into the slot as possible. Once the crossbar is in place, tighten both thumb screws completely.

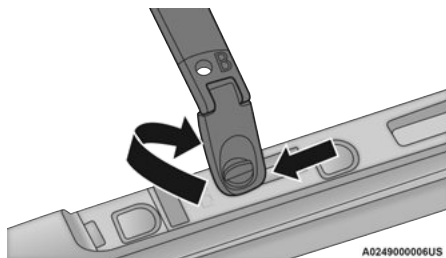

Installing Crossbars

A024900006US

- Deploy and tighten the second crossbar to complete the deployment of the crossbars.

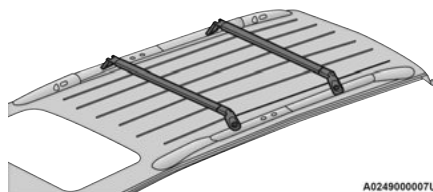

Deployed Crossbars

A024900007US

## STOWING THE CROSSBARS

- Starting with one crossbar, completely loosen the thumb screws at both ends. Slide the crossbar away from the matching letter to remove it from the deployed position. Repeat with the other crossbar.

### CAUTION!

Use care when removing and handling the crossbars to prevent damage to the vehicle.

- Starting with the one crossbar, bend up the pivot supports at each end.

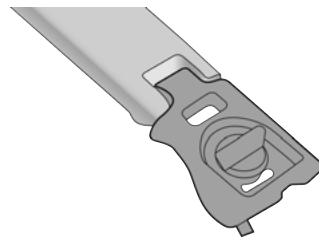

Crossbar Pivot

A024900004US

- Position the crossbar along the correct side rail. Make sure the letters on the crossbar align with the matching letters on the side rail.

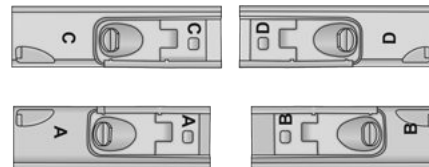

Stowing Crossbars

A024900008US

4. Slide the crossbar outward, away from the center of the roof. The crossbar will nest fully within the side rail.

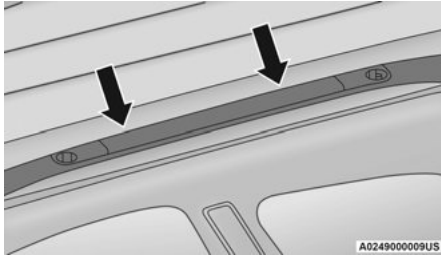

**Crossbar To Side Rail**

5. Once the driver's side crossbar is in place, tighten the thumb screws completely.

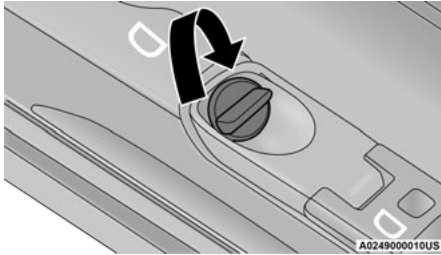

**Tightening Crossbar**

6. Repeat the procedure to stow the second crossbar on the opposite side.

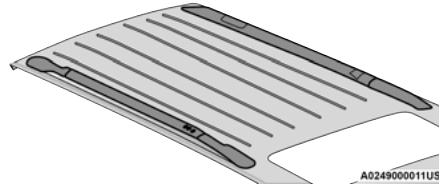

**Stowed Crossbars**

**NOTE:**

- To help control wind noise, stow the crossbars in the side rails when they are not in use.
- If any metallic object is placed over the satellite radio antenna (if equipped), you may experience interruption of satellite radio reception.

**WARNING!**

Cargo must be securely tied down before driving your vehicle. Improperly secured loads can fly off the vehicle, particularly at high speeds, resulting in personal injury or property damage. Follow the roof rack cautions when carrying cargo on your roof rack.

2

**CAUTION!**

- To prevent damage to the roof of your vehicle, DO NOT carry any loads on the roof rack without the crossbars deployed. The load should be secured and placed on top of the crossbars, not directly on the roof. If it is necessary to place the load on the roof, place a blanket or other protective layer between the load and the roof surface.
- To avoid damage to the roof rack and vehicle, do not exceed the maximum roof rack load capacity of 150 lb (68 kg). Always distribute heavy loads as evenly as possible and secure the load appropriately.

*(Continued)*

**CAUTION!**

- Load should always be secured to crossbars first, with tie down loops used as additional securing points if needed. Tie loops are intended as supplementary tie down points only. Do not use ratcheting mechanisms with the tie loops. Check the straps and thumb wheels frequently to be sure that the load remains securely attached.
- Long loads that extend over the windshield, such as wood panels or surfboards, or loads with large frontal area should be secured to both the front and rear of the vehicle.
- Travel at reduced speeds and turn corners carefully when carrying large or heavy loads on the roof rack. Wind forces, due to natural causes or nearby truck traffic, can add sudden upward lift to a load. This is especially true on large flat loads and may result in damage to the cargo or your vehicle.

# GETTING TO KNOW YOUR INSTRUMENT PANEL

## INSTRUMENT CLUSTER

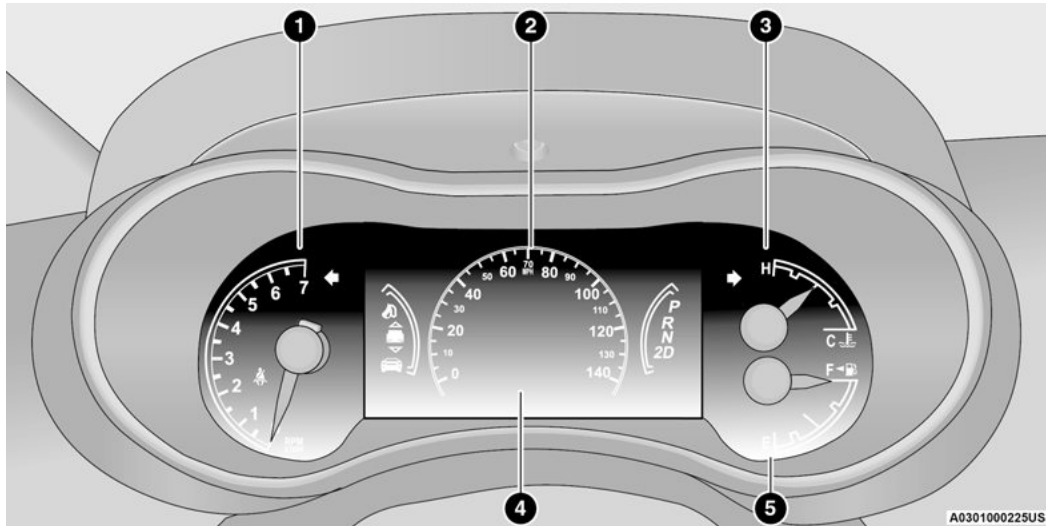

## INSTRUMENT CLUSTER DESCRIPTIONS

1. Tachometer
  - Indicates the engine speed in revolutions per minute (RPM x 1000).
2. Speedometer
  - Indicates vehicle speed.
3. Temperature Gauge
  - The temperature gauge shows engine coolant temperature. Any reading within the normal range indicates that the engine cooling system is operating satisfactorily.
  - The pointer will likely indicate a higher temperature when driving in hot weather, up mountain grades, or when towing a trailer. It should not be allowed to exceed the upper limits of the normal operating range.

### WARNING!

A hot engine cooling system is dangerous. You or others could be badly burned by steam or boiling coolant. You may want to call an authorized dealer for service if your vehicle overheats  
 ⇨ page 271.

### CAUTION!

Driving with a hot engine cooling system could damage your vehicle. If the temperature gauge reads "H", pull over and stop the vehicle. Idle the vehicle with the air conditioner turned off until the pointer drops back into the normal range. If the pointer remains on the "H", turn the engine off immediately and call an authorized dealer for service.

4. Instrument Cluster Display
  - The instrument cluster display features a driver interactive display ⇨ page 82.
5. Fuel Gauge
  - The pointer shows the level of fuel in the fuel tank when the Keyless Push Button Ignition is in the ON/RUN position.



○ The fuel pump symbol points to the side of the vehicle where the fuel door is located ⇨ page 136.

### NOTE:

The hard telltales will illuminate for a bulb check when the ignition is first cycled.

## INSTRUMENT CLUSTER DISPLAY

Your vehicle is equipped with an instrument cluster display, which offers useful information to the driver. With the ignition in the OFF mode, opening/closing of a door will activate the display for viewing, and display the total miles, or kilometers, in the odometer. Your instrument cluster display is designed to display important information about your vehicle's systems and features. Using a driver interactive display located on the instrument panel, your instrument cluster display can show how systems are working and give you warnings when they are not. The steering wheel mounted controls allow you to scroll through the main menus and submenus. You can access the specific information you want and make selections and adjustments.



## LOCATION AND CONTROLS

The instrument cluster display is located in the center of the instrument cluster.

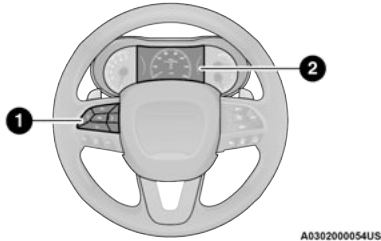

**Instrument Cluster Display/Controls Location**

- 1 - Instrument Cluster Display Controls
- 2 - Instrument Cluster Display Screen

The system allows the driver to select information by pushing the following buttons mounted on the steering wheel:

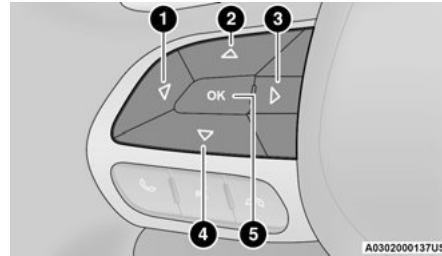

**Instrument Cluster Display Control Buttons**

- 1 - Left Arrow Button
- 2 - Up Arrow Button
- 3 - Right Arrow Button
- 4 - Down Arrow Button
- 5 - OK Button

- **Left Arrow Button**

Push the **left** ◀ arrow button to return to the main menu from an info screen or submenu item.

- **Up Arrow Button**

Push and release the **up** ▲ arrow button to scroll upward through the main menu.

- **Right Arrow Button**

Push and release the **right** ▶ arrow button to access the information screens or submenu screens of a main menu item.

- **Down Arrow Button**

Push and release the **down** ▼ arrow button to scroll downward through the main menu.

- **OK Button**

Push the **OK** button to access/select the information screens or submenu screens of a main menu item. Push and hold the **OK** button for one second to reset displayed/selected features that can be reset.

The instrument cluster display is located in the center portion of the cluster and consist of multiple sections:

- Main Screen — The inner ring of the display will illuminate in gray under normal conditions, yellow for non critical warnings, red for critical warnings, and white for on demand information.
- Submenu Dots — Whenever there are submenus available, the position within the submenus is shown here.
- Reconfigurable Telltales/Information
- Gear Selector Status (PRND)
- Driver Interactive Display (Compass, Temp, Range to Empty, Trip A, Trip B, Average Fuel Economy, Current Fuel Economy, Time, Trailer Trip and Gain)
- All Wheel Drive (AWD) Status — If Equipped

The instrument cluster display will normally display the main menu or the screens of a selected feature of the main menu. The main display area also displays pop-up messages that consist of approximately 60 possible warning or information messages. These pop-up messages fall into several categories:

#### ● Five Second Stored Messages

When the appropriate conditions occur, this type of message takes control of the main display area for five seconds and then returns to the previous screen. Most of the messages of this type are then stored (as long as the condition that activated it remains active) and can be reviewed from the “Messages” main menu item. Examples of this message type are “Right Front Turn Signal Lamp Out” and “Low Tire Pressure.”

#### ● Unstored Messages

This message type is displayed indefinitely or until the condition that activated the message is cleared. Examples of this message type are “Turn Signal On” (if a turn signal is left on) and “Lights On” (if driver leaves the vehicle with the lights on).

#### ● Unstored Messages Until RUN

These messages deal primarily with the Remote Start feature. This message type is displayed until the ignition is in the RUN state. Examples of this message type are “Remote Start Canceled - Door Ajar” and “Press Brake Pedal and Push Button to Start.”

#### ● Five Second Unstored Messages

When the appropriate conditions occur, this type of message takes control of the main display area for five seconds and then returns to the previous screen. An example of this message type is “Automatic High Beams On.”

## ENGINE OIL LIFE RESET

### Oil Change Required

Your vehicle is equipped with an engine oil change indicator system. The “Oil Change Required” message will display in the instrument cluster display for five seconds after a single chime has sounded, to indicate the next scheduled oil change interval. The engine oil change indicator system is duty cycle based, which means the engine oil change interval may fluctuate, dependent upon your personal driving style.

Unless reset, this message will continue to display each time the ignition is placed in the ON/RUN position. To turn off the message temporarily, push and release the **OK** or arrow buttons. To reset the oil change indicator system (after performing the scheduled maintenance), refer to the following procedure.

### Vehicles Equipped With Keyless Enter 'n Go™ — Ignition

Use the steering wheel instrument cluster display controls for the following procedure(s):

1. Without pressing the brake pedal, push the ENGINE START/STOP button and place the ignition in the ON/RUN position (do not start the engine).
2. Push and release the **down** ▾ arrow button to scroll downward through the main menu to "Vehicle Info."
3. Push and release the **right** ▷ arrow button to access the "Oil Life" screen.
4. Push and hold the **OK** button to reset oil life. If conditions are met, the gauge and numeric display will update to show 100%. If conditions

are not met a pop-up message of "To reset oil life engine must be off with ignition in run" will be displayed (for five seconds), and the user will remain at the Oil Life screen.

5. Push and release the **up** ▲ or **down** ▾ arrow button to exit the submenu screen.

#### NOTE:

If the indicator message illuminates when you start the vehicle, the oil change indicator system did not reset. If necessary, repeat this procedure.

#### Secondary Method Of Resetting Engine Oil Life

1. Without pressing the brake pedal, push the ENGINE START/STOP button and place the ignition to the ON/RUN position (do not start the engine).

2. Fully press the accelerator pedal, slowly, three times within 10 seconds.
3. Without pushing the brake pedal, push the ENGINE START/STOP button once to return the ignition to the OFF position.

#### NOTE:

If the indicator message illuminates when you start the vehicle, the oil change indicator system did not reset. If necessary, repeat this procedure.

## DISPLAY AND MESSAGES

Includes the following, but not limited to:

Front Seat Belts Unbuckled	Driver Seat Belt Unbuckled	Passenger Seat Belt Unbuckled
Traction Control Off	Washer Fluid Low	Oil Pressure Low
Oil Change Due	Fuel Low	Service Anti-lock Brake System
Service Electronic Throttle Control	Service Power Steering	Cruise Off
Cruise Ready	ACC Override	Cruise Set To XXX mph or km/h
Cruise Set To XXX km/h	Tire Pressure Screen With Low Tire(s)	Service Tire Pressure System
Park Brake Engaged	Brake Fluid Low	Engine Temperature Hot

Lights On	Right Front Turn Signal Light Out	Right Rear Turn Signal Light Out
Left Front Turn Signal Light Out	Left Rear Turn Signal Light Out	Ignition or Accessory On
Vehicle Not In Park	Remote Start Active Push Start Button	Remote Start Canceled Fuel Low
Remote Start Canceled Door Open	Remote Start Canceled Hood Open	Remote Start Canceled Liftgate Open
Remote Start Canceled Time Expired	Remote Start Disabled Start To Reset	Service Air Bag System
Service Air Bag Warning Light	Door Open	Liftgate Open
Hood Open	Shift Not Allowed	Vehicle Speed Too High To Shift to D
Vehicle Speed is Too High to Shift to R	Vehicle Speed is Too High to Shift to P	Service Transmission
Service Shifter		

The Reconfigurable Telltales section is divided into the white or yellow telltales area on the left, and the green or red telltales area on the right.

## INSTRUMENT CLUSTER DISPLAY MENU ITEMS

The instrument cluster display can be used to view the main menu items for several features. Use the **up**  $\Delta$  and **down**  $\nabla$  arrow buttons to scroll through the driver interactive display menu options until the desired menu is reached.

### NOTE:

Depending on the vehicle's options, feature settings may vary.

## Main Gauge

### Speedometer

Push and release the **up**  $\Delta$  or **down**  $\nabla$  arrow button until the main gauge menu icon is displayed in the instrument cluster display. Push and release the **left**  $\triangleleft$  or **right**  $\triangleright$  arrow button to select the analog or digital type speedometer display. Push and release the **OK** button to toggle units (mph or km/h) of the speedometer.

### Vehicle Info

Push and release the **up**  $\Delta$  or **down**  $\nabla$  arrow button until the Vehicle Info icon/title is highlighted in the instrument cluster display. Push the **left**  $\triangleleft$  or **right**  $\triangleright$  arrow button to scroll through the information submenus.

## Tire Pressure Monitor System

- If tire pressure is **OK** for all tires a vehicle icon is displayed with tire pressure values in each corner of the icon.
  - If one or more tires have low pressure, "Inflate Tire To XX" is displayed with the vehicle icon and the tire pressure values in each corner of the icon with the pressure value of the low tire are displayed in a different color than the other tire pressure value.
  - If the Tire Pressure system requires service, "Service Tire Pressure System" is displayed.
- Tire Pressure is an information only function, and cannot be reset  $\rightarrow$  page 198.

### Transmission Temperature

- Displays the actual transmission temperature.

### Oil Temperature

- Displays the actual oil temperature.

### Oil Pressure

- Displays the actual oil pressure.

### Oil Life

- Displays the current oil life of the vehicle.

### Battery Voltage

- Displays the current voltage level of the battery.

### Driver Assist — If Equipped

Push and release the **up**  $\triangle$  or **down**  $\nabla$  arrow button until the Driver Assist display icon/title is highlighted in the instrument cluster display  $\curvearrowright$  page 118.

### Fuel Economy

Push and release the **up**  $\triangle$  or **down**  $\nabla$  arrow button until the Fuel Economy Menu icon/title is highlighted. Push the **left**  $\triangleleft$  or **right**  $\triangleright$  arrow button to scroll the submenus, one with current fuel economy display and one without it.

- Range
- Current MPG, L/100 km, or km/L
- Average MPG, L/100 km, or km/L
- Press the **OK** button to reset the average fuel economy

### NOTE:

The Range feature is not able to be reset through the instrument cluster display controls.

### Trip

Push and release the **up**  $\triangle$  or **down**  $\nabla$  arrow button until the Trip icon/title is highlighted in the instrument cluster display, then push and release the **left**  $\triangleleft$  or **right**  $\triangleright$  arrow button to select Trip A or Trip B.

The Trip A and Trip B information will display the following:

- Distance
- Average Fuel Economy
- Elapsed Time

Hold the **OK** button to reset all the information.

### Trailer Tow — If Equipped

Push and release the **up**  $\triangle$  or **down**  $\nabla$  arrow button until the Trailer Tow Menu icon/title is highlighted in the instrument cluster display. Push and release the **left**  $\triangleleft$  or **right**  $\triangleright$  arrow button to select Trailer Trip or Trailer Brake.

Trailer Trip will display the following:

- Distance

### NOTE:

Press and hold the **OK** button to reset all the information.

Trailer Brake will display the following:

- Output
- Type
- Gain

### Stop/Start – If Equipped



Push and release the **up**  $\triangle$  or **down**  $\nabla$  arrow button on the steering wheel to scroll to the Stop/Start menu in the driver interactive display  $\curvearrowright$  page 115.

### Audio

Push and release the **up**  $\triangle$  or **down**  $\nabla$  arrow button until the Audio Menu icon/title is highlighted in the instrument cluster display. This menu will display the audio source information, including the Song name, Artist name, and audio source with an accompanying graphic.

### Messages

Push and release the **up**  $\triangle$  or **down**  $\nabla$  arrow button until the Messages Menu item is highlighted. This feature shows the number of stored warning messages. Pushing the **left**  $\triangleleft$  or **right**  $\triangleright$  arrow button will allow you to see what the stored messages are.

When no messages are present, main menu icon will be a closed envelope.

## Screen Setup

Push and release the **up** ▲ or **down** ▼ arrow button until the Screen Setup Menu icon/title is highlighted in the instrument cluster display. Push and release the **OK** button to enter the submenus and follow the prompts on the screen as needed. The Screen Setup feature allows you to change what information is displayed in the instrument cluster as well as the location that information is displayed.

### Current Gear

- On
- Off

### Gear Display

- Full
- Single

Favorite Menus		
Speedometer	Driver Assist (Show/Hide)	Stop/Start
Vehicle Info	Fuel Economy (Show/Hide)	Trailer Tow (Show/Hide)
Performance (Show/Hide)	Trip (Show/Hide)	Audio (Show/Hide)
Stored Messages	Screen Setup	

Upper Left		
None	Compass	Outside Temp
Time	Range To Empty (RTE)	Fuel Economy Average
Fuel Economy Current	Trip A	Trip B
Trailer Trip	Gain	

Upper Right		
None	Compass	Outside Temp
Time	Range To Empty (RTE)	Fuel Economy Average
Fuel Economy Current	Trip A	Trip B
Trailer Trip	Gain	

### NOTE:

Menus with (show/hide) can push the **OK** button to choose whether to show or hide this menu on the instrument cluster display.

### Defaults (Restores All Settings To Default Settings)

- Restore
- Cancel

## BATTERY SAVER ON/BATTERY SAVER MODE MESSAGE — ELECTRICAL LOAD REDUCTION ACTIONS — IF EQUIPPED

This vehicle is equipped with an Intelligent Battery Sensor (IBS) to perform additional monitoring of the electrical system and status of the vehicle battery.

In cases when the IBS detects charging system failure, or the vehicle battery conditions are deteriorating, electrical load reduction actions will take place to extend the driving time and distance of the vehicle. This is done by reducing power to or turning off non-essential electrical loads.

Load reduction is only active when the engine is running. It will display a message if there is a risk of battery depletion to the point where the vehicle may stall due to lack of electrical supply, or will not restart after the current drive cycle.

When load reduction is activated, the message “Battery Saver On” or “Battery Saver Mode” will appear in the instrument cluster.

These messages indicate the vehicle battery has a low state of charge and continues to lose electrical charge at a rate that the charging system cannot sustain.

**NOTE:**

- The charging system is independent from load reduction. The charging system performs a diagnostic on the charging system continuously.
- If the Battery Charge Warning Light is on it may indicate a problem with the charging system ↪ page 91.

The electrical loads that may be switched off (if equipped), and vehicle functions which can be affected by load reduction:

- Heated Seat/Vented Seats/Heated Wheel
- Rear Defroster And Heated Mirrors
- HVAC System
- 115 Volt AC Power Inverter System
- Audio and Telematics System

Loss of the battery charge may indicate one or more of the following conditions:

- The charging system cannot deliver enough electrical power to the vehicle system because the electrical loads are larger than the capability of the charging system. The charging system is still functioning properly.
- Turning on all possible vehicle electrical loads (e.g. HVAC to max settings, exterior and interior lights, overloaded power outlets +12 Volt, 115 Volt AC, USB ports) during certain driving conditions (city driving, towing, frequent stopping, etc.).

- Installing options like additional lights, upfitter electrical accessories, audio systems, alarms and similar devices.
- Unusual driving cycles (short trips separated by long parking periods).
- The vehicle was parked for an extended period of time (weeks, months).
- The battery was recently replaced and was not charged completely.
- The battery was discharged by an electrical load left on when the vehicle was parked.
- The battery was used for an extended period with the engine not running to supply radio, lights, chargers, +12 Volt portable appliances like vacuum cleaners, game consoles and similar devices.

**What to do when an electrical load reduction action message is present (“Battery Saver On” or “Battery Saver Mode”)**

During a trip:

- Reduce power to unnecessary loads if possible:
  - Turn off redundant lights (interior or exterior)
  - Check what may be plugged in to power outlets +12 Volt, 115 Volt AC, USB ports
  - Check HVAC settings (blower, temperature)
  - Check the audio settings (volume)

After a trip:

- Check if any aftermarket equipment was installed (additional lights, upfitter electrical accessories, audio systems, alarms) and review specifications if any (load and Ignition Off Draw currents).
- Evaluate the latest driving cycles (distance, driving time and parking time).
- The vehicle should have service performed if the message is still present during consecutive trips, and if the evaluation and driving pattern of the vehicle did not help to identify the cause.

## WARNING LIGHTS AND MESSAGES

The warning/indicator lights will illuminate in the instrument panel together with a dedicated message and/or acoustic signal when applicable. These indications are indicative and precautionary and as such must not be considered as exhaustive and/or alternative to the information contained in the Owner’s Manual, which you are advised to read carefully in all cases. Always refer to the information in this chapter in the event of a failure indication. All active telltales will display first if applicable. The system check menu may appear different based upon equipment options and current vehicle status. Some telltales are optional and may not appear.

## RED WARNING LIGHTS

### Seat Belt Reminder Warning Light



This warning light indicates when the driver or passenger seat belt is unbuckled. When the ignition is first placed in the ON/RUN or ACC/ON/RUN position and if the driver's seat belt is unbuckled, a chime will sound and the light will turn on. When driving, if the driver or front passenger seat belt remains unbuckled, the Seat Belt Reminder Light will flash or remain on continuously and a chime will sound ↪ page 201.

### Air Bag Warning Light



This warning light will illuminate to indicate a fault with the air bag, and will turn on for four to eight seconds as a bulb check when the ignition is placed in the ON/RUN or ACC/ON/RUN position. This light will illuminate with a single chime when a fault with the air bag has been detected, it will stay on until the fault is cleared. If the light is either not on during startup, stays on, or turns on while driving, have the system inspected at an authorized dealer as soon as possible.

### Brake Warning Light



This warning light monitors various brake functions, including brake fluid level and parking brake application. If the brake light turns on it may indicate that the parking brake is applied, that the brake fluid level is low, or that there is a problem with the Anti-Lock Brake System reservoir.

If the light remains on when the parking brake has been disengaged, and the fluid level is at the full mark on the master cylinder reservoir, it indicates a possible brake hydraulic system malfunction or that a problem with the Brake Booster has been detected by the Anti-Lock Brake System (ABS) / Electronic Stability Control (ESC) system. In this case, the light will remain on until the condition has been corrected. If the problem is related to the brake booster, the ABS pump will run when applying the brake, and a brake pedal pulsation may be felt during each stop.

The dual brake system provides a reserve braking capacity in the event of a failure to a portion of the hydraulic system. A leak in either half of the dual brake system is indicated by the Brake Warning Light, which will turn on when the brake fluid level in the master cylinder has dropped below a specified level.

The light will remain on until the cause is corrected.

### NOTE:

The light may flash momentarily during sharp cornering maneuvers, which change fluid level conditions. The vehicle should have service performed, and the brake fluid level checked. If brake failure is indicated, immediate repair is necessary.

### WARNING!

Driving a vehicle with the red brake light on is dangerous. Part of the brake system may have failed. It will take longer to stop the vehicle. You could have a collision. Have the vehicle checked immediately.

Vehicles equipped with the Anti-Lock Brake System (ABS) are also equipped with Electronic Brake Force Distribution (EBD). In the event of an EBD failure, the Brake Warning Light will turn on along with the ABS Light. Immediate repair to the ABS system is required.

Operation of the Brake Warning Light can be checked by turning the ignition switch from the OFF position to the ON/RUN position. The light should illuminate for approximately two seconds. The light should then turn off unless the parking brake is applied or a brake fault is detected. If the light does not illuminate, have the light inspected by an authorized dealer.



The light also will turn on when the parking brake is applied with the ignition switch in the ON/RUN position.

**NOTE:**

This light shows only that the parking brake is applied. It does not show the degree of brake application.

### Battery Charge Warning Light



This warning light will illuminate when the battery is not charging properly. If it stays on while the engine is running, there may be a malfunction with the charging system. Contact an authorized dealer as soon as possible.

This indicates a possible problem with the electrical system or a related component.

### Door Open Warning Light — If Equipped



This indicator will illuminate when a door is ajar/open and not fully closed.

**NOTE:**

If the vehicle is moving, there will also be a single chime.

### Electric Power Steering (EPS) Fault Warning Light



This warning light will turn on when there's a fault with the EPS system  
 ⇨ page 114.

### WARNING!

Continued operation with reduced assist could pose a safety risk to yourself and others. Service should be obtained as soon as possible.

### Electronic Throttle Control (ETC) Warning Light



This warning light will illuminate to indicate a problem with the ETC system. If a problem is detected while the vehicle is running, the light will either stay on or flash depending on the nature of the problem. Cycle the ignition when the vehicle is safely and completely stopped and the transmission is placed in the PARK (P) position. The light should turn off. If the light remains on with the vehicle running, your vehicle will usually be drivable; however, see an authorized dealer for service as soon as possible.

**NOTE:**

This light may turn on if the accelerator and brake pedals are pressed at the same time.

If the light continues to flash when the vehicle is running, immediate service is required and you may experience reduced performance, an elevated/rough idle, or engine stall and your vehicle may require towing. The light will come on when the ignition is placed in the ON/RUN or

ACC/ON/RUN position and remain on briefly as a bulb check. If the light does not come on during starting, have the system checked by an authorized dealer.

### Engine Coolant Temperature Warning Light



This warning light warns of an overheated engine condition. If the engine coolant temperature is too high, this indicator will illuminate and a single chime will sound. If the temperature reaches the upper limit, a continuous chime will sound for four minutes or until the engine is able to cool, whichever comes first.

If the light turns on while driving, safely pull over and stop the vehicle. If the Air Conditioning (A/C) system is on, turn it off. Also, shift the transmission into NEUTRAL (N) and idle the vehicle. If the temperature reading does not return to normal, turn the engine off immediately and call for service  
 ⇨ page 251.

### Hood Open Warning Light



This warning light will illuminate when the hood is left open and not fully closed.

**NOTE:**

If the vehicle is moving, there will also be a single chime.

### Liftgate Open Warning Light



This warning light will illuminate when the liftgate is open.

#### NOTE:

If the vehicle is moving, there will also be a single chime.

### Oil Pressure Warning Light



This warning light will illuminate to indicate low engine oil pressure. If the light turns on while driving, stop the vehicle, shut off the engine as soon as possible, and contact an authorized dealer. A chime will sound when this light turns on.

Do not operate the vehicle until the cause is corrected. This light does not indicate how much oil is in the engine. The engine oil level must be checked under the hood.

### Oil Temperature Warning Light



This warning light will illuminate to indicate the engine oil temperature is high. If the light turns on while driving, stop the vehicle and shut off the engine as soon as possible. Wait for oil temperature to return to normal levels.

### Trailer Brake Disconnected Warning Light



This warning light will illuminate when the Trailer Brake has been disconnected  
 ⇨ page 142.

### Transmission Temperature Warning Light



This warning light will illuminate to warn of a high transmission fluid temperature. This may occur with strenuous usage such as trailer towing. If this light turns on, stop the vehicle and run the engine at idle or slightly faster, with the transmission in PARK (P) or NEUTRAL (N), until the light turns off. Once the light turns off, you may continue to drive normally.

#### WARNING!

If you continue operating the vehicle when the Transmission Temperature Warning Light is illuminated you could cause the fluid to boil over, come in contact with hot engine or exhaust components and cause a fire.

#### CAUTION!

Continuous driving with the Transmission Temperature Warning Light illuminated will eventually cause severe transmission damage or transmission failure.

### Vehicle Security Warning Light — If Equipped



This light will flash at a fast rate for approximately 15 seconds when the vehicle security system is arming, and then will flash slowly until the vehicle is disarmed.

### YELLOW WARNING LIGHTS

#### Anti-Lock Brake System (ABS) Warning Light



This warning light monitors the ABS. The light will turn on when the ignition is placed in the ON/RUN or ACC/ON/RUN position and may stay on for as long as four seconds.

If the ABS light remains on or turns on while driving, then the Anti-Lock portion of the brake system is not functioning and service is required as soon as possible. However, the conventional brake system will continue to operate normally, assuming the Brake Warning Light is not also on.

If the ABS light does not turn on when the ignition is placed in the ON/RUN or ACC/ON/RUN position, have the brake system inspected by an authorized dealer.

### Electronic Stability Control (ESC) Active Warning Light



This warning light will indicate when the ESC system is Active. The ESC Indicator Light in the instrument cluster will come on when the ignition is placed in the ON/RUN or ACC/ON/RUN position, and when ESC is activated. It should go out with the engine running. If the ESC Indicator Light comes on continuously with the engine running, a malfunction has been detected in the ESC system. If this warning light remains on after several ignition cycles, and the vehicle has been driven several miles (kilometers) at speeds greater than 30 mph (48 km/h), see an authorized dealer as soon as possible to have the problem diagnosed and corrected.

- The ESC OFF Indicator Light and the ESC Indicator Light come on momentarily each time the ignition is placed in the ON/RUN or ACC/ON/RUN position.
- The ESC system will make buzzing or clicking sounds when it is active. This is normal; the sounds will stop when ESC becomes inactive.
- This light will come on when the vehicle is in an ESC event.

### Electronic Stability Control (ESC) OFF Warning Light



This warning light indicates the ESC is off. Each time the ignition is turned to ON/RUN or ACC/ON/RUN, the ESC system will be on, even if it was turned off previously.

### Service LaneSense Warning Light — If Equipped



This warning light will illuminate when the LaneSense system is not operating and requires service. Please see an authorized dealer.

### LaneSense Warning Light — If Equipped



The LaneSense Warning Light will be solid yellow when the vehicle is approaching a lane marker. The warning light will flash when the vehicle is crossing the lane marker → page 132.

### Low Washer Fluid Warning Light — If Equipped



This warning light will illuminate when the windshield washer fluid is low → page 261.

### Low Fuel Warning Light



When the fuel level reaches approximately 2 gal (7.5 L), this light will turn on and a chime will sound. The light will remain on until fuel is added.

### Engine Check/Malfunction Indicator Warning Light (MIL)



The Engine Check/Malfunction Indicator Light (MIL) is a part of an Onboard Diagnostic System called OBD II that monitors engine and automatic transmission control systems. This warning light will illuminate when the ignition is in the ON/RUN position before engine start. If the bulb does not come on when turning the ignition switch from OFF to ON/RUN, have the condition checked promptly.

Certain conditions, such as a loose or missing gas cap, poor quality fuel, etc., may illuminate the light after engine start. The vehicle should be serviced if the light stays on through several typical driving styles. In most situations, the vehicle will drive normally and will not require towing.

When the engine is running, the MIL may flash to alert serious conditions that could lead to immediate loss of power or severe catalytic converter damage. The vehicle should be serviced by an authorized dealer as soon as possible if this occurs.

**WARNING!**

A malfunctioning catalytic converter, as referenced above, can reach higher temperatures than in normal operating conditions. This can cause a fire if you drive slowly or park over flammable substances such as dry plants, wood, cardboard, etc. This could result in death or serious injury to the driver, occupants or others.

**CAUTION!**

Prolonged driving with the Malfunction Indicator Light (MIL) on could cause damage to the vehicle control system. It also could affect fuel economy and driveability. If the MIL is flashing, severe catalytic converter damage and power loss will soon occur. Immediate service is required.

**Service Forward Collision Warning (FCW) Light — If Equipped**

This warning light will illuminate to indicate a fault in the Forward Collision Warning System. Contact an authorized dealer for service → page 196.

**Service Adaptive Cruise Control (ACC)****Warning Light — If Equipped**

This light will turn on when the ACC is not operating and needs service  
→ page 118.

**Service AWD Warning Light — If Equipped**

This telltale will turn on to indicate the All Wheel Drive (AWD) system is not functioning properly and that service is required. Contact an authorized dealer.

**Service Stop/Start System Warning Light — If Equipped**

This warning light will illuminate when the Stop/Start system is not functioning properly and service is required. Contact an authorized dealer for service.

**Cruise Control Fault Warning Light — If Equipped**

This warning light will illuminate to indicate the Cruise Control System is not functioning properly and service is required. Contact an authorized dealer.

**Tire Pressure Monitoring System (TPMS) Warning Light**

The warning light switches on and a message is displayed to indicate that the tire pressure is lower than the

recommended value and/or that slow pressure loss is occurring. In these cases, optimal tire duration and fuel consumption may not be guaranteed.

Should one or more tires be in the condition mentioned above, the display will show the indications corresponding to each tire.

**CAUTION!**

Do not continue driving with one or more flat tires as handling may be compromised. Stop the vehicle, avoiding sharp braking and steering. If a tire puncture occurs, repair immediately using the dedicated tire repair kit and contact an authorized dealer as soon as possible.

Each tire, including the spare (if provided), should be checked monthly when cold and inflated to the inflation pressure recommended by the vehicle manufacturer on the vehicle placard or tire inflation pressure label. If your vehicle has tires of a different size than the size indicated on the vehicle placard or tire inflation pressure label, you should determine the proper tire inflation pressure for those tires.

As an added safety feature, your vehicle has been equipped with a TPMS that illuminates a low tire pressure telltale when one or more of your tires is significantly underinflated. Accordingly, when the low tire pressure telltale illuminates, you should

stop and check your tires as soon as possible, and inflate them to the proper pressure. Driving on a significantly underinflated tire causes the tire to overheat and can lead to tire failure. Underinflation also reduces fuel efficiency and tire tread life, and may affect the vehicle's handling and stopping ability.

Please note that the TPMS is not a substitute for proper tire maintenance, and it is the driver's responsibility to maintain correct tire pressure, even if underinflation has not reached the level to trigger illumination of the TPMS low tire pressure telltale.

Your vehicle has also been equipped with a TPMS malfunction indicator to indicate when the system is not operating properly. The TPMS malfunction indicator is combined with the low tire pressure telltale. When the system detects a malfunction, the telltale will flash for approximately one minute and then remain continuously illuminated. This sequence will continue upon subsequent vehicle start-ups as long as the malfunction exists. When the malfunction indicator is illuminated, the system may not be able to detect or signal low tire pressure as intended. TPMS malfunctions may occur for a variety of reasons, including the installation of replacement or alternate tires or wheels on the vehicle that prevent the TPMS from functioning properly. Always check the TPMS malfunction telltale after replacing one or more

tires or wheels on your vehicle to ensure that the replacement or alternate tires and wheels allow the TPMS to continue to function properly.

#### CAUTION!

The TPMS has been optimized for the original equipment tires and wheels. TPMS pressures and warning have been established for the tire size equipped on your vehicle. Undesirable system operation or sensor damage may result when using replacement equipment that is not of the same size, type, and/or style. Aftermarket wheels can cause sensor damage. Using aftermarket tire sealants may cause the Tire Pressure Monitoring System (TPMS) sensor to become inoperable. After using an aftermarket tire sealant it is recommended that you take your vehicle to an authorized dealer to have your sensor function checked.

## YELLOW INDICATOR LIGHTS

### All Wheel Drive (AWD) Low Indicator Light — If Equipped



This light alerts the driver that the vehicle is in the AWD Low mode. The front and rear driveshafts are mechanically locked together forcing the front and rear wheels to rotate at the same speed. AWD Low is designed for loose, slippery road surfaces only [↪ page 110](#).

### Forward Collision Warning (FCW) OFF Indicator Light — If Equipped



This indicator light illuminates to indicate that Forward Collision Warning is off [↪ page 196](#).

### NEUTRAL Indicator Light — If Equipped



This light alerts the driver that the 4WD power transfer case is in the NEUTRAL mode and the front and rear driveshafts are disengaged from the powertrain.

3

## GREEN INDICATOR LIGHTS

### Adaptive Cruise Control (ACC) Set With Target Light — If Equipped



This will display when the ACC is set and the vehicle in front is detected [↪ page 118](#).

### Adaptive Cruise Control (ACC) Set Without Target Light — If Equipped



This will display when the ACC is set and the vehicle in front is not detected [↪ page 118](#).

### Cruise Control Set Indicator Light — If Equipped



This indicator light will illuminate when the cruise control is set to the desired speed [↪ page 117](#).

**Front Fog Indicator Light — If Equipped**

This indicator light will illuminate when the front fog lights are on → page 48.

**LaneSense Indicator Light — If Equipped**

The LaneSense indicator light illuminates solid green when both lane markings have been detected and the system is “armed” and ready to provide visual and torque warnings if an unintentional lane departure occurs → page 132.

**Parking/Headlights On Indicator Light**

This indicator light will illuminate when the parking lights or headlights are turned on → page 48.

**Sport Mode Indicator Light**

This light will turn on when Sport Mode is active → page 110.

**Stop/Start Active Indicator Light — If Equipped**

This indicator light will illuminate when the Stop/Start function is in “Autostop” mode → page 115.

**Turn Signal Indicator Lights**

When the left or right turn signal is activated, the turn signal indicator will flash independently and the corresponding exterior turn signal lamps will flash. Turn signals can be activated when the multifunction lever is moved down (left) or up (right).

**NOTE:**

- A continuous chime will sound if the vehicle is driven more than 1 mile (1.6 km) with either turn signal on.
- Check for an inoperative outside light bulb if either indicator flashes at a rapid rate.

**WHITE INDICATOR LIGHTS****Adaptive Cruise Control (ACC) Ready Light — If Equipped**

This light will turn on when ACC has been turned on, but is not set → page 118.

**Cruise Control Ready Indicator Light**

This indicator light will illuminate when the cruise control is ready, but not set → page 117.

**LaneSense Indicator Light — If Equipped**

When the LaneSense system is ON, but not armed, the LaneSense indicator light illuminates solid white. This occurs when only left, right, or neither lane line has been detected. If a single lane line is detected, the system is ready to provide only visual warnings if an unintentional lane departure occurs on the detected lane line → page 132.

**BLUE INDICATOR LIGHTS****High Beam Indicator Light**

This indicator light will illuminate to indicate that the high beam headlights are on. With the low beams activated, push the multifunction lever forward (toward the front of the vehicle) to turn on the high beams. Pull the multifunction lever rearward (toward the rear of the vehicle) to turn off the high beams. If the high beams are off, pull the lever toward you for a temporary high beam on, “flash to pass” scenario.

## ONBOARD DIAGNOSTIC SYSTEM — OBD II

Your vehicle is equipped with a sophisticated Onboard Diagnostic system called OBD II. This system monitors the performance of the emissions, engine, and transmission control systems. When these systems are operating properly, your vehicle will provide excellent performance and fuel economy, as well as engine emissions well within current government regulations.

If any of these systems require service, the OBD II system will turn on the Malfunction Indicator Light (MIL). It will also store diagnostic codes and other information to assist your service technician in making repairs. Although your vehicle will usually be driveable and not need towing, see an authorized dealer for service as soon as possible.

### CAUTION!

- Prolonged driving with the MIL on could cause further damage to the emission control system. It could also affect fuel economy and driveability. The vehicle must be serviced before any emissions tests can be performed.
- If the MIL is flashing while the vehicle is running, severe catalytic converter damage and power loss will soon occur. Immediate service is required.

## ONBOARD DIAGNOSTIC SYSTEM (OBD II) CYBERSECURITY

Your vehicle is required to have an OBD II and a connection port to allow access to information related to the performance of your emissions controls. Authorized service technicians may need to access this information to assist with the diagnosis and service of your vehicle and emissions system → page 154.

### WARNING!

- ONLY an authorized service technician should connect equipment to the OBD II connection port in order to read the VIN, diagnose, or service your vehicle.
- If unauthorized equipment is connected to the OBD II connection port, such as a driver-behavior tracking device, it may:
  - Be possible that vehicle systems, including safety related systems, could be impaired or a loss of vehicle control could occur that may result in an accident involving serious injury or death.
  - Access, or allow others to access, information stored in your vehicle systems, including personal information.

## EMISSIONS INSPECTION AND MAINTENANCE PROGRAMS

In some localities, it may be a legal requirement to pass an inspection of your vehicle's emissions control system. Failure to pass could prevent vehicle registration.



For states that require an Inspection and Maintenance (I/M), this check verifies the Malfunction Indicator Light (MIL) is functioning and is not on when the

engine is running, and that the OBD II system is ready for testing.

Normally, the OBD II system will be ready. The OBD II system may **not** be ready if your vehicle was recently serviced, recently had a depleted battery or a battery replacement. If the OBD II system should be determined not ready for the I/M test, your vehicle may fail the test.

Your vehicle has a simple ignition actuated test, which you can use prior to going to the test station. To check if your vehicle's OBD II system is ready, you must do the following:

1. Cycle the ignition switch to the ON position, but do not crank or start the engine.

### NOTE:

If you crank or start the engine, you will have to start this test over.

2. As soon as you cycle the ignition switch to the ON position, you will see the Malfunction Indicator Light (MIL) symbol come on as part of a normal bulb check.
3. Approximately 15 seconds later, one of two things will happen:
  - The MIL will flash for about 10 seconds and then return to being fully illuminated until you turn OFF the ignition or start the engine. This means that your vehicle's OBD II system is **not ready** and you should **not** proceed to the I/M station.
  - The MIL will not flash at all and will remain fully illuminated until you place the ignition in the off position or start the engine. This means that your vehicle's OBD II system is **ready** and you can proceed to the I/M station.

If your OBD II system is **not ready**, you should see an authorized dealer or repair facility. If your vehicle was recently serviced or had a battery failure or replacement, you may need to do nothing more than drive your vehicle as you normally would in order for your OBD II system to update. A recheck with the above test routine may then indicate that the system is **now ready**.

Regardless of whether your vehicle's OBD II system is ready or not, if the MIL is illuminated during normal vehicle operation you should have your vehicle serviced before going to the I/M station. The I/M station can fail your vehicle because the MIL is on with the engine running.



# STARTING AND OPERATING

## STARTING THE ENGINE

Before starting your vehicle, adjust your seat, adjust the inside and outside mirrors, fasten your seat belt, and if present, instruct all other occupants to buckle their seat belts.

### WARNING!

- Before exiting a vehicle, always come to a complete stop, then shift the automatic transmission into PARK and apply the parking brake.
- Always make sure the keyless ignition node is in the OFF position, key fob is removed from the vehicle and vehicle is locked.
- Never leave children alone in a vehicle, or with access to an unlocked vehicle. Leaving children in a vehicle unattended is dangerous for a number of reasons. A child or others could be seriously or fatally injured. Children should be warned not to touch the parking brake, brake pedal or the gear selector.

*(Continued)*

### WARNING!

- Do not leave the key fob in or near the vehicle, or in a location accessible to children, and do not leave the ignition of a vehicle equipped with Keyless Enter 'n Go™ in the ACC or ON/RUN position. A child could operate power windows, other controls, or move the vehicle.
- Do not leave children or animals inside parked vehicles in hot weather. Interior heat build-up may cause serious injury or death.

## AUTOMATIC TRANSMISSION

The gear selector must be in the NEUTRAL (N) or PARK (P) position before you can start the engine. Apply the brakes before shifting into any driving gear.

### CAUTION!

Damage to the transmission may occur if the following precautions are not observed:

- Do not shift from REVERSE (R), PARK, or NEUTRAL into any forward gear when the engine is above idle speed.

*(Continued)*

### CAUTION!

- Shift into or out of PARK or REVERSE only after the vehicle has come to a complete stop and the engine is at idle speed.
- Before shifting into any gear, make sure your foot is firmly on the brake pedal.

4

## NORMAL STARTING

**To Turn On The Engine Using The ENGINE START/STOP Button**

1. The transmission must be in PARK (P).
2. Press and hold the brake pedal while pushing the ENGINE START/STOP button once.
3. The system starts the vehicle. If the vehicle fails to start, the starter will disengage automatically after 10 seconds.
4. If you wish to stop the cranking of the engine prior to the engine starting, push the ENGINE START/STOP button again.

### To Turn Off The Engine Using The ENGINE START/STOP Button

1. Place the gear selector in PARK, then push and release the ENGINE START/STOP button. The ignition will return to the OFF position.
2. If the gear selector is not in PARK, the ENGINE START/STOP button must be held for two seconds or three short pushes in a row with the vehicle speed above 5 mph (8 km/h) before the engine will shut off. The ignition will remain in the ACC position until the gear selector is in PARK and the button is pushed twice to the OFF position.
3. If the gear selector is not in PARK and the ENGINE START/STOP button is pushed once with the vehicle speed above 5 mph (8 km/h), the instrument cluster will display a “**Vehicle Not In Park**” message and the engine will remain running. Never leave a vehicle out of the PARK position, or it could roll.

#### NOTE:

If the gear selector is not in PARK, and the ENGINE START/STOP button is pushed once with the vehicle speed below 5 mph (8 km/h), the engine will shut off and the ignition will remain in the ACC position. If vehicle speed drops below 1.2 mph (1.9 km/h), the vehicle may AutoPark. See AutoPark section for further details.

### ENGINE START/STOP Button Functions — With Driver’s Foot OFF The Brake Pedal (In PARK Or NEUTRAL Position)

The ENGINE START/STOP button operates similar to an ignition switch. It has three positions: OFF, ACC, and ON/RUN. To change the ignition positions without starting the vehicle and use the accessories, follow these directions:

1. Start with the ignition in the OFF position.
2. Push the ENGINE START/STOP button once to place the ignition to the ACC position.
3. Push the ENGINE START/STOP button a second time to place the ignition to the ON/RUN position.
4. Push the ENGINE START/STOP button a third time to return the ignition to the OFF position.

#### NOTE:

Only press one pedal at a time while driving the vehicle. Torque performance of the vehicle could be reduced if both pedals are pressed at the same time. If pressure is detected on both pedals simultaneously, a warning message will display in the instrument cluster ↪ page 82.

## AUTOPARK

AutoPark is a supplemental feature to assist in placing the vehicle in PARK (P) if the below occur. It is a back-up system and should not be relied upon as the primary method by which the driver shifts the vehicle into PARK.

The conditions under which AutoPark will engage are outlined on the following pages.

#### WARNING!

- Driver inattention could lead to failure to place the vehicle in PARK. ALWAYS DO A VISUAL CHECK that your vehicle is in PARK by verifying that a solid (not blinking) “P” is indicated in the instrument cluster display and on the gear selector. If the “P” indicator is blinking, your vehicle is not in PARK. As an added precaution, always apply the parking brake when exiting the vehicle.
- AutoPark is a supplemental feature. It is not designed to replace the need to shift your vehicle into PARK. It is a back-up system and should not be relied upon as the primary method by which the driver shifts the vehicle into PARK.

**If the vehicle is not in PARK and the driver turns off the engine, the vehicle may AutoPark.**

AutoPark will engage when all of these conditions are met:

- Vehicle is equipped with an 8-speed transmission
- Vehicle is not in PARK
- Vehicle speed is 1.2 mph (1.9 km/h) or less
- Ignition switched from ON/RUN to ACC

**NOTE:**

For Keyless Enter 'n Go™ equipped vehicles, the engine will turn off and the ignition switch will change to the ACC position. After 60 seconds, the ignition switches to OFF automatically, unless the driver turns the ignition switch OFF.

**If the vehicle is not in PARK and the driver exits the vehicle with the engine running, the vehicle may AutoPark.**

AutoPark will engage when all of these conditions are met:

- Vehicle is equipped with an 8-speed transmission
- Vehicle is not in PARK
- Vehicle speed is 1.2 mph (1.9 km/h) or less
- Driver's seat belt is unbuckled
- Driver's door is ajar
- Brake pedal is not pressed

The message “**AutoPark Engaged Shift to P then Shift to Gear**” will display in the instrument cluster.

**NOTE:**

In some cases the ParkSense graphic will be displayed in the instrument cluster. In these cases, the gear selector must be returned to “P” to select desired gear.

**If the driver shifts into PARK while moving, the vehicle may AutoPark.**

AutoPark will engage **ONLY** when vehicle speed is 1.2 mph (1.9 km/h) or less.

The message “**Vehicle Speed is Too High to Shift to P**” will be displayed in the instrument cluster if vehicle speed is above 1.2 mph (1.9 km/h).

**WARNING!**

If vehicle speed is above 1.2 mph (1.9 km/h), the transmission will default to NEUTRAL until the vehicle speed drops below 1.2 mph (1.9 km/h). A vehicle left in the NEUTRAL position can roll. As an added precaution, always apply the parking brake when exiting the vehicle.

**4WD LOW – If Equipped**

**AutoPark will be disabled when operating the vehicle in 4WD LOW.**

The message “**AutoPark Disabled**” will be displayed in the instrument cluster.

**Additional customer warnings will be given when both of these conditions are met:**

- Vehicle is not in PARK
- Driver's door is ajar

The message “**AutoPark Not Engaged**” will be displayed in the instrument cluster. A warning chime will continue until you shift the vehicle into PARK or the driver's door is closed.

**ALWAYS DO A VISUAL CHECK** that your vehicle is in PARK by looking for the “P” in the instrument cluster display and on the gear selector. As an added precaution, always apply the parking brake when exiting the vehicle.

**EXTENDED PARK STARTING**

**NOTE:**

Extended Park condition occurs when the vehicle has not been started or driven for at least 30 days.

1. Install a battery charger or jumper cables to the battery to ensure a full battery charge during the crank cycle.
2. Place the ignition in the START position and release it when the engine starts.
3. If the engine fails to start within 10 seconds, place the ignition in the OFF position, wait 10 to 15 seconds to allow the starter to cool, then repeat the “Extended Park Starting” procedure.

4. If the engine fails to start after eight attempts, allow the starter to cool for at least 10 minutes, then repeat the procedure.

**CAUTION!**

To prevent damage to the starter, do not crank continuously for more than 10 seconds at a time. Wait 10 to 15 seconds before trying again.

**IF ENGINE FAILS TO START**

If the engine fails to start after you have followed the “Normal Starting” procedure and the vehicle has not experienced an extended park condition as defined previously, it may be flooded. Push the accelerator pedal all the way to the floor and hold it there while the engine is cranking. This should clear any excess fuel in case the engine is flooded. The starter motor will engage automatically, run for 10 seconds, and then disengage. Once this occurs, release the accelerator pedal and brake pedal, wait 10 to 15 seconds, then repeat the “Normal Starting” procedure.

**WARNING!**

- Never pour fuel or other flammable liquid into the throttle body air inlet opening in an attempt to start the vehicle. This could result in flash fire causing serious personal injury.

*(Continued)*

**WARNING!**

- Do not attempt to push or tow your vehicle to get it started. Vehicles equipped with an automatic transmission cannot be started this way. Unburned fuel could enter the catalytic converter and once the engine has started, ignite and damage the converter and vehicle.
- If the vehicle has a discharged battery, booster cables may be used to obtain a start from a booster battery or the battery in another vehicle. This type of start can be dangerous if done improperly ↪ page 247.

**CAUTION!**

To prevent damage to the starter, do not continuously crank the engine for more than 10 seconds at a time. Wait 10 to 15 seconds before trying again.

**COLD WEATHER OPERATION  
(BELOW -22 °F OR -30 °C)**

To ensure reliable starting at these temperatures, use of an externally powered electric engine block heater (available from an authorized dealer) is recommended.

**AFTER STARTING**

The idle speed is controlled automatically, and it will decrease as the engine warms up.

**ENGINE BREAK-IN RECOMMENDATIONS**

A long break-in period is not required for the engine and drivetrain (transmission and axle) in your vehicle.

Drive moderately during the first 300 miles (500 km). After the initial 60 miles (100 km), speeds up to 50 or 55 mph (80 or 90 km/h) are desirable.

Brief full-throttle acceleration within the limits of local traffic laws contributes to a good break-in. Wide-open throttle acceleration in low gear can be detrimental and should be avoided.

The engine oil installed in the engine at the factory is a high-quality energy conserving type lubricant. Oil changes should be consistent with anticipated climate conditions under which vehicle operations will occur. For the recommended viscosity and quality grades see ↪ page 309.

**CAUTION!**

Never use Non-Detergent Oil or Straight Mineral Oil in the engine or damage may result.

**NOTE:**

A new engine may consume some oil during its first few thousand miles (kilometers) of operation. This should be considered a normal part of the break-in and not interpreted as a problem. Please check your oil level with the engine oil indicator often during the break-in period. Add oil as required.

**PARKING BRAKE**

Before leaving the vehicle, make sure that the parking brake is fully applied and place the gear selector in the PARK (P) position.

The foot operated parking brake is located below the lower left corner of the instrument panel. To apply the parking brake, firmly push the parking brake pedal fully. To release the parking brake, press the parking brake pedal a second time and let your foot up as you feel the brake disengage.

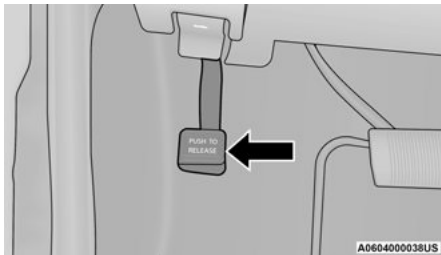

**Parking Brake**

When the parking brake is applied with the ignition switch in the ON/RUN position, the Brake Warning Light in the instrument cluster will illuminate.

**NOTE:**

- When the parking brake is applied and the transmission is placed in gear, the Brake Warning Light will flash. If vehicle speed is detected, a chime will sound to alert the driver. Fully release the parking brake before attempting to move the vehicle.
- This light only shows that the parking brake is applied. It does not show the degree of brake application.

When parking on a hill, it is important to turn the front wheels toward the curb on a downhill grade and away from the curb on an uphill grade. Apply the parking brake before placing the gear selector in PARK, otherwise the load on the transmission locking mechanism may make it difficult to move the gear selector out of PARK.

**WARNING!**

- Never use the PARK position as a substitute for the parking brake. Always apply the parking brake fully when parked to guard against vehicle movement and possible injury or damage.

*(Continued)*

**WARNING!**

- When leaving the vehicle, always remove the key fob from the ignition and lock your vehicle.
- Never leave children alone in a vehicle, or with access to an unlocked vehicle. Allowing children to be in a vehicle unattended is dangerous for a number of reasons. A child or others could be seriously or fatally injured. Children should be warned not to touch the parking brake, brake pedal or the gear selector.
- When leaving the vehicle, always make sure the keyless ignition node is in the OFF position, remove the key fob from the vehicle and lock the vehicle.
- Do not leave the key fob in or near the vehicle or in a location accessible to children, and do not leave the ignition of a vehicle equipped with Keyless Enter 'n Go™ in the ACC or ON/RUN position. A child could operate power windows, other controls, or move the vehicle.
- Be sure the parking brake is fully disengaged before driving; failure to do so can lead to brake failure and a collision.

*(Continued)*

**WARNING!**

- Always fully apply the parking brake when leaving your vehicle, or it may roll and cause damage or injury. Also be certain to leave the transmission in PARK. Failure to do so may allow the vehicle to roll and cause damage or injury.

**CAUTION!**

If the Brake Warning Light remains on with the parking brake released, a brake system malfunction is indicated. Have the brake system serviced by an authorized dealer immediately.

**AUTOMATIC TRANSMISSION**

You must press and hold the brake pedal while shifting out of PARK.

**WARNING!**

- Never use the PARK (P) position as a substitute for the parking brake. Always apply the parking brake fully when exiting the vehicle to guard against vehicle movement and possible injury or damage.

*(Continued)*

**WARNING!**

- Your vehicle could move and injure you and others if it is not in PARK. Check by trying to move the transmission gear selector out of PARK with the brake pedal released. Make sure the transmission is in PARK before exiting the vehicle.
- The transmission may not engage PARK if the vehicle is moving. Always bring the vehicle to a complete stop before shifting to PARK, and verify that the transmission gear position indicator solidly indicates PARK without blinking. Ensure that the vehicle is completely stopped, and the PARK position is properly indicated, before exiting the vehicle.
- It is dangerous to shift out of PARK or NEUTRAL (N) if the engine speed is higher than idle speed. If your foot is not firmly pressing the brake pedal, the vehicle could accelerate quickly forward or in reverse. You could lose control of the vehicle and hit someone or something. Only shift into gear when the engine is idling normally and your foot is firmly pressing the brake pedal.

*(Continued)*

**WARNING!**

- Unintended movement of a vehicle could injure those in or near the vehicle. As with all vehicles, you should never exit a vehicle while the engine is running. Before exiting a vehicle, always come to a complete stop, then apply the parking brake, shift the transmission into PARK, and turn the ignition OFF. When the ignition is in the OFF position, the transmission is locked in PARK, securing the vehicle against unwanted movement.
- When exiting the vehicle, always make sure the ignition is in the OFF position, remove the key fob from the vehicle, and lock the vehicle.
- Never leave children alone in a vehicle, or with access to an unlocked vehicle. Allowing children to be in a vehicle unattended is dangerous for a number of reasons. A child or others could be seriously or fatally injured. Children should be warned not to touch the parking brake, brake pedal or the transmission gear selector.
- Do not leave the key fob in or near the vehicle (or in a location accessible to children), and do not leave the ignition in the ACC or ON/RUN position. A child could operate power windows, other controls, or move the vehicle.

**CAUTION!**

Damage to the transmission may occur if the following precautions are not observed:

- Shift into or out of PARK or REVERSE (R) only after the vehicle has come to a complete stop.
- Do not shift between PARK, REVERSE, NEUTRAL, or DRIVE (D) when the engine is above idle speed.
- Before shifting into any gear, make sure your foot is firmly pressing the brake pedal.

**IGNITION PARK INTERLOCK**

This vehicle is equipped with an Ignition Park Interlock which requires the transmission to be in PARK (P) before the ignition can be turned to the OFF position. This helps the driver avoid inadvertently leaving the vehicle without placing the transmission in PARK. This system also locks the transmission in PARK whenever the ignition is in the OFF position.

**NOTE:**

The transmission is NOT locked in PARK when the ignition is in the ACC position (even though the engine will be off). Ensure that the transmission is in PARK, and the ignition is **OFF** (not in ACC position) before exiting the vehicle.

**BRAKE TRANSMISSION SHIFT INTERLOCK (BTSI) SYSTEM**

This vehicle is equipped with a BTSI system that holds the transmission gear selector in PARK unless the brakes are applied. To shift the transmission out of PARK, the engine must be running and the brake pedal must be pressed. The brake pedal must also be pressed to shift from NEUTRAL into DRIVE or REVERSE when the vehicle is stopped or moving at low speeds.

**FUEL ECONOMY (ECO) MODE**

The Fuel Economy (ECO) mode can improve the vehicle's overall fuel economy during normal driving conditions. Push the ECO button in the center stack of the instrument panel to activate or disable ECO mode. Or ECO mode can be enabled or disabled through your Uconnect system.

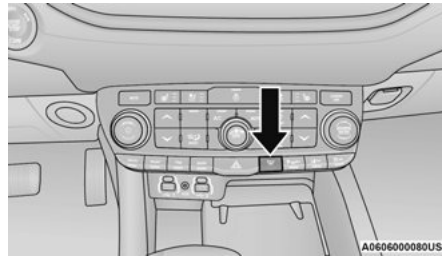
**ECO OFF Button**

When the Fuel Economy (ECO) mode is enabled, the vehicle control systems will change the following:

- The transmission will upshift sooner and downshift later.
- The overall driving performance will be more conservative.
- Some ECO mode functions may be temporarily inhibited based on temperature and other factors.

**8-SPEED AUTOMATIC TRANSMISSION**

The transmission gear range is displayed both on the gear selector and in the instrument cluster. To select a gear range, push the lock button on the gear selector and move the selector rearward or forward. To shift the transmission out of PARK, the engine must be running and the brake pedal must be pressed. You must also press the brake pedal to shift from NEUTRAL into DRIVE or REVERSE when the vehicle is stopped or moving at low speeds. Select the DRIVE range for normal driving.

**NOTE:**

- The transmission electronics are self-calibrating; therefore, the first few shifts on a new vehicle may be somewhat abrupt. This is a normal condition, and precision shifts will develop within a few hundred miles (kilometers).

- In the event of a mismatch between the gear selector position and the actual transmission gear (for example, driver selects PARK while driving), the position indicator will blink continuously until the selector is returned to the proper position, or the requested shift can be completed.

The electronically controlled transmission adapts its shift schedule based on driver inputs, along with environmental and road conditions.

Only shift from DRIVE to PARK or REVERSE when the accelerator pedal is released and the vehicle is stopped. Be sure to keep your foot on the brake pedal when shifting between these gears.

The transmission gear selector provides PARK, REVERSE, NEUTRAL, DRIVE, and MANUAL (AutoStick) shift positions. Manual shifts can be made using the AutoStick shift control. Toggling the gear selector forward (-) or rearward (+) while in the MANUAL (AutoStick) position (beside the DRIVE position), or tapping the paddle shifters (+/-) (if equipped) will manually select the transmission gear, and will display the current gear in the instrument cluster ↪ page 109.

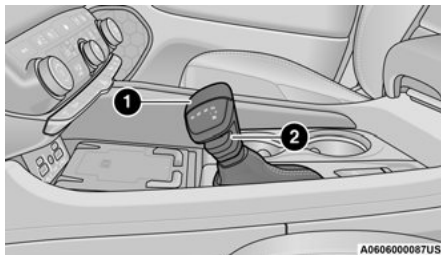

**Transmission Gear Selector**

- 1 – Gear Selector
- 2 – Lock Button

#### **NOTE:**

If the gear selector cannot be moved to the PARK, REVERSE, or NEUTRAL position (when pushed forward) it is probably in the MANUAL (AutoStick, +/-) position (beside the DRIVE position). In MANUAL (AutoStick) mode, the transmission gear is displayed in the instrument cluster (as 1, 2, 3, etc.). Move the gear selector to the right (into the DRIVE [D] position) for access to PARK, REVERSE, and NEUTRAL.

#### **Gear Ranges**

Do not press the accelerator pedal when shifting out of PARK (P) or NEUTRAL (N).

#### **NOTE:**

After selecting any gear range, wait a moment to allow the selected gear to engage before accelerating. This is especially important when the engine is cold.

#### **PARK (P)**

This range supplements the parking brake by locking the transmission. The engine can be started in this range. Never attempt to use PARK while the vehicle is in motion. Apply the parking brake when exiting the vehicle in this range.

When parking on a hill, apply the parking brake before shifting the transmission to PARK. As an added precaution, turn the front wheels toward the curb on a downhill grade and away from the curb on an uphill grade.

#### **NOTE:**

On vehicles equipped with the electronically shifted transfer case, ensure that the transfer case is in AWD AUTO or LOW RANGE position on the AWD Control Switch. Ensure that the NEUTRAL position light is NOT illuminated.

When exiting the vehicle, always:

- Apply the parking brake.
- Shift the transmission into PARK.
- Turn the ignition OFF.
- Remove the key fob from the vehicle.



**WARNING!**

- Never use the PARK (P) position as a substitute for the parking brake. Always apply the parking brake fully when exiting the vehicle to guard against vehicle movement and possible injury or damage.
- Your vehicle could move and injure you and others if it is not in PARK. Check by trying to move the transmission gear selector out of PARK with the brake pedal released. Make sure the transmission is in PARK before exiting the vehicle.
- The transmission may not engage PARK if the vehicle is moving. Always bring the vehicle to a complete stop before shifting to PARK, and verify that the transmission gear position indicator solidly indicates PARK without blinking. Ensure that the vehicle is completely stopped, and the PARK position is properly indicated, before exiting the vehicle.

*(Continued)***WARNING!**

- It is dangerous to shift out of PARK or NEUTRAL (N) if the engine speed is higher than idle speed. If your foot is not firmly pressing the brake pedal, the vehicle could accelerate quickly forward or in reverse. You could lose control of the vehicle and hit someone or something. Only shift into gear when the engine is idling normally and your foot is firmly pressing the brake pedal.
- Unintended movement of a vehicle could injure those in or near the vehicle. As with all vehicles, you should never exit a vehicle while the engine is running. Before exiting a vehicle, always come to a complete stop, then apply the parking brake, shift the transmission into PARK, and turn the ignition OFF. When the ignition is in the OFF position, the transmission is locked in PARK, securing the vehicle against unwanted movement.
- When exiting the vehicle, always make sure the ignition is in the OFF position, remove the key fob from the vehicle, and lock the vehicle.

*(Continued)***WARNING!**

- Never leave children alone in a vehicle, or with access to an unlocked vehicle. Allowing children to be in a vehicle unattended is dangerous for a number of reasons. A child or others could be seriously or fatally injured. Children should be warned not to touch the parking brake, brake pedal or the transmission gear selector.
- Do not leave the key fob in or near the vehicle (or in a location accessible to children), and do not leave the ignition in the ACC or ON/RUN position. A child could operate power windows, other controls, or move the vehicle.

**CAUTION!**

- Before moving the transmission gear selector out of PARK, you must start the engine, and also press the brake pedal. Otherwise, damage to the gear selector could result.
- DO NOT race the engine when shifting from PARK or NEUTRAL into another gear range, as this can damage the drivetrain.

The following indicators should be used to ensure that you have properly engaged the transmission into the PARK position:

- When shifting into PARK, push the lock button on the gear selector and firmly move the selector all the way forward until it stops and is fully seated.
- Look at the transmission gear position display and verify that it indicates the PARK position (P), and is not blinking.
- With brake pedal released, verify that the gear selector will not move out of PARK.

### REVERSE (R)

This range is for moving the vehicle backward. Shift into REVERSE only after the vehicle has come to a complete stop.

### NEUTRAL (N)

Use this range when the vehicle is standing for prolonged periods with the engine running. Apply the parking brake and shift the transmission into PARK (P) if you must exit the vehicle.

#### WARNING!

Do not coast in NEUTRAL and never turn off the ignition to coast down a hill. These are unsafe practices that limit your response to changing traffic or road conditions. You might lose control of the vehicle and have a collision.

#### CAUTION!

Towing the vehicle, coasting, or driving for any other reason with the transmission in NEUTRAL can cause severe transmission damage.

For Recreational Towing ⇨ page 147.

For Towing A Disabled Vehicle ⇨ page 253.

### DRIVE (D)

This range should be used for most city and highway driving. It provides the smoothest upshifts and downshifts, and the best fuel economy. The transmission automatically upshifts through all forward gears.

When frequent transmission shifting occurs (such as when operating the vehicle under heavy loading conditions, in hilly terrain, traveling into strong head winds, or while towing a heavy trailer), use the AutoStick shift control to select a lower gear ⇨ page 109. Under these conditions, using a lower

gear will improve performance and extend transmission life by reducing excessive shifting and heat buildup.

During cold temperatures, transmission operation may be modified depending on engine and transmission temperature as well as vehicle speed. This feature improves warm up time of the engine and transmission to achieve maximum efficiency. Engagement of the torque converter clutch is inhibited until the transmission fluid is warm. Normal operation will resume once the transmission temperature has risen to a suitable level.

### Manual (M)

The MANUAL (M, +/-) position (beside the DRIVE position) enables full manual control of transmission shifting (also known as AutoStick mode ⇨ page 109). Toggling the gear selector forward (-) or rearward (+) while in the MANUAL (AutoStick) position will manually select the transmission gear, and will display the current gear in the instrument cluster as 1, 2, 3, etc.

### Transmission Limp Home Mode

Transmission function is monitored electronically for abnormal conditions. If a condition is detected that could result in transmission damage, Transmission Limp Home Mode is activated. In this mode, the transmission may operate only in certain gears, or may not shift at all. Vehicle

performance may be severely degraded and the engine may stall. In some situations, the transmission may not re-engage if the engine is turned off and restarted. The Malfunction Indicator Light (MIL) may be illuminated. A message in the instrument cluster will inform the driver of the more serious conditions, and indicate what actions may be necessary.

In the event of a momentary problem, the transmission can be reset to regain all forward gears by performing the following steps:

**NOTE:**

In cases where the instrument cluster message indicates the transmission may not re-engage after engine shutdown, perform this procedure only in a desired location (preferably, at an authorized dealer):

1. Stop the vehicle.
2. Shift the transmission into PARK (P), if possible. If not, shift the transmission to NEUTRAL (N).
3. Push and hold the ignition switch until the engine turns off.
4. Wait approximately 30 seconds.
5. Restart the engine.
6. Shift into the desired gear range. If the problem is no longer detected, the transmission will return to normal operation.

**NOTE:**

Even if the transmission can be reset, we recommend that you visit an authorized dealer at your earliest possible convenience. An authorized dealer has diagnostic equipment to assess the condition of your transmission. If the transmission cannot be reset, authorized dealer service is required.

**AutoStick — If Equipped**

AutoStick is a driver-interactive transmission feature providing manual shift control, giving you more control of the vehicle. AutoStick allows you to maximize engine braking, eliminate undesirable upshifts and downshifts, and improve overall vehicle performance. This feature can also provide you with more control during passing, city driving, cold slippery conditions, mountain driving, trailer towing, and many other situations.

**Operation**

In AutoStick mode, you can use the gear selector (in the MANUAL position), or the paddle shifters to the MANUAL (M) position (beside the DRIVE (D) position), or tap one of the paddle shifters on the steering wheel. Tapping the (-) paddle shifter to enter AutoStick mode will downshift the transmission to the next lower gear, while tapping (+) to enter AutoStick mode will retain the current gear. The current transmission gear will be displayed in the instrument cluster.

**NOTE:**

The paddle shifters (if equipped) may be disabled using the Uconnect Personal Settings.

AutoStick mode has the following operational benefits:

- The transmission will automatically downshift as the vehicle slows (to prevent engine lugging) and will display the current gear.
- The transmission will automatically downshift to FIRST gear when coming to a stop. After a stop, the driver should manually upshift (+) the transmission as the vehicle is accelerated.
- You can start out, from a stop, in FIRST or SECOND gear. Tapping (+) at a stop will allow starting in SECOND gear. Starting out in SECOND gear can be helpful in snowy or icy conditions.
- If a requested downshift would cause the engine to over-speed, that shift will not occur.
- The system will ignore attempts to upshift at too low of a vehicle speed.
- Holding the (-) paddle pressed, or holding the gear selector in the (-) position, will downshift the transmission to the lowest gear possible at the current speed.

- Transmission shifting will be more noticeable when AutoStick is enabled.
- The system may revert to automatic shift mode if a fault or overheat condition is detected.

To disengage AutoStick mode, return the gear selector to the DRIVE (D) position, or press and hold the (+) paddle shifter until "D" is indicated in the instrument cluster. You can shift in or out of AutoStick mode at any time without taking your foot off the accelerator pedal.

#### WARNING!

Do not downshift for additional engine braking on a slippery surface. The drive wheels could lose their grip and the vehicle could skid, causing a collision or personal injury.

## SPORT MODE — IF EQUIPPED

Your vehicle is equipped with a SPORT Mode feature. The engine, transmission, and steering systems are all set to their SPORT settings. SPORT Mode will provide improved throttle response and modified transmission shift points for an enhanced driving experience, as well as greater amount of steering feel. This mode may be activated and deactivated by pushing the SPORT button on the instrument panel switch bank.

## ALL-WHEEL DRIVE OPERATION

### SINGLE-SPEED OPERATING INSTRUCTIONS/PRECAUTIONS — IF EQUIPPED

This system contains a single-speed (HI range only) transfer case, which provides convenient full-time All-Wheel Drive (AWD). No driver interaction is required. The Brake Traction Control (BTC) System, which combines standard ABS and Traction Control, provides resistance to any wheel that is slipping to allow additional torque transfer to wheels with traction.

#### NOTE:

This system is not appropriate for conditions where AWD LOW is recommended ⇨ page 151.

### ELECTRONICALLY SHIFTED TRANSFER CASE — IF EQUIPPED

This is an electronically shifted transfer case and it is operated by the AWD control switch, which is located on the center console.

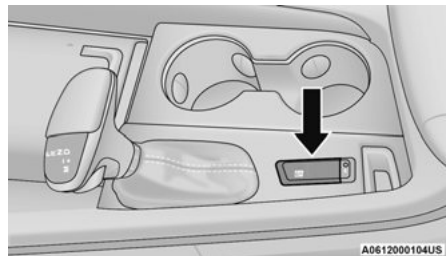

AWD Control Switch

This electronically shifted transfer case provides three positions:

- All-wheel drive auto range (AWD AUTO)
- All-wheel drive low range (AWD LOW)
- N (Neutral)

When additional traction is required, the transfer case AWD LOW position can be used to lock the front and rear driveshafts together forcing the front and rear wheels to rotate at the same speed. This is accomplished by pushing the AWD LOW switch ⇨ page 112. The AWD LOW position is designed for loose, slippery road surfaces only. Driving in the AWD LOW position on dry, hard surfaced roads may cause increased tire wear and damage to the driveline components.

## Transfer Case Position Indicator Messages

The Transfer Case Position Indicator message (AWD LOW) is located in the instrument cluster and indicate the current and desired transfer case selection ↗ page 82. When you select a different transfer case position, the position indicator lights will do the following:

### If All Shift Conditions Are Met:

1. The current position indicator light will turn off.
2. The selected position indicator light will flash until the transfer case completes the shift.
3. When the shift is complete, the indicator light for the selected position will stop flashing and remain on.

### If shift conditions are not met, one or more of the following events may occur:

1. The indicator light for the current position will remain on.
2. The newly selected position indicator light will continue to flash.
3. The transfer case **will not** shift.

### NOTE:

Before retrying a selection, make certain that all the necessary requirements for selecting a new transfer case position have been met ↗ page 112.

The “SERV AWD” Warning Light monitors the electronic shift all-wheel drive system. If this light remains on after engine start-up or illuminates during driving, it means that the all-wheel drive system is not functioning properly and that service is required.

### WARNING!

Always engage the parking brake when powering down the vehicle if the “SERV AWD” Warning Light is illuminated. Not engaging the parking brake may allow the vehicle to roll which may cause personal injury.

### NOTE:

Do not attempt to make a shift while only the front or rear wheels are spinning. This could cause damage to driveline components.

When operating your vehicle in AWD LOW, the engine speed is approximately three times that of the AWD AUTO position at a given road speed. Take care not to overspeed the engine and do not exceed 25 mph (40 km/h).

Proper operation of all-wheel drive vehicles depends on tires of equal size, type and circumference on each wheel. Any difference in tire size can cause damage to the transfer case.

Because all-wheel drive provides improved traction, there is a tendency to exceed safe turning

and stopping speeds. Do not go faster than road conditions permit.

For additional information on the appropriate use of each transfer case position, see the information below:

### AWD LOW

All-Wheel Drive Low Range – This range provides low speed all-wheel drive. Locks the front and rear driveshafts together forcing the front and rear wheels to rotate at the same speed. Additional traction and maximum pulling power for loose, slippery road surfaces only. Do not exceed 25 mph (40 km/h).

### N (Neutral)

This range disengages both the front and rear driveshafts from the powertrain. To be used for flat towing behind another vehicle ↗ page 147.

### WARNING!

You or others could be injured or killed if you leave the vehicle unattended with the transfer case in the N (Neutral) position without first fully engaging the parking brake. The transfer case N (Neutral) position disengages both the front and rear drive shafts from the powertrain and will allow the vehicle to roll, even if the transmission is in PARK. The parking brake should always be applied when the driver is not in the vehicle.

## SHIFTING PROCEDURE

### NOTE:

- If any of the requirements to select a new transfer case position have not been met, the transfer case will not shift. The position indicator light for the previous position will remain on and the newly selected position indicator light will continue to flash until all the requirements for the selected position have been met. To retry a shift: return the control switch back to the original position, make certain all shift requirements have been met, wait five seconds and try the shift again.
- If all the requirements to select a new transfer case position have been met, the current position indicator light will turn off, the selected position indicator light will flash until the transfer case completes the shift. When the shift is complete, the position indicator light for the selected position will stop flashing and remain on.

## AWD AUTO To AWD LOW

### NOTE:

When shifting into or out of AWD LOW some gear noise may be heard. This noise is normal and is not detrimental to the vehicle or occupants.

Shifting can be performed with the vehicle rolling 2 to 3 mph (3 to 5 km/h) or completely stopped. Use either of the following procedures:

### Preferred Procedure

1. With the engine running, slow the vehicle to 2 to 3 mph (3 to 5 km/h).
2. Shift the transmission into NEUTRAL.
3. While still rolling, push the AWD LOW control switch.
4. After the AWD LOW position indicator light is on (not flashing), shift the transmission back into gear.

### Alternate Procedure

1. Bring the vehicle to complete stop.
2. With the ignition in ON/RUN position and engine running, shift the transmission to NEUTRAL.

3. Push the AWD LOW control switch.
4. After the AWD LOW position indicator light is on (not flashing), shift the transmission back into gear.

### NOTE:

- If steps 1 or 2 of either the “Preferred” or “Alternate Procedure” are not satisfied prior to attempting the shift or if they no longer are being met while the shift attempt is in process, the desired position indicator light will flash continuously while the original position indicator light is on, until all requirements have been met.
- The ignition switch must be in the ON/RUN position for a shift to take place and for the position indicator lights to be operable. If the ignition switch is not in the ON/RUN position, then the shift will not take place and no position indicator lights will be on or flashing.

## N (Neutral) Shift Procedure

For information regarding the transfer case N (Neutral) shift procedure ⇨ page 149.

## TOW N GO — IF EQUIPPED

Tow N Go combines the capabilities of the vehicle control systems, along with driver input, to provide optimum performance for road conditions.

Push one of the four drive mode buttons to select the desired mode.

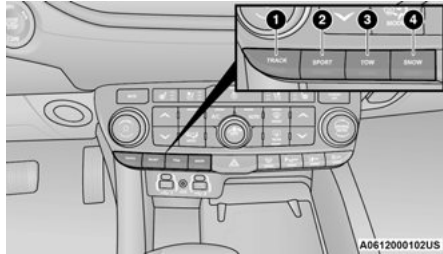

Drive Mode Buttons

- 1 — TRACK
- 2 — SPORT
- 3 — TOW
- 4 — SNOW

Tow N Go consists of the following positions:

- **TRACK** – Optimizes settings for transmission, engine, driveline, and suspension in order to maximize vehicle performance. Also the electric power steering offers more feedback of the tire

gripping the road. This feature will reset to AUTO upon an ignition cycle. To turn off Electronic Stability Control (ESC) ↗ page 190.

- **SPORT** – Dry weather, on-road calibration. Performance based tuning that provides a rear-wheel drive feel but with improved handling and acceleration over a two-wheel drive vehicle. This feature will reset to AUTO upon an ignition cycle.
- **TOW** – TOW drive mode also optimizes the transmission shifting for towing, as well as maximizing straight line traction by optimizing driveline settings on AWD system. Use this mode for towing/hauling. Vehicle suspension will go to SPORT mode. Trailer Sway Control (TSC) is always enabled in all drive modes provided that the ESC OFF indicator light is not illuminated. TSC is disabled when the ESC OFF lamp is illuminated. This feature will reset to AUTO upon an ignition cycle.
- **SNOW** – Tuning set for additional stability in inclement weather. Use on and off-road on loose traction surfaces such as snow. This feature will reset to AUTO upon an ignition cycle.

## GUIDELINES FOR TRACK USE

### NOTE:

The standard Black Brembo Brake Pads are not recommended for track use. Only the Red Brembo Performance calipers are appropriate for track use.

- If your vehicle is equipped with Drive Modes, they will alter the vehicle's performance in various driving situations. It is recommended that your vehicle operates in SPORT or TRACK modes during the track event.
- Prior to each track event, verify all fluids are at the correct levels.
- Prior to each track event, verify the front and rear brake pads have more than half pad thickness remaining. If the brake pads require changing, complete a brake burnish procedure prior to track outing at full pace.

### NOTE:

Use of DOT 4 brake fluid is suggested for extended track usage due to increased thermal capacity.

- At the conclusion of each track event, it is recommended that a brake bleed procedure is performed to maintain the pedal feel and stopping capability of your Brembo High Performance brake system.
- It is recommended that each track outing should end with a minimum of one cooldown lap using minimal braking.
- It is recommended that the suspension system, brake system, prop shaft, and half shaft boots be checked for wear or damage after every track event.
- Track usage results in increased operating temperatures of the engine, transmission, drive-

line and brake system. This may affect Noise Vibration Harshness (NVH) countermeasures designed into your vehicle. New components may need to be installed to return the system to the original NVH performance.

- Tire pressure:

- Recommended tire pressure of 33 psi (230 kPa) when tires are cold, or below 42 psi (290 kPa) when hot.

**NOTE:**

It is recommended that you target below 42 psi (290 kPa) when tires are hot at the conclusion of each track session. Starting at 33 psi (230 kPa) cold and adjusting based on ambient and track conditions is recommended. Tire pressure can be monitored via the instrument cluster display and can assist with adjustments.

**Track burnishing your brakes**

To avoid “green lining fade” during track use, the brake pads and rotors must have a thermal burnish for factory-installed components or when new brake friction components are installed:

1. Use one track session to burnish brakes by driving at 75% speed. Brake at approximately 0.60 - 0.80g max without Anti-Lock Brake System (ABS) intervention.
  2. Complete one lap in this manner until you start smelling the brakes. Continue for another half lap at speed, then complete a two lap
3. Getting the brakes to smoke is an indication that the brakes have overheated and may negatively affect future track usage.
  4. Allow vehicle to sit and cool for at least 30 minutes. If an infrared thermal gun is available, allow rotors to cool to 200°F (93.3°C) before returning to the track.
  5. There should be a thin layer of ash when inspecting the brake pads. Having the ash layer go more than half the thickness of the pad material is a sign of an overly aggressive burnish.
  6. Occasionally, a second burnish session is required. If the brake pads begin to emit an odor during the next track session, reduce vehicle speed and braking deceleration rate to burnish targets and follow steps 2-4.
  7. New brake pads installed on old rotors require a burnish. New rotors installed with old brake pads should be burnished at the track or driven for 300 miles (485 km) of city driving to develop an adequate lining transfer layer on the rotor surface prior to track use.
  8. Rotors that pulsate during track use should be replaced.

cooldown with minimal brake applications. Ensure the brakes are not smoking. If they are, complete another cooldown lap.

**NOTE:**

Resurfacing of the rotors is not recommended, as it removes mass from the rotor, reducing its thermal capacity. Resurfacing also thins the rotor cheek, making it less robust and increasing the likelihood of pulsation in further track use.

## FUEL SAVER TECHNOLOGY 5.7L ONLY — IF EQUIPPED

This feature offers improved fuel economy by shutting off four of the engine's eight cylinders during light load and cruise conditions. The system is automatic with no driver inputs.

**NOTE:**

This system may take some time to return to full functionality after a battery disconnect.

## POWER STEERING

The electric power steering system will provide increased vehicle response and ease of maneuverability. The power steering system adapts to different driving conditions and adjusts accordingly.

**WARNING!**

Continued operation with reduced assist could pose a safety risk to yourself and others. Service should be obtained as soon as possible.



Alternate electric power steering efforts can be selected through the Uconnect System  page 155.

If the Electric Power Steering warning icon is displayed and the “SERVICE POWER STEERING” or the “POWER STEERING ASSIST OFF – SERVICE SYSTEM” message is displayed within the instrument cluster display, this indicates the vehicle needs to be taken to the dealer for service  page 89.

#### NOTE:

- Even if the power steering assistance is no longer operational, it is still possible to steer the vehicle. Under these conditions there will be a substantial increase in steering effort, especially at low speeds and during parking maneuvers.
- If the condition persists, see an authorized dealer for service.

If the Steering icon is displayed and the “POWER STEERING SYSTEM OVER TEMP” message is displayed on the instrument cluster screen, this indicates an over temperature condition in the power steering system. Once driving conditions are safe, pull over and let the vehicle idle for a few moments until the icon and message turn off.

## STOP/START SYSTEM — IF EQUIPPED

The Stop/Start function is developed to reduce fuel consumption. The system will stop the engine automatically during a vehicle stop if the required conditions are met. Releasing the brake pedal or pressing the accelerator pedal will automatically re-start the engine.

This vehicle has been upgraded with a heavy duty starter, enhanced battery, and other upgraded engine parts, to handle the additional engine starts.

### AUTOSTOP MODE

The Stop/Start feature is enabled after every normal customer engine start. At that time, the system will go into STOP/START READY.

#### To Activate The Autostop Mode, The Following Must Occur:

- The system must be in STOP/START READY state. A STOP/START READY message will be displayed in the instrument cluster display within the Stop/Start section  page 82.
- The vehicle must be completely stopped.
- The gear selector must be in a forward gear and the brake pedal pressed.

The engine will shut down, the tachometer will move to the zero position and the Stop/Start telltale will illuminate indicating you are in

Autostop. Customer settings will be maintained upon return to an engine running condition.

## POSSIBLE REASONS THE ENGINE DOES NOT AUTOSTOP

Prior to engine shut down, the system will check many safety and comfort conditions to see if they are fulfilled. Detailed information about the operation of the Stop/Start system may be viewed in the instrument cluster display Stop/Start Screen. In the following situations, the engine will not stop:

- Driver’s seat belt is not buckled.
- Driver’s door is not closed.
- Battery temperature is too warm or cold.
- Battery charge is low.
- The vehicle is on a steep grade.
- Cabin heating or cooling is in process and an acceptable cabin temperature has not been achieved.
- HVAC is set to full defrost mode at a high blower speed.
- HVAC is set to MAX A/C.
- Engine has not reached normal operating temperature.
- The transmission is not in a forward gear.
- Hood is open.

- Brake pedal is not pressed with sufficient pressure.
- Accelerator pedal input.
- Engine temp is too high.
- 5 mph (8 km/h) threshold has not been achieved from previous Autostop.
- Steering angle is beyond threshold.
- ACC is on and speed is set.

It may be possible for the vehicle to be driven several times without the Stop/Start system going into a STOP/START READY state under more extreme conditions of the items listed above.

## To Start The Engine While In Autostop Mode

While in a forward gear, the engine will start when the brake pedal is released or the throttle pedal is pressed. The transmission will automatically re-engage upon engine restart.

### Conditions That Will Cause The Engine To Start Automatically While In Autostop Mode:

- The transmission selector is moved out of DRIVE.
- To maintain cabin temperature comfort.
- HVAC is set to full defrost mode.
- HVAC system temperature or fan speed is manually adjusted.

- Battery voltage drops too low.
- Stop/Start OFF switch is pushed.
- A Stop/Start system error occurs.
- Steering angle is beyond threshold.

## To Manually Turn Off The Stop/Start System

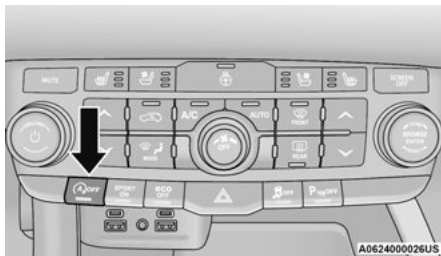

Stop/Start OFF Switch

Push the Stop/Start OFF switch (located on the switch bank). The light on the switch will illuminate. The “STOP/START OFF” message will appear in the instrument cluster display and the autostop mode will be disabled → page 82.

### NOTE:

The Stop/Start system will reset itself back to the ON mode every time the ignition is turned OFF and back ON.

## To Manually Turn On The Stop/Start System

Push the Stop/Start OFF switch (located on the switch bank). The light on the switch will turn off.

## SYSTEM MALFUNCTION

If there is a malfunction in the Stop/Start system, the system will not shut down the engine. A “SERVICE STOP/START SYSTEM” message and a yellow Stop/Start telltale will appear in the instrument cluster display → page 89.

If the “SERVICE STOP/START SYSTEM” message appears in the instrument cluster display, have the system checked by an authorized dealer.

## CRUISE CONTROL SYSTEMS — IF EQUIPPED

Your vehicle may be equipped with the Cruise Control system, or the Adaptive Cruise Control (ACC) system:

- Cruise Control will keep your vehicle at a constant preset speed.
- Adaptive Cruise Control (ACC) will adjust the vehicle speed up to the preset speed to maintain a distance with the vehicle ahead.

**NOTE:**

- In vehicles equipped with ACC, if ACC is not enabled, Fixed Speed Cruise Control will not detect vehicles directly ahead of you. Always be aware of the feature selected.
- Only one Cruise Control feature can operate at a time. For example, if Fixed Speed Cruise Control is enabled, Adaptive Cruise Control will be unavailable, and vice versa.

**CRUISE CONTROL**

When engaged, the Cruise Control takes over accelerator operations at speeds greater than 20 mph (32 km/h).

The Cruise Control buttons are located on the right side of the steering wheel.

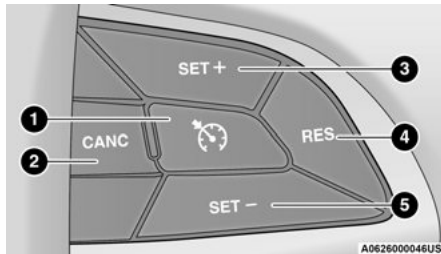

**Cruise Control Buttons**

- 1 — On/Off
- 2 — CANCEL/Cancel
- 3 — SET (+)/Accel
- 4 — RES/Resume
- 5 — SET (-)/Decel

**WARNING!**

Cruise Control can be dangerous where the system cannot maintain a constant speed. Your vehicle could go too fast for the conditions, and you could lose control and have an accident. Do not use Cruise Control in heavy traffic or on roads that are winding, icy, snow-covered or slippery.

**To Activate**

Push the on/off button to activate the Cruise Control. "CRUISE CONTROL READY" will appear in the instrument cluster display to indicate the Cruise Control is on. To turn the system off, push the on/off button a second time. "CRUISE CONTROL OFF" will appear in the instrument cluster display to indicate the Cruise Control is off. The system should be turned off when not in use.

**WARNING!**

Leaving the Cruise Control system on when not in use is dangerous. You could accidentally set the system or cause it to go faster than you want. You could lose control and have an accident. Always leave the system OFF when you are not using it.

**To Set A Desired Speed**

Turn the Cruise Control on. When the vehicle has reached the desired speed, push the SET (+) or SET (-) button and release. Release the accelerator and the vehicle will operate at the selected speed. Once a speed has been set, a message "CRUISE CONTROL SET TO MPH (km/h)" will appear indicating what speed was set. A cruise indicator lamp, along with set speed will also appear and stay on in the instrument cluster when the speed is set.

**To Vary The Speed Setting****To Increase Or Decrease The Set Speed**

When the Cruise Control is set, you can increase speed by pushing the SET (+) button, or decrease speed by pushing the SET (-) button.

**U.S. Speed (mph)**

- Pushing the SET (+), or SET (-) button once will result in a 1 mph speed adjustment. Each subsequent tap of the button results in an adjustment of 1 mph.
- If the button is continually pushed, the set speed will continue to adjust until the button is released, then the new set speed will be established.

**Metric Speed (km/h)**

- Pushing the SET (+), or SET (-) button once will result in a 1 km/h speed adjustment. Each subsequent tap of the button results in an adjustment of 1 km/h.
- If the button is continually pushed, the set speed will continue to adjust until the button is released, then the new set speed will be established.

**To Accelerate For Passing**

While the Cruise Control is set, press the accelerator to pass as you would normally. When the pedal is released, the vehicle will return to the set speed.

**USING CRUISE CONTROL ON HILLS**

The transmission may downshift on hills to maintain the vehicle set speed.

The Cruise Control system maintains speed up and down hills. A slight speed change on moderate hills is normal. On steep hills, a greater speed loss or gain may occur so it may be preferable to drive without Cruise Control.

**WARNING!**

Cruise Control can be dangerous where the system cannot maintain a constant speed. Your vehicle could go too fast for the conditions, and you could lose control and have an accident. Do not use Cruise Control in heavy traffic or on roads that are winding, icy, snow-covered or slippery.

**To Resume Speed**

To resume a previously set speed, push the RES button and release. Resume can be used at any speed above 20 mph (32 km/h).

**To Deactivate**

A tap on the brake pedal, pushing the CANC button, or normal brake pressure while slowing the vehicle will deactivate the Cruise Control system without erasing the set speed from memory.

The following conditions will also deactivate the Cruise Control without erasing the set speed from memory:

- Vehicle parking brake is applied
- Stability event occurs

- Gear selector is moved out of DRIVE
- Engine overspeed occurs

Pushing the on/off button or placing the ignition in the OFF position will erase the set speed from memory.

**ADAPTIVE CRUISE CONTROL (ACC)**

Adaptive Cruise Control (ACC) increases the driving convenience provided by Cruise Control while traveling on highways and major roadways. However, it is not a safety system and not designed to prevent collisions. The Cruise Control function performs differently ↷ page 117.

ACC will allow you to keep Cruise Control engaged in light to moderate traffic conditions without the constant need to reset your Cruise Control. ACC utilizes a radar sensor and a forward facing camera designed to detect a vehicle directly ahead of you.

**NOTE:**

- If the ACC sensor detects a vehicle ahead, ACC will apply limited braking or acceleration (not to exceed the original set speed) automatically to maintain a preset following distance, while matching the speed of the vehicle ahead.
- Any chassis/suspension or tire size modifications to the vehicle will affect the performance of the Adaptive Cruise Control and Forward Collision Warning system.

- Fixed Speed Cruise Control (ACC not enabled) will not detect vehicles directly ahead of you. Always be aware of the mode selected  
 ⇨ page 314.

### WARNING!

- Adaptive Cruise Control (ACC) is a convenience system. It is not a substitute for active driver involvement. It is always the driver's responsibility to be attentive of road, traffic, and weather conditions, vehicle speed, distance to the vehicle ahead; and, most importantly, brake operation to ensure safe operation of the vehicle under all road conditions. Your complete attention is always required while driving to maintain safe control of your vehicle. Failure to follow these warnings can result in a collision and death or serious personal injury.
- The ACC system:
  - Does not react to pedestrians, oncoming vehicles, and stationary objects (e.g., a stopped vehicle in a traffic jam or a disabled vehicle).
  - Cannot take street, traffic, and weather conditions into account, and may be limited upon adverse sight distance conditions.

(Continued)

### WARNING!

- Does not always fully recognize complex driving conditions, which can result in wrong or missing distance warnings.
- Will bring the vehicle to a complete stop while following a target vehicle and hold the vehicle for two seconds in the stop position. If the target vehicle does not start moving within two seconds the ACC system will display a message that the system will release the brakes and that the brakes must be applied manually. An audible chime will sound when the brakes are released.

You should switch off the ACC system:

- When driving in fog, heavy rain, heavy snow, sleet, heavy traffic, and complex driving situations (i.e., in highway construction zones).
- When entering a turn lane or highway off ramp; when driving on roads that are winding, icy, snow-covered, slippery, or have steep uphill or downhill slopes.
- When towing a trailer up or down steep slopes.
- When circumstances do not allow safe driving at a constant speed.

### Adaptive Cruise Control (ACC) Operation

The buttons on the right side of the steering wheel operate the ACC system.

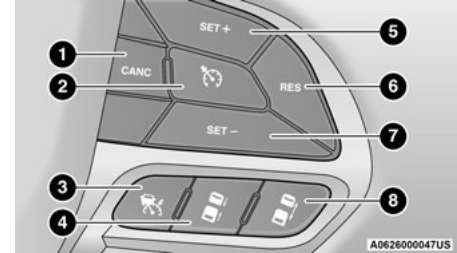

Adaptive Cruise Control Buttons

- 1 — CANCEL/Cancel
- 2 — Fixed Speed Cruise Control On/Off
- 3 — Adaptive Cruise Control (ACC) On/Off
- 4 — Distance Decrease Button
- 5 — SET (+)/Accel
- 6 — RES/Resume
- 7 — SET (-)/Decel
- 8 — Distance Increase Button

## Adaptive Cruise Control (ACC) Menu

The instrument cluster display will show the current ACC system settings. The information it displays depends on ACC system status.

Push the Adaptive Cruise Control (ACC) on/off button until one of the following appears in the instrument cluster display:

### Adaptive Cruise Control Off

When ACC is deactivated, the display will read “Adaptive Cruise Control Off.”

### Adaptive Cruise Control Ready

When ACC is activated but the vehicle speed setting has not been selected, the display will read “Adaptive Cruise Control Ready.”

### Adaptive Cruise Control Set

When the SET (+) or the SET (-) button is pushed, the display will read “ACC SET.”

When ACC is set, the set speed will show in the instrument cluster display.

The ACC screen may display once again if any of the following ACC activity occurs:

- System Cancel
- Driver Override
- System Off
- ACC Proximity Warning
- ACC Unavailable Warning

The instrument cluster display will return to the last display selected after five seconds of no ACC display activity.

## Activating Adaptive Cruise Control (ACC)

The minimum set speed for the ACC system is 20 mph (32 km/h).

When the system is turned on and in the ready state, the instrument cluster display will read “ACC Ready.”

When the system is off, the instrument cluster display will read “Adaptive Cruise Control (ACC) Off.”

### NOTE:

You cannot engage ACC under the following conditions:

- When in 4WD Low
- When the brakes are applied
- When the parking brake is applied
- When the automatic transmission is in PARK, REVERSE or NEUTRAL
- When the vehicle speed is below the minimum speed range
- When the brakes are overheated
- When the driver’s door is open at low speeds

- When the driver’s seat belt is unbuckled at low speeds
- When there is a stationary vehicle in front of your vehicle in close proximity

## To Activate/Deactivate

Push and release the Adaptive Cruise Control (ACC) on/off button. The ACC menu in the instrument cluster displays “ACC Ready.”

To turn the system off, push and release the Adaptive Cruise Control (ACC) on/off button again. At this time, the system will turn off and the instrument cluster displays “Adaptive Cruise Control (ACC) Off.”

### WARNING!

Leaving the Adaptive Cruise Control (ACC) system on when not in use is dangerous. You could accidentally set the system or cause it to go faster than you want. You could lose control and have a collision. Always leave the system off when you are not using it.

## To Set A Desired Speed

When the vehicle reaches the speed desired, push the SET (+) button or the SET (-) button and release. The instrument cluster display will show the set speed.

### NOTE:

Fixed Speed Cruise Control can be used without ACC enabled. To change between the different modes, push the **ACC on/off button** which turns the ACC and the Fixed Speed Cruise Control off. Pushing the **Fixed Speed Cruise Control on/off button** will result in turning on (changing to) Fixed Speed Cruise Control mode.

### WARNING!

In Fixed Speed Cruise Control mode (ACC not enabled), the system will not react to vehicles ahead. In addition, the proximity warning does not activate and no alarm will sound even if you are too close to the vehicle ahead since neither the presence of the vehicle ahead nor the vehicle-to-vehicle distance is detected. Be sure to maintain a safe distance between your vehicle and the vehicle ahead. Always be aware which mode is selected.

If ACC is set when the vehicle speed is **below** 20 mph (32 km/h), the set speed will default to 20 mph (32 km/h).

### NOTE:

Fixed Speed Cruise Control cannot be set below 20 mph (32 km/h).

If either system is set when the vehicle speed is **above** 20 mph (32 km/h), the set speed shall be the current speed of the vehicle.

### NOTE:

- Keeping your foot on the accelerator pedal can cause the vehicle to continue to accelerate beyond the set speed. If this occurs, the message "DRIVER OVERRIDE" will display in the instrument cluster display.
- If you continue to accelerate beyond the set speed while ACC is enabled, the system will not be controlling the distance between your vehicle and the vehicle ahead. The vehicle speed will only be determined by the position of the accelerator pedal.

## To Cancel

The following conditions cancel the ACC or Fixed Speed Cruise Control systems:

- The brake pedal is applied
- The CANC (cancel) button is pushed
- The Anti-Lock Brake System (ABS) activates
- The gear selector is removed from the DRIVE position
- The Electronic Stability Control/Traction Control System (ESC/TCS) activates

- The vehicle parking brake is applied
- The Trailer Sway Control (TSC) activates
- The driver switches ESC to Full Off mode
- The braking temperature exceeds normal range (overheated)

The following conditions will only cancel the ACC system:

- Driver seat belt is unbuckled at low speeds
- Driver door is opened at low speeds

## To Turn Off

The system will turn off and erase the set speed in memory if:

- The Adaptive Cruise Control (ACC) on/off button is pushed
- The Fixed Speed Cruise Control on/off button is pushed
- The ignition is placed in the OFF position
- 4WD Low is engaged

## To Resume

If there is a set speed in memory, push the RES (resume) button and remove your foot from the accelerator pedal. The instrument cluster display will show the last set speed.

Resume can be used at any speed above 20 mph (32 km/h) when only Fixed Speed Cruise Control is being used.

Resume can be used at any speed above 0 mph (0 km/h) when ACC is active.

#### NOTE:

- While in ACC mode when the vehicle comes to a complete stop longer than two seconds, the system will cancel. The driver will have to apply the brakes to keep the vehicle at a standstill.
- ACC cannot be resumed if there is a stationary vehicle in front of your vehicle in close proximity.

#### WARNING!

The Resume function should only be used if traffic and road conditions permit. Resuming a set speed that is too high or too low for prevailing traffic and road conditions could cause the vehicle to accelerate or decelerate too sharply for safe operation. Failure to follow these warnings can result in a collision and death or serious personal injury.

### To Vary The Speed Setting

#### To Increase Or Decrease The Set Speed

After setting a speed, you can increase the set speed by pushing the SET (+) button, or decrease speed by pushing the SET (-) button.

#### U.S. Speed (mph)

- Pushing the SET (+), or SET (-) button once will result in a 1 mph speed adjustment. Each subsequent tap of the button results in an adjustment of 1 mph.
- If the button is continually pushed, the set speed will continue to adjust in 5 mph increments until the button is released. The new set speed is reflected in the instrument cluster display.

#### Metric Speed (km/h)

- Pushing the SET (+), or SET (-) button once will result in a 1 km/h speed adjustment. Each subsequent tap of the button results in an adjustment of 1 km/h.
- If the button is continually pushed, the set speed will continue to adjust in 10 km/h increments until the button is released. The new set speed is reflected in the instrument cluster display.

#### NOTE:

When you override and push the SET (+) button or SET (-) button, the new set speed will be the current speed of the vehicle.

#### When ACC Is Active:

- When you use the SET (-) button to decelerate, if the engine's braking power does not slow the vehicle sufficiently to reach the set speed, the brake system will automatically slow the vehicle.
- The ACC system applies the brake down to a full stop when following the vehicle in front. If your vehicle follows the vehicle in front to a standstill, your vehicle will release the brakes two seconds after coming to a full stop.
- The ACC system maintains set speed when driving uphill and downhill. However, a slight speed change on moderate hills is normal. In addition, downshifting may occur while climbing uphill or descending downhill. This is normal operation and necessary to maintain set speed. When driving uphill and downhill, the ACC system will cancel if the braking temperature exceeds normal range (overheated).

### Setting The Following Distance In ACC

The specified following distance for ACC can be set by varying the distance setting between four bars (longest), three bars (long), two bars (medium) and one bar (short). Using this distance setting and the vehicle speed, ACC calculates and sets the distance to the vehicle ahead. This distance setting appears in the instrument cluster display.



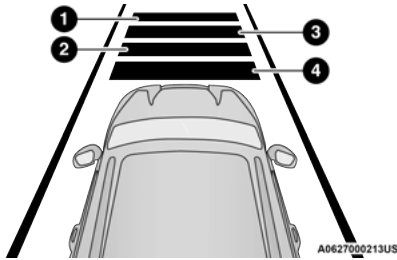

**Distance Settings**

- 1 – Longest Distance Setting (Four Bars)
- 2 – Medium Distance Setting (Two Bars)
- 3 – Long Distance Setting (Three Bars)
- 4 – Short Distance Setting (One Bar)

To increase the distance setting, push the Distance Increase button and release. Each time the button is pushed, the distance setting increases by one bar (longer).

To decrease the distance setting, push the Distance Decrease button and release. Each time the button is pushed, the distance setting decreases by one bar (shorter).

If there is no vehicle ahead, the vehicle will maintain the set speed. If a slower moving vehicle is detected in the same lane, the instrument cluster display will show the ACC Set With Target Detected Indicator Light. The system will then

adjust the vehicle speed automatically to maintain the distance setting, regardless of the set speed.

The vehicle will then maintain the set distance until:

- The vehicle ahead accelerates to a speed above the set speed.
- The vehicle ahead moves out of your lane or view of the sensor.
- The distance setting is changed.
- The system disengages → page 120.

The maximum braking applied by ACC is limited; however, the driver can always apply the brakes manually, if necessary.

**NOTE:**

The brake lights will illuminate whenever the ACC system applies the brakes.

A Proximity Warning will alert the driver if ACC predicts that its maximum braking level is not sufficient to maintain the set distance. If this occurs, a visual alert “BRAKE!” will flash in the instrument cluster display and a chime will sound while ACC continues to apply its maximum braking capacity.

**NOTE:**

The “BRAKE!” screen in the instrument cluster display is a warning for the driver to take action and does not necessarily mean that the Forward Collision Warning system is applying the brakes autonomously.

## Overtake Aid

When driving with Adaptive Cruise Control (ACC) engaged and following a vehicle, the system will provide an additional acceleration up to the ACC set speed to assist in passing the vehicle. This additional acceleration is triggered when the driver utilizes the left turn signal and will only be active when passing on the left hand side.

## ACC Operation At Stop

If the ACC system brings your vehicle to a standstill while following a vehicle ahead, your vehicle will resume motion, without any driver interaction, if the vehicle ahead starts moving within two seconds of your vehicle coming to a standstill.

If the target vehicle does not start moving within two seconds of your vehicle coming to a standstill, the ACC with Stop system will cancel and the brakes will release. A cancel message will display on the instrument cluster display and produce a warning chime. Driver intervention will be required at this moment.

While ACC with Stop is holding your vehicle at a standstill, if the driver seat belt is unbuckled or the driver door is opened, the ACC with Stop system will cancel and the brakes will release. A cancel message will display on the instrument cluster display and produce a warning chime. The driver must now manually operate the vehicle’s accelerator and brakes.

**WARNING!**

When the ACC system is resumed, the driver must ensure that there are no pedestrians, vehicles or objects in the path of the vehicle. Failure to follow these warnings can result in a collision and death or serious personal injury.

**Display Warnings And Maintenance****“WIPE FRONT RADAR SENSOR IN FRONT OF VEHICLE” WARNING**

The “ACC/FCW Unavailable Wipe Front Radar Sensor” warning will display and a chime will sound when conditions temporarily limit system performance.

This most often occurs at times of poor visibility, such as in snow or heavy rain. The ACC system may also become temporarily blinded due to obstructions, such as mud, dirt or ice. In these cases, the instrument cluster display will display the above message and the system will deactivate.

This message can sometimes be displayed while driving in highly reflective areas (i.e. ice and snow, or tunnels with reflective tiles). The ACC system will recover after the vehicle has left these areas. Under rare conditions, when the radar is not tracking any vehicles or objects in its path this warning may temporarily occur.

**NOTE:**

If the “ACC/FCW Unavailable Wipe Front Radar Sensor” warning is active, Fixed Speed Cruise Control is still available.

If weather conditions are not a factor, the driver should examine the sensor. It may require cleaning or removal of an obstruction. The sensor is located in the center of the vehicle behind the lower grille.

To keep the ACC system operating properly, it is important to note the following maintenance items:

- Always keep the sensor clean. Carefully wipe the sensor lens with a soft cloth. Be cautious not to damage the sensor lens.
- Do not remove any screws from the sensor. Doing so could cause an ACC system malfunction or failure and require a sensor realignment.
- If the sensor or front end of the vehicle is damaged due to a collision, see an authorized dealer for service.
- Do not attach or install any accessories near the sensor, including transparent material or aftermarket grilles. Doing so could cause an ACC system failure or malfunction.

When the condition that deactivated the system is no longer present, the system will return to the “Adaptive Cruise Control Off” state and will resume function by simply reactivating it.

**NOTE:**

- If the “ACC/FCW Unavailable Wipe Front Radar Sensor” message occurs frequently (e.g. more than once on every trip) without any snow, rain, mud, or other obstruction, have the radar sensor realigned at an authorized dealer.
- Installing a snowplow, front-end protector, an aftermarket grille or modifying the grille is not recommended. Doing so may block the sensor and inhibit ACC/FCW operation.

**“CLEAN FRONT WINDSHIELD” WARNING**

The “ACC/FCW Limited Functionality Clean Front Windshield” warning will display, and a chime will sound when conditions temporarily limit system performance. This most often occurs at times of poor visibility, such as in snow or heavy rain and fog. The ACC system may also become temporarily blinded due to obstructions, such as mud, dirt, or ice on windshield and fog on the inside of glass. In these cases, the instrument cluster display will read “ACC/FCW Limited Functionality Clean Front Windshield” and the system will have degraded performance.

This message can sometimes be displayed while driving in adverse weather conditions. The ACC/FCW system will recover after the vehicle has left these areas. Under rare conditions, when the camera is not tracking any vehicles or objects in its path this warning may temporarily occur.

If weather conditions are not a factor, the driver should examine the windshield and the camera located on the back side of the inside rearview mirror. They may require cleaning or removal of an obstruction.

When the condition that created limited functionality is no longer present, the system will return to full functionality.

#### NOTE:

If the “ACC/FCW Limited Functionality Clean Front Windshield” message occurs frequently (e.g. more than once on every trip) without any snow, rain, mud, or other obstruction, have the windshield and forward facing camera inspected at an authorized dealer.

#### SERVICE ACC/FCW WARNING

If the system turns off, and the instrument cluster display reads “ACC/FCW Unavailable Service Required” or “Cruise/FCW Unavailable Service Required”, there may be an internal system fault or a temporary malfunction that limits ACC functionality. Although the vehicle is still drivable under normal conditions, ACC will be temporarily unavailable. If this occurs, try activating ACC again later, following an ignition cycle. If the problem persists, see an authorized dealer.

#### Precautions While Driving With ACC

In certain driving situations, ACC may have detection issues. In these cases, ACC may brake

late or unexpectedly. The driver needs to stay alert and may need to intervene. The following are examples of these types of situations:

#### TOWING A TRAILER

ACC while towing a trailer is recommended only with an Integrated Trailer Brake Controller. Aftermarket trailer brake controllers will not activate the trailer brakes when ACC is braking.

#### OFFSET DRIVING

ACC may not detect a vehicle in the same lane that is offset from your direct line of travel, or a vehicle merging in from a side lane. There may not be sufficient distance to the vehicle ahead. The offset vehicle may move in and out of the line of travel, which can cause your vehicle to brake or accelerate unexpectedly.

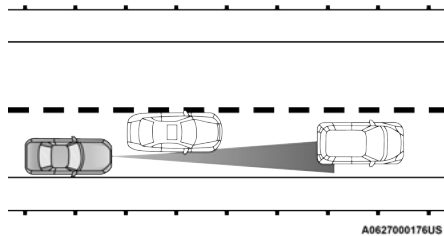

Offset Driving Condition Example

#### TURNS AND BENDS

When driving on a curve with ACC engaged, the system may decrease the vehicle speed and acceleration for stability reasons, with no vehicle in front detected. Once the vehicle is out of the curve the system will resume your original set speed. This is a part of normal ACC system functionality.

#### NOTE:

On tight turns ACC performance may be limited.

#### USING ACC ON HILLS

ACC performance may be limited when driving on hills. ACC may not detect a vehicle in your lane depending on the speed, vehicle load, traffic conditions, and the steepness of the hill.

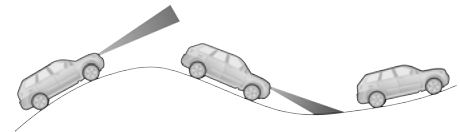

ACC Hill Example

## LANE CHANGING

ACC may not detect a vehicle until it is completely in the lane in which you are traveling. In the lane changing example below, ACC has not yet detected the vehicle changing lanes and it may not detect the vehicle until it's too late for the ACC system to take action. ACC may not detect a vehicle until it is completely in the lane. There may not be sufficient distance to the lane-changing vehicle. Always be attentive and ready to apply the brakes if necessary.

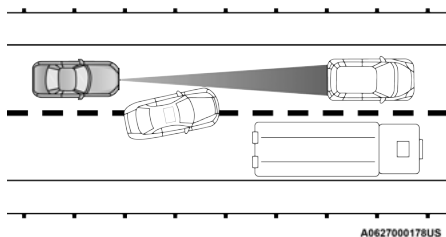

Lane Changing Example

## NARROW VEHICLES

Some narrow vehicles traveling near the outer edges of the lane or edging into the lane are not detected until they have moved fully into the lane. There may not be sufficient distance to the vehicle ahead.

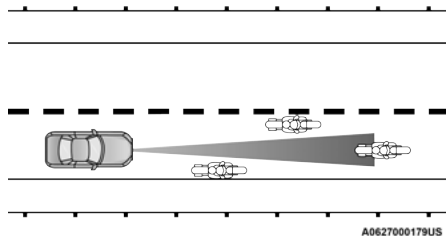

Narrow Vehicle Example

## STATIONARY OBJECTS AND VEHICLES

ACC does not react to stationary objects or vehicles. For example, ACC will not react in situations where the vehicle you are following exits your lane and the vehicle ahead is stopped in your lane. It will consider this stopped vehicle a stationary object as it did not previously detect movement from it. Always be attentive and ready to apply the brakes if necessary.

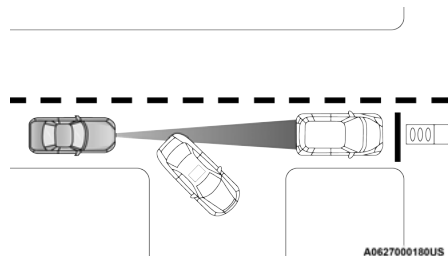

Stationary Object And Stationary Vehicle Example

## PARKSENSE FRONT/REAR PARK ASSIST SYSTEM — IF EQUIPPED

The ParkSense Park Assist system provides visual and audible indications of the distance between the rear, and if equipped, the front fascia/bumper and a detected obstacle when backing up or moving forward (e.g. during a parking maneuver). The vehicle brakes may be automatically applied and released when performing a reverse parking maneuver if the system detects a possible collision with an obstacle.

### NOTE:

- The driver can disable the automatic braking function by turning ParkSense off via the ParkSense switch. The driver can also override auto-

matic braking by changing the gear or by pressing the gas pedal over 90% of its capacity during the braking event.

- Automatic brakes are not available if the vehicle is in 4WD Low.
- Automatic brakes will not be available if there is a faulted condition detected with the ParkSense Park Assist system or the Braking System Module.
- The automatic braking function may only be applied if the vehicle deceleration is not enough to avoid colliding with a detected obstacle.
- The automatic braking function may not be applied fast enough for obstacles that move toward the rear of the vehicle from the left and/or right sides.
- The automatic braking function can be enabled/disabled from the Customer Programmable Features section of the Uconnect system.
- ParkSense will retain its last known configuration state for the automatic braking function through ignition cycles.

The automatic braking function is intended to assist the driver in avoiding possible collisions with detected obstacles when backing up in REVERSE gear.

#### NOTE:

- The system is designed to assist the driver and not to substitute the driver.
- The driver must stay in full control of the vehicle's acceleration and braking and is responsible for the vehicle's movements.

For limitations of this system and recommendations, see  page 131.

ParkSense will retain the last system state (enabled or disabled) from the last ignition cycle when the ignition is changed to the ON/RUN position.

ParkSense can be active only when the gear selector is in REVERSE or DRIVE. If ParkSense is enabled at one of these gear selector positions, the system will remain active until the vehicle speed is increased to approximately 7 mph (11 km/h) or above. The system will become active again if the vehicle speed is decreased to speeds less than approximately 6 mph (9 km/h). A display warning will appear in the instrument cluster display if the vehicle is in REVERSE and the speed exceeds 7 mph (11 km/h).

#### PARKSENSE SENSORS

Six ParkSense sensors located in the front fascia/bumper (if equipped) and six ParkSense sensors (four when vehicle is not equipped with front sensors) located in the rear fascia/bumper,

monitor the area in front and behind the vehicle that is within the sensors' field of view. The front sensors detect obstacles from approximately 12 inches (30 cm) up to 47 inches (120 cm) from the front fascia/bumper. The rear sensors can detect obstacles from approximately 12 inches (30 cm) up to 79 inches (200 cm) from the rear fascia/bumper. These distances depend on the location, type and orientation of the obstacle in the horizontal direction.

#### PARKSENSE DISPLAY

The warning display will turn on indicating the system status when the vehicle is in REVERSE or when the vehicle is in DRIVE and an obstacle has been detected.

The system will indicate a detected obstacle by showing a single arc in the left and/or right front or rear regions based on the object's distance and location relative to the vehicle.

If an object is detected in the left and/or right rear region, the display will show a single arc in the left and/or right rear region and the system will produce a tone. As the vehicle moves closer to the object, the display will show the single arc moving closer to the vehicle and the tone will change from a single 1/2 second tone to slow, to fast, to continuous.

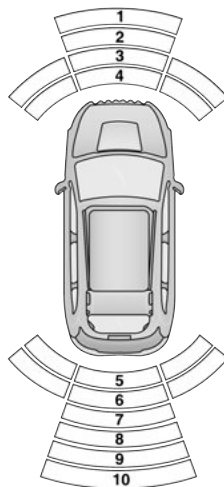

A0629000263US

**Front/Rear ParkSense Arcs**

- 1 – No Tone/Solid Arc
- 2 – No Tone/Flashing Arc
- 3 – Fast Tone/Flashing Arc
- 4 – Continuous Tone/Flashing Arc
- 5 – Continuous Tone/Flashing Arc

- 6 – Fast Tone/Flashing Arc
- 7 – Fast Tone/Flashing Arc
- 8 – Slow Tone/Solid Arc
- 9 – Slow Tone/Solid Arc
- 10 – Single 1/2 Second Tone/Solid Arc

The vehicle is close to the obstacle when the instrument cluster display shows one flashing arc and sounds a continuous tone. The following chart shows the warning alert operation when the system is detecting an obstacle:

WARNING ALERTS FOR REAR							
Rear Distance (inches/cm)	Greater than 79 inches (200 cm)	79-59 inches (200-150 cm)	59-47 inches (150-120 cm)	47-39 inches (120-100 cm)	39-25 inches (100-65 cm)	25-12 inches (65-30 cm)	Less than 12 inches (30 cm)
Audible Alert Chime	None	Single 1/2 Second Tone	Slow	Slow	Fast	Fast	Continuous
Arcs-Left	None	None	None	None	None	6th Flashing	5th Flashing
Arcs-Center	None	10th Solid	9th Solid	8th Solid	7th Flashing	6th Flashing	5th Flashing
Arcs-Right	None	None	None	None	None	6th Flashing	5th Flashing
Radio Volume Reduced	No	Yes	Yes	Yes	Yes	Yes	Yes

WARNING ALERTS FOR FRONT					
Front Distance (inches/cm)	Greater than 47 inches (120 cm)	47-39 inches (120-100 cm)	39-25 inches (100-65 cm)	25-12 inches (65-30 cm)	Less than 12 inches (30 cm)
Audible Alert Chime	None	None	None	Fast	Continuous
Arcs-Left	None	None	None	3rd Flashing	4th Flashing
Arcs-Center	None	1st Solid	2nd Flashing	3rd Flashing	4th Flashing
Arcs-Right	None	None	None	3rd Flashing	4th Flashing
Radio Volume Reduced	No	No	No	Yes	Yes

**NOTE:**

If the radio is on, ParkSense will reduce the volume of the radio when the system is sounding an audio tone.

### Front Park Assist Audible Alerts

ParkSense will turn off the Front Park Assist audible alert (chime) after approximately three seconds when an obstacle has been detected, the vehicle is stationary, and brake pedal is applied.

### Adjustable Chime Volume Settings

- Front and Rear chime volume settings can be selected from the Uconnect system ↪ page 155.
- The chime volume settings include low, medium, and high.
- ParkSense will retain its last known configuration state through ignition cycles.

### PARKSENSE WARNING DISPLAY

The ParkSense Warning screen is located within the instrument cluster display ↪ page 82. It provides visual warnings to indicate the distance between the rear fascia/bumper and/or front fascia/bumper and the detected obstacle.

The ParkSense Warning screen will only be displayed if Sound and Display is selected from the Customer Programmable Features section of the Uconnect system ↪ page 155.

### ENABLING AND DISABLING PARKSENSE



ParkSense can be enabled and disabled with the ParkSense switch.

When the ParkSense switch is pushed to disable the system, the instrument cluster will display the “PARKSENSE OFF” message for approximately five seconds. When the gear selector is moved to REVERSE and the system is disabled, the instrument cluster display will display the “PARKSENSE OFF” message for as long as the vehicle is in REVERSE.

#### NOTE:

When ParkSense is disabled and the gear selector is moved to the DRIVE position, no warning message will be displayed.

The ParkSense switch LED will be on when ParkSense is disabled or requires service. The ParkSense switch LED will be off when the system is enabled. If the ParkSense switch is pushed, and the system requires service, the ParkSense switch LED will blink momentarily, and then the LED will be on.

### OPERATION WITH A TRAILER

For vehicles equipped with an Integrated Trailer Brake Module (ITBM), the operation of the rear sensors is automatically deactivated when the trailer's electric plug is inserted in the vehicle's tow hook socket. The front system is still functional, and the arcs will be overlaid with a “Trailer” message. The rear sensors are automatically reactivated when the trailer's cable plug is removed.

When the vehicle is connected to a trailer, the instrument cluster display will show the “Rear ParkSense Unavailable Trailer Connected” message in the following situations:

- For five seconds at vehicle start up
- For five seconds when the ParkSense button is pushed, as long as an object is not detected in the front
- As long as the vehicle is in REVERSE (vehicle graphic displayed with a trailer overlay)

#### NOTE:

For more information on the Integrated Trailer Brake Module, see ↪ page 144.

For vehicles not equipped with ITBM, the automatic braking may falsely be applied if a trailer is hooked up, and park assist is not manually deactivated. It is also possible, the trailer may be mistaken as a close object.



**WARNING!**

Before using ParkSense, it is strongly recommended that the ball mount and hitch ball assembly be disconnected from the vehicle when the vehicle is not used for towing. Failure to do so can result in injury or damage to vehicles or obstacles because the hitch ball will be much closer to the obstacle than the rear fascia when the vehicle sounds the continuous tone. Also, the sensors could detect the ball mount and hitch ball assembly, depending on its size and shape, giving a false indication that an obstacle is behind the vehicle.

## SERVICE THE PARKSENSE PARK ASSIST SYSTEM

During vehicle start up, when the ParkSense System has detected a fault condition, the instrument cluster will actuate a single chime, once per ignition cycle, and it will display the "PARKSENSE UNAVAILABLE WIPE REAR SENSORS", "PARKSENSE UNAVAILABLE WIPE FRONT SENSORS", or the "PARKSENSE UNAVAILABLE SERVICE REQUIRED" message for five seconds.

When the gear selector is moved to REVERSE and the system has detected a fault condition, the instrument cluster display will display a

"PARKSENSE UNAVAILABLE WIPE REAR SENSORS", "PARKSENSE UNAVAILABLE WIPE FRONT SENSORS" or "PARKSENSE UNAVAILABLE SERVICE REQUIRED" pop-up message for five seconds. After five seconds, a vehicle graphic will be displayed with "UNAVAILABLE" at either the front or rear sensor location depending on where the fault is detected. The system will continue to provide arc alerts for the side that is functioning properly. These arc alerts will interrupt the "PARKSENSE UNAVAILABLE WIPE REAR SENSORS", "PARKSENSE UNAVAILABLE WIPE FRONT SENSORS", or "PARKSENSE UNAVAILABLE SERVICE REQUIRED" messages if an object is detected within the five second pop-up duration. The vehicle graphic will remain displayed for as long as the vehicle is in REVERSE.

If "PARKSENSE UNAVAILABLE WIPE REAR SENSORS" or "PARKSENSE UNAVAILABLE WIPE FRONT SENSORS" appears in the instrument cluster display make sure the outer surface and the underside of the rear fascia/bumper and/or front fascia/bumper is clean and clear of snow, ice, mud, dirt or other obstruction and then cycle the ignition. If the message continues to appear see an authorized dealer.

If the "PARKSENSE UNAVAILABLE SERVICE REQUIRED" message appears in the instrument cluster display, see an authorized dealer.

## CLEANING THE PARKSENSE SYSTEM

Clean the ParkSense sensors with water, car wash soap and a soft cloth. Do not use rough or hard cloths. Do not scratch or poke the sensors.

## PARKSENSE SYSTEM USAGE PRECAUTIONS

### NOTE:

- Ensure that the front and rear bumper are free of snow, ice, mud, dirt and debris to keep the ParkSense system operating properly.
- Jackhammers, large trucks, and other vibrations could affect the performance of ParkSense.
- When you turn ParkSense off, the instrument cluster will display "PARKSENSE OFF." Furthermore, once you turn ParkSense off, it remains off until you turn it on again, even if you cycle the ignition.
- When you move the gear selector to the REVERSE position and ParkSense is turned off, the instrument cluster will display "PARKSENSE OFF" for as long as the vehicle is in REVERSE.
- ParkSense, when on, will reduce the volume of the radio when it is sounding a tone.
- Clean the ParkSense sensors regularly, taking care not to scratch or damage them. The sensors must not be covered with ice, snow, slush, mud, dirt or debris. Failure to do so can

result in the system not working properly. The ParkSense system might not detect an obstacle behind or in front of the fascia/bumper, or it could provide a false indication that an obstacle is behind or in front of the fascia/bumper.

- Use the ParkSense switch to turn the ParkSense system off if objects such as bicycle carriers, trailer hitches, etc. are placed within 12 inches (30 cm) of the rear fascia/bumper. Failure to do so can result in the system misinterpreting a close object as a sensor problem, causing the “PARKSENSE UNAVAILABLE SERVICE REQUIRED” message to be displayed in the instrument cluster.
- ParkSense should be disabled when the liftgate is in the open position. An opened liftgate could provide a false indication that an obstacle is behind the vehicle.

#### WARNING!

- Drivers must be careful when backing up even when using ParkSense. Always check carefully behind your vehicle, look behind you, and be sure to check for pedestrians, animals, other vehicles, obstructions, and blind spots before backing up. You are responsible for safety and must continue to pay attention to your surroundings. Failure to do so can result in serious injury or death.

*(Continued)*

#### WARNING!

- Before using ParkSense, it is strongly recommended that the ball mount and hitch ball assembly be disconnected from the vehicle when the vehicle is not used for towing. Failure to do so can result in injury or damage to vehicles or obstacles because the hitch ball will be much closer to the obstacle than the rear fascia when the vehicle sounds the continuous tone. Also, the sensors could detect the ball mount and hitch ball assembly, depending on its size and shape, giving a false indication that an obstacle is behind the vehicle.

#### CAUTION!

- ParkSense is only a parking aid and it is unable to recognize every obstacle, including small obstacles. Parking curbs might be temporarily detected or not detected at all. Obstacles located above or below the sensors will not be detected when they are in close proximity.
- The vehicle must be driven slowly when using ParkSense in order to be able to stop in time when an obstacle is detected. It is recommended that the driver looks over his/her shoulder when using ParkSense.

## LANESENSE — IF EQUIPPED

### LANESENSE OPERATION

The LaneSense system is operational at speeds above 37 mph (60 km/h) and below 112 mph (180 km/h). The LaneSense system uses a forward looking camera to detect lane markings and measure vehicle position within the lane boundaries.

When both lane markings are detected and the driver drifts out of the lane (no turn signal applied), the LaneSense system provides a haptic warning in the form of torque applied to the steering wheel to prompt the driver to remain within the lane boundaries. If the driver continues to drift out of the lane, the LaneSense system provides a visual warning through the instrument cluster display to prompt the driver to remain within the lane boundaries.

The driver may manually override the haptic warning by applying force into the steering wheel at any time.

When only a single lane marking is detected and the driver drifts across the lane marking (no turn signal applied), the LaneSense system provides visual warnings through the instrument cluster display to prompt the driver to remain within the lane. When only a single lane marking is detected, a haptic or a torque warning will not be provided.

**NOTE:**

When operating conditions have been met, the LaneSense system will monitor if the driver's hands are on the steering wheel and provide an audible warning to the driver if removed. The system will cancel if the driver does not return their hands to the wheel.

**TURNING LANESENSE ON OR OFF**

The LaneSense button is located on the switch panel below the Uconnect display.

To turn the LaneSense system on, push the LaneSense button (LED turns off). A "LaneSense On" message is shown in the instrument cluster display.

To turn the LaneSense system off, push the LaneSense button once (LED turns on).

**NOTE:**

The LaneSense system will retain the last system state on or off from the last ignition cycle when the ignition is placed in the ON/RUN position.

**LANESENSE WARNING MESSAGE**

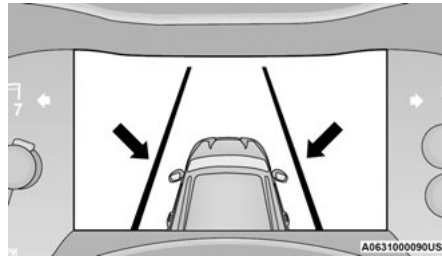

The LaneSense system will indicate the current lane drift condition through the instrument cluster display.

When the LaneSense system is on, the lane lines are gray when both of the lane boundaries have not been detected and the LaneSense telltale  is solid white.



System On (Gray Lines) With White Telltale 

**Left Lane Departure — Only Left Lane Detected**

- When the LaneSense system is on, the LaneSense telltale  is solid white when only the left lane marking has been detected and the system is ready to provide visual warnings in the instrument cluster display if an unintentional lane departure occurs.
- When the LaneSense system senses the lane has been approached and is in a lane departure situation, the left lane line flashes yellow (on/off), and the LaneSense telltale  changes from solid white to flashing yellow.

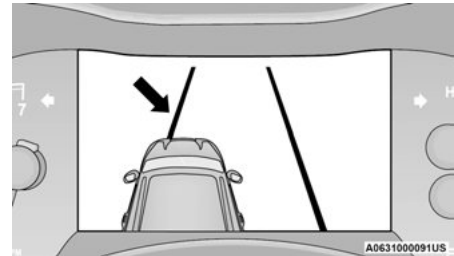

Lane Approached  
(Flashing Yellow Line With Flashing Yellow Telltale) 

**NOTE:**

The LaneSense system operates with similar behavior for a right lane departure when only the right lane marking has been detected.

**Left Lane Departure — Both Lanes Detected**

- When the LaneSense system is on, the lane lines turn from gray to white to indicate that both of the lane markings have been detected. The LaneSense telltale  is solid green when both lane markings have been detected and the system is on to provide visual warnings in the instrument cluster display and a torque warning in the steering wheel if an unintentional lane departure occurs.

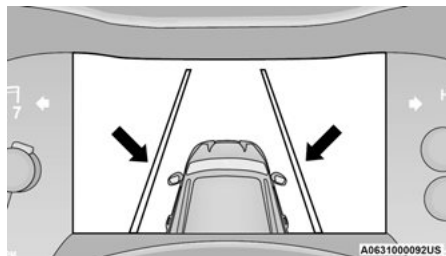

Lanes Sensed (White Lines) With Green Telltale 

- When the LaneSense system senses a lane drift situation, the left lane line will turn solid yellow. The LaneSense telltale  changes from solid green to solid yellow. At this time torque is applied to the steering wheel in the opposite direction of the lane boundary.

For example: If approaching the left side of the lane the steering wheel will turn to the right.

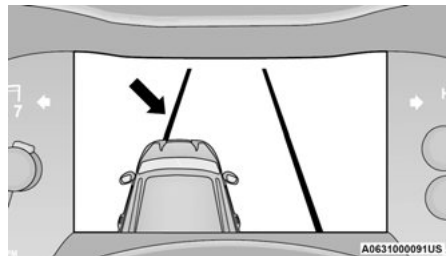

Lane Sensed  
(Solid Yellow Line With Solid Yellow Telltale) 

- When the LaneSense system senses the lane has been approached and is in a lane departure situation, the left lane line flashes yellow (on/off). The LaneSense telltale  changes from solid yellow to flashing yellow. At this time torque is applied to the steering wheel in the opposite direction of the lane boundary.

For example: If approaching the left side of the lane the steering wheel will turn to the right.

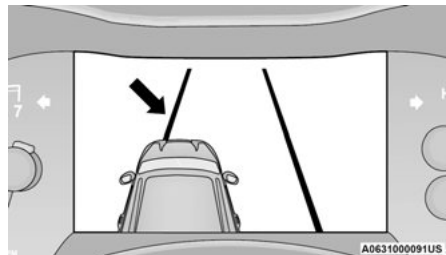

Lane Approached  
(Flashing Yellow Line With Flashing Yellow Telltale) 

**NOTE:**

The LaneSense system operates with similar behavior for a right lane departure.

## CHANGING LANESENSE STATUS

The LaneSense system has settings to adjust the intensity of the torque warning and the warning zone sensitivity (early/late) that you can configure through the Uconnect system → page 155.

### NOTE:

- When enabled the system operates above 37 mph (60 km/h) and below 112 mph (180 km/h).
- The warnings are disabled with use of the turn signal.
- The system will not apply torque to the steering wheel whenever a safety system engages (Anti-Lock Brakes, Traction Control System, Electronic Stability Control, Forward Collision Warning, etc.).

## PARKVIEW REAR BACK UP CAMERA

Your vehicle is equipped with the ParkView Rear Back Up Camera that allows you to see an on-screen image of the rear surroundings of your vehicle whenever the gear selector is put into REVERSE. The image will be displayed on the Navigation/Multimedia radio display screen along with a caution note to “Check Entire Surroundings” across the top of the screen. After five seconds this note will disappear. The ParkView camera is

located on the rear of the vehicle above the rear license plate.

When the vehicle is shifted out of REVERSE (with camera delay turned off), the rear camera mode is exited and the previous screen appears.

### Manual Activation Of The Backup Camera

1. Press the Vehicle Menu button located at the bottom of the Uconnect display. Then select the Controls tab.
2. Press the Rear View Camera button to turn the Rear View Camera system on.

### NOTE:

The ParkView Rear Back Up Camera has programmable modes of operation that may be selected through the Uconnect system → page 155. In certain radio configurations, these modes of operation will be found in the “Camera” section of the vehicle settings menu.

When the vehicle is shifted out of REVERSE (with camera delay turned off), the rear camera mode is exited and the previous screen appears. When the vehicle is shifted out of REVERSE (with camera delay turned on), the camera image will continue to be displayed for up to 10 seconds after shifting out of REVERSE unless the following conditions occur: the vehicle speed exceeds 8 mph (13 km/h), the

vehicle is shifted into PARK, the vehicle’s ignition is placed in the OFF position, or the touchscreen button “X” to disable the display of the Rear View Camera is pressed.

When enabled, active guidelines are overlaid on the image to illustrate the width of the vehicle and its projected backup path based on the steering wheel position. A dashed center line overlay indicates the center of the vehicle to assist with parking or aligning to a hitch/receiver. Different colored zones indicate the distance to the rear of the vehicle.

The following table shows the approximate distances for each zone:

Zone	Distance To The Rear Of The Vehicle
Red	0 - 1 ft (0 - 30 cm)
Yellow	1 ft - 6.5 ft (30 cm - 2 m)
Green	6.5 ft or greater (2 m or greater)

**WARNING!**

Drivers must be careful when backing up even when using the ParkView Rear Back Up Camera. Always check carefully behind your vehicle, and be sure to check for pedestrians, animals, other vehicles, obstructions, or blind spots before backing up. You are responsible for the safety of your surroundings and must continue to pay attention while backing up. Failure to do so can result in serious injury or death.

**CAUTION!**

- To avoid vehicle damage, ParkView should only be used as a parking aid. The ParkView camera is unable to view every obstacle or object in your drive path.
- To avoid vehicle damage, the vehicle must be driven slowly when using ParkView to be able to stop in time when an obstacle is seen. It is recommended that the driver look frequently over his/her shoulder when using ParkView.

**NOTE:**

If snow, ice, mud, or any foreign substance builds up on the camera lens, clean the lens, rinse with water, and dry with a soft cloth. Do not cover the lens.

**Rear View Camera — Viewing At Speed**

When the vehicle is in PARK, NEUTRAL or DRIVE, the Rear View Camera can be activated with the Rear View Camera button in the Controls tab of the Vehicle Menu. This feature allows the customer to monitor the area directly behind the vehicle (or trailer, if equipped) for up to 10 seconds while driving. If the vehicle speed remains below 8 mph (13 km/h), the Rear View Camera image will be displayed continuously until deactivated via the “X” button on the touchscreen.

**REFUELING THE VEHICLE**

1. Open the fuel filler door by pushing on the outer edge of the fuel door.

**NOTE:**

There is no fuel filler cap. Two flapper doors inside the pipe seal the system.

2. Insert the fuel nozzle fully into the filler pipe – the nozzle opens and holds the flapper doors while refueling.

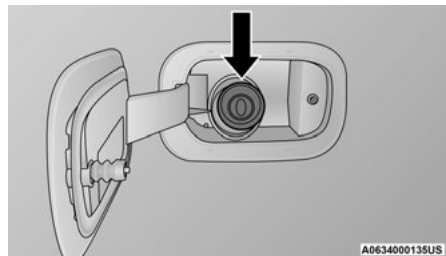
**Fuel Filler**

3. Fill the vehicle with fuel – when the fuel nozzle “clicks” or shuts off the fuel tank is full.
4. Wait five seconds before removing the fuel nozzle to allow fuel to drain from nozzle.
5. Remove the nozzle and push the fuel door all the way in to secure it in place.

**WARNING!**

- Never have any smoking materials lit in or near the vehicle when the fuel door is open or the tank is being filled.
- Never add fuel when the engine is running. This is in violation of most state and federal fire regulations and may cause the Malfunction Indicator Light to turn on.

*(Continued)*

**WARNING!**

- A fire may result if fuel is pumped into a portable container that is inside of a vehicle. You could be burned. Always place fuel containers on the ground while filling.

**CAUTION!**

To avoid fuel spillage and overfilling, do not “top off” the fuel tank after filling.

## VEHICLE LOADING

### CERTIFICATION LABEL

As required by National Highway Traffic Safety Administration regulations, your vehicle has a certification label affixed to the driver's side door or pillar.

This label contains the month and year of manufacture, Gross Vehicle Weight Rating (GVWR), front and rear Gross Axle Weight Rating (GAWR), and Vehicle Identification Number (VIN). A Month-Day-Hour (MDH) number is included on this label and indicates the Month, Day and Hour of manufacture. The bar code that appears on the bottom of the label is your VIN.

### Gross Vehicle Weight Rating (GVWR)

The GVWR is the total permissible weight of your vehicle including driver, passengers, vehicle, options and cargo. The label also specifies maximum capacities of front and rear (GAWR). Total load must be limited so GVWR and front and rear GAWR are not exceeded.

### Payload

The payload of a vehicle is defined as the allowable load weight a truck can carry, including the weight of the driver, all passengers, options and cargo.

### Gross Axle Weight Rating (GAWR)

The GAWR is the maximum permissible load on the front and rear axles. The load must be distributed in the cargo area so that the GAWR of each axle is not exceeded.

Each axle GAWR is determined by the components in the system with the lowest load carrying capacity (axle, springs, tires or wheels). Heavier axles or suspension components sometimes specified by purchasers for increased durability does not necessarily increase the vehicle's GVWR.

### Tire Size

The tire size on the Vehicle Certification Label represents the actual tire size on your vehicle. Replacement tires must be equal to the load capacity of this tire size.

### Rim Size

This is the rim size that is appropriate for the tire size listed.

### Inflation Pressure

This is the cold tire inflation pressure for your vehicle for all loading conditions up to full GAWR.

### Curb Weight

The curb weight of a vehicle is defined as the total weight of the vehicle with all fluids, including vehicle fuel, at full capacity conditions, and with no occupants or cargo loaded into the vehicle. The front and rear curb weight values are determined by weighing your vehicle on a commercial scale before any occupants or cargo are added.

### Loading

The actual total weight and the weight of the front and rear of your vehicle at the ground can best be determined by weighing it when it is loaded and ready for operation.

The entire vehicle should first be weighed on a commercial scale to ensure that the GVWR has not been exceeded. The weight on the front and rear of the vehicle should then be determined separately to be sure that the load is properly distributed over the front and rear axle. Weighing the vehicle may show that the GAWR of either the front or rear axles has been exceeded but the total load is within the specified GVWR and maximum Payload. If so,

weight must be shifted from front to rear or rear to front as appropriate until the specified weight limitations are met. Store the heavier items down low and be sure that the weight is distributed equally. Stow all loose items securely before driving.

Improper weight distributions can have an adverse effect on the way your vehicle steers and handles and the way the brakes operate.

#### CAUTION!

Do not load your vehicle any heavier than the GVWR, maximum Payload or the maximum front and rear GAWR. If you do, parts on your vehicle can break, or it can change the way your vehicle handles. This could cause you to lose control. Overloading can shorten the life of your vehicle.

## TRAILER TOWING

In this section you will find safety tips and information on limits to the type of towing you can reasonably do with your vehicle. Before towing a trailer, carefully review this information to tow your load as efficiently and safely as possible.

To maintain the New Vehicle Limited Warranty coverage, follow the requirements and recommendations in this manual concerning vehicles used for trailer towing.

## COMMON TOWING DEFINITIONS

The following trailer towing related definitions will assist you in understanding the following information:

### Gross Vehicle Weight Rating (GVWR)

The GVWR is the total allowable weight of your vehicle. This includes driver, passengers, cargo and tongue weight. The total load must be limited so that you do not exceed the GVWR → page 137.

### Gross Trailer Weight (GTW)

The GTW is the weight of the trailer plus the weight of all cargo, consumables and equipment (permanent or temporary) loaded in or on the trailer in its "loaded and ready for operation" condition.

The recommended way to measure GTW is to put your fully loaded trailer on a vehicle scale. The entire weight of the trailer must be supported by the scale.

#### WARNING!

If the gross trailer weight is 5,000 lb (2,267 kg) or more, it is recommended to use a weight-distributing hitch to ensure stable handling of your vehicle. If you use a standard weight-carrying hitch, you could lose control of your vehicle and cause a collision.

### Gross Combination Weight Rating (GCWR)

The GCWR is the total allowable weight of your vehicle and trailer when weighed in combination.

### Gross Axle Weight Rating (GAWR)

The GAWR is the maximum capacity of the front and rear axles. Distribute the load over the front and rear axles evenly. Make sure that you do not exceed either front or rear GAWR → page 137.

#### WARNING!

It is important that you do not exceed the maximum front or rear GAWR. A dangerous driving condition can result if either rating is exceeded. You could lose control of the vehicle and have a collision.

### Tongue Weight (TW)

The TW is the downward force exerted on the hitch ball by the trailer. You must consider this as part of the load on your vehicle.

### Trailer Frontal Area

The frontal area is the maximum height multiplied by the maximum width of the front of a trailer.



## Trailer Sway Control (TSC)

The TSC can be a mechanical telescoping link that can be installed between the hitch receiver and the trailer tongue that typically provides adjustable friction associated with the telescoping motion to dampen any unwanted trailer swaying motions while traveling.

If equipped, the electronic TSC recognizes a swaying trailer and automatically applies individual wheel brakes and/or reduces engine power to attempt to eliminate the trailer sway.

## Weight-Carrying Hitch

A weight-carrying hitch supports the trailer tongue weight, just as if it were luggage located at a hitch ball or some other connecting point of the vehicle. These kinds of hitches are commonly used to tow small and medium sized trailers.

## Weight-Distributing Hitch

A weight-distributing system works by applying leverage through spring (load) bars. They are typically used for heavier loads to distribute trailer tongue weight to the tow vehicle's front axle and the trailer axle(s). When used in accordance with the manufacturer's directions, it provides for a more level ride, offering more consistent steering and brake control thereby enhancing towing safety. The addition of a friction/hydraulic sway control also dampens sway caused by traffic and crosswinds and contributes positively to tow

vehicle and trailer stability. Trailer Sway Control (TSC) and a weight distributing (load equalizing) hitch are recommended for heavier Tongue Weights (TW) and may be required depending on vehicle and trailer configuration/loading to comply with Gross Axle Weight Rating (GAWR) requirements.

### WARNING!

- An improperly adjusted weight-distributing hitch system may reduce handling, stability, braking performance, and could result in a collision.
- Weight-distributing hitch systems may not be compatible with surge brake couplers. Consult with your hitch and trailer manufacturer or a reputable Recreational Vehicle dealer for additional information.

## RECOMMENDED DISTRIBUTION HITCH ADJUSTMENT

1. Measure the height from the top of the front wheel opening on the fender to the ground; this is height H1.



A0636000083US

### Measuring Height (H)

2. Attach the trailer to the vehicle without the weight distribution bars connected.
3. Measure the height from the top of the front wheel opening on the fender to the ground; this is height H2.
4. Install and adjust the tension in the weight distributing bars per the manufacturers' recommendations so that the height of the front fender is approximately  $(H2-H1)/2+H1$  (about 1/2 the difference between H2 and H1 above normal ride height [H1]).

5. The vehicle can now be driven.

Measurement Example	Example Height (mm)
H1	925
H2	946
H2-H1	21

Measurement Example	Example Height (mm)
$(H2-H1)/2$	10.5
$(H2-H1)/2 + H1$	935.5

**NOTE:**

For all towing conditions, we recommend towing with tow haul mode engaged (if equipped).

**TRAILER HITCH CLASSIFICATION**

The following chart provides the industry standard for the maximum trailer weight a given trailer hitch class can tow and should be used to assist you in selecting the correct trailer hitch for your intended towing condition.

Trailer Hitch Classification Definitions	
Class	Max. Trailer Hitch Industry Standards
Class I - Light Duty	2,000 lb (907 kg)
Class II - Medium Duty	3,500 lb (1,588 kg)
Class III - Heavy Duty	6,000 lb (2,721 kg)
Class IV - Extra Heavy Duty	10,000 lb (4,535 kg)
For the Maximum Gross Trailer Weight (GTW) towable for your given drivetrain see <a href="#">page 141</a> .	
All trailer hitches should be professionally installed on your vehicle.	

## TRAILER TOWING WEIGHTS (MAXIMUM TRAILER WEIGHT RATINGS)

Engine	GCWR	Maximum GTW	Maximum Trailer TW (See Note)
3.6L - RWD Light Duty Cooling	8,900 lb (4,037 kg)	3,500 lb (1,588 kg)	350 lb (159 kg)
3.6L - RWD	11,600 lb (5,262 kg)	6,200 lb (2,812 kg)	620 lb (281 kg)
3.6L - AWD Light Duty Cooling	8,900 lb (4,037 kg)	3,500 lb (1,588 kg)	350 lb (159 kg)
3.6L - AWD	11,600 lb (5,262 kg)	6,200 lb (2,812 kg)	620 lb (281 kg)
5.7L - RWD	13,100 lb (5,942 kg)	7,400 lb (3,357 kg)	740 lb (336 kg)
5.7L - AWD	13,100 lb (5,942 kg)	7,200 lb (3,266 kg)	720 lb (327 kg)
5.7L - AWD R/T Tow N Go	14,600 lb (6,622 kg)	8,700 lb (3,946 kg)	870 lb (395 kg)

Refer to local laws for maximum trailer towing speeds.

### NOTE:

The trailer tongue weight must be considered as part of the combined weight of occupants and cargo, and should never exceed the weight referenced on the Tire and Loading Information placard  page 285. The addition of passengers and cargo may require reducing trailer tongue load and Gross Trailer Weight (GTW).

### TRAILER HITCH RECEIVER COVER REMOVAL — IF EQUIPPED

Your vehicle may be equipped with a trailer hitch receiver cover, this must be removed to access the trailer hitch receiver (if equipped). This cover is located at the bottom center of the rear fascia/bumper.

1. Turn the two locking retainers located at the bottom of the hitch receiver cover a quarter turn counterclockwise and pull bottom of the hitch receiver cover outward (towards you).

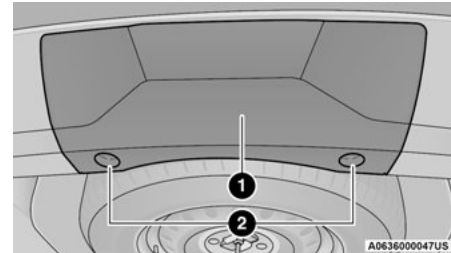

**Hitch Receiver Cover**

- 1 — Hitch Receiver Cover
- 2 — Locking Retainers

- Pull the bottom of the cover outward (towards you) then downwards to disengage the tabs located at the top of the hitch receiver cover to remove.

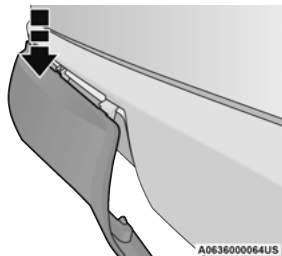

Hitch Receiver Cover

To reinstall the cover after towing, repeat the procedure in reverse order.

**NOTE:**

Be sure to engage all tabs of the hitch receiver cover in the bumper fascia prior to installation.

**TRAILER AND TONGUE WEIGHT**

Never exceed the maximum tongue weight stamped on your bumper or trailer hitch.

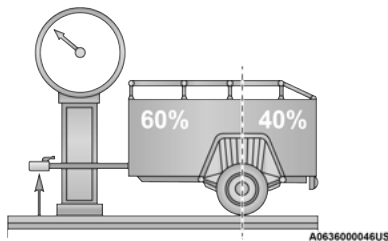

Weight Distribution

**CAUTION!**

Always load a trailer with 60% of the weight in the front of the trailer. This places 10% of the GTW on the tow hitch of your vehicle. Loads balanced over the wheels or heavier in the rear can cause the trailer to sway severely side to side which will cause loss of control of the vehicle and trailer. Failure to load trailers heavier in front is the cause of many trailer collisions.

Consider the following items when computing the weight on the rear axle of the vehicle:

- The tongue weight of the trailer.
- The weight of any other type of cargo or equipment put in or on your vehicle.
- The weight of the driver and all passengers.

**NOTE:**

Remember that everything put into or on the trailer adds to the load on your vehicle. Also, additional factory-installed options or dealer-installed options must be considered as part of the total load on your vehicle. Refer to the Tire And Loading Information placard for the maximum combined weight of occupants and cargo for your vehicle  
 ⇨ page 289.

**TOWING REQUIREMENTS**

To promote proper break-in of the new vehicle drivetrain components, the following guidelines are recommended.

**CAUTION!**

- Do not tow a trailer at all during the first 500 miles (805 km) the new vehicle is driven. The engine, axle or other parts could be damaged.

(Continued)

**CAUTION!**

- Then, during the first 500 miles (805 km) that a trailer is towed, do not drive over 50 mph (80 km/h) and do not make starts at full throttle. This helps the engine and other parts of the vehicle wear in at the heavier loads.

Perform the maintenance listed in Scheduled Servicing ⇨ page 256. When towing a trailer, never exceed the GAWR or GCWR ratings.

**WARNING!**

- Make certain that the load is secured in the trailer and will not shift during travel. When trailering cargo that is not fully secured, dynamic load shifts can occur that may be difficult for the driver to control. You could lose control of your vehicle and have a collision.
- When hauling cargo or towing a trailer, do not overload your vehicle or trailer. Overloading can cause a loss of control, poor performance or damage to brakes, axle, engine, transmission, steering, suspension, chassis structure or tires.

(Continued)

**WARNING!**

- Safety chains must always be used between your vehicle and trailer. Always connect the chains to the hook retainers of the vehicle hitch. Cross the chains under the trailer tongue and allow enough slack for turning corners.
- Vehicles with trailers should not be parked on a grade. When parking, apply the parking brake on the tow vehicle. Put the tow vehicle transmission in PARK (P). For four-wheel drive vehicles, make sure the transfer case is not in NEUTRAL (N). Always, block or "chock" the trailer wheels.
- GCWR must not be exceeded.
- **Total weight must be distributed between the tow vehicle and the trailer such that the following four ratings are not exceeded:**
  - GVWR
  - GTW
  - GAWR
  - Tongue weight rating for the trailer hitch utilized.

**Towing Requirements — Tires**

- Do not attempt to tow a trailer while using a compact spare tire.
- Do not drive more than 50 mph (80 km/h) when towing while using a full size spare tire.
- Proper tire inflation pressures are essential to the safe and satisfactory operation of your vehicle.
- Check the trailer tires for proper tire inflation pressures before trailer usage.
- Check for signs of tire wear or visible tire damage before towing a trailer.
- Replacing tires with a higher load carrying capacity will not increase the vehicle's GVWR and GAWR limits.
- For further information ⇨ page 285.

**Towing Requirements — Trailer Brakes**

- Do **not** interconnect the hydraulic brake system or vacuum system of your vehicle with that of the trailer. This could cause inadequate braking and possible personal injury.
- An electronically actuated trailer brake controller is required when towing a trailer with electronically actuated brakes. When towing a

trailer equipped with a hydraulic surge actuated brake system, an electronic brake controller is not required.

- Trailer brakes are recommended for trailers over 1,000 lb (453 kg) and required for trailers in excess of 2,000 lb (907 kg).

#### WARNING!

- Do not connect trailer brakes to your vehicle's hydraulic brake lines. It can overload your brake system and cause it to fail. You might not have brakes when you need them and could have an accident.
- Towing any trailer will increase your stopping distance. When towing, you should allow for additional space between your vehicle and the vehicle in front of you. Failure to do so could result in an accident.

#### CAUTION!

If the trailer weighs more than 1,000 lb (453 kg) loaded, it should have its own brakes and they should be of adequate capacity. Failure to do this could lead to accelerated brake lining wear, higher brake pedal effort, and longer stopping distances.

### Integrated Trailer Brake Module (ITBM) — If Equipped

Your vehicle may have an ITBM for electric and Electric Over Hydraulic (EOH) trailer brakes.

#### NOTE:

This module has been designed and verified with electric trailer brakes and EOH systems. Some previous EOH systems may not be compatible with ITBM.

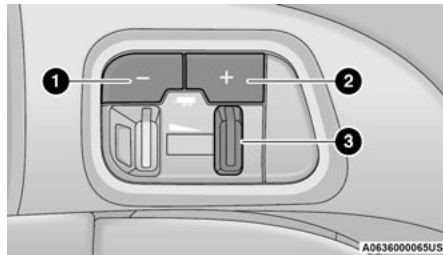

Integrated Trailer Brake Module (ITBM)

- 1 — GAIN Adjustment Button
- 2 — GAIN Adjustment Button
- 3 — Manual Brake Control Lever

The user interface consists of the following:

#### Manual Brake Control Lever

Slide the manual brake control lever to the left to activate power to the trailer's electric brakes independent of the tow vehicle's brakes. If the manual brake control lever is activated while the brake is also applied, the greater of the two inputs determines the power sent to the trailer brakes.

The trailer and the vehicle's brake lamps will come on when either vehicle braking or manual trailer brakes are applied.

#### Trailer Brake Status Indicator Light

This light indicates the trailer electrical connection status.

If no electrical connection is detected after the ignition is turned on, pushing the GAIN adjustment button or sliding the manual brake control lever will display the GAIN setting for 10 seconds and the Trailer Brake Status Indicator Light will not be displayed.

If a fault is detected in the trailer wiring or the Integrated Trailer Brake Module (ITBM), the Trailer Brake Status Indicator Light will flash.

### GAIN Adjustment Buttons (+/-)

Pushing these buttons will adjust the brake control power output to the trailer brakes in 0.5 increments. The GAIN setting can be increased to a maximum of 10 or decreased to a minimum of 0 (no trailer braking).

### GAIN

The GAIN setting is used to set the trailer brake control for the specific towing condition and should be changed as towing conditions change. Changes to towing conditions include trailer load, vehicle load, road conditions and weather.

### Adjusting GAIN

#### NOTE:

This should only be performed in a traffic free environment at speeds of approximately 20–25 mph (30–40 km/h).

1. Make sure the trailer brakes are in good working condition, functioning normally and properly adjusted. See a trailer dealer if necessary.
2. Hook up the trailer and make the electrical connections according to the trailer manufacturer's instructions.
3. When a trailer with electric/EOH brakes is plugged in, the trailer connected message should appear in the instrument cluster display (if the connection is not recognized by the ITBM, braking functions will not be

available), the GAIN setting will illuminate and the correct type of trailer must be selected from the instrument cluster display options.

4. Push the UP or DOWN button on the steering wheel until "TRAILER TOW" appears on the screen.
5. Push the RIGHT arrow on the steering wheel to enter "TRAILER TOW".
6. Push the UP or DOWN buttons until the Trailer Brake Type appears on the screen.
7. Push the RIGHT arrow and then push the UP or DOWN buttons until the proper Trailer Brake Type appears on the screen.
8. In a traffic-free environment, tow the trailer on a dry, level surface at a speed of 20–25 mph (30–40 km/h) and squeeze the manual brake control lever completely.
9. If the trailer wheels lockup (indicated by squealing tires), reduce the GAIN setting; if the trailer wheels turn freely, increase the GAIN setting.

Repeat steps 8 and 9 until the GAIN setting is at a point just below trailer wheel lockup. If towing a heavier trailer, trailer wheel lockup may not be attainable even with the maximum GAIN setting of 10.

### Display Messages

The trailer brake control interacts with the instrument cluster display. Display messages, along with a single chime, will be displayed when a malfunction is determined in the trailer connection, trailer brake control, or on the trailer  
 ⇨ page 82.

#### WARNING!

Connecting a trailer that is not compatible with the ITBM system may result in reduced or complete loss of trailer braking. There may be an increase in stopping distance or trailer instability which could result in personal injury.

#### CAUTION!

Connecting a trailer that is not compatible with the ITBM system may result in reduced or complete loss of trailer braking. There may be an increase in stopping distance or trailer instability which could result in damage to your vehicle, trailer, or other property.

**NOTE:**

- An aftermarket controller may be available for use with trailers with air or EOH trailer brake systems. To determine the type of brakes on your trailer and the availability of controllers, check with your trailer manufacturer or dealer.
- Removal of the ITBM will cause errors and it may cause damage to the electrical system and electronic modules of the vehicle. See an authorized dealer if an aftermarket module is to be installed.

**Towing Requirements – Trailer Lights And Wiring**

Whenever pulling a trailer, regardless of the trailer size, stoplights and turn signals on the trailer are required for motoring safety.

The Trailer Tow Package may include a four- and seven-pin wiring harness. Use a factory approved trailer harness and connector.

**NOTE:**

Do not cut or splice wiring into the vehicle's wiring harness.

The electrical connections are all complete to the vehicle but you must mate the harness to a trailer connector. Refer to the following illustrations.

**NOTE:**

- Disconnect trailer wiring connector from the vehicle before launching a boat (or any other device plugged into vehicle's electrical connect) into water.
- Be sure to reconnect once clear from water area.

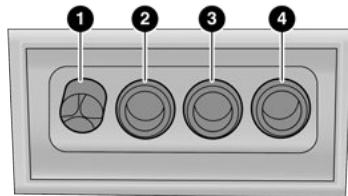
**Four-Pin Connector**

M0636000043US

- 1 – Ground
- 2 – Park
- 3 – Left Stop/Turn
- 4 – Right Stop/Turn

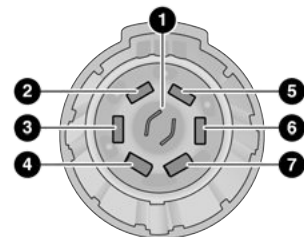
**Seven-Pin Connector**

A0636000085US

- 1 – Backup Lamps
- 2 – Running Lamps
- 3 – Left Stop/Turn
- 4 – Ground
- 5 – Battery
- 6 – Right Stop/Turn
- 7 – Electric Brakes

**TOWING TIPS**

Before towing, practice turning, stopping, and backing up the trailer in an area located away from heavy traffic.



## Automatic Transmission

Select the DRIVE (D) range when towing. The transmission controls include a drive strategy to avoid frequent shifting when towing. However, if frequent shifting does occur while in DRIVE, you can use the AutoStick shift control to manually select a lower gear.

If equipped with Tow N Go, it is recommended to place the vehicle in tow mode by pushing the TOW button.

### NOTE:

Using a lower gear while operating the vehicle under heavy loading conditions, will improve

performance and extend transmission life by reducing excessive shifting and heat buildup. This action will also provide better engine braking.

### AutoStick

- When using the AutoStick shift control, select the highest gear that allows for adequate performance and avoids frequent downshifts. For example, choose “5” if the desired speed can be maintained. Choose “4” or “3” if needed to maintain the desired speed.
- To prevent excess heat generation, avoid continuous driving at high RPM. Reduce vehicle speed as necessary to avoid extended driving at

high RPM. Return to a higher gear or vehicle speed when grade and road conditions allow.

### Cruise Control — If Equipped

- Do not use on hilly terrain or with heavy loads.
- When using the Cruise Control, if you experience speed drops greater than 10 mph (16 km/h), disengage until you can get back to cruising speed.
- Use Cruise Control in flat terrain and with light loads to maximize fuel efficiency.

## RECREATIONAL TOWING (BEHIND MOTORHOME)

### TOWING THIS VEHICLE BEHIND ANOTHER VEHICLE

Towing Condition	Wheels OFF The Ground	Rear-Wheel Drive Models	All-Wheel Drive Models With Single-Speed Transfer Case	All-Wheel Drive Models With Two-Speed Transfer Case
Flat Tow	NONE	<b>NOT ALLOWED</b>	<b>NOT ALLOWED</b>	<ul style="list-style-type: none"> <li>● See Instructions:</li> <li>● Transmission In PARK</li> <li>● Transfer Case In N (Neutral)</li> <li>● Tow In Forward Direction</li> </ul>
Dolly Tow	Front	<b>NOT ALLOWED</b>	<b>NOT ALLOWED</b>	<b>NOT ALLOWED</b>
	Rear	OK	<b>NOT ALLOWED</b>	<b>NOT ALLOWED</b>
On Trailer	ALL	OK	OK	OK

**NOTE:**

- When towing your vehicle, always follow applicable state and provincial laws. Contact state and provincial Highway Safety offices for additional details.
- A flat tow electric power steering enable kit is available for increased flat tow performance, contact an authorized dealer for further details.

## RECREATIONAL TOWING — REAR-WHEEL DRIVE MODELS

**DO NOT flat tow this vehicle. Damage to the drivetrain will result.**

Recreational towing (for two-wheel drive models) is allowed **ONLY** if the rear wheels are **OFF** the ground. This may be accomplished using a tow dolly or vehicle trailer. If using a tow dolly, follow this procedure:

1. Properly secure the dolly to the tow vehicle, following the dolly manufacturer's instructions.
2. Drive the rear wheels onto the tow dolly.
3. Firmly apply the parking brake. Shift the transmission into PARK.
4. Turn the ignition OFF.
5. Properly secure the rear wheels to the dolly, following the dolly manufacturer's instructions.

6. Install a suitable clamping device, designed for towing, to secure the front wheels in the straight position.

CAUTION!
Towing with the rear wheels on the ground will cause severe transmission damage. Damage from improper towing is not covered under the New Vehicle Limited Warranty.

## RECREATIONAL TOWING — ALL-WHEEL DRIVE MODELS (SINGLE-SPEED TRANSFER CASE)

**Recreational towing is not allowed.** These models do not have a N (Neutral) position in the transfer case.

**NOTE:**

This vehicle may be towed on a flatbed or vehicle trailer provided all four wheels are **OFF** the ground.

CAUTION!
Towing this vehicle in violation of the above requirements can cause severe transmission and/or transfer case damage. Damage from improper towing is not covered under the New Vehicle Limited Warranty.

## RECREATIONAL TOWING — ALL-WHEEL DRIVE MODELS (TWO-SPEED TRANSFER CASE)

The transfer case must be shifted into N (Neutral) and the transmission must be in PARK for recreational towing. The N (Neutral) selection button is adjacent to the transfer case selector switch. Shifts into and out of transfer case N (Neutral) can take place with the selector switch in any position. There is a Mopar® Flat Tow Harness kit available to enable the Electronic Power Steering (EPS) while flat towing the vehicle, to provide more front axle stability. See an authorized dealer for more information and installation.

**NOTE:**

If the Mopar® Flat Tow Harness kit is installed, the EPS will use power from the battery to keep the EPS powered during a flat tow. A battery charging system is recommended so that the battery is not depleted over a long trip.

CAUTION!
<ul style="list-style-type: none"> <li>• DO NOT dolly tow any AWD vehicle. Towing with only one set of wheels on the ground (front or rear) will cause severe transmission and/or transfer case damage. Tow with all four wheels either ON the ground, or OFF the ground (using a vehicle trailer).</li> </ul>



*(Continued)*

**CAUTION!**

- Tow only in the forward direction. Towing this vehicle backwards can cause severe damage to the transfer case.
- The transmission must be in PARK for recreational towing.
- Before recreational towing, be certain that the transfer case is fully in N (Neutral)
  - page 149. Otherwise, internal damage will result.
- Towing this vehicle in violation of the above requirements can cause severe transmission and/or transfer case damage. Damage from improper towing is not covered under the New Vehicle Limited Warranty.
- Do not use a bumper-mounted clamp-on tow bar on your vehicle. The bumper face bar will be damaged.

**Shifting Into N (Neutral)****WARNING!**

You or others could be injured or killed if you leave the vehicle unattended with the transfer case in the N (Neutral) position without first fully engaging the parking brake. The transfer case N (Neutral) position disengages both the front and rear driveshafts from the powertrain and will allow the vehicle to roll, even if the transmission is in PARK. The parking brake should always be applied when the driver is not in the vehicle.

Use the following procedure to prepare your vehicle for recreational towing.

**CAUTION!**

It is necessary to follow these steps to be certain that the transfer case is fully in N (Neutral) before recreational towing to prevent damage to internal parts.

1. Bring the vehicle to a complete stop on level ground, with the engine running.
2. Press and hold the brake pedal.
3. Shift the transmission into NEUTRAL.

**NOTE:**

- Steps 1 through 3 are requirements that must be met before pushing the N (Neutral) button, and must continue to be met until the shift has been completed. If any of these requirements are not met before pushing the N (Neutral) button or are no longer met during the shift, the N (Neutral) indicator light will flash continuously until all requirements are met or until the N (Neutral) button is released.
- The ignition must be in the ON/RUN mode for a shift to take place and for the position indicator lights to be operable. If the ignition is not in the ON/RUN mode, the shift will not take place and no position indicator lights will be on or flashing.
- A flashing N (Neutral) position indicator light indicates that shift requirements have not been met.

- Using a ballpoint pen or similar object, push and hold the recessed transfer case N (Neutral) button (located by the selector switch) for four seconds. The light behind the N symbol will blink, indicating shift in progress. The light will stop blinking (stay on solid) when the shift to N (Neutral) is complete. A “FOUR WHEEL DRIVE SYSTEM IN NEUTRAL” message will appear in the instrument cluster.

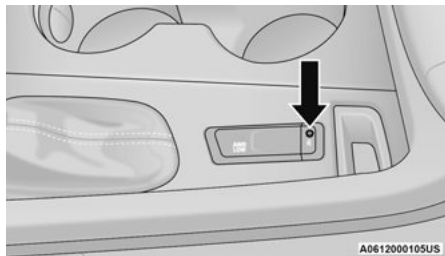

**N (Neutral) Button**

- After the shift is completed and the N (Neutral) light stays on, release the N (Neutral) button.
- Shift the transmission into REVERSE or DRIVE.
- Release the brake pedal for five seconds and ensure that there is no vehicle movement.
- Press and hold the brake pedal. Shift the transmission back into NEUTRAL.
- Firmly apply the parking brake.

- With the transmission and transfer case in NEUTRAL, push and hold the ENGINE START/STOP button until the engine turns off.
- Place the transmission gear selector in PARK. Release the brake pedal.
- Push the ENGINE START/STOP button twice (without pressing the brake pedal) to turn the ignition to the OFF mode.

#### CAUTION!

Damage to the transmission may occur if the transmission is shifted into PARK with the transfer case in N (Neutral) and the engine running. With the transfer case in N (Neutral) ensure that the engine is OFF before shifting the transmission into PARK.

- Attach the vehicle to the tow vehicle using a suitable tow bar.
- Release the parking brake.

#### Shifting Out Of N (Neutral)

Use the following procedure to prepare your vehicle for normal usage.

- Bring the vehicle to a complete stop, leaving it connected to the tow vehicle.
- Firmly apply the parking brake.

- Start the engine.
- Press and hold the brake pedal.
- Shift the transmission into NEUTRAL.

#### NOTE:

- Steps 1 through 5 are requirements that must be met before pushing the N (Neutral) button, and must continue to be met until the shift has been completed. If any of these requirements are not met before pushing the N (Neutral) button or are no longer met during the shift, the N (Neutral) indicator light will flash continuously until all requirements are met or until the N (Neutral) button is released.
- The ignition must be in the ON/RUN mode for a shift to take place and for the position indicator lights to be operable. If the ignition is not in the ON/RUN mode, the shift will not take place and no position indicator lights will be on or flashing.
- A flashing N (Neutral) position indicator light indicates that shift requirements have not been met.

- Using a ballpoint pen or similar object, push and hold the recessed transfer case N (Neutral) button (located by the selector switch) for one second.

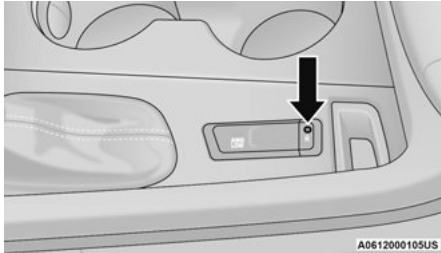

**N (Neutral) Button**

- When the N (Neutral) indicator light turns off, release the N (Neutral) button.
- After the N (Neutral) button has been released, the transfer case will shift to the position indicated by the selector switch.
- Shift the transmission into PARK and turn the engine off.**
  - Release the brake pedal.
  - Disconnect vehicle from the tow vehicle.
  - Start the engine.
  - Press and hold the brake pedal.
  - Release the parking brake.
- Shift the transmission into REVERSE or DRIVE, release the brake pedal, and check that the vehicle operates normally.

## DRIVING TIPS

### ON-ROAD DRIVING TIPS

Utility vehicles have higher ground clearance and a narrower track to make them capable of performing in a wide variety of off-road applications. Specific design characteristics give them a higher center of gravity than conventional passenger cars.

An advantage of the higher ground clearance is a better view of the road, allowing you to anticipate problems. They are not designed for cornering at the same speeds as conventional passenger cars any more than sports cars are designed to perform satisfactorily in off-road conditions. Avoid sharp turns or abrupt maneuvers. As with other vehicles of this type, failure to operate this vehicle correctly may result in loss of control or vehicle rollover.

### OFF-ROAD DRIVING TIPS

#### When To Use 4WD Low — If Equipped

When off-road driving, shift to 4WD Low for additional traction. This range should be limited to extreme situations such as deep snow, mud, or sand where additional low speed pulling power is

needed. Vehicle speeds in excess of 25 mph (40 km/h) should be avoided when in 4WD Low.

#### WARNING!

Do not drive in 4WD Low on dry pavement; driveline damage may result. 4WD Low locks front and rear drivelines together and does not allow for differential action between the front to rear driveshafts. Driving in 4WD Low on pavement will cause driveline binding; use only on wet or slippery surfaces.

4

### Driving Through Water

Although your vehicle is capable of driving through water, there are a number of precautions that must be considered before entering the water.

#### CAUTION!

When driving through water, do not exceed 5 mph (8 km/h). Always check water depth before entering as a precaution, and check all fluids afterward. Driving through water may cause damage not covered by the New Vehicle Limited Warranty.

Driving through water more than a few inches/centimeters deep will require extra caution to ensure safety and prevent damage to your vehicle. If you must drive through water, try to determine

the depth and the bottom condition (and location of any obstacles) prior to entering. Proceed with caution and maintain a steady controlled speed less than 5 mph (8 km/h) in deep water to minimize wave effects.

### Flowing Water

If the water is swift flowing and rising (as in storm run-off), avoid crossing until the water level recedes and/or the flow rate is reduced. If you must cross flowing water avoid depths in excess of 9 inches (23 cm). The flowing water can erode the streambed, causing your vehicle to sink into deeper water. Determine exit point(s) that are downstream of your entry point to allow for drifting.

### Standing Water

Avoid driving in standing water deeper than 20 inches (51 cm), and reduce speed appropriately to minimize wave effects. Maximum speed in 20 inches (51 cm) of water is less than 5 mph (8 km/h).

### Maintenance

After driving through deep water, inspect your vehicle fluids and lubricants (engine oil, transmission oil, axle, transfer case) to ensure the fluids have not been contaminated. Contaminated fluid (milky, foamy in appearance) should be flushed/changed as soon as possible to prevent component damage.

## Driving In Snow, Mud And Sand

In heavy snow, when pulling a load, or for additional control at slower speeds, shift the transmission to a low gear and shift the transfer case to AWD Low if necessary ↻ page 110. Only shift into a lower gear to maintain forward motion. Over-rewving the engine can spin the wheels and traction will be lost.

Avoid abrupt downshifts on icy or slippery roads, because engine braking may cause skidding and loss of control.

### Hill Climbing

#### NOTE:

Before attempting to climb a hill, determine the conditions at the crest and/or on the other side.

Before climbing a steep hill, shift the transmission to a lower gear and shift the transfer case to AWD Low. Use FIRST gear and AWD Low for very steep hills.

If you stall or begin to lose forward motion while climbing a steep hill, allow your vehicle to come to a stop and immediately apply the brakes. Restart the engine, and shift into REVERSE. Back slowly down the hill, allowing the compression braking of the engine to help regulate the speed. If the brakes are required to control vehicle speed, apply them lightly and avoid locking or skidding the tires.

### WARNING!

If the engine stalls, you lose forward motion, or cannot make it to the top of a steep hill or grade, never attempt to turn around. To do so may result in tipping and rolling the vehicle. Always back carefully straight down a hill in REVERSE gear. Never back down a hill in NEUTRAL using only the brake.

**Remember, never drive diagonally across a hill; always drive straight up or down.**

If the wheels start to slip as you approach the crest of a hill, ease off the accelerator and maintain forward motion by turning the front wheels slowly. This may provide a fresh "bite" into the surface and will usually provide traction to complete the climb.

### Traction Downhill

Shift the transmission into a low gear, and the transfer case into AWD Low. Let the vehicle go slowly down the hill with all four wheels turning against engine compression drag. This will permit you to control the vehicle speed and direction.

When descending mountains or hills, repeated braking can cause brake fade with loss of braking control. Avoid repeated heavy braking by downshifting the transmission whenever possible.

## After Driving Off-Road

Off-road operation puts more stress on your vehicle than does most on-road driving. After going off-road, it is always a good idea to check for damage. That way you can get any problems taken care of right away and have your vehicle ready when you need it.

- Completely inspect the underbody of your vehicle. Check tires, body structure, steering, suspension, and exhaust system for damage.
- Inspect the radiator for mud and debris and clean as required.
- Check threaded fasteners for looseness, particularly on the chassis, drivetrain components, steering, and suspension. Retighten them, if required, and torque to the values specified in the Service Manual.
- Check for accumulations of plants or brush. These things could be a fire hazard. They might hide damage to fuel lines, brake hoses, axle pinion seals, and propeller shafts.
- After extended operation in mud, sand, water, or similar dirty conditions, have the radiator, fan, brake rotors, wheels, brake linings, and axle yokes inspected and cleaned as soon as possible.

### WARNING!

Abrasive material in any part of the brakes may cause excessive wear or unpredictable braking. You might not have full braking power when you need it to prevent a collision. If you have been operating your vehicle in dirty conditions, get your brakes checked and cleaned as necessary.

- If you experience unusual vibration after driving in mud, slush or similar conditions, check the wheels for impacted material. Impacted material can cause a wheel imbalance and freeing the wheels of it will correct the situation.

# MULTIMEDIA

## UCONNECT SYSTEMS

For detailed information about your Uconnect 4 With 8.4-inch Display or Uconnect 5 NAV With 10.1-inch Display systems, refer to your Uconnect Owner's Manual Supplement.

### NOTE:

Uconnect screen images are for illustration purposes only and may not reflect exact software for your vehicle.

## CYBERSECURITY

Your vehicle may be a connected vehicle and may be equipped with both wired and wireless networks. These networks allow your vehicle to send and receive information. This information allows systems and features in your vehicle to function properly.

Your vehicle may be equipped with certain security features to reduce the risk of unauthorized and unlawful access to vehicle systems and wireless communications. Vehicle software technology continues to evolve over time and FCA US LLC, working with its suppliers, evaluates and takes appropriate steps as needed. Similar to a computer or other devices, your vehicle may require software updates to improve the usability

and performance of your systems or to reduce the potential risk of unauthorized and unlawful access to your vehicle systems.

The risk of unauthorized and unlawful access to your vehicle systems may still exist, even if the most recent version of vehicle software (such as Uconnect software) is installed.

### WARNING!

- It is not possible to know or to predict all of the possible outcomes if your vehicle's systems are breached. It may be possible that vehicle systems, including safety related systems, could be impaired or a loss of vehicle control could occur that may result in an accident involving serious injury or death.
- ONLY insert trusted devices/components into your vehicle. Media of unknown origin could possibly contain malicious software, and if installed in your vehicle, it may increase the possibility for vehicle systems to be breached.
- As always, if you experience unusual vehicle behavior, take your vehicle to your nearest authorized dealer immediately.

### NOTE:

- FCA US LLC or your dealer may contact you directly regarding software updates.
- To help further improve vehicle security and minimize the potential risk of a security breach, vehicle owners should:
  - Routinely check [www.driveuconnect.com](http://www.driveuconnect.com) (US Residents) or [www.driveuconnect.ca](http://www.driveuconnect.ca) (Canadian Residents) to learn about available Uconnect software updates.
  - Only connect and use trusted media devices (e.g. personal mobile phones, USBs, CDs).

Privacy of any wireless and wired communications cannot be assured. Third parties may unlawfully intercept information and private communications without your consent. For further information, refer to "Data Collection & Privacy" in your Uconnect Owner's Manual Supplement or "Onboard Diagnostic System (OBD II) Cybersecurity" [↗](#) page 97.



## UCONNECT SETTINGS

The Uconnect system uses a combination of buttons on the touchscreen and buttons on the faceplate located on the center of the instrument panel. These buttons allow you to access and change the customer programmable features. Many features can vary by vehicle.

Buttons on the faceplate are located below and/or beside the Uconnect system in the center of the instrument panel. In addition, there is a Scroll/Enter control knob located on the right side. Turn the control knob to scroll through menus and change settings. Push the center of the control knob one or more times to select or change a setting.

Your Uconnect system may also have Screen Off and Mute buttons on the faceplate.

Push the Screen Off button on the faceplate to turn off the Uconnect screen. Push the button again or tap the screen to turn the screen on.

Press the Back Arrow button to exit out of a Menu or certain option on the Uconnect system.

On the Uconnect 5/5 NAV With 10.1-inch Display, push and hold the Power button on the radio's faceplate for a minimum of 15 seconds to reset the radio.

## CUSTOMER PROGRAMMABLE FEATURES

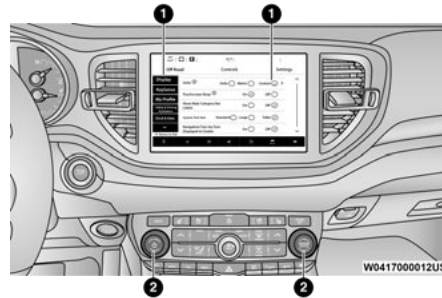

**Uconnect 5/5 NAV With 10.1-inch Display Buttons On Faceplate And Buttons On Touchscreen**

1 — Uconnect Buttons On The Touchscreen

2 — Uconnect Buttons On The Faceplate

### For the Uconnect 4 With 8.4-inch Display

Press the Apps  button, then press the Settings button on the touchscreen to display the menu settings screen. In this mode, the Uconnect system allows you to access all of the available programmable features.

#### NOTE:

- Only one touchscreen area may be selected at a time.
- Depending on the vehicle's options, feature settings may vary.

When making a selection, press the button on the touchscreen to enter the desired menu. Once in the desired menu, press and release the preferred setting option until a check mark appears next to the setting, showing that setting has been selected. Once the setting is complete, either press the Back Arrow button on the touchscreen to return to the previous menu, or press the X button on the touchscreen to close out of the settings screen. Pressing the Up or Down Arrow button on the right side of the screen will allow you to toggle up or down through the available settings.

### For the Uconnect 5 NAV With 10.1-inch Display

Press the Vehicle button, then press the Settings tab on the top of the touchscreen. In this menu, the Uconnect system allows you to access all of the available programmable features.

**NOTE:**

- Only one touchscreen area may be selected at a time.
- Depending on the vehicle's options, feature settings may vary.

When making a selection, press the button on the touchscreen to enter the desired menu. Once in the desired menu, press and release the preferred setting option until a check mark appears next to the setting, showing that setting has been selected. Once the setting is complete, press the Vehicle button to exit to the screen. Pressing the Up or Down Arrow button on the right side of the screen will allow you to toggle up or down through the available settings.

### Language

When the Language button is pressed on the touchscreen, the system displays the different language options. Once an option is selected, the system will display in the chosen language. The available setting is:

**NOTE:**

Depending on the vehicle's options, feature settings may vary.

Setting Name	Description
Language	This setting will change the language of the Uconnect system. The available languages are English, Español, and Français.

## Display

When the Display button is pressed on the touchscreen, the system will display the options related to the theme (if equipped), brightness, and color of the touchscreen. The available settings are:

### NOTE:

Depending on the vehicle's options, feature settings may vary.

Setting Name	Description
Language	This setting will change the language of the Uconnect system. The available languages are English, Français, and Español.
Display Mode	This setting will allow you to set the brightness manually or have the system set it automatically. The "Auto" setting has the system automatically adjust the display brightness. The "Manual" setting will allow the user to adjust the brightness of the display.
Display Brightness With Headlights ON/Brightness	This setting will allow you to set the brightness when the headlights are on. To access this setting, Display Mode must be set to "Manual". The "+" setting will increase the brightness; the "-" will decrease the brightness.
Display Brightness With Headlights OFF/Brightness	This setting will allow you to set the brightness when the headlights are off. To access this setting, Display Mode must be set to "Manual". The "+" setting will increase the brightness; the "-" will decrease the brightness.
Units	This setting changes the "Speed" (MPH or km/h), "Distance" (mi or km), "Fuel Consumption" (MPG [US], MPG [UK], L/100 km, or km/L), "Pressure" (psi, kPa, or bar), "Temperature" (°C or °F), "Power" (SRT only) (HP [US], HP [UK], or kW), and "Torque" (SRT only) (lb-ft or Nm) units of measurement independently.
Set Theme	This setting will allow you to change the display theme.

Setting Name	Description
Keyboard	This setting will change the keyboard type on the display. The selectable keyboards are “ABCDEF” Keyboard, “QWERTY” Keyboard, and “AZERTY” Keyboard.
Touchscreen Beep	This setting will allow you to turn the touchscreen beep on or off.
Show Main Category Bar Labels	This setting will allow the main category bar labels to be shown on or off.
Navigation Next Turn Pop-Ups Displayed in Cluster	This setting will display navigation prompts in the Instrument Cluster Display.
Phone Pop-Ups Displayed In Cluster	This setting will display smartphone notifications and messages in the Instrument Cluster Display.
Ready To Drive Pop-Ups	This setting will enable the Ready To Drive Pop-Ups in the Instrument Cluster Display.

## Units

When the Units button is pressed on the touchscreen, the system displays the different measurement options. The selected unit of measurement will display in the instrument cluster display and Navigation system (if equipped). The available settings are:

### NOTE:

Depending on the vehicle’s options, feature settings may vary.

Setting Name	Description
US	This setting will change the unit of measurement on the display to US.
Metric	This setting will change the unit of measurement on the display to Metric.
Custom	This setting changes the “Speed” (MPH or km/h), “Distance” (mi or km), “Fuel Consumption” (MPG [US], MPG [UK], L/100 km, or km/L), “Pressure” (psi, kPa, or bar), and “Temperature” (°C or °F) units of measurement independently.

## My Profile

When the My Profile button is pressed on the touchscreen, the system displays options related to the vehicle's profiles.

### NOTE:

Depending on the vehicle's options, feature settings may vary.

Setting Name	Description
Language	This setting will change the language of the Uconnect system. The available languages are English, Français, and Español. This setting will change the language of the Uconnect system. The available languages are Brasileiro, Deutsch, English, Español, Français, Italiano, Polski, Dutch, Português, Türk, and Arabic.
Display Mode	This setting will adjust the display for the radio to "Auto" or "Manual". "Manual" allows for more customization with the radio display.
Display Brightness Headlights On	This setting will allow you to set the brightness when the headlights are on. To access this setting, Display Mode must be set to "Manual". The "+" setting will increase the brightness; the "-" will decrease the brightness.
Display Brightness Headlights Off	This setting will allow you to set the brightness when the headlights are off. To access this setting, Display Mode must be set to "Manual". The "+" setting will increase the brightness; the "-" will decrease the brightness.
Set Theme	This setting will allow you to change the display theme.
Touchscreen Beep	This setting will allow you to turn the touchscreen beep on or off.
Show Main Category Bar Labels	This setting will allow the main category bar labels to be shown on or off.
Units	This setting will allow you to change the unit display. The available options are "Speed" (MPH or km/h), "Distance" (mi or km), "Fuel Consumption" (MPG [US], MPG [UK], L/100 km, or km/L), "Pressure" (psi, kPa, or bar), and "Temperature" (°C or °F) units of measurement independently.

Setting Name	Description
<b>Navigation Next Turn Pop-Ups Displayed in Cluster</b>	This setting will display navigation prompts in the Instrument Cluster Display.
<b>Ready To Drive Pop-Ups</b>	This setting will enable the Ready To Drive Pop-Ups in the Instrument Cluster Display.
<b>Phone Pop-Ups Displayed In Cluster</b>	This setting will display smartphone notifications and messages in the Instrument Cluster Display.
<b>Time Format</b>	This setting will allow you to set the time format (AM/PM). Sync Time With GPS must be "Off" for this setting to be available. The "12 hrs" setting will set the time to a 12-hour format. The "24 hrs" setting will set the time to a 24-hour format.
<b>Voice Options</b>	This setting will allow you to change the voice options for the radio to "Male" or "Female".
<b>Wake Up Word</b>	This setting will change the system's "Wake Up" word. The available options are "Hey Uconnect" and "Hey Dodge".
<b>Voice Barge-in</b>	This setting will allow voice barge-in to be turned on and off.
<b>Show Command List</b>	This setting will allow the Command List to be shown on and off.
<b>Key Off Power Delay</b>	This setting will keep certain electrical features running after the engine is turned off. When any door is opened, the electronics will deactivate. The available settings are "0 sec", "45 sec", "5 min", and "10 min".
<b>App Drawer Favoriting Pop-Ups</b>	This setting will allow you to favorite app drawer pop-ups with "On" and "Off" options.
<b>App Drawer Unfavoritings Pop-Ups</b>	This setting will allow you to unfavorite app drawer pop-ups with "On" and "Off" options.
<b>New Text Message Pop-Ups</b>	This setting will allow you to have pop-up notifications for new text messages. This setting options are "On" and "Off".

Setting Name	Description
<b>Missed Calls Message</b>	This setting will allow you to have pop-up notifications for missed calls. This setting options are “On” and “Off”.
<b>Personal Settings Linked to Key Fob</b>	This setting will recall preset radio stations and driver seat position that have been linked to the key fob.
<b>Navigation Pop-Ups</b>	This setting will allow you to have pop-up notifications for Navigation. This setting options are “On” and “Off”.
<b>Navigation</b>	This setting will direct you to the Navigation settings within Navigation Mode.
<b>Auto-On Driver Heated/Ventilated Seat &amp; Heated Steering Wheel With Vehicle Start</b>	This setting will activate the vehicle’s comfort systems and heated seats or heated steering wheel when the vehicle is remote started or ignition is started. The “Off” setting will not activate the comfort systems. The “Remote Start” setting will only activate the comfort systems when using Remote Start. The “All Start” setting will activate the comfort systems whenever the vehicle is started.
<b>Audio Settings</b>	This setting will take you to the Audio settings for the vehicle profiles.
<b>Reset App Drawer to Default Order</b>	This setting will reset the app drawer to its factory default layout.
<b>Restore Settings to Default</b>	This setting will return all the previously changed settings to their factory default.
<b>More Profile Options</b>	This setting will give access to more profile options.

## Safety & Driving Assistance

After pressing the Safety & Driving Assistance button on the touchscreen, the following settings will be available:

### NOTE:

Depending on the vehicle's options, feature settings may vary.

Setting Name	Description
<b>Automatic Emergency Braking</b>	This setting will take you to the selectable options for "Forward Collision Warning (FCW)" and "Forward Collision Warning Sensitivity".
<b>Forward Collision Warning</b>	This setting will turn the Forward Collision system on or off. The "Off" setting will deactivate the FCW system. The "Warning Only" setting will provide only an audible chime when a collision is detected. The "Warning + Active Braking" setting will provide an audible chime and apply some brake pressure when a collision is detected.
<b>Forward Collision Warning Sensitivity</b>	This setting will change the distance at which the Forward Collision Warning alert sounds. The "Medium" setting will have the FCW system signal when an object is in view, and the possibility of a collision is detected. The "Near" setting will have the FCW system signal when the object is closer to the vehicle. The "Far" setting will have the FCW system signal when an object is at a far distance from the vehicle.
<b>Active Lane Management</b>	This setting will change the distance at which the steering wheel will provide lane departure feedback. The available settings are "Early", "Medium", and "Late".
<b>Active Lane Management</b>	This setting will change the strength of the steering wheel feedback during a lane departure. The available settings are "Low", "Medium", and "High".
<b>ParkSense</b>	This setting will change the type of ParkSense alert when a close object is detected and provide both an audible chime and a visual display.



Setting Name	Description
<b>Front ParkSense Volume</b>	This setting adjusts the volume of the Front ParkSense system. The available settings are “Low”, “Medium”, and “High”.
<b>Rear ParkSense Volume</b>	This setting adjusts the volume of the Rear ParkSense system. The available settings are “Low”, “Medium”, and “High”.
<b>Rear ParkSense Braking Assist</b>	This setting will turn the Rear ParkSense Braking Assist on or off.
<b>Blind Spot Alert</b>	This setting will change the type of alert provided when an object is detected in a vehicle’s blind spot. The “Off” setting will turn off Blind Spot Alert. The “Lights” setting will activate the Blind Spot Alert lights on the outside mirrors. The “Lights & Chime” setting will activate both the lights on the outside mirrors and an audible chime.
<b>Electric Power Steering</b>	This setting will change the Electric Power setting to “Normal”, “Sport”, or “Comfort”.
<b>ParkView Backup Camera Delay</b>	This setting will add a timed delay to the ParkView Backup Camera when shifting out of REVERSE.
<b>ParkView Backup Camera Active Guidelines</b>	This setting will turn the ParkView Backup Camera Active Guidelines on or off.
<b>Hill Start Assist</b>	This setting will turn the Hill Start Assist system on or off.

## Clock/Clock & Date

When the Clock/Clock & Date button is pressed on the touchscreen, the system displays the different options related to the vehicle's internal clock.

### NOTE:

Depending on the vehicle's options, feature settings may vary.

Setting Name	Description
Sync Time With GPS	This setting will sync the time to the GPS receiver in the system. The system will control the time via the GPS location.
Set Time Hours	This setting will allow you to set the hours. Sync Time With GPS must be off for this setting to be available. The "+" setting will increase the hours. The "-" setting will decrease the hours.
Set Time Minutes	This setting will allow you to set the minutes. Sync Time With GPS must be off for this setting to be available. The "+" setting will increase the minutes. The "-" setting will decrease the minutes.
Time Format	This setting will allow you to set the time format (AM/PM). Sync Time With GPS must be off for this setting to be available. The "12 hrs" setting will set the time to a 12-hour format. The "24 hrs" setting will set the time to a 24-hour format.
Set Time	This setting will allow you to set the hours and minutes. Sync Time With GPS must be off for this setting to be available. The "+" setting will increase the hours and minutes. The "-" setting will decrease the hours and minutes.
Set Date	This setting will allow you to set the date. Sync Time With GPS must be off for this setting to be available.

## Phone/Bluetooth®

When the Phone/Bluetooth® button is pressed on the touchscreen, the system displays the options related to Bluetooth® connectivity from an external audio device or smartphone. The list of paired audio devices or smartphones can be accessed from this menu.

### NOTE:

Depending on the vehicle's options, feature settings may vary.

Setting Name	Description
Phone Pop-Ups Displayed In Cluster	This setting will activate phone message pop-ups in the Instrument Cluster Display.
Do Not Disturb	This setting will open the "Do Not Disturb" settings menu. The settings are "Auto Reply" (both, text, call), "Auto Reply Message" (custom, default), and "Custom Auto Reply Message" (create message).
Device Manager	This setting will open the Device Manager main screen.
Do Not Disturb All	This setting will open the "Do Not Disturb All" settings menu. The available options are "On" and "Off".
Paired Phones	This setting will show the list of paired phones.
Paired Audio Sources	This setting will show the list of paired audio sources.
Enable Two Active Phones	This setting will enable or disable two active phones with the vehicle. The setting options are "On" and "Off".
Paired Phones And Audio Devices	This setting will show the list of paired phones and audio devices.

## Voice

When the Voice button is pressed on the touchscreen, the system displays the options related to the vehicle's Voice Recognition feature.

### NOTE:

Depending on the vehicle's options, feature settings may vary.

Setting Name	Description
Voice Options	This setting will change the voice type during a Voice Recognition session. The available options are "Male" and "Female".
Voice Response Length	This setting will change the response length for the Voice Recognition system. The "Brief" setting provides a shortened audio description from the system. The "Detailed" setting provides the full audio description from the system.
Show Command List	This setting will allow you to turn the Command List on or off. The "Always" setting will always show the Command List. The "With Help" setting will show the Command List and provide a brief description of what the command does. The "Never" setting will turn the Command List off.
Wake Up Word	This setting will change the system's "Wake Up" word. The available options are "Hey Uconnect" and "Hey Dodge".
Voice Barge-in	This setting will turn the Voice Barge-in function on or off.

## Navigation

When the Navigation button is pressed on the touchscreen, the system displays options related to the vehicle's built-in Navigation system. These settings can change which icons display on the map, how "time to arrival is calculated", and route types.

For more information on Navigation and settings, refer to your Uconnect Owner's Manual Supplement.

### NOTE:

Depending on the vehicle's options, feature settings may vary.

## Trailer

When the Trailer button is pressed on the touchscreen, the system will display settings related to trailer towing.

### NOTE:

Depending on the vehicle's options, feature settings may vary.

Setting Name	Description
Trailer Select	Select from "Trailer 1", "Trailer 2", "Trailer 3", and "Trailer 4". These trailer designations can be used to save different trailer settings.
Trailer Brake Type	This setting will set the system to a specific trailer type. The available options are "Light Electric", "Heavy Electric", "Light Electric-Over-Hydraulic", and "Heavy Electric-Over-Hydraulic".
Trailer Name	This setting will personalize the trailer name depending on the type of trailer you are hauling. Select the trailer name from the following list: trailer, boat, car, cargo, equipment, flatbed, horse, livestock, motorcycle, snowmobile, travel, and utility.

## Camera

When the Camera button is pressed on the touchscreen, the system displays the options related to the vehicle's camera features.

### NOTE:

Depending on the vehicle's options, feature settings may vary.

Setting Name	Description
<b>ParkView Backup Camera Delay</b>	This setting will add a timed delay to the ParkView Backup Camera when shifting out of REVERSE.
<b>ParkView Backup Camera Active Guidelines</b>	This setting will turn the ParkView Backup Camera Active Guidelines on or off.

## Mirrors & Wipers

When the Mirrors & Wipers button is pressed on the touchscreen, the system displays the options related to the vehicle's mirrors and wipers.

### NOTE:

Depending on the vehicle's options, feature settings may vary.

Setting Name	Description
<b>Tilt Side Mirrors In Reverse</b>	This setting will tilt the outside side-view mirrors when the ignition is in the ON/RUN position and the transmission gear selector is in the REVERSE position. The mirrors will move back to their previous position when the transmission is shifted out of REVERSE. The available settings are "On" and "Off".
<b>Rain Sensing Auto Wipers</b>	This setting will turn the Rain Sensing Auto Wipers on or off.
<b>Headlights With Wipers</b>	This setting will turn the headlights on when the wipers are activated.

## Lights

When the Lights button is pressed on the touchscreen, the system displays the options related to the vehicle's exterior and interior lights.

### NOTE:

- When the "Daytime Running Lights" feature is selected, the daytime running lights can be turned on or off. This feature is only allowed by law in the country of the vehicle purchased.
- Depending on the vehicle's options, feature settings may vary.

Setting Name	Description
Headlight Off Delay	This setting will allow you to set the amount of time it takes for the headlights to shut off after the vehicle is turned off. The available settings are "0 sec", "30 sec", "60 sec", and "90 sec".
Headlight Illumination On Approach	This setting will allow you to set the amount of time it takes for the headlights to shut off after the vehicle is unlocked. The available settings are "0 sec", "30 sec", "60 sec", and "90 sec".
Headlights with Wipers	This setting will turn the headlights on when the wipers are activated.
Auto Dim High Beams	This setting will allow you to turn the Auto Dim High Beams on or off.
Daytime Running Lights	This setting will allow you to turn the Daytime Running Lights on or off.
Flash Lights With Lock	This setting will allow you to turn the flashing of the lights when the Lock button is pushed on the key fob on or off.

## Doors & Locks

When the Doors & Locks button is pressed on the touchscreen, the system displays the options related to locking and unlocking the vehicle's doors.

### NOTE:

- The Auto Door Locks feature default condition is enabled. When enabled, the door locks will lock automatically when the vehicle's speed exceeds 12 mph (20 km/h). The Auto Door Locks feature can be enabled or disabled by an authorized dealer per written request of the customer. Please see an authorized dealer for service.
- Depending on the vehicle's options, feature settings may vary.

Setting Name	Description
<b>Auto Door Locks</b>	This setting will allow you to change if the doors lock automatically when the vehicle reaches 12 mph (19 km/h).
<b>Auto Unlock On Exit</b>	This setting will unlock the doors when any of the doors are opened from the inside.
<b>Flash Lights With Lock</b>	This setting will allow you to turn the flashing of the lights when the Lock button is pushed on the key fob on or off.
<b>Sound Horn With Lock</b>	This setting will sound the horn when the Lock button is pushed on the key fob. The "Off" setting will not sound the horn when the Lock button is pushed. The "1st Press" setting will sound the horn when the Lock button is pushed once. The "2nd Press" setting will sound the horn when the Lock button is pushed twice.
<b>Sound Horn With Remote Start</b>	This setting will sound the horn when the remote start is activated from the key fob.
<b>Remote Door Unlock</b>	This setting will change how many pushes of the Unlock button on the key fob are needed to unlock all the doors. The "Driver Door" setting will only unlock the driver door on the first push on the Unlock button. The "All Doors" setting will unlock all doors with only one push of the Unlock button.



Setting Name	Description
Passive Entry	This setting will allow you to turn the Passive Entry feature (Keyless Enter 'n Go™) on or off.
Personal Settings Linked to Key Fob	This setting will recall preset radio stations and driver seat position that have been linked to the key fob.
Power Liftgate Alert	This setting will chime an audible alert when the power liftgate is raising or lowering. Selectable settings are “On” and “Off”.

### Seats & Comfort/Auto-On Comfort

When Seats & Comfort/Auto-On Comfort button is pressed on the touchscreen, the system displays the options related to the vehicle's comfort systems when remote start has been activated or the vehicle has been started.

#### NOTE:

Depending on the vehicle's options, feature settings may vary.

Setting Name	Description
Easy Exit Seats	This setting will automatically move the driver seat rearward when the engine is shut off. The available settings are “On” and “Off”.
Auto-On Driver Heated/Ventilated Seat & Heated Steering Wheel With Vehicle Start	This setting will activate the vehicle's comfort systems and heated seats or heated steering wheel when the vehicle is remote started or ignition is started. The “Off” setting will not activate the comfort systems. The “Remote Start” setting will only activate the comfort systems when using Remote Start. The “All Start” setting will activate the comfort systems whenever the vehicle is started. If equipped, the only selectable option will be “With Vehicle Start”.

## Key Off/Engine Off Options

When the Key Off /Engine Off Options button is pressed on the touchscreen, the system displays the options related to vehicle shutoff. These settings will only activate when the ignition is set to OFF.

### NOTE:

Depending on the vehicle's options, feature settings may vary.

Setting Name	Description
Easy Exit Seats	This setting adjusts the seats to make exiting the vehicle easier.
Key Off/Engine Off Power Delay	This setting will keep certain electrical features running after the engine is turned off. When any door is opened, the electronics will deactivate. The available settings are "0 sec", "45 sec", "5 min", and "10 min".
Headlight Off Delay	This setting will allow you to set the amount of time the headlights remain on after the vehicle has been turned off. The "+" will increase the amount of time. The "-" will decrease the amount of time.

## Audio

When the Audio button is pressed on the touchscreen, the system displays options related to the vehicle's sound system. These settings can change the audio location within the vehicle, adjust the bass or treble levels, and auto-play settings from an audio device or smartphone.

### NOTE:

Depending on the vehicle's options, feature settings may vary.

Setting Name	Description
Balance/Fade	This setting will adjust audio levels from specific speakers in the front/back and left/right of the vehicle. The Speaker icon can be moved to set audio location.
Equalizer	This setting will adjust the "Bass", "Mid", and "Treble" ranges of the audio.

Setting Name	Description
Speed Adjusted Volume	This setting will adjust audio volume as speeds increase. At a higher setting, the volume will increase more as the vehicle speeds up. The available settings are "Off", "1", "2", and "3".
Surround Sound	This setting will turn the Surround Sound system on or off.
AUX Volume Offset	This setting will tune the audio levels from a device connected through the AUX port. The available settings are "+" and "-".
Auto Play	This setting will automatically begin playing audio from a connected device.
Auto On Radio	This setting will turn the radio on with vehicle start and recall the last known radio state. The available options are "On", "Off", and "Last Recall".
Volume Adjustment	This setting will let you adjust the volume levels for "Media", "Phone", "Navigation", and "VR" (Voice Recognition).

## Notifications

When the Notifications button is pressed on the touchscreen, the system displays the options related to Notifications for the system.

### NOTE:

Depending on the vehicle's options, feature settings may vary.

Setting Name	Description
App Drawer Favoriting Pop-Ups	This setting turns the "App Favorited" pop-up on or off.
App Drawer Unfavoriting Pop-Ups	This setting turns the "App Unfavorited" pop-up on or off.
New Text Message Pop-Ups	This setting turns receiving/storing a pop-up for new text messages of any connected phone on or off.

Setting Name	Description
<b>Missed Calls Message</b>	This setting turns receiving/storing a pop-up for missed calls of any connected phone on or off.
<b>Navigation Pop-ups</b>	This setting turns receiving/storing predictive Navigation Pop-ups on or off.

### SiriusXM® Setup

When the SiriusXM® Setup button is pressed on the touchscreen, the system displays options related to SiriusXM® satellite radio. These settings can be used to skip specific radio channels and restart favorite songs from the beginning.

#### NOTE:

- A subscription to SiriusXM® satellite radio is required for these settings to be functional.
- Depending on the vehicle's options, feature settings may vary.

Setting Name	Description
<b>SiriusXM® Account, Profiles, &amp; Settings</b>	This setting will direct you to the SiriusXM® profile settings.
<b>Block Explicit</b>	This setting will skip over content labeled as explicit. The available settings are "On" and "Off".
<b>Tune Start</b>	This setting will play the current song from the beginning when you tune to a music channel using one of the 12 presets.
<b>Channel Skip</b>	This setting allows you to set channels that you wish to skip. A channel list will display of the skipped channels.
<b>Subscription Information</b>	This menu provides SiriusXM® subscription information.

## Accessibility

When the Accessibility button is pressed on the touchscreen, the system will display the option related to the vehicle's theater system.

### NOTE:

Depending on the vehicle's options, feature settings may vary.

Setting Name	Description
Accessibility	The "Accessibility" feature announces a function prior to performing the action selected when using DVD/Blu-ray™ and USB Video functions, when it is activated. For example, when activated, and the Play button is selected, the system will announce "play button selected", and then once pressed again the Play button will perform its action.

## Software Update

When the Software Update button is selected, the system will display a menu with possible Wi-Fi connections. From this page, you can select and connect to one of the available Wi-Fi networks to begin system software updates. To begin, make sure the system is set to allow for Wi-Fi updates.

1. Select the desired Wi-Fi network from the available list.
2. Enter the Wi-Fi password. If the password is entered incorrectly, the system will display a notification that the connection failed.
3. Once connected, the system will begin scanning for any system updates. Press the Stop Scan button to end this process.

### NOTE:

Depending on the vehicle's options, feature settings may vary.

## System Information

When the System Information button is pressed on the touchscreen, the system displays the radio system information.

### NOTE:

Depending on the vehicle's options, feature settings may vary.

Setting Name	Description
Version Information	When this feature is selected, the radio version build will be displayed.
License Information	When this feature is selected, a "Software License" screen will appear, displaying the system software version.

## Reset

When the Reset button is pressed on the touchscreen, the system displays the options related to resetting the Uconnect system back to its default settings. These settings can clear personal data and reset selected settings from other menus.

### NOTE:

Depending on the vehicle's options, feature settings may vary.

Setting Name	Description
Restart Radio	This setting will reboot the radio.
Reset App Drawer to Default Order	This setting will reset the App Drawer to its factory default layout.
Restore Apps	This setting will delete all installed Apps on the vehicle.
Restore Settings to Default	This setting will return all the previously changed settings to their factory default.
Clear Personal Data	This setting will display a pop-up that gives you the option to clear all personal data from the system, including Bluetooth® devices and presets.
Reset Wi-Fi Password For Projection	This setting will reset the password used for the in-vehicle Wi-Fi.
Factory Reset	This setting will restore the radio to its factory default settings.

## STEERING WHEEL AUDIO CONTROLS

The Remote Sound System controls are located on the rear surface of the steering wheel. Reach behind the wheel to access the switches.

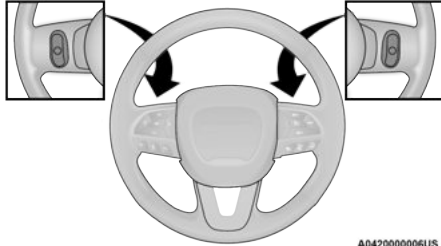

Steering Wheel Audio Controls

A042000006US

The right-hand control is a rocker-type switch with a push button in the center and controls the volume and mode of the sound system. Pushing the top of the rocker switch increases the volume, and pushing the bottom of the rocker switch decreases the volume.

Pushing the center button makes the radio switch between the various modes available (AM/FM/SXM or Media, etc.)

The left-hand control is a rocker-type switch with a push button in the center. The function of the left-hand control is different depending on which mode you are in.

The following describes the left-hand control operation in each mode.

### RADIO OPERATION

Pushing the top of the switch will “Seek” up for the next listenable station, and pushing the bottom of the switch will “Seek” down for the next listenable station.

The button located in the center of the left-hand control will tune to the next preset station that you have programmed in the radio preset button.

### MEDIA MODE

Pushing the top of the switch once goes to the next track on the selected media (AUX/USB/Bluetooth®). Pushing the bottom of the switch once goes to the beginning of the current track, or to the beginning of the previous track if it is within eight seconds after the current track begins to play.

## UNCONNECT REAR SEAT ENTERTAINMENT (RSE) SYSTEM — IF EQUIPPED

Your Rear Seat Entertainment (RSE) system plays your favorite CDs, DVDs or Blu-ray™ Discs. You can also listen to audio over the wireless headphones, or plug and play a variety of video games or audio devices.

## GETTING STARTED

1. Lift the LCD screen located in the rear of the front seats.

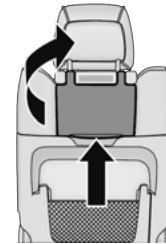

RSE System Screen

A1017000050US

5

2. Place the ignition in the ON/RUN or ACC position.

### NOTE:

If equipped with a Blu-ray™ disc player, the icon will be present on the player.

3. Turn on the Rear Seat Entertainment system by pushing the power button on the remote control.

**NOTE:**

- When the Video Screen(s) are open and a DVD/Blu-ray™ disc is inserted into the disc player, the screen(s) turn(s) on automatically, the headphones turn on, and playback begins.

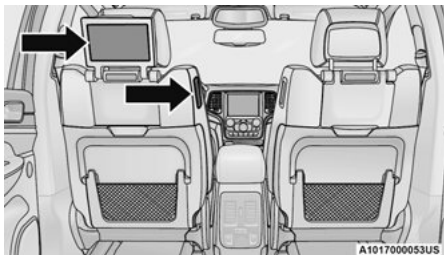
**RSE System Channel 1**

- With the Video Screen system, Channel 1 on the remote control and headphones refers to Screen 1 (driver's side), and Channel 2 on the remote control and headphones refers to Screen 2 (passenger's side). The remote control and headphones channel 1 and 2 refer to screen 1 (driver's side) and screen 2 (passenger's side).

The system can be controlled either by the front seat occupants utilizing the touchscreen or by the rear seat occupants using the remote control.

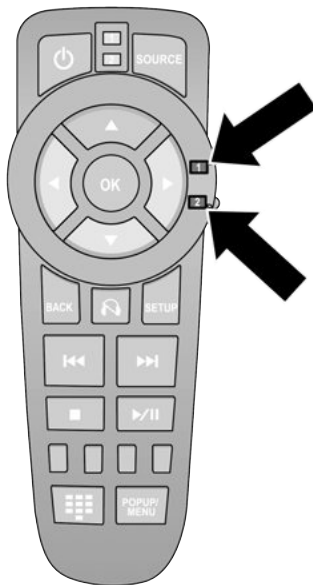
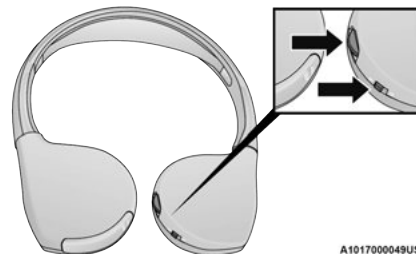
**RSE System Remote Control Channel Selectors****RSE System Headphone Channel Selectors****VIDEO SCREEN****NOTE:**

Typically there are two different ways to operate the features of the Rear Seat Entertainment system:

- The Remote Control
- The Uconnect system touchscreen



## PLAY A BLU-RAY™ DISC

The Blu-ray™ disc player is located in the center console.

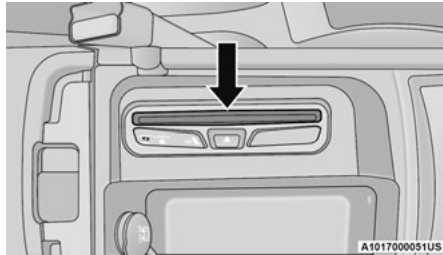

**Blu-ray™ Disc Player Location**

1. Insert the DVD/Blu-ray™ Disc with the label facing as indicated on the DVD/Blu-ray™ Disc player. The touchscreen automatically selects the appropriate mode after the disc is recognized and displays the menu screen or starts playing the first track.
2. To watch a DVD/Blu-ray™ Disc on Channel 1 (driver's side rear passenger), ensure the remote control and headphone channel selector switches are on Channel 1.
3. To watch a DVD/Blu-ray™ Disc on Channel 2 (passenger's side rear passenger), ensure the remote control and headphone channel selector switches are on Channel 2.

### Using The Front Touchscreen Radio

1. Press the Media button on the touchscreen, and then press the Rear Media button on the touchscreen.
2. Press the OK button on the touchscreen to begin playing the Blu-ray™ disc.

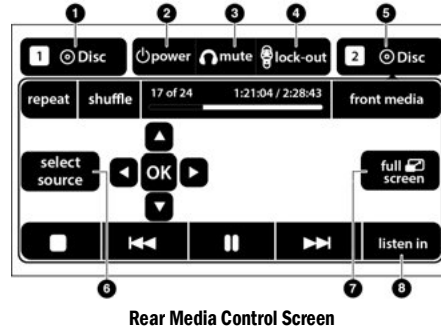

**Rear Media Control Screen**

#### 1. RSE Channel 1 Mode

Indicates the current source for Screen 1/ Channel 1. This button will be highlighted when it is being controlled by the front user. If this button is not highlighted, select the button to access controls for Screen 1/Channel 1 source.

#### 2. RSE Power

Press to turn RSE On/Off.

#### 3. RSE Mute

Mute rear headphones for the current ignition cycle. Pressing mute again will unmute rear headphones.

#### 4. RSE Remote Control Lock-Out

Press to enable/disable remote control functions.

#### 5. RSE Channel 2 Mode

Indicates the current source for Screen 2/ Channel 2. This button will be highlighted when it is being controlled by the front user. If this button is not highlighted, press the button to access controls for Screen 2/Channel 2 source.

#### 6. RSE Mode

Select this button to change the source for the active (highlighted) rear Screen/Channel on the Rear Media Control screen.

#### 7. Full Screen

Select this button to change to Full Screen Mode.

#### 8. Listen In

Press this button to change the cabin audio to the rear entertainment source currently shown on the Rear Media Control screen.

### Using The Remote Control

- Select an audio channel (Channel 1 or Channel 2), and then press the SOURCE key. Using the Up and Down arrows, highlight “Disc” from the menu and press the OK button.
- Press the POPUP/MENU key to navigate the disc menu and options.

### Using The Remote Control

1. Push the SOURCE button on the Remote Control.
2. While looking at Channel 1 or 2, highlight “Disc” by pushing Up/Down/Left/Right buttons, then push ENTER/OK.

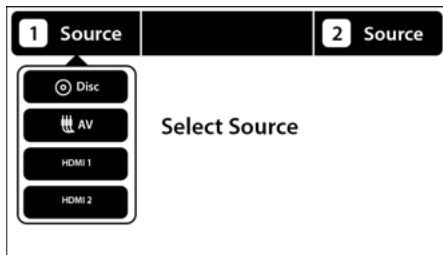

Select Disc Mode On The Rear Seat Entertainment Screen

### Using The Touchscreen Controls

1. Press the Media button on the Uconnect system touchscreen.
2. Press the Rear Media button to display the Rear Media Control Screen.

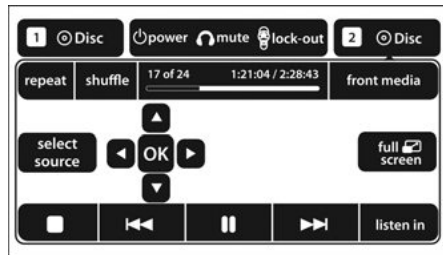

Rear Media Control Screen

3. Press the 1 or 2 button on the touchscreen, then the Select Source button on the touchscreen. Press the Disc button on the touchscreen in the Media column. To exit, press the X at the top right of the screen.

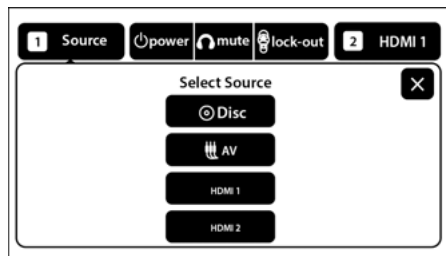

Rear Seat Entertainment Source Screen

### NOTE:

Pressing the screen on the Uconnect system while a DVD or Blu-ray™ Disc is playing brings up the basic remote control functions for DVD or Blu-ray™ Disc play such as scene selection, Play, Pause, FF, RW, and Stop. Pressing the X in the upper corner will turn OFF the remote control screen functions.

### PLAY VIDEO GAMES

Connect the video game console to the Audio/Video RCA/HDMI input jacks located on the side of each seat.

Audio/Video RCA/HDMI Jacks (AUX/HDMI Jacks) on the side of each seat enable the monitor to display video directly from a video camera, connect video games for display on the screen, or play music directly from an MP3 player.

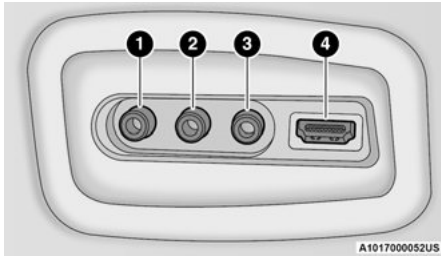

### Audio/Video Connector Ports/HDMI Input Jacks

When connecting an external source to the audio/video input, be sure to follow the standard color coding (numbers 1-3) for the audio/video jacks:

1. Right audio in (red)
2. Left audio in (white)
3. Video in (yellow)
4. HDMI Input

### NOTE:

Certain high-end video game consoles may exceed the power limit of the vehicle's power inverter. For more information about power inverters, [page 63](#).

## IMPORTANT NOTES FOR THE VIDEO SCREEN SYSTEM

- The Rear Seat Entertainment system is able to transmit two channels of stereo audio and video simultaneously.
- The Blu-ray™ Disc Player can play CDs, DVDs, and Blu-ray™ Discs.
- Selecting a video source on either Channel 1 or Channel 2 will display video and allow you to hear it on each respective channel.
- Audio can be heard through the headphones even when the screen(s) are closed.



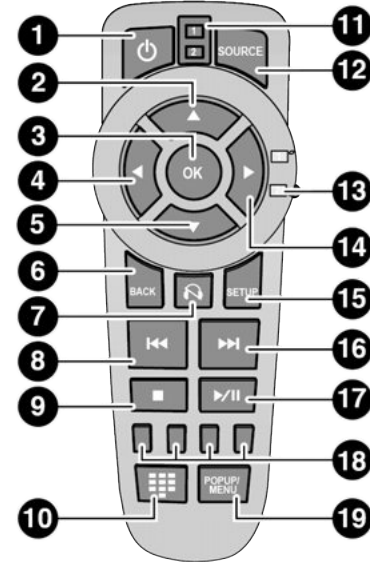





## BLU-RAY™ DISC PLAYER REMOTE CONTROL





A0423000013US

Blu-ray™ Player Remote Control

## Controls And Indicators

1.  — To hear audio while the screen is closed, push the Power button to turn the headphone transmitter on. This turns the screen and wireless headphone transmitter for the selected Channel on or off.
2.  — Push to navigate menus.
3. OK — Push to select the highlighted option in a menu.
4.  — Push to navigate menus.
5.  — Push to navigate menus.
6. BACK — Push to exit out of menus or return to source selection screen.
7.  — Mutes headphone audio.
8.  — Push and hold to fast rewind through the current audio track or video chapter.
9.  — Stops disc play.
10.  — Push to navigate chapters or titles.
11.  — When a button is pushed, the current channel or channel button is illuminated momentarily.
12. SOURCE — Push to enter Source Selection screen.
13. Channel/Screen Selector Switch — Indicates which channel is being controlled by the

remote control. When the selector switch is in the Channel 1 position, the remote controls the functionality of headphone Channel 1 (left screen). When the selector switch is in the Channel 2 position, the remote controls the functionality of headphone Channel 2 (right screen).

14.  — Push to navigate menus.
15. SETUP — Push to access the screen settings menu.
16.  — Push and hold to fast forward through the current audio track or video chapter.
17.  — Begin/resume or pause disc play.
18. Four Colored Buttons — Push to access Blu-ray™ Disc features.
19. POPUP/MENU — Push to bring up repeat and shuffle options, the Blu-ray™ Disc pop-up menu, the DVD title menu, or to access disc menus.

## HEADPHONES OPERATION

The headphones receive two separate channels of audio using an infrared transmitter from the video screen.

If no audio is heard after increasing the volume control, verify that the screen is turned on, the channel is not muted, and the headphone channel

selector switch is on the desired channel. If audio is still not heard, check that the batteries are charged.

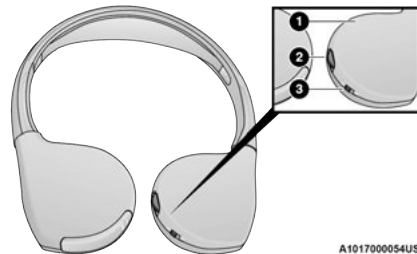

**Rear Seat Entertainment Headphones**

- 1 — Power Button
- 2 — Volume Control
- 3 — Channel Selection Switch

## CONTROLS

The headphone power indicator and controls are located on the right ear cup.

### NOTE:

The RSE system must be turned on before sound can be heard from the headphones. To conserve battery life, the headphones will automatically turn off approximately three minutes after the RSE system is turned off.

### Changing the Audio Mode for Headphones

1. Ensure the Remote Control channel/screen selector switch is in the same position as the headphones selector switch.

#### NOTE:

- When both the headphone and the remote control channel selector switches are on Channel 1, the Remote is controlling Channel 1 and the headphones are tuned to the audio on Channel 1.
  - When both the headphone and the remote control channel selector switches are on Channel 2, the Remote is controlling Channel 2 and the headphones are tuned to the audio on Channel 2.
2. Push the SOURCE button on the remote control.
  3. Pushing the SOURCE button will advance to the next mode.
  4. When the Mode Selection menu appears on screen, use the cursor buttons on the remote control to navigate to the available modes and push the OK button to select the new mode.
  5. To cancel out of the Mode Selection menu, push the BACK button on the remote control.

## REPLACING THE HEADPHONE BATTERIES

Each set of headphones requires two AAA batteries for operation. To replace the batteries:

1. Locate the battery compartment on the left ear cup of the headphones, and then slide the battery cover downward.
2. Replace the batteries, making sure to orient them according to the polarity diagram shown.
3. Replace the battery compartment cover.

## ACCESSIBILITY — IF EQUIPPED

Accessibility is a feature of the DVD/Blu-ray™ system that announces a function prior to performing the action → page 155.

## STEREO HEADPHONE LIFETIME LIMITED WARRANTY

**Who Does This Warranty Cover?** This warranty covers the initial user or purchaser ("you" or "your") of this particular Aptiv PLC ("Aptiv") wireless headphone ("Product"). The warranty is not transferable.

**How Long Does the Coverage Last?** This warranty lasts as long as you own the Product.

**What Does This Warranty Cover?** Except as specified below, this warranty covers any Product that in normal use is defective in workmanship or materials.

**What Does This Warranty Not Cover?** This warranty does not cover any damage or defect that results from misuse, abuse, or modification of the Product other than by Aptiv. Foam earpieces, which will wear over time through normal use, are specifically not covered (replacement foam is available for a nominal charge). APTIV IS NOT LIABLE FOR ANY INJURIES OR DAMAGES TO PERSONS OR PROPERTY RESULTING FROM THE USE OF, OR ANY FAILURE OR DEFECT IN, THE PRODUCT, NOR IS APTIV LIABLE FOR ANY GENERAL, SPECIAL, DIRECT, INDIRECT, INCIDENTAL, CONSEQUENTIAL, EXEMPLARY, PUNITIVE OR OTHER DAMAGES OF ANY KIND OR NATURE WHATSOEVER. Some states and jurisdictions may not allow the exclusion or limitation of incidental or consequential damages, so the above limitation may not apply to you. This warranty gives you specific legal rights. You may also have other rights, which vary from jurisdiction to jurisdiction.

**What Will Aptiv Do?** Aptiv, at its option, will repair or replace any defective Product. Aptiv reserves the right to replace any discontinued Product with a comparable model. THIS WARRANTY IS THE SOLE WARRANTY FOR THIS PRODUCT, SETS FORTH YOUR EXCLUSIVE REMEDY REGARDING

DEFECTIVE PRODUCTS, AND IS IN LIEU OF ALL OTHER WARRANTIES (EXPRESS OR IMPLIED), INCLUDING ANY WARRANTY FOR MERCHANTABILITY OR FITNESS FOR A PARTICULAR PURPOSE.

If you have any questions or comments regarding your Aptiv wireless headphones, please email [hpservice@aptiv.com](mailto:hpservice@aptiv.com) or phone: 888-293-3332

## System Information

### Disc Menu

When listening to a CD Audio or CD Data disc, pushing the remote control's POPUP/MENU button displays a list of all commands which control playback of the disc.

### Display Settings

When watching a video source (Blu-ray™ Disc or DVD Video with the disc in Play mode, AUX Video, etc.), pushing the remote control's SETUP button activates the Display Settings menu. These settings control the appearance of the video on the screen. The factory default settings are already set for optimum viewing, so there is no need to change these settings under normal circumstances.

To change the settings, push the remote control's navigation buttons to select an item, then push the remote control's navigation buttons to change the value for the currently selected item. To reset all values back to the original settings, select the

Default Settings menu option and push the remote control's ENTER/OK button.

Disc Features control the remote Blu-ray™ Disc player's settings of DVD being watched in the remote player.

### Listening To Audio With The Screen Closed

To listen to only the audio portion of the channel with the screen closed:

- Set the audio to the desired source and channel.
- Close the video screen.
- To change the current audio mode, push the remote control's SOURCE button. This will automatically select the next available audio mode without using the Mode/Source Select menu.
- When the screen is reopened, the video screen will automatically turn back on and show the display menu or media.

If the screen is closed and there is no audio heard, verify that the headphones are turned on (the ON indicator is illuminated) and the headphone selector switch is on the desired channel. If the headphones are turned on, push the remote control's power button to turn audio on. If audio is still not heard, check that fully charged batteries are installed in the headphones.

### Disc Formats

The Blu-ray™ Disc player is capable of playing the following types of 4.7-inch (12 centimeter) diameter discs:

- BD: BDMV (Profile 1.1), BDAV (Profile 1.1)
- DVD: DVD-Video, DVD-Audio, AVCREC, AVCHD, DVD-VR
- CD: CD-DA, VCD, CD-TEXT
- DVD/CD: MP3, WMA, AAC, DivX (versions 3–6) profile 3.0

### DVD Region Codes

The Blu-ray™ Disc player and many DVD discs are coded by geographic region. These region codes must match in order for the disc to play. If the region code for the DVD/Blu-ray™ disc does not match the region code for the player, the disc will not play.

### DVD Audio Support

When a DVD-Audio disc is inserted in the Blu-ray™ Disc player, the DVD-Audio title on the disc is played by default (most DVD-Audio discs also have a Video title, but the Video title is ignored). All multichannel program material is automatically mixed down to two channels, which may result in a lowered apparent volume level. If you increase the volume level to account for this change in level, remember to lower the volume before changing the disc or to another mode.

## Recorded Discs

The Blu-ray™ Disc player will play CD-R and CD-RW discs recorded in CD-Audio or Video-CD format, or as a CD-ROM containing MP3 or WMA files. The player will also play DVD-Video content recorded to a DVD-R or DVD-RW disc. DVD-ROM discs (either pressed or recorded) are not supported.

If you record a disc using a personal computer, there may be cases where the Blu-ray™ Disc player may not be able to play some or the entire disc, even if it is recorded in a compatible format and is playable on other players. To help avoid playback problems, use the following guidelines when recording discs:

- Open sessions are ignored. Only sessions that are closed are playable.
- For multi-session CDs that contain only multiple CD-Audio sessions, the player will renumber the tracks so each track number is unique.
- For CD Data (or CD-ROM) discs, always use the ISO-9660 (Level 1 or Level 2), Joliet, or Romeo format. Other formats (such as UDF, HFS, or others) are not supported.
- The player recognizes a maximum of 512 files and 99 folders per CD-R and CD-RW disc.
- Mixed media recordable DVD formats will only play the Video\_TS portion of the disc.

If you are still having trouble writing a disc that is playable in the Blu-ray™ Disc player, check with the

disc recording software publisher for more information about burning playable discs.

The recommended method for labeling recordable discs (CD-R, CD-RW, and DVD-R) is with a permanent marker. Do not use adhesive labels as they may separate from the disc, become stuck, and cause permanent damage to the DVD player.

## Compressed Audio Files (MP3 and WMA)

The Blu-ray™ Disc player is capable of playing MP3 (MPEG-1 Audio Layer 3) and WMA (Windows Media Audio) files from a CD Data disc (usually a CD-R or CD-RW).

- The Blu-ray™ Disc player always uses the file extension to determine the audio format, so MP3 files must always end with the extension “.mp3” or “.MP3” and WMA files must always end with the extension “.wma” or “.WMA”. To prevent incorrect playback, do not use these extensions for any other types of files.
- For MP3 files, only version 1 ID3 tag data (such as artist name, track title, album, etc.) are supported.
- Any file that is copy protected (such as those downloaded from many online music stores) will not play. The Blu-ray™ player will automatically skip the file and begin playing the next available file.

- Other compression formats such as AAC, MP3 Pro, Ogg Vorbis, and ATRAC3 will not play. The Blu-ray™ player will automatically skip the file and begin playing the next available file.
- If you are creating your own files, the recommended fixed bit rate for MP3 files is between 96 and 192 Kbps and the recommended fixed bit rate for WMA files is between 64 and 192Kbps. Variable bit rates are also supported. For both formats, the recommended sample rate is either 44.1 kHz or 48 kHz.
- To change the current file, use the remote control's or Blu-ray™ Disc player's button to advance to the next file.

## Disc Errors

If the Blu-ray™ Disc player is unable to read the disc, a “Disc Error” message is displayed on the rear screen and Uconnect system displays. A dirty, damaged, or incompatible disc format are all potential causes for a “Disc Error” message.

If a disc has a damaged track which results in audible or visible errors that persists for two seconds, the Blu-ray™ Disc player will attempt to continue playing the disc by skipping forward one to three seconds at a time. If the end of the disc is reached, the Blu-ray™ Disc player will return to the beginning of the disc and attempt to play the start of the first track.

The Blu-ray™ Disc player may shut down during extremely hot conditions, such as when the vehicle's interior temperature is above 120°F (48.9°C). When this occurs, the player will display "High Temp" and will shut off the rear seat displays until a safe temperature is reached. This shutdown is necessary to protect the optics of the Blu-ray™ Disc player.

### Product Agreement

This product incorporates copyright protection technology that is protected by US patents and other intellectual property rights. Use of this copyright protection technology must be authorized by Macrovision, and is intended for home or other limited viewing uses otherwise authorized by Macrovision. Reverse engineering or disassembly is prohibited.



Dolby Digital and MLP Lossless

Manufactured under license from Dolby Laboratories. "Dolby", "MLP Lossless", and the double-D symbol are trademarks of Dolby Laboratories. Confidential unpublished works. Copyright 1992-1997 Dolby Laboratories. All rights reserved.

## RADIO OPERATION AND MOBILE PHONES

Under certain conditions, the mobile phone being on in your vehicle can cause erratic or noisy performance from your radio. This condition may be lessened or eliminated by repositioning the mobile phone within the vehicle. This condition is not harmful to the radio. If your radio performance does not satisfactorily improve from repositioning the mobile phone, it is recommended that the volume be turned down or off during mobile phone operation when not using the Uconnect system.

## REGULATORY AND SAFETY INFORMATION

### US/CANADA

#### Exposure to Radio Frequency Radiation

The radiated output power of the internal wireless radio is far below the FCC and IC radio frequency exposure limits. Nevertheless, the wireless radio will be used in such a manner that the radio is 8 in (20 cm) or further from the human body.

The internal wireless radio operates within guidelines found in radio frequency safety standards and recommendations, which reflect the consensus of the scientific community.

The radio manufacturer believes the internal wireless radio is safe for use by consumers. The level of energy emitted is far less than the electromagnetic energy emitted by wireless devices such as mobile phones. However, the use of wireless radios may be restricted in some situations or environments, such as aboard airplanes. If you are unsure of restrictions, you are encouraged to ask for authorization before turning on the wireless radio ↪ page 314.



# SAFETY

## SAFETY FEATURES

### ANTI-LOCK BRAKE SYSTEM (ABS)

The ABS provides increased vehicle stability and brake performance under most braking conditions. The system automatically prevents wheel lock, and enhances vehicle control during braking.

The ABS performs a self-check cycle to ensure that the ABS is working properly each time the vehicle is started and driven. During this self-check, you may hear a slight clicking sound as well as some related motor noises.

The ABS is activated during braking when the system detects one or more wheels are beginning to lock. Road conditions such as ice, snow, gravel, bumps, railroad tracks, loose debris, or panic stops may increase the likelihood of ABS activation(s).

You also may experience the following normal characteristics when the ABS activates:

- ABS motor noise or clicking sounds (you may continue to hear for a short time after the stop).
- Brake pedal pulsations.
- A slight drop of the brake pedal at the end of the stop.

The ABS is designed to function with the Original Equipment Manufacturer (OEM) tires. Modification may result in degraded ABS performance.

#### WARNING!

- The ABS contains sophisticated electronic equipment that may be susceptible to interference caused by improperly installed or high output radio transmitting equipment. This interference can cause possible loss of anti-lock braking capability. Installation of such equipment should be performed by qualified professionals.
- Pumping of the Anti-Lock Brakes will diminish their effectiveness and may lead to a collision. Pumping makes the stopping distance longer. Just press firmly on your brake pedal when you need to slow down or stop.
- The ABS cannot prevent the natural laws of physics from acting on the vehicle, nor can it increase braking or steering efficiency beyond that afforded by the condition of the vehicle brakes and tires or the traction afforded.

*(Continued)*

#### WARNING!

- The ABS cannot prevent collisions, including those resulting from excessive speed in turns, following another vehicle too closely, or hydroplaning.
- The capabilities of an ABS equipped vehicle must never be exploited in a reckless or dangerous manner that could jeopardize the user's safety or the safety of others.

### Anti-Lock Brake System (ABS) Warning Light

The yellow ABS Warning Light will turn on when the ignition is placed in the ON/RUN mode and may stay on for as long as four seconds.

If the ABS Warning Light remains on or comes on while driving, it indicates that the anti-lock portion of the brake system is not functioning and that service is required. However, the conventional brake system will continue to operate normally if the ABS Warning Light is on.

If the ABS Warning Light is on, the brake system should be serviced as soon as possible to restore the benefits of Anti-Lock Brakes. If the ABS Warning Light does not come on when the ignition is placed in the ON/RUN mode, have the light repaired as soon as possible.

## REAR SEAT REMINDER ALERT (RSRA)

RSRA will consider the presence of an object in the rear seat when a rear entry/exit door is opened at the beginning of each key cycle. To activate, the rear door must be open for more than one second and the vehicle must be placed in the ON/RUN position within 10 minutes. When the potential presence of an object is determined and/or otherwise inferred, a message will appear in the instrument cluster display reminding driver to check the rear seat(s) immediately after key off accompanied by an alert upon exiting the vehicle.

## ELECTRONIC BRAKE CONTROL (EBC) SYSTEM

Your vehicle is equipped with an advanced Electronic Brake Control (EBC) system. This system includes Anti-Lock Brake System (ABS), Brake Assist System (BAS), Electronic Brake Force Distribution (EBD), Electronic Roll Mitigation (ERM), Electronic Stability Control (ESC), Hill Start Assist (HSA), and Traction Control System (TCS).

These systems work together to enhance both vehicle stability and control in various driving conditions.

Your vehicle may also be equipped with Dynamic Steering Torque (DST), Rain Brake Support (RBS), Ready Alert Braking (RAB), and Trailer Sway Control (TSC).

## Brake Assist System (BAS)

The BAS is designed to optimize the vehicle's braking capability during emergency braking maneuvers. The system detects an emergency braking situation by sensing the rate and amount of brake application and then applies optimum pressure to the brakes. This can help reduce braking distances. The BAS complements the Anti-Lock Brake System (ABS). Applying the brakes very quickly results in the best BAS assistance. To receive the benefit of the system, you must apply continuous braking pressure during the stopping sequence (do not "pump" the brakes). Do not reduce brake pedal pressure unless braking is no longer desired. Once the brake pedal is released, the BAS is deactivated.

### WARNING!

The Brake Assist System (BAS) cannot prevent the natural laws of physics from acting on the vehicle, nor can it increase the traction afforded by prevailing road conditions. BAS cannot prevent collisions, including those resulting from excessive speed in turns, driving on very slippery surfaces, or hydroplaning. The capabilities of a BAS-equipped vehicle must never be exploited in a reckless or dangerous manner, which could jeopardize the user's safety or the safety of others.

## Brake System Warning Light

The red Brake System Warning Light will turn on when the ignition is placed in the ON/RUN mode and may stay on for as long as four seconds.

If the Brake System Warning Light remains on or comes on while driving, it indicates that the brake system is not functioning properly and that immediate service is required. If the Brake System Warning Light does not come on when the ignition is placed in the ON/RUN mode, have the light repaired as soon as possible.

## Dynamic Steering Torque (DST)

DST is a feature of the ESC and Electric Power Steering (EPS) modules that, when equipped, provides torque at the steering wheel for certain driving conditions in which the ESC module is detecting vehicle instability. The torque that the steering wheel receives is only meant to help the driver realize optimal steering behavior in order to reach/maintain vehicle stability. The only notification the driver receives that the feature is active is the torque applied to the steering wheel.

### NOTE:

The DST feature is only meant to help the driver realize the correct course of action through small torques on the steering wheel, which means the effectiveness of the DST feature is highly dependent on the driver's sensitivity and overall reaction to the applied torque. It is very important to realize that this feature will not steer the vehicle, meaning the driver is still responsible for steering the vehicle.

## Electronic Brake Force Distribution (EBD)

EBD manages the distribution of the braking torque between the front and rear axles by limiting braking pressure to the rear axle. This is done to prevent overslip of the rear wheels to avoid vehicle instability, and to prevent the rear axle from entering ABS before the front axle.

## Electronic Roll Mitigation (ERM)

ERM anticipates the potential for wheel lift by monitoring the driver's steering wheel input and the speed of the vehicle. When Electronic Roll Mitigation (ERM) determines that the rate of change of the steering wheel angle and vehicle's speed are sufficient to potentially cause wheel lift, it then applies the appropriate brake and may also reduce engine power to lessen the chance that wheel lift will occur. ERM can only reduce the chance of wheel lift occurring during severe or evasive driving maneuvers; it cannot prevent wheel lift due to other factors, such as road conditions, leaving the roadway, or striking objects or other vehicles.

### WARNING!

Many factors, such as vehicle loading, road conditions and driving conditions, influence the chance that wheel lift or rollover may occur. ERM cannot prevent all wheel lift or roll overs, especially those that involve leaving the roadway or striking objects or other vehicles. The capabilities of an ERM-equipped vehicle must never be exploited in a reckless or dangerous manner which could jeopardize the user's safety or the safety of others.

## Electronic Stability Control (ESC)

ESC enhances directional control and stability of the vehicle under various driving conditions. ESC corrects for oversteering or understeering of the vehicle by applying the brake of the appropriate wheel(s) to counteract the above conditions. Engine power may also be reduced to help the vehicle maintain the desired path.

- Oversteer — when the vehicle is turning more than appropriate for the steering wheel position.
- Understeer — when the vehicle is turning less than appropriate for the steering wheel position.

ESC uses sensors in the vehicle to determine the vehicle path intended by the driver and compares it to the actual path of the vehicle. When the actual path does not match the intended path, ESC applies the brake of the appropriate wheel to assist in counteracting the oversteer or understeer condition.

The ESC Activation/Malfunction Indicator Light located in the instrument cluster will start to flash as soon as the ESC system becomes active. The ESC Activation/Malfunction Indicator Light also flashes when the Traction Control System (TCS) is active. If the ESC Activation/Malfunction Indicator Light begins to flash during acceleration, ease up on the accelerator and apply as little throttle as possible. Be sure to adapt your speed and driving to the prevailing road conditions.

**WARNING!**

- Electronic Stability Control (ESC) cannot prevent the natural laws of physics from acting on the vehicle, nor can it increase the traction afforded by prevailing road conditions. ESC cannot prevent accidents, including those resulting from excessive speed in turns, driving on very slippery surfaces, or hydroplaning. ESC also cannot prevent accidents resulting from loss of vehicle control due to inappropriate driver input for the conditions. Only a safe, attentive, and skillful driver can prevent accidents. The capabilities of an ESC equipped vehicle must never be exploited in a reckless or dangerous manner which could jeopardize the user's safety or the safety of others.

*(Continued)***WARNING!**

- Vehicle modifications, or failure to properly maintain your vehicle, may change the handling characteristics of your vehicle, and may negatively affect the performance of the ESC system. Changes to the steering system, suspension, braking system, tire type and size or wheel size may adversely affect ESC performance. Improperly inflated and unevenly worn tires may also degrade ESC performance. Any vehicle modification or poor vehicle maintenance that reduces the effectiveness of the ESC system can increase the risk of loss of vehicle control, vehicle rollover, personal injury and death.

**ESC Operating Modes**

Depending upon model and mode of operation, the ESC system may have multiple operating modes.

**ESC On**

This is the normal operating mode for the ESC. Whenever the vehicle is started, the ESC system will be in this mode. This mode should be used for most driving conditions. Alternate ESC modes should only be used for specific reasons as noted in the following paragraphs.

**Partial Off**

This mode may be useful if the vehicle becomes stuck. This mode may modify TCS and ESC thresholds for activation, which allows for more wheel spin than normally allowed.

To enter the "Partial Off" mode, momentarily push the ESC OFF button and the ESC OFF Indicator Light will illuminate. To turn the ESC on again, momentarily push the ESC OFF button and the ESC OFF Indicator Light will turn off.

**NOTE:**

For vehicles with multiple partial ESC modes, the push and release of the button will toggle the ESC modes. Multiple attempts may be required to return to "ESC On" mode.

**WARNING!**

- When in "Partial Off" mode, the TCS functionality of ESC, except for the limited slip feature described in the TCS section, has been disabled and the ESC OFF Indicator Light will be illuminated. When in "Partial Off" mode, the engine power reduction feature of TCS is disabled, and the enhanced vehicle stability offered by the ESC system is reduced.
- Trailer Sway Control (TSC) is disabled when the ESC system is in the "Partial Off" mode.

## ESC Activation/Malfunction Indicator Light And ESC OFF Indicator Light



The ESC Activation/Malfunction Indicator Light in the instrument cluster will come on when the ignition is placed in the ON/RUN mode. It should go out with the engine running. If the ESC Activation/Malfunction Indicator Light comes on continuously with the engine running, a malfunction has been detected in the ESC system. If this light remains on after several ignition cycles, and the vehicle has been driven several miles (kilometers) at speeds greater than 30 mph (48 km/h), see an authorized dealer as soon as possible to have the problem diagnosed and corrected.

The ESC Activation/Malfunction Indicator Light starts to flash as soon as the tires lose traction and the ESC system becomes active. The ESC Activation/Malfunction Indicator Light also flashes when TCS is active. If the ESC Activation/Malfunction Indicator Light begins to flash during acceleration, ease up on the accelerator and apply as little throttle as possible. Be sure to adapt your speed and driving to the prevailing road conditions.



The ESC OFF Indicator Light indicates that the Electronic Stability Control (ESC) is in a reduced mode.

### NOTE:

- The ESC Activation/Malfunction Indicator Light and the ESC OFF Indicator Light come on momentarily each time the ignition is placed in the ON position.
- Each time the ignition is placed in the ON position, the ESC system will be on even if it was turned off previously.
- The ESC system will make buzzing or clicking sounds when it is active. This is normal; the sounds will stop when ESC becomes inactive following the maneuver that caused the ESC activation.

### Hill Start Assist (HSA)

HSA is designed to mitigate roll back from a complete stop while on an incline. If the driver releases the brake while stopped on an incline, HSA will continue to hold the brake pressure for a short period. If the driver does not apply the throttle before this time expires, the system will release brake pressure and the vehicle will roll down the hill as normal.

The following conditions must be met in order for HSA to activate:

- The feature must be enabled.
- The vehicle must be stopped.
- The parking brake must be off.

- The driver door must be closed.
- The vehicle must be on a sufficient grade.
- The gear selection must match vehicle uphill direction (i.e., vehicle facing uphill is in forward gear; vehicle backing uphill is in REVERSE gear).
- HSA will work in REVERSE gear and all forward gears. The system will not activate if the transmission is in PARK or NEUTRAL. For vehicles equipped with a manual transmission, if the clutch is pressed, HSA will remain active.

### WARNING!

There may be situations where the Hill Start Assist (HSA) will not activate and slight rolling may occur, such as on minor hills or with a loaded vehicle, or while pulling a trailer. HSA is not a substitute for active driving involvement. It is always the driver's responsibility to be attentive to distance to other vehicles, people, and objects, and most importantly brake operation to ensure safe operation of the vehicle under all road conditions. Your complete attention is always required while driving to maintain safe control of your vehicle. Failure to follow these warnings can result in a collision or serious personal injury.

## Disabling And Enabling HSA

This feature can be turned on or turned off. To change the current setting see [↪ page 155](#).

## Towing With HSA

HSA will also provide assistance to mitigate roll back while towing a trailer.

### WARNING!

- If you use a trailer brake controller with your trailer, the trailer brakes may be activated and deactivated with the brake switch. If so, there may not be enough brake pressure to hold both the vehicle and the trailer on a hill when the brake pedal is released. In order to avoid rolling down an incline while resuming acceleration, manually activate the trailer brake or apply more vehicle brake pressure prior to releasing the brake pedal.
- HSA is not a parking brake. Always apply the parking brake fully when exiting your vehicle. Also, be certain to place the transmission in PARK.
- Failure to follow these warnings can result in a collision or serious personal injury.

## Rain Brake Support (RBS)

RBS may improve braking performance in wet conditions. It will periodically apply a small amount of brake pressure to remove any water buildup on the front brake rotors. It functions when the windshield wipers are in LO or HI speed. When Rain Brake Support is active, there is no notification to the driver and no driver interaction is required.

## Ready Alert Braking (RAB)

RAB may reduce the time required to reach full braking during emergency braking situations. It anticipates when an emergency braking situation may occur by monitoring how fast the throttle is released by the driver. The Electronic Brake Controller (EBC) will prepare the brake system for a panic stop.

## Traction Control System (TCS)

The TCS monitors the amount of wheel spin of each of the driven wheels. If wheel spin is detected, the TCS may apply brake pressure to the spinning wheel(s) and/or reduce engine power to provide enhanced acceleration and stability. A feature of the TCS, Brake Limited Differential (BLD) functions similarly to a limited slip differential and controls the wheel spin across a driven axle. If one wheel on a driven axle is spinning faster than the other, the system will apply the brake of the spinning wheel. This will allow more engine power

to be applied to the wheel that is not spinning. BLD may remain enabled even if TCS and ESC are in reduced modes.

## Trailer Sway Control (TSC)

TSC uses sensors in the vehicle to recognize an excessively swaying trailer and will take the appropriate actions to attempt to stop the sway. Note that TSC cannot stop all trailers from swaying. Always use caution when towing a trailer and follow the trailer tongue weight recommendations [↪ page 138](#).

When TSC is functioning, the ESC Activation/ Malfunction Indicator Light will flash, the engine power may be reduced and you may feel the brakes being applied to individual wheels to attempt to stop the trailer from swaying. TSC is disabled when the ESC system is in the "Partial Off" mode.

### WARNING!

If TSC activates while driving, slow the vehicle down, stop at the nearest safe location, and adjust the trailer load to eliminate trailer sway.

## AUXILIARY DRIVING SYSTEMS

### BLIND SPOT MONITORING (BSM) — IF EQUIPPED

BSM uses two radar sensors, located inside the rear fascia/bumper, to detect highway licensable vehicles (automobiles, trucks, motorcycles, etc.) that enter the blind spot zones from the rear/front/side of the vehicle.

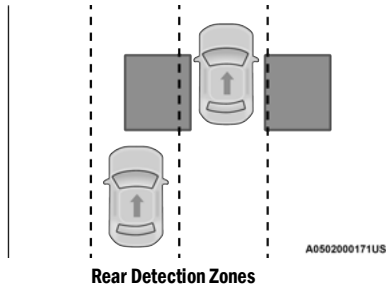

When the vehicle is started, the BSM Warning Light will momentarily illuminate in both outside rearview mirrors to let the driver know that the system is operational. The BSM system sensors operate when the vehicle is in any forward gear.

The BSM detection zone covers approximately one lane in width, on both sides of the vehicle 12 ft (3.8 m). The zone length starts at the side of the

vehicle, near the B-pillar, and extends approximately 10 ft (3 m) beyond the rear fascia/bumper of the vehicle. The BSM system monitors the detection zones on both sides of the vehicle when the vehicle speed has reached approximately 6 mph (10 km/h) or higher and will alert the driver of vehicles in these areas.

#### NOTE:

- The BSM system DOES NOT alert the driver about rapidly approaching vehicles that are outside the detection zones.
- The BSM system detection zone DOES NOT change if your vehicle is towing a trailer. Therefore, visually verify the adjacent lane is clear for both your vehicle and trailer before making a lane change. If the trailer or other object (i.e., bicycle, sports equipment) extends beyond the side of your vehicle, this may result in random false detections on the trailer, and false chimes when the turn signal is used → page 155.
- The BSM system can become blocked if snow, ice, mud, or other road contaminations accumulate on the rear fascia/bumper where the radar sensors are located. The system may also detect blockage if the vehicle is operated in areas with extremely low radar returns such as a desert or parallel to a large elevation drop. If blockage is detected, a “Blind Spot Temporarily Unavailable, Wipe Rear Corners” message will display in the cluster, both mirror lights will illu-

minate, and BSM and RCP alerts will not occur. This is normal operation. The system will automatically recover and resume function when the condition clears. To minimize system blockage, do not block the area of the rear fascia/bumper where the radar sensors are located with foreign objects (bumper stickers, bicycle racks, etc.) and keep it clear of road contaminations.

The area on the rear fascia/bumper where the radar sensors are located must remain free of snow, ice, and dirt/road contamination so that the BSM system can function properly. Do not block the area of the rear fascia/bumper where the radar sensors are located with foreign objects (bumper stickers, bicycle racks, etc.).

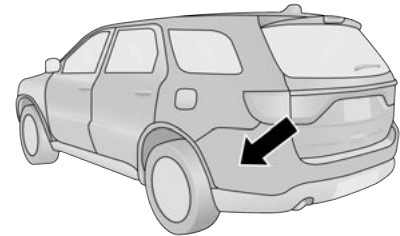

Sensor Location (Left Side Shown)

The BSM system notifies the driver of objects in the detection zones by illuminating the BSM warning light located in the outside mirrors. In addition, when the turn signal is activated during the alert on the side of the vehicle corresponding to the alert, an audible (chime) alert can be heard. During the audible (chime) alert, the radio volume will be reduced → page 196.

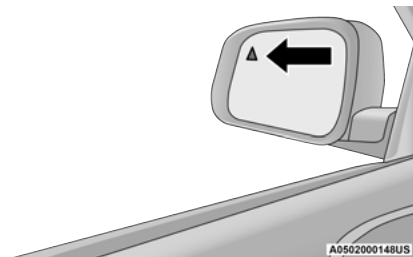

**BSM Warning Light**

The BSM system monitors the detection zone from three different entry points (Side, Rear, Front) while driving to see if an alert is necessary. The BSM system will issue an alert during these types of zone entries.

#### Entering From The Side

Vehicles that move into your adjacent lanes from either side of the vehicle.

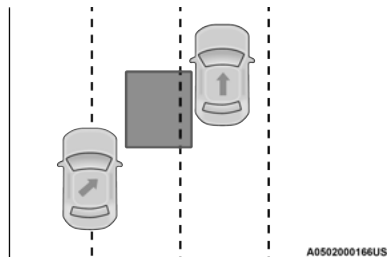

**Side Monitoring**

A0502000166US

#### Entering From The Rear

Vehicles that come up from behind your vehicle on either side and enter the rear detection zone with a relative speed of less than 30 mph (48 km/h).

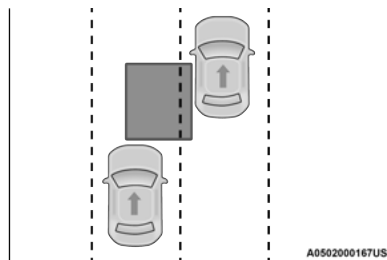

**Rear Monitoring**

A0502000167US

#### Overtaking Traffic

If you pass another vehicle slowly (with a relative speed of less than 15 mph (24 km/h)) and the vehicle remains in the blind spot for approximately 1.5 seconds, the warning light will be illuminated. If the difference in speed between the two vehicles is greater than 15 mph (24 km/h), the warning light will not illuminate.

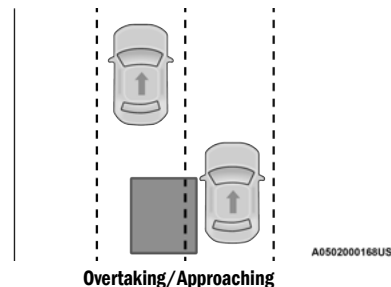

**Overtaking/Approaching**

A0502000168US



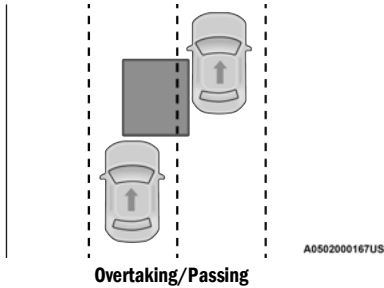

The BSM system is designed not to issue an alert on stationary objects such as guardrails, posts, walls, foliage, berms, etc. However, occasionally the system may alert on such objects. This is normal operation and your vehicle does not require service.

The BSM system will not alert you of objects that are traveling in the opposite direction of the vehicle in adjacent lanes ↪ page 314.

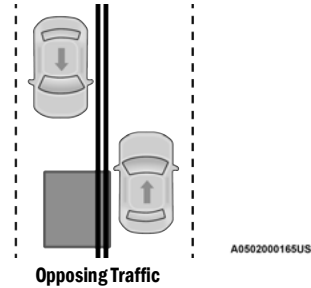

### WARNING!

The Blind Spot Monitoring system is only an aid to help detect objects in the blind spot zones. The BSM system is not designed to detect pedestrians, bicyclists, or animals. Even if your vehicle is equipped with the BSM system, always check your vehicle's mirrors, glance over your shoulder, and use your turn signal before changing lanes. Failure to do so can result in serious injury or death.

## Rear Cross Path (RCP)

RCP is intended to aid the driver when backing out of parking spaces where their vision of oncoming vehicles may be blocked. Proceed slowly and cautiously out of the parking space until the rear end of the vehicle is exposed. The RCP system will then have a clear view of the cross traffic and if an oncoming vehicle is detected, alert the driver.

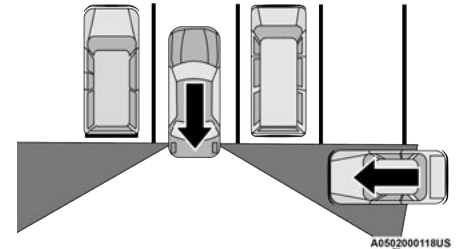

### RCP Detection Zones

RCP monitors the rear detection zones on both sides of the vehicle, for objects that are moving toward the side of the vehicle with a minimum speed of approximately 5 mph (8 km/h), to objects moving a maximum of approximately 20 mph (32 km/h), such as in parking lot situations.

When RCP is on and the vehicle is in REVERSE (R), the driver is alerted using both the visual and audible alarms, including reducing the radio volume.

**NOTE:**

In a parking lot situation, oncoming vehicles can be blocked by vehicles parked on either side. If the sensors are blocked by other structures or vehicles, the system will not be able to alert the driver.

**WARNING!**

Rear Cross Path (RCP) detection is not a backup aid system. It is intended to be used to help a driver detect an oncoming vehicle in a parking lot situation. Drivers must be careful when backing up, even when using RCP. Always check carefully behind your vehicle, look behind you, and be sure to check for pedestrians, animals, other vehicles, obstructions, and blind spots before backing up. Failure to do so can result in serious injury or death.

**Blind Spot Modes**

Blind Spot has three selectable modes of operation that are available in the Uconnect system.

**Blind Spot Alert Lights Only**

When operating in Blind Spot Alert mode, the BSM system will provide a visual alert in the appropriate side view mirror based on a detected object. However, when the system is operating in Rear Cross Path (RCP) mode, the system will respond

with both visual and audible alerts when a detected object is present. Whenever an audible alert is requested, the radio is muted.

**Blind Spot Alert Lights/Chime**

When operating in Blind Spot Alert Lights/Chime mode, the BSM system will provide a visual alert in the appropriate side view mirror based on a detected object. If the turn signal is then activated, and it corresponds to an alert present on that side of the vehicle, an audible chime will also be sounded. Whenever a turn signal and detected object are present on the same side at the same time, both the visual and audible alerts will be issued. In addition to the audible alert the radio (if on) will also be muted.

**NOTE:**

Whenever an audible alert is requested by the BSM system, the radio is also muted.

When the system is in RCP, the system shall respond with both visual and audible alerts when a detected object is present. Whenever an audible alert is requested, the radio is also muted. Turn/hazard signal status is ignored; the RCP state always requests the chime.

**Blind Spot Alert Off**

When the BSM system is turned off there will be no visual or audible alerts from either the BSM or RCP systems.

**NOTE:**

The BSM system will store the current operating mode when the vehicle is shut off. Each time the vehicle is started the previously stored mode will be recalled and used.

**FORWARD COLLISION WARNING (FCW) WITH MITIGATION**

FCW with Mitigation provides the driver with audible warnings, visual warnings (within the instrument cluster display), and may apply a brake jerk to warn the driver when it detects a potential frontal collision. The warnings and limited braking are intended to provide the driver with enough time to react, avoid or mitigate the potential collision.

**NOTE:**

FCW monitors the information from the forward looking sensors as well as the Electronic Brake Controller (EBC) to calculate the probability of a forward collision. When the system determines that a forward collision is probable, the driver will be provided with audible and visual warnings and may provide a brake jerk warning. If the driver does not take action based upon these progressive warnings, then the system will provide a limited level of active braking to help slow the vehicle and mitigate the potential forward collision. If the driver reacts to the warnings by braking and the system determines that the driver intends to avoid the

collision by braking but has not applied sufficient brake force, the system will compensate and provide additional brake force as required.

If an FCW with Mitigation event begins at a speed below 38 mph (62 km/h), the system may provide the maximum or partial braking to mitigate the potential forward collision. If the Forward Collision Warning with Mitigation event stops the vehicle completely, the system will hold the vehicle at a standstill for two seconds and then release the brakes.

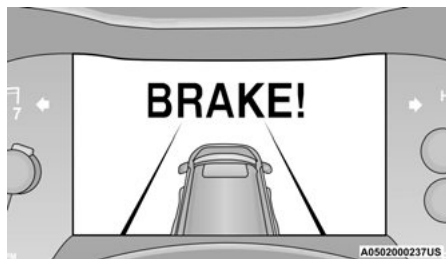

FCW Message

When the system determines a collision with the vehicle in front of you is no longer probable, the warning message will be deactivated.

#### NOTE:

- The minimum speed for FCW activation is 1 mph (2 km/h).
- The FCW alerts may be triggered on objects other than vehicles such as guard rails or sign posts based on the course prediction. This is expected and is a part of normal FCW activation and functionality.
- It is unsafe to test the FCW system. To prevent such misuse of the system, after four Active Braking events within an ignition cycle, the Active Braking portion of FCW will be deactivated until the next ignition cycle.
- The FCW system is intended for on-road use only. If the vehicle is taken off-road, the FCW system should be deactivated to prevent unnecessary warnings to the surroundings. If the vehicle enters 4WD Low, the FCW system will be automatically deactivated ⇨ page 314.

#### WARNING!

Forward Collision Warning (FCW) is not intended to avoid a collision on its own, nor can FCW detect every type of potential collision. The driver has the responsibility to avoid a collision by controlling the vehicle via braking and steering. Failure to follow this warning could lead to serious injury or death.

#### FCW Braking Status And Sensitivity

The FCW Sensitivity and Active Braking status are programmable through the Uconnect system ⇨ page 155.

The default sensitivity of FCW is the “Medium” setting and the system status is “Warning & Braking”. This allows the system to warn the driver of a possible collision with the vehicle in front using audible/visual warnings and it applies autonomous braking.

Changing the FCW status to the “Far” setting allows the system to warn the driver of a possible collision with the vehicle in front using audible/visual warnings when the latter is at a farther distance than the “Medium” setting. This provides the most reaction time to avoid a possible collision.

Changing the FCW status to the “Near” setting allows the system to warn the driver of a possible collision with the vehicle in front when the distance between the vehicle in the front is much closer. This setting provides less reaction time than the “Far” and “Medium” settings, which allows for a more dynamic driving experience.

#### NOTE:

- Changing the FCW status to “Only Warning” prevents the system from providing limited active braking, or additional brake support if the

driver is not braking adequately in the event of a potential frontal collision, but maintains the audible and visual warnings.

- Changing the FCW status to “Off” prevents the system from providing autonomous braking, or additional brake support if the driver is not braking adequately in the event of a potential frontal collision.
- The system will retain the last setting selected by the driver after ignition shut down.
- FCW may not react to irrelevant objects such as overhead objects, ground reflections, objects not in the path of the vehicle, stationary objects that are far away, oncoming traffic, or leading vehicles with the same or higher rate of speed.
- FCW will be disabled like ACC, with the unavailable screens.

### FCW Limited Warning

If the instrument cluster displays “ACC/FCW Limited Functionality” or “ACC/FCW Limited Functionality Clean Front Windshield” momentarily, there may be a condition that limits FCW functionality. Although the vehicle is still drivable under normal conditions, the active braking may not be fully available. Once the condition that limited the system performance is no longer present, the system will return to its full performance state. If the problem persists, see an authorized dealer.

### Service FCW Warning

If the system turns off, and the instrument cluster displays:

- ACC/FCW Unavailable Service Required
- Cruise/FCW Unavailable Service Required

This indicates there is an internal system fault. Although the vehicle is still drivable under normal conditions, have the system checked by an authorized dealer.

### TIRE PRESSURE MONITORING SYSTEM (TPMS)

The TPMS will warn the driver of a low tire pressure based on the vehicle recommended cold tire pressure.

The tire pressure will vary with temperature by about 1 psi (7 kPa) for every 12°F (6.5°C). This means that when the outside temperature decreases, the tire pressure will decrease. Tire pressure should always be set based on cold inflation tire pressure. This is defined as the tire pressure after the vehicle has not been driven for at least three hours, or driven less than 1 mile (1.6 km) after a three-hour period. The tire pressure will also increase as the vehicle is driven — this is normal and there should be no adjustment for this increased pressure.

See  page 285 on how to properly inflate the vehicle’s tires.

The TPMS will warn the driver of a low tire pressure if the tire pressure falls below the low pressure warning threshold for any reason, including low temperature effects, or natural pressure loss through the tire.

The TPMS will continue to warn the driver of low tire pressure as long as the condition exists, and will not turn off until the tire pressure is at or above recommended cold tire pressure. Once the low tire pressure warning has been illuminated, the tire pressure must be increased to the recommended cold tire pressure in order for the TPMS Warning Light to be turned off.

#### NOTE:

When filling warm tires, the tire pressure may need to be increased up to an additional 4 psi (28 kPa) above the recommended cold placard pressure in order to turn the TPMS Warning Light off.

The system will automatically update and the TPMS Warning Light will extinguish once the updated tire pressures have been received. The vehicle may need to be driven for up to 20 minutes above 15 mph (24 km/h) to receive this information.

For example, your vehicle has a recommended cold (parked for more than three hours) tire pressure of 33 psi (227 kPa). If the ambient temperature is 68°F (20°C) and the measured tire pressure is 28 psi (193 kPa), a temperature drop to 20°F (-7°C) will decrease the tire pressure to

approximately 24 psi (165 kPa). This tire pressure is sufficiently low enough to turn on the TPMS Warning Light. Driving the vehicle may cause the tire pressure to rise to approximately 28 psi (193 kPa), but the TPMS Warning Light will still be on. In this situation, the TPMS Warning Light will turn off only after the tires have been inflated to the vehicle's recommended cold tire pressure value.

#### CAUTION!

- The TPMS has been optimized for the original equipment tires and wheels. TPMS pressures and warnings have been established for the tire size equipped on your vehicle. Undesirable system operation or sensor damage may result when using replacement equipment that is not of the same size, type, and/or style. The TPMS sensor is not designed for use on aftermarket wheels and may contribute to a poor overall system performance or sensor damage. Customers are encouraged to use OEM wheels to assure proper TPMS feature operation.
- Using aftermarket tire sealants may cause the TPMS sensor to become inoperable. After using an aftermarket tire sealant it is recommended that you take your vehicle to an authorized dealership to have your sensor function checked.

(Continued)

#### CAUTION!

- After inspecting or adjusting the tire pressure, always reinstall the valve stem cap. This will prevent moisture and dirt from entering the valve stem, which could damage the TPMS sensor.

#### NOTE:

- The TPMS is not intended to replace normal tire care and maintenance, or to provide warning of a tire failure or condition.
- The TPMS should not be used as a tire pressure gauge while adjusting your tire pressure.
- Driving on a significantly underinflated tire causes the tire to overheat and can lead to tire failure. Underinflation also reduces fuel efficiency and tire tread life, and may affect the vehicle's handling and stopping ability.
- The TPMS is not a substitute for proper tire maintenance, and it is the driver's responsibility to maintain correct tire pressure using an accurate tire gauge, even if underinflation has not reached the level to trigger illumination of the TPMS Warning Light.
- Seasonal temperature changes will affect tire pressure, and the TPMS will monitor the actual tire pressure in the tire.

The TPMS uses wireless technology with wheel rim-mounted electronic sensors to monitor tire pressure levels. Sensors, mounted to each wheel as part of the valve stem, transmit tire pressure readings to the receiver module.

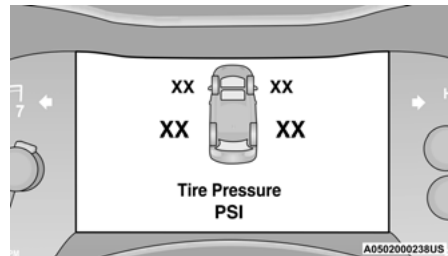

**Tire Pressure Monitoring System Display**

#### NOTE:

It is particularly important for you to regularly check the tire pressure in all of your tires and to maintain the proper pressure → page 314.

The TPMS consists of the following components:

- Receiver module
- Four TPMS sensors
- Various TPMS messages, which display in the instrument cluster, and a graphic displaying tire pressures
- TPMS Warning Light

## Tire Pressure Monitoring System Low Pressure Warnings



The TPMS Warning Light will illuminate in the instrument cluster, and an audible chime will be activated, when one or more of the four active road tire

pressures are low. In addition, the instrument cluster will display an "Inflate to XX" message and a graphic display of the pressure value(s) with the low tire(s) in a different color ↪ page 82.

### NOTE:

Your system can be set to display pressure units in PSI, BAR or kPa.

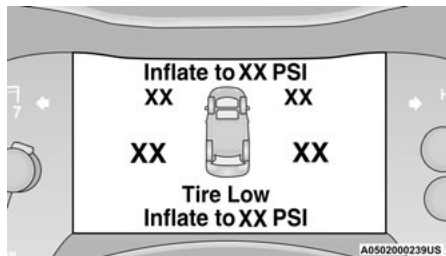

**Low Tire Pressure Monitoring System Display**

Should a low tire condition occur on any of the four active road tire(s), you should stop as soon as possible, and inflate the low tire(s) that is in a different color on the graphic display to the

vehicle's recommended cold tire pressure displayed in the "Inflate to XX" message.

### NOTE:

When filling warm tires, the tire pressure may need to be increased up to an additional 4 psi (28 kPa) above the recommended cold placard pressure in order to turn the TPMS Warning Light off.

The system will automatically update, the graphic display of the pressure value(s) will return to its original color and the TPMS Warning Light will extinguish once the updated tire pressure(s) have been received. The vehicle may need to be driven for up to 20 minutes above 15 mph (24 km/h) to receive this information.

## Service TPMS Warning

The TPMS Warning Light will flash on and off for 75 seconds, and remain on solid when a system fault is detected. The system fault will also sound a chime. The instrument cluster display will display a "SERVICE TPM SYSTEM" message for a minimum of five seconds. This message is then followed by a graphic display, with "--" in place of the pressure value(s), indicating which Tire Pressure Monitoring System sensor(s) is not being received.

If the ignition switch is cycled, this sequence will repeat, providing the system fault still exists. If the system fault no longer exists, the TPMS Warning Light will no longer flash, the "SERVICE TPM SYSTEM" message will not be present, and a

pressure value will be displayed instead of dashes. A system fault can occur by any of the following:

- Jamming due to electronic devices or driving next to facilities emitting the same Radio Frequencies as the TPMS sensors.
- Lots of snow or ice around the wheels or wheel housings.
- Using tire chains on the vehicle.
- Using wheels/tires not equipped with TPMS sensors.

### NOTE:

There is no TPMS sensor in the spare tire. The TPMS will not be able to monitor the tire pressure. If you install the spare tire in place of a road tire that has a pressure below the low-pressure warning limit, upon the next ignition switch cycle, the TPMS Warning Light will remain on, a chime will sound, and the instrument cluster display will still display a pressure value in the different color graphic display and an "Inflate to XX" message will be displayed. After driving the vehicle for up to 20 minutes above 15 mph (24 km/h), the TPMS Warning Light will flash on and off for 75 seconds and then remain on solid. In addition, the instrument cluster display will display a "SERVICE TPM SYSTEM" message for five seconds and then display dashes (-) in place of the pressure value. For each subsequent ignition switch cycle, a chime will sound, the TPMS Warning Light will flash on

and off for 75 seconds and then remain on solid, and the instrument cluster display will display a "SERVICE TPM SYSTEM" message for five seconds and then display dashes (–) in place of the pressure value. Once you repair or replace the original road tire, and reinstall it on the vehicle in place of the spare tire, the TPMS will update automatically.

In addition, the TPMS Warning Light will turn off and the graphic in the instrument cluster display will display a new pressure value instead of dashes (–), as long as no tire pressure is below the low-pressure warning limit in any of the four active road tires. The vehicle may need to be driven for up to 20 minutes above 15 mph (24 km/h) in order for the TPMS to receive this information.

### TPMS Deactivation — If Equipped

The TPMS can be deactivated if replacing all four wheel and tire assemblies (road tires) with wheel and tire assemblies that do not have TPMS sensors, such as when installing winter wheel and tire assemblies on your vehicle.

To deactivate the TPMS, first, replace all four wheel and tire assemblies (road tires) with tires not equipped with TPMS sensors. Then, drive the vehicle for 20 minutes above 15 mph (24 km/h). The TPMS will chime, the TPMS Warning Light will flash on and off for 75 seconds and then remain on. The instrument cluster will display the

"SERVICE TPM SYSTEM" message and then display dashes (–) in place of the pressure values.

Beginning with the next ignition cycle, the TPMS will no longer chime or display the "SERVICE TPM SYSTEM" message in the instrument cluster but dashes (–) will remain in place of the pressure values.

To reactivate the TPMS, replace all four wheel and tire assemblies (road tires) with tires equipped with TPMS sensors. Then, drive the vehicle for up to 20 minutes above 15 mph (24 km/h). The TPMS will chime, the TPMS Warning Light will flash on and off for 75 seconds and then turn off. The instrument cluster will display the "SERVICE TPM SYSTEM" message and then display pressure values in place of the dashes. On the next ignition cycle the "SERVICE TPM SYSTEM" message will no longer be displayed as long as no system fault exists.

## OCCUPANT RESTRAINT SYSTEMS

Some of the most important safety features in your vehicle are the restraint systems:

### OCCUPANT RESTRAINT SYSTEMS FEATURES

- Seat Belt Systems
- Supplemental Restraint Systems (SRS) Air Bags
- Child Restraints

Some of the safety features described in this section may be standard equipment on some models, or may be optional equipment on others. If you are not sure, ask an authorized dealer.

### IMPORTANT SAFETY PRECAUTIONS

Please pay close attention to the information in this section. It tells you how to use your restraint system properly, to keep you and your passengers as safe as possible.

Here are some simple steps you can take to minimize the risk of harm from a deploying air bag:

1. Children 12 years old and under should always ride buckled up in the rear seat of a vehicle with a rear seat.
2. A child who is not big enough to wear the vehicle seat belt properly must be secured in the appropriate child restraint or belt-positioning booster seat in a rear seating position ↪ page 220.
3. If a child from 2 to 12 years old (not in a rear-facing child restraint) must ride in the front passenger seat, move the seat as far back as possible and use the proper child restraint ↪ page 220.
4. Never allow children to slide the shoulder belt behind them or under their arm.

5. You should read the instructions provided with your child restraint to make sure that you are using it properly.
6. All occupants should always wear their lap and shoulder belts properly.
7. The driver and front passenger seats should be moved back as far as practical to allow the front air bags room to inflate.
8. Do not lean against the door or window. If your vehicle has side air bags, and deployment occurs, the side air bags will inflate forcefully into the space between occupants and the door and occupants could be injured.
9. If the air bag system in this vehicle needs to be modified to accommodate a disabled person, see  page 311 for customer service contact information.

**WARNING!**

- Never place a rear-facing child restraint in front of an air bag. A deploying passenger front air bag can cause death or serious injury to a child 12 years or younger, including a child in a rear-facing child restraint.

*(Continued)***WARNING!**

- Never install a rear-facing child restraint in the front seat of a vehicle. Only use a rear-facing child restraint in the rear seat. If the vehicle does not have a rear seat, do not transport a rear-facing child restraint in that vehicle.

**SEAT BELT SYSTEMS**

Buckle up even though you are an excellent driver, even on short trips. Someone on the road may be a poor driver and could cause a collision that includes you. This can happen far away from home or on your own street.

Research has shown that seat belts save lives, and they can reduce the seriousness of injuries in a collision. Some of the worst injuries happen when people are thrown from the vehicle. Seat belts reduce the possibility of ejection and the risk of injury caused by striking the inside of the vehicle. Everyone in a motor vehicle should be belted at all times.

**Enhanced Seat Belt Use Reminder System (BeltAlert)****Driver and Passenger BeltAlert — If Equipped**

BeltAlert is a feature intended to remind the driver and outboard front seat passenger (if equipped with outboard

front passenger seat BeltAlert) to buckle their seat belts. The BeltAlert feature is active whenever the ignition switch is in the START or ON/RUN position.

**Initial Indication**

If the driver is unbuckled when the ignition switch is first in the START or ON/RUN position, a chime will signal for a few seconds. If the driver or outboard front seat passenger (if equipped with outboard front passenger seat BeltAlert) is unbuckled when the ignition switch is first in the START or ON/RUN position the Seat Belt Reminder Light will turn on and remain on until both outboard front seat belts are buckled. The outboard front passenger seat BeltAlert is not active when an outboard front passenger seat is unoccupied.

**BeltAlert Warning Sequence**

The BeltAlert warning sequence is activated when the vehicle is moving above a specified vehicle speed range and the driver or outboard front seat passenger is unbuckled (if equipped with outboard front passenger seat BeltAlert) (the outboard front passenger seat BeltAlert is not active when the outboard front passenger seat is unoccupied). The BeltAlert warning sequence starts by blinking the Seat Belt Reminder Light and sounding an intermittent chime. Once the BeltAlert warning sequence has completed, the Seat Belt Reminder Light will remain on until the seat belts are buckled. The BeltAlert warning sequence may repeat based on vehicle speed until the driver and



occupied outboard front seat passenger seat belts are buckled. The driver should instruct all occupants to buckle their seat belts.

### Change Of Status

If the driver or outboard front seat passenger (if equipped with outboard front passenger seat BeltAlert) unbuckles their seat belt while the vehicle is traveling, the BeltAlert warning sequence will begin until the seat belts are buckled again.

The outboard front passenger seat BeltAlert is not active when the outboard front passenger seat is unoccupied. BeltAlert may be triggered when an animal or other items are placed on the outboard front passenger seat or when the seat is folded flat (if equipped). It is recommended that pets be restrained in the rear seat (if equipped) in pet harnesses or pet carriers that are secured by seat belts, and cargo is properly stowed.

BeltAlert can be activated or deactivated by an authorized dealer. FCA US LLC does not recommend deactivating BeltAlert.

### NOTE:

If BeltAlert has been deactivated and the driver or outboard front seat passenger (if equipped with outboard front passenger seat BeltAlert) is unbuckled the Seat Belt Reminder Light will turn on and remain on until the driver and outboard front seat passenger seat belts are buckled.

## Lap/Shoulder Belts

All seating positions in your vehicle are equipped with lap/shoulder belts.

The seat belt webbing retractor will lock only during very sudden stops or collisions. This feature allows the shoulder part of the seat belt to move freely with you under normal conditions. However, in a collision the seat belt will lock and reduce your risk of striking the inside of the vehicle or being thrown out of the vehicle.

### WARNING!

- Relying on the air bags alone could lead to more severe injuries in a collision. The air bags work with your seat belt to restrain you properly. In some collisions, the air bags won't deploy at all. Always wear your seat belt even though you have air bags.
- In a collision, you and your passengers can suffer much greater injuries if you are not properly buckled up. You can strike the interior of your vehicle or other passengers, or you can be thrown out of the vehicle. Always be sure you and others in your vehicle are buckled up properly.

*(Continued)*

### WARNING!

- It is dangerous to ride in a cargo area, inside or outside of a vehicle. In a collision, people riding in these areas are more likely to be seriously injured or killed.
- Do not allow people to ride in any area of your vehicle that is not equipped with seats and seat belts.
- Be sure everyone in your vehicle is in a seat and using a seat belt properly. Occupants, including the driver, should always wear their seat belts whether or not an air bag is also provided at their seating position to minimize the risk of severe injury or death in the event of a crash.
- Wearing your seat belt incorrectly could make your injuries in a collision much worse. You might suffer internal injuries, or you could even slide out of the seat belt. Follow these instructions to wear your seat belt safely and to keep your passengers safe, too.
- Two people should never be belted into a single seat belt. People belted together can crash into one another in a collision, hurting one another badly. Never use a lap/shoulder belt or a lap belt for more than one person, no matter what their size.

**WARNING!**

- A lap belt worn too high can increase the risk of injury in a collision. The seat belt forces won't be at the strong hip and pelvic bones, but across your abdomen. Always wear the lap part of your seat belt as low as possible and keep it snug.
- A twisted seat belt may not protect you properly. In a collision, it could even cut into you. Be sure the seat belt is flat against your body, without twists. If you can't straighten a seat belt in your vehicle, take it to an authorized dealer immediately and have it fixed.
- A seat belt that is buckled into the wrong buckle will not protect you properly. The lap portion could ride too high on your body, possibly causing internal injuries. Always buckle your seat belt into the buckle nearest you.
- A seat belt that is too loose will not protect you properly. In a sudden stop, you could move too far forward, increasing the possibility of injury. Wear your seat belt snugly.

*(Continued)***WARNING!**

- A seat belt that is worn under your arm is dangerous. Your body could strike the inside surfaces of the vehicle in a collision, increasing head and neck injury. A seat belt worn under the arm can cause internal injuries. Ribs aren't as strong as shoulder bones. Wear the seat belt over your shoulder so that your strongest bones will take the force in a collision.
- A shoulder belt placed behind you will not protect you from injury during a collision. You are more likely to hit your head in a collision if you do not wear your shoulder belt. The lap and shoulder belt are meant to be used together.
- A frayed or torn seat belt could rip apart in a collision and leave you with no protection. Inspect the seat belt system periodically, checking for cuts, frays, or loose parts. Damaged parts must be replaced immediately. Do not disassemble or modify the seat belt system. If your vehicle is involved in a collision, or if you have questions regarding seat belt or retractor conditions, take your vehicle to an authorized FCA dealer or authorized FCA Certified Collision Care Program facility for inspection.

**Lap/Shoulder Belt Operating Instructions**

1. Enter the vehicle and close the door. Sit back and adjust the seat.
2. The seat belt latch plate is above the back of the front seat, and next to your arm in the rear seat (for vehicles equipped with a rear seat). Grab the latch plate and pull out the seat belt. Slide the latch plate up the webbing as far as necessary to allow the seat belt to go around your lap.

**Pulling Out The Latch Plate**

- When the seat belt is long enough to fit, insert the latch plate into the buckle until you hear a “click.”



**Inserting Latch Plate Into Buckle**

- Position the lap belt so that it is snug and lies low across your hips, below your abdomen. To remove slack in the lap belt portion, pull up on the shoulder belt. To loosen the lap belt if it is too tight, tilt the latch plate and pull on the lap belt. A snug seat belt reduces the risk of sliding under the seat belt in a collision.



**Positioning The Lap Belt**

- Position the shoulder belt across the shoulder and chest with minimal, if any slack so that it is comfortable and not resting on your neck. The retractor will withdraw any slack in the shoulder belt.
- To release the seat belt, push the red button on the buckle. The seat belt will automatically retract to its stowed position. If necessary, slide the latch plate down the webbing to allow the seat belt to retract fully.

### Lap/Shoulder Belt Untwisting Procedure

Use the following procedure to untwist a twisted lap/shoulder belt.

- Position the latch plate as close as possible to the anchor point.
- At about 6 to 12 inches (15 to 30 cm) above the latch plate, grab and twist the seat belt webbing 180 degrees to create a fold that begins immediately above the latch plate.
- Slide the latch plate upward over the folded webbing. The folded webbing must enter the slot at the top of the latch plate.
- Continue to slide the latch plate up until it clears the folded webbing and the seat belt is no longer twisted.

## Adjustable Upper Shoulder Belt Anchorage

In the driver and outboard front passenger seats, the top of the shoulder belt can be adjusted upward or downward to position the seat belt away from your neck. Push or squeeze the anchorage button to release the anchorage, and move it up or down to the position that serves you best.

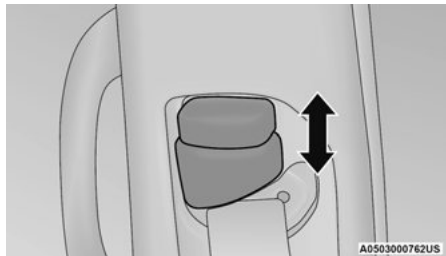

**Adjustable Upper Anchorage**

As a guide, if you are shorter than average, you will prefer the shoulder belt anchorage in a lower position, and if you are taller than average, you will prefer the shoulder belt anchorage in a higher position. After you release the anchorage button, try to move it up or down to make sure that it is locked in position.

### NOTE:

The adjustable upper shoulder belt anchorage is equipped with an Easy Up feature. This feature allows the shoulder belt anchorage to be adjusted in the upward position without pushing or squeezing the release button. To verify the shoulder belt anchorage is latched, pull downward on the shoulder belt anchorage until it is locked into position.

#### WARNING!

- Wearing your seat belt incorrectly could make your injuries in a collision much worse. You might suffer internal injuries, or you could even slide out of the seat belt. Follow these instructions to wear your seat belt safely and to keep your passengers safe, too.
- Position the shoulder belt across the shoulder and chest with minimal, if any slack so that it is comfortable and not resting on your neck. The retractor will withdraw any slack in the shoulder belt.
- Misadjustment of the seat belt could reduce the effectiveness of the safety belt in a crash.
- Always make all seat belt height adjustments when the vehicle is stationary.

## Seat Belt Extender

If a seat belt is not long enough to fit properly, even when the webbing is fully extended and the adjustable upper shoulder belt anchorage (if equipped) is in its lowest position, an authorized dealer can provide you with a Seat Belt Extender. The Seat Belt Extender should be used only if the existing seat belt is not long enough. When the Seat Belt Extender is not required for a different occupant, it must be removed.

#### WARNING!

- ONLY use a Seat Belt Extender if it is physically required in order to properly fit the original seat belt system. DO NOT USE the Seat Belt Extender if, when worn, the distance between the front edge of the Seat Belt Extender buckle and the center of the occupant's body is LESS than 6 inches.
- Using a Seat Belt Extender when not needed can increase the risk of serious injury or death in a collision. Only use the Seat Belt Extender when the lap belt is not long enough and only use in the recommended seating positions. Remove and store the Seat Belt Extender when not needed.

## Seat Belts And Pregnant Women

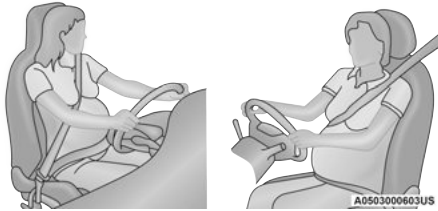

Seat Belts And Pregnant Women

Seat belts must be worn by all occupants including pregnant women: the risk of injury in the event of an accident is reduced for the mother and the unborn child if they are wearing a seat belt.

Position the lap belt snug and low below the abdomen and across the strong bones of the hips. Place the shoulder belt across the chest and away from the neck. Never place the shoulder belt behind the back or under the arm.

### Seat Belt Pretensioner

The front outboard seat belt system is equipped with pretensioning devices that are designed to remove slack from the seat belt in the event of a collision. These devices may improve the performance of the seat belt by removing slack

from the seat belt early in a collision. Pretensioners work for all size occupants, including those in child restraints.

### NOTE:

These devices are not a substitute for proper seat belt placement by the occupant. The seat belt still must be worn snugly and positioned properly.

The pretensioners are triggered by the Occupant Restraint Controller (ORC). Like the air bags, the pretensioners are single use items. A deployed pretensioner or a deployed air bag must be replaced immediately.

### Energy Management Feature

The front outboard seat belt system is equipped with an Energy Management feature that may help further reduce the risk of injury in the event of a collision. The seat belt system has a retractor assembly that is designed to release webbing in a controlled manner.

### Switchable Automatic Locking Retractor (ALR)

The seat belts in the passenger seating positions are equipped with a Switchable Automatic Locking Retractor (ALR) which is used to secure a child restraint system ↪ page 229.

The figure below illustrates the locking feature for each seating position.

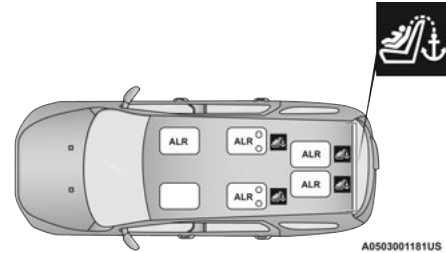

Captain's Chairs Second Row (6 Passenger) Automatic Locking Retractor (ALR) Locations

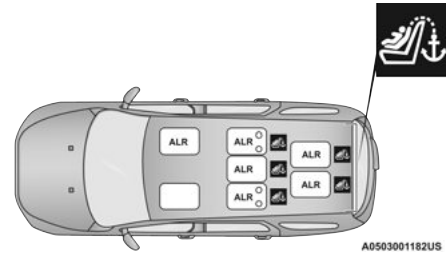

60/40 Second Row (7 Passenger) Automatic Locking Retractor (ALR) Locations

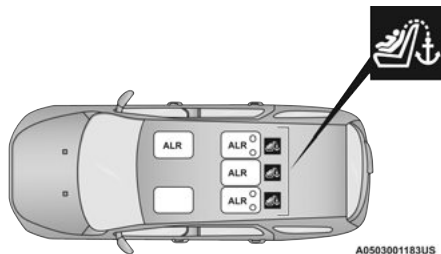

### 60/40 Second Row (5 Passenger) Automatic Locking Retractor (ALR) Locations

If the passenger seating position is equipped with an ALR and is being used for normal usage, only pull the seat belt webbing out far enough to comfortably wrap around the occupant's mid-section so as to not activate the ALR. If the ALR is activated, you will hear a clicking sound as the seat belt retracts. Allow the webbing to retract completely in this case and then carefully pull out only the amount of webbing necessary to comfortably wrap around the occupant's mid-section. Slide the latch plate into the buckle until you hear a "click".

In Automatic Locking Mode, the shoulder belt is automatically pre-locked. The seat belt will still retract to remove any slack in the shoulder belt. Use the Automatic Locking Mode anytime a child restraint is installed in a seating position that has

a seat belt with this feature. Children 12 years old and under should always be properly restrained in the rear seat of a vehicle with a rear seat.

#### WARNING!

- Never place a rear-facing child restraint in front of an air bag. A deploying passenger front air bag can cause death or serious injury to a child 12 years or younger, including a child in a rear-facing child restraint.
- Never install a rear-facing child restraint in the front seat of a vehicle. Only use a rear-facing child restraint in the rear seat. If the vehicle does not have a rear seat, do not transport a rear-facing child restraint in that vehicle.

#### How To Engage The Automatic Locking Mode

1. Buckle the combination lap and shoulder belt.
2. Grab the shoulder portion and pull downward until the entire seat belt is extracted.
3. Allow the seat belt to retract. As the seat belt retracts, you will hear a clicking sound. This indicates the seat belt is now in the Automatic Locking Mode.

#### How To Disengage The Automatic Locking Mode

Unbuckle the combination lap/shoulder belt and allow it to retract completely to disengage the Automatic Locking Mode and activate the vehicle sensitive (emergency) locking mode.

#### WARNING!

- The seat belt assembly must be replaced if the switchable Automatic Locking Retractor (ALR) feature or any other seat belt function is not working properly when checked according to the procedures in the Service Manual.
- Failure to replace the seat belt assembly could increase the risk of injury in collisions.
- Do not use the Automatic Locking Mode to restrain occupants who are wearing the seat belt or children who are using booster seats. The locked mode is only used to install rear-facing or forward-facing child restraints that have a harness for restraining the child.

## SUPPLEMENTAL RESTRAINT SYSTEMS (SRS)

Some of the safety features described in this section may be standard equipment on some models, or may be optional equipment on others. If you are not sure, ask an authorized dealer.

The air bag system must be ready to protect you in a collision. The Occupant Restraint Controller (ORC) monitors the internal circuits and interconnecting wiring associated with the electrical Air Bag System Components. Your vehicle may be equipped with the following Air Bag System Components:

### Air Bag System Components

- Occupant Restraint Controller (ORC)
- Air Bag Warning Light 
- Steering Wheel and Column
- Instrument Panel
- Knee Impact Bolsters
- Driver and Front Passenger Air Bags
- Seat Belt Buckle Switch
- Supplemental Side Air Bags
- Supplemental Knee Air Bags
- Front and Side Impact Sensors
- Seat Belt Pretensioners

- Seat Track Position Sensors
- Occupant Classification System

### Air Bag Warning Light



The Occupant Restraint Controller (ORC) monitors the readiness of the electronic parts of the air bag system whenever the ignition switch is in the START or ON/RUN position. If the ignition switch is in the OFF position or in the ACC position, the air bag system is not on and the air bags will not inflate.

The ORC contains a backup power supply system that may deploy the air bag system even if the battery loses power or it becomes disconnected prior to deployment.

The ORC turns on the Air Bag Warning Light in the instrument panel for approximately four to eight seconds for a self-check when the ignition switch is first in the ON/RUN position. After the self-check, the Air Bag Warning Light will turn off. If the ORC detects a malfunction in any part of the system, it turns on the Air Bag Warning Light, either momentarily or continuously. A single chime will sound to alert you if the light comes on again after initial startup.

The ORC also includes diagnostics that will illuminate the instrument panel Air Bag Warning Light if a malfunction is detected that could affect the air bag system. The diagnostics also record the nature of the malfunction. While the air bag system

is designed to be maintenance free, if any of the following occurs, have an authorized dealer service the air bag system immediately.

- The Air Bag Warning Light does not come on during the four to eight seconds when the ignition switch is first in the ON/RUN position.
- The Air Bag Warning Light remains on after the four to eight-second interval.
- The Air Bag Warning Light comes on intermittently or remains on while driving.

### NOTE:

If the speedometer, tachometer, or any engine related gauges are not working, the Occupant Restraint Controller (ORC) may also be disabled. In this condition the air bags may not be ready to inflate for your protection. Have an authorized dealer service the air bag system immediately.

### WARNING!

Ignoring the Air Bag Warning Light in your instrument panel could mean you won't have the air bag system to protect you in a collision. If the light does not come on as a bulb check when the ignition is first turned on, stays on after you start the vehicle, or if it comes on as you drive, have an authorized dealer service the air bag system immediately.

## Redundant Air Bag Warning Light



If a fault with the Air Bag Warning Light is detected, which could affect the Supplemental Restraint System (SRS), the Redundant Air Bag Warning Light will illuminate on the instrument panel. The Redundant Air Bag Warning Light will stay on until the fault is cleared. In addition, a single chime will sound to alert you that the Redundant Air Bag Warning Light has come on and a fault has been detected. If the Redundant Air Bag Warning Light comes on intermittently or remains on while driving have an authorized dealer service the vehicle immediately → page 89.

## Front Air Bags

This vehicle has front air bags and lap/shoulder belts for both the driver and front passenger. The front air bags are a supplement to the seat belt restraint systems. The driver front air bag is mounted in the center of the steering wheel. The passenger front air bag is mounted in the instrument panel, above the glove compartment. The words “SRS AIRBAG” or “AIRBAG” are embossed on the air bag covers.

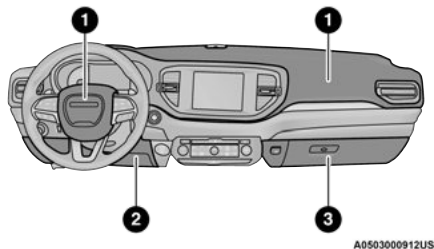

**Front Air Bag/Knee Bolster Locations**

- 1 – Driver And Passenger Front Air Bags
- 2 – Driver Knee Impact Bolster/Supplemental Driver Knee Air Bag
- 3 – Passenger Knee Impact Bolster

### WARNING!

- Being too close to the steering wheel or instrument panel during front air bag deployment could cause serious injury, including death. Air bags need room to inflate. Sit back, comfortably extending your arms to reach the steering wheel or instrument panel.

*(Continued)*

### WARNING!

- Never place a rear-facing child restraint in front of an air bag. A deploying passenger front air bag can cause death or serious injury to a child 12 years or younger, including a child in a rear-facing child restraint.
- Never install a rear-facing child restraint in the front seat of a vehicle. Only use a rear-facing child restraint in the rear seat. If the vehicle does not have a rear seat, do not transport a rear-facing child restraint in that vehicle.

## Driver And Passenger Front Air Bag Features

The Advanced Front Air Bag system has multistage driver and front passenger air bags. This system provides output appropriate to the severity and type of collision as determined by the Occupant Restraint Controller (ORC), which may receive information from the front impact sensors (if equipped) or other system components.

The first stage inflator is triggered immediately during an impact that requires air bag deployment. A low energy output is used in less severe collisions. A higher energy output is used for more severe collisions.



This vehicle may be equipped with a driver and/or front passenger seat belt buckle switch that detects whether the driver or front passenger seat belt is buckled. The seat belt buckle switch may adjust the inflation rate of the Advanced Front Air Bags.

This vehicle may be equipped with driver and/or front passenger seat track position sensors that may adjust the inflation rate of the Advanced Front Air Bags based upon seat position.

This vehicle is equipped with a right front passenger Occupant Classification System (OCS) that is designed to provide Passenger Advanced Front Air Bag output appropriate to the occupant's seated weight input, as determined by the OCS.

#### WARNING!

- No objects should be placed over or near the air bag on the instrument panel or steering wheel because any such objects could cause harm if the vehicle is in a collision severe enough to cause the air bag to inflate.
- Do not put anything on or around the air bag covers or attempt to open them manually. You may damage the air bags and you could be injured because the air bags may no longer be functional. The protective covers for the air bag cushions are designed to open only when the air bags are inflating.

(Continued)

#### WARNING!

- Relying on the air bags alone could lead to more severe injuries in a collision. The air bags work with your seat belt to restrain you properly. In some collisions, air bags won't deploy at all. Always wear your seat belts even though you have air bags.

### Front Air Bag Operation

Front Air Bags are designed to provide additional protection by supplementing the seat belts. Front air bags are not expected to reduce the risk of injury in rear, side, or rollover collisions. The front air bags will not deploy in all frontal collisions, including some that may produce substantial vehicle damage — for example, some pole collisions, truck underrides, and angle offset collisions.

On the other hand, depending on the type and location of impact, front air bags may deploy in crashes with little vehicle front-end damage but that produce a severe initial deceleration.

Because air bag sensors measure vehicle deceleration over time, vehicle speed and damage by themselves are not good indicators of whether or not an air bag should have deployed.

Seat belts are necessary for your protection in all collisions, and also are needed to help keep you in position, away from an inflating air bag.

When the Occupant Restraint Controller (ORC) detects a collision requiring the front air bags, it signals the inflator units. A large quantity of non-toxic gas is generated to inflate the front air bags.

The steering wheel hub trim cover and the upper passenger side of the instrument panel separate and fold out of the way as the air bags inflate to their full size. The front air bags fully inflate in less time than it takes to blink your eyes. The front air bags then quickly deflate while helping to restrain the driver and front passenger.

### Occupant Classification System (OCS) — Front Passenger Seat

The Occupant Classification System (OCS) is part of a Federally regulated safety system for this vehicle. It is designed to provide Passenger Advanced Front Air Bag output appropriate to the occupant's seated weight, as determined by the OCS.

The Occupant Classification System (OCS) consists of the following:

- Occupant Restraint Controller (ORC)
- Occupant Classification Module (OCM) and Sensor located in the front passenger seat
- Air Bag Warning Light 

**Occupant Classification Module (OCM) And Sensor**

The Occupant Classification Module (OCM) is located underneath the front passenger seat. The Sensor is located beneath the passenger seat cushion foam. Any weight on the seat will be sensed by the Sensor. The OCM uses input from the Sensor to determine the front passenger's most probable classification. The OCM communicates this information to the ORC. The ORC may reduce the inflation rate of the Passenger Advanced Front Air Bag deployment based on occupant classification. In order for the OCS to operate as designed, it is important for the front passenger to be seated properly and properly wearing the seat belt.

The OCS will NOT prevent deployment of the Passenger Advanced Front Air Bag. The OCS may reduce the inflation rate of the Passenger Advanced Front Air Bag if the OCS estimates that:

- The front passenger seat is unoccupied or has very light objects on it; or
- The front passenger seat is occupied by a small passenger, including a child; or
- The front passenger seat is occupied by a rear-facing child restraint; or
- The front passenger is not properly seated or his or her weight is taken off of the seat for a period of time.

Front Passenger Seat Occupant Status	Front Passenger Air Bag Output
Rear-facing child restraint	Reduced-power deployment
Child, including a child in a forward-facing child restraint or booster seat*	Reduced-power deployment OR full-power deployment
Properly seated adult	Full-power deployment OR reduced-power deployment
Unoccupied seat	Reduced-power deployment

\* It is possible for a child to be classified as an adult, allowing a full-power Passenger Advanced Front Air Bag deployment. Never allow children to ride in the front passenger seat and never install a child restraint system, including a rear-facing child restraint, in the front passenger seat.

<b>WARNING!</b>
<ul style="list-style-type: none"> <li>● Never place a rear-facing child restraint in front of an air bag. A deploying passenger front air bag can cause death or serious injury to a child 12 years or younger, including a child in a rear-facing child restraint.</li> </ul>

(Continued)

**WARNING!**

- Never install a rear-facing child restraint in the front seat of a vehicle. Only use a rear-facing child restraint in the rear seat. If the vehicle does not have a rear seat, do not transport a rear-facing child restraint in that vehicle.
- Children 12 years or younger should always ride buckled up in the rear seat of a vehicle with a rear seat.

The OCS determines the front passenger's most probable classification. The OCS estimates the seated weight on the front passenger seat and where that weight is located. The OCS communicates the classification status to the ORC. The ORC uses the classification to determine whether the Passenger Advanced Front Air Bag inflation rate should be adjusted.

In order for the OCS to operate as designed, it is important for the front passenger to be seated properly and properly wearing the seat belt. Properly seated passengers are:

- Sitting upright
- Facing forward
- Sitting in the center of the seat with their feet comfortably on or near the floor
- Sitting with their back against the seatback and the seatback in an upright position

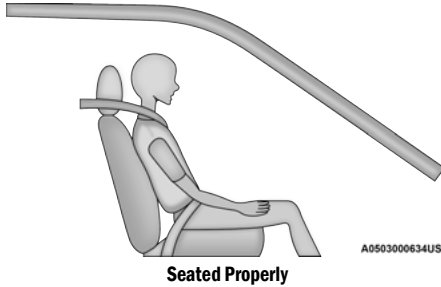

### Lighter Weight Passengers (Including Small Adults)

When a lighter weight passenger, including a small adult, occupies the front passenger seat, the OCS may reduce the inflation rate of the Passenger Advanced Front Air Bag. This does not mean that the OCS is working improperly.

### Do not decrease OR increase the front passenger's seated weight on the front passenger seat

The front passenger's seated weight must be properly positioned on the front passenger seat. Failure to do so may result in serious injury or death. The OCS determines the most probable classification of the occupant that it detects. The OCS will detect the front passenger's decreased or increased seated weight, which may result in an adjusted inflation rate of the Passenger Advanced Front Air Bag in a collision. This does not mean that the OCS is working improperly. Decreasing the

front passenger's seated weight on the front passenger seat may result in a reduced-power deployment of the Passenger Advanced Front Air Bag. Increasing the front passenger's seated weight on the front passenger seat may result in a full-power deployment of the Passenger Advanced Front Air Bag.

Examples of improper front passenger seating include:

- The front passenger's weight is transferred to another part of the vehicle (like the door, arm rest or instrument panel).
- The front passenger leans forward, sideways, or turns to face the rear of the vehicle.
- The front passenger's seatback is not in the full upright position.
- The front passenger carries or holds an object while seated (e.g., backpack, box, etc.).
- Objects are lodged under the front passenger seat.
- Objects are lodged between the front passenger seat and center console.
- Accessories that may change the seated weight on the front passenger seat are attached to the front passenger seat.
- Anything that may decrease or increase the front passenger's seated weight.

The OCS determines the front passenger's most probable classification. If an occupant in the front passenger seat is seated improperly, the occupant may provide an output signal to the OCS that is different from the occupant's properly seated weight input, for example:

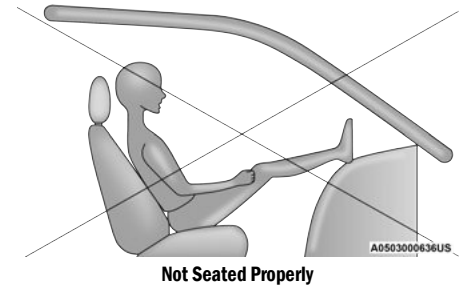
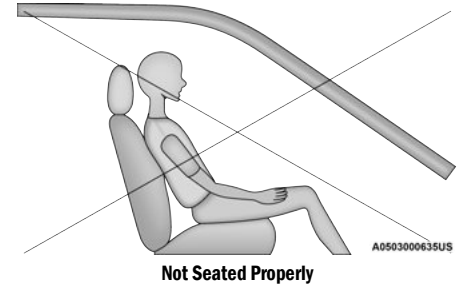

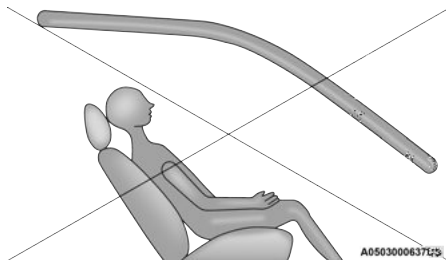

Not Seated Properly

A0503000637L25

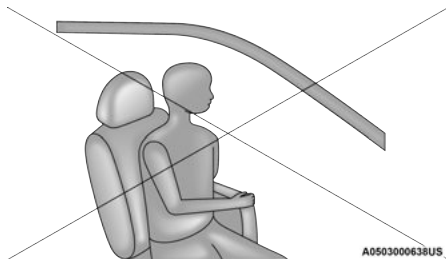



Not Seated Properly

A0503000638US

**WARNING!**

- If a child restraint system, child, small teenager or adult in the front passenger seat is seated improperly, the occupant may provide an output signal to the OCS that is different from the occupant's properly seated weight input. This may result in serious injury or death in a collision.
- Always wear your seat belt and sit properly, with the seatback in an upright position, your back against the seatback, sitting upright, facing forward, in the center of the seat, with your feet comfortably on or near the floor.
- Do not carry or hold any objects (e.g., backpacks, boxes, etc.) while seated in the front passenger seat. Holding an object may provide an output signal to the OCS that is different than the occupant's properly seated weight input, which may result in serious injury or death in a collision.
- Placing an object on the floor under the front passenger seat may prevent the OCS from working properly, which may result in serious injury or death in a collision. Do not place any objects on the floor under the front passenger seat.

The Air Bag Warning Light  in the instrument panel will turn on whenever the OCS is unable to classify the front passenger seat status. A malfunction in the OCS may affect the operation of the air bag system.

If the Air Bag Warning Light  does not come on, or stays on after you start the vehicle, or it comes on as you drive, take the vehicle to an authorized dealer for service immediately.

The passenger seat assembly contains critical OCS components that may affect the Passenger Advanced Front Air Bag inflation. In order for the OCS to properly classify the seated weight of a front seat passenger, the OCS components must function as designed. Do not make any modifications to the front passenger seat components, assembly, or to the seat cover. If the seat, trim cover, or cushion needs service for any reason, take the vehicle to an authorized dealer. Only FCA US LLC approved seat accessories may be used.

The following requirements must be strictly followed:

- Do not modify the front passenger seat assembly or components in any way.
- Do not use prior or future model year seat covers or cushions not designated by FCA US LLC for the specific model being repaired.

Always use the correct seat cover and cushion specified for the vehicle.

- Do not replace the seat cover or cushion with an aftermarket seat cover or cushion.
- Do not add a secondary seat cover or mat.
- At no time should any Supplemental Restraint System (SRS) component or SRS related component or fastener be modified or replaced with any part except those which are approved by FCA US LLC.

#### WARNING!

- Unapproved modifications or service procedures to the passenger seat assembly, its related components, seat cover or cushion may inadvertently change the air bag deployment in case of a frontal collision. This could result in death or serious injury to the front passenger if the vehicle is involved in a collision. A modified vehicle may not comply with required Federal Motor Vehicle Safety Standards (FMVSS) and/or Canadian Motor Vehicle Safety Standards (CMVSS).
- If it is necessary to modify the air bag system for persons with disabilities, contact an authorized dealer.

### Knee Impact Bolsters

The Knee Impact Bolsters help protect the knees of the driver and front passenger, and position the front occupants for improved interaction with the front air bags.

#### WARNING!

- Do not drill, cut, or tamper with the knee impact bolsters in any way.
- Do not mount any accessories to the knee impact bolsters such as alarm lights, stereos, citizen band radios, etc.

### Supplemental Driver Knee Air Bag

This vehicle is equipped with a Supplemental Driver Knee Air Bag mounted in the instrument panel below the steering column. The Supplemental Driver Knee Air Bag provides enhanced protection during a frontal impact by working together with the seat belts, pretensioners, and front air bags.

### Supplemental Side Air Bags

#### Supplemental Seat-Mounted Side Air Bags (SABs)

This vehicle is equipped with Supplemental Seat-Mounted Side Air Bags (SABs).

Supplemental Seat-Mounted Side Air Bags (SABs) are located in the outboard side of the front seats. The SABs are marked with "SRS AIRBAG" or "AIRBAG" on a label or on the seat trim on the outboard side of the seats.

The SABs may help to reduce the risk of occupant injury during certain side impacts, in addition to the injury reduction potential provided by the seat belts and body structure.

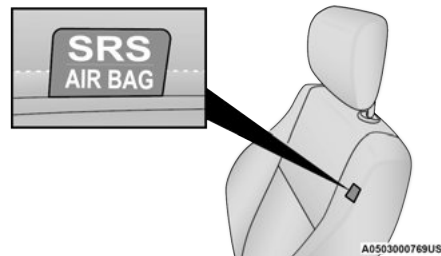

Front Supplemental Seat-Mounted Side Air Bag Label

When the SAB deploys, it opens the seam on the outboard side of the seatback's trim cover. The inflating SAB deploys through the seat seam into the space between the occupant and the door. The SAB moves at a very high speed and with such a high force that it could injure occupants if they are not seated properly, or if items are positioned in the area where the SAB inflates. Children are at an even greater risk of injury from a deploying air bag.

#### WARNING!

Do not use accessory seat covers or place objects between you and the Side Air Bags; the performance could be adversely affected and/or objects could be pushed into you, causing serious injury.

#### Supplemental Side Air Bag Inflatable Curtains (SABICs)

This vehicle is equipped with Supplemental Side Air Bag Inflatable Curtains (SABICs).

Supplemental Side Air Bag Inflatable Curtains (SABICs) are located above the side windows. The trim covering the SABICs is labeled "SRS AIRBAG" or "AIRBAG."

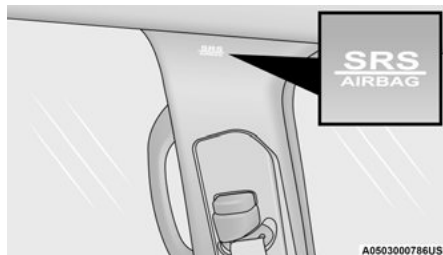

**Supplemental Side Air Bag Inflatable Curtain (SABIC)  
Label Location**

SABICs may help reduce the risk of head and other injuries to front and rear seat outboard occupants in certain side impacts, in addition to the injury reduction potential provided by the seat belts and body structure.

The SABIC deploys downward, covering the side windows. An inflating SABIC pushes the outside edge of the headliner out of the way and covers the window. The SABICs inflate with enough force to injure occupants if they are not belted and seated properly, or if items are positioned in the area where the SABICs inflate. Children are at an even greater risk of injury from a deploying air bag.

The SABICs may help reduce the risk of partial or complete ejection of vehicle occupants through side windows in certain side impact events.

#### WARNING!

- Do not mount equipment, or stack luggage or other cargo up high enough to block the deployment of the SABICs. The trim covering above the side windows where the SABIC and its deployment path are located should remain free from any obstructions.
- In order for the SABICs to work as intended, do not install any accessory items in your vehicle which could alter the roof. Do not add an after-market sunroof to your vehicle. Do not add roof racks that require permanent attachments (bolts or screws) for installation on the vehicle roof. Do not drill into the roof of the vehicle for any reason.

#### Side Impacts

The Side Air Bags are designed to activate in certain side impacts. The Occupant Restraint Controller (ORC) determines whether the deployment of the Side Air Bags in a particular impact event is appropriate, based on the severity and type of collision. The side impact sensors aid the ORC in determining the appropriate response to impact events. The system is calibrated to

deploy the Side Air Bags on the impact side of the vehicle during impacts that require Side Air Bag occupant protection. In side impacts, the Side Air Bags deploy independently; a left side impact deploys the left Side Air Bags only and a right-side impact deploys the right Side Air Bags only. Vehicle damage by itself is not a good indicator of whether or not Side Air Bags should have deployed.

The Side Air Bags will not deploy in all side collisions, including some collisions at certain angles, or some side collisions that do not impact the area of the passenger compartment. The Side Air Bags may deploy during angled or offset frontal collisions where the front air bags deploy.

Side Air Bags are a supplement to the seat belt restraint system. Side Air Bags deploy in less time than it takes to blink your eyes.

#### WARNING!

- Occupants, including children, who are up against or very close to Side Air Bags can be seriously injured or killed. Occupants, including children, should never lean on or sleep against the door, side windows, or area where the side air bags inflate, even if they are in an infant or child restraint.

*(Continued)*

#### WARNING!

- Seat belts (and child restraints where appropriate) are necessary for your protection in all collisions. They also help keep you in position, away from an inflating Side Air Bag. To get the best protection from the Side Air Bags, occupants must wear their seat belts properly and sit upright with their backs against the seats. Children must be properly restrained in a child restraint or booster seat that is appropriate for the size of the child.

#### WARNING!

- Side Air Bags need room to inflate. Do not lean against the door or window. Sit upright in the center of the seat.
- Being too close to the Side Air Bags during deployment could cause you to be severely injured or killed.
- Relying on the Side Air Bags alone could lead to more severe injuries in a collision. The Side Air Bags work with your seat belt to restrain you properly. In some collisions, Side Air Bags won't deploy at all. Always wear your seat belt even though you have Side Air Bags.

#### NOTE:

Air bag covers may not be obvious in the interior trim, but they will open during air bag deployment.

#### Rollover Events

Side Air Bags and seat belt pretensioners are designed to activate in certain rollover events. The Occupant Restraint Controller (ORC) determines whether deployment in a particular rollover event is appropriate, based on the severity and type of collision. Vehicle damage by itself is not a good indicator of whether or not Side Air Bags and seat belt pretensioners should have deployed.

The Side Air Bags and seat belt pretensioners will not deploy in all rollover events. The rollover sensing system determines if a rollover event may be in progress and whether deployment is appropriate. In the event the vehicle experiences a rollover or near rollover event, and deployment is appropriate, the rollover sensing system will deploy the side air bags and seat belt pretensioners on both sides of the vehicle.

The SABICs may help reduce the risk of partial or complete ejection of vehicle occupants through side windows in certain rollover or side impact events.

## Air Bag System Components

### NOTE:

The Occupant Restraint Controller (ORC) monitors the internal circuits and interconnecting wiring associated with electrical Air Bag System Components listed below:

- Occupant Restraint Controller (ORC)
- Air Bag Warning Light 
- Steering Wheel and Column
- Instrument Panel
- Knee Impact Bolsters
- Driver and Front Passenger Air Bags
- Seat Belt Buckle Switch
- Supplemental Side Air Bags
- Supplemental Knee Air Bags
- Front and Side Impact Sensors
- Seat Belt Pretensioners
- Seat Track Position Sensors
- Occupant Classification System

### If A Deployment Occurs

The front air bags are designed to deflate immediately after deployment.

### NOTE:

Front and/or side air bags will not deploy in all collisions. This does not mean something is wrong with the air bag system.

If you do have a collision which deploys the air bags, any or all of the following may occur:

- The air bag material may sometimes cause abrasions and/or skin reddening to the occupants as the air bags deploy and unfold. The abrasions are similar to friction rope burns or those you might get sliding along a carpet or gymnasium floor. They are not caused by contact with chemicals. They are not permanent and normally heal quickly. However, if you haven't healed significantly within a few days, or if you have any blistering, see your doctor immediately.
- As the air bags deflate, you may see some smoke-like particles. The particles are a normal by-product of the process that generates the non-toxic gas used for air bag inflation. These airborne particles may irritate the skin, eyes, nose, or throat. If you have skin or eye irritation, rinse the area with cool water. For nose or throat irritation, move to fresh air. If the irritation continues, see your doctor. If these particles settle on your clothing, follow the garment manufacturer's instructions for cleaning.

Do not drive your vehicle after the air bags have deployed. If you are involved in another collision, the air bags will not be in place to protect you.

### WARNING!

Deployed air bags and seat belt pretensioners cannot protect you in another collision. Have the air bags, seat belt pretensioners, and the seat belt retractor assemblies replaced by an authorized dealer immediately. Also, have the Occupant Restraint Controller System serviced as well.

### NOTE:

- Air bag covers may not be obvious in the interior trim, but they will open during air bag deployment.
- After any collision, the vehicle should be taken to an authorized dealer immediately.

### Enhanced Accident Response System

In the event of an impact, if the communication network remains intact, and the power remains intact, depending on the nature of the event, the Occupant Restraint Controller (ORC) will determine whether to have the Enhanced Accident Response System perform the following functions:

- Cut off fuel to the engine (if equipped).
- Cut off battery power to the electric motor (if equipped).



- Flash hazard lights as long as the battery has power.
- Turn on the interior lights, which remain on as long as the battery has power or for 15 minutes from the intervention of the Enhanced Accident Response System.
- Unlock the power door locks.

Your vehicle may also be designed to perform any of these other functions in response to the Enhanced Accident Response System:

- Turn off the Fuel Filter Heater, Turn off the HVAC Blower Motor, Close the HVAC Circulation Door
- Cut off battery power to the:
  - Engine
  - Electric Motor (if equipped)
  - Electric power steering
  - Brake booster
  - Electric park brake
  - Automatic transmission gear selector
  - Horn
  - Front wiper
  - Headlamp washer pump (if equipped)

#### NOTE:

After an accident, remember to cycle the ignition to the STOP (OFF/LOCK) position and remove the key from the ignition switch to avoid draining the

battery. Carefully check the vehicle for fuel leaks in the engine compartment and on the ground near the engine compartment and fuel tank before resetting the system and starting the engine. If there are no fuel leaks or damage to the vehicle electrical devices (e.g. headlights) after an accident, reset the system by following the procedure described below. If you have any doubt, contact an authorized dealer.

### Enhanced Accident Response System Reset Procedure

In order to reset the Enhanced Accident Response System functions after an event, the ignition switch must be changed from ignition START or ON/RUN to ignition OFF. Carefully check the vehicle for fuel leaks in the engine compartment and on the ground near the engine compartment and fuel tank before resetting the system and starting the engine.

After an accident, if the vehicle will not start after performing the reset procedure, the vehicle must be towed to an authorized dealer to be inspected and to have the Enhanced Accident Response System reset.

## Maintaining Your Air Bag System

### WARNING!

- Modifications to any part of the air bag system could cause it to fail when you need it. You could be injured if the air bag system is not there to protect you. Do not modify the components or wiring, including adding any kind of badges or stickers to the steering wheel hub trim cover or the upper passenger side of the instrument panel. Do not modify the front fascia/bumper, vehicle body structure, or add aftermarket side steps or running boards.
- It is dangerous to try to repair any part of the air bag system yourself. Be sure to tell anyone who works on your vehicle that it has an air bag system.
- Do not attempt to modify any part of your air bag system. The air bag may inflate accidentally or may not function properly if modifications are made. Take your vehicle to an authorized dealer for any air bag system service. If your seat, including your trim cover and cushion, needs to be serviced in any way (including removal or loosening/tightening of seat attachment bolts), take the vehicle to an authorized dealer. Only manufacturer approved seat accessories may be used. If it is necessary to modify the air bag system for persons with disabilities, contact an authorized dealer.

## Event Data Recorder (EDR)

This vehicle is equipped with an event data recorder (EDR). The main purpose of an EDR is to record, in certain crash or near crash-like situations, such as an air bag deployment or hitting a road obstacle, data that will assist in understanding how a vehicle's systems performed. The EDR is designed to record data related to vehicle dynamics and safety systems for a short period of time, typically 30 seconds or less. The EDR in this vehicle is designed to record such data as:

- How various systems in your vehicle were operating;
- Whether or not the driver and passenger safety belts were buckled/fastened;
- How far (if at all) the driver was depressing the accelerator and/or brake pedal; and,
- How fast the vehicle was traveling.

These data can help provide a better understanding of the circumstances in which crashes and injuries occur.

### NOTE:

EDR data are recorded by your vehicle only if a non-trivial crash situation occurs; no data are recorded by the EDR under normal driving conditions and no personal data (e.g., name, gender, age, and crash location) are recorded. However, other parties, such as law enforcement, could combine

the EDR data with the type of personally identifying data routinely acquired during a crash investigation.

To read data recorded by an EDR, special equipment is required, and access to the vehicle or the EDR is needed. In addition to the vehicle manufacturer, other parties, such as law enforcement, that have the special equipment, can read the information if they have access to the vehicle or the EDR.

## CHILD RESTRAINTS

Everyone in your vehicle needs to be buckled up at all times, including babies and children. Every state in the United States, and every Canadian province, requires that small children ride in proper restraint systems. This is the law, and you can be prosecuted for ignoring it.

Children 12 years or younger should ride properly buckled up in a rear seat, if available. According to crash statistics, children are safer when properly restrained in the rear seats rather than in the front.

### WARNING!

In a collision, an unrestrained child can become a projectile inside the vehicle. The force required to hold even an infant on your lap could become so great that you could not hold the child, no matter how strong you are. The child and others could be badly injured or killed. Any child riding in your vehicle should be in a proper restraint for the child's size.

There are different sizes and types of restraints for children from newborn size to the child almost large enough for an adult safety belt. Always check the child seat Owner's Manual to make sure you have the correct seat for your child. Carefully read and follow all the instructions and warnings in the child restraint Owner's Manual and on all the labels attached to the child restraint.

Before buying any restraint system, make sure that it has a label certifying that it meets all applicable Safety Standards. You should also make sure that you can install it in the vehicle where you will use it.

### NOTE:

- For additional information, refer to <http://www.nhtsa.gov/parents-and-caregivers> or call: 1-888-327-4236
- Canadian residents should refer to Transport Canada's website for additional information: <http://www.tc.gc.ca/en/services/road/child-car-seat-safety.html>

## Summary Of Recommendations For Restraining Children In Vehicles

	Child Size, Height, Weight Or Age	Recommended Type Of Child Restraint
Infants and Toddlers	Children who are two years old or younger and who have not reached the height or weight limits of their child restraint	Either an Infant Carrier or a Convertible Child Restraint, facing rearward in a rear seat of the vehicle
Small Children	Children who are at least two years old or who have outgrown the height or weight limit of their rear-facing child restraint	Forward-Facing Child Restraint with a five-point Harness, facing forward in a rear seat of the vehicle
Larger Children	Children who have outgrown their forward-facing child restraint, but are too small to properly fit the vehicle's seat belt	Belt Positioning Booster Seat and the vehicle seat belt, seated in a rear seat of the vehicle
Children Too Large for Child Restraints	Children 12 years old or younger, who have outgrown the height or weight limit of their booster seat	Vehicle Seat Belt, seated in a rear seat of the vehicle

### Infant And Child Restraints

Safety experts recommend that children ride rear-facing in the vehicle until they are two years old or until they reach either the height or weight limit of their rear-facing child restraint. Two types of child restraints can be used rear-facing: infant carriers and convertible child seats.

The infant carrier is only used rear-facing in the vehicle. It is recommended for children from birth until they reach the weight or height limit of the infant carrier. Convertible child seats can be used either rear-facing or forward-facing in the vehicle. Convertible child seats often have a higher weight limit in the rear-facing direction than infant carriers

do, so they can be used rear-facing by children who have outgrown their infant carrier but are still less than at least two years old. Children should remain rear-facing until they reach the highest weight or height allowed by their convertible child seat.

#### WARNING!

- Never place a rear-facing child restraint in front of an air bag. A deploying passenger front air bag can cause death or serious injury to a child 12 years or younger, including a child in a rear-facing child restraint.

(Continued)

#### WARNING!

- Never install a rear-facing child restraint in the front seat of a vehicle. Only use a rear-facing child restraint in the rear seat. If the vehicle does not have a rear seat, do not transport a rear-facing child restraint in that vehicle.

## Older Children And Child Restraints

Children who are two years old or who have outgrown their rear-facing convertible child seat can ride forward-facing in the vehicle.

Forward-facing child seats and convertible child seats used in the forward-facing direction are for children who are over two years old or who have outgrown the rear-facing weight or height limit of their rear-facing convertible child seat. Children should remain in a forward-facing child seat with a harness for as long as possible, up to the highest weight or height allowed by the child seat.

All children whose weight or height is above the forward-facing limit for the child seat should use a belt-positioning booster seat until the vehicle's seat belts fit properly. If the child cannot sit with knees bent over the vehicle's seat cushion while the child's back is against the seatback, they should use a belt-positioning booster seat. The child and belt-positioning booster seat are held in the vehicle by the seat belt.

### WARNING!

- Improper installation can lead to failure of an infant or child restraint. It could come loose in a collision. The child could be badly injured or killed. Follow the child restraint manufacturer's directions exactly when installing an infant or child restraint.

*(Continued)*

### WARNING!

- After a child restraint is installed in the vehicle, do not move the vehicle seat forward or rearward because it can loosen the child restraint attachments. Remove the child restraint before adjusting the vehicle seat position. When the vehicle seat has been adjusted, reinstall the child restraint.
- When your child restraint is not in use, secure it in the vehicle with the seat belt or LATCH anchorages, or remove it from the vehicle. Do not leave it loose in the vehicle. In a sudden stop or accident, it could strike the occupants or seatbacks and cause serious personal injury.

## Children Too Large For Booster Seats

Children who are large enough to wear the shoulder belt comfortably, and whose legs are long enough to bend over the front of the seat when their back is against the seatback, should use the seat belt in a rear seat. Use this simple 5-step test to decide whether the child can use the vehicle's seat belt alone:

1. Can the child sit all the way back against the back of the vehicle seat?
2. Do the child's knees bend comfortably over the front of the vehicle seat while the child is still sitting all the way back?

3. Does the shoulder belt cross the child's shoulder between the neck and arm?
4. Is the lap part of the belt as low as possible, touching the child's thighs and not the stomach?
5. Can the child stay seated like this for the whole trip?

If the answer to any of these questions was "no", then the child still needs to use a booster seat in this vehicle. If the child is using the lap/shoulder belt, check seat belt fit periodically and make sure the seat belt buckle is latched. A child's squirming or slouching can move the belt out of position. If the shoulder belt contacts the face or neck, move the child closer to the center of the vehicle, or use a booster seat to position the seat belt on the child correctly.

### WARNING!

Never allow a child to put the shoulder belt under an arm or behind their back. In a crash, the shoulder belt will not protect a child properly, which may result in serious injury or death. A child must always wear both the lap and shoulder portions of the seat belt correctly.

## Recommendations For Attaching Child Restraints

Restraint Type	Combined Weight of the Child + Child Restraint	Use Any Attachment Method Shown With An "X" Below			
		LATCH – Lower Anchors Only	Seat Belt Only	LATCH – Lower Anchors + Top Tether Anchor	Seat Belt + Top Tether Anchor
Rear-Facing Child Restraint	Up to 65 lbs (29.5 kg)	X	X		
Rear-Facing Child Restraint	More than 65 lbs (29.5 kg)		X		
Forward-Facing Child Restraint	Up to 65 lbs (29.5 kg)			X	X
Forward-Facing Child Restraint	More than 65 lbs (29.5 kg)				X

### Lower Anchors And Tethers For Children (LATCH) Restraint System



022668173

LATCH Label

Your vehicle is equipped with the child restraint anchorage system called LATCH, which stands for Lower Anchors and Tethers for Children. The LATCH system has three vehicle anchor points for installing LATCH-equipped child seats. There are two lower anchorages located at the back of the seat cushion where it meets the seatback and one top tether anchorage located behind the seating position. These anchorages are used to install LATCH-equipped child seats without using the vehicle's seat belts. Some seating positions may

have a top tether anchorage but no lower anchorages. In these seating positions, the seat belt must be used with the top tether anchorage to install the child restraint. Please see the following table for more information.

## LATCH Positions For Installing Child Restraints In This Vehicle

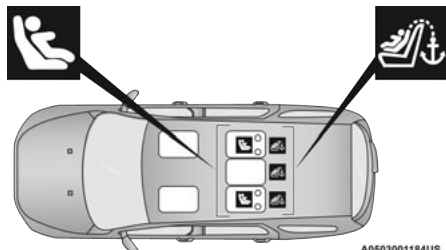

A0503001184US

### 60/40 Second Row LATCH Positions (5 Passenger)

 Lower Anchorage Symbol (2 Anchorages Per Seating Position)

 Top Tether Anchorage Symbol

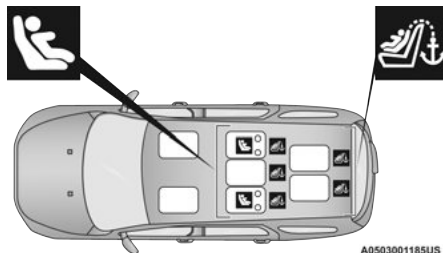

A0503001185US

### 60/40 Second Row LATCH Positions (7 Passenger)

 Lower Anchorage Symbol (2 Anchorages Per Seating Position)

 Top Tether Anchorage Symbol

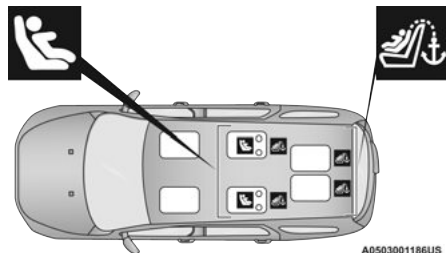

A0503001186US

### Captain's Chairs Second Row LATCH Positions (6 Passenger)

 Lower Anchorage Symbol (2 Anchorages Per Seating Position)

 Top Tether Anchorage Symbol

## Frequently Asked Questions About Installing Child Restraints With LATCH

<p>What is the weight limit (child's weight + weight of the child restraint) for using the LATCH anchorage system to attach the child restraint?</p>	<p>65 lbs (29.5 kg)</p>	<p>Use the LATCH anchorage system until the combined weight of the child and the child restraint is 65 lbs (29.5 kg). Use the seat belt and tether anchor instead of the LATCH system once the combined weight is more than 65 lbs (29.5 kg).</p>
<p>Can the LATCH anchorages and the seat belt be used together to attach a rear-facing or forward-facing child restraint?</p>	<p>No</p>	<p>Do not use the seat belt when you use the LATCH anchorage system to attach a rear-facing or forward-facing child restraint. Booster seats may be attached to the LATCH anchorages if allowed by the booster seat manufacturer. See your booster seat owner's manual for more information.</p>

### Frequently Asked Questions About Installing Child Restraints With LATCH

Can a child seat be installed in the center position using the inner LATCH lower anchorages from the outboard seating positions?	No – 5 Passenger N/A – 6 Passenger No – 7 Passenger	7 and 5 Passenger: Use the seat belt and tether anchor to install a child seat in the center seating position.
Can two child restraints be attached using a common lower LATCH anchorage?	No	Never “share” a LATCH anchorage with two or more child restraints. If the center position does not have dedicated LATCH lower anchorages, use the seat belt to install a child seat in the center position next to a child seat using the LATCH anchorages in an outboard position.
Can the rear-facing child restraint touch the back of the front passenger seat?	Yes	The child seat may touch the back of the front passenger seat if the child restraint manufacturer also allows contact. See your child restraint owner’s manual for more information.
Can the rear head restraints be removed?	No	

### Locating The LATCH Anchorages



The lower anchorages are round bars that are found at the rear of the seat cushion where it meets the seatback.

They are just visible when you lean into the rear seat to install the child restraint. You will easily feel them if you run your finger along the gap between the seatback and seat cushion.

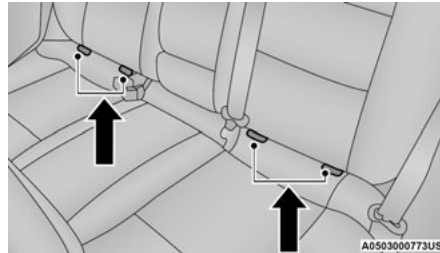

**Five Passenger Rear Seat Lower Anchorages**

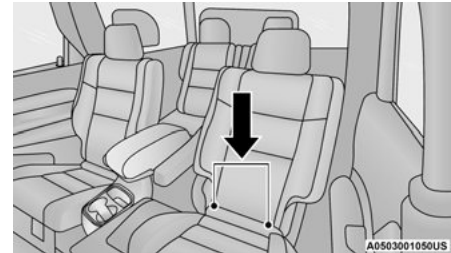

**Six Passenger Second Row Lower Anchorages**

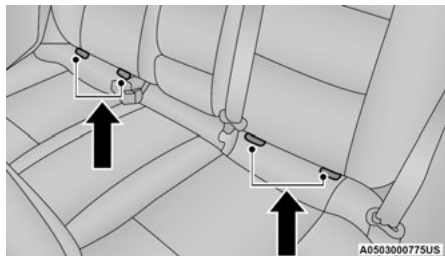

Seven Passenger Second Row Lower Anchorages

### Locating The Upper Tether Anchorages

#### Five Passenger Vehicles: 2nd Row Upper Tether Anchorage Locations



There are tether strap anchorages behind each rear seating position located on the back of the seat. To access them, pull the carpeted floor panel away from the seat back, this will expose the top tether strap anchorages.

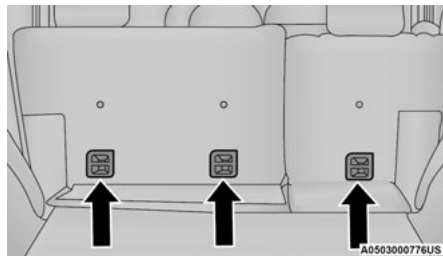

Pulling Down The Carpet Floor Panel To Access Top Tether Strap Anchorage (Five Passenger)

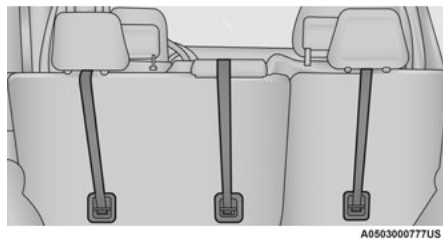

Five Passenger Top Tether Strap Mounting

#### Six And Seven Passenger Vehicles: 2nd Row Upper Tether Anchorage Locations

There are tether strap anchorages behind each rear seating position located on the back of the seat.

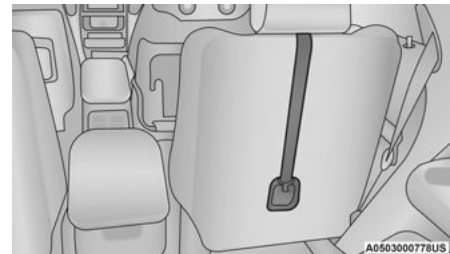

Six Passenger Top Tether Strap Mounting (Captain's Chair)

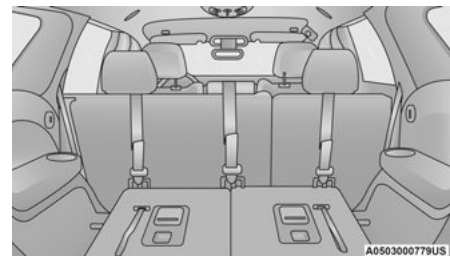

Seven Passenger Top Tether Strap Mounting (2nd Row Bench)



### Six And Seven Passenger Vehicles: 3rd Row Upper Tether Anchorage Locations

There are tether strap anchorages behind each rear seating position located on the back of the seat. To access them, pull the carpeted floor panel away from the seat back, this will expose the top tether strap anchorages.

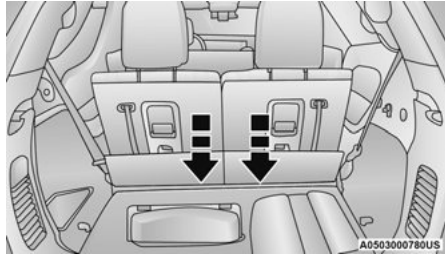

**Pulling Down The Carpet Floor Panel To Access Top Tether Strap (3rd Row Bench)**

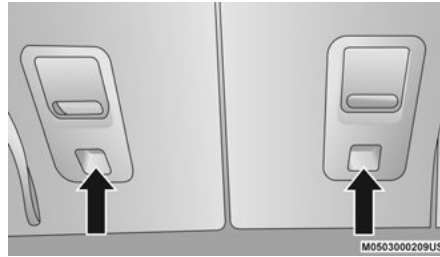

**Tether Anchorages (3rd Row Bench)**

LATCH-compatible child restraint systems will be equipped with a rigid bar or a flexible strap on each side. Each will have a hook or connector to attach to the lower anchorage and a way to tighten the connection to the anchorage. Forward-facing child restraints and some rear-facing child restraints will also be equipped with a tether strap. The tether strap will have a hook at the end to attach to the top tether anchorage and a way to tighten the strap after it is attached to the anchorage.

### Center Seat LATCH – Five Or Seven Passenger Vehicles Second Row Seating Only

#### WARNING!

- Do not install a child restraint in the center position using the LATCH system. This position is not approved for installing child seats using the LATCH attachments. You must use the seat belt and tether anchor to install a child seat in the center seating position.
- Never use the same lower anchorage to attach more than one child restraint. For typical installation instructions, see [page 228](#).

## Vehicle With A Center Arm Rest Tether — Five Or Seven Passenger Seating Only

For rear-facing child restraints secured in the center seat position with the vehicle seat belts, the rear center seat position has an armrest tether that secures the arm rest in the upward position.

1. To access the center seat arm rest tether, first lower the arm rest. The tether is located behind the armrest and hooked onto the plastic seat backing.

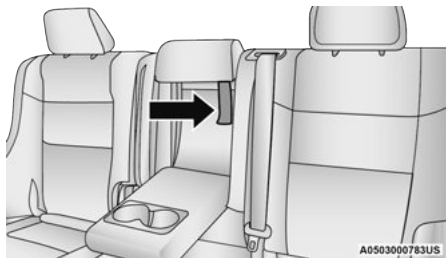

Center Seat Position Arm Rest Tether

2. Pull down on the tether to unhook it from the plastic seat backing.

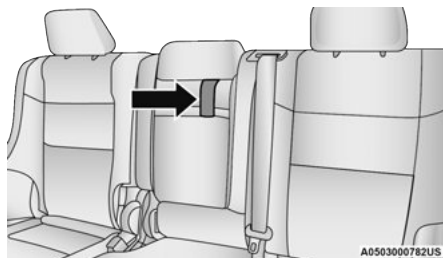

Center Seat Position Arm Rest Tether

3. Raise the armrest and attach the tether hook to the strap located on the front of the arm rest.

**Always follow the directions of the child restraint manufacturer when installing your child restraint. Not all child restraint systems will be installed as described here.**

### To Install A LATCH-Compatible Child Restraint

If the selected seating position has a Switchable Automatic Locking Retractor (ALR) seat belt, stow the seat belt, following the instructions below. See [page 229](#) to check what type of seat belt each seating position has.

1. Loosen the adjusters on the lower straps and on the tether strap of the child seat so that you can more easily attach the hooks or connectors to the vehicle anchorages.
2. Place the child seat between the lower anchorages for that seating position. If the second row seat can be reclined, you may recline the seat and/or raise the head restraint (if adjustable) to get a better fit. If the rear seat can be moved forward and rearward in the vehicle, you may wish to move it to its rear-most position to make room for the child seat. You may also move the front seat forward to allow more room for the child seat.
3. Attach the lower hooks or connectors of the child restraint to the lower anchorages in the selected seating position.
4. If the child restraint has a tether strap, connect it to the top tether anchorage. See [page 231](#) for directions to attach a tether anchor.
5. Tighten all of the straps as you push the child restraint rearward and downward into the seat. Remove slack in the straps according to the child restraint manufacturer's instructions.
6. Test that the child restraint is installed tightly by pulling back and forth on the child seat at the belt path. It should not move more than 1 inch (25.4 mm) in any direction.

## How To Stow An Unused Switchable-ALR (ALR) Seat Belt:

When using the LATCH attaching system to install a child restraint, stow all ALR seat belts that are not being used by other occupants or being used to secure child restraints. An unused belt could injure a child if they play with it and accidentally lock the seat belt retractor. Before installing a child restraint using the LATCH system, buckle the seat belt behind the child restraint and out of the child's reach. If the buckled seat belt interferes with the child restraint installation, instead of buckling it behind the child restraint, route the seat belt through the child restraint belt path and then buckle it. Do not lock the seat belt. Remind all children in the vehicle that the seat belts are not toys and that they should not play with them.

### WARNING!

- Improper installation of a child restraint to the LATCH anchorages can lead to failure of the restraint. The child could be badly injured or killed. Follow the child restraint manufacturer's directions exactly when installing an infant or child restraint.

*(Continued)*

### WARNING!

- Child restraint anchorages are designed to withstand only those loads imposed by correctly-fitted child restraints. Under no circumstances are they to be used for adult seat belts, harnesses, or for attaching other items or equipment to the vehicle.

## Installing Child Restraints Using The Vehicle Seat Belt

Child restraint systems are designed to be secured in vehicle seats by lap belts or the lap belt portion of a lap/shoulder belt.

### WARNING!

- Improper installation or failure to properly secure a child restraint can lead to failure of the restraint. The child could be badly injured or killed.
- Follow the child restraint manufacturer's directions exactly when installing an infant or child restraint.

The seat belts in the passenger seating positions are equipped with a Switchable Automatic Locking Retractor (ALR) that is designed to keep the lap portion of the seat belt tight around the child restraint so that it is not necessary to use a locking clip. The ALR retractor can be "switched" into a locked mode by pulling all of the webbing out of the retractor and then letting the webbing retract back into the retractor. If it is locked, the ALR will make a clicking noise while the webbing is pulled back into the retractor → page 207.

Please see the table below and the following sections for more information.

## Lap/Shoulder Belt Systems For Installing Child Restraints In This Vehicle

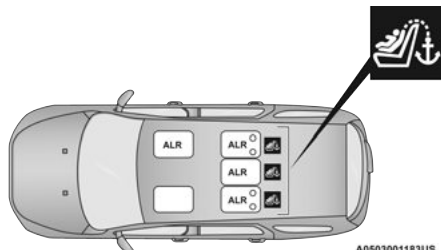

A0503001183US

**60/40 Second Row (5 Passenger) Automatic Locking Retractor (ALR) Locations**

ALR — Switchable Automatic Locking Retractor

 Top Tether Anchorage Symbol

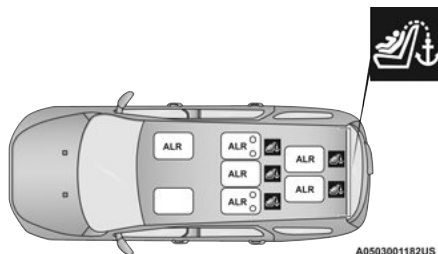

A0503001182US

**60/40 Second Row (7 Passenger) Automatic Locking Retractor (ALR) Locations**

ALR — Switchable Automatic Locking Retractor

 Top Tether Anchorage Symbol

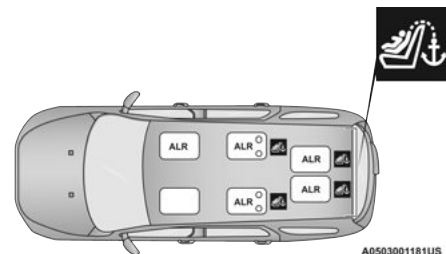

A0503001181US

**Captain's Chairs Second Row (6 Passenger) Automatic Locking Retractor (ALR) Locations**

ALR — Switchable Automatic Locking Retractor

 Top Tether Anchorage Symbol

### Frequently Asked Questions About Installing Child Restraints With Seat Belts

What is the weight limit (child's weight + weight of the child restraint) for using the Tether Anchor with the seat belt to attach a forward facing child restraint?	Weight limit of the Child Restraint	Always use the tether anchor when using the seat belt to install a forward facing child restraint, up to the recommended weight limit of the child restraint.
Can the rear-facing child restraint touch the back of the front passenger seat?	Yes	Contact between the front passenger seat and the child restraint is allowed, if the child restraint manufacturer also allows contact.
Can the rear head restraints be removed?	No	
Can the buckle stalk be twisted to tighten the seat belt against the belt path of the child restraint?	No	Do not twist the buckle stalk in a seating position with an ALR retractor.

## Installing A Child Restraint With A Switchable Automatic Locking Retractor (ALR):

Child restraint systems are designed to be secured in vehicle seats by lap belts or the lap belt portion of a lap/shoulder belt.

### WARNING!

- Improper installation or failure to properly secure a child restraint can lead to failure of the restraint. The child could be badly injured or killed.
- Follow the child restraint manufacturer's directions exactly when installing an infant or child restraint.

1. Place the child seat in the center of the seating position. If the second row seat can be reclined, you may recline the seat and/or raise the head restraint (if adjustable) to get a better fit. If the rear seat can be moved forward and rearward in the vehicle, you may wish to move it to its rear-most position to make room for the child seat. You may also move the front seat forward to allow more room for the child seat.

2. Pull enough of the seat belt webbing from the retractor to pass it through the belt path of the child restraint. Do not twist the belt webbing in the belt path.
3. Slide the latch plate into the buckle until you hear a "click."
4. Pull on the webbing to make the lap portion tight against the child seat.
5. To lock the seat belt, pull down on the shoulder part of the belt until you have pulled all the seat belt webbing out of the retractor. Then, allow the webbing to retract back into the retractor. As the webbing retracts, you will hear a clicking sound. This means the seat belt is now in the Automatic Locking mode.
6. Try to pull the webbing out of the retractor. If it is locked, you should not be able to pull out any webbing. If the retractor is not locked, repeat step 5.
7. Finally, pull up on any excess webbing to tighten the lap portion around the child restraint while you push the child restraint rearward and downward into the vehicle seat.
8. If the child restraint has a top tether strap and the seating position has a top tether anchorage, connect the tether strap to the anchorage and tighten the tether strap. For directions to attach a tether anchor, see ⇨ page 231.

9. Test that the child restraint is installed tightly by pulling back and forth on the child seat at the belt path. It should not move more than 1 inch (25.4 mm) in any direction.

Any seat belt system will loosen with time, so check the belt occasionally, and pull it tight if necessary.

## Installing Child Restraints Using The Top Tether Anchorage

### WARNING!

Do not attach a tether strap for a rear-facing car seat to any location in front of the car seat, including the seat frame or a tether anchorage. Only attach the tether strap of a rear-facing car seat to the tether anchorage that is approved for that seating position, located behind the top of the vehicle seat. See ⇨ page 223 for the location of approved tether anchorages in your vehicle.



0226047162

1. Look behind the seating position where you plan to install the child restraint to find the tether anchorage. You may need to move the seat forward to provide better access to the tether anchorage. If there is no top tether anchorage for that seating position, move the child restraint to another position in the vehicle if one is available.
2. To access the top tether strap anchorages behind the rear seat, pull the carpeted floor panel away from the seat back, this will expose the top tether strap anchorages.

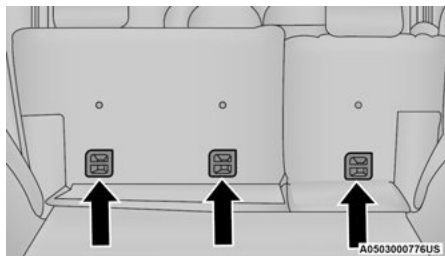

**Pulling Down The Carpet Floor Panel To Access Top Tether Strap Anchorage (Five Passenger)**

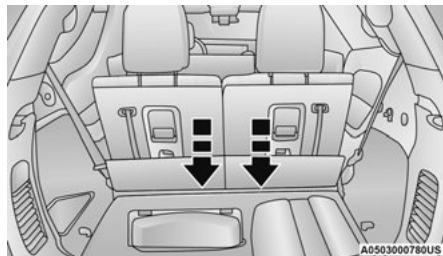

**Pulling Down The Carpet Floor Panel To Access Top Tether Strap Anchorage (3rd Row Bench)**

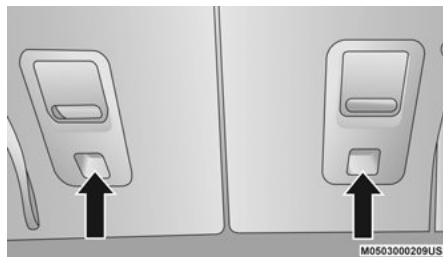

**Third Row Top Tether Strap Anchorage (Located On Seatback)**

3. Route the tether strap to provide the most direct path for the strap between the anchor and the child seat. If your vehicle is equipped with adjustable rear head restraints, raise the head restraint, and where possible, route the tether strap under the head restraint and between the two posts. If not possible, lower the head restraint and pass the tether strap around the outboard side of the head restraint.
4. For the center seating position, route the tether strap over the seatback and headrest then attach the hook to the tether anchor located on the back of the seat.
5. Attach the tether strap hook of the child restraint to the top tether anchorage as shown in the diagram.

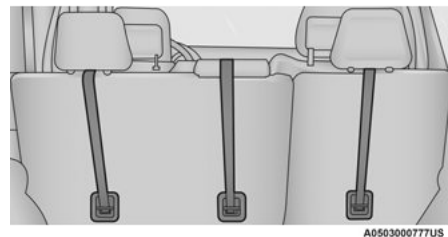

**Bench Seat Top Tether Strap Mounting (5 Passenger Seating)**

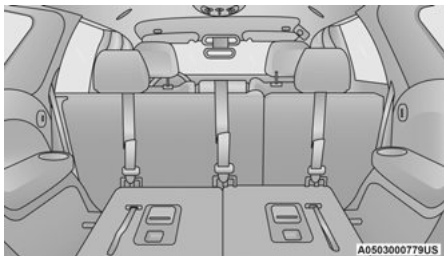

**Second Row Bench Seat Top Tether Strap Mounting  
(7 Passenger Seating)**

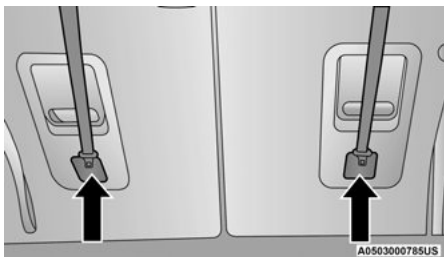

**Third Row Seating Top Tether Strap Mounting**

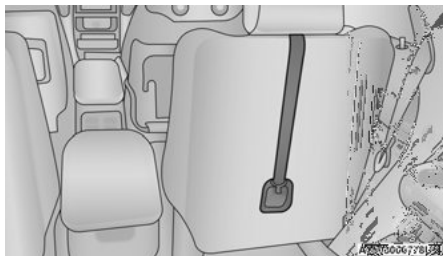

**Captain's Chair Top Tether Strap Mounting**

- Remove slack in the tether strap according to the child restraint manufacturer's instructions.

#### WARNING!

- The top tether anchorages are not visible until the gap panel is folded down. Do not use the visible cargo tie down hooks, located on the floor behind the seats, to attach a child restraint tether anchor.
- An incorrectly anchored tether strap could lead to increased head motion and possible injury to the child. Use only the anchorage position directly behind the child seat to secure a child restraint top tether strap.

*(Continued)*

#### WARNING!

- If your vehicle is equipped with a split rear seat, make sure the tether strap does not slip into the opening between the seatbacks as you remove slack in the strap.

## SAFETY TIPS

### TRANSPORTING PASSENGERS

NEVER TRANSPORT PASSENGERS IN THE CARGO AREA.

#### WARNING!

- Do not leave children or animals inside parked vehicles in hot weather. Interior heat build-up may cause serious injury or death.
- It is extremely dangerous to ride in a cargo area, inside or outside of a vehicle. In a collision, people riding in these areas are more likely to be seriously injured or killed.
- Do not allow people to ride in any area of your vehicle that is not equipped with seats and seat belts.
- Be sure everyone in your vehicle is in a seat and using a seat belt properly.

## TRANSPORTING PETS

Air Bags deploying in the front seat could harm your pet. An unrestrained pet will be thrown about and possibly injured, or injure a passenger during panic braking or in a collision.

Pets should be restrained in the rear seat (if equipped) in pet harnesses or pet carriers that are secured by seat belts.

## SAFETY CHECKS YOU SHOULD MAKE INSIDE THE VEHICLE

### Seat Belts

Inspect the seat belt system periodically, checking for cuts, frays, and loose parts. Damaged parts must be replaced immediately. Do not disassemble or modify the system.

If your vehicle is involved in a collision, or if you have questions regarding seat belt or retractor conditions, take your vehicle to an authorized FCA dealer or authorized FCA Certified Collision Care Program facility for inspection.

## Air Bag Warning Light



The Air Bag Warning Light will turn on for four to eight seconds as a bulb check when the ignition switch is first placed in the ON/RUN mode. If the light is either not on during starting, stays on, or turns on while driving, have the system inspected at an authorized dealer as soon as possible. After the bulb check, this light will illuminate with a single chime when a fault with the Air Bag System has been detected. If the light comes on intermittently or remains on while driving, have an authorized dealer service the vehicle immediately  page 201.

### Defroster

Check operation by selecting the defrost mode and place the blower control on high speed. You should be able to feel the air directed against the windshield. See an authorized dealer for service if your defroster is inoperable.

## Floor Mat Safety Information

Always use floor mats designed to fit your vehicle. Only use a floor mat that does not interfere with the operation of the accelerator, brake or clutch pedals. Only use a floor mat that is securely attached using the floor mat fasteners so it cannot slip out of position and interfere with the accelerator, brake or clutch pedals or impair safe operation of your vehicle in other ways.

### WARNING!

An improperly attached, damaged, folded, or stacked floor mat, or damaged floor mat fasteners may cause your floor mat to interfere with the accelerator, brake, or clutch pedals and cause a loss of vehicle control. To prevent SERIOUS INJURY or DEATH:



- ALWAYS securely attach your floor mat using the floor mat fasteners. DO NOT install your floor mat upside down or turn your floor mat over. Lightly pull to confirm mat is secured using the floor mat fasteners on a regular basis.



- ALWAYS REMOVE THE EXISTING FLOOR MAT FROM THE VEHICLE before installing any other floor mat. NEVER install or stack an additional floor mat on top of an existing floor mat.

(Continued)



**WARNING!**

- ONLY install floor mats designed to fit your vehicle. NEVER install a floor mat that cannot be properly attached and secured to your vehicle. If a floor mat needs to be replaced, only use a FCA approved floor mat for the specific make, model, and year of your vehicle.
- ONLY use the driver's side floor mat on the driver's side floor area. To check for interference, with the vehicle properly parked with the engine off, fully depress the accelerator, the brake, and the clutch pedal (if present) to check for interference. If your floor mat interferes with the operation of any pedal, or is not secure to the floor, remove the floor mat from the vehicle and place the floor mat in your trunk.
- ONLY use the passenger's side floor mat on the passenger's side floor area.
- ALWAYS make sure objects cannot fall or slide into the driver's side floor area when the vehicle is moving. Objects can become trapped under accelerator, brake, or clutch pedals and could cause a loss of vehicle control.

*(Continued)***WARNING!**

- NEVER place any objects under the floor mat (e.g., towels, keys, etc.). These objects could change the position of the floor mat and may cause interference with the accelerator, brake, or clutch pedals.
- If the vehicle carpet has been removed and re-installed, always properly attach carpet to the floor and check the floor mat fasteners are secure to the vehicle carpet. Fully depress each pedal to check for interference with the accelerator, brake, or clutch pedals then re-install the floor mats.
- It is recommended to only use mild soap and water to clean your floor mats. After cleaning, always check your floor mat has been properly installed and is secured to your vehicle using the floor mat fasteners by lightly pulling mat.

**PERIODIC SAFETY CHECKS YOU SHOULD MAKE OUTSIDE THE VEHICLE****Tires**

Examine tires for excessive tread wear and uneven wear patterns. Check for stones, nails, glass, or other objects lodged in the tread or sidewall. Inspect the tread for cuts and cracks. Inspect sidewalls for cuts, cracks, and bulges. Check the lug nut/bolt torque for tightness. Check the tires (including spare) for proper cold inflation pressure.

**Lights**

Have someone observe the operation of brake lights and exterior lights while you work the controls. Check turn signal and high beam indicator lights on the instrument panel.

**Door Latches**

Check for proper closing, latching, and locking.

**Fluid Leaks**

Check area under the vehicle after overnight parking for fuel, coolant, oil, or other fluid leaks. Also, if gasoline fumes are detected or if fuel or brake fluid leaks are suspected, the cause should be located and corrected immediately.

## EXHAUST GAS

### WARNING!

Exhaust gases can injure or kill. They contain carbon monoxide (CO), which is colorless and odorless. Breathing it can make you unconscious and can eventually poison you. To avoid breathing (CO), follow these safety tips:

- Do not run the engine in a closed garage or in confined areas any longer than needed to move your vehicle in or out of the area.
- If you are required to drive with the trunk/lift-gate/rear doors open, make sure that all windows are closed and the climate control BLOWER switch is set at high speed. DO NOT use the recirculation mode.
- If it is necessary to sit in a parked vehicle with the engine running, adjust your heating or cooling controls to force outside air into the vehicle. Set the blower at high speed.

The best protection against carbon monoxide entry into the vehicle body is a properly maintained engine exhaust system.

Whenever a change is noticed in the sound of the exhaust system, when exhaust fumes can be detected inside the vehicle, or when the underside or rear of the vehicle is damaged, have an authorized dealer inspect the complete exhaust system and adjacent body areas for broken, damaged, deteriorated, or mispositioned parts. Open seams or loose connections could permit exhaust fumes to seep into the passenger compartment. In addition, inspect the exhaust system each time the vehicle is raised for lubrication or oil change. Replace as required.

## CARBON MONOXIDE WARNINGS

### WARNING!

Carbon monoxide (CO) in exhaust gases is deadly. Follow the precautions below to prevent carbon monoxide poisoning:

- Do not inhale exhaust gases. They contain carbon monoxide, a colorless and odorless gas, which can kill. Never run the engine in a closed area, such as a garage, and never sit in a parked vehicle with the engine running for an extended period. If the vehicle is stopped in an open area with the engine running for more than a short period, adjust the ventilation system to force fresh, outside air into the vehicle.
- Guard against carbon monoxide with proper maintenance. Have the exhaust system inspected every time the vehicle is raised. Have any abnormal conditions repaired promptly. Until repaired, drive with all side windows fully open.

## IN CASE OF EMERGENCY

### HAZARD WARNING FLASHERS

The Hazard Warning Flashers button is located on the switch bank just below the climate controls.

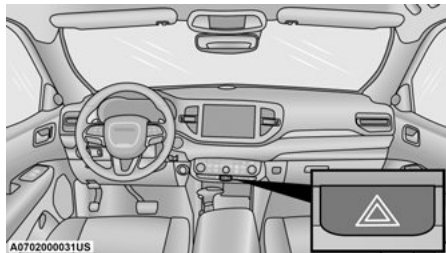

**Hazard Warning Flashers Button**

Push the button to turn on the Hazard Warning Flashers. When the button is activated, all directional turn signals will flash on and off to warn oncoming traffic of an emergency. Push the button a second time to turn off the Hazard Warning Flashers.

This is an emergency warning system and it should not be used when the vehicle is in motion. Use it when your vehicle is disabled and it is creating a safety hazard for other motorists.

When you must leave the vehicle to seek assistance, the Hazard Warning Flashers will continue to operate even though the ignition is placed in the OFF position.

**NOTE:**

With extended use, the Hazard Warning Flashers may discharge the battery.

### ASSIST AND SOS MIRROR — IF EQUIPPED



**Assist And SOS Mirror**

- 1 — SOS Button
- 2 — ASSIST Button

If equipped, the rearview mirror contains an ASSIST and a SOS button.

**WARNING!**

ALWAYS obey traffic laws and pay attention to the road. ALWAYS drive safely with your hands on the steering wheel. You have full responsibility and assume all risks related to the use of the features and applications in this vehicle. Only use the features and applications when it is safe to do so. Failure to do so may result in an accident involving serious injury or death.

**NOTE:**

- Your vehicle may be transmitting data as authorized by the subscriber ↪ page 314.
- The SOS and ASSIST buttons will only function if you are connected to an operable LTE (voice/data), 3G or 4G (data) network, which comes as a built in function. Other Uconnect services will only be operable if your SiriusXM Guardian™ service is active and you are connected to an operable LTE (voice/data), 3G or 4G (data) network.

**ASSIST Call**

The ASSIST Button is used to automatically connect you to any one of the following support centers:

- Roadside Assistance – If you get a flat tire, or need a tow, just push the ASSIST button and you will be connected to a representative for assistance. Roadside Assistance will know what vehicle you're driving and its location. Additional fees may apply for roadside assistance.
- SiriusXM Guardian™ Customer Care – In-vehicle support for SiriusXM Guardian™.
- Vehicle Customer Care – Total support for all other vehicle issues.
- Uconnect Customer Care - Total support for Radio, Phone and NAV issues.

**SOS Call**

1. Push the SOS Call button on the Rearview Mirror.

**NOTE:**

In case the SOS Call button is pushed in error, there will be a 10 second delay before the SOS Call system initiates a call to a SOS operator. To cancel the SOS Call connection, push the SOS call button on the Rearview Mirror or press the cancellation button on the Device Screen. Termination of the SOS Call will turn off the green LED light on the Rearview Mirror.

2. The LED light located between the ASSIST and SOS buttons on the Rearview Mirror will turn green once a connection to a SOS operator has been made.
3. Once a connection between the vehicle and a SOS operator is made, the SOS Call system may transmit the following important vehicle information to a SOS operator:
  - Indication that the occupant placed a SOS Call
  - The vehicle brand
  - The last known GPS coordinates of the vehicle
4. You should be able to speak with the SOS operator through the vehicle audio system to determine if additional assistance is needed.

**WARNING!**

ALWAYS obey traffic laws and pay attention to the road. ALWAYS drive safely with your hands on the steering wheel. You have full responsibility and assume all risks related to the use of the features and applications in this vehicle. Only use the features and applications when it is safe to do so. Failure to do so may result in an accident involving serious injury or death.

**NOTE:**

- Your vehicle may be transmitting data as authorized by the subscriber.
  - Once a connection is made between the vehicle's SOS Call system and the SOS operator, the SOS operator may be able to open a voice connection with the vehicle to determine if additional assistance is needed. Once the SOS operator opens a voice connection with the vehicle's SOS Call system, the operator should be able to speak with you or other vehicle occupants and hear sounds occurring in the vehicle. The vehicle's SOS Call system will attempt to remain connected with the SOS operator until the SOS operator terminates the connection.
5. The SOS operator may attempt to contact appropriate emergency responders and provide them with important vehicle information and GPS coordinates.

**WARNING!**

- If anyone in the vehicle could be in danger (e.g., fire or smoke is visible, dangerous road conditions or location), do not wait for voice contact from an Emergency Services Agent. All occupants should exit the vehicle immediately and move to a safe location.

(Continued)

**WARNING!**

- Never place anything on or near the vehicle's operable network and GPS antennas. You could prevent operable network and GPS signal reception, which can prevent your vehicle from placing an emergency call. An operable network and GPS signal reception is required for the SOS Call system to function properly.
- The SOS Call system is embedded into the vehicle's electrical system. Do not add aftermarket electrical equipment to the vehicle's electrical system. This may prevent your vehicle from sending a signal to initiate an emergency call. To avoid interference that can cause the SOS Call system to fail, never add aftermarket equipment (e.g., two-way mobile radio, CB radio, data recorder, etc.) to your vehicle's electrical system or modify the antennas on your vehicle. **IF YOUR VEHICLE LOSES BATTERY POWER FOR ANY REASON (INCLUDING DURING OR AFTER AN ACCIDENT), THE UCONNECT FEATURES, APPS AND SERVICES, AMONG OTHERS, WILL NOT OPERATE.**
- Modifications to any part of the SOS Call system could cause the air bag system to fail when you need it. You could be injured if the air bag system is not there to help protect you.

**SOS Call System Limitations**

Vehicles sold in Mexico **DO NOT** have SOS Call system capabilities.

SOS or other emergency line operators in Mexico may not answer or respond to SOS system calls.

If the SOS Call system detects a malfunction, any of the following may occur at the time the malfunction is detected, and at the beginning of each ignition cycle:

- The Rearview Mirror light located between the ASSIST and SOS buttons will continuously illuminate red.
- The Device Screen will display the following message "Vehicle device requires service. Please contact an authorized dealer."
- An In-Vehicle Audio message will state "Vehicle device requires service. Please contact an authorized dealer."

**WARNING!**

- Ignoring the Rearview Mirror light could mean you will not have SOS Call services. If the Rearview Mirror light is illuminated, have an authorized dealer service the SOS Call system immediately.

*(Continued)*

**WARNING!**

- The Occupant Restraint Control module turns on the air bag Warning Light on the instrument panel if a malfunction in any part of the system is detected. If the Air Bag Warning Light is illuminated, have an authorized dealer service the Occupant Restraint Control system immediately.

Even if the SOS Call system is fully functional, factors beyond FCA US LLC's control may prevent or stop the SOS Call system operation. These include, but are not limited to, the following factors:

- The ignition is in the OFF position
- The vehicle's electrical systems are not intact
- The SOS Call system software and/or hardware are damaged during a crash
- The vehicle battery loses power or becomes disconnected during a vehicle crash
- LTE (voice/data), 3G or 4G (data) network and/or Global Positioning Satellite signals are unavailable or obstructed
- Equipment malfunction at the SOS operator facility
- Operator error by the SOS operator

- LTE (voice/data), 3G or 4G (data) network congestion
- Weather
- Buildings, structures, geographic terrain, or tunnels

**WARNING!**

ALWAYS obey traffic laws and pay attention to the road. ALWAYS drive safely with your hands on the steering wheel. You have full responsibility and assume all risks related to the use of the features and applications in this vehicle. Only use the features and applications when it is safe to do so. Failure to do so may result in an accident involving serious injury or death.

**NOTE:**

- Your vehicle may be transmitting data as authorized by the subscriber.
- Never place anything on or near the vehicle's LTE (voice/data), 3G or 4G (data) and GPS antennas. You could prevent LTE (voice/data), 3G or 4G (data) and GPS signal reception, which can prevent your vehicle from placing an emergency call. An operable LTE (voice/data), 3G or 4G (data) network connection and a GPS signal is required for the SOS Call system to function properly.

**NOTE:**

Changes or modifications not expressly approved by the party responsible for compliance could void the user's authority to operate the equipment.

**CAUTION!**

To avoid damage to the mirror during cleaning, never spray any cleaning solution directly onto the mirror. Apply the solution onto a clean cloth and wipe the mirror clean.

**Automatic SOS — If Equipped**

Automatic SOS is a hands-free safety service that can immediately connect you with help in the event that your vehicle's airbags deploy. Please refer to your provided radio supplement for complete information.

**JACKING AND TIRE CHANGING****WARNING!**

- Do not attempt to change a tire on the side of the vehicle close to moving traffic. Pull far enough off the road to avoid the danger of being hit when operating the jack or changing the wheel.

*(Continued)*

**WARNING!**

- Being under a jacked-up vehicle is dangerous. The vehicle could slip off the jack and fall on you. You could be crushed. Never put any part of your body under a vehicle that is on a jack. If you need to get under a raised vehicle, take it to a service center where it can be raised on a lift.
- Never start or run the engine while the vehicle is on a jack.
- The jack is designed to be used as a tool for changing tires only. The jack should not be used to lift the vehicle for service purposes. The vehicle should be jacked on a firm level surface only. Avoid ice or slippery areas.

**PREPARATIONS FOR JACKING**

1. Park the vehicle on a firm, level surface as far from the edge of the roadway as possible. Avoid icy or slippery areas.

**WARNING!**

Do not attempt to change a tire on the side of the vehicle close to moving traffic. Pull far enough off the road to avoid being hit when operating the jack or changing the wheel.

2. Turn on the Hazard Warning Flashers.
3. Apply the parking brake.
4. Place the gear selector into PARK (P).
5. Turn OFF the ignition.
6. Block both the front and rear of the wheel diagonally opposite the jacking position. For example, if changing the driver's front tire, block the passenger's rear tire.

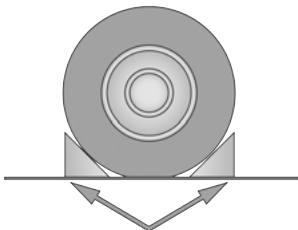

Wheel Blocked

A0707000523US

**NOTE:**

Passengers should not remain in the vehicle when the vehicle is being raised or lifted.

**JACK LOCATION**

The scissor-type jack and tire changing tools are located in rear cargo area, below the load floor.

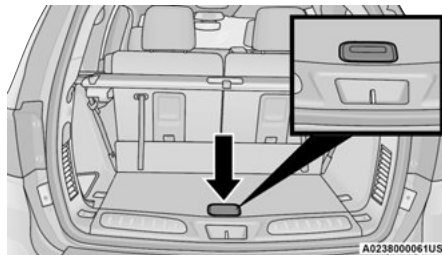

Load Floor Handle

A0238000061US

Lift up on the load floor handle to access the jack and tools in the cargo area.

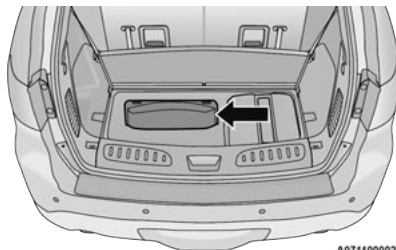

Jack And Tools Storage Cover

A0711000022US

To remove, press down firmly on the upper tabs of the jack storage cover to release.

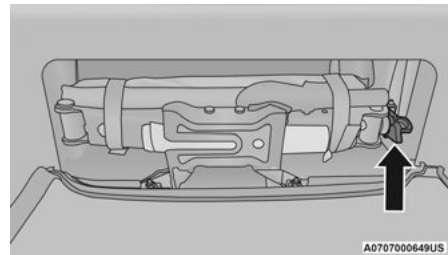

A0707000649US

Thumb Screw Location

Rotate the plastic thumb screw on the end of the jack to loosen the jack and remove from the bracket.

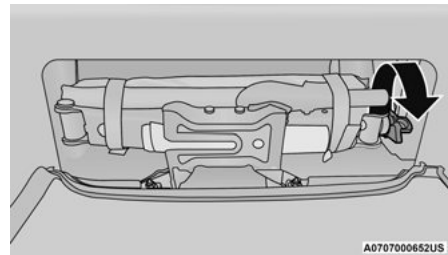

A0707000652US

Jack Removal

## SPARE TIRE STOWAGE

The spare tire is stowed under the rear of the vehicle by means of a cable winch mechanism. To remove or stow the spare, use the jack handle/lug wrench connected to the square socket extension to rotate the “spare tire drive” nut. The nut is located under a plastic cover at the center-rear of the cargo floor area, just inside the liftgate opening.

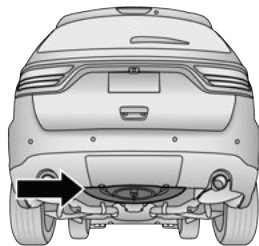

A0707000975US

**Spare Tire Location**

### CAUTION!

The winch mechanism is designed for use with the jack wrench extension tool only. Use of air wrench or power tool may damage the winch.

## SPARE TIRE REMOVAL

Remove the spare tire before attempting to jack up the vehicle. The spare tire is stowed underneath the rear cargo area on the outside of the vehicle.

For spare tire removal, follow the steps below:

1. Remove the jack tools from the bag.
2. Raise the rubber mat and remove the plug from storage compartment floor.

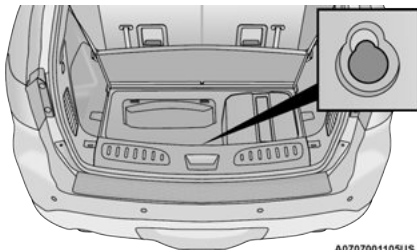

A0707001105US

**Winch Plug Location**

3. Fit the jack handle extension over the drive nut. Use the lug wrench handle and extension to completely lower the spare tire. Keep turning the handle counterclockwise until the winch stops.

### CAUTION!

The winch mechanism is designed for use with the jack wrench extension tool only. Use of air wrench or power tool may damage the winch.

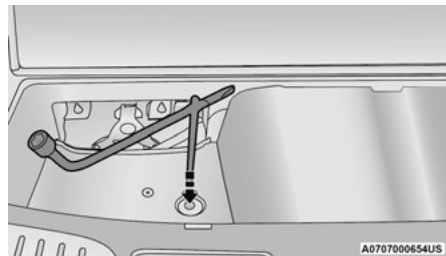

A0707000654US

**Winch Location**

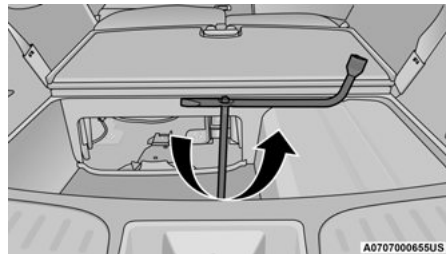

A0707000655US

**Wrench Rotation**



4. Slide the tire out from under the vehicle and rotate it vertically behind the rear fascia/ bumper.

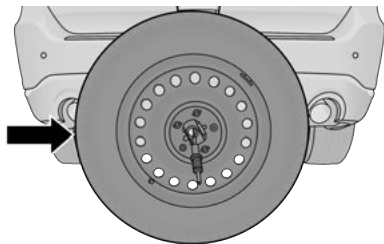

Spare Tire

A070700065TUS

**NOTE:**

Depending on the vehicle trim, the vehicle may come equipped with both, a metal retainer and plastic plate or a metal retainer only when removing the spare → page 296.

5. Pull the metal stamping toward you to release it from the plastic plate (if equipped).

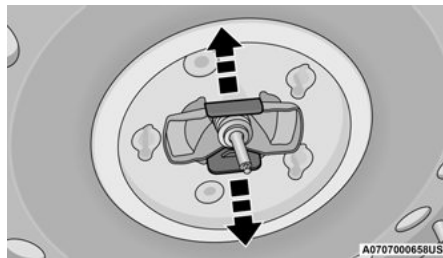

Spare Tire Retainer

A070700065SUS

6. Slide the metal stamping up the steel extension tube and winch cable. Rotate the metal stamping and push it through the hole in the plastic plate (if applicable) and wheel.

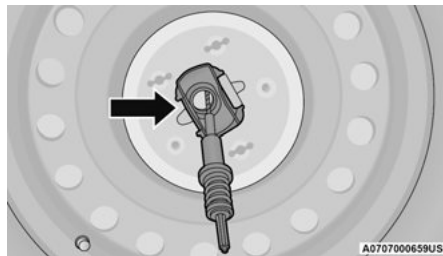

Sleeve And Cable

A0707000659US

7. If your vehicle is equipped with a spare tire retainer and plastic plate. Pinch the three short and two long tubes to remove the protective plate from the steel spare wheel.

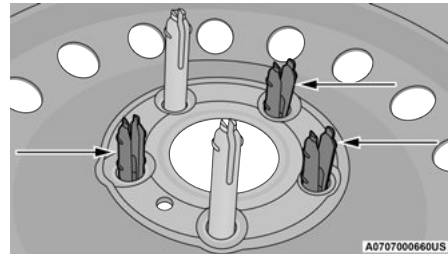

Releasing Protective Plate

A0707000660US

**JACKING INSTRUCTIONS****WARNING!**

Carefully follow these tire changing warnings to help prevent personal injury or damage to your vehicle:

- Always park on a firm, level surface as far from the edge of the roadway as possible before raising the vehicle.
- Turn on the Hazard Warning Flashers.

*(Continued)*

**WARNING!**

- Apply the parking brake firmly and set the transmission in PARK.
- Block the wheel diagonally opposite the wheel to be raised.
- Never start or run the engine with the vehicle on a jack.
- Do not let anyone sit in the vehicle when it is on a jack.
- Do not get under the vehicle when it is on a jack. If you need to get under a raised vehicle, take it to a service center where it can be raised on a lift.
- Only use the jack in the positions indicated and for lifting this vehicle during a tire change.
- If working on or near a roadway, be extremely careful of motor traffic.
- To assure that spare tires, flat or inflated, are securely stowed, spares must be stowed with the valve stem facing the ground.

**Jack Warning Label**

060600714

**CAUTION!**

Do not attempt to raise the vehicle by jacking on locations other than those indicated in the Jacking Instructions for this vehicle.

1. Loosen (but do not remove) the wheel lug nuts by turning them to the left, one turn, while the wheel is still on the ground.
2. Assemble the jack and jacking tools.

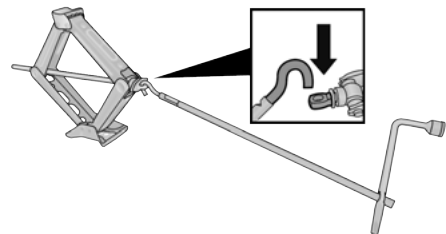
**Jack And Tool Assembly**

A0707000599US

**NOTE:**

Placement for the front and rear jacking locations are critical. See below images for proper jacking locations.

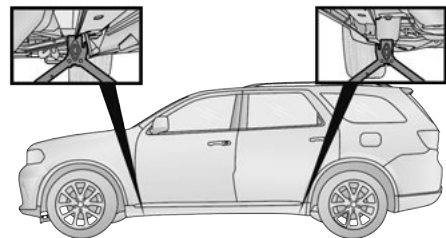
**Jacking Locations**

A0707000973US

3. For the front tire, place the jack on the body flange just behind the front tire. **Do not raise the vehicle until you are sure the jack is fully engaged.**

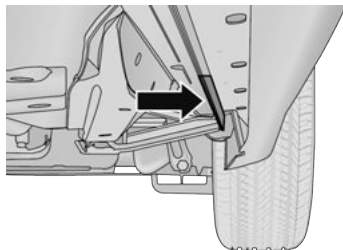

Front Lifting Point

A0707000957US

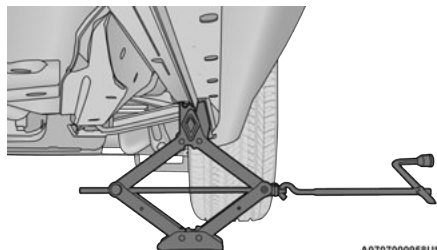

Front Jacking Location

A0707000958US

4. For a rear tire, place the jack in the slot on the rear tie-down bracket, just forward of the rear

tire. **Do not raise the vehicle until you are sure the jack is fully engaged.**

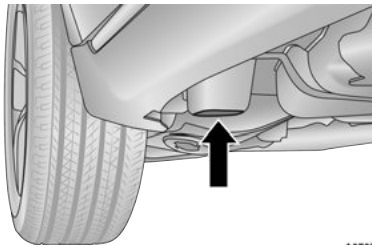

Rear Lifting Point

A0707000962US

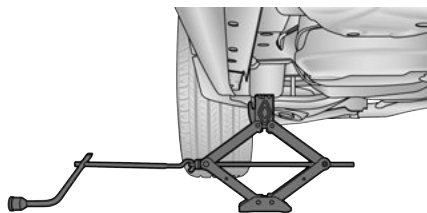

Rear Jacking Location

A0707000961US

5. Raise the vehicle by turning the jack screw clockwise. Raise the vehicle just enough to remove the flat tire.

<b>WARNING!</b>
Raising the vehicle higher than necessary can make the vehicle less stable. It could slip off the jack and hurt someone near it. Raise the vehicle only enough to remove the tire.

6. Remove the lug nuts and wheel.  
7. Install the spare wheel/tire on the vehicle and install the lug nuts with the cone-shaped end toward the wheel. Lightly tighten the nuts.

<b>WARNING!</b>
To avoid the risk of forcing the vehicle off the jack, do not tighten the wheel nuts fully until the vehicle has been lowered. Failure to follow this warning may result in serious injury.

7

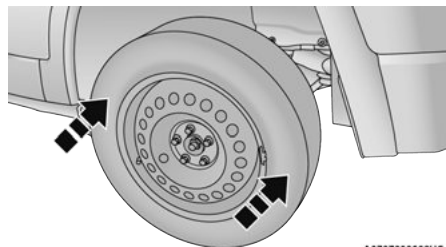

Mounting Spare Tire

A0707000666US

**CAUTION!**

Be sure to mount the spare tire with the valve stem facing outward. The vehicle could be damaged if the spare tire is mounted incorrectly.

8. Lower the vehicle by turning the jack screw counterclockwise, and remove the jack and wheel blocks.
9. Finish tightening the wheel bolts. Push down on the wrench while at the end of the handle for increased leverage. Tighten the wheel bolts in a star pattern until each wheel bolt has been tightened twice. If in doubt about the correct tightness, have them checked with a torque wrench by an authorized dealer or at a service station ↪ page 305.
10. Push out the small center cap using the jack tool from inside the aluminum road wheel and position the wheel behind the rear fascia/bumper with the protective plate facing outward.

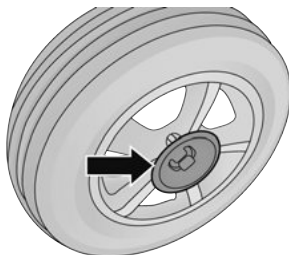

A0707000667US

**Installing Protective Plate On Damaged Wheel****NOTE:**

The plastic plate will prevent the road wheel from being scratched when sliding it under the vehicle.

11. Insert the two long tubes on the plastic protective plate in the lug holes of the road wheel. Push the end of the winch's cable, spring, steel sleeve and stamped cone shape wheel plate through the road wheel and protective plate.

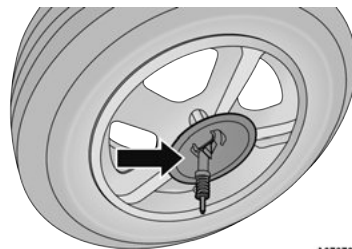

A0707000668US

**Installing Winch**

12. Slide the road wheel on the ground using the protective plate until it is directly under the winch and between the rear fascia/bumper and exhaust system heat shields. Raise the tire by turning the lug wrench on the winch extension clockwise until it clicks/ratchets three times to make sure the cable is tight.

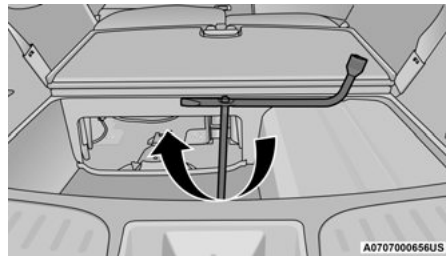

A0707000656US

**Wrench Rotation**

**NOTE:**

Double check to ensure the tire is snug against the underbody of the vehicle. Damage to the winch cable may result if the vehicle is driven with the tire loose.

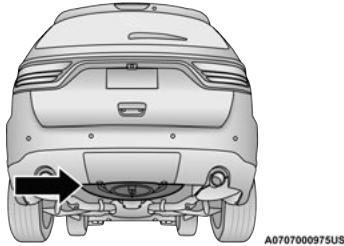

Road Wheel Installed In Spare Location

**CAUTION!**

The winch mechanism is designed for use with the jack wrench extension tool only. Use of air wrench or power tool may damage the winch.

13. After 25 miles (40 km), check the lug nut torque with a torque wrench to ensure that all lug nuts are properly seated against the wheel.

14. Lower the jack to the fully closed position.

Return the tools to the proper positions in the tool bag. Fold the flap on the tool bag under the tools and roll the tools in the bag underneath the others. Use the hook and loop fasteners to secure the tool bag to the jack with the lug wrench on the forward side of the jack. Expand the jack on the bracket by turning the thumb screw clockwise until it is tight to prevent rattles.

15. Reinstall the plastic plug into the floor of the cargo area. Roll up and store the Jack, Tool Kit and Tire Changing Instructions. Reinstall the cover for the jack in the rear storage bin.

16. Have the aluminum road wheel and tire repaired as soon as possible and properly secure the spare tire, jack and tool kit.

**WARNING!**

A loose tire or jack thrown forward in a collision or hard stop, could endanger the occupants of the vehicle. Always stow the jack parts and the spare tire in the places provided.

**JUMP STARTING**

If your vehicle has a discharged battery, it can be jump started using a set of jumper cables and a battery in another vehicle, or by using a portable battery booster pack. Jump starting can be dangerous if done improperly, so please follow the procedures in this section carefully.

**WARNING!**

Do not attempt jump starting if the battery is frozen. It could rupture or explode and cause personal injury.

**CAUTION!**

Do not use a portable battery booster pack or any other booster source with a system voltage greater than 12 Volts or damage to the battery, starter motor, alternator or electrical system may occur.

**NOTE:**

When using a portable battery booster pack, follow the manufacturer's operating instructions and precautions.

## PREPARATIONS FOR JUMP START

The battery in your vehicle is located under the passenger's front seat. There are remote terminals located under the hood to assist in jump starting.

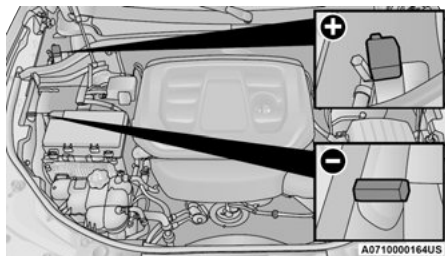

**Under Hood Jump Starting Location**

Remote Positive (+) Post  
(Covered With Protective Cap)  
Remote Negative (-) Post  
(Covered With Protective Cap)

### NOTE:

Be sure that the disconnected cable ends do not touch each other, or either vehicle, before properly connected for jump starting.

See below steps to prepare for jump starting:

1. Apply the parking brake, shift the automatic transmission into PARK (P) and turn the ignition OFF.
2. Turn off the heater, radio, and all electrical accessories.
3. Remove the protective cover over the remote positive (+) battery post. Pull upward on the cover to remove it.
4. Remove the protective cover over the remote negative (-) battery post.
5. If using another vehicle to jump start the battery, park the vehicle within the jumper cable's reach, apply the parking brake and make sure the ignition is OFF.

### WARNING!

Do not allow vehicles to touch each other as this could establish a ground connection and personal injury could result.

### WARNING!

- Take care to avoid the radiator cooling fan whenever the hood is raised. It can start anytime the ignition switch is ON. You can be injured by moving fan blades.

*(Continued)*

### WARNING!

- Remove any metal jewelry such as rings, watch bands and bracelets that could make an inadvertent electrical contact. You could be seriously injured.
- Batteries contain sulfuric acid that can burn your skin or eyes and generate hydrogen gas which is flammable and explosive. Keep open flames or sparks away from the battery.

## JUMP STARTING PROCEDURE

### WARNING!

Failure to follow this jump starting procedure could result in personal injury or property damage due to battery explosion.

### CAUTION!

Failure to follow these procedures could result in damage to the charging system of the booster vehicle or the discharged vehicle.

### NOTE:

Make sure at all times that unused ends of jumper cables are not contacting each other or either vehicle while making connections.

### Connecting The Jumper Cables

1. Connect the positive (+) end of the jumper cable to the remote positive (+) post of the discharged vehicle.
2. Connect the opposite end of the positive (+) jumper cable to the positive (+) post of the booster battery.
3. Connect the negative (-) end of the jumper cable to the negative (-) post of the booster battery.
4. Connect the opposite end of the negative (-) jumper cable to the remote negative (-) post (exposed metallic/unpainted post of the discharge vehicle) located on the right hand side next to the underhood fuse box.

#### WARNING!

Do not connect the jumper cable to the negative (-) post of the discharged battery. The resulting electrical spark could cause the battery to explode and could result in personal injury.

5. Start the engine in the vehicle that has the booster battery, let the engine idle a few minutes, and then start the engine in the vehicle with the discharged battery.

#### CAUTION!

Do not run the booster vehicle engine above 2,000 RPM since it provides no charging benefit, wastes fuel, and can damage booster vehicle engine.

6. Once the engine is started, follow the disconnecting procedure below.

### Disconnecting The Jumper Cables

1. Disconnect the negative (-) end of the jumper cable from the remote negative (-) post of the discharged vehicle.
2. Disconnect the opposite end of the negative (-) jumper cable from the negative (-) post of the booster battery.
3. Disconnect the positive (+) end of the jumper cable from the positive (+) post of the booster battery.
4. Disconnect the opposite end of the positive (+) jumper cable from the remote positive (+) post of the discharged vehicle.
5. Reinstall the protective covers over the remote positive (+) and negative (-) posts of the discharged vehicle.

If frequent jump starting is required to start your vehicle have the battery and charging system tested at an authorized dealer.

#### CAUTION!

Accessories plugged into the vehicle power outlets draw power from the vehicle's battery, even when not in use (i.e., cellular devices, etc.). Eventually, if plugged in long enough without engine operation, the vehicle's battery will discharge sufficiently to degrade battery life and/or prevent the engine from starting.

## REFUELING IN EMERGENCY – IF EQUIPPED

The vehicle is equipped with a refueling funnel for a Cap-Less Fuel System. The fuel funnel can be found in the rear cargo area with the jack and tools. If refueling is necessary, while using an approved gas can, insert the refueling funnel into the filler neck opening. Take care to open both flappers with the funnel to avoid spills.

#### WARNING!

- Never have any smoking materials lit in or near the vehicle when the fuel door is open or the tank is being filled.

(Continued)

**WARNING!**

- Never add fuel when the engine is running. This is in violation of most state and federal fire regulations and may cause the Malfunction Indicator Light to turn on.
- A fire may result if fuel is pumped into a portable container that is inside of a vehicle. You could be burned. Always place fuel containers on the ground while filling.

**NOTE:**

In certain cold conditions, ice may prevent the fuel door from opening. If this occurs, lightly push on the fuel door to break the ice buildup and re-release the fuel door using the inside release button. Do not pry on the door.

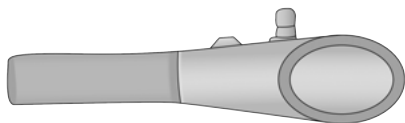

A0711000013US

**Refueling Funnel****Emergency Gas Can Refueling**

Most gas cans will not open the flapper doors. A funnel is provided to allow emergency refueling with a gas can.

See below steps for refueling:

1. Retrieve funnel from the rear cargo storage area.

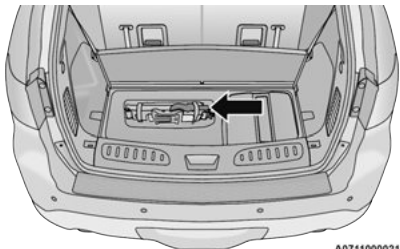

A0711000021US

**Refueling Funnel Location**

2. Insert funnel into same filler pipe opening as the fuel nozzle.

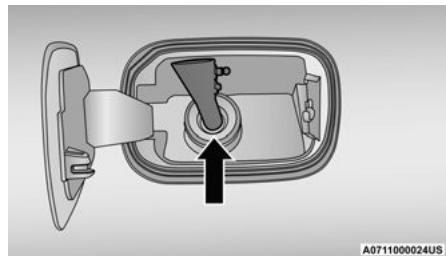

A0711000024US

**Inserting Funnel**

3. Ensure funnel is inserted fully to hold flapper doors open.
4. Pour fuel into funnel opening.

**CAUTION!**

To avoid fuel spillage and overfilling, do not "top off" the fuel tank after filling.

5. Remove funnel from filler pipe, clean off prior to putting back in the spare tire storage area.



## IF YOUR ENGINE OVERHEATS

If the vehicle is overheating, it will need to be serviced by an authorized dealer.

In any of the following situations, you can reduce the potential for overheating by taking the appropriate action.

- On the highways — slow down.
- In city traffic — while stopped, place the transmission in NEUTRAL (N), but do not increase the engine idle speed while preventing vehicle motion with the brakes.

### NOTE:

There are steps that you can take to slow down an impending overheat condition:

- If your Air Conditioner (A/C) is on, turn it off. The A/C system adds heat to the engine cooling system and turning the A/C off can help remove this heat.
- You can also turn the temperature control to maximum heat, the mode control to floor and the blower control to high. This allows the heater core to act as a supplement to the radiator and aids in removing heat from the engine cooling system.

### WARNING!

You or others can be badly burned by hot engine coolant (antifreeze) or steam from your radiator. If you see or hear steam coming from under the hood, do not open the hood until the radiator has had time to cool. Never try to open a cooling system pressure cap when the radiator or coolant bottle is hot.

### CAUTION!

Driving with a hot cooling system could damage your vehicle. If the temperature gauge reads HOT (H), pull over and stop the vehicle. Idle the vehicle with the air conditioner turned off until the pointer drops back into the normal range. If the pointer remains on HOT (H), and you hear continuous chimes, turn the engine off immediately and call for service.

## MANUAL PARK RELEASE

### WARNING!

Always secure your vehicle by fully applying the parking brake before activating the Manual Park Release. In addition, you should be seated in the driver's seat with your foot firmly on the brake pedal when activating the Manual Park Release. Activating the Manual Park Release will allow your vehicle to roll away if it is not secured by the parking brake, or by proper connection to a tow vehicle. Activating the Manual Park Release on an unsecured vehicle could lead to serious injury or death for those in or around the vehicle.

In order to move the vehicle in cases where the transmission will not shift out of PARK (P) (such as a depleted battery), a Manual Park Release is available.

Follow these steps to use the Manual Park Release:

1. Firmly apply the parking brake.
2. Open the center console and locate the Manual Park Release cover, remove it by snapping the cover away from the console hinges.

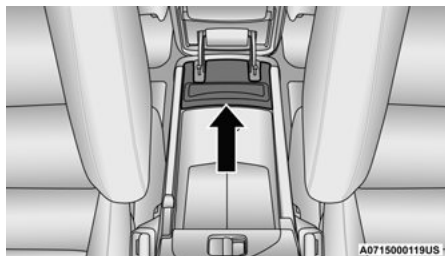

Manual Park Release Cover

**NOTE:**

Depending on your vehicle's trim level, the Manual Park Release cable may be located in a different area on the center console.

3. Press and maintain firm pressure on the brake pedal.
4. Using a screwdriver or similar tool, push the metal latch in towards the tether strap.

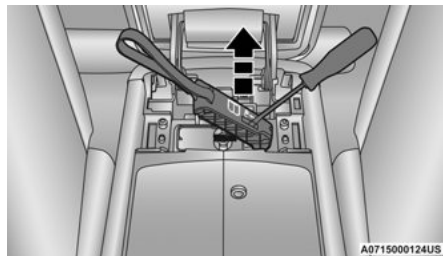

Release Latch

5. While the metal latch is in the open position, pull upward on the tether strap until the lever clicks and latches in the released position. The transmission is now out of PARK (P) and the vehicle can be moved.

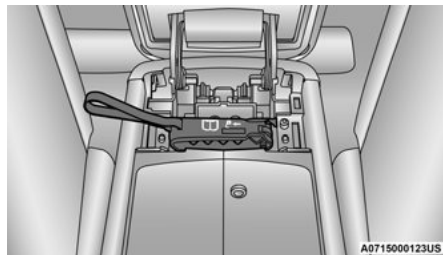

Released Position

**CAUTION!**

Closing the armrest while the Manual Park Release is activated may damage the Manual Park Release mechanism, the transmission, and/or the armrest.

**NOTE:**

To prevent the vehicle from rolling unintentionally, firmly apply the parking brake.

To Disengage The Manual Park Release Lever:

1. To disengage the Manual Park Release, apply tension upward while pushing the release latch towards the tether to unlock the lever.

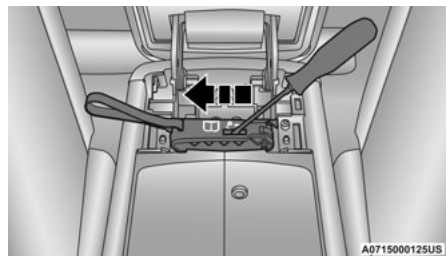

Release Latch

- Once the tension has been released and the lever has been unlocked, be sure it is stowed properly and locks into position.

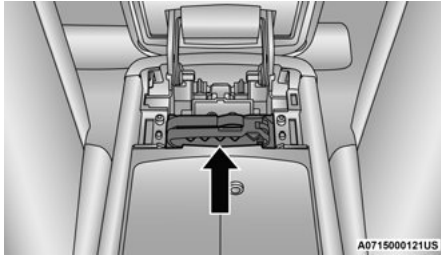

**Stowed Position**

**NOTE:**

Be sure to replace the cover by snapping it back in place.

## **FREEING A STUCK VEHICLE**

If your vehicle becomes stuck in mud, sand or snow, it can often be moved using a rocking motion. Turn the steering wheel right and left to clear the area around the front wheels. Push and hold the lock button on the gear selector. Then, shift back and forth between DRIVE (D) and REVERSE (R) while gently pressing the accelerator.

**NOTE:**

Shifts between DRIVE (D) and REVERSE (R) can only be achieved at wheel speeds of 5 mph (8 km/h) or less. Whenever the transmission remains in NEUTRAL (N) for more than two seconds, you must press the brake pedal to engage DRIVE (D) or REVERSE (R).

Use the least amount of accelerator pedal pressure that will maintain the rocking motion without spinning the wheels or racing the engine.

**NOTE:**

Push the ESC OFF button to place the Electronic Stability Control (ESC) system in “Partial OFF” mode, before rocking the vehicle ↪ page 189. Once the vehicle has been freed, push the ESC OFF button again to restore ESC On mode.

**WARNING!**

Fast spinning tires can be dangerous. Forces generated by excessive wheel speeds may cause damage, or even failure, of the axle and tires. A tire could explode and injure someone. Do not spin your vehicle's wheels faster than 30 mph (48 km/h) or for longer than 30 seconds continuously without stopping when you are stuck and do not let anyone near a spinning wheel, no matter what the speed.

**CAUTION!**

- Racing the engine or spinning the wheels may lead to transmission overheating and failure. Allow the engine to idle with the transmission in NEUTRAL for at least one minute after every five rocking-motion cycles. This will minimize overheating and reduce the risk of transmission failure during prolonged efforts to free a stuck vehicle.
- When “rocking” a stuck vehicle by shifting between DRIVE and REVERSE, do not spin the wheels faster than 15 mph (24 km/h), or drivetrain damage may result.
- Rewving the engine or spinning the wheels too fast may lead to transmission overheating and failure. It can also damage the tires. Do not spin the wheels above 30 mph (48 km/h) while in gear (no transmission shifting occurring).

## **TOWING A DISABLED VEHICLE**

This section describes procedures for towing a disabled vehicle using a commercial towing service.

If the transmission and drivetrain are operable, disabled 4x4 vehicles may also be towed as described under ↪ page 147.

Towing Condition	Wheels OFF The Ground	Rear-Wheel Drive Models	All-Wheel Drive Models With Single-Speed Transfer Case	All-Wheel Drive Models With Two-Speed Transfer Case
Flat Tow	NONE	NOT ALLOWED	NOT ALLOWED	<b>Detailed Instructions</b> ↪ <b>page 147</b> <ul style="list-style-type: none"> <li>● Transmission in PARK</li> <li>● Transfer case in NEUTRAL (N)</li> <li>● Tow in forward direction</li> </ul>
Wheel Lift Or Dolly Tow	Front	NOT ALLOWED	NOT ALLOWED	NOT ALLOWED
	Rear	OK	NOT ALLOWED	NOT ALLOWED
Flatbed	ALL	BEST METHOD	OK	BEST METHOD

**NOTE:**

When towing your vehicle, always follow applicable state and provincial laws. Contact state and provincial Highway Safety offices for additional details.

Proper towing or lifting equipment is required to prevent damage to your vehicle. Use only tow bars and other equipment designed for this purpose, following equipment manufacturer's instructions. Use of safety chains is mandatory. Attach a tow bar or other towing device to main structural members of the vehicle, not to fascia/bumpers or associated brackets. State and local laws regarding vehicles under tow must be observed.

If you must use the accessories (wipers, defrosters, etc.) while being towed, the ignition must be in the ON/RUN mode, not the ACC mode.

If the vehicle's battery is discharged, instructions on shifting the automatic transmission out of PARK (P) in order to move the vehicle can be found on ↪ page 251.

**CAUTION!**

- Do not use sling type equipment when towing. Vehicle damage may occur.
- When securing the vehicle to a flat bed truck, do not attach to front or rear suspension components. Damage to your vehicle may result from improper towing.

## REAR WHEEL DRIVE MODELS

FCA US LLC recommends towing your vehicle with all four wheels **OFF** the ground using a flatbed.

If flatbed equipment is not available, and the transmission is operable, the vehicle may be towed (with rear wheels off the ground) under the following conditions:

- The transmission must be in NEUTRAL (N). For instructions on shifting the transmission to NEUTRAL (N) when the engine is off ↪ page 251.
- The towing speed must not exceed 30 mph (48 km/h).
- The towing distance must not exceed 30 miles (48 km).

### CAUTION!

Towing faster than 30 mph (48 km/h) or farther than 30 miles (48 km) with rear wheels on the ground can cause severe transmission damage. Damage from improper towing is not covered under the New Vehicle Limited Warranty.

If the transmission is not operable, or the vehicle must be towed faster than 30 mph (48 km/h) or farther than 30 miles (48 km), tow with the rear wheels **OFF** the ground. Acceptable methods are to tow the vehicle on a flatbed, or with the front

wheels raised and the rear wheels on a towing dolly, or (when using a suitable steering wheel stabilizer to hold the front wheels in the straight position) with the rear wheels raised and the front wheels **ON** the ground.

## ALL WHEEL DRIVE MODELS

FCA US LLC recommends towing with all wheels **OFF** the ground. Acceptable methods are to tow the vehicle on a flatbed or with one end of the vehicle raised and the opposite end on a towing dolly.

If flatbed equipment is not available, and the transfer case is operable, vehicles **with a two-speed transfer case** may be towed (in the forward direction, with **ALL** wheels on the ground), **IF** the transfer case is in NEUTRAL (N) and the transmission is in **PARK** ↪ page 147.

Vehicles equipped with a single-speed transfer case have no NEUTRAL (N) position, and therefore **must** be towed with all four wheels **OFF** the ground.

### CAUTION!

- Front or rear wheel lifts must not be used (if the remaining wheels are on the ground). Internal damage to the transmission or transfer case will occur if a front or rear wheel lift is used when towing.

(Continued)

### CAUTION!

- Towing this vehicle in violation of the above requirements can cause severe transmission and/or transfer case damage. Damage from improper towing is not covered under the New Vehicle Limited Warranty.

## ENHANCED ACCIDENT RESPONSE SYSTEM (EARS)

This vehicle is equipped with an Enhanced Accident Response System.

This feature is a communication network that takes effect in the event of an impact ↪ page 218.

## EVENT DATA RECORDER (EDR)

This vehicle is equipped with an event data recorder (EDR). The main purpose of an EDR is to record data that will assist in understanding how a vehicle's systems performed under certain crash or near crash-like situations, such as an air bag deployment or hitting a road obstacle ↪ page 220.

# SERVICING AND MAINTENANCE

## SCHEDULED SERVICING

Your vehicle is equipped with an automatic oil change indicator system. The oil change indicator system will remind you that it is time to take your vehicle in for scheduled maintenance.

Based on engine operation conditions, the oil change indicator message will illuminate. This means that service is required for your vehicle. Operating conditions such as frequent short-trips, trailer tow, extremely hot or cold ambient temperatures, and E85 fuel usage will influence when the "Oil Change Required" message is

displayed. Have your vehicle serviced as soon as possible, within the next 500 miles (805 km).

An authorized dealer will reset the oil change indicator message after completing the scheduled oil change.

### NOTE:

Under no circumstances should oil change intervals exceed 10,000 miles (16,000 km), 12 months or 350 hours of engine run time, whichever comes first. The 350 hours of engine run or idle time is generally only a concern for fleet customers.

### Once A Month Or Before A Long Trip:

- Check engine oil level
- Check windshield washer fluid level
- Check the tire pressure and look for unusual wear or damage
- Check the fluid levels of the coolant reservoir, brake master cylinder and fill as needed
- Check function of all interior and exterior lights

## MAINTENANCE PLAN

Refer to the Maintenance Plans for required maintenance.

### At Every Oil Change Interval As Indicated By Oil Change Indicator System:

- Change oil and filter.
- Rotate the tires at the first sign of irregular wear, even if it occurs before the oil indicator system turns on.
- Inspect battery and clean and tighten terminals as required.
- Inspect the CV/Universal joints.
- Inspect brake pads, shoes, rotors, drums, hoses and parking brake.
- Inspect engine cooling system protection and hoses.
- Inspect exhaust system.
- Inspect engine air cleaner filter if using in dusty or off-road conditions. Replace engine air cleaner filter, if necessary.

Mileage or time passed (whichever comes first)	20,000	30,000	40,000	50,000	60,000	70,000	80,000	90,000	100,000	110,000	120,000	130,000	140,000	150,000
Or Years:	2	3	4	5	6	7	8	9	10	11	12	13	14	15
Or Kilometers:	32,000	48,000	64,000	80,000	96,000	112,000	128,000	144,000	160,000	176,000	192,000	208,000	224,000	240,000
<b>Additional Inspections</b>														
Inspect the CV/Universal joints.	X	X	X	X	X	X	X	X	X	X	X	X	X	X
Inspect front suspension, tie rod ends, and replace if necessary.	X		X		X		X		X		X		X	
Inspect the front and rear axle fluid, change if using your vehicle for police, taxi, fleet, off-road or frequent trailer towing.		X			X			X			X			X
Inspect the brake linings, parking brake function.	X		X		X		X		X		X		X	
Inspect transfer case fluid.		X			X			X			X			X
<b>Additional Maintenance</b>														
Replace engine air cleaner filter.		X			X			X			X			X
Replace the cabin air filter.	To be replaced every 12,000 mi (19,000 km).													
Replace spark plugs. <sup>1</sup>									X					
Flush and replace the engine coolant at 10 years or 150,000 miles (240,000 km) whichever comes first.									X					X
Replace accessory drive belt.														X

Mileage or time passed (whichever comes first)	20,000	30,000	40,000	50,000	60,000	70,000	80,000	90,000	100,000	110,000	120,000	130,000	140,000	150,000
Or Years:	2	3	4	5	6	7	8	9	10	11	12	13	14	15
Or Kilometers:	32,000	48,000	64,000	80,000	96,000	112,000	128,000	144,000	160,000	176,000	192,000	208,000	224,000	240,000
Inspect accessory drive belt tensioner and pulley, replace if necessary.														X
Change transfer case fluid - Normal Usage.											X			
Change transfer case fluid - Sever Usage (police, taxi, fleet, off-road or frequent trailer towing).						X							X	
Replace PCV valve.									X					

1. The spark plug change interval is mileage based only, yearly intervals do not apply.

#### WARNING!

- You can be badly injured working on or around a motor vehicle. Do only service work for which you have the knowledge and the right equipment. If you have any doubt about your ability to perform a service job, take your vehicle to a competent mechanic.
- Failure to properly inspect and maintain your vehicle could result in a component malfunction and effect vehicle handling and performance. This could cause an accident.



## ENGINE COMPARTMENT

### 3.6L ENGINE

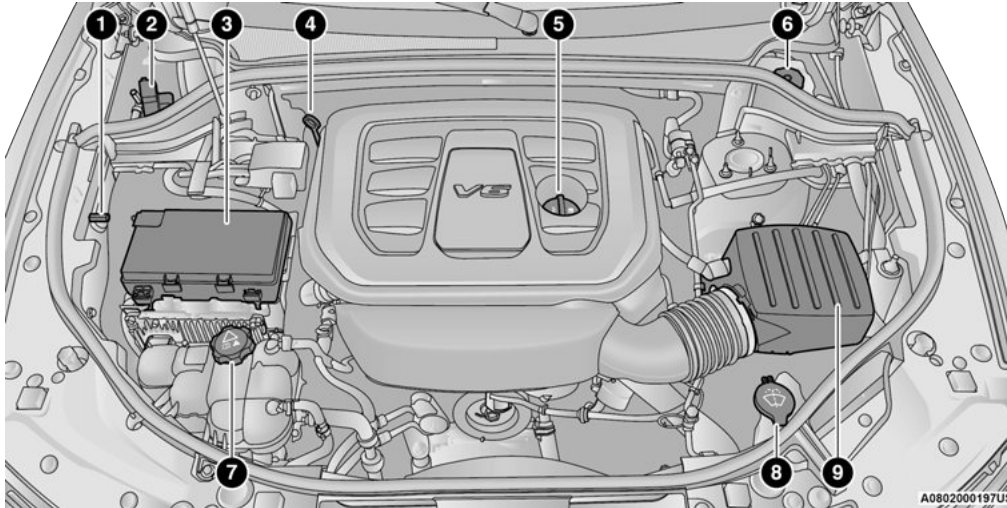

- 1 — Remote Jump Start Negative Terminal
- 2 — Remote Jump Start Positive Terminal
- 3 — Power Distribution Center (Fuses)
- 4 — Engine Oil Dipstick
- 5 — Engine Oil Fill

- 6 — Brake Fluid Reservoir Cap
- 7 — Engine Coolant Pressure Cap
- 8 — Washer Fluid Reservoir Cap
- 9 — Engine Air Cleaner Filter

## 5.7L ENGINE

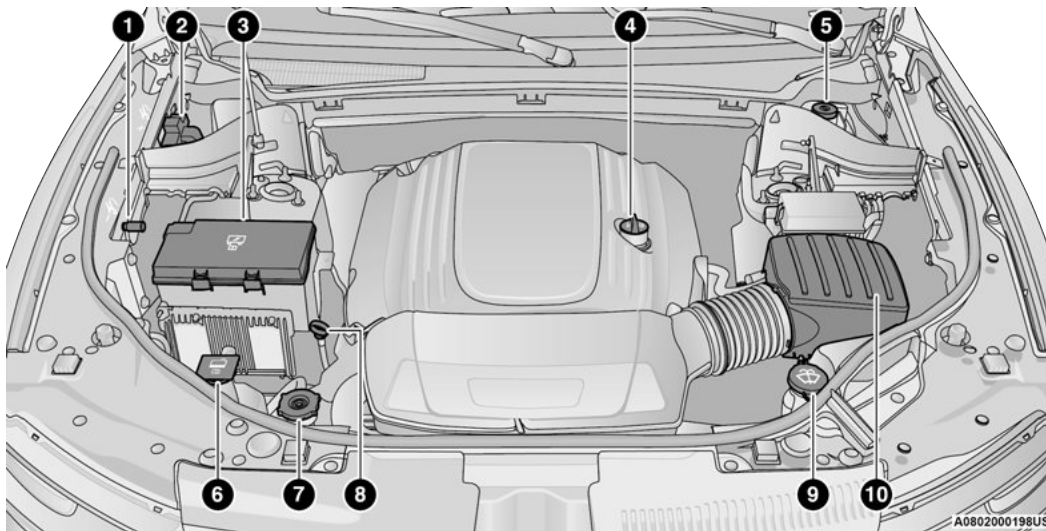

- 1 – Remote Jump Start Negative Terminal
- 2 – Remote Jump Start Positive Terminal
- 3 – Power Distribution Center (Fuses)
- 4 – Engine Oil Fill
- 5 – Brake Fluid Reservoir Cap

- 6 – Engine Coolant Reservoir Cap
- 7 – Engine Coolant Pressure Cap
- 8 – Engine Oil Dipstick
- 9 – Washer Fluid Reservoir Cap
- 10 – Engine Air Cleaner Filter

## CHECKING OIL LEVEL

To ensure proper engine lubrication, the engine oil must be maintained at the correct level. Check the oil level at regular intervals, such as every fuel stop. The best time to check the engine oil level is about five minutes after a fully warmed up engine is shut off.

Checking the oil while the vehicle is on level ground will improve the accuracy of the oil level readings.

There are four possible dipstick types:

- Crosshatched zone.
- Crosshatched zone marked SAFE.
- Crosshatched zone marked with MIN at the low end of the range and MAX at the high end of the range.
- Crosshatched zone marked with dimples at the MIN and the MAX ends of the range.

### NOTE:

Always maintain the oil level within the crosshatch markings on the dipstick.

Adding 1 quart (1.0 liter) of oil when the reading is at the low end of the dipstick range will raise the oil level to the high end of the range marking.

### CAUTION!

Overfilling or underfilling the crankcase will cause aeration or loss of oil pressure. This could damage your engine.

## ADDING WASHER FLUID

The instrument cluster display will indicate when the washer fluid level is low. When the sensor detects a low fluid level, the Low Washer Fluid Warning Light will illuminate and the "Washer Fluid Low" message will display.

The fluid reservoir for the windshield washers and the rear window washer is shared. The fluid reservoir is located in the engine compartment, be sure to check the fluid level at regular intervals. Fill the reservoir with windshield washer solvent only (not radiator antifreeze). When refilling the washer fluid reservoir, take some washer fluid and apply it to a cloth or towel and wipe clean the wiper blades, this will help blade performance. To prevent freeze-up of your windshield washer system in cold weather, select a solution or mixture that meets or exceeds the temperature range of your climate. This rating information can be found on most washer fluid containers.

### WARNING!

Commercially available windshield washer solvents are flammable. They could ignite and burn you. Care must be exercised when filling or working around the washer solution.

## MAINTENANCE-FREE BATTERY

Your vehicle is equipped with a maintenance-free battery. Water will never have to be added, and periodic maintenance is not required.

### WARNING!

- Battery fluid is a corrosive acid solution and can burn or even blind you. Do not allow battery fluid to contact your eyes, skin, or clothing. Do not lean over a battery when attaching clamps ↪ page 247. If acid splashes in eyes or on skin, flush the area immediately with large amounts of water.
- Battery gas is flammable and explosive. Keep flame or sparks away from the battery. Do not use a booster battery or any other booster source with an output greater than 12 Volts. Do not allow cable clamps to touch each other.
- Battery posts, terminals, and related accessories contain lead and lead compounds. Wash hands after handling.

**CAUTION!**

- It is essential when replacing the cables on the battery that the positive cable is attached to the positive post and the negative cable is attached to the negative post. Battery posts are marked positive (+) and negative (-) and are identified on the battery case. Cable clamps should be tight on the terminal posts and free of corrosion.
- If a “fast charger” is used while the battery is in the vehicle, disconnect both vehicle battery cables before connecting the charger to the battery. Do not use a “fast charger” to provide starting voltage.

**PRESSURE WASHING**

Cleaning the engine compartment with a high pressure washer is not recommended.

**CAUTION!**

Precautions have been taken to safeguard all parts and connections however, the pressures generated by these machines is such that complete protection against water ingress cannot be guaranteed.

**VEHICLE MAINTENANCE**

An authorized dealer has the qualified service personnel, special tools, and equipment to perform all service operations in an expert manner. Service Manuals are available which include detailed service information for your vehicle. Refer to these Service Manuals before attempting any procedure yourself.

**NOTE:**

Intentional tampering with emissions control systems may void your warranty and could result in civil penalties being assessed against you.

**WARNING!**

You can be badly injured working on or around a motor vehicle. Only do service work for which you have the knowledge and the proper equipment. If you have any doubt about your ability to perform a service job, take your vehicle to a competent mechanic.

**ENGINE OIL****Engine Oil Selection**

Use only the manufacturer's recommended fluid  
 ☞ page 309.

**NOTE:**

Hemi engines at times can tick right after startup and then quiet down after approximately

30 seconds. This is normal and will not harm the engine. This characteristic can be caused by short drive cycles. For example, if the vehicle is started then shut off after driving a short distance. Upon restarting, you may experience a ticking sound. Other causes could be if the vehicle is unused for an extended period of time, incorrect oil, extended oil changes or extended idling. If the engine continues to tick or if the Malfunction Indicator Light (MIL) comes on, see the nearest authorized dealer.

**American Petroleum Institute (API)  
Approved Engine Oil**

These symbols mean that the oil has been certified by the API. The manufacturer only recommends API trademark oils.



The API Starburst trademark certifies 0W-20, 0W-30 and 5W-30 engine oils.



The API Donut trademark certifies 0W-40 and 5W-40 engine oil.

**CAUTION!**

Do not use chemical flushes in your engine oil as the chemicals can damage your engine. Such damage is not covered by the New Vehicle Limited Warranty.

## Synthetic Engine Oils

Your engine was designed for synthetic engine oils, only use synthetic API approved engine oils.

Synthetic engine oils which do not have both the correct API trademark and the correct SAE viscosity grade numbers should not be used.

## Materials Added To Engine Oil

The manufacturer strongly recommends against the addition of any additives (other than leak detection dyes) to the engine oil. Engine oil is an engineered product and its performance may be impaired by supplemental additives.

## Disposing Of Used Engine Oil And Oil Filters

Care should be taken in disposing of used engine oil and oil filters from your vehicle. Used oil and oil filters, indiscriminately discarded, can present a problem to the environment. Contact an authorized dealer, service station or governmental agency for advice on how and where used oil and oil filters can be safely discarded in your area.

## ENGINE OIL FILTER

The engine oil filter should be replaced with a new filter at every engine oil change.

## Engine Oil Filter Selection

A full-flow type disposable oil filter should be used for replacement. The quality of replacement filters varies considerably. Only high quality Mopar® certified filters should be used.

## ENGINE AIR CLEANER FILTER

For the proper maintenance intervals ⇨ page 256.

### WARNING!

The air induction system (air cleaner, hoses, etc.) can provide a measure of protection in the case of engine backfire. Do not remove the air induction system (air cleaner, hoses, etc.) unless such removal is necessary for repair or maintenance. Make sure that no one is near the engine compartment before starting the vehicle with the air induction system (air cleaner, hoses, etc.) removed. Failure to do so can result in serious personal injury.

## Engine Air Cleaner Filter Selection

The quality of replacement filters varies considerably. Only high quality Mopar® certified filters should be used.

## Engine Air Cleaner Filter Inspection and Replacement

Inspect engine air cleaner filter for dirt and/or debris. If you find evidence of either dirt or debris, change the engine air cleaner filter.

## Engine Air Cleaner Filter Removal

1. Release the spring clips from the engine air cleaner filter cover.



Engine Air Cleaner Filter Cover

- 1 — Engine Air Cleaner Filter Cover
- 2 — Spring Clips

2. Lift the engine air cleaner filter cover to access the engine air cleaner filter.

- Remove the engine air cleaner filter from the housing assembly.

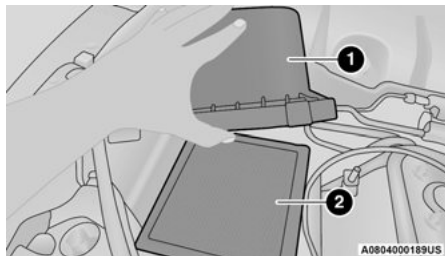

**Engine Air Cleaner Filter Assembly**

- Engine Air Cleaner Filter Cover
- Engine Air Cleaner Filter

### Engine Air Cleaner Filter Installation

#### NOTE:

Inspect and clean the housing if significant dirt or debris is present before replacing the engine air cleaner filter.

- Install the engine air cleaner filter into the housing assembly with the engine air cleaner filter inspection surface facing downward.
- Install the engine air cleaner filter cover onto the housing assembly locating tabs.
- Latch the spring clips and lock the engine air cleaner filter cover to the housing assembly.

## AIR CONDITIONER MAINTENANCE

For best possible performance, your air conditioner should be checked and serviced by an authorized dealer at the start of each warm season. This service should include cleaning of the condenser fins and a performance test. Drive belt tension should also be checked at this time.

### WARNING!

- Use only refrigerants and compressor lubricants approved by the manufacturer for your air conditioning system. Some unapproved refrigerants are flammable and can explode, injuring you. Other unapproved refrigerants or lubricants can cause the system to fail, requiring costly repairs. Refer to Warranty Information Book, for further warranty information.
- The air conditioning system contains refrigerant under high pressure. To avoid risk of personal injury or damage to the system, adding refrigerant or any repair requiring lines to be disconnected should be done by an experienced technician.

### CAUTION!

Do not use chemical flushes in your air conditioning system as the chemicals can damage your air conditioning components. Such damage is not covered by the New Vehicle Limited Warranty.

## Refrigerant Recovery And Recycling R-134a — If Equipped

R-134a Air Conditioning Refrigerant is a Hydrofluorocarbon (HFC) that is an ozone-friendly substance. The manufacturer recommends that air conditioning service be performed by an authorized dealer or other service facilities using recovery and recycling equipment.

#### NOTE:

Use only the manufacturer approved A/C system PAG compressor oil and refrigerants.

## Refrigerant Recovery And Recycling R-1234yf — If Equipped

R-1234yf Air Conditioning Refrigerant is a Hydrofluorolefin (HFO) that is endorsed by the Environmental Protection Agency and is an ozone-friendly substance with a low global-warming potential. The manufacturer recommends that air conditioning service be performed by an authorized dealer using recovery and recycling equipment.

#### NOTE:

Use only the manufacturer approved A/C system PAG compressor oil, and refrigerants.

## Cabin Air Filter

For the proper maintenance intervals → page 256.

### WARNING!

Do not remove the cabin air filter while the vehicle is running, or while the ignition is in the ACC or ON/RUN mode. With the cabin air filter removed and the blower operating, the blower can contact hands and may propel dirt and debris into your eyes, resulting in personal injury.

The cabin air filter is located in the fresh air inlet behind the glove compartment. Perform the following procedure to replace the filter:

1. Open the glove compartment and remove all contents.

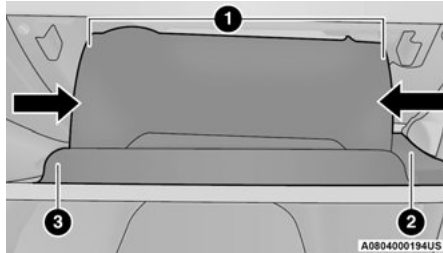

Glove Compartment

- 1 – Glove Compartment Travel Stops
- 2 – Glove Compartment Tension Tether
- 3 – Glove Compartment Door

2. There are glove compartment travel stops on both sides of the glove compartment door. Partially close the glove compartment door and push inward to release the glove compartment travel stop on one side and repeat this procedure for the opposite side.
3. Pull the right hand side of the glove compartment door toward the rear of the vehicle to disengage the glove compartment door from its hinges.

### NOTE:

When disengaging the glove compartment door from its hinges, there will be some resistance.

4. With the glove compartment door loose, remove the glove compartment tension tether and tether clip by sliding the clip toward the face of the glove compartment door and lifting the clip out of glove compartment door.

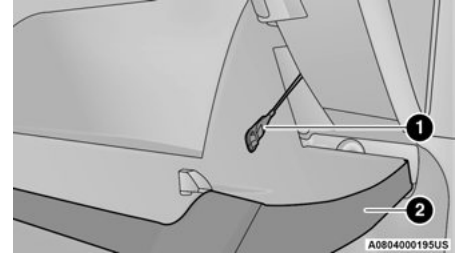

Right Side Of Glove Compartment

- 1 – Glove Compartment Tension Tether
- 2 – Glove Compartment Door

- Remove the filter cover by disengaging the retaining tab and mid way snap that secures the filter cover to the HVAC housing. Disengage the mid way snap by pulling the door outward. Unhinge the filter cover on the right side to fully remove the cover.

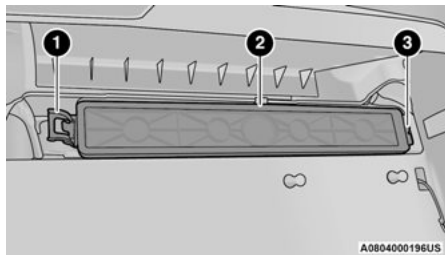

Cabin Air Filter Cover

- Retaining Tab
- Mid Way Snap
- Filter Cover Hinge

- Remove the cabin air filter by pulling it straight out of the housing.
- Install the cabin air filter with the arrow on the filter pointing toward the floor. When installing the filter cover, make sure the retaining tabs fully engage the cover.

**CAUTION!**

The cabin air filter is identified with an arrow to indicate airflow direction through the filter. Failure to properly install the filter will result in the need to replace it more often.

- Reinstall the glove compartment door on the door hinge and reattach the tension tether by inserting the tether clip in the glove compartment and sliding the clip away from the face of the glove compartment door.
- Push the door to the near closed position to reengage the glove compartment travel stops.

**NOTE:**

Ensure the glove compartment door hinges and glove compartment travel stops are fully engaged.

**ACCESSORY DRIVE BELT INSPECTION****WARNING!**

- Do not attempt to inspect an accessory drive belt with vehicle running.
- When working near the radiator cooling fan, disconnect the fan motor lead. The fan is temperature controlled and can start at any time regardless of ignition mode. You could be injured by the moving fan blades.

(Continued)

**WARNING!**

- You can be badly injured working on or around a motor vehicle. Only do service work for which you have the knowledge and the proper equipment. If you have any doubt about your ability to perform a service job, take your vehicle to a competent mechanic.

When inspecting accessory drive belts, small cracks that run across the ribbed surface of the belt from rib to rib, are considered normal. This is not a reason to replace belt. However, cracks running along a rib (not across) are not normal. Any belt with cracks running along a rib must be replaced. Also have the belt replaced if it has excessive wear, frayed cords or severe glazing.

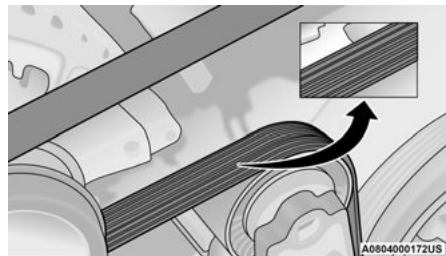

Accessory Belt (Serpentine Belt)



Conditions that would require replacement:

- Rib chunking (one or more ribs has separated from belt body)
- Rib or belt wear
- Longitudinal belt cracking (cracks between two ribs)
- Belt slips
- "Groove jumping" (belt does not maintain correct position on pulley)
- Belt broken (note: identify and correct problem before new belt is installed)
- Noise (objectionable squeal, squeak, or rumble is heard or felt while drive belt is in operation)

Some conditions can be caused by a faulty component such as a belt pulley. Belt pulleys should be carefully inspected for damage and proper alignment.

Belt replacement on some models requires the use of special tools. We recommend having your vehicle serviced at an authorized dealer.

## BODY LUBRICATION

Locks and all body pivot points, including such items as seat tracks, door hinge pivot points and rollers, liftgate, tailgate, decklid, sliding doors and hood hinges, should be lubricated periodically. Use a lithium-based grease, such as Mopar® Spray White Lube to ensure quiet, easy operation and to

protect against rust and wear. Prior to the application of any lubricant, the parts concerned should be wiped clean to remove dust and grit; after lubricating excess oil and grease should be removed. Particular attention should also be given to hood latching components to ensure proper function. When performing other underhood services, the hood latch, release mechanism and safety catch should be cleaned and lubricated.

The external lock cylinders should be lubricated twice a year, preferably in the Autumn and Spring. Apply a small amount of a high quality lubricant, such as Mopar® Lock Cylinder Lubricant directly into the lock cylinder.

## WINDSHIELD WIPER BLADES

Clean the rubber edges of the wiper blades and the windshield periodically with a sponge or soft cloth and a mild nonabrasive cleaner. This will remove accumulations of salt or road film.

Operation of the wipers on dry glass for long periods may cause deterioration of the wiper blades. Always use washer fluid when using the wipers to remove salt or dirt from a dry windshield.

Avoid using the wiper blades to remove frost or ice from the windshield. Keep the blade rubber out of contact with petroleum products such as engine oil, gasoline, etc.

### NOTE:

Life expectancy of wiper blades varies depending on geographical area and frequency of use. If chattering, marks, water lines or wet spots are present, clean the wiper blades or replace as necessary.

The wiper blades and wiper arms should be inspected periodically, not just when wiper performance problems are experienced. This inspection should include the following points:

- Wear or uneven edges
- Foreign material
- Hardening or cracking
- Deformation or fatigue

If a wiper blade or wiper arm is damaged, replace the affected wiper arm or blade with a new unit. Do not attempt to repair a wiper arm or blade that is damaged.

## Front Wiper Blade Removal/Installation

### CAUTION!

Do not allow the wiper arm to spring back against the glass without the wiper blade in place or the glass may be damaged.

1. Lift the wiper arm to raise the wiper blade off of the glass, until the wiper arm is in the full up position.

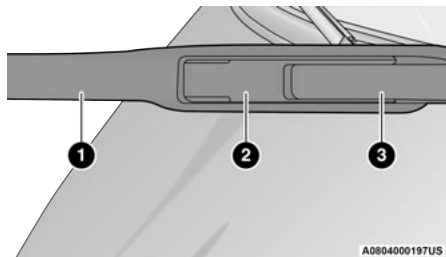

**Wiper Blade With Release Tab In Locked Position**

- 1 – Wiper
- 2 – Release Tab
- 3 – Wiper Arm

2. To disengage the wiper blade from the wiper arm, flip up the release tab on the wiper blade and while holding the wiper arm with one hand, slide the wiper blade down towards the base of the wiper arm.

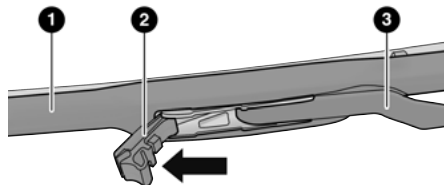

**Wiper Blade With Release Tab In Unlocked Position**

- 1 – Wiper Blade
- 2 – Release Tab
- 3 – Wiper Arm

3. With the wiper blade disengaged, remove the wiper blade from the wiper arm by holding the wiper arm with one hand and separating the wiper blade from the wiper arm with the other hand (move the wiper blade toward the right side of the vehicle to separate the wiper blade from the wiper arm).

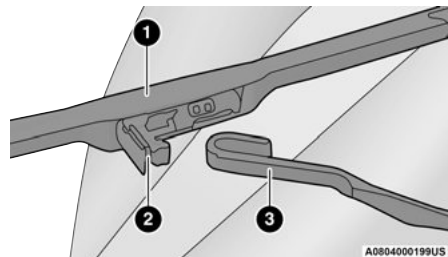

**Wiper Blade Removed From Wiper Arm**

- 1 – Wiper Blade
- 2 – Release Tab
- 3 – Wiper Arm

4. Gently lower the wiper arm onto the glass.

### Installing The Front Wipers

1. Lift the wiper arm off of the glass, until the wiper arm is in the full up position.
2. Position the wiper blade near the hook on the tip of the wiper arm with the wiper release tab open and the blade side of the wiper facing up and away from the windshield.
3. Insert the hook on the tip of the arm through the opening in the wiper blade under the release tab.

- Slide the wiper blade up into the hook on the wiper arm and rotate the wiper blade until it is flush against the wiper arm. Fold down the latch release tab and snap it into its locked position. Latch engagement will be accompanied by an audible click.
- Gently lower the wiper blade onto the glass.

### Rear Wiper Blade Removal/Installation

- Lift the rear wiper arm pivot cap away from the glass to allow the rear wiper blade to be raised off of the glass.

#### NOTE:

The rear wiper arm cannot be fully raised off the glass unless the wiper arm pivot cap is unsnapped first. Attempting to fully raise the rear wiper arm without unsnapping the wiper arm pivot cap may damage the vehicle.

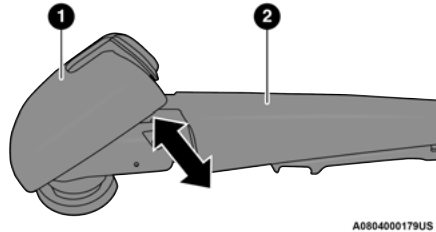

Wiper Pivot Cap In Unlocked Position

- Wiper Arm Pivot Cap
- Wiper Arm

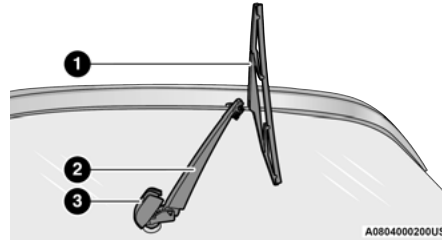

Wiper Blade In Folded Out Position

- Wiper Blade
- Wiper Arm
- Wiper Arm Pivot Cap

- To remove the wiper blade from the wiper arm, grasp the bottom end of the wiper blade nearest to wiper arm with your right hand. With your left hand hold the wiper arm as you pull the wiper blade away from the wiper arm past its stop far enough to unsnap the wiper blade pivot pin from the receptacle on the end of the wiper arm.

#### NOTE:

Resistance will be accompanied by an audible snap.

- Still grasping the bottom end of the wiper blade, move the wiper blade upward and away from the wiper arm to disengage.

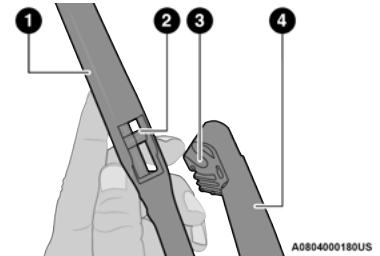

Wiper Blade Removed From Wiper Arm

- Wiper Blade
- Wiper Blade Pivot Pin
- Wiper Arm Receptacle
- Wiper Arm

- Gently lower the tip of the wiper arm onto the glass.

### Installing The Rear Wiper

1. Lift the rear wiper arm pivot cap away from the glass to allow the rear wiper blade to be raised off of the glass.

#### NOTE:

The rear wiper arm cannot be fully raised off the glass unless the wiper arm pivot cap is unsnapped first. Attempting to fully raise the rear wiper arm without unsnapping the wiper arm pivot cap may damage the vehicle.

2. Lift the rear wiper arm fully off the glass.
3. Insert the wiper blade pivot pin into the opening on the end of the wiper arm. Grab the bottom end of the wiper arm with one hand, and press the wiper blade flush with the wiper arm until it snaps into place.
4. Lower the wiper blade onto the glass and snap the wiper arm pivot cap back into place.

### EXHAUST SYSTEM

The best protection against carbon monoxide entry into the vehicle body is a properly maintained engine exhaust system.

If you notice a change in the sound of the exhaust system; or if the exhaust fumes can be detected inside the vehicle; or when the underside or rear of the vehicle is damaged; have an authorized technician inspect the complete exhaust system and adjacent body areas for broken, damaged,

deteriorated, or mispositioned parts. Open seams or loose connections could permit exhaust fumes to seep into the passenger compartment. In addition, have the exhaust system inspected each time the vehicle is raised for lubrication or oil change. Replace as required.

#### WARNING!

- Exhaust gases can injure or kill. They contain Carbon Monoxide (CO), which is colorless and odorless. Breathing it can make you unconscious and can eventually poison you. To avoid breathing CO see ↗ page 233.
- A hot exhaust system can start a fire if you park over materials that can burn. Such materials might be grass or leaves coming into contact with your exhaust system. Do not park or operate your vehicle in areas where your exhaust system can contact anything that can burn.

#### CAUTION!

- The catalytic converter requires the use of unleaded fuel only. Leaded gasoline will destroy the effectiveness of the catalyst as an emissions control device and may seriously reduce engine performance and cause serious damage to the engine.

*(Continued)*

#### CAUTION!

- Damage to the catalytic converter can result if your vehicle is not kept in proper operating condition. In the event of engine malfunction, particularly involving engine misfire or other apparent loss of performance, have your vehicle serviced promptly. Continued operation of your vehicle with a severe malfunction could cause the converter to overheat, resulting in possible damage to the converter and vehicle.

Under normal operating conditions, the catalytic converter will not require maintenance. However, it is important to keep the engine properly tuned to ensure proper catalyst operation and prevent possible catalyst damage.

#### NOTE:

Intentional tampering with emissions control systems can result in civil penalties being assessed against you.

In unusual situations involving grossly malfunctioning engine operation, a scorching odor may suggest severe and abnormal catalyst overheating. If this occurs, stop the vehicle, turn off the engine and allow it to cool. Service, including a tune-up to the manufacturer's specifications, should be obtained immediately.

To minimize the possibility of catalytic converter damage:

- Do not interrupt the ignition when the transmission is in gear and the vehicle is in motion.
- Do not try to start the vehicle by pushing or towing the vehicle.
- Do not idle the engine with any ignition components disconnected or removed, such as when diagnostic testing, or for prolonged periods during very rough idle or malfunctioning operating conditions.

## COOLING SYSTEM

### WARNING!

- You or others can be badly burned by hot engine coolant (antifreeze) or steam from your radiator. If you see or hear steam coming from under the hood, do not open the hood until the radiator has had time to cool. Never open a cooling system pressure cap when the radiator or coolant bottle is hot.
- Keep hands, tools, clothing, and jewelry away from the radiator cooling fan when the hood is raised. The fan starts automatically and may start at any time, whether the engine is running or not.

(Continued)

### WARNING!

- When working near the radiator cooling fan, disconnect the fan motor lead or turn the ignition to the OFF mode. The fan is temperature controlled and can start at any time the ignition is in the ON mode.

## Engine Coolant Checks

Check the engine coolant (antifreeze) protection every 12 months (before the onset of freezing weather, where applicable). If the engine coolant is dirty, the system should be drained, flushed, and refilled with fresh Organic Additive Technology (OAT) coolant (conforming to MS.90032) by an authorized dealer. Check the front of the A/C condenser for any accumulation of bugs, leaves, etc. If dirty, clean by gently spraying water from a garden hose vertically down the face of the condenser.

Check the engine cooling system hoses for brittle rubber, cracking, tears, cuts, and tightness of the connection at the coolant recovery bottle and radiator. Inspect the entire system for leaks. **DO NOT REMOVE THE COOLANT PRESSURE CAP WHEN THE COOLING SYSTEM IS HOT.**

## Cooling System — Drain, Flush And Refill

### NOTE:

Some vehicles require special tools to add coolant properly. Failure to fill these systems properly could lead to severe internal engine damage. If any coolant is needed to be added to the system please contact an authorized dealer.

If the engine coolant (antifreeze) is dirty or contains visible sediment, have an authorized dealer clean and flush with OAT coolant (conforming to MS.90032).

For the proper maintenance intervals ⇨ page 256.

### Selection Of Coolant

For further information ⇨ page 309.

### NOTE:

- Mixing of engine coolant (antifreeze) other than specified Organic Additive Technology (OAT) engine coolant, may result in engine damage and may decrease corrosion protection. OAT engine coolant is different and should not be mixed with Hybrid Organic Additive Technology (HOAT) engine coolant or any “globally compatible” coolant. If a non-OAT engine coolant is introduced into the cooling system in an emergency, the cooling system will need to be drained, flushed, and refilled with fresh OAT coolant (conforming to MS.90032), by an authorized dealer as soon as possible.

- Do not use water alone or alcohol-based engine coolant products. Do not use additional rust inhibitors or antirust products, as they may not be compatible with the radiator engine coolant and may plug the radiator.
- This vehicle has not been designed for use with propylene glycol-based engine coolant. Use of propylene glycol-based engine coolant is not recommended.
- Some vehicles require special tools to add coolant properly. Failure to fill these systems properly could lead to severe internal engine damage. If any coolant is needed to be added to the system please contact an authorized dealer.

### Adding Coolant

Your vehicle has been built with an improved engine coolant (OAT coolant conforming to MS.90032) that allows extended maintenance intervals. This engine coolant (antifreeze) can be used up to 10 years or 150,000 miles (240,000 km) before replacement. To prevent reducing this extended maintenance period, it is important that you use the same engine coolant (OAT coolant conforming to MS.90032) throughout the life of your vehicle.

Please review these recommendations for using Organic Additive Technology (OAT) engine coolant that meets the requirements of the manufacturer Material Standard MS.90032. When adding engine coolant:

- We recommend using Mopar® Antifreeze/Coolant 10 Year/150,000 Mile (240,000 km) Formula OAT that meets the requirements of the manufacturer Material Standard MS.90032.
- Mix a minimum solution of 50% OAT engine coolant that meets the requirements of the manufacturer Material Standard MS.90032 and distilled water. Use higher concentrations (not to exceed 70%) if temperatures below  $-34^{\circ}\text{F}$  ( $-37^{\circ}\text{C}$ ) are anticipated. Please contact an authorized dealer for assistance.
- Use only high purity water such as distilled or deionized water when mixing the water/engine coolant solution. The use of lower quality water will reduce the amount of corrosion protection in the engine cooling system.

### NOTE:

- It is the owner's responsibility to maintain the proper level of protection against freezing according to the temperatures occurring in the area where the vehicle is operated.
- Some vehicles require special tools to add coolant properly. Failure to fill these systems properly could lead to severe internal engine damage. If any coolant is needed to be added to the system, please contact an authorized dealer.
- Mixing engine coolant types is not recommended and can result in cooling system

damage. If HOAT and OAT coolant are mixed in an emergency, have an authorized dealer drain, flush, and refill with OAT coolant (conforming to MS.90032) as soon as possible.

### Cooling System Pressure Cap

The cap must be fully tightened to prevent loss of engine coolant (antifreeze), and to ensure that engine coolant will return to the radiator from the coolant expansion bottle/recovery tank if so equipped.

The cap should be inspected and cleaned if there is any accumulation of foreign material on the sealing surfaces.

### WARNING!

- Do not open hot engine cooling system. Never add engine coolant (antifreeze) when the engine is overheated. Do not loosen or remove the cap to cool an overheated engine. Heat causes pressure to build up in the cooling system. To prevent scalding or injury, do not remove the pressure cap while the system is hot or under pressure.
- Do not use a pressure cap other than the one specified for your vehicle. Personal injury or engine damage may result.

## Disposal Of Used Coolant

Used ethylene glycol-based coolant (antifreeze) is a regulated substance requiring proper disposal. Check with your local authorities to determine the disposal rules for your community. To prevent ingestion by animals or children, do not store ethylene glycol-based coolant in open containers or allow it to remain in puddles on the ground, clean up any ground spills immediately. If ingested, seek emergency assistance immediately.

## Cooling System Notes

### NOTE:

When the vehicle is stopped after a few miles/kilometers of operation, you may observe vapor coming from the front of the engine compartment. This is normally a result of moisture from rain, snow, or high humidity accumulating on the radiator and being vaporized when the thermostat opens, allowing hot engine coolant (antifreeze) to enter the radiator.

If an examination of your engine compartment shows no evidence of radiator or hose leaks, the vehicle may be safely driven. The vapor will soon dissipate.

- Do not overfill the coolant expansion bottle.
- Check the coolant freeze point in the radiator and in the coolant expansion bottle. If engine coolant needs to be added, the contents of the

coolant expansion bottle must also be protected against freezing.

- If frequent engine coolant additions are required, the cooling system should be pressure tested for leaks.
- Maintain engine coolant concentration at a minimum of 50% OAT coolant (conforming to MS.90032) and distilled water for proper corrosion protection of your engine which contains aluminum components.
- Make sure that the coolant expansion bottle overflow hoses are not kinked or obstructed.
- Keep the front of the radiator clean. If your vehicle is equipped with air conditioning, keep the front of the condenser clean.
- Do not change the thermostat for Summer or Winter operation. If replacement is ever necessary, install ONLY the correct type thermostat. Other designs may result in unsatisfactory engine cooling performance, poor gas mileage, and increased emissions.

## BRAKE SYSTEM

In order to ensure brake system performance, all brake system components should be inspected periodically. For the proper maintenance intervals ↪ page 256.

### WARNING!

Riding the brakes can lead to brake failure and possibly a collision. Driving with your foot resting or riding on the brake pedal can result in abnormally high brake temperatures, excessive lining wear, and possible brake damage. You would not have your full braking capacity in an emergency.

## Fluid Level Check — Brake Master Cylinder

The fluid level of the master cylinder should be checked whenever the vehicle is serviced, or immediately if the Brake System Warning Light is on. If necessary, add fluid to bring level within the designated marks on the side of the reservoir of the brake master cylinder. Be sure to clean the top of the master cylinder area before removing cap. With disc brakes, fluid level can be expected to fall as the brake pads wear. Brake fluid level should be checked when pads are replaced. If the brake fluid is abnormally low, check the system for leaks. For further information ↪ page 310.

**WARNING!**

- Use only the manufacturer's recommended brake fluid → page 310. Using the wrong type of brake fluid can severely damage your brake system and/or impair its performance. The proper type of brake fluid for your vehicle is also identified on the original factory installed hydraulic master cylinder reservoir.
- To avoid contamination from foreign matter or moisture, use only new brake fluid or fluid that has been in a tightly closed container. Keep the master cylinder reservoir cap secured at all times. Brake fluid in an open container absorbs moisture from the air resulting in a lower boiling point. This may cause it to boil unexpectedly during hard or prolonged braking, resulting in sudden brake failure. This could result in a collision.
- Overfilling the brake fluid reservoir can result in spilling brake fluid on hot engine parts, causing the brake fluid to catch fire. Brake fluid can also damage painted and vinyl surfaces, care should be taken to avoid its contact with these surfaces.
- Do not allow petroleum based fluid to contaminate the brake fluid. Brake seal components could be damaged, causing partial or complete brake failure. This could result in a collision.

**AUTOMATIC TRANSMISSION****Special Additives**

The manufacturer strongly recommends against using any special additives in the transmission. Automatic Transmission Fluid (ATF) is an engineered product and its performance may be impaired by supplemental additives. Therefore, do not add any fluid additives to the transmission. Avoid using transmission sealers as they may adversely affect seals.

**CAUTION!**

Do not use chemical flushes in your transmission as the chemicals can damage your transmission components. Such damage is not covered by the New Vehicle Limited Warranty.

**Fluid Level Check**

The fluid level is preset at the factory and does not require adjustment under normal operating conditions. Routine fluid level checks are not required; therefore the transmission has no dipstick. An authorized dealer can check your transmission fluid level using special service tools. If you notice fluid leakage or transmission malfunction, visit an authorized dealer immediately to have the transmission fluid level checked. Operating the vehicle with an improper fluid level can cause severe transmission damage.

**CAUTION!**

If a transmission fluid leak occurs, visit an authorized dealer immediately. Severe transmission damage may occur. An authorized dealer has the proper tools to adjust the fluid level accurately.

**Fluid And Filter Changes**

Under normal operating conditions, the fluid installed at the factory will provide satisfactory lubrication for the life of the vehicle.

Routine fluid and filter changes are not required. However, change the fluid and filter if the fluid becomes contaminated (with water, etc.), or if the transmission is disassembled for any reason.

**Selection Of Lubricant**

It is important to use the proper transmission fluid to ensure optimum transmission performance and life. Use only the manufacturer's specified transmission fluid → page 310. It is important to maintain the transmission fluid at the correct level using the recommended fluid.

**NOTE:**

No chemical flushes should be used in any transmission; only the approved lubricant should be used.



**CAUTION!**

Using a transmission fluid other than the manufacturer recommended fluid may cause deterioration in transmission shift quality and/or torque converter shudder ⇨ page 310.

**FRONT/REAR AXLE FLUID**

For normal service, periodic fluid level checks are not required. When the vehicle is serviced for other reasons the exterior surfaces of the axle assembly should be inspected. If gear oil leakage is suspected inspect the fluid level.

**Front Axle Fluid Level Check**

The front axle oil level needs to be no lower than 1/8 inch (3 mm) below the bottom of the fill hole.

The front axle fill and drain plugs should be tightened to 22 to 29 ft lbs (30 to 40 N·m).

**CAUTION!**

Do not overtighten the plugs as it could damage them and cause them to leak.

**Rear Axle Fluid Level Check**

The rear axle oil level needs to be no lower than 1/8 inch (3 mm) below the bottom of the fill hole.

The rear axle fill and drain plugs should be tightened to 22 to 29 ft lbs (30 to 40 N·m).

**CAUTION!**

Do not overtighten the plugs as it could damage them and cause them to leak.

**Selection Of Lubricant**

Use only the manufacturer's recommended fluid ⇨ page 310.

**TRANSFER CASE****Fluid Level Check**

For normal service, periodic fluid level checks are not required. When the vehicle is serviced for other reasons the exterior surfaces of the transfer case assembly should be inspected. If oil leakage is suspected inspect the fluid level.

**Adding Fluid**

With the vehicle in a level position, fill the transfer case to bottom edge of fill plug opening.

**Drain**

First remove fill plug, then remove drain plug. Recommended tightening torque for drain and fill plugs is 15 to 25 ft lbs (20 to 34 N·m).

**CAUTION!**

When installing plugs, do not overtighten. You could damage them and cause them to leak.

**Selection Of Lubricant**

Use only the manufacturer's recommended fluid ⇨ page 310.

**FUSES****General Information****WARNING!**

- When replacing a blown fuse, always use an appropriate replacement fuse with the same amp rating as the original fuse. Never replace a fuse with another fuse of higher amp rating. The use of a fuse with a rating other than indicated may result in a dangerous electrical system overload. If a properly rated fuse continues to blow, it indicates a problem in the circuit that must be corrected. Never replace a blown fuse with metal wires or any other material. Do not place a fuse inside a circuit breaker cavity or vice versa. Failure to use proper fuses may result in serious personal injury, fire and/or property damage.

(Continued)

**WARNING!**

- Before replacing a fuse, make sure that the ignition is off and that all the other services are switched off and/or disengaged.
- If the replaced fuse blows again, contact an authorized dealer.
- If a general protection fuse for safety systems (air bag system, braking system), power unit systems (engine system, transmission system) or steering system blows, contact an authorized dealer.

The fuses protect electrical systems against excessive current.

When a device does not work, you must check the fuse element inside the blade fuse for a break/melt.

Also, please be aware that using power outlets for extended periods of time with the engine off may result in vehicle battery discharge.

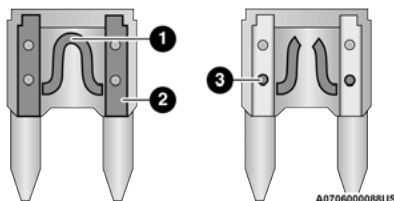
**Blade Fuses**

- 1 – Fuse Element
- 2 – Blade Fuse with a good/functional fuse element
- 3 – Blade fuse with a bad/not functional fuse element (blown fuse)

**Underhood Fuses**

The Power Distribution Center is located in the engine compartment near the battery jump start posts. This center contains cartridge fuses, micro fuses, relays, and circuit breakers. A description of each fuse and component may be stamped on the inside cover, otherwise the cavity number of each fuse is stamped on the inside cover that corresponds to the following chart.

**CAUTION!**

When installing the power distribution center cover, it is important to ensure the cover is properly positioned and fully latched. Failure to do so may allow water to get into the power distribution center and possibly result in an electrical system failure.

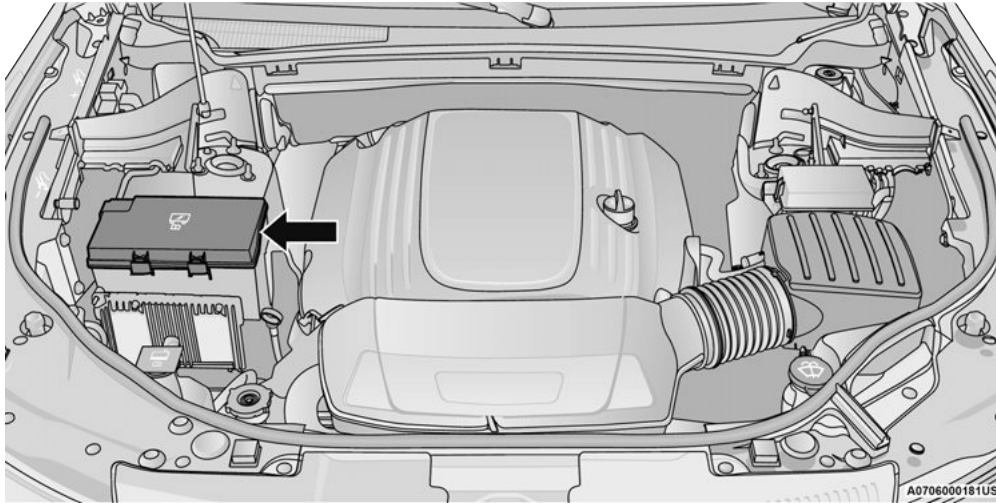

Power Distribution Center Location

Cavity	Cartridge Fuse	Micro Fuse	Description
<b>* If Equipped</b>			
F01	-	-	Spare
F02	-	-	Spare
F03	60 Amp Yellow	-	Rad Fan *
F04	60 Amp Yellow	-	ESP Pump

Cavity	Cartridge Fuse	Micro Fuse	Description
<b>* If Equipped</b>			
F05	-	-	Spare
F06	40 Amp Green	-	ABS Pump *
F07	30 Amp Pink	-	Starter Solenoid
F08	-	-	Spare
F09	30 Amp Pink	-	VAC PUMP *
F10	40 Amp Green	-	CBC #2 / EXT Light
F11	30 Amp Pink	-	Trlr Tow Brake *
F12	40 Amp Green	-	CBC #3 / Pwr Locks
F13	40 Amp Green	-	HVAC BLWR MTR
F14	40 Amp Green	-	CBC #4 / Ext Light
F15	40 Amp Green	-	LTR Engine Cooling *
F16	-	-	Spare
F17	-	-	Spare
F18	-	-	Spare
F19	20 Amp Blue	-	Solenoid Headrest *
F20	30 Amp Pink	-	Pass Door Mod
F21	-	-	Spare
F22	20 Amp Blue	-	ECM *
F23	30 Amp Pink	-	CBC #1 / Int Light
F24	30 Amp Pink	-	Driver Door Mod

Cavity	Cartridge Fuse	Micro Fuse	Description
<b>* If Equipped</b>			
F25	30 Amp Pink	-	Ft Wiper
F26	30 Amp Pink	-	ESP / ECU Valves
F27	-	-	Spare
F28	20 Amp Blue	-	Trlr Tow B/U *
F29	20 Amp Blue	-	Trlr Tow Park *
F30	30 Amp Pink	-	Trlr Tow Pwr *
F31	-	-	Spare
F32	30 Amp Pink	-	DTCM
F33	-	-	Spare
F34	30 Amp Pink	-	ELSD *
F35	30 Amp Pink	-	Sunroof *
F36	30 Amp Pink	-	EBL
F37	25 Amp Clear	-	HVAC RR Blower MTR *
F38	30 Amp Pink	-	Power Inverter
F39	30 Amp Pink	-	PLG
F40	-	10 Amp Red	DRL/ HEADLAMP LVL *
F41	-	-	Spare
F42	-	20 Amp Yellow	Horn
F43	-	-	Spare
F44	-	10 Amp Red	Diagnostic Port

Cavity	Cartridge Fuse	Micro Fuse	Description
<b>* If Equipped</b>			
F45	-	5 Amp Tan	Cyber Security MOD
F46	-	-	Spare
F47	-	-	Spare
F48	-	-	Spare
F49	-	10 Amp Red	ICS / HVAC
F50	-	20 Amp Yellow	ELSD *
F51	-	15 Amp Blue	KIN / RF HUB
F52	-	-	Spare
F53	-	20 Amp Yellow	Trlr Tow LT Turn / Stop *
F54	-	-	Spare
F55	-	-	Spare
F56	-	-	Spare
F57	-	-	Spare
F58	-	15 Amp Blue	HID Headlamps LH *
F59	-	-	Spare
F60	-	15 Amp Blue	TCM
F61	-	-	Spare
F62	-	10 Amp Red	A/C Clutch
F63	-	20 Amp Yellow	Ignition Coils */ Ignition Coil Capacitors*
F64	-	25 Amp Clear	Fuel Injectors / ECM

Cavity	Cartridge Fuse	Micro Fuse	Description
<b>* If Equipped</b>			
F65	-	-	Spare
F66	-	10 Amp Red	Sunroof */ LRSM */ RVM / DSRC / USB Port / DTV * / WCP *
F67	-	15 Amp Blue	CDM/UCI Port/USB Port
F68	-	20 Amp Yellow	RR Wiper Mtr
F69	-	15 Amp Blue	Spot Light Feed
F70	-	20 Amp Yellow	Fuel Pump Mtr
F71	-	30 Amp Green	Amplifier */ ANCM *
F72	-	10 Amp Red	ECM *
F73	-	15 Amp Blue	HID Headlamp RH *
F74	-	-	Spare
F75	-	10 Amp Red	Dual Batt Ctrl *
F76	-	10 Amp Red	ESP
F77	-	10 Amp Red	DTCM / ELSD *
F78	-	10 Amp Red	ECM / EPS
F79	-	-	Spare
F80	-	10 Amp Red	UGDO
F81	-	20 Amp Yellow	Trlr Tow RT Turn / Stop *
F82	-	10 Amp Red	SCCM / Cruise Control / DTV *
F83	-	10 Amp Red	Fuel Door
F84	-	15 Amp Blue	Cluster

Cavity	Cartridge Fuse	Micro Fuse	Description
<b>* If Equipped</b>			
F85	-	10 Amp Red	ORC (Airbag)
F86	-	10 Amp Red	ORC (Airbag)
F87	-	-	Spare
F88	-	15 Amp Blue	Cluster / CSG * / ITBM *
F89	-	-	Spare
F90	-	-	Spare
F91	-	20 Amp Yellow	Pwr Outlet Cargo Area
F92	-	10 Amp Red	Rr Console Lamp * / RR Pwr Outlet
F93	-	20 Amp Yellow	Cigar Lighter
F94	-	10 Amp Red	Sbw / Tcase Sw
F95	-	10 Amp Red	Rr Cam / Blind Spot Snsr *
F96	-	10 Amp Red	Rr Seat Heater Sw*
F97	-	20 Amp Yellow	Rr Htd Sts / Htd Str Wheel *
F98	-	20 Amp Yellow	Front Htd Sts * / Vent Sts
F99	-	10 Amp Red	Hvac / Dash / Hlfm/ Prktronx
F100	-	10 Amp Red	Active Damping *
F101	-	15 Amp Blue	In Car Temp Sensor / Humidity Sensor
F102	-	15 Amp Blue	Spare
F103	-	10 Amp Red	RR HVAC *
F104	-	20 Amp Yellow	PWR OUT-IP / Console / Trnk



## BULB REPLACEMENT

### Replacement Bulbs, Names, And Part Numbers

In the instance a bulb needs to be replaced, this section includes bulb description and replacement part numbers.

#### NOTE:

See an authorized dealer for LED bulb replacement.

Interior Bulbs	
Bulb Name	Bulb Number
Glove Compartment Lamp	194
Grab Handle Lamp	L002825W5W
Overhead Console Reading Lamps	VT4976
Visor Vanity Lamp	V26377
Rear Cargo Lamp	214-2
Underpanel Courtesy Lamps	906
Instrument Cluster (General Illumination)	103
Telltale/Hazard Lamp	74

Exterior Bulbs	
Bulb Name	Bulb Number
Low Beam/High Beam/LED Headlamps	LED (Serviced at an authorized dealer)
Front Turn Signal Lamps (Bulb Reflector)	7444NA
Front DRL/Turn/Park Lamp (Premium)	LED (Serviced at an authorized dealer)
Front DRL/Park Lamp (Base)	LED (Serviced at an authorized dealer)

Exterior Bulbs	
Bulb Name	Bulb Number
Front Side Marker Lamps	LED (Serviced at an authorized dealer)
Front Fog Lamps	LED (Serviced at an authorized dealer)
Rear Tail Lamps/Side Marker Lamps	LED (Serviced at an authorized dealer)
Rear Stop/Turn Signal Lamps	LED (Serviced at an authorized dealer)
Rear Liftgate Tail Lamps	LED (Serviced at an authorized dealer)
Rear Backup Lamps	921 (W16W)
Rear License Lamps	LED (Serviced at an authorized dealer)
Center High Mounted Stop Lamp (CHMSL)	LED (Serviced at an authorized dealer)

## Bulb Replacement

### NOTE:

Lens fogging can occur under certain atmospheric conditions. This will usually clear as atmospheric conditions change to allow the condensation to change back into a vapor. Turning the lamps on will usually accelerate the clearing process.

## FRONT TURN SIGNAL

See below steps to replace:

1. Open the hood.
2. Rotate the turn signal bulb a quarter turn counterclockwise to remove from housing.
3. Disconnect the electrical connector and replace the bulb.

## FRONT FOG LAMPS

The front fog lamps are LEDs. See an authorized dealer for service.

## REAR TAIL, STOP AND TURN SIGNAL LAMPS

The rear tail, stop, and turn signal lamps are LED. See an authorized dealer for replacement.

### CAUTION!

Do not touch the new bulb with your fingers. Oil contamination will severely shorten bulb life. If the bulb comes in contact with an oily surface, clean the bulb with rubbing alcohol.

## REAR LIFTGATE MOUNTED BACK-UP LAMPS

See below steps to replace:

1. Raise the liftgate.
2. Use a fiber stick or flat blade screw driver to pry the lower trim from the liftgate.
3. Back-up lamps are now visible. Rotate socket(s) counterclockwise.
4. Remove/replace bulb(s).
5. Reinstall the socket(s).
6. Reverse process to reinstall the liftgate trim.

## CENTER HIGH MOUNTED STOP LAMP (CHMSL)

The Center High Mounted Stop Lamp is an LED assembly. See an authorized dealer for replacement.

## REAR LICENSE LAMP

The rear license lamps are LEDs. See an authorized dealer for service.

## TIRES

### TIRE SAFETY INFORMATION

Tire safety information will cover aspects of the following information: Tire Markings, Tire Identification Numbers, Tire Terminology and Definitions, Tire Pressures, and Tire Loading.

## Tire Markings

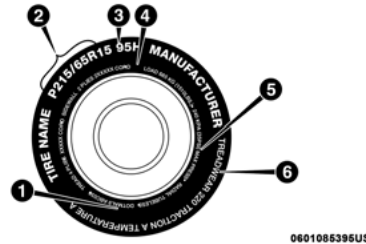

### Tire Markings

- 1 – US DOT Safety Standards Code (TIN)
- 2 – Size Designation
- 3 – Service Description
- 4 – Maximum Load
- 5 – Maximum Pressure
- 6 – Treadwear, Traction and Temperature Grades

## NOTE:

- P (Passenger) – Metric tire sizing is based on US design standards. P-Metric tires have the letter “P” molded into the sidewall preceding the size designation. Example: P215/65R15 95H.
- European – Metric tire sizing is based on European design standards. Tires designed to this standard have the tire size molded into the sidewall beginning with the section width. The letter “P” is absent from this tire size designation. Example: 215/65R15 96H.
- LT (Light Truck) – Metric tire sizing is based on US design standards. The size designation for LT-Metric tires is the same as for P-Metric tires except for the letters “LT” that are molded into the sidewall preceding the size designation. Example: LT235/85R16.
- Temporary spare tires are designed for temporary emergency use only. Temporary high pressure compact spare tires have the letter “T” or “S” molded into the sidewall preceding the size designation. Example: T145/80D18 103M.
- High flotation tire sizing is based on US design standards and it begins with the tire diameter molded into the sidewall. Example: 31x10.5 R15 LT.

## TIRE SIZING CHART

## EXAMPLE:

**Example Size Designation: P215/65R15XL 95H, 215/65R15 96H, LT235/85R16C, T145/80D18 103M, 31x10.5 R15 LT**

**P** = Passenger car tire size based on US design standards, or

**"...blank..."** = Passenger car tire based on European design standards, or

**LT** = Light truck tire based on US design standards, or

**T or S** = Temporary spare tire or

**31** = Overall diameter in inches (in)

**215, 235, 145** = Section width in millimeters (mm)

**65, 85, 80** = Aspect ratio in percent (%)

- Ratio of section height to section width of tire, or

**10.5** = Section width in inches (in)

**R** = Construction code

- "R" means radial construction, or
- "D" means diagonal or bias construction

**15, 16, 18** = Rim diameter in inches (in)

**Service Description:**

**95** = Load Index

- A numerical code associated with the maximum load a tire can carry

**H** = Speed Symbol

- A symbol indicating the range of speeds at which a tire can carry a load corresponding to its load index under certain operating conditions
- The maximum speed corresponding to the speed symbol should only be achieved under specified operating conditions (i.e., tire pressure, vehicle loading, road conditions, and posted speed limits)

**EXAMPLE:****Load Identification:**

Absence of the following load identification symbols on the sidewall of the tire indicates a Standard Load (SL) tire:

- **XL** = Extra load (or reinforced) tire, or
- **LL** = Light load tire or
- **C, D, E, F, G** = Load range associated with the maximum load a tire can carry at a specified pressure

**Maximum Load** – Maximum load indicates the maximum load this tire is designed to carry

**Maximum Pressure** – Maximum pressure indicates the maximum permissible cold tire inflation pressure for this tire

**Tire Identification Number (TIN)**

The TIN may be found on one or both sides of the tire; however, the date code may only be on one side. Tires with white sidewalls will have the full TIN, including the date code, located on the white sidewall side of the tire. Look for the TIN on the outboard side of black sidewall tires as mounted on the vehicle. If the TIN is not found on the outboard side, then you will find it on the inboard side of the tire.

**EXAMPLE:**

DOT MA L9 ABCD 0301

**DOT** = Department of Transportation

- This symbol certifies that the tire is in compliance with the US Department of Transportation tire safety standards and is approved for highway use

**MA** = Code representing the tire manufacturing location (two digits)

**L9** = Code representing the tire size (two digits)

**ABCD** = Code used by the tire manufacturer (one to four digits)

**03** = Number representing the week in which the tire was manufactured (two digits)

- 03 means the 3rd week

**EXAMPLE:**

**01** = Number representing the year in which the tire was manufactured (two digits)

- 01 means the year 2001
- Prior to July 2000, tire manufacturers were only required to have one number to represent the year in which the tire was manufactured. Example: 031 could represent the 3rd week of 1981 or 1991

**Tire Terminology And Definitions**

<b>Term</b>	<b>Definition</b>
<b>B-pillar</b>	The vehicle B-pillar is the structural member of the body located behind the front door.
<b>Cold Tire Inflation Pressure</b>	Cold tire inflation pressure is defined as the tire pressure after the vehicle has not been driven for at least three hours, or driven less than 1 mile (1.6 km) after sitting for a minimum of three hours. Inflation pressure is measured in units of PSI (pounds per square inch) or kPa (kilopascals).
<b>Maximum Inflation Pressure</b>	The maximum inflation pressure is the maximum permissible cold tire inflation pressure for this tire. The maximum inflation pressure is molded into the sidewall.
<b>Recommended Cold Tire Inflation Pressure</b>	Vehicle manufacturer's recommended cold tire inflation pressure as shown on the tire placard.
<b>Tire Placard</b>	A label permanently attached to the vehicle describing the vehicle's loading capacity, the original equipment tire sizes and the recommended cold tire inflation pressures.

## Tire Loading And Tire Pressure

### NOTE:

The proper cold tire inflation pressure is listed on the driver's side B-pillar or the rear edge of the driver's side door.

Check the inflation pressure of each tire, including the spare tire (if equipped), at least monthly and inflate to the recommended pressure for your vehicle.

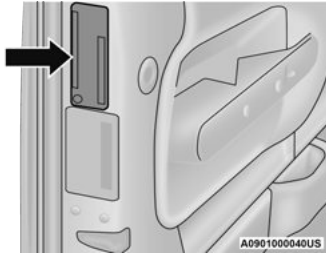

Example Tire Placard Location (Door)

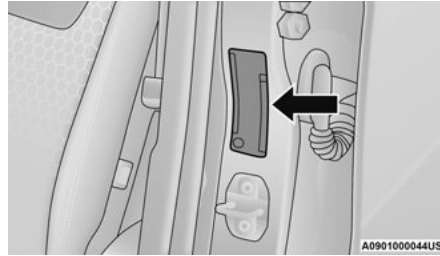

Example Tire Placard Location (B-pillar)

### Tire And Loading Information Placard

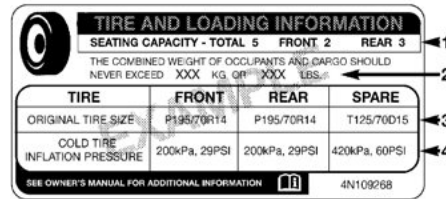

Tire And Loading Information Placard

This placard tells you important information about the:

1. Number of people that can be carried in the vehicle.
2. Total weight your vehicle can carry.
3. Tire size designed for your vehicle.
4. Cold tire inflation pressures for the front, rear, and spare tires.

### Loading

The vehicle maximum load on the tire must not exceed the load carrying capacity of the tire on your vehicle. You will not exceed the tire's load carrying capacity if you adhere to the loading conditions, tire size, and cold tire inflation pressures specified on the Tire and Loading Information placard ↪ page 137.

### NOTE:

Under a maximum loaded vehicle condition, Gross Axle Weight Ratings (GAWRs) for the front and rear axles must not be exceeded.

For further information on GAWRs, vehicle loading, and trailer towing ⇨ page 137.

To determine the maximum loading conditions of your vehicle, locate the statement “The combined weight of occupants and cargo should never exceed XXX kg or XXX lbs” on the Tire and Loading Information placard. The combined weight of occupants, cargo/luggage and trailer tongue weight (if applicable) should never exceed the weight referenced here.

### Steps For Determining Correct Load Limit—

- (1) Locate the statement “The combined weight of occupants and cargo should never exceed XXX kg or XXX lbs.” on your vehicle's placard.
- (2) Determine the combined weight of the driver and passengers that will be riding in your vehicle.
- (3) Subtract the combined weight of the driver and passengers from XXX kg or XXX lbs.

(4) The resulting figure equals the available amount of cargo and luggage load capacity. For example, if “XXX” amount equals 1400 lbs. and there will be five 150 lb passengers in your vehicle, the amount of available cargo and luggage load capacity is 650 lbs.  $(1400 - 750 (5 \times 150) = 650 \text{ lbs.})$

(5) Determine the combined weight of luggage and cargo being loaded on the vehicle. That weight may not safely exceed the available cargo and luggage load capacity calculated in Step 4.

(6) If your vehicle will be towing a trailer, load from your trailer will be transferred to your vehicle. Consult this manual to determine how this reduces the available cargo and luggage load capacity of your vehicle.

### Metric Example For Load Limit

For example, if “XXX” amount equals 635 kg and there will be five 68 kg passengers in your vehicle, the amount of available cargo and luggage load capacity is 295 kg  $(635 - 340 (5 \times 68) = 295 \text{ kg})$  as shown in step 4.

### NOTE:

- If your vehicle will be towing a trailer, load from your trailer will be transferred to your vehicle. The following table shows examples on how to calculate total load, cargo/luggage, and towing capacities of your vehicle with varying seating configurations and number and size of occupants. This table is for illustration purposes only and may not be accurate for the seating and load carry capacity of your vehicle.
- For the following example, the combined weight of occupants and cargo should never exceed 865 lbs (392 kg).



Occupants			Combined weight of occupants and cargo from Tire Placard	MINUS	Combined Occupant's weight	=	AVAILABLE Cargo/Luggage and Trailer Tongue Weight
TOTAL	FRONT	REAR					
<b>EXAMPLE 1</b>			865 lbs	minus	670 lbs	=	195 lbs
5	2	3					
<b>EXAMPLE 2</b>			865 lbs	minus	540 lbs	=	325 lbs
3	2	1					
<b>EXAMPLE 3</b>			865 lbs	minus	400 lbs	=	465 lbs
2	2	0					

811a4d11

8

**WARNING!**

Overloading of your tires is dangerous. Overloading can cause tire failure, affect vehicle handling, and increase your stopping distance. Use tires of the recommended load capacity for your vehicle. Never overload them.

## TIRES — GENERAL INFORMATION

### Tire Pressure

Proper tire inflation pressure is essential to the safe and satisfactory operation of your vehicle. Four primary areas are affected by improper tire pressure:

- Safety
- Fuel Economy
- Tread Wear
- Ride Comfort and Vehicle Stability

### Safety

#### WARNING!

- Improperly inflated tires are dangerous and can cause collisions.
- Underinflation increases tire flexing and can result in overheating and tire failure.
- Overinflation reduces a tire's ability to cushion shock. Objects on the road and chuckholes can cause damage that result in tire failure.
- Overinflated or underinflated tires can affect vehicle handling and can fail suddenly, resulting in loss of vehicle control.
- Unequal tire pressures can cause steering problems. You could lose control of your vehicle.

(Continued)

#### WARNING!

- Unequal tire pressures from one side of the vehicle to the other can cause the vehicle to drift to the right or left.
- Always drive with each tire inflated to the recommended cold tire inflation pressure.

Both underinflation and overinflation affect the stability of the vehicle and can produce a feeling of sluggish response or over responsiveness in the steering.

#### NOTE:

- Unequal tire pressures from side to side may cause erratic and unpredictable steering response.
- Unequal tire pressure from side to side may cause the vehicle to drift left or right.

#### Fuel Economy

Underinflated tires will increase tire rolling resistance resulting in higher fuel consumption.

#### Tread Wear

Improper cold tire inflation pressures can cause abnormal wear patterns and reduced tread life, resulting in the need for earlier tire replacement.

#### Ride Comfort And Vehicle Stability

Proper tire inflation contributes to a comfortable ride. Overinflation produces a jarring and uncomfortable ride.

#### Tire Inflation Pressures

The proper cold tire inflation pressure is listed on the driver's side B-pillar or rear edge of the driver's side door.

At least once a month:

- Check and adjust tire pressure with a good quality pocket-type pressure gauge. Do not make a visual judgment when determining proper inflation. Tires may look properly inflated even when they are underinflated.
- Inspect tires for signs of tire wear or visible damage.

#### CAUTION!

After inspecting or adjusting the tire pressure, always reinstall the valve stem cap. This will prevent moisture and dirt from entering the valve stem, which could damage the valve stem.

Inflation pressures specified on the placard are always "cold tire inflation pressure". Cold tire inflation pressure is defined as the tire pressure after the vehicle has not been driven for at least three hours, or driven less than 1 mile (1.6 km)

after sitting for a minimum of three hours. The cold tire inflation pressure must not exceed the maximum inflation pressure molded into the tire sidewall.

Check tire pressures more often if subject to a wide range of outdoor temperatures, as tire pressures vary with temperature changes.

Tire pressures change by approximately 1 psi (7 kPa) per 12 °F (7 °C) of air temperature change. Keep this in mind when checking tire pressure inside a garage, especially in the Winter.

Example: If garage temperature = 68 °F (20 °C) and the outside temperature = 32 °F (0 °C) then the cold tire inflation pressure should be increased by 3 psi (21 kPa), which equals 1 psi (7 kPa) for every 12 °F (7 °C) for this outside temperature condition.

Tire pressure may increase from 2 to 6 psi (13 to 40 kPa) during operation. DO NOT reduce this normal pressure build up or your tire pressure will be too low.

### Tire Pressures For High Speed Operation

The manufacturer advocates driving at safe speeds and within posted speed limits. Where speed limits or conditions are such that the vehicle can be driven at high speeds, maintaining correct tire inflation pressure is very important. Increased tire pressure and reduced vehicle loading may be

required for high-speed vehicle operation. Refer to an authorized tire dealer or original equipment vehicle dealer for recommended safe operating speeds, loading and cold tire inflation pressures.

#### WARNING!

High speed driving with your vehicle under maximum load is dangerous. The added strain on your tires could cause them to fail. You could have a serious collision. Do not drive a vehicle loaded to the maximum capacity at continuous speeds above 75 mph (120 km/h).

### Radial Ply Tires

#### WARNING!

Combining radial ply tires with other types of tires on your vehicle will cause your vehicle to handle poorly. The instability could cause a collision. Always use radial ply tires in sets of four. Never combine them with other types of tires.

### Tire Repair

If your tire becomes damaged, it may be repaired if it meets the following criteria:

- The tire has not been driven on when flat.
- The damage is only on the tread section of your tire (sidewall damage is not repairable).
- The puncture is no greater than a ¼ of an inch (6 mm).

Consult an authorized tire dealer for tire repairs and additional information.

Damaged Run Flat tires, or Run Flat tires that have experienced a loss of pressure should be replaced immediately with another Run Flat tire of identical size and service description (Load Index and Speed Symbol). Replace the tire pressure sensor as well as it is not designed to be reused.

### Run Flat Tires — If Equipped

Run Flat tires allow you the capability to drive 50 miles (80 km) at 50 mph (80 km/h) after a rapid loss of inflation pressure. This rapid loss of inflation is referred to as the Run Flat mode. A Run Flat mode occurs when the tire inflation pressure is of/or below 14 psi (96 kPa). Once a Run Flat tire reaches the Run Flat mode it has limited driving capabilities and needs to be replaced immediately. A Run Flat tire is not repairable. When a Run Flat tire is changed after driving with an underinflated

tire condition, please replace the TPMS sensor as it is not designed to be reused when driven under Run Flat mode 14 psi (96 kPa) condition.

#### NOTE:

TPMS sensor must be replaced after driving the vehicle on a flat tire condition.

It is not recommended driving a vehicle loaded at full capacity or to tow a trailer while a tire is in the Run Flat mode.

For more information ⇨ page 198.

### Tire Spinning

When stuck in mud, sand, snow, or ice conditions, do not spin your vehicle's wheels above 30 mph (48 km/h) or for longer than 30 seconds continuously without stopping.

#### WARNING!

Fast spinning tires can be dangerous. Forces generated by excessive wheel speeds may cause tire damage or failure. A tire could explode and injure someone. Do not spin your vehicle's wheels faster than 30 mph (48 km/h) for more than 30 seconds continuously when you are stuck, and do not let anyone near a spinning wheel, no matter what the speed.

### Tread Wear Indicators

Tread wear indicators are in the original equipment tires to help you in determining when your tires should be replaced.

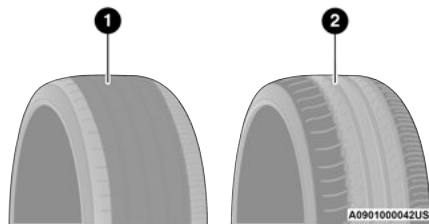

Tire Tread

- 1 – Worn Tire
- 2 – New Tire

These indicators are molded into the bottom of the tread grooves. They will appear as bands when the tread depth becomes a 1/16 of an inch (1.6 mm). When the tread is worn to the tread wear indicators, the tire should be replaced.

### Life Of Tire

The service life of a tire is dependent upon varying factors including, but not limited to:

- Driving style

- Tire pressure - Improper cold tire inflation pressures can cause uneven wear patterns to develop across the tire tread. These abnormal wear patterns will reduce tread life, resulting in the need for earlier tire replacement.
- Distance driven
- Performance tires, tires with a speed rating of V or higher, and Summer tires typically have a reduced tread life. Rotation of these tires per the vehicle scheduled maintenance is highly recommended.

#### WARNING!

Tires and the spare tire should be replaced after six years, regardless of the remaining tread. Failure to follow this warning can result in sudden tire failure. You could lose control and have a collision resulting in serious injury or death.

#### NOTE:

Wheel valve stem must be replaced as well when installing new tires due to wear and tear in existing tires.

Keep dismounted tires in a cool, dry place with as little exposure to light as possible. Protect tires from contact with oil, grease, and gasoline.

## Replacement Tires

The tires on your new vehicle provide a balance of many characteristics. They should be inspected regularly for wear and correct cold tire inflation pressures. The manufacturer strongly recommends that you use tires equivalent to the originals in size, quality and performance when replacement is needed → page 294. Refer to the Tire and Loading Information placard or the Vehicle Certification Label for the size designation of your tire. The Load Index and Speed Symbol for your tire will be found on the original equipment tire sidewall.

For more information relating to the Load Index and Speed Symbol of a tire → page 286.

It is recommended to replace the two front tires or two rear tires as a pair. Replacing just one tire can seriously affect your vehicle's handling. If you ever replace a wheel, make sure that the wheel's specifications match those of the original wheels.

It is recommended you contact an authorized tire dealer or original equipment dealer with any questions you may have on tire specifications or capability. Failure to use equivalent replacement tires may adversely affect the safety, handling, and ride of your vehicle.

### WARNING!

- Do not use a tire, wheel size, load rating, or speed rating other than that specified for your vehicle. Some combinations of unapproved tires and wheels may change suspension dimensions and performance characteristics, resulting in changes to steering, handling, and braking of your vehicle. This can cause unpredictable handling and stress to steering and suspension components. You could lose control and have a collision resulting in serious injury or death. Use only the tire and wheel sizes with load ratings approved for your vehicle.
- Never use a tire with a smaller load index or capacity, other than what was originally equipped on your vehicle. Using a tire with a smaller load index could result in tire overloading and failure. You could lose control and have a collision.
- Failure to equip your vehicle with tires having adequate speed capability can result in sudden tire failure and loss of vehicle control.

### CAUTION!

Replacing original tires with tires of a different size may result in false speedometer and odometer readings.

## TIRE TYPES

### All Season Tires — If Equipped

All Season tires provide traction for all seasons (Spring, Summer, Autumn, and Winter). Traction levels may vary between different all season tires. All season tires can be identified by the M+S, M&S, M/S or MS designation on the tire sidewall. Use all season tires only in sets of four; failure to do so may adversely affect the safety and handling of your vehicle.

### Summer Or Three Season Tires — If Equipped

Summer tires provide traction in both wet and dry conditions, and are not intended to be driven in snow or on ice. If your vehicle is equipped with Summer tires, be aware these tires are not designed for Winter or cold driving conditions. Install Winter tires on your vehicle when ambient temperatures are less than 40° F (5° C) or if roads are covered with ice or snow. For more information, contact an authorized dealer.

Summer tires do not contain the all season designation or mountain/snowflake symbol on the tire sidewall. Use Summer tires only in sets of four; failure to do so may adversely affect the safety and handling of your vehicle.

**WARNING!**

Do not use Summer tires in snow/ice conditions. You could lose vehicle control, resulting in severe injury or death. Driving too fast for conditions also creates the possibility of loss of vehicle control.

**Snow Tires**

Some areas of the country require the use of snow tires during the Winter. Snow tires can be identified by a “mountain/snowflake” symbol on the tire sidewall.



If you need snow tires, select tires equivalent in size and type to the original equipment tires. Use snow tires only in sets of four; failure to do so may adversely affect the safety and handling of your vehicle.

Snow tires generally have lower speed ratings than what was originally equipped with your vehicle and should not be operated at sustained speeds over 75 mph (120 km/h). For speeds above 75 mph (120 km/h) refer to original equipment or an authorized tire dealer for recommended safe operating speeds, loading and cold tire inflation pressures.

While studded tires improve performance on ice, skid and traction capability on wet or dry surfaces may be poorer than that of non-studded tires. Some states prohibit studded tires; therefore, local laws should be checked before using these tire types.

**SPARE TIRES — IF EQUIPPED****NOTE:**

For vehicles equipped with Tire Service Kit instead of a spare tire, please refer to “Tire Service Kit” in “In Case Of Emergency” for further information.

**CAUTION!**

Because of the reduced ground clearance, do not take your vehicle through an automatic car wash with a compact or limited use temporary spare installed. Damage to the vehicle may result.

For restrictions when towing with a spare tire designated for temporary emergency use  
 ☞ page 143.

**Spare Tire Matching Original Equipped Tire And Wheel — If Equipped**

Your vehicle may be equipped with a spare tire and wheel equivalent in look and function to the original equipment tire and wheel found on the front or rear axle of your vehicle. This spare tire may be used in the tire rotation for your vehicle. If your vehicle has this option, refer to an authorized tire dealer for the recommended tire rotation pattern.

**Compact Spare Tire — If Equipped**

The compact spare is for temporary emergency use only. You can identify if your vehicle is equipped with a compact spare by looking at the spare tire description on the Tire and Loading Information Placard located on the driver’s side door opening or on the sidewall of the tire. Compact spare tire descriptions begin with the letter “T” or “S” preceding the size designation. Example: T145/80D18 103M.

T, S = Temporary Spare Tire

Since this tire has limited tread life, the original equipment tire should be repaired (or replaced) and reinstalled on your vehicle at the first opportunity.

Do not install a wheel cover or attempt to mount a conventional tire on the compact spare wheel, since the wheel is designed specifically for the compact spare tire. Do not install more than one compact spare tire and wheel on the vehicle at any given time.

#### WARNING!

Compact and collapsible spares are for temporary emergency use only. With these spares, do not drive more than 50 mph (80 km/h). Temporary use spares have limited tread life. When the tread is worn to the tread wear indicators, the temporary use spare tire needs to be replaced. Be sure to follow the warnings, which apply to your spare. Failure to do so could result in spare tire failure and loss of vehicle control.

### Collapsible Spare Tire — If Equipped

The collapsible spare is for temporary emergency use only. You can identify if your vehicle is equipped with a collapsible spare by looking at the spare tire description on the Tire and Loading Information Placard located on the driver's side door opening or on the sidewall of the tire.

Collapsible spare tire description example:  
165/80-17 101P.

Since this tire has limited tread life, the original equipment tire should be repaired (or replaced) and reinstalled on your vehicle at the first opportunity.

Inflate collapsible tire only after the wheel is properly installed to the vehicle. Inflate the collapsible tire using the electric air pump before lowering the vehicle.

Do not install a wheel cover or attempt to mount a conventional tire on the collapsible spare wheel, since the wheel is designed specifically for the collapsible spare tire.

#### WARNING!

Compact and Collapsible spares are for temporary emergency use only. With these spares, do not drive more than 50 mph (80 km/h). Temporary use spares have limited tread life. When the tread is worn to the tread wear indicators, the temporary use spare tire needs to be replaced. Be sure to follow the warnings, which apply to your spare. Failure to do so could result in spare tire failure and loss of vehicle control.

### Full Size Spare — If Equipped

The full size spare is for temporary emergency use only. This tire may look like the originally equipped tire on the front or rear axle of your vehicle, but it is not. This spare tire may have limited tread life. When the tread is worn to the tread wear indicators, the temporary use full size spare tire needs to be replaced. Since it is not the same as your original equipment tire, replace (or repair) the original equipment tire and reinstall on the vehicle at the first opportunity.

### Limited Use Spare — If Equipped

The limited use spare tire is for temporary emergency use only. This tire is identified by a label located on the limited use spare wheel. This label contains the driving limitations for this spare. This tire may look like the original equipped tire on the front or rear axle of your vehicle, but it is not. Installation of this limited use spare tire affects vehicle handling. Since it is not the same as your original equipment tire, replace (or repair) the original equipment tire and reinstall on the vehicle at the first opportunity.

**WARNING!**

Limited use spares are for emergency use only. Installation of this limited use spare tire affects vehicle handling. With this tire, do not drive more than the speed listed on the limited use spare wheel. Keep inflated to the cold tire inflation pressures listed on your Tire and Loading Information Placard located on the driver's side B-pillar or the rear edge of the driver's side door. Replace (or repair) the original equipment tire at the first opportunity and reinstall it on your vehicle. Failure to do so could result in loss of vehicle control.

**WHEEL AND WHEEL TRIM CARE**

All wheels and wheel trim, especially aluminum and chrome plated wheels, should be cleaned regularly using mild (neutral Ph) soap and water to maintain their luster and to prevent corrosion. Wash wheels with the same soap solution recommended for the body of the vehicle and remember to always wash when the surfaces are not hot to the touch.

Your wheels are susceptible to deterioration caused by salt, sodium chloride, magnesium chloride, calcium chloride, etc., and other road chemicals used to melt ice or control dust on dirt roads. Use a soft cloth or sponge and mild soap to wipe away promptly. Do not use harsh chemicals or

a stiff brush. They can damage the wheel's protective coating that helps keep them from corroding and tarnishing.

**CAUTION!**

Avoid products or automatic car washes that use acidic solutions or strong alkaline additives or harsh brushes. Many aftermarket wheel cleaners and automatic car washes may damage the wheel's protective finish. Such damage is not covered by the New Vehicle Limited Warranty. Only car wash soap, Mopar® Wheel Cleaner or equivalent is recommended.

When cleaning extremely dirty wheels including excessive brake dust, care must be taken in the selection of tire and wheel cleaning chemicals and equipment to prevent damage to the wheels. Mopar® Wheel Treatment or Mopar® Chrome Cleaner or their equivalent is recommended or select a non-abrasive, non-acidic cleaner for aluminum or chrome wheels.

**CAUTION!**

Do not use scouring pads, steel wool, a bristle brush, metal polishes or oven cleaner. These products may damage the wheel's protective finish. Such damage is not covered by the New Vehicle Limited Warranty. Only car wash soap, Mopar® Wheel Cleaner or equivalent is recommended.

**NOTE:**

If you intend parking or storing your vehicle for an extended period after cleaning the wheels with wheel cleaner, drive your vehicle and apply the brakes to remove the water droplets from the brake components. This activity will remove the red rust on the brake rotors and prevent vehicle vibration when braking.

**Dark Vapor Chrome, Black Satin Chrome, or Low Gloss Clear Coat Wheels****CAUTION!**

If your vehicle is equipped with these specialty wheels, DO NOT USE wheel cleaners, abrasives, or polishing compounds. They will permanently damage this finish and such damage is not covered by the New Vehicle Limited Warranty. **HAND WASH ONLY USING MILD SOAP AND WATER WITH A SOFT CLOTH.** Used on a regular basis; this is all that is required to maintain this finish.



## SNOW TRACTION DEVICES

Use of traction devices require sufficient tire-to-body clearance. Due to limited clearance, the following snow traction devices are recommended. Follow these recommendations to guard against damage.

- Snow traction device must be of proper size for the tire, as recommended by the snow traction device manufacturer.
- No other tire sizes are recommended for use with the snow traction device.
- Please follow the table below for the recommended tire size, axle and snow traction device:

RWD Trim Level	Axle	Tire/Wheel Size	Snow Traction Device (maximum projection beyond tire profile or equivalent)
SPECIAL SERVICE	Rear	P265/60R18	THULE XG-12 PRO or Equivalent
SXT		265/60R18 265/50R20	
GT R/T CITADEL		265/50R20	

AWD Trim Level	Axle	Tire/Wheel Size	Snow Traction Device (maximum projection beyond tire profile or equivalent)
PURSUIT	Rear	P255/60R18	THULE XG-12 PRO or Equivalent
SXT		265/60R18 265/50R20	
GT CITADEL R/T		265/50R20	
R/T w/Tow N Go		295/45ZR20	

**WARNING!**

Using tires of different size and type (M+S, Snow) between front and rear axles can cause unpredictable handling. You could lose control and have a collision.

**CAUTION!**

To avoid damage to your vehicle or tires, observe the following precautions:

- Because of restricted traction device clearance between tires and other suspension components, it is important that only traction devices in good condition are used. Broken devices can cause serious damage. Stop the vehicle immediately if noise occurs that could indicate device breakage. Remove the damaged parts of the device before further use.
- Install device as tightly as possible and then retighten after driving about ½ mile (0.8 km). Autosock traction devices do not require retightening.
- Do not exceed 30 mph (48 km/h).
- Drive cautiously and avoid severe turns and large bumps, especially with a loaded vehicle.

(Continued)

**CAUTION!**

- Do not drive for a prolonged period on dry pavement.
- Observe the traction device manufacturer's instructions on the method of installation, operating speed, and conditions for use. Always use the suggested operating speed of the device manufacturer's if it is less than 30 mph (48 km/h).
- Do not use traction devices on a compact spare tire.

**TIRE ROTATION RECOMMENDATIONS**

The tires on the front and rear of your vehicle operate at different loads and perform different steering, handling, and braking functions. For these reasons, they wear at unequal rates.

These effects can be reduced by timely rotation of tires. The benefits of rotation are especially worthwhile with aggressive tread designs such as those on On/Off-Road type tires. Rotation will increase tread life, help to maintain mud, snow, and wet traction levels, and contribute to a smooth, quiet ride.

For the proper maintenance intervals ⇨ page 256. The reasons for any rapid or unusual wear should be corrected prior to rotation being performed.

**NOTE:**

The Tire Pressure Monitor System will automatically locate the pressure values displayed in the correct vehicle position following a tire rotation. The suggested rotation method is the "rearward cross" shown in the following diagram.

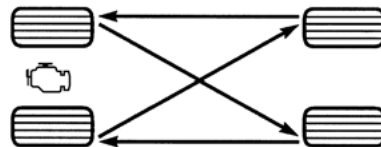

**Tire Rotation (Rearward Cross)**

055703771

## DEPARTMENT OF TRANSPORTATION UNIFORM TIRE QUALITY GRADES

The following tire grading categories were established by the National Highway Traffic Safety Administration. The specific grade rating assigned by the tire's manufacturer in each category is shown on the sidewall of the tires on your vehicle.

All passenger vehicle tires must conform to Federal safety requirements in addition to these grades.

### TREADWEAR

The Treadwear grade is a comparative rating, based on the wear rate of the tire when tested under controlled conditions on a specified government test course. For example, a tire graded 150 would wear one and one-half times as well on the government course as a tire graded 100. The relative performance of tires depends upon the actual conditions of their use, however, and may depart significantly from the norm due to

variations in driving habits, service practices, and differences in road characteristics and climate.

### TRACTION GRADES

The Traction grades, from highest to lowest, are AA, A, B, and C. These grades represent the tire's ability to stop on wet pavement, as measured under controlled conditions on specified government test surfaces of asphalt and concrete. A tire marked C may have poor traction performance.

#### WARNING!

The traction grade assigned to this tire is based on straight-ahead braking traction tests, and does not include acceleration, cornering, hydroplaning, or peak traction characteristics.

### TEMPERATURE GRADES

The Temperature grades are A (the highest), B, and C, representing the tire's resistance to the generation of heat and its ability to dissipate heat, when tested

under controlled conditions on a specified indoor laboratory test wheel. Sustained high temperature can cause the material of the tire to degenerate and reduce tire life, and excessive temperature can lead to sudden tire failure. The grade C corresponds to a level of performance, which all passenger vehicle tires must meet under the Federal Motor Vehicle Safety Standard No. 109. Grades B and A represent higher levels of performance on the laboratory test wheel, than the minimum required by law.

#### WARNING!

The temperature grade for this tire is established for a tire that is properly inflated and not overloaded. Excessive speed, underinflation, or excessive loading, either separately or in combination, can cause heat buildup and possible tire failure.

## STORING THE VEHICLE

If you are storing your vehicle for more than three weeks, we recommend that you take the following steps to minimize the drain on your vehicle's battery:

- Disconnect the negative cable from battery.
- Any time you store your vehicle or keep it out of service (i.e., vacation) for two weeks or more, run the air conditioning system at idle for about five minutes in the fresh air and high blower setting. This will ensure adequate system lubrication to minimize the possibility of compressor damage when the system is started again.

## BODYWORK

### PROTECTION FROM ATMOSPHERIC AGENTS

Vehicle body care requirements vary according to geographic locations and usage. Chemicals that make roads passable in snow and ice and those that are sprayed on trees and road surfaces during other seasons are highly corrosive to the metal in your vehicle. Outside parking, which exposes your vehicle to airborne contaminants, road surfaces on which the vehicle is operated, extreme hot or cold weather and other extreme conditions will have an adverse effect on paint, metal trim, and underbody protection.

The following maintenance recommendations will enable you to obtain maximum benefit from the corrosion resistance built into your vehicle.

### What Causes Corrosion?

Corrosion is the result of deterioration or removal of paint and protective coatings from your vehicle.

The most common causes are:

- Road salt, dirt and moisture accumulation.
- Stone and gravel impact.
- Insects, tree sap and tar.
- Salt in the air near seacoast localities
- Atmospheric fallout/industrial pollutants.

## BODY AND UNDERBODY MAINTENANCE

### Cleaning Headlights

Your vehicle is equipped with plastic headlights and fog lights that are lighter and less susceptible to stone breakage than glass headlights.

Plastic is not as scratch resistant as glass and therefore different lens cleaning procedures must be followed.

To minimize the possibility of scratching the lenses and reducing light output, avoid wiping with a dry cloth. To remove road dirt, wash with a mild soap solution followed by rinsing.

Do not use abrasive cleaning components, solvents, steel wool or other aggressive material to clean the lenses.

## PRESERVING THE BODYWORK

### Washing

- Wash your vehicle regularly. Always wash your vehicle in the shade using Mopar® Car Wash, or a mild car wash soap, and rinse the panels completely with water.
- If insects, tar, or other similar deposits have accumulated on your vehicle, use Mopar® Super Kleen Bug and Tar Remover to remove.
- Use a high quality cleaner wax, such as Mopar® Cleaner Wax to remove road film, stains and to protect your paint finish. Use precautions to not scratch the paint.
- Avoid using abrasive compounds and power buffing that may diminish the gloss or thin out the paint finish.

CAUTION!
<ul style="list-style-type: none"> <li>● Do not use abrasive or strong cleaning materials such as steel wool or scouring powder that will scratch metal and painted surfaces.</li> <li>● Use of power washers exceeding 1,200 psi (8,274 kPa) can result in damage or removal of paint and decals.</li> </ul>

## Special Care

- If you drive on salted or dusty roads or if you drive near the ocean, hose off the undercarriage at least once a month.
- It is important that the drain holes in the lower edges of the doors, rocker panels, and trunk be kept clear and open.
- If you detect any stone chips or scratches in the paint, touch them up immediately.
- If your vehicle is damaged due to a collision or similar cause that destroys the paint and protective coating, have your vehicle repaired as soon as possible.
- If you carry special cargo such as chemicals, fertilizers, de-icer salt, etc., be sure that such materials are well packaged and sealed.
- If a lot of driving is done on gravel roads, consider mud or stone shields behind each wheel.
- Use Mopar® Touch Up Paint on scratches as soon as possible. An authorized dealer has touch up paint to match the color of your vehicle.

## INTERIORS

### SEATS AND FABRIC PARTS

Use Mopar® Total Clean to clean fabric upholstery and carpeting.

#### WARNING!

Do not use volatile solvents for cleaning purposes. Many are potentially flammable, and if used in closed areas they may cause respiratory harm.

### Seat Belt Maintenance

Do not bleach, dye or clean the belts with chemical solvents or abrasive cleaners. This will weaken the fabric.

If the belts need cleaning, use a mild soap solution or lukewarm water. Do not remove the belts from the vehicle to wash them. Dry with a soft cloth.

Sun damage can also weaken the fabric. Replace the belts if they appear frayed or worn or if the buckles do not work properly.

#### WARNING!

A frayed or torn seat belt could rip apart in a collision and leave you with no protection. Inspect the seat belt system periodically, checking for cuts, frays, or loose parts. Damaged parts must be replaced immediately. Do not disassemble or modify the seat belt system. If your vehicle is involved in a collision, or if you have questions regarding seat belt or retractor conditions, take your vehicle to an authorized FCA dealer or authorized FCA Certified Collision Care Program facility for inspection.

### PLASTIC AND COATED PARTS

Use Mopar® Total Clean to clean vinyl upholstery.

#### CAUTION!

- Direct contact of air fresheners, insect repellents, suntan lotions, or hand sanitizers to the plastic, painted, or decorated surfaces of the interior may cause permanent damage. Wipe away immediately.
- Damage caused by these type of products may not be covered by your New Vehicle Limited Warranty.

## Cleaning Plastic Instrument Cluster

### Lenses

The lenses in front of the instruments in this vehicle are molded in clear plastic. When cleaning the lenses, care must be taken to avoid scratching the plastic.

Clean with a wet soft cloth. A mild soap solution may be used, but do not use high alcohol content or abrasive cleaners. If soap is used, wipe clean with a clean damp cloth. Dry with a soft cloth.

## LEATHER SURFACES

Mopar® Total Clean is specifically recommended for leather upholstery.

The leather upholstery can be best preserved by regular cleaning with a damp soft cloth. Small particles of dirt can act as an abrasive and damage the leather upholstery and should be removed promptly with a damp cloth. Stubborn soils can be removed easily with a soft cloth and Mopar® Total Clean. Care should be taken to avoid soaking your leather upholstery with any liquid. Please do not use polishes, oils, cleaning fluids, solvents, detergents, or ammonia-based cleaners to clean your leather upholstery.

### NOTE:

If equipped with light colored leather, it tends to show any foreign material, dirt, and fabric dye transfer more so than darker colors. The leather is designed for easy cleaning, and the manufacturer recommends Mopar® total care leather cleaner applied on a cloth to clean the leather seats as needed.

### CAUTION!

Do not use Alcohol and Alcohol-based and/or Ketone based cleaning products to clean leather upholstery, as damage to the upholstery may result.

## GLASS SURFACES

All glass surfaces should be cleaned on a regular basis with Mopar® Glass Cleaner, or any commercial household-type glass cleaner. Never use an abrasive type cleaner. Use caution when cleaning the inside rear window equipped with electric defrosters or windows equipped with radio antennas. Do not use scrapers or other sharp instruments that may scratch the elements.

When cleaning the rear view mirror, spray cleaner on the towel or cloth that you are using. Do not spray cleaner directly on the mirror.

# TECHNICAL SPECIFICATIONS

## VEHICLE IDENTIFICATION NUMBER (VIN)

The VIN is found on a label located on the left front corner of the instrument panel pad, visible from outside of the vehicle through the windshield.

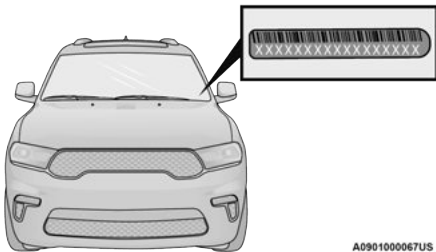

Windshield VIN Label Location

A0901000067US

### NOTE:

It is illegal to remove or alter the VIN.

## BRAKE SYSTEM

Your vehicle is equipped with dual hydraulic brake systems. If either of the two hydraulic systems loses normal capability, the remaining system will still function. However, there will be some loss of overall braking effectiveness. You may notice increased pedal travel during application, greater pedal force required to slow or stop, and potential activation of the Brake Warning Light.

In the event power assist is lost for any reason (i.e., repeated brake applications with the engine off) the brakes will still function. However, the effort required to brake the vehicle will be much greater than that required with the power system operating.

## WHEEL AND TIRE TORQUE SPECIFICATIONS

Proper lug nut/bolt torque is very important to ensure that the wheel is properly mounted to the vehicle. Any time a wheel has been removed and reinstalled on the vehicle, the lug nuts/bolts should be torqued using a properly calibrated torque wrench using a six sided (hex) deep wall socket.

## TORQUE SPECIFICATIONS

### Base Model Vehicle

Lug Nut/Bolt Torque	**Lug Nut/Bolt Size	Lug Nut/Bolt Socket Size
130 Ft-Lb (176 N·m)	M14 x 1.50	22 mm

\*\*Use only authorized dealer recommended lug nuts/bolts and clean or remove any dirt or oil before tightening.

Inspect the wheel mounting surface prior to mounting the tire and remove any corrosion or loose particles.

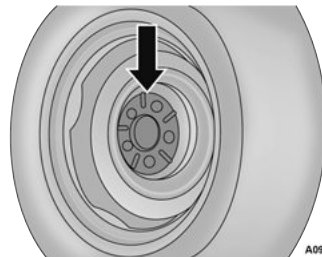

Wheel Mounting Surface

A091000006US

Tighten the lug nuts/bolts in a star pattern until each nut/bolt has been tightened twice. Ensure that the socket is fully engaged on the lug nut/bolt (do not insert it half way).

**NOTE:**

If in doubt about the correct tightness, have them checked with a torque wrench by an authorized dealer or service station.

After 25 miles (40 km), check the lug nut/bolt torque to be sure that all the lug nuts/bolts are properly tightened.

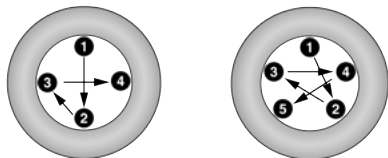

A0910000005US

**Torque Patterns**

**WARNING!**

To avoid the risk of forcing the vehicle off the jack, do not tighten the lug nuts/bolts fully until the vehicle has been lowered. Failure to follow this warning may result in personal injury.

## FUEL REQUIREMENTS

While operating on gasoline with the required octane number, hearing a light knocking sound from the engine is not a cause for concern. However, if the engine is heard making a heavy knocking sound, see a dealer immediately. Use of gasoline with a lower than recommended octane number can cause engine failure and may void the New Vehicle Limited Warranty.

Poor quality gasoline can cause problems such as hard starting, stalling, and hesitations. If you experience these symptoms, try another brand of gasoline before considering service for the vehicle.

### 3.6L ENGINE

Do not use E-85 flex fuel or ethanol blends greater than 15% in this engine.



This engine is designed to meet all emissions regulations and provide optimum fuel economy and performance when using high quality unleaded regular gasoline having a posted octane number of 87 as specified by the (R+M)/2 method. The use of higher octane premium gasoline is not required, as it will not provide any benefit over regular gasoline in these engines.

### 5.7L ENGINE

Do not use E-85 flex fuel or ethanol blends greater than 15% in this engine.



This engine is designed to meet all emissions regulations and provide satisfactory fuel economy and performance when using high-quality unleaded gasoline having an octane range of 87 to 89 as specified by the (R+M)/2 method. The use of 89 octane plus gasoline is recommended for optimum performance and fuel economy.

### REFORMULATED GASOLINE

Many areas of the country require the use of cleaner burning gasoline referred to as "reformulated gasoline". Reformulated gasoline contains oxygenates and are specifically blended to reduce vehicle emissions and improve air quality.

The use of reformulated gasoline is recommended. Properly blended reformulated gasoline will provide improved performance and durability of engine and fuel system components.



## MATERIALS ADDED TO FUEL

Besides using unleaded gasoline with the proper octane rating, gasolines that contain detergents, corrosion and stability additives are recommended. Using gasolines that have these additives will help improve fuel economy, reduce emissions, and maintain vehicle performance.



Designated TOP TIER Detergent Gasoline contains a higher level of detergents to further aid in minimizing engine and fuel system deposits. When available, the usage of TOP TIER Detergent Gasoline is recommended. Visit [www.toptiergas.com](http://www.toptiergas.com) for a list of TOP TIER Detergent Gasoline Retailers.

Indiscriminate use of fuel system cleaning agents should be avoided. Many of these materials intended for gum and varnish removal may contain active solvents or similar ingredients. These can harm fuel system gasket and diaphragm materials.

## GASOLINE/OXYGENATE BLENDS

Some fuel suppliers blend unleaded gasoline with oxygenates such as ethanol.

### CAUTION!

DO NOT use E-85, gasoline containing methanol, or gasoline containing more than 15% ethanol (E-15). Use of these blends may result in starting and drivability problems, damage critical fuel system components, cause emissions to exceed the applicable standard, and/or cause the Malfunction Indicator Light to illuminate. Please observe pump labels as they should clearly communicate if a fuel contains greater than 15% ethanol (E-15).

Problems that result from using gasoline containing more than 15% ethanol (E-15) or gasoline containing methanol are not the responsibility of the manufacturer and may void the New Vehicle Limited Warranty.

## Do Not Use E-85 In Non-Flex Fuel VEHICLES

Non-Flex Fuel Vehicles (FFV) are compatible with gasoline containing up to 15% ethanol (E-15). Use of gasoline with higher ethanol content may void the New Vehicle Limited Warranty.

If a Non-FFV vehicle is inadvertently fueled with E-85 fuel, the engine will have some or all of these symptoms:

- Operate in a lean mode.
- OBD II Malfunction Indicator Light on.
- Poor engine performance.
- Poor cold start and cold drivability.
- Increased risk for fuel system component corrosion.

## CNG AND LP FUEL SYSTEM MODIFICATIONS

Modifications that allow the engine to run on Compressed Natural Gas (CNG) or Liquid Propane (LP) may result in damage to the engine, emissions, and fuel system components. Problems that result from running CNG or LP are not the responsibility of the manufacturer and may void the New Vehicle Limited Warranty.

## METHYLCYCLOPENTADIENYL MANGANESE TRICARBONYL (MMT) IN GASOLINE

MMT is a manganese-containing metallic additive that is blended into some gasoline to increase octane. Gasoline blended with MMT provides no performance advantage beyond gasoline of the same octane number without MMT. Gasoline blended with MMT reduces spark plug life and reduces emissions system performance in some vehicles. The manufacturer recommends that gasoline without MMT be used in your vehicle. The MMT content of gasoline may not be indicated on the gasoline pump; therefore, you should ask your gasoline retailer whether the gasoline contains MMT. MMT is prohibited in Federal and California reformulated gasoline.

## FUEL SYSTEM CAUTIONS

### CAUTION!

Follow these guidelines to maintain your vehicle's performance:

- The use of leaded gasoline is prohibited by Federal law. Using leaded gasoline can impair engine performance and damage the emissions control system.
- An out-of-tune engine or certain fuel or ignition malfunctions can cause the catalytic converter to overheat. If you notice a pungent burning odor or some light smoke, your engine may be out of tune or malfunctioning and may require immediate service. Contact an authorized dealer for service assistance.

*(Continued)*

### CAUTION!

- The use of fuel additives, which are now being sold as octane enhancers, is not recommended. Most of these products contain high concentrations of methanol. Fuel system damage or vehicle performance problems resulting from the use of such fuels or additives is not the responsibility of the manufacturer and may void or not be covered under the New Vehicle Limited Warranty.

### NOTE:

Intentional tampering with the emissions control system can result in civil penalties being assessed against you.

## FLUID CAPACITIES

	US	Metric
<b>Fuel (Approximate)</b>		
3.6L and 5.7L Engines	24.6 Gallons	93 Liters
<b>Engine Oil With Filter</b>		
3.6L Engine	6 Quarts	5.6 Liters
5.7L Engine	7 Quarts	6.6 Liters
<b>Cooling System *</b>		
3.6L Engine - Without Trailer Tow Package	10.4 Quarts	9.9 Liters
3.6L Engine - With Trailer Tow Package	11 Quarts	10.4 Liters
5.7L Engine - Without Trailer Tow Package	15.4 Quarts	14.6 Liters
5.7L Engine - With Trailer Tow Package	16 Quarts	15.2 Liters

\* Includes heater and coolant recovery bottle filled to MAX level.

## ENGINE FLUIDS AND LUBRICANTS

Component	Fluid, Lubricant, or Genuine Part
Engine Coolant	We recommend using Mopar® Antifreeze/Coolant 10 Year/150,000 Mile (240,000 km) Formula OAT (Organic Additive Technology) meeting the requirements of the manufacturer Material Standard MS.90032.
Engine Oil - 3.6L & 5.7L Engine	We recommend using Mopar® SAE 0W-20 Full Synthetic Engine Oil which meets the requirements of the manufacturer Material Standard MS-6395. Equivalent full synthetic SAE 0W-20 engine oil can be used but must have the API Starburst trademark ⇨ page 262.

Component	Fluid, Lubricant, or Genuine Part
Engine Oil Filter	We recommend using a Mopar® Engine Oil Filter. If a Mopar® Engine Oil Filter is unavailable only use filters that meet or exceed SAE/USCAR-36 Filter Performance Requirements.
Fuel Selection – 3.6L Engine	87 Octane (R+M)/2 Method , 0-15% Ethanol (Do not use E-85).
Fuel Selection – 5.7L Engine	89 Octane Recommended - 87 Octane Acceptable (R+M)/2 Method, 0-15% Ethanol (Do not use E-85).

## CHASSIS FLUIDS AND LUBRICANTS

Component	Fluid, Lubricant, or Genuine Part
Automatic Transmission	Use only Mopar® ZF 8 & 9 Speed ATF Automatic Transmission Fluid or equivalent. Failure to use the correct fluid may affect the function or performance of your transmission.
Transfer Case	We recommend using Mopar® ATF+4 Automatic Transmission Fluid.
Axle Differential (Front-Rear) – Without Electronic Limited-Slip Differential (ELSD)	We recommend using Mopar® GL-5 Synthetic Axle Lubricant SAE 75W-85.
Axle Differential (Rear) – With Electronic Limited-Slip Differential (ELSD)	We recommend using Mopar® GL-5 Synthetic Axle Lubricant SAE 75W-85 with integrated friction modifier.
Brake Master Cylinder	We recommend using Mopar® DOT 3 Brake Fluid, SAE J1703.

# CUSTOMER ASSISTANCE

## SUGGESTIONS FOR OBTAINING SERVICE FOR YOUR VEHICLE

### PREPARE FOR THE APPOINTMENT

All work to be performed may not be covered by the warranty. Discuss additional charges with the service manager. Keep a maintenance log of your vehicle's service history. This can often provide a clue to the current problem.

### PREPARE A LIST

Make a written list of your vehicle's problems or the specific work you want done. If you've had an accident or work done that is not on your maintenance log, let the service advisor know.

### BE REASONABLE WITH REQUESTS

If you list a number of items and you must have your vehicle by the end of the day, discuss the situation with the service advisor and list the items in order of priority. At many authorized dealers, you may obtain a rental vehicle (additional charges may apply). If you need a rental, it is advisable to make these arrangements when you call for an appointment.

## IF YOU NEED ASSISTANCE

FCA US LLC and its authorized dealers are vitally interested in your satisfaction. We want you to be happy with our products and services.

Warranty service must be done by an authorized dealer. We strongly recommend that you take the vehicle to an authorized dealer. They know your vehicle the best, and are most concerned that you get prompt and high quality service. FCA US LLC's authorized dealers have the facilities, factory-trained technicians, special tools, and the latest information to ensure the vehicle is fixed correctly and in a timely manner.

This is why you should always talk to an authorized dealer's service manager first. If for some reason you are still not satisfied, talk to the general manager or owner of the authorized dealer. They want to know if you need assistance. If an authorized dealer is unable to resolve the concern, you may contact FCA US LLC's Customer Assistance center.

Any communication to FCA US LLC's customer center should include the following information:

- Owner's name and address
- Owner's telephone number (home, mobile, and office)

- Authorized dealer name
- Vehicle Identification Number (VIN)
- Vehicle delivery date and mileage

### FCA US LLC CUSTOMER CENTER

P.O. Box 21-8004

Auburn Hills, MI 48321-8004

Phone: (800) 423-6343

### FCA CANADA INC. CUSTOMER CENTER

P.O. Box 1621

Windsor, Ontario N9A 4H6

Phone: (800) 465-2001 English / (800) 387-9983 French

### MEXICO

Av. Prolongacion Paseo de la Reforma, 1240

Sante Fe C.P. 05109

Mexico, D. F.

In Mexico City: (800) 505-1300

Outside Mexico City: +(52) 55 50817568

## PUERTO RICO AND US VIRGIN ISLANDS SERVICE CONTRACT

FCA Caribbean LLC  
 P.O. Box 191857  
 San Juan 00919-1857  
 Phone: (800) 423-6343  
 Fax: (787) 782-3345

### CUSTOMER ASSISTANCE FOR THE HEARING OR SPEECH IMPAIRED (TDD/TTY)

To assist customers who have hearing difficulties, FCA US LLC has installed special Telecommunication Devices for the Deaf (TDD) equipment at its customer center. Any hearing or speech impaired customer, who has access to a TDD or a conventional teletypewriter (TTY) in the United States, can communicate with FCA US LLC by dialing 1-800-380-2479.

Canadian residents with hearing difficulties that require assistance can use the special needs relay service offered by Bell Canada. For TTY teletypewriter users, dial 711 and for Voice callers, dial 1-800-855-0511 to connect with a Bell Relay Service operator.

You may have purchased a service contract for a vehicle to help protect you from the high cost of unexpected repairs after FCA US LLC's New Vehicle Limited Warranty expires. The Mopar® Vehicle Protection plans are the ONLY vehicle extended protection plans authorized, endorsed and backed by FCA US LLC to provide additional protection beyond your vehicle's warranty. If you purchased a Mopar® Vehicle Protection Plan, you will receive Plan Provisions and an Owner Identification Card in the mail within three weeks of the vehicle delivery date. If you have any questions about the service contract, call FCA US LLC's Service Contract National Customer Hotline at 1-800-521-9922 (Canadian residents, call (800) 465-2001 English / (800) 387-9983 French).

FCA US LLC is not responsible for any service contract you may have purchased from another manufacturer. If you require service after the FCA US LLC New Vehicle Limited Warranty expires, please refer to the contract documents, and contact the person listed in those documents.

We appreciate that you have made a major investment when you purchased the vehicle. An authorized dealer has also made a major investment in facilities, tools, and training to assure that you are absolutely delighted with the ownership experience.

## WARRANTY INFORMATION

See the Warranty Information for the terms and provisions of FCA US LLC warranties applicable to this vehicle and market. Refer to [www.mopar.com](http://www.mopar.com) for further information.

See the Warranty Information for the terms and provisions of FCA Canada Inc. warranties applicable to this vehicle and market.

**Use this QR code to access your digital experience.**



## MOPAR® PARTS

Mopar® original equipment parts & accessories and factory filled fluids are available from an authorized dealer. They are recommended for your vehicle to keep it operating at its best and maintain its original condition.

## REPORTING SAFETY DEFECTS

### IN THE 50 UNITED STATES AND WASHINGTON, D.C.

If you believe that your vehicle has a defect that could cause a crash or cause injury or death, you should immediately inform the National Highway Traffic Safety Administration (NHTSA) in addition to notifying FCA US LLC.

If NHTSA receives similar complaints, it may open an investigation, and if it finds that a safety defect exists in a group of vehicles, it may order a recall and remedy campaign. However, NHTSA cannot become involved in individual problems between you, an authorized dealer or FCA US LLC.

To contact NHTSA, you may call the Vehicle Safety Hotline toll free at 1-888-327-4236 (TTY: 1-800-424-9153); or go to <http://www.safercar.gov>; or write to: Administrator, NHTSA, 1200 New Jersey Avenue, SE., West Building, Washington, D.C. 20590. You can also obtain other

information about motor vehicle safety from <http://www.safercar.gov>.

### IN CANADA

If you believe that your vehicle has a safety defect, you should contact the Customer Service Department immediately. Canadian customers who wish to report a safety defect to the Canadian government should contact Transport Canada, Motor Vehicle Defect Investigations and Recalls at 1-800-333-0510 or go to [www.apps.tc.gc.ca/Saf-Sec-Sur/7/PCDB-BDPP](http://www.apps.tc.gc.ca/Saf-Sec-Sur/7/PCDB-BDPP).

## PUBLICATION ORDER FORMS

To order the following manuals, you may use either the website or the phone numbers listed below.

### Service Manuals

These comprehensive Service Manuals provide a complete working knowledge of the vehicle, system, and/or components and is written in straightforward language with illustrations, diagrams, and charts.

### Diagnostic Procedure Manuals

Diagnostic Procedure Manuals are filled with diagrams, charts and detailed illustrations. These manuals make it easy to find and fix problems on computer-controlled vehicle systems and features. They show exactly how to find and correct problems, using step-by-step troubleshooting and drivability procedures, proven diagnostic tests and a complete list of all tools and equipment.

To order a hard copy of your Service or Diagnostic Procedure manuals, visit:

[www.techauthority.com](http://www.techauthority.com) (US and Canada).

### Owner's Manuals

These Owner's Manuals have been prepared with the assistance of service and engineering specialists to acquaint you with specific FCA vehicles.

To access your Owner's Information online, visit [www.mopar.com/om](http://www.mopar.com/om) (US) or [www.owners.mopar.ca](http://www.owners.mopar.ca) (Canada).

Or

Call Tech Authority toll free at:

● **1-800-890-4038 (US)**

Owner's Manuals, Radio Manuals and Warranty Information Books can be ordered through Archway at:

● **1-800-387-1143 (Canada)**

## GENERAL INFORMATION

The following regulatory statement applies to all Radio Frequency (RF) devices equipped in this vehicle:

This device complies with Part 15 of the FCC Rules and with Innovation, Science and Economic Development Canada license-exempt RSS standard(s). Operation is subject to the following two conditions:

1. This device may not cause harmful interference, and
2. This device must accept any interference received, including interference that may cause undesired operation.

Le présent appareil est conforme aux CNR d'Innovation, Science and Economic Development applicables aux appareils radio exempts de licence. L'exploitation est autorisée aux deux conditions suivantes:

1. l'appareil ne doit pas produire de brouillage, et
2. l'utilisateur de l'appareil doit accepter tout brouillage radioélectrique subi, même si le brouillage est susceptible d'en compromettre le fonctionnement.

La operación de este equipo está sujeta a las siguientes dos condiciones:

1. es posible que este equipo o dispositivo no cause interferencia perjudicial y
2. este equipo o dispositivo debe aceptar cualquier interferencia, incluyendo la que pueda causar su operación no deseada.

### NOTE:

Changes or modifications not expressly approved by the party responsible for compliance could void the user's authority to operate the equipment.



# INDEX

- A**
- About Your Brakes ..... 305
  - Adaptive Cruise Control (ACC) (Cruise Control)..... 116, 118
  - Adding Engine Coolant (Antifreeze) ..... 272
  - Adding Fuel..... 136
  - Additives, Fuel ..... 307
  - Adjust
    - Down ..... 34, 36
    - Forward ..... 34, 36
    - Rearward..... 34, 36
    - Up..... 34, 36
  - Air Bag
    - Air Bag Operation ..... 211
    - Air Bag Warning Light ..... 209, 211
    - Driver Knee Air Bag ..... 215
    - Enhanced Accident Response ..... 218, 255
    - Event Data Recorder (EDR) ..... 255
    - Front Air Bag ..... 211
    - If Deployment Occurs ..... 218
    - Knee Impact Bolsters ..... 215
    - Maintaining Your Air Bag System ..... 219
    - Maintenance ..... 219
    - Redundant Air Bag Warning Light ..... 210
    - Side Air Bags ..... 215
    - Transporting Pets ..... 234
  - Air Bag Light..... 90, 209, 234
  - Air Cleaner, Engine (Engine Air Cleaner Filter) ..... 263
  - Air Conditioner Maintenance ..... 264
  - Air Conditioner Refrigerant ..... 264
  - Air Conditioner System ..... 264
  - Air Conditioning
    - Rear..... 60
  - Air Conditioning Filter..... 62, 263, 265
  - Air Conditioning System ..... 61
  - Air Conditioning, Operating Tips..... 62
  - Air Filter ..... 263
  - Air Pressure
    - Tires ..... 292
  - Alarm
    - Arm The System ..... 21, 22
    - Disarm The System ..... 21
    - Rearm The System ..... 22
    - Security Alarm ..... 92
  - Alarm System
    - Security Alarm ..... 21
  - All Wheel Drive (AWD) ..... 110
  - Alterations/Modifications
    - Vehicle..... 10
  - Antifreeze (Engine Coolant) ..... 271, 309
  - Disposal ..... 273
  - Anti-Lock Brake System (ABS)..... 187
  - Anti-Lock Warning Light ..... 92
  - Assist, Hill Start..... 191
  - Audio Systems (Radio) ..... 154
  - Auto Down Power Windows..... 71
  - Automatic Headlights..... 50
  - Automatic High Beams..... 49
  - Automatic Temperature Control (ATC)..... 61
  - Automatic Transmission..... 99, 105
    - Adding Fluid ..... 274
    - Fluid And Filter Change..... 274
    - Fluid Change..... 274
    - Fluid Level Check..... 274
    - Fluid Type ..... 274, 310
    - Special Additives ..... 274
  - Automatic Transmission Limp Home Mode... 108
  - Auxiliary Driving Systems ..... 193
  - Auxiliary Electrical Outlet (Power Outlet) ..... 67
  - Auxiliary Power Outlet ..... 67
  - Axle Fluid..... 310
- B**
- Battery ..... 91, 261
    - Charging System Light ..... 91
    - Keyless Key Fob Replacement ..... 15
  - Battery Saver Feature ..... 51

Belts, Seat .....	234	Cargo Tie-Downs .....	76	Cooling System .....	271
Blind Spot Monitoring .....	193	Cellular Phone .....	186	Adding Coolant (Antifreeze) .....	272
Body Mechanism Lubrication .....	267	Center High Mounted Stop Light.....	285	Cooling Capacity .....	309
B-Pillar Location.....	289	Certification Label.....	137	Disposal Of Used Coolant .....	273
Brake Assist System .....	188	Chains, Tire .....	299	Drain, Flush, And Refill .....	271
Brake Control System, Electronic .....	188	Chart, Tire Sizing.....	286	Inspection .....	271
Brake Fluid .....	273, 310	Check Engine Light (Malfunction Indicator		Points To Remember .....	273
Brake System .....	273, 305	Light).....	97	Pressure Cap .....	272
Anti-Lock (ABS).....	305	Checking Your Vehicle For Safety .....	233	Radiator Cap.....	272
Fluid Check .....	273	Checks, Safety .....	233	Selection Of Coolant (Antifreeze) ....	271, 309
Master Cylinder .....	273	Child Restraint .....	220	Corrosion Protection .....	302
Parking .....	103	Child Restraints		Cruise Control (Speed Control)....	116, 117, 118
Warning Light .....	90	Booster Seats.....	222	Cruise Light .....	95, 96
Brake/Transmission Interlock .....	105	Child Seat Installation .....	231	Customer Assistance .....	311
Bulb Replacement.....	283, 284	How To Stow An unused ALR Seat Belt ...	229	Cybersecurity .....	154
Bulbs, Light.....	235	Infant And Child Restraints.....	221		
<b>C</b>		Locating The LATCH Anchorages .....	225	<b>D</b>	
Camera, Rear .....	135	Lower Anchors And Tethers For Children..	223	Daytime Running Lights .....	49
Capacities, Fluid .....	309	Older Children And Child Restraints .....	222	Defroster, Windshield .....	234
Caps, Filler		Seating Positions.....	223	De-Icer, Remote Start .....	20
Oil (Engine).....	259	Child Safety Locks .....	25	Diagnostic System, Onboard.....	97
Radiator (Coolant Pressure).....	272	Clean Air Gasoline.....	306	Dipsticks	
Car Washes .....	302	Cleaning		Oil (Engine) .....	261
Carbon Monoxide Warning .....	236	Wheels .....	298	Disabled Vehicle Towing .....	253
Cargo Area Cover .....	75	Climate Control.....	55	Disposal	
Cargo Compartment .....	75	Automatic .....	55	Antifreeze (Engine Coolant) .....	273
Light .....	75	Cold Weather Operation .....	102	Door Ajar .....	91, 92
Luggage Carrier .....	76	Compact Spare Tire .....	296	Door Ajar Light .....	91, 92
Cargo Light .....	75	Contract, Service .....	312	Door Locks .....	22, 25
		Cooling Pressure Cap (Radiator Cap).....	272	Child-Protection Door Lock — Rear Doors ....	25

Doors.....	22	Exhaust Gas Caution .....	236	Flooded Engine Starting.....	102
Driver's Seat Back Tilt .....	29	Fails To Start .....	102	Fluid Capacities .....	309
Driving .....	151	Flooded, Starting.....	102	Fluid Leaks.....	235
DVD Player (Video Entertainment System) ....	177	Fuel Requirements .....	306, 309	Fluid Level Checks	
<b>E</b>		Jump Starting .....	247	Brake .....	273
Economy (Fuel) Mode.....	105	Oil .....	262, 309	Engine Oil .....	261
Electric Brake Control System .....	188	Oil Filler Cap .....	259	Fluids And Lubricants.....	310
Anti-Lock Brake System.....	187	Oil Filter .....	263	Fog Lights .....	284
Electronic Roll Mitigation.....	189, 192	Oil Selection .....	262, 309	Fog Lights, Service .....	284
Electric Remote Mirrors.....	43	Oil Synthetic .....	263	Fold-Flat Seats .....	29
Electrical Outlet, Auxiliary (Power Outlet) .....	67	Overheating.....	251	Folding Rear Seats.....	31
Electronic Speed Control (Cruise Control).....	117	Starting.....	99	Forward Collision Warning .....	196
Electronic Stability Control (ESC) .....	189	Enhanced Accident Response		Four-Way Hazard Flasher .....	237
Electronic Throttle Control Warning Light .....	91	Feature .....	218, 255	Freeing A Stuck Vehicle.....	253
Electronically Shifted Transfer Case .....	110	Ethanol .....	307	Front Axle (Differential) .....	275
Emergency Gas Can Refueling .....	249	Exhaust Gas Cautions.....	236	Fuel .....	306
Emergency, In Case Of		Exhaust System .....	236, 270	Additives.....	307
Freeing Vehicle When Stuck.....	253	Exterior Lights.....	48, 235, 283	Clean Air .....	306
Hazard Warning Flasher.....	237	<b>F</b>		Economy Mode .....	105
Jacking .....	240	Filters		Ethanol .....	307
Jump Starting.....	247	Air Cleaner.....	263	Gasoline .....	306
Emission Control System Maintenance .....	97	Air Conditioning .....	62, 263, 265	Materials Added .....	307
Engine .....	259	Engine Oil .....	263	Methanol .....	307
Air Cleaner.....	263	Engine Oil Disposal.....	263	Octane Rating.....	306
Break-In Recommendations.....	102	Flashers.....	237	Requirements.....	306, 309
Checking Oil Level.....	261	Hazard Warning.....	237	Specifications .....	309
Compartment.....	259, 260	Turn Signals .....	96, 235, 284	Tank Capacity .....	309
Compartment Identification .....	259, 260	Flash-To-Pass.....	50	Fueling .....	136
Cooling .....	271			Fuses .....	275

**G**

Garage Door Opener (HomeLink) .....	44
Gasoline, (Fuel) .....	306
Gasoline, Clean Air .....	306
Gasoline, Reformulated.....	306
Gear Ranges.....	106
Glass Cleaning.....	304
Gross Axle Weight Rating.....	138
Gross Vehicle Weight Rating.....	138
GVWR .....	137

**H**

Hazard Warning Flashers .....	237
Head Restraints.....	38
Headlights	
Automatic.....	50
Cleaning.....	302
High Beam/Low Beam Select Switch .....	49
Lights On Reminder.....	50
On With Wipers.....	50
Passing.....	50
Heated Mirrors .....	43
Heated Seats.....	36
Heated Steering Wheel.....	27
Hill Start Assist .....	191
Hitches	
Trailer Towing.....	140
HomeLink (Garage Door Opener) .....	44
Hood Prop.....	73
Hood Release .....	73

**I**

Ignition.....	17
Key Fob Battery Low Or Dead .....	17
Key Fob Not Detected .....	17
Keyless Ignition .....	17
Keyless Push Button .....	17
Push Button Ignition .....	17
Switch.....	17
Illuminated Entry.....	53
Immobilizer (Sentry Key).....	16
Inside Rearview Mirror.....	42, 237
Instrument Cluster .....	81, 82
Display.....	82, 83, 85
Menu Items .....	86
Instrument Cluster Display	
Audio .....	87
Driver Assist .....	87
Messages .....	87
Screen Setup.....	88
Speedometer.....	86
Trailer Tow.....	87
Trip .....	87
Vehicle Info.....	86
Instrument Panel Lens Cleaning.....	304
Integrated Trailer Brake Control .....	144
Interior And Instrument Lights .....	51
Interior Appearance Care.....	303
Interior Lights.....	51
Intermittent Wipers (Delay Wipers) .....	53

**Inverter**

Power.....	69
iPod/USB/MP3 Control.....	65

**J**

Jack Location .....	241
Jack Operation .....	243
Jacking And Tire Changing Instructions.....	240
Jacking Instructions .....	243
Jump Starting.....	247

**K**

Key Fob.....	14
Arm The System.....	21
Disarm The System.....	21
Programming Additional Key Fobs.....	16
Key Fob Battery Service (Remote Keyless Entry) .....	15
Key Fob Programming (Remote Keyless Entry) .....	16
Keyless Enter 'n Go™	
Passive Entry .....	23
Passive Entry Programming.....	23
Keys .....	14
Replacement .....	16
Sentry (Immobilizer).....	16

**L**

Lane Change Assist .....	51	Forward Collision Warning.....	94, 95	Vanity Mirror .....	42
LaneSense .....	132	Hazard Warning Flasher .....	237	Warning Instrument Cluster Descriptions.....	91
Lap/Shoulder Belts .....	203	Headlights On With Wipers.....	50	Load Shed Battery Saver Mode.....	88
Latches.....	235	High Beam.....	96	Load Shed Battery Saver On .....	88
Hood .....	73	High Beam/Low Beam Select.....	49	Load Shed Electrical Load Reduction .....	88
Lead Free Gasoline.....	306	Hood Open .....	91	Load Shed Intelligent Battery Sensor.....	88
Leaks, Fluid .....	235	Interior.....	51	Loading Vehicle.....	137
Life Of Tires .....	294	LaneSense .....	93, 96	Tires.....	289
Liftgate .....	74	Lights On Reminder.....	50	Locks	
Liftgate Window Wiper/Washer .....	55	Low Fuel .....	93	Child Protection .....	25
Light Bulbs.....	235	Malfunction Indicator (Check Engine).....	93	Manual .....	22
Lights.....	235	NEUTRAL .....	95	Power Door .....	23
Air Bag.....	90, 209, 234	Oil Temperature.....	92	Lubrication, Body .....	267
Automatic Headlights.....	50	Park.....	50, 96	Lug Nuts/Bolts.....	305
AWD .....	95	Passing.....	50	Luggage Carrier.....	76
Brake Assist Warning .....	191	Reading.....	52		
Brake Warning .....	90	Rear Servicing .....	284	<b>M</b>	
Bulb Replacement.....	283, 284	Rear Tail Lamps .....	284	Maintenance .....	73
Cargo.....	75	Seat Belt Reminder .....	90	Maintenance Free Battery .....	261
Center Mounted Stop.....	285	Security Alarm .....	92	Maintenance Schedule .....	256
Cruise.....	94, 95, 96	Service .....	283, 284	Malfunction Indicator Light (Check Engine).....	93, 97
Daytime Running.....	49	Service AWD.....	94	Manual	
Dimmer Switch, Headlight.....	48	Side Marker.....	284	Service.....	313
Electric Power Steering .....	91	Sport Mode.....	96	Memory Feature (Memory Seats).....	27
Electronic Stability Control .....	93	Stop Start .....	94, 96	Memory Seat.....	27
Electronic Stability Program (ESP) Indicator.....	91	Traction Control .....	191	Memory Seats And Radio.....	27
Exterior.....	48, 235	Trailer Brake Disconnected .....	92	Methanol.....	307
Fog.....	96, 284	Transmission Temperature.....	92	Mirrors .....	42
		Turn Signals .....	48, 96, 235, 284	Electric Remote .....	43

Exterior Folding .....	43	Materials Added To .....	263	Sunroof.....	72
Heated .....	43	Pressure Warning Light .....	92	Tilt/Telescoping Steering Column.....	26
Outside.....	42	Recommendation.....	262, 309	Windows .....	70
Rearview .....	42, 237	Synthetic .....	263	Power Seats	
Vanity .....	42	Viscosity .....	309	Down .....	34, 36
Modifications/Alterations		Onboard Diagnostic System.....	97	Forward .....	34, 36
Vehicle .....	10	Operating Precautions .....	97	Rearward .....	34, 36
Monitor, Tire Pressure System.....	198	Operator Manual		Up .....	34, 36
Mopar Parts.....	312	Owner's Manual.....	313	Pregnant Women And Seat Belts .....	207
Multi-Function Control Lever.....	48	Outside Rearview Mirrors .....	42	Preparation For Jacking .....	240
<b>N</b>		Overheating, Engine.....	251	Pretensioners	
New Vehicle Break-In Period.....	102	<b>P</b>		Seat Belts .....	207
<b>O</b>		Paint Care.....	302	<b>R</b>	
Occupant Restraints .....	201	Parking Brake .....	103	Radial Ply Tires.....	293
Octane Rating, Gasoline (Fuel) .....	306	ParkSense System, Rear .....	126	Radiator Cap (Coolant Pressure Cap).....	272
Oil Change Indicator .....	84	Passive Entry .....	23	Radio Operation .....	186
Reset.....	84	Pets .....	234	Radio Remote Controls .....	177
Oil Filter, Change .....	263	Pinch Protection .....	73	Rain Sensitive Wiper System .....	54
Oil Filter, Selection.....	263	Placard, Tire And Loading Information.....	289	Rear Air Conditioning .....	60
Oil Pressure Light .....	92	Power		Rear Axle (Differential) .....	275
Oil, Engine .....	262	Brakes .....	305	Rear Camera .....	135
Capacity .....	309	Distribution Center (Fuses).....	276	Rear Cross Path .....	195
Checking .....	261	Door Locks .....	23	Rear ParkSense System.....	126
Dipstick .....	261	Inverter.....	69	Rear Seat Reminder Alert .....	188
Disposal .....	263	Liftgate .....	74	Rear Seats, Folding.....	31
Filter.....	263	Mirrors.....	43	Rear Wiper/Washer .....	55
Filter Disposal .....	263	Outlet (Auxiliary Electrical Outlet) .....	67	Reclining Front Seats .....	30
Identification Logo.....	262	Seats .....	34		
		Steering.....	114, 310		

Recreational Towing .....	147	<b>S</b>		
Shifting Into Transfer Case Neutral (N) .....	149	Safety Checks Inside Vehicle .....	234	Seat Belt Pretensioner.....
Shifting Out Of Transfer Case Neutral (N)..	150	Safety Checks Outside Vehicle .....	235	Untwisting Procedure.....
Reformulated Gasoline.....	306	Safety Defects, Reporting .....	313	Seat Belts Maintenance.....
Refrigerant .....	264	Safety Information, Tire .....	285	Seats.....
Release, Hood .....	73	Safety Tips .....	233	Adjustment .....
Reminder, Seat Belt .....	202	Safety, Exhaust Gas.....	236	Easy Entry.....
Remote Control		Schedule, Maintenance .....	256	Heated.....
Starting System.....	18	Seat Belt Reminder.....	90	Memory .....
Remote Keyless Entry.....	14	Seat Belts .....	202, 234	Rear Folding .....
Arm The Alarm.....	21	Adjustable Shoulder Belt.....	206	Reclining.....
Disarm The Alarm.....	21	Adjustable Upper Shoulder Anchorage.....	206	Seatback Release.....
Programming Additional Key Fobs .....	16	Adjustable Upper Shoulder Belt		Tilting.....
Remote Sound System (Radio) Control .....	177	Anchorage.....	206	Vented.....
Remote Starting		Automatic Locking Retractor (ALR).....	207	Ventilated .....
Exit Remote Start Mode .....	19	Child Restraints.....	220	Security Alarm
Remote Starting System .....	18	Energy Management Feature .....	207	Arm The System.....
Replacement Bulbs .....	283	Extender .....	206	Disarm The System.....
Replacement Keys.....	16	Front Seat.....	202, 203, 204	Security System .....
Replacement Tires.....	295	Inspection.....	234	Sentry Key (Immobilizer) .....
Reporting Safety Defects.....	313	Lap/Shoulder Belt Operation.....	204	Sentry Key Replacement.....
Restraints, Child .....	220	Lap/Shoulder Belt Untwisting.....	205	Service Assistance .....
Restraints, Head.....	38	Lap/Shoulder Belts .....	203	Service Contract.....
Retractable Cargo Area Cover .....	75	Operating Instructions.....	204	Service Manuals .....
Roll Over Warning.....	9	Pregnant Women.....	207	Shifting.....
Roof Type Carrier .....	76	Pretensioners .....	207	Automatic Transmission .....
Rotation, Tires .....	300	Rear Seat .....	203	Shoulder Belts .....
		Reminder.....	202	Signals, Turn .....
		Seat Belt Extender.....	206	Snow Chains (Tire Chains) .....
				Snow Tires .....
				Spare Tires.....

Speed Control		
Accel/Decel.....	117, 118	
Accel/Decel (ACC Only) .....	122	
Cancel .....	118	
Resume.....	118	
Set.....	117	
Speed Control (Cruise Control) .....	117, 118	
Starting.....	99	
Button .....	17	
Cold Weather .....	102	
Engine Fails To Start .....	102	
Remote .....	18	
Starting And Operating .....	99	
Starting Procedures.....	99	
Steering.....	26	
Power .....	114	
Tilt Column .....	26	
Wheel, Heated.....	27	
Wheel, Tilt .....	26	
Steering Wheel Audio Controls .....	177	
Steering Wheel Mounted Sound System		
Controls .....	177	
Storage.....	63	
Storage, Vehicle.....	62, 302	
Storing Your Vehicle .....	302	
Sun Roof.....	72, 73	
Sun Visor .....	42	
Sunglasses Storage.....	63	
Sunshade Operation.....	73	
Sway Control, Trailer.....	192	
Symbol Glossary .....	10	
Synthetic Engine Oil .....	263	
System		
Vehicle Security .....	21	
System, Remote Starting .....	18	
<b>T</b>		
Telescoping Steering Column .....	26	
Temperature Control, Automatic (ATC).....	61	
Tie Down Hooks, Cargo.....	76	
Tilt Steering Column .....	26	
Tire And Loading Information Placard.....	289	
Tire Markings.....	285	
Tire Safety Information .....	285	
Tires.....	235, 292, 296, 301	
Aging (Life Of Tires) .....	294	
Air Pressure .....	292	
Chains .....	299	
Changing .....	240	
Compact Spare.....	296	
General Information .....	292, 296	
High Speed.....	293	
Inflation Pressure .....	292	
Life Of Tires .....	294	
Load Capacity.....	289	
Pressure Monitoring System (TPMS) .....	94, 198	
Quality Grading.....	301	
Radial .....	293	
Replacement.....	295	
Rotation.....	300	
Safety .....	285, 292	
Sizes .....	286	
Snow Tires .....	296	
Spare Tires .....	242, 296, 297	
Spinning .....	294	
Trailer Towing .....	143	
Tread Wear Indicators .....	294	
Wheel Nut Torque.....	305	
To Open Hood .....	73	
Tongue Weight/Trailer Weight .....	142	
Tow N Go.....	113	
Towing.....	138, 253	
Disabled Vehicle .....	253	
Guide .....	141	
Recreational .....	147	
Weight .....	141	
Towing Behind A Motorhome .....	147	
Traction Control .....	192	
Trailer Sway Control (TSC).....	192	
Trailer Towing.....	138	
Hitches .....	140	
Minimum Requirements .....	142	
Tips.....	146	
Trailer And Tongue Weight.....	142	
Wiring .....	146	
Trailer Towing Guide .....	141	
Trailer Weight.....	141	



Transfer Case .....	275
Electronically Shifted.....	110
Fluid .....	310
Maintenance .....	275
Transmission .....	105
Automatic.....	105, 274
Fluid .....	310
Maintenance.....	274
Shifting.....	104
Transporting Pets .....	234
Tread Wear Indicators .....	294
Turn Signals.....	96, 284

## U

Uconnect Settings	
Customer Programmable Features .....	23, 25
Passive Entry Programming.....	23, 25
Uniform Tire Quality Grades.....	301
Universal Garage Door Opener	
(HomeLink®)  .....	44
Unleaded Gasoline .....	306
Untwisting Procedure, Seat Belt .....	205

## V

Vanity Mirrors .....	42
Vehicle Identification Number (VIN) .....	305
Vehicle Loading .....	137, 289
Vehicle Maintenance .....	262
Vehicle Modifications/Alterations.....	10
Vehicle Security System.....	21
Vehicle Storage.....	62, 302
Voice Command.....	40
Voice Recognition System (VR) .....	40

## W

Warning Flashers, Hazard.....	237
Warning Lights (Instrument Cluster	
Descriptions).....	93
Warnings, Roll Over .....	9
Warranty Information.....	312
Washers, Windshield .....	53, 261
Washing Vehicle .....	302
Wheel And Wheel Tire Care .....	298
Wheel And Wheel Tire Trim.....	298

Wind Buffeting .....	72
Window Fogging.....	62
Windows .....	70
Power.....	70
Reset Auto-Up.....	71
Windshield Defroster .....	234
Windshield Washers .....	53, 261
Fluid.....	261
Windshield Wiper Blades .....	267
Windshield Wipers .....	53
Wipers Blade Replacement.....	267
Wipers, Intermittent .....	53
Wipers, Rain Sensitive .....	54
Wireless Charging Pad .....	70

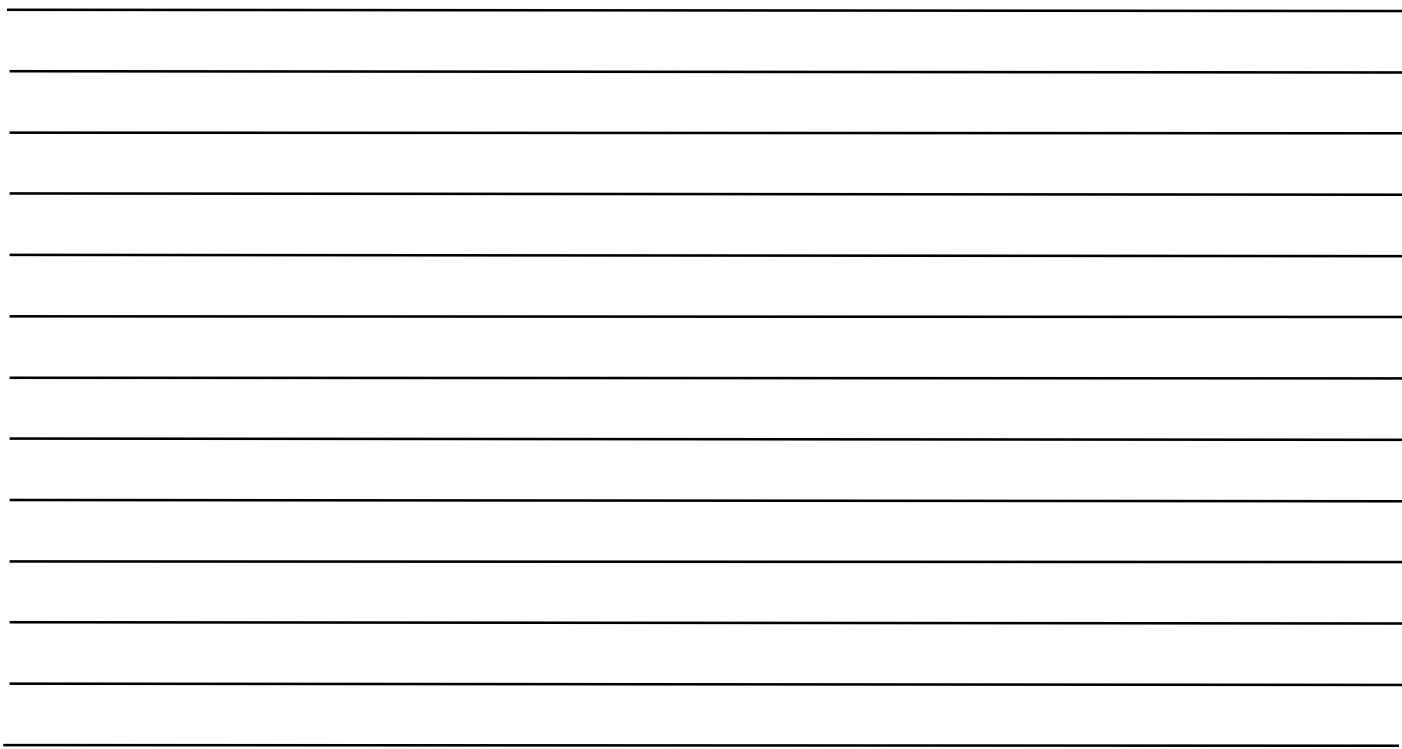

The driver's primary responsibility is the safe operation of the vehicle. Driving while distracted can result in loss of vehicle control, resulting in an accident and personal injury. FCA US LLC strongly recommends that the driver use extreme caution when using any device or feature that may take their attention off the road. Use of any electrical devices, such as cellular telephones, computers, portable radios, vehicle navigation or other devices, by the driver while the vehicle is moving is dangerous and could lead to a serious accident. Texting while driving is also dangerous and should never be done while the vehicle is moving. If you find yourself unable to devote your full attention to vehicle operation, pull off the road to a safe location and stop your vehicle. Some states or provinces prohibit the use of cellular telephones or texting while driving. It is always the driver's responsibility to comply with all local laws.

This Owner's Manual has been prepared to help you get acquainted with your new Dodge brand vehicle and to provide a convenient reference source for common questions.

Not all features shown in this manual may apply to your vehicle. For additional information, visit [mopar.com/om](http://mopar.com/om) (U.S.), [owners.mopar.ca](http://owners.mopar.ca) (Canada) or your local Dodge brand dealer.

## DRIVING AND ALCOHOL

Drunk driving is one of the most frequent causes of accidents. Your driving ability can be seriously impaired with blood alcohol levels far below the legal minimum. If you are drinking, don't drive. Ride with a designated non-drinking driver, call a cab, a rideshare, a friend, or use public transportation.

## WARNING

Driving after drinking can lead to an accident. Your perceptions are less sharp, your reflexes are slower and your judgment is impaired when you have been drinking. Never drink and then drive.





Whether it's providing information about specific product features, taking a tour through your vehicle's heritage, knowing what steps to take following an accident or scheduling your next appointment, we know you'll find the app an important extension of your Dodge brand vehicle. Simply download the app, select your make and model and enjoy the ride. To get this app, go directly to the App Store® or Google Play® Store and enter the search keyword "Dodge" (U.S. residents only).

U. S.



[mopar.com/om](https://mopar.com/om)

**DOWNLOAD THE MOST UP-TO-DATE OWNER'S MANUAL,  
RADIO AND WARRANTY BOOKS**

Canada



[owners.mopar.ca](https://owners.mopar.ca)