

	Pictorial index	Search by illustration	
1	For safety and security	Make sure to read through them	
2	Plug-in hybrid system	Plug-in hybrid system features, charging method, etc.	
3	Instrument cluster	How to read the gauges and meters, the variety of warning lights and indicators, etc.	
4	Operation of each component	Opening and closing the doors and windows, adjustment before driving, etc.	
5	Driving	Operations and advice which are necessary for driving	
6	Interior features	Usage of the interior features, etc.	
7	Maintenance and care	Caring for your vehicle and maintenance procedures	
8	When trouble arises	What to do in case of malfunction or emergency	
9	Vehicle specifications	Vehicle specifications, customizable features, etc.	
10	For owners	Reporting safety defects for U.S. owners, and seat belt, SRS airbag and headlight aim instructions for Canadian owners	
	Index	Search by symptom	
		Search alphabetically	

For your information.....	8
Reading this manual.....	14
How to search.....	15
Pictorial index	16

1 For safety and security

1-1. For safe use

Before driving	26
For safe driving	28
Seat belts	30
SRS airbags	36
Front passenger occupant classification system	50
Exhaust gas precautions.....	56

1-2. Child safety

Riding with children	57
Child restraint systems.....	58

1-3. Emergency assistance

Safety Connect.....	76
---------------------	----

1-4. Theft deterrent system

Immobilizer system	83
--------------------------	----

2 Plug-in hybrid system

2-1. Plug-in hybrid system

Plug-in hybrid system features	86
Plug-in hybrid system precautions	98
Plug-in hybrid vehicle driving tips.....	105
EV driving range.....	108

2-2. Charging

Charging equipment	110
Charging cable	115
Smart lid & connector locking system	121
Power sources that can be used.....	131
Charging methods	134
Charging tips	139
Things to know before charging.....	141
How to charge	146
Using the charging schedule function.....	157
When normal charging cannot be carried out.....	180

3 Instrument cluster

3. Instrument cluster

Combination meter	192
Warning lights and indicators	201
Main display.....	209
Multi-information display	220
Head-up display.....	253
Energy monitor/ consumption screen (vehicles with 7-inch display).....	261
Energy monitor/ consumption screen/ detail screen (vehicles with 11.6-inch display).....	267

4 Operation of each component

- 4-1. Key information**
 Keys 276
- 4-2. Opening, closing and locking the doors**
 Side doors 281
 Back door 287
 Smart key system 292
- 4-3. Adjusting the seats**
 Front seats 301
 Rear seats 303
 Head restraints 305
- 4-4. Adjusting the steering wheel and mirrors**
 Steering wheel 308
 Inside rear view mirror 310
 Outside rear view mirrors 312
- 4-5. Opening and closing the windows**
 Power windows 314

5 Driving

- 5-1. Before driving**
 Driving the vehicle 320
 Cargo and luggage 332
 Vehicle load limits 335
 Trailer towing 336
 Dinghy towing 337
- 5-2. Driving procedures**
 Power (ignition) switch 338
 Hybrid transmission 345
 Turn signal lever 351
 Parking brake 352
- 5-3. Operating the lights and wipers**
 Headlight switch 353
 AHB (Automatic High Beam) 358
 Fog light switch 363
 Windshield wipers and washer 365
- 5-4. Refueling**
 Opening the fuel tank cap 371

1

2

3

4

5

6

7

8

9

10

5-5. Using the driving support systems	
Toyota Safety Sense 2.0...	376
PCS (Pre-Collision System).....	384
LTA (Lane Tracing Assist)	395
RSA (Road Sign Assist)	410
Dynamic radar cruise control with full-speed range	414
Driving mode select switch	430
BSM	
(Blind Spot Monitor)	432
• The Blind Spot Monitor function	437
• The Rear Cross Traffic Alert function	440
Intuitive parking assist.....	445
Parking Support Brake function	455
S-APGS (Simple Advanced Parking Guidance System)	467
Driving assist systems.....	501
5-6. Driving tips	
Winter driving tips.....	507

6 Interior features

6-1. Using the air conditioning system and defogger	
Automatic air conditioning system (vehicles with 7-inch display)	512
Automatic air conditioning system (vehicles with 11.6-inch display)	524
Remote Air Conditioning System	535
Heated steering wheel/ seat heaters.....	539
6-2. Using the interior lights	
Interior lights list.....	541
• Front interior light	542
• Front personal lights.....	542
• Rear interior light.....	543
6-3. Using the storage features	
List of storage features	544
• Glove box	545
• Console box	545
• Cup holders	546
• Bottle holders/ door pockets.....	547
• Auxiliary boxes	548
• Seat back pockets	548
Luggage compartment features	549

6-4. Using the other interior features

Other interior features	553
• Sun visors	553
• Vanity mirrors.....	553
• Power outlets.....	554
• USB charging ports.....	555
• Wireless charger	557
• Armrest	566
• Coat hooks.....	566
• Assist grips	567
Garage door opener.....	568

7 Maintenance and care

7-1. Maintenance and care

Cleaning and protecting the vehicle exterior	576
Cleaning and protecting the vehicle interior	581

7-2. Maintenance

Maintenance requirements	587
General maintenance	590
Emission inspection and maintenance (I/M) programs	593

7-3. Do-it-yourself maintenance

Do-it-yourself service precautions.....	594
Hood.....	597
Positioning a floor jack.....	599
Engine compartment	600
Tires.....	614
Tire inflation pressure	623
Wheels.....	626
Replacing the tire.....	629
Air conditioning filter	640
Wiper insert replacement.....	644
Electronic key battery	647
Checking and replacing fuses.....	650
Headlight aim.....	653
Light bulbs	655

8 When trouble arises**8-1. Essential information**

- Emergency flashers 664
- If your vehicle has to be stopped in an emergency 665
- If the vehicle is trapped in rising water 666

8-2. Steps to take in an emergency

- If your vehicle needs to be towed 667
- If you think something is wrong 673
- If a warning light turns on or a warning buzzer sounds 674
- If a warning message is displayed 684
- If you have a flat tire 692
- If the hybrid system will not start 709
- If the electronic key does not operate properly 711
- If the 12-volt battery is discharged 715
- If your vehicle overheats ... 721
- If the vehicle becomes stuck 726

9 Vehicle specifications**9-1. Specifications**

- Maintenance data (fuel, oil level, etc.) 730
- Fuel information 739
- Tire information 742

9-2. Customization

- Customizable features 753

9-3. Initialization

- Items to initialize 765

10 For owners

- Reporting safety defects for U.S. owners 768
- Seat belt instructions for Canadian owners (in French) 769
- SRS airbag instructions for Canadian owners (in French) 771
- Headlight aim instructions for Canadian owners (in French) 780

Index

What to do if... (Troubleshooting)	784
Alphabetical index.....	788

1

2

3

4

5

6

7

8

9

10

For vehicles with the navigation system, refer to the “NAVIGATION SYSTEM OWNER’S MANUAL” for information regarding the equipment listed below.

- Navigation system
- Audio system
- Rear view monitor system
- Hands-free system
(for cellular phone)

For vehicles with the multimedia system, refer to the “MULTIMEDIA OWNER’S MANUAL” for information regarding the equipment listed below.

- Audio/visual system
- Rear view monitor system
- Hands-free system
(for cellular phone)

For your information

Main Owner's Manual

Please note that this manual applies to all models and explains all equipment, including options. Therefore, you may find some explanations for equipment not installed on your vehicle.

All specifications provided in this manual are current at the time of printing. However, because of the Toyota policy of continual product improvement, we reserve the right to make changes at any time without notice.

Depending on specifications, the vehicle shown in the illustrations may differ from your vehicle in terms of equipment.

Noise from under vehicle after turning off the hybrid system

Approximately five hours after the hybrid system is turned off, you may hear sound coming from under the vehicle for several minutes. This is the sound of a fuel evaporation leakage check and, it does not indicate a malfunction.

Accessories, spare parts and modification of your Toyota

A wide variety of non-genuine spare parts and accessories for Toyota vehicles are currently available in the market. You should know that Toyota does not warrant these products and is not responsible for their performance, repair, or replacement, or for any damage they may cause to, or adverse effect they may have on, your Toyota vehicle.

This vehicle should not be modified with non-genuine Toyota products. Modification with non-genuine Toyota products could affect its performance, safety or durability, and may even violate governmental regulations. In addition, damage or performance problems resulting from the modification may not be covered under warranty.

Installation of a mobile two-way radio system

The installation of a mobile two-way radio system in your vehicle could affect electronic systems such as:

- Hybrid system
- Multiport fuel injection system/sequential multiport fuel injection system
- Toyota Safety Sense 2.0
- Anti-lock brake system
- SRS airbag system
- Seat belt pretensioner system

Be sure to check with your Toyota dealer for precautionary measures or special instructions regarding installation of a mobile two-way radio system.

High voltage parts and cables on the hybrid vehicles emit approximately the same amount of electromagnetic waves as the conventional gasoline powered vehicles or home electronic appliances despite of their electromagnetic shielding.

Unwanted noise may occur in the reception of the mobile two-way radio.

Vehicle data recording

The vehicle is equipped with sophisticated computers that will record certain data, such as:

- Engine speed/Electric motor speed (traction motor speed)
- Accelerator status
- Brake status
- Vehicle speed
- Operation status of the driving assist systems
- Images from the cameras

Your vehicle is equipped with cameras. Contact your Toyota dealer for the location of recording cameras.

- Hybrid battery (traction battery) status

The recorded data varies according to the vehicle grade level and options with which it is equipped.

These computers do not record conversations or sounds, and only record images outside of the vehicle in certain situations.

● Data Transmission

Your vehicle may transmit the data recorded in these computers to Toyota without notification to you.

● Data usage

Toyota may use the data recorded in this computer to diagnose malfunctions, conduct research and development, and improve quality.

Toyota will not disclose the recorded data to a third party except:

- With the consent of the vehicle owner or with the consent of the lessee if the vehicle is leased
- In response to an official request by the police, a court of law or a government agency
- For use by Toyota in a lawsuit
- For research purposes where the data is not tied to a specific vehicle or vehicle owner

● Recorded image information can be erased by your Toyota dealer.

The image recording function can be disabled. However, if the function is disabled, data from when the system operates will not be available.

- To learn more about the vehicle data collected, used and shared by Toyota, please visit www.toyota.com/privacyvts/.

Usage of data collected through Safety Connect (U.S.mainland only)

If your Toyota has Safety Connect and if you have subscribed to those services, please refer to the Safety Connect Telematics Subscription Service Agreement for information on data collected and its usage.

- To learn more about the vehicle data collected, used and shared by Toyota, please visit www.toyota.com/privacyvts/.

Event data recorder

This vehicle is equipped with an event data recorder (EDR). The main purpose of an EDR is to record, in certain crash or near crash-like situations, such as an air bag deployment or hitting a road obstacle, data that will assist in understanding how a vehicle's systems performed. The EDR is designed to record data related to vehicle dynamics and safety systems for a short period of time, typically 30 seconds or less.

The EDR in this vehicle is designed to record such data as:

- How various systems in your vehicle were operating;
- Whether or not the driver and passenger safety belts were buckled/fastened;
- How far (if at all) the driver was depressing the accelerator and/or brake pedal; and,
- How fast the vehicle was traveling.

These data can help provide a better understanding of the circumstances in which crashes and injuries occur.

NOTE: EDR data are recorded by your vehicle only if a non-trivial crash situation occurs; no data are recorded by the EDR under normal driving conditions and no personal data (e.g., name, gender, age, and crash location) are recorded. However, other parties, such as law enforcement, could combine the EDR data with the type of personally identifying data routinely acquired during a crash investigation.

To read data recorded by an EDR, special equipment is required, and access to the vehicle or the EDR is needed. In addition to the vehicle manufacturer, other parties, such as law enforcement, that have the special equipment, can read the information if they have access to the vehicle or the EDR.

● Disclosure of the EDR data

Toyota will not disclose the data recorded in an EDR to a third party except when:

- An agreement from the vehicle's owner (or the lessee for a leased vehicle) is obtained
- In response to an official request by the police, a court of law or a government agency
- For use by Toyota in a lawsuit

However, if necessary, Toyota may:

- Use the data for research on vehicle safety performance
- Disclose the data to a third party for research purposes without disclosing information about the specific vehicle or vehicle owner

Scrapping of your Toyota

The SRS airbag and seat belt pretensioner devices in your Toyota contain explosive chemicals. If the vehicle is scrapped with the airbags and seat belt pretensioners left as they are, this may cause an accident such as fire. Be sure to have the systems of the SRS airbag and seat belt pretensioner removed and disposed of by a qualified service shop or by your Toyota dealer before you scrap your vehicle.

Perchlorate Material

Special handling may apply,
See www.dtsc.ca.gov/hazardouswaste/perchlorate.

Your vehicle has components that may contain perchlorate. These components may include airbag, seat belt pretensioners, and wireless remote control batteries.

WARNING

■ General precautions while driving

Driving under the influence: Never drive your vehicle when under the influence of alcohol or drugs that have impaired your ability to operate your vehicle. Alcohol and certain drugs delay reaction time, impair judgment and reduce coordination, which could lead to an accident that could result in death or serious injury.

Defensive driving: Always drive defensively. Anticipate mistakes that other drivers or pedestrians might make and be ready to avoid accidents.

Driver distraction: Always give your full attention to driving. Anything that distracts the driver, such as adjusting controls, talking on a cellular phone or reading can result in a collision with resulting death or serious injury to you, your occupants or others.

■ General precaution regarding children's safety

Never leave children unattended in the vehicle, and never allow children to have or use the key.

Children may be able to start the vehicle or shift the vehicle into neutral. There is also a danger that children may injure themselves by playing with the windows, or other features of the vehicle. In addition, heat build-up or extremely cold temperatures inside the vehicle can be fatal to children.

Reading this manual



WARNING:

Explains something that, if not obeyed, could cause death or serious injury to people.



NOTICE:

Explains something that, if not obeyed, could cause damage to or a malfunction in the vehicle or its equipment.

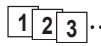

Indicates operating or working procedures. Follow the steps in numerical order.



Indicates the action (pushing, turning, etc.) used to operate switches and other devices.



Indicates the outcome of an operation (e.g. a lid opens).

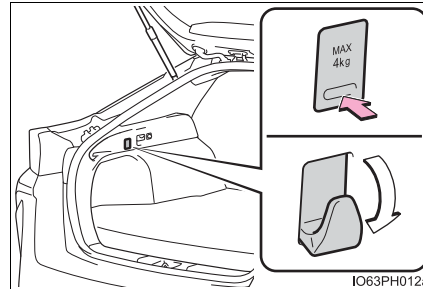

Indicates the component or position being explained.



Means “Do not”, “Do not do this”, or “Do not let this happen”.

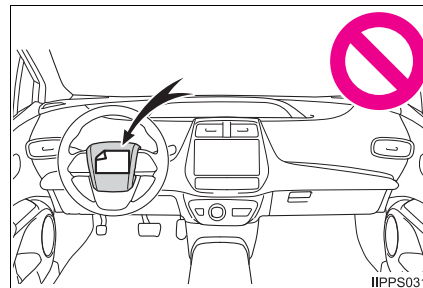

How to search

■ Searching by name

- Alphabetical index.....P. 788

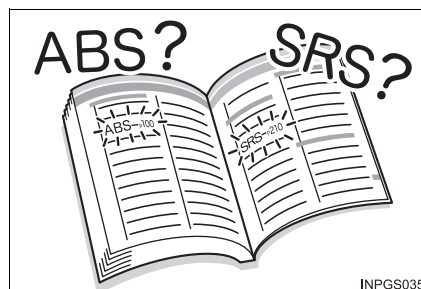

■ Searching by installation position

- Pictorial index.....P. 16

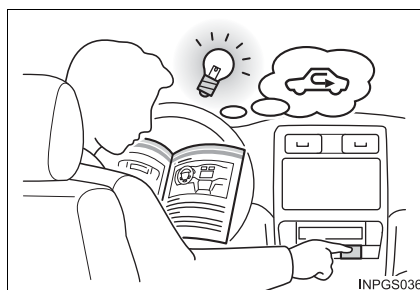

■ Searching by symptom or sound

- What to do if...
(Troubleshooting).....P. 784



■ Searching by title

- Table of contents.....P. 2

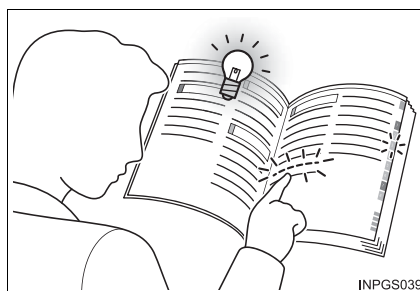

Pictorial index

■ Exterior

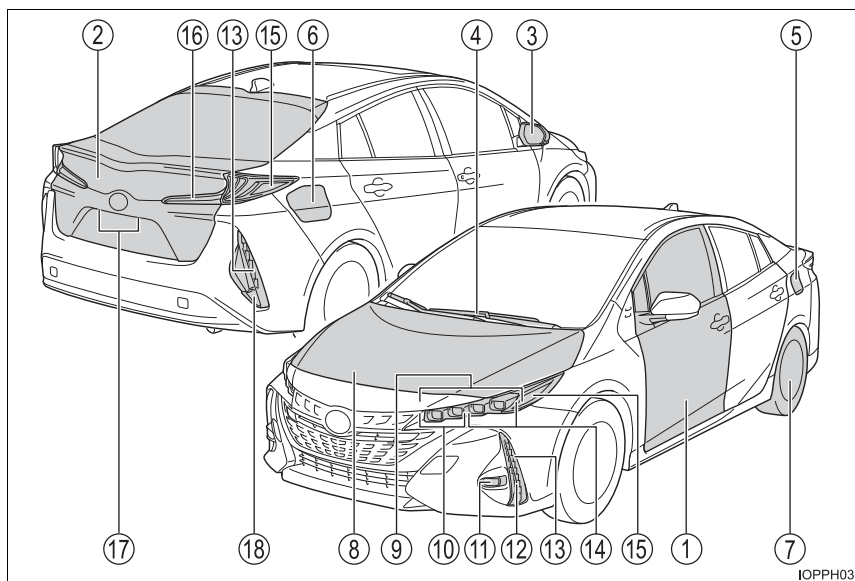

- ① **Side doors** **P. 281**
 Locking/unlocking P. 281
 Opening/closing the side windows P. 314
 Locking/unlocking by using the mechanical key P. 711
 Warning lights/warning messages P. 676, 684
- ② **Back door** **P. 287**
 Opening from outside P. 287
 Warning lights/warning messages P. 676, 684
- ③ **Outside rear view mirrors** **P. 312**
 Adjusting the mirror angle P. 312
 Folding the mirrors P. 312
 Defogging the mirrors P. 516, 527
- ④ **Windshield wipers** **P. 365**
 Precautions against winter season P. 507
 Precautions against car wash (vehicles with rain-sensing
 windshield wipers) P. 578
 Replacing the wiper insert P. 644

⑤	Fuel filler door	P. 371
	Refueling method	P. 371
	Fuel type/fuel tank capacity	P. 732
⑥	Charging port	P. 110
	Charging method	P. 134
⑦	Tires	P. 614
	Replacing	P. 629
	Tire size/inflation pressure	P. 737
	Winter tires/tire chain	P. 507
	Checking/rotation/tire pressure warning system	P. 614
	Coping with flat tires	P. 692
⑧	Hood	P. 597
	Opening	P. 597
	Engine oil	P. 734
	Coping with overheat	P. 721

Light bulbs of the exterior lights for driving

(Replacing method: P. 655, Watts: P. 738)

⑨	Headlights	P. 353
⑩	Parking lights	P. 353
⑪	Fog lights*	P. 363
⑫	LED accent lights*	P. 353
⑬	Turn signal lights	P. 351
⑭	Daytime running lights	P. 353
⑮	Side marker lights	P. 353
⑯	Tail lights	P. 353
⑰	License plate lights	P. 353
⑱	Back-up lights	
	Shifting the shift position to R	P. 345

*: If equipped

Instrument panel

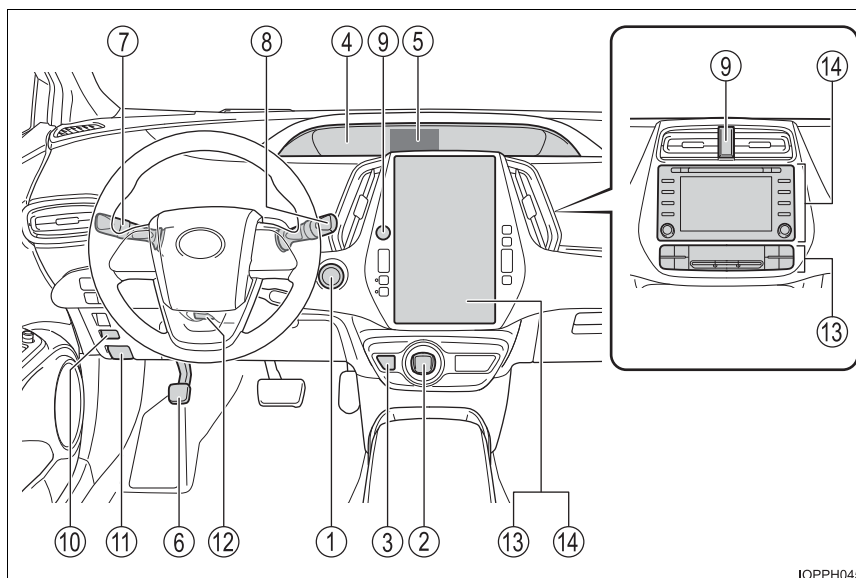

IOPPH045

- ① **Power switch** **P. 338**
 Starting the hybrid system/changing the modes P. 338
 Emergency stop of the hybrid system P. 665
 When the hybrid system will not start P. 709
 Warning messages P. 684
- ② **Shift lever** **P. 345**
 Changing the shift position P. 345
 Precautions against towing P. 667
- ③ **P position switch** **P. 346**
- ④ **Meters** **P. 192**
 Reading the meters/adjusting the instrument
 cluster light. P. 192, 194
 Warning lights/indicator lights P. 201
 When the warning lights come on P. 674

- ⑤ **Multi-information display** **P. 220**
 - Display P. 220
 - Energy monitor P. 223
 - When the warning messages are displayed P. 684
- ⑥ **Parking brake** **P. 352**
 - Applying/releasing P. 352
 - Precautions against winter season P. 507
 - Warning buzzer P. 352
- ⑦ **Turn signal lever** **P. 351**
 - Headlight switch** **P. 353**
 - Headlights/parking lights/tail lights/
daytime running lights P. 353
 - Fog lights*1 P. 363
- ⑧ **Windshield wipers and washer switch** **P. 365**
 - Usage P. 365
 - Adding washer fluid P. 612
- ⑨ **Emergency flasher switch** **P. 664**
- ⑩ **Fuel filler door opener** **P. 373**
- ⑪ **Hood lock release lever** **P. 597**
- ⑫ **Tilt and telescopic steering lock release lever** **P. 308**
- ⑬ **Air conditioning system** **P. 512, 524**
 - Usage P. 512, 525
 - Rear window defogger P. 516, 527
- ⑭ **Audio system***2

*1: If equipped

*2: Refer to "NAVIGATION SYSTEM OWNER'S MANUAL" or
"MULTIMEDIA OWNER'S MANUAL".

■ Switches

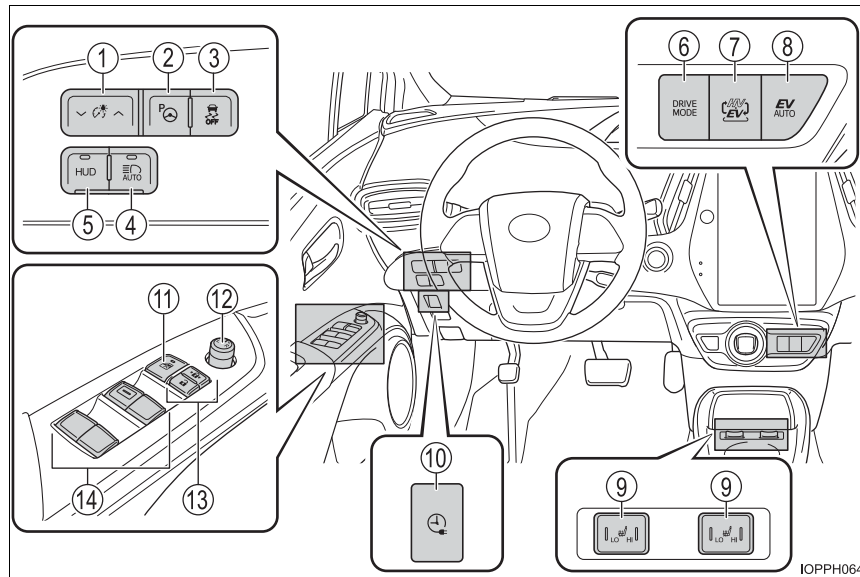

- ① Instrument cluster light control switch P. 194
- ② S-APGS (Simple Advanced Parking Guidance System) switch*1 P. 470
- ③ VSC OFF switch P. 502
- ④ Automatic High Beam switch P. 358
- ⑤ “HUD” (Head-up display) switch*1 P. 255
- ⑥ Driving mode select switch P. 430
- ⑦ EV/HV mode selection switch. P. 90
- ⑧ EV auto mode switch. P. 90
- ⑨ Seat heater switches P. 540
- ⑩ Charging schedule switch P. 161
- ⑪ Window lock switch. P. 314
- ⑫ Outside rear view mirror switch. P. 312
- ⑬ Door lock switches P. 283
- ⑭ Power window switches P. 314

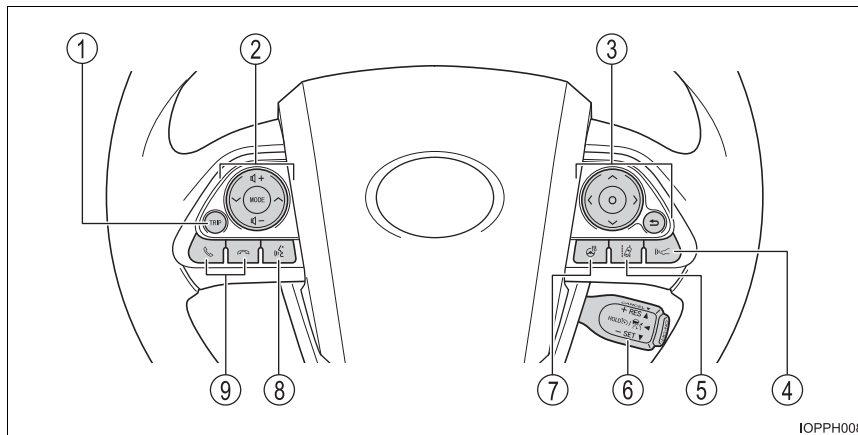

IOPPH008

- ① **TRIP switch** **P. 213**
- ② **Audio remote control switches**^{*2}
- ③ **Meter control switches** **P. 193**
- ④ **Vehicle-to-vehicle distance switch** **P. 422**
- ⑤ **LTA (Lane Tracing Assist) switch** **P. 403**
- ⑥ **Cruise control switch**
Dynamic radar cruise control with full-speed range **P. 414**
- ⑦ **Heated steering wheel switch**^{*1} **P. 540**
- ⑧ **Talk switch**^{*2}
- ⑨ **Telephone switches**^{*2}

^{*1}: If equipped

^{*2}: Refer to "NAVIGATION SYSTEM OWNER'S MANUAL" or
"MULTIMEDIA OWNER'S MANUAL".

Interior

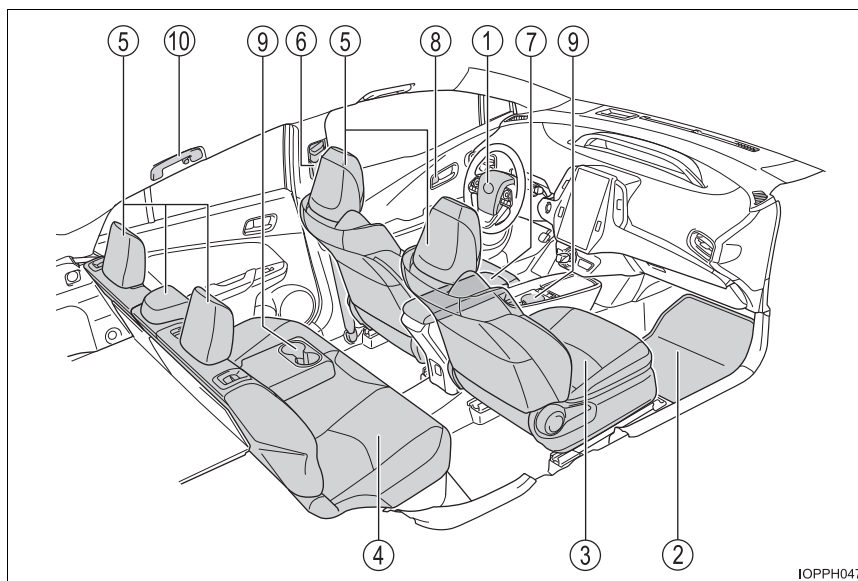

IOPPH047

① SRS airbags	P. 36
② Floor mats	P. 26
③ Front seats	P. 301
④ Rear seats	P. 303
⑤ Head restraints	P. 305
⑥ Seat belts	P. 30
⑦ Console box	P. 545
⑧ Inside lock buttons	P. 283
⑨ Cup holders	P. 546
⑩ Assist grips	P. 567

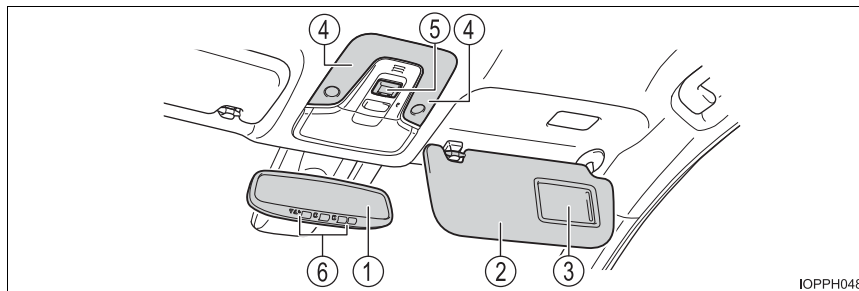

IOPPH048

- ① Inside rear view mirror P. 310
- ② Sun visors P. 553
- ③ Vanity mirrors P. 553
- ④ Interior lights*1 P. 542, 543
- Personal lights P. 542
- ⑤ “SOS” button*2 P. 76
- ⑥ Garage door opener switches*2 P. 568

*1: The illustration shows the front, but they are also equipped in the rear.

*2: If equipped

For safety and security

1

1-1. For safe use

Before driving 26
For safe driving 28
Seat belts 30
SRS airbags 36
Front passenger occupant
classification system 50
Exhaust gas precautions 56

1-2. Child safety

Riding with children 57
Child restraint systems 58

1-3. Emergency assistance

Safety Connect 76

1-4. Theft deterrent system

Immobilizer system 83

Before driving

Floor mat

Use only floor mats designed specifically for vehicles of the same model and model year as your vehicle. Fix them securely in place onto the carpet.

- 1 Insert the retaining hooks (clips) into the floor mat eyelets.

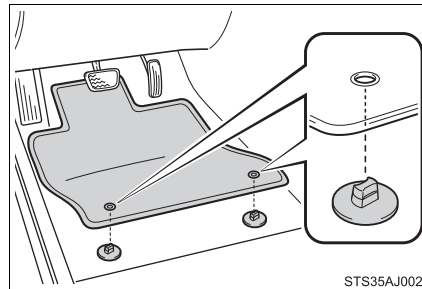

- 2 Turn the upper knob of each retaining hook (clip) to secure the floor mats in place.

*: Always align the \triangle marks.

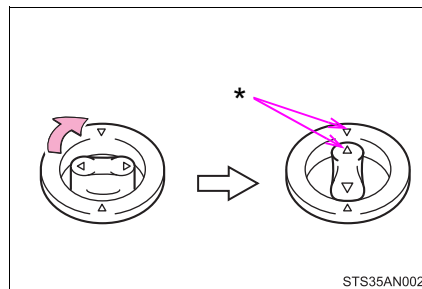

The shape of the retaining hooks (clips) may differ from that shown in the illustration.

⚠ WARNING

Observe the following precautions.

Failure to do so may cause the driver's floor mat to slip, possibly interfering with the pedals while driving. An unexpectedly high speed may result or it may become difficult to stop the vehicle. This could lead to an accident, resulting in death or serious injury.

■ When installing the driver's floor mat

- Do not use floor mats designed for other models or different model year vehicles, even if they are Toyota Genuine floor mats.
- Only use floor mats designed for the driver's seat.
- Always install the floor mat securely using the retaining hooks (clips) provided.
- Do not use two or more floor mats on top of each other.
- Do not place the floor mat bottom-side up or upside-down.

■ Before driving

- Check that the floor mat is securely fixed in the correct place with all the provided retaining hooks (clips). Be especially careful to perform this check after cleaning the floor.
- With the hybrid system stopped and the shift position in P, fully depress each pedal to the floor to make sure it does not interfere with the floor mat.

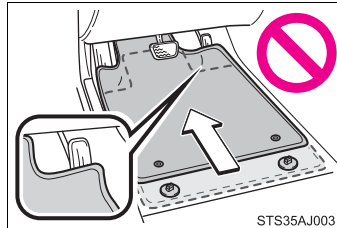

For safe driving

For safe driving, adjust the seat and mirror to an appropriate position before driving.

Correct driving posture

- ① Adjust the angle of the seat-back so that you are sitting straight up and so that you do not have to lean forward to steer. (→P. 301)
- ② Adjust the seat so that you can depress the pedals fully and so that your arms bend slightly at the elbow when gripping the steering wheel. (→P. 301)
- ③ Lock the head restraint in place with the center of the head restraint closest to the top of your ears. (→P. 305)
- ④ Wear the seat belt correctly. (→P. 30)

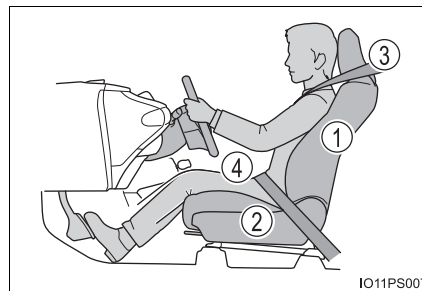

Correct use of the seat belts

Make sure that all occupants are wearing their seat belts before driving the vehicle. (→P. 30)

Use a child restraint system appropriate for the child until the child becomes large enough to properly wear the vehicle's seat belt. (→P. 58)

Adjusting the mirrors

Make sure that you can see backward clearly by adjusting the inside and outside rear view mirrors properly. (→P. 310, 312)

 **WARNING**

Observe the following precautions.

Failure to do so may result in death or serious injury.

- Do not adjust the position of the driver's seat while driving.
Doing so could cause the driver to lose control of the vehicle.
- Do not place a cushion between the driver or passenger and the seatback.
A cushion may prevent correct posture from being achieved, and reduce the effectiveness of the seat belt and head restraint.
- Do not place anything under the front seats.
Objects placed under the front seats may become jammed in the seat tracks and stop the seat from locking in place. This may lead to an accident and the adjustment mechanism may also be damaged.
- Always observe the legal speed limit when driving on public roads.
- When driving over long distances, take regular breaks before you start to feel tired.
Also, if you feel tired or sleepy while driving, do not force yourself to continue driving and take a break immediately.

Seat belts

Make sure that all occupants are wearing their seat belts before driving the vehicle.

Correct use of the seat belts

- Extend the shoulder belt so that it comes fully over the shoulder, but does not come into contact with the neck or slide off the shoulder.
- Position the lap belt as low as possible over the hips.
- Adjust the position of the seat-back. Sit up straight and well back in the seat.
- Do not twist the seat belt.

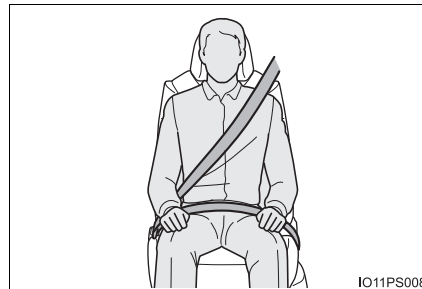

Fastening and releasing the seat belt

- ① To fasten the seat belt, push the plate into the buckle until a click sound is heard.
- ② To release the seat belt, press the release button with a hand on the plate.

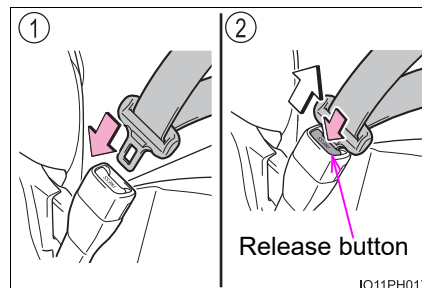

Adjusting the seat belt shoulder anchor height (front seats)

- ① Push the seat belt shoulder anchor down while pressing the release button.
- ② Push the seat belt shoulder anchor up while pressing the release button.

Move the height adjuster up and down as needed until you hear a click.

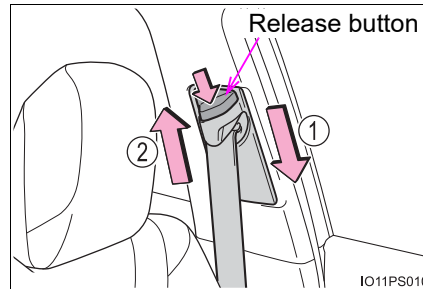

Seat belt pretensioners (front seats)

The pretensioners help the seat belts to quickly restrain the occupants by retracting the seat belts when the vehicle is subjected to certain types of severe frontal or side collision or a vehicle rollover.

The pretensioners do not activate in the event of a minor frontal impact, a minor side impact or a rear impact.

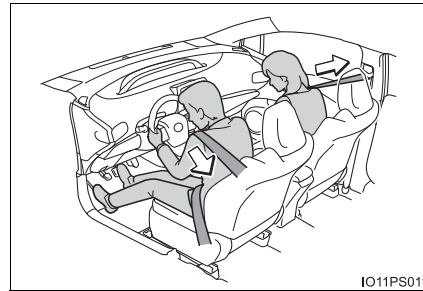

■ Emergency locking retractor (ELR)

The retractor will lock the belt during a sudden stop or on impact. It may also lock if you lean forward too quickly. A slow, easy motion will allow the belt to extend so that you can move around fully.

■ Automatic locking retractor (ALR)

When a passenger's shoulder belt is completely extended and then retracted even slightly, the belt is locked in that position and cannot be extended. This feature is used to hold the child restraint system (CRS) firmly. To free the belt again, fully retract the belt and then pull the belt out once more.

■ Child seat belt usage

The seat belts of your vehicle were principally designed for persons of adult size.

- Use a child restraint system appropriate for the child, until the child becomes large enough to properly wear the vehicle's seat belt. (→P. 58)
- When the child becomes large enough to properly wear the vehicle's seat belt, follow the instructions regarding seat belt usage. (→P. 30)

■ Replacing the belt after the pretensioner has been activated

If the vehicle is involved in multiple collisions, the pretensioner will activate for the first collision, but will not activate for the second or subsequent collisions.

■ Seat belt extender

If your seat belts cannot be fastened securely because they are not long enough, a personalized seat belt extender is available from your Toyota dealer free of charge.

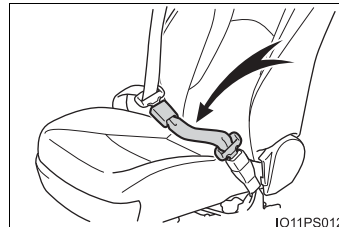

⚠ WARNING

Observe the following precautions to reduce the risk of injury in the event of sudden braking, sudden swerving or an accident. Failing to do so may cause death or serious injury.

■ Wearing a seat belt

- Ensure that all passengers wear a seat belt.
- Always wear a seat belt properly.
- Each seat belt should be used by one person only. Do not use a seat belt for more than one person at once, including children.
- Toyota recommends that children be seated in the rear seat and always use a seat belt and/or an appropriate child restraint system.
- To achieve a proper seating position, do not recline the seat more than necessary. The seat belt is most effective when the occupants are sitting up straight and well back in the seats.
- Do not wear the shoulder belt under your arm.
- Always wear your seat belt low and snug across your hips.

⚠ WARNING**■ Pregnant women**

Obtain medical advice and wear the seat belt in the proper way. (→P. 30)

Women who are pregnant should position the lap belt as low as possible over the hips in the same manner as other occupants, extending the shoulder belt completely over the shoulder and avoiding belt contact with the rounding of the abdominal area.

If the seat belt is not worn properly, not only the pregnant woman, but also the fetus could suffer death or serious injury as a result of sudden braking or a collision.

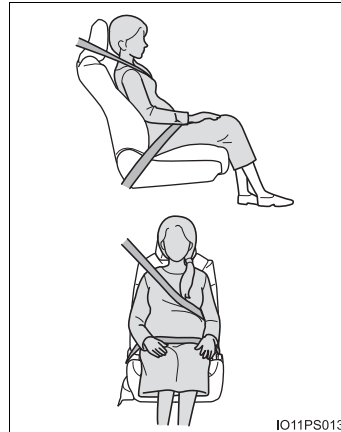
**■ People suffering illness**

Obtain medical advice and wear the seat belt in the proper way. (→P. 30)

■ When children are in the vehicle

→P. 69

■ Seat belt pretensioners

- Do not place anything, such as a cushion, on the front passenger's seat. Doing so will disperse the passenger's weight, which prevents the sensor from detecting the passenger's weight properly. As a result, the seat belt pretensioner for the front passenger's seat may not activate in the event of a collision.
- If the pretensioner has activated, the SRS warning light will come on. In that case, the seat belt cannot be used again and must be replaced at your Toyota dealer.

 **WARNING****■ Adjustable shoulder anchor**

Always make sure the shoulder belt is positioned across the center of your shoulder. The belt should be kept away from your neck, but not falling off your shoulder. Failure to do so could reduce the amount of protection in an accident and cause death or serious injuries in the event of a sudden stop, sudden swerve or accident. (→P. 31)

■ Seat belt damage and wear

- Do not damage the seat belts by allowing the belt, plate, or buckle to be jammed in the door.
- Inspect the seat belt system periodically. Check for cuts, fraying, and loose parts. Do not use a damaged seat belt until it is replaced. Damaged seat belts cannot protect an occupant from death or serious injury.
- Ensure that the belt and plate are locked and the belt is not twisted. If the seat belt does not function correctly, immediately contact your Toyota dealer.
- Replace the seat assembly, including the belts, if your vehicle has been involved in a serious accident, even if there is no obvious damage.
- Do not attempt to install, remove, modify, disassemble or dispose of the seat belts. Have any necessary repairs carried out by your Toyota dealer. Inappropriate handling may lead to incorrect operation.

■ Using a seat belt extender

- Do not wear the seat belt extender if you can fasten the seat belt without the extender.
- Do not use the seat belt extender when installing a child restraint system because the belt will not securely hold the child restraint system, increasing the risk of death or serious injury in the event of an accident.
- The personalized extender may not be safe on another vehicle, when used by another person, or at a different seating position other than the one originally intended.

 NOTICE

■ **When using a seat belt extender**

When releasing the seat belt, press on the buckle release button on the extender, not on the seat belt.

This helps prevent damage to the vehicle interior and the extender itself.

SRS airbags

The SRS airbags inflate when the vehicle is subjected to certain types of severe impacts that may cause significant injury to the occupants. They work together with the seat belts to help reduce the risk of death or serious injury.

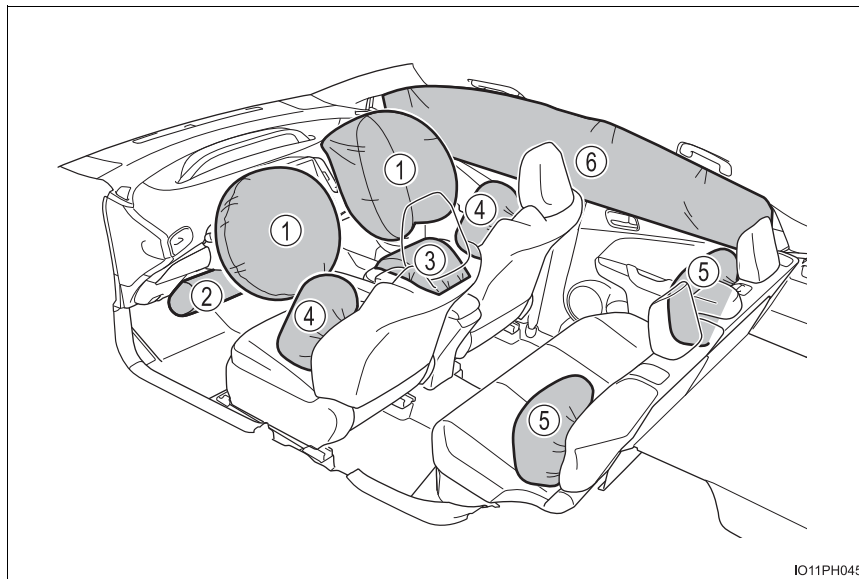

◆ SRS front airbags

- ① SRS driver airbag/front passenger airbag
Can help protect the head and chest of the driver and front passenger from impact with interior components
- ② SRS knee airbag
Can help provide driver protection
- ③ SRS seat cushion airbag
Can help restrain the front passenger

◆ SRS side and curtain shield airbags

- ④ SRS front side airbags
Can help protect the torso of the front seat occupants
- ⑤ SRS rear side airbags
Can help protect the torso of occupants in the rear outer seats
- ⑥ SRS curtain shield airbags
 - Can help protect primarily the head of occupants in the outer seats
 - Can help prevent the occupants from being thrown from the vehicle in the event of vehicle rollover

SRS airbag system components

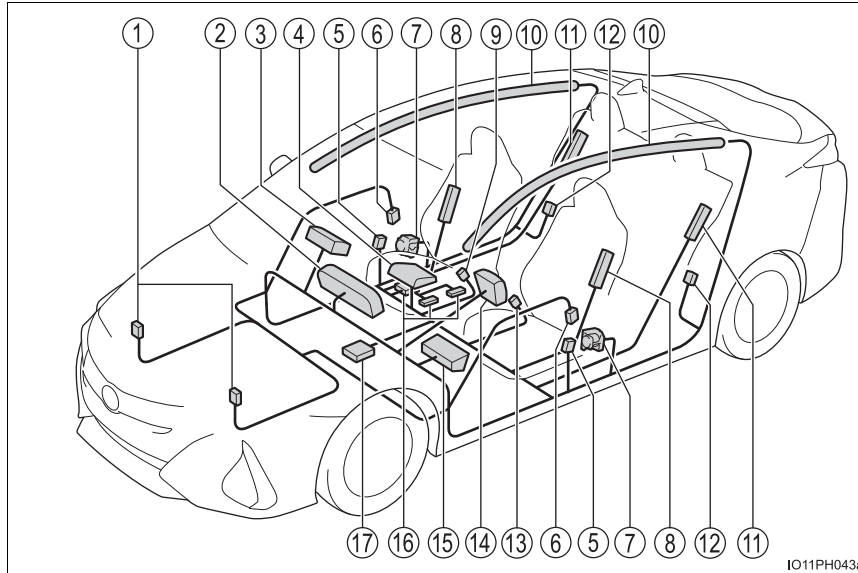

- | | |
|---|--|
| ① Front impact sensors | ⑨ Front passenger's seat belt buckle switch |
| ② SRS warning light and "AIR BAG ON" and "AIR BAG OFF" indicator lights | ⑩ Curtain shield airbags |
| ③ Front passenger airbag | ⑪ Rear side airbags |
| ④ Passenger seat cushion airbag | ⑫ Side impact sensors (rear) |
| ⑤ Side impact sensors (front) | ⑬ Driver's seat belt buckle switch |
| ⑥ Side impact sensors (front door) | ⑭ Driver airbag |
| ⑦ Seat belt pretensioners and force limiters | ⑮ Driver's knee airbag |
| ⑧ Front side airbags | ⑯ Front passenger occupant classification system (ECU and sensors) |
| | ⑰ Airbag sensor assembly |

Your vehicle is equipped with ADVANCED AIRBAGS designed based on the US motor vehicle safety standards (FMVSS208). The airbag sensor assembly (ECU) controls airbag deployment based on information obtained from the sensors etc. shown in the system components diagram above. This information includes crash severity and occupant information. As the airbags deploy, a chemical reaction in the inflators quickly fills the airbags with non-toxic gas to help restrain the motion of the occupants.

 **WARNING**

■ **SRS airbag precautions**

Observe the following precautions regarding the SRS airbags. Failure to do so may cause death or serious injury.

- The driver and all passengers in the vehicle must wear their seat belts properly.

The SRS airbags are supplemental devices to be used with the seat belts.

- The SRS driver airbag deploys with considerable force, and can cause death or serious injury especially if the driver is very close to the airbag. The National Highway Traffic Safety Administration (NHTSA) advises:

Since the risk zone for the driver's airbag is the first 2 - 3 in. (50 - 75 mm) of inflation, placing yourself 10 in. (250 mm) from your driver airbag provides you with a clear margin of safety. This distance is measured from the center of the steering wheel to your breastbone. If you sit less than 10 in. (250 mm) away now, you can change your driving position in several ways:

- Move your seat to the rear as far as you can while still reaching the pedals comfortably.
- Slightly recline the back of the seat. Although vehicle designs vary, many drivers can achieve the 10 in. (250 mm) distance, even with the driver seat all the way forward, simply by reclining the back of the seat somewhat. If reclining the back of your seat makes it hard to see the road, raise yourself by using a firm, non-slippery cushion, or raise the seat if your vehicle has that feature.
- If your steering wheel is adjustable, tilt it downward. This points the airbag toward your chest instead of your head and neck.

The seat should be adjusted as recommended by NHTSA above, while still maintaining control of the foot pedals, steering wheel, and your view of the instrument panel controls.

⚠ WARNING**■ SRS airbag precautions**



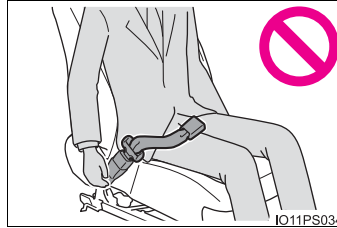

● If the seat belt extender has been connected to the front seat belt buckles but the seat belt extender has not also been fastened to the latch plate of the seat belt, the SRS front airbags will judge that the driver and front passenger are wearing the seat belt even though the seat belt has not been connected. In this case, the SRS front airbags may not activate correctly in a collision, resulting in death or serious injury in the event of a collision. Be sure to wear the seat belt with the seat belt extender.

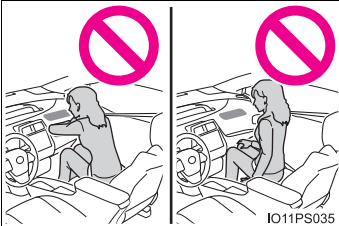
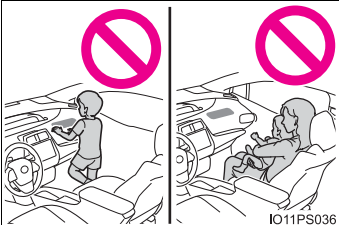

- The SRS front passenger airbag also deploys with considerable force, and can cause death or serious injury especially if the front passenger is very close to the airbag. The front passenger seat should be as far from the airbag as possible with the seatback adjusted, so the front passenger sits upright.
- Improperly seated and/or restrained infants and children can be killed or seriously injured by a deploying airbag. An infant or child who is too small to use a seat belt should be properly secured using a child restraint system. Toyota strongly recommends that all infants and children be placed in the rear seats of the vehicle and properly restrained. The rear seats are safer for infants and children than the front passenger seat. (→P. 58)

⚠ WARNING

■ SRS airbag precautions

- Do not sit on the edge of the seat or lean against the dashboard.
 
- Do not allow a child to stand in front of the SRS front passenger airbag unit or sit on the knees of a front passenger.
 
- Do not allow the front seat occupants to hold items on their knees.
 
- Do not lean against the door, the roof side rail or the front, side and rear pillars.
 
- Do not allow anyone to kneel on the passenger seat toward the door or put their head or hands outside the vehicle.
 

⚠ WARNING

■ SRS airbag precautions

- Do not attach anything to or lean anything against areas such as the dashboard, steering wheel pad and lower portion of the instrument panel. These items can become projectiles when the SRS driver, front passenger and knee airbags deploy.

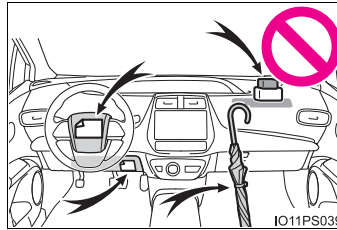

- Do not attach anything to areas such as a door, windshield, side windows, front or rear pillar, roof side rail and assist grip.

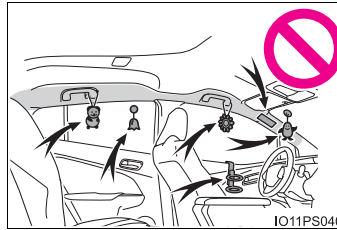

- Do not hang coat hangers or other hard objects on the coat hooks. All of these items could become projectiles and may cause death or serious injury, should the SRS curtain shield airbags deploy.
- If a vinyl cover is put on the area where the SRS knee airbag will deploy, be sure to remove it.
- Do not use seat accessories which cover the parts where the SRS side airbags and SRS seat cushion airbag inflate as they may interfere with inflation of the SRS airbags. Such accessories may prevent the side airbags and seat cushion airbag from activating correctly, disable the system or cause the side airbags and seat cushion airbag to inflate accidentally, resulting in death or serious injury.
- Do not strike or apply significant levels of force to the area of the SRS airbag components or the front doors. Doing so can cause the SRS airbags to malfunction.
- Do not touch any of the component parts immediately after the SRS airbags have deployed (inflated) as they may be hot.

 **WARNING****■ SRS airbag precautions**

- If breathing becomes difficult after the SRS airbags have deployed, open a door or side window to allow fresh air in, or leave the vehicle if it is safe to do so. Wash off any residue as soon as possible to prevent skin irritation.
- If the areas where the SRS airbags are stored, such as the steering wheel pad and front and rear pillar garnishes, are damaged or cracked, have them replaced by your Toyota dealer.
- Do not place anything, such as a cushion, on the front passenger's seat. Doing so will disperse the passenger's weight, which prevents the sensor from detecting the passenger's weight properly. As a result, the SRS front airbags for the front passenger may not deploy in the event of a collision.

■ Modification and disposal of SRS airbag system components

Do not dispose of your vehicle or perform any of the following modifications without consulting your Toyota dealer. The SRS airbags may malfunction or deploy (inflate) accidentally, causing death or serious injury.

- Installation, removal, disassembly and repair of the SRS airbags
- Repairs, modifications, removal or replacement of the steering wheel, instrument panel, dashboard, seats or seat upholstery, front, side and rear pillars, roof side rails, front door panels, front door trims or front door speakers
- Modifications to the front door panel (such as making a hole in it)
- Repairs or modifications of the front fender, front bumper, or side of the occupant compartment
- Installation of a grille guard (bull bars, kangaroo bar, etc.), snow plows, winches or roof luggage carrier
- Modifications to the vehicle's suspension system
- Installation of electronic devices such as mobile two-way radios and CD players
- Modifications to your vehicle for a person with a physical disability

■ If the SRS airbags deploy (inflate)

- Slight abrasions, burns, bruising etc., may be sustained from SRS airbags, due to the extremely high speed deployment (inflation) by hot gases.
- A loud noise and white powder will be emitted.
- Parts of the airbag module (steering wheel hub, airbag cover and inflator) as well as the front seats, parts of the front and rear pillars, and roof side rails, may be hot for several minutes. The airbag itself may also be hot.
- The windshield may crack.
- The hybrid system will be stopped and fuel supply to the engine will be stopped. (→P. 99)
- The emergency flashers will turn on automatically. (→P. 664)
- For Safety Connect subscribers, if any of the following situations occur, the system is designed to send an emergency call to the response center, notifying them of the vehicle's location (without needing to push the "SOS" button) and an agent will attempt to speak with the occupants to ascertain the level of emergency and assistance required. If the occupants are unable to communicate, the agent automatically treats the call as an emergency and helps to dispatch the necessary emergency services. (→P. 76)
 - An SRS airbag is deployed.
 - A seat belt pretensioner is activated.
 - The vehicle is involved in a severe rear-end collision.

■ SRS airbag deployment conditions (SRS front airbags)

- The SRS front airbags will deploy in the event of an impact that exceeds the set threshold level (the level of force corresponding to an approximately 12 - 18 mph [20 - 30 km/h] frontal collision with a fixed wall that does not move or deform).

However, this threshold velocity will be considerably higher in the following situations:

- If the vehicle strikes an object, such as a parked vehicle or sign pole, which can move or deform on impact
- If the vehicle is involved in an underride collision, such as a collision in which the front of the vehicle "underrides", or goes under, the bed of a truck
- Depending on the type of collision, it is possible that only the seat belt pretensioners and seat cushion airbag will activate.
- The SRS front airbags for the front passenger will not activate if there is no passenger sitting in the front passenger seat. However, the SRS front airbags for the front passenger may deploy if luggage is put in the seat, even if the seat is unoccupied.
- The SRS seat cushion airbag on the front passenger seat will not operate if the occupant is not wearing a seat belt.

■ SRS airbag deployment conditions (SRS side and curtain shield airbags)

- The SRS side and curtain shield airbags will deploy in the event of an impact that exceeds the set threshold level (the level of force corresponding to the impact force produced by an approximately 3300 lb. [1500 kg] vehicle colliding with the vehicle cabin from a direction perpendicular to the vehicle orientation at an approximate speed of 12 - 18 mph [20 - 30 km/h]).
- Both SRS curtain shield airbags will deploy in the event of vehicle rollover.
- Both SRS curtain shield airbags may also deploy in the event of a severe frontal collision.

■ Conditions under which the SRS airbags may deploy (inflate), other than a collision

The SRS front airbags and SRS curtain shield airbags may also deploy if a serious impact occurs to the underside of your vehicle. Some examples are shown in the illustration.

- Hitting a curb, edge of pavement or hard surface
- Falling into or jumping over a deep hole
- Landing hard or falling

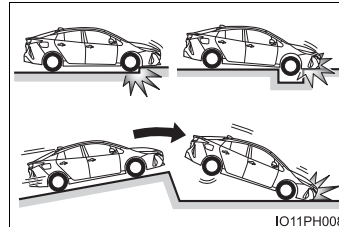

The SRS curtain shield airbags may also deploy under the situations shown in the illustration.

- The angle of vehicle tip-up is marginal.
- The vehicle skids and hits a curb stone.

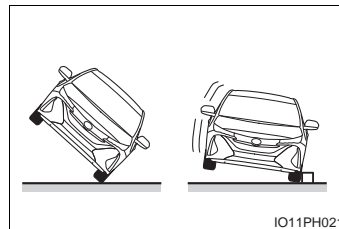

■ Types of collisions that may not deploy the SRS airbags (SRS front airbags)

The SRS front airbags do not generally inflate if the vehicle is involved in a side or rear collision, if it rolls over, or if it is involved in a low-speed frontal collision. But, whenever a collision of any type causes sufficient forward deceleration of the vehicle, deployment of the SRS front airbags may occur.

- Collision from the side
- Collision from the rear
- Vehicle rollover

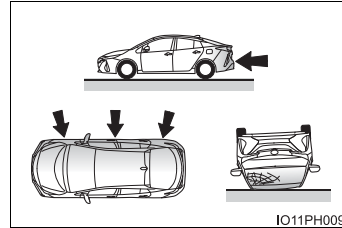

■ Types of collisions that may not deploy the SRS airbags (SRS side and curtain shield airbags)

The SRS side and curtain shield airbags may not activate if the vehicle is subjected to a collision from the side at certain angles, or a collision to the side of the vehicle body other than the passenger compartment.

- Collision from the side to the vehicle body other than the passenger compartment
- Collision from the side at an angle

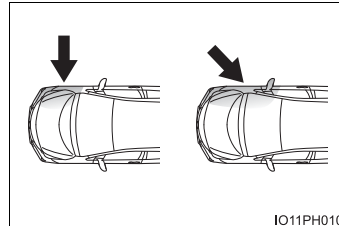

The SRS side airbags do not generally inflate if the vehicle is involved in a frontal or rear collision, if it rolls over, or if it is involved in a low-speed side collision.

- Collision from the front
- Collision from the rear
- Vehicle rollover

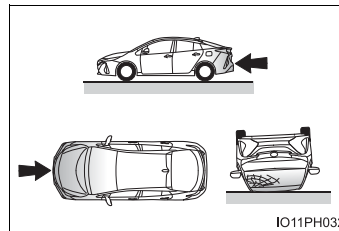

The SRS curtain shield airbags do not generally inflate if the vehicle is involved in a rear collision, if it pitches end over end, or if it is involved in a low-speed side or low-speed frontal collision.

- Collision from the rear
- Pitching end over end

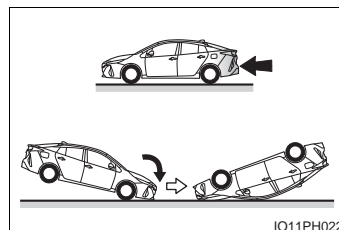

■ When to contact your Toyota dealer

In the following cases, the vehicle will require inspection and/or repair. Contact your Toyota dealer as soon as possible.

- Any of the SRS airbags have been inflated.
- The front of the vehicle is damaged or deformed, or was involved in an accident that was not severe enough to cause the SRS front airbags to inflate.

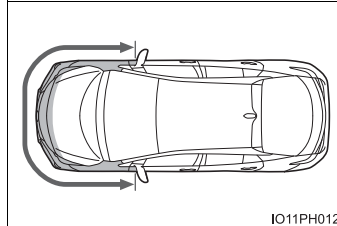

- A portion of a door or its surrounding area is damaged, deformed or has had a hole made in it, or the vehicle was involved in an accident that was not severe enough to cause the SRS side and curtain shield airbags to inflate.

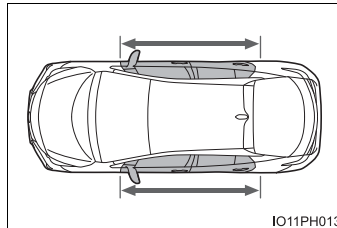

- The pad section of the steering wheel, dashboard near the front passenger airbag or lower portion of the driver's side instrument panel is scratched, cracked, or otherwise damaged.

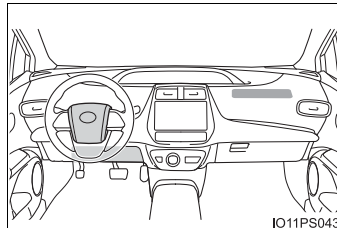

- The front passenger's seat cushion surface is scratched, cracked, or otherwise damaged.

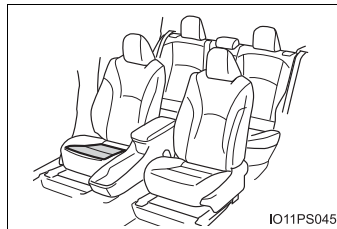

- The surface of the seats with the SRS side airbag is scratched, cracked, or otherwise damaged.

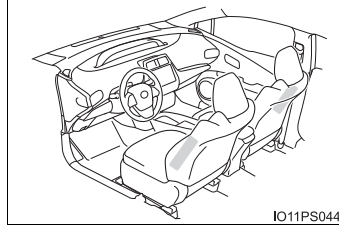

- The portion of the front pillars, rear pillars or roof side rail garnishes (padding) containing the SRS curtain shield airbags inside is scratched, cracked, or otherwise damaged.

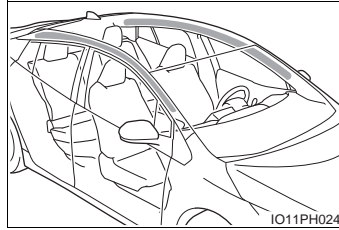

Front passenger occupant classification system

Your vehicle is equipped with a front passenger occupant classification system. This system detects the conditions of the front passenger seat and activates or deactivates the front passenger airbag and seat cushion airbag in the front passenger side.

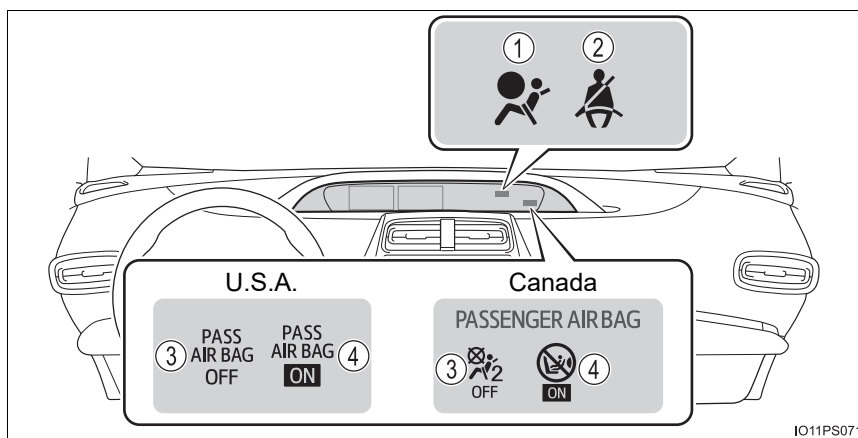

- ① SRS warning light
- ② Seat belt reminder light
- ③ "AIR BAG OFF" indicator light
- ④ "AIR BAG ON" indicator light

Condition and operation in the front passenger occupant classification system

■ Adult*1

Indicator/ warning light	"AIR BAG ON" and "AIR BAG OFF" indicator lights	"AIR BAG ON"
	SRS warning light	Off
	Seat belt reminder light	Off*2 or flashing*3
Devices	Front passenger airbag	Activated
	Seat cushion airbag in the front passenger side	Activated*2 or deactivated*3

■ Child*4

Indicator/ warning light	"AIR BAG ON" and "AIR BAG OFF" indicator lights	"AIR BAG OFF" or "AIR BAG ON"*4
	SRS warning light	Off
	Seat belt reminder light	Off*2 or flashing*3
Devices	Front passenger airbag	Deactivated or activated*4
	Seat cushion airbag in the front passenger side	Deactivated or activated*4, 2

1

For safety and security

■ Child restraint system with infant*5

Indicator/ warning light	“AIR BAG ON” and “AIR BAG OFF” indicator lights	“AIR BAG OFF”*6
	SRS warning light	Off
	Seat belt reminder light	Off*2 or flashing*3
Devices	Front passenger airbag	Deactivated
	Seat cushion airbag in the front passenger side	Deactivated

■ Unoccupied

Indicator/ warning light	“AIR BAG ON” and “AIR BAG OFF” indicator lights	“AIR BAG OFF”
	SRS warning light	Off
	Seat belt reminder light	
Devices	Front passenger airbag	Deactivated
	Seat cushion airbag in the front passenger side	Deactivated

■ There is a malfunction in the system

Indicator/ warning light	“AIR BAG ON” and “AIR BAG OFF” indicator lights	“AIR BAG OFF”
	SRS warning light	On
	Seat belt reminder light	
Devices	Front passenger airbag	Deactivated
	Seat cushion airbag in the front passenger side	Deactivated

- *1: The system judges a person of adult size as an adult. When a smaller adult sits in the front passenger seat, the system may not recognize him/her as an adult depending on his/her physique and posture.
- *2: In the event the front passenger is wearing a seat belt.
- *3: In the event the front passenger does not wear a seat belt.
- *4: For some children, child in seat, child in booster seat or child in convertible seat, the system may not recognize him/her as a child. Factors which may affect this can be the physique or posture.
- *5: Never install a rear-facing child restraint system on the front passenger seat. A forward-facing child restraint system should only be installed on the front passenger seat when it is unavoidable. (→P. 61)
- *6: In case the indicator light is not illuminated, consult this manual on how to install the child restraint system properly. (→P. 58)

 **WARNING****■ Front passenger occupant classification system precautions**

Observe the following precautions regarding front passenger occupant classification system.

Failure to do so may cause death or serious injury.

- Wear the seat belt properly.
- Make sure the front passenger's seat belt plate has not been left inserted into the buckle before someone sits in the front passenger seat.
- Make sure the "AIR BAG OFF" indicator light is not illuminated when using the seat belt extender for the front passenger seat. If the "AIR BAG OFF" indicator light is illuminated, disconnect the extender tongue from the seat belt buckle, and reconnect the seat belt. Reconnect the seat belt extender after making sure the "AIR BAG ON" indicator light is illuminated. If you use the seat belt extender while the "AIR BAG OFF" indicator light is illuminated, the SRS airbags for the front passenger will not activate, which could cause death or serious injury in the event of a collision.
- Do not apply a heavy load to the front passenger seat or equipment (e.g. seatback pocket).
- Do not put weight on the front passenger seat by putting your hands or feet on the front passenger seat seatback from the rear passenger seat.
- Do not let a rear passenger lift the front passenger seat with their feet or press on the seatback with their legs.
- Do not put objects under the front passenger seat.
- Do not recline the front passenger seatback so far that it touches a rear seat. This may cause the "AIR BAG OFF" indicator light to be illuminated, which indicates that the SRS airbags for the front passenger will not activate in the event of a severe accident. If the seatback touches the rear seat, return the seatback to a position where it does not touch the rear seat. Keep the front passenger seatback as upright as possible when the vehicle is moving. Reclining the seatback excessively may lessen the effectiveness of the seat belt system.

 **WARNING****■ Front passenger occupant classification system precautions**

- If an adult sits in the front passenger seat, the “AIR BAG ON” indicator light is illuminated. If the “AIR BAG OFF” indicator is illuminated, ask the passenger to sit up straight, well back in the seat, feet on the floor, and with the seat belt worn correctly. If the “AIR BAG OFF” indicator still remains illuminated, either ask the passenger to move to the rear seat, or if that is not possible, move the front passenger seat fully rearward.
- When it is unavoidable to install a forward-facing child restraint system on the front passenger seat, install the child restraint system on the front passenger seat in the proper order. (→P. 58)
- Do not modify or remove the front seats.
- Do not kick the front passenger seat or subject it to severe impact. Otherwise, the SRS warning light may come on to indicate a malfunction of the front passenger occupant classification system. In this case, contact your Toyota dealer immediately.
- Child restraint systems installed on the rear seat should not contact the front seatbacks.
- Do not use a seat accessory, such as a cushion and seat cover, that covers the seat cushion surface.
- Do not modify or replace the upholstery of the front seat.
- Adjust the front passenger seat so that the head restraint does not touch the ceiling. If the head restraint is left in contact with the ceiling, the system may not detect the front passenger properly, leading to improper operation of the airbags.

Exhaust gas precautions

Harmful substance to the human body is included in exhaust gases if inhaled.

WARNING

Exhaust gases include harmful carbon monoxide (CO), which is colorless and odorless. Observe the following precautions.

Failure to do so may cause exhaust gases enter the vehicle and may lead to an accident caused by light-headedness, or may lead to death or a serious health hazard.

■ Important points while driving

- Keep the back door closed.
- If you smell exhaust gases in the vehicle even when the back door is closed, open the side windows and have the vehicle inspected at your Toyota dealer as soon as possible.

■ When parking

- If the vehicle is in a poorly ventilated area or a closed area, such as a garage, stop the hybrid system.
- Do not leave the vehicle with the hybrid system on for a long time. If such a situation cannot be avoided, park the vehicle in an open space and ensure that exhaust fumes do not enter the vehicle interior.
- Do not leave the hybrid system operating in an area with snow build-up, or where it is snowing. If snowbanks build up around the vehicle while the hybrid system is operating, exhaust gases may collect and enter the vehicle.

■ Exhaust pipe

The exhaust system needs to be checked periodically. If there is a hole or crack caused by corrosion, damage to a joint or abnormal exhaust noise, be sure to have the vehicle inspected and repaired by your Toyota dealer.

Riding with children

Observe the following precautions when children are in the vehicle.

Use a child restraint system appropriate for the child, until the child becomes large enough to properly wear the vehicle's seat belt.

- It is recommended that children sit in the rear seats to avoid accidental contact with the shift lever, wiper switch etc.
- Use the rear door child-protector lock or the window lock switch to avoid children opening the door while driving or operating the power window accidentally. (→P. 284, 314)
- Do not let small children operate equipment which may catch or pinch body parts, such as the power window, hood, back door, seats etc.

WARNING

Never leave children unattended in the vehicle, and never allow children to have or use the key.

Children may be able to start the vehicle or shift the vehicle into neutral. There is also a danger that children may injure themselves by playing with the side windows or other features of the vehicle. In addition, heat build-up or extremely cold temperatures inside the vehicle can be fatal to children.

Child restraint systems

Before installing a child restraint system in the vehicle, there are precautions that need to be observed, different types of child restraint systems, as well as installation methods, etc., written in this manual.

- Use a child restraint system when riding with a small child that cannot properly use a seat belt. For the child's safety, install the child restraint system to a rear seat. Be sure to follow the installation method that is in the operation manual enclosed with the restraint system.

Table of contents

Points to remember.....	P. 58
Child restraint system	P. 60
When using a child restraint system	P. 61
Child restraint system installation method	
• Fixed with a seat belt	P. 64
• Fixed with a child restraint LATCH anchor	P. 70
• Using an anchor bracket (for top tether strap)	P. 73

Points to remember

The laws of all 50 states of the U.S.A. as well as Canada now require the use of child restraint systems.

- Prioritize and observe the warnings, as well as the laws and regulations for child restraint systems.
- Use a child restraint system until the child becomes large enough to properly wear the vehicle's seat belt.
- Choose a child restraint system that suits your vehicle and is appropriate to the age and size of the child.

 **WARNING****■ When a child is riding**

Observe the following precautions.

Failure to do so may result in death or serious injury.

- For effective protection in automobile accidents and sudden stops, a child must be properly restrained, using a seat belt or child restraint system which is correctly installed. For installation details, refer to the operation manual enclosed with the child restraint system. General installation instructions are provided in this manual.
- Toyota strongly urges the use of a proper child restraint system that conforms to the weight and size of the child, installed on the rear seat. According to accident statistics, the child is safer when properly restrained in the rear seat than in the front seat.
- Holding a child in your or someone else's arms is not a substitute for a child restraint system. In an accident, the child can be crushed against the windshield or between the holder and the interior of the vehicle.

■ Handling the child restraint system

If the child restraint system is not properly fixed in place, the child or other passengers may be seriously injured or even killed in the event of sudden braking, sudden swerving, or an accident.

- If the vehicle were to receive a strong impact from an accident, etc., it is possible that the child restraint system has damage that is not readily visible. In such cases, do not reuse the restraint system.
- Make sure you have complied with all installation instructions provided with the child restraint system manufacturer and that the system is properly secured.
- Keep the child restraint system properly secured on the seat even if it is not in use. Do not store the child restraint system unsecured in the passenger compartment.
- If it is necessary to detach the child restraint system, remove it from the vehicle or store it securely in the luggage compartment.

Child restraint system

■ Types of child restraint system installation methods

Confirm with the operation manual enclosed with the child restraint system about the installation of the child restraint system.

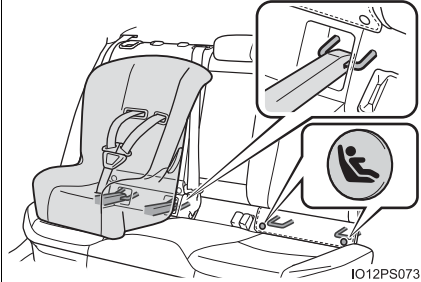
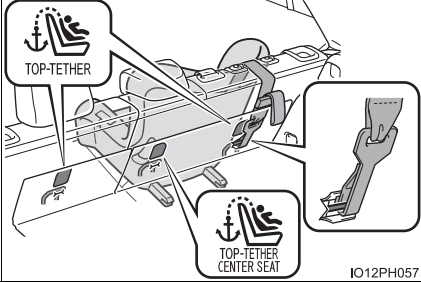
	Installation method	Page
Seat belt attachment		P. 64
Child restraint LATCH anchors attachment		P. 70
Anchor brackets (for top tether strap) attachment		P. 73

When using a child restraint system**■ When installing a child restraint system to a front passenger seat**

For the safety of a child, install a child restraint system to a rear seat. When installing child restraint system to the front passenger seat is unavoidable, adjust the seat as follows and install the child restraint system.

- Raise the seatback as much as possible
- Move the seat to the rear-most position
- If the head restraint interferes with the child restraint system installation and the head restraint can be removed, remove the head restraint

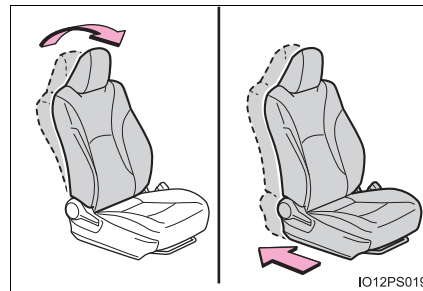

⚠ WARNING

■ **When using a child restraint system**

Observe the following precautions.

Failure to do so may result in death or serious injury.

- Never install a rear-facing child restraint system on the front passenger seat even if the "AIR BAG OFF" indicator light is illuminated. In the event of an accident, the force of the rapid inflation of the front passenger airbag can cause death or serious injury to the child if the rear-facing child restraint system is installed on the front passenger seat.

- A forward-facing child restraint system may be installed on the front passenger seat only when it is unavoidable. A child restraint system that requires a top tether strap should not be used in the front passenger seat since there is no top tether strap anchor for the front passenger seat.

- A forward-facing child restraint system may be installed on the front passenger seat only when it is unavoidable. When installing a forward-facing child restraint system on the front passenger seat, move the seat as far back as possible, even if the "AIR BAG OFF" indicator light is illuminated.



If the head restraint interferes with the child restraint system installation and the head restraint can be removed, remove the head restraint.

- Do not allow the child to lean his/her head or any part of his/her body against the door or the area of the seat, front or rear pillars, or roof side rails from which the SRS side airbags or SRS curtain shield airbags deploy even if the child is seated in the child restraint system. It is dangerous if the SRS side airbags and curtain shield airbags inflate, and the impact could cause death or serious injury to the child.

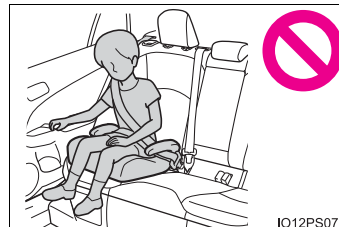

- When a booster seat is installed, always ensure that the shoulder belt is positioned across the center of the child's shoulder. The belt should be kept away from the child's neck, but not so that it could fall off the child's shoulder.

⚠ WARNING**■ When using a child restraint system**

- Use a child restraint system suitable to the age and size of the child and install it to the rear seat.
- If the driver's seat interferes with the child restraint system and prevents it from being attached correctly, attach the child restraint system to the right-hand rear seat.
- Adjust the front passenger seat so that it does not interfere with the child restraint system.

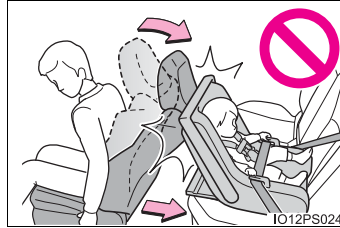

Child restraint system fixed with a seat belt

A child restraint system for a small child or baby must itself be properly restrained on the seat with the lap portion of the lap/shoulder belt.

◆ Installing child restraint system using a seat belt (child restraint lock function belt)

Install the child restraint system in accordance to the operation manual enclosed with the child restraint system.

■ Rear-facing — Infant seat/convertible seat

- 1 Place the child restraint system on the rear seat facing the rear of the vehicle.

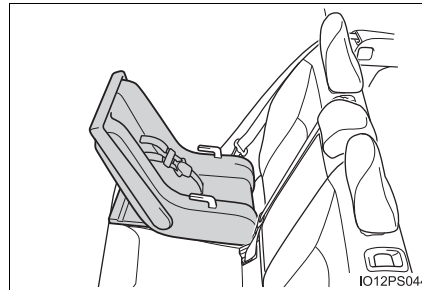

- 2 Run the seat belt through the child restraint system and insert the plate into the buckle. Make sure that the belt is not twisted.

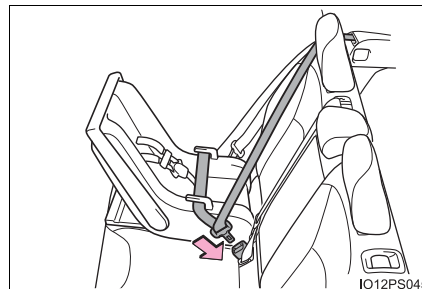

- 3 Fully extend the shoulder belt and allow it to retract to put it in lock mode. In lock mode, the belt cannot be extended.

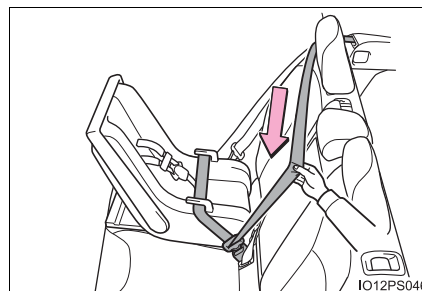

- 4 While pushing the child restraint system down into the rear seat, allow the shoulder belt to retract until the child restraint system is securely in place.

After the shoulder belt has retracted to a point where there is no slack in the belt, pull the belt to check that it cannot be extended.

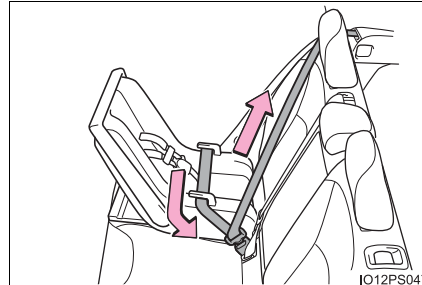

- 5 After installing the child restraint system, rock it back and forth to ensure that it is installed securely. (→P. 69)

■ Forward-facing — Convertible seat

- 1 If installing the child restraint system to the front passenger seat is unavoidable, refer to P. 61 for front passenger seat adjustment.

- 2 If the head restraint interferes with the child restraint system installation and the head restraint can be removed, remove the head restraint. (→P. 306)

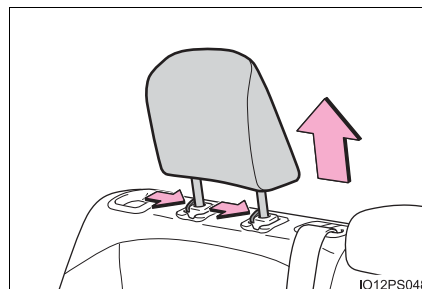

- 3 Place the child restraint system on the seat facing the front of the vehicle.

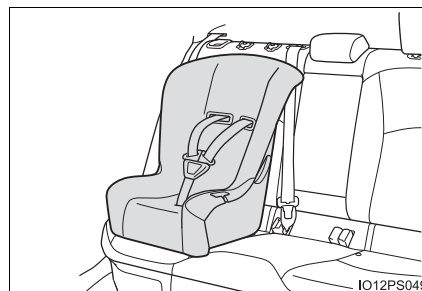

- 4 Run the seat belt through the child restraint system and insert the plate into the buckle. Make sure that the belt is not twisted.

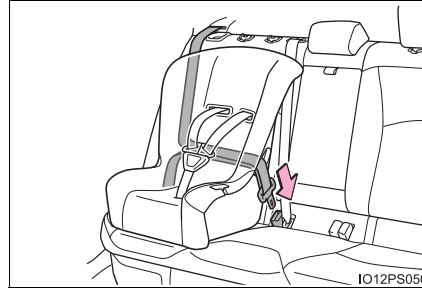

- 5 Fully extend the shoulder belt and allow it to retract to put it in lock mode. In lock mode, the belt cannot be extended.

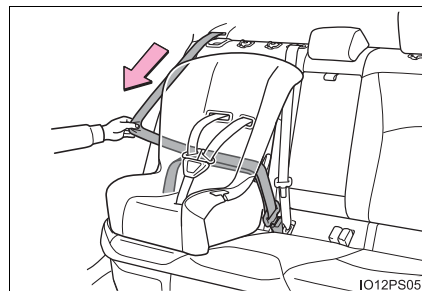

- 6 While pushing the child restraint system into the rear seat, allow the shoulder belt to retract until the child restraint system is securely in place.

After the shoulder belt has retracted to a point where there is no slack in the belt, pull the belt to check that it cannot be extended.

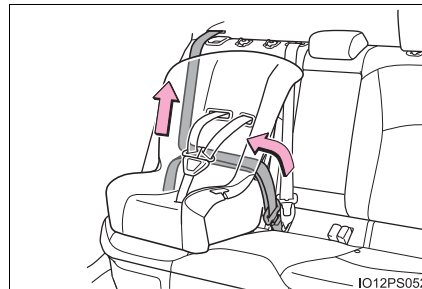

- 7 If the child restraint has a top tether strap, follow the child restraint manufacturer's operation manual regarding the installation, using the top tether strap to latch onto the top tether strap anchor. (→P. 73)
- 8 After installing the child restraint system, rock it back and forth to ensure that it is installed securely. (→P. 69)

■ Booster seat

1 If installing the child restraint system to the front passenger seat is unavoidable, refer to P. 61 for front passenger seat adjustment.

2 High back type: If the head restraint interferes with your child restraint system, and the head restraint can be removed, remove the head restraint. (→P. 306)

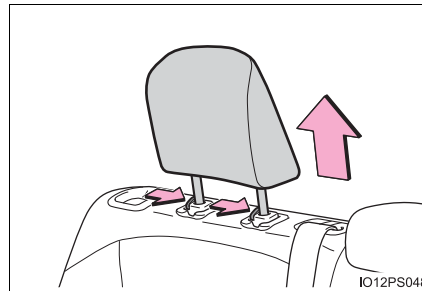

3 Place the child restraint system on the seat facing the front of the vehicle.

▶ Booster type

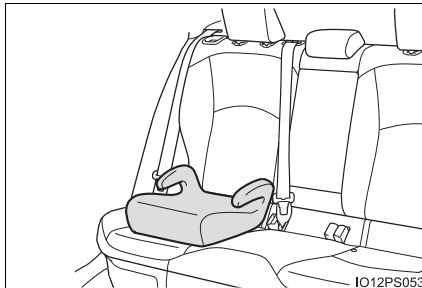

▶ High back type



4 Sit the child in the child restraint system. Fit the seat belt to the child restraint system according to the manufacturer's instructions and insert the plate into the buckle. Make sure that the belt is not twisted.



Check that the shoulder belt is correctly positioned over the child's shoulder and that the lap belt is as low as possible. (→P. 30)

◆ Removing a child restraint system installed with a seat belt

Press the buckle release button and fully retract the seat belt.

When releasing the buckle, the child restraint system may spring up due to the rebound of the seat cushion. Release the buckle while holding down the child restraint system.

Since the seat belt automatically reels itself, slowly return it to the stowing position.

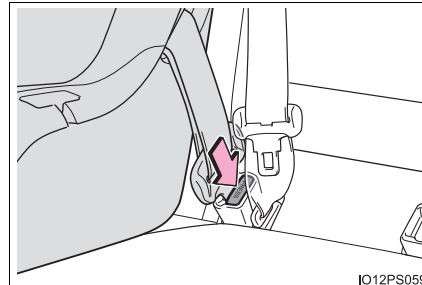

 **WARNING****■ When installing a child restraint system**

Observe the following precautions.

Failure to do so may result in death or serious injury.

- Do not allow children to play with the seat belt. If the seat belt becomes twisted around a child's neck, it may lead to choking or other serious injuries that could result in death.
If this occurs and the buckle cannot be unfastened, scissors should be used to cut the belt.
- Ensure that the belt and plate are securely locked and the seat belt is not twisted.
- Shake the child restraint system left and right, and forward and backward to ensure that it has been securely installed.
- After securing a child restraint system, never adjust the seat.
- When a booster seat is installed, always ensure that the shoulder belt is positioned across the center of the child's shoulder. The belt should be kept away from the child's neck, but not so that it could fall off the child's shoulder.
- Follow all installation instructions provided by the child restraint system manufacturer.
- When securing some types of child restraint systems in rear seats, it may not be possible to properly use the seat belts in positions next to the child restraint without interfering with it or affecting seat belt effectiveness. Be sure your seat belt fits snugly across your shoulder and low on your hips. If it does not, or if it interferes with the child restraint, move to a different position. Failure to do so may result in death or serious injury.

■ When installing a booster seat

To prevent the belt from going into ALR lock mode, do not fully extend the shoulder belt. ALR mode causes the belt to tighten only. This could cause injury or discomfort to the child. (→P. 31)

■ Do not use a seat belt extender

If a seat belt extender is used when installing a child restraint system, the seat belt will not securely hold the child restraint system, which could cause death or serious injury to the child or other passengers in the event of sudden braking, sudden swerving or an accident.

Child restraint system fixed with a child restraint LATCH anchor**■ Child restraint LATCH anchors**

LATCH anchors are provided for the rear outboard seats. (Buttons displaying the location of the anchors are attached to the seats.)

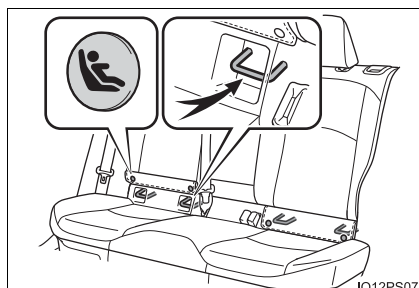
**■ When installing in the rear outboard seats**

Install the child restraint system in accordance to the operation manual enclosed with the child restraint system.

- 1 If the head restraint interferes with the child restraint system installation and the head restraint can be removed, remove the head restraint. (→P. 306)
- 2 Flip up and fold the cover, and fix it with the hook-and-loop fastener.

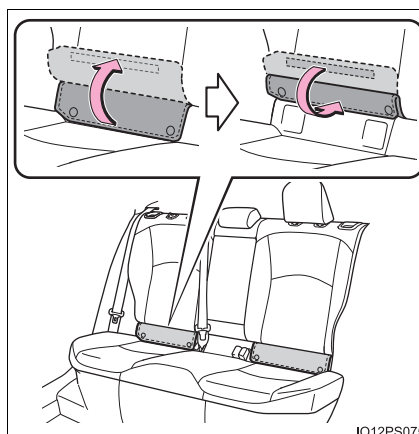

► With flexible lower attachments

- 3 Latch the hooks of the lower attachments onto the LATCH anchors.

For owners in Canada:

The symbol on a child restraint system indicates the presence of a lower connector system.



► With rigid lower attachments

- 3 Latch the buckles onto the LATCH anchors.

For owners in Canada:

The symbol on a child restraint system indicates the presence of a lower connector system.



- 4 If the child restraint has a top tether strap, follow the child restraint manufacturer's operation manual regarding the installation, using the top tether strap to latch onto the top tether strap anchor. (→P. 73)

- 5 After installing the child restraint system, rock it back and forth to ensure that it is installed securely. (→P. 69)

■ **Laws and regulations pertaining to anchors**

The LATCH system conforms to FMVSS225 or CMVSS210.2.

Child restraint systems conforming to FMVSS213 or CMVSS213 specifications can be used.

This vehicle is designed to conform to SAE J1819.

 **WARNING**

■ **When installing a child restraint system**

Observe the following precautions.

Failure to do so may result in death or serious injury.

- When using the LATCH anchors, be sure that there are no foreign objects around the anchors and that the seat belt is not caught behind the child restraint system.
- Follow all installation instructions provided by the child restraint system manufacturer.
- When securing some types of child restraint systems in rear seats, it may not be possible to properly use the seat belts in positions next to the child restraint without interfering with it or affecting seat belt effectiveness. Be sure your seat belt fits snugly across your shoulder and low on your hips. If it does not, or if it interferes with the child restraint, move to a different position. Failure to do so may result in death or serious injury.
- If the seat is adjusted, reconfirm the security of the child restraint system.

Using an anchor bracket (for top tether strap)

■ Anchor brackets (for top tether strap)

Anchor brackets are provided for each rear seat.

Use anchor brackets when fixing the top tether strap.

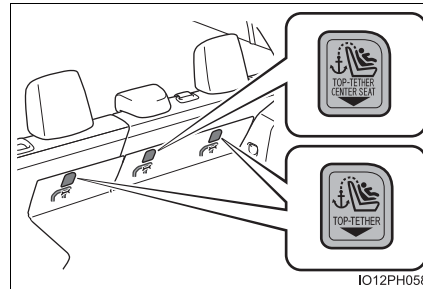

■ Fixing the top tether strap to the anchor bracket

Install the child restraint system in accordance to the operation manual enclosed with the child restraint system.

▶ Rear outboard seats

- 1 Remove the head restraint.
(→P. 306)

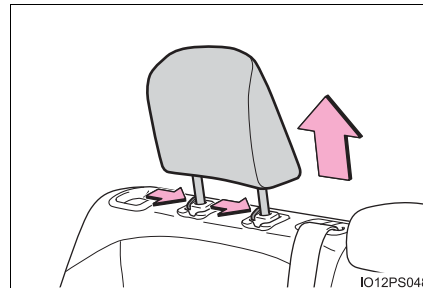

- 2 Flip down the board, and latch the hook onto the anchor bracket and tighten the top tether strap.

Make sure the top tether strap is securely latched. (→P. 69)

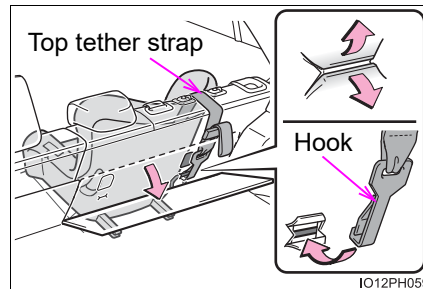

- 3 If the head restraint does not interfere with the child restraint system installation, install the head restraint.

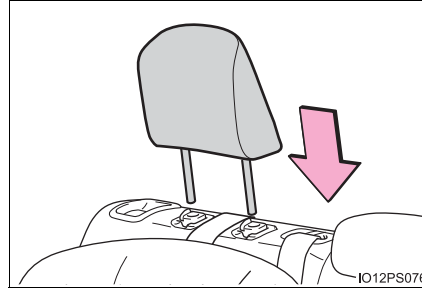

► Rear center seat

- 1 Adjust the head restraint to the upmost position.

If the head restraint interferes with your child restraint system, and the head restraint can be removed, remove the head restraint. (→P. 306)

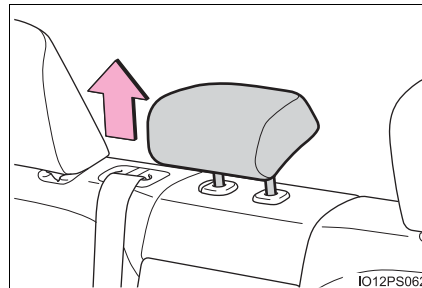

- 2 Flip down the board, and latch the hook onto the anchor bracket and tighten the top tether strap.

Make sure the top tether strap is securely latched.

When installing the child restraint system with the head restraint being raised, be sure to have the top tether strap pass underneath the head restraint.

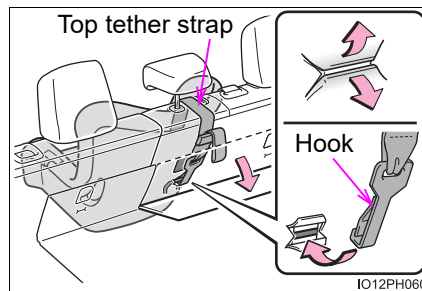

■ **Laws and regulations pertaining to anchors**

The LATCH system conforms to FMVSS225 or CMVSS210.2.

Child restraint systems conforming to FMVSS213 or CMVSS213 specifications can be used.

This vehicle is designed to conform to SAE J1819.

 **WARNING****■ When installing a child restraint system**

Observe the following precautions.

Failure to do so may result in death or serious injury.

- Firmly attach the top tether strap and make sure that the belt is not twisted.
- Do not attach the top tether strap to anything other than the anchor bracket.
- After securing a child restraint system, never adjust the seat.
- Follow all installation instructions provided by the child restraint system manufacturer.
- Rear center seat: When installing the child restraint system with the head restraint being raised, after the head restraint has been raised and then the anchor bracket has been fixed, do not lower the head restraint.

1

For safety and security

Safety Connect*

Safety Connect is a subscription-based telematics service that uses Global Positioning System (GPS) data and embedded cellular technology to provide safety and security features to subscribers. Safety Connect is supported by Toyota's designated response center, which operates 24 hours per day, 7 days per week.

Safety Connect service is available by subscription on select, telematics hardware-equipped vehicles.

By using the Safety Connect service, you are agreeing to be bound by the Telematics Subscription Service Agreement and its Terms and Conditions, as in effect and amended from time to time, a current copy of which is available at Toyota.com in the United States, Toyotapr.com in Puerto Rico and Toyota.ca in Canada. All use of the Safety Connect service is subject to such then-applicable Terms and Conditions.

System components

- ① Microphone
- ② LED light indicators
- ③ "SOS" button

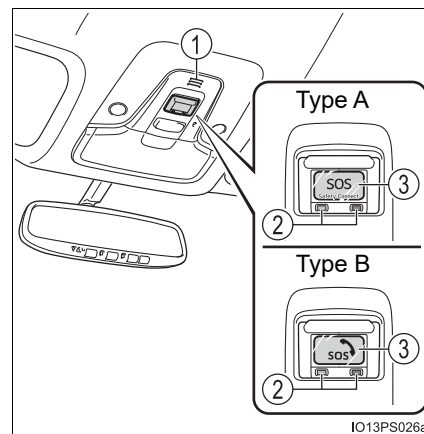

*: If equipped

Services

Subscribers have the following Safety Connect services available:

- **Automatic Collision Notification***
Helps drivers receive necessary response from emergency service providers. (→P. 79)
- *: U.S. Patent No. 7,508,298 B2
- **Stolen Vehicle Location**
Helps drivers in the event of vehicle theft. (→P. 79)
- **Emergency Assistance Button (SOS)**
Connects drivers to response-center support. (→P. 79)
- **Enhanced Roadside Assistance**
Provides drivers various on-road assistance. (→P. 80)

Subscription

After you have signed the Telematics Subscription Service Agreement and are enrolled, you can begin receiving services.

A variety of subscription terms is available for purchase. Contact your Toyota dealer, call the following appropriate Customer Experience Center or push the “SOS” button in your vehicle for further subscription details.

- The United States
1-800-331-4331
- Canada
1-888-869-6828
- Puerto Rico
1-877-855-8377

■ Safety Connect Services Information

- Phone calls using the vehicle's Bluetooth® technology will not be possible when Safety Connect is active and in use.
- Safety Connect is available beginning Fall 2009 on select Toyota models (in the contiguous United States only). Contact with the Safety Connect response center is dependent upon the telematics device being in operative condition, cellular connection availability, and GPS satellite signal reception, which can limit the ability to reach the response center or receive emergency service support. Enrollment and Telematics Subscription Service Agreement required. A variety of subscription terms is available; charges vary by subscription term selected and location.
- Automatic Collision Notification, Emergency Assistance and Stolen Vehicle Location are available in the United States, including Hawaii and Alaska, Puerto Rico and Canada, and Enhanced Roadside Assistance are available in the United States, Puerto Rico and Canada.
- Automatic Collision Notification, Emergency Assistance, Stolen Vehicle and Enhanced Road Assistance are not available in the U.S. Virgin Islands. For vehicles first sold in the U.S. Virgin Islands, no Safety Connect services will function in or outside the U.S. Virgin Islands.
- Safety Connect services are not subject to section 255 of the Telecommunications Act and the device is not TTY compatible.

■ Languages

The Safety Connect response center will offer support in multiple languages. The Safety Connect system will offer voice prompts in English, Spanish, and French. Please indicate your language of choice when enrolling.

■ When contacting the response center

You may be unable to contact the response center if the network is busy.

Safety Connect LED light Indicators

When the power switch is turned to ON mode, the red indicator light comes on for 2 seconds then turns off. Afterward, the green indicator light comes on, indicating that the service is active.

The following indicator light patterns indicate specific system usage conditions:

- Green indicator light on = Active service
- Green indicator light flashing = Safety Connect call in process
- Red indicator light (except at vehicle start-up) = System malfunction (contact your Toyota dealer)
- No indicator light (off) = Safety Connect service not active

Safety Connect services

■ Automatic Collision Notification

In case of either airbag deployment or severe rear-end collision, the system is designed to automatically call the response center. The responding agent receives the vehicle's location and attempts to speak with the vehicle occupants to assess the level of emergency. If the occupants are unable to communicate, the agent automatically treats the call as an emergency, contacts the nearest emergency services provider to describe the situation, and requests that assistance be sent to the location.

■ Stolen Vehicle Location

If your vehicle is stolen, Safety Connect can work with local authorities to assist them in locating and recovering the vehicle.

After filing a police report, call the Customer Experience Center at 1-800-331-4331 in the United States, 1-877-855-8377 in Puerto Rico or 1-888-869-6828 in Canada, and follow the prompts for Safety Connect to initiate this service.

In addition to assisting law enforcement with recovery of a stolen vehicle, Safety-Connect-equipped vehicle location data may, under certain circumstances, be shared with third parties to locate your vehicle. Further information is available at Toyota.com in the United States, Toyotapr.com in Puerto Rico and Toyota.ca in Canada.

■ Emergency Assistance Button (“SOS”)

In the event of an emergency on the road, push the “SOS” button to reach the Safety Connect response center. The answering agent will determine your vehicle's location, assess the emergency, and dispatch the necessary assistance required.

If you accidentally press the “SOS” button, tell the response-center agent that you are not experiencing an emergency.

■ Enhanced Roadside Assistance

Enhanced Roadside Assistance adds GPS data to the already included warranty-based Toyota roadside service.

Subscribers can press the “SOS” button to reach a Safety Connect response-center agent, who can help with a wide range of needs, such as: towing, flat tire, fuel delivery, etc. For a description of the Roadside Assistance services and their limitations, please see the Safety Connect Terms and Conditions, which are available at Toyota.com in the United States, Toyotapr.com in Puerto Rico and Toyota.ca in Canada.

Safety information for Safety Connect

Important! Read this information before using Safety Connect.

■ Exposure to radio frequency signals

The Safety Connect system installed in your vehicle is a low-power radio transmitter and receiver. It receives and also sends out radio frequency (RF) signals.

In August 1996, the Federal Communications Commission (FCC) adopted RF exposure guidelines with safety levels for mobile wireless phones. Those guidelines are consistent with the safety standards previously set by the following U.S. and international standards bodies.

- ANSI (American National Standards Institute) C95.1 [1992]
- NCRP (National Council on Radiation Protection and Measurement) Report 86 [1986]
- ICNIRP (International Commission on Non-Ionizing Radiation Protection) [1996]

Those standards were based on comprehensive and periodic evaluations of the relevant scientific literature. Over 120 scientists, engineers, and physicians from universities, and government health agencies and industries reviewed the available body of research to develop the ANSI Standard (C95.1).

The design of Safety Connect complies with the FCC guidelines in addition to those standards.

■ Free/Open Source Software Information

This product contains Free/Open Source Software (FOSS).

The license information and/or the source code of such FOSS can be found at the following URL.

<https://www.denso.com/global/en/opensource/dcm/toyota/>

■ Certifications for the Safety Connect

FCC ID: JOYJ79

NOTE

This device complies with part 15 of the FCC Rules. Operation is subject to the following two conditions: (1) This device may not cause harmful interference, and (2) this device must accept any interference received, including interference that may cause undesired operation.

FCC WARNING

Changes or modifications not expressly approved by the party responsible for compliance could void the user's authority to operate the equipment.

Co-location: This transmitter must not be co-located or operated in conjunction with any other antenna or transmitter.

CAUTION : Radio Frequency Radiation Exposure

This equipment complies with FCC radiation exposure limits set forth for an uncontrolled environment and meets the FCC radio frequency (RF) Exposure Guidelines. This equipment should be installed and operated keeping the radiator at least 20cm or more away from person's body.

FCC ID: JOYDA39

NOTE

This device complies with part 15 of the FCC Rules. Operation is subject to the following two conditions: (1) This device may not cause harmful interference, and (2) this device must accept any interference received, including interference that may cause undesired operation.

FCC WARNING

Changes or modifications not expressly approved by the party responsible for compliance could void the user's authority to operate the equipment.

Co-location: This transmitter must not be co-located or operated in conjunction with any other antenna or transmitter.

CAUTION : Radio Frequency Radiation Exposure

This equipment complies with FCC radiation exposure limits set forth for an uncontrolled environment and meets the FCC radio frequency (RF) Exposure Guidelines. This equipment should be installed and operated keeping the radiator at least 20cm or more away from person's body.

IC: 574B-DA39

NOTE

This device contains licence-exempt transmitter(s)/receiver(s) that comply with Innovation, Science and Economic Development Canada's licence-exempt RSS(s). Operation is subject to the following two conditions:

- (1) This device may not cause interference.
- (2) This device must accept any interference, including interference that may cause undesired operation of the device.

The antenna cannot be removed (and changed) by user.

Co-location: This transmitter must not be co-located or operated in conjunction with any other antenna or transmitter.

CAUTION: Radio Frequency Radiation Exposure

This equipment complies with ISED radiation exposure limits set forth for an uncontrolled environment and meets RSS-102 of the ISED radio frequency (RF) Exposure rules. This equipment should be installed and operated keeping the radiator at least 20 cm or more away from person's body.

NOTE

L'émetteur/récepteur exempt de licence contenu dans le présent appareil est conforme aux CNR d'Innovation, Sciences et Développement économique Canada applicables aux appareils radio exempts de licence. L'exploitation est autorisée aux deux conditions suivantes :

- (1) L'appareil ne doit pas produire de brouillage;
- (2) L'appareil doit accepter tout brouillage radioélectrique subi, même si le brouillage est susceptible d'en compromettre le fonctionnement.

L'utilisateur n'est pas autorisé à retirer (ou modifier) l'antenne.

Emplacement: Cet émetteur ne doit pas être installé ou utilisé conjointement avec d'autres antennes ou émetteurs.

ATTENTION : exposition aux radiofréquences

Cet équipement est conforme aux limites d'exposition aux rayonnements ISDE établies pour un environnement non contrôlé et satisfait à la norme CNR-102 de la réglementation ISDE sur l'exposition aux radiofréquences (RF). Cet équipement doit être installé et utilisé avec un minimum de 20 cm de distance entre la source de rayonnement et le corps.

Immobilizer system

The vehicle's keys have built-in transponder chips that prevent the hybrid system from starting if a key has not been previously registered in the vehicle's on-board computer.

Never leave the keys inside the vehicle when you leave the vehicle.

This system is designed to help prevent vehicle theft but does not guarantee absolute security against all vehicle thefts.

The indicator light flashes after the power switch has been turned off to indicate that the system is operating.

The indicator light stops flashing after the power switch has been turned to ACCESSORY or ON mode to indicate that the system has been canceled.

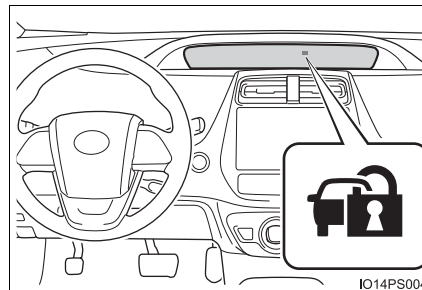

■ System maintenance

The vehicle has a maintenance-free type immobilizer system.

■ Conditions that may cause the system to malfunction

- If the grip portion of the key is in contact with a metallic object
- If the key is in close proximity to or touching a key registered to the security system (key with a built-in transponder chip) of another vehicle

■ Certifications for the immobilizer system

- ▶ For vehicles sold in the U.S.A. and Hawaii

FCC ID: NI4TMIMB-3

This device complies with part 15 of the FCC Rules. Operation is subject to the following two conditions: (1) This device may not cause harmful interference, and (2) this device must accept any interference received, including interference that may cause undesired operation.

Changes or modifications not expressly approved by the party responsible for compliance could void the user's authority to operate the equipment.

- ▶ For vehicles sold in Canada

This device complies with Industry Canada's licence-exempt RSSs. Operation is subject to the following two conditions: (1) This device may not cause interference; and (2) This device must accept any interference, including interference that may cause undesired operation of the device.

Le présent appareil est conforme aux CNR d'Industrie Canada applicables aux appareils radio exempts de licence. L'exploitation est autorisée aux deux conditions suivantes : 1) l'appareil ne doit pas produire de brouillage; 2) l'utilisateur de l'appareil doit accepter tout brouillage radioélectrique subi, même si le brouillage est susceptible d'en compromettre le fonctionnement.

 **NOTICE****■ To ensure the system operates correctly**

Do not modify or remove the system. If modified or removed, the proper operation of the system cannot be guaranteed.

Plug-in hybrid system

2

2-1. Plug-in hybrid system

Plug-in hybrid system features	86
Plug-in hybrid system precautions	98
Plug-in hybrid vehicle driving tips.....	105
EV driving range	108

2-2. Charging

Charging equipment.....	110
Charging cable	115
Smart lid & connector locking system	121
Power sources that can be used	131
Charging methods.....	134
Charging tips.....	139
Things to know before charging	141
How to charge	146
Using the charging schedule function	157
When normal charging cannot be carried out	180

Plug-in hybrid system features

The plug-in hybrid system is a system excellent in both economical efficiency of electric vehicles and practicality of hybrid vehicles.

- EV driving can be performed using electricity charged from an external power source.*
- If the amount of electricity remaining in the hybrid battery (traction battery) becomes low, the vehicle is automatically controlled in such a way that it can be driven as a hybrid vehicle through the joint use of the gasoline engine.

*: The EV driving range will vary in accordance with conditions such as vehicle speed, the amount of charge remaining in the hybrid battery (traction battery) and the usage of the air conditioning system. The gasoline engine may also be used simultaneously in accordance with driving conditions.

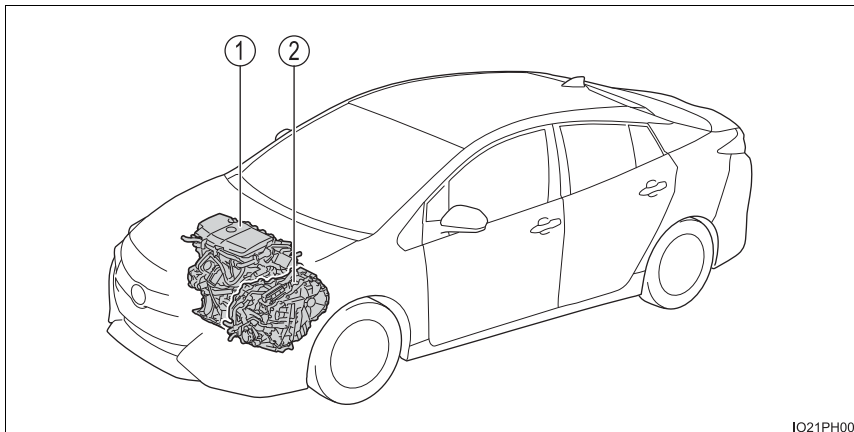

IO21PH001

The illustration is an example for explanation and may differ from the actual item.

- ① Gasoline engine
- ② Electric motor (traction motor)

Plug-in hybrid system operation mode

The plug-in hybrid system operates in the following modes.

The multi-information display can be used to check which mode the plug-in hybrid system is currently being driven in. (→P. 220)

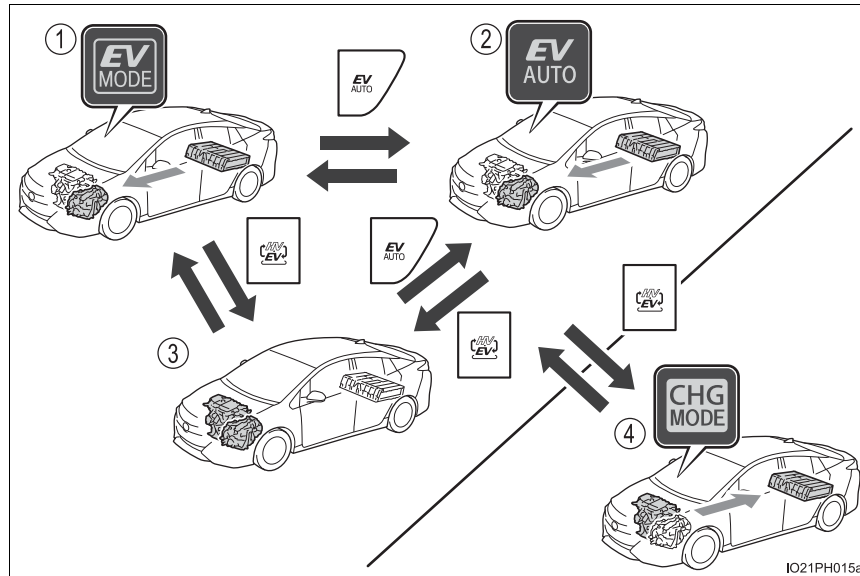

① EV mode

When a sufficient amount of electricity is remaining after charging^{*1}, EV driving is performed using electricity stored in the hybrid battery (traction battery).^{*2}

When in EV mode, the EV drive mode indicator illuminates.

^{*1}: The amount of remaining charge can be checked on the multi-information display etc. (→P. 231)

^{*2}: Depending on the situation, EV driving may be canceled and both gasoline engine and electric motor are used. (→P. 95)

② EV auto mode (→P. 90)

When a sufficient amount of electricity for EV driving is remaining in the hybrid battery (traction battery) after charging*, the operation mode can be switched to EV auto mode.

Switching to EV auto mode make powerful driving possible by using both the gasoline engine and electric motor in a driving condition that requires large driving force, such as when passing a vehicle on a highway or driving on a steep slope.

When in EV auto mode, the EV auto mode indicator illuminates.

*: The amount of remaining charge can be checked on the multi-information display etc. (→P. 231)

③ HV mode

When in HV mode, the vehicle is driven using both the gasoline engine and electric motor (traction motor). (→P. 92)

● If electricity needed for EV driving in EV mode or EV auto mode is not remaining, the operation mode will be automatically switched to HV mode.

● The operation mode can be switched to HV mode at any timing by operating the switch to keep electricity for EV driving etc.* (→P. 90). Switching to HV mode when driving on a highway or when driving uphill is recommended in order to conserve battery power.

When in HV mode, the EV drive mode indicator and EV auto mode indicator turn off.

*: The EV driving range may reduce even after switching to HV mode.

④ Hybrid battery (traction battery) charge mode (→P. 91)

Electricity generated in the gasoline engine can be charged in the hybrid battery (traction battery) by switching to the hybrid battery (traction battery) charge mode when electricity needed for EV driving is not remaining.*

- The system may not be able to switch to the hybrid battery (traction battery) charge mode due to the state of the plug-in hybrid system. (→P. 91)
- Charging time differs depending on the driving state of the vehicle when driving in hybrid battery (traction battery) charge mode.

When in the hybrid battery (traction battery) charge mode, the hybrid battery charge mode indicator illuminates.

*: When in the hybrid battery (traction battery) charge mode, the hybrid battery can be charged while driving. However, the gasoline engine runs to charge the battery and fuel consumption becomes higher compared with driving in HV mode.

Plug-in hybrid system operation mode selection switches

The plug-in hybrid system operation modes can be switched using the switches.

If there is not enough charge remaining in the hybrid battery (traction battery) to allow EV driving, EV/EV auto mode will not be selectable.

The hybrid battery (traction battery) charge mode cannot be selected if the hybrid battery (traction battery) is almost completely charged.

■ **Switching the plug-in hybrid system operation modes**

Press the EV/HV mode selection switch or EV auto mode switch to change modes as the following table shows.

When in EV mode, the EV drive mode indicator illuminates.



When in EV auto mode, the EV auto mode indicator illuminates.

When in HV mode, the EV drive mode indicator and EV auto mode indicator turn off.

▶ EV/HV mode selection switch

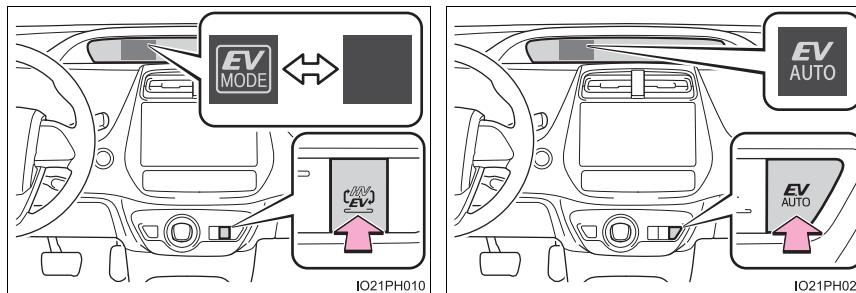
▶ EV auto mode switch



Current mode	Switch operated	
		
EV mode	HV mode	EV auto mode
EV auto mode	HV mode	EV mode
HV mode	EV mode*	EV auto mode*

*: If there is not enough charge remaining in the hybrid battery (traction battery) to allow EV driving, EV/EV auto mode will not be selectable.

■ Switching to the hybrid battery (traction battery) charge mode

Press and hold the switch.

Take your hand off the switch once the hybrid battery charge mode indicator starts to blink.

The hybrid battery charge mode indicator illuminates when the switch to hybrid battery (traction battery) charge mode is complete.

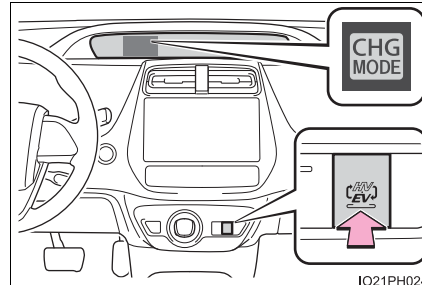

When the hybrid battery (traction battery) is fully charged*, the hybrid battery (traction battery) charge mode is automatically canceled and the operation mode will be switched to HV mode.

The hybrid battery (traction battery) charge mode will be canceled by pressing EV/HV mode selection switch or EV auto mode switch.

*: The maximum charge amount in the hybrid battery (traction battery) charge mode is approximately 80% of the fully charged capacity for the charging from an external power source.

■ If the plug-in hybrid system operation mode cannot be changed

In the following situations, the plug-in hybrid system operation mode cannot be changed even if the EV/HV mode selection switch or EV auto mode switch is pressed. (In this case, the warning message is displayed on the multi-information display when the switch is pressed.)

- When electricity needed for EV driving is not remaining (when in EV/EV auto mode)
- When the traction battery is almost completely charged (hybrid battery [traction battery] charge mode)

■ When switching from EV mode to another mode using the switch

When the power switch is turned off, operation mode switching is canceled and the system returns to EV mode the next time the vehicle is started.

■ Hybrid battery (traction battery) charge mode

- The following may occur to protect the system, etc.
 - Cannot switch to hybrid battery (traction battery) charge mode or cannot cancel it
 - Gasoline engine does not start or stops even after switching to hybrid battery (traction battery) charge mode
- If a load to the system is large, such as when the power consumption of the air conditioning system is large or when the temperature of the engine coolant is high, it may take longer time than usual to charge using the hybrid battery (traction battery) charge mode, or charging to the hybrid battery (traction battery) may not be performed.

Control when driving in each mode

■ When in EV/EV auto mode

In EV/EV auto mode, EV driving (driving using only the electric motor)* is possible. However, depending on the situation, EV driving may be canceled and both gasoline engine and electric motor are used (→P. 95). Also, if a little electricity is remaining in the hybrid battery (traction battery), HV mode is automatically selected. To drive in EV/EV auto mode long, observe the followings.

- Avoid sudden acceleration and sudden deceleration, and be sure to drive smoothly.

If you repeatedly accelerate, the hybrid battery (traction battery) charge will deplete quickly. Also, EV driving may be canceled by rapid acceleration or vehicle speed.

- Restrain your speed as much as possible. The distance that can be driven in EV/EV auto mode will reduce considerably at high speeds.

*: The EV driving range can be checked using the multi-information display etc. (→P. 214, 230, 237, 254)

■ When in HV mode

The vehicle can be used in the same way as a standard hybrid vehicle.

In HV mode, controls are primarily carried out as follows in accordance with the driving conditions.

- The gasoline engine stops* when the vehicle is stopped.
- During start off, the electric motor (traction motor) drives the vehicle.
- During normal driving, the gasoline engine and electric motor (traction motor) are controlled effectively, and the vehicle is driven with optimum fuel efficiency. Also, when necessary, the electric motor (traction motor) operates as an electrical generator to charge the hybrid battery (traction battery).
- When the accelerator pedal is depressed heavily, drive force from both the gasoline engine and the electric motor (traction motor) is used to accelerate.

*: When the hybrid battery (traction battery) requires charging or the engine is warming up, etc., the gasoline engine will not automatically stop. (→P. 95)

■ When braking (regenerative braking)

The electric motor (traction motor) charges the hybrid battery (traction battery).

The EV driving range can be extended by actively using this regenerative braking to store electricity in the hybrid battery (traction battery).

Moreover, as fuel consumption is also reduced when in HV mode, the regenerative braking system can be used effectively.

Charging (→P. 110)

In order to make EV/EV auto mode available, charge the hybrid battery (traction battery) from an external power source before using the vehicle.

Even if charging the hybrid battery (traction battery) has not been completed, the vehicle can be driven. However, if there is not enough charge remaining, it is possible that the vehicle cannot be driven in EV/EV auto mode or the EV driving range will become shorter.

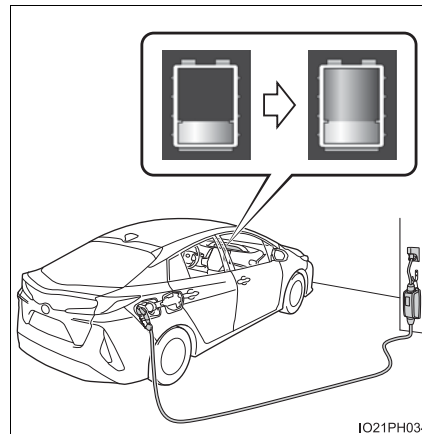

2

Plug-in hybrid system

Vehicle proximity notification system

When driving with the gasoline engine stopped, a sound, which changes in accordance with the driving speed, will be played in order to warn people nearby of the vehicle's approach. The sound will stop when the vehicle speed exceeds approximately 22 mph (35 km/h).

■ Regenerative braking

In the following situations, kinetic energy is converted to electric energy and deceleration force can be obtained in conjunction with the recharging of the hybrid battery (traction battery).

- The accelerator pedal is released while driving with the shift position in D or B.
- The brake pedal is depressed while driving with the shift position in D or B.

■ EV driving range

- The EV driving range is displayed on the multi-information display etc. (→P. 214, 230, 237, 254)
- The EV driving range changes in accordance with the charge status of the hybrid battery (traction battery), the speed of the vehicle, etc.
- Even if there is enough charge remaining in the hybrid battery (traction battery), EV driving may be canceled and both gasoline engine and electric motor are used depending on the situation. (→P. 95)

■ After EV mode has switched to HV mode due to low hybrid battery (traction battery) charge

If the hybrid battery (traction battery) is regenerated by driving continuously down a long slope, the EV driving range etc. will be displayed on the multi-information display and EV mode will be automatically switched to.

If EV mode is not switched to even though EV driving range is being displayed, EV mode can be switched to by pressing the EV/HV mode selection switch.

■ Refilling fuel

Plug-in hybrid vehicles can be driven using electricity charged from an external power source. However, as the gasoline engine is used depending on the situation even if in EV mode, and the gasoline engine is provided on board as a power source for driving in HV mode, it is needed to refueling the vehicle. Check the fuel amount and refill immediately when the fuel level becomes low. (→P. 371)

■ Gasoline engine operation in EV/EV auto mode

Even if there is a sufficient amount of electricity remaining in the hybrid battery (traction battery) and EV driving range (→P. 214, 230, 237, 254) is being displayed on the multi-information display etc., EV driving (driving using only the electric motor) may be canceled and both gasoline engine and electric motor are used depending on the situation (EV driving will be returned to automatically after EV driving becomes possible again).

EV driving may be canceled automatically in the following circumstances:

- When vehicle speed is more than approximately 84 mph (135 km/h).
- When power is needed temporarily, for example when the accelerator pedal is depressed firmly or when accelerating suddenly.*
- When the temperature of the hybrid system is high.
The vehicle has been left in the sun, driven on a hill, driven at high speeds, etc.
- When the temperature of the hybrid system is low.
- When the heater is switched on when the outside temperature is below about 14°F (-10°C).
- When the windshield defogger switch is pressed. (→P. 515, 527)
- When the system determines that the gasoline engine needs to be started.

The gasoline engine may also operate in circumstances other than those listed above, depending on conditions.

*: When traveling in the EV auto mode only

■ Conditions in which the gasoline engine may not stop

The gasoline engine starts and stops automatically. However, it may not stop automatically in the following conditions*:

- During gasoline engine warm-up
- During hybrid battery (traction battery) charging
- When the temperature of the hybrid battery (traction battery) is high or low
- When the windshield defogger switch is pressed. (→P. 515, 527)

*: Depending on the circumstances, the gasoline engine may also not stop automatically in situations other than those above.

■ If the vehicle is not used for a long time

- The 12-volt battery may discharge. In this event, charge the 12-volt battery. (→P. 607)

In order to prevent the hybrid battery (traction battery) from becoming extremely low in charge, charge the hybrid battery (traction battery) from external power source or start the hybrid system at least once every 2 or 3 months, and turn the power switch off after the gasoline engine has stopped automatically. (If the gasoline engine does not start up even after approximately 10 seconds have passed since the "READY" indicator came on, the power switch can be turned to off without any further action.)

- When the vehicle is left with the charging cable connected, the electricity consumption amount of the 12-volt battery increases due to controls, such as the system checking, operating. When the charging cable is not needed, immediately remove it from the vehicle.

■ Sounds and vibrations specific to a hybrid vehicle

There may be no engine sound or vibration even though the vehicle is able to move with the "READY" indicator is illuminated. For safety, apply the parking brake and make sure to shift the shift position to P when parked.

The following sounds or vibrations may occur when the hybrid system is operating and are not a malfunction.

- Motor sounds may be heard from the engine compartment.
- Sounds may be heard from the hybrid battery (traction battery) when the hybrid system starts or stops.
- Relay operating sounds such as a snap or soft clank will be emitted from the hybrid battery (traction battery), behind the rear seats, when the hybrid system is started or stopped.
- Sounds from the hybrid system may be heard when the back door is open.
- Sounds may be heard from the transmission when the gasoline engine starts or stops, when driving at low speeds, or during idling.
- Engine sounds may be heard when accelerating sharply.
- Sounds may be heard due to regenerative braking when the brake pedal is depressed or as the accelerator pedal is released.
- Vibration may be felt when the gasoline engine starts or stops.
- Cooling fan sounds may be heard from the air intake vents. (→P. 99)

■ Vehicle proximity notification system

In the following cases, the vehicle proximity notification system may be difficult for surrounding people to hear.

- In very noisy areas
- In the wind or the rain

Also, as the vehicle proximity notification system is installed on the front of the vehicle, it may be more difficult to hear from the rear of the vehicle compared to the front.

■ **When “Proximity Notification System Malfunction Visit Your Dealer” is displayed on the multi-information display**

The vehicle proximity notification system may be malfunctioning. Have the vehicle inspected by your Toyota dealer immediately.

■ **Maintenance, repair, recycling, and disposal**

Contact your Toyota dealer regarding maintenance, repair, recycling and disposal. Do not dispose of the vehicle yourself.

 **WARNING**

■ **When using the hybrid battery (traction battery) charge mode**

Observe the following precautions when using the hybrid battery (traction battery) charge mode while parking.

Failure to do so may lead to death or serious health hazard, as the gasoline engine operates when in the hybrid battery (traction battery) charge mode.

- Do not stop the vehicle near flammable materials.
- Do not use the hybrid battery (traction battery) charge mode in a closed area where ventilation is insufficient, such as in a garage or area with snow buildup.

Plug-in hybrid system precautions

Take care when handling the hybrid system, as it contains a high voltage system (about 600V at maximum) as well as parts that become extremely hot when the hybrid system is operating. Obey the caution labels attached to the vehicle.

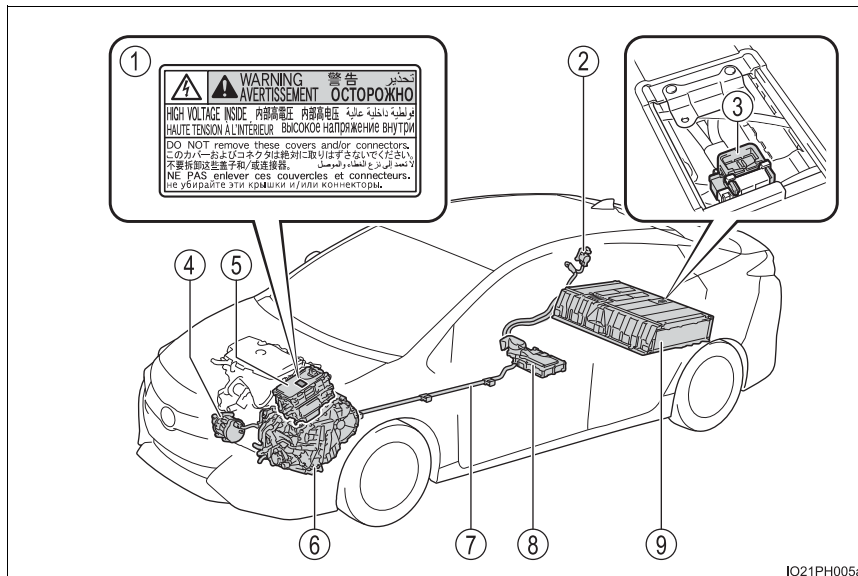

The illustration is an example for explanation and may differ from the actual item.

- | | |
|--|-------------------------------------|
| ① Caution label | ⑥ Electric motor (traction motor) |
| ② Charging inlet | ⑦ High voltage cables (orange) |
| ③ Service plug | ⑧ Onboard traction battery charger |
| ④ Air conditioning compressor | ⑨ Hybrid battery (traction battery) |
| ⑤ Power control unit and DC/DC converter | |

Hybrid battery (traction battery) air vents

There are air intake vents on both sides of the rear seatback for the purpose of cooling the hybrid battery (traction battery). If the vents are blocked, charging/discharging of the hybrid battery (traction battery) may become limited.

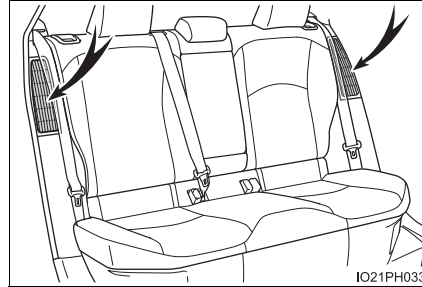

Emergency shut off system

When a certain level of impact is detected by the impact sensor, the emergency shut off system blocks off the high voltage current and stops the fuel pump to minimize the risk of electrocution and fuel leakage. If the emergency shut off system activates, your vehicle will not restart. To restart the hybrid system, contact your Toyota dealer.

Hybrid warning message

A message is automatically displayed when a malfunction occurs in the hybrid system or an improper operation is attempted.

If a warning message is shown on the multi-information display, read the message and follow the instructions.

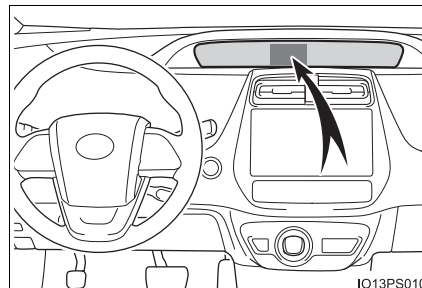

■ If a warning light comes on, a warning message is displayed or the 12-volt battery is disconnected

The hybrid system may not start. In that case, try to start the system again. If the "READY" indicator does not come on, contact your Toyota dealer.

■ Running out of fuel

When the vehicle has run out of fuel and the hybrid system cannot be started, refuel the vehicle with at least enough gasoline to make the low fuel level warning light (→P. 676) go off. If there is only a small amount of fuel, the hybrid system may not be able to start. (The standard amount of fuel is about 2.0 gal. [7.5 L, 1.7 Imp.gal.], when the vehicle is on a level surface. This value may vary when the vehicle is on a slope. Add extra fuel when the vehicle is inclined.)

■ Electromagnetic waves

- High voltage parts and cables on the hybrid vehicles incorporate electromagnetic shielding, and therefore emit approximately the same amount of electromagnetic waves as conventional gasoline powered vehicles or home electronic appliances.
- Your vehicle may cause sound interference in some third party-produced radio parts.

■ Effect of magnetic forces

If objects that generate strong magnetic forces, such as large speakers, are placed inside the luggage compartment or installed nearby, the generated magnetic forces may negatively affect the hybrid system.

■ Hybrid battery (traction battery) (lithium-ion battery)

The hybrid battery (traction battery) has a limited service life.

The hybrid battery (traction battery) capacity (the ability to hold a charge) reduces with time and use in the same way as other rechargeable batteries. The extent at which capacity reduces changes drastically depending on the environment (ambient temperature, etc.) and usage conditions, such as how the vehicle is driven and how the hybrid battery (traction battery) is charged.

This is a natural characteristic of lithium-ion batteries, and is not a malfunction. Also, even though the distance that can be driven in EV mode decreases when the hybrid battery (traction battery) capacity reduces, vehicle performance does not significantly become worse.

In order to reduce the possibility of the capacity reducing, follow the directions listed on P. 143, "Capacity reduction of the hybrid battery (traction battery)".

■ Starting the hybrid system in an extremely cold environment

When the hybrid battery (traction battery) is extremely cold (below approximately -22°F [-30°C]) under the influence of the outside temperature, it may not be possible to start the hybrid system. In this case, try to start the hybrid system again after the temperature of the hybrid battery increases due to the outside temperature increase etc.

⚠ WARNING**■ High voltage precautions**

The vehicle has high voltage DC and AC systems as well as a 12-volt system. DC and AC high voltage is very dangerous and can cause severe burns and electric shock that may result in death or serious injury.

- Never touch, disassemble, remove or replace the high voltage parts, cables or their connectors.
- The hybrid system will become hot after starting as the system uses high voltage. Be careful of both the high voltage and the high temperature, and always obey the caution labels attached to the vehicle.
- Never try to open the service plug access hole located in the luggage compartment. The service plug is used only when the vehicle is serviced and is subject to high voltage.

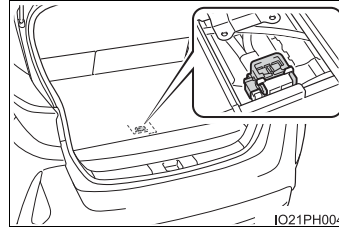

 **WARNING****■ Road accident cautions**

Observe the following precautions to reduce the risk of death or serious injury:

- Pull your vehicle off the road, apply the parking brake, shift the shift position to P, and turn the hybrid system off.
- Do not touch the high voltage parts, cables and connectors.
- If electric wires are exposed inside or outside your vehicle, an electric shock may occur. Never touch exposed electric wires.
- Do not touch the battery if liquid is leaking from or adhering to it.
If electrolyte (carbonic-based organic electrolyte) from the hybrid battery (traction battery) comes into contact with the eyes or skin, it could cause blindness or skin wounds. In the unlikely event that it comes into contact with the eyes or skin, wash it off immediately with a large amount of water, and seek immediate medical attention.
- If electrolyte is leaking from the hybrid battery (traction battery), do not approach the vehicle.
Even in the unlikely event that the hybrid battery (traction battery) is damaged, the internal construction of the battery will prevent a large amount of electrolyte from leaking out. However, any electrolyte that does leak out will give off a vapor. This vapor is an irritant to skin and eyes and could cause acute poisoning if inhaled.
- Do not bring burning or high-temperature items close to the electrolyte.
The electrolyte may ignite and cause a fire.
- If a fire occurs in the hybrid vehicle, leave the vehicle as soon as possible. Never use a fire extinguisher that is not meant for electric fires. Using even a small amount of water may be dangerous.
- If your vehicle needs to be towed, do so with front wheels raised. If the wheels connected to the electric motor (traction motor) are on the ground when towing, the motor may continue to generate electricity. This may cause a fire. (→P. 667)
- Carefully inspect the ground under the vehicle. If you find that liquid has leaked onto the ground, the fuel system may have been damaged. Leave the vehicle as soon as possible.

 **WARNING****■ Hybrid battery (traction battery)**

- Your vehicle contains a sealed lithium-ion battery.
- Never resell, hand over or modify the hybrid battery. To prevent accidents, hybrid batteries that have been removed from a disposed vehicle are collected through Toyota dealer. Do not dispose of the battery yourself. Unless the battery is properly collected, the following may occur, resulting in death or serious injury:
 - The hybrid battery may be illegally disposed of or dumped, and it is hazardous to the environment or someone may touch a high voltage part, resulting in an electric shock.
 - The hybrid battery is intended to be used exclusively with your hybrid vehicle. If the hybrid battery is used outside of your vehicle or modified in any way, accidents such as electric shock, heat generation, smoke generation, an explosion and electrolyte leakage may occur. When reselling or handing over your vehicle, the possibility of an accident is extremely high because the person receiving the vehicle may not be aware of these dangers.
- If your vehicle is disposed of without the hybrid battery having been removed, there is a danger of serious electric shock if high voltage parts, cables and their connectors are touched. In the event that your vehicle must be disposed of, the hybrid battery must be disposed of by your Toyota dealer or a qualified service shop. If the hybrid battery is not disposed of properly, it may cause electric shock that can result in death or serious injury.

 NOTICE**Hybrid battery (traction battery) air vents**

- Make sure not to block the air intake vent with anything, such as a seat cover, plastic cover, or luggage. If the vents are blocked, the charging/discharging of the hybrid battery (traction battery) may become limited.
- When dust etc. has accumulated in the air intake vent, clean it with a vacuum cleaner to prevent the vent from clogging.
- Do not wet or allow foreign substances to enter the air vents as this may cause a short circuit and damage the hybrid battery (traction battery).
- Do not carry large amounts of water such as water cooler bottles in the vehicle. If water spills onto the hybrid battery (traction battery), the battery may be damaged. Have the vehicle inspected by your Toyota dealer.
- A filter is installed to the air intake vent. When the filter remains noticeably dirty even after cleaning the air intake vent, filter cleaning or replacement is recommended. When cleaning the filter, refer to P. 582.

Notice about fuel

- For plug-in hybrid vehicles, fuel may remain in the tank for a long time and undergo changes in quality depending on the how the vehicle is used. Refuel at least 5.3 gal. (20 L, 4.4 Imp.gal.) of fuel every 12 months (refuel a total of at least 5.3 gal. [20 L, 4.4 Imp.gal.] over a 12-month period), as this may affect components of the fuel system or the gasoline engine.
- If the vehicle has not been refueled for a certain amount of time and it is possible that the quality of the fuel remaining in the tank has changed, "No new fuel has been added recently. Please refuel" is displayed on the multi-information display when the power switch is turned to ON mode. If the message is displayed, refuel the vehicle immediately.

Plug-in hybrid vehicle driving tips

For economical and ecological driving, pay attention to the following points:

◆ Using EV mode and HV mode effectively

Primarily using EV mode when driving in cities and using HV mode when driving on highways (or freeways) can help conserve fuel and electricity. (→P. 90)

◆ Using Eco drive mode

When using Eco drive mode, the torque corresponding to the accelerator pedal depression amount can be generated more smoothly than it is in normal conditions. In addition, the operation of the air conditioning system (heating/cooling) will be minimized, improving fuel and electricity economy. (→P. 430)

◆ Use of Hybrid System Indicator

Eco-friendly driving is possible by keeping the Hybrid System Indicator within Eco area. (→P. 225)

◆ Shift position operation

Shift the shift position to D when stopped at a traffic light, or driving in heavy traffic etc. Shift the shift position to P when parking. When using the N, there is no positive effect on fuel consumption. In the N, the gasoline engine operates but electricity cannot be generated. Also, when using the air conditioning system, etc., the hybrid battery (traction battery) power is consumed.

◆ Accelerator pedal/brake pedal operation

- Drive your vehicle smoothly. Avoid abrupt acceleration and deceleration. Gradual acceleration and deceleration will make more effective use of the electric motor (traction motor) without having to use gasoline engine power.
- Avoid repeated acceleration. Repeated acceleration consumes hybrid battery (traction battery) power, resulting in poor fuel consumption. Battery power can be restored by driving with the accelerator pedal slightly released.

◆ When braking

Make sure to operate the brakes gently and a timely manner. A greater amount of electrical energy can be regenerated when slowing down.



◆ Delays

Repeated acceleration and deceleration, as well as long waits at traffic lights, will lead to high fuel and electricity consumption. Check traffic reports before leaving and avoid delays as much as possible. When driving in a traffic jam, gently release the brake pedal to allow the vehicle to move forward slightly while avoiding overuse of the accelerator pedal. Doing so can help control excessive electricity and fuel consumption.

◆ Highway driving

- Control and maintain the vehicle at a constant speed. Before stopping at a toll booth or similar, allow plenty of time to release the accelerator and gently apply the brakes. A greater amount of electrical energy can be regenerated when slowing down.
- Electricity consumption will increase significantly when driving at high speeds in EV mode. If there will be a long distance to the next external charging point after leaving a freeway, it is recommended to drive in HV mode while on the freeway and change to EV mode after leaving the freeway.

◆ Air conditioning

- Turn the “A/C” switch ( *1 •  *2) off when it is not needed. Doing so can help reduce excessive electricity and fuel consumption.

In summer: When the ambient temperature is high, use the recirculated air mode. Doing so will help to reduce the burden on the air conditioning system and reduce electricity and fuel consumption as well.

In winter: Avoid excessive and unnecessary use of the heater. Usage of the heated steering wheel (if equipped) and seat heaters is effective. (→P. 539)

- Using the Remote Air Conditioning System (→P. 535) while the charging cable is connected to the vehicle can reduce electricity consumption immediately after starting off by operating air conditioning mainly using electricity from an external power source.
- When setting the charging schedule, selecting the start time setting mode and setting “Climate Prep” to “On” can reduce electricity consumption immediately after starting off by operating air conditioning before charging is completed. (→P. 157)

*1: Vehicles with 7-inch display

*2: Vehicles with 11.6-inch display

◆ Checking tire inflation pressure

Make sure to check the tire inflation pressure frequently. If there is improper tire inflation pressure in the tires, the EV driving range will become shorter, and fuel consumption when in HV mode will increase.

Also, as snow tires can cause large amounts of friction, their use on dry roads can lead to increased fuel and electricity consumption.

◆ Luggage

Carrying heavy luggage will lead to poor fuel economy. Avoid carrying unnecessary luggage. Installing a large roof rack will also cause poor fuel economy.

◆ Warming up before driving

Since the gasoline engine starts up and cuts out automatically, warming up is not necessary.

EV driving range

The EV driving range displayed on the multi-information display etc. shows the reference distance that EV driving (driving using only the electric motor) is possible, and the actual distance that can be driven may differ from that displayed.

Even if the EV driving range is displayed, EV driving may be canceled and both gasoline engine and electric motor are used depending on the situation. (→P. 95)

Displayed value

The value displayed on the multi-information display etc. (→P. 214, 230, 237, 254) is estimated from the following information.

- The amount of hybrid battery (traction battery) charge currently remaining
- The electricity consumption (the estimated distance that can be driven in EV mode per unit of electrical energy) based on the recorded value
- Past air conditioning system electricity consumption amount

The electricity consumption varies depending on how the vehicle is driven. The vehicle automatically records the electricity consumption when being charged and uses the electricity consumption for estimating the EV driving range. Therefore, the EV driving range displayed when the hybrid battery (traction battery) is fully charged may differ from the previous EV driving range depending on how the vehicle was driven.

The EV driving range may change significantly with each charging until the electricity consumption based on the recorded value is stable (for approximately the first month or two). However, this does not indicate a malfunction.

When the air conditioning system is turned on, the EV driving range (with using the air conditioning system) is estimated based on the past air conditioning electricity consumption amount considering that the electricity consumption may become higher.

Tips for extending the EV driving range

The distance that can be driven in EV mode varies significantly depending on how the vehicle is driven, road conditions, the weather, the outside temperature, usage conditions of electrical components and the number of occupants.

The distance that can be driven in EV mode can be extended if the following is performed:

- Maintain a safe distance from the vehicle in front and avoid unnecessary acceleration and deceleration
- Accelerate and decelerate the vehicle as smoothly as possible
- Drive at moderate speeds as much as possible and maintain a constant speed
- Set the air conditioning to a moderate temperature and turn the “A/C”

switch ( *1 •  *2) off when it is not needed

- Use tires of the specified size and maintain the specified tire pressure
- Use the EV/HV mode selection switch to drive in HV mode when driving on a highway
Electricity consumption will increase substantially when driving on a highway in EV mode.
- Do not add unnecessary weight to the vehicle

*1: Vehicles with 7-inch display

*2: Vehicles with 11.6-inch display

Display when charging is completed

The following indicate that charging has been carried out properly.

- The charging indicator turns off
- The Hybrid battery (traction battery) status indicators illuminate for approximately 15 seconds. (→P. 112)
- “Charging Complete” is displayed on the multi-information display when starting off (→P. 140)

Regardless of the type of power source or whether the charging schedule function is used, charging is completed if the above can be confirmed.

Charging-related messages: →P. 185

Charging equipment

This vehicle features equipment for connecting to an external power source.

Charging equipment and names

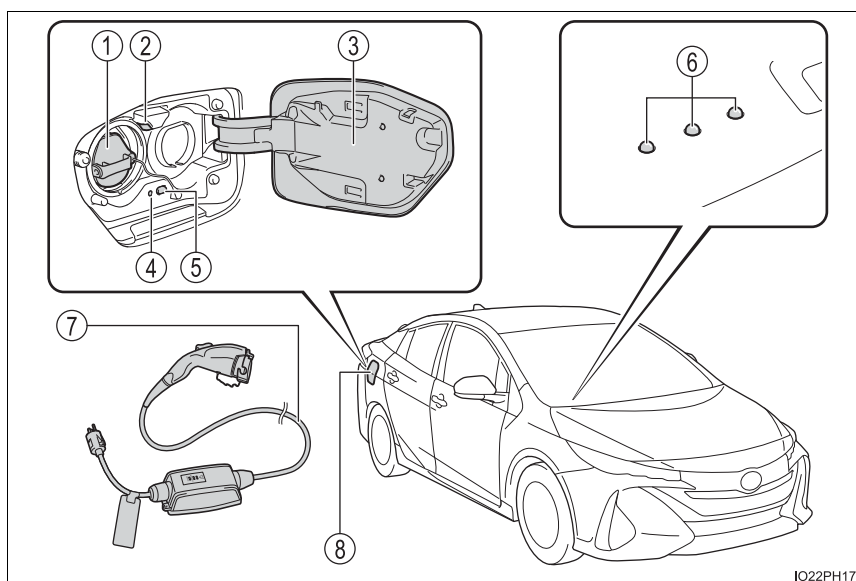

- ① Charging inlet
- ② Charging inlet light
- ③ Charging port lid (→P. 111, 122)
- ④ Charging indicator (→P. 114)
- ⑤ Charging connector lock switch* (→P. 125)
- ⑥ Hybrid battery (traction battery) status indicator (→P. 112)
- ⑦ Charging cable (→P. 115)
- ⑧ Charging port

*: If equipped

Opening and closing the charging port lid

■ Opening the charging port lid

Vehicles without smart lid & connector locking system:

Press the rear edge of the charging port lid (the position shown in the illustration).

Push and take your hand away to slightly open the charging port lid. Then open the lid fully by hand.

Vehicles with smart lid & connector locking system:

Press the rear edge of the charging port lid (the position shown in the illustration) with the doors unlocked.

Push and take your hand away to slightly open the charging port lid. Then open the lid fully by hand.

While the doors are locked, only the charging port lid can be unlocked by carrying an electronic key and pressing the charging port lid.

(→P. 122)

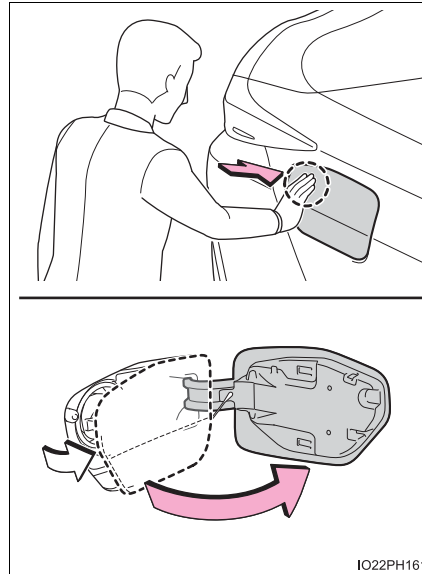

2

Plug-in hybrid system

■ **Closing the charging port lid**

Close the charging port lid and press the rear edge of the charging port lid (the position shown in the illustration).

Vehicles with smart lid & connector locking system:

- When the doors are locked with the smart key system, wireless remote control or door lock switch, the charging port lid is also locked. (→P. 281, 283)
- If the charging port lid is closed with the doors locked, the charging port lid locks.

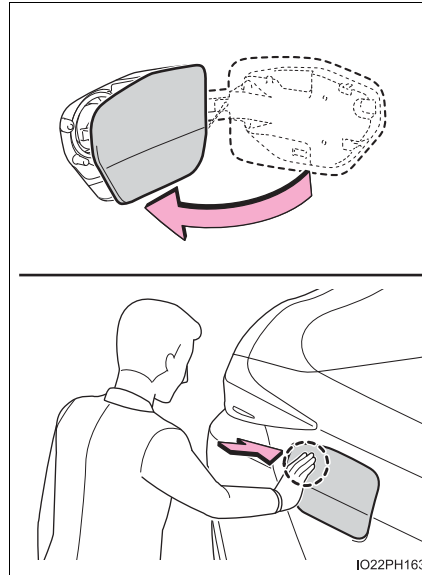

Hybrid battery (traction battery) status indicator

When the charging cable is connected to the charging inlet, the user is informed of the charging status of the hybrid battery (traction battery) by the statuses of 3 indicators (turned off, illuminated or flashing).

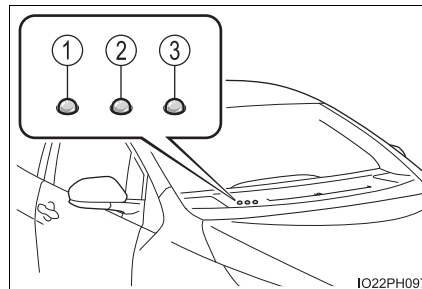

■ **During charging**

Charging status of the hybrid battery (traction battery)	Hybrid battery (traction battery) status indicator		
	①	②	③
About less than half	Flashes	Not illuminated	Not illuminated
About more than half	Illuminated	Flashes	Not illuminated
Full	Illuminated	Illuminated	Flashes

■ **Except during charging**

The hybrid battery (traction battery) status indicators illuminate*1 while the charging port lid is open and any of the followings are performed.

- When an electronic key is carried near the effective range*2, 3 (→P. 293)
- When the doors are unlocked

Charging status of the hybrid battery (traction battery)	Hybrid battery (traction battery) status indicator		
	①	②	③
About less than half	Illuminated	Not illuminated	Not illuminated
About more than half	Illuminated	Illuminated	Not illuminated
Full	Illuminated	Illuminated	Illuminated

*1: The indicators illuminate for a maximum of approximately 15 seconds.

*2: Excluding the effective range of the charging port lid.

*3: Vehicles with smart lid & connector locking system only

■ **When the hybrid battery (traction battery) is fully charged**

When the charging cable is connected, all 3 hybrid battery (traction battery) status indicators illuminate to inform the user that the hybrid battery (traction battery) is fully charged.*

*: If the push lifter (→P. 152) is pushed in, the hybrid battery (traction battery) status indicators may flash.

Charging indicator

The illumination/flashing pattern changes to inform the user of the charging status in the following ways.

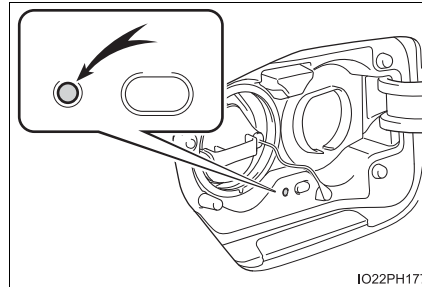

Illumination/flashing pattern	Vehicle condition
Illuminated	<ul style="list-style-type: none"> • Charging is in progress • Charging is possible • “Traction Battery Heater” (→P. 135) is operating • “Traction Battery Cooler” (→P. 136) is operating
Flashing (normally)*	When charge schedule is registered (→P. 157) and charging cable is connected to vehicle
Rapidly flashing*	When charging cannot be carried out due to malfunction in a power source or the vehicle etc. (→P. 182)
Not illuminated	<ul style="list-style-type: none"> • Charging connector is not inserted into charging inlet • When the charging schedule (→P. 157) is on standby • When charging is completed

*: Turns off after flashing for a certain period of time.

Charging indicator

When a system malfunction occurs while charging or using the Remote Air Conditioning System, the charging indicator rapidly flashes for a certain period of time, and then turns off.

If this occurs, the next time the hybrid system is started, a message is displayed on the multi-information display. When a message is displayed, follow the instructions displayed on the screen.

Charging cable

The function, correct operating, etc. of the charging cable are written.

The names of each part of the charging cable

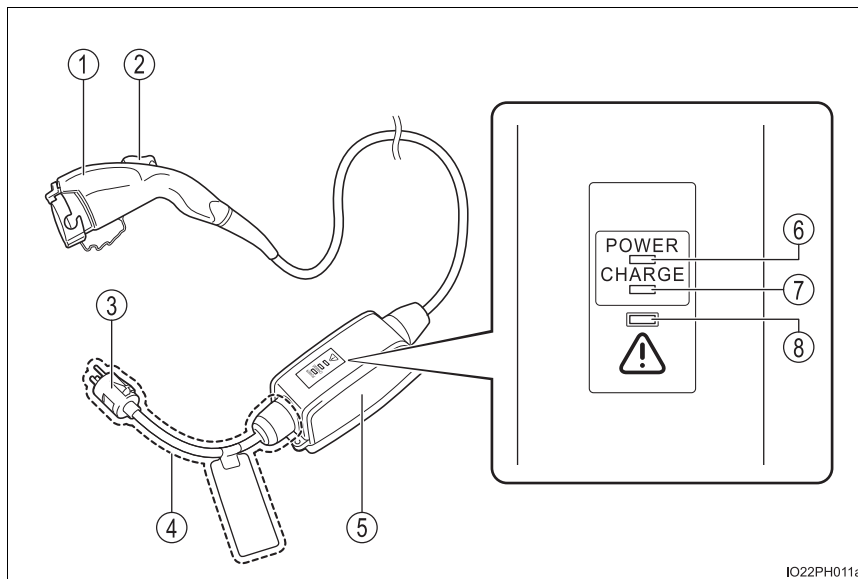

- ① Charging connector
- ② Latch release button
- ③ Plug
- ④ Plug-cord
- ⑤ CCID (Charging Circuit Interrupting Device)
- ⑥ Power indicator (→P. 117)
- ⑦ Charging indicator (→P. 117)
- ⑧ Error warning indicator (→P. 117)

2

Plug-in hybrid system

Safety functions

The CCID (Charging Circuit Interrupting Device) has the following safety features.

■ Electrical leakage detection function

If an electrical leakage is detected during charging, the power source will be automatically interrupted, thus preventing fires or electrical shocks caused by electrical leakage.

If the power source is interrupted, the error warning indicator flashes.

If the power source is interrupted: →P. 118

■ Automatic check function

This is an automatic system check that is run before charging begins to check for problems in the operation of the electrical leakage detection function.

If a malfunction is found in the electrical leakage detection function as a result of the check, the error warning indicator flashes to inform the user. (→P. 118)

■ Temperature detection function

A temperature detection function is equipped to the plug. While charging, if heat is generated due to looseness on the outlet side etc., this function suppresses heat by controlling the charging current.

■ Conditions for supplying current to the vehicle

The CCID (Charging Circuit Interrupting Device) is designed to prevent electrical current from being supplied to the charging connector when it is not connected to the vehicle, even if the plug is inserted into the outlet.

CCID (Charging Circuit Interrupting Device) indicators

■ Indicator operation

3 indicators are used to indicate the following conditions.

- ① Power indicator
Illuminates when electricity is flowing to the CCID (Charging Circuit Interrupting Device).
- ② Charging indicator
Illuminates when charging is in progress.
- ③ Error warning indicator
Flashes when there is an electrical leakage or when a malfunction occurs in the CCID (Charging Circuit Interrupting Device).

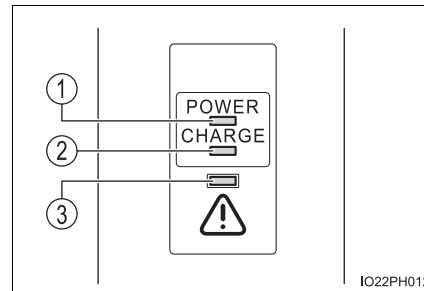

2

Plug-in hybrid system

■ When a malfunction occurs during charging

The indicators on the CCID (Charging Circuit Interrupting Device) use a combination of different statuses (not illuminated, illuminated or flashing) to inform the user of internal malfunctions.

When the error warning indicator is illuminated or flashing, temporarily remove the plug from the outlet and then reconnect it to check if the error indicator turns off.

If the error warning indicator turns off, charging is now possible.

If it does not turn off, perform the correction procedure in the following chart.

Status	Power indicator	Error warning indicator	Cause/Correction procedure
Charging system error	Not illuminated	Not illuminated or illuminated	An electrical leakage is detected and charging is canceled, or there is a malfunction in the charging cable. → Consult your Toyota dealer
	Illuminated	Flashes	
Plug temperature detection malfunction	Flashes	Flashes	There is a malfunction in the plug temperature detection part.*1 → Consult your Toyota dealer
Plug temperature increase detection	Flashes	Not illuminated	An increase in the temperature of the plug is detected due to an improper connection between the outlet and plug.*2 → Check that the plug is securely connected to the outlet.
Charging cable life span notice	Illuminated	Flashes	The number of charges using the charging cable is nearing the end of its usable life span. → Consult your Toyota dealer
Charging cable life span	Illuminated	Illuminated	The number of charges using the charging cable has exceeded its usable number of charges. → Consult your Toyota dealer

*1: When this occurs, charging is carried out without a limited charging current.

*2: When this occurs, charging is carried out with a limited charging current.

⚠ WARNING**■ When using the charging cable and CCID (Charging Circuit Interrupting Device)**

Observe the following precautions.

Failure to do so may cause an unexpected accident, resulting in death or serious injury.

- Do not attempt to disassemble or repair the charging cable, charging connector, plug or CCID (Charging Circuit Interrupting Device).
If a problem arises with the charging cable or the CCID (Charging Circuit Interrupting Device), stop charging immediately and contact your Toyota dealer.
- Do not subject the charging cable, charging connector, plug or CCID (Charging Circuit Interrupting Device) to strong force or impact.
- Do not apply excessive force to the charging cable by forcefully folding, twisting, pulling or dragging the charging cable.
- Do not damage the charging cable with sharp objects.
- Do not fold the charging connector or plug or insert foreign objects into them.
- Do not put the charging connector and plug into water.
- Do not bring the charging cable to a high-temperature item such as a heating device.
- Do not apply a load to the charging cable and plug-cord (such as wrapping the charging cable around the CCID (Charging Circuit Interrupting Device) and the charging connector).
- Do not use or leave the charging cable in situations where a load is applied to the outlet and the plug (such as when the CCID (Charging Circuit Interrupting Device) is hanging in the air without contacting the ground).

⚠ NOTICE**■ When use the charging cable and related parts**

→P. 155

■ Precautions for low temperatures

In low temperatures, the charging cable and plug-cord may become hard.

Therefore, make sure to not apply excessive force when they are hard. If excessive force is applied to the hardened charging cable and plug-cord, they may be damaged.

Inspecting and maintaining the charging cable

For safety, inspect the charging cable on a routine basis.

⚠ WARNING**■ Routine inspection**

Check the following points regularly.

Failure to do so may cause an unexpected accident, resulting in death or serious injury.

- The charging cable, plug, charging connector, CCID (Charging Circuit Interrupting Device) etc. have not been damaged
- The outlet has not been damaged
- The plug can be securely inserted into the outlet
- The plug does not get extremely hot during use
- The tip of the plug has not been deformed
- The plug is not dirtied by dust etc.

Remove the plug from the outlet before inspecting it. If any abnormalities are found in the charging cable as a result of the inspection, immediately stop use and consult your Toyota dealer.

■ Maintaining the charging cable

When the charging cable is dirty, first remove the dirt with a hard, wringed cloth, and then wipe the cable with a dry cloth.

However, never wash it with water. If the charging cable is washed with water, fire or electric shock may occur during charging, possibly resulting in death or serious injury.

■ When not using the charging cable for a long time

Remove the plug from the outlet. Dust could accumulate on the plug or in the outlet, possibly causing overheating which could lead to a fire.

Also, keep the cable in a place free from moisture.

Smart lid & connector locking system*

When carrying the electronic key on your person, for example in your pocket, only the charging port lid can be unlocked, and the charging connector can be locked or unlocked with the doors of the vehicle locked.

Smart lid & connector locking system operation

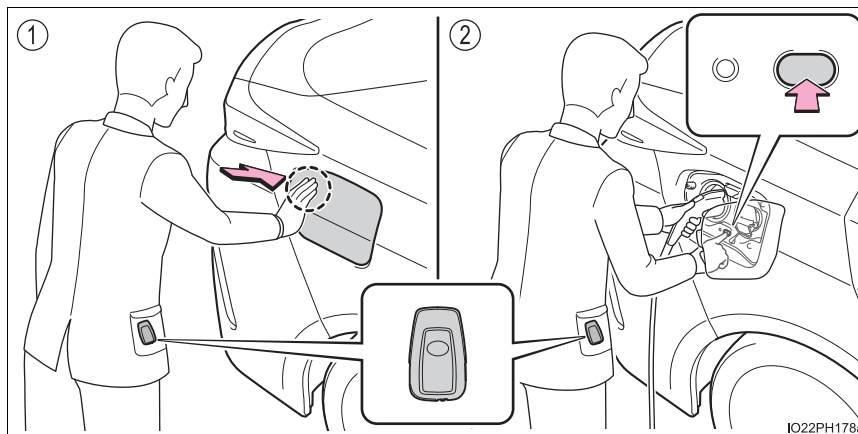

① Smart lid system

Operating the charging port lid carrying the electronic key on your person, for example in your pocket, can unlock only the charging port lid with the doors of the vehicle locked.

② Charging connector locking system

Operating the charging connector lock switch carrying the electronic key on your person, for example in your pocket, can lock and unlock the charging connector.

It can be used to prevent the charging cable removed or stolen while charging.

■ Antenna location

→P. 292

■ Effective range (areas within which the electronic key is detected)

→P. 293

*: If equipped

2

Plug-in hybrid system

Using the smart lid system

■ Unlocking the charging port lid

Pressing the rear edge of the charging port lid (the position shown in the illustration) carrying the electronic key on your person, for example in your pocket, can unlock the charging port lid.

Push and take your hand away to slightly open the charging port lid.



■ Locking the charging port lid

- 1 Close the charging port lid and press the rear edge of the charging port lid (the position shown in the illustration).

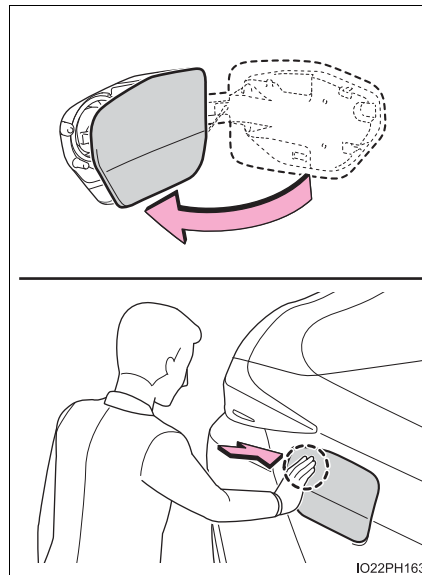

- 2 Locking the doors using the smart key system or wireless remote control. (→P. 281, 282)

The charging port lid will be locked.

If the charging port lid is closed with the doors locked, the charging port lid locks.

■ Charging port lid

- If the rear edge of the charging port lid (the position shown in the illustrations on P. 111 and 122) is pressed when the doors are locked and you are not carrying the electronic key, the charging port lid opens slightly, but remains locked. Carry an electronic key or unlock the doors, and then press the charging port lid twice to open it.
- If the charging port lid is opened and closed repeatedly, the charging port lid lock may not operate in order to protect the system. In this case, press the charging port lid twice after a while.

■ If the smart key system has been deactivated in a customized setting

The smart lid & connector locking system will also be deactivated. If the smart key system has been deactivated in a customized setting, the charging port lid can be locked and unlocked by performing the following procedures.

- Locking the charging port lid

- 1 Close the charging port lid. (→P. 112)
- 2 Locking the doors using the wireless remote control or door lock switch. (→P. 282, 283)

The charging port lid can be locked if the steps 1 and 2 are performed in reverse.

- Unlocking the charging port lid

- 1 Unlocking the doors using the wireless remote control or door lock switch. (→P. 282, 283)
- 2 Open the charging port lid. (→P. 111)

■ If the charging port lid does not open

If the charging port lid does not open when using the normal procedure, it can be opened in an emergency by performing the following steps.

- 1 Open the back door. (→P. 287)
- 2 Prepare the wheel nut wrench. (→P. 630)
- 3 Pull the knob and remove the cover shown in the illustration.

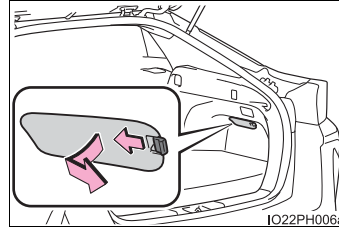

- 4 Insert a wheel nut wrench as shown in the illustration.

- ① Insert the end of the wheel nut wrench along the cutout of the cover installation area.
- ② Temporarily place the L-shaped part of the wheel nut wrench where it contacts the deck board.
(Place the wheel nut wrench so that it is perpendicular to the work hole.)

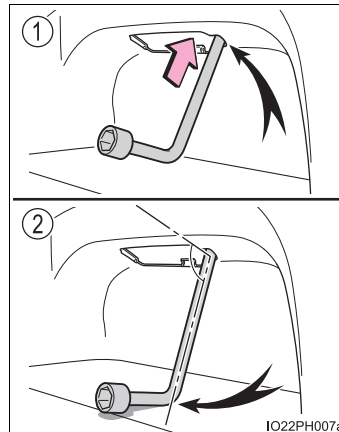

- 5 From the condition in step 4, insert the wheel nut wrench upwards into the vehicle.

Pressing the emergency release lever inside the work hole will unlock the charging port lid.

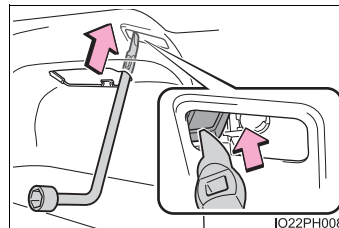

- 6 Press the center of the rear edge of the charging port lid to open it. (→P. 111)

This unlocking method is a temporary correction procedure for emergency use only. If the problem persists, have the vehicle inspected by your Toyota dealer immediately.

Using the charging connector locking system**■ Locking and unlocking the charging connector**

Carry the electronic key on your person, for example in your pocket.

- 1 Insert the charging connector into the charging inlet.
(→P. 147)

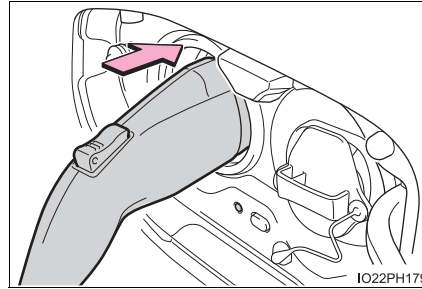

- 2 Press the charging connector lock switch.
The charging connector is locked and unlocked each time the switch is pressed.

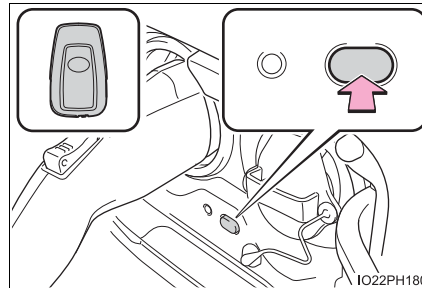

2

Plug-in hybrid system

■ Changing the charging connector lock settings

The method for locking and unlocking the charging connector can be changed as follows in the “Vehicle Settings” settings on the multi-information display.

Refer to P. 246 for details on how to change the settings.

Setting	Operation description
“Manual Lock” (Default setting)	The charging connector is locked and unlocked by pressing the charging connector lock switch when carrying the electronic key or after unlocking the doors.
“Auto Lock”	The charging connector is automatically locked when the charging connector is connected.*1, 2
“Auto Lock & Auto Unlock”	The charging connector is automatically locked when the charging connector is connected and automatically unlocked when charging is completed.*1, 2, 3

*1: Carrying the electronic key and unlocking the doors is not necessary.

*2: The charging connector can be locked and unlocked by similar operations to that of “Manual Lock”.

*3: The charging connector will be unlocked if power supply is interrupted due to a power outage etc. after the charging connector is automatically locked.

■ Charging connector locking system

- If the charging connector lock switch is operated repeatedly, the charging connector locking system may not work to protect the system. In this case, wait for a while before operating the switch again.
- The charging connector locking system does not guarantee to prevent theft of the charging cable, and is not necessarily effective for all the situations.

■ When the charging connector cannot be inserted into the charging inlet

Check that the connector lock pin is not lowered.

If the connector lock pin is lowered, the connector lock is operating. Carry an electronic key or unlock the doors, and then press the charging connector lock switch to unlock the connector lock and check that the connector lock pin is not lowered.

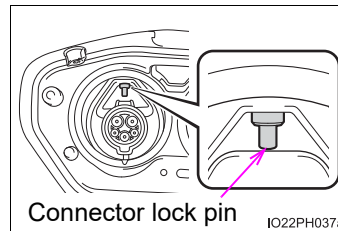

■ If the smart key system has been deactivated in a customized setting

- The smart lid & connector locking system will also be deactivated. If the smart key system has been deactivated in a customized setting, the charging connector can be locked and unlocked by performing the following procedure.
 - 1 Unlock the doors using the wireless remote control or door lock switch. (→P. 282, 283)
 - 2 Insert the charging connector into the charging inlet (only when locking the charging connector).
 - 3 Press the charging connector lock switch.
The charging connector will lock or unlock.
- When the charging connector lock setting (→P. 126) is set to “Auto Lock”, the above procedures are only necessary when unlocking. When set to “Auto Lock & Auto Unlock”, the connector lock function operates, even if the smart key system is deactivated.

■ **If the charging cable cannot be unlocked**

If the charging connector cannot be unlocked by pressing the charging connector lock switch even after carrying an electronic key or unlocking the doors, the charging connector can be unlocked by operating the emergency release lever.

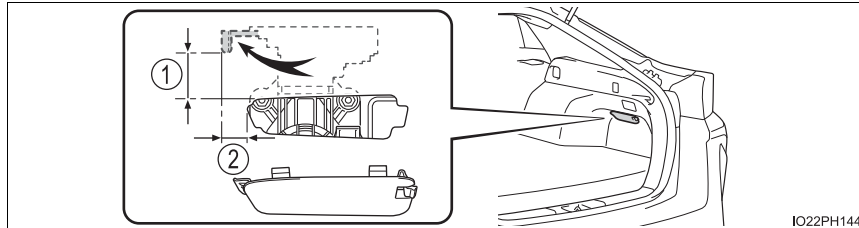

- ① Approximately 2.0 in. (50 mm)
- ② Approximately 0.9 in. (20 mm)
- 1 Open the back door. (→P. 287)
- 2 Pull the knob and remove the cover as shown in the illustration.

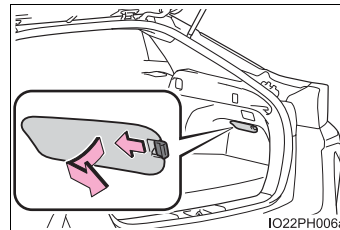

- 3 Insert a hand from the lower side of the vehicle obliquely upward, and hook a finger to the emergency release lever.

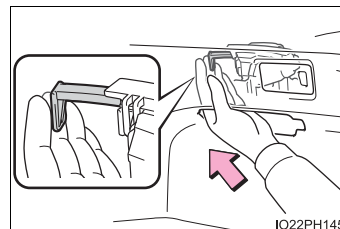

- 4 Move the emergency release lever in the direction shown in the illustration.* The charging connector is unlocked and can be removed.

*: Make sure to move in the direction shown in the illustration. Applying force in other directions may damage the emergency release lever.

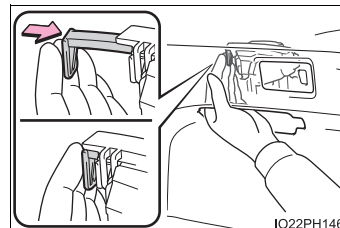

- 5 Reinstall the cover to the its original position.

This method is a temporary correction procedure for emergency use only. If the problem persists, have the vehicle inspected by your Toyota dealer immediately.

Do not operate the emergency release lever when the charging connector can be unlocked in the normal procedure.

■ When recharging or replacing the 12-volt battery

→P. 718

⚠ WARNING

■ When connecting the charging connector to the charging inlet

- Do not insert hand into the connector lock portion.
A hand may be caught in the connector lock pin, resulting in an injury.

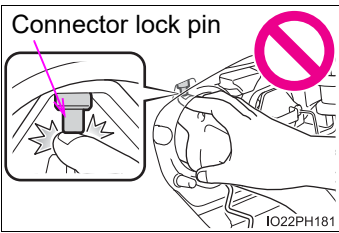

- Be careful not to touch the charging port lid lock portion.
When the connector lock operates, the charging port lid lock will also operate. The charging port lid lock pin may hit a hand, resulting in an injury.

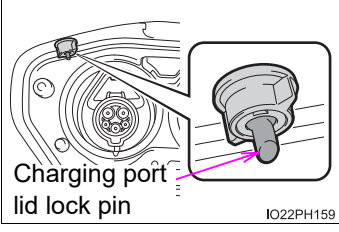

 NOTICE

■ **When locking the charging connector**

Observe the following precautions. Failure to do so may cause a malfunction in the charging connector locking system.

- Check that the charging connector is compatible with this vehicle
A charging connector of the different type or a charging connector with damaged or deformed insertion part may not be locked.
- Do not operate the charging connector lock switch before the charging connector is connected
- Operate the charging connector lock switch after firmly inserting the charging connector into the charging inlet
- Do not apply excessive force to the charging connector when the charging connector is locked
When removing the charging connector, make sure to unlock the charging connector.

Power sources that can be used

An external power source that fulfills the following criteria is necessary for charging this vehicle. Confirm this before charging.

⚠ WARNING

■ Warnings for electrical faults

Make sure to observe the precautions in this Owner's Manual when charging the vehicle.
 Failure to use a power source that fulfills the requirements, or failure to observe regulations while charging could lead to an accident, possibly resulting in death or serious injury.

Power sources

- Connect to an AC 120 V outlet (NEMA 5-15R) with a Ground-Fault Circuit-Interrupter (GFCI) and a circuit breaker. Use of a 15A individual circuit is strongly recommended to ensure charging cable will operate properly.
- When charging outdoors, make sure to connect to a weatherproof outlet that is certified for outdoor use.
 Checking Ground-Fault Circuit-Interrupter (GFCI) operation before its use is recommended.

Outlets that can be connected

NEMA 5-15R outlet

The illustration is an example shown for demonstration purposes, and may differ from the actual configuration.

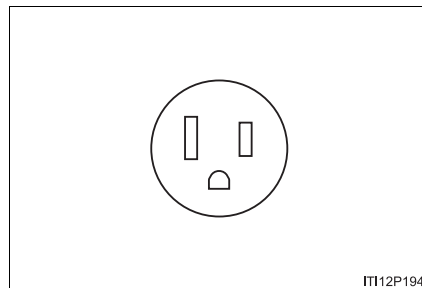

2
 Plug-in hybrid system

■ The charging environment

For safe charging, the following charging equipment and settings are recommended.

● Weatherproof outlet















When charging outdoors, connect the plug to a weatherproof outlet, and ensure that the plug remains waterproof while the plug is connected.

● Dedicated circuit

- To reduce the risk of fire, connect only to an at least 15A branch circuit with an over-current protection in accordance with the National Electric Code, ANSI/NFPA 70.
- To reduce the risk of electric shock when working with the plug, connect to a outlet with a Ground-Fault Circuit-Interrupter (GFCI) or that has an Earth Leakage Circuit Breaker installed.

■ When your circuit breaker trips during charging

The upper limit of the charging current can be changed in the “Vehicle Settings” settings on the multi-information display.

- 1 Press  or  of the meter control switches to select  (“Vehicle Settings”) in the  screen, and then press .
- 2 Press  or  of the meter control switches to select “Charge Settings”, and then press .
The “Charge Settings” screen will display.
- 3 Press  or  of the meter control switches to select “Charge Current”, and then press .
The “Charge Current” screen will display.
- 4 Press  or  of the meter control switches to select “8A”, and then press .

The maximum charging current during charging will be restricted to 8A.*

If the breaker still trips while charging, even after changing the upper limit of the charging current, check if the connected power source meets the specified charging conditions. (→P. 131)

*: Restricting the charging current will lengthen the charging time.

⚠ WARNING

■ Power sources precautions

Observe the following precautions.
If you do not follow them, fire, electrical shock or damage may occur, possibly resulting in death or serious injury.

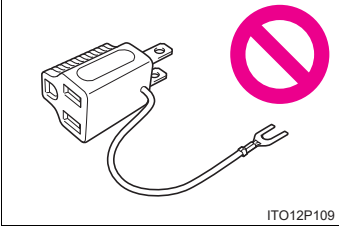
- Connect to an AC 120 V outlet (NEMA 5-15R) with a Ground-Fault Circuit-Interrupter (GFCI) and supplied by a circuit breaker per your local code. Use of a 15A individual circuit is strongly recommended.
- Do not connect the charging cable to a multi-outlet adaptor, multi-plugs, or conversion plug.
 

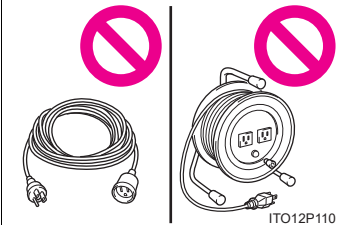
ITO12P109
- Connecting the charging cable to an extension cord is strictly prohibited. The extension cord may overheat and does not contain a Ground-Fault Circuit-Interrupter (GFCI). The leakage detection function of the CCID (Charging Circuit Interrupting Device) may not operate correctly.
 

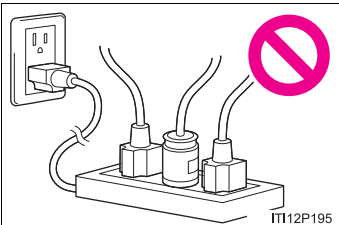
ITO12P110
- Do not connect to a power strip.
 

IT112P195
- Use of a block heater for charging is prohibited.
- Make sure to connect the charging connector and charging inlet directly. Do not connect a converting adaptor or extension cord between the charging connector and charging inlet.

Charging methods

The following methods can be used to charge the hybrid battery (traction battery).

◆ Charging from an external power source (→P. 146)

This is a charging method used when charging from an AC outlet (120 V) with the charging cable equipped to the vehicle or charging at a public charging station.

The charging start time (or departure time) and day can be set to carry out charging using the charging schedule at the desired date and time. (→P. 157)

◆ Using the hybrid battery (traction battery) charge mode (→P. 89)

The plug-in hybrid system can be switched to hybrid battery (traction battery) charge mode to charge the hybrid battery (traction battery) using electricity generated by gasoline engine operation.

The maximum charge amount in the hybrid battery (traction battery) charge mode is approximately 80% of the fully charged capacity for the charging from an external power source.

Estimated charging time

The time required to charge the hybrid battery (traction battery) differs according to the charging voltage and charging current.

Connected power source	Charging station	Home power source
Charging voltage	AC 240 V	AC 120 V
Charging current*1	16A	12A
Estimated charging time*2	Approximately 2 hours	Approximately 5 hours 10 minutes

*1: This is the maximum value. Furthermore, the upper limit of the charging current can be changed in the "Vehicle Settings" settings. (→P. 132)

*2: The time required for charging to complete depends on conditions such as the remaining charge of the hybrid battery (traction battery), the outside temperature and specifications of a charger (charging station).

■ Charging time may increase

In the following situations, charging time may become longer than normal:

- In very hot or very cold temperatures.
- The vehicle is consuming a lot of electricity, for example, when the head light switch is on etc.
- There is a power outage during charging.
- There is an interruption in the electrical supply.
- There is a drop in the voltage of external power source.
- The charge in the 12-volt battery is low, for example due to the vehicle being left unused for a long period of time.
- The maximum charging current is set to 8A through the “Vehicle Settings” settings. (→P. 132)
- When the “Traction Battery Heater” operates.
- When the “Traction Battery Cooler” is operated before charging. (→P. 136)
- When the plug generates heat due to a loose outlet connection etc.

■ Using a DC Charger

DC Chargers cannot be used with this vehicle.

Charging-linked functions

This vehicle is equipped with several functions that are linked with charging.

■ “Traction Battery Heater”

When the outside temperature is low and the charging cable is connected to the vehicle, this function automatically warms the hybrid battery (traction battery) until it reaches or exceeds a certain temperature.

- When the charging cable is removed from the vehicle or remains connected to the vehicle for approximately 3 days, the system automatically stops.
- When the charging schedule is used (→P. 157), this function will operate according to the charging schedule.

■ **Hybrid battery (traction battery) warming control (Alaska and Canada only)**

This control operates after the charging cable remains connected to the vehicle for 3 days and “Traction Battery Heater” automatically stops. It automatically insulates the hybrid battery (traction battery) in extremely low temperatures.

- This control stops 31 days after the charging cable is connected, even if it is still connected to the vehicle.
- When this control operates, charging schedule settings are ignored and charging starts.

■ **“Traction Battery Cooler”**

When the hybrid battery (traction battery) is hot, this function protects it by using the vehicle air conditioning to cool it before charging is carried out.

When the hybrid battery (traction battery) is above a certain temperature and the power switch is turned off, a check screen is displayed on the multi-information display that indicates whether “Traction Battery Cooler” is implemented.

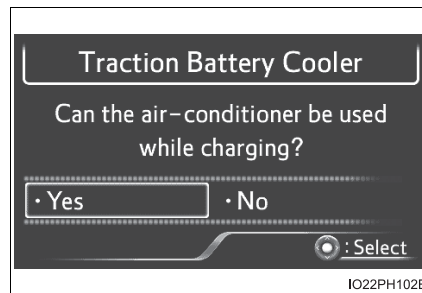

When “No” is selected, the hybrid battery (traction battery) cooling system does not operate.

■ “Traction Battery Heater”

- “Traction Battery Heater” may operate when charging is not being performed.
- When “Traction Battery Heater” is operating, the charging indicator illuminates.
- When “Traction Battery Heater” is operating during charging, the charging time may be longer than normal.
- If the outside temperature becomes high while “Traction Battery Heater” is operating, charging may complete earlier than the “Departure” time set. (→P. 157)
- “Traction Battery Heater” can be turned on and off in the “Vehicle Settings” settings on the multi-information display. (→P. 753)
- “Traction Battery Heater” may operate even when the hybrid battery (traction battery) is fully charged depending on the temperature of the hybrid battery (traction battery).
 - The remaining charge of the hybrid battery (traction battery) decreases when “Traction Battery Heater” operates. The charging operation may start again to charge the hybrid battery (traction battery).
 - “Charging Stopped Due to Pulled Charging Connector” may be shown when the charging connector is removed while recharging. (→P. 185)

■ “Traction Battery Cooler”

- When the hybrid battery (traction battery) is above a certain temperature and the power switch is turned off, a check screen is displayed on the multi-information display that indicates whether “Traction Battery Cooler” is implemented. Approximately 5 minutes after selecting “Yes” on this screen, system operation becomes possible.
- When charging starts, “Traction Battery Cooler” only operates if the hybrid battery (traction battery) temperature is hot.
- The charging indicator is illuminated while “Traction Battery Cooler” is on standby or operating.
- “Traction Battery Cooler” is implemented for a maximum of approximately 30 minutes. However, when the “Departure” time is set (→P. 157) and there is not sufficient time between the current time and the time that charging will complete, “Traction Battery Cooler” operation time may become shorter.
- When there is a small amount of remaining charge in the hybrid battery (traction battery), even if the hybrid battery (traction battery) is hot, “Traction Battery Cooler” may not be implemented.
- When the following operations are performed while “Traction Battery Cooler” is operating, the hybrid battery (traction battery) cooling operation stops.
 - A door is opened
 - The hood is opened
 - The power switch is turned to any mode other than off
 - The shift position is changed to any position other than P
 - The Remote Air Conditioning System is operated (→P. 535)
 - “Charge Now” is implemented (→P. 158)
 - The amount of remaining charge in the hybrid battery (traction battery) is below a certain amount
- When the power switch is turned off, a check screen is displayed on the multi-information display that indicates whether “Traction Battery Cooler” is implemented. This check screen can be turned on and off in the “Meter Customize” settings on the multi-information display (→P. 248). However, when the check screen is set to “Off”, “Traction Battery Cooler” is no longer operates.
- “Traction Battery Cooler” uses the power of the hybrid battery (traction battery) and external power source.
 - While “Traction Battery Cooler” is operating, the amount of the remaining charge of the hybrid battery (traction battery) increases and decreases in a certain range, and does not increase as in normal charging.
 - The operation of “Traction Battery Cooler” is recognized as charging by a charger. The charger that calculates the fee according to charging time causes a charging fee.

Charging tips

This section explains methods for using the charging function for this vehicle and checking information related to charging.

Systematically charging

To enable the use of EV mode, we recommend systematically charging the vehicle.

① Before leaving home

In order to use EV mode, charge the hybrid battery (traction battery) at home before leaving.

The charging schedule function (→P. 157) can be used to set the system to automatically fully charge the hybrid battery (traction battery) before your desired departure time. It is also possible to set the air conditioning to make the interior in a comfortable state before your desired departure time.

② At your destination

Use a public charging station to charge the hybrid battery (traction battery).

If there are no charging facilities at your destination, the hybrid battery (traction battery) can be charged using the hybrid battery (traction battery) charge mode. (→P. 89)*

③ After returning home

In order to drive the next time, charge the hybrid battery (traction battery).

Settings the charge schedule allows you to charge the hybrid battery (traction battery) at the desired time such as late at night or early in the morning. Furthermore, the charging schedule can be set to automatically charge the hybrid battery (traction battery) every day or at the same time on certain days. (→P. 157)

*: When using the hybrid battery (traction battery) charge mode while parked, make sure that no flammable objects are near the vehicle and the vehicle is parked in a well-ventilated area. (→P. 97)

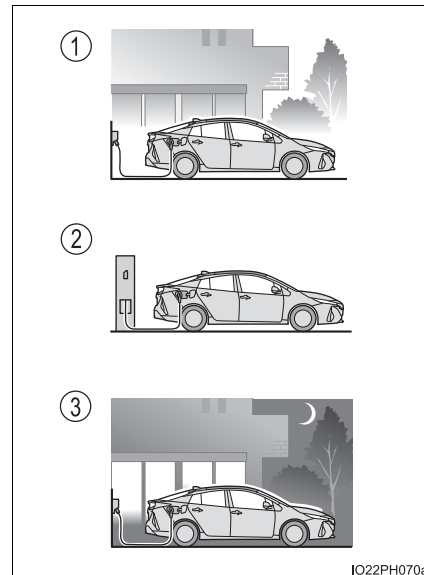

2

Plug-in hybrid system

■ Searching charging stations (vehicles with 11.6-inch display)

After applying to Entune App Suite, it is possible to use the smartphone application to search the nearby charging stations.

For details about Entune App Suite, refer to <http://www.toyota.com/entune/>.

■ Checking information related to charging

Information related to charging can be displayed and checked on the multi-information display or 11.6-inch display (if equipped).

Refer to P. 267 for details on the screen display for the 11.6-inch display (if equipped).

■ While charging

When any door is opened during charging, the current charging condition and remaining time until charging is complete can be checked.

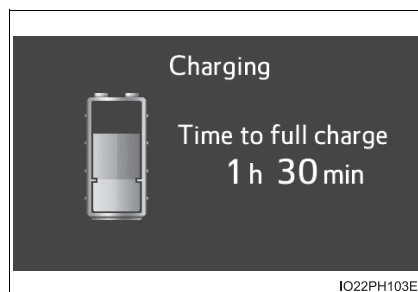

■ After charging is complete

After charging is complete, the first time that the hybrid system is started, a message detailing the results of the charging is displayed. Also, a message is displayed if an operation that stops charging is performed or a situation where charging cannot be performed occurs.



When a message is displayed, follow the instructions displayed on the screen. (→P. 185)

■ Combination meter display during charging

If approximately 100 seconds elapse after the power switch is turned to ON mode during charging, the power switch will automatically turn off and the display will disappear.

Things to know before charging

Make sure to read the following precautions before connecting the charging cable to the vehicle and charging the hybrid battery (traction battery).

Charging precautions

This vehicle has been designed to allow charging from an external power source using a charging cable for exclusive use with standard household AC outlets.

However, the vehicle differs greatly from standard household electrical goods in the following ways, and incorrect usage could cause fire or electric shock, possibly leading to death or serious injury.

- The charging operation is designed to operate at 12A continuously for the charge duration (up to 5 hours 10 minutes). (→P. 134)
- Charging can be conducted outdoors.

To charge properly, follow the procedure after reading the explanation below. Charging is intended to be carried out by licensed drivers only who properly understand the charging procedure.

- Do not allow children to use the charging cable without supervision. Also, keep the charging cable out of reach of infants.
- When charging with a charger, follow the procedures for using each charger.
- When charging using a public charging facility, check the setting of the charging schedule function.
 - When the charge schedule is registered, temporarily turn off the function or turn "Charge Now" on. (→P. 164, 166, 174, 175)
 - When the charge schedule is set to ON, charging will not start even if the charging cable is connected. Also, charging fee may occur due to connection of the charging cable.

Confirm the following before charging

Before charging, always check the following items.

- The parking brake is applied. (→P. 352)
- The headlights are switched off or set to AUTO, and lights such as the emergency flashers and interior lights etc. are switched off.

If these light switches are turned ON, then these features will consume electricity, and charging time will increase.

- The power switch is off. (→P. 338)

Inspecting the charging cable

Before charging, make sure that each part of the charging cable is in good condition. (→P. 120)

Safety functions

- The hybrid system will not start while the charging cable is attached to the vehicle, even if the power switch is operated.
- If the charging cable is connected while the "READY" indicator is illuminated, the hybrid system will stop automatically and driving will not be possible.
- When the charging cable is connected to the vehicle, the shift position cannot be changed from P to another position.

During charging

The followings occur, however, it does not indicate a malfunction.

- The charging starting time may differ depending on the state of the vehicle.
- During charging, the sound of the fan may be heard from the onboard traction battery charger cooling air intake vents. (→P. 145)
- During and after charging, the rear seat and its surrounding area in which the onboard traction battery charger is installed may get warm.

■ Capacity reduction of the hybrid battery (traction battery)

The capacity of the hybrid battery (traction battery) will decline gradually when the hybrid battery (traction battery) is in use. The rate at which it declines will differ in accordance with environmental conditions and the way in which the vehicle is used. Observing the following can help suppress battery capacity decline.

- Avoid parking the vehicle in areas with a high temperature under direct sunlight when the hybrid battery (traction battery) is fully charged.
- Avoid accelerating and decelerating frequently and suddenly when EV driving.
- Avoid frequent driving near the top speed for EV driving. (→P. 95)
- Leave a low level of charge in the hybrid battery (traction battery) when leaving the vehicle undriven for a long period of time.
After confirming that EV mode has switched to HV mode, turn the power switch off.
- Use the charging schedule function as much as possible in order to fully charge the hybrid battery (traction battery) immediately before starting off. (→P. 157)

Also, if the hybrid battery (traction battery) capacity reduces, the distance that can be driven in EV mode decreases. However, vehicle performance does not significantly become worse.

■ When the remaining charge of the hybrid battery (traction battery) is low after charging

In the following situations, the remaining charge of the hybrid battery (traction battery) after charging completes may be less than normal in order to protect the system (the EV driving range after the battery is fully charged may be shorter).*

- Charging is carried out when the outside temperature is low or high
- Charging is carried out immediately after high-load driving or in extreme heat

When none of the above situations apply and there is a drastic drop in the remaining charge of the hybrid battery (traction battery) after charging completes, have the vehicle inspected by your Toyota dealer.

*: When this occurs, even if the remaining charge display of the hybrid battery (traction battery) shows that it is fully charged, the remaining charge rapidly decreases faster than normal.

■ When the charging amount sent to the hybrid battery (traction battery) decreases

When the amount of power supplied by the charger is low or operation of the "Traction Battery Heater", etc., reduces the charging power sent to the hybrid battery (traction battery), the charging amount sent to the hybrid battery (traction battery) may decrease.

■ Certification

This device complies with Part 15 of the FCC Rules.

Operation is subject to the following two conditions:

- (1) this device may not cause harmful interference, and
- (2) this device must accept any interference received, including interference that may cause undesired operation.

⚠ WARNING**■ Caution when charging**

People with implantable cardiac pacemakers or cardiac resynchronization therapy-pacemakers should not carry out the charging procedure. Ask someone else to do it.

- Do not approach the charger and charging cable while charging. Charging procedure may affect the operation of such devices.
- Do not remain in the vehicle during charging. Charging procedure may affect the operation of such devices.
- Do not enter the vehicle even to take something out of the luggage compartment. Charging procedure may affect the operation of such devices.

■ When the charging cable is connected to the vehicle

Do not operate the shift lever.

In the unlikely event that the charging cable has been damaged, the shift position may change from P to another position and the vehicle could move, possibly leading to an accident.

⚠ NOTICE**■ Precautions when handling charging cable**

Make sure to observe the following precautions. Failure to observe these precautions may result in damage to the charging cable and charging inlet.

- Insert the charging connector straight into the charging inlet.
- After inserting the charging connector, do not apply excessive force to or twist the connector. Also, do not lean on the connector or hang any objects from it.
- Do not step on or trip over the charging cable.
- Vehicles with smart lid & connector locking system: Before removing the charging connector, make sure that it is unlocked. (→P. 152)
- After removing the charging cable, promptly return it to its proper location.
- After removing the charging connector, securely install the charging inlet cap.

 NOTICE**■ Onboard traction battery charger cooling air intake vents**

The grilles under the rear seats are the cooling air intake vents for the onboard traction battery charger installed under the seats.

Make sure to observe the following precautions regarding the cooling air intake vents. Failure to observe these precautions may result in a charging system malfunction.

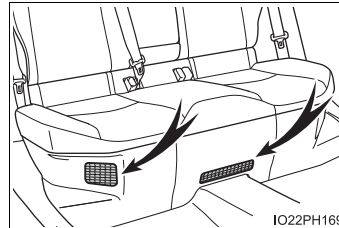

- Do not block the air intake vents with seat covers or luggage
- If the air intake vents are clogged with dust, clean them with a vacuum cleaner
- Do not allow water or foreign matter to enter the air intake vents
- Do not spill large amounts of water near the air intake vents
If water is spilled, have the vehicle inspected by your Toyota dealer and do not charge the hybrid battery (traction battery) before the inspection.

2

Plug-in hybrid system

How to charge

This section explains the procedure for charging the hybrid battery (traction battery) with the equipped charging cable.

When using a charging station, make sure to check the operation instructions on the charging station.

When the charge schedule is registered, make sure "Charge Now" is turned on before charging. (→P. 166, 175)

Confirm the following before charging

→P. 142

When charging

- 1 Prepare the charging cable.
- 2 Insert the charging cable into the outlet of the external power source.

Make sure to hold the body of the plug and insert it firmly into the outlet.

Check that the power indicator on the CCID (Charging Circuit Interrupting Device) is illuminated. (If it is not illuminated, refer to P. 180)

In order to reduce the load on the outlet and plug, when inserting the plug, use a string, etc. to hang the CCID (Charging Circuit Interrupting Device) on a hook or equivalent.

- 3 Open the charging port lid. (→P. 111)

The charging inlet light will illuminate.

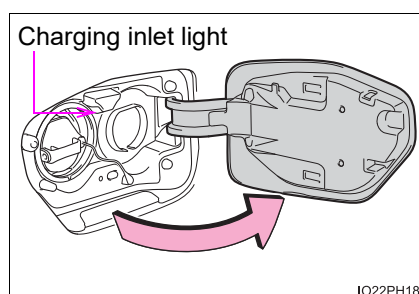
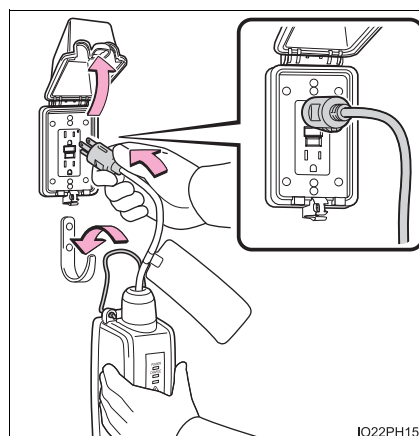

- 4 Remove the charging inlet cap and secure it as shown in the illustration.

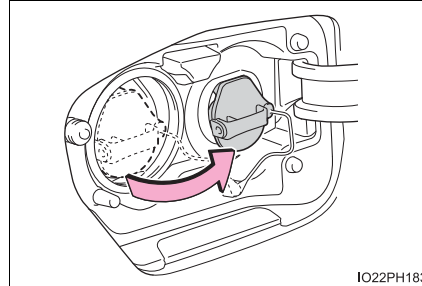

- 5 Remove the protective cap of the charging connector and secure it to the cable.

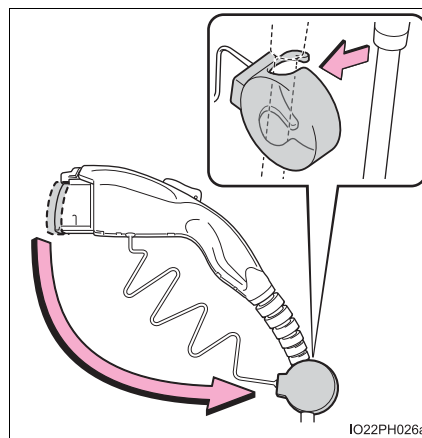

- 6 Insert the charging connector into the charging inlet.

Align the guide position on the bottom of the charging connector, and push the charging connector straight into the charging inlet as far as possible.

Once a “click” sound is heard, check that the charging connector is securely locked.

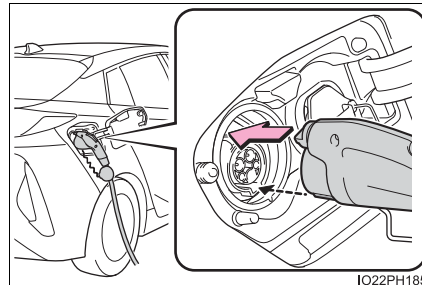

2

Plug-in hybrid system

- 7 Confirm that the charging indicator is illuminated.

Charging will not start if the charging indicator does not illuminate when the charging connector is inserted. (→P. 181)

If the charging indicator is flashing, the charge schedule is registered. (→P. 149)

If the error warning indicator on the CCID (Charging Circuit Interrupting Device) flashes during charging, check P. 118 and follow the correction procedure.

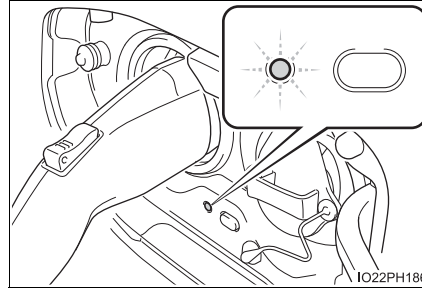

- 8 Vehicles with smart lid & connector locking system:

When you wish to lock the charging connector, carry an electronic key and press the charging connector lock switch.

The charging connector will be locked by the smart lid & connector locking system. After the charging connector is locked, the charging connector cannot be unlocked by pressing the charging connector lock switch if the electronic key is not in detection area of charging port lid. (→P. 293)

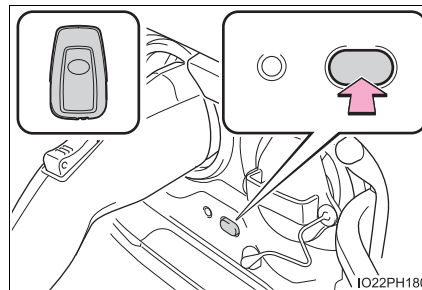

The charging indicator will turn off when charging is completed.

■ During charging

- The surface of the CCID (Charging Circuit Interrupting Device) may become hot, but this does not indicate a malfunction.
- Depending on radio wave conditions, interference may be heard on the radio.
- The current charging condition and the estimated time until charging will complete can be checked on the multi-information display or 11.6-inch display (if equipped). (→P. 140, 273)
- During charging, the hybrid battery (traction battery) status indicator illuminates and flashes, and changes according to the charging amount. (→P. 112)

■ If the charging indicator flashes after connecting the charging cable

The charge schedule (→P. 157) is registered and charging cannot be performed. To cancel charging using the charging schedule and start charging, perform any of the following procedures.

- Turn “Charge Now” on (→P. 166, 175)
- While the charging indicator is flashing, remove and reconnect the charging connector within 5 seconds

■ When the charging connector cannot be inserted into the charging inlet (vehicles with smart lid & connector locking system)

→P. 127

After charging

To prevent electrical shock, be sure to remove by following the procedures below.

- 1 Vehicles with smart lid & connector locking system:
When the charging connector is locked, carry an electronic key and press the charging connector lock switch.

The charging connector is unlocked by the smart lid & connector locking system.

Carrying an electronic key and moving near the charging inlet will cause the charging inlet light to illuminate.

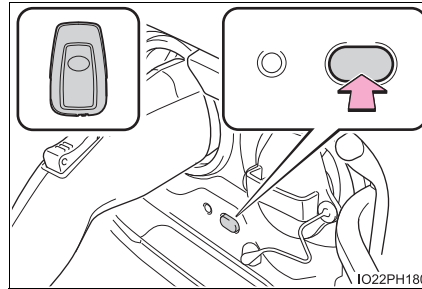

- 2 Pull the charging connector towards you while pressing the latch release button.

If the latch release button is pressed during charging (while the charging indicator is on), charging will be interrupted.

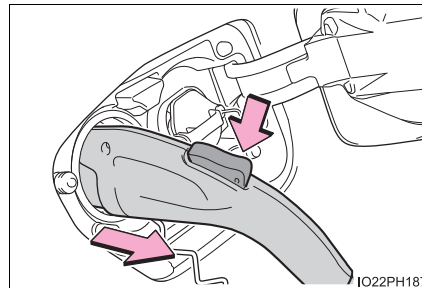

- 3 Attach the charging connector cap.

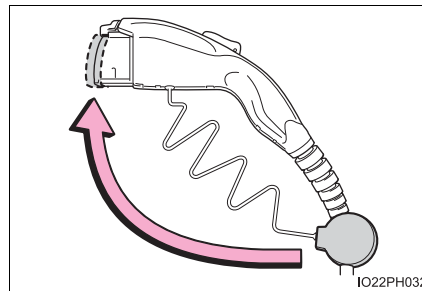

- 4 Attach the charging inlet cap and close the charging port lid.

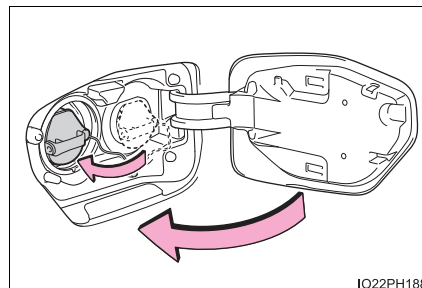

- 5 Remove the plug from the outlet when the charging equipment will not be used for a prolonged period of time.

Hold the body of the plug when removing.

Make sure to put the cable away immediately after disconnecting. (→P. 155)

When leaving the plug inserted, inspect the plug and connector once a month to check if dirt or dust has accumulated.

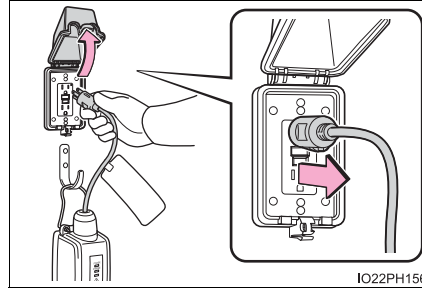

■ Charging time

→P. 134

■ Safety function

If the latch release button is pressed, charging will not begin even if the charging cable is connected.

Also, charging will be stopped if the latch release button is pressed and held for several seconds during charging. When restarting charging, reinsert the charging connector after pulling it out, and check that the charging indicator illuminates.

■ When the outside temperature is low or high

The level shown on the remaining charge display (→P. 231) may drop slightly when the power switch is turned to ON mode, even if charging has been completed and the hybrid battery (traction battery) is fully charged. However, this does not indicate a malfunction.

■ Charging time may increase

→P. 135

■ While charging

When the power switch is turned to ON mode and the energy monitor displays, the charging connector is displayed on the energy monitor and the flow of electricity during charging is displayed (→P. 223). Also, when the charging connector is locked,  is displayed.*

*: Vehicles with smart lid & connector locking system only

■ If the charging cable cannot be unlocked

→P. 128

■ When removing the charging connector

Press the latch release button, check that the lever raises up, and then pull the charging connector towards you.

Vehicles with smart lid & connector locking system: If the lever does not raise up even after the latch release button is pressed, the charging connector is locked. If this occurs, carry an electronic key and press the charging connector lock switch to unlock the charging connector.

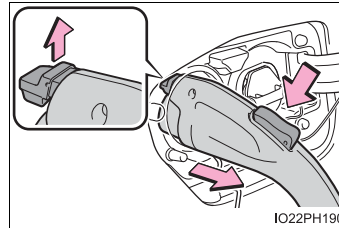
**■ Push lifter (vehicles with smart lid & connector locking system)**

When the charging port lid is open, make sure not to touch the push lifter. If it is touched accidentally, the charging port lid or connector lock may operate.

If they are accidentally operated, carry an electronic key or unlock the doors, and then press the charging connector lock switch to unlock.

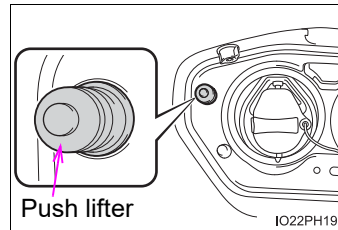

⚠ WARNING**■ When charging**

Observe the following precautions.

Failure to do so may cause an unexpected accident, resulting in death or serious injury.

- Connect to a power source suitable for charging. (→P. 131)
- Before charging, check that the charging inlet does not have deformations, damage, corrosion, dust or other foreign materials such as snow or ice adhering to it. If anything is adhering to the inlet, be sure to completely remove the material before connecting the charging connector.
- Do not let the terminals of the charging inlet get wet.
- Make sure that the charging cable, plug and socket are free of foreign matter and not deformed or damaged.
- Only use outlets where the plug can be securely inserted.
- Do not charge if the charging cable is coiled or bundled.
- Wrapping 120 V charging cable while in-use is not recommended because cable may overheat. Failure to rewrap charging cable when not in-use could result in strangulation or tripping hazard.
- Do not touch the terminals of the charging connector and charging inlet with a sharp metal objects (needles etc.) or hands, or short them with foreign objects.
- When charging outdoors, make sure to connect to a weatherproof outlet for outdoor use.
- If any heat, smoke, odors, noise or other abnormalities are noticed during charging, stop charging immediately.
- Do not insert the plug if the outlet is submerged in water or snow.
- When charging during rain or snow, do not pull out or insert the plug with wet hands. Also, do not get the electrical socket and plug wet.
- Do not charge the vehicle during a lightning storm.
- Do not let the wheels on the charging cable, plug, charging connector and CCID (Charging Circuit Interrupting Device).
- Firmly insert the plug into the outlet.
- Do not use an extension cord and converting adaptor.
- After connecting the charging cable, confirm that it is not wound around anything.
- If the power indicator light does not illuminate after plugging the charging cable into the socket-outlet, unplug it immediately.

 **WARNING****■ If the error warning indicator on the CCID (Charging Circuit Interrupting Device) illuminates or flashes during charging**

There may be an electrical leakage in the power source path, or there may be a malfunction in the charging cable or CCID (Charging Circuit Interrupting Device). Refer to P. 118 and follow the correction procedure. If the error warning indicator does not turn off even after performing the correction procedure, immediately stop charging, remove the charging cable and contact your Toyota dealer. Continuing to charge the vehicle in that condition may lead to unforeseen accidents or serious injury.

■ After charging

Remove the plug if it will not be used for a long time. Dirt and dust may accumulate plug or outlet, which could cause a malfunction or fire, possibly leading to death or serious injury.

■ Onboard traction battery charger

The onboard traction battery charger is located under the rear seats. Make sure to observe the following precautions regarding the onboard traction battery charger. Failure to observe these precautions may result in death or serious injury such as burns and electric shocks.

- The onboard traction battery charger is hot during charging. Do not touch the onboard traction battery charger, as doing so may result in burns.
- Do not disassemble, repair or modify the onboard traction battery charger. When the onboard traction battery charger needs to be repaired, consult your Toyota dealer.

■ Charging inlet

Do not disassemble, repair or modify the charging inlet. It may lead to unforeseen accidents or serious injury. When the charging inlet needs to be repaired, consult your Toyota dealer.

 NOTICE**■ When use the charging cable and related parts**

To prevent damage to the charging cable and related parts, observe the following precautions.

- When interrupting or canceling charging, remove the charging connector before removing the plug.
- Vehicles with smart lid & connector locking system: When removing the charging cable, check that the charging connector is unlocked.
- Do not forcefully pull the connector cap and charging inlet cap.
- Do not apply a vibration to the charging connector while charging. Charging may be stopped.
- Do not insert anything but the charging connector.
- When inserting the plug into or removing the plug from the outlet, make sure to hold the body of the plug.
- Do not damage the charging inlet cap with a sharp object.
- Do not forcefully pull the charging cable that is caught or entangled. If the cable is entangled, disentangle it before using.
- When charging from the external device, use the charging cable equipped with the vehicle.

■ When charging

Do not insert the plug into the charging inlet.
The charging inlet may be damaged.

■ After charging

- Store the charging cable out of reach from infants and children.
- After disconnecting the charging connector from the charging inlet, make sure to put on the charging inlet cap and close the charging port lid. If the charging inlet cap is not put on, water or foreign objects may enter the charging inlet, which could lead to vehicle damage.
- After removing the plug from the outlet, keep it in a safe place free from moisture and dust.
The charging cable or plug may be damaged if the cable is stepped on or ridden over by the vehicle.

 NOTICE

■ **Using private power generator**

Do not use private power generators as a power source for charging. Doing so may make charging unstable, the voltage may be insufficient, and the error warning indicator on the CCID (Charging Circuit Interrupting Device) of the charging cable may flash.

■ **Charging station**

Due to the environment in which the power equipment is located, charging may be unstable due to noise, the voltage may be insufficient, and the error warning indicator on the CCID (Charging Circuit Interrupting Device) of the charging cable may flash.

Using the charging schedule function

Charging can be carried out at the desired time by registering the charge schedule. Also, it is possible to set the charging schedule to one's preferences, such as having charging complete by a certain departure time or be carried out at the same time on certain days.

Settings of the charging schedule function

When registering the charge schedule, the following settings can be changed.

■ Select the charging mode

One of the two following charging modes can be selected.

Charging mode	Operation description
"Start"	Starts charging at the set time* ¹ and finishes charging when fully charged.* ²
"Departure"	Starts charging to finish at the set time. When this setting is selected, the air conditioning-linked function can be used.

*¹: Charging schedule function is performed in accordance with the clock in the instrument cluster. Before registering the charge schedule, check the clock settings to the proper time.

*²: There might be a slight error in the timing when charging starts due to the state of the hybrid battery (traction battery).

■ Repeated setting

The periodic charging schedule can be set by selecting your desired day of the week.

■ Air conditioning-linked setting ("Climate Prep")

When the charging mode is set to "Departure", the vehicle air conditioning system (→P. 512, 524) can be set to automatically operate* according to the set time.

By adjusting the cabin temperature in advance, passengers can enjoy a pleasant interior immediately after entering the vehicle.

*: Operation starts approximately 10 minutes before the set departure time.

■ Turning “Charge Now” on and off

If even one charge schedule is registered, charging does not start until the set time, even if the charging cable is connected to the vehicle. To start charging without changing the charge schedule setting, turn “Charge Now” on to temporarily cancel the charge schedule and enable charging after connecting the charging cable.

■ Changing “Next Charging Event”^{*1}

It is possible to temporarily set the time of the next scheduled charge without changing the registered repeated setting.^{*2}

^{*1}: The “Next Charging Event” refers to the closest charge schedule from the current time among the registered charge schedules. Charging schedule is performed based on the “Next Charging Event”.

^{*2}: When “Next Charging Event” is changed, the current charge schedule will be temporarily ignored and charging will not be carried out until the time specified by “Next Charging Event”. (For example, when “Next Charging Event” is set for 2 days later, even if items are registered on the charge schedule, charging will not be carried out until the time specified by “Next Charging Event”.)

Registering the charge schedule

The charge schedule can be registered on the multi-information display or 11.6-inch display (if equipped).

- Multi-information display operation: →P. 161
- 11.6-inch display operation (if equipped): →P. 170

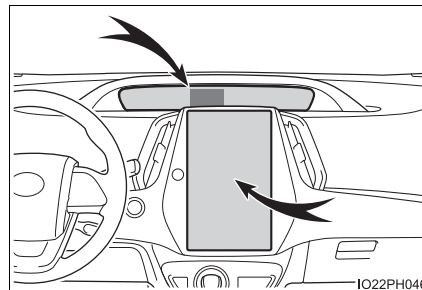

■ Charging schedule

- The charge schedule cannot be set while driving.
- A maximum of 15 charge schedules can be registered.

■ To make sure that the charging schedule function operates correctly

Check the following items.

- Adjust the clock to the correct time (→P. 197)
- The calendar is set to the correct date (→P. 199)
- Check that the power switch is turned off
- After registering the charge schedule, connect the charging cable
 - The charging start time is determined based on the charge schedule at the time that the charging cable was connected.
- After connecting the charging cable, check that the charging indicator flashes (→P. 114)
- Do not use an outlet that has a power cut off function (including a timer function)

Use an outlet that constantly supplies electricity. For outlets where the power is cut off due to a timer function, etc., charging may not be carried out according to plan if the power is cut off during the set time.

■ When the charging cable remains connected to the vehicle

Even if multiple consecutive charge schedules are registered, the next charge will not be carried out according to the charging schedule until the charging cable is removed and reconnected after charging completes. Also, when the hybrid battery (traction battery) is fully charged, charging according to the charging schedule will not be carried out.

■ “Climate Prep”

- When the air conditioning-linked setting is turned on, the air conditioning operates until the set departure time. Therefore, the air conditioning will consume electricity and charging may not complete by the set departure time.
- If the hybrid battery (traction battery) is fully charged, charging will not be carried out, even if the charge schedule is set. However, if “Climate Prep” is turned on, the air conditioning will operate only once when it nears the time set in “Departure”. If this occurs, the air conditioning will consume electricity and the remaining charge of the hybrid battery (traction battery) when departing may be decreased.
- When the doors are unlocked, the air conditioning system does not operate.

■ Smartphone-linked operation (vehicles with 11.6-inch display)

After applying to Entune App Suite, it is possible to use the smartphone application to change charging schedule settings.

For details about Entune App Suite, refer to <http://www.toyota.com/entune/>.

■ When charging schedules are ignored

When the following operations are performed while the charging schedule is on standby, charging schedule is temporarily canceled and charging is started.

- When the Remote Air Conditioning System (→P. 535) is operated
- When turning “Charge Now” on (→P. 166, 175)
- When an operation that temporarily cancels charging using the charging schedule is performed (→P. 149)

■ Effects of outside temperature

When the charging mode is set to “Departure”, charging schedule may be ignored due to the outside temperature and charging may start.

■ “Traction Battery Cooler” (→P. 136)

When charging is carried out using the charging schedule, the hybrid battery (traction battery) cooling function may operate according to the temperature of the hybrid battery (traction battery).

- When the charging mode is set to “Start”, cooling starts at the set charging start time.
- When the charging mode is set to “Departure”, cooling starts approximately 30 minutes before the charging start time. However, if there is no time to finish charging by the charging schedule, the hybrid battery (traction battery) cooling time may be shortened and “Traction Battery Cooler” may not operate.

Setting operations on multi-information display

When operating charging schedule, use the charging schedule switch and meter control switches.

- ① Charging schedule switch
- ② Meter control switches
(→P. 193)
- ③ Multi-information display

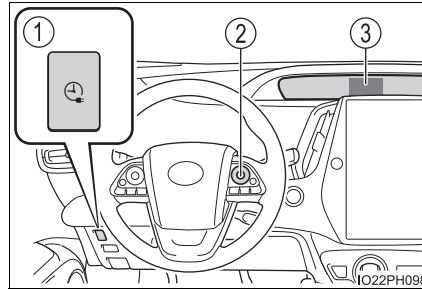

2

Plug-in hybrid system

■ Registering the charge schedule

- 1 Press the charging schedule switch.

The “Charge Schedule” screen will display on the multi-information display.

- 2 Press or of the meter control switches to select “Scheduled Events”, and then press .

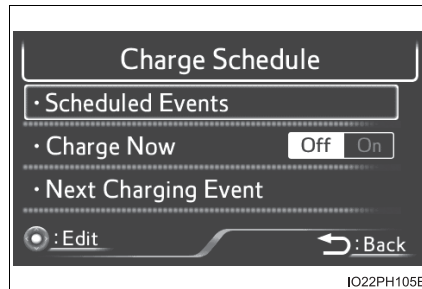

The “Scheduled Events” screen will display.

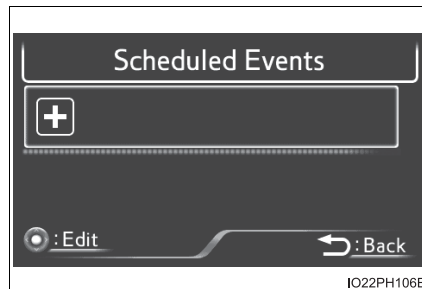

- 3 Press or of the meter control switches to select “+”, and then press .

The “Edit Charging Event” screen will display.





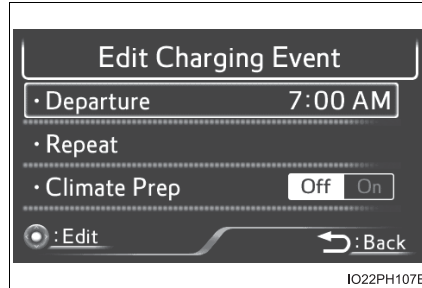

- 4 Press  or  of the meter control switches to select the charging mode/time settings row, and then press .

The charging mode/time settings screen will display.

The clock display (12-hour display/24-hour display) changes according to the clock settings. (→P. 197)



IO22PH107E

- 5 Press  or  of the meter control switches to select the item to change with the cursor, and then press  or  to change the setting.



Set the desired charging mode and charging start (or departure) time.

When the charging mode is “Start”, this sets the charging start time. When it is “Departure”, this sets the charging end time.

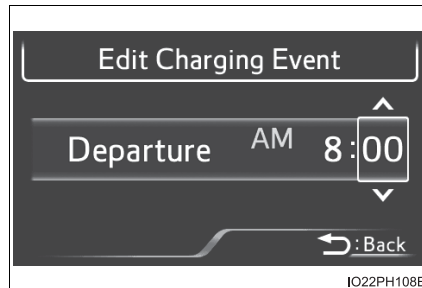
After changing the settings to the desired settings, press  to return to the previous screen.



IO22PH108E

- 6 To activate the repeated setting, press  or  of the meter control switches to select “Repeat”, and then press .

A screen where the repeated day can be selected will display.

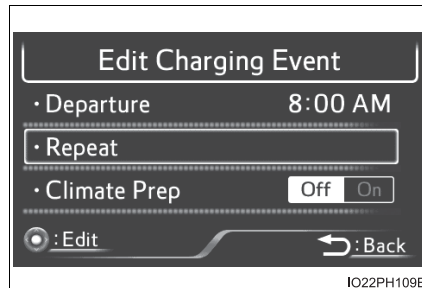

IO22PH109E

- 7 Press **<** or **>** of the meter control switches to select the desired day to activate for the repeated setting, and then press **○**.

Each time **○** is pressed, the repeated setting switches between on and off.

When set to on, the selected day is highlighted and the charging schedule is repeated on that day. It is possible to set more than one day to on. If no days are set to on, charging is only carried out once according to the charging schedule for the next 24 hours.

After changing the settings to the desired settings, press **➡** to return to the previous screen.

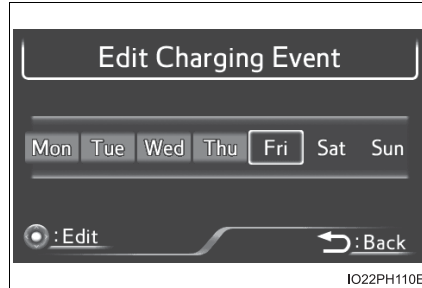

- 8 When the charging mode is set to “Departure”, set the “Climate Prep” (→P. 157) to on or off.

To turn the function on and operate the air conditioning, press **▲** or **▼** of the meter control switches to select “Climate Prep”, and then press **○**.

Each time **○** is pressed, the function switches between on and off.

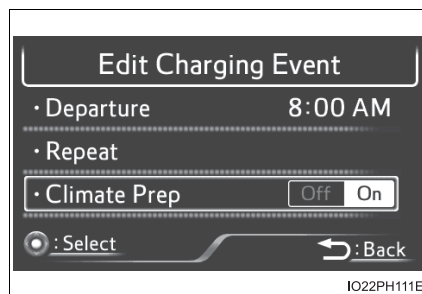

- 9 After setting operations are complete, press **➡**.

A screen where the settings can be saved will display.

Press **<** or **>** of the meter control switches to select “Yes”, and then press **○** to save the settings.

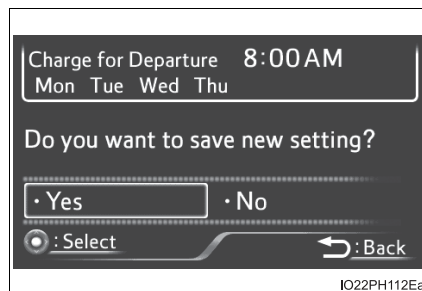

If you wish to change the settings, select “No” and perform the setting procedure from step 3 again.



After setting operations are complete, when the charging cable is connected to the vehicle, charging will be carried out according to the charging schedule settings.

■ **Changing the registered charge schedules**

The registered charge schedules can be turned on, off, deleted or modified.



- 1 Press the charging schedule switch.

The “Charge Schedule” screen will display on the multi-information display.

- 2 Press  or  of the meter control switches to select “Scheduled Events”, and then press .

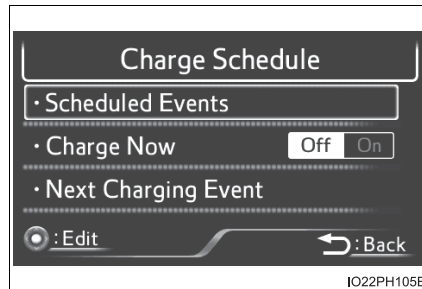

The “Scheduled Events” screen is displayed, which displays a list of the registered charge schedule.

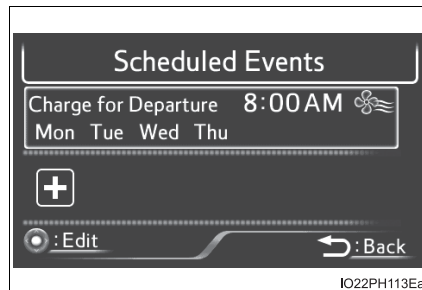

- 3 Press  or  of the meter control switches to select the item to change, and then press .

The “Edit Charging Event” screen will display.



- 4 Press  or  of the meter control switches to select the item to operate and perform the necessary operation.

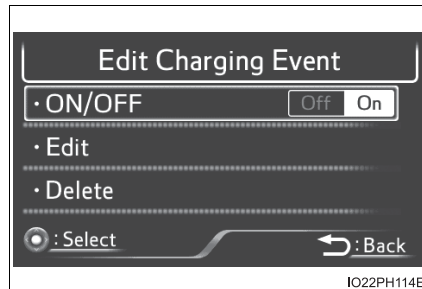

● “ON/OFF”



Each time  of the meter control switch is pressed, the selected charge schedule switches between “On” and “Off”.

When set to “Off”, a charging schedule is ignored and charging according to the charging schedule is not carried out.

When  is pressed, setting is complete.

● “Edit”

Change the desired settings as described starting from step 4 of the “Registering the charge schedule” procedure. (→P. 161)



Press  or  of the meter control switches to select “Yes”, and then press  to save the charging schedule.

Press  to return to the previous screen.

When canceling any changes, select “No” and then press .

● “Delete”

Pressing  of the meter control switch displays a deletion confirmation screen.

Press  or  of the meter control switches to select “Yes”, and then press  to delete the selected charge schedule.

Press  to return to the previous screen.

To cancel deletion, select “No” and then press .

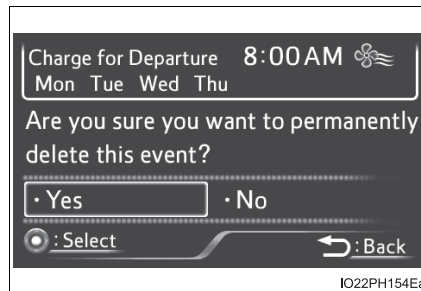
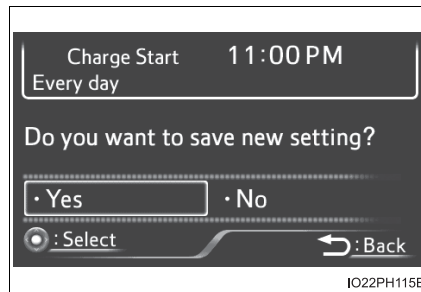

2
Plug-in hybrid system



■ Setting “Charge Now” to “On”

The “Charge Now” setting can be changed by performing one of the two following procedures.

▶ Operation on “Charge Schedule” screen

- 1 Press the charging schedule switch.

The “Charge Schedule” screen will display on the multi-information display.

- 2 Press  or  of the meter control switches to select “Charge Now”, and then press .

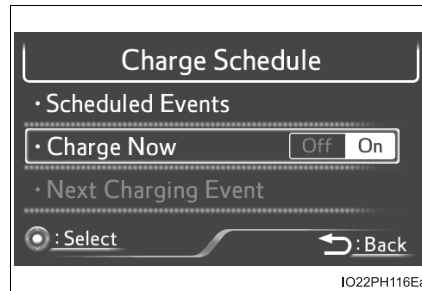

Each time  is pressed, “Charge Now” switches between “On” and “Off”.



▶ Operation on “Ending” screen

- 1 Turn the power switch off.

The “Ending” screen is displayed on the multi-information display. (→P. 196)

- 2 While the “Ending” screen is displayed, press  or  of the meter control switches to display the “Next Event” screen.*

*: When the power switch is turned off, the “Charge Now” setting screen may be displayed.

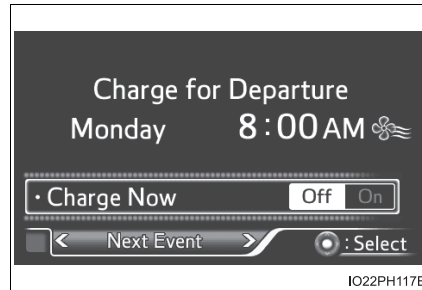

- 3 Press  to set “Charge Now” to “On”.

Each time  is pressed, “Charge Now” switches between “On” and “Off”.

After setting operations are complete, charging starts when the charging cable is connected. (→P. 146)

■ Changing “Next Charging Event”*

*: When “Charge Now” is set to “On” etc., it is not possible to change the registered “Next Charging Event”.

- 1 Press the charging schedule switch.

The “Charge Schedule” screen will display on the multi-information display.

- 2 Press or of the meter control switches to select “Next Charging Event”, and then press .

The “Edit Next Charging Event” screen will display.

- 3 Press or of the meter control switches to select the item to change, and then press .

Change the registered settings in accordance with the following table.

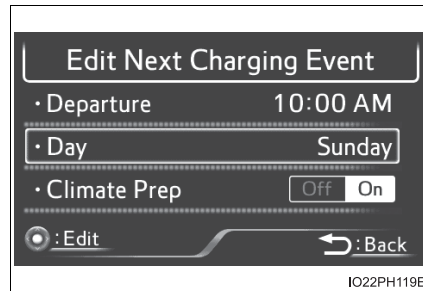
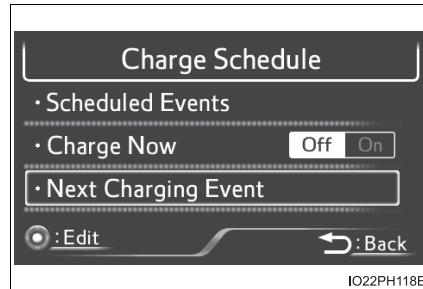





2
Plug-in hybrid system

Setting	Operation
Charging Mode/Time	Operate , , and of the meter control switches to set the charging mode (“Start” or “Departure”) and charging start (or departure) time. After changing the settings, press to return the previous screen.
“Day”	Operate or of the meter control switches to select the day to carry out charging according to the charging schedule. After changing the setting, press to return the previous screen.
“Climate Prep”	This can be set when the charging mode is set to “Departure”. Each time is pressed, air conditioning-linked operation switches between “On” and “Off”.

- 4 After setting operations are complete, press .

A confirmation screen of changing “Next Charging Event” will display.

Press  or  of the meter control switches to select “Yes”, and then press  to save the charging schedule.

Press  to return to the previous screen.

When canceling the “Next Charging Event”, select “No” and then press

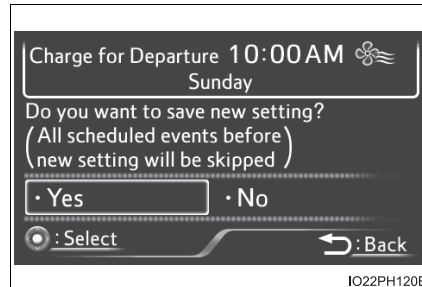

■ Charging schedule switch

- The charging schedule switch functions regardless of the condition of the power switch.
However, when the charging schedule switch is pressed while the power switch is not turned to ON mode, if the meter control switches are not operated for a certain amount of time after the charging schedule setting screen is displayed, the display automatically turns off.
- The charging schedule switch cannot be used while driving.

■ When charging schedule setting operations are canceled

When the vehicle is in the following conditions, charging schedule setting operations are canceled.

- A message is displayed while performing a setting operation
- The power switch is operated before the settings are confirmed
- The vehicle starts off
- A display with a higher priority than that of the charging schedule setting is shown

■ Charging schedule

The “Charge Schedule” screen can be displayed and setting operations can be performed from the “Vehicle Settings” setting on the multi-information display. (→P. 753)

■ “Next Charging Event”

After charging completes, the “Next Charging Event” displayed on the multi-information display will not change until the charging cable is removed, even after charging is performed according to the “Next Charging Event” schedule.



■ **To return to original setting after changing “Next Charging Event” setting**

Turning the setting of “Charge Now” on and then off can return the setting of “Next Charging Event” to its original setting.

■ **When “Next Charging Event” is changed while charging**

- When the charging mode is “Departure”, the current charging is interrupted or continued depending on the remaining time until the charging is completed.
- When the charging mode is “Start”, the current charging is interrupted, the next charging will start at the set time.

■ **When the power switch is turned off**

It is possible to check the next charge schedule (“Next Charging Event”) by operating  or  of the meter control switches while the power switch is turned off and the “Ending” screen ^{*1} (→P. 196) is displayed. ^{*2}



^{*1}: The “Ending” screen may not be displayed during charging.

^{*2}: When the power switch is turned off, the “Next Charging Event” confirmation screen may be displayed.

2
Plug-in hybrid system

 **WARNING**

■ **Cautions while performing the setting operation**

When performing the setting operation while the hybrid system is operated, ensure that the vehicle is parked in a place with adequate ventilation. In a closed area such as a garage, exhaust gases including harmful carbon monoxide (CO) may collect and enter the vehicle. This may lead to death or a serious health hazard.

 **NOTICE**

■ **While performing the setting operation**

When performing the setting operation while the hybrid system is stopped, be careful that the 12-volt battery will not be discharged.

Setting operations on the 11.6-inch display (if equipped)

Setting operations related to the charging schedule are performed on the “Charge Schedule” screen.

For details on how to operate the 11.6-inch display, refer to “NAVIGATION SYSTEM OWNER’S MANUAL”.

■ **Displaying the “Charge Schedule” screen**

- 1 Press the “MENU” button to display the menu screen.

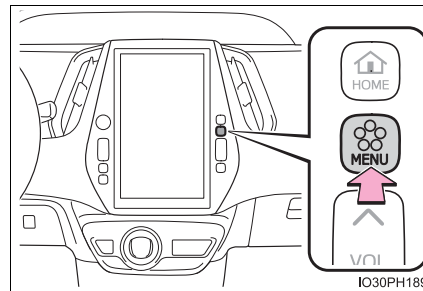

- 2 Select “Info” and “Charge Schedule”, in that order.
The “Charge Schedule” screen will display.

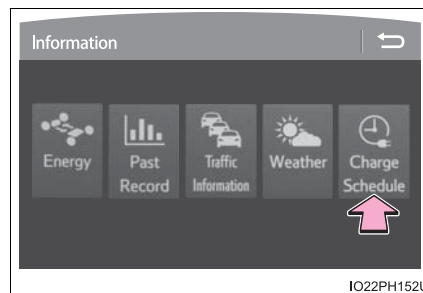

■ How to read the “Charge Schedule” screen



2
Plug-in hybrid system

- ① Charge schedules (calendar display)
Displays the week-long registered charge schedule in a list using icons.
- ② “Add” button
Press to add a new item to the charge schedule. (→P. 172)
- ③ Charge schedules (list display)
A list of items on the registered charge schedule is displayed. If there are more than 3 registered items, the list can be scrolled up and down to change the displayed items.
- ④ “Edit” button
Press to change or delete registered items on the charge schedule. (→P. 174)
- ⑤ Return button
Press to close the “Charge Schedule” screen.
- ⑥ Charge schedules (icon display)
When an item is registered on the charge schedule, an icon is displayed on the calendar.
- ⑦ “Charge Now” button
Press to set “Charge Now” to on. (→P. 175)

⑧ “ON”/“OFF” button

The charge schedule switches between “ON” and “OFF” each time this button is pressed. (→P. 174)

⑨ Scroll bar

When the number of registered charge schedules exceeds 3, the displayed contents can be changed by operating the button.

Main content displayed on the calendar:

Display	Content
Red line*1	Current time
Orange icon*2, 3	Charge schedule for “Next Charging Event”*4
Green icon*2	The charging mode is set to “Departure”
Blue icon*2	The charging mode is set to “Start”

*1: A row with a red line indicates the current time.

*2: While a registered setting is being changed, the icon of the related setting is highlighted (except when the icon overlaps with another icon).

*3: When “Charge Now” (→P. 175) is set to on, the orange icon moves to the position of the red line and changes to display “Charge Now”.

*4: The content of the charge schedule that corresponds to the “Next Charging Event” is not displayed in the list.

■ Registering the charge schedule

1 Display the “Charge Schedule” screen. (→P. 170)

2 Press “Add”.

The settings screen will display on the bottom of the screen.

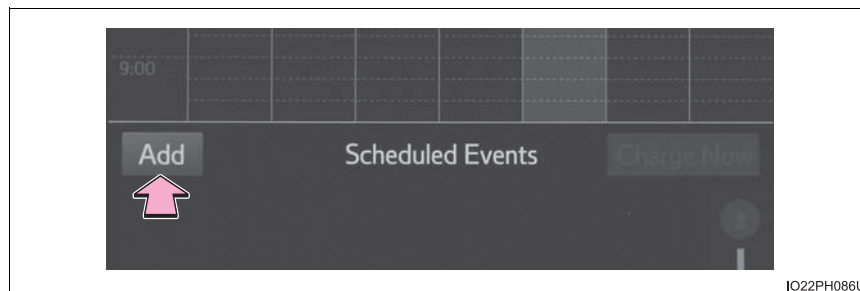

3 Select the charging mode.

Press “Start” or “Departure” to turn the button (charging mode) on and highlight the button.

4 Operate the time setting wheel to set the start (or departure) time.

When the charging mode is “Start”, set the charging start time (start time). When it is “Departure”, set the charging end time (departure time).

Operate the each wheel up and down to display the desired time in the center.

5 When activating the repeated settings, press the desired day button.

Each time the button is pressed, the repeated setting for the selected day switches between on and off.

When turned on, the button is highlighted and the charging schedule is repeated on that day. It is possible to turn more than one day on.

If no buttons are turned on, charging is only carried out once according to the charging schedule for the next 24 hours.

6 When the charging mode is set to “Departure”, set the “Climate Prep” (→P. 157) to on or off.

To operate the air conditioning, press the “Climate Prep” button to set the function to “ON”.

Each time the button is pressed, the function switches between “ON” and “OFF”.

7 After setting operations are complete, press “Save”.

The charge schedule is added to the list and an icon is added to the calendar.

To cancel registration of the charging schedule, press .

After setting operations are complete, when the power switch is turned off and the charging cable is connected to the vehicle, charging is carried out according to the charging schedule settings.

2
Plug-in hybrid system

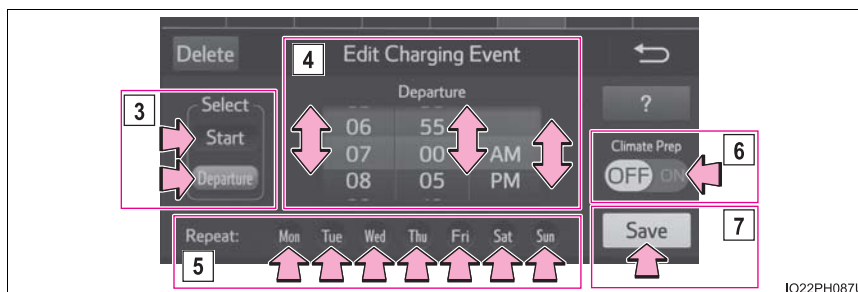

IO22PH087U

■ **Switching charge schedules between “ON” and “OFF”**

- 1 Display the “Charge Schedule” screen. (→P. 170)
- 2 From the items in the list displayed on the bottom of the screen, press “ON” or “OFF” in the row of the charge schedule you wish to change.

Setting “ON” or “OFF” is possible by sliding the bar to the left or right.

If the charge schedule you wish to change is not displayed on the bottom of the screen, scroll the list up and down to display it.

Each time the button is pressed, the charge schedule switches between “ON” and “OFF”.

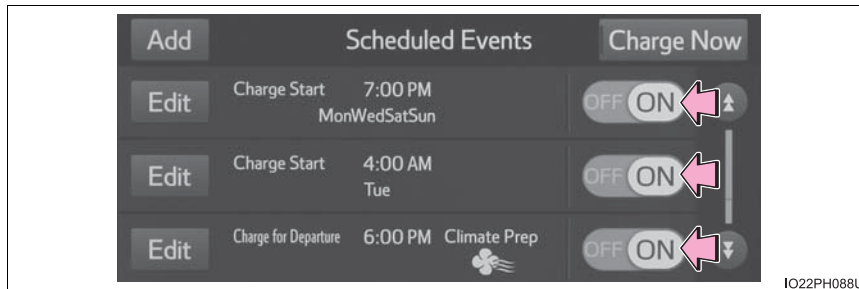

■ **Changing the registered charge schedules**

- 1 Display the “Charge Schedule” screen. (→P. 170)
- 2 From the items displayed on the bottom of the screen, press “Edit” in the row of the charge schedule you wish to change.

The settings screen will display on the bottom of the screen.

It is also possible to display the settings screen by pressing the icon of the charge schedule you wish to change from those displayed on the calendar.

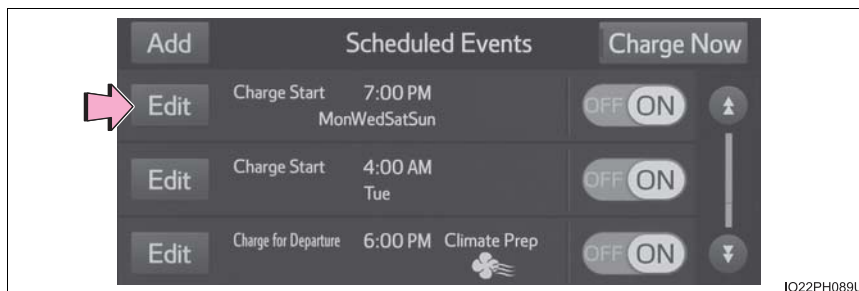

- **Changing registered items:**
 Change the desired settings as described in step 3 to step 7 of the “Registering the charge schedule” procedure. (→P. 172)
 When a setting is changed, its icon on the calendar also changes.
- **Deleting registered items:**
 Press “Delete”.
 A deletion confirmation message will display.
 Press “Yes” to delete the selected charge schedule.
 To cancel deletion, press “No”.
 When a charge schedule is deleted, its icon is also deleted from the calendar.

2

Plug-in hybrid system

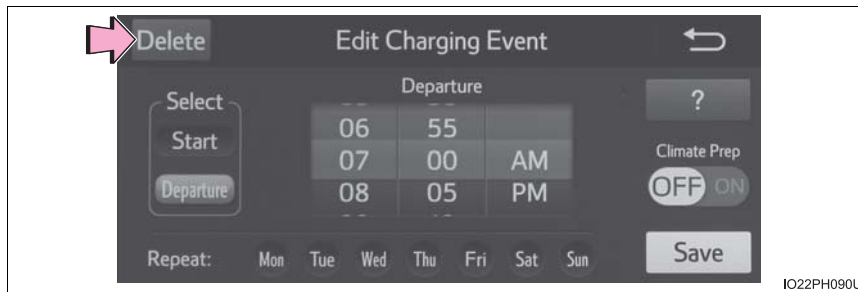

■ **Turning “Charge Now” on**

The “Charge Now” setting can be changed by performing one of the two following procedures.

▶ Operations on “Charge Schedule” screen

- 1 Display the “Charge Schedule” screen. (→P. 170)
- 2 Press “Charge Now”.

Each time the button is pressed, “Charge Now” switches between on and off and the indicator on the button turns on and off.

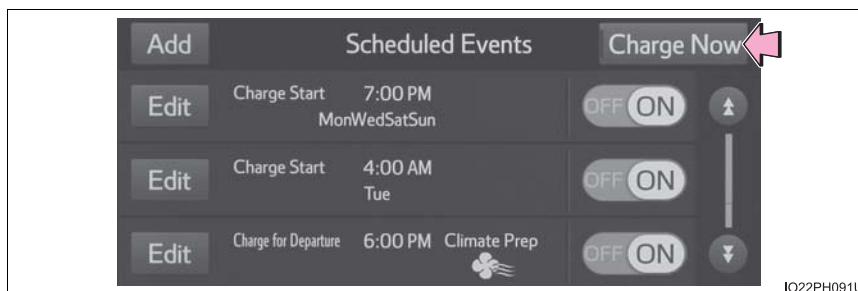

► Operation on ending screen

- 1 Turn the power switch off.

The ending screen is displayed on the 11.6-inch display.

- 2 While the ending screen is displayed, press “Charge Now”.

Each time the button is pressed, “Charge Now” switches between on and off and the indicator on the button turns on and off.

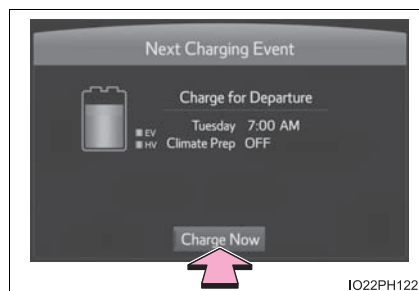

After setting operations are complete, charging starts when the charging cable is connected. (→P. 146)

■ Changing “Next Charging Event”*

*: When “Charge Now” is turned on etc., the registered “Next Charging Event” cannot be changed.

- 1 Display the “Charge Schedule” screen. (→P. 170)

“Next Charging Event” is displayed on the “Charge Schedule” screen with an orange icon.

- 2 To change “Next Charging Event”, press the orange .*

The settings screen will display on the bottom of the screen.

*: Icons are displayed differently according to the type of charging mode. (→P. 172)

- 3 Select the desired charging mode.

Press “Start” or “Departure” to turn the button (charging mode) on and highlight the button.

- 4 Operate the day setting wheel and time setting wheels up and down to set the charging day and start (or departure) time.

Operate each wheel up and down to display the desired date and time in the center.

When the charging mode is “Start”, set the charging start time. When it is “Departure”, set the charging end time.

- 5 When the charging mode is set to “Departure”, set the “Climate Prep” (→P. 157) to on or off.

To operate the air conditioning, press the “Climate Prep” button to set the function to “ON”.

Each time the button is pressed, the function switches between “ON” and “OFF”.

- 6 After setting operations are complete, press “Save”.

The charging schedule settings are saved and icons are added to the charge schedule.

To cancel changing “Next Charging Event”, press .

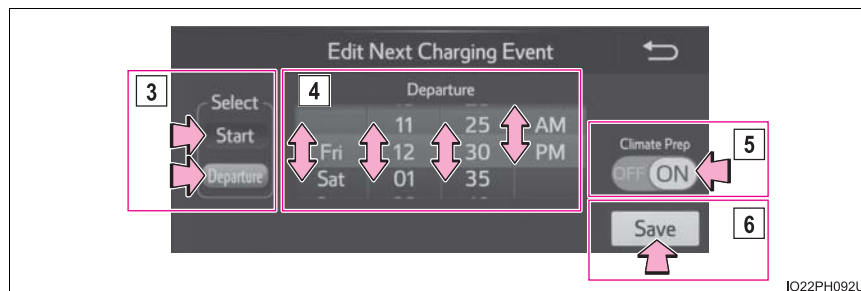

2
Plug-in hybrid system

■ When charging schedule setting operations are canceled

When the vehicle is in the following conditions, charging schedule setting operations are canceled.

- The power switch is turned off before the settings are confirmed
- The vehicle starts off
- A display with a higher priority than that of the charging schedule setting is shown

■ “Next Charging Event”

After charging completes, the “Next Charging Event” displayed on the display will not change until the charging cable is removed, even after charging is performed according to the “Next Charging Event” schedule.

■ To return to original setting after changing “Next Charging Event” setting

Turning the setting of “Charge Now” on and then off can return the setting of “Next Charging Event” to its original setting.

■ When “Next Charging Event” is changed while charging

- When the charging mode is “Departure”, the current charging is interrupted or continued depending on the remaining time until the charging is completed.
- When the charging mode is “Start”, the current charging is interrupted, the next charging will start at the set time.

■ Displaying advice related to charge schedule settings

When “?” is pressed on the “Edit Charging Event” screen (→P. 173), an explanation of the setting item on the “Edit Charging Event” screen will display.

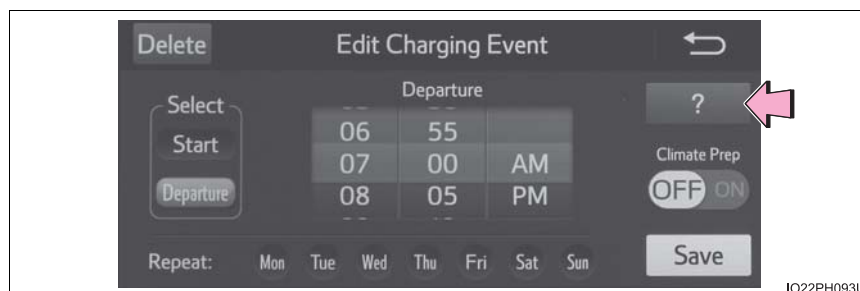

■ **When the power switch is turned off**

The next charge schedule (“Next Charging Event”) can be checked on the ending screen* that is displayed when the power switch is turned off.

*: The ending screen may not be displayed during charging.



⚠ WARNING

■ **Cautions performing the setting operation**

As the hybrid system needs to be operating during setting up the display, ensure that the vehicle is parked in a place with adequate ventilation. In a closed area such as a garage, exhaust gases including harmful carbon monoxide (CO) may collect and enter the vehicle. This may lead to death or a serious health hazard.

⚠ NOTICE

■ **While performing the setting operation**

To prevent 12-volt battery discharge, ensure that the hybrid system is operating while setting up the display features.

2

Plug-in hybrid system

When normal charging cannot be carried out

When charging does not start, even though the normal procedure is followed, check each of the following items.

If a message is shown on the multi-information display, also refer to P. 185.

When normal charging cannot be carried out

Refer to the following table and carry out the appropriate correction procedure.

Likely cause	Correction procedure
<input type="checkbox"/> The power source indicator on the CCID (Charging Circuit Interrupting Device) does not illuminate, even though the plug is connected to an external power source.	
Plug is not properly connected to outlet	Check that the plug is properly connected to the outlet.
Power is out	After power is restored, carry out the charging procedure again.
Building breaker is tripped and power is cut off	Check that the breaker is connected and if there is no malfunction, check if the vehicle can be charged through another outlet. If charging is possible, the first outlet may have a malfunction. Contact the building or facility manager, or an electrician.
Short circuit between CCID (Charging Circuit Interrupting Device) and plug	Immediately stop charging and contact your Toyota dealer.

Likely cause	Correction procedure
<p><input type="checkbox"/> The error warning indicator on the CCID (Charging Circuit Interrupting Device) flashes.</p>	
<p>Electrical leakage detection function or self- diagnostic function operates and power is cut off</p>	<p>When the voltage is insufficient, the error warning indicator may flash when there is noise interference. Perform a reset and connect to a proper power source. (→P. 118) If charging does not start, immediately stop charging and contact your Toyota dealer.</p>
<p><input type="checkbox"/> Charging indicator does not illuminate, even though charging connector is connected.</p>	
<p>The plug is not properly connected to the outlet</p>	<p>Check whether the plug is properly connected to the outlet.</p>
<p>Charging connector is not securely connected to charging inlet</p>	<p>Check the connection status of the charging connector.</p> <ul style="list-style-type: none"> When connecting the charging connector, make sure not to touch the latch release button. Insert the charging connector securely until you hear a click. The charging connector may not be connected correctly if the latch release button is pressed while inserting. After connecting the charging connector, check that the latch release button is not pressed and the charging indicator is turned on. <p>If the charging indicator does not illuminate, even though the charging connector is securely connected, there may be a malfunction in the system. Immediately stop charging and contact your Toyota dealer.</p>
<p>Hybrid battery (traction battery) is already fully charged</p>	<p>When the hybrid battery (traction battery) is fully charged, charging is not performed.</p>
<p>The charger does not operate</p>	<p>Please contact the facility manager when there is a problem with charger.</p>

Likely cause	Correction procedure
<input type="checkbox"/> Charging indicator flashes and charging cannot be carried out.	
When charging indicator flashes*: Charge schedule is registered	When you wish to charge according to the charging schedule, wait until the set time. To start charging, set "Charge Now" to "On". (→P. 166, 175)
When charging indicator rapidly flashes*: Malfunction occurred in an external power source or the vehicle	Start the hybrid system and follow the instructions displayed by the message on the multi-information display. (→P. 185)

*: Refer to P. 114 for details regarding charging indicator illumination and flashing.

When charging schedule function does not operate normally

Refer to the following table and carry out the appropriate correction procedure.

Likely cause	Correction procedure
<input type="checkbox"/> Cannot charge at desired time	
Vehicle clock is not properly adjusted	Check the clock settings and adjust it to the proper time. (→P. 197)
The vehicle calendar is not set correctly.	Check the calendar setting and set it to the correct date. (→P. 199)
Charging cable is not connected to vehicle	Before using the charging schedule, connect the charging cable.
Incorrect charging mode selected	Check the charging mode setting. (→P. 157) When the charging mode is "Start", charging starts at the set time, but when it is "Departure", charging is completed by the set time. (The charging start time is automatically controlled by the system.)
<input type="checkbox"/> Cannot change charging schedule from smartphone application (vehicles with 11.6-inch display)*	
Smartphone is outside its coverage area	Check the signal strength. If the smartphone is outside its coverage area, move to a place with a better signal.

Likely cause	Correction procedure
<input type="checkbox"/> Charging starts, even though charge schedule is registered	
"Charge Now" is set to "On"	When charging according to the charging schedule, set "Charge Now" to "Off". (→P. 166, 175)
Charge schedule is set to "Off"	Check that charge schedule is not set to "Off". (→P. 164, 174)
Charging mode is set to "Departure" and schedule departure time is close to current time	When the system determines that there is no time to finish charging by the set scheduled departure time, it starts charging. Check the charge schedules.
Charging cable was removed and reinserted while charging indicator was flashing	If the charging cable is removed and reinserted while the charging indicator is flashing, the charging schedule is canceled (→P. 149). Temporarily remove the charging cable, and then reconnect it.
The Remote Air Conditioning System was operated	When the Remote Air Conditioning System is operated, the system will start charging, even if the charge schedule is registered. To carry out charging using the charging schedule, stop the Remote Air Conditioning System, and then reconnect the charging cable.
"Traction Battery Heater" (→P. 135) operated	When the charging mode is set to "Departure", "Traction Battery Heater" may operate before charging starts. Check the status of the charging indicator. (→P. 114)
Outside temperature is low and hybrid battery (traction battery) warming control (→P. 136) operated (Alaska and Canada only)	When hybrid battery (traction battery) warming control operates, the charging schedule are ignored and charging starts. In order to protect the hybrid battery (traction battery), allow charging to continue.

2
Plug-in hybrid system

Likely cause	Correction procedure
<input type="checkbox"/> Charging ends earlier than time set in "Departure"	
Charging end time does not match estimated end time due to condition of power source or outside temperature	If sudden changes in temperature or changes in the condition of the power source occur while charging, charging may end earlier than the time estimated by the system.
<input type="checkbox"/> Charging is not complete, even though it is time set in "Departure"	
"Climate Prep" is set to "On"	When "Climate Prep" is set to "On", the air conditioning operates until the set departure time. Therefore, charging may not complete by the set time due to charging conditions. To have the hybrid battery (traction battery) fully charged, allow charging to continue.
Charging end time does not match estimated end time due to condition of power source or outside temperature	If sudden changes in temperature or changes in the condition of the power source occur while charging, charging may not end exactly at the time estimated by the system.
<input type="checkbox"/> Charging does not start, even though it is time set in "Start"	
Charging cable was connected after set time	Connect the charging cable before the time set in "Start".

*: In order to use the smartphone application, it is necessary to apply to Entune App Suite.

For details about Entune App Suite, refer to <http://www.toyota.com/entune/>.

When charging-related message is displayed

When the hybrid system is started after charging, a message is displayed in the multi-information display.

When this occurs, follow the instructions displayed on the screen.

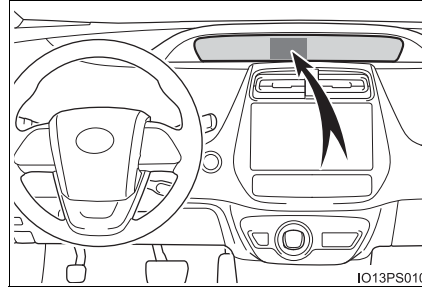

2

Plug-in hybrid system

Likely cause	Correction procedure
<p><input type="checkbox"/> If “Charging Stopped Due to Pulled Charging Connector” is shown</p>	
<p>Charging connector is removed while charging</p> <p>After the hybrid battery (traction battery) is fully charged, the charging connector is removed while the hybrid battery (traction battery) is being recharged again because electricity-consuming functions* have been used and the remaining charge is now reduced.</p> <p>*:Electricity is consumed when operating “Traction Battery Heater” (→P. 135), the air conditioning-linked function (→P. 157) or Remote Air Conditioning System (→P. 535).</p>	<p>When the charging connector is removed while charging, charging stops. If you want to fully charge the hybrid battery (traction battery), reconnect the charging connector.</p>

Likely cause	Correction procedure
<input type="checkbox"/> If “Charging Stopped Due to Pulled Charging Connector” is shown	
Charging connector is not securely connected	Check the connection status of the charging connector. <ul style="list-style-type: none"> • When connecting the charging connector, make sure not to touch the latch release button. Insert the charging connector securely until you hear a click. The charging connector may not be connected correctly if the latch release button is pressed while inserting. • After connecting the charging connector, check that the latch release button is not pressed and the charging indicator is turned on. If charging cannot be carried out, even though the proper procedures were followed, have the vehicle inspected by your Toyota dealer.
Latch release button of charging connector was pressed while charging	When the latch release button is pressed while charging, charging stops. To continue charging, reconnect the charging connector.
<input type="checkbox"/> If “Charging Complete Limited Due to Battery Temp” is shown	
Charging was stopped to protect the hybrid battery (traction battery) as it continued to remain hot for a certain period of time.	Allow the hybrid battery (traction battery) to cool down and perform charging again if the charging amount has not reached the desired amount.

Likely cause	Correction procedure
<p><input type="checkbox"/> If “Charging Stopped Check Charging Source” is shown (1)</p>	
<p>Problem in power supply from external power source</p>	<p>Check the following items.</p> <ul style="list-style-type: none"> • Plug is not disconnected • Power source indicator on the CCID (Charging Circuit Interrupting Device) is illuminated • The circuit breaker has not tripped <p>If there is no problem with any of the above items, there may be a problem with the outlet of the building. Contact an electrician and request an inspection. (Contact the facility manager of the charging station when there is a problem with charging station.)</p> <p>If charging cannot be carried out, even though there is no problem with the power source path, there may be a malfunction in the system. Have the vehicle inspected by your Toyota dealer.</p> <p>Furthermore, if the error warning indicator on the CCID (Charging Circuit Interrupting Device) is flashing, there may be an electrical leakage. Consult your Toyota dealer.</p>
<p>Charger has stopped charging</p>	<ul style="list-style-type: none"> • Charging may be canceled by an interruption of power supply depending on specifications of a charger. Refer to the instructions of the charger. • When charging is stopped using the charger • Equipment with charging schedule function • Equipment that is not compatible with the charging schedule function of the vehicle • Check if it is possible to charge with the charging cable equipped to the vehicle. <p>If charging cannot be carried out, even when using the genuine charging cable, consult your Toyota dealer.</p>

2

Plug-in hybrid system

Likely cause	Correction procedure
<input type="checkbox"/> If “Charging Stopped Check Charging Source” is shown (2)	
Charger is not compatible with vehicle	Check if it is possible to charge with the charging cable equipped to the vehicle. If charging cannot be carried out, even when using the genuine charging cable, consult your Toyota dealer.
Charger has stopped charging	
<input type="checkbox"/> If “Charging Stopped Check Charging Source” is shown (3)	
Problem in power supply from external power source	Check the following items. <ul style="list-style-type: none"> • Plug is securely inserted • Extension cord is not used and outlet is not overloaded • Connected to a dedicated power line • Electrical leakage has occurred or not If there is no problem with any of the above items, there may be a problem with the outlet of the building. Contact an electrician to request an inspection. If charging cannot be carried out, even though there is no problem with the power source path, there may be a malfunction in the system. Have the vehicle inspected by your Toyota dealer.
Charger has stopped charging	Check if it is possible to charge with the charging cable equipped to the vehicle. If charging cannot be carried out, even when using the genuine charging cable, consult your Toyota dealer.

Likely cause	Correction procedure
<input type="checkbox"/> If “Charging Stopped High Energy Use See Owner’s Manual” is shown	
Power is being consumed by electrical components of vehicle	Check the following items, and then carry out charging again. <ul style="list-style-type: none"> • If the headlights and audio are turned on, turn them off. • Turn the power switch off. If charging cannot be carried out, even after performing the above, the auxiliary battery may not be sufficiently charged. Operate the hybrid system for approximately 15 minutes or more to charge the auxiliary battery.
<input type="checkbox"/> If “Charging System Malfunction See Owner’s Manual” is shown	
Malfunction occurred in charging system	Have the vehicle inspected by your Toyota dealer.
<input type="checkbox"/> If “The Traction Battery became low temperature System put priority on charging to preserve battery condition” is shown (Alaska and Canada only)	
The Hybrid battery (traction battery) warming control was operated (→P. 136)	When the hybrid battery (traction battery) warning control operates, the charging schedule is not used and charging is performed. This is a control to protect the hybrid battery (traction battery), and not a malfunction.

Instrument cluster**3****3. Instrument cluster**

Combination meter.....	192
Warning lights and indicators	201
Main display	209
Multi-information display.....	220
Head-up display	253
Energy monitor/ consumption screen (vehicles with 7-inch display)	261
Energy monitor/ consumption screen/ detail screen (vehicles with 11.6-inch display)	267

Combination meter

The large meter uses 2 liquid crystal displays to display information such as the vehicle condition, driving status, electricity consumption and fuel consumption.

Combination meter layout

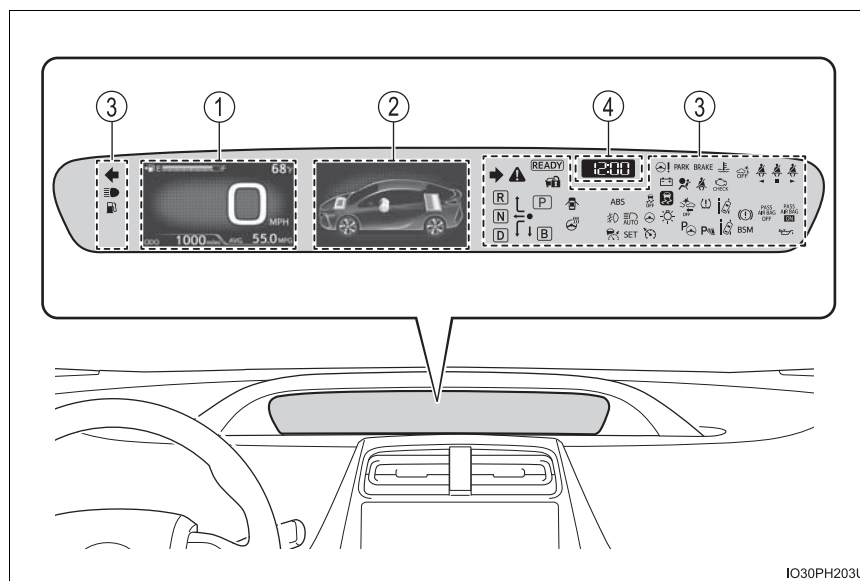

The units used on the display may differ depending on the target region.

① Main display (→P. 209)

The main display shows basic information related to driving, such as the vehicle speed and remaining fuel amount.

② Multi-information display (→P. 220)

The multi-information display shows information which makes the vehicle convenient-to-use, such as the hybrid system operation condition, electricity consumption and fuel consumption history. Also, the operation contents of the driving support systems and the combination meter display settings can be changed by switching to the settings screen.





③ Warning lights and indicators (→P. 201)

The warning lights and indicators comes on or flashes to indicate problems with the vehicle or to show the operation status of the vehicle's systems.



④ Clock (→P. 197)

Operations related to the combination meter

The meter control switches equipped on the steering wheel can be used to switch the screen display and change settings related to functions displayed on the screen.

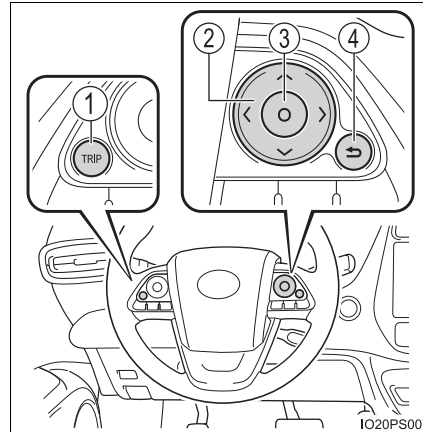
- ① Each time the button is pressed, the mileage display switches among odometer, trip meters, etc., and the fuel consumption information for each distance switches as well.
(→ P. 213)
- ② Pressing , ,  or  performs such operations as scrolling the screen*, switching the contents of the display* and moving the cursor.
- ③ This button is used to perform such operations as selecting the current item or switching between on and off.
- ④ When pressed, the display returns to the previous screen.



*: On screens where the screen can be scrolled and the display can be switched, marks are displayed to indicate the direction of operation (such as  and .

Instrument cluster light control

When the switches are pressed, the instrument cluster light changes as follows.

The instrument cluster brightness levels that can be selected differ depending on whether the tail lights are on and surrounding brightness levels. (→P. 199)

- ① Darker
- ② Brighter

When the switches are pressed, the adjustment level check screen (pop-up display^{*}) is displayed on the main display.

When the instrument cluster light is adjusted, the brightness of the instrument panel light also changes.

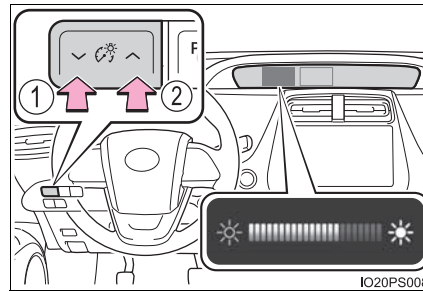

- ^{*}: A short time after the operation is completed, the pop-up display turns off. Furthermore, the pop-up display can be turned on and off in the “Meter Customize” settings. (→P. 248)

Information automatically displayed

Some information will be displayed automatically according to power switch operation, vehicle condition, etc.

■ When starting the hybrid system

When the hybrid system starts, an opening animation is displayed on the main display.

After the animation ends, the screens switch to the normal screen.

The opening animation will be stopped in any of the following situations.

- When the shift position is changed to other than P
- When the Simple Advanced Parking Guidance System (if equipped) is turned on



■ When the driving assist systems are operating

When using driving assist systems such as the dynamic radar cruise control with full-speed range (→P. 414) and LTA (Lane Tracing Assist) (→P. 395), information related to each system is automatically displayed on the multi-information display depending on the situation.

For details regarding the displayed information and the contents of the display, refer to the explanation page of each system.

■ When there is information to be notified about the vehicle

When a shift position is mistakenly selected or a problem occurs in a vehicle system, a warning message (or image) is displayed on the multi-information display.

When a warning message is displayed, follow the instructions displayed on the display. (→P. 684)

■ **When stopping the hybrid system**

● When the hybrid system is stopped, the “Ending” screen is displayed on the multi-information display (for approximately 30 seconds*1).

While the “Ending” screen is displayed, the following information can be displayed by pressing , ,  or  of the meter control switches.

- ① Score for each Eco score items (→P. 229, 243)
- ② Eco score result and advice
- ③ Driving time since the hybrid system started
- ④ Distance traveled since the hybrid system started
- ⑤ Average fuel consumption after the hybrid system started
- ⑥ Information for next charge schedule*2
- ⑦ On/off setting for “Charge Now” (→P. 166)

The setting can be switched each time  is pressed.

*1: The screen will be turned off immediately if the doors are locked.

*2: It can be displayed when the charge schedules are registered. (→P. 157)

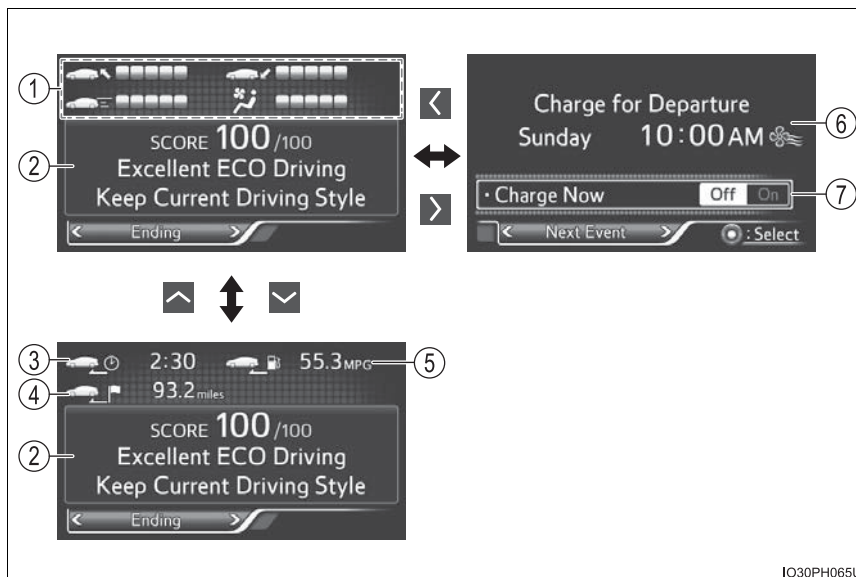







● A check screen for “Traction Battery Cooler” may be displayed when the hybrid system is stopped. (→P. 136)

Clock adjustment





To adjust the time, perform operations on the  screen (→P. 239) of the multi-information display.

■ Adjusting the time

1 Press  or  of the meter control switches on the steering wheel and select .

2 Press  or  of the meter control switches and select .

3 Press  to display the cursor.

4 Press  or  of the meter control switches to adjust the cursor position, and then press  or  to change the setting.

When the 12-hour display is selected, "12H" is displayed, and when the 24-hour display is selected, "24H" is displayed.

When adjusting minutes, operation automatically starts from 00 seconds.

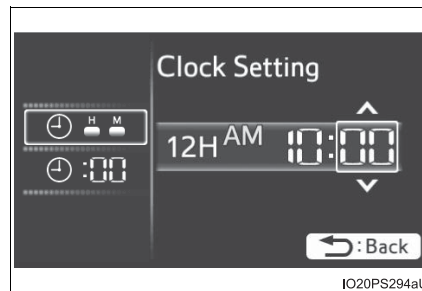

After changing the settings, press  to return to the previous screen.





3

Instrument cluster

■ **Resetting the minutes display**

1 Press  or  of the meter control switches on the steering wheel and select .

2 Press  or  of the meter control switches and select .



3 Press .

The minutes display switches to "00".*

*: e.g. 1:00 to 1:29 → 1:00

1:30 to 1:59 → 2:00

■ **The meters and display illuminate when**

The power switch is in ON mode.

■ **Adjusting the instrument cluster brightness (→P. 194)**

- The brightness levels that can be selected differ depending on whether the tail lights are on and surrounding brightness levels, as shown in the table below.

	The tail lights are off	The tail lights are on
In a bright place	2 levels*	2 levels*
In a dark place		22 levels

*: 22 levels of the brightness are displayed on the setting screen. However, the brightness setting will be the brightest when other than 1st level (the darkest) is selected. If other than 1st or 22nd level is selected, when the tail lights are turned on in a dark place, the instrument cluster brightness setting will be the selected level.

- If the taillights are illuminated in a dark environment, the instrument cluster light dims. However, when the brightness of the instrument cluster is set to minimum or maximum (1st or 22nd level of the instrument cluster brightness), even if the taillights are illuminated, the instrument cluster light will not dim.

■ **When disconnecting and reconnecting 12-volt battery terminals**

The settings of the clock will be reset.

■ **Calendar setting**

If calendar recording is interrupted due to replacement of the 12-volt battery or 12-volt battery discharge, etc., when the power switch is turned to ON mode after maintenance, the calendar setting check screen is automatically displayed on the multi-information display.

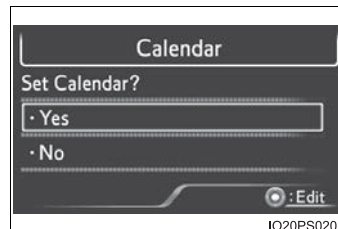

- If date information is not set, the electricity and fuel consumption record cannot be stored correctly. Also, the charging schedule function can not operate properly. When the calendar setting check screen is displayed, make sure to complete the calendar setting. (→P. 246)
- Until the calendar setting is completed, the check screen is displayed every time the power switch is turned to ON mode.
- After the calendar information is set, it can be changed in the “Meter Customize” settings. (→P. 248)

■ **When the menu screen on the navigation system is operated (vehicles with 11.6-inch display)**

A pop-up display of the menu screen icon is displayed on the multi-information display.*

*: The pop-up display on the navigation system can be turned off in the "Meter Customize" settings. (→P. 249)

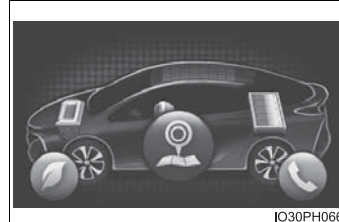

■ **Liquid crystal display**

Small spots or light spots may appear on the display. This phenomenon is characteristic of liquid crystal displays, and there is no problem continuing to use the display.

■ **Pop-up display**

Some functions, such as the driving mode select switch and air conditioning system, are operation-linked and display pop-up screens on the multi-information display. If the pop-up screens of these functions are not desired, they can be turned off in the "Meter Customize" settings. (→P. 248)

⚠ WARNING

■ **To prevent an accident**

Do not place anything or attach a sticker in front of the instrument cluster. The item may obscure or obstruct the display, or could reflect off the display, possibly causing an accident.

■ **Caution for use while driving**

For safety, avoid operating the meter control switch while driving as much as possible, and do not look continuously at the multi-information display while driving. Stop the vehicle and operate the meter control switch. Failure to do so may cause a steering wheel operation error, resulting in an unexpected accident.

⚠ NOTICE

■ **The information display at low temperatures**

Allow the interior of the vehicle to warm up before using the liquid crystal information display. At extremely low temperatures, the information display monitor may respond slowly, and display changes may be delayed.

Warning lights and indicators





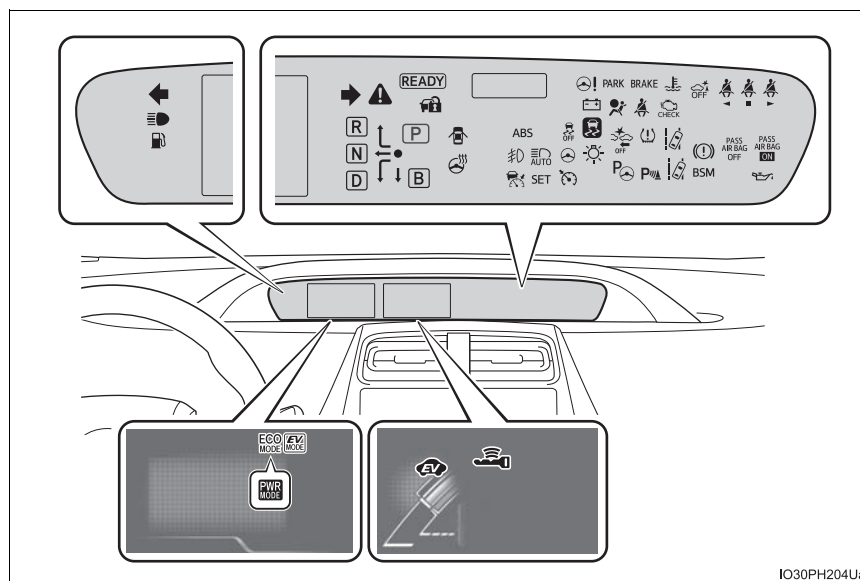







The warning lights and indicators inform the driver of the status of the vehicle's various systems.









For the purpose of explanation, the following illustration displays all indicators and warning lights illuminated.



Warning lights

Warning lights inform the driver of malfunctions in any of the vehicle's systems.

Warning lights			Pages
*1	BRAKE	Brake system warning light (U.S.A.)	P. 674
*1		Brake system warning light (Canada) (Red)	P. 674
*1		Brake system warning light (Yellow)	P. 674
*1		Charging system warning light	P. 674
*1		Low engine oil pressure warning light	P. 674
*1		Malfunction indicator lamp (U.S.A.)	P. 674
*1		Malfunction indicator lamp (Canada)	P. 674
*1		SRS warning light	P. 675
*1	ABS	ABS warning light (U.S.A.)	P. 675
*1		ABS warning light (Canada)	P. 675
*1		Electric power steering system warning light (Red/yellow)	P. 675
*1, 2		PCS warning light	P. 675
		LTA indicator (Orange)	P. 675
*1		Slip indicator light	P. 676

Warning lights			Pages
*1		High coolant temperature warning light	P. 676
*1, 3		PKSB OFF indicator (if equipped)	P. 676
		Open door warning light	P. 676
		Low fuel level warning light	P. 676
		Driver's and front passenger's seat belt reminder light	P. 677
		Rear passengers' seat belt reminder light (U.S.A.)	P. 677
		Rear passengers' seat belt reminder light (Canada)	P. 677
*1		Master warning light	P. 677
*1		Tire pressure warning light	P. 677













*1: These lights turn on when the power switch is turned to ON mode to indicate that a system check is being performed. They will turn off after the hybrid system is on, or after a few seconds. There may be a malfunction in a system if a light does not come on, or turn off. Have the vehicle inspected by your Toyota dealer.











*2: The light flashes or illuminates to indicate a malfunction.

*3: The light flashes to indicate a malfunction.

Indicators

The indicators inform the driver of the operating state of the vehicle's various systems.







Indicators		Pages
	Turn signal indicator	P. 351
	Headlight indicator (U.S.A.)	P. 353
	Tail light indicator (Canada)	P. 355
PARK	Parking brake indicator (U.S.A.)	P. 352
	Parking brake indicator (Canada)	P. 352
	Headlight high beam indicator	P. 355
	Fog light indicator (if equipped)	P. 363
	Security indicator	P. 83
READY	"READY" indicator	P. 338
	Shift position indicators	P. 345
*1, 2	 Slip indicator light	P. 502
*1, 3	 VSC OFF indicator	P. 503
	 Cruise control indicator	P. 425
	 Dynamic radar cruise control indicator	P. 420

Indicators			Pages
	SET	Cruise control "SET" indicator	P. 420
*1, 3	 OFF	PCS warning light	P. 388
*4		LTA indicator	P. 404
		Steering control indicator	P. 404
		Automatic High Beam indicator	P. 358
		Heated steering wheel indicator (if equipped)	P. 540
	BSM	"BSM" indicator (if equipped)	P. 432
		Intuitive parking assist indicator (if equipped)	P. 445
*1, 3	 OFF	PKSB OFF indicator (if equipped)	P. 456
*1		S-APGS indicator (if equipped)	P. 471
*1		"AIR BAG ON/OFF" indicator (U.S.A.)	P. 50
*1		"AIR BAG ON/OFF" indicator (Canada)	P. 50

- *1: These lights turn on when the power switch is turned to ON mode to indicate that a system check is being performed. They will turn off after the hybrid system is on, or after a few seconds. There may be a malfunction in a system if a light does not come on, or turn off. Have the vehicle inspected by your Toyota dealer.
- *2: The light flashes to indicate that the system is operating.
- *3: The light comes on when the system is turned off.
- *4: Depending on the operating condition, the color and illuminating/flashing state of the light change.

Indicators and symbols displayed on the display





■ Main display and multi-information display

Indicators			Pages
*1		EV drive mode indicator	P. 90
*1		EV auto mode indicator	P. 90
*1		Hybrid battery charge mode indicator	P. 91
*2		“ECO MODE” indicator	P. 430
*2		“PWR MODE” indicator	P. 430
		EV indicator	P. 227

*1: The displayed indicator changes according to the current plug-in hybrid system operation mode.

*2: The displayed indicator changes according to the current driving mode.

■ Multi-information display (symbol display*)

Symbol display		Pages
	Smart key system	P. 338
	Brake Override System/ Drive-Start Control/Parking Support Brake function (if equipped)	P. 678
	LTA (Lane Tracing Assist)	P. 408
		P. 408
	Low engine oil pressure warning (Canada only)	P. 678

*: These symbols are displayed along with a message. Also, the symbol displays listed here are only an example, and different symbols may be displayed according to the contents of the multi-information display.

■ BSM (Blind Spot Monitor) outside rear view mirror indicators (if equipped) (→P. 432)

- Indicators are also displayed on the outside rear view mirrors.
- In order to confirm operation, the BSM outside rear view mirror indicators illuminate in the following situations:

- When the power switch is in ON mode, the BSM function is enabled

on the  screen of the multi-information display.

- When the BSM function is enabled on the  screen of the multi-information display, the power switch is turned to ON mode.

If the system is functioning correctly, the BSM outside rear view mirror indicators will turn off after a few seconds.

If the BSM outside rear view mirror indicators do not illuminate or do not turn off, there may be a malfunction in the system.

If this occurs, have the vehicle inspected by your Toyota dealer.

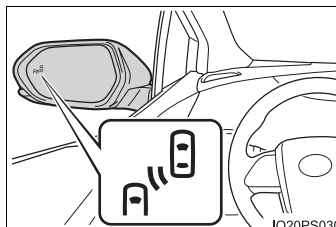

WARNING

■ If a safety system warning light does not come on

Should a safety system light such as the ABS and SRS warning light not come on when you start the hybrid system, this could mean that these systems are not available to help protect you in an accident, which could result in death or serious injury. Have the vehicle inspected by your Toyota dealer immediately if this occurs.

NOTICE

■ To prevent damage to the engine and its components

The engine may be overheating if the high coolant temperature warning light comes on or flashes. In this case, immediately stop the vehicle in a safe place, and check the engine after it has cooled completely. (→P. 721)

Main display

The main display shows basic information, such as the vehicle speed and remaining fuel amount. Also, the displayed information can be switched according to user preference.

Display contents (vehicles without RSA [Road Sign Assist])

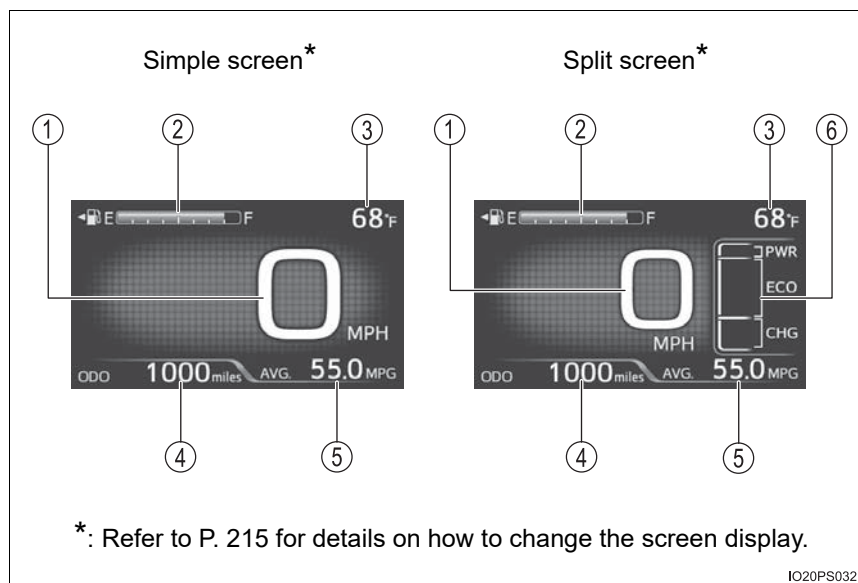

3

Instrument cluster

The units used on the display may differ depending on the target region.

- ① **Speedometer**
Displays the vehicle speed
- ② **Fuel gauge**
Displays the quantity of fuel remaining in the tank
- ③ **Outside temperature**
Displays the outside temperature within the range of -40°F (-40°C) to 122°F (50°C).
The temperature display flashes for approximately 10 seconds when the outside temperature drops to approximately 37°F (3°C) or less, and then stops flashing.
- ④ **Mileage display (odometer/trip meters/driving range)**
The possible driving range estimated from the mileage and current remaining fuel amount can be displayed. (→P. 213)
- ⑤ **Average fuel consumption display**
The average electricity and fuel consumption that is linked with the contents of the mileage display can be displayed. (→P. 213)
- ⑥ **Sub-screen**
When split screen is selected for the main display, information such as the Hybrid System Indicator and current fuel consumption can be displayed. (→P. 215)

Display contents (vehicles with RSA [Road Sign Assist])

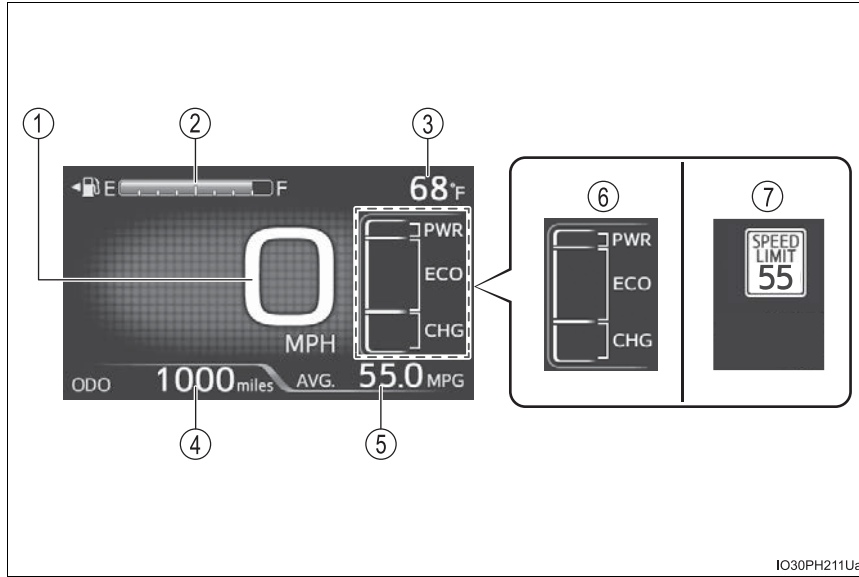

The units used on the display may differ depending on the target region.

3
Instrument cluster

-
- ① **Speedometer**
Displays the vehicle speed
 - ② **Fuel gauge**
Displays the quantity of fuel remaining in the tank
 - ③ **Outside temperature**
Displays the outside temperature within the range of -40°F (-40°C) to 122°F (50°C).
The temperature display flashes for approximately 10 seconds when the outside temperature drops to approximately 37°F (3°C) or less, and then stops flashing.
 - ④ **Mileage display (odometer/trip meters/driving range)**
The possible driving range estimated from the mileage and current remaining fuel amount can be displayed. (→P. 213)
 - ⑤ **Average fuel consumption display**
The average fuel consumption that is linked with the contents of the mileage display can be displayed. (→P. 213)
 - ⑥ **Sub-screen (when RSA [Road Sign Assist] is off)**
Information such as the Hybrid System Indicator and current fuel consumption can be displayed. (→P. 216)
 - ⑦ **Sub-screen (when RSA [Road Sign Assist] is on)**
Displays information related to RSA (Road Sign Assist)*. (→P. 410)
- *: When RSA (Road Sign Assist) information is displayed in the  screen of the multi-information display (→P. 245), RSA (Road Sign Assist) information is not displayed on the sub-screen.

Switching the mileage display and average fuel consumption display

Each time  is pressed, the mileage display and fuel consumption display change in the following order from 1 to 7.

- ① Mileage display
- ② Average fuel consumption display

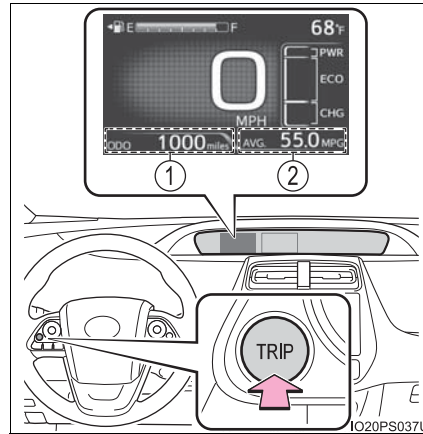

After 1 to 7 are displayed, the displays return to 1.

Use the displayed average fuel consumption as a reference.



3

Instrument cluster

	① Mileage display	② Average fuel consumption display
1	ODO (Odometer) Total mileage	Average fuel consumption since last reset Average fuel consumption since last reset* ¹
2	TRIP A (Trip meter A) Mileage since last reset* ¹	TRIP A average fuel consumption Average fuel consumption since TRIP A was reset* ¹
3	TRIP B (Trip meter B) Mileage since last reset* ¹	TRIP B average fuel consumption Average fuel consumption since TRIP B was reset* ¹
4	 (Mileage since hybrid system was started) Mileage since hybrid system started* ²	Average fuel consumption after hybrid system started Average fuel consumption since hybrid system was started* ²
5	 (Distance to empty) Approximate distance vehicle can travel based on current remaining fuel amount	Blank screen
6	 (EV driving range) Approximate driving range using only the electric motor (traction motor) (→P. 108)* ^{3, 4, 5}	Blank screen
7	Blank screen	Blank screen

*¹: If  is pressed and held while this item is displayed, the information is reset.

*²: This item is reset each time the hybrid system starts.

*³: This value is not displayed if electricity needed for EV driving is not remaining.









*⁴: When the air conditioning system is operating, the icon display changes to  and the driving range with the air conditioning system on is displayed.

*⁵: The EV driving range may shorten even when not driving due to power consumption by the system.



Switching the display mode (vehicles without RSA [Road Sign Assist])

Simple screen or split screen can be selected for the main display.

When split screen is selected, a variety of information can be displayed on a sub-screen in addition to the contents of the simple screen.

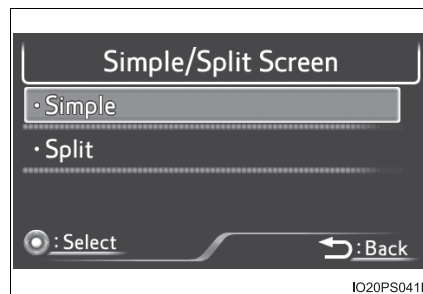
- 1 Select the "Meter Customize" settings () screen on the  screen of the multi-information display, and then press  .
(→P. 246)
- 2 Press  or  of the meter control switches to select "Simple/ Split Screen".
- 3 Press  to display the setting screen.
- 4 Press  or  of the meter control switches to select a display mode.



- 5 Press  .
The contents of the main display switch to the selected display mode.
Press  to return to the previous screen.

3
Instrument cluster



Switching contents displayed on the sub-screen

▶ Vehicles without RSA (Road Sign Assist)

When split screen is selected for the main display, display contents on the sub-screen can be selected.

▶ Vehicles with RSA (Road Sign Assist)



When RSA (Road Sign Assist) is off, display contents on the sub-screen can be selected.

- 1 Press  or  of the meter control switches and select the sub-screen.

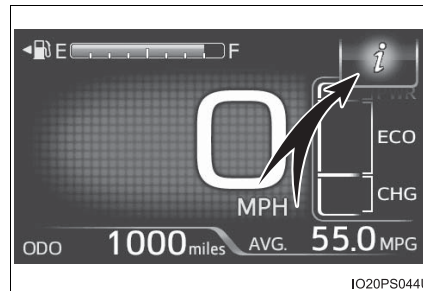

When the sub-screen is selected,

 is displayed on the sub-screen.

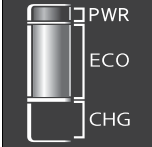
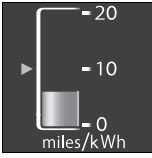
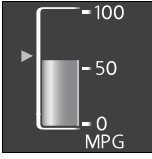

- 2 Press  or  of the meter control switches to select the display item.

One of the following 4 items can be displayed.

Display contents	Detail
	<p>Hybrid System Indicator A convenient Hybrid System Indicator is displayed. Refer to P. 225 for details on how to read the Hybrid System Indicator.</p>
	<p>Current electricity consumption When in EV/EV auto mode, the current electricity consumption during driving is displayed.</p> <ul style="list-style-type: none"> • The ► mark indicates the total average electricity consumption since last reset until it is reset again. • When “Electricity Consumption Reset” (→P. 250) is performed, the data of the total average electricity consumption is deleted and the ► mark is reset to 0.
	<p>Current fuel consumption When in HV mode, the current fuel consumption during driving is displayed.</p> <ul style="list-style-type: none"> • The ► mark indicates the value displayed in the average fuel consumption display (→P. 213). Switching the average fuel consumption display also changes the position of the ► mark. • When the average fuel consumption is reset, the position of the ► mark is reset to 0.
	<p>Hybrid battery (traction battery) status The same contents as the hybrid battery (traction battery) status on the Hybrid System Indicator are displayed. (→P. 225)</p>

■ Outside temperature display

- In the following situations, the correct outside temperature may not be displayed, or the display may take longer than normal to change.

- When stopped, or driving at low speeds (less than 12 mph [20 km/h])
- When the outside temperature has changed suddenly (at the entrance/exit of a garage, tunnel, etc.)

- When “-” or “E” is displayed, the system may be malfunctioning.

Take your vehicle to your Toyota dealer.

■ Electricity consumption

When the unit is set to “MPH”:

Electricity consumption is the consumption rate of the electricity when EV driving is performed and equivalent to the fuel consumption for the gasoline vehicles. For this vehicle, driven distance per kWh of electricity consumed (“miles/kWh”) is displayed as electricity consumption on each screen.

When the unit is set to “km/h”:

Electricity consumption is the consumption rate of the electricity when EV driving is performed and equivalent to the fuel consumption for the gasoline vehicles. For this vehicle, electricity consumed per 100 km (“kWh/100 km”) is displayed as electricity consumption on each screen.

■ EV driving range

→P. 108

■ Distance to empty

- This distance is computed based on your average fuel consumption. As a result, the actual distance that can be driven may differ from that displayed.
- When only a small amount of fuel is added to the tank, the display may not be updated.

When refueling, turn the power switch off. If the vehicle is refueled without turning the power switch off, the display may not be updated.

■ **Switching the driving mode (→P. 430)**

When the driving mode is switched, the driving mode indicator changes and an animation* is displayed on the multi-information display.

Also, the background color of the main display, energy monitor (→P. 223) and Hybrid System Indicator (→P. 225) change as follows.

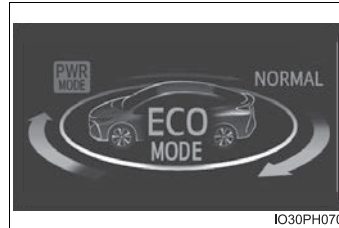

Driving modes	Background color
Normal mode	Green
Power mode	Red
Eco drive mode	Blue



*: The animation displayed when the driving mode is switched can be turned off in the “Meter Customize” settings. (→P. 248)

Multi-information display

A variety of information related to the vehicle can be displayed, including the operation status of each system and data related to Eco driving, and the settings of each system can be changed according to user preference.







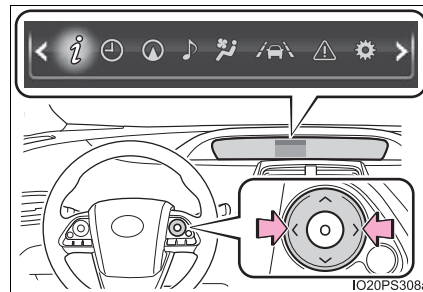

Display contents

Information related to each icon on the upper portion of the multi-information display can be displayed by operating the meter control switches to select the icon.

Icons are displayed when pressing  or  of the meter control switches and turn off shortly after pressing the switch.



Screens linked with vehicle functions may be automatically displayed according to the operation status of the corresponding functions.



Menu icons	Contents	Pages
	Drive information The energy monitor that shows the operation status of the hybrid system, or other information such as electricity consumption and fuel consumption are displayed.	P. 222
	Clock setting display The clock settings can be changed.	P. 239
	Navigation system-linked display (if equipped) The information related to the navigation system is displayed.	P. 240
	Audio system-linked display The audio system settings can be changed.	P. 240
	Air conditioning system settings screen The air conditioning system settings can be changed.	P. 241
	Driving assist system information The information related to driving assist systems such as the LTA (Lane Tracing Assist) and dynamic radar cruise control with full-speed range is displayed.	P. 245
	Warning message display* The warning messages are displayed.	P. 245
	Settings display The settings of the vehicle functions, meter display, etc. can be changed.	P. 246

*: When there is a warning message that can be displayed, the color of  changes to amber.



Basic Operations

- 1 Press  or  of the meter control switches and select the icon of the desired item.



The selected icon is highlighted and the display switches to the information screen.

When split screen display is selected for the main display or RSA (Road Sign Assist)* is off, the sub-screen of the main display can also be selected. (→P. 216)

*: If equipped

- 2 Press  or  of the meter control switches to switch the contents of the display.

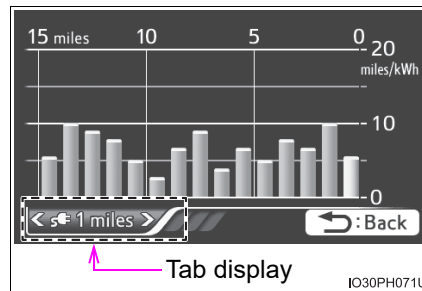

- 3 Press  on screens where it is necessary to select or confirm an item.

On screens with tab displays, pressing  selects the tab display, and the screen display can be changed by pressing  or  of the meter control switches.



- 4 Press  to return to the previous screen.

Drive information

When  is selected, the following information can be displayed by pressing  or  of the meter control switches.

- Energy monitor (→P. 223)
- Hybrid System Indicator (→P. 225)
- “Fuel Consumption Record” (→P. 233)
- “Drive Monitor” (→P. 236)
- “Drive Monitor 2” (→P. 237)
- “Eco-Diary” (→P. 238)

◆ Energy monitor

The energy monitor can be used to check the vehicle drive status, hybrid system operation status and energy regeneration status.

While charging from the external power source, the flow of electrical energy while charging is displayed.

When energy is flowing, an arrow appears and a bright point of light moves to show the direction of the flow of energy. When energy is not flowing, the bright point of light is not displayed.

- The arrows from the image of the engine to that of the electric motor (traction motor) or tires are displayed in red.
- The arrow indicating energy consumption is displayed in yellow, and the arrow indicating energy regeneration or charging is displayed in green. Also, the color around the image of the hybrid battery (traction battery) is changed.

As an example, all arrows are shown in the illustration, but the actual contents of the display will differ.

■ Except when charging

- ① Gasoline engine
- ② Electric motor (traction motor)
- ③ Air conditioning system operation*1
- ④ Hybrid battery (traction battery)
- ⑤ Tire
- ⑥ Bright point of light showing the flow of energy

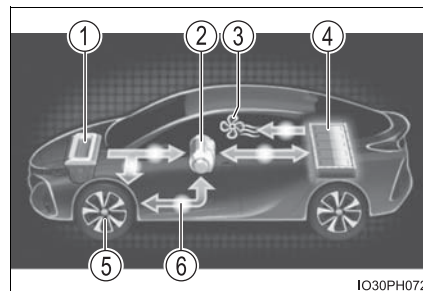

(Display example)

- When the hybrid battery (traction battery) is being charged, the bright point of light moves towards ④.
- During driving, the bright point of light moves from ① or ② (or both depending on the situation) towards ⑤.*2
- When the air conditioning compressor is operating, a bright point of light moves from ④ to ③.
- During driving, the image of the tires rotates.

*1: It is displayed while the air conditioning system is operating.

*2: The display may differ depending on the driving status.

■ **While charging**

- ① Hybrid battery (traction battery)
- ② Charging connector

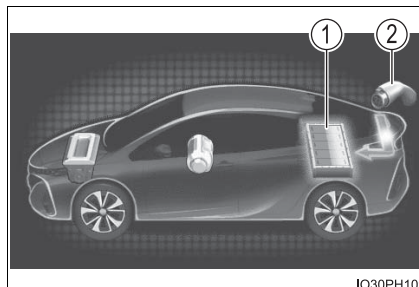

(Display example)

When the hybrid battery (traction battery) is being charged, a bright point of light moves from ② to ①.

■ **When the charging connector is locked (vehicles with smart lid & connector locking system) (→P. 148)**

 is displayed in the charging connector display portion on the energy monitor.

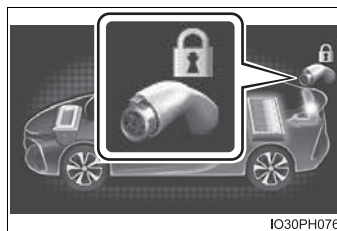

◆ Hybrid System Indicator

The display changes according to accelerator pedal operation and displays the current driving status and energy regeneration status.

The display contents of the Hybrid System Indicator are different in EV mode and HV mode.

The Hybrid System Indicator can be displayed on the sub-screen of the main display (→P. 217) and the head-up display (if equipped) (→P. 254).

■ How to read the display

► In EV mode

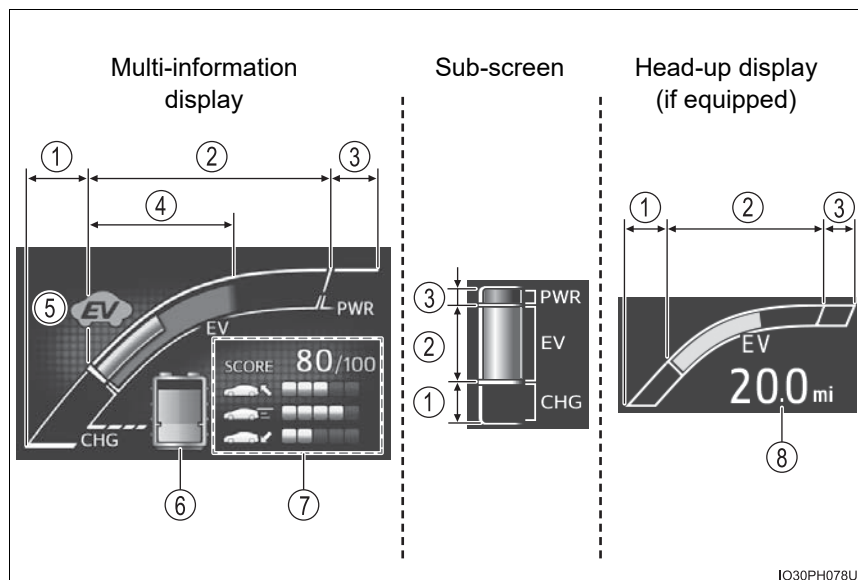

- ① Charge area
Shows that energy is being recovered via the regenerative charging.
- ② EV driving area
Shows that the vehicle is driven using only the electric motor (traction motor).
- ③ Gasoline engine running area
Shows that the gasoline engine is used as auxiliary power.
- ④ Eco area
Shows that the vehicle is being driven in an Eco-friendly manner.
Changed within the “ECO Accelerator Guidance” range. (→P. 228)*1

⑤ EV indicator*^{1, 2}

The EV indicator comes on when the vehicle is driven using only the electric motor (traction motor) or the gasoline engine is stopped.

⑥ Hybrid battery (traction battery) status

→P. 231

⑦ Eco score

→P. 229

⑧ EV driving range

→P. 254

● By keeping the indicator within Eco area, more Eco-friendly driving can be achieved.

● Charge area indicates regeneration*³ status. Regenerated energy will be used to charge the hybrid battery (traction battery).

*¹: Not displayed on the sub-screen or head-up display.

*²: The EV indicator function can be turned off in the "Meter Customize" settings. (→P. 248)

*³: When used in this manual, "regeneration" refers to the conversion of energy created by the movement of the vehicle into electrical energy.

► In HV mode

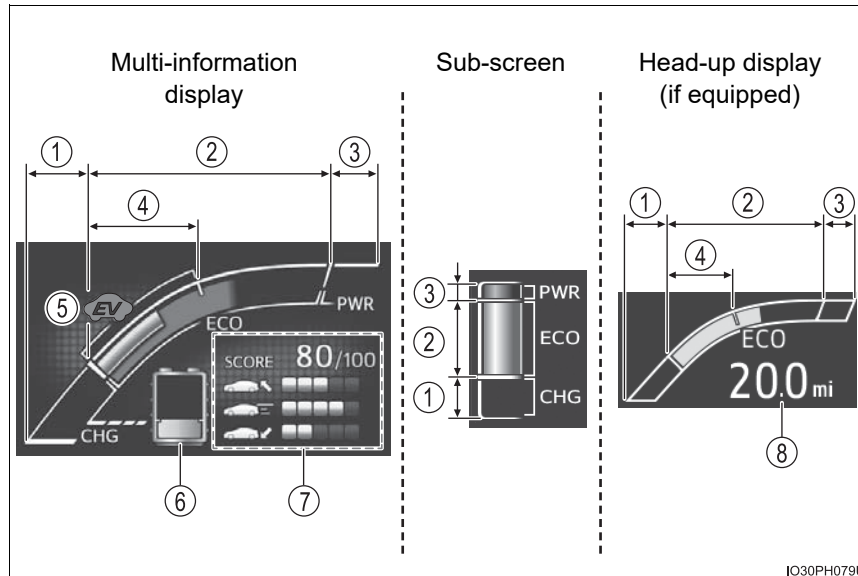

- ① Charge area
Shows that energy is being recovered via the regenerative charging.
- ② Eco area
Shows that the vehicle is being driven in an Eco-friendly manner.
Changed within the “ECO Accelerator Guidance” range. (→P. 228)*1
- ③ Power area
Shows that an Eco-friendly driving range is being exceeded (during full power driving etc.)
- ④ Hybrid Eco area*2
Shows that gasoline engine power is not being used very often.
The gasoline engine will automatically stop and restart under various conditions.
- ⑤ EV indicator*1, 3
The EV indicator comes on when the vehicle is driven using only the electric motor (traction motor) or the gasoline engine is stopped.
- ⑥ Hybrid battery (traction battery) status
→P. 231
- ⑦ Eco score
→P. 229
- ⑧ EV driving range
→P. 254

3
Instrument cluster

- By keeping the indicator within Eco area, more Eco-friendly driving can be achieved.
- Charge area indicates regeneration*4 status. Regenerated energy will be used to charge the hybrid battery (traction battery).

*1: Not displayed on the sub-screen or head-up display.

*2: Not displayed on the sub-screen.

*3: The EV indicator function can be turned off in the “Meter Customize” settings. (→P. 248)

*4: When used in this manual, “regeneration” refers to the conversion of energy created by the movement of the vehicle into electrical energy.

■ **“ECO Accelerator Guidance”**

A blue zone is displayed in the Eco area which can be used as a reference operation range for using the accelerator pedal according to driving conditions such as starting off and cruising.

The “ECO Accelerator Guidance” display changes according to the driving status, such as when starting off or cruising.

It is easier to drive in an Eco-friendly manner by driving according to the display showing the accelerator pedal operations and staying within the “ECO Accelerator Guidance” range. (→P. 322)

The “ECO Accelerator Guidance” function can be turned off in the “Meter Customize” settings. (→P. 248)

▶ In EV mode

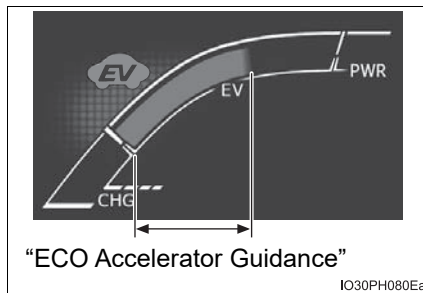

▶ In HV mode

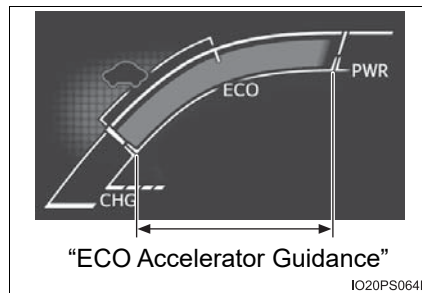

■ **Eco score**

The driving status for the following 3 situations are evaluated in 5 levels: Smooth start-off acceleration (“Eco-Start”), driving without sudden acceleration (“Eco-Cruise”) and smooth stopping (“Eco-Stop”). Each time the vehicle is stopped, a score result is displayed out of a perfect score of 100 points.

- ① Score result
- ② “Eco-Start” status
- ③ “Eco-Cruise” status
- ④ “Eco-Stop” status

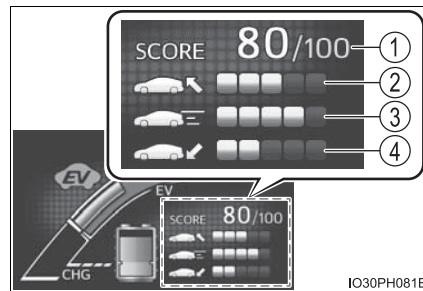

3

Instrument cluster

How to read the bar display:

Score	Low*	High
Bar display		

*: For items not currently evaluated, the display reads 0.

- The Eco score is reset each time the vehicle starts off to start a new evaluation.
- When the shift position is P, only the Eco score display area is enlarged and displayed. When the shift position is shifted from P, the display returns to normal.
- When the hybrid system stops, the current total score result and advice on how to increase the score are displayed. (→P. 196)

■ **Information display of EV driving**

One of the following 2 information in the items of “HV System Indicator” in “Meter Customize” settings can be selected to display in the left upper corner of the Hybrid System Indicator. (→P. 248)

▶ “EV Energy”

The percentage of the remaining hybrid battery (traction battery) that can be used for EV driving is displayed.

Becomes 100% when the hybrid battery (traction battery) is fully charged.

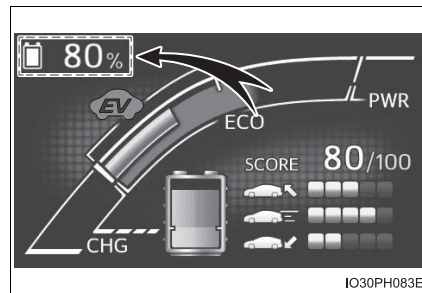

▶ “EV Distance”

The approximate distance that can be driven using only the electric motor (traction motor). (→P. 108)

When the air conditioning system is operating, the icon display changes to  and the driving range with the air conditioning system on is displayed.

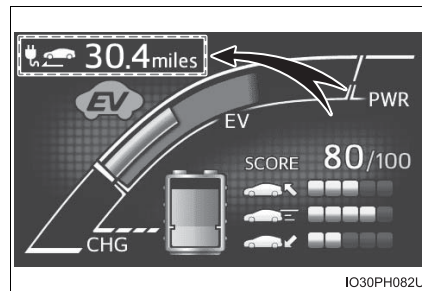

■ When operation of each function stops

- The Hybrid System Indicator stops operating in the following situations.
 - The “READY” indicator is not illuminated.
 - The shift position is not D or B.
- The Eco score and “ECO Accelerator Guidance” stop operating in the following situations.
 - The Hybrid System Indicator is not operating.
 - Dynamic radar cruise control with full-speed range is being used.

■ Display of the remaining hybrid battery (traction battery)

- The current amount of the remaining hybrid battery (traction battery) is displayed in the Hybrid System Indicator or the sub-screen on the main display. (→P. 217)
 - The remaining battery for EV driving in EV mode is displayed in green, and the remaining battery used in HV mode is displayed in blue.
 - The amount of the remaining battery displayed decrease as the vehicle is driven and increase when the hybrid battery (traction battery) is charged, electrical energy is regenerated using the regenerative braking (→P. 94) or electricity is generated by the gasoline engine.
 - If the remaining battery is not displayed in green, HV mode is automatically selected and EV mode cannot be used. To enable EV driving, charge the hybrid battery (traction battery). (→P. 110)

- ① The hybrid battery (traction battery) is fully charged
- ② The hybrid battery (traction battery) for EV mode is not remaining

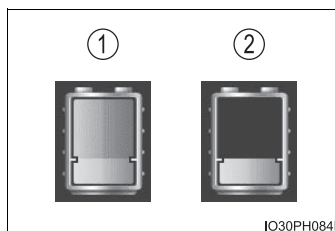

- The amount of the hybrid battery (traction battery) in HV mode is automatically controlled by the hybrid system. The amount of remaining hybrid battery (traction battery) in HV mode may not reach the top line* even if electrical energy is regenerated using the regenerative braking (→P. 94) or electricity is generated by the gasoline engine. However, this does not indicate a malfunction. Also, even if the display of the remaining hybrid battery (traction battery) exceeds the top line, the display is shown in blue until the vehicle returns to EV mode.

*: The position of the boundary line between EV mode and HV mode on the display of the remaining hybrid battery (traction battery).

- Depending on the charging situation, when the display of the remaining hybrid battery (traction battery) is shown during charging, charging continues even after the display of the remaining hybrid battery (traction battery) shows a fully charged state. However, this does not indicate a malfunction. Please wait until charging is finished.

■ Remaining charge amount warning of hybrid battery (traction battery)

- The buzzer sounds intermittently when the hybrid battery (traction battery) remains without charging while the shift position is in N, or the remaining charge amount drops below a certain level.
If the remaining charge amount drops further, the buzzer sounds continuously.
- When a warning message is shown on the multi-information display and the buzzer sounds, follow the instructions displayed on the screen to perform troubleshooting.

■ About the Eco score

- After starting off, Eco score display does not start until the vehicle speed exceeds approximately 19 mph (30 km/h).
- In addition to the vehicle driving status, the Eco score also evaluates the air conditioning system usage condition (→P. 243). The score displayed when the hybrid system stops is the total result of the driving status after the hybrid system starts and the air conditioning usage condition.

■ “EV Energy” and “EV Distance” display

The rate at which the “EV Energy” and “EV Distance” remaining amount decreases depends on the driving conditions of the vehicle. Also, the “EV Energy” and “EV Distance” remaining amount may decrease due to system power consumption even though the vehicle is not being driven.

■ Predictive Efficient Drive (Predictive Deceleration Support) (vehicles with 11.6-inch display)

When a predictive deceleration support point registered in the navigation system is approached, the system turns off the Eco accelerator guide and informs the driver of releasing the accelerator pedal early.

For details about Predictive Efficient Drive (Predictive Deceleration Support), refer to “NAVIGATION SYSTEM OWNER’S MANUAL”.

◆ **“Fuel Consumption Record”**

▶ When the unit is set to “MPH”

The transitions of the average fuel consumption after the hybrid system starts can be checked in units of 1 mile (1.6 km) or 5 miles (8 km) of driving.

▶ When the unit is set to “km/h”

The transitions of the average fuel consumption after the hybrid system starts can be checked in units of 1 km (0.6 mile) or 5 km (3.1 miles) of driving.

■ **How to read the screen**

The “ 1 miles” display is shown as an example. However, the basic method for how to read the screen is the same for each fuel consumption history screen.

- ① Current average electricity and fuel consumption record (yellow display)

When the unit is set to “MPH”:

When the recorded unit is exceeded (every 1 mile [1.6 km] or 5 miles [8 km]) the currently displayed history moves towards the left side and the oldest record is deleted.

When the unit is set to “km/h”:

When the recorded unit is exceeded (every 1 km [0.6 mile] or 5 km [3.1 miles]) the currently displayed history moves towards the left side and the oldest record is deleted.



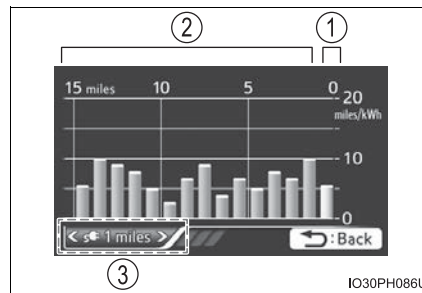

- ② Past average electricity and fuel consumption record (green display)
- ③ Tab display

Displays types of “Fuel Consumption Record”.







■ Types of “Fuel Consumption Record”

▶ When the unit is set to “MPH”

Tab display	Recorded contents	Recorded range
“  1 miles”	Average electricity consumption of every 1 mile (1.6 km) driven [*]	The last 15 miles (24.1 km) driven
“  5 miles”	Average electricity consumption of every 5 miles (8 km) driven [*]	The last 30 miles (48.3 km) driven
“  1 miles”	Average fuel consumption of every 1 mile (1.6 km) driven [*]	The last 15 miles (24.1 km) driven
“  5 miles”	Average fuel consumption of every 5 miles (8 km) driven [*]	The last 30 miles (48.3 km) driven

^{*}: This record is reset each time the hybrid system stops.

▶ When the unit is set to “km/h”



Tab display	Recorded contents	Recorded range
“  1 km”	Average electricity consumption of every 1 km (0.6 mile) driven [*]	The last 15 km (9.3 miles) driven
“  5 km”	Average electricity consumption of every 5 km (3.1 miles) driven [*]	The last 30 km (18.6 miles) driven
“  1 km”	Average fuel consumption of every 1 km (0.6 mile) driven [*]	The last 15 km (9.3 miles) driven
“  5 km”	Average fuel consumption of every 5 km (3.1 miles) driven [*]	The last 30 km (18.6 miles) driven

^{*}: This record is reset each time the hybrid system stops.

■ Switching the electricity and fuel consumption history screen





- 1 While the “Fuel Consumption Record” screen is displayed, press .

The tab display is selected and it is possible to switch the contents of the display.





- 2 Press  or  of the meter control switches to switch the contents of the display.

Each time  is pressed, the display switches in the following order:

- ▶ When the unit is set to “MPH”

“ 1 miles”, “ 5 miles”, “ 1 miles” and “ 5 miles”^{*1}. When  is pressed, it switches in the reverse order.

- ▶ When the unit is set to “km/h”

“ 1 km”, “ 5 km”, “ 1 km” and “ 5 km”^{*2}. When  is pressed, it switches in the reverse order.

^{*1}: After “ 5 miles”, the display returns to “ 1 miles”.

^{*2}: After “ 5 km”, the display returns to “ 1 km”.

◆ “Drive Monitor”

Displays information such as the driving time and average vehicle speed, which are linked with the current mileage display. (→P. 213)

- ① Current contents of the display

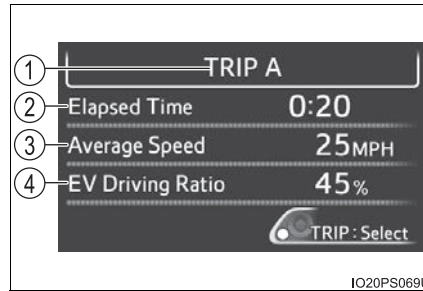

Displayed information shows which driving record the currently displayed contents are based on.

- ② “Elapsed Time”
- ③ “Average Speed”
- ④ “EV Driving Ratio”



For the displayed distance of the mileage display, the percent traveled using only electric motor power is displayed.

Each time  is pressed, the mileage display (→P. 213) switches and the contents of the “Drive monitor” change as follows.

Mileage display	①	Contents of the “Drive monitor”
ODO	After Reset	Information since last reset*1
TRIP A	TRIP A	Information based on driving record of TRIP A*2
TRIP B	TRIP B	Information based on driving record of TRIP B*2
	After Start	Information since hybrid system was started*3
		
		
Blank screen		

*1: When the average fuel consumption is reset (→P. 214), the “Drive monitor” display is also reset.

*2: When the trip meter is reset (→P. 214), the “Drive monitor” display is also reset.

*3: This item is reset each time the hybrid system starts.

◆ “Drive Monitor 2”

The following information of EV driving is displayed.

- ① Total average electricity consumption

Indicates the total average electricity consumption since last reset until it is reset again.*1

- ② EV driving range (without using the air conditioning system)

Indicates the estimated distance that can be driven using the current remaining hybrid battery (traction battery). (→P. 108)*2

- ③ EV driving range (with using the air conditioning system)

Indicates the estimated distance that can be driven using the current remaining hybrid battery (traction battery) while using the air conditioning system.*2

*1: When “Electricity Consumption Reset” (→P. 250) is performed, the data of the total average electricity consumption is deleted.

*2: The EV driving range may shorten even when not driving due to power consumption by the system.

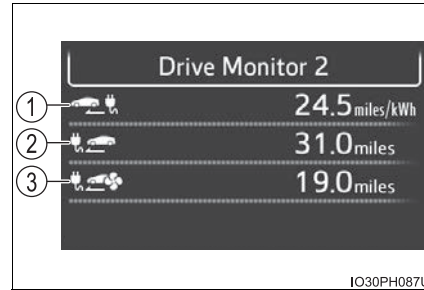

◆ “Eco-Diary”

The history of the average electricity consumption, air conditioning system load ratio (“A/C Load Ratio”)*, distance traveled and average fuel consumption can be displayed in a table according to day (“Daily”) or month (“Monthly”) units.

*: It indicates the percentage of the electricity consumed from the hybrid battery (traction battery) that is consumed by the air conditioning system.

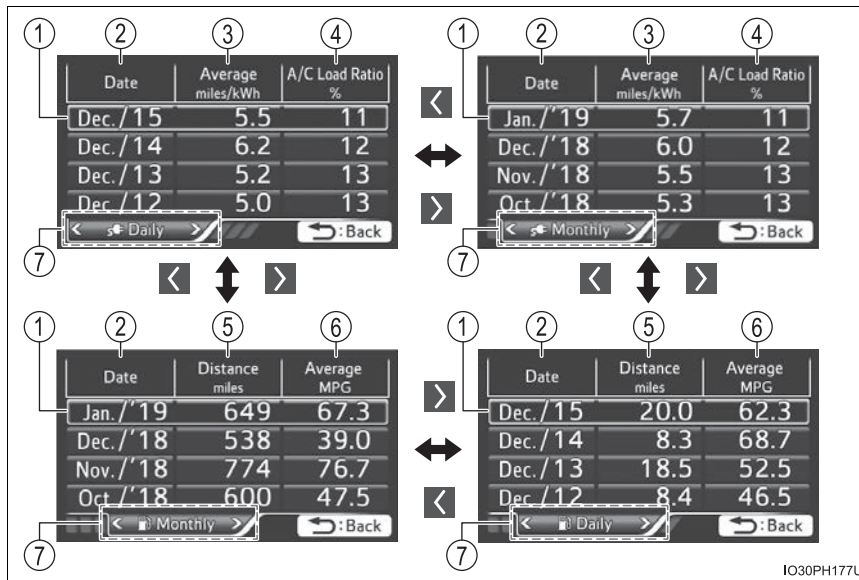

■ How to read the display



- ① Record of the day/month
- ② Date/month of stored information
- ③ Average electricity consumption of the day/month
- ④ “A/C Load Ratio” of the day/month
- ⑤ Total distance traveled for the day/month
- ⑥ Average fuel consumption of the day/month
- ⑦ Tab display

The display can be switched by pressing to enter the select condition, and then operating or of the meter control switches.

■ **Checking history**

When each screen is selected, past records from the following ranges can be displayed by pressing  or  of the meter control switches.

Displayed screen	Displayed information	Stored information
“Daily”	4 reports	Up to 32 reports (8 screens)
“Monthly”		Up to 12 reports (3 screens)



- If the above number of records is exceeded, the oldest information is deleted.
- To reset the history, perform “History Reset” in the “Meter Customize” settings (→P. 248). (“Daily” and “Monthly” information can be reset independently.)

■ **Calendar setting**

→P. 251

 **Clock setting display**

The clock settings can be changed.

Item	Setting result
	Adjusts the clock. (→P. 197)
	Sets the minutes to “00”. (→P. 198)

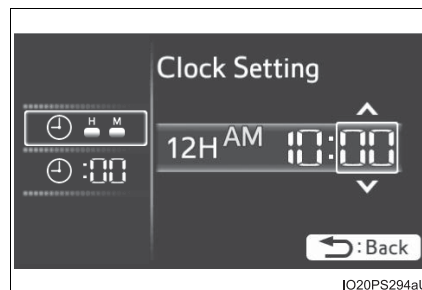



Navigation system-linked display (if equipped)

Displays a compass linked with the navigation system. Also, when the navigation system is performing intersection guidance during destination guidance, the intersection guidance is also displayed on the multi-information display.

The illustration is only an example and may differ from the actual screen.

For details on how to set the destination and switch the map direction, refer to "NAVIGATION SYSTEM OWNER'S MANUAL".

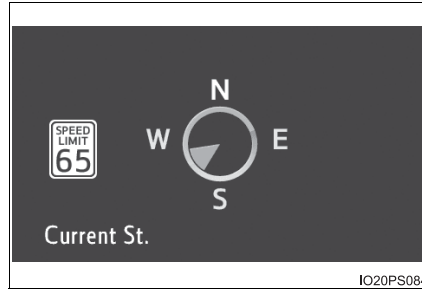

Audio system-linked display

The information about the currently selected audio source is displayed.

The illustration is only an example and may differ from the actual screen.

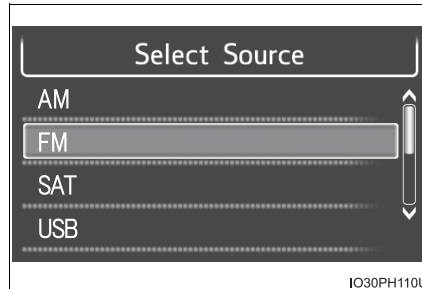

To switch the audio source, press to display the audio source selection screen, press or of the meter control switches and select the desired audio source, and then press .

To stop audio source selection, press on the audio source selection screen.



 **Air conditioning system settings screen**

The condition of the air conditioning system settings can be checked on the screen and the air conditioning system settings can be changed using the meter control switches.



On the air conditioning settings screen, press  or  of the meter control switches to switch the contents of the display.

For details regarding the air conditioning system function, refer to P. 512 and 524.

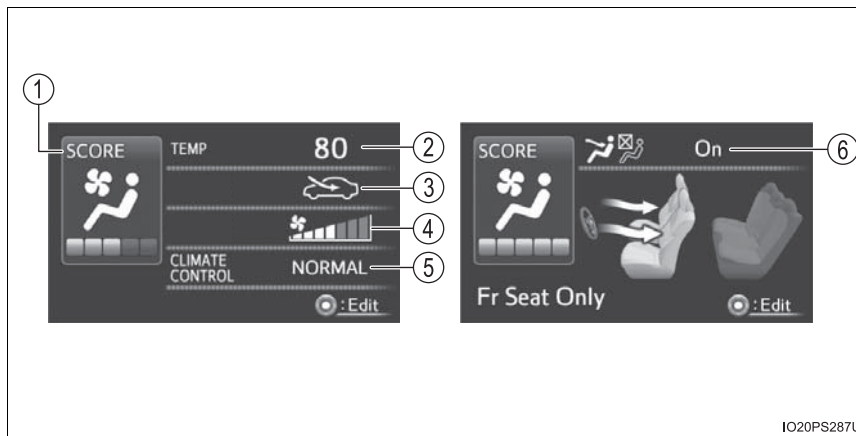
■ **Screen display and setting items that can be changed**







3
Instrument cluster

Item		Settings		
①	Eco score (A/C score)	→P. 243		
②	Temperature setting	Changes according to operation of the meter control switches*1		
③	Outside air and recirculated air modes	 (Outside air mode)	 (Recirculated air mode)	
④	Fan speed	1 to 7		
⑤	“CLIMATE CONTROL”	“NORMAL”	“ECO”	
⑥	Front seat concentrated airflow mode (S-FLOW)	“On (Driver Priority)”*2	“On (Fr Seat Only)”*2	“Off (All seat)”

*1: “LO” is displayed if the temperature is adjusted to the lowest setting, and “HI” is displayed if the temperature is adjusted to the highest setting.

*2: The selectable modes differ depending on whether a passenger is present. (→P. 514, 526)

■ Adjusting the settings

- 1 Press  to display the cursor.
- 2 Press  or  of the meter control switches to select the desired item to set.
- 3 Press  or  of the meter control switches to select the setting item or setting value.

The air conditioning system cannot be stopped by performing operations on the air conditioning settings screen. Please use the air conditioning switch or navigation system* to stop the air conditioning system.

*: Vehicles with 11.6-inch display only

■ Eco score (A/C score)

The current air conditioning system usage status is evaluated in 5 levels to determine whether it is Eco-friendly.

The evaluation changes according to the air conditioning system usage status. When the power switch is turned off, the current total driving score*¹ and advice*² related to using the air conditioning system are displayed. (→P. 196)

- ① Low score*³
- ② High score

Avoiding excessive use of the air conditioning system and using the air conditioning system at the appropriate setting according to the ambient temperature and number of passengers and with the front seat concentrated airflow mode (S-FLOW) (🌀) and “CLIMATE CONTROL” will result in a high evaluation.

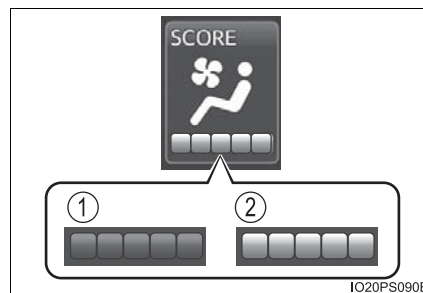

- *1: The Eco score (A/C score) is not evaluated for approximately 1 minute after the power switch is turned to ON mode.
- *2: This advice may not be displayed depending on the situation.
- *3: For items not evaluated with an Eco score (A/C score), the display reads 0.

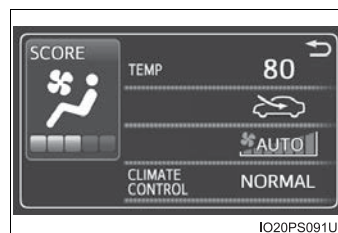

■ Operating switches of the air conditioning system operation panel

- When the air conditioning system switches are operated to change the air conditioning settings while a screen other than the air conditioning system settings screen is displayed on the multi-information display, a pop-up display for the air conditioning settings contents is displayed. However, air conditioning system settings cannot be changed on the pop-up display.



- The pop-up display function that displays when the air conditioning settings are changed using the air conditioning system switches can be turned off in the “Meter Customize” settings. (→P. 248)

■ Eco score (A/C score)

- The setting status of the following air conditioning system functions are reflected in the score.
 - Temperature setting
 - Fan speed setting
 - Outside air and recirculated air modes
 - “A/C” button
 - Front seat concentrated airflow mode (S-FLOW)
 - “CLIMATE CONTROL”
- The Eco score (A/C score) is evaluated according to the ambient temperature and cabin temperature. Accordingly, even if the same settings are always used for the air conditioning system, the evaluation will change according to such factors as the season and weather.
- When the air conditioning system is not being used or the airflow mode is set to  or , the Eco score (A/C score) is not evaluated. (While the air conditioning system is not evaluated, its usage status is not reflected in the total Eco score result.)
- The Eco score (A/C score) is a function that helps select an air conditioning system setting which reduces electricity and fuel consumption, not a function that satisfies both comfortability and low fuel consumption.



Driving assist system information

The operation status of driving support system such as the LTA (Lane Tracing Assist) and dynamic radar cruise control with full-speed range and warning information are displayed.

For details regarding the driving support functions, refer to the page for the corresponding function.

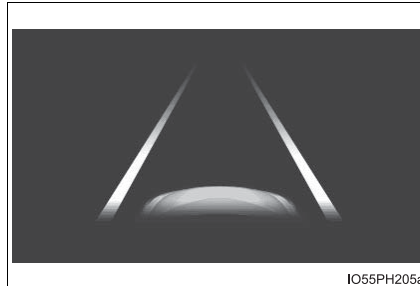

IO55PH205a



Warning message display

The warning messages that have been displayed since the power switch was turned to ON mode can be checked.

When multiple warning messages have been displayed, the display can be switched by pressing or of the meter control switches.

Warning messages that have been currently cleared and some warning messages are not displayed. Also, when there are no warning messages that can be checked, the display indicates that there are no messages.

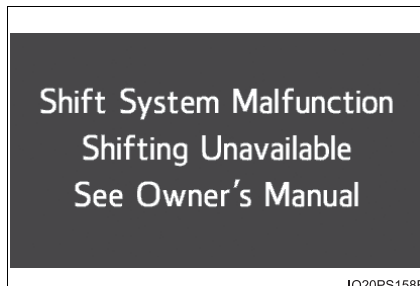







IO20PS158E

 **Settings display**

The operation contents of the driving support systems and settings related to the combination meter display can be changed.

Driving support systems such as the PCS (Pre-Collision System) and Blind Spot Monitor (if equipped) is turned on and off by simply pressing . Make sure not to cancel the systems accidentally.

■ **Setting procedure**

- 1 Press  or  of the meter control switches on the steering wheel and select .
- 2 Press  or  of the meter control switches and select the item to change, and then press .

If the function is turned on and off or the sensitivity, etc. is changed on the setting screen, the setting is changed each time the  is pressed.

For functions that allow operation contents, display contents, etc., of a function to be selected, the setting screen is displayed.



- 3 When the setting screen is displayed, select the setting or desired value (time, etc.) with the meter control switches.*1, 2

For selectable operation contents and setting values, select the desired setting or value, and then press .

To stop the selection, press .



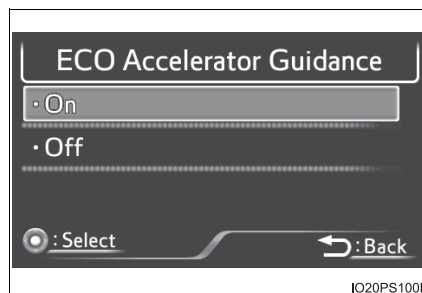



When the setting check screen is displayed, select proceed or cancel and press .





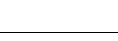
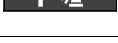
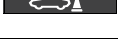

*1: Depending on the items, a subsequent setting screen may be displayed after selecting an item.

*2: For items which set the adjustment level or time, after the item is set, the setting screen remains displayed until  is pressed.

■ Settings table

Item	Settings	Setting result
	"On"	Turns the LTA (Lane Tracing Assist) lane centering function on and off. (→P. 395)
	"Off"	
	"On"	Turns the LTA (Lane Tracing Assist) steering assist function on and off. (→P. 395)
	"Off"	
	"High"	Switches the LTA (Lane Tracing Assist) alert sensitivity. (→P. 395)
	"Standard"	
	"On"	Turns the PCS (Pre-Collision System) on and off. (→P. 388)
	"Off"	
	Early	Switches the PCS (Pre-Collision System) warning timing. (→P. 388)
	Middle	
	Late	
	"On"	Turns the Intuitive parking assist on and off. (→P. 445)
	"Off"	
	"On"	Turns the Parking Support Brake function on and off. (→P. 456)
	"Off"	
	"On"	Turns the Blind Spot Monitor on and off. (→P. 433)
	"Off"	
	"On"	Turns the LTA (Lane Tracing Assist) vehicle sway warning on and off. (→P. 395)
	"Off"	
	"High"	Switches the LTA (Lane Tracing Assist) vehicle sway warning sensitivity. (→P. 395)
	"Standard"	
	"Low"	

Item	Settings	Setting result
 *	Height	Changes the display position and brightness of the head-up display. (→P. 256)
	Brightness	
 *	“On”	Turns the RSA (Road Sign Assist) on and off. (→P. 410)
	“Off”	
	“km/h”	Switches the speed unit used by the screen display.
	“MPH”	
	“Meter Customize” settings: →P. 248	
	“Vehicle Settings” settings: →P. 753	

*: If equipped

■ **“Meter Customize” settings ()**

Item	Settings	Setting result	
“Simple/Split Screen” ^{*1}	“Simple”	Switches the display mode of the main display. (→P. 215)	
	“Split”		
“Screen OFF” ^{*2}	“Yes”	Turns the multi-information display off.	
	“No”		
“HV System Indicator” (→P. 225)	“ECO Accelerator Guidance”	“On”	Turns the “ECO Accelerator Guidance” on and off.
		“Off”	
	“EV Indicator Light On/Off”	“On”	Turns the EV indicator on and off.
		“Off”	
	“EV Drive Monitor”	“EV Energy”	Switches the information display in the left upper corner of the Hybrid System Indicator. (→P. 230)
		“EV Distance”	
“Blank”			

Item	Settings	Setting result	
"Pop-up Display On/Off"	"Navigation"*1	"On"	Turns the pop-up display of the selected item on the multi-information display on and off.
		"Off"	
	"Instrument Panel Light"	"On"	
		"Off"	
	"Climate Settings"	"On"	
		"Off"	
	"Cruise Control Operation Display"	"On"	
		"Off"	
	"HUD Settings"*1	"On"	
		"Off"	
"Driving Mode Select"	"On"		
	"Off"		
"Multimedia Menu"*1	"On"		
	"Off"		
"Traction Battery Cooler"	"On"		
	"Off"		
"Speed Limit"*1, 3 (→P. 258)	"Off"	Switches the operation contents of the speed limit function.	
	"Only Display"		
	"With Caution"		
"Language"	"English" (English)	Switches the language displayed on the screen.	
	"Français" (French)		
	"Español" (Spanish)		
"Calendar"	Month/Day/Year*4	Changes the date used for the electricity and fuel consumption record and the charging schedule function.	
	Day/Month/Year*5		

Item	Settings	Setting result	
"History Reset"	"Eco-Diary (Daily)"	"Yes"	Deletes data of "Eco-Diary (Daily)". (→P. 238)
		"No"	
	"Eco-Diary (Monthly)"	"Yes"	Deletes data of "Eco-Diary (Monthly)". (→P. 238)
		"No"	
"Electricity Consumption Reset"	"Yes"	Deletes the data of the total average electricity consumption. (→P. 217, 237)	
	"No"		
"Initialization"	"Yes"	Returns the combination meter settings to their initial settings.	
	"No"		

*1: If equipped

*2: When the screen is turned off, pressing  displays the setting screen again.

*3: U.S.A. only

*4: Except for Canada

*5: For Canada

■ Setting items

- “Meter Customize” and “Vehicle Settings” setting items are not selectable during driving and cannot be operated.
Also, the settings screen is temporarily canceled in the following situations.
 - A warning message is displayed.
 - The vehicle starts off.
- Settings for functions not equipped to the vehicle are not displayed.
- When a function is turned off, the related settings for that function are not selectable.

■ Calendar setting

Calendar setting contents are linked to the recorded information of “Eco-Diary” (→P. 238). When the calendar date is changed, “Eco-Diary” record is processed as follows:

Contents of date change	“Eco-Diary” record
Date changed to future date	Not cleared*
Date changed to before last month	All cleared
Date changed to earlier date within current month	Only “Daily” data cleared

*: Month/date information not recorded is set to “0” or “0.0”.

 **WARNING****■ Cautions while setting up the display**

As the hybrid system needs to be operating during setting up the display, ensure that the vehicle is parked in a place with adequate ventilation. In a closed area such as a garage, exhaust gases including harmful carbon monoxide (CO) may collect and enter the vehicle. This may lead to death or a serious health hazard.

 **NOTICE****■ While setting up the display**

To prevent 12-volt battery discharge, ensure that the hybrid system is operating while setting up the display features.

Head-up display*

The head-up display can display the current vehicle speed and Hybrid System Indicator in front of the driver. Also, it can display various types of information to assist the driver.

Operation switches and display contents

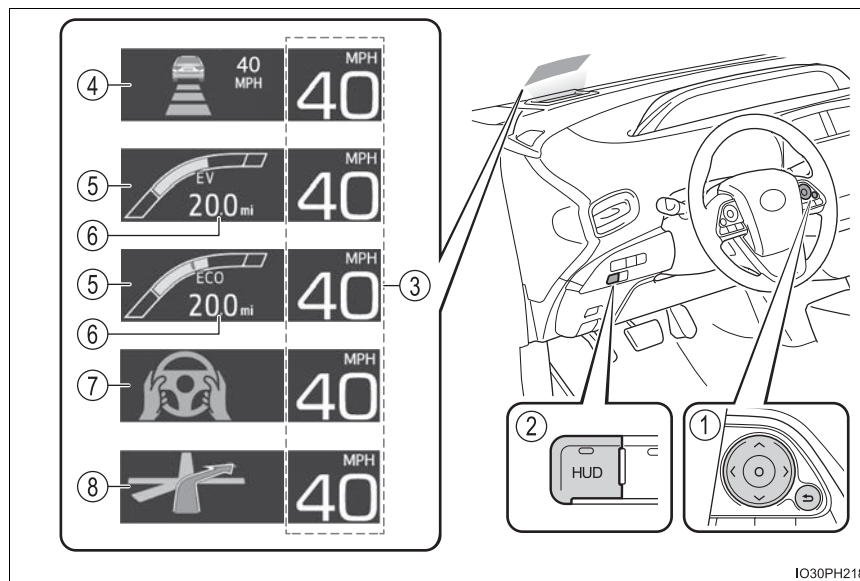

3
Instrument cluster

The units used on the display may differ depending on the target region.

*: If equipped

① Meter control switches

These switches are used when adjusting the display position and brightness of the head-up display. (→P. 256)

② “HUD” (Head-up display) switch (→P. 255)

③ Vehicle speed display

④ Cruise control display (→P. 414)

⑤ Hybrid System Indicator (→P. 225)

The display contents of the Hybrid System Indicator are different in EV mode and HV mode.

⑥ EV driving range

Indicates the estimated distance that can be driven using the current remaining hybrid battery (traction battery). (→P. 108)

When the air conditioning system is operating, the driving range with the air conditioning system on is displayed.

The EV driving range may shorten even when not driving due to power consumption by the system.

⑦ Insert display (→P. 257)

This display inserts information from each driving support system according to driving conditions.

⑧ Route guidance display (→P. 258)

This display is automatically shown when the navigation system is performing route guidance.

“HUD” (Head-up display) switch

The “HUD” switch can be used to turn the head-up display on and off, or switch the display contents.

■ When the head-up display is off

Pressing the “HUD” switch turns the head-up display on and starts the display.

The indicator light on the “HUD” switch comes on.

The display position and brightness adjustment screen is automatically displayed on the multi-information display. (→P. 256)

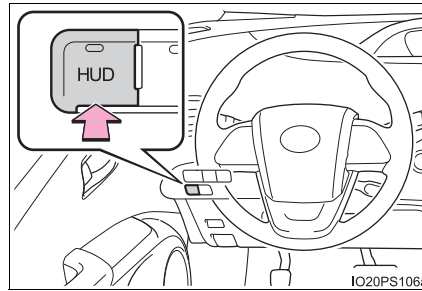

■ When the head-up display is on

Display items can be switched by pressing the “HUD” switch.

- ① Vehicle speed display and cruise control display*1
- ② Vehicle speed display/Hybrid System Indicator*1, 2/EV driving range
- ③ No display (head-up display is off)

Refer to P. 225 for details of the Hybrid System Indicator.

The indicator light on the “HUD” switch turns off.

*1: When the insert display of each driving support system is displayed, the display is temporarily turned off.

*2: The display contents of the Hybrid System Indicator are different in EV mode and HV mode.

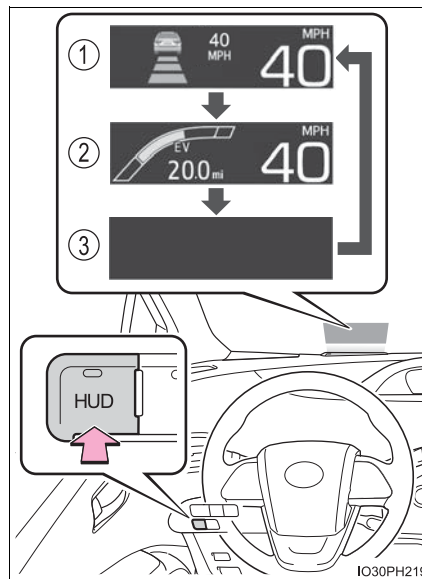



Display position and brightness adjustment

In order to improve the visibility of the head-up display, the display position and brightness can be adjusted.

- 1 Displaying the adjustment screen on the multi-information display.

When the head-up display is on:



Select **HUD** on the  screen of the multi-information display, and then press . (→P. 246)



When the head-up display is off:

When the “HUD” switch is pressed, the adjustment screen for the head-up display automatically displays.*1

If an adjustment operation is not performed for approximately 6 seconds*2, the multi-information display automatically returns to the previous screen.

- 2 Adjusting the display position and brightness by operating the meter control switches.

When  or  is pressed, the position of the head-up display changes.

When  or  is pressed, the brightness of the head-up display changes.

When the  is pressed, the multi-information display returns to the previous screen.

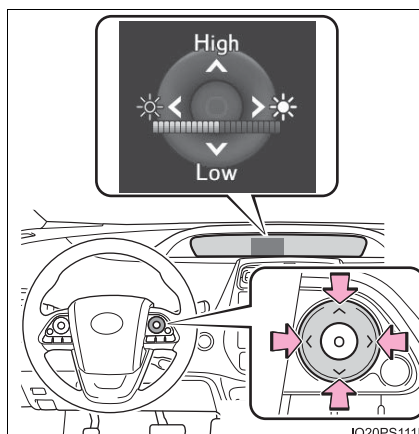

*1: This function can be turned off. (→P. 248)

*2: The adjustment screen may suddenly be canceled if it is interrupted by a warning message shown on the display.

Insert display

■ **Insert displays of the driving support systems**

Insert displays are linked with the operation of the following systems and used to show some of the information shown on the multi-information display on the head-up display.

System	Displayed information
PCS (Pre-Collision System) (→P. 384)	Pre-collision warning
LTA (Lane Tracing Assist) (→P. 395)	Lane departure alert function display
	Hands off steering wheel warning
	Vehicle sway warning function display
Dynamic radar cruise control with full-speed range (→P. 414)	Approach warning display
RSA (Road Sign Assist) (→P. 410)	Road signs
Parking Support Brake function* (→P. 455)	Operation display (symbol display)

*: If equipped

■ **Master warning light insert display**

When the master warning light (→P. 677) is illuminated or flashing, an insert display is shown on the head-up display to inform the driver.

When the master warning light is illuminated or flashing, check the message displayed on the multi-information display and perform the corresponding troubleshooting procedure. (→P. 684)



Route guidance display

When the navigation system route guidance is set, convenient route guidance is displayed.

When approaching an intersection, the shape of the intersection and the remaining distance to the intersection*¹ are displayed.

Once the vehicle is within a fixed distance from the intersection, an arrow animation*², ³ is displayed to inform the driver of which direction to proceed in.

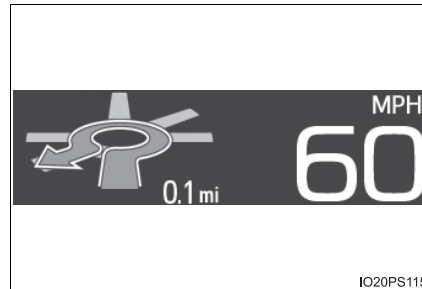

*¹: While the animation is displayed, the remaining distance to the intersection is hidden.

*²: When the distance unit of the navigation system is "km" or "mile", the animation does not display.

*³: If the vehicle is stopped while the animation is displayed, the arrow begins flashing.

The route guidance display can be switched on and off as necessary. (→P. 753)

Speed limit display (if equipped) (U.S.A. only)

Displays the speed limit for the current road.

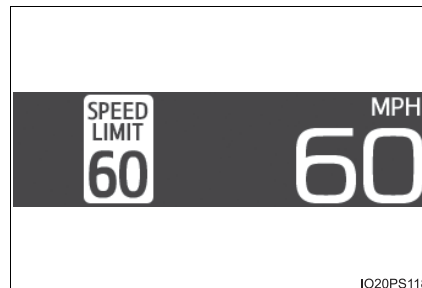

The speed limit display settings can be changed. (→P. 248)

■ Enabling/disabling of the head-up display

When the head-up display is turned off with the “HUD” switch, it is not displayed until the “HUD” switch is used to turn the head-up display on again. (Operation of the head-up display is not linked with the power switch.)

■ Display brightness

- The brightness of the head-up display is automatically adjusted according to the operation status of the headlights (on/off) and the brightness of the surroundings.
- When the brightness of the head-up display is adjusted to a certain level or higher, the display automatically dims when the vehicle is stopped. Once the vehicle starts off and the vehicle speed reaches approximately 3.1 mph (5 km/h) or more, the display automatically returns to its previous brightness.

■ Vehicle speed display

In extremely cold environments, the display of the speedometer and the vehicle speed of the head-up display may slightly differ.

■ Head-up display

The head-up display may seem dark and hard to see when viewed through sunglasses, especially polarized sunglasses.

■ When the 12-volt battery is disconnected

The customize settings of the head-up display will be reset.

■ Route guidance display

The route guidance is not displayed on both the head-up display and multi-information display simultaneously. When the route guidance is displayed on the head-up display, the multi-information display does not display the route guidance even if the navigation system-linked display (→P. 240) is selected on the multi-information display.

⚠ WARNING**■ Before using the head-up display**

- Check that the position and brightness of the head-up display image does not interfere with safe driving. Incorrect adjustment of the image's position or brightness may obstruct the driver's view and lead to an accident, resulting in death or serious injury.
- Do not continuously look at the head-up display while driving as you may fail to see pedestrians, objects on the road, etc. ahead of the vehicle.

⚠ NOTICE**■ To prevent damage to components**

- Do not place any drinks near the head-up display projector. If the projector gets wet, electrical malfunctions may result.
- Do not place anything on or put stickers onto the head-up display projector. Doing so could interrupt head-up display indications.
- Do not touch the inside of the head-up display projector or thrust sharp edges or the like into the projector. Doing so could cause mechanical malfunctions.

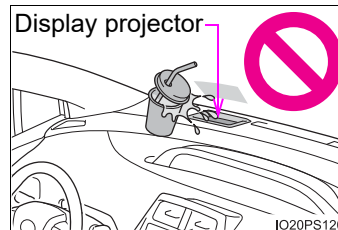

Energy monitor/consumption screen (vehicles with 7-inch display)

You can view the status of your vehicle on the multi-information display and the audio system screen*.

*: For multimedia system

◆ Multi-information display

→P. 220

◆ Audio system screen

Display the energy monitor, trip information or history screen

- 1 Press the "MENU" button.
- 2 Select "Info" on the "Menu" screen.
- 3 Select "ECO" on the "Information" screen.

How to read the energy monitor



■ **Function summary**

The energy monitor can be used to check the vehicle drive status, hybrid system operation status and energy regeneration status.

■ **Flow of energy and display details**

When energy is flowing, an arrow appears and a bright point of light moves to show the direction of the flow of energy. When energy is not flowing, the bright point of light are not displayed.

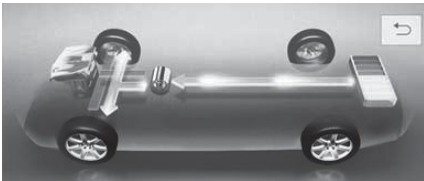
If a screen other than “Energy monitor” is displayed, select “Energy”.

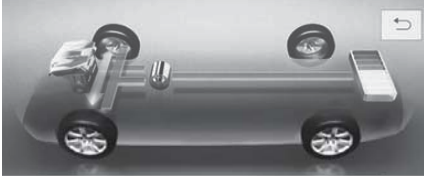
	Audio system screen
When the vehicle is powered by the electric motor (traction motor)	
When the vehicle is powered by both the gasoline engine and the electric motor (traction motor)	
When the vehicle is powered by the gasoline engine	

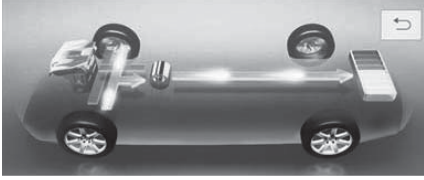
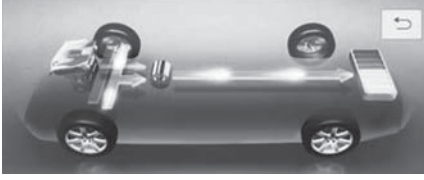
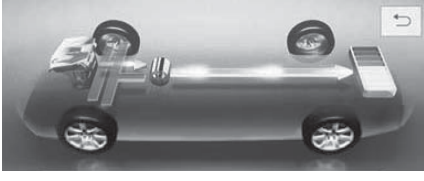
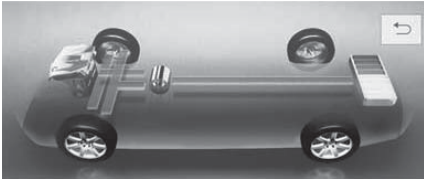
	Audio system screen
<p>When the vehicle is charging the hybrid battery (traction battery)</p>	
	
	
<p>When there is no energy flow</p>	

These images are examples only, and may vary slightly from actual conditions.

Display of the remaining hybrid battery (traction battery)

The current remaining charge in the hybrid battery (traction battery) is displayed on the energy monitor screen.

The system automatically switches to the HV mode when the necessary amount of battery charge for EV driving in EV mode is insufficient.

- ① The hybrid battery (traction battery) for EV mode is fully charged
- ② There is a remaining charge in the hybrid battery (traction battery).
- ③ The hybrid battery (traction battery) for EV mode is not remaining
- ④ The hybrid battery (traction battery) for HV mode is fully charged

When the hybrid battery (traction battery) charge for EV mode is depleted, the hybrid battery (traction battery) charge for HV mode is displayed.

- ⑤ The hybrid battery (traction battery) is not remaining

The image is an example only, and may vary slightly from actual conditions.

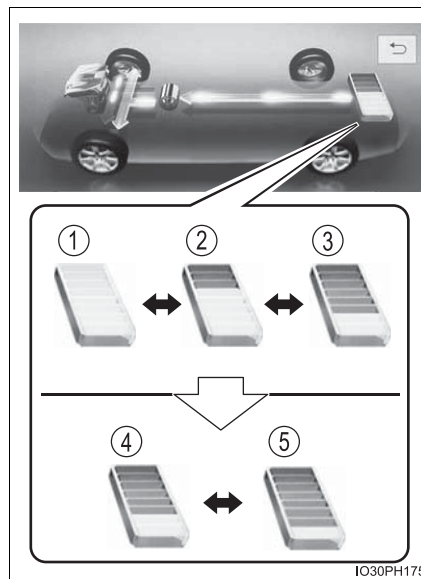

Fuel consumption

■ Trip information

If a screen other than “Trip information” is displayed, select “Trip information”.

- ① Fuel consumption in the past 15 minutes
- ② Regenerated energy in the past 15 minutes

One **E** symbol indicates 30 Wh.
Up to 5 symbols are shown.
- ③ Current fuel consumption
- ④ Resetting the consumption data
- ⑤ Average vehicle speed since the hybrid system was started
- ⑥ Elapsed time since the hybrid system was started
- ⑦ Cruising range

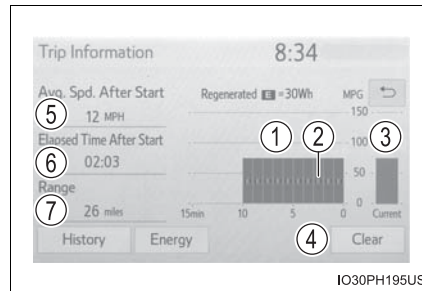

Average fuel consumption for the past 15 minutes is divided by color into past averages and averages attained since the power switch was last turned to ON mode. Use the displayed average fuel consumption as a reference.

The image is an example only, and may vary slightly from actual conditions.

■ History

If a screen other than “History” is displayed, select “History”.

- ① Best recorded fuel consumption
- ② Latest fuel consumption
- ③ Previous fuel consumption record

Displays the daily average fuel consumption. (Instead of the date, “Trip 1” through “Trip 5” will be displayed.)

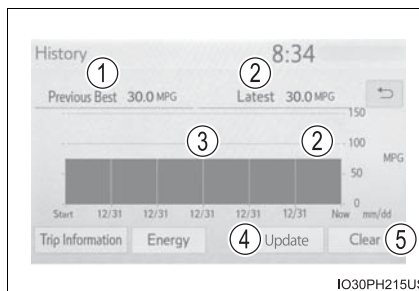

- ④ Updating the latest fuel consumption data
- ⑤ Resetting the history data

The average fuel consumption history is divided by color into past averages and the average fuel consumption since the last updated.

Use the displayed average fuel consumption as a reference.

The image is an example only, and may vary slightly from actual conditions.

■ Updating the history data

Update the latest fuel consumption by selecting “Update” to measure the current fuel consumption again.

■ Resetting the data

The fuel consumption data can be deleted by selecting “Clear”.

■ Cruising range

Displays the estimated maximum distance that can be driven with the quantity of fuel remaining.

This distance is computed based on your average fuel consumption. As a result, the actual distance that can be driven may differ from that displayed.

Energy monitor/consumption screen/detail screen (vehicles with 11.6-inch display)

You can view the status of your vehicle on the multi-information display and the audio system screen*.

*: For navigation system

◆ Multi-information display

→P. 220

◆ Audio system screen

■ Display the energy monitor, trip information or past record screen

- 1 Press the "MENU" button.

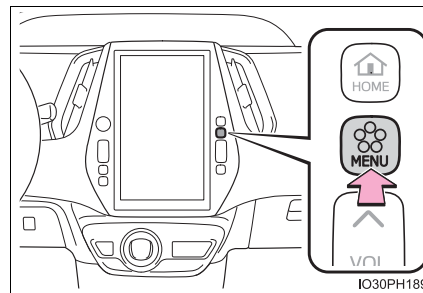

- 2 Select "Info" on the screen
- 3 Display the "Energy monitor", "Trip information" or "Past record" screen.

- ① "Energy Monitor":
Select "Energy" on the screen.
- ② "Trip Information" or "Past Record" screen:
Select "Past Record" on the screen.

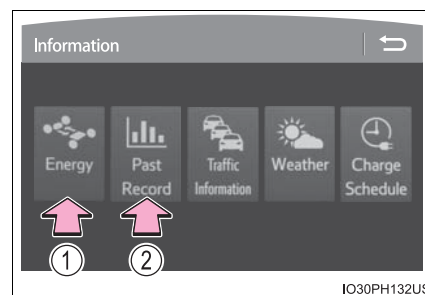

"Trip Information" or "Past Record" screen will be displayed.

Press the "HOME" button and select "Info" on the screen. You can select "Energy" and "Past Record".

■ Display the detail screen (→P. 273)

- 1 Display “Energy Monitor” screen.
- 2 Select  on the upper right screen.

How to read the energy monitor

■ Function summary

The energy monitor can be used to check the vehicle drive status, hybrid system operation status and energy regeneration status.





The flow of electric energy during charging is displayed when charging from an external power source.

For vehicles equipped with a solar charging system, a guide for the state of the solar charging system is displayed.

■ Flow of energy and display details

When energy is flowing, an arrow appears and a bright point of light moves to show the direction of the flow of energy. When energy is not flowing, the bright point of light are not displayed.

- The display when the engine is operating is in blue while the engine is being warmed up and yellow afterwards.
- The arrow from the engine to the motor and tires is displayed in red.
- The arrow indicating energy consumption is displayed in yellow and the arrow indicating energy regeneration or charging is displayed in green. Also, the hybrid battery (traction battery) changes color accordingly.

- There are icons , ,  on the lower side of the screen. The screen switches to each point of view when you select it.
- When you select , this screen is displayed in the lower half of the screen, it will be displayed together with the navigation screen.
- These images are examples only, and may vary slightly from actual conditions.

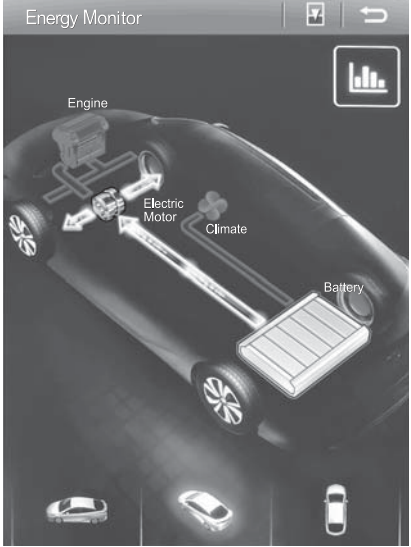
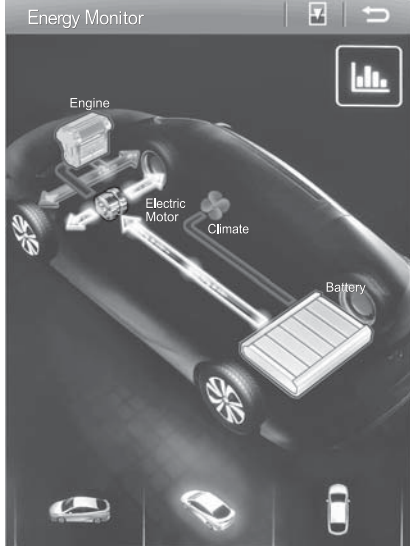
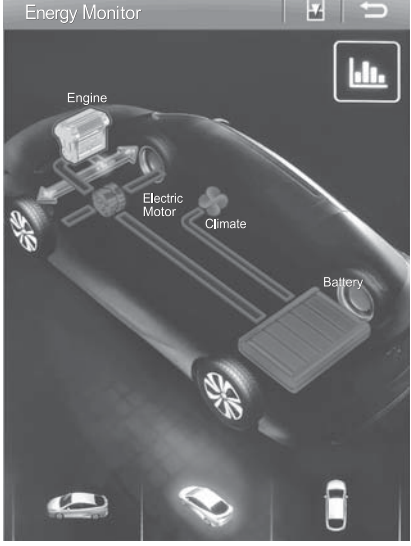
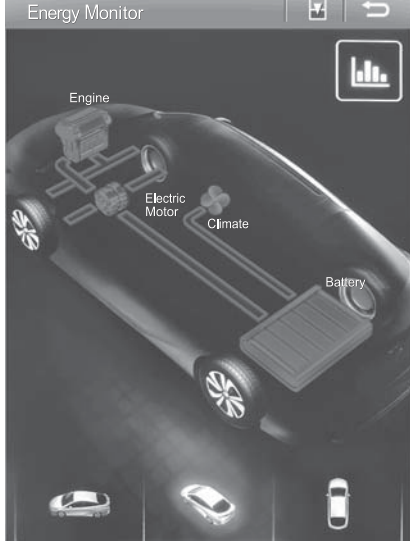
<p>When the vehicle is powered by the electric motor (traction motor)</p>	<p>When the vehicle is powered by both the gasoline engine and the electric motor (traction motor)</p>
 <p>IO30PH021USa</p>	 <p>IO30PH022USa</p>
<p>When the vehicle is powered by the gasoline engine</p>	<p>When there is no energy flow</p>
 <p>IO30PH023USa</p>	 <p>IO30PH024USa</p>

3
Instrument cluster

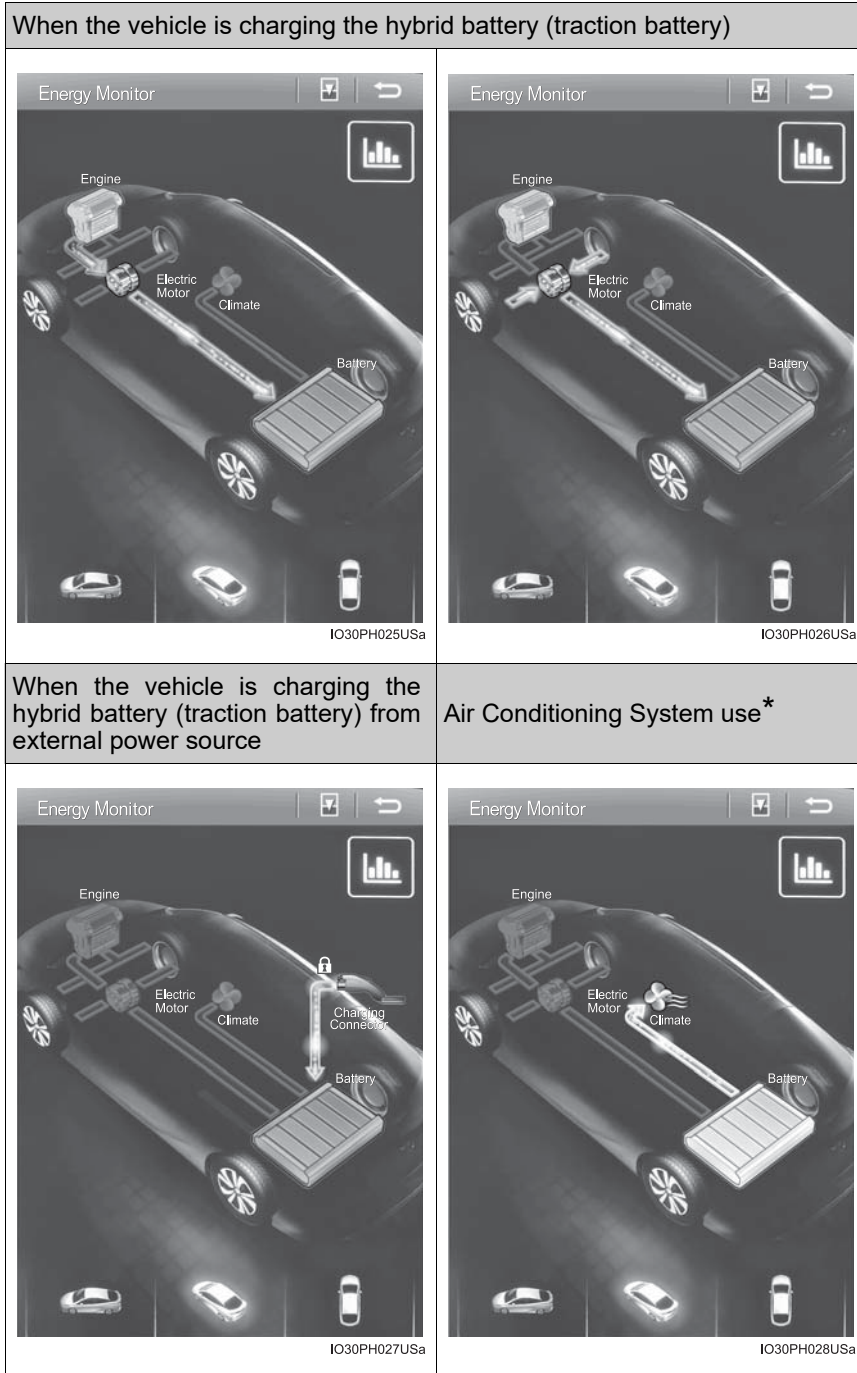

*: When the air conditioning compressor is not operating, an arrow does not appear and the bright point of light are not displayed.

Fuel consumption

■ Trip information

If the “Trip Information” screen does not appear, select “Trip Information”.

- ① Previous fuel consumption per minute
- ② Current fuel consumption
- ③ Reset the trip information data
- ④ Regenerated energy in the past 15 minutes

One **E** symbol indicates 30 Wh.

Up to 5 symbols are shown.

- ⑤ “Past Record” screen appears
- ⑥ Cruising range
- ⑦ Elapsed time
- ⑧ Average vehicle speed

Average fuel consumption for the past 15 minutes is divided by color into past averages and averages attained since the power switch was last turned to ON mode. Use the displayed average fuel consumption as a reference.

The image is an example only, and may vary slightly from actual conditions.

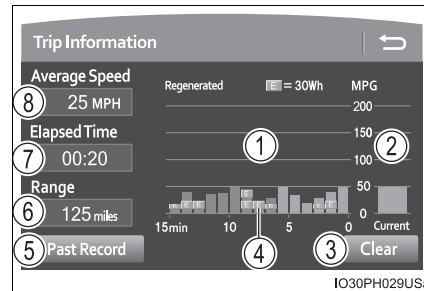

3

Instrument cluster

■ Past record

- ① Best recorded fuel consumption
- ② Average fuel consumption
- ③ Current fuel consumption
- ④ Previous fuel consumption record
- ⑤ Reset the past record data
- ⑥ Update the past record data
- ⑦ “Trip Information” screen appears

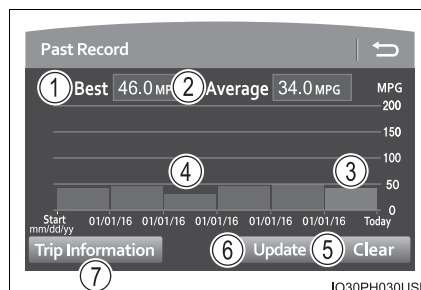

The image is an example only, and may vary slightly from actual conditions.

How to see the detail screen

Displays information about each selected item.

When you select the “x”, and close the screen.

■ **Select “Battery”**

● Display of battery charging state

Displayed when charging from an external power supply.

- ① Display of charge status
- ② The remaining time until the charging completed
- ③ The remaining hybrid battery (traction battery) capacity of the HV mode
- ④ The remaining hybrid battery (traction battery) capacity of the EV mode

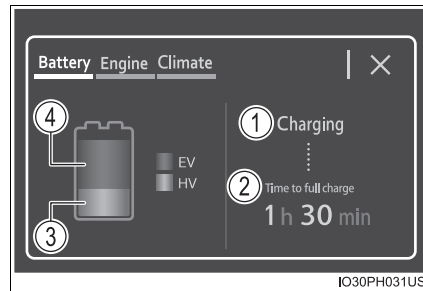

● Display the “Next Charging Event”

It appears when the charging schedule function is waiting to charge the external power source.

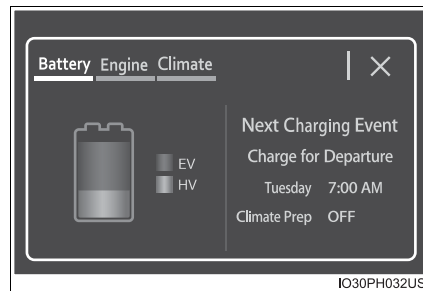

● Regenerated amount of energy

It appears during driving or parked.

- ① Shows the energy regenerated every minute.
- ② Shows the energy being regenerated while hybrid system is operating.

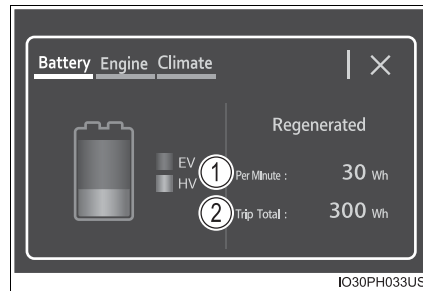

Every time the power switch is turned to off, the value is reset.

3 Instrument cluster

■ Select “Engine”

Display of the engine status.

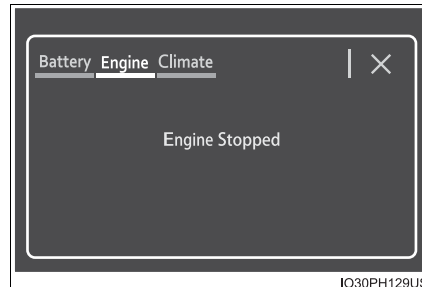

■ Select “Climate”

Display the power consumption of the air conditioner

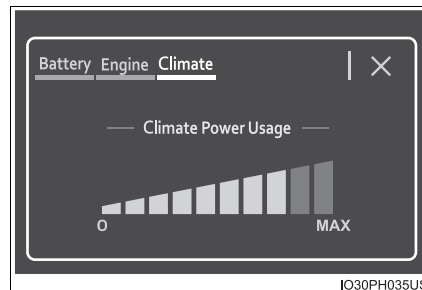

■ Resetting the data

- Selecting “Clear” on the “Trip Information” screen will reset the trip information data.
- Selecting “Clear” on the “Past Record” screen will reset the past record data.

■ Updating the past record data

Selecting “Update” on the “Past Record” screen will update the past record data.

Also, the average fuel consumption displayed in the multi-information display will be reset at the same time.

■ Cruising range

Displays the estimated maximum distance that can be driven with the quantity of fuel remaining.

This distance is computed based on your average fuel consumption. As a result, the actual distance that can be driven may differ from that displayed.

■ Display of navigation screen during charging

After the power switch is turned to ON mode during charging, the power switch will automatically turn off after approximately 100 seconds.

**Operation of
each component****4**

- 4-1. Key information**
 - Keys 276
- 4-2. Opening, closing and locking the doors**
 - Side doors 281
 - Back door 287
 - Smart key system 292
- 4-3. Adjusting the seats**
 - Front seats 301
 - Rear seats 303
 - Head restraints 305
- 4-4. Adjusting the steering wheel and mirrors**
 - Steering wheel 308
 - Inside rear view mirror 310
 - Outside rear view mirrors 312
- 4-5. Opening and closing the windows**
 - Power windows 314

Keys

The keys

The following keys are provided with the vehicle.

- ① Electronic keys
 - Operating the smart key system (→P. 292)
 - Operating the wireless remote control function
 - Operating the Remote Air Conditioning System (→P. 535)
- ② Mechanical keys
- ③ Key number plate

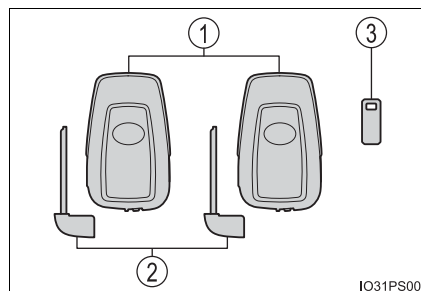

Wireless remote control

- ① Locks all the doors (→P. 282)
- ② Unlocks all the doors (→P. 282)
- ③ Opens the side windows* (→P. 282)
- ④ Operates Remote Air Conditioning System (→P. 535)
- ⑤ Sounds the alarm (→P. 277)

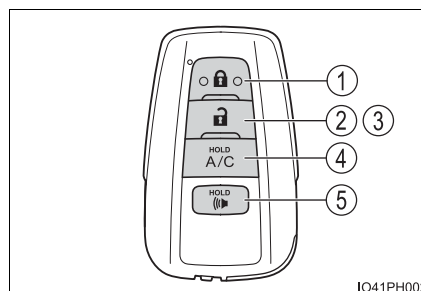

*: This setting must be customized at your Toyota dealer.

Using the mechanical key

To take out the mechanical key, slide the release lever and take the key out.

The mechanical key can only be inserted in one direction, as the key only has grooves on one side. If the key cannot be inserted in a lock cylinder, turn it over and re-attempt to insert it.

After using the mechanical key, store it in the electronic key. Carry the mechanical key together with the electronic key. If the electronic key battery is depleted or the entry function does not operate properly, you will need the mechanical key. (→P. 711)

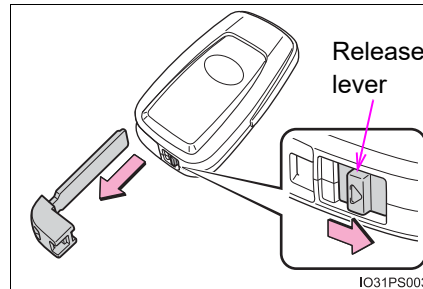

■ Panic mode

When (Panic) is pressed for longer than about one second, an alarm will sound intermittently and the vehicle lights will flash to deter any person from trying to break into or damage your vehicle.

To stop the alarm, press any button on the electronic key.

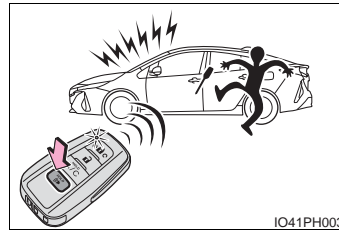

■ If you lose your mechanical keys

New genuine mechanical keys can be made by your Toyota dealer using another mechanical key and the key number stamped on your key number plate. Keep the plate in a safe place such as your wallet, not in the vehicle.

■ When riding in an aircraft

When bringing an electronic key onto an aircraft, make sure you do not press any buttons on the electronic key while inside the aircraft cabin. If you are carrying an electronic key in your bag etc., ensure that the buttons are not likely to be pressed accidentally. Pressing a button may cause the electronic key to emit radio waves that could interfere with the operation of the aircraft.

■ Electronic key battery depletion

- The standard battery life is 1 to 2 years.
- If the battery becomes low, an alarm will sound in the cabin and a message will be displayed on the multi-information display when the hybrid system stops.
- As the electronic key always receives radio waves, the battery will become depleted even if the electronic key is not used. The following symptoms indicate that the electronic key battery may be depleted. Replace the battery when necessary. (→P. 647)
 - The smart key system or the wireless remote control does not operate.
 - The detection area becomes smaller.
 - The LED indicator on the key surface does not turn on.You can replace the battery by yourself (→P. 647). However, as there is a danger that the electronic key may be damaged, it is recommended that replacement is carried out by your Toyota dealer.
- To avoid serious deterioration, do not leave the electronic key within 3 ft. (1 m) of the following electrical appliances that produce a magnetic field:
 - TVs
 - Personal computers
 - Cellular phones, cordless phones and battery chargers
 - Table lamps
 - Induction cookers

■ If a message regarding the state of the electronic key or power switch mode, etc. is shown

To prevent trapping the electronic key inside the vehicle, leaving the vehicle without turning off the power switch or other passengers from unintentionally taking the key out of the vehicle, etc., a message that prompts the user to confirm the state of the electronic key or power switch mode may be shown on the multi-information display. In those cases, follow the instructions on the display immediately.

■ If “Key Battery Low Replace Key Battery” is displayed on the multi-information display

The electronic key has a low battery. Replace the electronic key battery. (→P. 647)

■ Replacing the battery

→P. 647

■ Confirmation of the registered key number

The number of keys already registered to the vehicle can be confirmed. Ask your Toyota dealer.

■ If “A New Key has been Registered Contact Your Dealer for Details” is displayed on the multi-information display

This message will be displayed each time the driver’s door is opened when the doors are unlocked from the outside for approximately 10 days after a new electronic key has been registered.

If this message is displayed but you have not had a new electronic key registered, ask your Toyota dealer to check if an unknown electronic key (other than those in your possession) has been registered.

■ If a wrong key is used

The key cylinder rotates freely to isolate inside mechanism.

 NOTICE

■ **To prevent key damage**

- Do not drop the keys, subject them to strong shocks or bend them.
- Do not expose the keys to high temperatures for long periods of time.
- Do not get the keys wet or wash them in an ultrasonic washer etc.
- Do not attach metallic or magnetic materials to the keys or place the keys close to such materials.
- Do not disassemble the keys.
- Do not attach a sticker or anything else to the surface of the electronic key.
- Do not place the keys near objects that produce magnetic fields, such as TVs, audio systems and induction cookers.
- Do not place the keys near medical electrical equipment such as low-frequency therapy equipment or microwave therapy equipment, and do not receive medical attention with the keys on your person.

■ **Carrying the electronic key on your person**

Carry the electronic key 3.9 in. (10 cm) or more away from electric appliances that are turned on. Radio waves emitted from electric appliances within 3.9 in. (10 cm) of the electronic key may interfere with the key, causing the key to not function properly.

■ **In case of a smart key system malfunction or other key-related problems**

Take your vehicle with all the electronic keys provided with your vehicle to your Toyota dealer.

■ **When an electronic key is lost**

If the electronic key remains lost, the risk of vehicle theft increases significantly. Visit your Toyota dealer immediately with all remaining electronic keys that were provided with your vehicle.

Side doors

The vehicle can be locked and unlocked using the entry function, wireless remote control or door lock switches.

Unlocking and locking the doors from the outside

◆ Smart key system

Carry the electronic key to enable this function.

- ① Grip the driver's door handle to unlock the door. Holding the driver's door handle for approximately 2 seconds unlocks all the doors. Some models, grip the front passenger's door handle to unlock all the doors*.

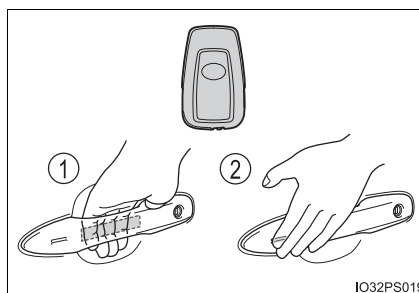

Make sure to touch the sensor on the back of the handle.

The doors cannot be unlocked for 3 seconds after the doors are locked.

- *: The door unlock settings can be changed. (→P. 285)
- ② Touch the lock sensor (the indentation on the surface of the front door handle) to lock the doors.
Check that the door is securely locked.

◆ **Wireless remote control**

- ① Locks all the doors
Check that the door is securely locked.
- ② Unlocks all the doors
Pressing the button unlocks the driver's door. Pressing the button again within 3 seconds unlocks the other doors.
Press and hold to open the side windows.*

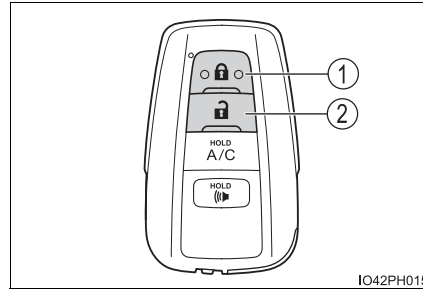

*: This setting must be customized at your Toyota dealer.

■ **Operation signals**

Doors:
A buzzer sounds and the emergency flashers flash to indicate that the doors have been locked/unlocked. (Locked: Once; Unlocked: Twice)

Side windows:
A buzzer sounds to indicate that the side windows are operating.

■ **Security feature**

If a door is not opened within approximately 60 seconds after the vehicle is unlocked, the security feature automatically locks the vehicle again.

■ **When the door cannot be locked by the lock sensor on the surface of the door handle**

When the door cannot be locked even if the lock sensor on the surface of the door handle is touched by a finger, touch the lock sensor with the palm.
When gloves are being worn, remove the gloves.

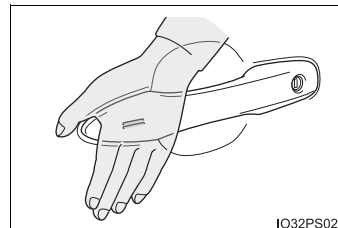

■ **Door lock buzzer**

If an attempt to lock the doors is made when a door is not fully closed, a buzzer sounds continuously for 5 seconds. Fully close the door to stop the buzzer, and lock the vehicle once more.

■ **If the smart key system or the wireless remote control does not operate properly**

- Use the mechanical key to lock and unlock the doors. (→P. 711)
- Replace the key battery with a new one if it is depleted. (→P. 647)

Locking and unlocking the doors from the inside

◆ Door lock switches

- ① Locks all the doors
- ② Unlocks all the doors

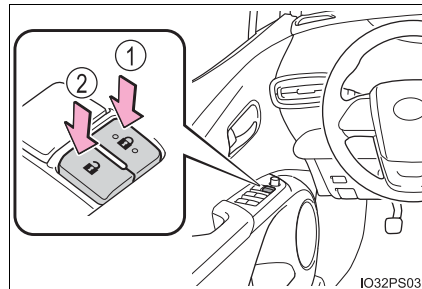

◆ Inside lock buttons

- ① Locks the door
- ② Unlocks the door

The front doors can be opened by pulling the inside handle even if the lock buttons are in the lock position.

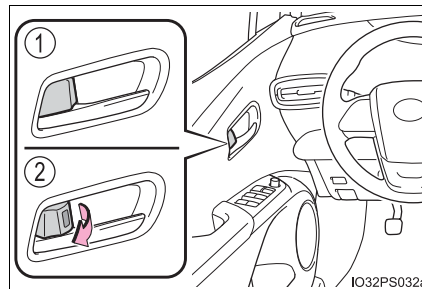

Locking the front doors from the outside without a key

- 1 Move the inside lock button to the lock position.
- 2 Close the door.

The door cannot be locked if the power switch is in ACCESSORY or ON mode, or the electronic key is left inside the vehicle.

The key may not be detected correctly and the door may be locked.

Rear door child-protector lock

The door cannot be opened from inside the vehicle when the lock is set.

- ① Unlock
- ② Lock

These locks can be set to prevent children from opening the rear doors. Push down on each rear door switch to lock both rear doors.



IO42PH077

Automatic door locking and unlocking systems



The following functions can be set or canceled:

For instructions on customizing, refer to P. 753.



Function	Operation
Shift position linked door locking function	Shifting the shift position to any positions other than P locks all the doors.
Shift position linked door unlocking function	Shifting the shift position to P unlocks all the doors.
Speed linked door locking function	All the doors are locked when the vehicle speed is approximately 12 mph (20 km/h) or higher.
Driver's door linked door unlocking function	All the doors are unlocked when the driver's door is opened within approximately 45 seconds after turning the power switch off.

Switching the door unlock function

It is possible to set which doors the entry function unlocks.

- 1 Turn the power switch off.
- 2 When the indicator on the key surface is turned off, push and hold , “A/C” or  for approximately 5 seconds while pushing the  button on the key.

The setting changes each time an operation is performed, as shown below. (When changing the setting continuously, release the buttons, wait for at least 5 seconds, and repeat step 2.)

Multi-information display	Unlocking doors	Beep
	Hold the driver's door handle to unlock only the driver's door.	Exterior: Beeps three times Interior: Pings once
	Hold the passenger's door handle or back door opener to unlock all the doors.	
	Hold the front door handle or back door opener to unlock all the doors.	Exterior: Beeps twice Interior: Pings once

Using the mechanical key

The doors can also be locked and unlocked with the mechanical key. (→P. 711)

Open door warning buzzer

If the vehicle speed reaches 3 mph (5 km/h), the master warning light flashes and a buzzer sounds to indicate that the door(s) is not fully closed. The open door(s) is displayed on the multi-information display.

Conditions affecting the operation of the smart key system or wireless remote control

→P. 295

Customization

Settings (e.g. unlocking function using a key) can be changed. (Customizable features: →P. 753)

 **WARNING****■ To prevent an accident**

Observe the following precautions while driving the vehicle.

Failure to do so may result in a door opening and an occupant could be thrown out of the vehicle, resulting in death or serious injury.

- Ensure that all doors are properly closed and locked.
- Do not pull the inside handle of the doors while driving.
Be especially careful for the front doors, as the doors may be opened even if the inside lock buttons are in locked position.
- Set the rear door child-protector locks when children are seated in the rear seats.

■ When opening or closing a door

Check the surroundings of the vehicle such as whether the vehicle is on an incline, whether there is enough space for a door to open and whether a strong wind is blowing. When opening or closing the door, hold the door handle tightly to prepare for any unpredictable movement.

■ When using the wireless remote control and operating the power windows

Operate the power window after checking to make sure that there is no possibility of any passenger having any of their body parts caught in the side window. Also, do not allow children to operate the wireless remote control. It is possible for children and other passengers to get caught in the power window.

Back door

The back door can be unlocked/locked and opened/closed by the following procedures.

◆ Smart key system (if equipped)

Carry the electronic key to enable this function.

- ① Locks all the doors
Check that the door is securely locked.
- ② Unlocks all the doors
The doors cannot be unlocked for 3 seconds after the doors are locked.

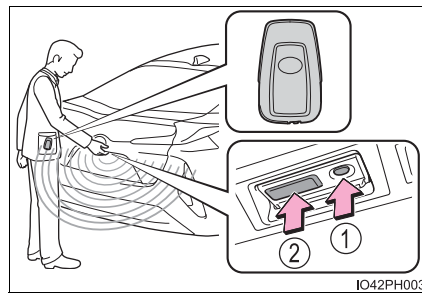

◆ Wireless remote control

→P. 282

◆ Door lock switches

→P. 283

Opening the back door from outside the vehicle

Raise the back door while pushing up the back door opener switch.

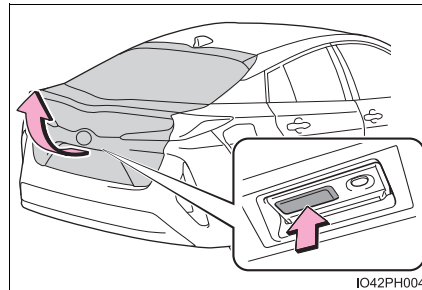

When closing the back door

Lower the back door using the back door handle, and make sure to push the back door down from the outside to close it.

Be careful not to pull the back door sideways when closing the back door with the handle.

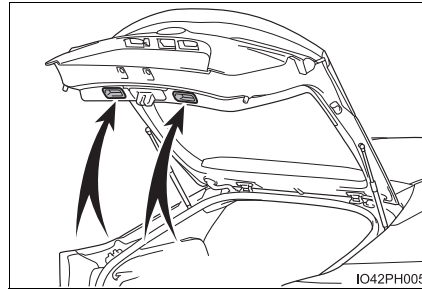

Luggage compartment light

The luggage compartment light turns on when the back door is opened with the luggage compartment light switch on.

- ① On
- ② Off

When the power switch is turned off, the light will go off automatically after 20 minutes.

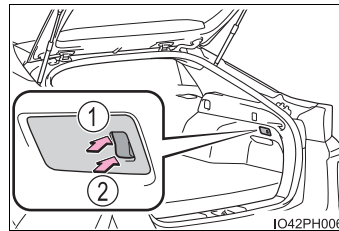

If the back door opener is inoperative

The back door can be unlocked from the inside.

- ① Remove the cover.

To prevent damage, cover the tip of the screwdriver with a rag.

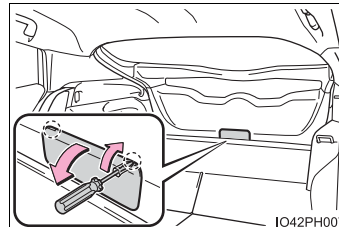

- ② Move the lever.

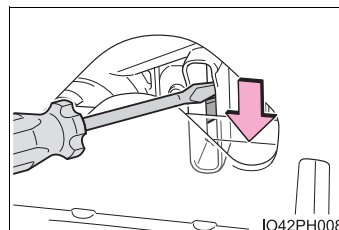

 **WARNING**

Observe the following precautions.

Failure to do so may result in death or serious injury.

■ **Before driving**

- Make sure that the back door is fully closed. If the back door is not fully closed, it may open unexpectedly while driving and hit near-by objects or luggage in the luggage compartment may be thrown out, causing an accident.
- Do not allow children to play in the luggage compartment.
If a child is accidentally locked in the luggage compartment, they could have heat exhaustion or other injuries.
- Do not allow a child to open or close the back door.
Doing so may cause the back door to open unexpectedly, or cause the child's hands, head, or neck to be caught by the closing back door.

■ **Important points while driving**

- Keep the back door closed while driving.
If the back door is left open, it may hit near-by objects or luggage in the luggage compartment may be thrown out, causing an accident.
- Never let anyone sit in the luggage compartment. In the event of sudden braking, sudden swerving or a collision, they are susceptible to death or serious injury.

⚠ WARNING

■ Operating the back door

Observe the following precautions.

Failure to do so may cause parts of the body to be caught, resulting in death or serious injury.

- Remove any heavy loads, such as snow and ice, from the back door before opening it. Failure to do so may cause the back door to suddenly shut again after it is opened.
- When opening or closing the back door, thoroughly check to make sure the surrounding area is safe.
- If anyone is in the vicinity, make sure they are safe and let them know that the back door is about to open or close.
- Use caution when opening or closing the back door in windy weather as it may move abruptly in strong wind.

- The back door may suddenly shut if it is not opened fully. It is more difficult to open or close the back door on an incline than on a level surface, so beware of the back door unexpectedly opening or closing by itself. Make sure that the back door is fully open and secure before using the luggage compartment.

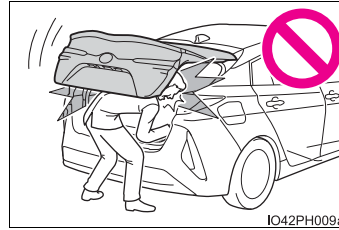

- When closing the back door, take extra care to prevent your fingers etc. from being caught.
- When closing the back door, make sure to press it lightly on its outer surface. If the back door handle is used to fully close the back door, it may result in hands or arms being caught.

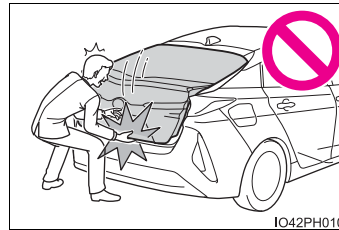

- Do not pull on the back door damper stay to close the back door, and do not hang on the back door damper stay. Doing so may cause hands to be caught or the back door damper stay to break, causing an accident.
- If a bicycle carrier or similar heavy object is attached to the back door, it may suddenly shut again after being opened, causing someone's hands, head or neck to be caught and injured. When installing an accessory part to the back door, using a genuine Toyota part is recommended.

 NOTICE**Back door damper stays**

The back door is equipped with damper stays that hold the back door in place.

Observe the following precautions.

Failure to do so may cause damage to the back door damper stay, resulting in malfunction.

- Do not attach any foreign objects, such as stickers, plastic sheets, or adhesives to the damper stay rod.
- Do not touch the damper stay rod with gloves or other fabric items.
- Do not attach any accessories other than genuine Toyota parts to the back door.
- Do not place your hand on the damper stay or apply lateral forces to it.

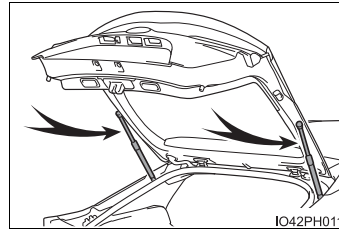

Smart key system

The following operations can be performed simply by carrying the electronic key on your person, for example in your pocket. The driver should always carry the electronic key.

- Unlocks and locks the doors (→P. 281)
- Unlocks and locks the back door (if equipped) (→P. 287)
- Unlocks the charging port lid (if equipped) (→P. 122)
- Unlocks and locks the charging connector (if equipped) (→P. 125)
- Starts the hybrid system (→P. 338)

■ Antenna location

- ① Antenna outside the cabin (driver's side)
- ② Antenna outside the cabin (front passenger's side)*
- ③ Antennas inside the cabin
- ④ Antenna outside the luggage compartment*
- ⑤ Antenna outside the charging port lid*

*: If equipped

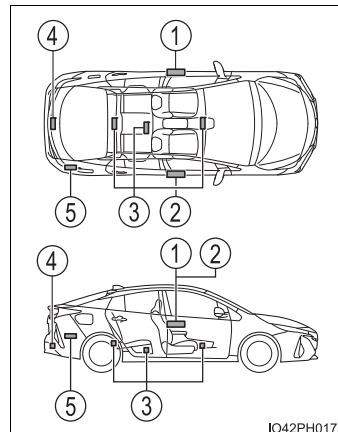

■ **Effective range (areas within which the electronic key is detected)**

- When locking or unlocking the doors
 The system can be operated when the electronic key is within about 2.3 ft. (0.7 m) of driver's door handle, front passenger's door handle* and back door opener switch*. (Only the doors detecting the key can be operated.)

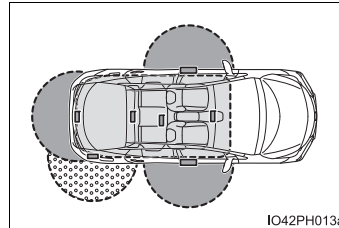

- When unlocking the charging port lid, when locking and unlocking the charging connector*
 The system can be operated when the electronic key is within about 2.3 ft. (0.7 m) of the charging port lid.
- When starting the hybrid system or changing power switch modes
 The system can be operated when the electronic key is inside the vehicle.

*: If equipped

■ **Alarms and warning messages**

An alarm sounds and warning message displays shown on the multi-information display are used to protect against unexpected accidents or theft of the vehicle resulting from erroneous operation. When a warning message is displayed, take appropriate measures based on the displayed message.

When only an alarm sounds, circumstances and correction procedures are as follows.

Alarm	Situation	Correction procedure
Exterior alarm sounds once for 5 seconds	An attempt was made to lock the vehicle while a door was open.	Close all of the doors and lock the doors again.
Interior alarm pings repeatedly	The power switch was turned to ACCESSORY mode while the driver's door was open (The driver's door was opened when the power switch was in ACCESSORY mode).	Turn the power switch off and close the driver's door.

■ **When “Smart Key System malfunction See owner’s manual” is displayed on the multi-information display**

The system may be malfunctioning. Have the vehicle inspected by your Toyota dealer immediately.



■ **Battery-saving function**

The battery-saving function will be activated in order to prevent the electronic key battery and the 12-volt battery from being discharged while the vehicle is not in operation for a long time.

- In the following situations, the smart key system may take some time to unlock the doors.
 - The electronic key has been left in an area of approximately 6 ft. (2 m) of the outside of the vehicle for 10 minutes or longer.
 - The smart key system has not been used for 5 days or longer.
- If the smart key system has not been used for 14 days or longer, the doors cannot be unlocked at any doors except the driver’s door. In this case, take hold of the driver’s door handle, or use the wireless remote control or the mechanical key, to unlock the doors.

■ **Electronic Key Battery-Saving Function**

When battery-saving mode is set, battery depletion is minimized by stopping the electronic key from receiving radio waves.

Press  twice while pressing and holding . Confirm that the electronic key indicator flashes 4 times.

While the battery-saving mode is set, the smart key system cannot be used. To cancel the function, press any of the electronic key buttons.

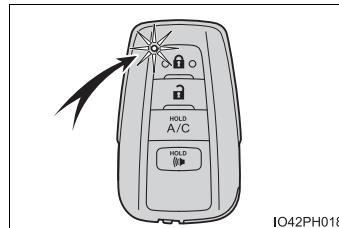

■ Conditions affecting operation

The smart key system, wireless remote control and immobilizer system use weak radio waves. In the following situations, the communication between the electronic key and the vehicle may be affected, preventing the smart key system, wireless remote control and immobilizer system from operating properly. (Ways of coping: →P. 711)

- When the electronic key battery is depleted
- Near a TV tower, electric power plant, gas station, radio station, large display, airport or other facility that generates strong radio waves or electrical noise
- When the electronic key is in contact with, or is covered by the following metallic objects
 - Cards to which aluminum foil is attached
 - Cigarette boxes that have aluminum foil inside
 - Metallic wallets or bags
 - Coins
 - Hand warmers made of metal
 - Media such as CDs and DVDs
- When other wireless key (that emit radio waves) is being used nearby
- When carrying the electronic key together with the following devices that emit radio waves
 - Portable radio, cellular phone, cordless phone or other wireless communication devices
 - Another vehicle's electronic key or a wireless key that emits radio waves
 - Personal computers or personal digital assistants (PDAs)
 - Digital audio players
 - Portable game systems
- If window tint with a metallic content or metallic objects are attached to the rear window
- When the electronic key is placed near a battery charger or electronic devices

■ Note for the entry function

- Even when the electronic key is within the effective range (detection areas), the system may not operate properly in the following cases:
 - The electronic key is too close to the window or outside door handle, near the ground, or in a high place when the doors are locked or unlocked.
 - The electronic key is on the instrument panel, floor, or in the door pockets or glove box when the hybrid system is started or power switch modes are changed.
- Do not leave the electronic key on top of the instrument panel or near the door pockets when exiting the vehicle. Depending on the radio wave reception conditions, it may be detected by the antenna outside the cabin and the door will become lockable from the outside, possibly trapping the electronic key inside the vehicle.
- As long as the electronic key is within the effective range, the doors may be unlocked or locked by anyone.
- Even if the electronic key is not inside the vehicle, it may be possible to start the hybrid system if the electronic key is near the window.
- The doors may unlock if a large amount of water splashes on the door handle, such as in the rain or in a car wash when the electronic key is within the effective range. (The door will automatically be locked after approximately 60 seconds if the doors are not opened and closed.)
- If the wireless remote control is used to lock the doors when the electronic key is near the vehicle, there is a possibility that the door may not be unlocked by the entry function. (Use the wireless remote control to unlock the doors.)
- Touching the door lock sensor while wearing gloves may delay or prevent lock operation. Remove the gloves and touch the lock sensor again.
- If the door handle becomes wet while the electronic key is within the effective range, the door may lock and unlock repeatedly. In this case, follow the following correction procedures to wash the vehicle.
 - Place the electronic key in a location 6 ft. (2 m) or more away from the vehicle. (Take care to ensure that the key is not stolen.)
 - Set electronic key to battery-saving mode to disable the smart key system. (→P. 294)
- If the electronic key is inside the vehicle and a door handle becomes wet during a car wash, a message may be shown on the multi-information display and a buzzer will sound outside the vehicle. To turn off the alarm, lock all the doors.
- The lock sensor may not work properly if it comes into contact with ice, snow, mud, etc. Clean the lock sensor and attempt to operate it again.
- A sudden approach to the effective range or door handle may prevent the doors from being unlocked. In this case, return the door handle to the original position and check that the doors unlock before pulling the door handle again.
- If there is another electronic key in the detection area, it may take slightly longer to unlock the doors after the door handle is gripped.

■ When the vehicle is not driven for extended periods

- To prevent theft of the vehicle, do not leave the electronic key within 6 ft. (2 m) of the vehicle.
- The smart key system can be deactivated in advance. (→P. 753)

■ To operate the system properly

Make sure to carry the electronic key when operating the system. Do not get the electronic key too close to the vehicle when operating the system from the outside of the vehicle.

Depending on the position and holding condition of the electronic key, the key may not be detected correctly and the system may not operate properly. (The alarm may go off accidentally, or the door lock prevention may not operate.)

■ If the smart key system does not operate properly

- Locking and unlocking the doors: Use the mechanical key. (→P. 711)
- Starting the hybrid system: →P. 712

■ Customization

Settings (e.g. smart key system) can be changed.
(Customizable features: →P. 753)

■ If the smart key system has been deactivated in a customized setting

- Unlocking and locking the doors:
Use the wireless remote control or mechanical key. (→P. 282, 711)
- Unlocking the charging port lid: →P. 123
- Unlocking and locking the charging connector: →P. 127
- Starting the hybrid system and changing power switch modes: →P. 712
- Stopping the hybrid system: →P. 339

■ **Certifications for the smart key system**

- ▶ For vehicles sold in the U.S.A. and Hawaii

FCC ID:HYQ23ABL

FCC ID:HYQ14FLA

NOTE:

This device complies with part 15 of the FCC Rules. Operation is subject to the following two conditions: (1) This device may not cause harmful interference, and (2) this device must accept any interference received, including interference that may cause undesired operation.

FCC WARNING:

Changes or modifications not expressly approved by the party responsible for compliance could void the user's authority to operate the equipment.

FCC ID:NI4TMLF15-1 ✓

This device complies with part 15 of the FCC Rules. Operation is subject to the following two conditions: (1) This device may not cause harmful interference, and (2) this device must accept any interference received, including interference that may cause undesired operation.

Changes or modifications not expressly approved by the party responsible for compliance could void the user's authority to operate the equipment.

► For vehicles sold in Canada

NOTE:

This device contains licence-exempt transmitter(s)/receiver(s) that comply with Innovation, Science and Economic Development Canada's licence-exempt RSS(s).

Operation is subject to the following two conditions:

- (1) This device may not cause interference.
- (2) This device must accept any interference, including interference that may cause undesired operation of the device.

NOTE:

L'émetteur/récepteur exempt de licence contenu dans le présent appareil est conforme aux CNR d'Innovation, Sciences et Développement économique Canada applicables aux appareils radio exempts de licence.

L'exploitation est autorisée aux deux conditions suivantes :

- (1) L'appareil ne doit pas produire de brouillage;
- (2) L'appareil doit accepter tout brouillage radioélectrique subi, même si le brouillage est susceptible d'en compromettre le fonctionnement.

This device complies with Industry Canada's licence-exempt RSSs. Operation is subject to the following two conditions: (1) This device may not cause interference; and (2) This device must accept any interference, including interference that may cause undesired operation of the device.

Le présent appareil est conforme aux CNR d'Industrie Canada applicables aux appareils radio exempts de licence. L'exploitation est autorisée aux deux conditions suivantes : 1) l'appareil ne doit pas produire de brouillage; 2) l'utilisateur de l'appareil doit accepter tout brouillage radioélectrique subi, même si le brouillage est susceptible d'en compromettre le fonctionnement.

 **WARNING****■ Caution regarding interference with electronic devices**

- People with implantable cardiac pacemakers, cardiac resynchronization therapy-pacemakers or implantable cardioverter defibrillators should keep away from the smart key system antennas. (→P. 292)

The radio waves may affect the operation of such devices. If necessary, the entry function can be disabled. Ask your Toyota dealer for details, such as the frequency of radio waves and timing of the emitted radio waves. Then, consult your doctor to see if you should disable the entry function.

- Users of any electrical medical device other than implantable cardiac pacemakers, cardiac resynchronization therapy-pacemakers or implantable cardioverter defibrillators should consult the manufacturer of the device for information about its operation under the influence of radio waves.

Radio waves could have unexpected effects on the operation of such medical devices.

Ask your Toyota dealer for details on disabling the entry function.

Front seats

Adjustment procedure

► Manual seat

- ① Seat position adjustment lever
- ② Seatback angle adjustment lever
- ③ Vertical height adjustment lever (for driver's side)

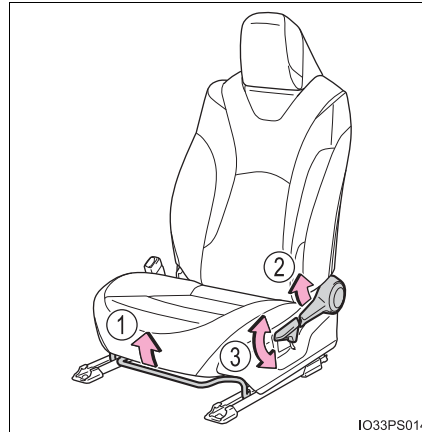

► Power seat (if equipped for driver's side)

- ① Seat position adjustment switch
- ② Seat cushion (front) angle adjustment switch
- ③ Vertical height adjustment switch
- ④ Seatback angle adjustment switch
- ⑤ Lumbar support adjustment switch

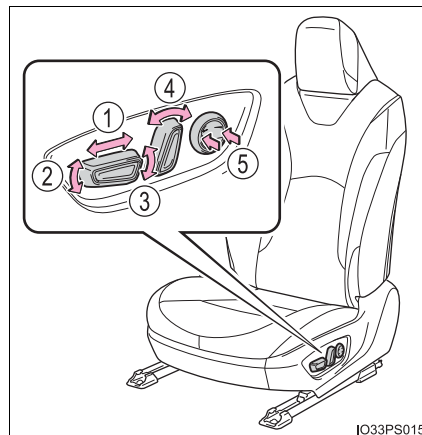

4

Operation of each component

■ When adjusting the seat

Take care when adjusting the seat so that the head restraint does not touch the ceiling.

⚠ WARNING**■ When adjusting the seat position**

- Take care when adjusting the seat position to ensure that other passengers are not injured by the moving seat.
- Do not put your hands under the seat or near the moving parts to avoid injury.
Fingers or hands may become jammed in the seat mechanism.

■ Seat adjustment

- To reduce the risk of sliding under the lap belt during a collision, do not recline the seat more than necessary.
If the seat is too reclined, the lap belt may slide past the hips and apply restraint forces directly to the abdomen, or your neck may contact the shoulder belt, increasing the risk of death or serious injury in the event of an accident.
Adjustments should not be made while driving as the seat may unexpectedly move and cause the driver to lose control of the vehicle.
- Manual seats: After adjusting the seat, make sure that the seat is locked in position.

Rear seats

The seatbacks can be folded down.

Before folding down the seatbacks

- 1 Park the vehicle in a safe place.
Apply the parking brake firmly (→P. 352) and shift the shift position to P. (→P. 346)
- 2 Adjust the position of the front seat and the angle of the seatback. (→P. 301)
Depending on the position of the front seat, if the seatback is folded backward, it may interfere with the operation of the rear seat.
- 3 Lift up and push down the head restraints of the rear outboard seats, and lower the head restraint of the rear center seat. (→P. 305)
- 4 Stow the armrest of the rear seat if it is pulled out. (→P. 566)
This step is not necessary when operating the left side seat only.

Folding down the seatbacks

Pull the seatback lock release lever and fold the seatback down.

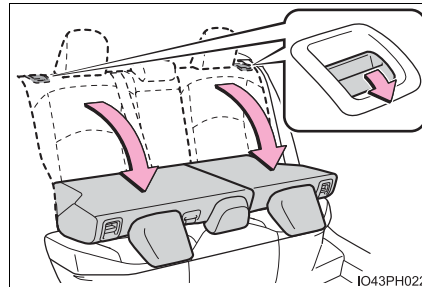

Returning the rear seatbacks

To avoid trapping the seat belt between the seat and the inside of the vehicle, pass the seat belt inside the seat belt guide and then return the seatback securely to the locked position.

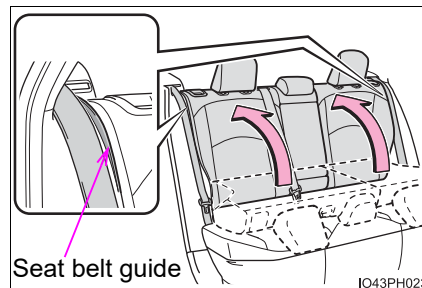

⚠ WARNING**■ When folding the seatbacks down**

Observe the following precautions. Failure to do so may result in death or serious injury.

- Do not fold the seatbacks down while driving.
- Stop the vehicle on level ground, apply the parking brake firmly and shift the shift position to P.
- Do not allow anyone to sit on a folded seatback or in the luggage compartment while driving.
- Do not allow children to enter the luggage compartment.
- Do not operate the rear seat if it is occupied.
- Be careful not to get feet or hands caught in the moving parts or joints of the seats during operation.
- Do not allow children to operate the seat.

■ After returning the seatback to the upright position

Observe the following precautions. Failure to do so may result in death or serious injury.

- Make sure that the seatback is securely locked in position by lightly pushing it back and forth.
If the seatback is not securely locked, the red marking will be visible on the seatback lock release lever. Make sure that the red marking is not visible.

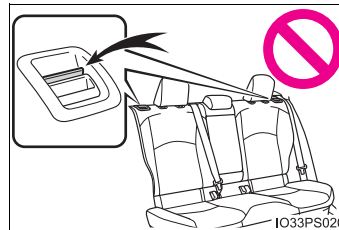

- Check that the seat belts are not twisted or caught in the seatback.

Head restraints

Head restraints are provided for all seats.

Front seats

- ① Up
Pull the head restraints up.
- ② Down
Push the head restraint down while pressing the lock release button.

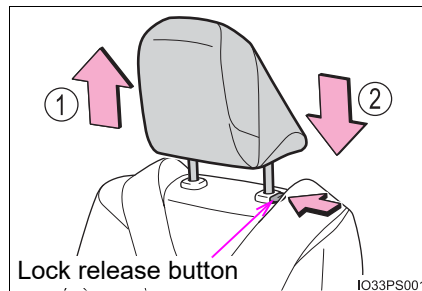

Rear seats

■ Rear outboard seats

- ① To fold
Pull the head restraint up while pressing the lock release button.
- ② To use
Lift up and push down the head restraint to the lowest lock position.

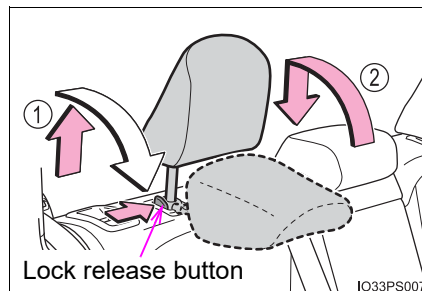

■ Rear center seat

- ① Up
Pull the head restraints up.
- ② Down
Push the head restraint down while pressing the lock release button.

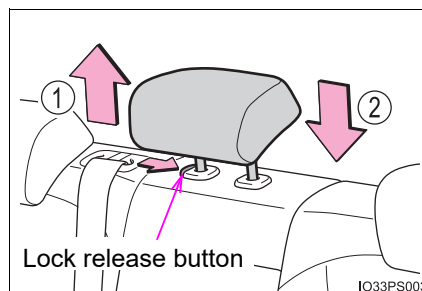

4

Operation of each component

■ **Removing the head restraints**

▶ Front and rear center seats

Pull the head restraint up while pressing the lock release button.

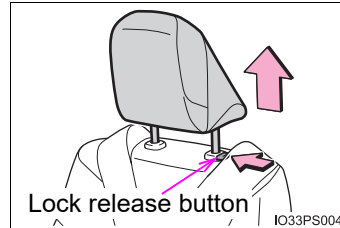

▶ Rear outboard seats

- 1 Pull the seatback lock release lever and fold down the seatback until it reaches the position where the head restraints can be removed.

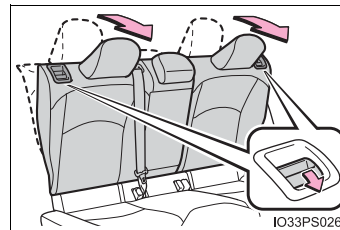

- 2 Pull the head restraint up while pressing the lock release buttons.

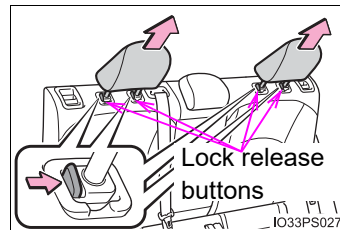

■ **Installing the head restraints**

▶ Front and rear center seats

Align the head restraint with the installation holes and push it down to the lock position.

Press and hold the lock release button when lowering the head restraint.

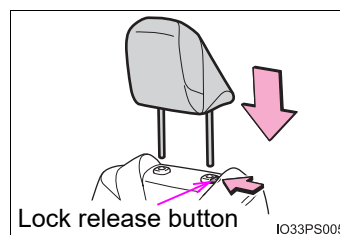

► Rear outboard seats

- 1 Pull the seatback lock release lever and fold down the seatback until it reaches the position where the head restraints can be installed.

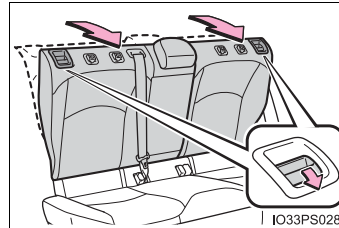

- 2 Align the head restraint with the installation holes and push it down to the lowest lock position.

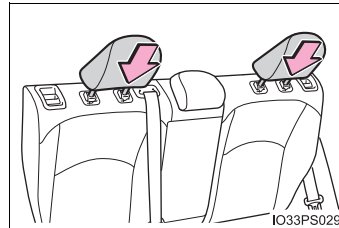

■ Adjusting the height of the head restraints (front seats)

Make sure that the head restraints are adjusted so that the center of the head restraint is closest to the top of your ears.

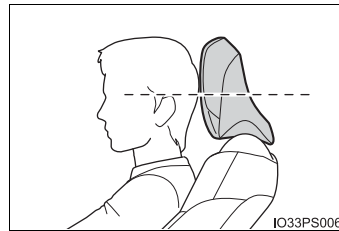

■ Adjusting the rear center seat head restraint

Always raise the head restraint one level from the stowed position when using.

⚠ WARNING

■ Head restraint precautions

Observe the following precautions regarding the head restraints. Failure to do so may result in death or serious injury.

- Use the head restraints designed for each respective seat.
- Adjust the head restraints to the correct position at all times.
- After adjusting the head restraints, push down on them and make sure they are locked in position.
- Do not drive with the head restraints removed.

4
Operation of each component

Steering wheel

Adjustment procedure

- 1 Hold the steering wheel and push the lever down.

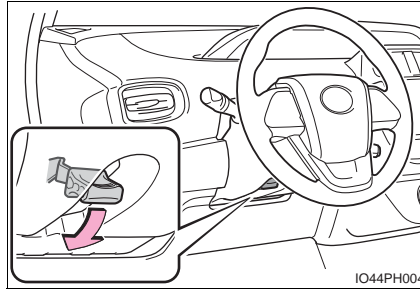

- 2 Adjust to the ideal position by moving the steering wheel horizontally and vertically. After adjustment, pull the lever up to secure the steering wheel.

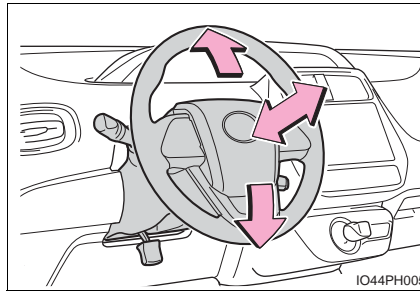

Horn

To sound the horn, press on or close to the  mark.

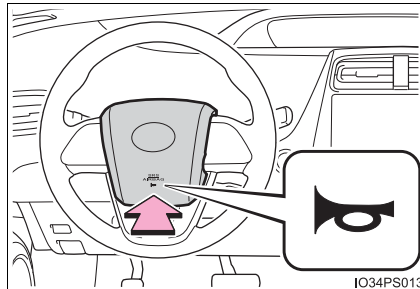

 **WARNING****■ Caution while driving**

Do not adjust the steering wheel while driving. Doing so may cause the driver to mishandle the vehicle and cause an accident, resulting in death or serious injury.

■ After adjusting the steering wheel

Make sure that the steering wheel is securely locked. Otherwise, the steering wheel may move suddenly, possibly causing an accident, and resulting in death or serious injury. Also, the horn may not sound if the steering wheel is not securely locked.

Inside rear view mirror

The rear view mirror's position can be adjusted to enable sufficient confirmation of the rear view.

Adjusting the height of rear view mirror

The height of the rear view mirror can be adjusted to suit your driving posture.

Adjust the height of the rear view mirror by moving it up and down.

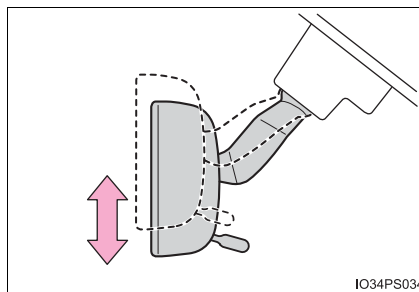

Anti-glare function

► Manual anti-glare inside rear view mirror

Reflected light from the headlights of vehicles behind can be reduced by operating the lever.

- ① Normal position
- ② Anti-glare position

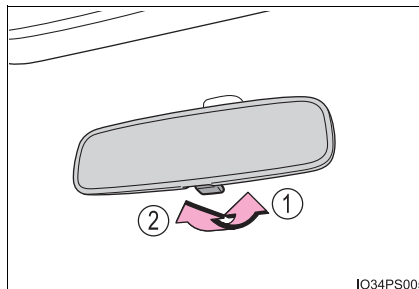

▶ Auto anti-glare inside rear view mirror

Responding to the level of brightness of the headlights of vehicles behind, the reflected light is automatically reduced.

Changing automatic anti-glare function mode

On/off

When the automatic anti-glare function is in ON mode, the indicator illuminates.

The function will set to ON mode each time the power switch is turned to ON mode.

Pressing the button turns the function to OFF mode. (The indicator also turns off.)

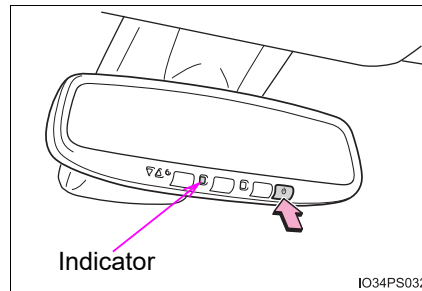

■ To prevent sensor error (vehicles with auto anti-glare inside rear view mirror)

To ensure that the sensors operate properly, do not touch or cover them.

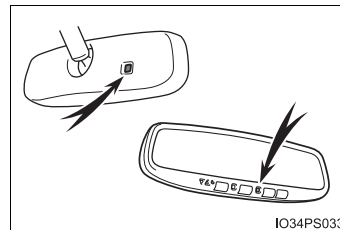

⚠ WARNING

Do not adjust the position of the mirror while driving.
Doing so may lead to mishandling of the vehicle and cause an accident, resulting in death or serious injury.

Outside rear view mirrors

Adjustment procedure

1 To select a mirror to adjust, turn the switch.

- ① Left
- ② Right

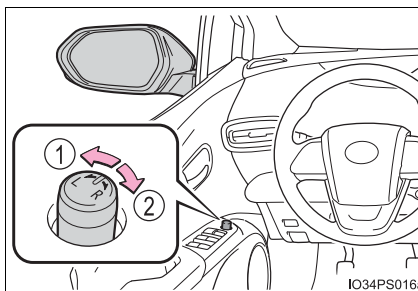

2 To adjust the mirror, operate the switch.

- ① Up
- ② Right
- ③ Down
- ④ Left

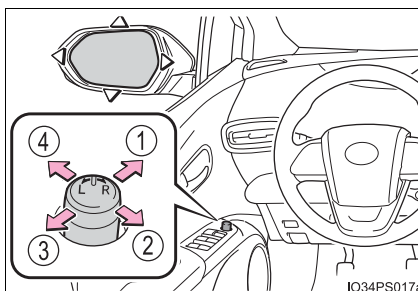

Folding the mirrors

Push the mirror back in the direction of the vehicle's rear.

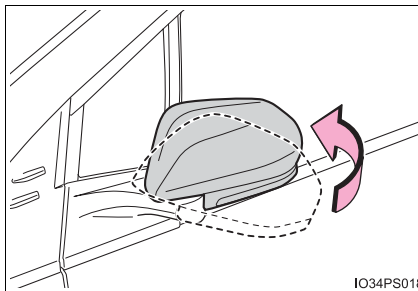

■ Mirror angle can be adjusted when

The power switch is in ACCESSORY or ON mode.

■ When the mirrors are fogged up

The outside rear view mirrors can be cleared using the mirror defoggers. Turn on the rear window defogger to turn on the outside rear view mirror defoggers. (→P. 516, 527)

⚠ WARNING**■ Important points while driving**

Observe the following precautions while driving.

Failing to do so may result in loss of control of the vehicle and cause an accident, resulting in death or serious injury.

- Do not adjust the mirrors while driving.
- Do not drive with the mirrors folded.
- Both the driver and passenger side mirrors must be extended and properly adjusted before driving.

■ When a mirror is moving

To avoid personal injury and mirror malfunction, be careful not to get your hand caught by the moving mirror.

■ When the mirror defoggers are operating

Do not touch the rear view mirror surfaces, as they can become very hot and burn you.

Power windows

Opening and closing procedures

The power windows can be opened and closed using the switches.

Operating the switch moves the side windows as follows:

- ① Closing
- ② One-touch closing*
- ③ Opening
- ④ One-touch opening*

*: To stop the side window partway, operate the switch in the opposite direction.

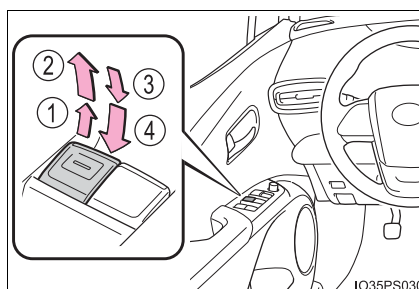

Window lock switch

Press the switch to lock the passenger windows.

The indicator will come on.

Use this switch to prevent children from accidentally opening or closing a passenger window.

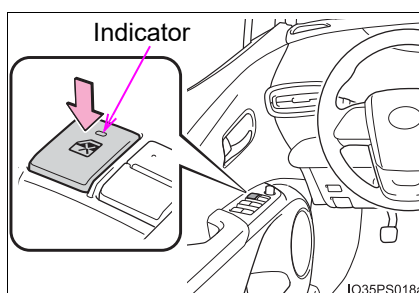

■ The power windows can be operated when

The power switch is in ON mode.

■ Operating the power windows after turning the hybrid system off

The power windows can be operated for approximately 45 seconds even after the power switch is turned to ACCESSORY mode or turned off. They cannot, however, be operated once either front door is opened.

■ Jam protection function

If an object becomes jammed between the side window and the window frame while the side window is closing, side window movement is stopped and the side window is opened slightly.

■ Catch protection function

If an object becomes caught between the door and side window while the side window is opening, side window movement is stopped.

■ When the window cannot be opened or closed

When the jam protection function or catch protection function operates unusually and the side window cannot be opened and closed, perform the following operations with the power window switch of that door.

- Stop the vehicle. With the power switch in ON mode, within 4 seconds of the jam protection function or catch protection function activating, continuously operate the power window switch in the one-touch closing direction or one-touch opening direction so that the side window can be opened and closed.
- If the side window cannot be opened and closed even when performing the above operations, perform the following procedure for function initialization.

- 1 Turn the power switch to ON mode.
- 2 Pull and hold the power window switch in the one-touch closing direction and completely close the side window.
- 3 Release the power window switch for a moment, resume pulling the switch in the one-touch closing direction, and hold it there for approximately 6 seconds or more.
- 4 Press and hold the power window switch in the one-touch opening direction. After the side window is completely opened, continue holding the switch for an additional 1 second or more.
- 5 Release the power window switch for a moment, resume pressing the switch in the one-touch opening direction, and hold it there for approximately 4 seconds or more.
- 6 Pull and hold the power window switch in the one-touch closing direction again. After the side window is completely closed, continue holding the switch for a further 1 second or more.

If you release the switch while the side window is moving, start again from the beginning.

If the side window reverses and cannot be fully closed or opened, have the vehicle inspected by your Toyota dealer.

■ Door lock linked window operation

- The power windows can be opened and closed using the mechanical key.* (→P. 711)
- The power windows can be opened using the wireless remote control.* (→P. 282)

*: These settings must be customized at your Toyota dealer.

■ When the 12-volt battery is disconnected

The window lock switch is disabled. If necessary, press the window lock switch after reconnecting the 12-volt battery.

■ Power window open reminder function

The buzzer sounds and a message is shown on the multi-information display in the instrument cluster when the power switch is turned off and the driver's door is opened with the power windows open.

■ Customization

Settings (e.g. linked door lock operation) can be changed.
(Customizable features: →P. 753)

⚠ WARNING

Observe the following precautions.
Failing to do so may result in death or serious injury.

■ Closing the windows

- The driver is responsible for all the power window operations, including the operation for the passengers. In order to prevent accidental operation, especially by a child, do not let a child operate the power windows. It is possible for children and other passengers to have body parts caught in the power window. Also, when riding with a child, it is recommended to use the window lock switch. (→P. 314)

- Check to make sure that all passengers do not have any part of their body in a position where it could be caught when a side window is being operated.

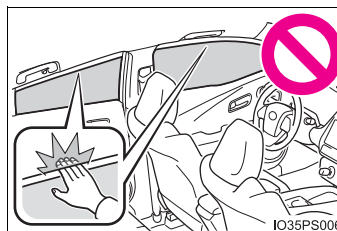

- When using the wireless remote control or mechanical key and operating the power windows, operate the power window after checking to make sure that there is no possibility of any passenger having any of their body parts caught in the side window. Also do not let a child operate side window by the wireless remote control or mechanical key. It is possible for children and other passengers to get caught in the power window.
- When exiting the vehicle, turn the power switch off, carry the key and exit the vehicle along with the child. There may be accidental operation, due to mischief, etc., that may possibly lead to an accident.

 **WARNING****■ Jam protection function**

- Never use any part of your body to intentionally activate the jam protection function.
- The jam protection function may not work if something gets jammed just before the side window is fully closed. Be careful not to get any part of your body jammed in the side window.

■ Catch protection function

- Never use any part of your body or clothing to intentionally activate the catch protection function.
- The catch protection function may not work if something gets caught just before the side window is fully opened. Be careful not to get any part of your body or clothing caught in the side window.

Driving

5

5-1. Before driving		5-5. Using the driving support systems	
Driving the vehicle.....	320	Toyota Safety Sense 2.0...	376
Cargo and luggage	332	PCS (Pre-Collision System).....	384
Vehicle load limits	335	LTA (Lane Tracing Assist).....	395
Trailer towing.....	336	RSA (Road Sign Assist).....	410
Dinghy towing	337	Dynamic radar cruise control with full-speed range.....	414
5-2. Driving procedures		Driving mode select switch.....	430
Power (ignition) switch	338	BSM (Blind Spot Monitor)	432
Hybrid transmission.....	345	• The Blind Spot Monitor function	437
Turn signal lever.....	351	• The Rear Cross Traffic Alert function.....	440
Parking brake.....	352	Intuitive parking assist.....	445
5-3. Operating the lights and wipers		Parking Support Brake function	455
Headlight switch	353	S-APGS (Simple Advanced Parking Guidance System)	467
AHB (Automatic High Beam)	358	Driving assist systems	501
Fog light switch	363	5-6. Driving tips	
Windshield wipers and washer	365	Winter driving tips	507
5-4. Refueling			
Opening the fuel tank cap	371		

Driving the vehicle

The following procedures should be observed to ensure safe driving:

Before starting the hybrid system

Check that the charging cable is disconnected. (→P. 146)

Starting the hybrid system

→P. 338

Driving

- 1 With the brake pedal depressed, shift the shift position to D.
(→P. 345)
Check that the shift position indicator shows D.
- 2 Release the parking brake. (→P. 352)
- 3 Gradually release the brake pedal and gently depress the accelerator pedal to accelerate the vehicle.

Stopping

- 1 With the shift position in D, depress the brake pedal.
- 2 If necessary, set the parking brake.
If the vehicle is to be stopped for an extended period of time, shift the shift position to P. (→P. 346)

Parking the vehicle

- 1 Stop the vehicle completely.
- 2 Set the parking brake. (→P. 352)
- 3 Shift the shift position to P. (→P. 346)
Check that the shift position indicator shows P.
- 4 Press the power switch to stop the hybrid system.
- 5 Slowly release the brake pedal.
- 6 Lock the door, making sure that you have the electronic key on your person.
If parking on a hill, block the wheels as needed.

Starting off on a steep uphill

- 1 Firmly set the parking brake with the brake pedal depressed, and then shift the shift position to D.
- 2 Release the brake pedal and gently depress the accelerator pedal.
- 3 Release the parking brake.

■ When starting off on an uphill

The hill-start assist control will activate. (→P. 502)

■ For electricity-saving and fuel-efficient driving

Understand the system characteristics of the vehicle to use the functions of the hybrid system. Also, keep in mind that hybrid vehicles are similar to conventional vehicles, and it is necessary to refrain from activities such as sudden acceleration. Refer to "Plug-in hybrid vehicle driving tips" (→P. 105).

■ Driving in the rain

- Drive carefully when it is raining, because visibility will be reduced, the windows may become fogged-up, and the road will be slippery.
- Drive carefully when it starts to rain, because the road surface will be especially slippery.
- Refrain from high speeds when driving on an expressway in the rain, because there may be a layer of water between the tires and the road surface, preventing the steering and brakes from operating properly.

■ Restraining the hybrid system output (Brake Override System)

- When the accelerator and brake pedals are depressed at the same time, the hybrid system output may be restrained.
- A warning message is displayed on the multi-information display while the system is operating. (→P. 689)

■ “ECO Accelerator Guidance” (→P. 228)

It is easier to drive in an Eco-friendly manner by driving while referring to the “ECO Accelerator Guidance” display. Also, by using the “ECO Accelerator Guidance”, it is easier to increase the Eco score evaluation.

- When starting off:
While staying within the “ECO Accelerator Guidance” range, gradually depress the accelerator pedal and accelerate to the desired speed. If excessive acceleration is avoided, the “Eco-Start” score will increase.
- When driving:
After accelerating to the desired speed, release the accelerator pedal and drive at a stable speed within the “ECO Accelerator Guidance” range. By keeping the vehicle within the “ECO Accelerator Guidance” range, the “Eco-Cruise” score will increase.
- When stopping:
When stopping the vehicle, early releasing the accelerator pedal will cause the “Eco-Stop” score to increase.

■ Restraining sudden start (Drive-Start Control)

- When the following unusual operation is performed, the hybrid system output may be restrained.
 - When the shift position is shifted from R to D/B, D/B to R, N to R, P to D/B*, P to R* with the accelerator pedal depressed, a warning message appears on the multi-information display. If a warning message is shown on the multi-information display, read the message and follow the instructions.
 - When the accelerator pedal is depressed too much while the vehicle is in reverse.
- While Drive-Start Control is being activated, your vehicle may have trouble escaping from the mud or fresh snow. In such case, deactivate TRAC (→P. 502) to cancel Drive Start Control so that the vehicle may become able to escape from the mud or fresh snow.

*: Depending on the situation, the shift position may not be changed.

■ Breaking in your new Toyota

To extend the life of the vehicle, observing the following precautions is recommended:

- For the first 200 miles (300 km):
Avoid sudden stops.
- For the first 600 miles (1000 km):
 - Do not drive at extremely high speeds.
 - Avoid sudden acceleration.
 - Do not drive at a constant speed for extended periods.

■ Operating your vehicle in a foreign country

Comply with the relevant vehicle registration laws and confirm the availability of the correct fuel. (→P. 732)

■ For efficient use

- Shift the shift position to D when driving.
In the N position, the gasoline engine operates but electricity cannot be generated. The hybrid battery (traction battery) will discharge, requiring unnecessary engine power to charge.
- Drive your vehicle smoothly.
Avoid abrupt acceleration and deceleration. Gradual acceleration and deceleration will make more effective use of the electric motor (traction motor) without having to use gasoline engine power.
- Avoid repeated acceleration.
Repeated acceleration consumes hybrid battery (traction battery) power, resulting in poor acceleration. Battery power can be restored by driving with the accelerator pedal slightly released.
- Shift the shift position to P when parking.
In the N position, the hybrid battery (traction battery) does not charge. Leaving the shift position in the N position for an extended period of time may discharge the hybrid battery (traction battery). The vehicle cannot run if the hybrid battery (traction battery) is discharged.

 **WARNING**

Observe the following precautions.
Failure to do so may result in death or serious injury.

■ When starting the vehicle

Always keep your foot on the brake pedal while stopped with the “READY” indicator is illuminated. This prevents the vehicle from creeping.

■ When driving the vehicle

- Do not drive if you are unfamiliar with the location of the brake and accelerator pedals to avoid depressing the wrong pedal.
 - Accidentally depressing the accelerator pedal instead of the brake pedal will result in sudden acceleration that may lead to an accident.
 - When backing up, you may twist your body around, leading to a difficulty in operating the pedals. Make sure to operate the pedals properly.
 - Make sure to keep a correct driving posture even when moving the vehicle only slightly. This allows you to depress the brake and accelerator pedals properly.
 - Depress the brake pedal using your right foot. Depressing the brake pedal using your left foot may delay response in an emergency, resulting in an accident.
- The driver should pay extra attention to pedestrians when the vehicle is powered only by the electric motor (traction motor). As there is no engine noise, the pedestrians may misjudge the vehicle’s movement. Even though the vehicle is equipped with the vehicle proximity notification system, drive with care as pedestrians in the vicinity may still not notice the vehicle if the surrounding area is noisy.
- Do not drive the vehicle over or stop the vehicle near flammable materials such as leaves, paper or rags.
The exhaust system and exhaust gases can be extremely hot. These hot parts may cause a fire if there is any flammable material nearby.
- During normal driving, do not turn off the hybrid system. Turning the hybrid system off while driving will not cause loss of steering or braking control, however, power assist to the steering will be lost. This will make it more difficult to steer smoothly, so you should pull over and stop the vehicle as soon as it is safe to do so.
In the event of an emergency, such as if it becomes impossible to stop the vehicle in the normal way: →P. 665

 **WARNING**

Observe the following precautions.
Failure to do so may result in death or serious injury.

■ When driving the vehicle

- Use engine braking (shift position B instead of shift position D) to maintain a safe speed when driving down a steep hill.
Using the brakes continuously may cause the brakes to overheat and lose effectiveness. (→P. 346)
- Do not adjust the positions of the steering wheel, the seat, or the inside or outside rear view mirrors while driving.
Doing so may result in a loss of vehicle control.
- Always check that all passengers' arms, head or other parts of their body are not outside the vehicle.
- Do not drive across river crossings or through other bodies of water.
This may cause electric/electronic components to short circuit, damage the hybrid system or cause other serious damage to the vehicle.
- Do not drive in excess of the speed limit. Even if the legal speed limit permits it, do not drive over 85 mph (140 km/h) unless your vehicle has high-speed capability tires. Driving over 85 mph (140 km/h) may result in tire failure, loss of control and possible injury. Be sure to consult a tire dealer to determine whether the tires on your vehicle are high-speed capability tires or not before driving at such speeds.

■ When driving on slippery road surfaces

- Sudden braking, acceleration and steering may cause tire slippage and reduce your ability to control the vehicle.
- Sudden acceleration, engine braking due to shifting, or changes in engine speed could cause the vehicle to skid, resulting in an accident.
- After driving through a puddle, depress the brake pedal to make sure that the brakes are functioning properly. Wet brake pads may prevent the brakes from functioning properly. If the brakes on only one side are wet and not functioning properly, steering control may be affected.

 **WARNING**

Observe the following precautions.
Failure to do so may result in death or serious injury.

■ When shifting the shift position

- Do not let the vehicle roll backward while a forward driving position is selected, or roll forward while the shift position is in R.
Doing so may result in an accident or damage to the vehicle.
- Do not shift the shift position to P while the vehicle is moving.
Doing so can damage the transmission and may result in a loss of vehicle control.
- Do not shift the shift position to R while the vehicle is moving forward.
Doing so can damage the transmission and may result in a loss of vehicle control.
- Do not shift the shift position to a driving position while the vehicle is moving backward.
Doing so can damage the transmission and may result in a loss of vehicle control.
- Changing the shift position to N while the vehicle is moving will disengage the hybrid system. Engine braking is not available with the hybrid system disengaged.
- Be careful not to change the shift position with the accelerator pedal depressed.
Changing the shift position to any position other than P or N may lead to unexpected rapid acceleration of the vehicle that may cause an accident and result in death or serious injury.
After changing the shift position, make sure to confirm the current shift position displayed on the shift position indicator inside the meter.

 **WARNING**

Observe the following precautions.

Failure to do so may result in death or serious injury.

■ **If you hear a squealing or scraping noise (brake pad wear limit indicators)**

Have the brake pads checked and replaced by your Toyota dealer as soon as possible.

Rotor damage may result if the pads are not replaced when needed.

It is dangerous to drive the vehicle when the wear limits of the brake pads and/or those of the brake discs are exceeded.

■ **When the vehicle is stopped**

- Do not depress the accelerator pedal unnecessarily.

If the shift position is in any position other than P or N, the vehicle may accelerate suddenly and unexpectedly, causing an accident.

- In order to prevent accidents due to the vehicle rolling away, always keep depressing the brake pedal while stopped with the "READY" indicator is illuminated, and apply the parking brake as necessary.

- If the vehicle is stopped on an incline, in order to prevent accidents caused by the vehicle rolling forward or backward, always depress the brake pedal and securely apply the parking brake as needed.

- Avoid revving or racing the engine.

Running the engine at high speed while the vehicle is stopped may cause the exhaust system to overheat, which could result in a fire if combustible material is nearby.

 **WARNING**

Observe the following precautions.

Failure to do so may result in death or serious injury.

■ **When the vehicle is parked**

- Do not leave glasses, cigarette lighters, spray cans, or soft drink cans in the vehicle when it is in the sun.
Doing so may result in the following:
 - Gas may leak from a cigarette lighter or spray can, and may lead to a fire.
 - The temperature inside the vehicle may cause the plastic lenses and plastic material of glasses to deform or crack.
 - Soft drink cans may fracture, causing the contents to spray over the interior of the vehicle, and may also cause a short circuit in the vehicle's electrical components.
- Do not leave cigarette lighters in the vehicle. If a cigarette lighter is in a place such as the glove box or on the floor, it may be lit accidentally when luggage is loaded or the seat is adjusted, causing a fire.
- Do not attach adhesive discs to the windshield or windows. Do not place containers such as air fresheners on the instrument panel or dashboard. Adhesive discs or containers may act as lenses, causing a fire in the vehicle.
- Do not leave a door or window open if the curved glass is coated with a metallized film such as a silver-colored one. Reflected sunlight may cause the glass to act as a lens, causing a fire.
- Always apply the parking brake, shift the shift position to P, stop the hybrid system and lock the vehicle.
Do not leave the vehicle unattended while the "READY" indicator is illuminated.
If the vehicle is parked with the shift position in P but the parking brake is not set, the vehicle may start to move, possibly leading to an accident.
- Do not touch the exhaust pipe while the "READY" indicator is illuminated or immediately after turning the hybrid system off.
Doing so may cause burns.

 **WARNING**

Observe the following precautions.

Failure to do so may result in death or serious injury.

■ **When taking a nap in the vehicle**

Always turn the hybrid system off. Otherwise, if you accidentally move the shift lever or depress the accelerator pedal, this could cause an accident or fire due to hybrid system overheating. Additionally, if the vehicle is parked in a poorly ventilated area, exhaust gases may collect and enter the vehicle, leading to death or a serious health hazard.

■ **When braking**

- When the brakes are wet, drive more cautiously.

Braking distance increases when the brakes are wet, and this may cause one side of the vehicle to brake differently than the other side. Also, the parking brake may not securely hold the vehicle.

- If the electronically controlled assist function does not operate, do not follow other vehicles closely and avoid downhill or sharp turns that require braking.

In this case, braking is still possible, but the brake pedal should be depressed more firmly than usual. Also, the braking distance will increase. Have your brakes fixed immediately.

- The brake system consists of 2 or more individual hydraulic systems; if one of the systems fails, the other(s) will still operate. In this case, the brake pedal should be depressed more firmly than usual and the braking distance will increase. Have your brakes fixed immediately.

 NOTICE

■ **When driving the vehicle**

- Do not depress the accelerator and brake pedals at the same time during driving, as this may restrain the hybrid system output.
- Do not use the accelerator pedal or depress the accelerator and brake pedals at the same time to hold the vehicle on a hill.

■ **When parking the vehicle**

Always set the parking brake, and shift the shift position to P. Failure to do so may cause the vehicle to move or the vehicle may accelerate suddenly if the accelerator pedal is accidentally depressed.

■ **Avoiding damage to vehicle parts**

- Do not turn the steering wheel fully in either direction and hold it there for an extended period of time.
Doing so may damage the power steering motor.
- When driving over bumps in the road, drive as slowly as possible to avoid damaging the wheels, underside of the vehicle, etc.

■ **If you get a flat tire while driving**

A flat or damaged tire may cause the following situations. Hold the steering wheel firmly and gradually depress the brake pedal to slow down the vehicle.

- It may be difficult to control your vehicle.
- The vehicle will make abnormal sounds or vibrations.
- The vehicle will lean abnormally.

Information on what to do in case of a flat tire: →P. 692

 NOTICE**■ When encountering flooded roads**

Do not drive on a road that has flooded after heavy rain etc. Doing so may cause the following serious damage to the vehicle:

- Engine stalling
- Short in electrical components
- Engine damage caused by water immersion

In the event that you drive on a flooded road and the vehicle is flooded, be sure to have your Toyota dealer check the following:

- Brake function
- Changes in quantity and quality of oil and fluid used for the engine, hybrid transmission, etc.
- Lubricant condition for the bearings and suspension joints (where possible), and the function of all joints, bearings, etc.

If the shift control system is damaged by flooding, it may not be possible to shift the shift position to P, or from P to other positions. When the shift position cannot be changed from P to any other position, the front wheels will lock, and you will be unable to tow the vehicle with the front wheels on the ground, as the front wheels may be locked. In this case, transport the vehicle with both front wheels or all four wheels lifted. (→P. 667)

Cargo and luggage

Take notice of the following information about storage precautions, cargo capacity and load.

Capacity and distribution

Cargo capacity depends on the total weight of the occupants.

$(\text{Cargo capacity}) = (\text{Total load capacity}) - (\text{Total weight of occupants})$

Steps for Determining Correct Load Limit —

- (1) Locate the statement “The combined weight of occupants and cargo should never exceed XXX kg or XXX lbs.” on your vehicle’s placard.
- (2) Determine the combined weight of the driver and passengers that will be riding in your vehicle.
- (3) Subtract the combined weight of the driver and passengers from XXX kg or XXX lbs.
- (4) The resulting figure equals the available amount of cargo and luggage load capacity.
For example, if the “XXX” amount equals 1400 lbs. and there will be five 150 lb passengers in your vehicle, the amount of available cargo and luggage load capacity is 650 lbs. $(1400 - 750 (5 \times 150) = 650 \text{ lbs.})$
- (5) Determine the combined weight of luggage and cargo being loaded on the vehicle. That weight may not safely exceed the available cargo and luggage load capacity calculated in Step 4.
- (6) If your vehicle will be towing a trailer, load from your trailer will be transferred to your vehicle. Consult this manual to determine how this reduces the available cargo and luggage load capacity of your vehicle. (→P. 335)

Toyota does not recommend towing a trailer with your vehicle. Your vehicle is not designed for trailer towing.

Calculation formula for your vehicle

- ① Cargo capacity
- ② Total load capacity (vehicle capacity weight) (→P. 730)

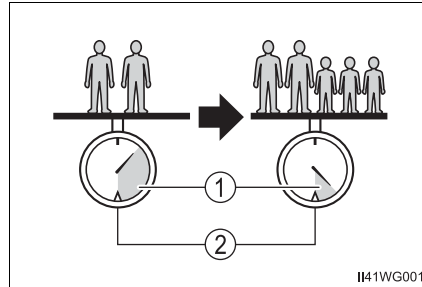

When 2 people with the combined weight of A lb. (kg) are riding in your vehicle, which has a total load capacity (vehicle capacity weight) of B lb. (kg), the available amount of cargo and luggage load capacity will be C lb. (kg) as follows:

$$B^{*2} \text{ lb. (kg)} - A^{*1} \text{ lb. (kg)} = C^{*3} \text{ lb. (kg)}$$

- *1: A = Weight of people
- *2: B = Total load capacity
- *3: C = Available cargo and luggage load

In this condition, if 3 more passengers with the combined weight of D lb. (kg) get on, the available cargo and luggage load will be reduced E lb. (kg) as follows:

$$C \text{ lb. (kg)} - D^{*4} \text{ lb. (kg)} = E^{*5} \text{ lb. (kg)}$$

- *4: D = Additional weight of people
- *5: E = Available cargo and luggage load

As shown in the example above, if the number of occupants increases, the cargo and luggage load will be reduced by an amount that equals the increased weight due to the additional occupants. In other words, if an increase in the number of occupants causes an excess of the total load capacity (combined weight of occupants plus cargo and luggage load), you must reduce the cargo and luggage on your vehicle.

 **WARNING****■ Things that must not be carried in the luggage compartment**

The following things may cause a fire if loaded in the luggage compartment:

- Receptacles containing gasoline
- Aerosol cans

■ Storage precautions

Observe the following precautions.

Failure to do so may prevent the pedals from being depressed properly, may block the driver's vision, or may result in items hitting the driver or passengers, possibly causing an accident.

- Stow cargo and luggage in the luggage compartment whenever possible.
- Do not stack cargo and luggage in the luggage compartment higher than the seatbacks.
- When you fold down the rear seats, long items should not be placed directly behind the front seats.
- Never allow anyone to ride in the luggage compartment. It is not designed for passengers. They should ride in their seats with their seat belts properly fastened.
- Do not place cargo or luggage in or on the following locations.
 - At the feet of the driver
 - On the front passenger or rear seats (when stacking items)
 - On the luggage cover
 - On the instrument panel
 - On the dashboard
- Secure all items in the occupant compartment.

■ Capacity and distribution

- Do not exceed the maximum axle weight rating or the total vehicle weight rating.
- Even if the total load of occupant's weight and the cargo load is less than the total load capacity, do not apply the load unevenly. Improper loading may cause deterioration of steering or braking control which may cause death or serious injury.

Vehicle load limits

Vehicle load limits include total load capacity, seating capacity, towing capacity and cargo capacity.

◆ **Total load capacity (vehicle capacity weight): →P. 730**

Total load capacity means the combined weight of occupants, cargo and luggage.

◆ **Seating capacity: →P. 730**

Seating capacity means the maximum number of occupants whose estimated average weight is 150 lb. (68 kg) per person.

◆ **Towing capacity**

Toyota does not recommend towing a trailer with your vehicle.

◆ **Cargo capacity**

Cargo capacity may increase or decrease depending on the weight and the number of occupants.

■ **Total load capacity and seating capacity**

These details are also described on the tire and loading information label. (→P. 623)

 **WARNING**

■ **Overloading the vehicle**

Do not overload the vehicle. It may not only cause damage to the tires, but also degrade steering and braking ability, resulting in an accident.

Trailer towing

Toyota does not recommend towing a trailer with your vehicle. Toyota also does not recommend the installation of a tow hitch or the use of a tow hitch carrier for a wheelchair, scooter, bicycle, etc. Your vehicle is not designed for trailer towing or for the use of tow hitch mounted carriers.

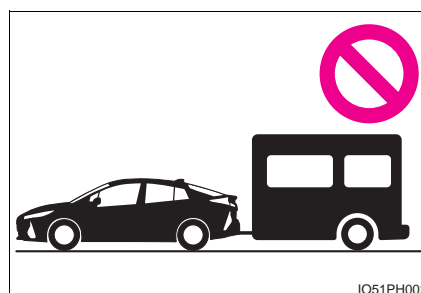

Dinghy towing

Your vehicle is not designed to be dinghy towed (with 4 wheels on the ground) behind a motor home.

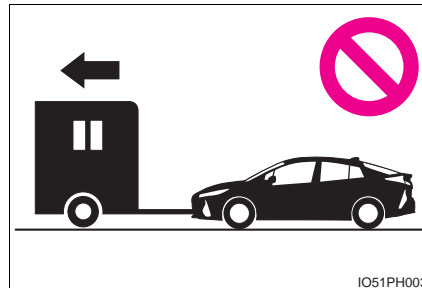

 NOTICE

- **To avoid serious damage to your vehicle**
Do not tow your vehicle with the four wheels on the ground.

Power (ignition) switch

Performing the following operations when carrying the electronic key on your person starts the hybrid system or changes power switch modes.

Starting the hybrid system

- 1 Check that the charging cable is disconnected. (→P. 146)
- 2 Check that the parking brake is set.
- 3 Firmly depress the brake pedal.

 and a message will be displayed on the multi-information display.

When the shift position is N, the hybrid system cannot start. Shift the shift position to P when starting the hybrid system. (→P. 346)

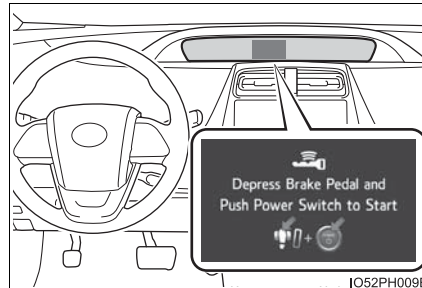

- 4 Press the power switch shortly and firmly.

When operating the power switch, one short, firm press is enough. It is not necessary to press and hold the switch.

If the "READY" indicator turns on, the hybrid system will operate normally.

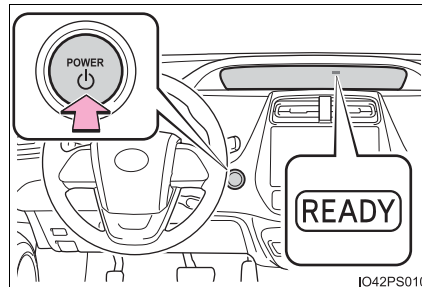

Continue depressing the brake pedal until the "READY" indicator is illuminated.

The hybrid system can be started from any power switch mode.

- 5 Check that the "READY" indicator is illuminated.

If the "READY" indicator changes from a flashing light to a solid light and the buzzer sounds, the hybrid system is starting normally.

The vehicle will not move when the "READY" indicator is off.

The vehicle can move when the "READY" indicator is on even if the engine is stopped. (The gasoline engine starts or stops automatically in accordance with the state of the vehicle.)

Stopping the hybrid system

- 1 Stop the vehicle completely.
- 2 Set the parking brake. (→P. 352)
- 3 Shift the shift position to P.
(→P. 346)
Check that the shift position indicator shows P. (→P. 345)

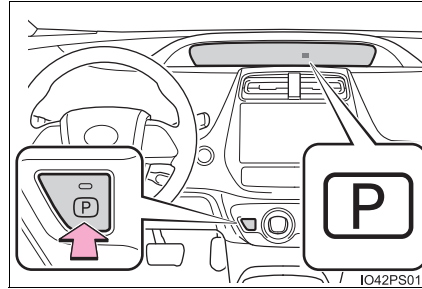

- 4 Press the power switch.
The hybrid system will stop.
- 5 Slowly release the brake pedal and check that the display on the instrument cluster is off.
The meter display sequentially turns off after the hybrid system stops.
(→P. 342)

Changing power switch modes

Modes can be changed by pressing the power switch with the brake pedal released. (The mode changes each time the switch is pressed.)

① Off

The emergency flashers can be used.

② ACCESSORY mode

Some electrical components such as the audio system can be used.

“Accessory” is displayed on the main display.

③ ON mode

All electrical components can be used.

“Ignition ON” is displayed on the main display.

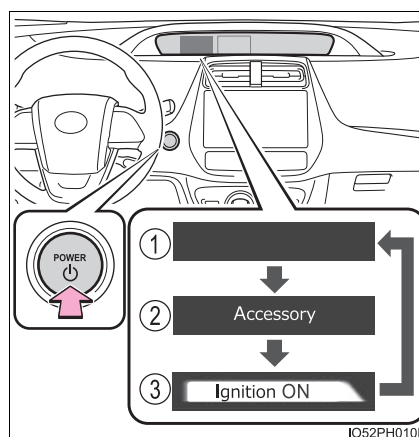

■ Auto power off function

If the vehicle is left in ACCESSORY mode for more than 20 minutes or ON mode (the hybrid system is not operating) for more than an hour with the shift position in P, the power switch will automatically turn off. However, this function cannot entirely prevent the 12-volt battery discharge. Do not leave the vehicle with the power switch in ACCESSORY or ON mode for long periods of time when the hybrid system is not operating.

■ Sounds and vibrations specific to a hybrid vehicle

→P. 96

■ Electronic key battery depletion

→P. 278

■ When the ambient temperature is low, such as during winter driving conditions

- When starting the hybrid system, the flashing time of the “READY” indicator may be long. Leave the vehicle as it is until the “READY” indicator is steady on, as steady means the vehicle is able to move.
- When the hybrid battery (traction battery) is extremely cold (below approximately -22°F [-30°C]) under the influence of the outside temperature, it may not be possible to start the hybrid system. In this case, try to start the hybrid system again after the temperature of the hybrid battery increases due to the outside temperature increase etc.

■ Conditions affecting operation

→P. 295

■ Note for the entry function

→P. 296

■ If the hybrid system does not start

- The immobilizer system may not have been deactivated. (→P. 83)
Contact your Toyota dealer.
- The charging cable may be connected to the vehicle. (→P. 142)
- If a message related to start-up is shown on the multi-information display, read the message and follow the instructions.

■ If the “READY” indicator does not come on

In the event that the “READY” indicator does not come on even after performing the proper procedures for starting the vehicle, contact your Toyota dealer immediately.

■ If the hybrid system is malfunctioning

→P. 99

■ If the electronic key battery is depleted

→P. 647

■ Operation of the power switch

- If the switch is not pressed shortly and firmly, the power switch mode may not change or the hybrid system may not start.
- If attempting to restart the hybrid system immediately after turning the power switch off, the hybrid system may not start in some cases. After turning the power switch off, please wait a few seconds before restarting the hybrid system.

■ Automatic hybrid system shut off feature

- The vehicle is equipped with a feature that automatically shuts off the hybrid system when the shift position is in P with the hybrid system operating for an extended period.
- The hybrid system will automatically shut off after approximately 1 hour if it has been left running while the shift position is in P.
- The timer for the automatic hybrid system shut off feature will reset if the brake pedal is depressed or if the shift position is in a position other than P.
- After the vehicle is parked, if the door is locked with the door lock switch (→P. 283) from the inside or the mechanical key (→P. 711) from the outside, the automatic hybrid system shut off feature will be disabled. The timer for the automatic hybrid system shut off feature will be re-enabled if the driver's door is opened.

■ **Automatic P position selection function**

→P. 348

■ **When the shift control system malfunctions**

When attempting to turn the power switch off while there is a malfunction in the shift control system, the power switch mode may change to ACCESSORY mode. In this case, ACCESSORY mode may be turned off by applying the parking brake and pressing the power switch again. If there is a malfunction in the system, have the vehicle inspected by your Toyota dealer immediately.

■ **Meter display**

When the power switch is turned off, each display will turn off as follows.

- The shift position indicator will turn off after approximately 2 seconds.
- The multi-information display, clock, etc. will turn off after approximately 30 seconds. (Each display will also turn off immediately if a door is locked before 30 seconds has elapsed.)

■ **If the smart key system has been deactivated in a customized setting**

→P. 712

⚠ WARNING**■ When starting the hybrid system**

Always start the hybrid system while sitting in the driver's seat. Do not depress the accelerator pedal while starting the hybrid system under any circumstances.

Doing so may cause an accident resulting in death or serious injury.

■ Stopping the hybrid system in an emergency

● If you want to stop the hybrid system in an emergency while driving the vehicle, press and hold the power switch for more than 2 seconds, or press it briefly 3 times or more in succession. (→P. 665)

However, do not touch the power switch while driving except in an emergency. Turning the hybrid system off while driving will not cause loss of steering or braking control, however, power assist to the steering will be lost. This will make it more difficult to steer smoothly, so you should pull over and stop the vehicle as soon as it is safe to do so.

● If the power switch is operated while the vehicle is running, a warning message will be shown on the multi-information display and a buzzer sounds.

● When restarting the hybrid system after an emergency shutdown while driving, press the power switch. When restarting the hybrid system after stopping the vehicle, change the shift position to P and then press the power switch.

■ When parking

Exhaust gases include harmful carbon monoxide (CO), which is colorless and odorless. Observe the following precautions.

Failure to do so may cause exhaust gases to enter the vehicle and may lead to an accident caused by light-headedness, or may lead to death or a serious health hazard.

● If the vehicle is in a poorly ventilated area or a closed area, such as a garage, stop the hybrid system.

● Do not leave the vehicle with the hybrid system operating for a long time. If such a situation cannot be avoided, park the vehicle in an open space and ensure that exhaust fumes do not enter the vehicle interior.

● Do not leave the hybrid system operating in an area with snow build-up, or where it is snowing. If snowbanks build up around the vehicle while the hybrid system is operating, exhaust gases may collect and enter the vehicle.

 NOTICE

■ **To prevent 12-volt battery discharge**

- Do not leave the power switch in ACCESSORY or ON mode for long periods of time without the hybrid system on.
- If “Accessory”, “Ignition ON” or mileage display (→P. 213) is displayed on the main display while the hybrid system is not operating, the power switch is not off. Exit the vehicle after turning the power switch off.

■ **When starting the hybrid system**

If the hybrid system becomes difficult to start, have your vehicle checked by your Toyota dealer immediately.

■ **Symptoms indicating a malfunction with the power switch**

If the power switch seems to be operating somewhat differently than usual, such as the switch sticking slightly, there may be a malfunction. Contact your Toyota dealer immediately.

Hybrid transmission

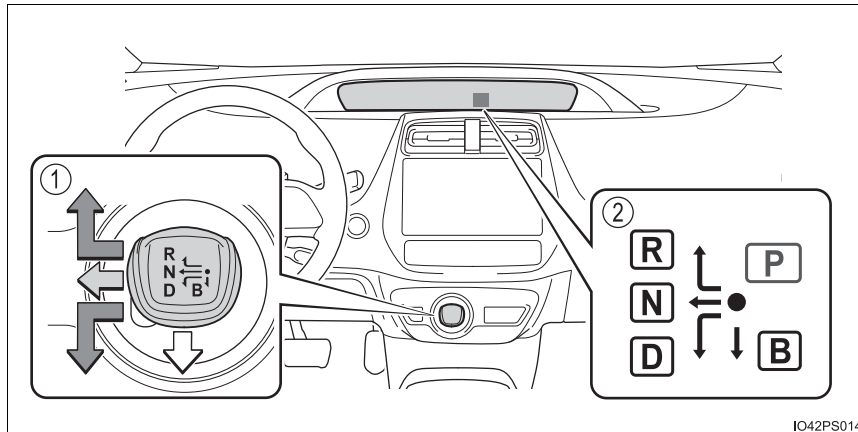

Shifting the shift lever



① Shift lever

Operate the shift lever gently and ensure correct shifting operation.

Release the shift lever after each shifting operation to allow it to return to the ● position.

-  When shifting to the D or R, move the shift lever along the shift gate.
-  To shift to the N, slide the shift lever to the left and hold it. The shift position will change to N.
-  To shift to the B, pull the shift lever down. Shifting to B is only possible when shift position D is selected.

When shifting from P to N, D or R, from D to R, or from R to D, ensure that the brake pedal is being depressed and the vehicle is stationary.

② Shift position indicator

The current shift position is highlighted.

When any shift position other than D or B is selected, the arrow toward B and B position indicator disappear from the shift position indicator.

When selecting the shift position, make sure that the shift position has been changed to the desired position by checking the shift position indicator provided on the instrument cluster.

Shift position purpose

Shift position	Objective or function
P	Parking the vehicle/starting the hybrid system
R	Reversing
N	Neutral (Condition in which the power is not transmitted)
D	Normal driving*
B	Applying engine braking or strong braking when the accelerator pedal has been released on steep downward slopes etc.

*: For good fuel economy and noise reduction, the D position should usually be used.

Selecting a driving mode

→P. 430

P position switch**■ When shifting the shift position to P**

Fully stop the vehicle and set the parking brake, and then press the P position switch.

When the shift position is changed to P, the switch indicator comes on.

Check that the P position is highlighted on the shift position indicator.

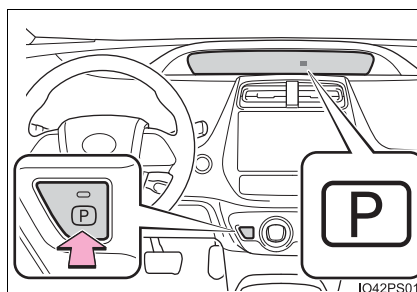
**■ Shifting the shift position from P to other positions**

- While depressing the brake pedal firmly, operate the shift lever. If the shift lever is operated without depressing the brake pedal, the buzzer will sound and the shifting operation will be disabled.
- When selecting the shift position, make sure that the shift position has been changed to the desired position by checking the shift position indicator provided on the instrument cluster.
- The shift position cannot be changed from P to B directly.

■ For the shift positions

- When the power switch is off, the shift position cannot be changed.
- When the power switch is in ON mode (the hybrid system is not operating), the shift position can only be changed to N. The shift position will be changed to N even if the shift lever is shifted to D or R and held in that position.
- When the “READY” indicator is on, the shift position can be changed from P to D, N or R.
- When the “READY” indicator is flashing, the shift position cannot be changed from P to another position even if the shift lever is operated. Wait until the “READY” indicator changes from a flashing to a solid light, and then operate the shift lever again.
- The shift position can only be changed to B directly from D.

In addition, if an attempt is made to change the shift position by moving the shift lever or by pressing the P position switch in any of the following situations, the buzzer will sound and the shifting operation will be disabled or the shift position will automatically change to N. When this happens, select an appropriate shift position.

- Situations where the shifting operation will be disabled:
 - When an attempt is made to change the shift position from P to another position by moving the shift lever without depressing the brake pedal.
 - When an attempt is made to change the shift position from P or N to B by moving the shift lever.
 - When an attempt is made to change the shift position from P to another position by moving the shift lever while the charging cable is connected to the vehicle.
 - Situations where the shift position will automatically change to N:
 - When the P position switch is pressed while the vehicle is running.*1
 - When an attempt is made to select the R position by moving the shift lever when the vehicle is moving forward.*2
 - When an attempt is made to select the D position by moving the shift lever when the vehicle is moving in reverse.*3
 - When an attempt is made to change the shift position from R to B by moving the shift lever.
- *1: Shift position may be changed to P when driving at extremely low speeds.
- *2: Shift position may be changed to R when driving at low speeds.
- *3: Shift position may be changed to D when driving at low speeds.
- If N is selected while driving at a certain speed, even if the shift lever is not held in the N position, the shift position changes to N. In this situation, the buzzer sounds and a confirmation message is displayed on the multi-information display to inform the driver that the shift position has changed to N.

■ Reverse warning buzzer

When shifting into R, a buzzer will sound to inform the driver that the shift position is in R.

■ Restraining sudden start (Drive-Start Control)

→P. 322

■ Automatic P position selection function

- If the power switch is on and the shift position is not already P, completely stopping the vehicle and pressing the power switch causes the shift position to automatically switch to P and the power switch to turn off.*
- The shift position may also automatically switch to P if one of the following conditions is detected while the vehicle is stopped by dynamic radar cruise control with full-speed range.
 - Driver's seat belt is not fastened
 - Driver's door is opened
 - Approximately 3 minutes elapse after the vehicle stopped

*: If the power switch is pressed when driving at very low speeds (for example, just before the vehicle stops), the shift position may automatically switch to P. Press the power switch after completely stopping the vehicle to prevent unexpected sudden stopping of the vehicle.

■ If the shift position cannot be shifted from P

There is a possibility that the 12-volt battery is discharged. Check the 12-volt battery in this situation. (→P. 715)

■ About engine braking

When shift position B is selected, releasing the accelerator pedal will apply engine braking.

- When the vehicle is driven at high speeds, compared to ordinary gasoline-fueled vehicles, the engine braking deceleration is felt less than that of other vehicles.
- The vehicle can be accelerated even when shift position B is selected.

If the vehicle is driven continuously in the B position, fuel efficiency will become low. Usually, select the D position.

■ After recharging/reconnecting the 12-volt battery

→P. 608

■ **When a message related to shift operations is displayed on the multi-information display**

When the shift position does not switch due to a mistaken operation, system conditions, etc., or when the attempted shift operation is invalid, a message indicating the correct operation or the reason why switching cannot be performed is shown on the multi-information display. In these cases, follow the instructions and retry the operation.

■ **Customization**

Settings (e.g. reverse warning buzzer) can be changed.
(Customizable features: →P. 753)

 **WARNING**

■ **When driving on slippery road surfaces**

Do not accelerate or shift the shift position suddenly.
Sudden changes in engine braking may cause the vehicle to spin or skid, resulting in an accident.

■ **Shift lever and P position switch**

- Do not remove the shift lever knob or use anything but a genuine Toyota shift lever knob. Also, do not hang anything on the shift lever.
Doing so could prevent the shift lever from returning to position, causing unexpected accidents to occur when the vehicle is in motion.
- Do not press the P position switch while the vehicle is moving.
If the P position switch is pressed when driving at very low speeds (for example, just before the vehicle stops), the vehicle may stop suddenly when the shift position switches to P, which could lead to an accident.
- In order to prevent the shift position from accidentally being changed, do not touch the shift lever or P position switch when not using them.

**NOTICE****■ Hybrid battery (traction battery) charge**

If the shift position is in N, the hybrid battery (traction battery) will not be charged. To help prevent the battery from discharging, avoid leaving the N position selected for an extended period of time.

■ Situations where shift control system malfunctions are possible

If any of the following situations occurs, shift control system malfunctions are possible.

Immediately stop the vehicle in a safe place on level ground, apply the parking brake, and then contact your Toyota dealer.

- When the warning message indicating the shift control system appears on the multi-information display.
- The display indicates that no shift position is selected for more than a few seconds.

■ Notes regarding shift lever and P position switch operation

Avoid repeatedly operating the shift lever and P position switch in quick succession.

The system protection function may activate and it will not be temporarily possible to shift the shift position other than P. If this happens, please wait for approximately 20 seconds before attempting to change the shift position again.

Turn signal lever

Operating instructions

- ① Right turn
- ② Lane change to the right (move the lever partway and release it)
The right hand signals will flash 3 times.
- ③ Lane change to the left (move the lever partway and release it)
The left hand signals will flash 3 times.
- ④ Left turn

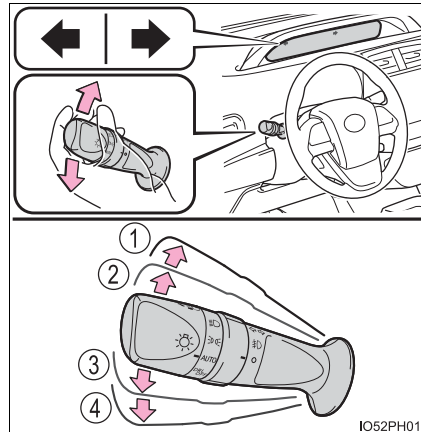

■ Turn signals can be operated when

The power switch is in ON mode.

■ If the indicator flashes faster than usual

Check that each turn signal light flashes correctly.

■ If the turn signals stop flashing before a lane change has been performed

Operate the lever again.

■ Customization

The number of times the turn signals flash during a lane change can be changed. (Customizable features: →P. 753)

Parking brake

Operating instructions

To set the parking brake, fully depress the parking brake pedal with your left foot while depressing the brake pedal with your right foot.

(Depressing the pedal again releases the parking brake.)

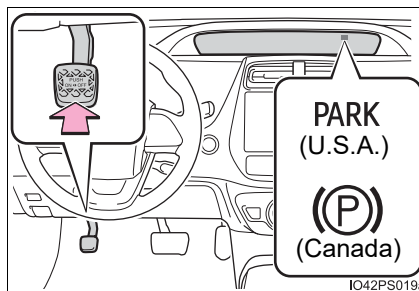

■ Parking the vehicle

→P. 321

■ Parking brake engaged warning buzzer

A buzzer will sound if the vehicle is driven with the parking brake engaged. "Release Parking Brake" is displayed on the multi-information display (with the vehicle reached a speed of 3 mph [5 km/h]).

■ Usage in winter time

→P. 508

⚠ NOTICE

■ Before driving

Fully release the parking brake.

Driving the vehicle with the parking brake set will lead to brake components overheating, which may affect braking performance and increase brake wear.





Headlight switch

The headlights can be operated manually or automatically.

Operating instructions



Operating the  switch turns on the lights as follows:

► U.S.A. (type A)

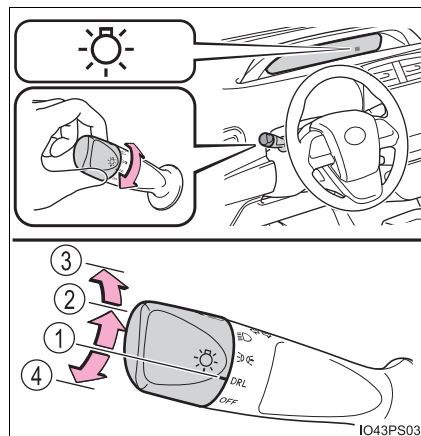
- ① **DRL**  The daytime running lights turn on. (→P. 356)
- ②  The side marker, parking, tail, license plate, instrument panel lights, and daytime running lights (→P. 356) turn on.
- ③  The headlights and all the lights listed above (except daytime running lights) turn on.
- ④ **OFF**  The daytime running lights turn off.



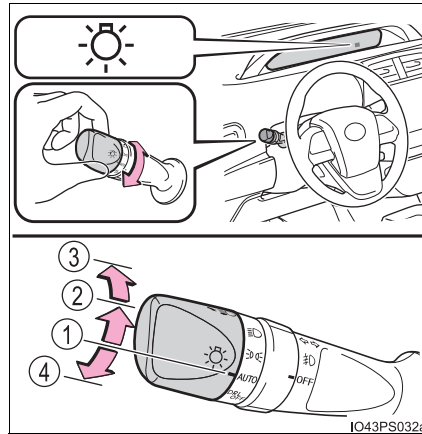

► U.S.A. (type B)

- ① AUTO (if equipped) The headlights, side marker, parking, LED accent (if equipped), daytime running lights (→P. 356) and so on turn on and off automatically (when the power switch is in ON mode).
- ②  The side marker, parking, LED accent (if equipped), tail, license plate, instrument panel lights, and daytime running lights (→P. 356) turn on.
- ③  The headlights and all the lights listed above (except daytime running lights) turn on.
- ④  The daytime running lights turn off.



► Canada

- ① AUTO The headlights, side marker, parking, LED accent (if equipped), daytime running lights (→P. 356) and so on turn on and off automatically (when the power switch is in ON mode).
- ②  The side marker, parking, LED accent (if equipped), tail, license plate, instrument panel lights, and daytime running lights (→P. 356) turn on.
- ③  The headlights and all the lights listed above (except daytime running lights) turn on.
- ④  The daytime running lights turn on. (→P. 356)

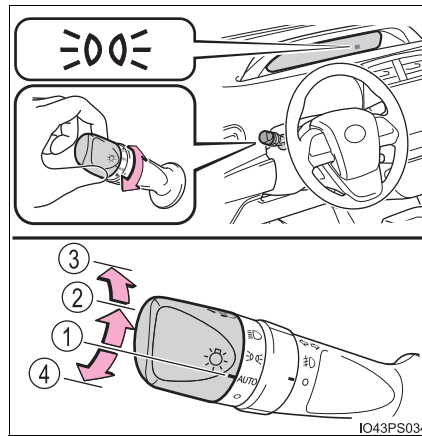

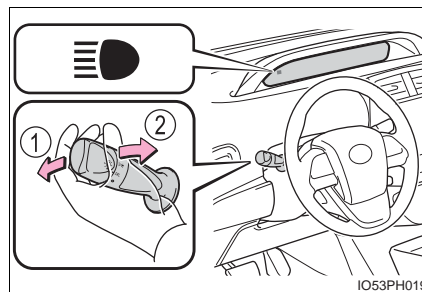

Turning on the high beam headlights

- ① With the headlights on, push the lever away from you to turn on the high beams.
Pull the lever toward you to the center position to turn the high beams off.
- ② Pull the lever toward you and release it to flash the high beams once.



You can flash the high beams with the headlights on or off.

■ Daytime running light system

- The daytime running lights illuminate using the same lights as the headlights, and illuminate dimmer than the headlights.
- To make your vehicle more visible to other drivers during daytime driving, the daytime running lights turn on automatically when all of the following conditions are met. (The daytime running lights are not designed for use at night.)
 - The hybrid system is operating
 - The parking brake is released
 - The headlight switch is in the DRL ,  ,  or AUTO * position

*: When the surroundings are bright

The daytime running lights remain on after they illuminate, even if the parking brake is set again.

- For the U.S.A.: Daytime running lights can be turned off by operating the switch.
- Compared to turning on the headlights, the daytime running light system offers greater durability and consumes less electricity, so it can help improve fuel economy.

■ Headlight control sensor (if equipped)

The sensor may not function properly if an object is placed on the sensor, or anything that blocks the sensor is affixed to the windshield.



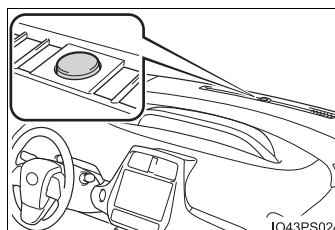

Doing so interferes with the sensor detecting the level of ambient light and may cause the automatic headlight system to malfunction.

Air conditioning operation may also be interrupted.



■ **Automatic light off system**

- When the headlights come on: The headlights and tail lights turn off 30 seconds after a door is opened and closed if the power switch is turned to ACCESSORY mode or turned off. (The lights turn off immediately if  on the key is pressed after all the doors are locked.)
- When only the tail lights come on: The tail lights turn off automatically if the power switch is turned to ACCESSORY mode or turned off and the driver's door is opened.

To turn the lights on again, turn the power switch to ON mode, or turn the light switch to the OFF ,  ,  or AUTO position once and then back to the  or  position.

■ **12-volt battery-saving function**

In order to prevent the 12-volt battery of the vehicle from discharging, if the headlights and/or tail lights are on when the power switch is turned off, the 12-volt battery saving function will operate and automatically turn off all the lights after approximately 20 minutes.

When any of the following are performed, the 12-volt battery-saving function is canceled once and then reactivated. All the lights will turn off automatically 20 minutes after the 12-volt battery-saving function has been reactivated:

- When the headlight switch is operated
- When a door is opened or closed

■ **If “Headlight System Malfunction Visit Your Dealer” is displayed on the multi-information display**

The system may be malfunctioning. Have the vehicle inspected by your Toyota dealer.

■ **Customization**

Settings (e.g. light sensor sensitivity) can be changed.
(Customizable features: →P. 753)

 NOTICE

■ **To prevent 12-volt battery discharge**
Do not leave the lights on longer than necessary when the hybrid system is off.

AHB (Automatic High Beam)

The Automatic High Beam uses an in-vehicle front camera to assess the brightness of streetlights, the lights of vehicles ahead etc., and automatically turns the high beam on or off as necessary.

WARNING

■ Limitations of the Automatic High Beam

Do not rely on the Automatic High Beam. Always drive safely, taking care to observe your surroundings and turning the high beam on or off manually if necessary.

■ To prevent incorrect operation of the Automatic High Beam system

Do not overload the vehicle.

Activating the Automatic High Beam system

- 1 Push the lever away from you with the headlight switch in the AUTO or  position.

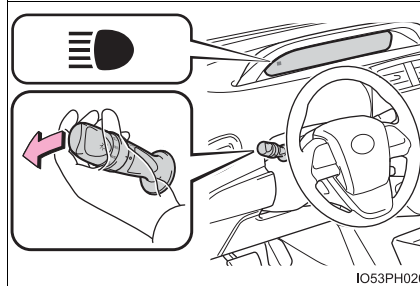

- 2 Press the Automatic High Beam switch.

The Automatic High Beam indicator will come on when the headlights are turned on automatically to indicate that the system is active.

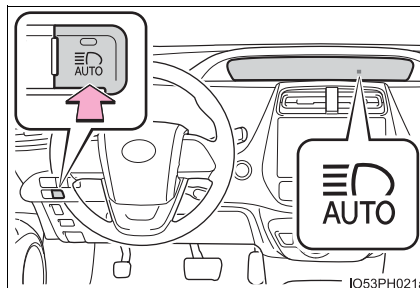

Turning the high beam on/off manually**■ Switching to low beam**

Pull the lever to the original position.

The Automatic High Beam indicator will turn off.

Push the lever away from you to activate the Automatic High Beam system again.

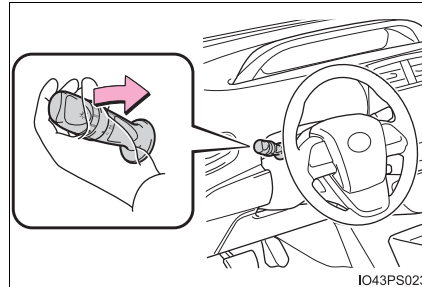
**■ Switching to high beam**

Press the Automatic High Beam switch.

The Automatic High Beam indicator will turn off and the high beam indicator will turn on.

Press the switch to activate the Automatic High Beam system again.

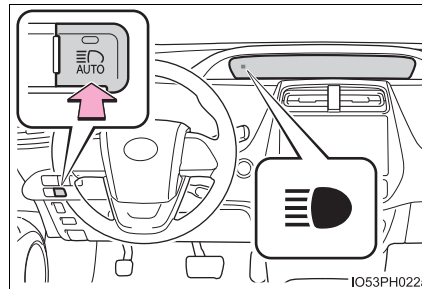

■ High beam automatic turning on or off conditions

- When all of the following conditions are fulfilled, the high beam will be automatically turned on (after approximately 1 second):
 - Vehicle speed is above approximately 21 mph (34 km/h).
 - The area ahead of the vehicle is dark.
 - There are no vehicles ahead with headlights or tail lights turned on.
 - There are few streetlights on the road ahead.
- If any of the following conditions are fulfilled, the high beam will be automatically turned off:
 - Vehicle speed drops below approximately 17 mph (27 km/h).
 - The area ahead of the vehicle is not dark.
 - Vehicles ahead have headlights or tail lights turned on.
 - There are many streetlights on the road ahead.

■ Front camera detection information

- The high beam may not be automatically turned off in the following situations:
 - When oncoming vehicles suddenly appear from a curve
 - When the vehicle is cut in front of by another vehicle
 - When vehicles ahead are hidden from sight due to repeated curves, road dividers or roadside trees
 - When vehicles ahead appear from the faraway lane on wide road
 - When vehicles ahead vehicles have no lights
- The high beam may be turned off if a vehicle ahead that is using fog lights without using the headlights is detected.
- House lights, street lights, traffic signals, and illuminated billboards or signs may cause the high beam to switch to the low beams, or the low beams to remain on.
- The following factors may affect the amount of time taken to turn the high beam on or off:
 - The brightness of headlights, fog lights, and tail lights of vehicles ahead
 - The movement and direction of vehicles ahead
 - When a vehicle ahead only has operational lights on one side
 - When a vehicle ahead is a two-wheeled vehicle
 - The condition of the road (gradient, curve, condition of the road surface etc.)
 - The number of passengers and amount of luggage
- The high beam may be turned on or off when the driver does not expect it.
- Bicycles or similar objects may not be detected.

- In the situations shown below, the system may not be able to accurately detect surrounding brightness levels. This may cause the low beams to remain on or the high beams to cause problems for pedestrians, vehicles ahead or other parties. In these cases, manually switch between the high and low beams.
 - In bad weather (rain, snow, fog, sandstorms etc.)
 - The windshield is obscured by fog, mist, ice, dirt etc.
 - The windshield is cracked or damaged.
 - The front camera is deformed or dirty.
 - The front camera temperature is extremely high.
 - Surrounding brightness levels are equal to those of headlights, tail lights or fog lights.
 - Vehicles ahead have headlights that are either switched off, dirty, are changing color, or are not aimed properly.
 - When driving through an area of intermittently changing brightness and darkness.
 - When frequently and repeatedly driving ascending/descending roads, or roads with rough, bumpy or uneven surfaces (such as stone-paved roads, gravel tracks etc.).
 - When frequently and repeatedly taking curves or driving on a winding road.
 - There is a highly reflective object ahead of the vehicle, such as a sign or a mirror.
 - The back of a vehicle ahead is highly reflective, such as a container on a truck.
 - The vehicle's headlights are damaged or dirty.
 - The vehicle is listing or tilting, due to a flat tire, a trailer being towed etc.
 - The high beam and low beam are repeatedly being switched between in an abnormal manner.
 - The driver believes that the high beam may be causing problems or distress to other drivers or pedestrians nearby.

■ **Temporarily lowering sensor sensitivity**

The sensitivity of the sensor can be temporarily lowered.

- 1 Turn the power switch off while the following conditions are met.
 - The headlight switch is in the AUTO or  position.
 - The headlight switch lever is in high beam position.
 - Automatic High Beam switch is on.
- 2 Turn the power switch to ON mode.
- 3 Within 60 seconds after step 2, repeat pulling the headlight switch lever to the original position then pushing it to the high beam position quickly 10 times, then leave the lever in high beam position.
- 4 If the sensitivity is changed, the Automatic High Beam indicator is turn on and off 3 times.

Automatic High Beam (headlights) may turn on even the vehicle is stopped.

■ **If “Headlight System Malfunction Visit Your Dealer” is displayed on the multi-information display**

The system may be malfunctioning. Have the vehicle inspected by your Toyota dealer.

Fog light switch*

The fog lights offer improved visibility in difficult driving conditions, such as in rain and fog.

Operating instructions

► Type A

- ① **OFF** Turns the fog lights off
- ② **☹** Turns the fog lights on

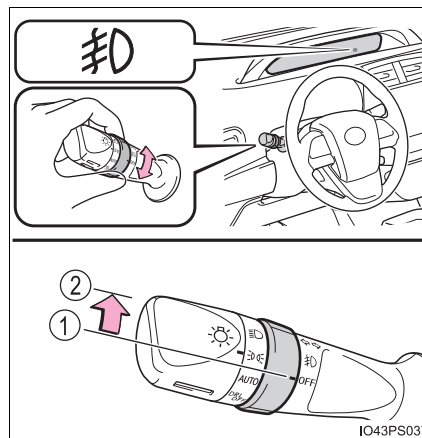

*: If equipped

► Type B

- ① ○ Turns the fog lights off
- ② ⓧ Turns the fog lights on



■ **Fog lights can be used when**
The headlights are on in low beam.

 NOTICE

■ **To prevent 12-volt battery discharge**
Do not leave the lights on longer than necessary when the hybrid system is off.

Windshield wipers and washer

Operating the wiper lever





Operating the  lever operates the wipers or washer as follows.

■ Intermittent windshield wipers with interval adjuster (if equipped)

▶ Type A

- ① **OFF** Off
- ② **INT** Intermittent operation
- ③ **LO** Low speed operation
- ④ **HI** High speed operation
- ⑤ **MIST** Temporary operation

▶ Type B

- ①  Off
- ②  Intermittent operation
- ③  Low speed operation
- ④  High speed operation
- ⑤  Temporary operation

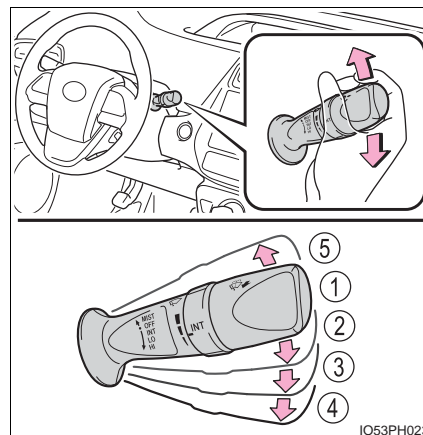

Wiper intervals can be adjusted when intermittent operation is selected.

- ⑥ Increases the intermittent windshield wiper frequency
- ⑦ Decreases the intermittent windshield wiper frequency

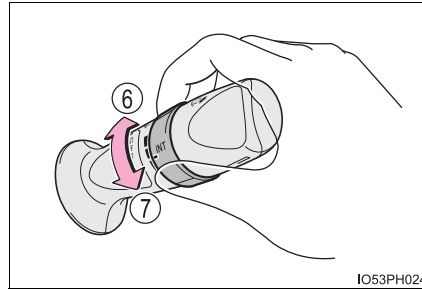

- ⑧  Washer/wiper dual operation

Pulling the lever operates the wipers and washer.

The wipers will automatically operate a couple of times after the washer squirts.

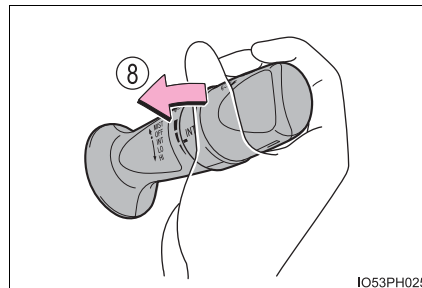

■ **Rain-sensing windshield wipers (if equipped)**

▶ Type A

- ① **OFF** Off
- ② **AUTO** Rain-sensing operation
- ③ **LO** Low speed operation
- ④ **HI** High speed operation
- ⑤ **MIST** Temporary operation

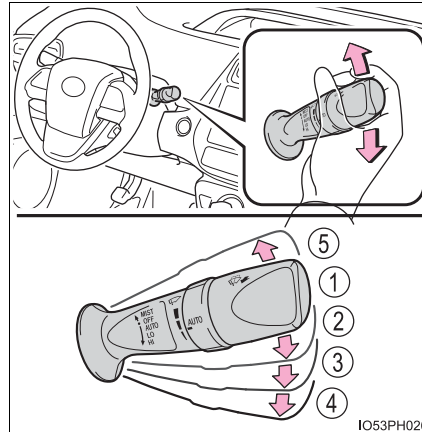

▶ Type B

- ① **○** Off
- ② **AUTO** Rain-sensing operation
- ③ **▼** Low speed operation
- ④ **▼▼** High speed operation
- ⑤ **△** Temporary operation

When **AUTO** is selected, the wipers will operate automatically when the sensor detects falling rain. The system automatically adjusts wiper timing in accordance with rain volume and vehicle speed.

The sensor sensitivity can be adjusted when **AUTO** is selected.

- ⑥ Increases the sensitivity
- ⑦ Decreases the sensitivity

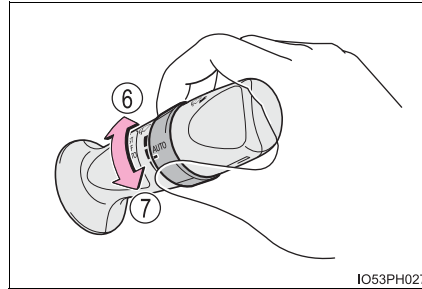

- ⑧  Washer/wiper dual operation

Pulling the lever operates the wipers and washer.

The wipers will automatically operate a couple of times after the washer squirts.

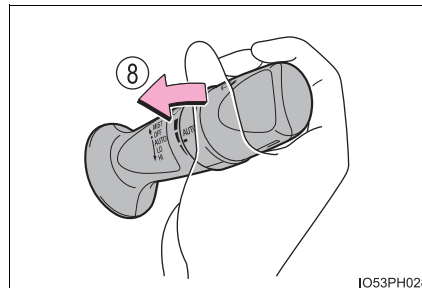

■ **The windshield wipers and washer can be operated when**

The power switch is in ON mode.

■ **Dripping prevention wiper sweep (vehicles with rain-sensing windshield wipers)**

After washing and wiping operation several times, the wipers operate one more time after a short delay to prevent dripping. However, this function will not operate while driving.

■ **Raindrop sensor (vehicles with rain-sensing windshield wipers)**

- The raindrop sensor judges the amount of raindrops.

An optical sensor is adopted. It may not operate properly when sunlight from the rising or setting of the sun intermittently strikes the windshield, or if bugs, etc. are present on the windshield.

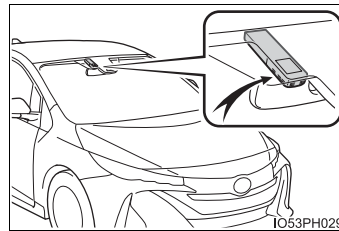

- If the wiper switch is turned to the **AUTO** position while the power switch is in ON mode, the wipers will operate once to show that AUTO mode is activated.
- If the wiper sensitivity is adjusted to higher, the wiper may operate once to indicate the change of sensitivity.
- If the temperature of the raindrop sensor is 185°F (85°C) or higher, or 5°F (-15°C) or lower, automatic operation may not occur. In this case, operate the wipers in any mode other than AUTO mode.

■ **If no windshield washer fluid sprays**

Check that the washer nozzles are not blocked, if there is washer fluid in the washer fluid tank.

■ **Customization**

Settings of AUTO mode operation can be changed.
(Customizable features: →P. 753)

 **WARNING**

■ **Caution regarding the use of windshield wipers in AUTO mode (vehicles with rain-sensing windshield wipers)**

The windshield wipers may operate unexpectedly if the sensor is touched or the windshield is subject to vibration in AUTO mode. Take care that your fingers, etc. do not become caught in the windshield wipers.

■ **Caution regarding the use of washer fluid**

When it is cold, do not use the washer fluid until the windshield becomes warm. The fluid may freeze on the windshield and cause low visibility. This may lead to an accident, resulting in death or serious injury.

 **NOTICE**

■ **When the windshield is dry**

Do not use the wipers, as they may damage the windshield.

■ **When the washer fluid tank is empty**

Do not operate the switch continually as the washer fluid pump may overheat.

■ **When a nozzle becomes blocked**

In this case, contact your Toyota dealer.

Do not try to clear it with a pin or other object. The nozzle will be damaged.

■ **To prevent 12-volt battery discharge**

Do not leave the wipers on longer than necessary when the hybrid system is off.

Opening the fuel tank cap

The fuel tank of your vehicle has a special structure, which requires a reduction in fuel tank pressure before refueling. After the opener switch has been pressed, it will take several seconds until the vehicle is ready for refueling.

Before refueling the vehicle

- Turn the power switch off and ensure that all the doors and windows are closed.
- Confirm the type of fuel.

■ Fuel types

→P. 739

■ Fuel tank opening for unleaded gasoline

To help prevent incorrect fueling, your vehicle has a fuel tank opening that only accommodates the special nozzle on unleaded fuel pumps.

 **WARNING****■ When refueling the vehicle**

Observe the following precautions while refueling the vehicle. Failure to do so may result in death or serious injury.

- After exiting the vehicle and before opening the fuel door, touch an unpainted metal surface to discharge any static electricity. It is important to discharge static electricity before refueling because sparks resulting from static electricity can cause fuel vapors to ignite while refueling.
- Always hold the grips on the fuel tank cap and turn it slowly to remove it. A whooshing sound may be heard when the fuel tank cap is loosened. Wait until the sound cannot be heard before fully removing the cap. In hot weather, pressurized fuel may spray out of the filler neck and cause injury.
- Do not allow anyone that has not discharged static electricity from their body to come close to an open fuel tank.
- Do not inhale vaporized fuel.
Fuel contains substances that are harmful if inhaled.
- Do not smoke while refueling the vehicle.
Doing so may cause the fuel to ignite and cause a fire.
- Do not return to the vehicle or touch any person or object that is statically charged.
This may cause static electricity to build up, resulting in a possible ignition hazard.

■ When refueling

Observe the following precautions to prevent fuel overflowing from the fuel tank:

- Securely insert the fuel nozzle into the fuel filler neck.
- Stop filling the tank after the fuel nozzle automatically clicks off.
- Do not top off the fuel tank.

 NOTICE

■ Refueling

- Finish refueling within 30 minutes. If more than 30 minutes passes, the internal valve closes. In this condition, fuel may overflow during the refueling process.

Press the fuel filler door opener switch again.

- Do not spill fuel during refueling.

Doing so may damage the vehicle, such as causing the emission control system to operate abnormally or damaging fuel system components or the vehicle's painted surface.

■ Notice about fuel

→P. 104

Opening the fuel tank cap

- 1 Press the opener to open the fuel filler door.

The fuel filler door will open within about 10 seconds of the switch being pressed. Before refueling is possible, a message will be shown on the multi-information display in the instrument cluster to indicate the progress of the fuel filler door opener.

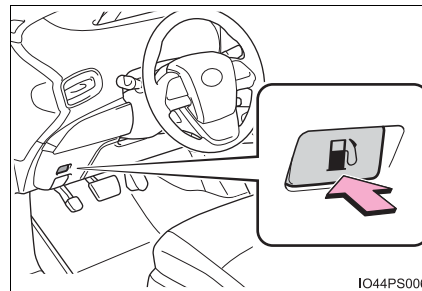

- 2 Turn the fuel tank cap slowly to open and hang it on the back of the fuel filler door.

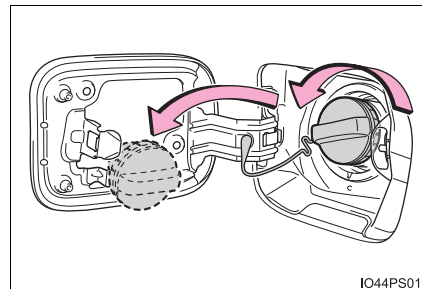

■ **When the fuel filler door cannot be opened by pressing the inside switch**

- 1 Open the back door and remove the cover underneath the luggage compartment light.

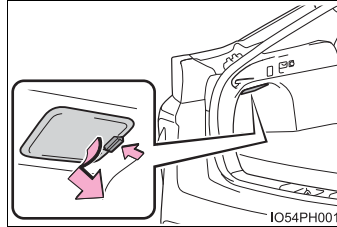

- 2 Pull the lever backward and check that the fuel lid opens.

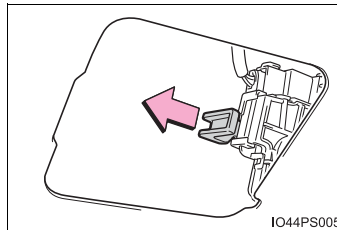

Using the lever to open the fuel filler door may not allow for an adequate reduction in fuel tank pressure before refueling. To prevent fuel from spilling out, turn the cap slowly when removing it.

During refueling, fuel may spill out from the filler opening due to air being discharged from inside the fuel tank. Therefore, fill the fuel tank carefully and slowly.

 **NOTICE**

■ **When refueling**

When refueling your vehicle, make sure that the fuel filler door lock is not pushed by the fuel nozzle boot, etc., as this may cause a valve to close, possibly resulting in a fuel spill.

If the fuel filler door lock has been pushed, operate the fuel filler door opener switch in the vehicle before continuing to refuel.

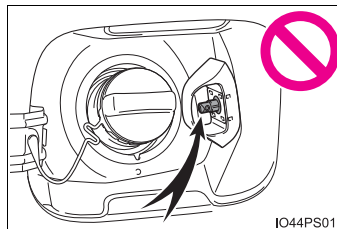

Closing the fuel tank cap

After refueling, turn the fuel tank cap until you hear a click. Once the cap is released, it will turn slightly in the opposite direction.

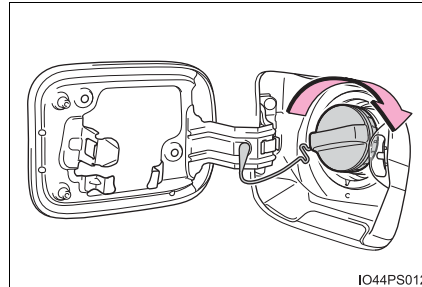
**⚠ WARNING****■ When replacing the fuel tank cap**

Do not use anything but a genuine Toyota fuel tank cap designed for your vehicle. Doing so may cause a fire or other incident which may result in death or serious injury.

Toyota Safety Sense 2.0

The Toyota Safety Sense 2.0 consists of the following drive assist systems and contributes to a safe and comfortable driving experience:

Driving assist system

◆ PCS (Pre-Collision System)

→P. 384

◆ LTA (Lane Tracing Assist)

→P. 395

◆ AHB (Automatic High Beam)

→P. 358

◆ RSA (Road Sign Assist)

→P. 410

◆ Dynamic radar cruise control with full-speed range

→P. 414

WARNING

■ Toyota Safety Sense 2.0

The Toyota Safety Sense 2.0 is designed to operate under the assumption that the driver will drive safely, and is designed to help reduce the impact to the occupants and the vehicle in the case of a collision or assist the driver in normal driving conditions.

As there is a limit to the degree of recognition accuracy and control performance that this system can provide, do not overly rely on this system. The driver is always responsible for paying attention to the vehicle's surroundings and driving safely.

Sensors

Two types of sensors, located behind the front grille and windshield, detect information necessary to operate the drive assist systems.

- ① Radar sensor
- ② Front camera

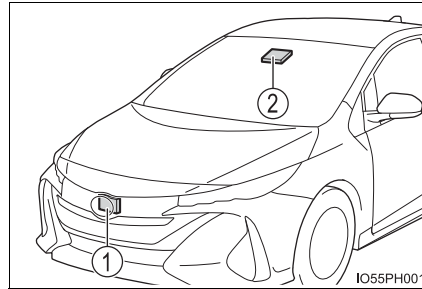

⚠ WARNING**■ To avoid malfunction of the radar sensor**

Observe the following precautions.

Otherwise, the radar sensor may not operate properly, possibly leading to an accident resulting in death or serious injury.

● Keep the radar sensor and the radar sensor cover clean at all times.

- ① Radar sensor
- ② Radar sensor cover

If the front of the radar sensor or the front or back of the radar sensor cover is dirty or covered with water droplets, snow, etc., clean it.

Clean the radar sensor and radar sensor cover with a soft cloth to avoid damaging them.

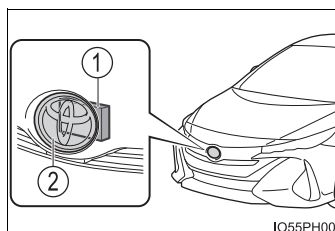

- Do not attach accessories, stickers (including transparent stickers) or other items to the radar sensor, radar sensor cover or surrounding area.
- Do not subject the radar sensor or its surrounding area to a strong impact. If the radar sensor, front grille, or front bumper has been subjected to a strong impact, have the vehicle inspected by your Toyota dealer.
- Do not disassemble the radar sensor.
- Do not modify or paint the radar sensor or radar sensor cover.
- In the following cases, the radar sensor must be recalibrated. Contact your Toyota dealer for details.
 - When the radar sensor or front grille are removed and installed, or replaced
 - When the front bumper is replaced

⚠ WARNING**■ To avoid malfunction of the front camera**

Observe the following precautions.

Otherwise, the front camera may not operate properly, possibly leading to an accident resulting in death or serious injury.

- Keep the windshield clean at all times.
 - If the windshield is dirty or covered with an oily film, water droplets, snow, etc., clean the windshield.
 - If a glass coating agent is applied to the windshield, it will still be necessary to use the windshield wipers to remove water droplets, etc. from the area of the windshield in front of the front camera.
 - If the inner side of the windshield where the front camera is installed is dirty, contact your Toyota dealer.
- Do not attach objects, such as stickers, transparent stickers, etc., to the outer side of the windshield in front of the front camera (shaded area in the illustration).

A: From the top of the windshield to approximately 0.4 in. (1 cm) below the bottom of the front camera

B: Approximately 7.9 in. (20 cm) (Approximately 4.0 in. [10 cm] to the right and left from the center of the front camera)

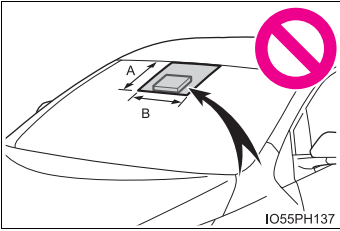
- If the part of the windshield in front of the front camera is fogged up or covered with condensation, or ice, use the windshield defogger to remove the fog, condensation, or ice. (→P. 515, 527)
- If water droplets cannot be properly removed from the area of the windshield in front of the front camera by the windshield wipers, replace the wiper insert or wiper blade.
- Do not attach window tint to the windshield.
- Replace the windshield if it is damaged or cracked.
After replacing the windshield, the front camera must be recalibrated. Contact your Toyota dealer for details.
- Do not allow liquids to contact the front camera.
- Do not allow bright lights to shine into the front camera.

⚠ WARNING

- Do not dirty or damage the front camera.
When cleaning the inside of the windshield, do not allow glass cleaner to contact the lens of the front camera. Also, do not touch the lens.
If the lens is dirty or damaged, contact your Toyota dealer.
- Do not subject the front camera to a strong impact.
- Do not change the installation position or direction of the front camera or remove it.
- Do not disassemble the front camera.
- Do not modify any components of the vehicle around the front camera (inside rear view mirror, etc.) or ceiling.
- Do not attach any accessories to the hood, front grille or front bumper that may obstruct the front camera. Contact your Toyota dealer for details.
- If a surfboard or other long object is to be mounted on the roof, make sure that it will not obstruct the front camera.
- Do not modify the headlights or other lights.

■ Certifications

- ▶ For vehicles sold in the U.S.A. and Hawaii

FCC ID: HYQDNMWR009

NOTE:

This device complies with part 15 of the FCC Rules. Operation is subject to the following two conditions: (1) This device may not cause harmful interference, and (2) this device must accept any interference received, including interference that may cause undesired operation.

FCC WARNING:

Changes or modifications not expressly approved by the party responsible for compliance could void the user's authority to operate the equipment.

Radiofrequency radiation exposure Information:

This equipment complies with FCC radiation exposure limits set forth for an uncontrolled environment. This equipment should be installed and operated with minimum distance of 20 cm between the radiator (antenna) and your body. This transmitter must not be co-located or operating in conjunction with any other antenna or transmitter.

► For vehicles sold in Canada

NOTE:

This device contains licence-exempt transmitter(s)/receiver(s) that comply with Innovation, Science and Economic Development Canada's licence-exempt RSS(s). Operation is subject to the following two conditions:

- (1) This device may not cause interference.
- (2) This device must accept any interference, including interference that may cause undesired operation of the device.

This equipment complies with ISED radiation exposure limits set forth for an uncontrolled environment and meets RSS-102 of the ISED radio frequency (RF) Exposure rules. This equipment should be installed and operated keeping the radiator at least 20 cm or more away from person's body.

NOTE:

L'émetteur/récepteur exempt de licence contenu dans le présent appareil est conforme aux CNR d'Innovation, Sciences et Développement économique Canada applicables aux appareils radio exempts de licence. L'exploitation est autorisée aux deux conditions suivantes :

- 1) L'appareil ne doit pas produire de brouillage;
- 2) L'appareil doit accepter tout brouillage radioélectrique subi, même si le brouillage est susceptible d'en compromettre le fonctionnement.

Cet équipement est conforme aux limites d'exposition aux rayonnements énoncées pour un environnement non contrôlé et respecte les règles d'exposition aux fréquences radioélectriques (RF) CNR-102 de l'ISDE. Cet équipement doit être installé et utilisé en gardant une distance de 20 cm ou plus entre le dispositif rayonnant et le corps.

■ **If a warning message is displayed on the multi-information display**

A system may be temporarily unavailable or there may be a malfunction in the system.

- In the following situations, perform the actions specified in the table. When the normal operating conditions are detected, the message will disappear and the system will become operational.

If the message does not disappear, contact your Toyota dealer.

Situation	Actions
When the area around a sensor is covered with dirt, moisture (fogged up, covered with condensation, ice, etc.), or other foreign matter	To clean the part of the windshield in front of the front camera, use the windshield wipers or the windshield defogger of the air conditioning system (→P. 515, 527).
When the temperature around the front camera is outside of the operational range, such as when the vehicle is in the sun or in an extremely cold environment	If the front camera is hot, such as after the vehicle had been parked in the sun, use the air conditioning system to decrease the temperature around the front camera. If a sunshade was used when the vehicle was parked, depending on its type, the sunlight reflected from the surface of the sunshade may cause the temperature of the front camera to become excessively high.
	If the front camera is cold, such after the vehicle is parked in an extremely cold environment, use the air conditioning system to increase the temperature around the front camera.
The area in front of the front camera is obstructed, such as when the hood is open or a sticker is attached to the part of the windshield in front of the front camera.	Close the hood, remove the sticker, etc. to clear the obstruction.

● In the following situations, if the situation has changed (or the vehicle has been driven for some time) and the normal operating conditions are detected, the message will disappear and the system will become operational.

If the message does not disappear, contact your Toyota dealer.

- When the temperature around the radar sensor is outside of the operational range, such as when the vehicle is in the sun or in an extremely cold environment
- When the front camera cannot detect objects in front of the vehicle, such as when driving in the dark, snow, or fog, or when bright lights are shining into the front camera

PCS (Pre-Collision System)

The pre-collision system uses a radar sensor and front camera to detect objects (→P. 384) in front of the vehicle. When the system determines that the possibility of a frontal collision with an object is high, a warning operates to urge the driver to take evasive action and the potential brake pressure is increased to help the driver avoid the collision. If the system determines that the possibility of a frontal collision with an object is extremely high, the brakes are automatically applied to help avoid the collision or help reduce the impact of the collision.

The pre-collision system can be disabled/enabled and the warning timing can be changed. (→P. 388)

Detectable objects

The system can detect the following:

- Vehicles
- Bicyclists
- Pedestrians

System functions

■ Pre-collision warning

When the system determines that the possibility of a frontal collision is high, a buzzer will sound and a warning message will be displayed on the multi-information display to urge the driver to take evasive action.

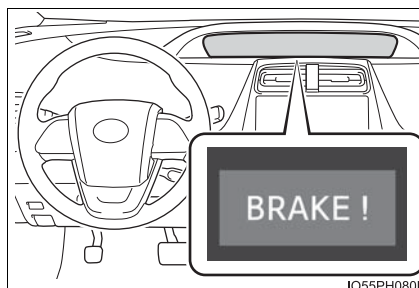

■ Pre-collision brake assist

When the system determines that the possibility of a frontal collision is high, the system applies greater braking force in relation to how strongly the brake pedal is depressed.

■ Pre-collision braking

If the system determines that the possibility of a frontal collision is extremely high, the brakes are automatically applied to help avoid the collision or reduce the impact of the collision.

 **WARNING****■ Limitations of the pre-collision system**

- The driver is solely responsible for safe driving. Always drive safely, taking care to observe your surroundings.

Do not use the pre-collision system instead of normal braking operations under any circumstances. This system will not prevent collisions or lessen collision damage or injury in every situation. Do not overly rely on this system. Failure to do so may lead to an accident, resulting in death or serious injury.

- Although this system is designed to help avoid a collision or help reduce the impact of the collision, its effectiveness may change according to various conditions, therefore the system may not always be able to achieve the same level of performance.

Read the following conditions carefully. Do not overly rely on this system and always drive carefully.

- Conditions under which the system may operate even if there is no possibility of a collision: →P. 390
- Conditions under which the system may not operate properly: →P. 392

- Do not attempt to test the operation of the pre-collision system yourself. Depending on the objects used for testing (dummies, cardboard objects imitating detectable objects, etc.), the system may not operate properly, possibly leading to an accident.

■ Pre-collision braking

- When the pre-collision braking function is operating, a large amount of braking force will be applied.
- If the vehicle is stopped by the operation of the pre-collision braking function, the pre-collision braking function operation will be canceled after approximately 2 seconds. Depress the brake pedal as necessary.
- The pre-collision braking function may not operate if certain operations are performed by the driver. If the accelerator pedal is being depressed strongly or the steering wheel is being turned, the system may determine that the driver is taking evasive action and possibly prevent the pre-collision braking function from operating.
- In some situations, while the pre-collision braking function is operating, operation of the function may be canceled if the accelerator pedal is depressed strongly or the steering wheel is turned and the system determines that the driver is taking evasive action.
- If the brake pedal is being depressed, the system may determine that the driver is taking evasive action and possibly delay the operation timing of the pre-collision braking function.

 **WARNING****■ When to disable the pre-collision system**

In the following situations, disable the system, as it may not operate properly, possibly leading to an accident resulting in death or serious injury:

- When the vehicle is being towed
- When your vehicle is towing another vehicle
- When transporting the vehicle via truck, boat, train or similar means of transportation
- When the vehicle is raised on a lift with the hybrid system on and the tires are allowed to rotate freely
- When inspecting the vehicle using a drum tester such as a chassis dynamometer or speedometer tester, or when using an on vehicle wheel balancer
- When a strong impact is applied to the front bumper or front grille, due to an accident or other reasons
- If the vehicle cannot be driven in a stable manner, such as when the vehicle has been in an accident or is malfunctioning
- When the vehicle is driven in a sporty manner or off-road
- When the tires are not properly inflated
- When the tires are very worn
- When tires of a size other than specified are installed
- When tire chains are installed
- When a compact spare tire or an emergency tire puncture repair kit is used
- If equipment (snow plow, etc.) that may obstruct the radar sensor or front camera is temporarily installed to the vehicle

Changing settings of the pre-collision system

■ Enabling/disabling the pre-collision system

The pre-collision system can be enabled/disabled on  (→P. 246) of the multi-information display.

The system is automatically enabled each time the power switch is turned to ON mode.

If the system is disabled, the PCS warning light will turn on and a message will be displayed on the multi-information display.

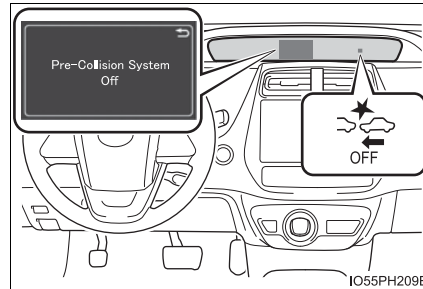

■ Changing the pre-collision warning timing

The pre-collision warning timing can be changed on  (→P. 246) of the multi-information display.

The warning timing setting is retained when the power switch is turned off.

However, if the pre-collision system is disabled and re-enabled, the operation timing will return to the default setting (middle).

- ① Early
- ② Middle
This is the default setting.
- ③ Late

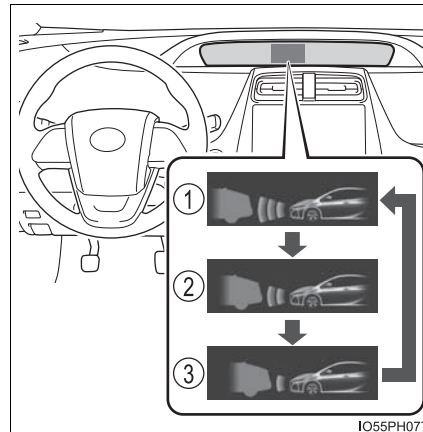

Operational conditions

The pre-collision system is enabled and the system determines that the possibility of a frontal collision with a detected object is high.

Each function is operational at the following speed

● Pre-collision warning

Detectable objects	Vehicle speed	Relative speed between your vehicle and object
Vehicles	Approx. 7 to 110 mph (10 to 180 km/h)	Approx. 7 to 110 mph (10 to 180 km/h)
Bicyclists and pedestrians	Approx. 7 to 50 mph (10 to 80 km/h)	Approx. 7 to 50 mph (10 to 80 km/h)

● Pre-collision brake assist

Detectable objects	Vehicle speed	Relative speed between your vehicle and object
Vehicles	Approx. 20 to 110 mph (30 to 180 km/h)	Approx. 20 to 110 mph (30 to 180 km/h)
Bicyclists and pedestrians	Approx. 20 to 50 mph (30 to 80 km/h)	Approx. 20 to 50 mph (30 to 80 km/h)

● Pre-collision braking

Detectable objects	Vehicle speed	Relative speed between your vehicle and object
Vehicles	Approx. 7 to 110 mph (10 to 180 km/h)	Approx. 7 to 110 mph (10 to 180 km/h)
Bicyclists and pedestrians	Approx. 7 to 50 mph (10 to 80 km/h)	Approx. 7 to 50 mph (10 to 80 km/h)

The system may not operate in the following situations:

- If a 12-volt battery terminal has been disconnected and reconnected and then the vehicle has not been driven for a certain amount of time
- If the shift position is in R
- When the VSC OFF indicator is illuminated (only the pre-collision warning function will be operational)

■ Object detection function

The system detects objects based on their size, profile, motion, etc. However, an object may not be detected depending on the surrounding brightness and the motion, posture, and angle of the detected object, preventing the system from operating properly. (→P. 392)

The illustration shows an image of detectable objects.

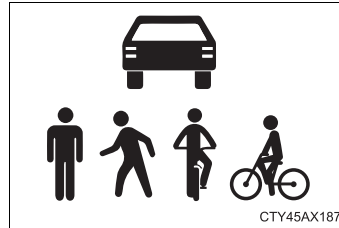

■ Cancellation of the pre-collision braking

If either of the following occur while the pre-collision braking function is operating, it will be canceled:

- The accelerator pedal is depressed strongly.
- The steering wheel is turned sharply or abruptly.

■ Conditions under which the system may operate even if there is no possibility of a collision

- In some situations such as the following, the system may determine that there is a possibility of a frontal collision and operate.
 - When passing a detectable object, etc.
 - When changing lanes while overtaking a detectable object, etc.
 - When approaching a detectable object in an adjacent lane or on the roadside, such as when changing the course of travel or driving on a winding road

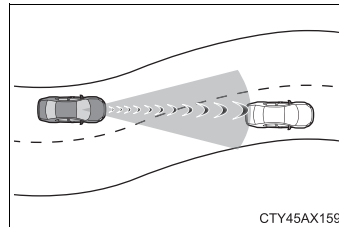

- When rapidly closing on a detectable object, etc.
- When approaching objects on the roadside, such as detectable objects, guardrails, utility poles, trees, or walls

- When there is a detectable object or other object by the roadside at the entrance of a curve

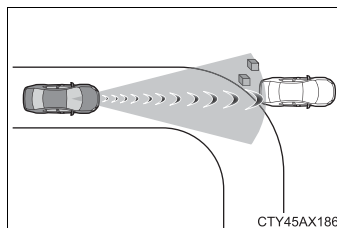

- When there are patterns or paint in front of your vehicle that may be mistaken for a detectable object
- When the front of your vehicle is hit by water, snow, dust, etc.
- When overtaking a detectable object that is changing lanes or making a right/left turn

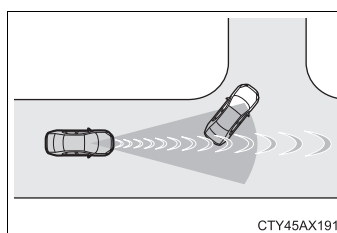

- When passing a detectable object in an oncoming lane that is stopped to make a right/left turn

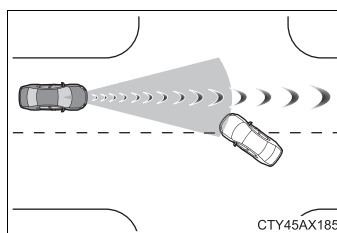

- When a detectable object approaches very close and then stops before entering the path of your vehicle
- If the front of your vehicle is raised or lowered, such as when on an uneven or undulating road surface
- When driving on a road surrounded by a structure, such as in a tunnel or on an iron bridge
- When there is a metal object (manhole cover, steel plate, etc.), steps, or a protrusion in front of your vehicle
- When passing under an object (road sign, billboard, etc.)

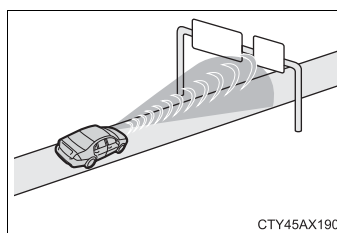

- When approaching an electric toll gate barrier, parking area barrier, or other barrier that opens and closes
- When using an automatic car wash

- When driving through or under objects that may contact your vehicle, such as thick grass, tree branches, or a banner

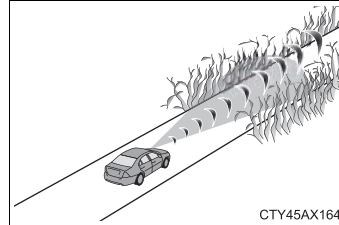

- When driving through steam or smoke
- When driving near an object that reflects radio waves, such as a large truck or guardrail
- When driving near a TV tower, broadcasting station, electric power plant, or other location where strong radio waves or electrical noise may be present

■ **Situations in which the system may not operate properly**

● In some situations such as the following, an object may not be detected by the radar sensor and front camera, preventing the system from operating properly:

- When a detectable object is approaching your vehicle
- When your vehicle or a detectable object is wobbling
- If a detectable object makes an abrupt maneuver (such as sudden swerving, acceleration or deceleration)
- When your vehicle approaches a detectable object rapidly
- When a detectable object is not directly in front of your vehicle

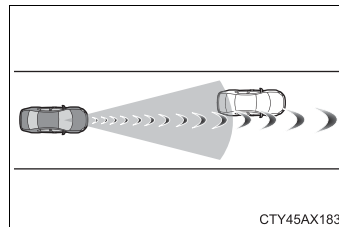

- When a detectable object is near a wall, fence, guardrail, manhole cover, vehicle, steel plate on the road, etc.
- When a detectable object is under a structure
- When part of a detectable object is hidden by an object, such as large baggage, an umbrella, or guardrail
- When multiple detectable objects are close together
- If the sun or other light is shining directly on a detectable object
- When a detectable object is a shade of white and looks extremely bright
- When a detectable object appears to be nearly the same color or brightness as its surroundings
- If a detectable object cuts or suddenly emerges in front of your vehicle
- When the front of your vehicle is hit by water, snow, dust, etc.
- When a very bright light ahead, such as the sun or the headlights of oncoming traffic, shines directly into the front camera
- When approaching the side or front of a vehicle ahead
- If a vehicle ahead is a motorcycle

- If a vehicle ahead is narrow, such as a personal mobility vehicle
- If a preceding vehicle has a small rear end, such as an unloaded truck
- If a preceding vehicle has a low rear end, such as a low bed trailer

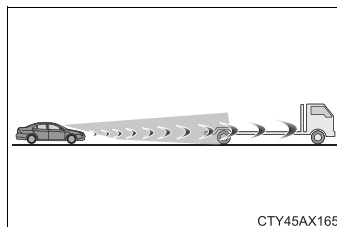

- If a vehicle ahead has extremely high ground clearance

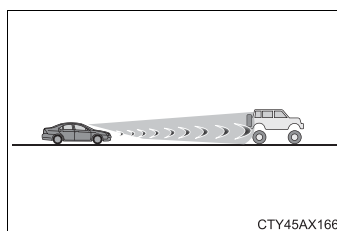

- If a vehicle ahead is carrying a load which protrudes past its rear bumper
- If a vehicle ahead is irregularly shaped, such as a tractor or side car
- If a vehicle ahead is a child sized bicycle, a bicycle that is carrying a large load, a bicycle ridden by more than one person, or a uniquely shaped bicycle (bicycle with a child seat, tandem bicycle, etc.)
- If a pedestrian/or the riding height of a bicyclist ahead is shorter than approximately 3.2 ft. (1 m) or taller than approximately 6.5 ft. (2 m)
- If a pedestrian/bicyclist is wearing oversized clothing (a rain coat, long skirt, etc.), making their silhouette obscure
- If a pedestrian is bending forward or squatting or bicyclist is bending forward
- If a pedestrian/bicyclist is moving fast
- If a pedestrian is pushing a stroller, wheelchair, bicycle or other vehicle
- When driving in inclement weather such as heavy rain, fog, snow or a sandstorm
- When driving through steam or smoke
- When the surrounding area is dim, such as at dawn or dusk, or while at night or in a tunnel, making a detectable object appear to be nearly the same color as its surroundings
- When driving in a place where the surrounding brightness changes suddenly, such as at the entrance or exit of a tunnel
- After the hybrid system has started the vehicle has not been driven for a certain amount of time
- While making a left/right turn and for a few seconds after making a left/right turn
- While driving on a curve and for a few seconds after driving on a curve
- If your vehicle is skidding

- If the front of the vehicle is raised or lowered

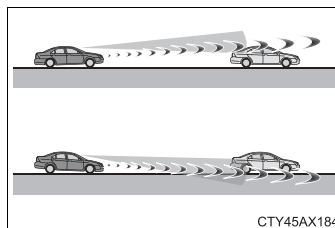

- If the wheels are misaligned
 - If a wiper blade is blocking the front camera
 - The vehicle is being driven at extremely high speeds
 - When driving on a hill
 - If the radar sensor or front camera is misaligned
 - In some situations such as the following, sufficient braking force may not be obtained, preventing the system from performing properly:
 - If the braking functions cannot operate to their full extent, such as when the brake parts are extremely cold, extremely hot, or wet
 - If the vehicle is not properly maintained (brakes or tires are excessively worn, improper tire inflation pressure, etc.)
 - When the vehicle is being driven on a gravel road or other slippery surface
- **If VSC is disabled**
- If VSC is disabled (→P. 503), the pre-collision brake assist and pre-collision braking functions are also disabled.
 - The PCS warning light will turn on and “VSC Turned Off Pre-Collision Brake System Unavailable” will be displayed on the multi-information display.

LTA (Lane Tracing Assist)

Summary of functions

While driving on a road with clear white (yellow) lane lines, the LTA system warns the driver if the vehicle may deviate from the current lane or course*, and also can slightly operate the steering wheel to help avoid deviation from the lane or course*. Also, while the dynamic radar cruise control with full-speed range is operating, this system will operate the steering wheel to maintain the vehicle's lane position.

The LTA system recognizes white (yellow) lane lines or a course* using the front camera. Additionally, it detects preceding vehicles using the front camera and radar.

*: Boundary between asphalt and the side of the road, such as grass, soil, or a curb

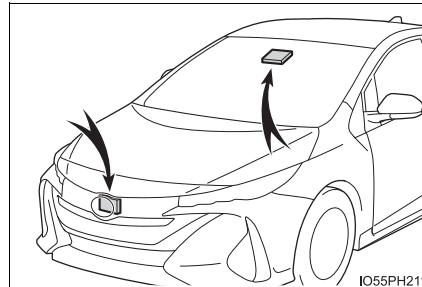

 **WARNING****■ Before using LTA system**

- Do not rely solely upon the LTA system. The LTA system does not automatically drive the vehicle or reduce the amount of attention that must be paid to the area in front of the vehicle. The driver must always assume full responsibility for driving safely by paying careful attention to the surrounding conditions and operating the steering wheel to correct the path of the vehicle. Also, the driver must take adequate breaks when fatigued, such as from driving for a long period of time.
- Failure to perform appropriate driving operations and pay careful attention may lead to an accident, resulting in death or serious injury.
- When not using the LTA system, use the LTA switch to turn the system off.

■ Situations unsuitable for LTA system

In the following situations, use the LTA switch to turn the system off. Failure to do so may lead to an accident, resulting in death or serious injury.

- Vehicle is driven on a road surface which is slippery due to rainy weather, fallen snow, freezing, etc.
- Vehicle is driven on a snow-covered road.
- White (yellow) lines are difficult to see due to rain, snow, fog, dust, etc.
- Vehicle is driven in a temporary lane or restricted lane due to construction work.
- Vehicle is driven in a construction zone.
- A spare tire, tire chains, etc. are equipped.
- When the tires have been excessively worn, or when the tire inflation pressure is low.
- During emergency towing.

■ Preventing LTA system malfunctions and operations performed by mistake

- Do not modify the headlights or place stickers, etc. on the surface of the lights.
- Do not modify the suspension etc. If the suspension etc. needs to be replaced, contact your Toyota dealer.
- Do not install or place anything on the hood or grille. Also, do not install a grille guard (bull bars, kangaroo bar, etc.).
- If your windshield needs repairs, contact your Toyota dealer.

⚠ WARNING**■ Conditions in which functions may not operate properly**

In the following situations, the functions may not operate properly and the vehicle may depart from its lane. Drive safely by always paying careful attention to your surroundings and operate the steering wheel to correct the path of the vehicle without relying solely on the functions.

- When the follow-up cruising display is displayed (→P. 405) and the preceding vehicle changes lanes. (Your vehicle may follow the preceding vehicle and also change lanes.)

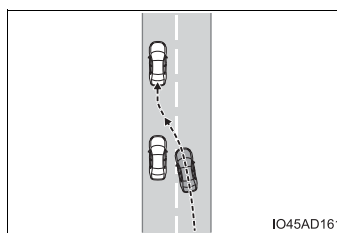

- When the follow-up cruising display is displayed (→P. 405) and the preceding vehicle is swaying. (Your vehicle may sway accordingly and depart from the lane.)
- When the follow-up cruising display is displayed (→P. 405) and the preceding vehicle departs from its lane. (Your vehicle may follow the preceding vehicle and depart from the lane.)
- When the follow-up cruising display is displayed (→P. 405) and the preceding vehicle is being driven extremely close to the left/right lane line. (Your vehicle may follow the preceding vehicle and depart from the lane.)
- Vehicle is being driven around a sharp curve.

- Objects or patterns that could be mistaken for white (yellow) lines are present on the side of the road (guardrails, reflective poles, etc.).

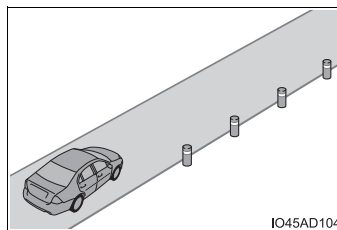

⚠ WARNING

- Vehicle is driven where the road diverges, merges, etc.

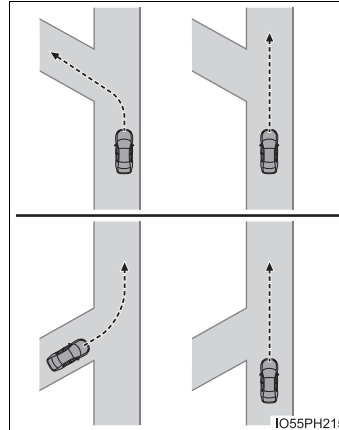

IO55PH215

- Repair marks of asphalt, white (yellow) lines, etc. are present due to road repair.

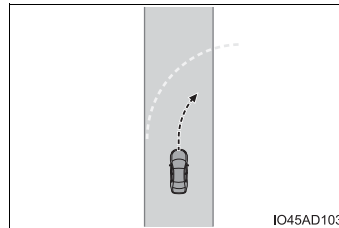

IO45AD103

- There are shadows on the road that run parallel with, or cover, the white (yellow) lines.
- The vehicle is driven in an area without white (yellow) lines, such as in front of a tollgate or checkpoint, or at an intersection, etc.
- The white (yellow) lines are cracked, “Botts’ dots”, “Raised pavement marker” or stones are present.
- The white (yellow) lines cannot be seen or are difficult to see due to sand, etc.
- The vehicle is driven on a road surface that is wet due to rain, puddles, etc.
- The traffic lines are yellow (which may be more difficult to recognize than lines that are white).
- The white (yellow) lines cross over a curb, etc.
- The vehicle is driven on a bright surface, such as concrete.
- If the edge of the road is not clear or straight.
- The vehicle is driven on a surface that is bright due to reflected light, etc.

 **WARNING**

- The vehicle is driven in an area where the brightness changes suddenly, such as at the entrances and exits of tunnels, etc.
- Light from the headlights of an oncoming vehicle, the sun, etc. enters the camera.
- The vehicle is driven on a slope.
- The vehicle is driven on a road which tilts left or right, or a winding road.
- The vehicle is driven on an unpaved or rough road.
- The traffic lane is excessively narrow or wide.
- The vehicle is extremely tilted due to carrying heavy luggage or having improper tire pressure.
- The distance to the preceding vehicle is extremely short.
- The vehicle is moving up and down a large amount due to road conditions during driving (poor roads or road seams).
- When driving in a tunnel or at night with the headlights off or when a headlight is dim due to its lens being dirty or it being misaligned.
- The vehicle is struck by a crosswind.
- The vehicle is affected by wind from a vehicle driven in a nearby lane.
- The vehicle has just changed lanes or crossed an intersection.
- Tires which differ by structure, manufacturer, brand or tread pattern are used.
- When tires of a size other than specified are installed.
- Snow tires, etc. are equipped.
- The vehicle is being driven at extremely high speeds.

Functions included in LTA system

■ Lane departure alert function

When the system determines that the vehicle might depart from its lane or course*, a warning is displayed on the multi-information display, and a warning buzzer will sound to alert the driver.

When the warning buzzer sounds, check the area around your vehicle and carefully operate the steering wheel to move the vehicle back to the center of the lane.

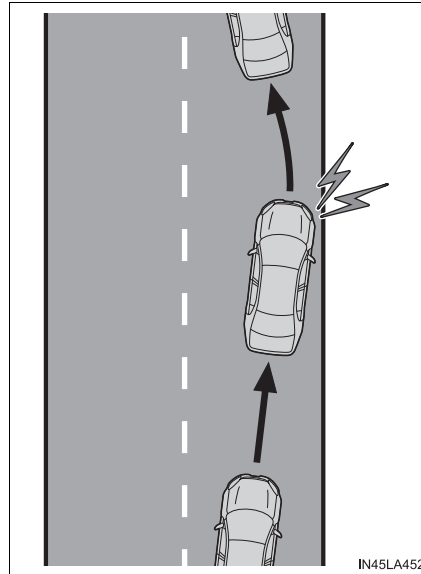

*: Boundary between asphalt and the side of the road, such as grass, soil, or a curb

■ Steering assist function

When the system determines that the vehicle might depart from its lane or course*, the system provides assistance as necessary by operating the steering wheel in small amounts for a short period of time to keep the vehicle in its lane.

If the system detects that the steering wheel has not been operated for a fixed amount of time or the steering wheel is not being firmly gripped, a warning is displayed on the multi-information display and the function is temporarily canceled.

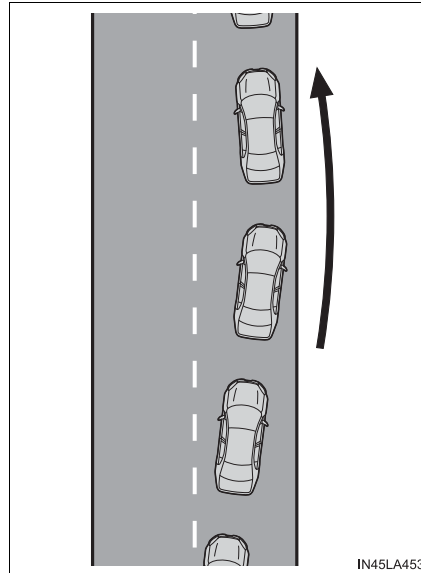

*: Boundary between asphalt and the side of the road, such as grass, soil, or a curb

■ Vehicle sway warning function

When the vehicle is swaying within a lane, the warning buzzer will sound and a message will be displayed on the multi-information display to alert the driver.

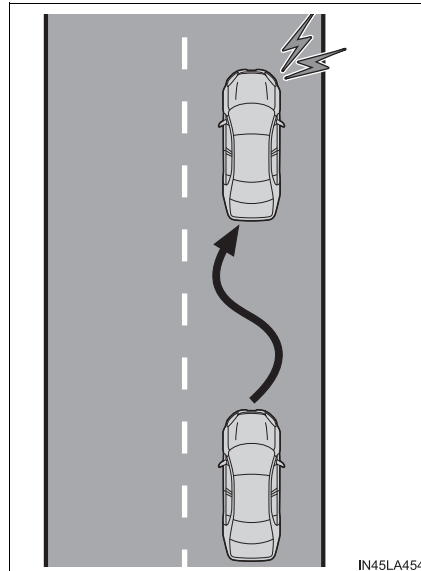

■ Lane centering function

This function is linked with dynamic radar cruise control with full-speed range and provides the required assistance by operating the steering wheel to keep the vehicle in its current lane.

When dynamic radar cruise control with full-speed range is not operating, the lane centering function does not operate.

In situations where the white (yellow) lane lines are difficult to see or are not visible, such as when in a traffic jam, this function will operate to help follow a preceding vehicle by monitoring the position of the preceding vehicle.

If the system detects that the steering wheel has not been operated for a fixed amount of time or the steering wheel is not being firmly gripped, a warning is displayed on the multi-information display and the function is temporarily canceled.

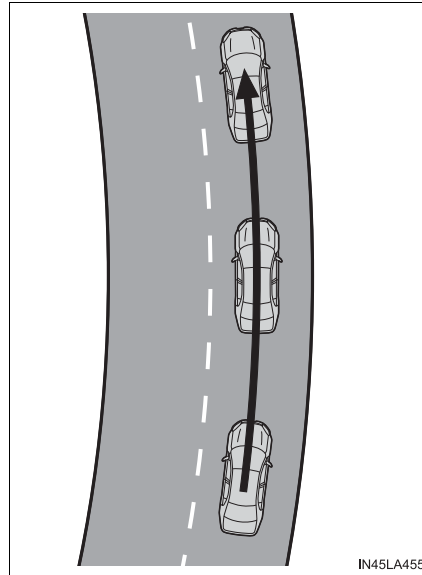

Turning LTA system on

Press the LTA switch to turn the LTA system on.

The LTA indicator illuminates and a message is displayed on the multi-information display.

Press the LTA switch again to turn the LTA system off.

When the LTA system is turned on or off, operation of the LTA system continues in the same condition the next time the hybrid system is started.

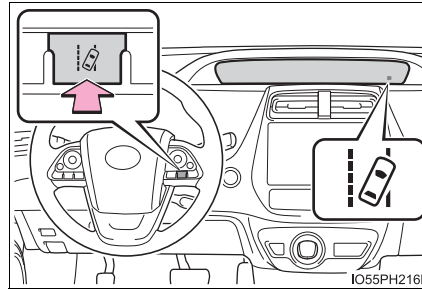

Indications on combination meter

① LTA indicator

The illumination condition of the indicator informs the driver of the system operation status.

Illuminated in green: LTA system is operating.

Flashing in orange: Lane departure alert function is operating.

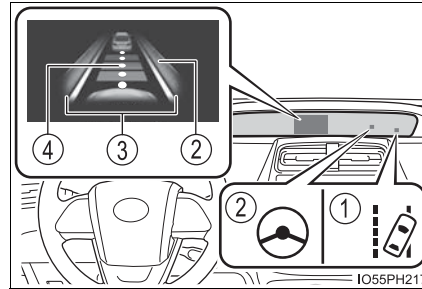

② Steering control indicator and operation display of steering wheel operation support

When that steering wheel assistance of the steering assist function or lane centering function is operating, the indicator illuminates and the operation display on the multi-information display is turned on.

③ Lane departure alert function display

Displayed when the multi-information display is switched to the driving assist system information screen.

▶ Inside of displayed lines is white

▶ Inside of displayed lines is black

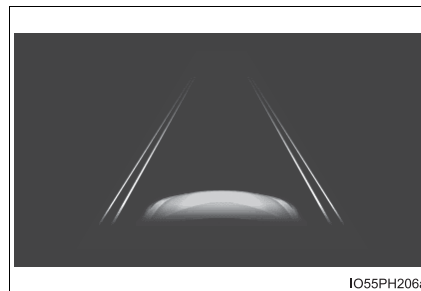
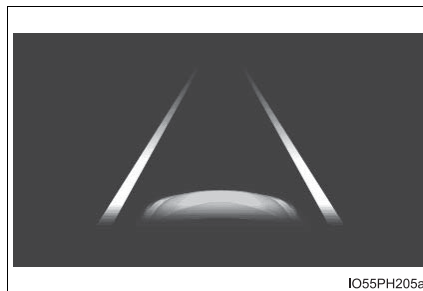

Indicates that the system is recognizing white (yellow) lines or a course*. When the vehicle departs from its lane, the white line displayed on the side the vehicle departs from flashes orange.

Indicates that the system is not able to recognize white (yellow) lines or a course* or is temporarily canceled.

*: Boundary between asphalt and the side of the road, such as grass, soil, or a curb

④ Follow-up cruising display

Displayed when the multi-information display is switched to the driving assist system information screen.

Indicates that steering assist of the lane centering function is operating by monitoring the position of a preceding vehicle.

When the follow-up cruising display is displayed, if the preceding vehicle moves, your vehicle may move in the same way. Always pay careful attention to your surroundings and operate the steering wheel as necessary to correct the path of the vehicle and ensure safety.

■ Operation conditions of each function

● Lane departure alert function

This function operates when all of the following conditions are met.



- LTA is turned on.
- Vehicle speed is approximately 32 mph (50 km/h) or more.*1
- System recognizes white (yellow) lane lines or a course*2. (When a white [yellow] line or course*2 is recognized on only one side, the system will operate only for the recognized side.)
- Width of traffic lane is approximately 9.8 ft. (3 m) or more.
- Turn signal lever is not operated.
- Vehicle is not being driven around a sharp curve.
- No system malfunctions are detected. (→P. 409)

*1: The function operates even if the vehicle speed is less than approximately 32 mph (50 km/h) when the lane centering function is operating.

*2: Boundary between asphalt and the side of the road, such as grass, soil, or a curb



● Steering assist function

This function operates when all of the following conditions are met in addition to the operation conditions for the lane departure alert function.

- Setting for  ("LTA Steering Assist Mode") in  of the multi-information display is set to "On". (→P. 220)
- Vehicle is not accelerated or decelerated by a fixed amount or more.
- Steering wheel is not operated with a steering force level suitable for changing lanes.
- ABS, VSC, TRAC and PCS are not operating.
- TRAC or VSC is not turned off.
- Hands off steering wheel warning is not displayed. (→P. 408)



● Vehicle sway warning function

This function operates when all of the following conditions are met.

- Setting for  (“Lane Sway Warning Status”) in  of the multi-information display is set to “On”. (→P. 220)
- Vehicle speed is approximately 32 mph (50 km/h) or more.
- Width of traffic lane is approximately 9.8 ft. (3 m) or more.
- No system malfunctions are detected. (→P. 409)

● Lane centering function

This function operates when all of the following conditions are met.

- LTA is turned on.
- Setting for  (“LTA Steering Assist Mode”) and  (“Center Trace”) in  of the multi-information display are set to “On”. (→P. 220)
- This function recognizes white (yellow) lane lines or the position of a preceding vehicle (except when the preceding vehicle is small, such as a motorcycle).
- The dynamic radar cruise control with full-speed range is operating in vehicle-to-vehicle distance control mode.
- Width of traffic lane is approximately 10 to 13 ft. (3 to 4 m).
- Turn signal lever is not operated.
- Vehicle is not being driven around a sharp curve.
- No system malfunctions are detected. (→P. 409)
- Vehicle does not accelerate or decelerate by a fixed amount or more.
- Steering wheel is not operated with a steering force level suitable for changing lanes.
- ABS, VSC, TRAC and PCS are not operating.
- TRAC or VSC is not turned off.
- Hands off steering wheel warning is not displayed. (→P. 408)
- The vehicle is being driven in the center of a lane.
- Steering assist function is not operating.

■ Temporary cancelation of functions

- When operation conditions are no longer met, a function may be temporarily canceled. However, when the operation conditions are met again, operation of the function is automatically restored. (→P. 405)
- If the operation conditions (→P. 406) are no longer met while the lane centering function is operating, the buzzer may sound to indicate that the function has been temporarily canceled.

■ Steering assist function/lane centering function

- Depending on the vehicle speed, lane departure situation, road conditions, etc., the driver may not feel the function is operating or the function may not operate at all.
- The steering control of the function is overridden by the driver's steering wheel operation.
- Do not attempt to test the operation of the steering assist function.

■ Lane departure alert function

- The warning buzzer may be difficult to hear due to external noise, audio playback, etc.
- If the edge of the course* is not clear or straight, the lane departure alert function may not operate.
- Do not attempt to test the operation of the lane departure alert function.

*: Boundary between asphalt and the side of the road, such as grass, soil, or a curb

■ Hands off steering wheel warning

In the following situations, a warning message urging the driver to hold the steering wheel and the symbol shown in the illustration are displayed on the multi-information display to warn the driver. The warning stops when the system determines that the driver holds the steering wheel. Always keep your hands on the steering wheel when using this system, regardless of warnings.



IO45AD141

- When the system determines that the driver is driving without holding the steering wheel while the system is operating

If the driver continues to keep their hands off of the steering wheel, the buzzer sounds, the driver is warned and the function is temporarily canceled. This warning also operates in the same way when the driver continuously operates the steering wheel only a small amount.

- When the system determines that the vehicle may deviate from the lane while driving around a curve while the lane centering function is operating

Depending on the vehicle condition and road conditions, the warning may not operate. Also, if the system determines that the vehicle is driving around a curve, warnings will occur earlier than during straight-lane driving.

- When the system determines that the driver is driving without holding the steering wheel while the steering wheel assist of the steering assist function is operating.

If the driver continues to keep their hands off of the steering wheel and the steering wheel assist is operating, the buzzer sounds and the driver is warned. Each time the buzzer sounds, the continuing time of the buzzer becomes longer.

■ Vehicle sway warning function

When the system determines that the vehicle is swaying while the vehicle sway warning function is operating, a buzzer sounds and a warning message urging the driver to rest and the symbol shown in the illustration are simultaneously displayed on the multi-information display.



IO45AD153

Depending on the vehicle and road conditions, the warning may not operate.

■ Warning message

If the following warning message is displayed on the multi-information display and the LTA indicator illuminates in orange, follow the appropriate troubleshooting procedure. Also, if a different warning message is displayed, follow the instructions displayed on the screen.

- “LTA Malfunction Visit Your Dealer”
The system may not be operating properly. Have the vehicle inspected by your Toyota dealer.
- “LTA Unavailable”
The system is temporarily canceled due to a malfunction in a sensor other than the front camera. Turn the LTA system off, wait for a little while, and then turn the LTA system back on.
- “LTA Unavailable at Current Speed”
The function cannot be used as the vehicle speed exceeds the LTA operation range. Drive slower.

■ Customization

Function settings can be changed.
(Customizable features: →P. 246)

RSA (Road Sign Assist)*

Summary of function

The RSA system recognizes specific road signs using the front camera to provide information to the driver via the display.

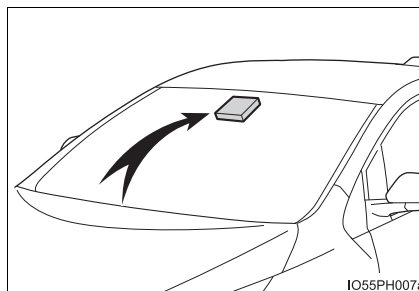

If the system judges that the vehicle is being driven over the speed limit, performing prohibited actions, etc. according to the recognized road signs, it notifies the driver through a visual notification and notification buzzer.

WARNING

■ Before using the RSA

Do not rely solely upon the RSA system. RSA is a system which supports the driver by providing information, but it is not a replacement for a driver's own vision and awareness. Drive safely by always paying careful attention to the traffic rules.

*: If equipped

Indication on the main display or multi-information display

When the front camera recognizes a sign, the sign will be displayed on the main display or multi-information display.

- When the driving assist system information is selected in multi-information display, a maximum of 2 signs can be displayed on the multi-information display. (→P. 220)

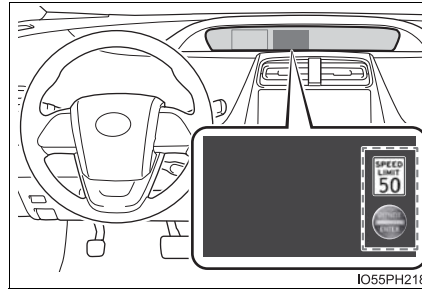

- When a tab other than the driving assist system information is selected, the following types of road signs will be displayed on the main display. (→P. 209)

- Speed limit sign
- Do Not Enter sign (when notification is necessary)

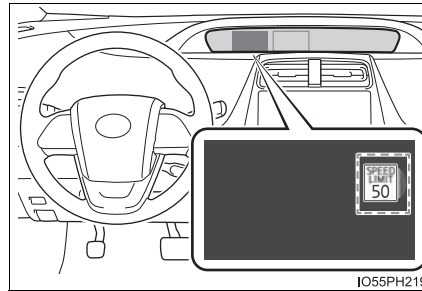

If signs other than speed limit signs are recognized, they will be displayed in an overlapping stack under the current speed limit sign.

Supported types of road signs

The following types of road signs, including electronic signs and blinking signs, are recognized.

A non-official or a recently introduced traffic sign may not be recognized.



Speed limit



Do Not Enter



Stop



Yield

Notification function

In the following situations, the RSA system will notify the driver.

- When the vehicle speed exceeds the speed notification threshold of the speed limit sign displayed, the sign display will be emphasized and a buzzer will sound.
- When the RSA system recognizes a do not enter sign and determines that your vehicle has entered a no-entry area, the displayed sign will flash and a buzzer will sound.

Depending on the situation, a notification function may not operate properly.

Setting procedure

→P. 246

Automatic turn-off of RSA sign display

In the following situations, a displayed speed limit sign and/or do not enter sign will stop being displayed automatically:

- No sign has been recognized for a certain distance.
- The road changes due to a left or right turn, etc.

In the following situations, stop and yield signs will stop being displayed automatically:

- The system determines that your vehicle has passed the sign.
- The road changes due to a left or right turn, etc.

Conditions in which the function may not operate or detect correctly

In the following situations, RSA does not operate normally and may not recognize signs, display the incorrect sign, etc. However, this does not indicate a malfunction.

- The front camera is misaligned due to a strong impact being applied to the sensor, etc.
- Dirt, snow, stickers, etc. are on the windshield near the front camera.
- In inclement weather such as heavy rain, fog, snow or sand storms
- Light from an oncoming vehicle, the sun, etc. enters the front camera.
- The sign is dirty, faded, tilted or bent.
- The contrast of electronic sign is low.
- All or part of the sign is hidden by the leaves of a tree, a pole, etc.
- The sign is only visible to the front camera for a short amount of time.
- The driving scene (turning, lane change, etc.) is judged incorrectly.
- If a sign not appropriate for the currently traveled lane, but the sign exists directly after a freeway branches, or in an adjacent lane just before merging.
- Stickers are attached to the rear of the preceding vehicle.

- A sign resembling a system compatible sign is recognized.
- Side road speed signs may be detected and displayed (if positioned in sight of the front camera) while the vehicle is traveling on the main road.
- Roundabout exit road speed signs may be detected and displayed (if positioned in sight of the front camera) while traveling on a roundabout.
- The front of the vehicle is raised or lowered due to the carried load
- The surrounding brightness is not sufficient or changes suddenly.
- When a sign intended for trucks, etc. is recognized.
- The speed information displayed on the meter and on the navigation system may be different due to the navigation system using map data.

■ **Speed limit sign display**

If the power switch was last turned off while a speed limit sign was displayed on the main display or multi-information display, the same sign displays again when the power switch is turned to ON mode.

■ **If “RSA Malfunction Visit Your Dealer” is shown**

The system may be malfunctioning. Have the vehicle inspected by your Toyota dealer.

■ **Customization**

Some functions can be customized. (Customizable features: →P. 753)

Dynamic radar cruise control with full-speed range

Summary of functions

In vehicle-to-vehicle distance control mode, the vehicle automatically accelerates, decelerates and stops to match the speed changes of the preceding vehicle even if the accelerator pedal is not depressed. In constant speed control mode, the vehicle runs at a fixed speed.

Use the dynamic radar cruise control with full-speed range on free-ways and highways.

- Vehicle-to-vehicle distance control mode (→P. 418)
- Constant speed control mode (→P. 425)

System Components

- ① Vehicle-to-vehicle distance switch
- ② Indicators
- ③ Multi-information display
- ④ Set speed
- ⑤ Cruise control switch

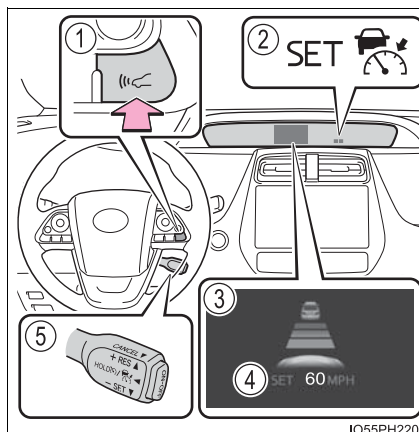

 **WARNING****■ Before using dynamic radar cruise control with full-speed range**

- Driving safely is the sole responsibility of the driver. Do not rely solely on the system, and drive safely by always paying careful attention to your surroundings.
- The dynamic radar cruise control with full-speed range provides driving assistance to reduce the driver's burden. However, there are limitations to the assistance provided.
Read the following conditions carefully. Do not overly rely on this system and always drive carefully.
 - When the sensor may not be correctly detecting the vehicle ahead:
→P. 428
 - Conditions under which the vehicle-to-vehicle distance control mode may not function correctly:→P. 429
- Set the speed appropriately depending on the speed limit, traffic flow, road conditions, weather conditions, etc. The driver is responsible for checking the set speed.
- Even when the system is functioning normally, the condition of the preceding vehicle as detected by the system may differ from the condition observed by the driver. Therefore, the driver must always remain alert, assess the danger of each situation and drive safely. Relying solely on this system or assuming the system ensures safety while driving can lead to an accident, resulting in death or serious injury.
- Switch the dynamic radar cruise control with full-speed range setting to off using the "ON-OFF" button when not in use.

 **WARNING**

■ **Cautions regarding the driving assist systems**

Observe the following precautions, as there are limitations to the assistance provided by the system.

Failure to do so may cause an accident resulting in death or serious injury.

● **Assisting the driver to measure following distance**

The dynamic radar cruise control with full-speed range is only intended to help the driver in determining the following distance between the driver's own vehicle and a designated vehicle traveling ahead. It is not a mechanism that allows careless or inattentive driving, and it is not a system that can assist the driver in low-visibility conditions. It is still necessary for driver to pay close attention to the vehicle's surroundings.

● **Assisting the driver to judge proper following distance**

The dynamic radar cruise control with full-speed range determines whether the following distance between the driver's own vehicle and a designated vehicle traveling ahead is within a set range. It is not capable of making any other type of judgement. Therefore, it is absolutely necessary for the driver to remain vigilant and to determine whether or not there is a possibility of danger in any given situation.

● **Assisting the driver to operate the vehicle**

The dynamic radar cruise control with full-speed range does not include functions which will prevent or avoid collisions with vehicles ahead of your vehicle. Therefore, if there is ever any possibility of danger, the driver must take immediate and direct control of the vehicle and act appropriately in order to ensure the safety of all involved.

 **WARNING****■ Situations unsuitable for dynamic radar cruise control with full-speed range**

Do not use dynamic radar cruise control with full-speed range in any of the following situations.

Doing so may result in inappropriate speed control and could cause an accident resulting in death or serious injury.

- Roads where there are pedestrians, cyclists, etc.
- In heavy traffic
- On roads with sharp bends
- On winding roads
- On slippery roads, such as those covered with rain, ice or snow
- On steep downhills, or where there are sudden changes between sharp up and down gradients
Vehicle speed may exceed the set speed when driving down a steep hill.
- At entrances to freeways and highways
- When weather conditions are bad enough that they may prevent the sensors from detecting correctly (fog, snow, sandstorm, heavy rain, etc.)
- When there is rain, snow, etc. on the front surface of the radar or front camera
- In traffic conditions that require frequent repeated acceleration and deceleration
- During emergency towing
- When an approach warning buzzer is heard often

Driving in vehicle-to-vehicle distance control mode

This mode employs a radar to detect the presence of vehicles up to approximately 328 ft. (100 m) ahead, determines the current vehicle-to-vehicle following distance, and operates to maintain a suitable following distance from the vehicle ahead. The desired vehicle-to-vehicle distance can also be set by operating the vehicle-to-vehicle distance switch.

When driving on downhill slopes, the vehicle-to-vehicle distance may become shorter.

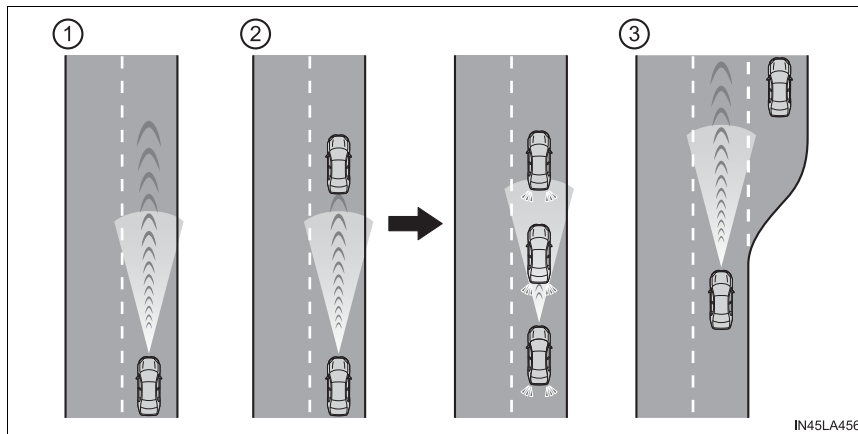

① Example of constant speed cruising

When there are no vehicles ahead

The vehicle travels at the speed set by the driver.

② Example of deceleration cruising and follow-up cruising

When a preceding vehicle driving slower than the set speed appears

When a vehicle is detected running ahead of you, the system automatically decelerates your vehicle. When a greater reduction in vehicle speed is necessary, the system applies the brakes (the stop lights will come on at this time). The system will respond to changes in the speed of the vehicle ahead in order to maintain the vehicle-to-vehicle distance set by the driver. Approach warning warns you when the system cannot decelerate sufficiently to prevent your vehicle from closing in on the vehicle ahead.

When the vehicle ahead of you stops, your vehicle will also stop (vehicle is stopped by system control). After the vehicle ahead starts off, pushing the cruise control lever up or depressing the accelerator pedal (start-off operation) will resume follow-up cruising. If the start-off operation is not performed, system control continues to keep your vehicle stopped.

When the turn signal lever is operated and your vehicle moves to an overtaking lane while driving at 50 mph (80 km/h) or more, the vehicle will accelerate to help to overtake a passing vehicle.

The system's identification of what is an overtaking lane may be determined solely based on the location of the steering wheel in the vehicle (left side driver position versus right side driver position.) If the vehicle is driven to a region where the overtaking lane is on a different side from where the vehicle is normally driven, the vehicle may accelerate when the turn signal lever is operated in the opposite direction to the overtaking lane (e.g., if the driver normally operates the vehicle in a region where the overtaking lane is to the right but then drives to a region where the overtaking lane is to the left, the vehicle may accelerate when the right turn signal is activated).

③ Example of acceleration

When there are no longer any preceding vehicles driving slower than the set speed

The system accelerates until the set speed is reached. The system then returns to constant speed cruising.

Setting the vehicle speed (vehicle-to-vehicle distance control mode)

- 1 Press the “ON-OFF” button to activate the cruise control.

Dynamic radar cruise control indicator will come on and a message will be displayed on the multi-information display.

Press the button again to deactivate the cruise control.

If the “ON-OFF” button is pressed and held for 1.5 seconds or more, the system turns on in constant speed control mode. (→P. 425)

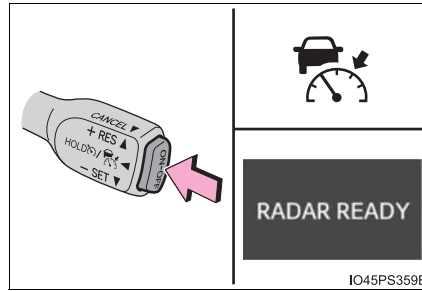

- 2 Accelerate or decelerate, with accelerator pedal operation, to the desired vehicle speed (at or above approximately 20 mph [30 km/h]) and push the lever down to set the speed.

Cruise control “SET” indicator will come on.

The vehicle speed at the moment the lever is released becomes the set speed.

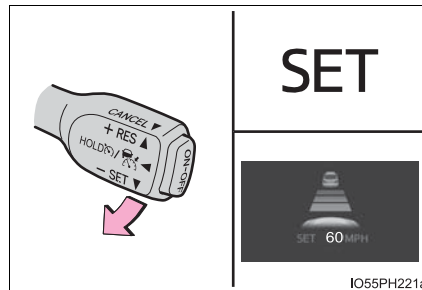

Adjusting the set speed

● Adjusting the set speed by the lever

To change the set speed, operate the lever until the desired set speed is displayed.

① Increases the speed

(Except when the vehicle has been stopped by system control in vehicle-to-vehicle distance control mode)

② Decreases the speed

Fine adjustment: Momentarily move the lever in the desired direction.

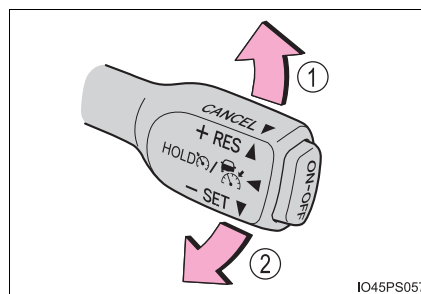

Large adjustment: Hold the lever up or down to change the speed, and release when the desired speed is reached.

In the vehicle-to-vehicle distance control mode, the set speed will be increased or decreased as follows:

► For the U.S. mainland and Hawaii

Fine adjustment: By 1 mph (1.6 km/h)^{*1} or 1 km/h (0.6 mph)^{*2} each time the lever is operated

Large adjustment: Increases or decreases in 1 mph (1.6 km/h)^{*1} or 1 km/h (0.6 mph)^{*2} increments for as long as the lever is held

► For Canada

Fine adjustment: By 1 mph (1.6 km/h)^{*1} or 1 km/h (0.6 mph)^{*2} each time the lever is operated

Large adjustment: Increases or decreases in 5 mph (8 km/h)^{*1} or 5 km/h (3.1 mph)^{*2} increments for as long as the lever is held

In the constant speed control mode (→P. 425), the set speed will be increased or decreased as follows:

Fine adjustment: By 1 mph (1.6 km/h)^{*1} or 1 km/h (0.6 mph)^{*2} each time the lever is operated

Large adjustment: The speed will continue to change while the lever is held.

*1: When the set speed is shown in "MPH"

*2: When the set speed is shown in "km/h"

● Increasing the set speed by the accelerator pedal

- 1 Accelerate with accelerator pedal operation to the desired vehicle speed.
- 2 Push the lever down.

Changing the vehicle-to-vehicle distance (vehicle-to-vehicle distance control mode)

Pressing the switch changes the vehicle-to-vehicle distance as follows:

- 1 Long
- 2 Medium
- 3 Short

The vehicle-to-vehicle distance is set automatically to long mode when the power switch is turned to ON mode.

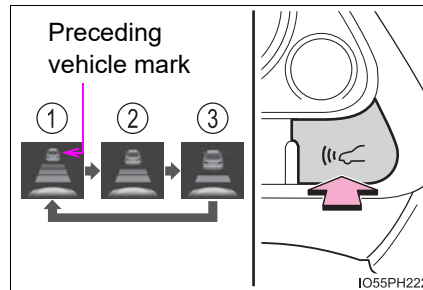

Vehicle-to-vehicle distance settings (vehicle-to-vehicle distance control mode)

Select a distance from the table below. Note that the distances shown correspond to a vehicle speed of 50 mph (80 km/h). Vehicle-to-vehicle distance increases/decreases in accordance with vehicle speed. When the vehicle is stopped by system control, the vehicle stops at a certain vehicle-to-vehicle distance depending on the situation.

Distance options	Vehicle-to-vehicle distance
Long	Approximately 160 ft. (50 m)
Medium	Approximately 130 ft. (40 m)
Short	Approximately 100 ft. (30 m)

Resuming follow-up cruising when the vehicle has been stopped by system control (vehicle-to-vehicle distance control mode)

After the vehicle ahead of you starts off, push the lever up.

Your vehicle will also resume follow-up cruising if the accelerator pedal is depressed after the vehicle ahead of you starts off.

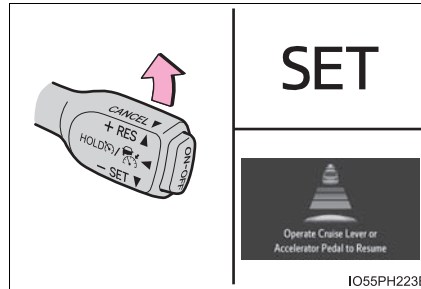

Canceling and resuming the speed control

- ① Pulling the lever toward you cancels the speed control.

The speed control is also canceled when the brake pedal is depressed.

(When the vehicle has been stopped by system control, depressing the brake pedal does not cancel the setting.)

- ② Pushing the lever up resumes the cruise control and returns vehicle speed to the set speed.

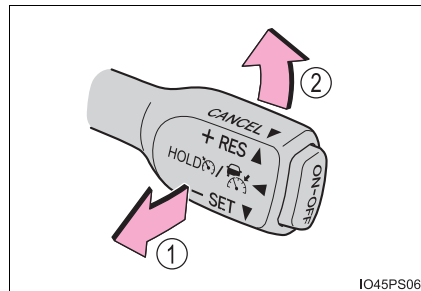

Approach warning (vehicle-to-vehicle distance control mode)

When your vehicle is too close to a vehicle ahead, and sufficient automatic deceleration via the cruise control is not possible, the display will flash and the buzzer will sound to alert the driver. An example of this would be if another driver cuts in front of you while you are following a vehicle. Depress the brake pedal to ensure an appropriate vehicle-to-vehicle distance.

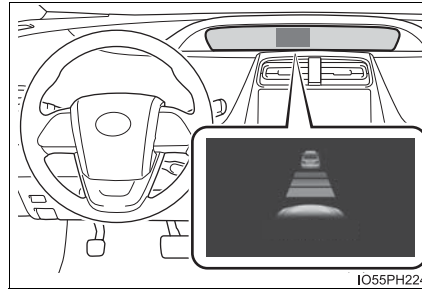
**■ Warnings may not occur when**

In the following instances, warnings may not occur even when the vehicle-to-vehicle distance is small.

- When the speed of the preceding vehicle matches or exceeds your vehicle speed
- When the preceding vehicle is traveling at an extremely slow speed
- Immediately after the cruise control speed was set
- When depressing the accelerator pedal

Selecting constant speed control mode

When constant speed control mode is selected, your vehicle will maintain a set speed without controlling the vehicle-to-vehicle distance. Select this mode only when vehicle-to-vehicle distance control mode does not function correctly due to a dirty radar, etc.

- 1 With the cruise control off, press and hold the “ON-OFF” button for 1.5 seconds or more.

Immediately after the “ON-OFF” button is pressed, the dynamic radar cruise control indicator will come on. Afterwards, it switches to the cruise control indicator.

Switching to constant speed control mode is only possible when operating the lever with the cruise control off.

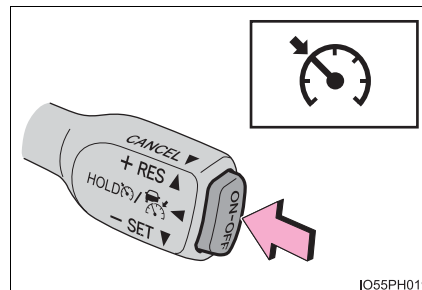

- 2 Accelerate or decelerate, with accelerator pedal operation, to the desired vehicle speed (at or above approximately 20 mph [30 km/h]) and push the lever down to set the speed.

Cruise control “SET” indicator will come on.

The vehicle speed at the moment the lever is released becomes the set speed.

Adjusting the speed setting: →P. 421

Canceling and resuming the speed setting: →P. 423

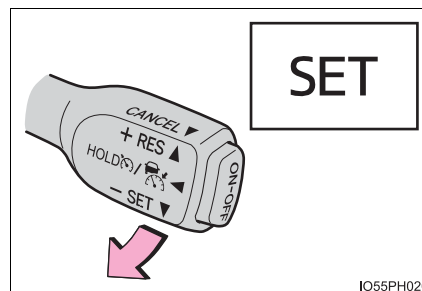

■ Dynamic radar cruise control with full-speed range can be set when

- The shift position is in D.
- The desired set speed can be set when the vehicle speed is approximately 20 mph (30 km/h) or more.
(However, when the vehicle speed is set while driving at below approximately 20 mph [30 km/h], the set speed will be set to approximately 20 mph [30 km/h].)

■ Accelerating after setting the vehicle speed

The vehicle can accelerate by operating the accelerator pedal. After accelerating, the set speed resumes. However, during vehicle-to-vehicle distance control mode, the vehicle speed may decrease below the set speed in order to maintain the distance to the preceding vehicle.

■ When the vehicle stops while follow-up cruising

- Pushing the lever up while the vehicle ahead stops will resume follow-up cruising if the vehicle ahead starts off within approximately 3 seconds after the lever is pushed up.
- If the vehicle ahead starts off within 3 seconds after your vehicle stops, follow-up cruising will be resumed.

■ Automatic cancelation of vehicle-to-vehicle distance control mode

Vehicle-to-vehicle distance control mode is automatically canceled in the following situations.

- VSC is activated.
- TRAC is activated for a period of time.
- When the VSC or TRAC system is turned off.
- The sensor cannot detect correctly because it is covered in some way.
- Pre-collision braking is activated.
- The parking brake is operated.
- The vehicle is stopped by system control on a steep incline.
- The following are detected when the vehicle has been stopped by system control:
 - The driver is not wearing a seat belt.
 - The driver's door is opened.
 - The vehicle has been stopped for about 3 minutes.

In this situation, the shift position may automatically switch to P. (→P. 348)

If vehicle-to-vehicle distance control mode is automatically canceled for any reasons other than the above, there may be a malfunction in the system. Contact your Toyota dealer.

■ Automatic cancelation of constant speed control mode

Constant speed control mode is automatically canceled in the following situations:

- Actual vehicle speed is more than approximately 10 mph (16 km/h) below the set vehicle speed.
- Actual vehicle speed falls below approximately 20 mph (30 km/h).
- VSC is activated.
- TRAC is activated for a period of time.
- When the VSC or TRAC system is turned off.
- Pre-collision braking is activated.

If constant speed control mode is automatically canceled for any reasons other than the above, there may be a malfunction in the system. Contact your Toyota dealer.

■ Brake operation

A brake operation sound may be heard and the brake pedal response may change, but these are not malfunctions.

■ Warning messages and buzzers for dynamic radar cruise control with full-speed range

Warning messages and buzzers are used to indicate a system malfunction or to inform the driver of the need for caution while driving. If a warning message is shown on the multi-information display, read the message and follow the instructions. (→P. 382, 684)

■ **When the sensor may not be correctly detecting the vehicle ahead**

In the case of the following and depending on the conditions, operate the brake pedal when deceleration of the system is insufficient or operate the accelerator pedal when acceleration is required.

As the sensor may not be able to correctly detect these types of vehicles, the approach warning (→P. 424) may not be activated.

- Vehicles that cut in suddenly
- Vehicles traveling at low speeds
- Vehicles that are not moving in the same lane
- Vehicles with small rear ends (trailers with no load on board, etc.)

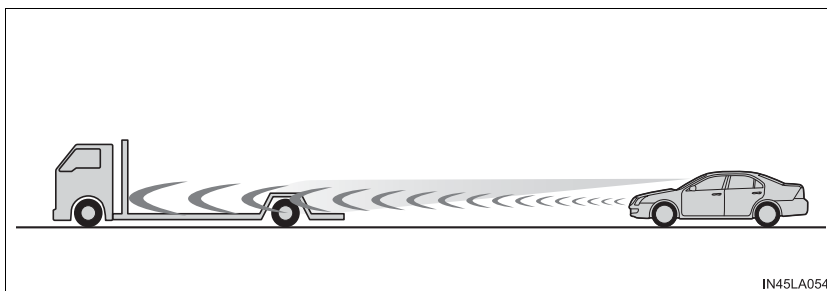

- Motorcycles traveling in the same lane
- When water or snow thrown up by the surrounding vehicles hinders the detecting of the sensor
- When your vehicle is pointing upwards (caused by a heavy load in the luggage compartment, etc.)

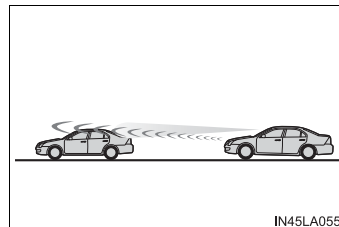

- Preceding vehicle has an extremely high ground clearance

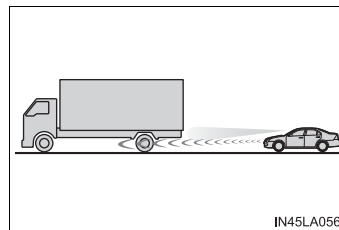

■ **Conditions under which the vehicle-to-vehicle distance control mode may not function correctly**

In the case of the following conditions, operate the brake pedal (or accelerator pedal, depending on the situation) as necessary.

As the sensor may not be able to correctly detect vehicles ahead, the system may not operate properly.

- When the road curves or when the lanes are narrow

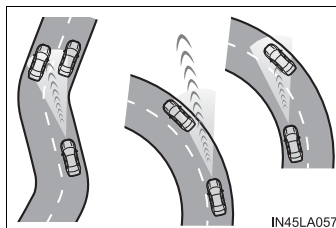

- When steering wheel operation or your position in the lane is unstable

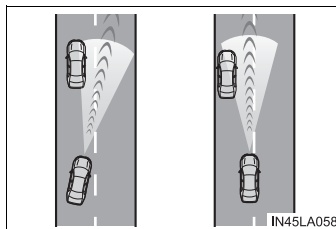

- When the vehicle ahead of you decelerates suddenly
- When driving on a road surrounded by a structure, such as in a tunnel or on a bridge
- While the vehicle speed is decreasing to the set speed after the vehicle accelerates by depressing the accelerator pedal

Driving mode select switch

In response to driving conditions, one of 3 driving modes can be selected.

Driving modes

Repeatedly press the switch until the system changes to the intended driving mode.

Each time the switch is pressed, the driving mode changes in the following order and the “ECO MODE” and “PWR MODE” indicators turn on or off accordingly.

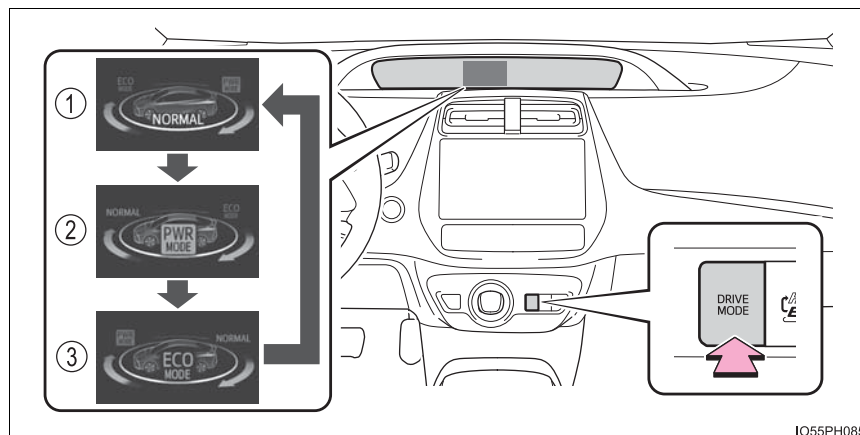

① Normal mode

Suitable for normal driving.

When normal mode is selected, the “ECO MODE” and “PWR MODE” indicators turn off.

② Power mode

Suitable for when crisp handling and enhanced accelerator response are desired, such as when driving on mountainous roads.

When power mode is selected, the “PWR MODE” indicator will illuminate on the main display.

③ Eco drive mode

Suitable for driving that improves fuel economy by generating torque in response to accelerator pedal operations more smoothly than in normal mode.

When Eco drive mode is selected, the “ECO MODE” indicator will illuminate on the main display.

While the air conditioning is being used, the system automatically switches to air conditioning eco mode (→P. 515, 527), allowing for driving that leads to even better fuel economy.

■ **The driving mode after turning the power switch off**

The driving mode will not be changed automatically until the switch is pressed, even if the power switch is turned off.

BSM (Blind Spot Monitor)*

Summary of the Blind Spot Monitor

The Blind Spot Monitor is a system that has 2 functions;

- The Blind Spot Monitor function
Assists the driver in making the decision when changing lanes
- The Rear Cross Traffic Alert function
Assists the driver when backing up

These functions use same sensors.

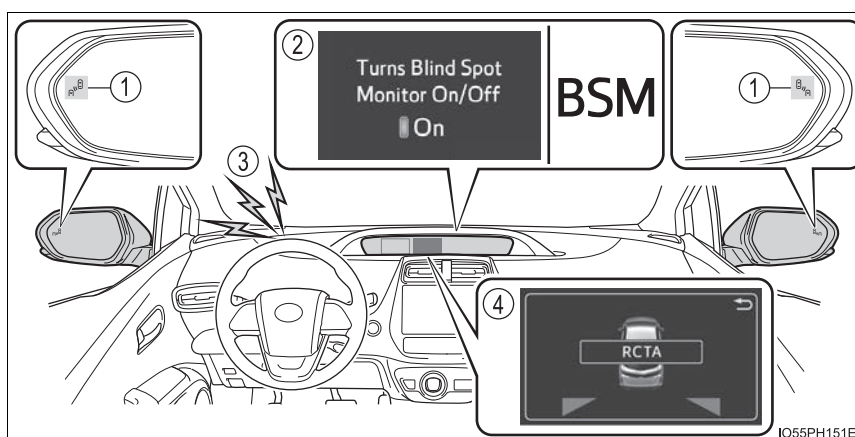

① Outside rear view mirror indicators

Blind Spot Monitor function:

When a vehicle is detected in the blind spot, the outside rear view mirror indicator comes on while the turn signal lever is not operated. If the turn signal lever is operated toward the detected side, the outside rear view mirror indicator flashes.

Rear Cross Traffic Alert function:

When a vehicle approaching from the right or left rear of the vehicle is detected, the outside rear view mirror indicators flash.

*: If equipped

② The Blind Spot Monitor on/off screen and indicator

The Blind Spot Monitor function and Rear Cross Traffic Alert function can be switched on and off using the multi-information display. (→P. 246)

When switched on, the BSM indicator illuminates on the meter and the buzzer sounds.

③ Rear Cross Traffic Alert buzzer (Rear Cross Traffic Alert function only)

When a vehicle approaching from the right or left rear of the vehicle is detected, a buzzer sounds from the driver's side instrument panel.

④ RCTA detection screen (RCTA function only)

If a vehicle approaching from the right or left at the rear of the vehicle is detected, the RCTA detection screen will be shown on the multi-information display.

Changing settings of the Blind Spot Monitor function and Rear Cross Traffic Alert function

The Blind Spot Monitor function and Rear Cross Traffic Alert function can be enabled/disabled on the  screen (→P. 246) of the multi-information display.

Once the systems are disabled, the systems will not be enabled until they are enabled by the  screen of multi-information display again. (The systems are not automatically enabled even when the hybrid system is restarted.)

■ **The BSM outside rear view mirror indicators visibility**

When under strong sunlight, the outside rear view mirror indicator may be difficult to see.

■ **The Rear Cross Traffic Alert buzzer hearing**

The Rear Cross Traffic Alert buzzer may be difficult to hear over loud noises such as high audio volume.

■ **When “Blind Spot Monitor Unavailable” is shown on the multi-information display**

The sensor voltage has become abnormal, water, snow mud, etc., may be built up in the vicinity of the sensor area of bumper (→P. 436). Removing the water, snow, mud, etc., from the vicinity of the sensor area bumper should return it to normal. Also, the sensor may not function normally when used in extremely hot or cold weather.

■ **When “Blind Spot Monitor System Malfunction Visit Your Dealer” is shown on the multi-information display**

There may be a sensor malfunction or misaligned. Have the vehicle inspected by your Toyota dealer.

■ **Certifications for the Blind Spot Monitor**

▶ For vehicles sold in the U.S.A. and Hawaii

FCC ID : OAYSRR3A

This device complies with part 15 of the FCC Rules. Operation is subject to the following two conditions:

- (1) This device may not cause harmful interference, and
- (2) this device must accept any interference received, including interference that may cause undesired operation.

FCC Warning

Changes or modifications not expressly approved by the party responsible for compliance could void the user's authority to operate the equipment.

► For vehicles sold in Canada

This device contains licence-exempt transmitter(s)/receiver(s) that comply with Innovation, Science and Economic Development Canada's licence-exempt RSS(s). Operation is subject to the following two conditions:

1. This device may not cause interference.
2. This device must accept any interference, including interference that may cause undesired operation of the device.

Radiofrequency radiation exposure information:

This equipment complies with radiation exposure limits set forth for an uncontrolled environment. This equipment should be installed and operated with minimum distance of 20 cm between the radiator and your body.

L'émetteur/récepteur exempt de licence contenu dans le présent appareil est conforme aux CNR d'Innovation, Sciences et Développement économique Canada applicables aux appareils radio exempts de licence. L'exploitation est autorisée aux deux conditions suivantes:

1. L'appareil ne doit pas produire de brouillage;
2. L'appareil doit accepter tout brouillage radioélectrique subi, même si le brouillage est susceptible d'en compromettre le fonctionnement.

Informations sur l'exposition aux rayonnements radiofréquences:

Cet équipement est conforme aux limites d'exposition aux rayonnements définies pour un environnement non contrôlé. Cet équipement doit être installé et utilisé avec un minimum de 20 cm de distance entre la source de rayonnement et votre corps.

⚠ WARNING**■ Handling the radar sensor**

One Blind Spot Monitor sensor is installed inside the left and right side of the vehicle rear bumper respectively. Observe the following to ensure the Blind Spot Monitor can function correctly.

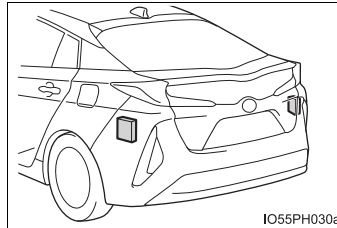

- Keep the sensor and its surrounding area on the bumper clean at all times.
- Do not subject a sensor or its surrounding area on the rear bumper to a strong impact.
If a sensor is moved even slightly off position, the system may malfunction and vehicles may not be detected correctly.
In the following situations, have your vehicle inspected by your Toyota dealer.
 - A sensor or its surrounding area is subject to a strong impact.
 - If the surrounding area of a sensor is scratched or dented, or part of them has become disconnected.
- Do not disassemble the sensor.
- Do not attach accessories or stickers to the sensor or surrounding area on the bumper.
- Do not modify the sensor or surrounding area on the bumper.
- Do not paint the rear bumper any color other than an official Toyota color.

The Blind Spot Monitor function

The Blind Spot Monitor function uses radar sensors to detect vehicles that are traveling in an adjacent lane in the area that is not reflected in the outside rear view mirror (the blind spot), and advises the driver of the vehicle's existence via the outside rear view mirror indicator.

The Blind Spot Monitor function detection areas

The areas that vehicles can be detected in are outlined below.

The range of the detection area extends to:

- ① Approximately 11.5 ft. (3.5 m) from the side of the vehicle
The first 1.6 ft. (0.5 m) from the side of the vehicle is not in the detection area
- ② Approximately 9.8 ft. (3 m) from the rear bumper
- ③ Approximately 3.3 ft. (1 m) forward of the rear bumper

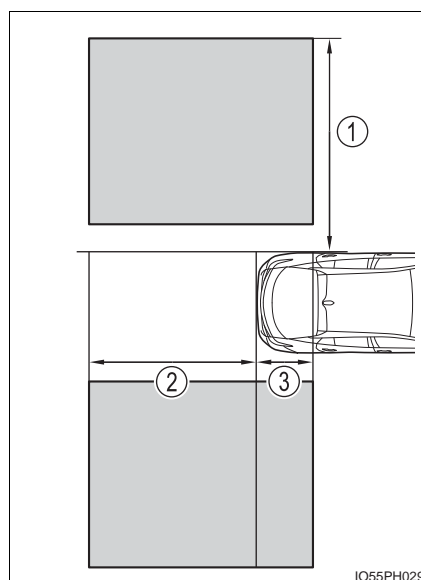

⚠ WARNING**■ Cautions regarding the use of the system**

The driver is solely responsible for safe driving. Always drive safely, taking care to observe your surroundings.

The Blind Spot Monitor function is a supplementary function which alerts the driver that a vehicle is present in the blind spot. Do not overly rely on the Blind Spot Monitor function. The function cannot judge if it is safe to change lanes, therefore over reliance could cause an accident resulting in death or serious injury.

According to conditions, the system may not function correctly. Therefore the driver's own visual confirmation of safety is necessary.

■ The Blind Spot Monitor function is operational when

- The BSM system is set to on (→P. 246)
- Vehicle speed is greater than approximately 10 mph (16 km/h)

■ The Blind Spot Monitor function will detect a vehicle when

- A vehicle in an adjacent lane overtakes your vehicle.
- You overtake a vehicle in adjacent lane slowly.
- Another vehicle enters the detection area when it changes lanes.

■ Conditions under which the Blind Spot Monitor function will not detect a vehicle

The Blind Spot Monitor function is not designed to detect the following types of vehicles and/or objects:

- Small motorcycles, bicycles, pedestrians etc.*
- Vehicles traveling in the opposite direction
- Guardrails, walls, signs, parked vehicles and similar stationary objects*
- Following vehicles that are in the same lane*
- Vehicles driving 2 lanes across from your vehicle*
- Vehicles which are being overtaken rapidly by your vehicle*

*: Depending on conditions, detection of a vehicle and/or object may occur.

■ Conditions under which the Blind Spot Monitor function may not function correctly

- The Blind Spot Monitor function may not detect vehicles correctly in the following situations:
 - When the sensor is misaligned due to a strong impact to the sensor or its surrounding area
 - When mud, snow, ice, a sticker, etc. is covering the sensor or surrounding area on the rear bumper
 - When driving on a road surface that is wet with standing water during bad weather, such as heavy rain, snow, or fog
 - When multiple vehicles are approaching with only a small gap between each vehicle
 - When the distance between your vehicle and a following vehicle is short
 - When there is a significant difference in speed between your vehicle and the vehicle that enters the detection area
 - When the difference in speed between your vehicle and another vehicle is changing
 - When a vehicle enters a detection area traveling at about the same speed as your vehicle
 - As your vehicle starts from a stop, a vehicle remains in the detection area
 - When driving up and down consecutive steep inclines, such as hills, dips in the road, etc.
 - When driving on roads with sharp bends, consecutive curves, or uneven surfaces
 - When vehicle lanes are wide, or when driving on the edge of a lane, and the vehicle in an adjacent lane is far away from your vehicle
 - When a bicycle carrier or other accessory is installed to the rear of the vehicle
 - When there is a significant difference in height between your vehicle and the vehicle that enters the detection area
 - Immediately after the Blind Spot Monitor function is turned on
- Instances of the Blind Spot Monitor function unnecessarily detecting a vehicle and/or object may increase in the following situations:
 - When the sensor is misaligned due to a strong impact to the sensor or its surrounding area
 - When the distance between your vehicle and a guardrail, wall, etc. that enters the detection area is short
 - When driving up and down consecutive steep inclines, such as hills, dips in the road, etc.
 - When vehicle lanes are narrow, or when driving on the edge of a lane, and a vehicle traveling in a lane other than the adjacent lanes enters the detection area
 - When driving on roads with sharp bends, consecutive curves, or uneven surfaces
 - When the tires are slipping or spinning
 - When the distance between your vehicle and a following vehicle is short
 - When a bicycle carrier or other accessory is installed to the rear of the vehicle

The Rear Cross Traffic Alert function

The Rear Cross Traffic Alert functions when your vehicle is in reverse. It can detect other vehicles approaching from the right or left rear of the vehicle. It uses radar sensors to alert the driver of the other vehicle's existence through flashing the outside rear view mirror indicators and sounding a buzzer.

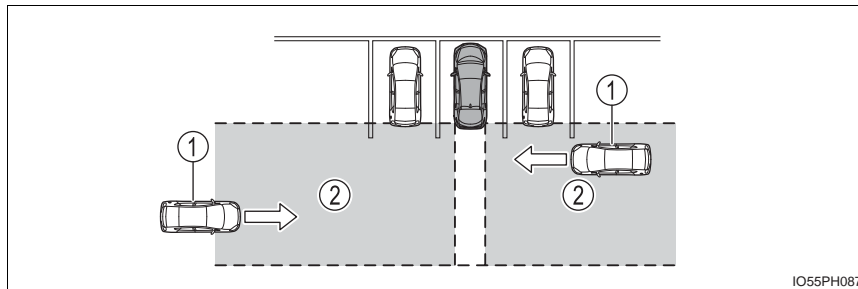

① Approaching vehicles

② Detection areas

⚠ WARNING

■ Cautions regarding the use of the system

The driver is solely responsible for safe driving. Always drive safely, taking care to observe your surroundings.

The Rear Cross Traffic Alert function is only an assist and is not a replacement for careful driving. The driver must be careful when backing up, even when using the Rear Cross Traffic Alert function. The driver's own visual confirmation of behind you and your vehicle is necessary and be sure there are no pedestrians, other vehicles etc. before backing up. Failure to do so could cause death or serious injury.

According to conditions, the system may not function correctly. Therefore the driver's own visual confirmation of safety is necessary.

The Rear Cross Traffic Alert function detection areas

The areas that vehicles can be detected in are outlined below.

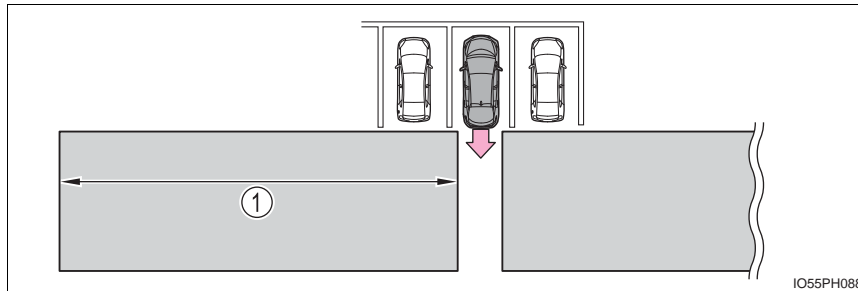

To give the driver a more consistent time to react, the buzzer can alert for faster vehicles from farther away.

Example:

Approaching vehicle	Speed	① Approximate alert distance
Fast	18 mph (28 km/h)	65 ft. (20 m)
Slow	5 mph (8 km/h)	18 ft. (5.5 m)

■ The Rear Cross Traffic Alert function is operational when

- The BSM system is set to on. (→P. 246)
- The shift position is in R.
- Vehicle speed is less than approximately 5 mph (8 km/h).
- Approaching vehicle speed is between approximately 5 mph (8 km/h) and 18 mph (28 km/h).

■ **Conditions under which the Rear Cross Traffic Alert function will not detect a vehicle**

The Rear Cross Traffic Alert function is not designed to detect the following types of vehicles and/or objects:

- Vehicles approaching from directly behind
- Vehicles backing up in a parking space next to your vehicle
- Vehicles that the sensors cannot detect due to obstructions

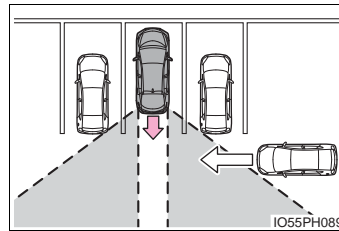

- Guardrails, walls, signs, parked vehicles and similar stationary objects*
- Small motorcycles, bicycles, pedestrians, etc.*
- Vehicles moving away from your vehicle
- Vehicles approaching from the parking spaces next to your vehicle*

*: Depending on the conditions, detection of a vehicle and/or object may occur.

■ **Conditions under which the Rear Cross Traffic Alert function may not function correctly**

- The Rear Cross Traffic Alert function may not detect vehicles correctly in the following situations:
 - When the sensor is misaligned due to a strong impact to the sensor or its surrounding area
 - When mud, snow, ice, a sticker, etc. is covering the sensor or surrounding area on the rear bumper
 - When driving on a road surface that is wet with standing water during bad weather, such as heavy rain, snow, or fog
 - When multiple vehicles are approaching with only a small gap between each vehicle
 - When a vehicle is approaching at high speed

- When backing up on a slope with a sharp change in grade

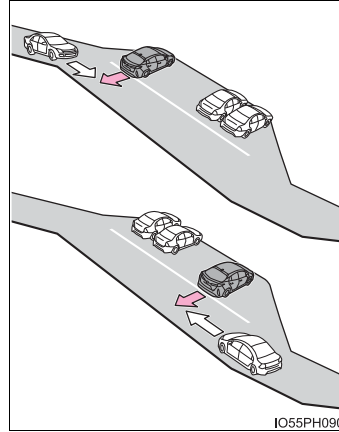

- When backing out of a shallow angle parking spot

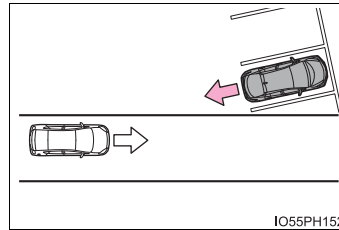

- Immediately after the Blind Spot Monitor function is turned on
- Immediately after the hybrid system is started with the Blind Spot Monitor function on
- When the sensors cannot detect a vehicle due to obstructions

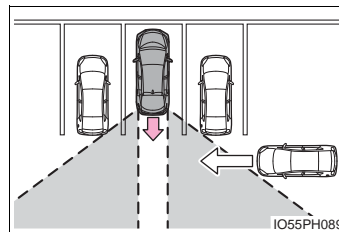

● Instances of the Rear Cross Traffic Alert function unnecessarily detecting a vehicle and/or object may increase in the following situations:

- When a vehicle passes by the side of your vehicle
- When the parking space faces a street and vehicles are being driven on the street

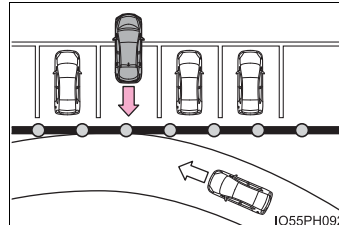

- When the distance between your vehicle and metal objects, such as a guardrail, wall, sign, or parked vehicle, which may reflect electrical waves toward the rear of the vehicle, is short

Intuitive parking assist*

The distance from your vehicle to nearby obstacles when parallel parking or maneuvering into a garage is measured by the sensors and communicated via the displays and a buzzer. Always check the surrounding area when using this system.

Types of sensors

- ① Front corner sensors
- ② Front center sensors
- ③ Rear corner sensors
- ④ Rear center sensors
- ⑤ Front side sensors
- ⑥ Rear side sensors

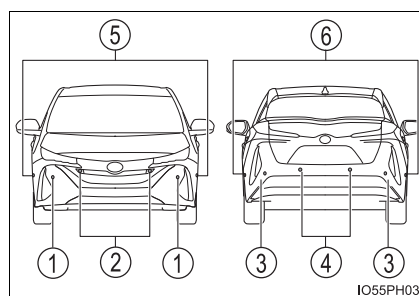

Turning the intuitive parking assist on/off

The intuitive parking assist can be enabled/disabled on the  screen (→P. 246) of the multi-information display.

When on is selected, intuitive parking assist indicator will come on.

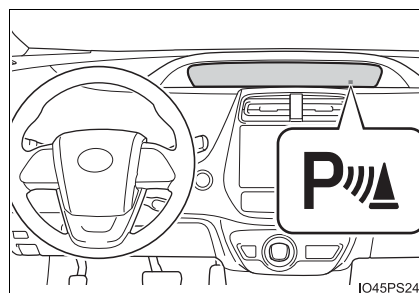

Once off is selected, the intuitive parking assist will not return to on until it is turned to on by the  screen of multi-information display again. (The system does not automatically return to on even when the hybrid system is restarted.)

5

Driving

*: If equipped

Display

When the sensors detect an obstacle, the following displays inform the driver of the position and distance to the obstacle.

■ Multi-information display

- ① Front center sensor operation
- ② Front corner sensor operation
- ③ Front side sensor operation
- ④ Rear side sensor operation
- ⑤ Rear corner sensor operation
- ⑥ Rear center sensor operation

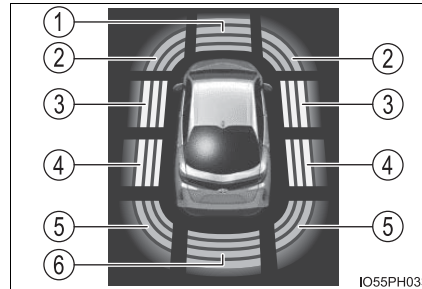





- The operation display is gray when the sensors are operating.
- The front side sensor operation displays and rear side sensor operation displays are not shown until a scan of the side areas is completed.

Sensor detection display, obstacle distance

■ **Distance display**

Sensors that detect an obstacle will illuminate continuously or blink.

Display*		Approximate distance to obstacle	
		Front corner, front center and front side sensors	Rear corner, rear center and rear side sensors
 (continuous)	Far ↑ ↓ Near	① 3.3 ft. (100 cm) to 2.0 ft (60 cm)	⑥ 4.9 ft. (150 cm) to 2.0 ft. (60 cm)
 (continuous)		① 2.0 ft. (60 cm) to 1.5 ft (45 cm) ② 2.0 ft. (60 cm) to 1.5 ft. (45 cm) ③ 3.3 ft. (100 cm) to 2.3 ft. (70 cm)	④ 3.3 ft. (100 cm) to 2.3 ft. (70 cm) ⑤ 2.0 ft. (60 cm) to 1.5 ft (45 cm) ⑥ 2.0 ft. (60 cm) to 1.5 ft. (45 cm)
 (continuous)		① 1.5 ft. (45 cm) to 1.2 ft. (35 cm) ② 1.5 ft. (45 cm) to 1.2 ft. (35 cm) ③ 2.3 ft. (70 cm) to 1.0 ft. (30 cm)	④ 2.3 ft. (70 cm) to 1.0 ft. (30 cm) ⑤ 1.5 ft. (45 cm) to 1.2 ft. (35 cm) ⑥ 1.5 ft. (45 cm) to 1.2 ft. (35 cm)
 (blinking)		① Less than 1.2 ft. (35 cm) ② Less than 1.2 ft. (35 cm) ③ Less than 1.0 ft. (30 cm)	④ Less than 1.0 ft. (30 cm) ⑤ Less than 1.2 ft. (35 cm) ⑥ Less than 1.2 ft. (35 cm)

- ① Front center sensors
- ② Front corner sensors
- ③ Front side sensors
- ④ Rear side sensors
- ⑤ Rear corner sensors
- ⑥ Rear center sensors

*: The images may differ from those shown in the illustrations depending on the detection status. (→P. 446)

Buzzer

When an obstacle is detected, the buzzer sounds.

- As the obstacle is approached, the buzzer sounds more rapidly. When the obstacle is extremely close, the buzzer switches from sounding intermittently (short beeps) to continuously (a long beep).
 - Distance to obstacle detected by front corner sensor is approximately 1.2 ft. (35 cm) or less
 - Distance to obstacle detected by front side sensor or rear side sensor is approximately 1.0 ft. (30 cm) or less
 - Distance to obstacle detected by front sensor is approximately 1.2 ft. (35 cm) or less
 - Distance to obstacle detected by rear corner sensor is approximately 1.2 ft. (35 cm) or less
 - Distance to obstacle detected by back sensor is approximately 1.2 ft. (35 cm) or less
- When an obstacle is detected by multiple sensors simultaneously, the buzzer sounds according to the distance to the closest obstacle.
- When obstacles are simultaneously detected to the front and rear of the vehicle, separate buzzers sound patterns according to the distance to each obstacle.

The volume and timing of the buzzer can be changed. (→P. 753)

Detection range of the sensors

- ① Approximately 3.3 ft. (100 cm)
- ② Approximately 4.9 ft. (150 cm)
- ③ Approximately 2.0 ft. (60 cm)
- ④ Approximately 3.3 ft. (100 cm)
 - The detection range is shown in the illustration to the right. However, the sensor will not detect the obstacle if it is too close.
 - For details regarding obstacle detection in the side areas. (→P. 450)
 - The distance at which an obstacle can be detected and whether it can be detected depends on the shape and condition of the obstacle.

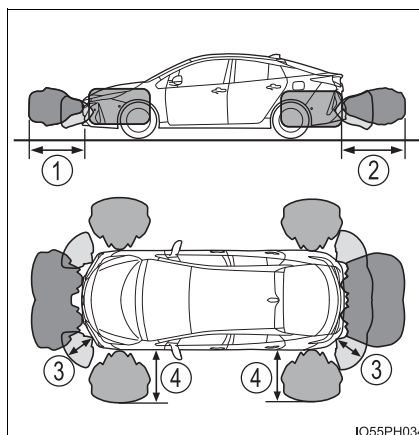

IO55PH034

The obstacle detection range can be changed. (→P. 753)

■ Operation conditions

The power switch is turned on.

- Front corner sensors:
 - Shift position is not in P
 - Vehicle speed is approximately 6 mph (10 km/h) or less
- Front side sensors/rear side sensors:
 - Shift position is not in P
 - Vehicle speed is approximately 6 mph (10 km/h) or less
 - Steering wheel is turned approximately 90° or more
- Front center sensors:
 - Shift position is not in P or R
 - Vehicle speed is approximately 6 mph (10 km/h) or less
- Rear corner sensors/rear center sensors:
 - Shift position is in R

■ Intuitive parking assist pop-up display

→P. 471

■ Sensor detection information

- The sensor's detection areas are limited to the areas around the vehicle's bumper.
- Depending on the shape of the obstacle and other factors, the detection distance may shorten, or detection may be impossible.
- Obstacles may not be detected if they are too close to the sensor.
- There will be a short delay between obstacle detection and display. Even when traveling at a low speed, if you come too close to an obstacle before the display and buzzer activate, the display and buzzer may not activate at all.
- Thin posts or objects lower than the sensor may not be detected when approached, even if they have been detected once.
- It might be difficult to hear beeps due to the volume of audio system or air flow noise of the air conditioning system.

■ Obstacle warning function

When an obstacle in the side areas is within the vehicle course while the vehicle is moving forward or backward, this function inform the driver by the display and the buzzer. (→P. 447, 448)

- ① Obstacle
- ② Calculated vehicle course

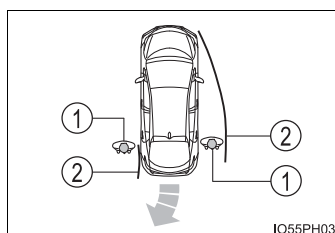

■ Obstacle detection in side areas

- Obstacles in the side areas are detected while driving by scanning the side areas with the side sensors. Recognized obstacles are retained in memory for up to approximately 2 minutes.
- Obstacles may not be detected in the side areas until the scan completes. After the power switch is turned on, scanning completes after driving the vehicle for a short period of time.
- When an obstacle such as another vehicle, pedestrian or animal is detected by the side sensors, the obstacle may continue to be detected even after it has left the side sensor detection area.

■ If “Clean Parking Assist Sensor” is displayed on the multi-information display

A sensor may be dirty or covered with snow or ice. In such cases, if it is removed from the sensor, the system should return to normal.

Also, due to the sensor being frozen at low temperatures, a malfunction display may appear or an obstacle may not be detected. If the sensor thaws out, the system should return to normal.

■ If “Parking Assist Malfunction” is displayed on the multi-information display

Depending on the malfunction of the sensor, the device may not be working normally. Have the vehicle inspected by your Toyota dealer.

■ Certification (Canada only)

This ISM device complies with Canadian ICES-001.

■ Customization

Settings (e.g. buzzer volume) can be changed.
(Customizable features: →P. 753)

**WARNING****■ When using intuitive parking assist**

Observe the following precautions to avoid an unexpected accident.

- Do not exceed the speed limit of 6 mph (10 km/h).
- The sensors' detection areas and reaction times are limited. When moving forward or reversing, check the areas surrounding the vehicle (especially the sides of the vehicle) for safety, and drive slowly, using the brake to control the vehicle's speed.
- Do not install accessories within the sensors' detection areas.

 **WARNING****■ Sensors**

Certain vehicle conditions and the surrounding environment may affect the ability of the sensor to correctly detect obstacles. Particular instances where this may occur are listed below.

- There is dirt, snow or ice on the sensor. (Wiping the sensors will resolve this problem.)
- The sensor is frozen. (Thawing the area will resolve this problem.)
In especially cold weather, if a sensor is frozen, the screen may show an abnormal display, or obstacles may not be detected.
- The sensor is covered in any way.
- In harsh sunlight or intense cold weather
- On an extremely bumpy road, on an incline, on gravel, or on grass
- The vicinity of the vehicle is noisy due to vehicle horns, motorcycle engines, air brakes of large vehicles, or other loud noises producing ultrasonic waves.
- The sensor is splashed with water or drenched with heavy rain.
- The sensor is drenched with water on a flooded road.
- The vehicle is leaning considerably to one side.
- The vehicle is equipped with a fender pole or wireless antenna.
- The vehicle is approaching a tall or curved curb.
- The area directly under the bumpers is not detected.
- If obstacles draw too close to the sensor.
- The bumper or sensor receives a strong impact.
- A non-genuine Toyota suspension (lowered suspension etc.) is installed.
- There is another vehicle equipped with parking assist sensors in the vicinity.
- Towing eyelets are installed.
- A backlit license plate is installed.

In addition to the examples above, depending on the shape and condition of obstacles, detection may not be possible, or the detection range may be shortened.

 **WARNING****■ Side sensors**

In the following situations, the intuitive parking assist may not operate normally and may result in an unexpected accident. Drive carefully.

- Obstacles may not be detected in the side areas until the vehicle is driven for a short time and a scan of the side areas is completed. (→P. 450)
- Even after the scan of the side areas is completed, obstacles such as other vehicles, people or animals that approach from the sides cannot be detected.
- Even after the scan of the side areas is completed, obstacles may not be detected depending on the surrounding situation of the vehicle.

At that time, the side sensor operation displays (→P. 446) temporary turn off.

■ Obstacles which may not be properly detected

The shape of the obstacle may prevent the sensor from detecting it. Pay particular attention to the following obstacles:

- Wires, fences, ropes, etc.
- Cotton, snow and other materials that absorb sound waves
- Sharply-angled objects
- Low obstacles
- Tall obstacles with upper sections projecting outwards in the direction of your vehicle
- People may not be detected if they are wearing certain types of clothing.
- Moving objects such as people or animals

 NOTICE

■ **When using intuitive parking assist**

In the following situations, the system may not function correctly due to a sensor malfunction etc. Have the vehicle checked by your Toyota dealer.

- Intuitive parking assist operation display flashes, and a beep sounds when no obstacles are detected.
- If the area around a sensor collides with something, or is subjected to strong impact.
- If the bumper collides with something.
- If the display shows up and remains on without a beep.
- If a display error occurs, first check the sensor.
If the error occurs even when there is no ice, snow or mud on the sensor, it is likely that the sensor is malfunctioning.

■ **Notes when washing the vehicle**

- Do not apply intensive bursts of water or steam to the sensor area.
Doing so may result in the sensor malfunctioning.
- When using steam to wash the vehicle, do not direct steam too close to the sensors. The sensors may not function properly if subjected to steam.

Parking Support Brake function*

When a collision may occur with an obstacle while parking or traveling at low speeds, when the vehicle suddenly moves forward due to mistaken accelerator pedal operation, or when the vehicle moves due to the wrong shift position being selected, the sensors detect obstacles to the front or rear in the traveling direction of the vehicle, and the system operates to lessen impact with obstacles such as walls, and reduce resulting damage.

Examples of system operation

The system operates in the following situations when an obstacle is detected in the traveling direction of the vehicle.

- ◆ The vehicle is driven at low speeds and the brake pedal is not depressed, or is depressed too late

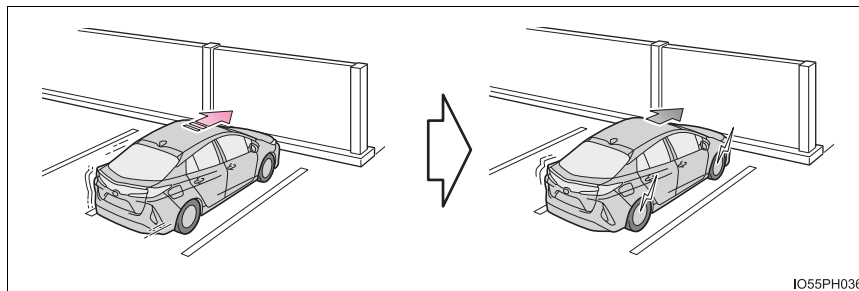

- ◆ The accelerator pedal is depressed too far

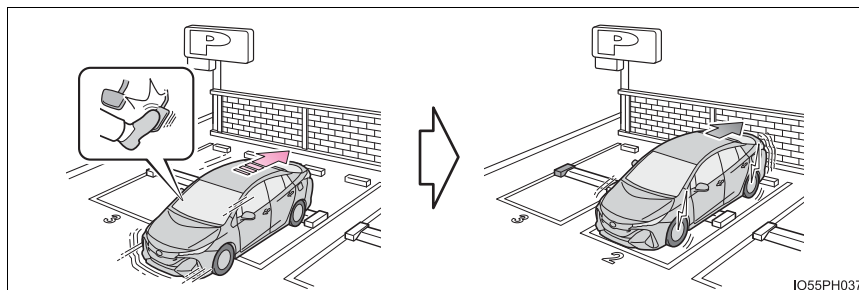

*: If equipped

◆ **The vehicle moves due to the wrong shift position being selected**

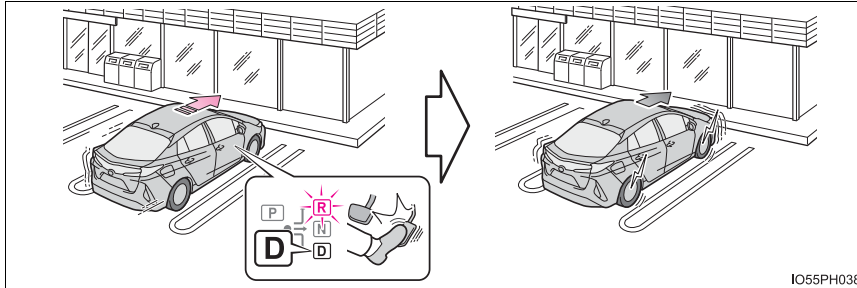

IO55PH038

Types of sensors

- ① Front corner sensors
- ② Front center sensors
- ③ Rear corner sensors
- ④ Rear center sensors

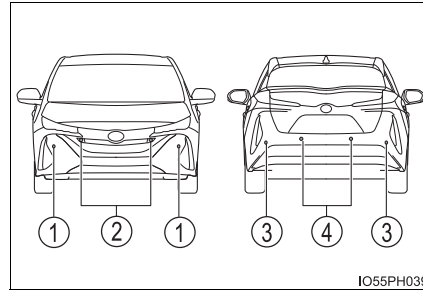

IO55PH039

Changing settings of the Parking Support Brake function

The Parking Support Brake function can be enabled/disabled on the



screen (→P. 246) of the multi-information display.

When the Parking Support Brake function is off, the PKSB OFF indicator illuminates.

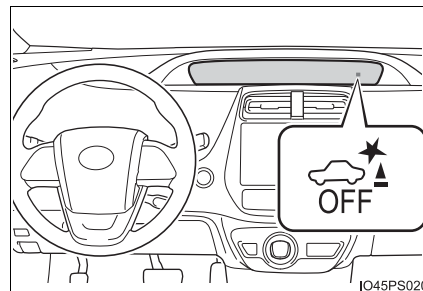

IO45PS020

When the Parking Support Brake function is switched off, system operation does not resume until the function is switched back on through the  screen on the multi-information display. (System operation does not resume by operating the power switch.)

Operation

When the Parking Support Brake function detects an obstacle with a probability of collision, hybrid system output is restricted to restrain an increase in vehicle speed. (Hybrid system output restriction control: A)

Furthermore, when the accelerator pedal continues to be depressed, the brakes are applied to reduce the vehicle speed. (Brake control: B)

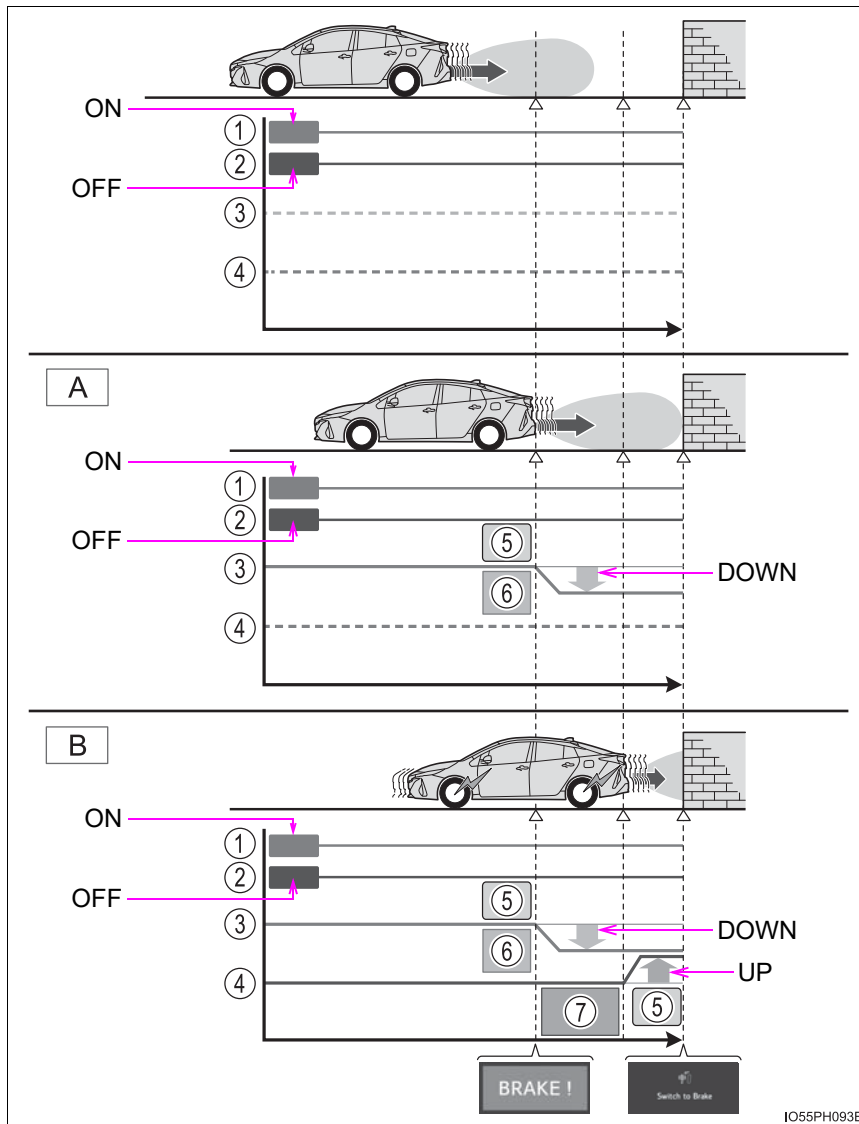

- ① Accelerator pedal
- ② Brake pedal
- ③ Hybrid system output
- ④ Braking force
- ⑤ Control starts
- ⑥ Collision is possible
- ⑦ Collision is likely

Operation conditions

■ Operation starting conditions

When the PKSB OFF indicator is not illuminated or flashing (→P. 464, 676) and all of the following conditions are met, the system operates.

- ▶ Hybrid system output restriction control
 - The Parking Support Brake function is on.
 - The vehicle speed is 10 mph (15 km/h) or less.
 - There is an obstacle in the traveling direction of the vehicle (6 to 13 ft. [2 to 4 m ahead]).
 - The system determined that a stronger-than-normal brake operation was necessary to avoid a collision.
- ▶ Brake control
 - Hybrid system output restriction control is being performed.
 - The system determined that an emergency brake operation was necessary to avoid a collision.

■ Operation ending conditions



In any of the following situations, the system stops operating.

- ▶ Hybrid system output restriction control
 - The Parking Support Brake function has been turned off (stopped).
 - The collision became avoidable with normal brake operation.
 - The obstacle is no longer in the traveling direction of the vehicle (6 to 13 ft. [2 to 4 m ahead]).
- ▶ Brake control
 - The Parking Support Brake function has been turned off (stopped).
 - Approximately 2 seconds elapsed after the vehicle was stopped by brake control.
 - The brake pedal was depressed after the vehicle was stopped by brake control.
 - The obstacle is no longer in the traveling direction of the vehicle (6 to 13 ft. [2 to 4 m ahead]).

Display and buzzer for hybrid system output restriction control and brake control

When the hybrid system output restriction control or brake control operates, the buzzer sounds and a message is displayed on the multi-information display to alert the driver.

Depending on the situation, output restriction control operates to either limit acceleration or restrict output as much as possible.

Control	Situation	Multi-information display	PKSB OFF Indicator	Buzzer
Hybrid system output restriction control is operating (acceleration limitation control)	Acceleration at a certain speed or higher is not possible.		Not illuminated	Short beep
Hybrid system output restriction control is operating (control to restrict output as much as possible)	A stronger-than-normal brake operation is necessary		Not illuminated	
Brake control is operating	Emergency braking is necessary			
The vehicle is stopped by system operation	The vehicle is stopped after brake control operation		Illuminated	

■ Sensor detection range

The detection range of the Parking Support Brake function differs from the detection range of the intuitive parking assist. (→P. 449)

Therefore, even if the intuitive parking assist detects an obstacle and provides a warning, the Parking Support Brake function may not start operating.

■ System operation

When the vehicle is stopped by system operation, the Parking Support Brake function stops and the PKSB OFF indicator illuminates.

■ System recovery

When the Parking Support Brake function is stopped by system operation and you would like to resume operation, either turn the Parking Support Brake function on again (→P. 456), or turn the power switch off and then back on. Furthermore, when the vehicle moves with an obstacle no longer in the traveling direction of the vehicle, or when the traveling direction of the vehicle changes (such as when switching from moving forward to backing up, and vice versa), system operation automatically resumes.

■ Obstacles not detected by the sensors

The following obstacles may not be detected by the sensors.

- Objects such as people, cloth and snow, that are difficult for sonic waves to reflect off of. (In particular, people may also not be detected depending on the type of clothing they are wearing.)
- Objects not perpendicular with the ground, objects not at a right angle to the traveling direction of the vehicle, uneven objects or waving objects
- Low objects
- Thin objects such as wires, fences, ropes and signposts
- Objects that are extremely close to the bumper

■ Intuitive parking assist buzzer

Regardless of whether the intuitive parking assist is on or off (→P. 445), if the Parking Support Brake function is not stopped (→P. 456), when the front or rear sensors detect an obstacle and brake control is performed, the intuitive parking assist buzzer also sounds and a notification of the approximate distance to the obstacle is provided.

■ **Situations when the system may operate even though there is no possibility of a collision**

In the following situations, the system may operate even though there is no possibility of a collision.

● **Environmental influence**

- The vehicle is driven on a narrow road

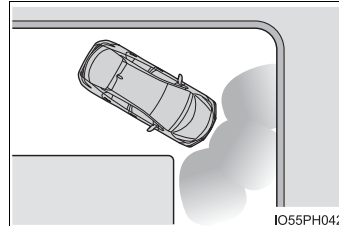

- The vehicle is driven on a gravel road or in an area with tall grass

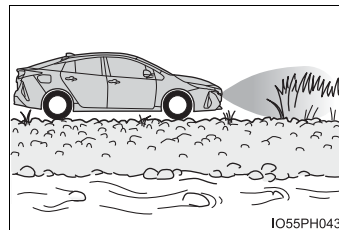

- The vehicle is driven toward a banner or flag, a low-hanging branch or a boom barrier (such as those used at railroad crossings, toll gates and parking lots).
- There is an obstacle on the shoulder of the road (when the vehicle is driven in a narrow tunnel, on a narrow bridge or on a narrow road)
- The vehicle is being parallel parked
- There is a rut or hole in the surface of the road
- When the vehicle is driven on a metal cover (grating), such as those used for drainage ditches
- The vehicle is driven on a steep slope
- The sensor is covered by water on a flooded road

● **Influence from the weather**

- Ice, snow, dirt, etc., has adhered to the sensor (if removed, the system returns to normal)
- Heavy rain or water strikes the vehicle
- In severe weather such as fog, snow or a sand storm

● **Influence from other sonic waves**

- An ultrasonic wave source is nearby, such as the horn or parking assist sensors of another vehicle, a vehicle detector, a motorcycle engine or the air brake of a large vehicle
- Electronic components (such as a backlit license plate (especially fluorescent types), fog lights, a fender pole or a wireless antenna) are installed near the sensors

- Changes in the vehicle

- The vehicle is tilted a large amount
- The height of the vehicle has drastically changed due to the carried load (the nose tilts up or down)
- The direction of the sensor has deviated due to a collision or other impact

- **In the unlikely event that the Parking Support Brake function mistakenly operates at a crossing or elsewhere**

Even in the unlikely event that the Parking Support Brake function mistakenly operates at a crossing or elsewhere, brake control is canceled after approximately 2 seconds, allowing you to proceed forward and leave the area. Furthermore, brake control is also canceled when the brake pedal is depressed. Depressing the accelerator pedal again allows you to proceed forward and leave the area.

- **Situations in which the system may not operate normally**

In the following situations, the system may not operate normally.

- Environmental influence

- There is an obstacle that cannot be detected between the vehicle and another obstacle that can be detected
- An obstacle such as another vehicle, a motorcycle, a bicycle or a pedestrian cuts in front of the vehicle or jumps out from the side.

- Influence from the weather

- The area around the sensor is extremely hot or cold

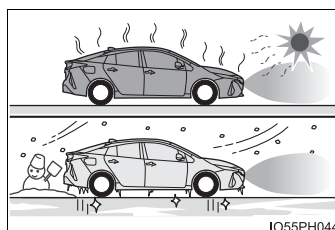

- The wind is strong

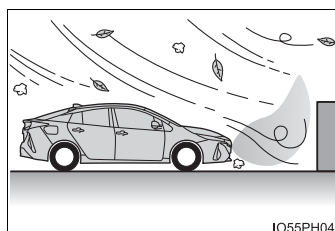

- Ice, snow, dirt, etc., has adhered to the sensor (if removed, the system returns to normal)
- Heavy rain or water strikes the vehicle
- In severe weather such as fog, snow or a sand storm

- Influence from other sonic waves
 - An ultrasonic wave source is nearby, such as the horn or parking assist sensors of another vehicle, a vehicle detector, a motorcycle engine or the air brake of a large vehicle
 - Electronic components (such as a backlit license plate (especially fluorescent types), fog lights, a fender pole or a wireless antenna) are installed near the sensors
- Changes in the vehicle
 - When driving with the shift position in N
 - The vehicle is tilted a large amount
 - The height of the vehicle has drastically changed due to the carried load (the nose tilts up or down)
 - The direction of the sensor has deviated due to a collision or other impact

■ **Parking Support Brake function while the Simple Advanced Parking Guidance System is operating**

→P. 469

■ **When removing and installing the 12-volt battery**

The system needs to be initialized.

The system can be initialized by driving the vehicle straight ahead for 5 seconds or more at a speed of approximately 22 mph (35 km/h) or higher.

■ **When “PKSB Unavailable” is displayed on the multi-information display and the PKSB OFF indicator flashes**

● Ice, snow, dirt, etc., may have adhered to the sensor. If this occurs, remove the ice, snow, dirt, etc., from the sensor to return the system to normal. Also, a warning message may be displayed at low temperatures due to ice forming on the sensor, and the sensor may not detect obstacles. Once the ice melts, the system will return to normal.

● If this message is shown even after removing dirt from the sensor, or shown when the sensor was not dirty to begin with, have the vehicle inspected at your Toyota dealer.

● System initialization may not have been performed after removal and installation of the 12-volt battery. Perform system initialization.

■ **When “PKSB Malfunction Visit Your Dealer” is displayed on the multi-information display, the PKSB OFF indicator flashes and the buzzer sounds**

The system may not be operating properly. Have the vehicle inspected at your Toyota dealer.

 **WARNING****■ For safe use**

Do not rely solely upon the system. Relying solely upon the system may lead to an unexpected accident.

- Driving safely is the sole responsibility of the driver. Pay careful attention to the surrounding conditions in order to ensure safe driving. The Parking Support Brake function can provide support to lessen the severity of collisions. However, it may not operate depending on the situation.
- The Parking Support Brake function is not a system designed to completely stop the vehicle. Furthermore, even if the Parking Support Brake function is able to stop the vehicle, brake control is canceled after approximately 2 seconds, so depress the brake pedal immediately.

■ In order for the system to operate properly

Make sure to observe the following precautions regarding the sensors (→P. 456). Failure to observe these precautions may cause the sensors not to operate properly, and may result in an unexpected accident.

- Do not perform work such as modification, disassembly or painting
- Only perform replacements using genuine parts
- Do not subject the area around the sensors to any impacts
- Do not damage the sensors, and always keep them clean

■ Handling the suspension

Do not modify the suspension, as changes to the height or incline of the vehicle may prevent the sensors from correctly detecting obstacles, may cause the system not to operate, or may cause the system to operate unnecessarily.

 NOTICE**■ Preventing sensor malfunctions**

- If the area around a sensor is subjected to an impact, equipment may not operate properly due to a sensor malfunction. Have the vehicle inspected at your Toyota dealer.
- When using a high-pressure washer to wash the vehicle, do not spray water directly on the sensors. The sensors may not function properly if subjected to an impact from strong water pressure.
- When using steam to wash the vehicle, do not direct steam too close to the sensors. The sensors may not function properly if subjected to steam.

■ Preventing unnecessary operation

In the following situations, turn the Parking Support Brake function off. The system may operate even though there is no possibility of a collision.

- A chassis roller, chassis dynamo, free roller or similar equipment is being used for an inspection, etc.
- The vehicle is being loaded onto a ship, truck or other transport vessel
- The suspension has been lowered or tires that have a different size than the genuine tires are equipped
- The height of the vehicle has drastically changed due to the carried load (the nose tilts up or down).
- A towing eyelet is installed
- When using an automatic car wash

S-APGS (Simple Advanced Parking Guidance System)*

Simple Advanced Parking Guidance System

■ Function summary

The Simple Advanced Parking Guidance System automatically operates the steering wheel to provide support when backing into an area near a target parking spot, and when departing from a parallel parking spot. (Changing the shift position and speed adjustment when moving forward or backing up are not performed automatically.)

- The Simple Advanced Parking Guidance System does not park the vehicle automatically. It is a system that provides support when pulling out of a perpendicular or parallel parking spot.
- The Simple Advanced Parking Guidance System provides steering wheel operation assistance to guide the vehicle toward the selected intended parking spot. The selected intended parking spot may not always be reachable, depending on road and vehicle conditions at the time of parking, and the distance to the intended parking spot.

■ Linking with the Parking Support Brake function

While the Simple Advanced Parking Guidance System is operating, if the system detects an obstacle that could result in a collision, the emergency brakes operate, regardless of whether the Parking Support Brake function is on or off. (→P. 469)

WARNING

- When backing up or proceeding forward, be sure to directly confirm the safety of the area to the front or rear, and the area around the vehicle, and slowly back up or proceed forward while adjusting the vehicle speed by depressing the brake pedal.
- If it seems the vehicle may make contact with a pedestrian, another vehicle or any other obstacles, stop the vehicle by depressing the brake pedal, and then press the S-APGS switch (→P. 470) to turn the system off.

*: If equipped

Chart of Simple Advanced Parking Guidance System assist modes and functions

Assist mode	Type of parking	Function summary	See page
Parallel parking assist mode	Parallel parking	Guidance is provided to detect the intended parking spot and reach a position to begin backing up from. Assistance is provided from when the vehicle begins backing up until it reaches the intended parking spot.	P. 473
Exit parallel parking assist mode	Exit parallel parking	Assistance starts after the vehicle has been parallel parked. Assistance is provided to guide the vehicle from the parking space to a position from which it can take off.	P. 480
Back-in parking assist mode (with forward guidance function)	Back-in parking	Assistance starts after stopping the vehicle in front of the intended parking spot, and is provided for backing into a parking space, including guidance to reach a position to begin backing up from.	P. 485

■ Parking Support Brake function while the Simple Advanced Parking Guidance System is operating

While the Simple Advanced Parking Guidance System is operating, if the system detects an obstacle that could result in a collision, hybrid system output restriction control and brake control of the Parking Support Brake function are operated, regardless of whether the Parking Support Brake function is on or off. (→P. 456)

- After the Parking Support Brake function operates, operation of the Simple Advanced Parking Guidance System is temporarily stopped, and operation of the Parking Support Brake function is indicated on the multi-information display. (→P. 460)
- When operation of the Simple Advanced Parking Guidance System is stopped 3 times by operation of the Parking Support Brake function, the Simple Advanced Parking Guidance System is canceled.
- Once the Simple Advanced Parking Guidance System becomes available after the Parking Support Brake function is operated, a message prompting you to shift is displayed on the multi-information display. Operation of the Simple Advanced Parking Guidance System can be resumed by shifting according to the prompt on the multi-information display and pressing the S-APGS switch (→P. 470) again.

■ Shifting while the Simple Advanced Parking Guidance System is operating

If the system determines that the driver intends to move forward or in reverse, assistance continues even if the driver shifted before being prompted to do so by the system. However, because driver operation differs from the guidance provided by the system, the number of turning maneuvers may increase.

■ Customization

Settings (e.g. obstacle detection range) can be changed. (Customizable features: →P. 753)

Switching assist mode

■ Switching using the S-APGS switch

Press the switch

This allows you to switch functions and cancel or restart assist modes.

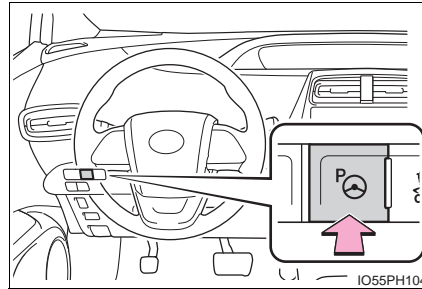

While the power switch is on, the vehicle speed is approximately 19 mph (30 km/h) or less, each time the S-APGS switch is pressed the function switches as follows.

The selected function is indicated on the operation display area of the multi-information display. (→P. 471)

- ▶ When the S-APGS switch is pressed with the shift position not in P
- ▶ When the S-APGS switch is pressed with the shift position in P

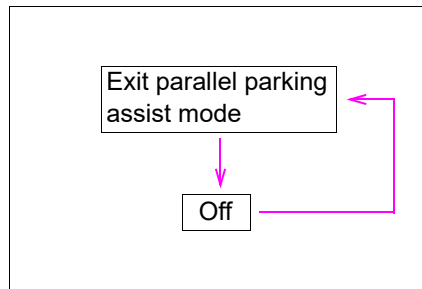
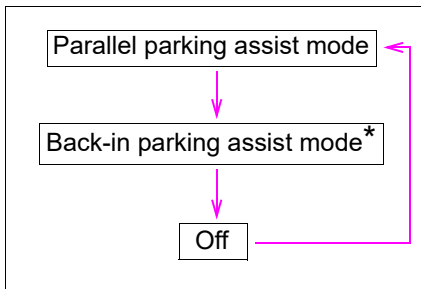

*: The back-in parking assist mode can be switched to when its operating conditions are met (→P. 489). When the operating conditions are not met, it switches to off.

Guidance screen

The guidance screen is displayed on the multi-information display.

① Assistance level indicator

Displays a gauge indicating the level until the vehicle's stopping position/the position at which assist control ends.

② Stop display

When illuminated, depress the brake pedal and stop the vehicle at once.

③ Operation display area

Displays the operating condition of the Simple Advanced Parking Guidance System.

④ Advice display

Follow the instructions on the display and perform any indicated operations. As an example, the illustration shows the display indicating it is necessary to depress the brake pedal in order to control the vehicle speed and to confirm the safety of your surroundings.

⑤ S-APGS switch icon

Displayed when the assist mode can be changed and the system can be turned off or on using the S-APGS switch.

⑥ Steering wheel auto operation display

Displays when the steering wheel auto operation is being performed.

⑦ Intuitive parking assist display/door position (open/close) display

→P. 446

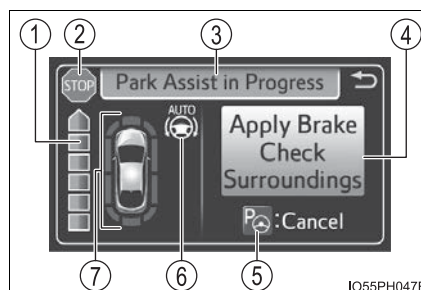

■ S-APGS indicator inside the meter (→P. 205)

This indicator illuminates when the steering wheel auto operation is being performed by the Simple Advanced Parking Guidance System. After control ends, the indicator blinks for a short period of time and then turns off.

■ Intuitive parking assist pop-up display

While the Simple Advanced Parking Guidance System is operating, if the intuitive parking assist detects an obstacle, the intuitive parking assist display automatically pops up on the guidance screen (→P. 446), regardless of whether the intuitive parking assist is on or off. (→P. 445)

Canceling or stopping assist mode

Assist mode will be canceled or stopped in the following cases.

■ Assist control is canceled when

- The system temperature preservation function operates
- There is a system malfunction
- System determined that the parking environment is not suitable for assist to continue

When assist control is canceled, firmly grasp the steering wheel, depress the brake pedal and stop the vehicle.

Start again from the beginning, as the system will already be canceled. When continuing to park manually, operate the steering wheel as you normally would.

■ Assist control is stopped when

- The steering wheel is operated
- The vehicle speed exceeds 4 mph (7 km/h) during assist control
- The Parking Support Brake function operates

When assist control is stopped, it can be resumed by following the guidance shown on the screen.

■ If the vehicle speed is about to exceed the speed limit during assist control

A buzzer sounds and the message indicating there is possibility that the vehicle speed may exceed the speed limit.

When the message is displayed, immediately depress the brake pedal to decelerate. If the vehicle continues to accelerate, assist control will be canceled when the vehicle speed exceeds a certain speed.

(→P. 494)

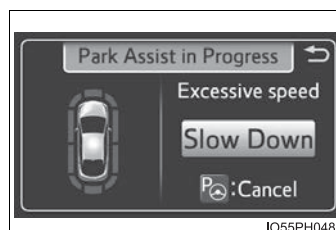

How to parallel park (parallel parking assist mode)

■ Function summary

If a parking space can be detected, you will be guided forward until you reach the assist control starting position, and then the parallel parking assist mode can be used. Furthermore, depending on the parking space and other conditions, multi-turn maneuvering assist control is also provided if necessary.

- ① Continue moving forward with the vehicle parallel to the curb or road, and stop so that the center of the target parking spot appears nearly perpendicular to the vehicle. Then press the S-APGS switch 1 time to select the parallel parking assist mode.

- ② Travel straight ahead parallel with the road or curb so that the parking space is detected.

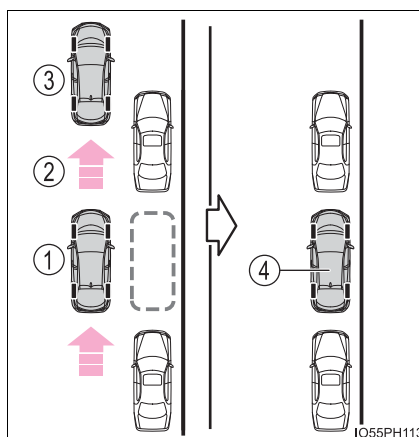

- ③ A sound is issued and a display is shown to notify you when the vehicle reaches a position where assist control can be used to begin backing up from, and then when the shift position is changed according to guidance provided by the system, steering wheel auto operation begins.

If the detected parking space or road width (distance to the side of the road across from the parking space) is narrow, or if there are obstacles in front of the vehicle, guidance will not be issued.

- ④ Parking is complete

This completes the assist mode. Depending on the condition of the parking space, guidance to starting points for moving forward and backing up, as well as the steering wheel auto operation, are repeated any time multi-turn maneuvering is necessary following step ③ from the time the vehicle begins backing up until parking completes.

■ Parking

- 1 Stop so that the center of the target parking spot appears nearly perpendicular to vehicle. Then press the S-APGS switch 1 time and check that the display on the multi-information display switches to “Parallel Parking”.
- The mode switches each time the S-APGS switch is pressed.
(→P. 470)
 - When the vehicle speed is approximately 19 mph (30 km/h) or higher, pressing the S-APGS switch will not cause the screen to switch to the “Parallel Parking” display.

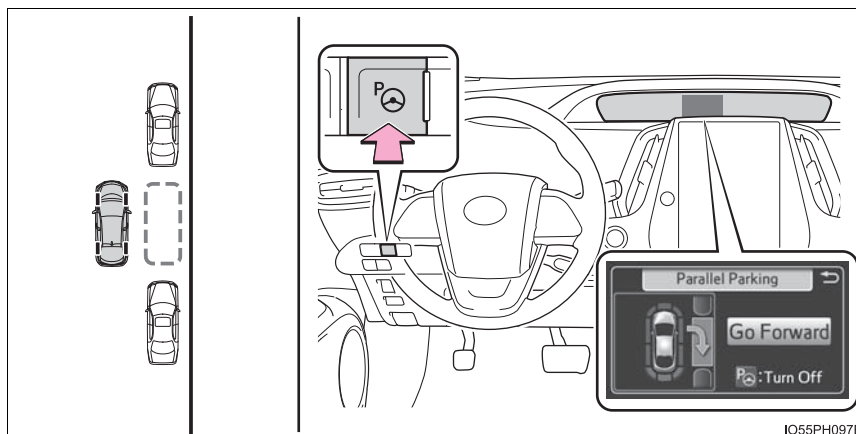

- 2 Travel straight ahead parallel with the road (or curb), and maintain a gap of approximately 3.3 ft. (1 m) from any parked vehicles.

- Proceed slowly.
- The system will begin searching for a parking space.
- While searching for a space, the turn signal lever (→P. 351) can be operated to select a parking space on the left or right.
- When stopping the function, press the S-APGS switch once to turn the function off.
- When a parking space is detected, the screen will change.

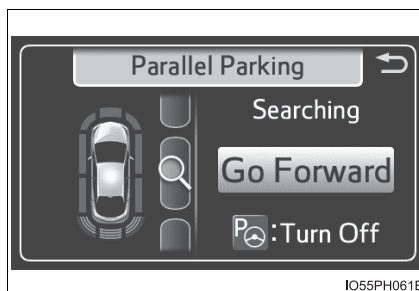
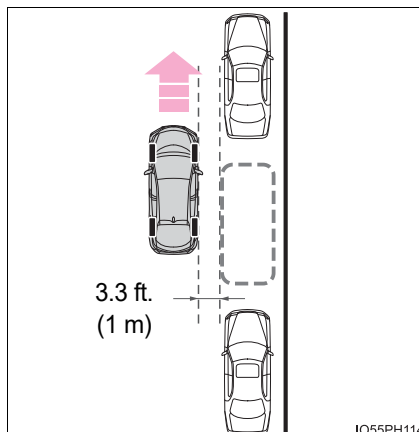

- 3 When a beep sounds once and the stop display (→P. 471) is shown on the display, stop the vehicle.

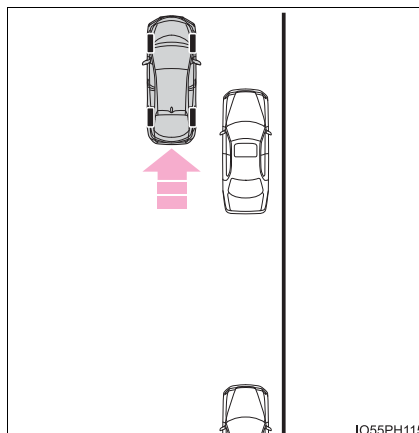

- 4 When the shift position is changed to R, a high-pitched beep is emitted and assist control will start.
- When the steering wheel auto operation starts, the steering wheel auto operation display (→P. 471) and assistance level indicator (→P. 471) will be shown in the display area.
 - To stop assist control, press the S-APGS switch.
- 5 Assume an ordinary posture for backing up, rest your hands lightly on the steering wheel without applying any force, directly confirm the safety of the area to the rear and around the vehicle, confirm that there are no obstacles in the parking space, and slowly back up while adjusting your speed by depressing the brake pedal.
- When backing up too quickly, a sharp beeping sound is emitted and assist control is stopped. (→P. 494)
 - When the vehicle cannot be cleanly entered within the target parking spot on the first try and multi-turn maneuvering is necessary, proceed to step 6.
- When multi-turn maneuvering is not necessary, proceed to step 12.

- 6 When a beep sounds once and the stop display (→P. 471) is shown on the display, stop the vehicle.

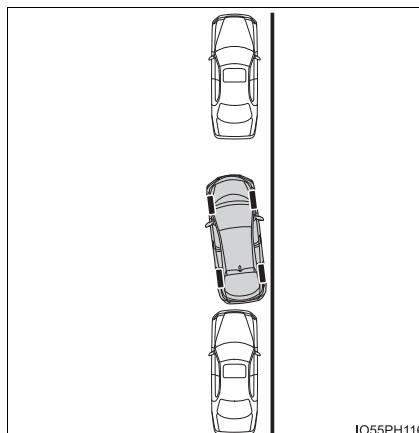

- 7 Change the shift position to D.
- 8 Assume an ordinary driving posture, rest your hands lightly on the steering wheel without applying any force, directly confirm the safety of the area to the front and around the vehicle and slowly proceed forward while adjusting your speed by depressing the brake pedal.
- 9 When a beep sounds once and the stop display (→P. 471) is shown on the display, stop the vehicle.
- 10 Change the shift position to R.
- 11 Assume an ordinary posture for backing up, rest your hands lightly on the steering wheel without applying any force, directly confirm the safety of the area to the rear and around the vehicle and slowly back up while adjusting your speed by depressing the brake pedal.

Depending on the condition of the parking space, steps 6 to 11 may need to be repeated.

12 When the vehicle is almost entirely within the target parking spot, a high-pitched beep is emitted and the stop display is shown on the display, stop the vehicle.

This completes the parallel parking assist mode.

- After stopping, feel free to maneuver the vehicle to reach the desired parking spot.
- Be sure to back up while checking the area to the front and rear of the vehicle directly and by using the mirrors.

■ Parallel parking assist mode operating conditions

- In order to operate the parallel parking assist mode correctly, drive slowly (at a speed at which the vehicle can be quickly stopped) parallel to the road (or shoulder) while maintaining a distance of approximately 3.3 ft. (1 m) to any parked vehicles.
- The function cannot be used when the vehicle speed is approximately 19 mph (30 km/h) or higher.
- The front side sensors and rear side sensors are used to detect parked vehicles and determine the parking spot. Therefore, when detection is not possible (→P. 500), guidance is not issued.
- If there are no parked vehicles, the parking spot cannot be determined. Therefore, the parallel parking assist mode cannot be operated.
- If unable to detect the environment surrounding the parking space, the parallel parking assist mode may not be able to operate.
- Guidance will continue until the vehicle speed meets or exceeds approximately 19 mph (30 km/h) or the function is turned off using the S-APGS switch.

■ Timing for pressing the S-APGS switch

In the following cases, the assist mode may also operate during the steps taken to park using the parallel parking assist mode. However, in these cases, conduct parking procedures according to the information on the multi-information display.

- In step 1 the S-APGS switch is pressed after already passing over the target parking spot.
If the vehicle is not stopped in step 1, pressing the S-APGS switch 1 time while the vehicle is in motion allows you to select "Parallel Parking" and proceed directly to step 2.
- The vehicle is moved up to the position in step 3 without the S-APGS switch being pressed. Then the S-APGS switch is pressed after having changed the shift position to R.

 NOTICE

- If the road surface has any dips or inclines, the target parking spot cannot be correctly set. Therefore, the vehicle may be parked at an angle or may deviate from the parking spot. In these cases, do not use the parallel parking assist mode.

- When the other parked vehicle is narrow or parked extremely close to the curb, assist control will also guide the vehicle to a position close to the curb. If it seems the vehicle may make contact with the curb or any other obstacles, or if it seems the tire position will deviate from the intended parking spot, stop the vehicle by depressing the brake pedal, and then press the S-APGS switch to turn off the system.

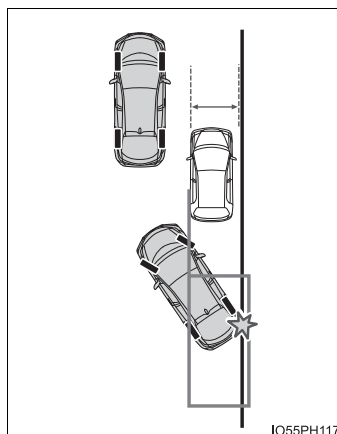

- When there is a wall or other obstacle on the inner side of the parking space, or when another parked vehicle extends into the road from its parking spot, the target parking spot may be set in a position that juts out slightly into the road.

- Depending on the surrounding environment, such as other parked vehicles, the vehicle may be parked at an angle or may deviate from the parking spot. Manually adjust vehicle alignment as necessary.

- The system provides assistance to guide the vehicle based on position of adjacent vehicles, even if there are obstacles, bumps, drops or curb stones in the parking space.

If it seems the vehicle may make contact, stop the vehicle by depressing the brake pedal, and then press the S-APGS switch to turn off the system.

- It may not be possible to detect objects that are low to the ground. Directly confirm the safety of your surroundings and, if it seems the vehicle may make contact with an obstacle, stop the vehicle by depressing the brake pedal.

How to depart from a parallel parking position (exit parallel parking assist mode)

■ Function summary

When departing from a parallel parking position, select the direction you would like to depart in, and steering wheel operation assist control will be provided to guide the vehicle to a position from which you can take off.

- ① With the shift position in P, press the S-APGS switch, select exit parallel parking assist mode, and then operate the turn signal lever to select the desired departure direction.
- ② Steering wheel auto operation starts when the shift position is changed according to guidance provided by the system.
- ③ A sound is issued and a display is shown to notify you when the vehicle reaches a position from which you can take off.

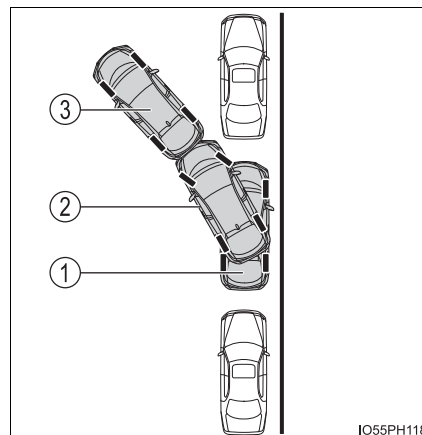

Depending on the condition of the parking space, guidance to starting points for moving forward and backing up, as well as the steering wheel auto operation, are repeated any time multi-turn maneuvering is necessary from the time the steering wheel auto operation begins in step ② up until the vehicle reaches a position from which it can take off.

■ Using the exit parallel parking assist mode to depart

- 1 With the shift position in P, press the S-APGS switch and check that the display on the multi-information display switches to “Exit Parallel Parking”.

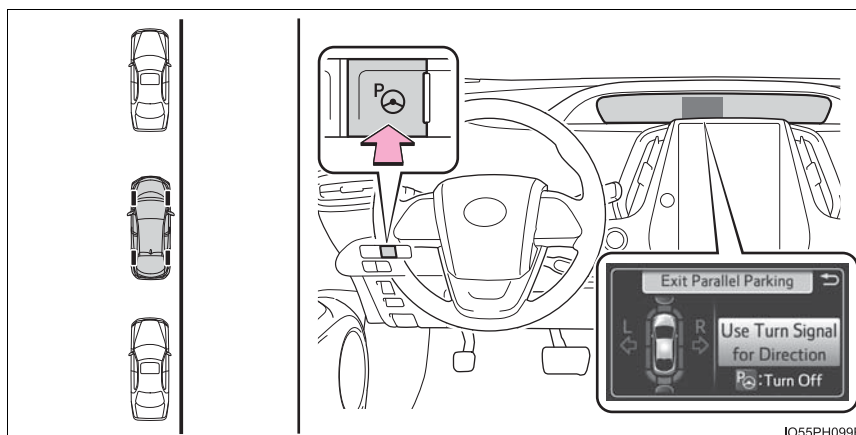

- 2 Operate the turn signal lever (→P. 351) to select whether you would like to depart to the left or right.

If there are any obstacles in the direction the vehicle is departing in, the system determines that it is not possible to depart, and assist control is stopped.

- 3 When the shift position is changed to R (or D) according to the advice display on the screen (→P. 471), a high-pitched beep is emitted and assist control will start.

Step 4 and onward is for cases in which the advice display shows “Shift to [R]” after operating the turn signal lever to select a departure direction.

- When the steering wheel auto operation starts, the steering wheel auto operation display (→P. 471) and assistance level indicator (→P. 471) will be shown in the display area.
- To stop assist control, press the S-APGS switch.

- 4 Assume an ordinary posture for backing up, rest your hands lightly on the steering wheel without applying any force, directly confirm the safety of the area to the rear and around the vehicle and slowly back up while adjusting your speed by depressing the brake pedal.

- When backing up too quickly, a sharp beeping sound is emitted and assist control is stopped. (→P. 494)

- 5 When a beep sounds once and the stop display (→P. 471) is shown on the display, stop the vehicle.

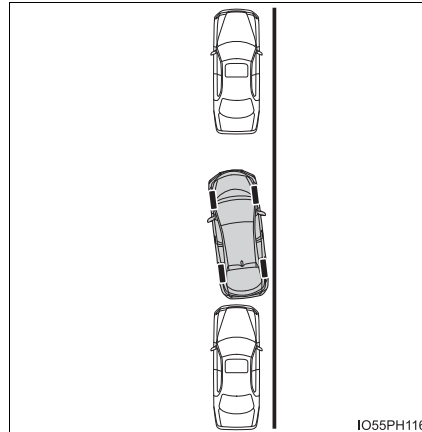

- 6 Change the shift position to D.
- 7 Assume an ordinary driving posture, rest your hands lightly on the steering wheel without applying any force, directly confirm the safety of the area to the front and around the vehicle and slowly proceed forward while adjusting your speed by depressing the brake pedal.
- When departure cannot be accomplished on the first try and multi-turn maneuvering is necessary, proceed to step 8.
 - When multi-turn maneuvering is not necessary, proceed to step 14 (→P. 484).

- 8 When a beep sounds once and the stop display (→P. 471) is shown on the display, stop the vehicle.

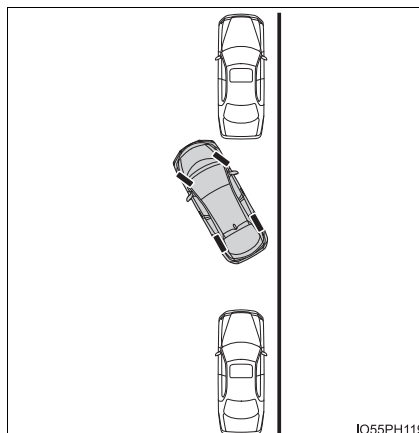

- 9 Change the shift position to R.
- 10 Assume an ordinary posture for backing up, rest your hands lightly on the steering wheel without applying any force, directly confirm the safety of the area to the rear and around the vehicle and slowly back up while adjusting your speed by depressing the brake pedal.

Depending on the condition of the parking space, steps 5 to 10 may need to be repeated.

- 11 When a beep sounds once and the stop display (→P. 471) is shown on the display, stop the vehicle.

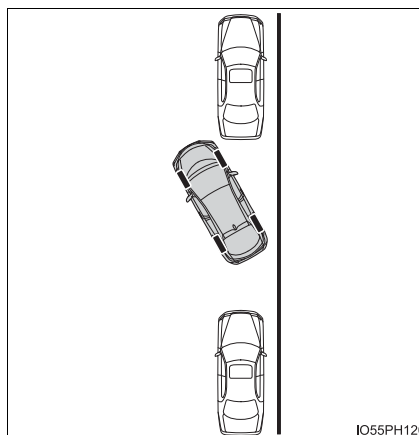

- 12 Change the shift position to D.

13 Assume an ordinary driving posture, rest your hands lightly on the steering wheel without applying any force, directly confirm the safety of the area to the front and around the vehicle and slowly proceed forward while adjusting your speed by depressing the brake pedal.

14 When the vehicle has nearly reached the take-off point, a high-pitched beep is emitted and assist control finishes. From there, grasp the steering wheel and proceed forward.

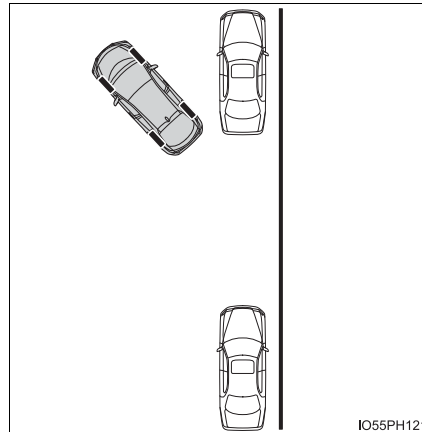

■ Exit parallel parking assist mode

- During assist control, if the driver determines that they are at a position where take-off is possible and operates the steering wheel, assist control is stopped at that position.
- Assist control cannot be used if there are no parked vehicles ahead, or if the gap between the front of your vehicle and the vehicle parked ahead is too large.
- When using the exit parallel parking assist mode, the assist mode may not be able to operate depending on the surrounding environment.

⚠ NOTICE

- The detection range of the sensors (→P. 449) is limited. Directly confirm the safety of your surroundings, and if there is a possibility of a contact accident, stop the vehicle by depressing the brake pedal.
- It may not be possible to detect objects that are low to the ground. Directly confirm the safety of your surroundings and, if it seems the vehicle may make contact with an obstacle, stop the vehicle by depressing the brake pedal.
- When departing for a position from which you can take off, directly confirm the safety of your surroundings.

How to park next to other vehicles (back-in parking assist mode)**■ Function summary**

Stop so that the center of the target parking spot appears nearly perpendicular to the vehicle. If the space is detectable, the forward guidance function can be used. Furthermore, depending on the parking space and other conditions, multi-turn maneuvering assist control is also provided if necessary.

- ① Stop so that the center of the target parking spot appears nearly perpendicular to the vehicle. Then press the S-APGS switch 2 times to select back-in parking assist mode.
- ② Steering wheel auto operation starts when the vehicle begins to move.
- ③ A sound is issued and a display is shown to notify you when the vehicle reaches the position to start backing up from.

If the detected parking space or road width (distance to the side of the road across from the parking space) is narrow, or if there are obstacles in front of the vehicle, guidance will not be issued.

- ④ Parking is complete

This completes the assist mode.

Depending on the condition of the parking space, guidance to starting points for moving forward and backing up, as well as the steering wheel auto operation, are repeated any time multi-turn maneuvering is necessary following step ③ from the time the vehicle begins backing up until parking completes.

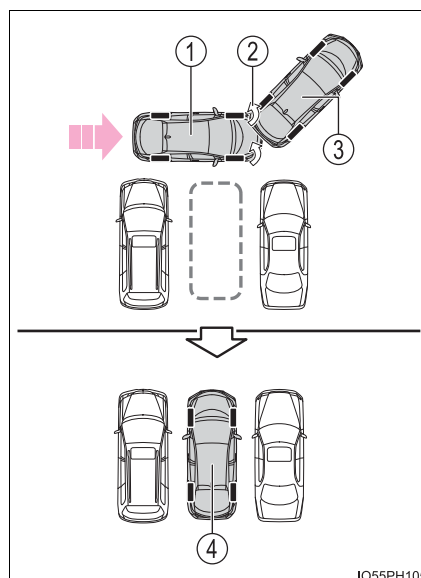

■ Parking

1 Stop so that the center of the target parking spot appears nearly perpendicular to vehicle. Then press the S-APGS switch 2 times and check that the display on the multi-information display switches to “Back-in Parking”.

- Visually check the area in the direction of the arrow indicating the direction of the steering wheel auto operation and the target parking spot on the display.
- The mode switches each time the S-APGS switch is pressed. (→P. 470)
- When the shift position is not in D or B, the screen will not switch to the “Back-in Parking” display.
- When the vehicle speed has been detected, the screen switches to the “Parallel Parking” display. To switch the screen to the “Back-in Parking” display, stop the vehicle completely and press the S-APGS switch again.
- The turn signal lever (→P. 351) can be operated to select whether you would like to park to the left or right.
- The system cannot be used when the parking space is narrow or there is not a sufficient enough area for assist control to operate. Please refer to the information shown on the multi-information display to use a different parking space.

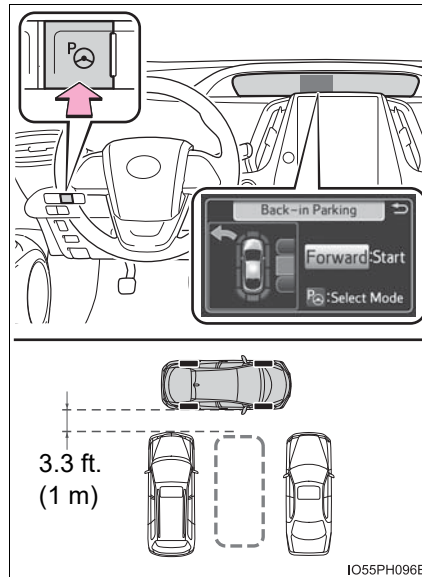

- 2 Assume an ordinary driving posture, rest your hands lightly on the steering wheel without applying any force, directly confirm the safety of the area to the front and around the vehicle and slowly proceed forward while adjusting your speed by depressing the brake pedal. When this is done, a high-pitched beep is emitted and an indicator on the meter illuminates at the same time, after which assist control will start.

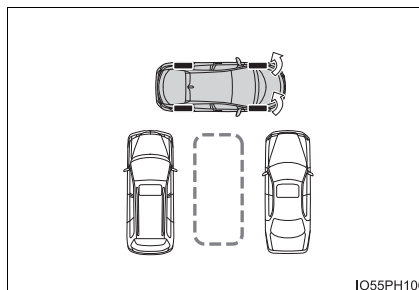

- When the steering wheel auto operation starts, the steering wheel auto operation display (→P. 471) and assistance level indicator (→P. 471) will be shown in the display area.
- To stop assist control, press the S-APGS switch.
- When the vehicle speed is too high, a sharp beeping sound is emitted and assist control is stopped. (→P. 494)
- If the space turns out to be too narrow after assist control starts, a sharp beeping sound is emitted and assist control is stopped.

- 3 When a beep sounds once and the stop display (→P. 471) is shown on the display, stop the vehicle.

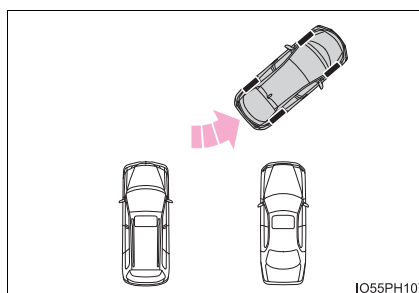

- 4 Change the shift position to R.

- 5 Assume an ordinary posture for backing up, rest your hands lightly on the steering wheel without applying any force, directly confirm the safety of the area to the rear and around the vehicle, confirm that there are no obstacles in the parking space, and slowly back up while adjusting your speed by depressing the brake pedal.
- When the vehicle cannot be cleanly entered within the target parking spot on the first try and multi-turn maneuvering is necessary, proceed to step 6.
 - When multi-turn maneuvering is not necessary, proceed to step 12. (→P. 489)

- 6 When a beep sounds once and the stop display (→P. 471) is shown on the display, stop the vehicle.

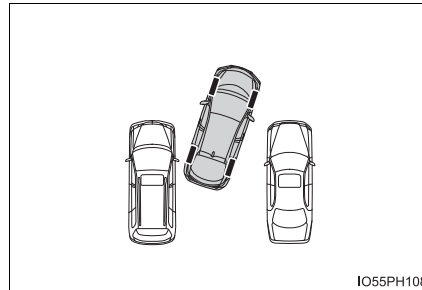

- 7 Change the shift position to D.
When you would like to end assist control at your current position, change the shift position to P.
- 8 Assume an ordinary driving posture, rest your hands lightly on the steering wheel without applying any force, directly confirm the safety of the area to the front and around the vehicle and slowly proceed forward while adjusting your speed by depressing the brake pedal.

- 9 When a beep sounds once and the stop display (→P. 471) is shown on the display, stop the vehicle.

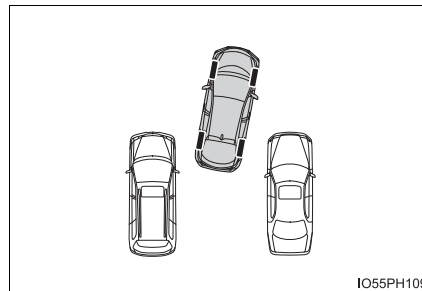

- 10 Change the shift position to R.

- 11 Assume an ordinary posture for backing up, rest your hands lightly on the steering wheel without applying any force, directly confirm the safety of the area to the rear and around the vehicle slowly back up while adjusting your speed by depressing the brake pedal.

Depending on the condition of the parking space, steps 6 to 11 may need to be repeated.

- 12 When the vehicle is almost entirely within the target parking spot, a high-pitched beep is emitted and the stop display is shown on the display (→P. 471), stop the vehicle.

This completes the back-in parking assist mode.

- For safety, the buzzer sounds slightly before the vehicle is completely entered within the target parking spot. Furthermore, at that point, system operation will also finish. Firmly hold the steering wheel and slowly back up while adjusting your speed by depressing the brake pedal to reach the desired parking spot.
- Be sure to back up while checking the area to the front and rear of the vehicle directly and by using the mirrors.

■ Back-in parking assist mode operating conditions

- In order to operate the function correctly, drive slowly (at a speed at which the vehicle can be quickly stopped).
- In order to operate the function correctly, drive slowly (at a speed at which the vehicle can be quickly stopped). Come to a full stop so that the center of the parking space is nearly perpendicular to the vehicle, and then operate the S-APGS switch.
- The function cannot be used when the vehicle speed is approximately 19 mph (30 km/h) or higher.
- The front side sensors and rear side sensors are used to detect parked vehicles and determine the parking spot. Therefore, when detection is not possible (→P. 500), guidance is not issued.
- If there are no parked vehicles, the parking spot cannot be determined. Therefore, the back-in parking assist mode cannot be operated.
- If unable to detect the environment surrounding the parking space, the back-in parking assist mode may not be able to operate.

- Depending on the condition of the parking space, if there is not enough space in front of the vehicle required to perform the parking operation, the target parking spot may not be reachable.

- ① Intended parking spot
- ② Wall

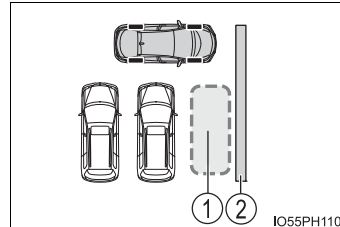

■ **Tips for using the back-in parking assist mode**

- Leave a gap of approximately 3.3 ft. (1 m) from any parked vehicles and approach the target parking spot. If the gap between your vehicle and any parked vehicles is too large, the front side sensors and rear side sensors may not be able to detect the parked vehicles.

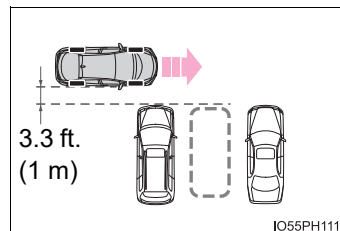

- Stop so that the center of the target parking spot is perpendicular to the vehicle. Furthermore, only push the S-APGS switch when the vehicle is at a complete stop.

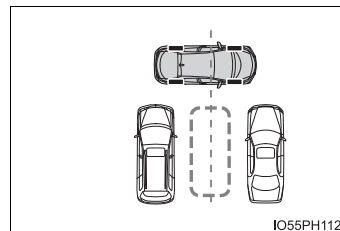





⚠ NOTICE





- If the road surface has any dips or inclines, the target parking spot cannot be correctly set. Therefore, the vehicle may be parked at an angle or may deviate from the parking spot. In these cases, do not use the back-in parking assist mode.
- When parking in a narrow space, the vehicle will come close to adjacent vehicles. If it seems the vehicle may make contact, stop the vehicle by depressing the brake pedal.
- It may not be possible to detect objects that are low to the ground. Directly confirm the safety of your surroundings and, if it seems the vehicle may make contact with an obstacle, stop the vehicle by depressing the brake pedal.
- Depending on the surrounding environment, such as other parked vehicles, the vehicle may be parked at an angle or may deviate from the parking spot. Manually adjust vehicle alignment as necessary.

Multi-information display messages

When the Simple Advanced Parking Guidance System cannot be operated, or when operation is stopped, canceled, etc., the one of the following message is displayed on the multi-information display. Take appropriate action according to the display.



■ **When it is not possible to operate**

Message	Situation/Handling method
	<p>The system may be malfunctioning. → Turn the power switch off and then start the hybrid system. Have the vehicle inspected by your Toyota dealer if the message is displayed again.</p>
	<p>There may be a system failure.</p>
	<p>Power steering equipment is temporarily overheating. → Turn the power switch off, wait for a little while, and then start the hybrid system again.</p>
	<p>The hybrid system is not operating. → Start the hybrid system.</p>
	<p>Ice, snow, dirt, etc., has adhered to the sensor. → Remove any ice, snow, dirt, etc.</p>
	<p>The sensor is frozen. → Once the sensor thaws, the system will return to normal.</p>
	<p>The 12-volt battery has been removed and reinstalled. → Drive the vehicle straight ahead for 5 seconds or more at a speed of approximately 22 mph (35 km/h) or higher.</p>
	<p>The S-APGS switch is operated when the vehicle speed exceeds 19 mph (30 km/h). → Operate the switch when the vehicle speed is approximately 19 mph (30 km/h) or less.</p>
	<p>Assist control is started while the steering wheel is held. → Rest your hands on the steering wheel without applying any force. Assist control will start.</p>

Message	Situation/Handling method
	<p>The vehicle is moved and assist control is started while the steering wheel is held.</p> <p>→ Stop the vehicle and follow the guidance provided by the system to start assist control.</p>
	<p>The S-APGS switch is operated when there is not enough space to the front and rear of the vehicle when departing from a parallel parking spot.</p> <p>→ The vehicle cannot depart using assist control as there is not enough space to the front and rear of the vehicle. Confirm the safety of your surroundings before departing.</p>
	<p>The S-APGS switch is operated in an area where there are no obstacles to the front of the vehicle, or there are obstacles to the sides and the vehicle cannot depart from the parallel parking spot.</p> <p>→ Assist control cannot be used for departure, as there are obstacles to the sides of the vehicle or departure can easily be performed manually. Confirm the safety of your surroundings before departing.</p>
	<p>The S-APGS switch is operated in an area with no parking spaces, or operated in an area where the road width for parking is narrow.</p> <p>→ Assist control cannot be used, as there is no parking space. Proceed to a parking space which width is approximately 8.5 ft. (2.6 m) or larger.</p> <p>→ Assist control cannot be used, as the road width is narrow. Proceed to a parking space where the road width is approximately 15 ft. (4.5 m) or larger.</p>
	<p>The S-APGS switch is operated at a space that is too narrow for the vehicle to park in.</p> <p>→ Assist control cannot be used, as there is no parking space. Proceed to a parking space that is approximately 8.5 ft. (2.6 m) or larger.</p>

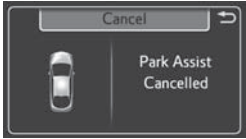
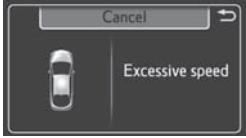
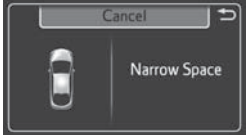
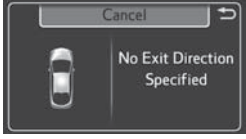

Message	Situation/Handling method
	<p>The S-APGS switch is operated in an area where there are obstacles to the front, and the vehicle cannot move forward to the starting point for backing up.</p> <p>→ Assist control cannot be used, as there are obstacles in front of the vehicle. Use parking spaces that have no obstacles in front of them.</p>

■ When the operation is canceled

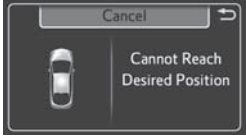
Message	Situation/Handling method
	<p>While assist control is operating, the driver changes the shift position to P or operates the S-APGS switch.</p>
	<p>The vehicle speed exceeds 19 mph (30 km/h) when searching for a parallel parking assist mode space.</p>
	<p>Assist control is started in an area with narrow parking spaces.</p>
	<p>The shift position is changed without having used the turn signal lever to select a departure direction when using the exit parallel parking assist mode.</p> <p>→ Follow the guidance provided by the system.</p>
	<p>When assist control starts, the vehicle proceeds in a direction opposite to the guidance.</p> <p>→ Follow the guidance provided by the system to proceed forward.</p>

Message	Situation/Handling method
	<p>The maximum number of movements for multi-turn maneuvering is reached during assist control, or the target parking spot cannot be reached due to the control being used on a road with steep grade.</p> <p>→ Follow the assist control guidance and use the system in a wide space that does not have a steep grade.</p>

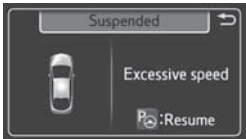
■ When the operation is suspended

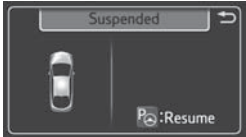
Message	Situation/Handling method	
	<p>The driver holds the steering wheel during assist control.</p>	<p>→ Stop the vehicle and rest your hands on the steering wheel without applying any force. Then press the S-APGS switch to restart assist control.</p>
	<p>The vehicle speed exceeds 4 mph (7 km/h) during assist control.</p>	
	<p>The S-APGS switch is pressed while assist control is temporarily stopped and the steering wheel is firmly held.</p>	<p>→ Rest your hands on the steering wheel without applying any force. Then stop the vehicle to restart assist control.</p>
	<p>The S-APGS switch is pressed while assist control is temporarily stopped and the vehicle is moving.</p>	
	<p>Assist control is temporarily stopped (able to be restarted)</p>	<p>→ Stop the vehicle and rest your hands on the steering wheel without applying any force. Then press the S-APGS switch to restart assist control.</p>

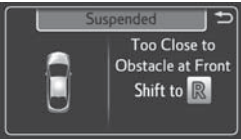
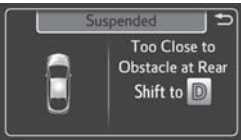
Message	Situation/Handling method	
	<p>The vehicle moved too close to an obstacle in front of the vehicle.</p>	<p>→ Press the S-APGS switch after changing the shift position to R to restart assist control.</p>
	<p>The vehicle moved too close to an obstacle to the rear of the vehicle.</p>	<p>→ Press the S-APGS switch after changing the shift position to D to restart assist control.</p>

Precautions during use

■ Sensors

Detect the vehicle to help determine the parking spot.

- ① Front side sensors
- ② Rear side sensors

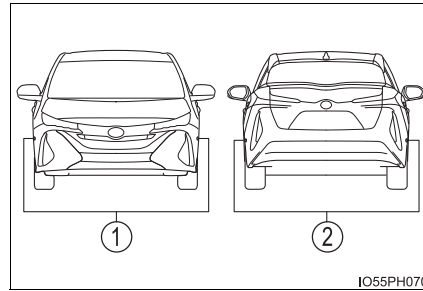

● The sensor detection range when using back-in parking assist mode

- ① Intended parking spot

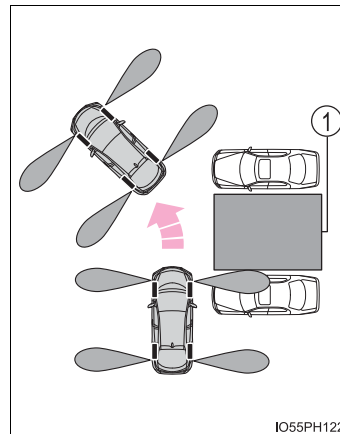

● The sensor detection range when using parallel parking assist mode

- ① Intended parking spot

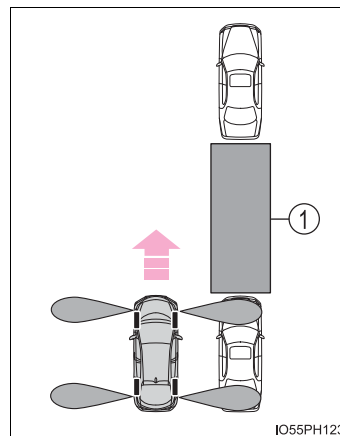

- When there is a parked vehicle behind the target parking spot, it may not be detected due to the distance. Also, depending on the shape of the vehicle and other conditions, the detectable range may shorten or detection may not be possible.

- Objects other than parked vehicles, such as poles and walls, may not be detected. Also, even if these objects can be detected, the target parking spot may deviate.

- ① Poles
- ② Wall

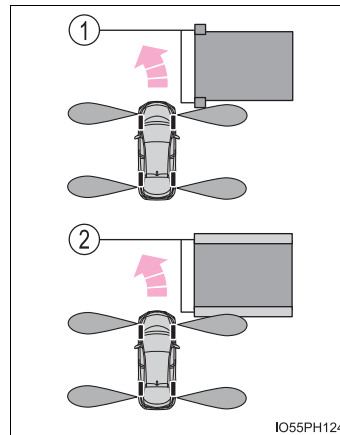

- Also, the target parking spot may deviate when a pedestrian, etc. is detected.

- ① Pedestrian

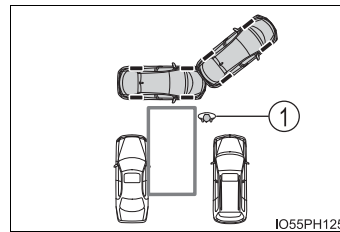

- The Simple Advanced Parking Guidance System may not operate if grating, diamond plates or similar materials are detected on the surface of the parking space.

 **WARNING**

- Do not rely solely upon the Simple Advanced Parking Guidance System. As with unequipped vehicles, move forward and back up carefully while directly confirming the safety of your surroundings and the area to the rear of the vehicle.
- Do not back up while viewing the multi-information display. Backing up while only viewing the monitor screen may cause a collision or lead to an accident, as the image displayed on the monitor screen may differ from actual conditions. Make sure to visually check the surrounding areas and the area to the rear of the vehicle with and without the mirror while backing up.
- Drive slowly while adjusting your speed by depressing the brake pedal when backing up or moving forward.
- If it seems the vehicle may make contact with a pedestrian, another vehicle or any other obstacles, stop the vehicle by depressing the brake pedal, and then press the S-APGS switch to turn off the system.
- Use the system in a parking lot with a flat surface.
- Observe the following precautions, as the steering wheel automatically turns during use.
 - There is risk of a necktie, scarf, your arm, etc. being caught on the steering wheel. Please do not allow your upper body to be close to the steering wheel. Also, do not allow children close to the steering wheel.
 - There is a possibility of injury when the steering wheel turns if you have long fingernails.
 - In case of emergency, stop the vehicle by depressing the brake pedal, and then press the S-APGS switch to turn off the system.
- Always confirm that there is appropriate space before attempting to park the vehicle and operate the system.

 **WARNING**

- Do not use the system in the following situations, as the system may be unable to correctly assist you in reaching the target parking spot and may lead to an unexpected accident.
 - In an area that is not a parking lot
 - A parking lot that is not paved and has no parking space lines, such as a sand or gravel parking lot
 - A parking lot that has a slope or undulations in the road
 - A frozen, snow-covered or slippery road
 - The asphalt is melting due to hot weather
 - There is an obstacle between the vehicle and the target parking spot
 - Using tire chains
- Do not use tire other than that provided by the manufacturer. The system may not operate properly. When replacing tires, contact your Toyota dealer.
- The system may not be able position the vehicle in the set location in the following situations.
 - The tires are extremely worn or the tire pressure is low
 - The vehicle is carrying very heavy load
 - The vehicle is tilted due to having luggage, etc. located on one side of the vehicle
 - There are road heaters installed in the parking lot to prevent the road surface from freezing.In any other situations when the set position and vehicle position greatly differ, have the vehicle inspected by your Toyota dealer.
- Make sure to observe the following precautions regarding the exit parallel parking assist mode.

Exit parallel parking assist mode is a function used when departing from a parallel parking spot. However, this function may not be usable if obstacles or people are detected in front of the vehicle. Only use this function when departing from a parallel parking spot. In the event that the steering control operates, either turn the system off using the S-APGS switch or operate the steering wheel to stop the control.
- If exit parallel parking assist mode is mistakenly used in the following situations, the vehicle may make contact with an obstacle.

The departure function is operated in a direction where an obstacle is present, but the obstacle is not detected by the side sensors (situations such as when the vehicle is directly beside a pole).

 **WARNING**

- Observe the following precautions, as the sensors may stop functioning properly which may lead to an accident.
 - Do not subject the sensor to strong shocks by hitting it, etc. The sensors may not function properly.
 - When using a high-pressure washer to wash the vehicle, do not spray water directly on the sensors. Equipment may not function properly if subjected to an impact from strong water pressure. If the vehicle bumper strikes something, equipment may not operate properly due to a sensor malfunction. Have the vehicle inspected at your Toyota dealer.
- In the following situations, the sensors may not operate normally and may lead to an accident. Drive carefully.
 - Obstacles cannot be detected in the side areas until a scan of the side areas is completed. (→P. 450)
 - Even after the scan of the side areas is completed, obstacles such as other vehicles, people or animals that approach from the sides cannot be detected.
 - The sensor is frozen (if it thaws, the system returns to normal).
A warning message may display at particularly low temperatures due to the sensor freezing and it may not detect parked vehicles.
 - The sensor is blocked by someone's hand.
 - The vehicle is tilted a large amount.
 - The temperature is extremely hot or cold.
 - The vehicle is driven on undulating roads, slopes, gravel roads, in areas with tall grass, etc.
 - An ultrasonic wave source is nearby, such as the horn or sensors of another vehicle, a motorcycle engine or the air brake of a large vehicle.
 - Heavy rain or a water strikes the vehicle.
 - The angle of the sensor may be deviated when assist control starts even if there is a parked vehicle in the target parking spot. Have the vehicle inspected at your Toyota dealer.
 - Do not install any accessories within the sensor detection range.

Driving assist systems

To keep driving safety and performance, the following systems operate automatically in response to various driving situations. Be aware, however, that these systems are supplementary and should not be relied upon too heavily when operating the vehicle.

◆ ECB (Electronically Controlled Brake System)

The electronically controlled system generates braking force corresponding to the brake operation

◆ ABS (Anti-lock Brake System)

Helps to prevent wheel lock when the brakes are applied suddenly, or if the brakes are applied while driving on a slippery road surface

◆ Brake assist

Generates an increased level of braking force after the brake pedal is depressed when the system detects a panic stop situation

◆ VSC (Vehicle Stability Control)

Helps the driver to control skidding when swerving suddenly or turning on slippery road surfaces.

◆ Enhanced VSC (Enhanced Vehicle Stability Control)

Provides cooperative control of the ABS, TRAC, VSC and EPS.

Helps to maintain directional stability when swerving on slippery road surfaces by controlling steering performance.

◆ TRAC (Traction Control)

Helps to maintain drive power and prevent the drive wheels from spinning when starting the vehicle or accelerating on slippery roads

◆ **Hill-start assist control**

Helps to reduce the backward movement of the vehicle when starting on an uphill

◆ **EPS (Electric Power Steering)**

Employs an electric motor to reduce the amount of effort needed to turn the steering wheel.

When the TRAC/VSC/ABS systems are operating

The slip indicator light will flash while the TRAC/VSC/ABS systems are operating.

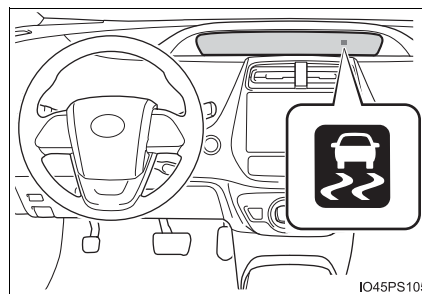

Disabling the TRAC system

If the vehicle gets stuck in mud, dirt or snow, the TRAC system may reduce power from the hybrid system to the wheels. Pressing  to turn the system off may make it easier for you to rock the vehicle in order to free it.

To turn the TRAC system off, quickly press and release .

The “Traction Control Turned Off” will be shown on the multi-information display.

Press  again to turn the system back on.

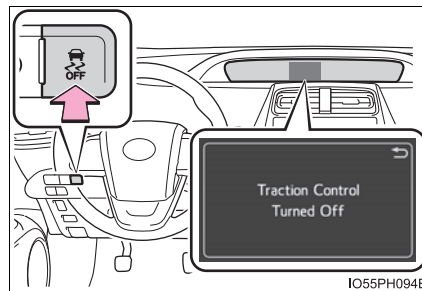

■ Turning off both TRAC and VSC systems

To turn the TRAC and VSC systems off, press and hold  for more than 3 seconds while the vehicle is stopped.

The VSC OFF indicator will come on and the "Traction Control Turned Off" will be shown on the multi-information display.*

Press  again to turn the systems back on.

*: Pre-collision brake assist and pre-collision braking will also be disabled. The PCS warning light will come on and the message will be shown on the multi-information display. (→P. 675)

■ When the message is displayed on the multi-information display showing that TRAC has been disabled even if has not been pressed

TRAC is temporary deactivated. If the information continues to show, contact your Toyota dealer.

■ Operating conditions of hill-start assist control

When the following four conditions are met, the hill-start assist control will operate:

- The shift position is in a position other than P or N (when starting off forward/backward on an upward incline)
- The vehicle is stopped
- The accelerator pedal is not depressed
- The parking brake is not engaged

■ Automatic system cancelation of hill-start assist control

The hill-start assist control will turn off in any of the following situations:

- Shift the shift position to P or N
- The accelerator pedal is depressed
- The parking brake is engaged
- No more than 2 seconds have elapsed after the brake pedal is released.

■ Sounds and vibrations caused by the ABS, brake assist, VSC, TRAC and hill-start assist control systems

- A sound may be heard from the engine compartment when the brake pedal is depressed repeatedly, when the hybrid system is started or just after the vehicle begins to move. This sound does not indicate that a malfunction has occurred in any of these systems.
- Any of the following conditions may occur when the above systems are operating. None of these indicates that a malfunction has occurred.
 - Vibrations may be felt through the vehicle body and steering.
 - A motor sound may be heard also after the vehicle comes to a stop.

■ ECB operating sound

ECB operating sound may be heard in the following cases, but it does not indicate that a malfunction has occurred.

- Operating sound heard from the engine compartment when the brake pedal is operated.
- Motor sound of the brake system heard from the front part of the vehicle when the driver's door is opened.
- Operating sound heard from the engine compartment when one or two minutes passed after the stop of the hybrid system.

■ EPS operation sound

When the steering wheel is operated, a motor sound (whirring sound) may be heard. This does not indicate a malfunction.

■ Automatic reactivation of TRAC and VSC systems

After turning the TRAC and VSC systems off, the systems will be automatically re-enabled in the following situations:

- When the power switch is turned off
- If only the TRAC system is turned off, the TRAC will turn on when vehicle speed increases

If both the TRAC and VSC systems are turned off, automatic re-enabling will not occur when vehicle speed increases.

■ Reduced effectiveness of the EPS system

The effectiveness of the EPS system is reduced to prevent the system from overheating when there is frequent steering input over an extended period of time. The steering wheel may feel heavy as a result. Should this occur, refrain from excessive steering input or stop the vehicle and turn the hybrid system off. The EPS system should return to normal within 10 minutes.

■ Electric power steering system warning light (warning buzzer)

→P. 675

 **WARNING****■ The ABS does not operate effectively when**

- The limits of tire gripping performance have been exceeded (such as excessively worn tires on a snow covered road).
- The vehicle hydroplanes while driving at high speed on wet or slick roads.

■ Stopping distance when the ABS is operating may exceed that of normal conditions

The ABS is not designed to shorten the vehicle's stopping distance. Always maintain a safe distance from the vehicle in front of you, especially in the following situations:

- When driving on dirt, gravel or snow-covered roads
- When driving with tire chains
- When driving over bumps in the road
- When driving over roads with potholes or uneven surfaces

■ TRAC/VSC may not operate effectively when

Directional control and power may not be achievable while driving on slippery road surfaces, even if the TRAC/VSC system is operating. Drive the vehicle carefully in conditions where stability and power may be lost.

■ Hill-start assist control does not operate effectively when

- Do not overly rely on hill-start assist control. Hill-start assist control may not operate effectively on steep inclines and roads covered with ice.
- Unlike the parking brake, hill-start assist control is not intended to hold the vehicle stationary for an extended period of time. Do not attempt to use hill-start assist control to hold the vehicle on an incline, as doing so may lead to an accident.

■ When the TRAC/ABS/VSC is activated

The slip indicator light flashes. Always drive carefully. Reckless driving may cause an accident. Exercise particular care when the indicator light flashes.

**WARNING****■ When the TRAC/VSC systems are turned off**

Be especially careful and drive at a speed appropriate to the road conditions. As these are the systems to help ensure vehicle stability and driving force, do not turn the TRAC/VSC systems off unless necessary.

■ Replacing tires

Make sure that all tires are of the specified size, brand, tread pattern and total load capacity. In addition, make sure that the tires are inflated to the recommended tire inflation pressure level.

The ABS, TRAC and VSC systems will not function correctly if different tires are installed on the vehicle.

Contact your Toyota dealer for further information when replacing tires or wheels.

■ Handling of tires and the suspension

Using tires with any kind of problem or modifying the suspension will affect the driving assist systems, and may cause a system to malfunction.

Winter driving tips

Carry out the necessary preparations and inspections before driving the vehicle in winter. Always drive the vehicle in a manner appropriate to the prevailing weather conditions.

Preparation for winter

- Use fluids that are appropriate to the prevailing outside temperatures.
 - Engine oil
 - Engine/power control unit coolant
 - Washer fluid
- Have a service technician inspect the condition of the 12-volt battery.
- Have the vehicle fitted with four snow tires or purchase a set of tire chains for the front tires.

Ensure that all tires are the same size and brand, and that chains match the size of the tires.

Before driving the vehicle

Perform the following according to the driving conditions:

- Do not try to forcibly open a window or move a wiper that is frozen. Pour warm water over the frozen area to melt the ice. Wipe away the water immediately to prevent it from freezing.
- To ensure proper operation of the climate control system fan, remove any snow that has accumulated on the air inlet vents in front of the windshield.
- Check for and remove any excess ice or snow that may have accumulated on the exterior lights, vehicle's roof, chassis, around the tires or on the brakes.
- Remove any snow or mud from the bottom of your shoes before getting in the vehicle.

When driving the vehicle

Accelerate the vehicle slowly, keep a safe distance between you and the vehicle ahead, and drive at a reduced speed suitable to road conditions.

When parking the vehicle

Park the vehicle and shift the shift position to P and block the wheel under the vehicle without setting the parking brake. The parking brake may freeze up, preventing it from being released. If the vehicle is parked without setting the parking brake, make sure to block the wheels.

Failure to do so may be dangerous because it may cause the vehicle to move unexpectedly, possibly leading to an accident.

Selecting tire chains

Use the correct tire chain size when mounting the tire chains. Chain size is regulated for each tire size.

Side chain

- ① 0.12 in. (3.0 mm)
- ② 1.18 in. (30.0 mm)
- ③ 0.39 in. (10.0 mm)

Cross chain

- ④ 0.16 in. (4.0 mm)
- ⑤ 0.98 in. (25.0 mm)
- ⑥ 0.55 in. (14.0 mm)

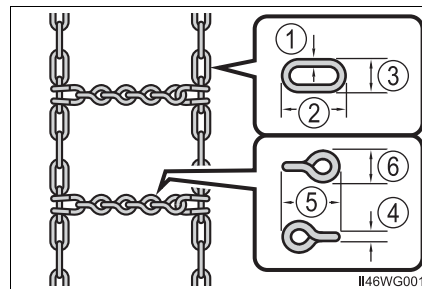

Regulations on the use of tire chains

Regulations regarding the use of tire chains vary depending on location and type of road. Always check local regulations before installing chains.

■ Tire chain installation

Observe the following precautions when installing and removing chains:

- Install and remove tire chains in a safe location.
- Install tire chains on the front tires only. Do not install tire chains on the rear tires.
- Install tire chains on front tires as tightly as possible. Retighten chains after driving 1/4 - 1/2 mile (0.5 - 1.0 km).
- Install tire chains following the instructions provided with the tire chains.

■ Consumption of fuel and electricity

In cold temperatures, resistance of the parts of a vehicle (transmission, tires, etc.) generally increases, resulting in increase of energy consumption. As a result, fuel economy is likely to decrease.

Consumption of fuel and electricity of this vehicle is also likely to become worse in cold temperatures.

 WARNING
<p>■ Driving with snow tires</p> <p>Observe the following precautions to reduce the risk of accidents. Failure to do so may result in a loss of vehicle control and cause death or serious injury.</p> <ul style="list-style-type: none"> ● Use tires of the specified size. ● Maintain the recommended level of air pressure. ● Do not drive in excess of 75 mph (120 km/h), regardless of the type of snow tires being used. ● Use snow tires on all, not just some wheels. <p>■ Driving with tire chains</p> <p>Observe the following precautions to reduce the risk of accidents. Failure to do so may result in the vehicle being unable to be driven safely, and may cause death or serious injury.</p> <ul style="list-style-type: none"> ● Do not drive in excess of the speed limit specified for the tire chains being used, or 30 mph (50 km/h), whichever is lower. ● Avoid driving on bumpy road surfaces or over potholes. ● Avoid sudden acceleration, abrupt steering, sudden braking and shifting operations that cause sudden engine braking. ● Slow down sufficiently before entering a curve to ensure that vehicle control is maintained. ● Do not use LTA (Lane Tracing Assist). <p>■ When parking the vehicle</p> <p>When parking the vehicle without applying the parking brake, make sure to chock the wheels. If you do not chock the wheels, the vehicle may move unexpectedly, possibly resulting in an accident.</p>

 NOTICE

■ **Repairing or replacing snow tires**

Request repairs or replacement of snow tires from Toyota dealers or legitimate tire retailers.

This is because the removal and attachment of snow tires affects the operation of the tire pressure warning valves and transmitters.

■ **Fitting tire chains**

The tire pressure warning valves and transmitters may not function correctly when tire chains are fitted.

Interior features

6

6-1. Using the air conditioning system and defogger

- Automatic air conditioning system (vehicles with 7-inch display)..... 512
- Automatic air conditioning system (vehicles with 11.6-inch display)..... 524
- Remote Air Conditioning System 535
- Heated steering wheel/ seat heaters 539

6-2. Using the interior lights

- Interior lights list 541
 - Front interior light..... 542
 - Front personal lights 542
 - Rear interior light 543

6-3. Using the storage features

- List of storage features 544
 - Glove box..... 545
 - Console box..... 545
 - Cup holders 546
 - Bottle holders/ door pockets 547
 - Auxiliary boxes..... 548
 - Seat back pockets 548
- Luggage compartment features 549

6-4. Using the other interior features

- Other interior features 553
 - Sun visors 553
 - Vanity mirrors..... 553
 - Power outlets 554
 - USB charging ports..... 555
 - Wireless charger 557
 - Armrest 566
 - Coat hooks..... 566
 - Assist grips 567
- Garage door opener..... 568

Automatic air conditioning system (vehicles with 7-inch display)

Air outlets and fan speed are automatically adjusted according to the temperature setting.

Air conditioning controls

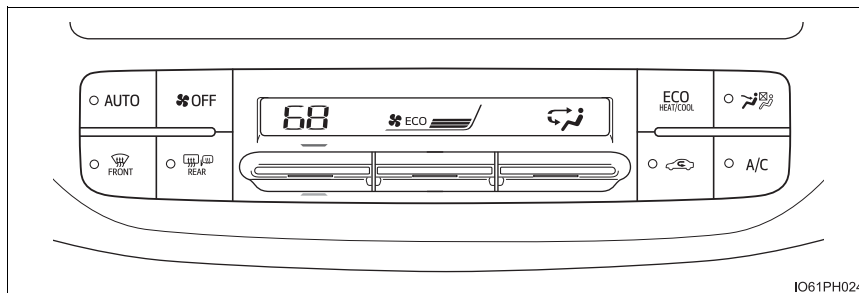

■ Adjusting the temperature setting

Move the temperature setting knob upwards to increase the temperature and downwards to decrease the temperature.

If  is not pressed, the system will blow ambient temperature air or heated air.

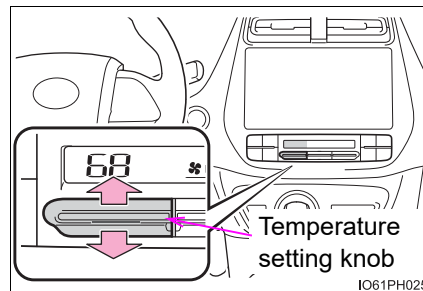

■ Fan speed setting

Move the fan speed setting knob upwards to increase the fan speed and downwards to decrease the fan speed.

The fan speed is shown on the display. (7 levels)

Press  to turn the fan off.

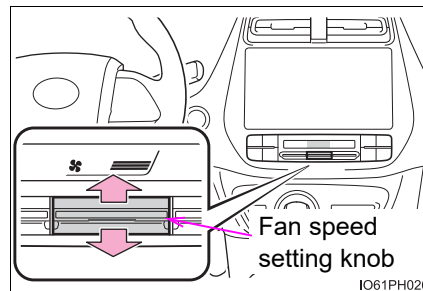

■ Change the airflow mode

Move the airflow change knob upwards or downwards to change the airflow mode.

The air outlets used are switched each time the knob is operated.

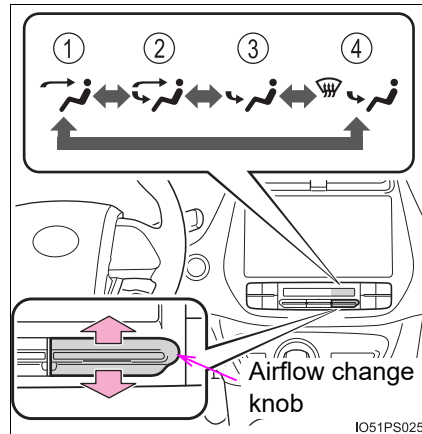

- ① Air flows to the upper body
- ② Air flows to the upper body and feet
- ③ Air flows to the feet
- ④ Air flows to the feet and the windshield defogger operates



■ Other functions

- Switching between outside air and recirculated air modes (→P. 515)
- Defogging the windshield (→P. 515)
- Defogging the rear window and outside rear view mirrors (→P. 516)

Using automatic mode

- 1 Press  .
- 2 Adjust the temperature setting. (→P. 512)
- 3 To stop the operation, press  .

■ Automatic mode indicator

If the fan speed setting or air flow modes are operated, the  indicator goes off. However, automatic mode for functions other than that operated is maintained.

Front seat concentrated airflow mode (S-FLOW)

This function automatically controls the air conditioning airflow so that priority is given to the front seats. When the front passenger seat is not occupied, airflow may switch to only the driver's seat. Unnecessary air conditioning is suppressed, contributing to increased fuel efficiency.

Front seat concentrated airflow mode operates in the following situations.

- No passengers are detected in the rear seats
- The windshield defogger is not operating

While operating,  illuminates.

■ Manually turning front seat concentrated airflow mode on/off

In front seat concentrated airflow mode, directing airflow to the front seats only and to all seats can be switched via switch operation. When the mode has been switched manually, automatic airflow control stops operating.

Press  on the air conditioning operation panel and switch the airflow.

- Indicator illuminated: Airflow to the front seats only
- Indicator off: Airflow to all the seats

Other functions

■ Switching between outside air and recirculated air modes

Press  .

The mode switches between outside air mode and recirculated air mode each time  is pressed.

The  indicator illuminates when the recirculated air mode is selected.

■ Air conditioning eco mode

The air conditioning system is controlled with low fuel consumption prioritized such as reducing fan speed, etc.

Press  .

The air conditioning eco mode switches between on and off each time  is pressed.

“ECO” is displayed on the air conditioning screen when the air conditioning eco mode is on.

■ Defogging the windshield

Defoggers are used to defog the windshield and front side windows.

Press  .

Set  to outside air mode if the recirculated air mode is used. (It may switch automatically.)

To defog the windshield and the side windows early, turn the air flow and temperature up.

The  indicator illuminates when the defoggers are on.

To return to the previous mode, press  again when the windshield is defogged. Also, turning the power switch off during operation can return to the previous mode.

■ **Defogging the rear window and outside rear view mirrors**

Defoggers are used to defog the rear window and to remove rain-drops, dew and frost from the outside rear view mirrors.

Press  .

Defoggers switch between on and off each time  is pressed.

The  indicator illuminates when defoggers are on.

The defoggers will automatically turn off after a period of time.

■ **Eco score (A/C score)**

→P. 229

Air outlets

■ **Location of air outlets**

The air outlets and air volume change according to the selected airflow mode.

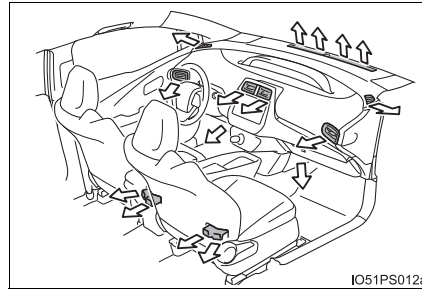

IO51PS012a

■ **Adjusting the air flow direction**

Direct air flow to the left or right, up or down.

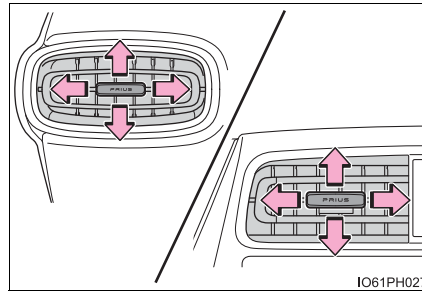

IO61PH027

■ **Opening and closing the air outlets**

▶ **Left side outlet/right side outlet**

▶ **Center outlets**

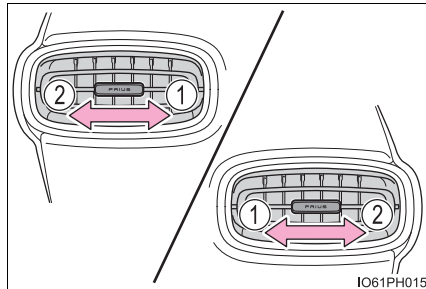

IO61PH015

- ① Open the vent
- ② Close the vent

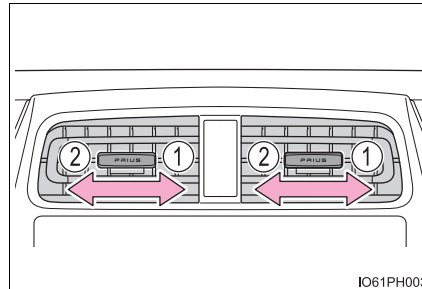



IO61PH003

- ① Open the vent
- ② Close the vent

■ Heating

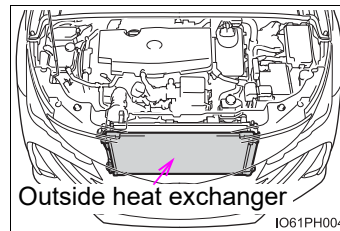
- In HV mode, the gasoline engine may operate in order to extract heat from the engine coolant via the heater.
- In EV mode, heating is done by a heat pump system.
 - When the outside temperature is low or it is snowing, compared to conventional vehicles, heating may be less effective and warm air may not come out.
 - When the outside heat exchanger is frosted over, fan speed declines and it may become harder to heat the interior. However, it is not a malfunction. In this situation, the air temperature from the outlets may not change even though the set temperature is raised.



- If frost has formed on the outside heat exchanger, the heating performance will decline. The frost can be removed from the outside heat exchanger by operating the Remote Air Conditioning System before driving (→P. 535). When frosted over, the heating operation of the Remote Air Conditioning System starts after defrosting.
- When  is turned on, the heating is controlled optimally. Therefore, the set heating performance may not be achieved even if the fan speed setting is increased.
- In the following situations the gasoline engine may operate in order to extract heat from the engine coolant via the heater even in EV mode.
 - The outside temperature is approximately 14°F (-10°C) or low
 -  is operating

■ Using automatic mode

Fan speed is adjusted automatically according to the temperature setting and the ambient conditions.

Therefore, the fan may stop for a while until warm or cool air is ready to flow immediately after  is pressed.

■ Water droplets during air conditioning operation

The outside heat exchanger, accumulator and air conditioning piping may incur condensation or frost may form. During or after the air conditioning operation, water droplets may fall from the vehicle. However, it is not a malfunction.

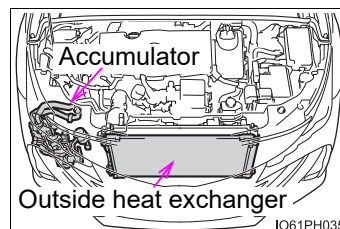

■ Setting confirmation screen

When changing the settings of the air conditioning system, the setting confirmation screen is shown as a pop-up on the multi-information display.

Press  of the meter control switches to go back to the previous screen.

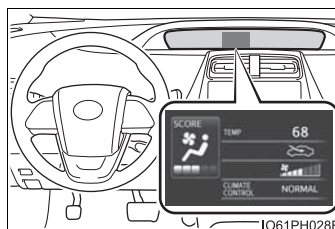

■ Operation of automatic airflow control

- In order to maintain a comfortable interior, airflow may be directed to seats without passengers immediately after the hybrid system is started and at other times depending on the outside temperature.
- After the hybrid system is started, if passengers move around inside or enter/exit the vehicle, the system cannot accurately detect the presence of passengers and automatic airflow control will not operate.

■ Operation of manual airflow control

Even if the function is manually switched to directing airflow to only the front seats, when a rear seat is occupied, it may automatically direct airflow to all seats.

■ To return to automatic airflow control

- 1 With the indicator off, turn the power switch off.
- 2 After 60 minutes or more elapse, turn the power switch to ON.

■ Front seat concentrated airflow mode (S-FLOW) operation

When  is pressed, the front seat concentrated airflow mode (S-FLOW) status is displayed on the multi-information display.

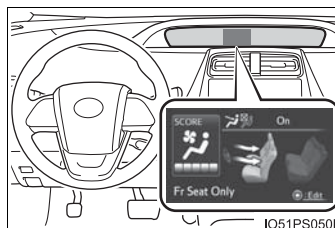



■ Changing settings using the multi-information display

The air conditioning system settings can be changed on the  screen of the multi-information display. (→P. 241)

■ Fogging up of the windows

- The windows will easily fog up when the humidity in the vehicle is high.

Turning  on will dehumidify the air from the outlets and defog the windshield effectively.

- If you turn  off, the windows may fog up more easily.
- The windows may fog up if the recirculated air mode is used.

■ Windshield fog detection function

When automatic mode is set, the humidity sensor (→P. 523) detects fog on the windshield and controls the air conditioning system to prevent fog.

■ When driving on dusty roads

Close all windows. If dust thrown up by the vehicle is still drawn into the vehicle after closing the windows, it is recommended that the air intake mode be set to outside air mode and the fan speed to any setting except off.

■ Outside/recirculated air mode

- Setting to the recirculated air mode temporarily is recommended in preventing dirty air from entering the vehicle interior and helping to cool the vehicle when the outside air temperature is high.
- Outside/recirculated air mode may automatically switch depending on the temperature setting or the inside temperature.

■ Fresh air intake system while parking

When parking, the system automatically switches to outside air mode to encourage better air circulation throughout the vehicle, helping to reduce odors that occur when starting the vehicle.

■ Operation of the air conditioning system in the air conditioning eco mode

- In the air conditioning eco mode, the air conditioning system is controlled as follows to prioritize fuel efficiency:
 - Engine speed and compressor operation controlled to restrict heating/cooling capacity
 - Fan speed restricted when automatic mode is selected
- To improve air conditioning performance, perform the following operations:
 - Adjust the fan speed
 - Adjust the temperature setting
 - Turn off the air conditioning eco mode
- When the driving mode is set to Eco driving mode, the air conditioning eco mode will be turned on automatically. Even in this case, the air conditioning eco mode can be turned off by pressing . (→P. 430)

■ When the outside temperature falls to nearly 32°F (0°C)

The dehumidification function may not operate even when  is pressed.

■ **When the outside temperature exceeds 75°F (24°C) and the air conditioning system is on**

- In order to reduce the air conditioning power consumption, the air conditioning system may switch to recirculated air mode automatically. This may also reduce fuel consumption.
- Recirculated air mode is selected as a default mode when the power switch is turned to ON mode.
- It is possible to switch to outside air mode at any time by pressing  .

■ **Ventilation and air conditioning odors**

- To let the fresh air in, set the air conditioning system to the outside air mode.
- During use, various odors from inside and outside the vehicle may enter into and accumulate in the air conditioning system. This may then cause odor to be emitted from the vents.
- In order to suppress odors that occur when the air conditioning system starts, fresh air is automatically taken in when parked.
- To reduce potential odors from occurring, the start timing of the blower may be delayed for a short period of time immediately after the air conditioning system is started in automatic mode.

■ **Air conditioning filter**



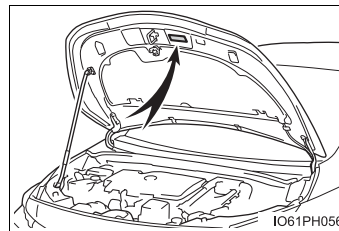

→P. 640

■ **Air conditioning system refrigerant**

- A label regarding the refrigerant of the air conditioning system is attached to the hood at the location shown in the following illustration.



- The meaning of each symbol on the label are as follows:

	Caution
	Air conditioning system
	Air conditioning system lubricant type
	Requires registered technician to service air conditioning system
	Flammable refrigerant

■ **Customization**

Settings (e.g. A/C auto switching operation) can be changed. (Customizable features: →P. 753)

 **WARNING**

■ **To prevent the windshield from fogging up**

- Do not use  during cool air operation in extremely humid weather. The difference between the temperature of the outside air and that of the windshield can cause the outer surface of the windshield to fog up, blocking your vision.
- Do not place anything on the instrument panel which may cover the air outlets. Otherwise, air flow may be obstructed, preventing the windshield defoggers from defogging.

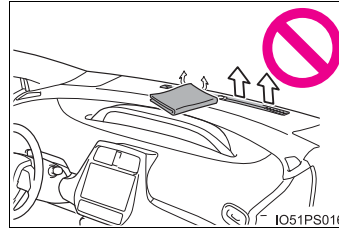

■ **To prevent burns**

Do not touch the rear view mirror surfaces when the outside rear view mirror defoggers are on.

 NOTICE**■ Humidity sensor**

In order to detect fog on the windshield, a sensor which monitors the temperature of the windshield, the surround humidity, etc. is installed. (→P. 520)

Follow these points to avoid damaging the sensor:

- Do not disassemble the sensor
- Do not spray the glass cleaner on the sensor or subject it to strong impacts
- Do not stick anything on the sensor

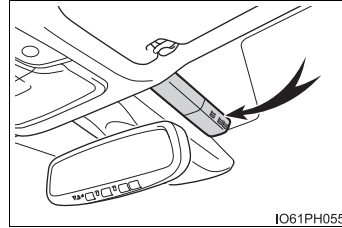
**■ To prevent 12-volt battery discharge**

Do not leave the air conditioning system on longer than necessary when the hybrid system is off.

■ When repairing/replacing parts of the air conditioning system

Have repair/replacement performed by your Toyota dealer. When a part of the air conditioning system, such as the evaporator, is to be replaced, it must be replaced with a new one.

■ Air outlets

The air outlets become hot when used for heating. Therefore, use caution and adjust the air outlets accordingly.

Automatic air conditioning system (vehicles with 11.6-inch display)

Air outlets and fan speed are automatically adjusted according to the temperature setting.



IO61PH030US

Air conditioner information area

The following informations are displayed on the navigation system screen.

- ① Temperature setting
- ② Fan speed setting
- ③ Automatic mode setting
- ④ Airflow mode setting
- ⑤ Front seat concentrated airflow mode (S-FLOW) setting
- ⑥ Air conditioning eco mode setting
- ⑦ A/C setting
- ⑧ Outside/recirculated air mode setting

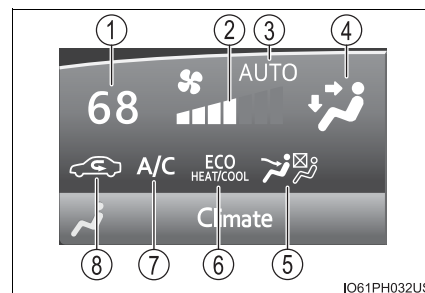

IO61PH032US

Air conditioning control screen

The air conditioning control screen can be displayed by touching the air conditioner information area on the navigation system screen.

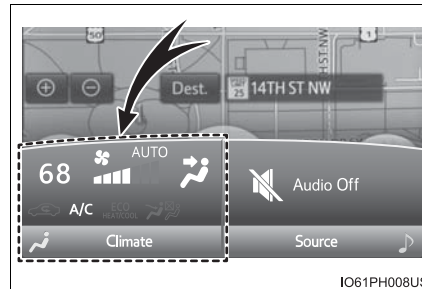



Air conditioning controls

■ Adjusting the temperature setting

Press “^” on  to increase the temperature and “v” to decrease the temperature.

If the  indicator is turned off, the system will blow ambient temperature air or heated air.

■ Adjusting the fan speed setting

Select  on the air conditioning control screen to increase the fan speed and  to decrease the fan speed.

The fan speed is shown on the control screen. (7 levels)

Select  to turn the fan off.

■ Change the airflow mode

To change the air outlets, select any switch on the air conditioning control screen.



- ① Air flows to the upper body
- ② Air flows to the upper body and feet
- ③ Air flows to the feet
- ④ Air flows to the feet and the windshield defogger operates



■ Other functions

- Switching between outside air and recirculated air modes (→P. 527)
- Defogging the windshield (→P. 527)
- Defogging the rear window and outside rear view mirrors (→P. 527)

Using automatic mode

- 1 Select  on the air conditioning control screen.
- 2 Adjust the temperature setting. (→P. 525)
- 3 To stop the operation, select  .

■ Automatic mode indicator

If the fan speed setting or air flow modes are operated, the  indicator goes off. However, automatic mode for functions other than that operated is maintained.

Front seat concentrated airflow mode (S-FLOW)

This function automatically controls the air conditioning airflow so that priority is given to the front seats. When the front passenger seat is not occupied, airflow may switch to only the driver's seat. Unnecessary air conditioning is suppressed, contributing to increased fuel efficiency.

Front seat concentrated airflow mode operates in the following situations.

- No passengers are detected in the rear seats
- The windshield defogger is not operating

While operating,  illuminates.

■ Manually turning front seat concentrated airflow mode on/off

In front seat concentrated airflow mode, directing airflow to the front seats only and to all seats can be switched via switch operation. When the mode has been switched manually, automatic airflow control stops operating.

Select  on the center display and switch the airflow.

- Indicator illuminated: Airflow to the front seats only
- Indicator off: Airflow to all the seats

Other functions

■ Switching between outside air and recirculated air modes

Select  on the air conditioning control screen.

The mode switches between outside air mode and recirculated air mode each time  is selected.

The  indicator illuminates when recirculated air mode is selected.

■ Air conditioning eco mode

The air conditioning system is controlled with low fuel consumption prioritized such as reducing fan speed, etc.

Select  on the air conditioning control screen.

The air conditioning eco mode switches between on and off each time  is selected.

The  indicator illuminates when the air conditioning eco mode is on.

■ Defogging the windshield

Defoggers are used to defog the windshield and front side windows.

Press .

Set  to outside air mode if the recirculated air mode is used. (It may switch automatically.)

To defog the windshield and the side windows early, turn the air flow and temperature up.

The switch indicator illuminates when the defoggers are on.

To return to the previous mode, press  again when the windshield is defogged. Also, turning the power switch off during operation can return to the previous mode.

■ Defogging the rear window and outside rear view mirrors

Defoggers are used to defog the rear window and to remove rain-drops, dew and frost from the outside rear view mirrors.

Press .

Defoggers switch between on and off each time  is pressed.

The switch indicator illuminates when defoggers are on.

The defoggers will automatically turn off after a period of time.

■ **Eco score (A/C score)**

→P. 229

Air outlets

■ **Location of air outlets**

The air outlets and air volume change according to the selected airflow mode.

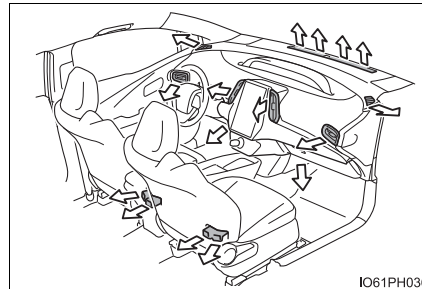

■ **Adjusting the air flow direction**

Direct air flow to the left or right, up or down.

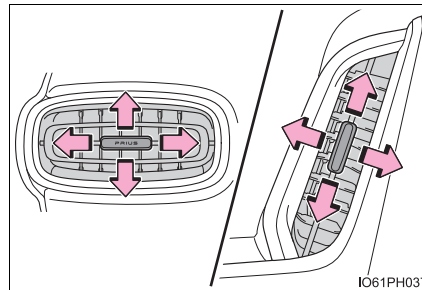

■ **Opening and closing the air outlets**

- ▶ Left side outlet/right side outlet
- ▶ Center outlets

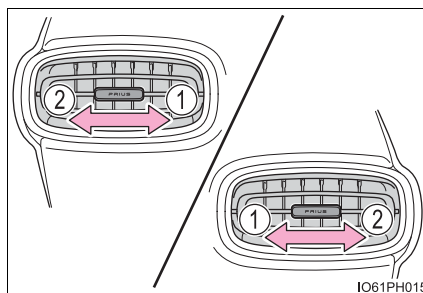

- ① Open the vent
- ② Close the vent

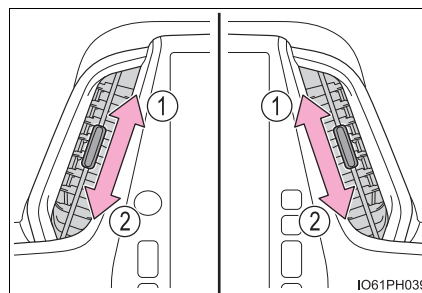

- ① Open the vent
- ② Close the vent

■ Heating

- In HV mode, the gasoline engine may operate in order to extract heat from the engine coolant via the heater.
- In EV mode, heating is done by a heat pump system.
 - When the outside temperature is low or it is snowing, compared to conventional vehicles, heating may be less effective and warm air may not come out.
 - When the outside heat exchanger is frosted over, fan speed declines and it may become harder to heat the interior. However, it is not a malfunction. In this situation, the air temperature from the outlets may not change even though the set temperature is raised.

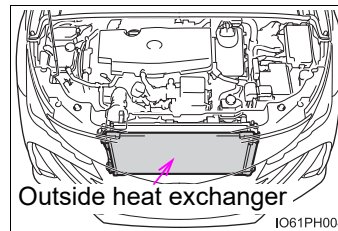

- If frost has formed on the outside heat exchanger, the heating performance will decline. The frost can be removed from the outside heat exchanger by operating the Remote Air Conditioning System before driving (→P. 535). When frosted over, the heating operation of the Remote Air Conditioning System starts after defrosting.
- When **AUTO** is turned on, the heating is controlled optimally. Therefore, the set heating performance may not be achieved even if the fan speed setting is increased.
- In the following situations the gasoline engine may operate in order to extract heat from the engine coolant via the heater even in EV mode.
 - The outside temperature is approximately 14°F (-10°C) or low
 -  is operating

■ Using automatic mode

Fan speed is adjusted automatically according to the temperature setting and the ambient conditions.

Therefore, the fan may stop for a while until warm or cool air is ready to flow immediately after **AUTO** is pressed.

■ Water droplets during air conditioning operation

The outside heat exchanger, accumulator and air conditioning piping may incur condensation or frost may form. During or after the air conditioning operation, water droplets may fall from the vehicle. However, it is not a malfunction.

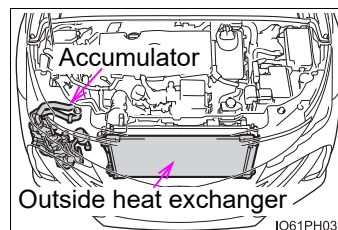

■ Setting confirmation screen

When changing the settings of the air conditioning system, the setting confirmation screen is shown as a pop-up on the multi-information display.

Press  of the meter control switches to go back to the previous screen.

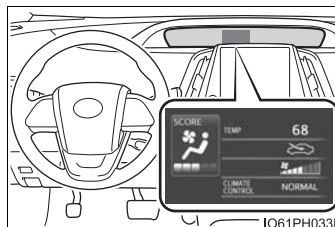

■ Operation of automatic airflow control

- In order to maintain a comfortable interior, airflow may be directed to seats without passengers immediately after the hybrid system is started and at other times depending on the outside temperature.
- After the hybrid system is started, if passengers move around inside or enter/exit the vehicle, the system cannot accurately detect the presence of passengers and automatic airflow control will not operate.

■ Operation of manual airflow control

Even if the function is manually switched to directing airflow to only the front seats, when a rear seat is occupied, it may automatically direct airflow to all seats.

■ To return to automatic airflow control

- 1 With the indicator off, turn the power switch off.
- 2 After 60 minutes or more elapse, turn the power switch to ON.

■ Front seat concentrated airflow mode (S-FLOW) operation

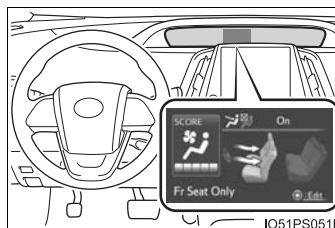

When  is selected, the front seat concentrated airflow mode (S-FLOW) status is displayed on the multi-information display.



■ Changing settings using the multi-information display

The air conditioning system settings can be changed on the  screen of the multi-information display. (→P. 241)

■ Fogging up of the windows

- The windows will easily fog up when the humidity in the vehicle is high.
Turning  on will dehumidify the air from the outlets and defog the windshield effectively.
- If you turn  off, the windows may fog up more easily.
- The windows may fog up if the recirculated air mode is used.

■ Windshield fog detection function

When automatic mode is set, the humidity sensor (→P. 534) detects fog on the windshield and controls the air conditioning system to prevent fog.

■ When driving on dusty roads

Close all windows. If dust thrown up by the vehicle is still drawn into the vehicle after closing the windows, it is recommended that the air intake mode be set to outside air mode and the fan speed to any setting except off.

■ Outside/recirculated air mode

- Setting to the recirculated air mode temporarily is recommended in preventing dirty air from entering the vehicle interior and helping to cool the vehicle when the outside air temperature is high.
- Outside/recirculated air mode may automatically switch depending on the temperature setting or the inside temperature.

■ Fresh air intake system while parking

When parking, the system automatically switches to outside air mode to encourage better air circulation throughout the vehicle, helping to reduce odors that occur when starting the vehicle.

■ Operation of the air conditioning system in the air conditioning eco mode

- In the air conditioning eco mode, the air conditioning system is controlled as follows to prioritize fuel efficiency:
 - Engine speed and compressor operation controlled to restrict heating/cooling capacity
 - Fan speed restricted when automatic mode is selected
- To improve air conditioning performance, perform the following operations:
 - Adjust the fan speed
 - Adjust the temperature setting
 - Turn off the air conditioning eco mode
- When the driving mode is set to Eco driving mode, the air conditioning eco mode will be turned on automatically. Even in this case, the air conditioning eco mode can be turned off by selecting . (→P. 430)

■ When the outside temperature falls to nearly 32°F (0°C)

The dehumidification function may not operate even when  is selected.

■ When the outside temperature exceeds 75°F (24°C) and the air conditioning system is on

- In order to reduce the air conditioning power consumption, the air conditioning system may switch to recirculated air mode automatically. This may also reduce fuel consumption.
- Recirculated air mode is selected as a default mode when the power switch is turned to ON mode.
- It is possible to switch to outside air mode at any time by pressing



■ **Ventilation and air conditioning odors**

- To let the fresh air in, set the air conditioning system to the outside air mode.
- During use, various odors from inside and outside the vehicle may enter into and accumulate in the air conditioning system. This may then cause odor to be emitted from the vents.
- In order to suppress odors that occur when the air conditioning system starts, fresh air is automatically taken in when parked.
- To reduce potential odors from occurring, the start timing of the blower may be delayed for a short period of time immediately after the air conditioning system is started in automatic mode.

■ **Air conditioning filter**



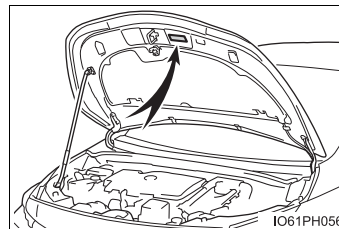

→P. 640

■ **Air conditioning system refrigerant**

- A label regarding the refrigerant of the air conditioning system is attached to the hood at the location shown in the following illustration.



- The meaning of each symbol on the label are as follows:

	Caution
	Air conditioning system
	Air conditioning system lubricant type
	Requires registered technician to service air conditioning system
	Flammable refrigerant

■ Customization

Settings (e.g. A/C auto switching operation) can be changed. (Customizable features: →P. 753)

▲ WARNING**■ To prevent the windshield from fogging up**

- Do not use  during cool air operation in extremely humid weather. The difference between the temperature of the outside air and that of the windshield can cause the outer surface of the windshield to fog up, blocking your vision.
- Do not place anything on the instrument panel which may cover the air outlets. Otherwise, air flow may be obstructed, preventing the windshield defoggers from defogging.

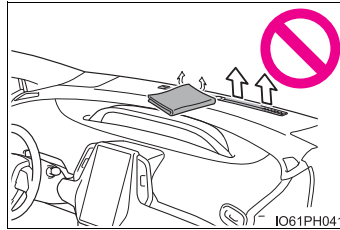
**■ To prevent burns**

Do not touch the rear view mirror surfaces when the outside rear view mirror defoggers are on.

 NOTICE**■ Humidity sensor**

In order to detect fog on the windshield, a sensor which monitors the temperature of the windshield, the surround humidity, etc. is installed. (→P. 531)

Follow these points to avoid damaging the sensor:

- Do not disassemble the sensor
- Do not spray the glass cleaner on the sensor or subject it to strong impacts
- Do not stick anything on the sensor

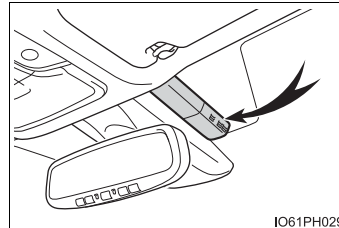
**■ To prevent 12-volt battery discharge**

Do not leave the air conditioning system on longer than necessary when the hybrid system is off.

■ When repairing/replacing parts of the air conditioning system

Have repair/replacement performed by your Toyota dealer. When a part of the air conditioning system, such as the evaporator, is to be replaced, it must be replaced with a new one.

■ Air outlets

The air outlets become hot when used for heating. Therefore, use caution and adjust the air outlets accordingly.

Remote Air Conditioning System

The Remote Air Conditioning System uses electrical energy stored in the hybrid battery (traction battery) and allows the air conditioning to be operated by remote control.

If the Remote Air Conditioning System is used while the charging cable is connected to the vehicle, the reduction of charge in the hybrid battery (traction battery) will be suppressed to allow you to use electricity from an external power source.

Charging will be conducted automatically after the Remote Air Conditioning System is stopped.

Before leaving the vehicle

Check the temperature setting of the air conditioning system.
(→P. 512, 525)

The Remote Air Conditioning System will operate in accordance with the temperature settings of the air conditioning system.

Activating the Remote Air Conditioning System

Press and hold "A/C" on the wireless remote control to operate the Remote Air Conditioning System.

The system will shut off if a door is opened.

The system can be stopped by pressing "A/C" twice.

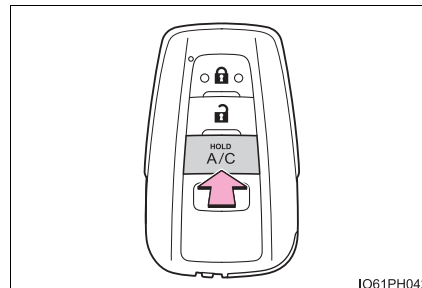

■ **Operating conditions**

The system will only operate if all of the following conditions are met:

- The shift position is in P.
- The power switch is off.*
- All doors are closed.
- The hood is closed.

*: The Remote Air Conditioning System cannot be used for approximately 3 minutes and a half after the power switch is turned off.

■ **Remote Air Conditioning System automatic shut-off**

The system will automatically shut off under the following conditions:

- About 10 minutes have passed since operation began
- Any one of the operating conditions is not met

The system may also shut off if the charge level of the hybrid battery (traction battery) drops to low.

■ **Conditions affecting operation**

The system may not start in the following situations:

- The charge level of the hybrid battery (traction battery) is low
- The outside temperature is extremely low
- When the hybrid system is cool (for example, after being left for a long time in low temperatures)

■ **Windshield defogger**

When defogging the windshield using the Remote Air Conditioning System, defogging may be insufficient due to the power being restricted more than during normal air conditioning operation. Also, the outside of the windshield may fog up due to the outside temperature, humidity or air conditioning set temperature.

■ **Using the heater via the Remote Air Conditioning System**

When the outside heat exchanger becomes frosted over, heating performance may decline due to automatically switching to the frost removal operation.

■ Security feature

Any unlocked doors will be automatically locked when the system is operating. The buzzer sounds and the emergency flashers flash to indicate that the doors have been locked or the system has been turned off.
(The doors locked: Once; The system turned off: Twice)

■ Conditions affecting operation

→P. 295

■ When using the Remote Air Conditioning System

A charging message will be displayed on the multi-information display. Different messages will be displayed depending on when the Remote Air Conditioning System was started (after charging or during charging).

■ While the Remote Air Conditioning System is operating

- Depending on the operating condition of the Remote Air Conditioning System, the electric fan may spin and an operating noise may be heard. However, this does not indicate a malfunction.
- The Remote Air Conditioning System may stop operating temporarily if other features that use electricity (for example, the seat heater, lights, windshield wipers) are in operation or if the charge level of the 12-volt battery becomes low.
- The headlights, windshield wiper, combination meter, etc. will not operate while the Remote Air Conditioning System is operating.

■ Electronic key battery depletion

→P. 278

■ When the electronic key battery is fully depleted

→P. 647

■ Customization

Setting (e.g. Operation using "A/C" on the wireless remote control) can be changed. (Customizable features: →P. 753)

 **WARNING****■ Precautions for the Remote Air Conditioning System**

- Do not use the system if people are in the vehicle.
Even when the system is in use, the internal temperature may still reach a high or low level due to features such as the automatic shut-off. Children and pets left inside the vehicle may suffer heatstroke dehydration or hypothermia or could result in death or serious injury.
- Depending on the surrounding environment, signals from the wireless switch may transmit further than expected. Pay appropriate attention to the vehicle's surroundings and use the switch only when necessary.
- Do not operate "A/C" if the hood is open. The air conditioning may operate unintentionally and objects may be drawn into the electrical cooling fan.

 **NOTICE****■ To prevent the hybrid battery (traction battery) from being discharged through incorrect operation**

Use "A/C" only when necessary.

Heated steering wheel*/seat heaters

- Heated steering wheel
Warm up the grip of the steering wheel
- Seat heaters (front seats)
Warm up the seat upholstery

WARNING

- Care should be taken to prevent injury if anyone in the following categories comes in contact with the steering wheel and seats when the heater is on:
 - Babies, small children, the elderly, the sick and the physically challenged
 - Persons with sensitive skin
 - Persons who are fatigued
 - Persons who have taken alcohol or drugs that induce sleep (sleeping drugs, cold remedies, etc.)
- Observe the following precautions to prevent minor burns or overheating:
 - Do not cover the seat with a blanket or cushion when using the seat heater.
 - Do not use seat heater more than necessary.

NOTICE

- Do not put heavy objects that have an uneven surface on the seat and do not stick sharp objects (needles, nails, etc.) into the seat.
- To prevent 12-volt battery discharge, do not use the functions when the hybrid system is off.

*: If equipped

Heated steering wheel (if equipped)

Turns the heated steering wheel on/off

The indicator in the instrument cluster comes on when the heated steering wheel is operating.

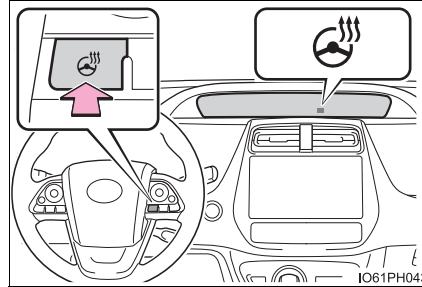

- The heated steering wheel can be used when the power switch is in ON mode.
- The heated steering wheel will automatically turn off after about 30 minutes.

Seat heaters

- ① Heats the seat at low temperature (LO)
- ② Heats the seat at high temperature (HI)

The indicator light comes on when one side of the switch is pressed.

To stop the operation, gently press the other side of the switch.

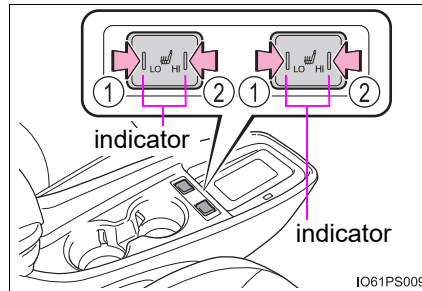

- The seat heaters can be used when the power switch is in ON mode.
- When not in use, turn off the switch. The indicator light goes off.

Interior lights list

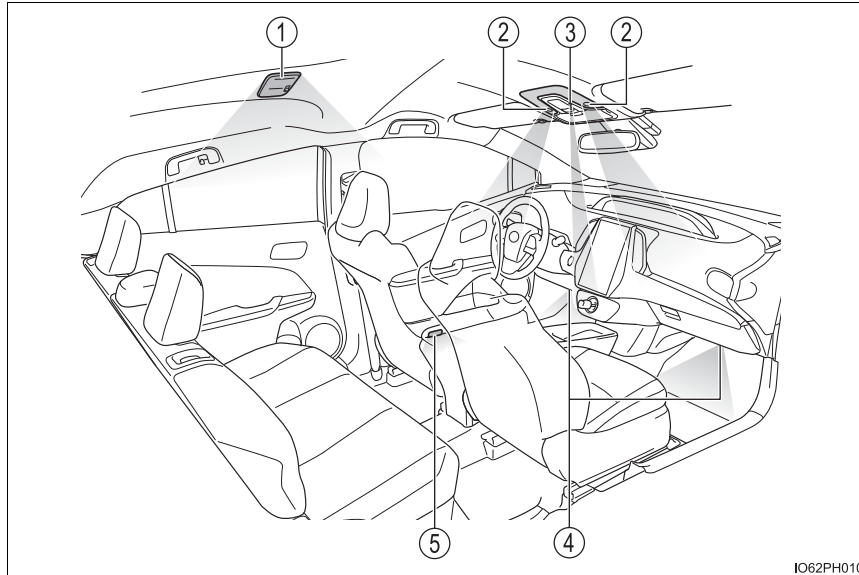

- ① Rear interior light (→P. 543)
- ② Front personal/interior lights (→P. 542)
- ③ Shift lever lighting
- ④ Footwell lights (if equipped)
- ⑤ Front door courtesy lights

Front interior light

- ① Turns the lights off
- ② Turns the door position on
- ③ Turns the lights on

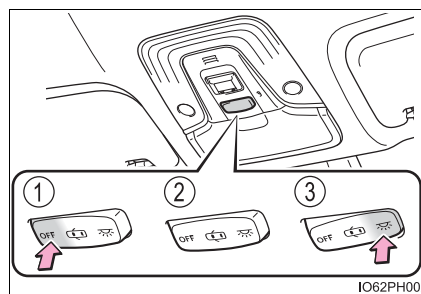

Front personal lights

Turns the lights on/off

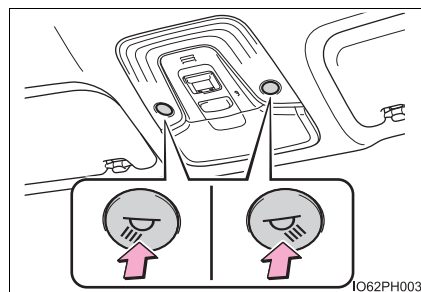

Rear interior light

- ① Turns the switch to the door position (door linked)

Operation is linked with the front interior light main switch. When the switch is off, the light does not illuminate.

- ② Turns the light on

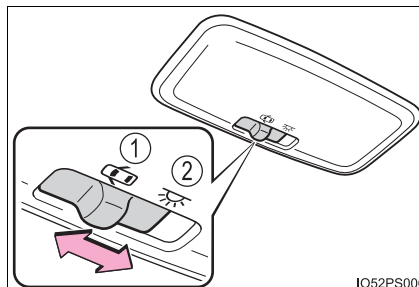

IO52PS006

■ Illuminated entry system

The lights automatically turn on/off according to power switch mode, the presence of the electronic key, whether the doors are locked/unlocked, and whether the doors are opened/closed.

■ To prevent the 12-volt battery from being discharged

If the interior lights remain on when the power switch is turned off, the light will go off automatically after 20 minutes.

■ Customization

Settings (e.g. the time elapsed before the lights turn off) can be changed. (Customizable features: →P. 753)

⚠ NOTICE

To prevent 12-volt battery discharge, do not leave the lights on longer than necessary when the hybrid system is off.

List of storage features

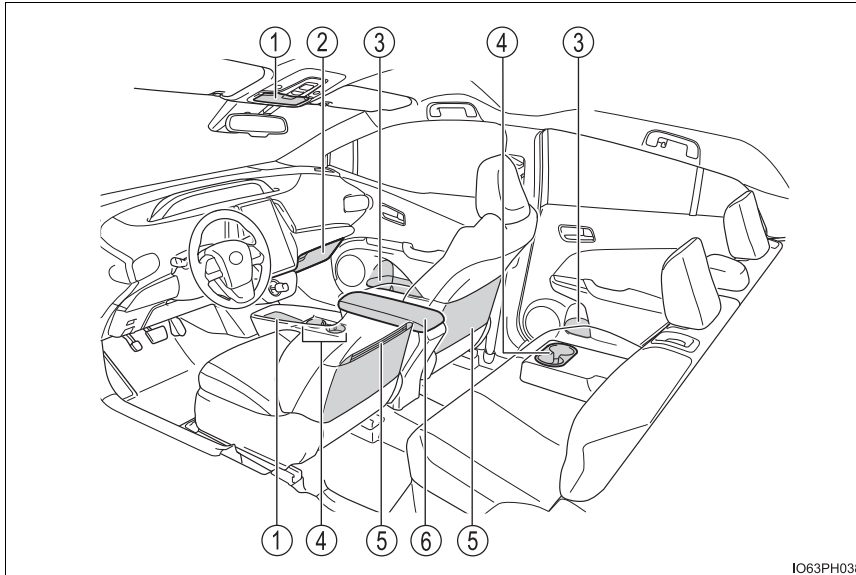

- | | |
|--|-------------------------------|
| ① Auxiliary boxes (→P. 548) | ④ Cup holders (→P. 546) |
| ② Glove box (→P. 545) | ⑤ Seat back pockets (→P. 548) |
| ③ Bottle holders/door pockets
(→P. 547) | ⑥ Console box (→P. 545) |

WARNING

- Do not leave glasses, lighters or spray cans in the storage spaces, as this may cause the following when cabin temperature becomes high:
 - Glasses may be deformed by heat or cracked if they come into contact with other stored items.
 - Lighters or spray cans may explode. If they come into contact with other stored items, the lighter may catch fire or the spray can may release gas, causing a fire hazard.
- When driving or when the storage compartments are not in use, keep the lids closed.
In the event of sudden braking or sudden swerving, an accident may occur due to an occupant being struck by an open lid or the items stored inside.

Glove box

Pull up the lever.

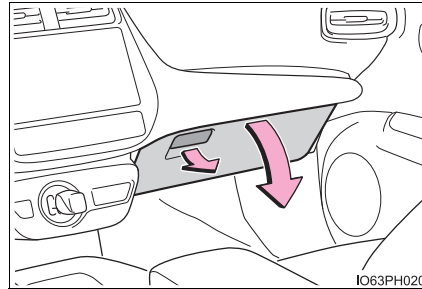

The glove box light turns on when the tail lights are on.

Console box

Press the knob and open the lid.

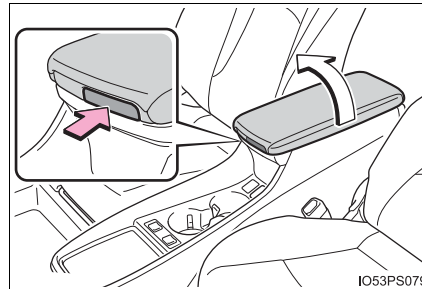

The tray slides forward/backward and can be removed.

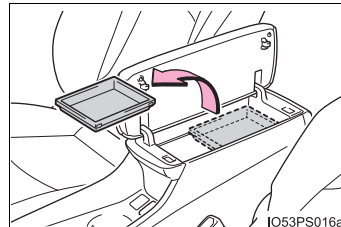

Cup holders

► Front

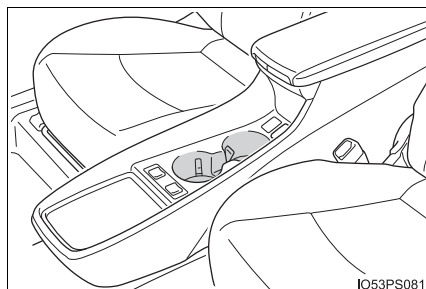

► Rear

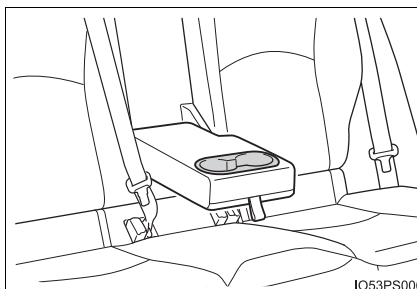

Pull down the armrest.

⚠ WARNING

Do not place anything other than cups or beverage cans in the cup holders. Other items may be thrown out of the holders in the event of an accident or sudden braking, causing injury. If possible, cover hot drinks to prevent burns.

Bottle holders/door pockets

▶ Front doors

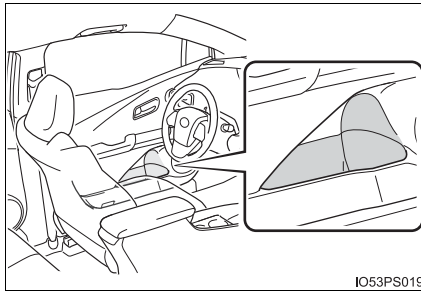

▶ Rear doors

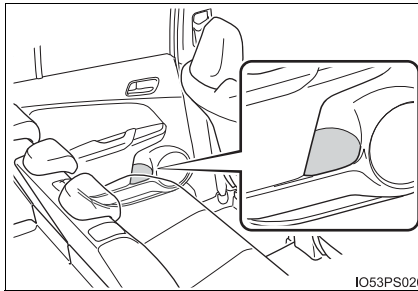

- When storing a bottle, close the cap.
- The bottle may not be stored depending on its size or shape.

 NOTICE

Put the cap on before stowing a bottle. Do not place open bottles or glass and paper cups containing liquid in the bottle holders. The contents may spill and glasses may break.

Auxiliary boxes

► Type A

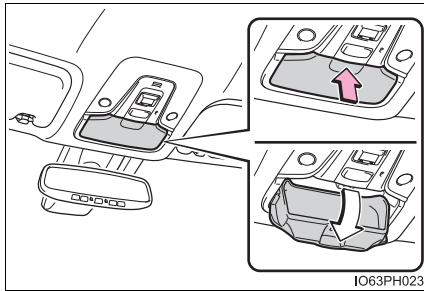

Press in the lid.
The overhead console is useful for temporarily storing small items.

► Type B (if equipped)

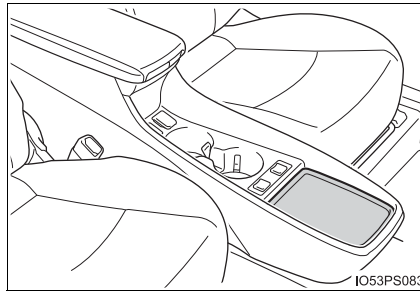

Vehicles with the wireless charger: →P. 557

⚠ WARNING

Type A:
Do not store items heavier than 0.44 lb. (200 g).
Doing so may cause the auxiliary box to open and the items inside may fall out, resulting in an accident.

Seat back pockets

Owner's manual etc. can be stored in the left-side seatback pocket with the slide fastener.

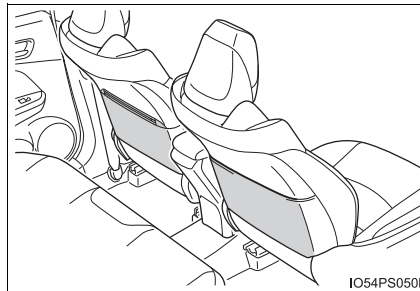

Luggage compartment features

Auxiliary boxes

► Center

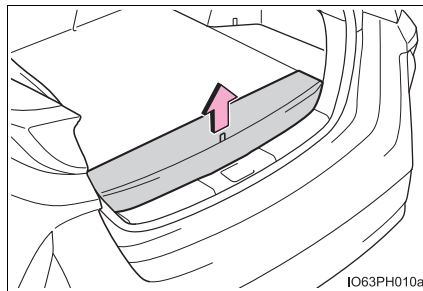

Pull the strap upwards to lift up the deck board.

The luggage cover, charging cable, tool bag, etc. can be stowed.

► Right side

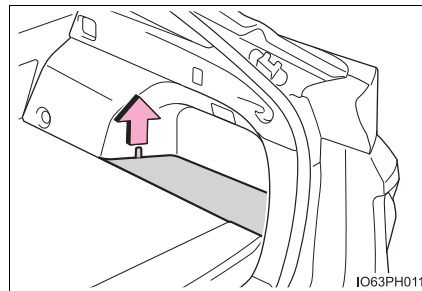

Pull the strap upwards to lift up the deck board.

■ When installing the deck board

Insert the claw in to the hole, and return the deck board.

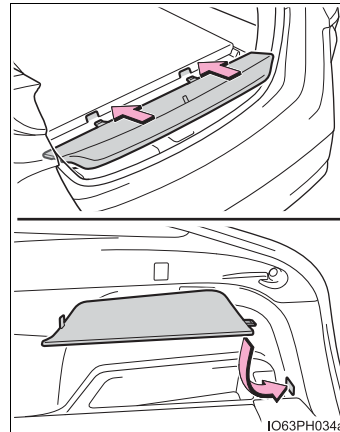

⚠ WARNING

If the deck board is removed, return it to its original positions before driving. In the event of sudden braking, an accident may occur due to an occupant being struck by the deck board or the items stored in the auxiliary box.

 NOTICE

To prevent damage to the deck board, do not apply too much load on the deck board.

Grocery bag hooks

When using the hooks, press the bottom side to lift it up.

There also is a hook on the other side.

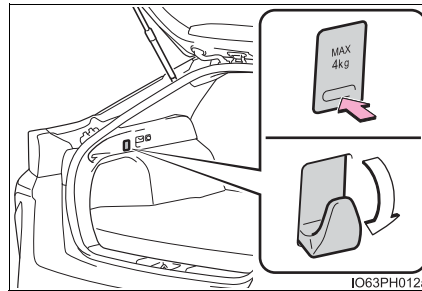

 NOTICE

In order to prevent damage to the grocery bag hooks, do not place large objects or objects that weight more than 8.8 lb. (4 kg) onto the hooks.

Warning reflector storage space

The warning reflector can be stowed.
(The warning reflector itself is not included as an original equipment)

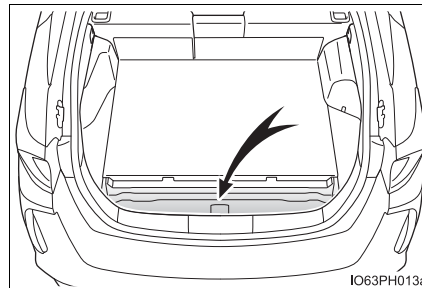

Depending on the size and shape of the warning reflector case, etc., you may not be able to store it.

 WARNING

When storing the warning reflector, etc., make sure that it is properly stored. If the warning reflector is not properly stored, it may fly out during emergency braking and lead to an accident.

Luggage cover

■ Installing the luggage cover

Install one side of the luggage cover to the holder. While pushing that side in, install the other side to the opposite holder.

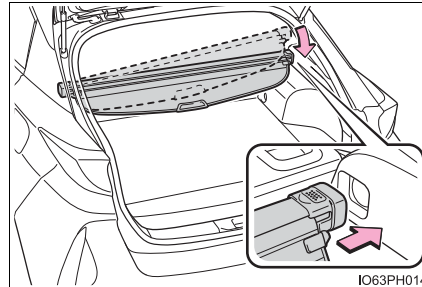

■ Using the luggage cover

Pull out the luggage cover and secure it to the hook brackets.

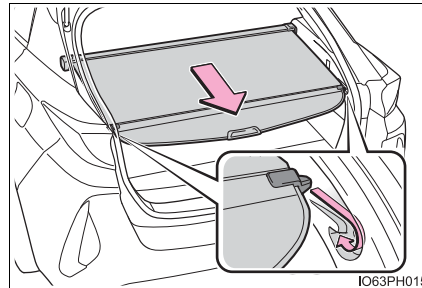

■ Removing the luggage cover

Push one end of the luggage cover inward and remove it from the holder.

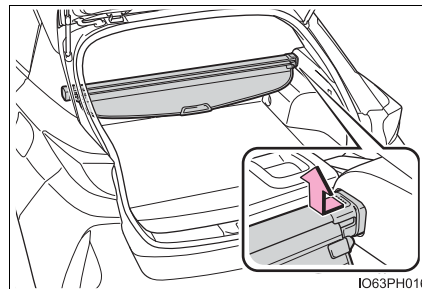

■ **Stowing the luggage cover**

- 1 Remove the deck boards.

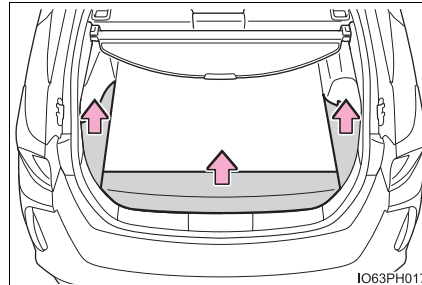

- 2 Store cover in the center auxiliary box.

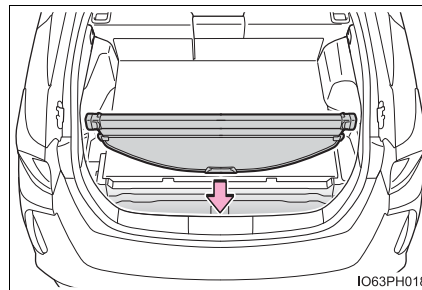

- 3 Return the deck boards to its original position and close it.

⚠ WARNING

- Do not place anything on the luggage cover. In the event of sudden braking or turning, the item may go flying and strike an occupant. This could lead to an unexpected accident, resulting in death or serious injury.
- Do not allow children to climb on the luggage cover. Climbing on the luggage cover could result in damage to the luggage cover, possibly causing death or serious injury to the child.
- Make sure that the rear edge of the cover is laying flat. If the cover is installed with the rear edge raised, the view from the rear window may be obstructed, which could cause an accident.
- Make sure that seat belts are not caught up in the luggage cover. If a seat belt is caught up in the cover, it may not be able to restrain passengers properly.

Other interior features

Sun visors

- ① To set the visor in the forward position, flip it down.
- ② To set the visor in the side position, flip down, unhook, and swing it to the side.
- ③ To use the side extender, place the visor in the side position, then slide it backward.

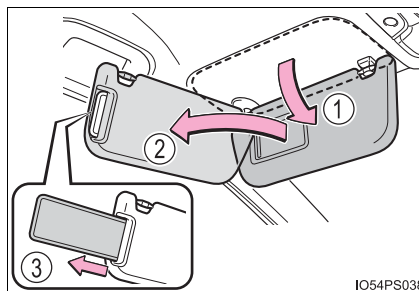

Vanity mirrors

Slide the cover to open.

The light turns on when the cover is opened.

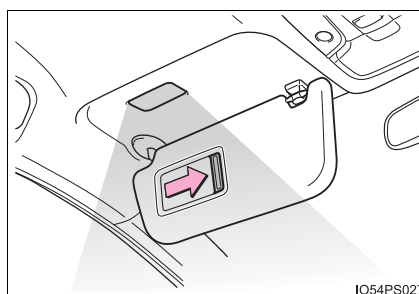

If the vanity light remain on when the power switch is turned off, the light will go off automatically after 20 minutes.

NOTICE

To prevent 12-volt battery discharge, do not leave the vanity lights on for extended periods while the hybrid system is off.

Power outlets

Please use as a power supply for electronic goods that use less than 12 V DC/10 A (power consumption of 120 W).

Open the lid.

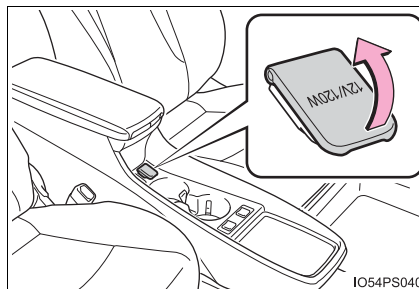

■ The power outlet can be used when

The power switch is in ACCESSORY or ON mode.

■ When stopping the hybrid system

Disconnect electrical devices with charging functions, such as mobile battery packs.

If such devices are left connected, the hybrid system may not stop normally.



NOTICE

- To avoid damaging the power outlets, close the lid when the power outlet is not in use.
Foreign objects or liquids that enter the power outlets may cause a short circuit.
- To prevent 12-volt battery discharge, do not use the power outlet longer than necessary when the hybrid system is off.

USB charging ports

The USB charging ports are used to supply 2.1 A of electricity at 5 V to external devices. The USB charging ports are for charging only. They are not designed for data transfer or other purposes.

Depending on the external device, it may not charge properly. Refer to the manual included with the device before using a USB charging port.

Open the lid.

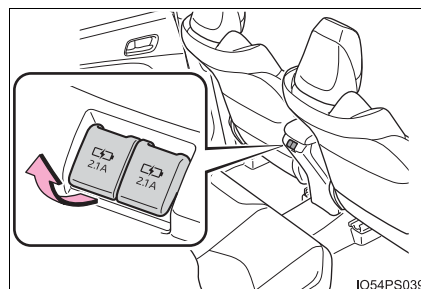

■ The USB charging ports can be used when

The power switch is in ACCESSORY or ON mode.

■ Situations in which the USB charging ports may not operate correctly

- If a device which consumes more than 2.1 A at 5 V is connected
- If a device designed to communicate with a personal computer, such as a USB memory device, is connected
- If the connected external device is turned off (depending on device)
- If the temperature inside the vehicle is high, such as after the vehicle has been parked in the sun

■ About connected external devices

Depending on the connected external device, charging may occasionally be suspended and then start again. This is not a malfunction.

 NOTICE

■ **To prevent damage to the USB charging ports**

- Do not insert foreign objects into the ports.
- Do not spill water or other liquids into the ports.
- When the USB charging ports are not in use, close the lids. If a foreign object or liquid enters a port may cause a short circuit.
- Do not apply excessive force to or impact the USB charging ports.
- Do not disassemble or modify the USB charging ports.

■ **To prevent damage to external devices**

- Do not leave external devices in the vehicle. The temperature inside the vehicle may become high, resulting in damage to an external device.
- Do not push down on or apply unnecessary force to an external device or the cable of an external device while it is connected.

■ **To prevent 12-volt battery discharge**

Do not use the USB charging ports for a long period of time with the hybrid system stopped.

Wireless charger (if equipped)

A portable device can be charged by just placing Qi standard wireless charge compatible portable devices according to the Wireless Power Consortium, such as smart phones and mobile batteries, etc., on the charge area.

This function cannot be used with portable devices that are larger than the charging area. Also, depending on the portable device, it may not operate as normal. Please read the operation manual for portable devices to be used.

■ The “Qi” symbol

The “Qi” symbol is a trademark of the Wireless Power Consortium.

**■ Name for all parts**

- ① Power supply switch
- ② Operation indicator light
- ③ Charge area

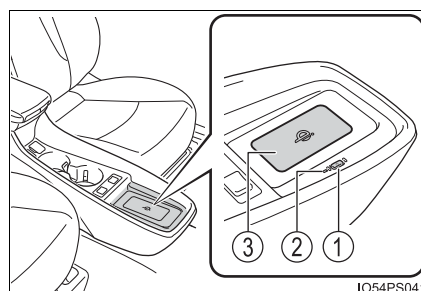

■ Using the wireless charger

- 1 Press the power supply switch of the wireless charger.

Switches on and off with each press of the power supply switch.

When turned on, the operation indicator light (green) comes on.

Even with the hybrid system off, the on/off state of the power supply switch is memorized.

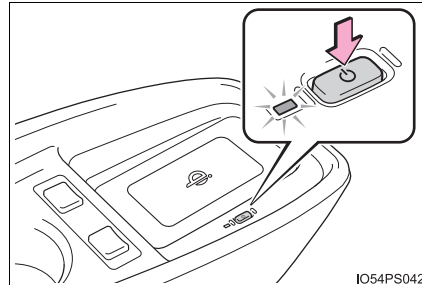

- 2 Place the charging side of the portable device down.

When charging, the operation indicator light (orange) comes on.

If charging is not occurring, try placing the portable device as close to the center of the charging area as possible.

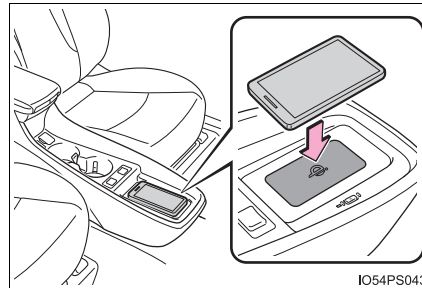

When charging is complete, the operation indicator light (green) comes on.

● Recharging function

- When charging is complete and after a fixed time in the charge suspension state, charging restarts.
- When the portable device is moved, charging is stopped for a moment and then it restarts.

■ **Lighting conditions of operation indicator light**

Operation indicator light	Conditions
Turning off	When the Wireless charger power supply is off
Green (comes on)	On Standby (charging possible state)
	When charging is complete*
Orange (comes on)	When placing the portable device on the charging area (detecting the portable device)
	Charging

*: Depending on the portable device, there are cases where the operation indicator light will continue being lit up orange even after the charging is complete.

● **When the operation indicator light flashes**

When an error occurs, the operation indicator light flashes an orange color. Handle the error based on the following table.

Operation indicator light	Suspected causes	Handling method
Flashing repeatedly once every second (Orange)	Vehicle to charger communication failure.	Contact your Toyota dealer.
Repeatedly flashes 3 times continuously (Orange)	A foreign substance is between the portable device and charge area.	Remove the foreign substance from between portable device and the charge area.
	The portable device is out of sync due to the device being shifted from its position.	Place the portable device near the center of the charge area.
Repeatedly flashes 4 times continuously (Orange)	Temperature rising within the wireless charger.	Stop charging at once and start charging again after for a while.

■ **The wireless charger can be operated when**

The power switch is in ACCESSORY or ON mode.

■ **Usable portable devices**

Qi standard wireless charge standard can be used on compatible devices. However, not all Qi standard devices and compatibility are guaranteed.

Starting with mobile phones and smart phones, it is aimed for low power electrically supplied portable devices of no more than 5W.

■ **When covers and accessories are attached to portable devices**

Do not charge in situations where cover and accessories not able to handle Qi are attached to the portable device. Depending on the type of cover and accessory, it may not be possible to charge. When charging is not performed even with the portable device placed on the charge area, remove the cover and accessories.

■ **While charging, noise enters the AM radio**

Turn off the wireless charger and confirm that the noise has decreased. If the noise decreases, continuously pushing the power supply switch of the wireless charger for 2 seconds, the frequency of the charger can be changed and the noise can be reduced.

Also, on that occasion, the operation indicator light will flash orange 2 times.

■ **Important points of the wireless charger**

● If the electronic key cannot be detected within the vehicle interior, charging cannot be done. When the door is opened and closed, charging may be temporarily suspended.

● When charging, the wireless charging device and portable device will get warmer, however this is not a malfunction.

When a portable device gets warm while charging, charging may stop due to the protection function on the portable device side. In this case, when the temperature of the portable device drops significantly, charge again.

■ **Operation sounds**

When the power supply is turned on, while searching for the portable device a sound will be produced, however this is not a malfunction.

■ Certifications for the wireless charger

Panasonic

PRODUCT SAFETY AND COMPLIANCE DEPARTMENT . PANASONIC CORPORATION OF NORTH AMERICA . TWO RIVERFRONT PLAZA, 9TH FLOOR, NEWARK, NJ 07102-5490

FCC Declaration of Conformity
Summary

Product Name	In-Vehicle Wireless Charger	
Model Number	AT1701	
Brand Name	Panasonic	
Size and Mass	<ul style="list-style-type: none"> • 245mm (w), 136mm (l) and 48mm (h) and mass is 515grams 	
Purpose Updated DoC	Added similarity variant model / AT1701 contains CA-QS03J1AJ	
Compliance Information	<ul style="list-style-type: none"> • 47 CFR, FCC Part 18, Subpart C for ISM Equipment • FCC's KDB 680106 D01 RF Exposure Wireless Charging Apps v02 • Industry Canada RSS-216, Issue 1, dated August 2014 • For Wireless Power Transfer Devices (Wireless Chargers) 	
Responsible Applicant	Panasonic Corporation Automotive & Industrial Systems Company Automotive Infotainment Systems Business Division 4261, Ikonobe-cho, Tsuzuki-ku, Yokohama-shi, 224-8520, Japan	
Responsible Factories	<ul style="list-style-type: none"> • Panasonic Corporation, Automotive & Industrial Systems Company Automotive Infotainment / Systems Business Division Global Manufacturing Innovation Center, Matsumoto Factory 5652 Sasaga, Matsumoto city, Nagano 399-8730, Japan • Panasonic Automotive Systems Czech, s.r.o. U Panasonicu 266, 530 06 Pardubice-Stare Cvice, Czech Republic • Panasonic Automotive Systems Asia Pacific (Thailand) Co.,Ltd. 101 Moo 2 Teparak Road, T.Bangsaothong Ging A.Bangsaothong Samutprakarn 10540 Thailand • Panasonic Automotive Systems Dalian Co., Ltd. No.300, HongGang Road, GanJingZi District, Dalian, Liaoning Province, 116033 China 	
Responsible Sales Company	Panasonic Consumer Electronics Company Division of Panasonic Corporation of North America Two Riverfront Plaza, Newark, NJ 07102-5490 General Contact: http://shop.panasonic.com/support	
Special Conditions For Compliance	In-Vehicle Wireless Charger will be installed and used exclusively within transportation vehicle and as such, it is exempt from the following requirements: (1) Part 15 digital device technical rules in accordance with §15.103(a); and (2) §15.105(b) full text information to user to appear in User Manual in accordance with §18.213.	
EMI Test Report	TCB	UL Japan
	Test Report	10120384-R2
PSCD	Model Tested	AT1701 contains CA-QS03J1AJ
	Date Issued	12/14/2015
	Methodology	FCC-OET MP-4
Panasonic		

6 Interior features

Panasonic
PRODUCT SAFETY AND COMPLIANCE DEPARTMENT . PANASONIC CORPORATION OF NORTH AMERICA . TWO RIVERFRONT PLAZA, 9TH FLOOR, NEWARK, NJ 07102-5490

FCC Declaration of Conformity
Summary

RF Exposure Evaluation	TCB	UL Japan
	MPE	10197157S-E-R1
	Test Report	
	Model Tested	AT1701 contains CA-QS03J1AJ
	Date Issued	12/14/2015
	Methodology	KDB 680106 D01 RF Exposure Wireless Charging Apps v02
Importation	The subject In-Vehicle Wireless Charger can be imported on behalf of Panasonic affiliated sales companies by PNA's Logistics Import Customs, or their authored brokers, by electrically filing FCC Form 740 while declaring Box 2 with no reference to any FCC ID.	

This DoC is granted for the subject In-Vehicle Wireless Charger on the basis of the manufacturer's attested compliance with the above described conditions and in accordance with FCC Part 18 and FCC's KDB 0680106 D01 RF Exposure Wireless Charging Apps v02.

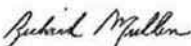
 Issued by: Richard Mullen
 Issue Date: January 14, 2016

Certificate Number: DoC 2014-008C
 Applicant Ref No.: PAS-16-F001

PRODUCT SAFETY AND COMPLIANCE DEPARTMENT . PANASONIC CORPORATION OF NORTH AMERICA . TWO RIVERFRONT PLAZA, 9TH FLOOR, NEWARK, NJ 07102-5490

FCC Provided Information:

This equipment has been tested and found to comply with Part 18 of the FCC Rules. These limits are designed to provide reasonable protection against harmful interference in a residential installation. Any changes or modifications not expressly approved by the party responsible for compliance could void the user's authority to operate this equipment.

This device complies with Part 18 of the FCC Rules. Operation is subject to the following two conditions:

(1) This device may not cause harmful interference, and (2) this device must accept any interference received, including interference that may cause undesired operation.

Declaration of Conformity

Trade Name: Panasonic
Model Numbers: AT1701 contains CA-QS03J1AJ
Responsible Party: Panasonic Corporation of North America
Two Riverfront Plaza, Newark, NJ 07102-5490
Support Contact: <http://shop.panasonic.com/support>

 **WARNING**

■ **Caution while driving**

When charging a portable device, for safety reasons, the driver should not operate the main part of the portable device while driving.

■ **Caution regarding interference with electronic devices**

People with implantable cardiac pacemakers, cardiac resynchronization therapy-pacemakers or implantable cardioverter defibrillators, as well as any other electrical medical device, should consult their physician about the usage of the wireless charger. The operations of the wireless charger may have an affect on medical devices.

■ **To prevent damage or burns**

Observe the following precautions.

Failure to do so may result in a possibility of equipment failure and damage, catch fire, burns due to overheat.

- Do not insert any metallic objects between the charging area and the portable device while charging
- Do not attach stickers, metallic objects, etc., to the charger area or portable device
- Do not cover with cloth, etc., and charge
- Do not charge portable devices other than designated
- Do not attempt to dismantle for disassembly or modifications
- Do not hit or apply a strong force

 NOTICE**■ Conditions in which the function may not operate correctly**

In the following conditions, it may not operate correctly

- The portable device is fully charged
- There is foreign matter between the charge area and portable device
- The temperature of the portable device gets higher from charging
- The charging surface of the portable device is facing up
- The placement of the portable device is out of alignment with the charge area
- Near a TV tower, electric power plant, gas station, radio station, large display, airport or other facility that generates strong radio waves or electrical noise
- When the electronic key is in contact with, or is covered by the following metallic objects
 - Cards to which aluminum foil is attached
 - Cigarette boxes that have aluminum foil inside
 - Metallic wallets or bags
 - Coins
 - Hand warmers made of metal
 - Media such as CDs and DVDs
- When other wireless keys (that emit radio waves) are being used nearby

In addition, excluding the above-mentioned, when the charger does not perform normally or the operation display lamp is flashing continuously, it is considered that the wireless charger is malfunctioning. Contact your Toyota dealer.

■ To prevent failure or damage to data

- Do not bring magnetic cards, such as credit cards, or magnetic recording media, etc., close to the charger while charging, otherwise, data may disappear under the influence of magnetism. Also, do not bring precision instruments such as wrist watches, etc., close to the charger, as such objects may break.
- Do not leave portable devices in the cabin. The temperature inside the cabin may become high, when under the sun, and cause damage to the device.

■ To prevent 12-volt battery discharge

When the hybrid system is stopped, do not use the wireless charger for a long time.

Armrest

Pull the armrest down for use.

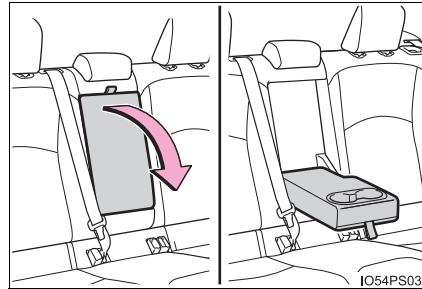

NOTICE

To prevent damage to the armrest, do not place too much strain on the armrest.

Coat hooks

The coat hooks are provided with the rear assist grips.

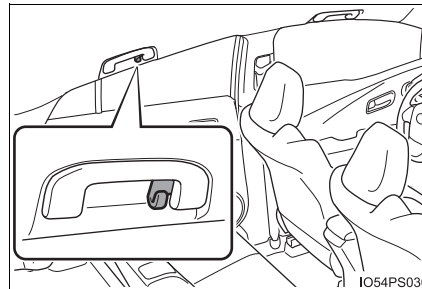

WARNING

Do not hang coat hangers or other hard or sharp objects on the hook. If the SRS curtain shield airbags deploy, these items may become projectiles, causing death or serious injury.

Assist grips

An assist grip installed on the ceiling can be used to support your body while sitting on the seat.

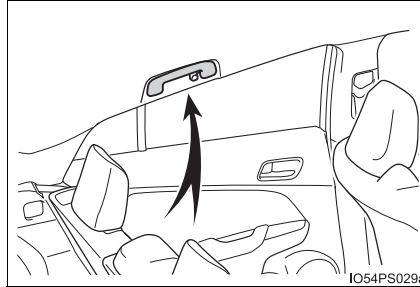
**⚠ WARNING**

Do not use the assist grip when getting in or out of the vehicle or rising from your seat.

⚠ NOTICE

To prevent damage to the assist grip, do not hang any heavy object or put a heavy load on the assist grip.

Garage door opener*

The garage door opener can be programmed to operate garage doors, gates, entry doors, door locks, home lighting systems, security systems, and other devices.

HomeLink®

The HomeLink® wireless control system in your vehicle has 3 buttons which can be programmed to operate 3 different devices. Refer to the programming methods on the following pages to determine the method which is appropriate for the device.

- ① HomeLink® indicator light
- ② Garage door operation indicators
- ③ Buttons

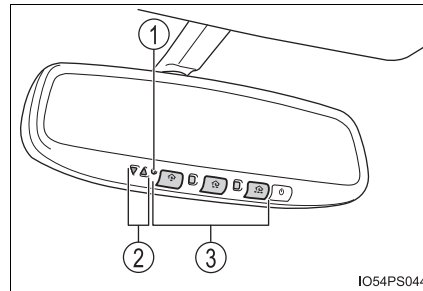

■ Before programming the HomeLink®

- During programming, it is possible that garage doors, gates, or other devices may operate. For this reason, make sure that people and objects are clear of the garage door or other devices to prevent injury or other potential harm.
- It is recommended that a new battery be placed in the remote control transmitter for more accurate programming.
- Garage door opener motors manufactured after 1995 may be equipped with rolling code protection. If this is the case, you may need a stepladder or other sturdy, safe device to reach the “Learn” or “Smart” button on the garage door opener motor.

*: If equipped

■ Programming the HomeLink®

Steps 1 through 3 must be performed within 60 seconds, otherwise the indicator light will stop flashing and programming will not be able to be completed.

- 1 Press and release the HomeLink® button you want to program and check that the HomeLink® indicator light flashes orange.

- 2 Point the remote control transmitter for the device at the rear view mirror, 1 to 3 in. (25 to 75 mm) from the HomeLink® buttons.

Keep the HomeLink® indicator light in view while programming.

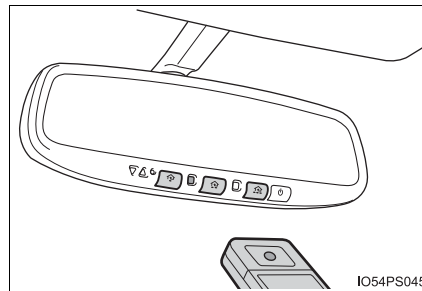

- 3 Program a device.

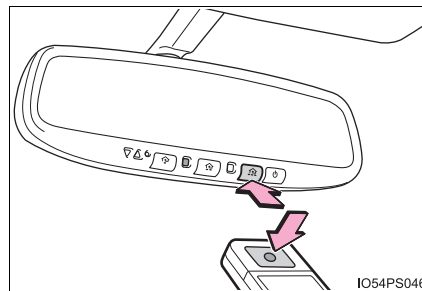

- ▶ Programming a device other than an entry gate (for U.S.A. owners)

Press and hold the remote control transmitter button until the HomeLink® indicator light changes from slowly flashing orange to rapidly flashing green (rolling code) or continuously lit green (fixed code), then release the button.

- ▶ Programming an entry gate (for U.S.A. owners)/Programming a device in the Canadian market

Press and release the remote control transmitter button at 2 second intervals, repeatedly, until the HomeLink® indicator light changes from slowly flashing orange to rapidly flashing green (rolling code) or continuously lit green (fixed code).

- 4 Test the HomeLink[®] operation by pressing the newly programmed button and observing the indicator light:
 - Indicator light illuminates: Programming of a fixed code device has completed. The garage door or other device should operate when a HomeLink[®] button is pressed and released.
 - Indicator light flashes rapidly: The garage door opener motor or other device is equipped with a rolling code. To complete programming, firmly press and hold the HomeLink[®] button for 2 seconds then release it.
 - If the garage door or other device does not operate, proceed to “Programming a rolling code system”.
- 5 Repeat the steps above to program another device for any of the remaining HomeLink[®] buttons.

■ Programming a rolling code system

2 or more people may be necessary to complete rolling code programming.

- 1 Locate the “Learn” or “Smart” button on the garage door opener motor in the garage.

This button can usually be found where the hanging antenna wire is attached to the unit. The name and color of the button may vary by manufacturer. Refer to the Owner’s manual supplied with the garage door opener motor for details.

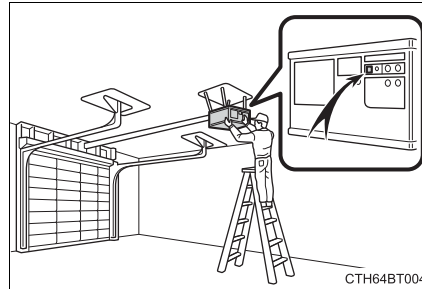

- 2 Press and release the “Learn” or “Smart” button. Perform 3 within 30 seconds after performing 2.

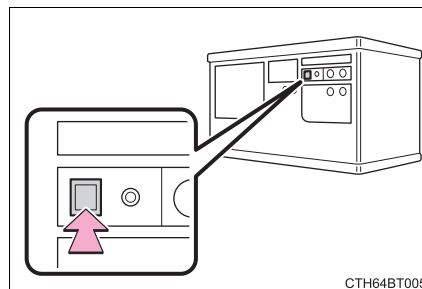

- 3 Press and hold the desired HomeLink® button (inside the vehicle) for 2 seconds and release it. Repeat this sequence (press/hold/release) up to 3 times to complete programming.

If the garage door opener motor operates when the HomeLink® button is pressed, the garage door opener motor recognizes the HomeLink® signal.

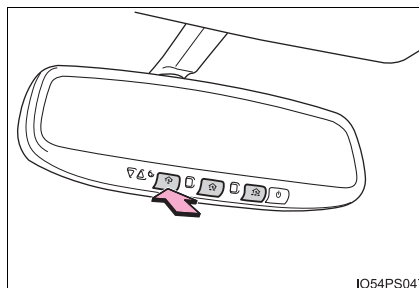

■ Enabling 2-way communication with a garage door (only available for compatible devices)

When enabled, 2-way communication allows you to check the status of the opening and closing of a garage door through indicators in your vehicle.

2-way communication is only available if the garage door opener motor used is a compatible device. (To check device compatibility, refer to www.HomeLink.com.)

- 1 Within 5 seconds after programming the garage door opener has been completed, if the garage door opener motor is trained to HomeLink®, both garage door operation indicators will flash rapidly green and the light on the garage door opener motor will blink twice, indicating that 2-way communication is enabled.

If the indicators do not flash, perform 2 and 3 within the first 10 presses of the HomeLink® button after programming has been completed.

- 2 Press a programmed HomeLink® button to operate a garage door.
- 3 Within 1 minute of pressing the HomeLink® button, after the garage door operation has stopped, press the “Learn” or “Smart” button on the garage door opener motor. Within 5 seconds of the establishment of 2-way communication with the garage door opener, both garage door operation indicators in the vehicle will flash rapidly green and the light on the garage door opener motor will blink twice, indicating that 2-way communication is enabled.

■ Reprogramming a single HomeLink® button

When the following procedure is performed, buttons which already have devices registered to them can be overwritten:

- 1 With one hand, press and hold the desired HomeLink® button.
- 2 When the HomeLink® indicator starts flashing orange, continue to hold the HomeLink® button and perform “Programming the HomeLink®” 1 (it takes 20 seconds for the HomeLink® indicator to start flashing).

Operating the HomeLink®

Press the appropriate HomeLink® button. The HomeLink® indicator light should turn on.

Garage door operation indicators

The status of the opening and closing of a garage door is shown by the indicators.

- 1 Opening
- 2 Closing

This function is only available if the garage door opener motor used is a compatible device. (To check device compatibility, refer to www.HomeLink.com.)

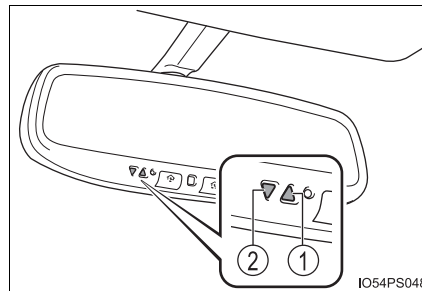

Color	Status
Orange (flashing)	Currently opening/closing
Green	Opening/closing has completed
Red (flashing)	Feedback signals cannot be received

The indicators can operate within approximately 820 ft. (250 m) of the garage door. However, if there are obstructions between the garage door and the vehicle, such as houses and trees, feedback signals from the garage door may not be received. To recall the previous door operation status, press and release either HomeLink® buttons

and or and simultaneously. The last recorded status will be displayed for 3 seconds.

Erasing the entire HomeLink® memory (all three codes)

Press and hold the 2 outside buttons for 10 seconds until the HomeLink® indicator light changes from continuously lit orange to rapidly flashing green.

If you sell your vehicle, be sure to erase the programs stored in the HomeLink® memory.

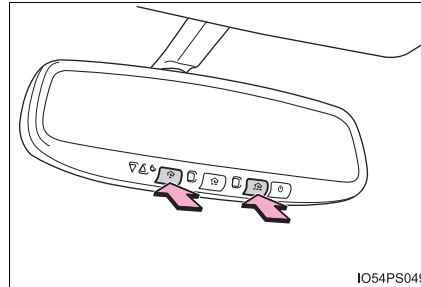

Codes stored in the HomeLink® memory

- The registered codes are not erased even if the battery cable is disconnected.
- If learning failed when registering a different code to a HomeLink® button that already has a code registered to it, the already registered code will not be erased.

Before programming

- Install a new battery in the transmitter.
- The battery side of the transmitter must be pointed away from the HomeLink®.

Certifications for the garage door opener

- ▶ For vehicles sold in the U.S.A. and Hawaii

This device complies with FCC rules part 15 and Innovation, Science, and Economic Development Canada RSS-210. Operation is subject to the following two conditions: (1) This device may not cause harmful interference, and (2) This device must accept any interference that may be received including interference that may cause undesired operation. WARNING: The transmitter has been tested and complies with FCC and ISED rules. Changes or modifications not expressly approved by the party responsible for compliance could void the user's authority to operate the device.

This equipment complies with FCC and ISED radiation exposure limits set forth for an uncontrolled environment. End Users must follow the specific operating instructions for satisfying RF exposure compliance. This transmitter must be at least 20 cm from the user and must not be co-located or operating in conjunction with any other antenna or transmitter.

► For vehicles sold in Canada

This device complies with FCC rules part 15 and Innovation, Science, and Economic Development Canada RSS-210. Operation is subject to the following two conditions: (1) This device may not cause harmful interference, and (2) This device must accept any interference that may be received including interference that may cause undesired operation. WARNING: The transmitter has been tested and complies with FCC and ISDE rules. Changes or modifications not expressly approved by the party responsible for compliance could void the user's authority to operate the device.

This equipment complies with FCC and ISDE radiation exposure limits set forth for an uncontrolled environment. End Users must follow the specific operating instructions for satisfying RF exposure compliance. This transmitter must be at least 20 cm from the user and must not be co-located or operating in conjunction with any other antenna or transmitter.

Cet appareil est conforme aux règlements de la FCC, section 15, et au CNR-210 d'Innovation, Sciences et Développement économique Canada. Le fonctionnement est assujéti aux deux conditions suivantes : (1) cet appareil ne doit pas causer d'interférences nuisibles et (2) cet appareil doit accepter toute interférence reçue, y compris celle qui pourrait entraîner un dysfonctionnement. MISE EN GARDE : L'émetteur a subi des tests et est conforme aux règlements de la FCC et d'ISDE. Les changements ou modifications non approuvés explicitement par la partie responsable de la conformité pourraient rendre caduque l'autorisation de l'utilisateur de se servir du dispositif.

Cet appareil est conforme aux limites d'exposition aux radiations de la FCC et d'ISDE établies pour un environnement non contrôlé. Les utilisateurs finaux doivent respecter les instructions d'utilisation spécifiques pour satisfaire aux exigences de conformité aux expositions de RF. L'émetteur doit se trouver à 20 cm au minimum de l'utilisateur et ne doit pas être situé au même endroit que tout autre émetteur ou antenne ni fonctionner avec un autre émetteur ou antenne.

■ When support is necessary

Visit on the web at www.homelink.com/toyota or call 1-800-355-3515.

 **WARNING**

■ When programming a garage door or other remote control device

The garage door or other device may operate, so ensure people and objects are out of danger to prevent potential harm.

■ Conforming to federal safety standards

Do not use the HomeLink[®] compatible transceiver with any garage door opener or device that lacks safety stop and reverse features as required by federal safety standards. This includes any garage door that cannot detect an interfering object. A door or device without these features increases the risk of death or serious injury.

■ When operating or programming HomeLink[®]

Never allow a child to operate or play with the HomeLink[®] buttons.

Maintenance and care

7

7-1. Maintenance and care	
Cleaning and protecting the vehicle exterior.....	576
Cleaning and protecting the vehicle interior.....	581
7-2. Maintenance	
Maintenance requirements.....	587
General maintenance.....	590
Emission inspection and maintenance (I/M) programs.....	593
7-3. Do-it-yourself maintenance	
Do-it-yourself service precautions	594
Hood	597
Positioning a floor jack	599
Engine compartment.....	600
Tires	614
Tire inflation pressure	623
Wheels	626
Replacing the tire	629
Air conditioning filter.....	640
Wiper insert replacement	644
Electronic key battery.....	647
Checking and replacing fuses	650
Headlight aim	653
Light bulbs.....	655

Cleaning and protecting the vehicle exterior

Perform the following to protect the vehicle and maintain it in prime condition:

- Working from top to bottom, liberally apply water to the vehicle body, wheel wells and underside of the vehicle to remove any dirt and dust.
- Wash the vehicle body using a sponge or soft cloth, such as a chamois.
- For hard-to-remove marks, use car wash soap and rinse thoroughly with water.
- Wipe away any water.
- Wax the vehicle when the waterproof coating deteriorates.

If water does not bead on a clean surface, apply wax when the vehicle body is cool.

■ Before car washes

Check that the fuel filler door and charging port lid on your vehicle are closed properly.

■ Automatic car washes

- Fold the mirrors before washing the vehicle. Start washing from the front of the vehicle. Make sure to extend the mirrors before driving.
- Brushes used in automatic car washes may scratch the vehicle surface, parts (wheel, etc.) and harm your vehicle's paint.
- Rear spoiler may not be washable in some automatic car washes. There may also be an increased risk of damage to vehicle.

■ High pressure car washes

As water may enter the cabin, do not bring the nozzle tip near the gaps around the doors or perimeter of the windows, or spray these areas continuously.

■ Note for a smart key system

If the door handle becomes wet while the electronic key is within the effective range, the door may lock and unlock repeatedly. In that case, follow the following correction procedures to wash the vehicle:

- Place the key in a position 6 ft. (2 m) or more separate from the vehicle while the vehicle is being washed. (Take care to ensure that the key is not stolen.)
- Set the electronic key to battery-saving mode to disable the smart key system. (→P. 294)

■ Wheels and wheel ornaments

- Remove any dirt immediately by using a neutral detergent.
- Wash detergent off with water immediately after use.
- To protect the paint from damage, make sure to observe the following precautions.
 - Do not use acidic, alkaline or abrasive detergent
 - Do not use hard brushes
 - Do not use detergent on the wheels when they are hot, such as after driving or parking in hot weather

■ Bumpers

Do not scrub with abrasive cleaners.

■ Front side windows water-repellent coating

The following precautions can extend the effectiveness of the water-repellent coating.

- Remove any dirt, etc. from the front side windows regularly.
- Do not allow dirt and dust to accumulate on the windows for a long period. Clean the windows with a soft, damp cloth as soon as possible.
- Do not use wax or glass cleaners that contain abrasives when cleaning the windows.
- Do not use any metallic objects to remove condensation build up.

■ Plated portions

If dirt cannot be removed, clean the parts as follows:

- Use a soft cloth dampened with an approximately 5% solution of neutral detergent and water to clean the dirt off.
- Wipe the surface with a dry, soft cloth to remove any remaining moisture.
- To remove oily deposits, use alcohol wet wipes or a similar product.

⚠ WARNING**■ When washing the vehicle**

Do not apply water to the inside of the engine compartment. Doing so may cause the electrical components etc. to catch fire.

■ While charging

Do not wash the vehicle.

Doing so may cause the electrical components to malfunction or catch fire and also you may get an electric shock that may result in death or serious injury.

■ When cleaning the windshield (vehicles with rain-sensing windshield wipers)

Set the wiper switch to the off position.

If the wiper switch is in the **AUTO** position, the wipers may operate unexpectedly in the following situations, and may result in hands being caught or other serious injuries and cause damage to the wiper blades.

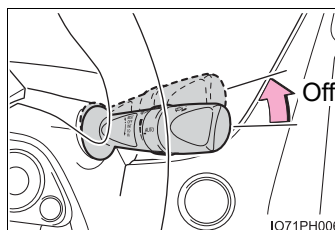

- When the upper part of the windshield where the raindrop sensor is located is touched by hand

- When a wet rag or similar is held close to the raindrop sensor

- If something bumps against the windshield

- If you directly touch the raindrop sensor body or if something bumps into the raindrop sensor

■ Precautions regarding the exhaust pipe

Exhaust gasses cause the exhaust pipe to become quite hot.

When washing the vehicle, be careful not to touch the pipe until it has cooled sufficiently, as touching a hot exhaust pipe can cause burns.

■ Precaution regarding the rear bumper with Blind Spot Monitor (if equipped)

If the paint of the rear bumper is chipped or scratched, the system may malfunction. If this occurs, consult your Toyota dealer.

 NOTICE

■ **To prevent paint deterioration and corrosion on the body and components (aluminum wheels etc.)**

- Wash the vehicle immediately in the following cases:
 - After driving near the sea coast
 - After driving on salted roads
 - If coal tar or tree sap is present on the paint surface
 - If dead insects, insect droppings or bird droppings are present on the paint surface
 - After driving in an area contaminated with soot, oily smoke, mine dust, iron powder or chemical substances
 - If the vehicle becomes heavily soiled with dust or mud
 - If liquids such as benzene and gasoline are spilled on the paint surface
- If the paint is chipped or scratched, have it repaired immediately.
- To prevent the wheels from corroding, remove any dirt and store in a place with low humidity when storing the wheels.

■ **To prevent damage to the windshield wiper arms**

When lifting the wiper arms away from the windshield pull the driver side wiper arm upward first, and repeat for the passenger's side. When returning the wipers to their original position, do so from the passenger's side first.

■ **Cleaning the exterior lights**

- Wash carefully. Do not use organic substances or scrub with a hard brush. This may damage the surfaces of the lights.
- Do not apply wax to the surfaces of the lights. Wax may cause damage to the lenses.

■ **When using an automatic car wash (vehicles with rain-sensing windshield wipers)**

Set the wiper switch to the off position.

If the wiper switch is in the **AUTO** position, the wipers may operate and the wiper blades may be damaged.

 NOTICE**■ When using a high pressure car wash**

- When washing the vehicle, do not let water of the high pressure washer hit directly or the vicinity of the camera. Due to the shock from the high pressure water, it is possible the device may not operate as normal.
- Do not bring the nozzle tip close to boots (rubber or resin manufactured cover), connectors or the following parts. The parts may be damaged if they come into contact with high-pressure water.
 - Traction related parts
 - Steering parts
 - Suspension parts
 - Brake parts
- Keep the cleaning nozzle at least 11.9 in. (30 cm) away from the vehicle body. Otherwise resin section, such as moldings and bumpers, may be deformed and damaged. Also, do not continuously hold the nozzle in the same place.
- Do not spray the lower part of the windshield continuously. If water enters the air conditioning system intake located near the lower part of the windshield, the air conditioning system may not operate correctly.
- Do not wash the underside of the vehicle using a high pressure car washer.
- Do not use the washer on the area around the charging port lid. Water could get into the charging inlet and could damage the vehicle.

■ When raising the windshield wiper arms

Make sure to hold the hook parts of the wiper arms to raise them.

Do not hold only the wiper blades when raising them, or it may cause deformation of the wiper blades.

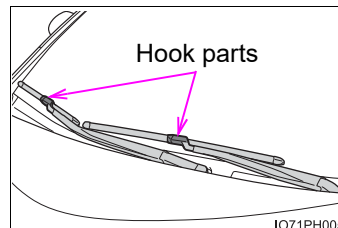

Cleaning and protecting the vehicle interior

The following procedures will help protect your vehicle's interior and keep it in top condition:

Protecting the vehicle interior

- Remove dirt and dust using a vacuum cleaner. Wipe dirty surfaces with a cloth dampened with lukewarm water.
- If dirt cannot be removed, wipe it off with a soft cloth dampened with neutral detergent diluted to approximately 1%.

Wring out any excess water from the cloth and thoroughly wipe off remaining traces of detergent and water.

Cleaning the leather areas

- Remove dirt and dust using a vacuum cleaner.
- Wipe off any excess dirt and dust with a soft cloth dampened with diluted detergent.

Use a diluted water solution of approximately 5% neutral wool detergent.

- Wring out any excess water from the cloth and thoroughly wipe off all remaining traces of detergent.
- Wipe the surface with a dry, soft cloth to remove any remaining moisture. Allow the leather to dry in a shaded and ventilated area.

Cleaning the synthetic leather areas

- Remove dirt and dust using a vacuum cleaner.
- Wipe it off with a soft cloth dampened with neutral detergent diluted to approximately 1%.
- Wring out any excess water from the cloth and thoroughly wipe off remaining traces of detergent and water.

Cleaning the air intake vents and filters

Clean the air intake vents and filters by the following procedures to prevent dust from accumulating in them, or to prevent them from clogging.

The filters are attached to the back side of the air intake vent grilles.

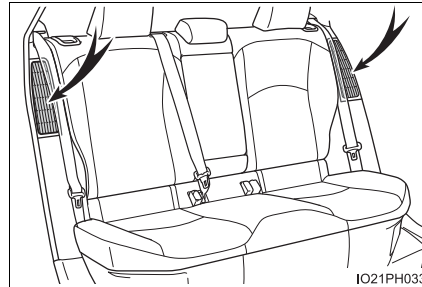

■ Cleaning the air intake vents and filters

Remove the dust from the vents and filters with a vacuum cleaner etc.

Clean the vents of the both sides.

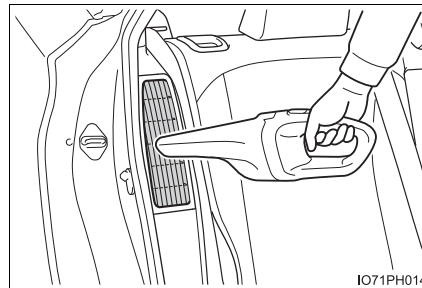

■ Cleaning the filters

If “Maintenance required for Traction battery cooling parts See owner’s manual” is shown on the multi-information display, remove the air intake vent grilles on the both sides of the rear seat and clean the filters.

- 1 Insert a flathead screwdriver etc. to the notch at the top of the grille, and disconnect the tab at the bottom to remove the grille.

Turn over the rubber portion beside the grille to insert the flat-head screwdriver.

To prevent damage, cover the tip of the flathead screwdriver with a rag.

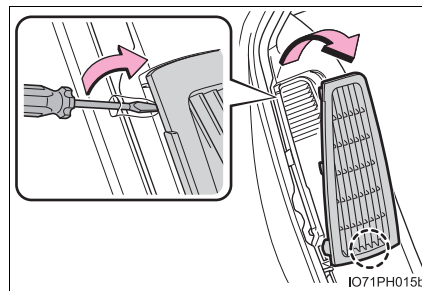

- 2 Remove the filter.

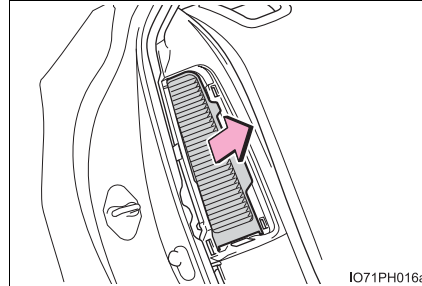

- 3 Remove dust using a vacuum cleaner etc. to clean the filter.

Also, remove dust on the grille as well as on the filter using a vacuum cleaner.

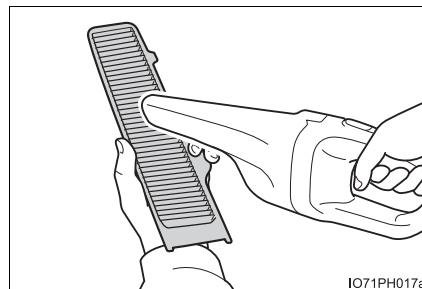

- 4 Reinstall the filter to the original position.

Be careful not to deform the filter or allow a gap between the filter and the installation position when installing the filter.

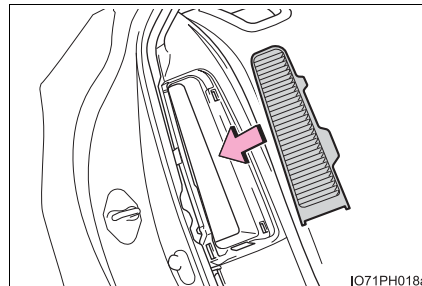

- 5 Insert the tab at the bottom of the grille to the position, and push the opposite side edge in to secure the grille.

Reinstall the grille to the original position while turning over the rubber portion.

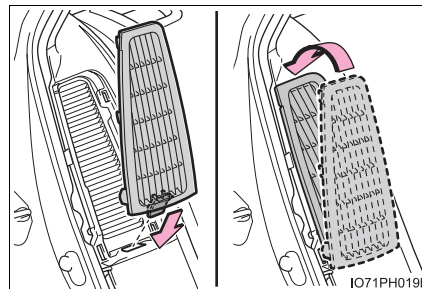

- 6 Start the hybrid system and check that the warning message on the multi-information display disappears.

It may take several minutes before the warning message disappears.

■ Caring for leather areas

Toyota recommends cleaning the interior of the vehicle at least twice a year to maintain the quality of the vehicle's interior.

■ Shampooing the carpets

There are several commercial foaming-type cleaners available. Use a sponge or brush to apply the foam. Rub in overlapping circles. Do not use water. Wipe dirty surfaces and let them dry. Excellent results are obtained by keeping the carpet as dry as possible.

■ Seat belts

Clean with mild soap and lukewarm water using a cloth or sponge. Also check the belts periodically for excessive wear, fraying or cuts.

■ Cleaning the air intake vents and filters

- Dust on the air intake vents or filters may interfere with cooling of the hybrid battery (traction battery) and results in poor electricity and fuel consumption. Clean the air intake vents and filters periodically.
- If continuing to drive the vehicle with "Maintenance required for Traction battery cooling parts See owner's manual" shown on the multi-information display, the hybrid battery (traction battery) may overheat, leading to decreasing in distance that can be driven using the electric motor. It may cause poor electricity and fuel consumption or a malfunction. If the warning message is shown, clean the air intake vents and filters immediately.
- Improper handling may result in damage to the grille or filters. If you have any concerns about cleaning the filters, contact your Toyota dealer.
- If the warning message on the multi-information display does not disappear after cleaning the filters, have the vehicle inspected by your Toyota dealer.
- Timing of cleaning filters differs depending on the use environment of the vehicle.

 **WARNING****■ Water in the vehicle**

- Do not splash or spill liquid in the vehicle, such as on the floor, in the hybrid battery (traction battery) air intake vent, and in the luggage compartment.
Doing so may cause the hybrid battery (traction battery), electrical components, etc. to malfunction or catch fire.
- Do not get any of the SRS components or wiring in the vehicle interior wet. (→P. 38)
An electrical malfunction may cause the airbags to deploy or not function properly, resulting in death or serious injury.
- Vehicles with wireless charger:
Do not let the wireless charger (→P. 557) get wet. Failure to do so may cause the charger to become hot and cause burns or could cause electric shock resulting in death or serious injury.

■ Cleaning the interior (especially instrument panel)

Do not use polish wax or polish cleaner. The instrument panel may reflect off the windshield, obstructing the driver's view and leading to an accident, resulting in death or serious injury.

 **NOTICE****■ Cleaning detergents**

- Do not use the following types of detergent, as they may discolor the vehicle interior or cause streaks or damage to painted surfaces:
 - Non-seat portions: Organic substances such as benzene or gasoline, alkaline or acidic solutions, dye, and bleach
 - Seats: Alkaline or acidic solutions, such as thinner, benzene, and alcohol
- Do not use polish wax or polish cleaner. The instrument panel's or other interior part's painted surface may be damaged.

■ Preventing damage to leather surfaces

Observe the following precautions to avoid damage to and deterioration of leather surfaces:

- Remove any dust or dirt from leather surfaces immediately.
- Do not expose the vehicle to direct sunlight for extended periods of time. Park the vehicle in the shade, especially during summer.
- Do not place items made of vinyl, plastic, or containing wax on the upholstery, as they may stick to the leather surface if the vehicle interior heats up significantly.

 NOTICE**■ Water on the floor**

Do not wash the vehicle floor with water.

Vehicle systems such as the audio system may be damaged if water comes into contact with electrical components such as the audio system above or under the floor of the vehicle. Water may also cause the body to rust.

■ When cleaning the inside of the windshield

Do not allow glass cleaner to contact the lens. Also, do not touch the lens. (→P. 377).

■ Cleaning the inside of the rear window

- Do not use glass cleaner to clean the rear window, as this may cause damage to the rear window defogger heater wires or antenna. Use a cloth dampened with lukewarm water to gently wipe the window clean. Wipe the window in strokes running parallel to the heater wires or antenna.

- Be careful not to scratch or damage the heater wires or antenna.

■ When cleaning the air intake vents and filters

Observe the following precautions. Failure to do so may cause damage to the vehicle.

- When removing the air intake vent grille, make sure to turn the power switch off to stop the hybrid system.

- Do not use water or other liquid to clean the air intake vents or filters.

- Do not allow water or foreign matter to enter the air intake vent when the grille is removed.

- Carefully handle the removed filters not to damage.

If the filter is damaged, have it replaced with a new filter by your Toyota dealer.

- Make sure to reinstall the filters and vents to its original positions after cleaning.

The shape of the left side and right side filters are different. When removing both filters, be careful not to mistake the left-right installation direction.

- Do not install anything but the filters exclusive for this vehicle to the air intake vents or use the vehicle without installing the filters.

Maintenance requirements

To ensure safe and economical driving, day-to-day care and regular maintenance are essential. It is the owner's responsibility to perform regular checks. Toyota recommends the following maintenance:

General maintenance

General maintenance should be performed on a daily basis. This can be done by yourself or by a Toyota dealer.

Scheduled maintenance

Scheduled maintenance should be performed at specified intervals according to the maintenance schedule.

For details about maintenance items and schedules, refer to the "Scheduled Maintenance Guide" or "Owner's Manual Supplement".

Do-it-yourself maintenance

You can perform some maintenance procedures by yourself. Please be aware that do-it-yourself maintenance may affect warranty coverage.

The use of Toyota repair manuals is recommended.

For details about warranty coverage, refer to the separate "Owner's Warranty Information Booklet" or "Owner's Manual Supplement".















■ Repair and replacement

It is recommended that genuine Toyota parts be used for repairs to ensure performance of each system. If non-Toyota parts are used in replacement or if a repair shop other than a Toyota dealer performs repairs, confirm the warranty coverage.

■ Resetting the message indicating maintenance is required (U.S.A. only)

After the required maintenance is performed according to the maintenance schedule, please reset the message.

To reset the message, follow the procedures described below:

- 1 While the hybrid system is operating, switch the multi-information display to the  screen. (→P. 246)
- 2 Press  or  of the meter control switches, select  (“Vehicle Settings”), and then press .
- 3 Press  or  of the meter control switches, select “Maintenance System”, and then press .
- 4 Press  or  of the meter control switches, select “Oil Maintenance”, and then press .
- 5 Press  or  of the meter control switches, select “Yes”, and then press .

A message will be displayed when the reset procedure has been completed.

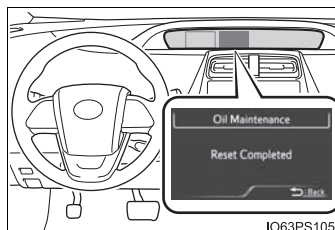

■ Allow inspection and repairs to be performed by a Toyota dealer

- Toyota technicians are well-trained specialists and are kept up to date with the latest service information. They are well informed about the operation of all systems on your vehicle.
- Keep a copy of the repair order. It proves that the maintenance that has been performed is under warranty coverage. If any problem should arise while your vehicle is under warranty, your Toyota dealer will promptly take care of it.

 **WARNING****■ If your vehicle is not properly maintained**

Improper maintenance could result in serious damage to the vehicle and possible serious injury or death.

■ Handling of the 12-volt battery

- Engine exhaust, some of its constituents, and a wide variety of automobile components contain or emit chemicals known to the State of California to cause cancer and birth defects and other reproductive harm. Work in a well ventilated area.
- Oils, fuels and fluids contained in vehicles as well as waste produced by component wear contain or emit chemicals known to the State of California to cause cancer and birth defects or other reproductive harm. Avoid exposure and wash any affected area immediately.
- 12-volt battery posts, terminals and related accessories contain lead and lead compounds which are known to cause brain damage. Wash your hands after handling. (→P. 607)

General maintenance

Listed below are the general maintenance items that should be performed at the intervals specified in the “Owner’s Warranty Information Booklet” or “Owner’s Manual Supplement/Scheduled Maintenance Guide”. It is recommended that any problem you notice should be brought to the attention of your Toyota dealer or qualified service shop for advice.

Engine compartment

Items	Check points
12-volt battery	Check the connections. (→P. 607)
Brake fluid	Is the brake fluid at the correct level? (→P. 610)
Engine/power control unit coolant	Is the engine/power control unit coolant at the correct level? (→P. 604)
Engine oil	Is the engine oil at the correct level? (→P. 601)
Exhaust system	There should not be any fumes or strange sounds.
Radiator/condenser	The radiator and condenser should be free from foreign objects. (→P. 606)
Washer fluid	Is there sufficient washer fluid? (→P. 612)

Vehicle interior

Items	Check points
Accelerator pedal	<ul style="list-style-type: none"> The accelerator pedal should move smoothly (without uneven pedal effort or catching).
Hybrid transmission "Park" mechanism	<ul style="list-style-type: none"> When parked on a slope and the shift position is in P, is the vehicle securely stopped?
Brake pedal	<ul style="list-style-type: none"> Does the brake pedal move smoothly? Does the brake pedal have appropriate clearance from the floor? (→P. 737) Does the brake pedal have the correct amount of free play? (→P. 737)
Brakes	<ul style="list-style-type: none"> The vehicle should not pull to one side when the brakes are applied. The brakes should work effectively. The brake pedal should not feel spongy. The brake pedal should not get too close to the floor when the brakes are applied.
Head restraints	<ul style="list-style-type: none"> Do the head restraints move smoothly and lock securely?
Indicators/buzzers	<ul style="list-style-type: none"> Do the indicators and buzzers function properly?
Lights	<ul style="list-style-type: none"> Do all the lights come on? Are the headlights aimed correctly? (→P. 653)
Parking brake	<ul style="list-style-type: none"> Does the parking brake pedal move smoothly? When parked on a slope and the parking brake is on, is the vehicle securely stopped?
Seat belts	<ul style="list-style-type: none"> Do the seat belts operate smoothly? The seat belts should not be damaged.
Seats	<ul style="list-style-type: none"> Do the seat controls operate properly?
Steering wheel	<ul style="list-style-type: none"> Does the steering wheel rotate smoothly? Does the steering wheel have the correct amount of free play? There should not be any strange sounds coming from the steering wheel.

Vehicle exterior

Items	Check points
Doors	<ul style="list-style-type: none"> Do the doors operate smoothly?
Engine hood	<ul style="list-style-type: none"> Does the engine hood lock system work properly?
Fluid leaks	<ul style="list-style-type: none"> There should not be any signs of fluid leakage after the vehicle has been parked.
Tires	<ul style="list-style-type: none"> Is the tire inflation pressure correct? The tires should not be damaged or excessively worn. Have the tires been rotated according to the maintenance schedule? The wheel nuts should not be loose.
Windshield wipers	<ul style="list-style-type: none"> The wiper blades should not show any signs of cracking, splitting, wear, contamination or deformation. The wiper blades should clear the windshield without streaking or skipping.

Charging equipment

Items	Check points
Charging cable	<ul style="list-style-type: none"> Check the conditions of the charging cable and charging connector. (→P. 120)

⚠ WARNING**■ If the hybrid system is operating**

Turn the hybrid system off and ensure that there is adequate ventilation before performing maintenance checks.

Emission inspection and maintenance (I/M) programs

Some states have vehicle emission inspection programs which include OBD (On Board Diagnostics) checks. The OBD system monitors the operation of the emission control system.

If the malfunction indicator lamp comes on

The OBD system determines that a problem exists somewhere in the emission control system. Your vehicle may not pass the I/M test and may need to be repaired. Contact your Toyota dealer to service the vehicle.

Your vehicle may not pass the I/M test in the following situations:

- When the 12-volt battery is disconnected or discharged
Readiness codes that are set during ordinary driving are erased. Also, depending on your driving habits, the readiness codes may not be completely set.
- When the fuel tank cap is loose
The malfunction indicator lamp comes on indicating a temporary malfunction and your vehicle may not pass the I/M test.

When the malfunction indicator lamp still remains on after several driving trips

The error code in the OBD system will not be cleared unless the vehicle is driven 40 or more times.

If your vehicle does not pass the I/M test

Contact your Toyota dealer to prepare the vehicle for re-testing.

Do-it-yourself service precautions

If you perform maintenance by yourself, be sure to follow the correct procedure as given in these sections.

Items	Parts and tools
12-volt battery condition (→P. 607)	<ul style="list-style-type: none"> • Grease • Conventional wrench (for terminal clamp bolts)
Brake fluid level (→P. 610)	<ul style="list-style-type: none"> • SAE J1703 or FMVSS No.116 DOT 3 or SAE J1704 or FMVSS No.116 DOT 4 brake fluid • Rag or paper towel • Funnel (used only for adding brake fluid)
Engine/power control unit coolant level (→P. 604)	<ul style="list-style-type: none"> • “Toyota Super Long Life Coolant” or a similar high quality ethylene glycol-based non-silicate, non-amine, non-nitrite and non-borate coolant with long-life hybrid organic acid technology <p>For the U.S.A.:</p> <p>“Toyota Super Long Life Coolant” is pre-mixed with 50% coolant and 50% deionized water.</p> <p>For Canada:</p> <p>“Toyota Super Long Life Coolant” is pre-mixed with 55% coolant and 45% deionized water.</p> <ul style="list-style-type: none"> • Funnel (used only for adding coolant)
Engine oil level (→P. 601)	<ul style="list-style-type: none"> • “Toyota Genuine Motor Oil” or equivalent • Rag or paper towel • Funnel (used only for adding engine oil)
Fuses (→P. 650)	<ul style="list-style-type: none"> • Fuse with same amperage rating as original
Hybrid battery (traction battery) air intake vent (→P. 582)	<ul style="list-style-type: none"> • Vacuum cleaner, etc. • Flathead screwdriver
Headlight aim (→P. 653)	<ul style="list-style-type: none"> • Phillips-head screwdriver
Light bulbs (→P. 655)	<ul style="list-style-type: none"> • Bulb with same number and wattage rating as original • Flathead screwdriver • Wrench
Radiator and condenser (→P. 606)	—

Items	Parts and tools
Tire inflation pressure (→P. 623)	<ul style="list-style-type: none"> • Tire pressure gauge • Compressed air source
Washer fluid (→P. 612)	<ul style="list-style-type: none"> • Water or washer fluid containing antifreeze (for winter use) • Funnel (used only for adding water or washer fluid)

 **WARNING**

The engine compartment contains many mechanisms and fluids that may move suddenly, become hot, or become electrically energized. To avoid death or serious injury, observe the following precautions.

■ **When working on the engine compartment**

- Make sure that the “Accessory”, “Ignition ON” or mileage display (→P. 210) on the main display and the “READY” indicator are both off.
- Keep hands, clothing and tools away from the moving fan.
- Be careful not to touch the engine, power control unit, radiator, exhaust manifold, etc. right after driving as they may be hot. Oil and other fluids may also be hot.
- Do not leave anything that may burn easily, such as paper and rags, in the engine compartment.
- Do not smoke, cause sparks or expose an open flame to fuel. Fuel fumes are flammable.
- Be extremely cautious when working on the 12-volt battery. It contains poisonous and corrosive sulfuric acid.

■ **When working near the electric cooling fans or radiator grille**

Be sure the power switch is off.

With the power switch in ON mode, the electric cooling fans may automatically start to run if the air conditioning is on and/or the coolant temperature is high. (→P. 606)

■ **Safety glasses**

Wear safety glasses to prevent flying or falling material, fluid spray, etc. from getting in your eyes.



NOTICE

■ **If you remove the air cleaner filter**

Driving with the air cleaner filter removed may cause excessive engine wear due to dirt in the air.

Hood

Release the lock from the inside of the vehicle to open the hood.

- 1 Pull the hood lock release lever.
The hood will pop up slightly.

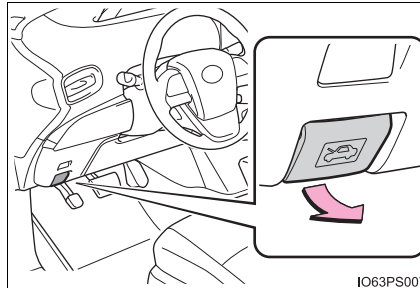

- 2 Pull the auxiliary catch lever and lift the hood.

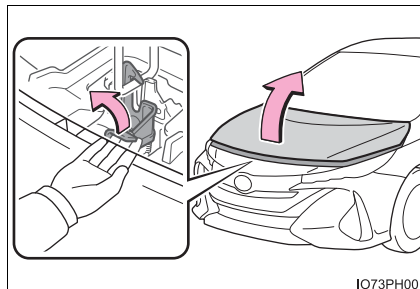

- 3 Hold the hood open by inserting the supporting rod into the slot.

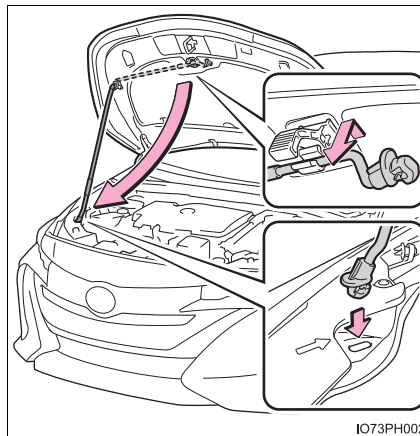

⚠ WARNING**■ Pre-driving check**

Check that the hood is fully closed and locked.

If the hood is not locked properly, it may open while the vehicle is in motion and cause an accident, which may result in death or serious injury.

■ To prevent burns

Do not touch the air conditioning pipes when the air conditioning compressor is operating or after it is stopped, because the air conditioning pipes are hot.

Touching by hands before the air conditioning pipes cool down may cause burns.

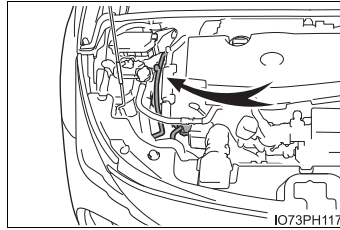
**■ After installing the support rod into the slot**

Make sure the rod supports the hood securely from falling down on to your head or body.

■ When closing the hood

When closing the hood, take extra care to prevent your fingers etc. from being caught.

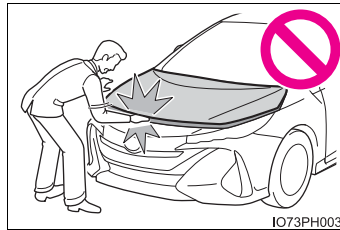
**⚠ NOTICE****■ When closing the hood**

Be sure to return the supporting rod to its clip before closing the hood. Closing the hood without returning the support rod properly could cause the hood to bend.

Positioning a floor jack

When using a floor jack, follow the instructions in the manual provided with the jack and perform the operation safely.

When raising your vehicle with a floor jack, position the jack correctly. Improper placement may damage your vehicle or cause injury.

◆ Front

Set a floor jack against the front suspension member.

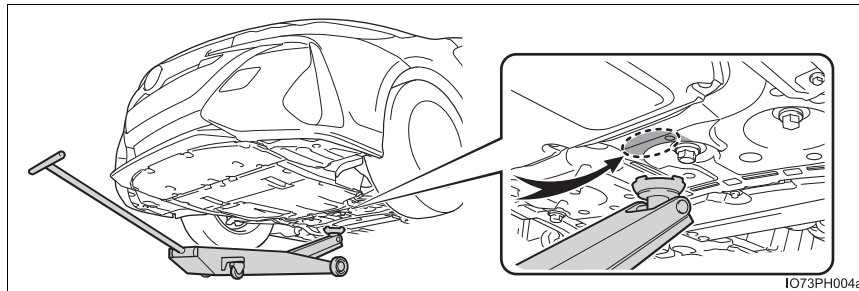

◆ Rear

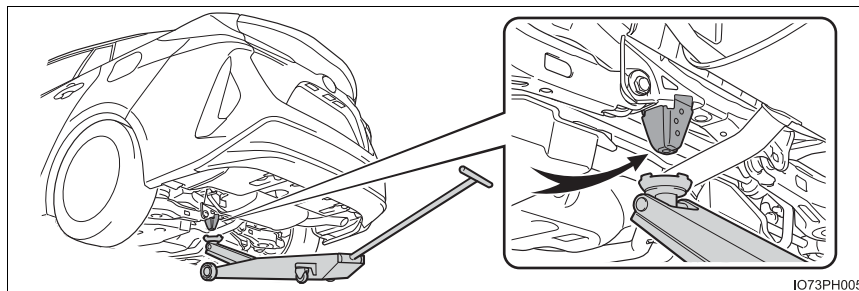

Engine compartment

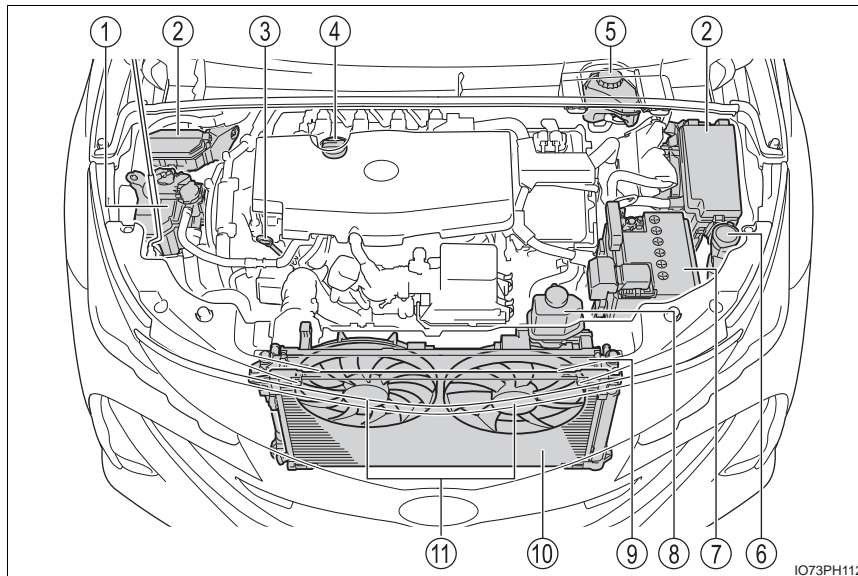

- | | |
|--|---|
| ① Engine coolant reservoir
(→P. 604) | ⑥ Washer fluid tank (→P. 612) |
| ② Fuse boxes (→P. 650) | ⑦ 12-volt battery (→P. 607) |
| ③ Engine oil level dipstick
(→P. 601) | ⑧ Power control unit coolant
reservoir (→P. 604) |
| ④ Engine oil filler cap (→P. 602) | ⑨ Radiator (→P. 606) |
| ⑤ Brake fluid reservoir
(→P. 610) | ⑩ Condenser (→P. 606) |
| | ⑪ Electric cooling fans |

Engine oil

With the engine at operating temperature and turned off, check the oil level on the dipstick.

■ Checking the engine oil

- 1 Park the vehicle on level ground. After warming up the engine and turning off the hybrid system, wait more than 5 minutes for the oil to drain back into the bottom of the engine.

- 2 Holding a rag under the end, pull the dipstick out.

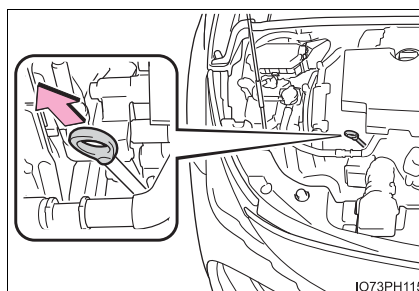

- 3 Wipe the dipstick clean.

- 4 Reinsert the dipstick fully.

- 5 Holding a rag under the end, pull the dipstick out and check the oil level.

- 1 Low
- 2 Normal
- 3 Excessive

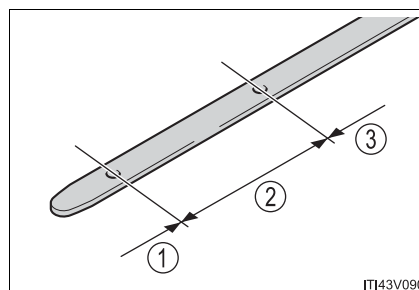

- 6 Wipe the dipstick and reinsert it fully.

■ Adding engine oil

If the oil level is below or near the low level mark, add engine oil of the same type as that already in the engine.

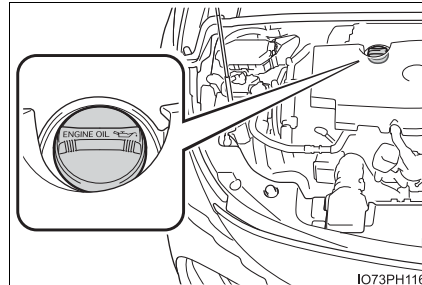

Make sure to check the oil type and prepare the items needed before adding oil.

Engine oil selection	→P. 734
Oil quantity (Low → Full)	1.6 qt. (1.5 L, 1.3 Imp.qt.)
Items	Clean funnel

- 1 Remove the oil filler cap by turning it counterclockwise.
- 2 Add engine oil slowly, checking the dipstick.
- 3 Install the oil filler cap by turning it clockwise.

■ Engine oil consumption

A certain amount of engine oil will be consumed while driving. In the following situations, oil consumption may increase, and engine oil may need to be refilled in between oil maintenance intervals.

- When the engine is new, for example directly after purchasing the vehicle or after replacing the engine
- If low quality oil or oil of an inappropriate viscosity is used
- When driving at high engine speeds or with a heavy load, or when driving while accelerating or decelerating frequently
- When leaving the engine idling for a long time, or when driving frequently through heavy traffic

 **WARNING****■ Used engine oil**

- Used engine oil contains potentially harmful contaminants which may cause skin disorders such as inflammation and skin cancer, so care should be taken to avoid prolonged and repeated contact. To remove used engine oil from your skin, wash thoroughly with soap and water.
- Dispose of used oil and filters only in a safe and acceptable manner. Do not dispose of used oil and filters in household trash, in sewers or onto the ground. Call your Toyota dealer, service station or auto parts store for information concerning recycling or disposal.
- Do not leave used engine oil within the reach of children.

 **NOTICE****■ To prevent serious engine damage**

Check the oil level on a regular basis.

■ When replacing the engine oil

- Be careful not to spill engine oil on the vehicle components.
- Avoid overfilling, or the engine could be damaged.
- Check the oil level on the dipstick every time you refill the vehicle.
- Be sure the engine oil filler cap is properly tightened.

Coolant

The coolant level is satisfactory if it is between the “MAX” and “MIN” lines on the reservoir when the hybrid system is cold.

■ Engine coolant reservoir

- ① Reservoir cap
- ② “MAX” line
- ③ “MIN” line

If the level is on or below the “MIN” line, add coolant up to the “MAX” line. (→P. 721)

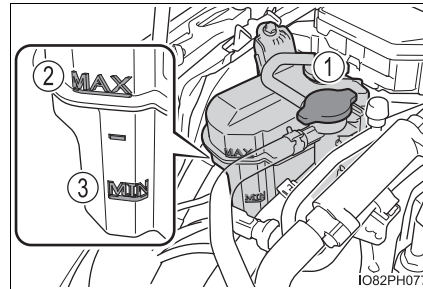

■ Power control unit coolant reservoir

- ① Reservoir cap
- ② “FULL” line
- ③ “LOW” line

If the level is on or below the “LOW” line, add coolant up to the “FULL” line. (→P. 721)

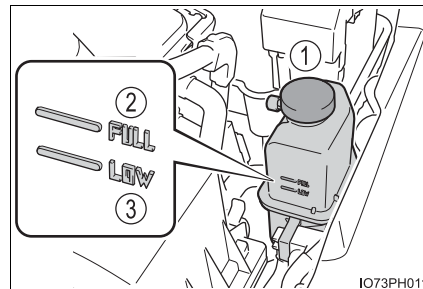

■ Coolant selection

Only use “Toyota Super Long Life Coolant” or a similar high quality ethylene glycol based non-silicate, non-amine, non-nitrite, and non-borate coolant with long-life hybrid organic acid technology.

U.S.A.:

“Toyota Super Long Life Coolant” is a mixture of 50% coolant and 50% deionized water. (Minimum temperature: -31°F [-35°C])

Canada:

“Toyota Super Long Life Coolant” is a mixture of 55% coolant and 45% deionized water. (Minimum temperature: -44°F [-42°C])

For more details about coolant, contact your Toyota dealer.

■ If the coolant level drops within a short time of replenishing

Visually check the radiator, hoses, engine/power control unit coolant reservoir caps, drain cock and water pump.

If you cannot find a leak, have your Toyota dealer test the cap and check for leaks in the cooling system.

WARNING

■ When the hybrid system is hot

Do not remove the engine/power control unit coolant reservoir caps.

The cooling system may be under pressure and may spray hot coolant if the cap is removed, causing serious injuries, such as burns.

NOTICE

■ When adding coolant

Coolant is neither plain water nor straight antifreeze. The correct mixture of water and antifreeze must be used to provide proper lubrication, corrosion protection and cooling. Be sure to read the antifreeze or coolant label.

■ If you spill coolant

Be sure to wash it off with water to prevent it from damaging parts or paint.

Radiator and condenser

Check the radiator and condenser and clear away any foreign objects. If either of the above parts is extremely dirty or you are not sure of their condition, have your vehicle inspected by your Toyota dealer.

WARNING

■ **When the hybrid system is hot**

Do not touch the radiator or condenser as they may be hot and cause serious injuries, such as burns.

■ **When the electric cooling fans are operating**

Do not touch the engine compartment.

With the power switch in ON mode, the electric cooling fans may automatically start to run if the air conditioning is on and/or the coolant temperature is high. Be sure the power switch is off when working near the electric cooling fans or radiator grille.

12-volt battery

Check the 12-volt battery as follows:

■ 12-volt battery exterior

Make sure that the 12-volt battery terminals are not corroded and that there are no loose connections, cracks, or loose clamps.

Terminals

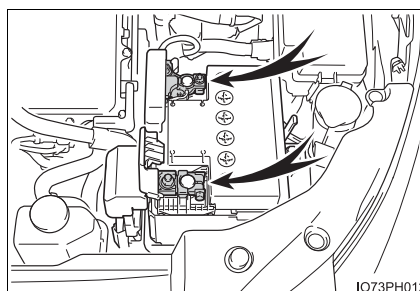

IO73PH012

■ When opening the cover of the positive (+) battery terminal

While pushing the portion shown in the illustration from both sides, lift the end of the cover up.

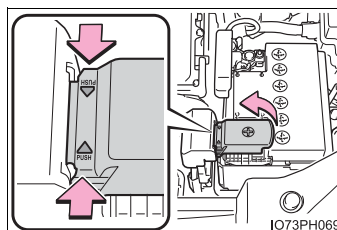

IO73PH069

■ Before recharging

When recharging, the 12-volt battery produces hydrogen gas which is flammable and explosive. Therefore, observe the following precautions before recharging:

- If recharging with the 12-volt battery installed on the vehicle, be sure to disconnect the ground cable.
- Make sure the power switch on the charger is off when connecting and disconnecting the charger cables to the 12-volt battery.

■ After recharging/reconnecting the 12-volt battery

- Unlocking the doors using the smart key system may not be possible immediately after reconnecting the 12-volt battery. If this happens, use the wireless remote control or the mechanical key to lock/unlock the doors.
- Start the hybrid system with the power switch in ACCESSORY mode. The hybrid system may not start with the power switch turned off. However, the hybrid system will operate normally from the second attempt.
- The power switch mode is recorded by the vehicle. If the 12-volt battery is reconnected, the vehicle will return the power switch mode to the status it was in before the 12-volt battery was disconnected. Make sure to turn off the power before disconnect the 12-volt battery. Take extra care when connecting the 12-volt battery if the power switch mode prior to discharge is unknown.

If the system will not start even after multiple attempts at all methods above, contact your Toyota dealer.



WARNING

■ Chemicals in the 12-volt battery

The 12-volt battery contains poisonous and corrosive sulfuric acid and may produce hydrogen gas which is flammable and explosive. To reduce the risk of death or serious injury, take the following precautions while working on or near the 12-volt battery:

- Do not cause sparks by touching the 12-volt battery terminals with tools.
- Do not smoke or light a match near the 12-volt battery.
- Avoid contact with eyes, skin and clothes.
- Never inhale or swallow electrolyte.
- Wear protective safety glasses when working near the 12-volt battery.
- Keep children away from the 12-volt battery.

■ Where to safely charge the 12-volt battery

Always charge the 12-volt battery in an open area. Do not charge the 12-volt battery in a garage or closed room where there is insufficient ventilation.

■ How to recharge the 12-volt battery

Only perform a slow charge (5 A or less). The 12-volt battery may explode if charged at a quicker rate.

 **WARNING****■ Emergency measures regarding electrolyte**

- If electrolyte gets in your eyes
Flush your eyes with clean water for at least 15 minutes and get immediate medical attention. If possible, continue to apply water with a sponge or cloth while traveling to the nearest medical facility.
- If electrolyte gets on your skin
Wash the affected area thoroughly. If you feel pain or burning, get medical attention immediately.
- If electrolyte gets on your clothes
It can soak through clothing on to your skin. Immediately take off the clothing and follow the procedure above if necessary.
- If you accidentally swallow electrolyte
Drink a large quantity of water or milk. Get emergency medical attention immediately.

■ When disconnecting the 12-volt battery

Do not disconnect the negative (-) terminal on the body side. The disconnected negative (-) terminal may touch the positive (+) terminal, which may cause a short and result in death or serious injury.

 **NOTICE****■ When recharging the 12-volt battery**

Never recharge the 12-volt battery while the hybrid system is operating. Also, be sure all accessories are turned off.

Brake fluid

■ Checking fluid level

The brake fluid level should be between the “MAX” and “MIN” lines on the tank.

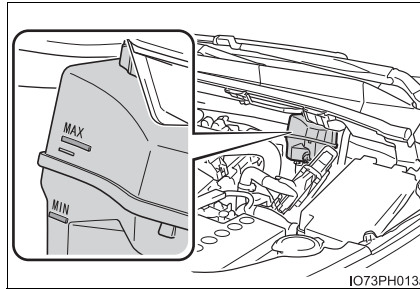

■ Adding fluid

- 1 Slide and lift up the rubber strip to partly remove it as shown.

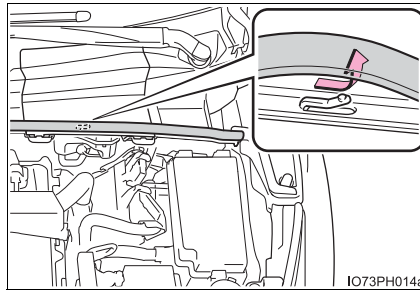

- 2 Disconnect the claws and remove the service cover.

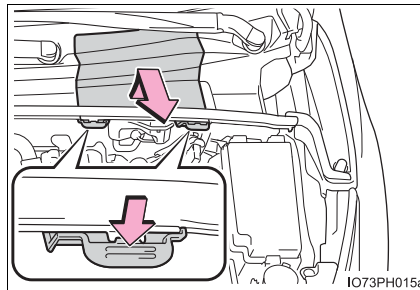

- 3 Remove the reservoir cap.

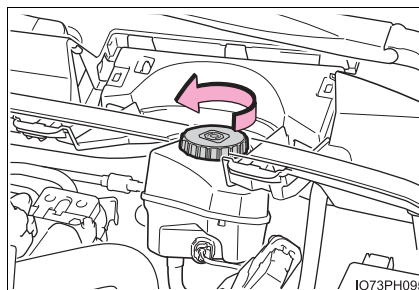

- 4 Add brake fluid slowly while checking the fluid level.

Make sure to check the fluid type and prepare the necessary item.

Fluid type	SAE J1703 or FMVSS No.116 DOT 3 brake fluid SAE J1704 or FMVSS No.116 DOT 4 brake fluid
Items	Clean funnel

■ **Brake fluid can absorb moisture from the air**

Excess moisture in the brake fluid can cause a dangerous loss of braking efficiency. Use only newly opened brake fluid.

⚠ WARNING

■ **When filling the reservoir**

Take care as brake fluid can harm your hands and eyes and damage painted surfaces.

If fluid gets on your hands or in your eyes, flush the affected area with clean water immediately.

If you still experience discomfort, see a doctor.

⚠ NOTICE

■ **If the brake fluid level is low or high**

It is normal for the brake fluid level to go down slightly as the brake pads wear out or when the fluid level in the accumulator is high.

If the reservoir needs frequent refilling, there may be a serious problem.

Washer fluid

- 1 Open the lid.

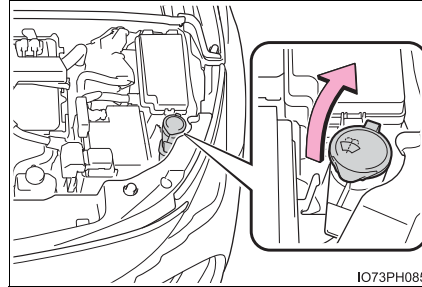

- 2 Check the washer fluid level on the level gauge.

- ① "NORMAL"
- ② "LOW"

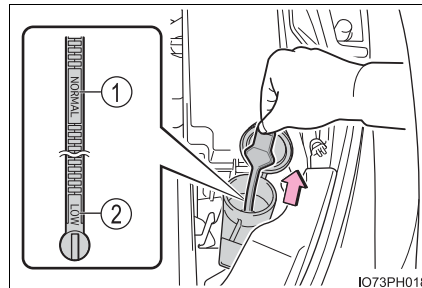

- 3 If the washer fluid level is at "LOW", add washer fluid.

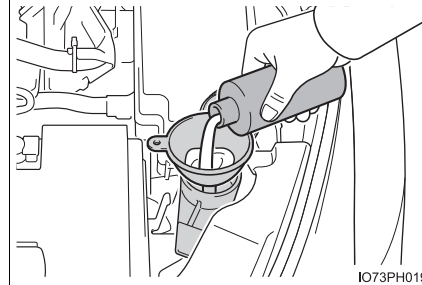

 **WARNING****■ When adding washer fluid**

Do not add washer fluid when the hybrid system is hot or operating as washer fluid contains alcohol and may catch fire if spilled on the engine etc.

 **NOTICE****■ Do not use any fluid other than washer fluid**

Do not use soapy water or engine antifreeze instead of washer fluid. Doing so may cause streaking on the vehicle's painted surfaces, as well as damaging the pump leading to problems of the washer fluid not spraying.

■ Diluting washer fluid

Dilute washer fluid with water as necessary.
Refer to the freezing temperatures listed on the label of the washer fluid bottle.

Tires

Replace or rotate tires in accordance with maintenance schedules and treadwear.

Checking tires

Check if the treadwear indicators are showing on the tires. Also check the tires for uneven wear, such as excessive wear on one side of the tread.

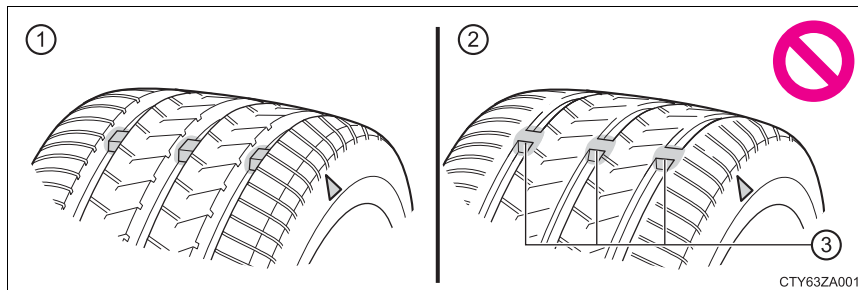

- ① New tread
- ② Worn tread
- ③ Treadwear indicator

The location of treadwear indicators is shown by the “TWI” or “Δ” mark, etc., molded into the sidewall of each tire.

Replace the tires if the treadwear indicators are showing on a tire.

Tire rotation

Rotate the tires in the order shown.

To equalize tire wear and extend tire life, Toyota recommends that tire rotation is carried out at the same interval as tire inspection.

Do not fail to initialize the tire pressure warning system after tire rotation.

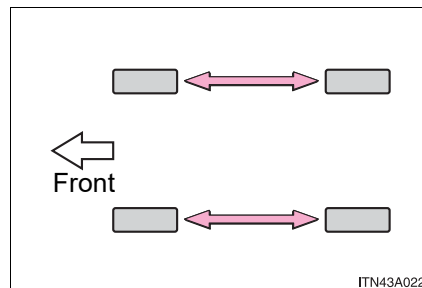

Tire pressure warning system

Your vehicle is equipped with a tire pressure warning system that uses tire pressure warning valves and transmitters to detect low tire inflation pressure before serious problems arise.

If the tire pressure drops below a predetermined level, the driver is warned by a warning light. (→P. 677)

◆ Installing tire pressure warning valves and transmitters

When replacing tires or wheels, tire pressure warning valves and transmitters must also be installed.

When new tire pressure warning valves and transmitters are installed, new ID codes must be registered in the tire pressure warning computer and the tire pressure warning system must be initialized. Have tire pressure warning valve and transmitter ID codes registered by your Toyota dealer. (→P. 616)













◆ Initializing the tire pressure warning system

■ The tire pressure warning system must be initialized in the following circumstances:

- When rotating front and rear tires which have different tire inflation pressures
- When the tire inflation pressure is changed such as when changing traveling speed or load weight

When the tire pressure warning system is initialized, the current tire inflation pressure is set as the benchmark pressure.

■ How to initialize the tire pressure warning system

- 1 Park the vehicle in a safe place and turn the power switch off.
Initialization cannot be performed while the vehicle is moving.
- 2 Adjust the tire inflation pressure to the specified cold tire inflation pressure level. (→P. 737)
Make sure to adjust the tire pressure to the specified cold tire inflation pressure level. The tire pressure warning system will operate based on this pressure level.
- 3 Turn the power switch to ON mode.
- 4 Switch the multi-information display to the  screen.
(→P. 246)
- 5 Press  or  of the meter control switches, select  (“Vehicle Settings”), and then press .
- 6 Press  or  of the meter control switches, select “Maintenance System”, and then press .
- 7 Press  or  of the meter control switches, select “TPMS”, and then press .
- 8 Press and hold .
- 9 When initialization completes, a message is displayed on the multi-information display and the tire pressure warning light illuminates.

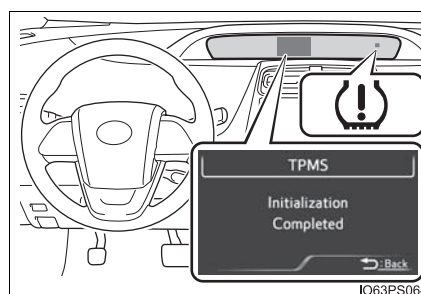

◆ Registering ID codes

The tire pressure warning valve and transmitter is equipped with a unique ID code. When replacing a tire pressure warning valve and transmitter, it is necessary to register the ID code. Have the ID code registered by your Toyota dealer.

■ When to replace your vehicle's tires

Tires should be replaced if:

- The treadwear indicators are showing on a tire.
- You have tire damage such as cuts, splits, cracks deep enough to expose the fabric, and bulges indicating internal damage.
- A tire goes flat repeatedly or cannot be properly repaired due to the size or location of a cut or other damage.

If you are not sure, consult with your Toyota dealer.

■ Replacing tires and wheels

If the ID code of the tire pressure warning valve and transmitter is not registered, the tire pressure warning system will not work properly. After driving for about 20 minutes, the tire pressure warning light blinks for 1 minute and stays on to indicate a system malfunction.

■ Tire life

Any tire over 6 years old must be checked by a qualified technician even if it has seldom or never been used or damage is not obvious.

■ Routine tire inflation pressure checks

The tire pressure warning system does not replace routine tire inflation pressure checks. Make sure to check tire inflation pressure as part of your routine of daily vehicle checks.

■ Maximum load of tire

Check that the maximum load of the replacement tire is greater than 1/2 of the Gross Axle Weight Ratings (GAWR) of either the front axle or the rear axle, whichever is greater.

For the GAWR, see the Certification Label. For the maximum load of the tire, see the load limit at maximum cold tire inflation pressure mentioned on the sidewall of the tire. (→P. 742)

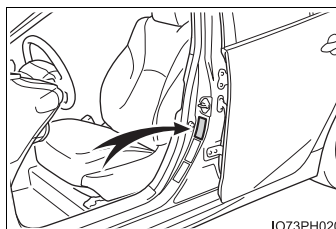

■ Tire types**● Summer tires**

Summer tires are high-speed performance tires best suited to highway driving under dry conditions. Since summer tires do not have the same traction performance as snow tires, summer tires are inadequate for driving on snow-covered or icy roads. For driving on snow-covered roads or icy roads, the use of snow tires is recommended. When installing snow tires, be sure to replace all four tires.

● All season tires

All season tires are designed to provide better traction in snow and to be adequate for driving in most winter conditions as well as for use year-round. All season tires, however, do not have adequate traction performance compared with snow tires in heavy or loose snow. Also, all season tires fall short in acceleration and handling performance compared with summer tires in highway driving.

● Snow tires

For driving on snow-covered roads or icy roads, we recommend using snow tires. If you need snow tires, select tires of the same size, construction and load capacity as the originally installed tires. Since your vehicle has radial tires as original equipment, make sure your snow tires also have radial construction. Do not install studded tires without first checking local regulations for possible restrictions. Snow tires should be installed on all wheels. (→P. 507)

■ If the tread on snow tires wears down below 0.16 in. (4 mm)

The effectiveness of the tires as snow tires is lost.

■ Situations in which the tire pressure warning system may not operate properly

- In the following cases, the tire pressure warning system may not operate properly.
 - If non-genuine Toyota wheels are used.
 - When a replacement tire is used, the system may not operate correctly due to the structure of the replacement tire.
 - A tire has been replaced with a tire that is not of the specified size.
 - Tire chains etc. are equipped.
 - An auxiliary-supported run-flat tire is equipped.
 - If a window tint that affects the radio wave signals is installed.
 - If there is a lot of snow or ice on the vehicle, particularly around the wheels or wheel housings.
 - If the tire inflation pressure is extremely higher than the specified level.
 - If wheel without the tire pressure warning valve and transmitter is used.
 - If the ID code on the tire pressure warning valves and transmitters is not registered in the tire pressure warning computer.
- Performance may be affected in the following situations.
 - Near a TV tower, electric power plant, gas station, radio station, large display, airport or other facility that generates strong radio waves or electrical noise
 - When carrying a portable radio, cellular phone, cordless phone or other wireless communication device
- When the vehicle is parked, the time taken for the warning to start or go off could be extended.
- When tire inflation pressure declines rapidly for example when a tire has burst, the warning may not function.

■ The initialization operation

- Make sure to carry out initialization after adjusting the tire inflation pressure.
Also, make sure the tires are cold before carrying out initialization or tire inflation pressure adjustment.
- If you have accidentally turned the power switch off during initialization, it is not necessary to press the reset switch again as initialization will restart automatically when the power switch has been turned to ON mode for the next time.
- If you accidentally press the reset switch when initialization is not necessary, adjust the tire inflation pressure to the specified level when the tires are cold, and conduct initialization again.

■ **When initialization of the tire pressure warning system has failed**

Initialization can be completed in a few minutes. However, in the following cases, the settings have not been recorded and the system will not operate properly. If repeated attempts to record tire inflation pressure settings are unsuccessful, have the vehicle inspected by your Toyota dealer.

- When operating the initialization of the system, the tire pressure warning light does not flash 3 times and the setting message does not appear on the multi-information display.
- After driving for a certain period of time since the initialization has been completed, the warning light comes on after blinking for 1 minute.

■ **Certifications for the tire pressure warning system**

- ▶ For vehicles sold in the U.S.A. and Hawaii

FCC ID: PAXPMVC015

NOTE

This device complies with part 15 of the FCC Rules. Operation is subject to the following two conditions:
(1) This device may not cause harmful interference, and (2) this device must accept any interference received, including interference that may cause undesired operation.

FCC WARNING

Changes or modifications not expressly approved by the party responsible for compliance could void the user's authority to operate the equipment.

► For vehicles sold in Canada

Model:PMV-C015

NOTE

This device complies with Industry Canada licence-exempt RSS standard(s). Operation is subject to the following two conditions: (1) this device may not cause interference, and (2) this device must accept any interference, including interference that may cause undesired operation of the device.

NOTE

Le présent appareil est conforme aux CNR d'Industrie Canada applicables aux appareils radio exempts de licence. L'exploitation est autorisée aux deux conditions suivantes : (1) l'appareil ne doit pas produire de brouillage, et (2) l'utilisateur de l'appareil doit accepter tout brouillage radioélectrique subi, même si le brouillage est susceptible d'en compromettre le fonctionnement.

WARNING

■ When inspecting or replacing tires

Observe the following precautions to prevent accidents. Failure to do so may cause damage to parts of the drive train as well as dangerous handling characteristics, which may lead to an accident resulting in death or serious injury.

- Do not mix tires of different makes, models or tread patterns. Also, do not mix tires of remarkably different treadwear.
- Do not use tire sizes other than those recommended by Toyota.
- Do not mix differently constructed tires (radial, bias-belted or bias-ply tires).
- Do not mix summer, all season and snow tires.
- Do not use tires that have been used on another vehicle. Do not use tires if you do not know how they were used previously.

■ When initializing the tire pressure warning system

Do not initialize the tire pressure warning system without first adjusting the tire inflation pressure to the specified level. Otherwise, the tire pressure warning light may not come on even if the tire inflation pressure is low, or it may come on when the tire inflation pressure is actually normal.

 NOTICE**■ Repairing or replacing tires, wheels, tire pressure warning valves, transmitters and tire valve caps**

- When removing or fitting the wheels, tires or the tire pressure warning valves and transmitters, contact your Toyota dealer as the tire pressure warning valves and transmitters may be damaged if not handled correctly.
- Make sure to install the tire valve caps. If the tire valve caps are not installed, water could enter the tire pressure warning valves and the tire pressure warning valves could be bound.
- When replacing tire valve caps, do not use tire valve caps other than those specified. The cap may become stuck.

■ To avoid damage to the tire pressure warning valves and transmitters

When a tire is repaired with liquid sealants, the tire pressure warning valve and transmitter may not operate properly. If a liquid sealant is used, contact your Toyota dealer or other qualified service shop as soon as possible. After use of liquid sealant, make sure to replace the tire pressure warning valve and transmitter when repairing or replacing the tire. (→P. 615)

■ Driving on rough roads

Take particular care when driving on roads with loose surfaces or potholes.

These conditions may cause losses in tire inflation pressure, reducing the cushioning ability of the tires. In addition, driving on rough roads may cause damage to the tires themselves, as well as the vehicle's wheels and body.

■ If tire inflation pressure of each tire becomes low while driving

Do not continue driving, or your tires and/or wheels may be ruined.

Tire inflation pressure

Tire inflation pressure

The recommended cold tire inflation pressure and tire size are displayed on the tire and loading information label. (→P. 737)

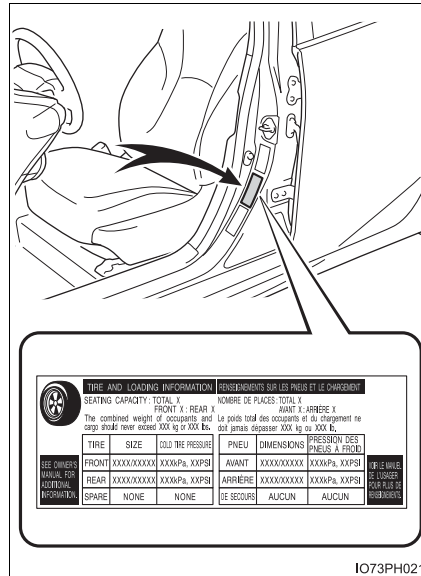

Inspection and adjustment procedure

- ① Tire valve
- ② Tire pressure gauge

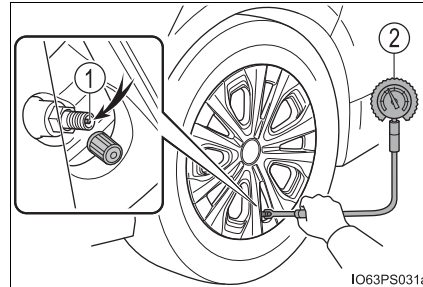

- 1 Remove the tire valve cap.
- 2 Press the tip of the tire pressure gauge onto the tire valve.
- 3 Read the pressure using the gauge gradations.
- 4 If the tire inflation pressure is not at the recommended level, adjust the pressure.
If you add too much air, press the center of the valve to deflate.
- 5 After completing the tire inflation pressure measurement and adjustment, apply soapy water to the valve and check for leakage.
- 6 Put the tire valve cap back on.

■ Tire inflation pressure check interval

You should check tire inflation pressure every two weeks, or at least once a month.

Do not forget to check the spare.

■ Effects of incorrect tire inflation pressure

Driving with incorrect tire inflation pressure may result in the following:

- Reduced fuel economy
- Reduced driving comfort and poor handling
- Reduced tire life due to wear
- Reduced safety
- Damage to the drive train

If a tire needs frequent inflating, have it checked by your Toyota dealer.

■ Instructions for checking tire inflation pressure

When checking tire inflation pressure, observe the following:

- Check only when the tires are cold.
If your vehicle has been parked for at least 3 hours or has not been driven for more than 1 mile or 1.5 km, you will get an accurate cold tire inflation pressure reading.
- Always use a tire pressure gauge.
It is difficult to judge if a tire is properly inflated based only on its appearance.
- It is normal for the tire inflation pressure to be higher after driving as heat is generated in the tire. Do not reduce tire inflation pressure after driving.
- Never exceed the vehicle capacity weight.
Passengers and luggage weight should be placed so that the vehicle is balanced.

WARNING

■ Proper inflation is critical to save tire performance

Keep your tires properly inflated.

If the tires are not properly inflated, the following conditions may occur which could lead to an accident resulting in death or serious injury:

- Excessive wear
- Uneven wear
- Poor handling
- Possibility of blowouts resulting from overheated tires
- Air leaking from between tire and wheel
- Wheel deformation and/or tire damage
- Greater possibility of tire damage while driving (due to road hazards, expansion joints, sharp edges in the road, etc.)

NOTICE

■ When inspecting and adjusting tire inflation pressure

Be sure to put the tire valve caps back on.

If a valve cap is not installed, dirt or moisture may get into the valve and cause an air leak, resulting in decreased tire inflation pressure.

Wheels

If a wheel is bent, cracked or heavily corroded, it should be replaced. Otherwise, the tire may separate from the wheel or cause a loss of handling control.

Wheel selection

When replacing wheels, care should be taken to ensure that they are equivalent to those removed in load capacity, diameter, rim width and inset*.

Replacement wheels are available at your Toyota dealer.

*: Conventionally referred to as "offset".

Toyota does not recommend using the following:

- Wheels of different sizes or types
- Used wheels
- Bent wheels that have been straightened

Aluminum wheel precautions

- Use only Toyota wheel nuts and wrenches designed for use with your aluminum wheels.
- When rotating, repairing or changing your tires, check that the wheel nuts are still tight after driving 1000 miles (1600 km).
- Be careful not to damage the aluminum wheels when using tire chains.
- Use only Toyota genuine balance weights or equivalent and a plastic or rubber hammer when balancing your wheels.

■ When replacing wheels

The wheels of your vehicle are equipped with tire pressure warning valves and transmitters that allow the tire pressure warning system to provide advance warning in the event of a loss in tire inflation pressure. Whenever wheels are replaced, tire pressure warning valves and transmitters must be installed. (→P. 615)

⚠ WARNING**■ When replacing wheels**

- Do not use wheels that are a different size from those recommended in the Owner's Manual, as this may result in a loss of handling control.
- Never use an inner tube in a leaking wheel which is designed for a tubeless tire. Doing so may result in an accident, causing death or serious injury.

■ When installing the wheel nuts

Never use oil or grease on the wheel bolts or wheel nuts. Oil and grease may cause the wheel nuts to be excessively tightened, leading to bolt or disc wheel damage. In addition, the oil or grease can cause the wheel nuts to loosen and the wheel may fall off, causing an accident and resulting in death or serious injury. Remove any oil or grease from the wheel bolts or wheel nuts.

■ Use of defective wheels prohibited

Do not use cracked or deformed wheels. Doing so could cause the tire to leak air during driving, possibly causing an accident.

 NOTICE**■ Replacing tire pressure warning valves and transmitters**

- Because tire repair or replacement may affect the tire pressure warning valves and transmitters, make sure to have tires serviced by your Toyota dealer or other qualified service shop. In addition, make sure to purchase your tire pressure warning valves and transmitters at your Toyota dealer.
- Ensure that only genuine Toyota wheels are used on your vehicle. Tire pressure warning valves and transmitters may not work properly with non-genuine wheels.

Replacing the tire

When raising your vehicle with a jack, position the jack correctly.

Improper placement may damage your vehicle or cause injury.

Before jacking up the vehicle

- Stop the vehicle in a safe place on a hard, flat surface.
- Set the parking brake.
- Shift the shift position to P.
- Stop the hybrid system.

Location of the jack and tools

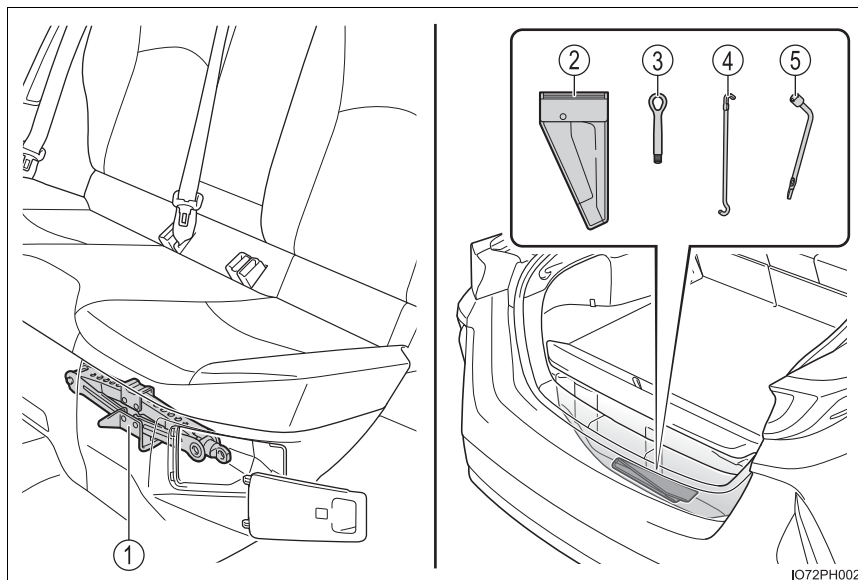

- ① Jack
- ② Tool bag
- ③ Towing eyelet

- ④ Jack handle
- ⑤ Wheel nut wrench

⚠ WARNING

■ **Using the tire jack**

Observe the following precautions.

Improper use of the tire jack may cause the vehicle to suddenly fall off the jack, leading to death or serious injury.

- Only use the tire jack that comes with this vehicle for replacing a tire. Do not use it on other vehicles, and do not use other tire jacks for replacing tires on this vehicle.
- Do not raise the vehicle while someone is inside.
- Do not use the tire jack for any purpose other than replacing tires or installing and removing tire chains.
- Put the jack properly in its jack point.
(→P. 635)

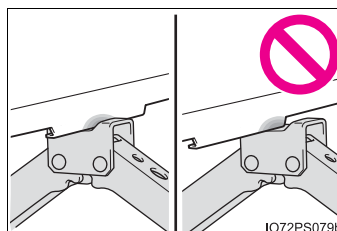

- Do not put any part of your body under the vehicle while it is supported by the jack.
- Do not start the hybrid system or drive the vehicle while the vehicle is supported by the jack.
- When raising the vehicle, do not put an object on or under the jack.
- Do not raise the vehicle to a height greater than that required to replace the tire.
- Use a jack stand if it is necessary to get under the vehicle.
- When lowering the vehicle, make sure that there is no-one near the vehicle. If there are people nearby, warn them vocally before lowering.

■ **When removing the jack from the storage location**

The jack may be hot due to heat from the charging equipment during or after charging. Please use gloves when handling the jack. If it is touched with bare hands, it may result in burns.

Taking out the tools

- 1 Open the back door. (→P. 287)
- 2 Lift the deck under box cover up and take out the tool bag.

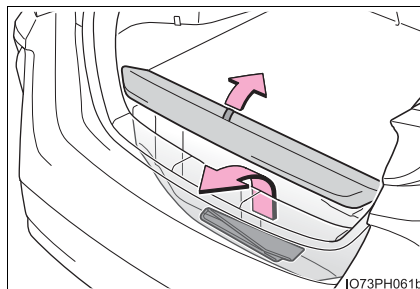

- 3 Open the tool bag and then take out the jack handle and wheel nut wrench.

After using the tools, stow them by reversing the steps listed.

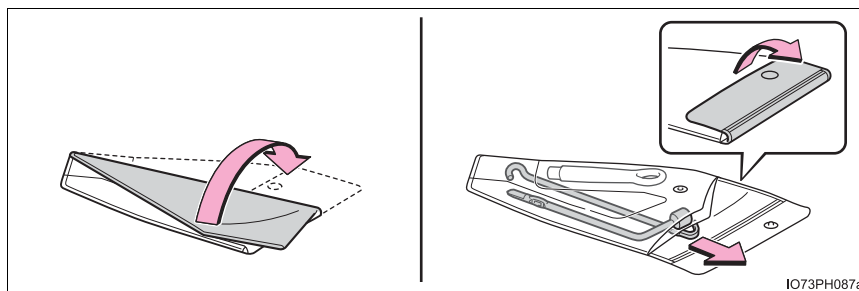

Taking out the jack

- 1 Pull the cover to disconnect the tabs, and remove the cover.

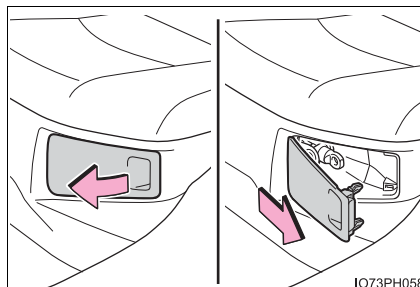

- 2 Turn the portion (A) to loosen the jack, and slowly take out the jack.

Be careful when handling the jack, as it may become hot depending on conditions.
(→P. 631)

If the portion (A) can not be loosened, turn it using the jack handle.

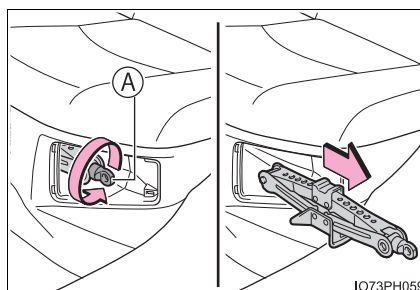

Replacing a tire

- 1 Check the tires.

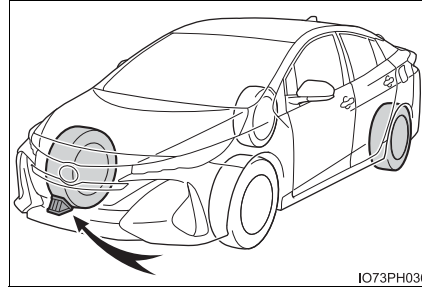

Tire position		Wheel chock positions
Front	Left-hand side	Behind the rear right-hand side tire
	Right-hand side	Behind the rear left-hand side tire
Rear	Left-hand side	In front of the front right-hand side tire
	Right-hand side	In front of the front left-hand side tire

- 2 Vehicles with the wheel ornament: Remove the wheel ornament using the wrench. To prevent damage, cover the tip of the wrench with a rag.

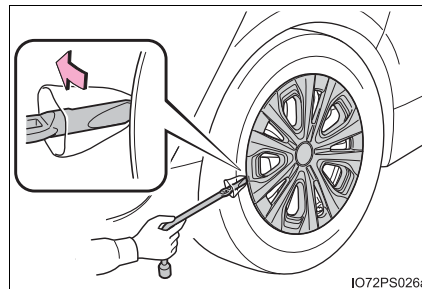

- 3 Slightly loosen the wheel nuts (one turn).

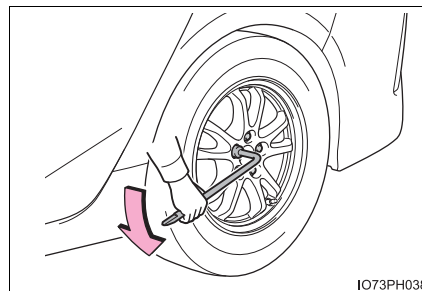

- 4 Turn the tire jack portion (A) by hand until the center of the recessed portion of the jack is in contact with the center of the jack point.

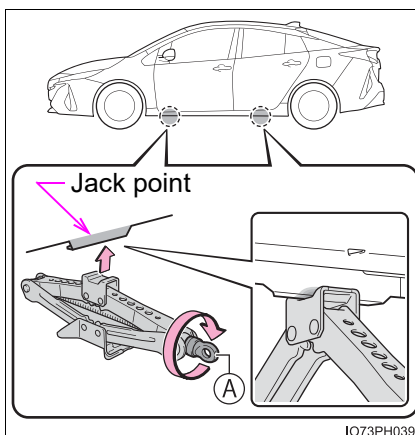

- 5 Assemble the jack handle and the wheel nut wrench as shown in the illustration.

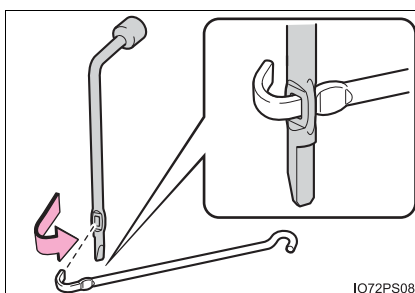

- 6 Raise the vehicle until the tire is slightly raised off the ground.

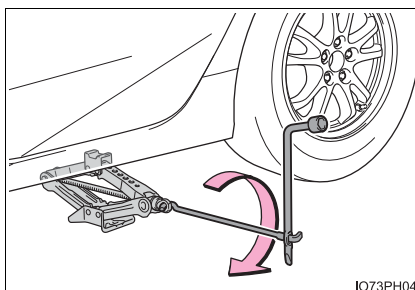

- 7 Remove all the wheel nuts and the tire.

When resting the tire on the ground, place the tire so that the wheel design faces up to avoid scratching the wheel surface.

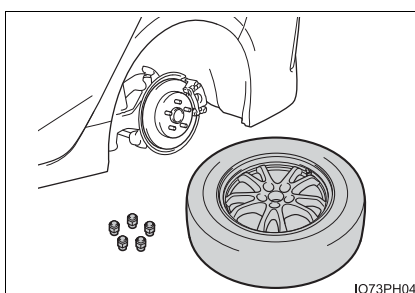

 **WARNING****■ Replacing a tire**

- Do not touch the disc wheels or the area around the brakes immediately after the vehicle has been driven.
After the vehicle has been driven the disc wheels and the area around the brakes will be extremely hot. Touching these areas with hands, feet or other body parts while changing a tire, etc. may result in burns.
- Failure to follow these precautions could cause the wheel nuts to loosen and the tire to fall off, resulting in death or serious injury.
 - Have the wheel nuts tightened with a torque wrench to 76 ft•lbf (103 N•m, 10.5 kgf•m) as soon as possible after changing wheels.
 - When installing a tire, only use wheel nuts that have been specifically designed for that wheel.
 - If there are any cracks or deformations in the bolt screws, nut threads or bolt holes of the wheel, have the vehicle inspected by your Toyota dealer.
 - When installing the wheel nuts, be sure to install the wheel nuts with the tapered ends facing inward. (→P. 627)

Installing the tire

- 1 Remove any dirt or foreign matter from the wheel contact surface.

If foreign matter is on the wheel contact surface, the wheel nuts may loosen while the vehicle is in motion, causing the tire to come off.

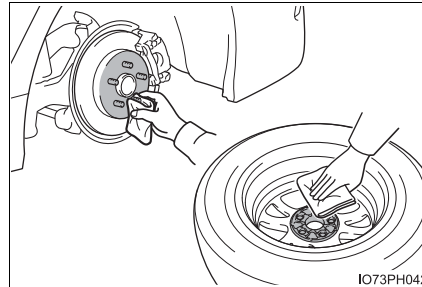

- 2 Install the tire and loosely tighten each wheel nut by hand by approximately the same amount.

Turn the wheel nuts until the washers come into contact with the disc wheel.

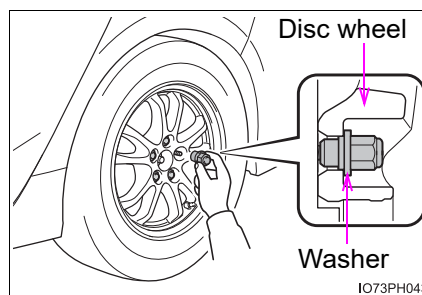

- 3 Lower the vehicle.

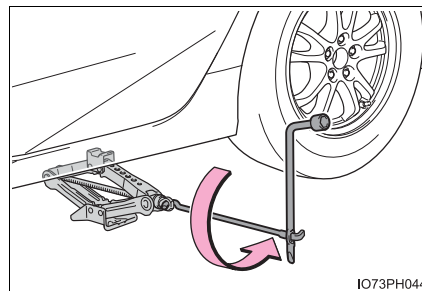

- 4 Firmly tighten each wheel nut two or three times in the order shown in the illustration.

Tightening torque:
76 ft•lbf (103 N•m, 10.5 kgf•m)

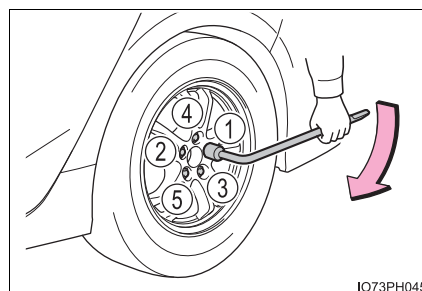

- 5 Vehicles with the wheel ornament: Reinstall the wheel ornament.

Align the cutout of the wheel ornament with the valve stem as shown.

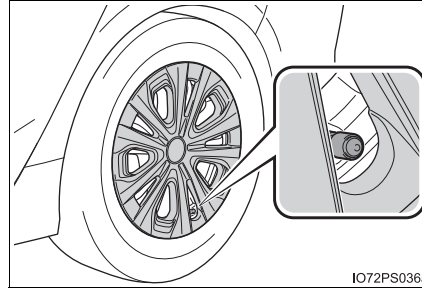

- 6 Stow the tire jack and all tools.

■ Jack point

The mark indicating the jack point is stamped on the underside of the vehicle.

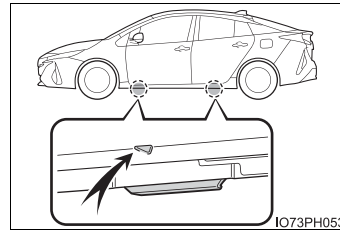

■ Storing the jack

Fully insert the jack in the stowing position, and turn the portion (A) to secure the jack.

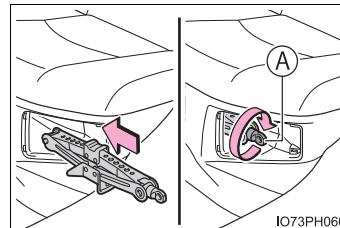

 **WARNING****■ After using the tools and jack**

Before driving, make sure all the tools and jack are securely in place in their storage location to reduce the possibility of personal injury during a collision or sudden braking.

 **NOTICE****■ When replacing the tires**

When removing or fitting the wheels, tires or the tire pressure warning valve and transmitter, contact your Toyota dealer as the tire pressure warning valve and transmitter may be damaged if not handled correctly.

Air conditioning filter

The air conditioning filter must be changed regularly to maintain air conditioning efficiency.

Replacing the air conditioning filter

- 1 Turn the power switch off.

Confirm that the charging connector is not connected. Also, do not use the Remote Air Conditioning System during the procedure.

- 2 Open the front passenger's door.

By keeping the door open, unexpected operation of the Remote Air Conditioning System can be prevented. (→P. 536)

- 3 Open the glove box and slide off the damper.

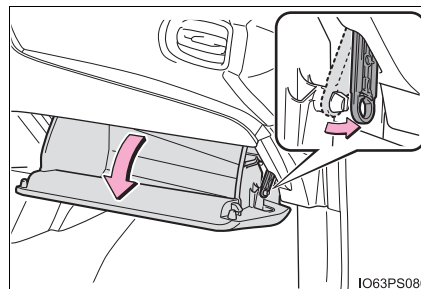

- 4 Push in each side of the glove box to disconnect the claws, and then slowly and fully open the glove box while supporting it.

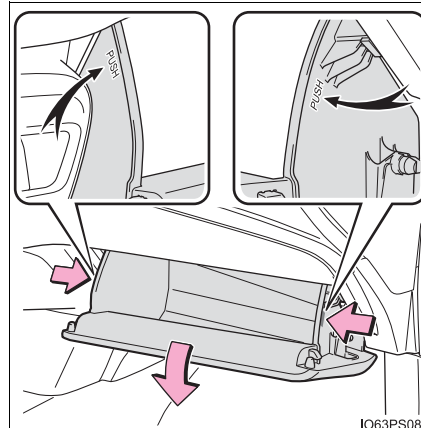

- 5 With the glove box fully open, slightly lift up the glove box and pull toward the seat to detach the bottom of the glove box.

Do not use excessive force if the glove box does not detach when lightly pulled. Instead, pull toward the seat while slightly adjusting the height of the glove box.

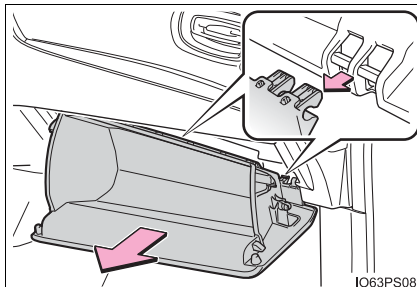

- 6 Remove the filter cover.

- 1 Unlock the filter cover.
- 2 Move the filter cover in the direction of the arrow, and then pull it out of the claws.

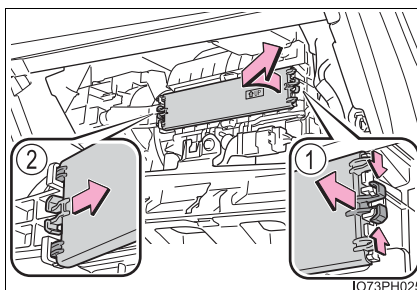

- 7 Remove the filter case.

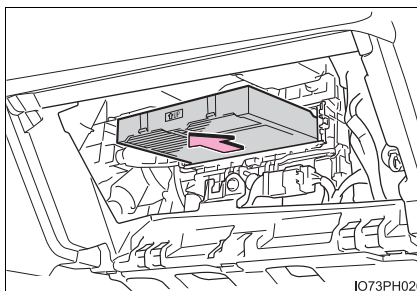

- 8 Remove the air conditioning filter from the filter case and replace it with a new one.

The "↑UP" marks shown on the filter should be pointing up.

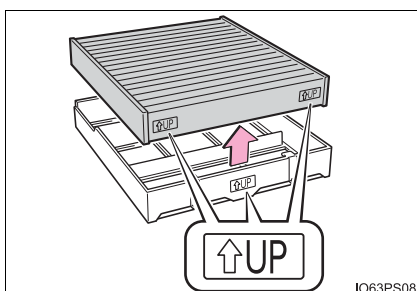

- 9 When installing, reverse the steps listed.

■ **Checking interval**

Inspect and replace the air conditioning filter according to the maintenance schedule. In dusty areas or areas with heavy traffic flow, early replacement may be required. (For scheduled maintenance information, please refer to the “Scheduled Maintenance Guide” or “Owner’s Manual Supplement”.)

■ **If air flow from the vents decreases dramatically**

The filter may be clogged. Check the filter and replace if necessary.



WARNING

■ **When replacing the air conditioning filter**

Observe the following precautions. Failure to do so may result in the air conditioning system operating during the procedure, possibly resulting in injury.

- Check that the charging connector is not connected
The air conditioning may operate due to the “Climate Prep” (→P. 157) or “Traction Battery Cooler” (→P. 136) setting.
- Do not use the Remote Air Conditioning System

 NOTICE**■ When using the air conditioning system**

Make sure that a filter is always installed.

Using the air conditioning system without a filter may cause damage to the system.

■ When removing the glove box

Always follow the specified procedure to remove the glove box (→P. 640). If the glove box is removed without following the specified procedure, the hinge of the glove box may become damaged.

■ To prevent damage to the filter cover

When moving the filter cover in the direction of arrow to release the fitting, pay attention not to apply excessive force to the claws. Otherwise, the claws may be damaged.

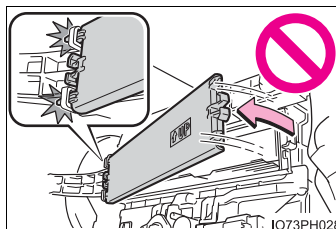

Wiper insert replacement

When replacing the wiper insert, perform the following procedure.

Windshield wiper blade removal and installation

- 1 While securely supporting the wiper blade connection by hand, press the lock knob to release the lock, and then pull out the wiper blade.

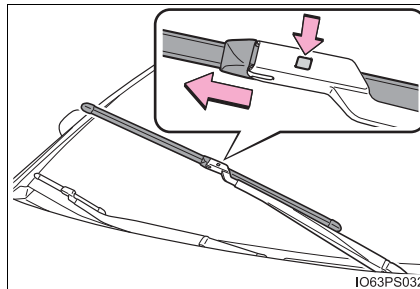

- 2 Align the wiper blade with the connecting portion of the wiper arm, and then slide it in the direction it was removed from.
After installing the wiper blade, check that the connection is locked.

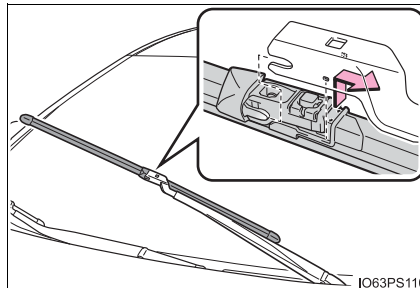

Wiper insert replacement

- 1 Pull the wiper insert until it protrudes from the slit on the back of the wiper blade.

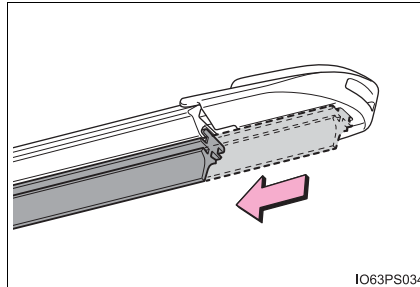

- 2 Pull out the end of the wiper insert from the slit, and then pull out the rest of the wiper insert.

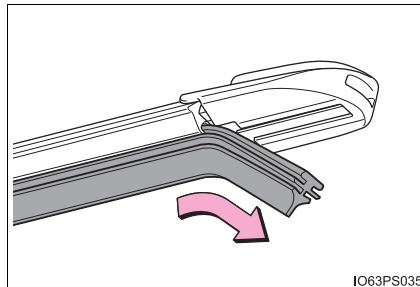

- 3 When installing a new wiper insert, perform the procedure in reverse.

After installation, check that the end of the wiper insert is installed all the way to the end of the cap.

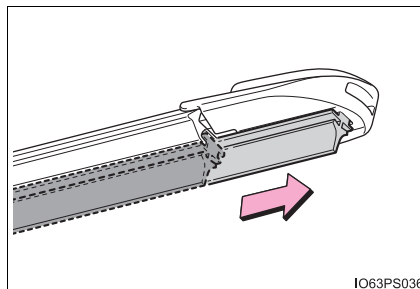

■ **Wiper blade and wiper insert handling**

Improper handling may result in damage to the wiper blades or wiper insert. If you have any concerns about replacing the wiper blades or wiper insert yourself, contact your Toyota dealer.

■ **Wiper blade cap**

The cap cannot be removed, as it is integrated with the front wiper blade.



NOTICE

■ **To prevent damage**

- Be careful not to damage the claws when replacing the wipers.
- After the wiper blade is removed from the wiper arm, place a cloth, etc., between the windshield and wiper arm to prevent damage to the windshield.
- Be sure not to pull excessively on the wiper insert.

Electronic key battery

Replace the battery with a new one if it is depleted.

You will need the following items:

- Flathead screwdriver
- Lithium battery CR2032

Replacing the battery

- 1 Release the lock and take out the mechanical key.

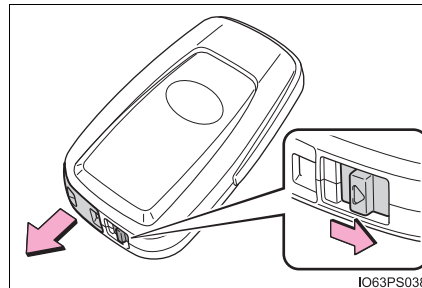

- 2 Remove the cover.

Use a screwdriver of an appropriate size. Forcedly prying may cause the cover damaged.

To prevent damage to the key, cover the tip of the screwdriver with a rag.

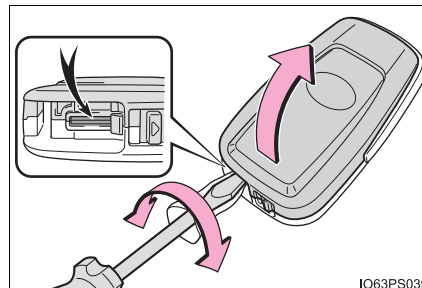

3 Remove the depleted battery.

When removing the cover, if the battery cannot be seen due to the electronic key module attaching to the upper cover, remove the electronic key module from the cover so that the battery is visible as shown in the illustration.

When removing the battery, use a screwdriver of an appropriate size.

Insert a new battery with the “+” terminal facing up.

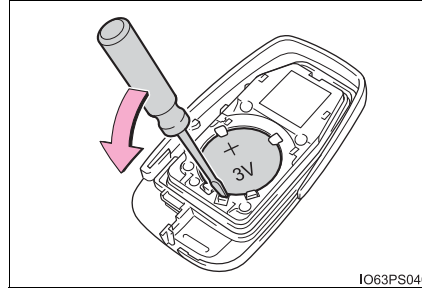

4 When installing, reverse the steps listed.

■ **Use a CR2032 lithium battery**

- Batteries can be purchased at your Toyota dealer, local electrical appliance shops or camera stores.
- Replace only with the same or equivalent type recommended by the manufacturer.
- Dispose of used batteries according to the local laws.

■ **If the electronic key battery is depleted**

The following symptoms may occur:

- The smart key system and wireless remote control will not function properly.
- The operational range will be reduced.

 **WARNING****■ Battery precautions**

Observe the following precautions.

Failure to do so may result in death or serious injury.

- Do not swallow the battery. Doing so may cause chemical burns.
- A coin battery or button battery is used in the electronic key. If a battery is swallowed, it may cause severe chemical burns in as little as 2 hours and may result in death or serious injury.
- Keep away new and removed batteries from children.
- If the cover cannot be firmly closed, stop using the electronic key and stow the key in the place where children cannot reach, and then contact your Toyota dealer.
- If you accidentally swallow a battery or put a battery into a part of your body, get emergency medical attention immediately.

■ To prevent battery explosion or leakage of flammable liquid or gas

- Replace the battery with a new battery of the same type. If a wrong type of battery is used, it may explode.
- Do not expose batteries to extremely low pressure due to high altitude or extremely high temperatures.
- Do not burn, break or cut a battery.

 **NOTICE****■ For normal operation after replacing the battery**

Observe the following precautions to prevent accidents:

- Always work with dry hands.
Moisture may cause the battery to rust.
- Do not touch or move any other component inside the remote control.
- Do not bend either of the battery terminals.

Checking and replacing fuses

If any of the electrical components do not operate, a fuse may have blown. If this happens, check and replace the fuses as necessary.

- 1 Turn the power switch off.

Confirm that the charging connector is not connected. Also, do not use the Remote Air Conditioning System during the procedure.

- 2 Open the fuse box cover.

► Engine compartment type A fuse box

While pushing the 2 claws, lift up the cover.

When closing the cover, make sure to attach the 2 claws.

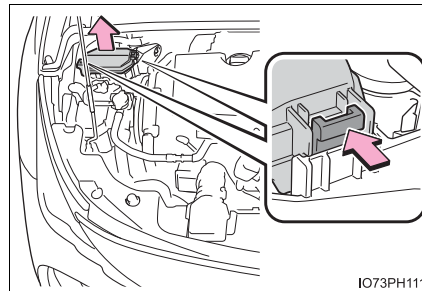

IO73PH111

► Engine compartment type B fuse box

While pushing the 3 claws, lift up the cover.

When closing the cover, make sure to attach the 3 claws.

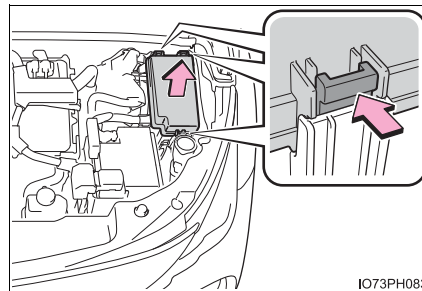

IO73PH083

► Left side instrument panel

Remove the lid.

Make sure to press the claw during removal or installation.

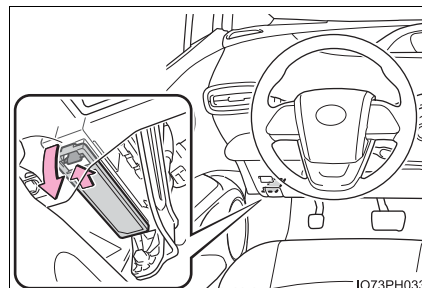

IO73PH033

3 Remove the fuse.

Only type A fuse can be removed using the pullout tool.

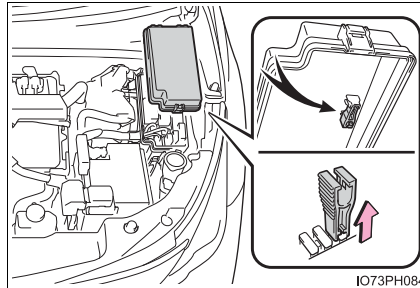

4 Check if the fuse is blown.

- ① Normal fuse
- ② Blown fuse

Replace the blown fuse with a new fuse of an appropriate amperage rating. The amperage rating can be found on the fuse box lid.

► Type A

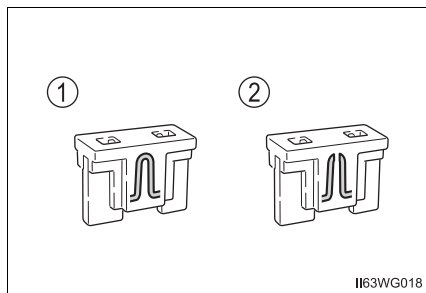

► Type B

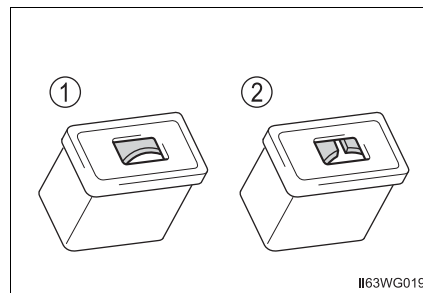

► Type C

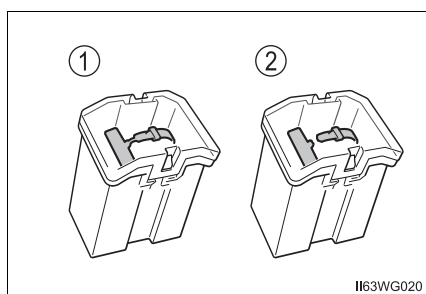

■ After a fuse is replaced

- If the lights do not turn on even after the fuse has been replaced, a bulb may need replacement. (→P. 655)
- If the replaced fuse blows again, have the vehicle inspected by your Toyota dealer.

■ If there is an overload in a circuit

The fuses are designed to blow, protecting the wiring harness from damage.

■ When replacing light bulbs

Toyota recommends that you use genuine Toyota products designed for this vehicle. Because certain bulbs are connected to circuits designed to prevent overload, nongenuine parts or parts not designed for this vehicle may be unusable.

 **WARNING****■ To prevent system breakdowns and vehicle fire**

Observe the following precautions.

Failure to do so may cause damage to the vehicle, and possibly a fire or injury.

- Never use a fuse of a higher amperage rating than that indicated, or use any other object in place of a fuse.
- Always use a genuine Toyota fuse or equivalent.
Never replace a fuse with a wire, even as a temporary fix.
- Do not modify the fuses or fuse boxes.

 **NOTICE****■ Before replacing fuses**

Have the cause of electrical overload determined and repaired by your Toyota dealer as soon as possible.

Headlight aim

Vertical movement adjusting bolts

- ① Adjustment bolt A
- ② Adjustment bolt B

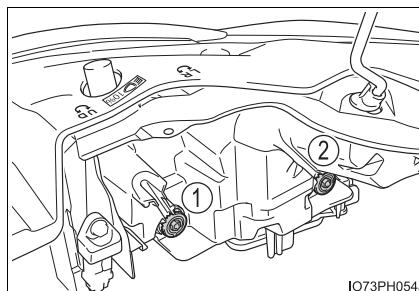

Before checking the headlight aim

- 1 Make sure the vehicle has a full tank of gasoline and the area around the headlight is not deformed.
- 2 Park the vehicle on level ground.
- 3 Sit in the driver's seat.
- 4 Bounce the vehicle several times.

Adjusting the headlight aim

- 1 Using a Phillips-head screwdriver, turn bolt A in either direction.

Remember the turning direction and the number of turns.

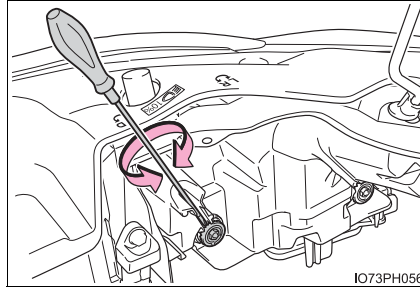

- 2 Turn bolt B the same number of turns and in the same direction as step 1.

If the headlight cannot be adjusted using this procedure, take the vehicle to your Toyota dealer to adjust the headlight aim.

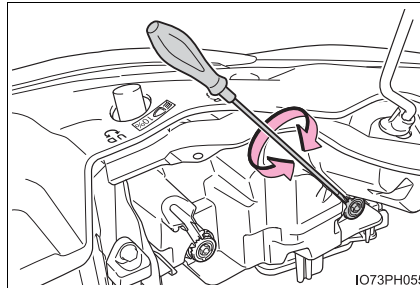

Light bulbs

You may replace the following bulbs by yourself. The difficulty level of replacement varies depending on the bulb. If necessary bulb replacement seems difficult to perform, contact your Toyota dealer.

For more information about replacing other light bulbs, contact your Toyota dealer.

Preparing for light bulb replacement

Check the wattage of the light bulb to be replaced. (→P. 738)

Bulb locations

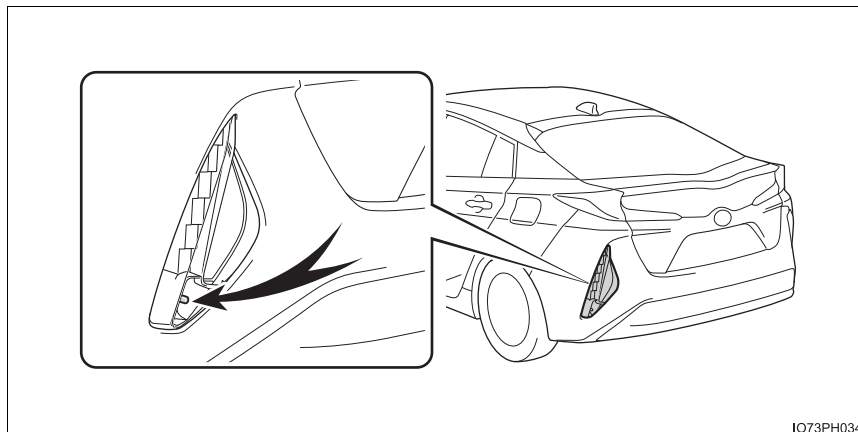

Back-up light

Replacing light bulbs

■ Back-up lights

- 1 Remove the 2 clips that secure the lower portion of the cover at the back of the rear tire.

Pull out the center portion of the clip to unlock using a flat-head screwdriver, and then pull it to remove.

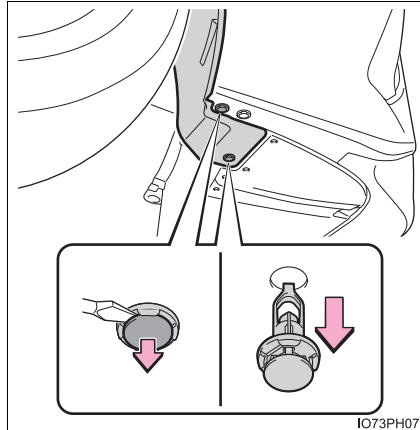

- 2 Remove the 3 clips that secure the upper portion of the cover.

- ① Turn the clip counterclockwise to remove.
- ② Pull out the center portion of the clip to unlock using a flathead screwdriver, and then pull it to remove.
- ③ Pull out the center portion of the clip to unlock using a flathead screwdriver, and then pull it to remove.

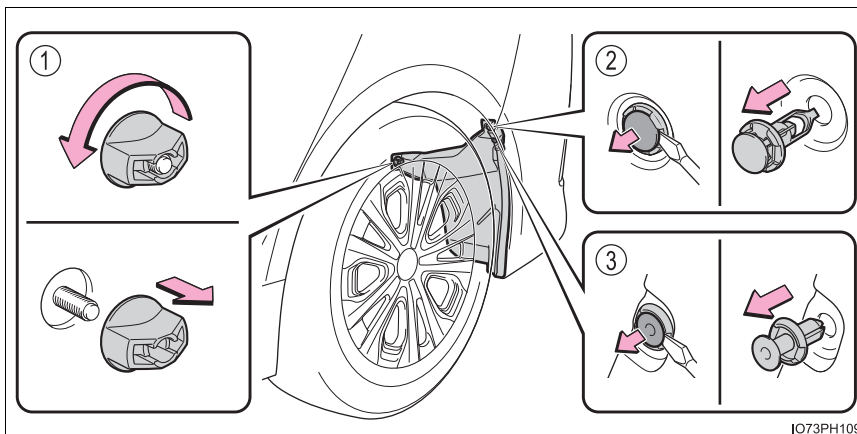

- 3 Remove the cover end and pull the cover toward the front of the vehicle to make a gap between the cover and rear bumper.

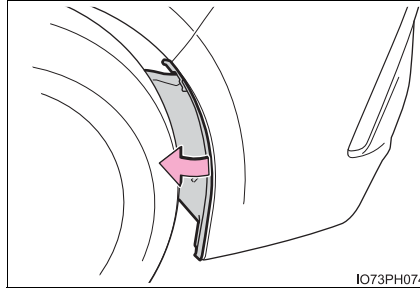

- 4 Remove the clip inside of the cover, and remove the cover.

Pull out the center portion of the clip to unlock using a flat-head screwdriver, and then pull it to remove.

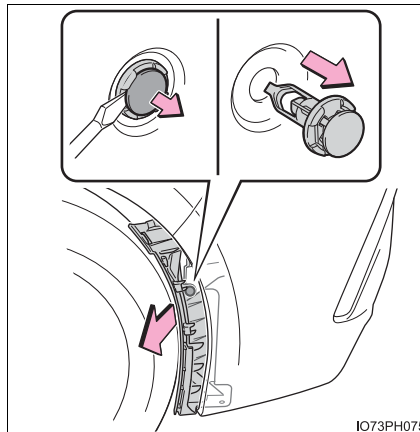

- 5 Turn the bulb base counter-clockwise, and then remove the light bulb.

To remove the light bulb, insert a hand from the gap between the rear tire and rear bumper.

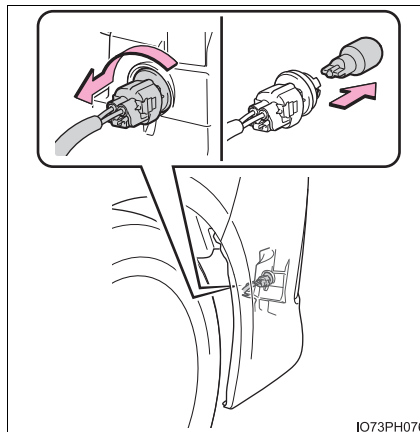

- 6 Install a new light bulb then install the bulb base to the light unit by inserting it and turning the bulb base clockwise.

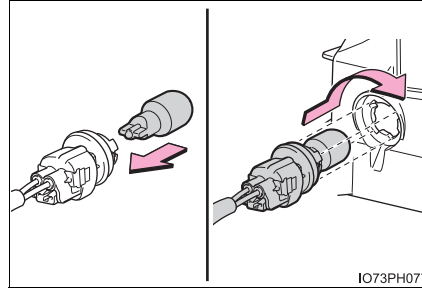

- 7 Reinstall the cover to its original position, and attach the clip inside of the cover.

Attach the clip on the cover, then press the center portion of the clip to lock.

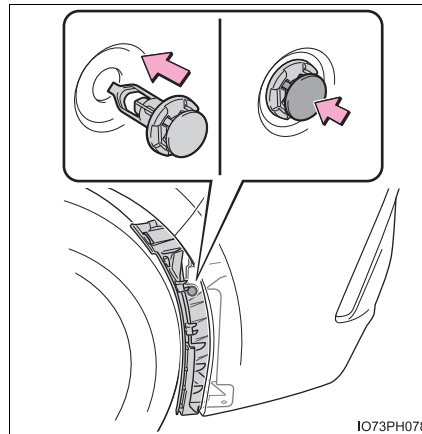

- 8 Reinsert the cover end to the rear bumper.

Make sure to secure the 2 tabs on the cover end.

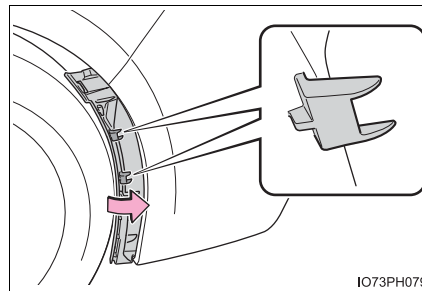

9 Reinsert the 3 clips to the upper portion of the cover.

- ① Turn the clip clockwise to lock.
- ② Attach the clip on the cover, and then press the center portion of the clip to lock.
- ③ Attach the clip on the cover, and then press the center portion of the clip to lock.

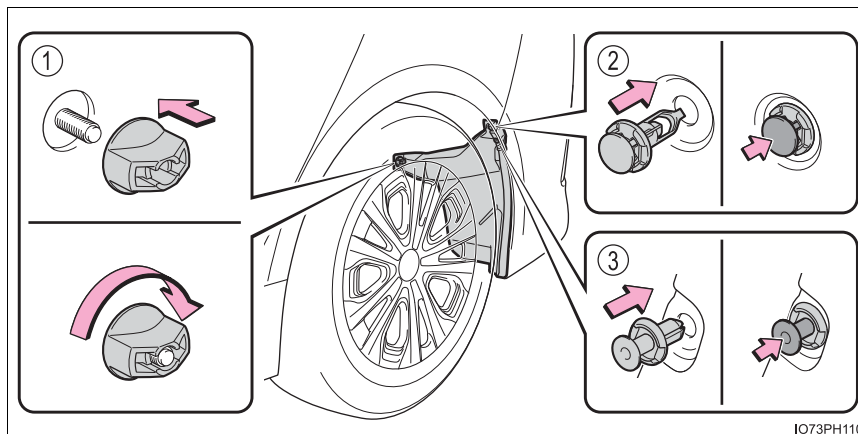
**10** Reinsert the 2 clips to the lower portion of the cover.

Attach the clip on the cover, and then press the center portion of the clip to lock.

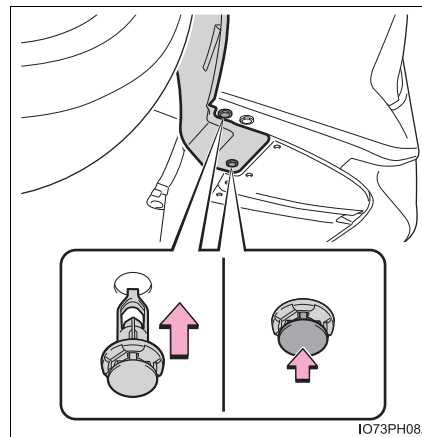

■ **Replacing the following bulbs**

If any of the lights listed below has burnt out, have it replaced by your Toyota dealer.

- Headlights and daytime running lights
- Front side marker lights
- Parking lights
- Fog lights (if equipped)
- LED accent lights (if equipped)
- Front turn signal lights
- Rear turn signal lights
- Rear side marker lights
- Tail lights
- Stop lights
- High mounted stoplight
- License plate lights

■ **LED lights**

The lights other than the back-up lights each consist of a number of LEDs. If any of the LEDs burn out, take your vehicle to your Toyota dealer to have the light replaced.

■ **Condensation build-up on the inside of the lens**

Temporary condensation build-up on the inside of the lens does not indicate a malfunction. Contact your Toyota dealer for more information in the following situations:

- Large drops of water have built up on the inside of the lens.
- Water has built up inside the light.

■ **When replacing light bulbs**

→P. 652

 **WARNING****■ Replacing light bulbs**

- Be sure to stop the hybrid system and turn off the lights. Do not attempt to replace the bulb immediately after turning off the lights.
The bulbs become very hot and may cause burns.
- Do not touch the glass portion of the light bulb with bare hands. When it is unavoidable to hold the glass portion, use and hold with a clean dry cloth to avoid getting moisture and oils on the bulb.
Also, if the bulb is scratched or dropped, it may blow out or crack.
- Fully install light bulbs and any parts used to secure them. Failure to do so may result in heat damage, fire, or water entering the light unit. This may damage the back-up lights or cause condensation to build up on the lens.
- Do not attempt to repair or disassemble light bulbs, connectors, electric circuits or component parts.
Doing so may result in death or serious injury due to electric shock.
- Do not replace the right-hand back-up light immediately after the vehicle has been driven.
After the vehicle has been driven the exhaust pipe will be extremely hot, and touching the exhaust pipe may result in burns.
- Use gloves and other protection to prevent injuries on vehicle parts.
There is the danger of being injured on the edges of parts.

■ To prevent damage or fire

- Make sure bulbs are fully seated and locked.
- Check the wattage of the bulb before installing to prevent heat damage.

When trouble arises**8****8-1. Essential information**

- Emergency flashers 664
- If your vehicle has to
be stopped in an
emergency 665
- If the vehicle is trapped
in rising water 666

8-2. Steps to take in an emergency

- If your vehicle needs to
be towed 667
- If you think something is
wrong 673
- If a warning light turns on
or a warning buzzer
sounds 674
- If a warning message is
displayed 684
- If you have a flat tire 692
- If the hybrid system will
not start 709
- If the electronic key does
not operate properly 711
- If the 12-volt battery is
discharged 715
- If your vehicle overheats ... 721
- If the vehicle becomes
stuck 726

Emergency flashers

The emergency flashers are used to warn other drivers when the vehicle has to be stopped in the road due to a breakdown, etc.

Press the switch.

All the turn signal lights will flash. To turn them off, press the switch once again.

▶ Vehicles with 7-inch display

▶ Vehicles with 11.6-inch display

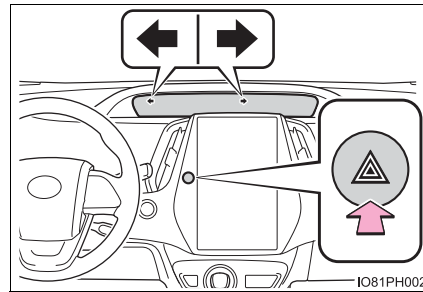
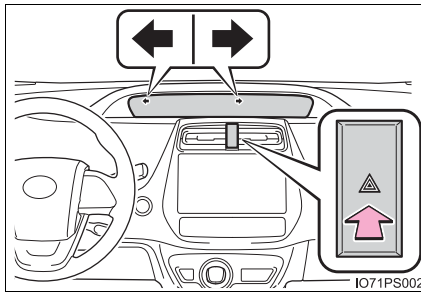

■ Emergency flashers

- If the emergency flashers are used for a long time while the hybrid system is not operating (while the “READY” indicator is not illuminated), the 12-volt battery may discharge.
- If any of the SRS airbags deploy (inflate) or in the event of a strong rear impact, the emergency flashers will turn on automatically.

The emergency flashers will turn off automatically after operating for approximately 20 minutes. To manually turn the emergency flashers off, press the switch twice.

(The emergency flashers may not turn on automatically depending on the force of the impact and conditions of the collision.)

If your vehicle has to be stopped in an emergency

Only in an emergency, such as if it becomes impossible to stop the vehicle in the normal way, stop the vehicle using the following procedure:

- 1 Steadily step on the brake pedal with both feet and firmly depress it.
Do not pump the brake pedal repeatedly as this will increase the effort required to slow the vehicle.
- 2 Shift the shift position to N.
 - ▶ If the shift position is shifted to N
- 3 After slowing down, stop the vehicle in a safe place by the road.
- 4 Stop the hybrid system.
 - ▶ If the shift position cannot be shifted to N
- 3 Keep depressing the brake pedal with both feet to reduce vehicle speed as much as possible.
- 4 To stop the hybrid system, press and hold the power switch for 2 consecutive seconds or more, or press it briefly 3 times or more in succession.

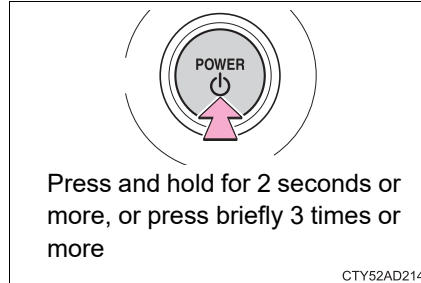

- 5 Stop the vehicle in a safe place by the road.

WARNING

■ If the hybrid system has to be turned off while driving

Power assist for the steering wheel will be lost, making the steering wheel heavier to turn. Decelerate as much as possible before turning off the hybrid system.

If the vehicle is trapped in rising water

In the event the vehicle is submerged in water, remain calm and perform the following.

- Remove the seat belt first.
- If the door can be opened, open the door and exit the vehicle.
- If the door can not be opened, open the window using the power window switch and exit the vehicle through the window.
- If the window can not be opened using the power window switch, remain calm, wait until the water level inside the vehicle rises to the point that the water pressure inside of the vehicle equals the water pressure outside of the vehicle, and then open the door and exit the vehicle.

WARNING

■ Using an emergency hammer* for emergency escape

The rear side windows and rear window of this vehicle can be shattered by an emergency hammer* used for emergency escape, however, since the windshield and front side windows are laminated glass they can not be shattered by an emergency hammer*.

*: Contact your Toyota dealer or aftermarket accessory manufacturer for further information about an emergency hammer.

■ Escaping the vehicle from the window

There are cases where escaping the vehicle from the window is not possible due to seating position, passenger body type, etc.

When using an emergency hammer, consider your seat location and the size of the window opening to ensure that the opening is accessible and large enough to escape.

If your vehicle needs to be towed

If towing is necessary, we recommend having your vehicle towed by your Toyota dealer or commercial towing service, using a wheel-lift type truck or flatbed truck. Use a safety chain system for all towing, and abide by all state/provincial and local laws.

Situations when it is not possible to be towed by another vehicle

In the following situations, it is not possible to be towed by another vehicle using cables or chains, as the front wheels may be locked due to the parking lock. Contact your Toyota dealer or commercial towing service.

- There is a malfunction in the shift control system. (→P. 342, 691)
- There is a malfunction in the immobilizer system. (→P. 83)
- There is a malfunction in the smart key system. (→P. 711)
- The 12-volt battery is discharged. (→P. 715)

Situations when it is necessary to contact dealers before towing

The following may indicate a problem with your hybrid transmission. Contact your Toyota dealer or commercial towing service before towing.

- The hybrid system warning message is displayed and the vehicle does not move.
- The vehicle makes an abnormal sound.

Towing with a wheel-lift type truck

► From the front

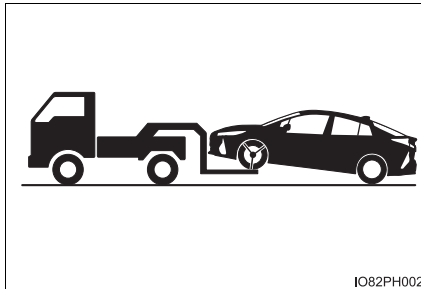

Release the parking brake.

► From the rear

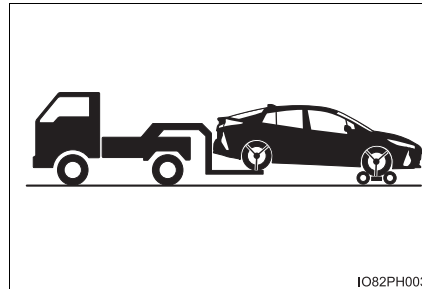

Use a towing dolly under the front wheels.

Using a flatbed truck

When using a flatbed truck to transport the vehicle, use tire strapping belts. Refer to the owner's manual of the flatbed truck for the tire strapping method.

In order to suppress vehicle movement during transportation, set the parking brake and turn the power switch off.

Emergency towing

If a tow truck is not available in an emergency, your vehicle may be temporarily towed using cables or chains secured to the emergency towing eyelets. This should only be attempted on hard surfaced roads for short distances at under 18 mph (30 km/h).

A driver must be in the vehicle to steer and operate the brakes. The vehicle's wheels, drive train, axles, steering and brakes must be in good condition.

Emergency towing procedure

To have your vehicle towed by another vehicle, the towing eyelet must be installed to your vehicle. Install the towing eyelet using the following procedure.

- 1 Take out the wheel nut wrench and towing eyelet. (→P. 630)

- 2 Remove the eyelet cover using a flathead screwdriver.

To protect the bodywork, place a rag between the screwdriver and the vehicle body as shown in the illustration.

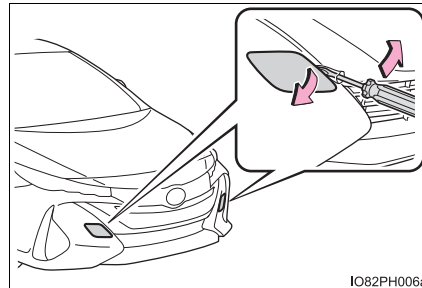

- 3 Insert the towing eyelet into the hole and tighten partially by hand.

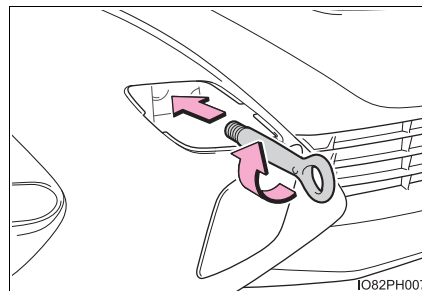

- 4 Tighten down the towing eyelet securely using a wheel nut wrench or hard metal bar.

When tightening with a wheel nut wrench or hard metal bar, make sure not to damage the vehicle body.

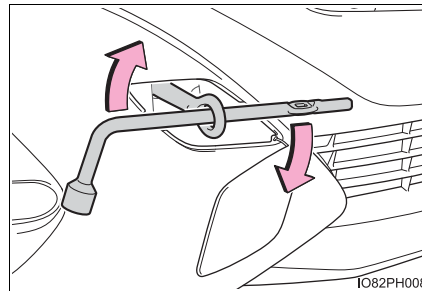

- 5 Securely attach cables or chains to the towing eyelet.

Take care not to damage the vehicle body.

- 6 Enter the vehicle being towed and start the hybrid system.

If the hybrid system does not start, turn the power switch to ON mode.

Turn off the Parking Support Brake function. (if equipped): →P. 456

- 7 Shift the shift position to N* and release the parking brake.

*: If the shift position cannot be changed or the current shift position cannot be confirmed, contact your Toyota dealer or commercial towing service before towing.

■ **While towing**

If the hybrid system is off, the power assist for the brakes and steering will not function, making steering and braking more difficult.

■ **Wheel nut wrench**

Wheel nut wrench is installed in luggage compartment. (→P. 630)

■ **Towing eyelet installation hole on the rear of the vehicle**

The hole is equipped for fastening the vehicle while shipping. Your vehicle cannot tow another vehicle.

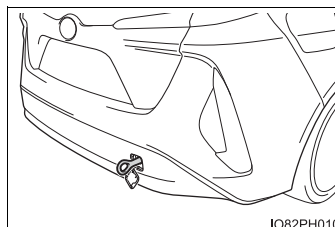

⚠ WARNING

Observe the following precautions.
Failure to do so may result in death or serious injury.

■ When towing the vehicle

Be sure to transport the vehicle with the front wheels raised or with all four wheels raised off the ground. If the vehicle is towed with the front wheels contacting the ground, the drivetrain and related parts may be damaged or electricity generated by the operation of the motor may cause a fire to occur depending on the nature of the damage or malfunction.

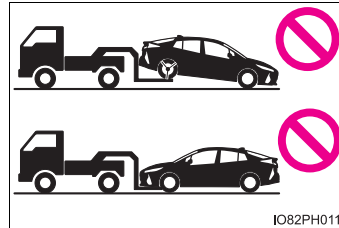
**■ While towing**

- When towing using cables or chains, avoid sudden starts, etc. which place excessive stress on the towing eyelets, cables or chains. The towing eyelets, cables or chains may become damaged, broken debris may hit people, and cause serious damage.
- Do not turn the power switch off.
This may lead to an accident as the front wheels will be locked by the parking lock.

■ Installing towing eyelets to the vehicle

- The towing eyelets are only for the vehicle equipped with them. Do not use the towing eyelets for another vehicle, and do not use the towing eyelets for this vehicle on another vehicle.
- Make sure that towing eyelets are installed securely.
If not securely installed, towing eyelets may come loose during towing.

 NOTICE

■ **Towing with a sling-type truck**

Do not tow with a sling-type truck to prevent body damage.

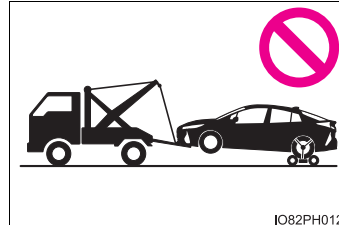

■ **To prevent damage to the vehicle when towing using a wheel-lift type truck**

When raising the vehicle, ensure adequate ground clearance for towing at the opposite end of the raised vehicle. Without adequate clearance, the vehicle could be damaged while being towed.

■ **To prevent damage to the vehicle when towing with a sling-type truck**

Do not tow with a sling-type truck, either from the front or rear.

■ **To prevent damage to the vehicle during emergency towing**

Do not secure cables or chains to the suspension components.

If you think something is wrong

If you notice any of the following symptoms, your vehicle probably needs adjustment or repair. Contact your Toyota dealer as soon as possible.

Visible symptoms

- Fluid leaks under the vehicle
(Water dripping from the air conditioning after use is normal.)
- Flat-looking tires or uneven tire wear
- High coolant temperature warning light flashes or comes on

Audible symptoms

- Changes in exhaust sound
- Excessive tire squeal when cornering
- Strange noises related to the suspension system
- Pinging or other noises related to the hybrid system







Operational symptoms





- Engine missing, stumbling or running roughly
- Appreciable loss of power
- Vehicle pulls heavily to one side when braking
- Vehicle pulls heavily to one side when driving on a level road
- Loss of brake effectiveness, spongy feeling, pedal almost touches the floor

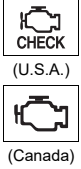



If a warning light turns on or a warning buzzer sounds



Calmly perform the following actions if any of the warning lights comes on or flashes. If a light comes on or flashes, but then goes off, this does not necessarily indicate a malfunction in the system. However, if this continues to occur, have the vehicle inspected by your Toyota dealer.



Warning light and warning buzzer list

Warning light	Warning light/Details/Actions
 <p>BRAKE (U.S.A.)  (Canada)</p>	<p>Brake system warning light and warning buzzer (red indicator)*1 Indicates that:</p> <ul style="list-style-type: none"> • The brake fluid level is low; or • The brake system is malfunctioning <p>→ Immediately stop the vehicle in a safe place and contact your Toyota dealer. Continuing to drive the vehicle may be dangerous.</p>
	<p>Brake system warning light (yellow indicator) Indicates a malfunction in:</p> <ul style="list-style-type: none"> • The regenerative braking system; or • The electronically controlled brake system <p>→ Have the vehicle inspected by your Toyota dealer immediately.</p>
	<p>Charging system warning light Indicates a malfunction in the vehicle's charging system → Immediately stop the vehicle in a safe place and contact your Toyota dealer.</p>
	<p>Low engine oil pressure warning light (warning buzzer)*2 Indicates that the engine oil pressure is too low → Immediately stop the vehicle in a safe place and contact your Toyota dealer.</p>
 <p> CHECK (U.S.A.)  (Canada)</p>	<p>Malfunction indicator lamp Indicates a malfunction in:</p> <ul style="list-style-type: none"> • The hybrid system; • The electronic engine control system; or • The electronic throttle control system <p>→ Have the vehicle inspected by your Toyota dealer immediately.</p>

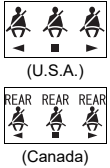
Warning light	Warning light/Details/Actions
	<p>SRS warning light Indicates a malfunction in:</p> <ul style="list-style-type: none"> • The SRS airbag system; • The front passenger occupant classification system; or • The seat belt pretensioner system <p>→ Have the vehicle inspected by your Toyota dealer immediately.</p>
	<p>ABS warning light Indicates a malfunction in:</p> <ul style="list-style-type: none"> • The ABS; or • The brake assist system <p>→ Have the vehicle inspected by your Toyota dealer immediately.</p>
 <p>(Red/yellow)</p>	<p>Electric power steering system warning light (warning buzzer) Indicates a malfunction in the EPS (Electric Power Steering) system</p> <p>→ Have the vehicle inspected by your Toyota dealer immediately.</p>
 <p>(Flashes or illuminates)</p>	<p>PCS warning light</p> <ul style="list-style-type: none"> • When a buzzer sounds simultaneously: Indicates a malfunction has occurred in the PCS (Pre-Collision System). <p>→ Have the vehicle inspected by your Toyota dealer immediately.</p> <ul style="list-style-type: none"> • When a buzzer does not sound: The PCS (Pre-Collision System) has become temporarily unavailable, corrective action may be necessary. <p>→ Follow the instructions displayed on the multi-information display. (→P. 382, 684)</p> <p>If the PCS (Pre-Collision System) or VSC (Vehicle Stability Control) system is disabled, the PCS warning light will illuminate.</p> <p>→ P. 394</p>
 <p>(Orange)</p>	<p>LTA indicator (warning buzzer) Indicates a malfunction in the LTA (Lane Tracing Assist)</p> <p>→ Follow the instructions displayed on the multi-information display. (→P. 409)</p>

Warning light	Warning light/Details/Actions
	<p>Slip indicator light Indicates a malfunction in:</p> <ul style="list-style-type: none"> • The VSC system; • The TRAC system; or • The hill-start assist control system <p>→ Have the vehicle inspected by your Toyota dealer immediately. The light will flash when the ABS, VSC or TRAC system is operating.</p>
	<p>High coolant temperature warning light</p> <ul style="list-style-type: none"> • When the light flashes: Indicates that the engine coolant temperature is too high The light changes from a flashing to a solid light when the temperature further increases <p>→ Immediately stop the vehicle in a safe place. (→P. 721)</p> <ul style="list-style-type: none"> • When the light comes on without flashing: Indicates a malfunction in the exhaust heat recirculator system <p>→ Have the vehicle inspected by your Toyota dealer immediately.</p>
 <p>(Flashes) (If equipped)</p>	<p>PKSB OFF indicator Indicates a malfunction in the Parking Support Brake function</p> <p>→ Have the vehicle inspected by your Toyota dealer. The warning light will operate as follows, even when the system is not malfunctioning:</p> <ul style="list-style-type: none"> • The light will come on when the Parking Support Brake function is turned off (→P. 456) • The light will come on when the Parking Support Brake function is operating (→P. 460) • The light will flash when the system cannot be temporarily used (→P. 464)
	<p>Open door warning light (warning buzzer)*3 Indicates that a door is not fully closed</p> <p>→ Check that all the doors are closed.</p>
	<p>Low fuel level warning light Indicates that remaining fuel is approximately 1.7 gal. (6.4 L, 1.4 Imp.gal.) or less</p> <p>→ Refuel the vehicle.</p>

Warning light	Warning light/Details/Actions
	<p>Driver's and front passenger's seat belt reminder light (warning buzzer)*4 Warns the driver and/or front passenger to fasten their seat belts → Fasten the seat belt. If the front passenger's seat is occupied, the front passenger's seat belt also needs to be fastened to make the warning light (warning buzzer) turn off.</p>
 <p>(U.S.A.) (Canada)</p>	<p>Rear passengers' seat belt reminder light (warning buzzer)*5 Warns the rear passengers to fasten their seat belts → Fasten the seat belt.</p>
	<p>Master warning light A buzzer sounds and the warning light comes on and flashes to indicate that the master warning system has detected a malfunction. → P. 684</p>
	<p>Tire pressure warning light When the light comes on: Low tire inflation pressure such as • Natural causes (→P. 680) • Flat tire (→P. 692) → Adjust the tire inflation pressure to the specified level. The light will turn off after a few minutes. In case the light does not turn off even if the tire inflation pressure is adjusted, have the system checked by your Toyota dealer.</p> <p>When the light comes on after blinking for 1 minute: Malfunction in the tire pressure warning system (→P. 681) → Have the system checked by your Toyota dealer.</p>

Warning light	Warning light/Details/Actions
	<p>Brake Override System/Drive-Start Control/ Parking Support Brake function (symbol display)*6 Brake Override System Indicates that the accelerator and brake pedals are being depressed simultaneously, and the Brake Override System is operating → Release the accelerator pedal and depress the brake pedal. Indicates a malfunction in the Brake Override System (with warning buzzer) → Have the vehicle inspected by your Toyota dealer immediately.</p> <p>Drive-Start Control Indicates that the shift position was changed and Drive-Start Control was operated while depressing the accelerator pedal (with warning buzzer) → Momentarily release the accelerator pedal. Indicates a malfunction in the Drive-Start Control system (with warning buzzer) → Have the vehicle inspected by your Toyota dealer immediately.</p> <p>Parking Support Brake function Indicates that the Parking Support Brake function (if equipped) is operating (→P. 460) → Follow the instruction that is displayed on the multi-information display.</p>
 (Canada only)	<p>Low engine oil pressure warning (symbol display)*6 Indicates that the engine oil pressure is too low → Immediately stop the vehicle in a safe place and contact your Toyota dealer.</p>

- *1: Brake system warning buzzer:
When there is a possible problem that could affect braking performance, the warning light will come on and a warning buzzer will sound.
- *2: Low engine oil pressure warning buzzer:
A buzzer also sounds continuously for approximately 30 seconds at maximum in addition to the low engine oil pressure warning light when the "READY" indicator is illuminated.
- *3: Open door warning buzzer:
The open door warning buzzer sounds to alert one or more of the doors is not fully closed (with the vehicle having reached a speed of 3 mph [5 km/h]).
- *4: Driver's seat belt warning buzzer:
The driver's seat belt warning buzzer sounds to alert the driver that his or her seat belt is not fastened. Once the power switch is turned to ON mode, the buzzer sounds. If the seat belt is still unfastened, the buzzer sounds intermittently for a certain period of time after the vehicle reaches a certain speed.
Front passenger's seat belt warning buzzer:
The front passenger's seat belt warning buzzer sounds to alert the front passenger that his or her seat belt is not fastened. If the seat belt is unfastened, the buzzer sounds intermittently for a certain period of time after the vehicle reaches a certain speed.
- *5: Rear passengers' seat belt warning buzzer:
The rear passengers' seat belt warning buzzer sounds to alert the rear passenger that his or her seat belt is not fastened. If the seat belt is unfastened, the buzzer sounds intermittently for a certain period of time, after the seat belt is fastened and unfastened and the vehicle reaches a certain speed.
- *6: This symbol is displayed on the multi-information display.

■ SRS warning light

This warning light system monitors the airbag sensor assembly, front impact sensors, side impact sensors (front door), side impact sensors (front), side impact sensors (rear), driver's seat belt buckle switch, front passenger occupant classification system (ECU and sensors), "AIR BAG ON" indicator light, "AIR BAG OFF" indicator light, front passenger's seat belt buckle switch, seat belt pretensioners, airbags, interconnecting wiring and power sources.
(→P. 36)

■ Front passenger detection sensor, seat belt reminder and warning buzzer

- If luggage is placed on the front passenger seat, the front passenger detection sensor may cause the warning light to flash and the warning buzzer to sound even if a passenger is not sitting in the seat.
- If a cushion is placed on the seat, the sensor may not detect a passenger, and the warning light may not operate properly.

■ Electric power steering system warning light (warning buzzer)

When the 12-volt battery charge becomes insufficient or the voltage temporarily drops, the electric power steering system warning light may come on and the warning buzzer may sound.

■ If the malfunction indicator lamp comes on while driving

First check the following:

- Is the fuel tank empty?
If it is, fill the fuel tank immediately.
- Is the fuel tank cap loose?
If it is, tighten it securely.

The malfunction indicator lamp will go off after several driving trips.

If the malfunction indicator lamp does not go off even after several trips, contact your Toyota dealer as soon as possible.

■ When the tire pressure warning light comes on

Inspect the appearance of the tire to check that the tire is not punctured.

If the tire is punctured: →P. 692

If the tire is not punctured:

Check the tire inflation pressure and adjust to the appropriate level. Initializing the tire pressure warning system will not turn off the tire pressure warning light.

■ The tire pressure warning light may come on due to natural causes

The tire pressure warning light may come on due to natural causes such as natural air leaks and tire inflation pressure changes caused by temperature. In this case, adjusting the tire inflation pressure will turn off the warning light (after a few minutes).

■ Conditions that the tire pressure warning system may not function properly

→P. 619

■ **If the tire pressure warning light frequently comes on after blinking for 1 minute**

If the tire pressure warning light frequently comes on after blinking for 1 minute when the power switch is turned to ON mode, have it checked by your Toyota dealer.

■ **Warning buzzer**

In some cases, the buzzer may not be heard due to being in a noisy location or audio sound.

 **WARNING**

■ **When the electric power steering system warning light comes on**

When the light comes on yellow, the assist to the power steering is restricted. When the light comes on red, the assist to the power steering is lost and handling operations of the steering wheel become extremely heavy. When steering wheel operations are heavier than usual, grip the steering wheel firmly and operate it using more force than usual.

■ **If the tire pressure warning light comes on**

Be sure to observe the following precautions. Failure to do so could cause a loss of vehicle control and result in death or serious injury.

- Stop your vehicle in a safe place as soon as possible. Adjust the tire inflation pressure immediately.
- If the tire pressure warning light comes on even after tire inflation pressure adjustment, it is probable that you have a flat tire. Check the tires. If a tire is flat, repair the flat tire by using emergency tire puncture repair kit.
- Avoid abrupt maneuvering and braking. If the vehicle tires deteriorate, you could lose control of the steering wheel or the brakes.

■ **If a blowout or sudden air leakage should occur**

The tire pressure warning system may not activate immediately.

 **WARNING****■ Maintenance of the tires**

Each tire, including the spare (if provided), should be checked monthly when cold and inflated to the inflation pressure recommended by the vehicle manufacturer on the vehicle placard or tire inflation pressure label (tire and load information label). (If your vehicle has tires of a different size than the size indicated on the vehicle placard or tire inflation pressure label [tire and load information label], you should determine the proper tire inflation pressure for those tires.)

As an added safety feature, your vehicle has been equipped with a tire pressure monitoring system (TPMS-tire pressure warning system) that illuminates a low tire pressure telltale (tire pressure warning light) when one or more of your tires is significantly under-inflated. Accordingly, when the low tire pressure telltale (tire pressure warning light) illuminates, you should stop and check your tires as soon as possible, and inflate them to the proper pressure. Driving on a significantly under-inflated tire causes the tire to overheat and can lead to tire failure. Under-inflation also reduces fuel efficiency and tire tread life, and may affect the vehicle's handling and stopping ability.

Please note that the TPMS (tire pressure warning system) is not a substitute for proper tire maintenance, and it is the driver's responsibility to maintain correct tire pressure, even if under-inflation has not reached the level to trigger illumination of the TPMS low tire pressure telltale (tire pressure warning light).

Your vehicle has also been equipped with a TPMS (tire pressure warning system) malfunction indicator to indicate when the system is not operating properly. The TPMS (tire pressure warning system) malfunction indicator is combined with the low tire pressure telltale (tire pressure warning light). When the system detects a malfunction, the telltale will flash for approximately one minute and then remain continuously illuminated. This sequence will continue upon subsequent vehicle start-ups as long as the malfunction exists. When the malfunction indicator is illuminated, the system may not be able to detect or signal low tire pressure as intended.

TPMS (tire pressure warning system) malfunctions may occur for a variety of reasons, including the installation of replacement or alternate tires or wheels on the vehicle that prevent the TPMS (tire pressure warning system) from functioning properly. Always check the TPMS (tire pressure warning system) malfunction telltale after replacing one or more tires or wheels on your vehicle to ensure that the replacement or alternate tires and wheels allow the TPMS (tire pressure warning system) to continue to function properly.

 NOTICE

■ **To ensure the tire pressure warning system operates properly**

Do not install tires with different specifications or makers, as the tire pressure warning system may not operate properly.

If a warning message is displayed

The multi-information display shows warnings of system malfunctions, incorrectly performed operations, and messages that indicate a need for maintenance. When a message is shown, perform the correction procedure appropriate to the message.

When a message about charging is displayed, refer to P. 185.

① Master warning light

The master warning light also comes on or flashes in order to indicate that a message is currently being displayed on the multi-information display.*

② Multi-information display

③ Handling method

Follow the instructions of the message on the multi-information display.

If any of the warning messages are shown again after the following actions have been performed, contact your Toyota dealer.

*: The master warning light may not come on or flash when a warning message is displayed.

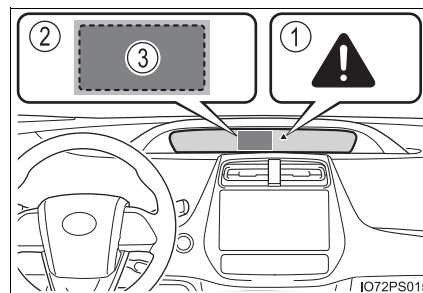

Messages and warnings

The warning lights and warning buzzers operate as follows depending on the content of the message. If a message indicates the need for inspection by a dealer, have the vehicle inspected by your Toyota dealer immediately.

	System warning light	Warning buzzer*	Warning
Comes on	—	Sounds	Indicates an important situation, such as when a system related to driving is malfunctioning or that danger may result if the correction procedure is not performed
—	Comes on or flashes	Sounds	Indicates an important situation, such as when the systems shown on the multi-information display may be malfunctioning
Flashes	—	Sounds	Indicates a situation, such as when damage to the vehicle or danger may result
Comes on	—	Does not sound	Indicates a condition, such as malfunction of electrical components, their condition, or indicates the need for maintenance
Flashes	—	Does not sound	Indicates a situation, such as when an operation has been performed incorrectly, or indicates how to perform an operation correctly

The operation of the warning lights and warning buzzers may differ from those stated. In this case, perform the correction procedure according to the displayed message.

*: A buzzer sounds the first time a message is shown on the multi-information display.

■ Warning messages

The warning messages explained below may differ from the actual messages according to operation conditions and vehicle specifications.

■ System warning lights

The master warning light does not come on or flash in the following cases. Instead, a separate system warning light will come on along with a message or image shown on the multi-information display.

- “Antilock Brake System Malfunction Visit Your Dealer”:
The ABS warning light comes on. (→P. 675)
- “Braking Power Low Visit Your Dealer”:
The brake system warning light (yellow) will come on. (→P. 674)
- Indicates that a door is not fully closed while the vehicle is stopped.:
The Open door warning light comes on. (→P. 676)

■ If “Visit Your Dealer” is shown

The system or part shown on the multi-information display is malfunctioning. Have the vehicle inspected by your Toyota dealer.

■ If a message about an operation is shown

- If a message about an operation of the accelerator pedal or brake pedal is shown
 - A warning message about an operation of the brake pedal may be shown while the driving assist systems such as PCS (Pre-Collision System) or the dynamic radar cruise control with full-speed range is operating. If a warning message is shown, be sure to decelerate the vehicle or follow an instruction shown on the multi-information display.
 - A warning message is shown when Brake Override System operates. (→P. 322, 689)
 - A warning message is shown when Drive-Start Control or Parking Support Brake function (if equipped) operates (→P. 322, 460). Follow the instructions on the multi-information display.
- If a message about an operation of the power switch is shown
An instruction for operation of the power switch is shown when the incorrect procedure for starting the hybrid system is performed or the power switch is operated incorrectly. Follow the instructions shown on the multi-information display to operate the power switch again.
- If a message about a shift operation is shown
To prevent the shift position from being selected incorrectly or the vehicle from moving unexpectedly, the shift position may be changed automatically (→P. 347) or shift operation may be required. In this case, change the shift position following the instructions on the multi-information display.
- If a message or image about an open/close state of a part or replenishment of a consumable is shown
Confirm the part indicated by the multi-information display or a warning light, and then perform the coping method such as closing the open door or replenishing a consumable.

■ **If “See Owner’s Manual” is shown**

- If “Braking Power Low Stop in a Safe Place See Owner’s Manual” is shown, this may be a malfunction. Immediately stop the vehicle in a safe place and contact your Toyota dealer. Continuing to drive the vehicle may be dangerous.
- If “Engine Oil Pressure Low” is shown, this may be a malfunction. Immediately stop the vehicle in a safe place and contact your Toyota dealer.
- If the following messages are shown, there may be a malfunction. Immediately have the vehicle inspected by your Toyota dealer.
 - “Plug-in charging system malfunction.”
 - “Hybrid System Malfunction”
 - “Check Engine”
 - “Hybrid Battery System Malfunction”
 - “Accelerator System Malfunction”
 - “Smart Key System Malfunction See Owner’s Manual”

■ **If “Shift System Not Active Apply Parking Brake Securely While Parking See Owner’s Manual” is shown**

Indicates a temporary operation failure or malfunction in the shift control system. Immediately have the vehicle inspected by your Toyota dealer.

When the message is shown, the hybrid system may not be started or the shift position may not be changed normally. (Coping method: →P. 691)

■ **If “Shift System Malfunction Apply Parking Brake Securely While Parking See Owner’s Manual” is shown**

Indicates a malfunction in the shift control system. Immediately have the vehicle inspected by your Toyota dealer.

When the message is shown, the hybrid system may not be started or the shift position may not be changed normally. (Coping method: →P. 691)

■ **If “ Switch Malfunction Apply Parking Brake Securely While Parking See Owner’s Manual” is shown**

The P position switch may not operate. Immediately have the vehicle inspected by your Toyota dealer.

When parking the vehicle, stop the vehicle on level ground and apply the parking brake firmly.

■ **If “Shift System Malfunction Shifting Unavailable See Owner’s Manual” is shown**

Indicates a malfunction in the shift control system. Immediately have the vehicle inspected by your Toyota dealer.

The shift position may not be shifted from P to other than P.

■ **If “Shift System Malfunction Stop in a Safe Place See Owner’s Manual” is shown**

Indicates a malfunction in the shift control system. Immediately have the vehicle inspected by your Toyota dealer.

The shift position may not be changed. Stop the vehicle in a safe place.

■ If “Shift System Malfunction See Owner’s Manual” is shown

Indicates a malfunction in the shift control system. Immediately have the system inspected by your Toyota dealer.

The system may not operate properly.

■ If “Low 12-Volt Battery Apply Parking Brake Securely While Parking See Owner’s Manual” is shown

Indicates that the 12-volt battery charge is insufficient. Charge or replace the 12-volt battery.

- When the message is shown, the hybrid system may not start or the shift position may not be changed normally. (Coping method: →P. 691)

- After charging the 12-volt battery, the message may not go off until the shift position is changed from P.

■ If “Shifting Unavailable Low 12-Volt Battery See Owner’s Manual” is shown

Indicates that the shift position cannot be changed because the voltage of the 12-volt battery drops. Charge or replace the 12-volt battery.

(Coping method in the case the 12-volt battery is discharged: →P. 715)

■ If “Hybrid System Overheated. Reduced Output Power.” is shown

The message may be shown when driving under severe operating conditions. (For example, when driving up a long steep hill or driving up a steep hill in reverse.)

Coping method: →P. 721

■ If “Maintenance required for Traction battery cooling parts See owner’s manual” is shown

There is a possibility that the filter may be clogged, the air intake vent may be blocked or there may be a gap in the duct.

- When the air intake vents or filters are dirty, clean them by the procedures on P. 582.

- When the air intake vents or filters are not dirty and the warning message is shown, have the vehicle inspected at your Toyota dealer.

■ If “Traction Battery Needs to be Protected Refrain From the Use of  Position” is shown

This message may be displayed when the shift position is in N.

As the hybrid battery (traction battery) can not be charged when the shift position is in N, shift the shift position to P when the vehicle is stopped.

■ If “Traction Battery Needs to be Protected Shift into  to Restart” is shown

This message is displayed when the hybrid battery (traction battery) charge has become extremely low because the vehicle has been left with the N shift position selected for a certain amount of time.

When operating the vehicle, shift to P and restart the hybrid system.

- **If “Shift to **P** Before Exiting Vehicle” is shown**

Message is displayed when the driver’s door is opened without turning the power switch to off with the shift position in any position other than P.
Shift the shift position to P.
- **If “Shift is in **N** Release Accelerator Before Shifting” is shown**

Message is displayed when the accelerator pedal has been depressed and the shift position is in N.
Release the accelerator pedal and shift the shift position to D or R.
- **If “Depress Brake When Vehicle is Stopped. Hybrid System may Overheat.” is shown**

The message may be shown when the accelerator pedal is depressed to hold the vehicle while the vehicle is stopped on an uphill, etc.
The hybrid system may overheat. Release the accelerator pedal and depress the brake pedal.
- **If “Shifted to **N** Stop Vehicle to Shift to **P**” is shown**

If the P position switch is pressed while driving, the shift position is changed to N and the message is shown. (→P. 347)
- **If “Auto Power OFF to Conserve Battery” is shown**

The power switch has been turned off by the automatic power off function.
When starting the hybrid system next time, operate the hybrid system for approximately 5 minutes to recharge the 12-volt battery.
- **If “Engine Oil Level Low Add or Replace” is displayed**

The engine oil level may be low. Check the level of the engine oil, and add engine oil if necessary. This message may be displayed if the vehicle is stopped on a slope. Move the vehicle to a level surface and check if the message disappears.
- **If “Accelerator and Brake Pedals Pressed Simultaneously” is shown**

The accelerator and brake pedals are being depressed simultaneously.
(→P. 322)
Release the accelerator pedal and depress the brake pedal.
- **If a message that indicates the malfunction of front camera is displayed**

The following systems may be suspended until the problem shown in the message is resolved. (→P. 382, 674)

 - PCS (Pre-Collision System)
 - LTA (Lane Tracing Assist)
 - AHB (Automatic High Beam)
 - RSA (Road Sign Assist)*
 - Dynamic radar cruise control with full-speed range

*: If equipped

■ **If “Radar Cruise Control Unavailable See Owner’s Manual” is shown**

The dynamic radar cruise control with full-speed range system is suspended temporarily or until the problem shown in the message is resolved. (causes and coping methods: →P. 382)

■ **If “Radar Cruise Control Unavailable” is shown**

The dynamic radar cruise control with full-speed range system cannot be used temporarily. Use the system when it becomes available again.

■ **If “Maintenance Required Soon” is displayed (U.S.A. only)**

Indicates that all maintenance according to the driven distance on the maintenance schedule* should be performed soon.

Comes on approximately 4500 miles (7200 km) after the message has been reset.

If necessary, perform maintenance. Please reset the message after the maintenance is performed. (→P. 588)

*: Refer to the separate “Scheduled Maintenance Guide” or “Owner’s Manual Supplement” for the maintenance interval applicable to your vehicle.

■ **If “Maintenance Required Visit Your Dealer” is displayed (U.S.A. only)**

Indicates that all maintenance is required to correspond to the driven distance on the maintenance schedule*.

Comes on approximately 5000 miles (8000 km) after the message has been reset. (The indicator will not work properly unless the message has been reset.)

Perform the necessary maintenance. Please reset the message after the maintenance is performed. (→P. 588)

*: Refer to the separate “Scheduled Maintenance Guide” or “Owner’s Manual Supplement” for the maintenance interval applicable to your vehicle.

■ **If the shift position cannot be changed or the power switch is turned to ACCESSORY mode even if trying to turn the power switch off when a warning message is shown**

If the 12-volt battery is discharged or the shift control system is malfunctioning, the followings may occur.

- The shift position may not be changed to P.
When parking, stop the vehicle on level ground and apply the parking brake firmly.
- The hybrid system may not start.
- The power switch may be turned to ACCESSORY mode even if trying to turn the power switch off.
In this case, the power switch may be turned off after applying the parking brake.
- The automatic P position selection function (→P. 348) may not operate.
Before turning the power switch off, be sure to press the P position switch and check that the shift position is in P by the shift position indicator or P position switch indicator.

■ **Warning buzzer**

→P. 681

 NOTICE

■ **If “Have Traction Battery Inspected” is shown**

The hybrid battery (traction battery) is scheduled to be inspected or replaced. Have the vehicle inspected by your Toyota dealer immediately.

- Continuing to drive the vehicle without having the hybrid battery (traction battery) inspected will cause the hybrid system not to start.
- If the hybrid system does not start, contact your Toyota dealer immediately.

If you have a flat tire

Your vehicle is not equipped with a spare tire, but instead is equipped with an emergency tire puncture repair kit.

A puncture caused by a nail or screw passing through the tire tread can be repaired temporarily using the emergency tire puncture repair kit. (The kit contains a bottle of sealant. The sealant can be used only once to temporarily repair one tire without removing the nail or screw from the tire.) After temporarily repairing the tire with the kit, have the tire repaired or replaced by your Toyota dealer.

WARNING

■ **If you have a flat tire**

Do not continue driving with a flat tire.

Driving even a short distance with a flat tire can damage the tire and the wheel beyond repair, which could result in an accident.

Before repairing the tire

- Stop the vehicle in a safe place on a hard, flat surface.
- Set the parking brake.
- Shift the shift position to P.
- Stop the hybrid system.
- Turn on the emergency flashers.
- Check the degree of the tire damage.

A tire should only be repaired with the emergency tire puncture repair kit if the damage is caused by a nail or screw passing through the tire tread.

- Do not remove the nail or screw from the tire. Removing the object may widen the opening and make emergency repair with the repair kit impossible.
- To avoid sealant leakage, move the vehicle until the area of the puncture, if known, is positioned at the top of the tire.

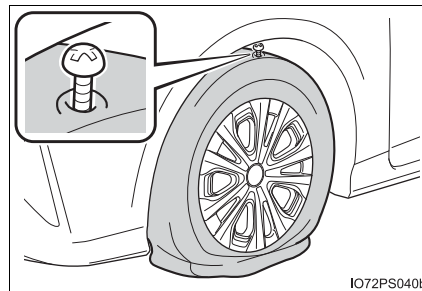

■ A flat tire that cannot be repaired with the emergency tire puncture repair kit

In the following cases, the tire cannot be repaired with the emergency tire puncture repair kit. Contact your Toyota dealer.

- When the tire is damaged due to driving without sufficient air pressure
- When there are any cracks or damage at any location on the tire, such as on the side wall, except the tread
- When the tire is visibly separated from the wheel
- When the cut or damage to the tread is 0.16 in. (4 mm) long or more
- When the wheel is damaged
- When two or more tires have been punctured
- When more than one sharp objects such as nails or screws have passed through the tread on a single tire
- When the sealant has expired

Location of the emergency tire puncture repair kit

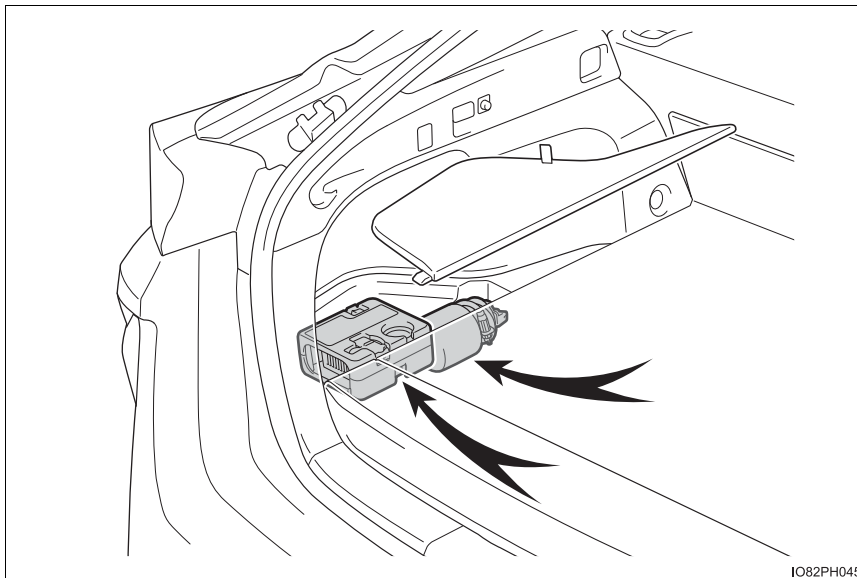

Emergency tire puncture repair kit

I082PH045

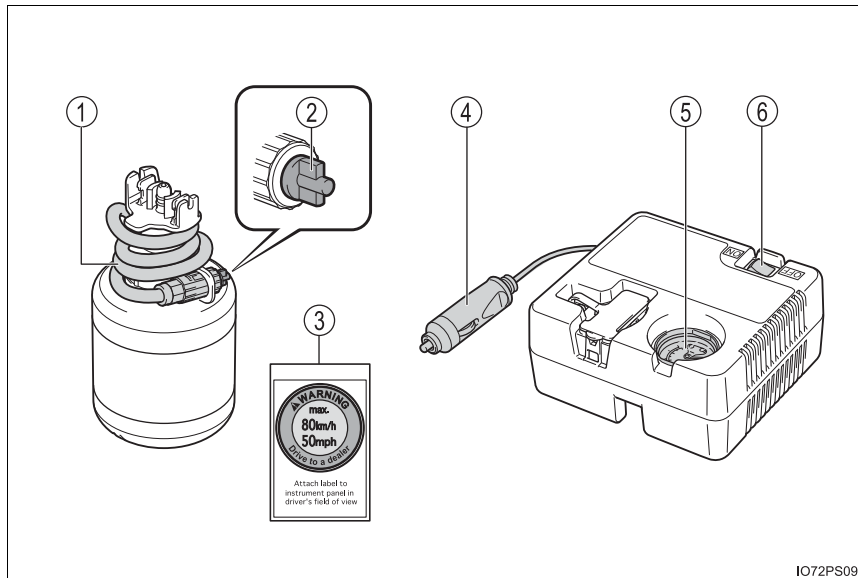
Emergency tire puncture repair kit components

- ① Hose
- ② Air release cap
- ③ Sticker
- ④ Power plug
- ⑤ Air pressure gauge
- ⑥ Compressor switch

Taking out the emergency tire puncture repair kit

- 1 Pull the strap up and remove the cover.

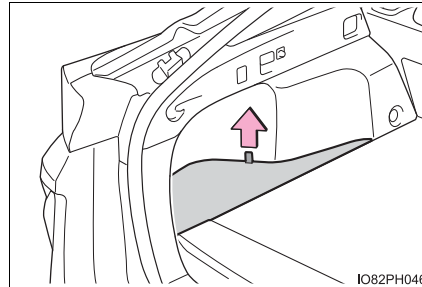

- 2 Take out the emergency tire puncture repair kit.

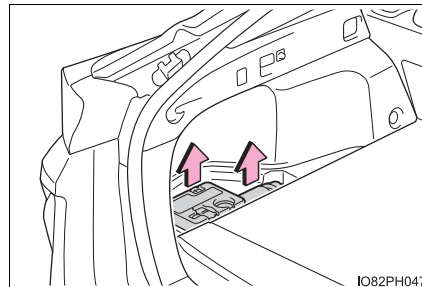

■ When installing the cover

Insert the claw in to the hole, and return the cover.

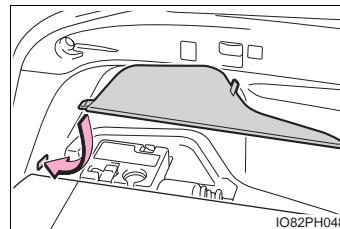

Emergency repair method

- 1 Take out the repair kit from the plastic bag.

- 2 Remove the valve cap from the valve of the punctured tire.

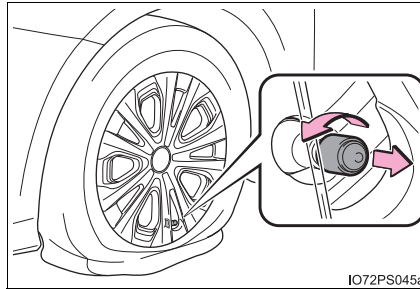

- 3 Extend the hose. Remove the air release cap from the hose.

Attach the sticker enclosed with the bottle on the specified locations. (See step 10.)

You will use the air release cap again. Therefore keep it in a safe place.

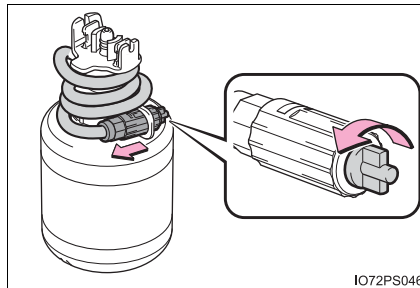

- 4 Connect the hose to the valve.

Screw the end of the hose clockwise as far as possible.

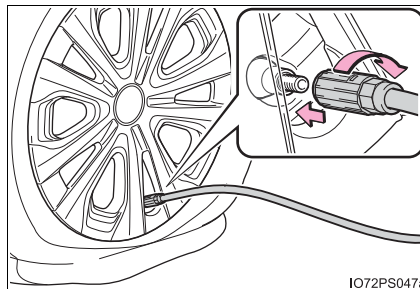

- 5 Make sure that the compressor switch is off.

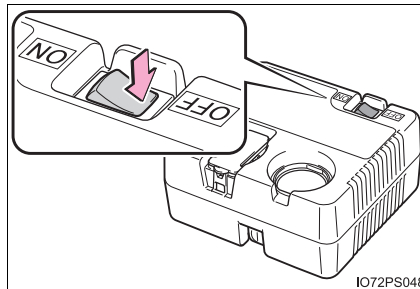

- 6 Lift the rubber stopper on the compressor.

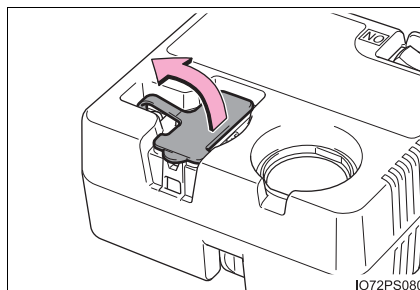

- 7 Remove the power plug from the compressor.

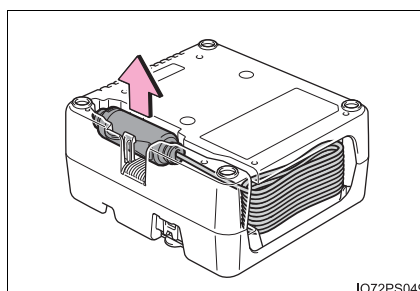

- 8 Connect the power plug to the power outlet socket. (→P. 554)

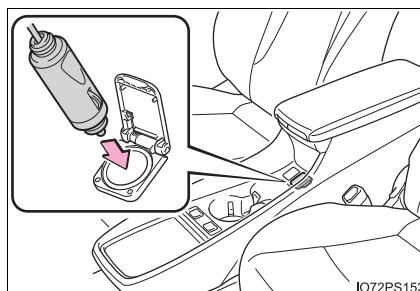

- 9 Connect the bottle to the compressor.

As shown in the illustration, insert the bottle securely into the compressor until the upper side of the mark on the bottle is aligned with the upper end of the notch.

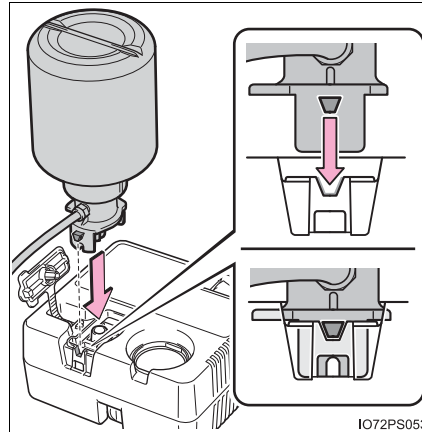

- 10 Attach the sticker provided with the tire puncture repair kit to a position easily seen from the driver's seat.

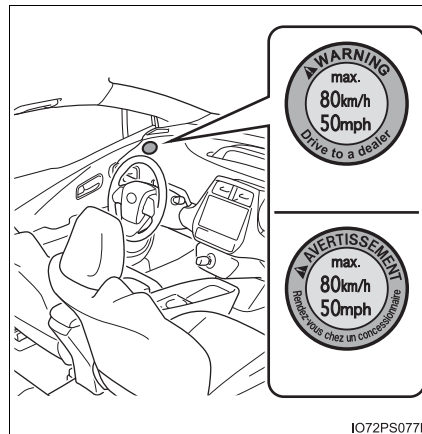

- 11 Check the specified tire inflation pressure.

Tire inflation pressure is specified on the label on the driver's side pillar as shown. (→P. 737)

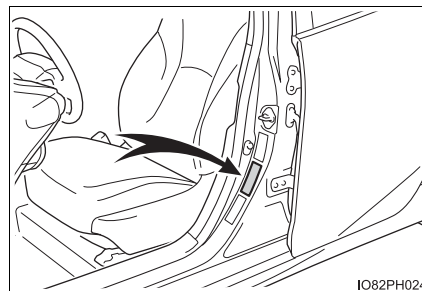

- 12 Start the hybrid system. (→P. 338)

- 13 To inject the sealant and inflate the tire, turn the compressor switch on.

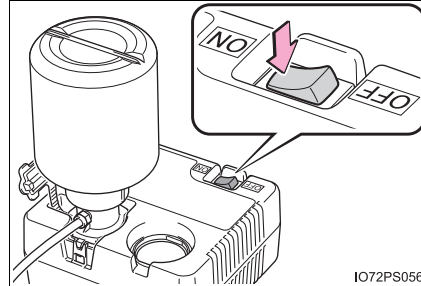

- 14 Inflate the tire until the specified air pressure is reached.

- ① The sealant will be injected and the pressure will spike to between 44 psi (300 kPa, 3.0 kgf/cm² or bar) and 58 psi (400 kPa, 4.0 kgf/cm² or bar), then gradually decrease.

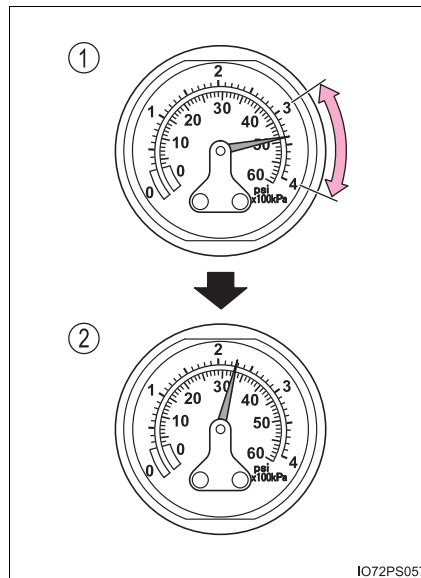

- ② The air pressure gauge will display the actual tire inflation pressure about 1 to 5 minutes after the switch is turned on.

- Turn the compressor switch off and then check the tire inflation pressure. Being careful not to over inflate, check and repeat the inflation procedure until the specified tire inflation pressure is reached.
- The tire can be inflated for about 5 to 20 minutes (depending on the outside temperature). If the tire inflation pressure is still lower than the specified point after inflation for 25 minutes, the tire is too damaged to be repaired. Turn the compressor switch off and contact your Toyota dealer.
- If the tire inflation pressure exceeds the specified air pressure, let out some air to adjust the tire inflation pressure. (→P. 703, 737)

- 15 With the compressor switch off, disconnect the hose from the valve on the tire and then pull out the power plug from the power outlet socket.

Some sealant may leak when the hose is removed.

- 16 Install the valve cap onto the valve of the emergency repaired tire.

- 17 Attach the air release cap to the end of the hose.

If the air release cap is not attached, the sealant may leak and the vehicle may get dirty.

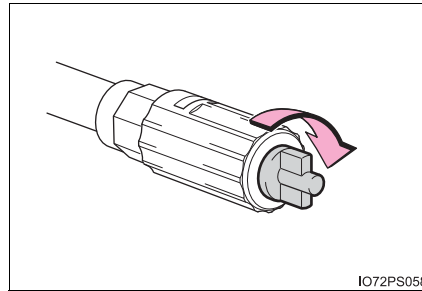

- 18 Temporarily store the bottle in the luggage compartment while it is connected to the compressor.

- 19 To spread the liquid sealant evenly within the tire, immediately drive safely for about 3 miles (5 km) below 50 mph (80 km/h).

- 20 After driving, stop your vehicle in a safe place on a hard, flat surface and reconnect the repair kit.

Remove the air release cap from the hose before reconnecting the hose.

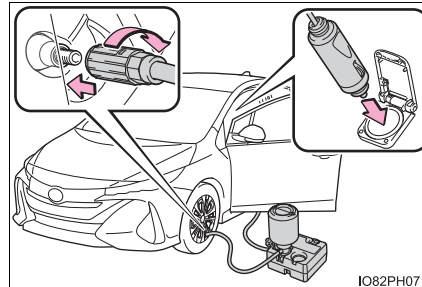

21 Turn the compressor switch on and wait for several seconds, then turn it off. Check the tire inflation pressure.

① If the tire inflation pressure is under 19 psi (130 kPa, 1.3 kgf/cm² or bar): The puncture cannot be repaired. Contact your Toyota dealer.

② If the tire inflation pressure is 19 psi (130 kPa, 1.3 kgf/cm² or bar) or higher, but less than the specified air pressure: Proceed to step 22.

③ If the tire inflation pressure is the specified air pressure (→P. 737): Proceed to step 23.

22 Turn the compressor switch on to inflate the tire until the specified air pressure is reached. Drive for about 3 miles (5 km) and then perform step 20.

23 Attach the air release cap to the end of the hose.

If the air release cap is not attached, the sealant may leak and the vehicle may get dirty.

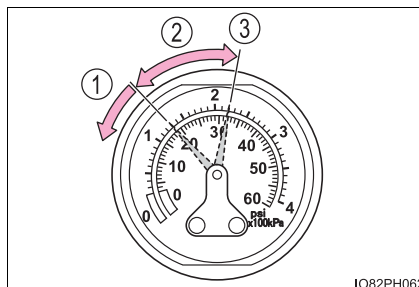

IO82PH062

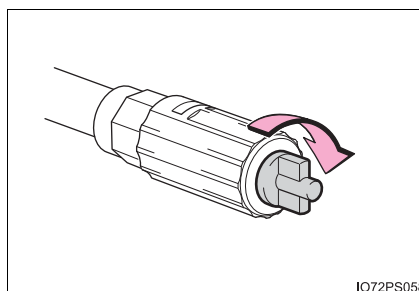

IO72PS058

24 Store the bottle in the luggage compartment while it is connected to the compressor.

25 Taking precautions to avoid sudden braking, sudden acceleration and sharp turns, drive carefully at under 50 mph (80 km/h) to the nearest Toyota dealer that is less than 62 miles (100 km) away for tire repair or replacement.

When having the tire repaired or replaced, make sure to tell the Toyota dealer that the sealant is injected.

■ If the tire is inflated to more than the specified air pressure

- 1 Disconnect the hose from the valve.
- 2 Install the air release cap to the end of the hose and push the protrusion on the air release cap into the tire valve to let some air out.

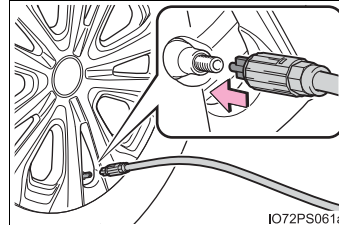

- 3 Disconnect the hose from the valve, remove the air release cap from the hose and then reconnect the hose.
- 4 Turn the compressor switch on and wait for several seconds, and then turn it off. Check that the air pressure indicator shows the specified air pressure. (→P. 737)

If the air pressure is under the designated pressure, turn the compressor switch on again and repeat the inflation procedure until the specified air pressure is reached.

■ The valve of a tire that has been repaired

After a tire is repaired with the emergency tire puncture repair kit, the valve should be replaced.

■ After a tire is repaired with the emergency tire puncture repair kit

- The tire pressure warning valve and transmitter should be replaced.
- Even if the tire inflation pressure is at the recommended level, the tire pressure warning light may come on/flash.

■ Note for checking the emergency tire puncture repair kit

Check the sealant expiry date occasionally.

The expiry date is shown on the bottle. Do not use sealant whose expiry date has already passed. Otherwise, repairs conducted using the emergency tire puncture repair kit may not be performed properly.

■ **Emergency tire puncture repair kit**

- The emergency tire puncture repair kit is for filling the car tire with air.
- The sealant has a limited life span. The expiry date is marked on the bottle. The sealant should be replaced before the expiry date. Contact your Toyota dealer for replacement.
- The sealant stored in the emergency tire puncture repair kit can be used only once to temporarily repair a single tire. If the sealant in the bottle and other parts of the kit have been used and need to be replaced, contact your Toyota dealer.
- The compressor can be used repeatedly.
- The sealant can be used when the outside temperature is from -40°F (-40°C) to 140°F (60°C).
- The kit is exclusively designed for size and type of tires originally installed on your vehicle. Do not use it for tires that a different size than the original ones, or for any other purposes.
- If the sealant gets on your clothes, it may stain.
- If the sealant adheres to a wheel or the surface of the vehicle body, the stain may not be removable if it is not cleaned at once. Immediately wipe away the sealant with a wet cloth.
- During operation of the repair kit, a loud operation noise is produced. This does not indicate a malfunction.
- Do not use to check or to adjust the tire pressure.

 **WARNING****■ Do not drive the vehicle with a flat tire**

Do not continue driving with a flat tire.

Driving even a short distance with a flat tire can damage the tire and the wheel beyond repair.

Driving with a flat tire may cause a circumferential groove on the side wall. In such a case, the tire may explode when using a repair kit.

■ Caution while driving

- Store the repair kit in the luggage compartment.
Injuries may result in the event of an accident or sudden braking.
- The repair kit is exclusively only for your vehicle.
Do not use repair kit on other vehicles, which could lead to an accident causing death or serious injury.
- Do not use repair kit for tires that are different size than the original ones, or for any other purpose. If the tires have not been completely repaired, it could lead to an accident causing death or serious injury.

■ Precautions for use of the sealant

- Ingesting the sealant is hazardous to your health. If you ingest sealant, consume as much water as possible, and then immediately consult a doctor.
- If sealant gets in eyes or adheres to skin, immediately wash it off with water. If discomfort persists, consult a doctor.

 **WARNING****■ When fixing the flat tire**

- Stop your vehicle in a safe and flat area.
- Do not touch the wheels or the area around the brakes immediately after the vehicle has been driven.
After the vehicle has been driven, the wheels and the area around the brakes may be extremely hot. Touching these areas with hands, feet or other body parts may result in burns.
- Connect the valve and hose securely with the tire installed on the vehicle. If the hose is not properly connected to the valve, air leakage may occur as sealant may be sprayed out.
- If the hose comes off the valve while inflating the tire, there is a risk that the hose will move abruptly due to air pressure.
- After inflation of the tire has completed, the sealant may splatter when the hose is disconnected or some air is let out of the tire.
- Follow the operation procedure to repair the tire. If the procedures not followed, the sealant may spray out.
- Keep back from the tire while it is being repaired, as there is a chance of it bursting while the repair operation is being performed. If you notice any cracks or deformation of the tire, turn off the compressor switch and stop the repair operation immediately.
- The repair kit may overheat if operated for a long period of time. Do not operate the repair kit continuously for more than 40 minutes.
- Parts of the repair kit become hot during operation. Be careful handling the repair kit during and after operation. Do not touch the metal part connecting the bottle and the compressor. It will be extremely hot.
- Do not attach the vehicle speed warning sticker to an area other than the one indicated. If the sticker is attached to an area where an SRS airbag is located, such as the pad of the steering wheel, it may prevent the SRS airbag from operating properly.

 **WARNING****■ Driving to spread the liquid sealant evenly**

Observe the following precautions to reduce the risk of accidents. Failing to do so may result in a loss of vehicle control and cause death or serious injury.

- Drive the vehicle carefully at a low speed. Be especially careful when turning and cornering.
- If the vehicle does not drive straight or you feel a pull through the steering wheel, stop the vehicle and check the following.
 - Tire condition. The tire may have separated from the wheel.
 - Tire inflation pressure. If the tire inflation pressure is 19 psi (130 kPa, 1.3 kgf/cm² or bar) or less, the tire may be severely damaged.

 **NOTICE****■ When performing an emergency repair**

- A tire should only be repaired with the emergency tire puncture repair kit if the damage is caused by a sharp object such as nail or screw passing through the tire tread.
Do not remove the sharp object from the tire. Removing the object may widen the opening and disenable emergency repair with the repair kit.
- The repair kit is not waterproof. Make sure that the repair kit is not exposed to water, such as when it is being used in the rain.
- Do not put the repair kit directly onto dusty ground such as sand at the side of the road. If the repair kit vacuums up dust etc., a malfunction may occur.

■ Precautions for the emergency tire puncture repair kit

- The repair kit power source should be 12 V DC suitable for vehicle use. Do not connect the repair kit to any other source.
- If fuel splatters on the repair kit, the repair kit may deteriorate. Take care not to allow fuel to contact it.
- Place the repair kit in a storage to prevent it from being exposed to dirt or water.
- Store the repair kit in the luggage compartment out of reach of children.
- Do not disassemble or modify the repair kit. Do not subject parts such as the air pressure indicator to impacts. This may cause a malfunction.

 NOTICE

■ **To avoid damage to the tire pressure warning valves and transmitters**

When a tire is repaired with liquid sealants, the tire pressure warning valve and transmitter may not operate properly. If a liquid sealant is used, contact your Toyota dealer or other qualified service shop as soon as possible. After use of liquid sealant, make sure to replace the tire pressure warning valve and transmitter when repairing or replacing the tire. (→P. 615)

If the hybrid system will not start

Reasons for the hybrid system not starting vary depending on the situation. Check the following and perform the appropriate procedure:

The hybrid system will not start even though the correct starting procedure is being followed. (→P. 338)

One of the following may be the cause of the problem:

- The charging cable may be attached to the vehicle. (→P. 146)
- The electronic key may not be functioning properly.* (→P. 711)
- There may not be sufficient fuel in the vehicle's tank.
Refuel the vehicle. (→P. 100)
- There may be a malfunction in the immobilizer system.* (→P. 83)
- There may be a malfunction in the shift control system.*
(→P. 342, 691)
- The hybrid system may be malfunctioning due to an electrical problem such as electronic key battery depletion or a blown fuse. However, depending on the type of malfunction, an interim measure is available to start the hybrid system. (→P. 710)
- There is a possibility that the temperature of the hybrid battery (traction battery) is extremely low (approximately below -22°F [-30°C]). (→P. 100, 340)

*: It may not be possible to shift the shift position other than P.

The interior lights and headlights are dim, or the horn does not sound or sounds at a low volume.

One of the following may be the cause of the problem:

- The 12-volt battery may be discharged. (→P. 715)
- The 12-volt battery terminal connections may be loose or corroded.
(→P. 607)

The interior lights and headlights do not turn on, or the horn does not sound.

One of the following may be the cause of the problem:

- The 12-volt battery may be discharged. (→P. 715)
- One or both of the 12-volt battery terminals may be disconnected. (→P. 607)

Contact your Toyota dealer if the problem cannot be repaired, or if repair procedures are unknown.

Emergency start function

When the hybrid system does not start, the following steps can be used as an interim measure to start the hybrid system if the power switch is functioning normally.

Do not use this starting procedure except in cases of emergency.

- 1 Set the parking brake.
- 2 Turn the power switch to ACCESSORY mode.
- 3 Press and hold the power switch for about 15 seconds while depressing the brake pedal firmly.

Even if the hybrid system can be started using the above steps, the system may be malfunctioning. Have the vehicle inspected by your Toyota dealer.

If the electronic key does not operate properly

If communication between the electronic key and vehicle is interrupted (→P. 295) or the electronic key cannot be used because the battery is depleted, the smart key system and wireless remote control cannot be used. In such cases, the doors can be opened and the hybrid system can be started by following the procedure below.

Locking and unlocking the doors

Use the mechanical key (→P. 277) in order to perform the following operations:

- ① Locks all the doors
- ② Closes the windows (turn and hold)*
- ③ Unlocks the door
Turning the key rearward unlocks the driver's door. Turning the key once again within 3 seconds unlocks the other doors.
- ④ Opens the windows (turn and hold)*

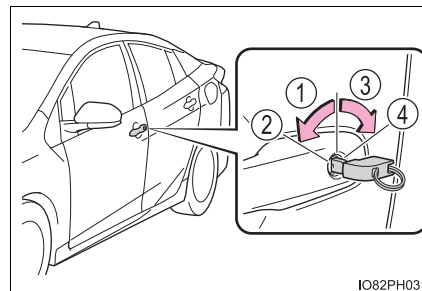



*: This setting must be customized at your Toyota dealer. (→P. 753)

Starting the hybrid system

- 1 Depress the brake pedal.
- 2 Touch the Toyota emblem side of the electronic key to the power switch.

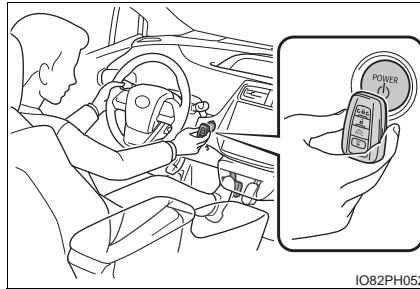
When the electronic key is detected, a buzzer sounds and the power switch will turn to ON mode. When the smart key system is deactivated in customization setting, the power switch will turn to ACCESSORY mode.



- 3 Firmly depress the brake pedal and check that  is shown on the multi-information display.

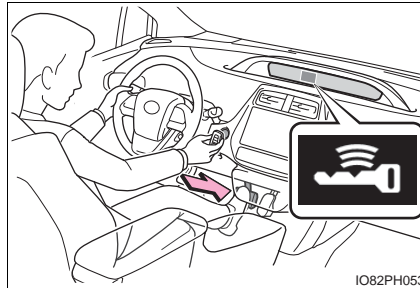

- 4 Press the power switch.

In the event that the hybrid system still cannot be operated, contact your Toyota dealer.

Locking and unlocking the charging port lid***■ Locking the charging port lid**

- 1 Close the charging port lid. (→P. 112)
- 2 Lock the doors using the mechanical key. (→P. 711)

The charging port lid can be locked if the steps 1 and 2 are performed in reverse.

■ Unlocking the charging port lid

- 1 Unlock the doors using the mechanical key. (→P. 711)
- 2 Open the charging port lid. (→P. 111)

*: Vehicles with smart lid & connector locking system only

Locking and unlocking the charging connector***■ Locking the charging connector**

- 1 Unlock the doors using the mechanical key. (→P. 711)
- 2 Open the charging port lid. (→P. 111)
- 3 Insert the charging connector into the charging inlet. (→P. 147)
- 4 Push the charging connector lock switch. (→P. 148)

The charging connector will be locked.

■ Unlocking the charging port lid

- 1 Unlock the doors using the mechanical key. (→P. 711)
- 2 Push the charging connector lock switch. (→P. 150)

The charging connector will be unlocked.

*: Vehicles with smart lid & connector locking system only

■ **Stopping the hybrid system**

Set the parking brake, shift the shift position to P and press the power switch as you normally do when stopping the hybrid system.

■ **Replacing the key battery**

As the above procedure is a temporary measure, it is recommended that the electronic key battery be replaced immediately when the battery is depleted. (→P. 647)

■ **Changing power switch modes**

Release the brake pedal and press the power switch in step 3 above. The hybrid system does not start and modes will be changed each time the switch is pressed. (→P. 340)

■ **When the electronic key does not work properly**

- Make sure that the smart key system has not been deactivated in the customization setting. If it is off, turn the function on. (Customizable features: →P. 753)
- Check if battery-saving mode is set. If it is set, cancel the function. (→P. 294)

 **WARNING**

■ **When using the mechanical key and operating the power windows**

Operate the power window after checking to make sure that there is no possibility of any passenger having any of their body parts caught in the window.

Also, do not allow children to operate the mechanical key. It is possible for children and other passengers to get caught in the power window.

If the 12-volt battery is discharged

The following procedures may be used to start the hybrid system if the vehicle's 12-volt battery is discharged. You can also call your Toyota dealer or a qualified repair shop.

If you have a set of jumper (or booster) cables and a second vehicle with a 12-volt battery, you can jump start your vehicle by following the steps below.

- 1 Open the hood. (→P. 597)
- 2 Remove the engine cover.
Pull up the both ends of the cover vertically.

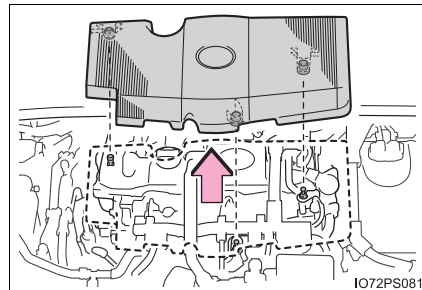

- 3 Connect the jumper cables according to the following procedure:
 - ① Connect a positive jumper cable clamp to the positive (+) battery terminal on your vehicle.
 - ② Connect the clamp on the other end of the positive cable to the positive (+) battery terminal on the second vehicle.
 - ③ Connect a negative cable clamp to the negative (-) battery terminal on the second vehicle.
 - ④ Connect the clamp at the other end of the negative cable to a solid, stationary, unpainted metallic point away from the 12-volt battery and any moving parts, as shown in the illustration.

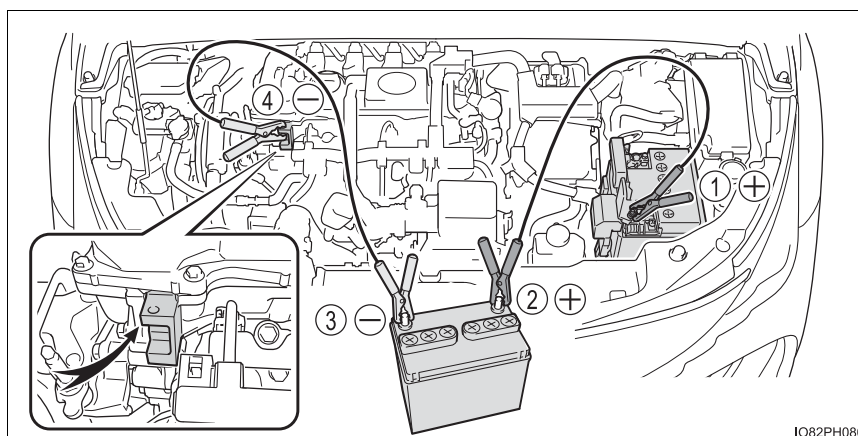

- 4 Start the engine of the second vehicle. Increase the engine speed slightly and maintain at that level for approximately 5 minutes to recharge the 12-volt battery of your vehicle.
- 5 Maintain the engine speed of the second vehicle and start the hybrid system of your vehicle by turning the power switch to ON mode.
- 6 Make sure the "READY" indicator comes on. If the indicator light does not come on, contact your Toyota dealer.
- 7 Once the hybrid system has started, remove the jumper cables in the exact reverse order from which they were connected.
- 8 To install the engine cover, conduct the removal procedure in reverse. After installing, check that the fixed pins are inserted securely.

Once the hybrid system starts, have the vehicle inspected at your Toyota dealer as soon as possible.

■ When opening the cover of the positive (+) battery terminal

→P. 607

■ Starting the hybrid system when the 12-volt battery is discharged

The hybrid system cannot be started by push-starting.

■ To prevent 12-volt battery discharge

- Turn off the headlights and the audio system while the hybrid system is off.
- Turn off any unnecessary electrical components when the vehicle is running at a low speed for an extended period, such as in heavy traffic.

■ When the 12-volt battery is removed or discharged

- Information stored in the ECU is cleared. When the 12-volt battery is depleted, have the vehicle inspected at your Toyota dealer.
- Some systems may require initialization. (→P. 765)

■ When removing the 12-volt battery terminals

When the 12-volt battery terminals are removed, the information stored in the ECU is cleared. Before removing the 12-volt battery terminals, contact your Toyota dealer.

■ Charging the 12-volt battery

The electricity stored in the 12-volt battery will discharge gradually even when the vehicle is not in use, due to natural discharge and the draining effects of certain electrical appliances. If the vehicle is left for a long time, the 12-volt battery may discharge, and the hybrid system may be unable to start. (The 12-volt battery recharges automatically while the hybrid system is operating.)

■ When recharging or replacing the 12-volt battery

- In some cases, it may not be possible to unlock the doors using the smart key system when the 12-volt battery is discharged. Use the wireless remote control or the mechanical key to lock or unlock the doors.
- The hybrid system may not start on the first attempt after the 12-volt battery has recharged but will start normally after the second attempt. This is not a malfunction.
- Vehicles with smart lid & connector locking system:
It may be impossible to unlock the charging port lid or locking and unlocking the charging connector immediately after the 12-volt battery is reconnected. In this case, carry the electronic key on your person and operate the charging port lid or charging connector lock switch again.
- The power switch mode is memorized by the vehicle. When the 12-volt battery is reconnected, the system will return to the mode it was in before the 12-volt battery was discharged. Before disconnecting the 12-volt battery, turn the power switch off.
If you are unsure what mode the power switch was in before the 12-volt battery discharged, be especially careful when reconnecting the 12-volt battery.
- If the 12-volt battery discharges while the shift position is in P, it may not be possible to shift the shift position to other positions. In this case, the vehicle cannot be towed without lifting both front wheels because the front wheels will be locked. (→P. 667)

■ When replacing the 12-volt battery

- Use a 12-volt battery that conforms to European regulations.
- Use a 12-volt battery that the case size is same as the previous one (LN1), 20 hour rate capacity (20HR) is equivalent (45Ah) or greater, and performance rating (CCA) is equivalent (295A) or greater.
 - If the sizes differ, the 12-volt battery cannot be properly secured.
 - If the 20 hour rate capacity is low, even if the time period where the vehicle is not used is a short time, the 12-volt battery may discharge and the hybrid system may not be able to start.
- For details, consult your Toyota dealer.

 **WARNING****■ When removing the 12-volt battery terminals**

Always remove the negative (-) terminal first. If the positive (+) terminal contacts any metal in the surrounding area when the positive (+) terminal is removed, a spark may occur, leading to a fire in addition to electrical shocks and death or serious injury.

■ Avoiding 12-volt battery fires or explosions

Observe the following precautions to prevent accidentally igniting the flammable gas that may be emitted from the 12-volt battery:

- Make sure each jumper cable is connected to the correct terminal and that it is not unintentionally in contact with any other than the intended terminal.
- Do not allow the other end of the jumper cable connected to the “+” terminal to come into contact with any other parts or metal surfaces in the area, such as brackets or unpainted metal.
- Do not allow the + and - clamps of the jumper cables to come into contact with each other.
- Do not smoke, use matches, cigarette lighters or allow open flame near the 12-volt battery.

■ 12-volt battery precautions

The 12-volt battery contains poisonous and corrosive acidic electrolyte, while related parts contain lead and lead compounds. Observe the following precautions when handling the 12-volt battery:

- When working with the 12-volt battery, always wear safety glasses and take care not to allow any battery fluids (acid) to come into contact with skin, clothing or the vehicle body.
- Do not lean over the 12-volt battery.
- In the event that battery fluid comes into contact with the skin or eyes, immediately wash the affected area with water and seek medical attention. Place a wet sponge or cloth over the affected area until medical attention can be received.
- Always wash your hands after handling the 12-volt battery support, terminals, and other battery-related parts.
- Do not allow children near the 12-volt battery.

 NOTICE

■ **When handling jumper cables**

When connecting the jumper cables, ensure that they do not become entangled in the cooling fans, etc.

If your vehicle overheats

The following may indicate that your vehicle is overheating.

- The high coolant temperature warning light (→P. 676) comes on or flashes, or a loss of hybrid system power is experienced. (For example, the vehicle speed does not increase.)
- “Hybrid System Overheated” is shown on the multi-information display.
- Steam comes out from under the hood.

Correction procedures

■ If the high coolant temperature warning light comes on or flashes

- 1 Stop the vehicle in a safe place and turn off the air conditioning system, and then stop the hybrid system.
- 2 If you see steam:
Carefully lift the hood after the steam subsides.
If you do not see steam:
Carefully lift the hood.
- 3 After the hybrid system has cooled down sufficiently, inspect the hoses and radiator core (radiator) for any leaks.

① Radiator

② Cooling fans

If a large amount of coolant leaks, immediately contact your Toyota dealer.

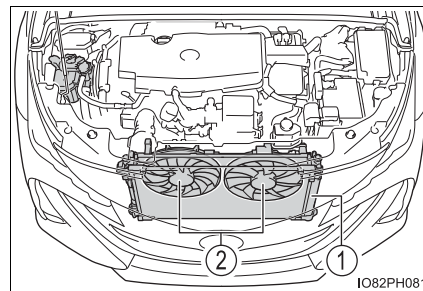

- 4 The coolant level is satisfactory if it is between the “MAX” and “MIN” lines on the reservoir.

- ① Reservoir
- ② “MAX” line
- ③ “MIN” line

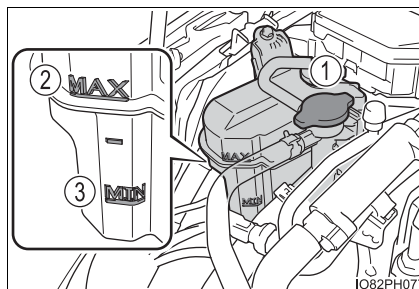

- 5 Add coolant if necessary.
Water can be used in an emergency if coolant is unavailable.

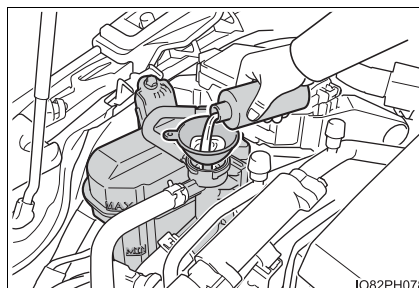

- 6 Start the hybrid system and turn the air conditioning system on to check that the radiator cooling fans operate and to check for coolant leaks from the radiator or hoses.

The fans operate when the temperature setting is adjusted to “LO” and “A/C” switch (A/C *1 • A/C *2) is turned on immediately after a cold start. Confirm that the fans are operating by checking the fan sound and air flow. If it is difficult to check these, turn the “A/C” switch (A/C *1 • A/C *2) on and off repeatedly. (The fans may not operate in freezing temperatures.)

*1: Vehicles with 7-inch display

*2: Vehicles with 11.6-inch display

- 7 If the fans are not operating:
Stop the hybrid system immediately and contact your Toyota dealer.
If the fans are operating:
Have the vehicle inspected at the nearest Toyota dealer.

■ If “Hybrid System Overheated” is shown on the multi-information display

- 1 Stop the vehicle in a safe place.
- 2 Stop the hybrid system and carefully lift the hood.
- 3 After the hybrid system has cooled down, inspect the hoses and radiator core (radiator) for any leaks.

- ① Radiator
- ② Cooling fans

If a large amount of coolant leaks, immediately contact your Toyota dealer.

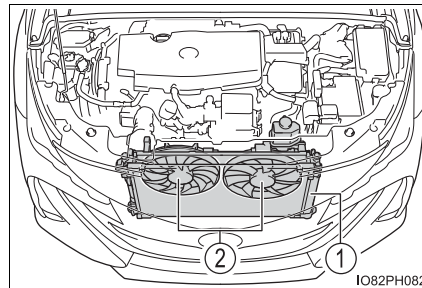

- 4 The coolant level is satisfactory if it is between the “FULL” and “LOW” lines on the reservoir.

- ① Reservoir
- ② “FULL” line
- ③ “LOW” line

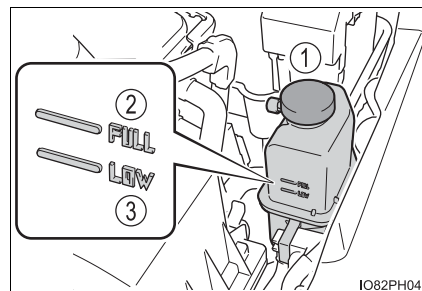

- 5 Add coolant if necessary.

Water can be used in an emergency if coolant is unavailable.

If water was added in an emergency, have the vehicle inspected at your Toyota dealer as soon as possible.

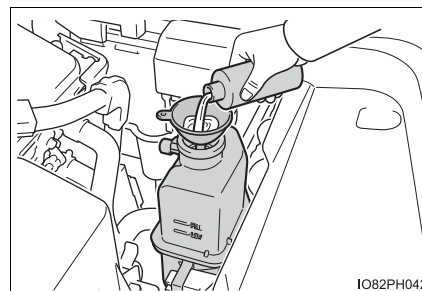

- 6 After stopping the hybrid system and waiting for 5 minutes or more, start the hybrid system again and check if “Hybrid System Overheated” is shown on the multi-information display.

If the message does not disappear:

Stop the hybrid system and contact your Toyota dealer.

If the message is not displayed:

The hybrid system temperature has dropped and the vehicle may be driven normally.

However, if the message appears again frequently, contact your Toyota dealer.

**WARNING****■ To prevent an accident or injury when inspecting under the hood of your vehicle**

Observe the following precautions.

Failure to do so may result in serious injury such as burns.

- If steam is seen coming from under the hood, do not open the hood until the steam has subsided. The engine compartment may be very hot.

- After the hybrid system has been turned off, check that the “Accessory”, “Ignition ON” or mileage display (→P. 210) on the main display and the “READY” indicator are off.

When the hybrid system is operating, the gasoline engine may automatically start, or the cooling fans may suddenly operate even if the gasoline engine stops. Do not touch or approach rotating parts such as the fan, which may lead to fingers or clothing (especially a tie, a scarf or a muffler) getting caught, resulting in serious injury.

- Do not loosen the coolant reservoir caps while the hybrid system and radiator are hot.

High temperature steam or coolant could spray out.

 NOTICE**■ When adding engine/power control unit coolant**

Add coolant slowly after the hybrid system has cooled down sufficiently. Adding cool coolant to a hot hybrid system too quickly can cause damage to the hybrid system.

■ To prevent damage to the cooling system

Observe the following precautions:

- Avoid contaminating the coolant with foreign matter (such as sand or dust etc.).
- Do not use any coolant additive.

If the vehicle becomes stuck

Carry out the following procedures if the tires spin or the vehicle becomes stuck in mud, dirt or snow:

- 1 Set the parking brake and shift the shift position to P. Stop the hybrid system.
- 2 Remove the mud, snow or sand from around the front wheels.
- 3 Place wood, stones or some other material under the front wheels to help provide traction.
- 4 Restart the hybrid system.
- 5 Shift the shift position to D or R and release the parking brake. Then, while exercising caution, depress the accelerator pedal.

■ When it is difficult to free the vehicle

Press  to turn off TRAC. (→P. 502)

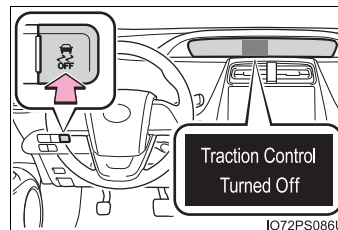

 **WARNING****■ When attempting to free a stuck vehicle**

If you choose to push the vehicle back and forth to free it, make sure the surrounding area is clear to avoid striking other vehicles, objects or people. The vehicle may also lunge forward or lunge back suddenly as it becomes free. Use extreme caution.

■ When changing the shift position

Be careful not to change the shift position with the accelerator pedal depressed.

This may lead to unexpected rapid acceleration of the vehicle that may cause an accident resulting in death or serious injury.

 **NOTICE****■ To avoid damage to the hybrid transmission and other components**

- Avoid spinning the front wheels and depressing the accelerator pedal more than necessary.
- If the vehicle remains stuck even after these procedures are performed, the vehicle may require towing to be freed.

Vehicle specifications**9****9-1. Specifications**

- Maintenance data
(fuel, oil level, etc.)..... 730
- Fuel information 739
- Tire information 742

9-2. Customization

- Customizable features 753

9-3. Initialization

- Items to initialize 765

Maintenance data (fuel, oil level, etc.)

Dimensions and weight

Overall length	182.9 in. (4645 mm)	
Overall width	69.3 in. (1760 mm)	
Overall height*	57.9 in. (1470 mm)	
Wheelbase	106.3 in. (2700 mm)	
Tread*	Front	60.2 in. (1530 mm)
	Rear	60.6 in. (1540 mm)
Vehicle capacity weight (Occupants + luggage)	840 lb. (385 kg)	

*: Unladen vehicle

Seating capacity

Seating capacity	5 (Front 2, Rear 3)
------------------	---------------------

Vehicle identification

■ **Vehicle identification number**

The vehicle identification number (VIN) is the legal identifier for your vehicle. This is the primary identification number for your Toyota. It is used in registering the ownership of your vehicle.

This number is stamped on the top left of the instrument panel.

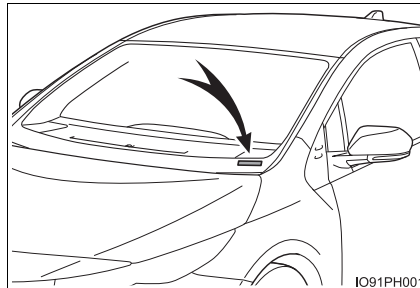

This number is also stamped under the right-hand front seat.

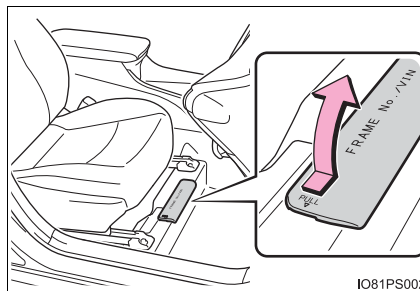

This number is also on the Certification label.

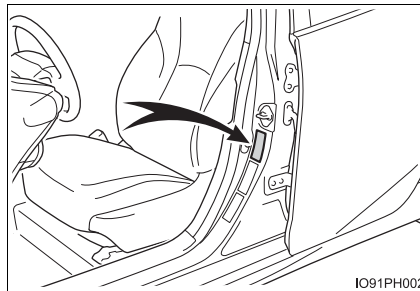

■ Engine number

The engine number is stamped on the engine block as shown.

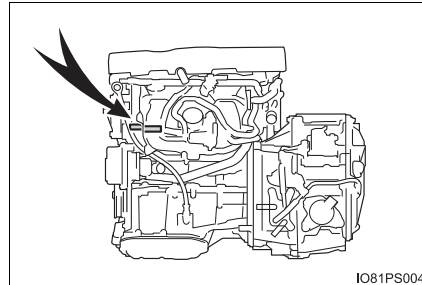

IO81PS004

Engine

Model	1.8 L 4-cylinder (2ZR-FXE)
Type	4-cylinder in line, 4-cycle, gasoline
Bore and stroke	3.17 × 3.48 in. (80.5 × 88.3 mm)
Displacement	109.7 cu.in. (1798 cm ³)
Valve clearance	Automatic adjustment

Fuel

Fuel type	Unleaded gasoline only
Octane Rating	87 (Research Octane Number 91) or higher
Fuel tank capacity (Reference)	11.4 gal. (43 L, 9.5 Imp.gal.)

Electric motor (generation motor/traction motor)

▶ Generation/traction motor

Type	Permanent magnet synchronous motor
Maximum output	22.5 kW
Maximum torque	29.5 ft•lbf (40 N•m, 4.1 kgf•m)

▶ Traction motor

Type	Permanent magnet synchronous motor
Maximum output	53 kW
Maximum torque	120.2 ft•lbf (163 N•m, 16.6 kgf•m)

Hybrid battery (traction battery)

Type	Lithium-ion battery
Voltage	3.7 V/cell
Capacity	25 Ah
Quantity	95 cells
Nominal voltage	351.5 V

Lubrication system

■ Oil capacity (Drain and refill [Reference*])

With filter	4.4 qt. (4.2 L, 3.7 Imp.qt.)
Without filter	4.1 qt. (3.9 L, 3.4 Imp.qt.)

*: The engine oil capacity is a reference quantity to be used when changing the engine oil. Park the vehicle on level ground. After warming up the engine and turning off the hybrid system, wait more than 5 minutes, and check the oil level on the dipstick.

■ Engine oil selection

“Toyota Genuine Motor Oil” is used in your Toyota vehicle. Use Toyota approved “Toyota Genuine Motor Oil” or equivalent to satisfy the following grade and viscosity.

Oil grade: API SN/RC multigrade engine oil

Recommended viscosity: SAE 0W-16

SAE 0W-16 is the best choice for good fuel economy and good starting in cold weather.

If SAE 0W-16 is not available, SAE 0W-20 oil may be used. However, it must be replaced with SAE 0W-16 at the next oil change.

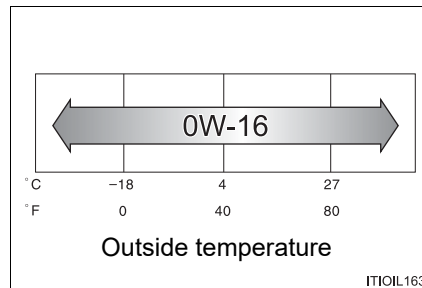

Oil viscosity (0W-16 is explained here as an example):

- The 0W in 0W-16 indicates the characteristic of the oil which allows cold startability. Oils with a lower value before the W allow for easier starting of the engine in cold weather.
- The 16 in 0W-16 indicates the viscosity characteristic of the oil when the oil is at high temperature. An oil with a higher viscosity (one with a higher value) may be better suited if the vehicle is operated at high speeds, or under extreme load conditions.

How to read oil container label:
 API registered mark is added to some oil containers to help you select the oil you should use.



Cooling system

Capacity*	Gasoline engine	6.6 qt. (6.2 L, 5.5 Imp.qt.)
	Power control unit	1.6 qt. (1.5 L, 1.3 Imp.qt.)
Coolant type	Use either of the following: <ul style="list-style-type: none"> • “Toyota Super Long Life Coolant” • Similar high-quality ethylene glycol-based non-silicate, non-amine, non-nitrite, and non-borate coolant with long-life hybrid organic acid technology Do not use plain water alone.	

*: The coolant capacity is a reference quantity.
 If replacement is necessary, contact your Toyota dealer.

Ignition system (spark plug)

Make	DENSO FC16HR-CY9
Gap	0.035 in. (0.9 mm)

NOTICE

Iridium-tipped spark plugs

Use only iridium-tipped spark plugs. Do not adjust the spark plug gap.

Electrical system (12-volt battery)

Open voltage at 68°F (20°C):	12.0 V or higher If the voltage is lower than the standard value, charge the battery. (After charging the battery, turn on the high beam headlights for 30 seconds with the power switch off, and turn the headlights off.)
Charging rates	5 A max.

Transmission

Fluid capacity*	3.9 qt. (3.7 L, 3.3 Imp.qt.)
Fluid type	Toyota Genuine ATF WS

*: The fluid capacity is the quantity of reference.
If replacement is necessary, contact your Toyota dealer.

 **NOTICE**
 **Transmission fluid type**

Using transmission fluid other than the above type may cause abnormal noise or vibration, or ultimately damage the transmission of your vehicle.

Brakes

Pedal clearance* ¹	4.69 in. (119 mm) Min.
Pedal free play	0.04 — 0.24 in. (1.0 — 6.0 mm)
Brake pad wear limit	0.04 in. (1.0 mm)
Parking brake pedal travel* ²	8 — 11 clicks
Fluid type	SAE J1703 or FMVSS No.116 DOT 3 or SAE J1704 or FMVSS No.116 DOT 4

*1: Minimum pedal clearance when depressed with a force of 67.4 lbf (300 N, 30.6 kgf) while the hybrid system is operating.

*2: Parking brake pedal travel when depressed with a force of 67.4 lbf (300 N, 30.6 kgf).

Steering

Free play	Less than 1.2 in. (30 mm)
-----------	---------------------------

Tires and wheels

Tire size	195/65R15 91S	
Tire inflation pressure (Recommended cold tire inflation pressure)	Front	36 psi (250 kPa, 2.5 kgf/cm ² or bar)
	Rear	35 psi (240 kPa, 2.4 kgf/cm ² or bar)
	Spare	None
Wheel size	15 × 6 1/2J	
Wheel nut torque	76 ft•lbf (103 N•m, 10.5 kgf•m)	

Light bulbs

	Light bulbs	Bulb No.	W	Type
Exterior	Back-up lights	921	16	A
Interior	Vanity lights	—	8	A
	Front interior/personal lights	—	5	A
	Rear interior light	—	8	B
	Door courtesy lights	—	5	A
	Luggage compartment light	—	5	A

A: Wedge base bulbs (clear)

B: Double end bulbs

Fuel information

You must only use unleaded gasoline.

Select octane rating 87 (Research Octane Number 91) or higher. Use of unleaded gasoline with an octane rating lower than 87 may result in engine knocking. Persistent knocking can lead to engine damage.

At minimum, the gasoline you use should meet the specifications of ASTM D4814 in the U.S.A..

■ Gasoline quality

In very few cases, driveability problems may be caused by the brand of gasoline you are using. If driveability problems persist, try changing the brand of gasoline. If this does not correct the problem, consult your Toyota dealer.

■ Recommendation of the use of gasoline containing detergent additives

- Toyota recommends the use of gasoline that contains detergent additives to avoid the build-up of engine deposits.
- All gasoline sold in the U.S.A. contains minimum detergent additives to clean and/or keep clean intake systems, per EPA's lowest additives concentration program.
- Toyota strongly recommends the use of Top Tier Detergent Gasoline. For more information on Top Tier Detergent Gasoline and a list of marketers, please go to the official website www.toptiergas.com.

■ Recommendation of the use of low emissions gasoline

Gasolines containing oxygenates such as ethers and ethanol, as well as reformulated gasolines, are available in some cities. These fuels are typically acceptable for use, providing they meet other fuel requirements.

Toyota recommends these fuels, since the formulations allow for reduced vehicle emissions.

■ Non-recommendation of the use of blended gasoline

- Use only gasoline containing up to 15% ethanol.

DO NOT use any flex-fuel or gasoline that could contain more than 15% ethanol, including from any pump labeled E30, E50, E85 (which are only some examples of fuel containing more than 15% ethanol).

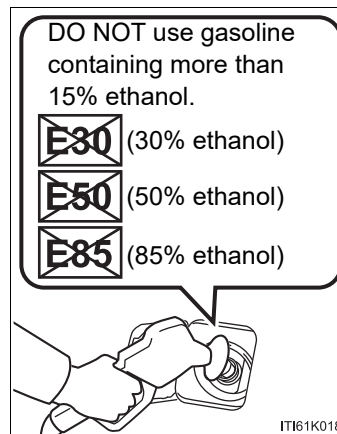

- If you use gasohol in your vehicle, be sure that it has an octane rating no lower than 87.
- Toyota does not recommend the use of gasoline containing methanol.

■ Non-recommendation of the use of gasoline containing MMT

Some gasoline contains an octane enhancing additive called MMT (Methylcyclopentadienyl Manganese Tricarbonyl).

Toyota does not recommend the use of gasoline that contains MMT. If fuel containing MMT is used, your emission control system may be adversely affected.

The malfunction indicator lamp on the instrument cluster may come on. If this happens, contact your Toyota dealer for service.

■ If your engine knocks

- Consult your Toyota dealer.
- You may occasionally notice light knocking for a short time while accelerating or driving uphill. This is normal and there is no need for concern.

 NOTICE**■ Notice on fuel quality**

- Do not use improper fuels. If improper fuels are used, the engine will be damaged.
- Do not use leaded gasoline.
Leaded gasoline can cause damage to your vehicle's three-way catalytic converters causing the emission control system to malfunction.
- Do not use gasohol other than the type previously stated.
Other gasohol may cause fuel system damage or vehicle performance problems.
- Using unleaded gasoline with an octane number or rating lower than the level previously stated will cause persistent heavy knocking.
At worst, this will lead to engine damage.

■ Fuel-related poor driveability

If poor driveability (poor hot starting, vaporization, engine knocking, etc.) is encountered after using a different type of fuel, discontinue the use of that type of fuel.

■ When refueling with gasohol

Take care not to spill gasohol. It can damage your vehicle's paint.

■ Notice about fuel

→P. 104

Tire information

Typical tire symbols

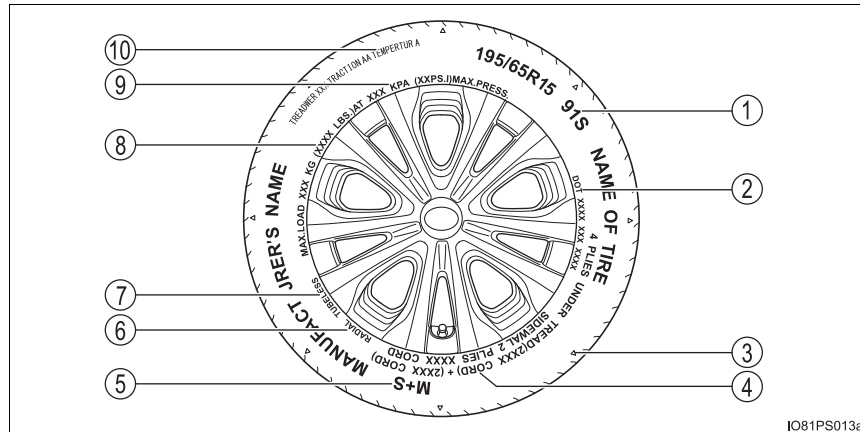

- ① Tire size (→P. 743)
- ② DOT and Tire Identification Number (TIN) (→P. 743)
- ③ Location of treadwear indicators (→P. 614)
- ④ Tire ply composition and materials
Plies are layers of rubber-coated parallel cords. Cords are the strands which form the plies in a tire.
- ⑤ Summer tires or all season tires (→P. 618)
An all season tire has “M+S” on the sidewall. A tire not marked “M+S” is a summer tire.
- ⑥ Radial tires or bias-ply tires
A radial tire has “RADIAL” on the sidewall. A tire not marked “RADIAL” is a bias-ply tire.
- ⑦ TUBELESS or TUBE TYPE
A tubeless tire does not have a tube and air is directly put into the tire. A tube type tire has a tube inside the tire and the tube maintains the air pressure.
- ⑧ Load limit at maximum cold tire inflation pressure (→P. 617)
- ⑨ Maximum cold tire inflation pressure (→P. 737)
This means the pressure to which a tire may be inflated.
- ⑩ Uniform tire quality grading
For details, see “Uniform Tire Quality Grading” that follows.

Typical DOT and Tire Identification Number (TIN)

▶ Type A

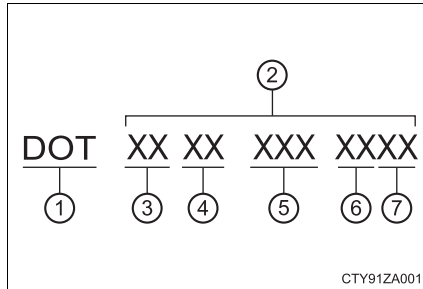

▶ Type B

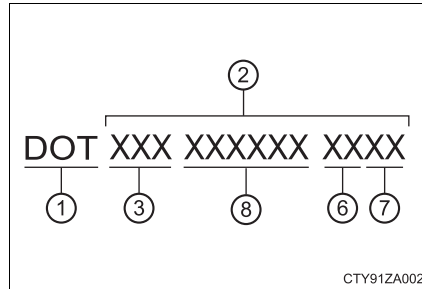

- ① DOT symbol*
- ② Tire Identification Number (TIN)
- ③ Tire manufacturer's identification mark
- ④ Tire size code
- ⑤ Manufacturer's optional tire type code (3 or 4 letters)
- ⑥ Manufacturing week
- ⑦ Manufacturing year
- ⑧ Manufacturer's code

*: The DOT symbol certifies that the tire conforms to applicable Federal Motor Vehicle Safety Standards.

Tire size

■ Typical tire size information

The illustration indicates typical tire size.

- ① Tire use
(P = Passenger car,
T = Temporary use)
- ② Section width (millimeters)
- ③ Aspect ratio
(tire height to section width)
- ④ Tire construction code (R = Radial, D = Diagonal)
- ⑤ Wheel diameter (inches)
- ⑥ Load index (2 digits or 3 digits)
- ⑦ Speed symbol (alphabet with one letter)

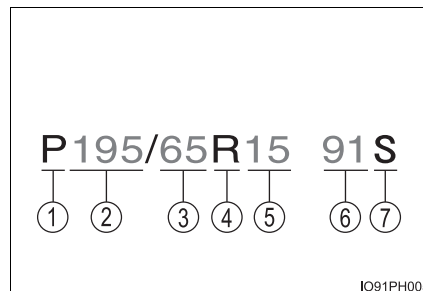

■ **Tire dimensions**

- ① Section width
- ② Tire height
- ③ Wheel diameter

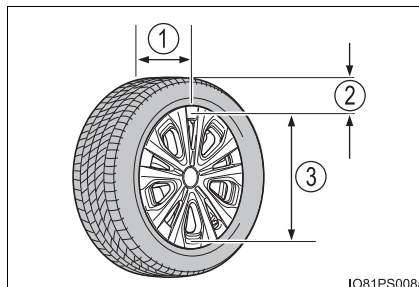

■ **Tire section names**

- ① Bead
- ② Sidewall
- ③ Shoulder
- ④ Tread
- ⑤ Belt
- ⑥ Inner liner
- ⑦ Reinforcing rubber
- ⑧ Carcass
- ⑨ Rim lines
- ⑩ Bead wires
- ⑪ Chafer

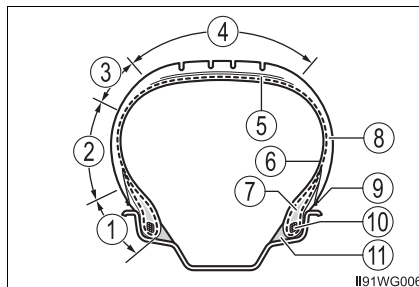

Uniform Tire Quality Grading

This information has been prepared in accordance with regulations issued by the National Highway Traffic Safety Administration of the U.S. Department of Transportation.

It provides the purchasers and/or prospective purchasers of Toyota vehicles with information on uniform tire quality grading.

Your Toyota dealer will help answer any questions you may have as you read this information.

■ DOT quality grades

All passenger vehicle tires must conform to Federal Safety Requirements in addition to these grades. Quality grades can be found where applicable on the tire sidewall between tread shoulder and maximum section width.

For example: Treadwear 200 Traction AA Temperature A

■ Treadwear

The treadwear grade is a comparative rating based on the wear rate of the tire when tested under controlled conditions on a specified government test course.

For example, a tire graded 150 would wear one and a half (1 - 1/2) times as well on the government course as a tire graded 100.

The relative performance of tires depends upon the actual conditions of their use. Performance may differ significantly from the norm due to variations in driving habits, service practices and differences in road characteristics and climate.

■ Traction AA, A, B, C

The traction grades, from highest to lowest, are AA, A, B and C, and they represent the tire's ability to stop on wet pavement as measured under controlled conditions on specified government test surfaces of asphalt and concrete.

A tire marked C may have poor traction performance.

Warning: The traction grade assigned to this tire is based on braking (straight ahead) traction tests and does not include cornering (turning) traction.

■ **Temperature A, B, C**

The temperature grades are A (the highest), B, and C, representing the tire's resistance to the generation of heat and its ability to dissipate heat when tested under controlled conditions on a specified indoor laboratory test wheel.

Sustained high temperature can cause the material of the tire to degenerate and reduce tire life, and excessive temperature can lead to sudden tire failure.

Grade C corresponds to a level of performance which all passenger car tires must meet under the Federal Motor Vehicle Safety Standard No. 109.

Grades B and A represent higher levels of performance on the laboratory test wheel than the minimum required by law.

Warning: The temperature grades of a tire assume that it is properly inflated and not overloaded.

Excessive speed, underinflation, or excessive loading, either separately or in combination, can cause heat buildup and possible tire failure.

Glossary of tire terminology

Tire related term	Meaning
Cold tire inflation pressure	Tire pressure when the vehicle has been parked for three hours or more, or has not been driven more than 1 mile or 1.5 km under that condition
Maximum inflation pressure	The maximum cold inflated pressure to which a tire may be inflated, shown on the sidewall of the tire
Recommended inflation pressure	Cold tire inflation pressure recommended by a manufacturer
Accessory weight	The combined weight (in excess of those standard items which may be replaced) of hybrid transmission, power steering, power brakes, power windows, power seats, radio and heater, to the extent that these items are available as factory-installed equipment (whether installed or not)
Curb weight	The weight of a motor vehicle with standard equipment, including the maximum capacity of fuel, oil and coolant, and if so equipped, air conditioning and additional weight optional engine
Maximum loaded vehicle weight	The sum of: (a) Curb weight (b) Accessory weight (c) Vehicle capacity weight (d) Production options weight
Normal occupant weight	150 lb. (68 kg) times the number of occupants specified in the second column of Table 1* that follows
Occupant distribution	Distribution of occupants in a vehicle as specified in the third column of Table 1* below

Tire related term	Meaning
Production options weight	The combined weight of installed regular production options weighing over 5 lb. (2.3 kg) in excess of the standard items which they replace, not previously considered in curb weight or accessory weight, including heavy duty brakes, ride levelers, roof rack, heavy duty 12-volt battery, and special trim
Rim	A metal support for a tire or a tire and tube assembly upon which the tire beads are seated
Rim diameter (Wheel diameter)	Nominal diameter of the bead seat
Rim size designation	Rim diameter and width
Rim type designation	The industry manufacturer's designation for a rim by style or code
Rim width	Nominal distance between rim flanges
Vehicle capacity weight (Total load capacity)	The rated cargo and luggage load plus 150 lb. (68 kg) times the vehicle's designated seating capacity
Vehicle maximum load on the tire	The load on an individual tire that is determined by distributing to each axle its share of the maximum loaded vehicle weight, and dividing by two
Vehicle normal load on the tire	The load on an individual tire that is determined by distributing to each axle its share of curb weight, accessory weight, and normal occupant weight (distributed in accordance with Table 1* below), and dividing by two
Weather side	The surface area of the rim not covered by the inflated tire
Bead	The part of the tire that is made of steel wires, wrapped or reinforced by ply cords and that is shaped to fit the rim

Tire related term	Meaning
Bead separation	A breakdown of the bond between components in the bead
Bias ply tire	A pneumatic tire in which the ply cords that extend to the beads are laid at alternate angles substantially less than 90 degrees to the centerline of the tread
Carcass	The tire structure, except tread and sidewall rubber which, when inflated, bears the load
Chunking	The breaking away of pieces of the tread or sidewall
Cord	The strands forming the plies in the tire
Cord separation	The parting of cords from adjacent rubber compounds
Cracking	Any parting within the tread, sidewall, or innerliner of the tire extending to cord material
CT	A pneumatic tire with an inverted flange tire and rim system in which the rim is designed with rim flanges pointed radially inward and the tire is designed to fit on the underside of the rim in a manner that encloses the rim flanges inside the air cavity of the tire
Extra load tire	A tire designed to operate at higher loads and at higher inflation pressures than the corresponding standard tire
Groove	The space between two adjacent tread ribs
Innerliner	The layer(s) forming the inside surface of a tubeless tire that contains the inflating medium within the tire
Innerliner separation	The parting of the innerliner from cord material in the carcass

Tire related term	Meaning
Intended outboard sidewall	(a) The sidewall that contains a whitewall, bears white lettering, or bears manufacturer, brand, and/or model name molding that is higher or deeper than the same molding on the other sidewall of the tire, or (b) The outward facing sidewall of an asymmetrical tire that has a particular side that must always face outward when mounted on a vehicle
Light truck (LT) tire	A tire designated by its manufacturer as primarily intended for use on lightweight trucks or multipurpose passenger vehicles
Load rating	The maximum load that a tire is rated to carry for a given inflation pressure
Maximum load rating	The load rating for a tire at the maximum permissible inflation pressure for that tire
Maximum permissible inflation pressure	The maximum cold inflation pressure to which a tire may be inflated
Measuring rim	The rim on which a tire is fitted for physical dimension requirements
Open splice	Any parting at any junction of tread, sidewall, or innerliner that extends to cord material
Outer diameter	The overall diameter of an inflated new tire
Overall width	The linear distance between the exteriors of the sidewalls of an inflated tire, including elevations due to labeling, decorations, or protective bands or ribs
Passenger car tire	A tire intended for use on passenger cars, multipurpose passenger vehicles, and trucks, that have a gross vehicle weight rating (GVWR) of 10,000 lb. or less.
Ply	A layer of rubber-coated parallel cords
Ply separation	A parting of rubber compound between adjacent plies

Tire related term	Meaning
Pneumatic tire	A mechanical device made of rubber, chemicals, fabric and steel or other materials, that, when mounted on an automotive wheel, provides the traction and contains the gas or fluid that sustains the load
Radial ply tire	A pneumatic tire in which the ply cords that extend to the beads are laid at substantially 90 degrees to the centerline of the tread
Reinforced tire	A tire designed to operate at higher loads and at higher inflation pressures than the corresponding standard tire
Section width	The linear distance between the exteriors of the sidewalls of an inflated tire, excluding elevations due to labeling, decoration, or protective bands
Sidewall	That portion of a tire between the tread and bead
Sidewall separation	The parting of the rubber compound from the cord material in the sidewall
Snow tire	A tire that attains a traction index equal to or greater than 110, compared to the ASTM E-1136 Standard Reference Test Tire, when using the snow traction test as described in ASTM F-1805-00, Standard Test Method for Single Wheel Driving Traction in a Straight Line on Snow-and Ice-Covered Surfaces, and which is marked with an Alpine Symbol () on at least one sidewall
Test rim	The rim on which a tire is fitted for testing, and may be any rim listed as appropriate for use with that tire
Tread	That portion of a tire that comes into contact with the road
Tread rib	A tread section running circumferentially around a tire

Tire related term	Meaning
Tread separation	Pulling away of the tread from the tire carcass
Treadwear indicators (TWI)	The projections within the principal grooves designed to give a visual indication of the degrees of wear of the tread
Wheel-holding fixture	The fixture used to hold the wheel and tire assembly securely during testing

*: Table 1 — Occupant loading and distribution for vehicle normal load for various designated seating capacities

Designated seating capacity, Number of occupants	Vehicle normal load, Number of occupants	Occupant distribution in a normally loaded vehicle
2 through 4	2	2 in front
5 through 10	3	2 in front, 1 in second seat
11 through 15	5	2 in front, 1 in second seat, 1 in third seat, 1 in fourth seat
16 through 20	7	2 in front, 2 in second seat, 2 in third seat, 1 in fourth seat

Customizable features













Your vehicle includes a variety of electronic features that can be personalized to suit your preferences. The settings of these features can be changed using the multi-information display, the navigation system, the multimedia system, or at your Toyota dealer.

Some function settings are changed simultaneously with other functions being customized. Contact your Toyota dealer for further details.

Customizing vehicle features

When customizing vehicle features, ensure that the vehicle is parked in a safe place with the parking brake set and the shift position in P.

■ Changing using the multi-information display

- 1 Press  or  of the meter control switches, select .
- 2 Press  or  of the meter control switches, select  ("Vehicle Settings"), and then press .
- 3 Press  or  of the meter control switches, select the item, and then press .
- 4 Press  or  of the meter control switches, select the desired setting, and then press .

To go back to the previous screen or exit the customize mode, press .

■ Changing using the navigation system or the multimedia system**▶ Vehicles with the navigation system**

- 1 Press the "MENU" button on the navigation system.
- 2 Select "Settings".
- 3 Select "Vehicle" on the "Setup" screen and select "Vehicle Customization".

Various settings can be changed. Refer to the list of settings that can be changed for details.

▶ Vehicles with the multimedia system

- 1 Press the "MENU" button on the multimedia system.
- 2 Select "Setup".
- 3 Select "Vehicle" on the "Setup" screen and select "Vehicle Customization".

Various settings can be changed. Refer to the list of settings that can be changed for details.

Customizable features

- ① Settings that can be changed using the multi-information display
- ② Settings that can be changed using the navigation system or the multimedia system
- ③ Settings that can be changed by your Toyota dealer

Definition of symbols: O = Available, – = Not available

■ **Instrument cluster (→P. 192)**

Function	Default setting	Customized setting	①	②	③
Sensor sensitivity for darkening the brightness of the instrument cluster depending on the outside brightness	Standard	-2 to 2	–	–	O
Sensor sensitivity for returning the brightness of the instrument cluster to the original level depending on the outside brightness	Standard	-2 to 2	–	–	O



Vehicle specifications

■ HUD (Head-up display)* (→P. 253)

Function	Default setting	Customized setting	①	②	③
Route guidance*	On	Off	○	–	–

*: If equipped

■ Door lock (→P. 281, 711)

Function	Default setting	Customized setting	①	②	③
Automatic door locking	Shift position linked	Speed linked	–	○	○
		Off			
Automatic door unlocking	Shift position linked	Driver's door linked	–	○	○
		Off			
Unlocking using a mechanical key	Driver's door unlocked in first step, all doors unlocked in second step	All doors unlocked in first step	–	–	○

■ Smart key system and wireless remote control (→P. 282, 292)

Function	Default setting	Customized setting	①	②	③
Operation signal (buzzer)	5	Off	–	○	○
		1 to 7			
Operation signal (emergency flashers)	On	Off	–	○	○
Time elapsed before the automatic door lock function is activated if a door is not opened after being unlocked	60 seconds	Off	–	○	○
		30 seconds			
		120 seconds			
Open door reminder buzzer (when locking the vehicle)	On	Off	–	–	○

■ Smart key system (→P. 292)

Function	Default setting	Customized setting	①	②	③
Smart key system	On	Off	–	–	○
Smart door unlocking*	Driver's door	All the doors	–	○	○
Time elapsed before unlocking all the door when gripping and holding the driver's door handle	2 seconds	Off	–	–	○
Number of consecutive door lock operations	As many as desired	2 times	–	–	○

*: This function can also be changed using the wireless remote control.
(→P. 285)

■ Wireless remote control (→P. 282)

Function	Default setting	Customized setting	①	②	③
Unlocking operation	Driver's door unlocked in first step, all doors unlocked in second step	All doors unlocked in first step	–	○	○
Wireless remote control	On	Off	–	–	○
Locking operation when door opened	On	Off	–	○	○

■ Power windows (→P. 314)

Function	Default setting	Customized setting	①	②	③
Mechanical key linked operation (open)	Off	On	-	-	O
Mechanical key linked operation (close)	Off	On	-	-	O
Wireless remote control linked operation (open only)	Off	On	-	-	O
Mechanical key, wireless remote control linked operation signal (buzzer)	On	Off	-	-	O

■ Reverse warning buzzer (→P. 348)

Function	Default setting	Customized setting	①	②	③
Signal (buzzer) when the shift position is in R	Intermittent	Single	-	-	O

■ Turn signal lever (→P. 351)

Function	Default setting	Customized setting	①	②	③
Times of flashing of the lane change signal flashers	3	Off	-	-	O
		5			
		7			

■ Automatic light control system*1 (→P. 353)

Function	Default setting	Customized setting	①	②	③
Time elapsed before the headlights turn off	30 seconds	Off			
		60 seconds	–	○	○
		90 seconds			
Light sensor sensitivity	Level 0	Level -2 to 2	–	○	○
Daytime running lights*2	On	Off	–	○	○

*1: If equipped

*2: This function cannot be customized for vehicles sold in Canada.

■ Rain-sensing windshield wipers* (→P. 367)

Function	Default setting	Customized setting	①	②	③
Wiper operation when the wiper switch is in the AUTO position	Rain-sensing operation	Intermittent operation linked to vehicle speed (with interval adjuster)	–	–	○

*: If equipped

■ RSA (Road Sign Assist)* (→P. 410)

Function	Default setting	Customized setting	①	②	③
RSA (Road Sign Assist)	On	Off	O	-	-
Excess speed notification method	Display only	No notification	O	-	-
		Display and buzzer			
Excess speed notification level	1 mph (2 km/h)	3 mph (5 km/h)	O	-	-
		5 mph (10 km/h)			
Other notifications method (No-entry notification)	Display only	No notification	O	-	-
		Display and buzzer			

*: If equipped

■ BSM (Blind Spot Monitor)* (→P. 432)

Function	Default setting	Customized setting	①	②	③
Outside rear view mirror indicator brightness	Bright	Dim	-	-	O

*: If equipped

■ Intuitive parking assist* (→P. 445)

Function	Default setting	Customized setting	①	②	③
Detection distance of the front center sensors	Far	Near	-	-	O
Detection distance of the rear center sensors	Far	Near	-	-	O
Buzzer volume	3	1 to 5	-	-	O

*: If equipped

■ **S-APGS (Simple Advanced Parking Guidance System)***
 (→P. 467)

Function	Default setting	Customized setting	①	②	③
Obstacle detection range	Standard	Near			
		Slightly far	–	–	O
		Far			
Back-in parking space	Standard	Narrow			
		Slightly wide	–	–	O
		Wide			
Parallel parking space	Standard	Narrow			
		Slightly wide	–	–	O
		Wide			

*: If equipped

■ **Automatic air conditioning system (→P. 512, 524)**

Function	Default setting	Customized setting	①	②	③
A/C auto switching operation	On	Off	–	O	O

■ Remote Air Conditioning System (→P. 535)

Function	Default setting	Customized setting	①	②	③
Operation using the "A/C" button on the wireless remote control	Press and hold for 0.8 seconds	Press once	-	-	O
		Press twice			
		Press and hold for 2.4 seconds			
		Off			
Stopping the operation using the "A/C" button on the wireless remote control	Press twice	Press once	-	-	O
		Press and hold for 0.8 seconds			
		Press and hold for 2.4 seconds			
		Off			

■ Illumination (→P. 541)

Function	Default setting	Customized setting	①	②	③
Time elapsed before the interior lights turn off	15 seconds	Off	-	O	O
		7.5 seconds			
		30 seconds			
Operation after the power switch is turned off	On	Off	-	-	O
Operation when the doors are unlocked	On	Off	-	-	O
Operation when you approach the vehicle with the electronic key on your person	On	Off	-	-	O
Footwell lighting*	On	Off	-	-	O
Interior lights illumination control	On	Off	-	-	O

*: If equipped

■ **Seat belt reminder (→P. 679)**

Function	Default setting	Customized setting	①	②	③
Vehicle speed linked seat belt reminder buzzer	On	Off	-	-	O

■ **Charge settings**

Charge schedule	Setting the charging schedule: →P. 161
Charge current	Changing the upper limit of the charging current:→P. 132
Charging connector lock (if equipped)	Changing the charging connector lock settings: →P. 126
Traction battery heater	Setting “Traction Battery Heater” on/off: →P. 135

■ **Maintenance system**

Oil Maintenance (U.S.A. only)	Resetting the message indicating maintenance is required: →P. 588
Tire pressure warning system	Initializing the tire pressure warning system: →P. 615

■ **Vehicle customization**

- When the Speed linked door locking function and the Shift position linked door locking function are both on, the door lock operates as follows.
 - When shifting the shift position to any position other than P, all the doors will be locked.
 - If the vehicle is started with all the doors locked, the Speed linked door locking function would not operate.
 - If the vehicle is started with any door unlocked, the Speed linked door locking function will operate.
 - When the smart key system is off, Smart door unlocking cannot be customized.
 - When the doors remain closed after unlocking the doors and the automatic door lock function is activated, the signals will be generated in accordance with the operation signal (buzzer) and the operation signal (emergency flashers) settings.
- **In the following situations, customize mode in which the settings can be changed through the multi-information display will automatically be turned off.**
- The power switch is turned off.
 - The vehicle begins to move while the customize mode screen is displayed.

 **WARNING**

■ **Cautions during customization**

As the hybrid system needs to be operating during customization, ensure that the vehicle is parked in a place with adequate ventilation. In a closed area such as a garage, exhaust gases including harmful carbon monoxide (CO) may collect and enter the vehicle. This may lead to death or a serious health hazard.

 **NOTICE**

■ **During customization**

To prevent 12-volt battery discharge, ensure that the hybrid system is operating while customizing features.

Items to initialize

The following items must be initialized for normal system operation after such cases as the 12-volt battery being reconnected, or maintenance being performed on the vehicle.

Item	When to initialize	Reference
Power window	<ul style="list-style-type: none"> When functioning abnormally 	P. 315
Parking Support Brake function (if equipped)	<ul style="list-style-type: none"> After reconnecting or changing the 12-volt battery 	P. 464
S-APGS (Simple Advanced Parking Guidance System) (if equipped)	<ul style="list-style-type: none"> After reconnecting or changing the 12-volt battery 	P. 491
Message indicating maintenance is required (U.S.A. only)	<ul style="list-style-type: none"> After the maintenance is performed 	P. 588
Tire pressure warning system	<ul style="list-style-type: none"> When rotating the tires on vehicles with differing front and rear tire inflation pressures When changing the tire inflation pressure by changing traveling speed or load weight, etc. 	P. 615



For owners

10

Reporting safety defects
for U.S. owners..... 768

Seat belt instructions
for Canadian owners
(in French)..... 769

SRS airbag instructions
for Canadian owners
(in French)..... 771

Headlight aim instructions
for Canadian owners
(in French)..... 780

Reporting safety defects for U.S. owners

If you believe that your vehicle has a defect which could cause a crash or could cause injury or death, you should immediately inform the National Highway Traffic Safety Administration (NHTSA) in addition to notifying Toyota Motor Sales, U.S.A., Inc. (Toll-free: 1-800-331-4331).

If NHTSA receives similar complaints, it may open an investigation, and if it finds that a safety defect exists in a group of vehicles, it may order a recall and remedy campaign. However, NHTSA cannot become involved in individual problems between you, your dealer, or Toyota Motor Sales, U.S.A., Inc.

To contact NHTSA, you may call the Vehicle Safety Hotline toll-free at 1-888-327-4236 (TTY: 1-800-424-9153); go to <http://www.safercar.gov>; or write to: Administrator, NHTSA, 1200 New Jersey Ave, SE., Washington, DC 20590. You can also obtain other information about motor vehicle safety from <http://www.safercar.gov>.

Seat belt instructions for Canadian owners (in French)

The following is a French explanation of seat belt instructions extracted from the seat belt section in this manual.

See the seat belt section for more detailed seat belt instructions in English.

Utilisation adéquate des ceintures de sécurité

- Tirez sur la ceinture épaulière jusqu'à ce qu'elle recouvre entièrement l'épaule; elle ne doit cependant pas toucher le cou ni glisser de l'épaule.
- Placez la ceinture abdominale le plus bas possible sur les hanches.
- Réglez la position du dossier. Tenez-vous assis bien au fond du siège, le dos droit.
- Ne vrillez pas la ceinture de sécurité.

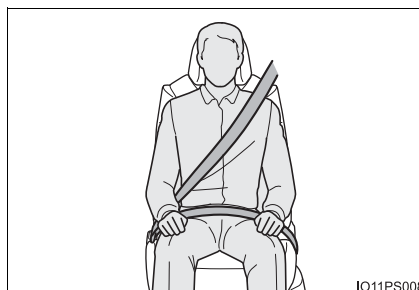

Entretien et nettoyage

■ Ceintures de sécurité

Avec un chiffon ou une éponge, nettoyez à l'aide d'un savon doux et de l'eau tiède. Vérifiez aussi les ceintures régulièrement pour vous assurer qu'elles ne présentent pas d'usure excessive, d'effilochage ou de coupures.

AVERTISSEMENT

■ Dommages et usure de la ceinture de sécurité

Vérifiez périodiquement le système de ceintures de sécurité. Vérifiez qu'il n'y a pas de coupures, d'effilochures ni de pièces desserrées. N'utilisez pas une ceinture de sécurité endommagée avant qu'elle ne soit remplacée. Les ceintures de sécurité endommagées ne peuvent pas protéger les occupants contre les blessures graves, voire mortelles.

SRS airbag instructions for Canadian owners (in French)

The following is a French explanation of SRS airbag instructions extracted from the SRS airbag section in this manual.

See the SRS airbag section for more detailed SRS airbag instructions in English.

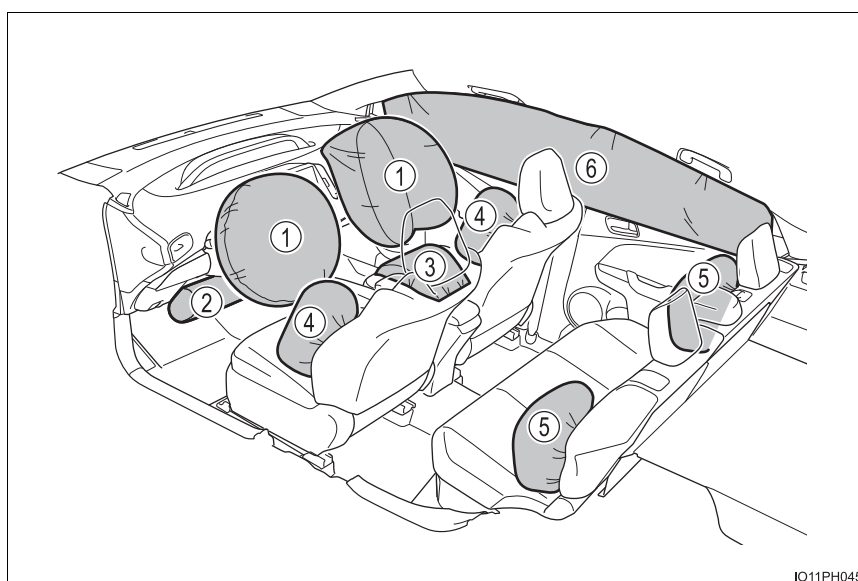

◆ Coussins gonflables SRS avant

- ① Coussin gonflable SRS du conducteur/coussin gonflable SRS du passager avant
Peuvent aider à protéger la tête et la poitrine du conducteur et du passager avant contre les impacts avec des composants intérieurs
- ② Coussin gonflable SRS de protection des genoux
Peut aider à protéger le conducteur
- ③ Coussin gonflable SRS du coussin de siège
Peut aider à retenir le passager avant

◆ Coussins gonflables SRS latéraux et en rideau

- ④ Coussins gonflables SRS latéraux
Peuvent aider à protéger le torse des occupants des sièges avant
- ⑤ Coussins gonflables SRS latéraux arrière
Peuvent aider à protéger le torse des occupants des sièges latéraux arrière
- ⑥ Coussins gonflables SRS en rideau
 - Peuvent aider à protéger principalement la tête des occupants des sièges latéraux
 - Peuvent aider à empêcher les occupants d'être éjectés du véhicule en cas de tonneaux

Composants du système de coussins gonflables SRS

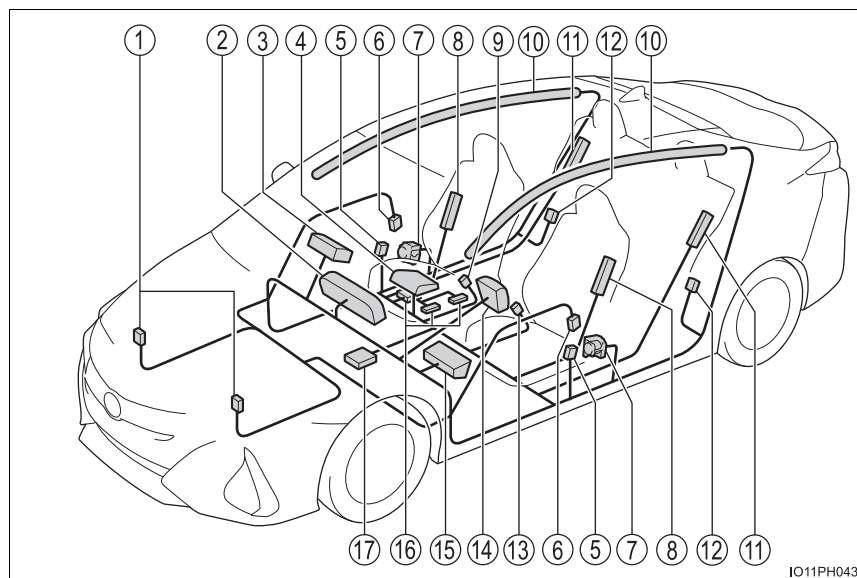

- | | |
|--|--|
| ① Capteurs d'impact avant | ⑩ Coussins gonflables en rideau |
| ② Lampe témoin SRS, et voyants "AIR BAG ON" et "AIR BAG OFF" | ⑪ Coussins gonflables latéraux arrière |
| ③ Coussin gonflable du passager avant | ⑫ Capteurs d'impact latéral (arrière) |
| ④ Coussin gonflable du coussin de siège du passager | ⑬ Contacteur de boucle de ceinture de sécurité du conducteur |
| ⑤ Capteurs d'impact latéral (avant) | ⑭ Coussin gonflable du conducteur |
| ⑥ Capteurs d'impact latéral (portière avant) | ⑮ Coussin gonflable de protection des genoux du conducteur |
| ⑦ Limiteurs de force et dispositifs de tension des ceintures de sécurité | ⑯ Système de classification de l'occupant du siège du passager avant (ECU et capteurs) |
| ⑧ Coussins gonflables latéraux avant | ⑰ Module de capteur de coussin gonflable |
| ⑨ Contacteur de boucle de ceinture de sécurité du passager | |

Votre véhicule est doté de COUSSINS GONFLABLES ÉVOLUÉS dont la conception s'appuie sur les normes de sécurité des véhicules à moteur américains (FMVSS208). Le module de capteur de coussin gonflable (ECU) contrôle le déploiement des coussins gonflables en fonction des informations obtenues des capteurs et d'autres éléments affichés dans le diagramme des composants du système ci-dessus. Ces informations comprennent des données relatives à la gravité de l'accident et aux occupants. Au moment du déploiement des coussins gonflables, une réaction chimique se produit dans les gonfleurs de coussin gonflable et les coussins gonflables se remplissent rapidement d'un gaz non toxique pour aider à limiter le mouvement des occupants.

 **AVERTISSEMENT**

■ **Précautions relatives aux coussins gonflables SRS**

Observez les précautions suivantes en ce qui concerne les coussins gonflables SRS.

Les négliger pourrait occasionner des blessures graves, voire mortelles.

- Le conducteur et tous les passagers du véhicule doivent porter leur ceinture de sécurité de la manière appropriée.

Les coussins gonflables SRS sont des dispositifs supplémentaires qui doivent être utilisés avec les ceintures de sécurité.

- Le coussin gonflable SRS du conducteur se déploie avec une force considérable et peut occasionner des blessures graves, voire mortelles, notamment lorsque le conducteur se trouve très près du coussin gonflable. La National Highway Traffic Safety Administration (NHTSA), aux États-Unis, fait les recommandations suivantes :

La zone à risque du coussin gonflable du conducteur couvre 2 à 3 in. (50 à 75 mm) de la zone de déploiement du coussin gonflable. Pour assurer une marge de sécurité suffisante, restez à 10 in. (250 mm) du coussin gonflable. Cette distance est mesurée depuis le centre du volant jusqu'à votre sternum. Si maintenant vous vous tenez assis à moins de 10 in. (250 mm), vous pouvez changer votre position de conduite de plusieurs manières :

- Reculez votre siège à la position maximale vous permettant d'atteindre encore aisément les pédales.
- Inclinez légèrement le dossier du siège. Bien que les véhicules soient conçus différemment, la plupart des conducteurs peuvent maintenir une distance de 10 in. (250 mm), même si leur siège se trouve complètement vers l'avant, simplement en inclinant un peu le dossier du siège vers l'arrière. Si la visibilité avant est moindre après avoir incliné le dossier de votre siège, utilisez un coussin ferme et non glissant pour être assis plus haut ou relevez le siège si cette option est disponible sur votre véhicule.
- Si votre volant est réglable en hauteur, inclinez-le vers le bas. Cela vous permet d'orienter le coussin gonflable vers votre buste plutôt que vers votre tête et vers votre cou.

Le siège doit être réglé de la manière recommandée ci-dessus par la NHTSA, tout en gardant le contrôle des pédales et du volant, ainsi que la vue sur les commandes du tableau de bord.

⚠ AVERTISSEMENT

■ Précautions relatives aux coussins gonflables SRS

● Si la rallonge de ceinture de sécurité a été reliée à la boucle des ceintures de sécurité des sièges avant sans avoir aussi été attachée à la plaque de blocage des ceintures de sécurité, les coussins gonflables SRS avant considéreront que le conducteur et le passager avant portent tout de même leur ceinture de sécurité même si les ceintures de sécurité ne sont pas attachées. Les coussins gonflables SRS avant peuvent alors ne pas s'activer correctement lors d'une collision, ce qui pourrait occasionner des blessures graves, voire mortelles, en cas de collision. Assurez-vous de toujours porter la ceinture de sécurité avec la rallonge de ceinture de sécurité.



● Le coussin gonflable SRS du passager avant se déploie également avec une force considérable et peut occasionner des blessures graves, voire mortelles, notamment lorsque le passager avant se trouve très près du coussin gonflable. Le siège du passager avant doit se trouver le plus loin possible du coussin gonflable et le dossier doit être réglé de manière à ce que le passager avant soit assis bien droit.

● Le déploiement d'un coussin gonflable risque d'infliger des blessures graves, voire mortelles, aux bébés et aux enfants mal assis et/ou mal attachés. Un bébé ou un enfant trop petit pour utiliser une ceinture de sécurité doit être correctement retenu à l'aide d'un dispositif de retenue pour enfants. Toyota recommande vivement de placer et d'attacher correctement tous les bébés et tous les enfants sur les sièges arrière du véhicule à l'aide de dispositifs de retenue adaptés. Les sièges arrière sont plus sécuritaires pour les bébés et les enfants que le siège du passager avant.

● N'installez jamais un dispositif de retenue pour enfants de type dos à la route sur le siège du passager avant, même si le voyant "AIR BAG OFF" est allumé. En cas d'accident, la force et la vitesse de déploiement du coussin gonflable du passager avant pourraient infliger à l'enfant des blessures graves, voire mortelles, si le dispositif de retenue pour enfants de type dos à la route était installé sur le siège du passager avant.

⚠ AVERTISSEMENT

■ Précautions relatives aux coussins gonflables SRS

- Ne vous asseyez pas sur le bord du siège et ne vous appuyez pas sur la planche de bord.

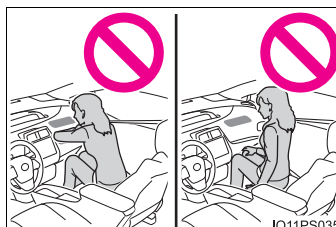

- Ne laissez pas un enfant se tenir face au coussin gonflable SRS du passager avant ni s'asseoir sur les genoux d'un passager avant.

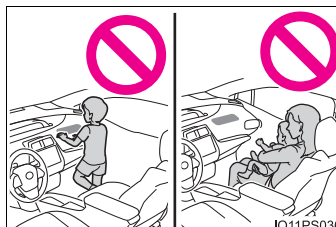

- Ne laissez pas les occupants des sièges avant tenir des objets sur leurs genoux.

- Ne vous appuyez pas sur la portière ou sur le brancard de pavillon, ni sur les montants avant, latéraux ou arrière.

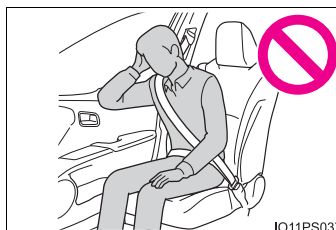

- Ne laissez personne s'agenouiller face à la portière sur le siège du passager ni sortir la tête ou les mains à l'extérieur du véhicule.

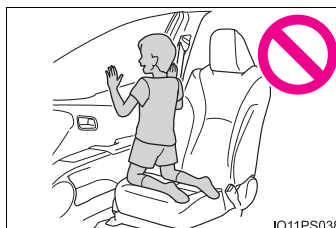

⚠ AVERTISSEMENT

■ Précautions relatives aux coussins gonflables SRS

- Ne fixez et n'appuyez rien sur des zones telles que la planche de bord, le tampon de volant ou encore la partie inférieure du tableau de bord.

Ces objets peuvent se transformer en projectiles lorsque les coussins gonflables SRS du conducteur, du passager avant et de protection des genoux se déploient.

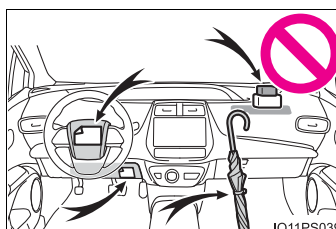

IO11PS039

- Ne fixez rien sur des zones telles que les portières, le pare-brise, les glaces latérales, les montants avant ou arrière, le brancard de pavillon et la poignée de maintien.

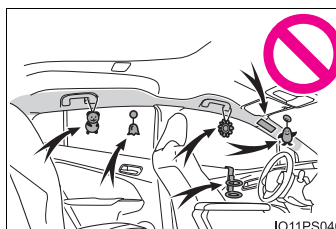

IO11PS040

- N'accrochez pas de cintres ni d'autres objets rigides sur les crochets porte-vêtements. Tous ces objets pourraient se transformer en projectiles et vous occasionner des blessures graves, voire mortelles, en cas de déploiement des coussins gonflables SRS en rideau.
- Si un recouvrement de vinyle est placé sur la zone de déploiement du coussin gonflable SRS de protection des genoux, veillez à le retirer.
- N'utilisez pas d'accessoires recouvrant les parties du siège où les coussins gonflables SRS latéraux et le coussin gonflable SRS du coussin de siège se déploient, car ces accessoires pourraient entraver le déploiement des coussins SRS. De tels accessoires peuvent empêcher les coussins gonflables latéraux et le coussin gonflable du coussin de siège de se déployer correctement, rendre le système inopérant ou provoquer accidentellement le déploiement des coussins gonflables latéraux et du coussin gonflable du coussin de siège, occasionnant des blessures graves, voire mortelles.
- Ne frappez pas et n'appliquez pas une pression importante à l'emplacement des portières avant ou des composants des coussins gonflables SRS. Cela peut provoquer un mauvais fonctionnement des coussins gonflables SRS.
- Ne touchez à aucun composant des coussins gonflables SRS immédiatement après leur déploiement (gonflage), car ils pourraient être chauds.

 AVERTISSEMENT

■ **Précautions relatives aux coussins gonflables SRS**

- Si vous avez de la difficulté à respirer après le déploiement des coussins gonflables SRS, ouvrez une portière ou une glace latérale pour laisser entrer l'air frais, ou quittez le véhicule si vous pouvez le faire en toute sécurité. Dès que possible, nettoyez tous les résidus afin d'éviter les irritations cutanées.
- Si les emplacements de stockage des coussins gonflables SRS, tels que le tampon de volant et les garnitures des montants avant et arrière, sont endommagés ou fissurés, faites-les remplacer par votre concessionnaire Toyota.
- Ne placez aucun objet, par exemple un coussin, sur le siège du passager avant. Cela disperserait le poids du passager, ce qui empêcherait le capteur de le détecter correctement. Cela pourrait empêcher le déploiement des coussins gonflables SRS du passager avant en cas de collision.

■ **Modification et mise au rebut des composants du système de coussins gonflables SRS**

Ne mettez pas votre véhicule au rebut et n'effectuez aucune des modifications suivantes sans d'abord consulter votre concessionnaire Toyota. Les coussins gonflables SRS pourraient fonctionner de manière incorrecte ou se déployer (gonfler) accidentellement, ce qui serait susceptible d'occasionner des blessures graves, voire mortelles.

- Installation, retrait, démontage et réparation des coussins gonflables SRS
- Réparations, modifications, retrait ou remplacement du volant, du tableau de bord, de la planche de bord, des sièges ou du capitonnage des sièges, des montants avant, latéraux et arrière, des brancards de pavillon, des panneaux des portières avant, des garnitures des portières avant ou des hautparleurs des portières avant
- Modifications du panneau de la portière avant (comme le perforer)
- Réparations ou modifications de l'aile avant, du pare-chocs avant ou du côté de l'habitacle
- Installation d'une protection de calandre (barre safari, barre kangourou, etc.), de lames de déneigement, de treuils ou d'un porte-bagages de toit
- Modifications du système de suspension du véhicule
- Installation d'appareils électroniques tels qu'un émetteur-récepteur radio ou un lecteur de CD
- Modifications à votre véhicule pour une personne aux capacités physiques réduites

Headlight aim instructions for Canadian owners (in French)

The following is a French explanation of headlight aim instructions from the headlight aim section in this manual.

Boulons de réglage vertical

- ① Boulon de réglage A
- ② Boulon de réglage B

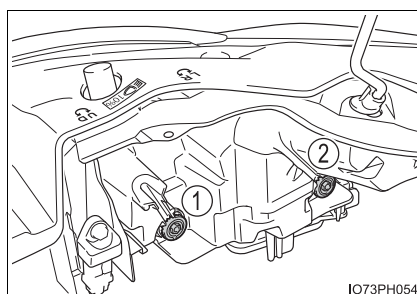

IO73PH054a

Avant de vérifier la portée des phares

- ① Assurez-vous que le réservoir de carburant du véhicule est plein et que la partie de carrosserie située autour des phares n'est pas déformée.
- ② Garez le véhicule sur un sol parfaitement horizontal.
- ③ Asseyez-vous sur le siège du conducteur.
- ④ Faites rebondir le véhicule à plusieurs reprises.

Réglage de la portée des phares

- 1 Tournez le boulon A vers la droite ou vers la gauche à l'aide d'un tournevis cruciforme.

Retenez le sens de rotation et le nombre de tours.

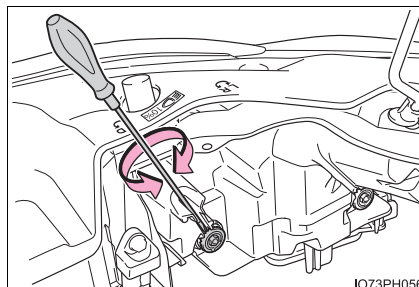

- 2 Tournez le boulon B du même nombre de tours et dans le même sens qu'à l'étape 1.

Si vous n'arrivez pas à régler vos phares en suivant cette procédure, apportez le véhicule chez votre concessionnaire Toyota afin qu'il règle la portée des phares.

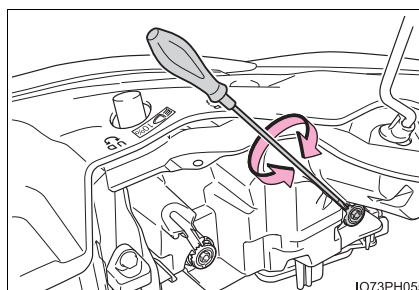

Index

What to do if... (Troubleshooting)	784
Alphabetical index	788

For vehicles with the navigation system, refer to the “NAVIGATION SYSTEM OWNER’S MANUAL” for information regarding the equipment listed below.

- Navigation system
- Audio system
- Rear view monitor system
- Hands-free system (for cellular phone)

For vehicles with the multimedia system, refer to the “MULTIMEDIA OWNER’S MANUAL” for information regarding the equipment listed below.

- Audio/visual system
- Rear view monitor system
- Hands-free system (for cellular phone)

What to do if... (Troubleshooting)

If you have a problem, check the following before contacting your Toyota dealer.

The doors cannot be locked, unlocked, opened or closed



You lose your keys

- If you lose your mechanical keys, new genuine mechanical keys can be made by your Toyota dealer. (→P. 277)
- If you lose your electronic keys, the risk of vehicle theft increases significantly. Contact your Toyota dealer immediately. (→P. 280)



The doors cannot be locked or unlocked

- Is the electronic key battery weak or depleted? (→P. 647)
- Is the power switch in ON mode?
When locking the doors, turn the power switch off. (→P. 340)
- Is the electronic key left inside the vehicle?
When locking the doors, make sure that you have the electronic key on your person.
- The function may not operate properly due to the condition of the radio wave. (→P. 295)



The rear door cannot be opened

- Is the child-protector lock set?
The rear door cannot be opened from inside the vehicle when the lock is set. Open the rear door from outside and then unlock the child-protector lock. (→P. 284)

If you think something is wrong**The hybrid system does not start**

- Did you press the power switch while firmly depressing the brake pedal?
(→P. 338)
- Is the shift position in P? (→P. 346)
- Is the electronic key anywhere detectable inside the vehicle? (→P. 293)
- Is the electronic key battery weak or depleted?
In this case, the hybrid system can be started in a temporary way.
(→P. 712)
- Is the 12-volt battery discharged? (→P. 715)

**The windows do not open or close by operating the power window switches**

- Is the window lock switch pressed?
The power windows except for the one at the driver's seat cannot be operated if the window lock switch is pressed. (→P. 314)

**The power switch is turned off automatically**

- The auto power off function will be operated if the vehicle is left in ACCESSORY or ON mode (the hybrid system is not operating) for a period of time. (→P. 340)



A warning buzzer sounds during driving

- The seat belt reminder light is flashing
Are the driver and all the passengers wearing the seat belts? (→P. 679)
 - The parking brake indicator is on
Is the parking brake released? (→P. 352)
- Depending on the situation, other types of warning buzzer may also sound.
(→P. 674, 684)



A warning buzzer sounds when leaving the vehicle

- Is the electronic key left inside the vehicle?
Check the message on the multi-information display. (→P. 684)



A warning light turns on or a warning message is displayed

- When a warning light turns on or a warning message is displayed, refer to P. 674, 684.

When a problem has occurred



If you have a flat tire

- Stop the vehicle in a safe place and repair the flat tire temporarily with the emergency tire puncture repair kit. (→P. 692)



The vehicle becomes stuck

- Try the procedure for when the vehicle becomes stuck in mud, dirt, or snow. (→P. 726)

Alphabetical index

A

A/C	512, 524
Air conditioning eco	
mode	515, 527
Air conditioning filter	640
Automatic air	
conditioning system....	512, 524
Eco score (A/C score).....	243
Front seat concentrated	
airflow mode	
(S-FLOW).....	514, 526
Humidity sensor	523, 534
Remote Air Conditioning	
System	535
ABS (Anti-lock Brake	
System)	501
Function	501
Warning light.....	675
AHB (Automatic High	
Beam)	358
Air conditioning filter	640
Air conditioning	
system	512, 524
Air conditioning eco	
mode	515, 527
Air conditioning filter	640
Automatic air	
conditioning system....	512, 524
Eco score (A/C score).....	243
Front seat concentrated	
airflow mode	
(S-FLOW).....	514, 526
Humidity sensor	523, 534
Remote Air Conditioning	
System	535
Air intake vent	99
Cleaning.....	582

Airbags	36
Airbag operating conditions	44
Airbag precautions for your	
child.....	40
Airbag warning light	675
Correct driving posture	28
Curtain shield airbag	
operating conditions	45
Curtain shield airbag	
precautions.....	42
Front passenger occupant	
classification system	50
General airbag precautions	39
Locations of airbags	36
Modification and disposal of	
airbags	43
Side airbag operating	
conditions	45
Side airbag precautions.....	41
Side and curtain shield	
airbags operating	
conditions	45
Side and curtain shield	
airbags precautions.....	42
SRS airbag instructions for	
Canadian owners	771
SRS airbags	36
Anchor brackets	73
Antenna	
Smart key system	292
Anti-lock brake system	
(ABS)	501
Function.....	501
Warning light.....	675

Approach warning 424
Armrest..... 566
Assist grips 567
Audio input*
Audio system*
Automatic air conditioning system 512, 524
 Air conditioning eco mode 515, 527
 Air conditioning filter 640
 Automatic air conditioning system.... 512, 524
 Eco score (A/C score)..... 243
 Front seat concentrated airflow mode (S-FLOW)..... 514, 526
 Humidity sensor 523, 534
 Remote Air Conditioning System 535
Automatic door locking and unlocking systems 284
Automatic High Beam (AHB) 358
Automatic light control system..... 356
AUX port*
Auxiliary boxes 548

B

Back door 287
Back-up light..... 655
 Replacing light bulbs..... 656
 Wattage 738

Battery (12-volt battery) 607
 Battery checking 607
 Exchanging..... 718
 If the 12-volt battery is discharged..... 715
 Preparing and checking before winter 507
 Replacing..... 718
 Warning light..... 674
Battery (traction battery) 98
 Air intake vent..... 99
 Charging 110
 Location 98
 Specification 733
 Status indicator..... 112
Blind Spot Monitor (BSM)..... 432
 Blind Spot Monitor function..... 437
 Rear Cross Traffic Alert function..... 440
Bluetooth®*
Bottle holders 547
Brake
 Fluid 737
 Parking brake 352
 Regenerative braking 94
 Warning light..... 674
Brake assist 501
Brake Override System..... 322
Break-in tips..... 323
Brightness control
 Instrument cluster light control 194
BSM (Blind Spot Monitor)..... 432
 Blind Spot Monitor function..... 437
 Rear Cross Traffic Alert function..... 440

*: Refer to "NAVIGATION SYSTEM OWNER'S MANUAL" or "MULTIMEDIA OWNER'S MANUAL".

C

Care	576, 581
Aluminum wheels.....	577
Exterior	576
Front camera	379
Interior.....	581
Radar sensor	378
Seat belts.....	584
Water-repellent coating.....	577
Cargo capacity	335
Catch protection function	315
CD player*	
Chains	508
Charging	110
Charging cable.....	115
Charging equipment	110
Charging indicator.....	114
Charging messages.....	185
Charging precautions.....	153
Charging procedure	146
Charging time may increase.....	135
Charging schedule function ..	157
High voltage components	98
Information related to charging display	140
Opening and closing the charging port lid.....	111
Power sources precautions.....	133
Power sources that can be used.....	131
Safety functions	142, 151
When normal charging cannot be carried out.....	180
Charging cable	115
CCID (Charging Circuit Interrupting Device).....	115
If the charging cable cannot be unlocked	128
Indicator.....	117
Maintenance	120
Safety functions	116

Charging port	110
Opening and closing.....	111
Smart lid & connector locking system.....	121
If the charging port lid does not open	124
Child restraint system	58
Fixed with a LATCH system.....	70
Fixed with a seat belt.....	64
Front passenger occupant classification system	50
Points to remember	58
Riding with children	57
Types of child restraint system installation method	60
Using an anchor bracket.....	73
Child safety	57
12-volt battery precautions ...	608
Airbag precautions.....	40
Back door precautions.....	289
Charging precautions	141
Child restraint system	58
How your child should wear the seat belt.....	32
Installing child restraints	60
Power window lock switch ...	314
Power window precautions... ..	316
Rear door child-protectors ...	284
Removed key battery precautions.....	649
Riding with children	57
Seat belt extender precautions.....	34
Seat belt precautions.....	69
Seat heater precautions	539
Child-protectors	284
Cleaning	576, 581
Aluminum wheels	577
Exterior	576
Front camera	379
Hybrid battery (traction battery) air intake vent.....	582
Interior	581

Radar sensor 378
 Seat belts 584
 Water-repellent coating 577
Clock 192
 Adjustment 197
Coat hooks 566
Combination meter 192
 Clock adjustment 197
 Main display 209
 Multi-information display 220
 Warning lights and indicators 201
Condenser 606
Console box 545
Consumption screen 265, 271
Coolant 604
 Capacity 735
 Checking 604
 Preparing and checking before winter 507
Cooling system 604
 Engine overheating 721
 Hybrid system overheating ... 723
Cruise control
 Dynamic radar cruise control with full-speed range 414
Cup holders 546
Curtain shield airbags 36
Customizable features 753

D

Daytime running light system 356
Deck board 549
Defogger
 Outside rear view mirrors 516, 527
 Rear window 516, 527
 Windshield 515, 527

Dimension 730
Dinghy towing 337
Display
 BSM (Blind Spot Monitor) 432
 Drive information 222
 Dynamic radar cruise control with full-speed range 414
 Energy monitor 223, 262, 268
 Head-up display 253
 Intuitive parking assist 446
 LTA (Lane Tracing Assist) 404
 Main display 209
 Multi-information display 220
 Parking Support Brake function 460
 Pre-collision warning 385
 RSA (Road Sign Assist) 411
 S-APGS (Simple Advanced Parking Guidance System) 471
 Warning messages 684
Do-it-yourself maintenance 594
Door courtesy lights 541
 Location 541
 Wattage 738
Doors 281, 287
 Automatic door locking and unlocking system 284
 Back door 287
 Door glasses 314
 Door lock 281
 Open door warning buzzer ... 285
 Open door warning light 676
 Outside rear view mirrors 312
 Rear door child-protectors 284
 Side doors 281
 Side windows 314

*: Refer to "MULTIMEDIA OWNER'S MANUAL".

Drive information.....	222
Drive-Start Control	322
Driver's seat belt reminder light.....	677
Driving	320
Break-in tips.....	323
Correct driving posture	28
Driving in the rain.....	321
Driving mode select switch ...	430
Plug-in hybrid vehicle driving tips.....	105
Procedures	320
Winter drive tips.....	507
Dynamic radar cruise control with full-speed range	414

E

ECB (Electronically Controlled Brake System)	501
Eco drive mode.....	430
EDR (Event data recorder).....	11
Electric motor (traction motor).....	86
Location	86
Specification	733
Electric Power Steering (EPS).....	502
Function.....	502
Warning light.....	675
Electronic key	276
Battery-saving function	294
If the electronic key does not operate properly	711
Replacing the battery.....	647

Electronically Controlled Brake System (ECB)	501
Emergency, in case of	
If a warning buzzer sounds...	674
If a warning light turns on	674
If a warning message is displayed	684
If the 12-volt battery is discharged.....	715
If the electronic key does not operate properly	711
If the hybrid system will not start	709
If the vehicle becomes stuck.....	726
If the vehicle is trapped in rising water.....	666
If you have a flat tire	692
If you lose your keys.....	277, 280
If you think something is wrong.....	673
If your vehicle has to be stopped in an emergency...	665
If your vehicle needs to be towed.....	667
If your vehicle overheats.....	721
Emergency flashers	664
Emergency tire puncture repair kit.....	692
Energy monitor.....	223, 262, 268

Engine

Accessory mode 340
 Compartment 600
 Engine switch 338
 Exhaust gas precautions 56
 Hood 597
 How to start the hybrid system 338
 Identification number 732
 If the hybrid system will not start 709
 If your vehicle has to be stopped in an emergency ... 665
 Ignition switch (power switch) 338
 Overheating 721
 Power switch 338
Engine coolant 604
 Capacity 735
 Checking 604
 Preparing and checking before winter 507
Engine oil 601
 Capacity 734
 Checking 601
 Oil pressure warning light 674
 Preparing and checking before winter 507
Engine switch (power switch) 338
 Auto power off function 340
 Changing the power switch modes 340
 If your vehicle has to be stopped in an emergency ... 665
 Starting the hybrid system 338

EPS (Electronic Power

Steering) 502
 Function 502
 Warning light 675
EV auto mode 87
EV driving range 108
EV mode 87
EV/HV mode selection switch 90
Event data recorder (EDR) 11
Exhaust gas precautions 56

F

Flat tire 692
Floor mats 26
Fluid
 Brake 737
 Transmission 736
 Washer 612
Fog lights 363
 Replacing light bulbs 660
 Switch 363
Footwell lights 541
Front doors 281
Front fog lights 363
 Replacing light bulbs 660
 Switch 363
Front passenger occupant classification system 50
Front passenger's seat belt reminder light 677
Front seat concentrated airflow mode (S-FLOW) 514, 526

Front seats 301
 Adjustment..... 301
 Cleaning..... 581
 Correct driving posture 28
 Head restraints 305
 Seat heaters 539
Front side marker lights..... 353
 Light switch..... 353
 Replacing light bulbs..... 660
Front turn signal lights 351
 Replacing light bulbs..... 660
 Turn signal lever 351
Fuel 371
 Capacity..... 732
 Fuel gauge..... 209
 Information..... 739
 Refueling..... 371
 Type..... 732
 Warning light..... 676
Fuel consumption.... 233, 265, 271
 Average fuel consumption 233
 Current fuel consumption..... 271
Fuel filler door..... 371
 Opener 373
 Refueling..... 371
 When the fuel filler door
 cannot be opened..... 374
Fuses 650

G

Garage door opener 568
Glove box 545

H

**Hands-free system (for
 cellular phone)***
Head restraints 305
Head-up display..... 253
Headlights 353
 AHB (Automatic High
 Beam)..... 358
 Headlight aim..... 653, 780
 Light switch..... 353
 Replacing light bulbs 660
Heated steering wheel 539
Heaters
 Automatic air
 conditioning system.... 512, 524
 Heated steering wheel..... 539
 Hybrid battery (traction
 battery)..... 135
 Outside rear view
 mirrors 516, 527
 Seat heaters 539
**High coolant temperature
 warning light..... 676**
High mounted stoplight
 Replacing..... 660
High-voltage components 98
Hill-start assist control 502
Hood 597
Hooks
 Coat hooks 566
 Grocery bag hook..... 550
 Retaining hooks (floor mat) 26
Horn 308
HV mode..... 87

Hybrid battery (traction battery) 98
 Air intake vent 99
 Charging 110
 Location 98
 Specification 733
 Status indicator 112

Hybrid battery (traction battery) air intake vent 99
 Cleaning 582

Hybrid system 86
 Brake Override System 322
 Consumption
 screen 233, 265, 271
 Drive-Start Control 322
 Emergency shut off system 99
 Energy monitor 223, 262, 268
 High voltage components 98
 Hybrid System Indicator 225
 If the hybrid system will not
 start 709
 Overheating 721
 Plug-in hybrid system
 precautions 98
 Plug-in hybrid vehicle driving
 tips 105
 Power switch 338
 Regenerative braking 94
 Starting the hybrid system 338
 Vehicle proximity notification
 system 93

Hybrid System Indicator 225
Hybrid transmission 345

I

I/M test 593
Identification 731
 Engine 732
 Vehicle 731

Ignition switch (power switch) 338
 Auto power off function 340
 Changing the power switch
 modes 340
 If your vehicle has to be
 stopped in an emergency... 665
 Starting the hybrid system 338

Illuminated entry system 543
Immobilizer system 83
Indicators 201
Initialization 765
 Items to initialize 765
 Maintenance data 588
 Parking Support Brake
 function 464
 Power windows 315
 S-APGS (Simple Advanced
 Parking Guidance
 System) 491
 Tire pressure warning
 system 616

Inside rear view mirror 310
**Instrument cluster light
 control 194**
Interior lights 541
 Switch 542, 543
 Wattage 738

Intuitive parking assist 445

*: Refer to "NAVIGATION SYSTEM OWNER'S MANUAL" or "MULTIMEDIA OWNER'S MANUAL".

J

Jack	630
Positioning a floor jack.....	599
Vehicle-equipped jack.....	630
Jack handle	630
Jam protection function	315

K

Keyless entry	282
Smart key system	292
Wireless remote control	282
Keys	276
Battery-saving function	294
Electronic key	276
Engine switch.....	338
If the electronic key does not operate properly	711
If you lose your keys	277, 280
Key number plate.....	276
Keyless entry	282
Mechanical key.....	277
Power switch.....	338
Replacing the battery.....	647
Smart key system	292
Warning buzzer.....	293
Wireless remote control	276
Knee airbags	36

L

Language (multi-information display)	248
LATCH system	70
Lever	
Auxiliary catch lever.....	597
Hood lock release lever.....	597
Shift lever.....	345
Tilt and telescopic steering lock release lever	308
Turn signal lever	351
Wiper lever	365
License plate lights	353
Light switch.....	353
Replacing light bulbs	660
Light	
AHB (Automatic High Beam).....	358
Door courtesy lights.....	541
Emergency flasher switch.....	664
Fog light switch.....	363
Headlight switch	353
Illuminated entry system.....	543
Interior lights	542, 543
Interior light list	541
Luggage compartment light.....	288
Personal lights	542
Replacing light bulbs	655
Shift lever light.....	541
Turn signal lever	351
Vanity lights	553
Wattage	738
Light bulbs	
Replacing.....	655
Wattage	738
Load capacity	335
LTA (Lane Tracing Assist)	395
Luggage cover	551

M

Main display 209

Maintenance

- Do-it-yourself maintenance... 594
- General maintenance 590
- Maintenance data 730
- Maintenance requirements ... 587

Malfunction indicator lamp..... 674

Master warning light..... 684

Meter 192

- Clock adjustment 197
- Combination meter 192
- Head-up display 253
- Indicators 204
- Instrument cluster light control..... 194
- Main display 209
- Multi-information display 220
- Warning lights 202
- Warning messages 684

Microphone^{*1, 2} 76

Mirrors

- Inside rear view mirror 310
- Outside rear view mirror defoggers 516, 527
- Outside rear view mirrors..... 312
- Vanity mirrors..... 553

MP3 disc^{*1}

Multi-information display..... 220

- Air conditioning system settings screen 241
- Audio system-linked display 240
- BSM (Blind Spot Monitor) 432
- Display contents 220
- Drive information..... 222
- Driving assist system information..... 245
- Dynamic radar cruise control with full-speed range 414

- Energy monitor 223
- Intuitive parking assist 446
- Language..... 248
- LTA (Lane Tracing Assist) 404
- Navigation system-linked display 240
- Parking Support Brake function..... 460
- Pre-collision warning 385
- RSA (Road Sign Assist) 411
- S-APGS (Simple Advanced Parking Guidance System)..... 471
- Settings..... 246
- Warning message..... 245

N

Navigation system^{*2}

Noise from under vehicle 8

O

Odometer 213

Oil

- Engine oil..... 734

Opener

- Back door 287
- Fuel filler door..... 373
- Garage door 568
- Hood 597

Outside rear view mirrors..... 312

- Adjustment..... 312
- BSM (Blind Spot Monitor) 432
- Folding 312
- Outside rear view mirror defoggers 516, 527

Outside temperature display..... 209

Overhead console 548

Overheating 721

*1: Refer to "MULTIMEDIA OWNER'S MANUAL".

*2: Refer to "NAVIGATION SYSTEM OWNER'S MANUAL".

P

P position switch	346
Panic mode	277
Parking assist sensors	
Intuitive parking assist	445
Parking Support Brake function	455
S-APGS (Simple Advanced Parking Guidance System)	467
Parking brake	352
Operation	352
Parking brake engaged warning buzzer	352
Parking lights	353
Light switch	353
Replacing light bulbs	660
Parking lock	346
Parking Support Brake function	455
PCS (Pre-Collision System)	384
Enabling/disabling the system	388
Function	384
Warning light	675
Personal lights	541
Switch	542
Wattage	738
Plug-in hybrid system	86
Driving tips	105
EV auto mode	87
EV driving range	108
EV mode	87
EV/HV mode selection switch	90
Features	86
How to charge	146
HV mode	87
Hybrid battery (traction battery) charge mode	87

Power control unit coolant	604
Capacity	735
Checking	604
Preparing and checking before winter	507
Radiator	606
Power outlets	554
Power sources	131
Power steering (Electric Power Steering)	502
Function	502
Warning light	675
Power switch	338
Auto power off function	340
Changing the power switch modes	340
If your vehicle has to be stopped in an emergency ...	665
Starting the hybrid system ...	338
Power windows	314
Catch protection function	315
Door lock linked window operation	315
Jam protection function	315
Operation	314
Window lock switch	314
Pre-Collision System (PCS)	384
Enabling/disabling the system	388
Function	384
Warning light	675

R

Radar cruise control
 Dynamic radar cruise control
 with full-speed range 414

Radiator 606

Radio*

RCTA (Rear Cross Traffic Alert)..... 440
 Blind Spot Monitor
 function..... 437
 Rear Cross Traffic Alert
 function..... 440

Rear Cross Traffic Alert (RCTA)..... 440
 Blind Spot Monitor
 function..... 437
 Rear Cross Traffic Alert
 function..... 440

Rear passengers' seat belt reminder light 677

Rear seat 303

Rear side marker lights..... 353
 Light switch..... 353
 Replacing light bulbs..... 660

Rear turn signal lights..... 351
 Replacing light bulbs..... 660
 Turn signal lever 351

Rear view mirror
 Inside rear view mirror 310
 Outside rear view mirrors..... 312

Rear view monitor system*

Rear window defogger.... 516, 527

Refueling 371
 Capacity..... 732
 Fuel types 732
 Opening the fuel tank cap.... 373
 When the fuel filler door
 cannot be opened..... 374

Regenerative braking 94

Remote Air Conditioning System 535

Replacing

Electronic key battery 647
 Fuses..... 650
 Light bulbs 655
 Tires..... 629
 Wiper insert 644

Reporting safety defects for U.S. owners..... 768

Resetting the message indicating maintenance is required..... 588

Road accident cautions 102

Road Sign Assist (RSA)..... 410

RSA (Road Sign Assist) 410

S

S-APGS (Simple Advanced Parking Guidance System) 467

S-FLOW (Front seat concentrated airflow mode) 514, 526

Safety Connect 76

Seat back pockets 548

Seat belts 30
 Adjusting the seat belt 31
 Automatic Locking Retractor (ALR)..... 31
 Child restraint system
 installation 64
 Cleaning and maintaining
 the seat belt..... 584
 Emergency Locking Retractor (ELR)..... 31
 How to wear your seat belt.... 30
 How your child should wear
 the seat belt..... 32
 Pregnant women, proper
 seat belt use..... 33
 Reminder light and buzzer.... 677
 Seat belt extender 32

*: Refer to "NAVIGATION SYSTEM OWNER'S MANUAL" or "MULTIMEDIA OWNER'S MANUAL".

- Seat belt instructions for
 - Canadian owners 769
 - Seat belt pretensioners..... 31
 - SRS warning light 675
- Seat heaters 539**
- Seating capacity 335**
- Seats 301, 303**
 - Adjustment..... 301
 - Adjustment precautions 302
 - Armrest 566
 - Child seats/child restraint
 - system installation 60
 - Cleaning..... 581
 - Front seats..... 301
 - Head restraint 305
 - Properly sitting in the seat 28
 - Rear seats 303
 - Seat back pocket 548
 - Seat heaters 539
- Sensor**
 - Automatic headlight
 - system 356
 - Automatic High Beam 358
 - BSM (Blind Spot Monitor) 436
 - Door handle 281
 - Front camera 377
 - Humidity sensor 523, 534
 - Inside rear view mirror 311
 - Intuitive parking assist 445
 - LTA (Lane Tracing Assist) 395
 - Parking Support Brake
 - function 456
 - Radar sensor 377
 - Rain-sensing windshield
 - wipers 369
 - RCTA (Rear Cross Traffic
 - Alert function) 436
 - S-APGS (Simple Advanced
 - Parking Guidance
 - System) 496
- Service plug 98**
- Service reminder indicators ... 201**
- Shift lever 345**
- Shift lever light..... 541**
- Side airbags 36**
- Side doors..... 281**
- Side marker lights 353**
 - Light switch..... 353
 - Replacing light bulbs 660
- Side mirrors 312**
 - Adjustment..... 312
 - BSM (Blind Spot Monitor) 432
 - Folding..... 312
 - Outside rear view mirror
 - defoggers 516, 527
- Side windows..... 314**
 - Water-repellent coating 577
- Simple Advanced Parking

 - Guidance System

 - (S-APGS)..... 467****
- Smart key system 292**
 - Antenna location..... 292
 - Entry functions..... 281
 - Starting the hybrid system 338
- Smart lid & connector

 - locking system 121****
- Snow tires 507**
- “SOS” button 76**
- Spark plug..... 735**
- Specifications 730**
- Speedometer..... 209**
- SRS airbags 36**
- Steering wheel 308**
 - Adjustment..... 308
 - Audio switches*
 - Heated steering wheel..... 539
 - Meter control switches..... 193
 - Talk switch*
 - Telephone switches*
 - TRIP switch 213
- Stop lights

 - Replacing light bulbs 660**
- Storage feature 544**
- Storage precautions..... 544**
- Stuck

 - If the vehicle becomes
 - stuck..... 726**
- Sun visors 553**

Switch

Audio remote control switches*
 Automatic High Beam
 switch 358
 Charging schedule switch..... 161
 Cruise control switch..... 414
 Door lock switches..... 283
 Driving mode select switch ... 430
 Emergency flashers switch... 664
 Engine switch..... 338
 EV auto mode switch 90
 EV/HV mode selection
 switch 90
 Fog light switch 363
 Fuel filler door opener
 switch 373
 Garage door opener
 switches..... 568
 Heated steering wheel
 switch 540
 "HUD" (Head-up display)
 switch 255
 Ignition switch 338
 Instrument cluster light
 control switch..... 194
 LTA (Lane Tracing Assist)
 switch 403
 Light switch 353
 Meter control switches 193
 Outside rear view mirror
 switches..... 312
 P position switch 346
 Power door lock switches 283
 Power switch..... 338
 Power window switch..... 314
 Rear window and outside
 rear view mirror
 defoggers switch 516, 527
 S-APGS switch 470
 Seat heater switches 540

"SOS" button..... 76
 Talk switch*
 Telephone switches*
 TRIP switch 213
 Vehicle-to-vehicle distance
 switch 422
 VSC OFF switch 502
 Window lock switch 314
 Windshield wipers and
 washer switch..... 365
 Wireless charger power
 supply switch..... 557

T

Tail lights..... 353
 Light switch..... 353
 Replacing light bulbs 660
Talk switch*
Telephone switch*
Theft deterrent system
 Immobilizer system..... 83
Tire inflation pressure..... 623
 Maintenance data 737
 Warning light..... 677
Tire information 742
 Glossary 747
 Size..... 743
 Tire Identification Number 743
 Uniform Tire Quality
 Grading 745
**Tire pressure warning
 system..... 615**
 Function..... 615
 Initializing..... 615
 Installing tire pressure
 warning valves and
 transmitters 615
 Registering ID codes 616
 Warning light..... 677

*: Refer to "NAVIGATION SYSTEM OWNER'S MANUAL" or "MULTIMEDIA OWNER'S MANUAL".

Tires	614	Toyota Safety Sense 2.0	376
Chains.....	508	TRAC (Traction Control)	501
Checking.....	614	Function.....	501
Emergency tire puncture repair kit.....	694	VSC OFF switch	502
Glossary.....	747	Traction battery (hybrid battery)	98
If you have a flat tire	692	Air intake vent.....	99
Inflation pressure	623	Charging.....	110
Information.....	742	Location	98
Replacing.....	629	Specification	733
Rotating tires.....	614	Status indicator	112
Size.....	737	Traction control (TRAC)	501
Snow tires	507	Function.....	501
Tire pressure warning system.....	615	VSC OFF switch	502
Uniform Tire Quality Grading.....	745	Traction motor (electric motor)	86
Warning light.....	677	Trailer towing	336
Tonneau cover	551	Transmission	345
Tools	630	Driving mode select switch ...	430
Top tether strap	73	Hybrid transmission	345
Total load capacity (vehicle capacity weight)	730	P position switch.....	346
Towing		Trip meters	213
Dinghy towing	337	Turn signal lights	351
Emergency towing	667	Replacing light bulbs	660
Towing eyelet.....	669	Turn signal lever	351
Trailer towing	336		
		U	
		USB charging ports	555
		USB port *	

V

Vanity lights 553
 Wattage 738
Vanity mirrors 553
Vehicle data recording 10
Vehicle identification
 number 731
Vehicle proximity notification
 system 93
Vehicle Stability Control
 (VSC) 501
Voice command system*
VSC (Vehicle Stability
 Control) 501

W

Warning buzzers
 Approach warning 424
 Brake system 674
 Intuitive parking assist 448
 LTA (Lane Tracing Assist) 400
 Open door 285, 676
 Parking Support Brake
 function 460
 Pre-collision warning 384
 Radar cruise control 424
 RCTA (Rear Cross Traffic
 Alert) 432
 RSA (Road Sign Assist) 410
 Seat belt reminder 677
 Shift position 347

Warning lights 202

 ABS 675
 Brake Override System 678
 Brake system 674
 Charging system 674
 Drive-Start Control 678
 Driver's seat belt reminder
 light 677
 Electronic engine control
 system 674
 Electric power steering
 system 675
 Front passenger's seat belt
 reminder light 677
 High coolant temperature 676
 Low engine oil pressure 674
 Low fuel level 676
 Malfunction indicator lamp 674
 Master warning light 677
 Open door 676
 Parking Support Brake
 function 678
 PCS 675
 PKSB OFF indicator 676
 Rear passengers' seat belt
 reminder light 677
 Seat belt reminder light 677
 Slip indicator 676
 SRS 675
 Tire pressure 677

*: Refer to "NAVIGATION SYSTEM OWNER'S MANUAL" or "MULTIMEDIA OWNER'S MANUAL".

Warning messages	684	Windows	314
Warning reflector storage		Power windows.....	314
space	550	Rear window	
Washer	365	defogger.....	516, 527
Checking.....	612	Washer.....	365
Preparing and checking		Windshield wipers	365
before winter.....	507	Handling the wiper arms.....	580
Switch.....	365	Rain-sensing windshield	
Washing and waxing	576	wipers.....	367
Water-repellent coating	577	Replacing the wiper insert	644
Weights	730	Winter driving tips	507
Cargo capacity.....	335	Wiper insert replacement	644
Load limits.....	730	Wireless charger	557
Wheels	626	Wireless remote control	276
Replacing wheels.....	629	Battery-Saving Function	294
Size.....	737	Locking/Unlocking	282
Window glasses	314	Panic mode.....	277
Window lock switch	314	Remote Air Conditioning	
		System	535
		Replacing the battery.....	647
		WMA disc*	

*: Refer to "MULTIMEDIA OWNER'S MANUAL".

GAS STATION INFORMATION

Auxiliary catch lever P. 597		Fuel filler door P. 373
<p style="text-align: right; font-size: small;">IOPPH061</p>		
Fuel filler door opener P. 373	Hood lock release lever P. 597	Tire inflation pressure P. 737

Fuel tank capacity (Reference)	11.4 gal. (43 L, 9.5 Imp.gal.)	
Fuel type	Unleaded gasoline only	P. 732
Cold tire inflation pressure		P. 737
Engine oil capacity (Drain and refill — reference)	With filter	4.4 qt. (4.2 L, 3.7 Imp.qt.)
	Without filter	4.1 qt. (3.9 L, 3.4 Imp.qt.)
Engine oil type	“Toyota Genuine Motor Oil” or equivalent Oil grade: API SN/RC multigrade engine oil P. 734	