

TOYOTA
TUNDRA
2 0 2 6

OWNER'S MANUAL



WARNING: Operating, servicing and maintaining a passenger vehicle or off-highway motor vehicle can expose you to chemicals including engine exhaust, carbon monoxide, phthalates, and lead, which are known to the State of California to cause cancer and birth defects or other reproductive harm. To minimize exposure, avoid breathing exhaust, do not idle the engine except as necessary, service your vehicle in a well-ventilated area and wear gloves or wash your hands frequently when servicing your vehicle. For more information go to www.P65Warnings.ca.gov/passenger-vehicle.

Your Toyota dealer

Your Toyota dealer will provide quality maintenance and any other assistance you may require.

If there is not a Toyota dealer near you, please call the following number:

■ U.S. OWNERS

- In the U.S. mainland or Canada:
Toyota Customer Experience Center
1-800-331-4331 (Toll-Free)
- In Hawaii:
Servco Automotive Customer Services
1-888-272-5515 (Toll-Free)

■ CANADIAN OWNERS

- In Canada or the U.S. mainland:
Toyota Canada Customer Interaction Centre
1-888-TOYOTA-8 or **1-888-869-6828** (Toll-Free)

Please access our **websites** for further information.

- The U.S. mainland: **www.toyota.com**
- Hawaii: **www.toyotahawaii.com**
- Canada : **www.toyota.ca**

©2025 TOYOTA MOTOR CORPORATION

All rights reserved. This material may not be reproduced or copied, in whole or in part, without the written permission of Toyota Motor Corporation.

NOTICE TO QUEBEC CONSUMERS:

Toyota Canada Inc. is pleased to offer a 36 month / 60,000 km (whichever occurs first) limited new-vehicle warranty on your vehicle. This limited warranty covers repairs on any part of the vehicle supplied by Toyota Canada that is defective in material or workmanship, subject to certain exceptions that are stated in your warranty manual. For more details of the warranty, check the Owner's Manual Supplement included with your vehicle, or visit toyota.ca.

Quebec's Consumer Protection Act requires Toyota Canada to disclose whether we guarantee the availability of replacement parts, repair services, and information necessary to maintain or repair the vehicle or its components. While Toyota Canada is pleased to honour the terms of our limited warranty, **please note that Toyota in no way guarantees the availability of replacement parts, repair services and information necessary to maintain or repair the vehicle or its components.**

Pictorial index	Search by illustration	
For safety and security	Make sure to read through them (Main topics: Child seat, theft deterrent system)	1
Vehicle status information and indicators	Reading driving-related information (Main topics: Meters, multi-information display)	2
Before driving	Opening and closing the doors and windows, adjustment before driving (Main topics: Keys, doors, seats)	3
Driving	Operations and advice which are necessary for driving (Main topics: Starting hybrid system, refueling)	4
Interior features	Usage of the interior features (Main topics: Air conditioner, storage features)	5
Maintenance and care	Caring for your vehicle and maintenance procedures (Main topics: Interior and exterior, light bulbs)	6
When trouble arises	What to do in case of malfunction and emergency (Main topics: 12-volt battery discharge, flat tire)	7
Vehicle specifications	Vehicle specifications, customizable features (Main topics: Fuel, oil, tire inflation pressure)	8
For owners	Reporting safety defects for U.S. owners, seat belt and SRS airbag instructions for Canadian owners	9
Index	Search by symptom	
	Search alphabetically	

2 TABLE OF CONTENTS

For your information.....	6
Reading this manual	12
How to search.....	13
Pictorial index	14

1 For safety and security

1-1. For safe use

Before driving	26
For safe driving	27
Seat belts	29
SRS airbags	36
Front passenger occupant classification system	46
Exhaust gas precautions..	51

1-2. Child safety

Riding with children	52
Child restraint systems.....	53

1-3. Emergency assistance

Safety Connect	68
----------------------	----

1-4. Hybrid system

Hybrid system features	73
Hybrid system precautions	77

1-5. Theft deterrent system

Immobilizer system	82
Alarm.....	83

2 Vehicle status information and indicators

2-1. Instrument cluster

Warning lights and indicators	86
Gauges and meters.....	91
Multi-information display...	95
Head-up display	102
Fuel consumption information	107

3 Before driving

3-1. Key information

Keys	110
------------	-----

3-2. Opening, closing and locking the doors and tailgate

Side doors	113
Power running boards ...	117
Tailgate	120
Power bed step	129
Smart key system.....	131

3-3. Adjusting the seats

Front seats	136
Rear seats	141
Driving position memory	144
Head restraints	148

3-4. Adjusting the steering wheel and mirrors

Steering wheel.....	151
Inside rear view mirror...	153
Digital Rear-view Mirror.	154
Outside rear view mirrors	164

3-5. Opening, closing the windows and moon roof
 Power windows **169**
 Power back window **172**
 Panoramic moon roof.... **173**

4 Driving

4-1. Before driving
 Driving the vehicle..... **181**
 Cargo and luggage **188**
 Vehicle load limits **190**
 Trailer towing..... **191**
 Dinghy towing **206**

4-2. Driving procedures
 Power (ignition) switch .. **207**
 Automatic transmission. **212**
 Turn signal lever..... **216**
 Parking brake **217**
 Brake Hold **220**

4-3. Operating the lights and wipers
 Headlight switch **223**
 Fog light switch **226**
 AHB (Automatic High Beam)
 **226**
 Light bar **230**
 Windshield wipers and
 washer..... **230**

4-4. Refueling
 Opening the fuel tank cap
 **234**

4-5. Using the driving support systems
 Toyota Safety Sense 2.5 **237**
 PCS (Pre-Collision System)
 **242**
 LTA (Lane Tracing Assist)
 **254**
 RSA (Road Sign Assist). **265**
 Dynamic radar cruise control
 with full-speed range ... **268**
 BSM (Blind Spot Monitor)
 **281**
 Intuitive parking assist... **288**
 RCTA (Rear Cross Traffic
 Alert)..... **295**
 PKSB (Parking Support
 Brake)..... **301**
 Parking Support Brake func-
 tion (static objects) **306**
 Parking Support Brake func-
 tion (rear-crossing vehicles)
 **309**
 Toyota parking assist monitor
 **311**
 Panoramic view monitor **324**
 Multi-terrain Monitor **361**
 Electronically modulated air
 suspension **373**
 Driving mode select switch
 **376**
 Four-wheel drive system **379**
 AUTO LSD system **381**
 Rear differential lock system
 **382**
 Crawl Control..... **383**
 Multi-terrain Select **387**
 Downhill assist control sys-
 tem **390**



4 TABLE OF CONTENTS

- Driving assist systems .. **393**
- Trailer brake controller .. **398**
- Trailer Backup Guide **401**
- Active front spoiler **406**

4-6. Driving tips

- Hybrid Electric Vehicle driving tips..... **408**
- Off-road precautions **410**
- Winter driving tips **413**

5 Interior features

5-1. Using the air conditioning system and defogger

- Automatic air conditioning system..... **418**
- Heated steering wheel/seat heaters/seat ventilators **425**

5-2. Using the interior lights

- Interior lights list **428**

5-3. Using the storage features

- List of storage features . **431**
- Luggage compartment features **435**

5-4. Using the other interior features

- Other interior features ... **440**
- Garage door opener..... **457**

6 Maintenance and care

6-1. Maintenance and care

- Cleaning and protecting the vehicle exterior **466**
- Cleaning and protecting the vehicle interior **469**

6-2. Maintenance

- Maintenance requirements **472**
- General maintenance **473**
- Emission inspection and maintenance (I/M) programs **476**

6-3. Do-it-yourself maintenance

- Do-it-yourself service precautions..... **478**
- Hood..... **480**
- Engine compartment **481**
- 12-volt battery..... **488**
- Tires **490**
- Tire inflation pressure **501**
- Wheels **503**
- Air conditioning filter **505**
- Cleaning the hybrid battery (traction battery) air intake vents..... **506**
- Electronic key battery **510**
- Checking and replacing fuses **512**
- Light bulbs **515**

7 When trouble arises

7-1. Essential information

- Emergency flashers..... **520**
- If your vehicle has to be stopped in an emergency **520**
- If the vehicle is submerged or water on the road is rising **521**

7-2. Steps to take in an emergency

- If your vehicle needs to be towed..... **523**

If you think something is wrong **525**

If a warning light turns on or a warning buzzer sounds **527**

If a warning message is displayed..... **537**

If you have a flat tire..... **541**

If the hybrid system will not start **551**

If you lose your keys **553**

If the electronic key does not operate properly **553**

If the vehicle 12-volt battery is discharged..... **555**

If your vehicle overheats **561**

If the vehicle becomes stuck **564**

Seat belt instructions for Canadian owners (in French)..... **603**

SRS airbag instructions for Canadian owners (in French)..... **605**

Camper information..... **613**

Index

What to do if... (Troubleshooting) **620**

Alphabetical Index..... **623**

8 Vehicle specifications

8-1. Specifications

Maintenance data (fuel, oil level, etc.)..... **566**

Fuel information **576**

Tire information **578**

8-2. Customization

Customizable features .. **588**

8-3. Initialization

Items to initialize **600**

9 For owners

9-1. For owners

Reporting safety defects for U.S. owners..... **602**

Reporting safety defects for Canadian owners **602**

1

2

3

4

5

6

7

8

9

For your information

Main Owner's Manual

Please note that this manual applies to all models and explains all equipment, including options. Therefore, you may find explanations for equipment not installed on your vehicle and the illustrations used may differ from your vehicle.

All specifications provided in this manual are current at the time of printing. Over time, your vehicle may receive updates that modify the vehicle and make material in this manual incomplete and/or inaccurate. Because of Toyota's interest in continual product improvement, Toyota reserves the right to make changes to this manual at any time without notice.

If Toyota chooses to update the manual, updated versions can be viewed by selecting your vehicle by model and year at the following URL or on your mobile device if you have access to the Toyota app.

www.toyota.com/owners

Noise from under vehicle after turning off the hybrid system

Approximately five hours after the hybrid system is turned off,

you may hear sound coming from under the vehicle for several minutes. This is the sound of a fuel evaporation leakage check and it does not indicate a malfunction.

Accessories, spare parts and modification of your Toyota

A wide variety of non-genuine spare parts and accessories for Toyota vehicles are currently available in the market. You should know that Toyota does not warrant these products and is not responsible for their performance, repair, or replacement, or for any damage they may cause to, or adverse effect they may have on, your Toyota vehicle.

This vehicle should not be modified with non-genuine Toyota products. Modification with non-genuine Toyota products could affect its performance, safety or durability, and may even violate governmental regulations. In addition, damage or performance problems resulting from the modification may not be covered under warranty.

Also, remodeling like this will have an effect on advanced safety equipment such as Toyota Safety Sense 2.5 and there is a danger that it will not

work properly or the danger that it may work in situations where it should not be working.

Cyber Attack Risk

Installing electronic devices and radios increases the risk of cyber attacks through the installed parts, which may lead to unexpected accidents and leakage of personal information. Toyota does not make any guarantees for problems caused by installing non-genuine Toyota products.

Installation of a mobile two-way radio system

The installation of a mobile two-way radio system in your vehicle could affect electronic systems such as:

- Multiport fuel injection system/sequential multiport fuel injection system
- Toyota Safety Sense 2.5
- Anti-lock brake system
- Vehicle dynamics integrated management
- SRS airbag system
- Seat belt pretensioner system

Be sure to check with your Toyota dealer for precautionary measures or special instructions regarding installation of a mobile two-way radio system.

Vehicle data recording

The vehicle is equipped with sophisticated computers that will record certain data, such as:

- Engine speed / Electric motor speed (traction motor speed)
- Accelerator status
- Brake status
- Vehicle speed
- Operation status of the driving assist systems
- Images from the cameras

Your vehicle is equipped with cameras. Contact your Toyota dealer for the location of recording cameras.

The recorded data varies according to the vehicle grade level and options with which it is equipped.

These computers do not record conversations or sounds, and only record images outside of the vehicle in certain situations.

● Data Transmission

Your vehicle may transmit the data recorded in these computers to Toyota without notification to you.

● Data usage

Toyota may use the data recorded in this computer to diagnose malfunctions, conduct research and development, and improve quality.

Toyota will not disclose the recorded data to a third party except:

- With the consent of the vehicle owner or with the consent of the

lessee if the vehicle is leased

- In response to an official request by the police, a court of law or a government agency
- For use by Toyota in a lawsuit
- For research purposes where the data is not tied to a specific vehicle or vehicle owner
- Recorded image information can be erased by your Toyota dealer.

The image recording function can be disabled. However, if the function is disabled, data from when the system operates will not be available.

- To learn more about the vehicle data collected, used and shared by Toyota, please visit www.toyota.com/privacyvts/.

Usage of data collected through Safety Connect (U.S.mainland only)

If your Toyota has Safety Connect and if you have subscribed to those services, please refer to the Safety Connect Telematics Subscription Service Agreement for information on data collected and its usage.

- To learn more about the vehicle data collected, used and shared by Toyota, please visit www.toyota.com/privacyvts/.

Statement on Warranty Coverage for Aftermarket and Recycled Parts (For U.S. Owners)

The Magnuson-Moss Warranty Act, 15 U.S.C. s.2301 et seq., makes it illegal for motor vehicle manufacturers to void a motor vehicle warranty or deny warranty coverage solely because an aftermarket or recycled part has been used to repair the vehicle or someone other than the authorized service provider performed service on the vehicle. This provision does not apply to a new motor vehicle purchased solely for commercial or industrial use.

Under federal law, a manufacturer may deny warranty coverage and charge for repairs to a vehicle if it is discovered that an aftermarket or recycled part installed on the vehicle is defective or was installed incorrectly and caused damage to another part of the vehicle otherwise covered under warranty. The Federal Trade Commission requires that a manufacturer demonstrate that an aftermarket or recycled part or service performed by a person other than an authorized service provider caused damage to another part of the vehicle otherwise covered under warranty before

denying warranty coverage. Additionally, federal law allows a manufacturer to void a motor vehicle warranty or deny warranty coverage if the manufacturer provides the article or service to consumers free of charge under the warranty or the manufacturer has secured a waiver from the Federal Trade Commission.

Event data recorder

This vehicle is equipped with an event data recorder (EDR). The main purpose of an EDR is to record, in certain crash or near crash-like situations, such as an air bag deployment or hitting a road obstacle, data that will assist in understanding how a vehicle's systems performed. The EDR is designed to record data related to vehicle dynamics and safety systems for a short period of time, typically 30 seconds or less.

The EDR in this vehicle is designed to record such data as:

- How various systems in your vehicle were operating;
- Whether or not the driver and passenger safety belts were buckled/fastened;
- How far (if at all) the driver was depressing the accelerator and/or brake pedal; and,
- How fast the vehicle was trav-

eling.

These data can help provide a better understanding of the circumstances in which crashes and injuries occur.

NOTE: EDR data are recorded by your vehicle only if a non-trivial crash situation occurs; no data are recorded by the EDR under normal driving conditions and no personal data (e.g., name, gender, age, and crash location) are recorded. However, other parties, such as law enforcement, could combine the EDR data with the type of personally identifying data routinely acquired during a crash investigation.

To read data recorded by an EDR, special equipment is required, and access to the vehicle or the EDR is needed. In addition to the vehicle manufacturer, other parties, such as law enforcement, that have the special equipment, can read the information if they have access to the vehicle or the EDR.

● Disclosure of the EDR data

Toyota will not disclose the data recorded in an EDR to a third party except when:

- An agreement from the vehicle's owner (or the lessee for a leased vehicle) is obtained
- In response to an official request by the police, a court of law or a government agency

- For use by Toyota in a lawsuit
- However, if necessary, Toyota may:
- Use the data for research on vehicle safety performance
- Disclose the data to a third party for research purposes without disclosing information about the specific vehicle or vehicle owner

Scrapping of your Toyota

The SRS airbag and seat belt pretensioner devices in your Toyota contain explosive chemicals. If the vehicle is scrapped with the airbags and seat belt pretensioners left as they are, this may cause an accident such as fire. Be sure to have the systems of the SRS airbag and seat belt pretensioner removed and disposed of by a qualified service shop or by your Toyota dealer before you scrap your vehicle.

Perchlorate Material

Special handling may apply, See www.dtsc.ca.gov/hazardouswaste/perchlorate.

Your vehicle has components that may contain perchlorate. These components may include airbags, seat belt pretensioners, and wireless remote control batteries.





“QR Code”

The word “QR Code” is registered trademark of DENSO WAVE INCORPORATED in Japan and other countries.

Caution symbols attached to the high voltage components

High voltage components, such as the power control unit, may have labels attached indicating care required.

Each caution symbol indicates the following:

Symbols	Meanings
	Indicates danger
	Indicates high voltage part
	Indicates not to touch
	Indicates high temperature part

**WARNING****■ General precautions while driving**

Driving under the influence: Never drive your vehicle when under the influence of alcohol or drugs that have impaired your ability to operate your vehicle. Alcohol and certain drugs delay reaction time, impair judgment and reduce coordination, which could lead to an accident that could result in death or serious injury.

Defensive driving: Always drive defensively. Anticipate mistakes that other drivers or pedestrians might make and be ready to avoid accidents.

Driver distraction: Always give your full attention to driving. Anything that distracts the driver, such as adjusting controls, talking on a cellular phone or reading can result in a collision with resulting death or serious injury to you, your occupants or others.

■ General precaution regarding children's safety



Never leave children unattended in the vehicle, and never allow children to have or use the key.



Children may be able to start the vehicle or shift the vehicle into neutral. There is also a danger that children may injure themselves by playing with the windows, the panoramic moon roof, or other features of the vehicle. In addition, heat build-up or extremely cold temperatures inside the vehicle can be fatal to children.

Reading this manual



Explains symbols used in this manual.

Symbols in this manual

Symbols	Meanings
	WARNING: Explains something that, if not obeyed, could cause death or serious injury to people.
	NOTICE: Explains something that, if not obeyed, could cause damage to or a malfunction in the vehicle or its equipment.
1 2 3...	Indicates operating or working procedures. Follow the steps in numerical order.

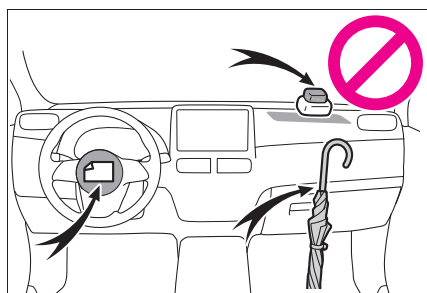
Symbols	Meanings
	Indicates the action (pushing, turning, etc.) used to operate switches and other devices.
	Indicates the outcome of an operation (e.g. a lid opens).



Symbols	Meanings
	Indicates the component or position being explained.
	Means Do not , Do not do this , or Do not let this happen .

Symbols in illustrations

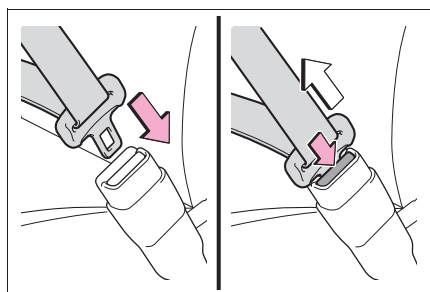

How to search

■ Searching by name

- Alphabetical index: →P.623

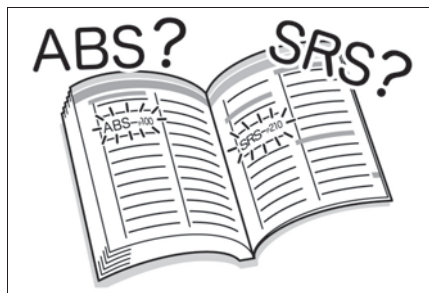

■ Searching by installation position

- Pictorial index: →P.14

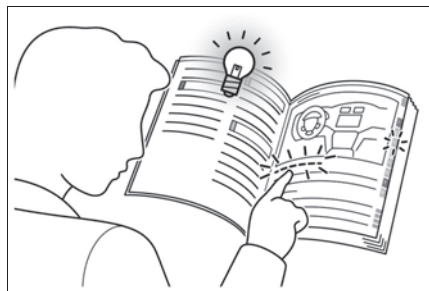

■ Searching by symptom or sound

- What to do if... (Troubleshooting): →P.620



■ Searching by title

- Table of contents: →P.2

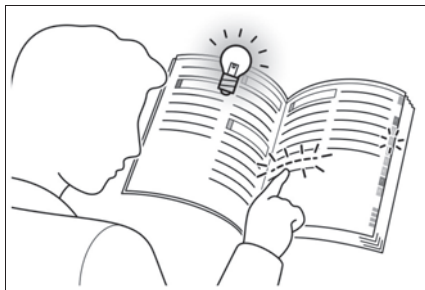

Pictorial index

Exterior

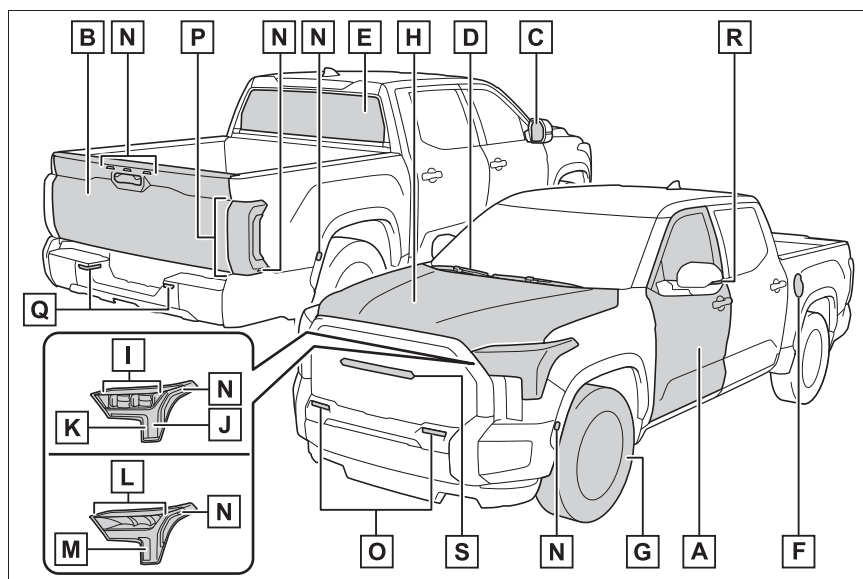

A	Side doors	P.113
	Locking/unlocking	P.113
	Opening/closing the side windows	P.169
	Locking/unlocking by using the mechanical key	P.554
	Warning messages	P.527
B	Tailgate	P.120
	Locking/unlocking	P.120
	Opening/closing the tailgate	P.121
	Removing the tailgate	P.126
C	Outside rear view mirrors	P.164
	Adjusting the mirror angle	P.164
	Folding the mirrors	P.166
	Driving position memory	P.144
	Defogging the mirrors	P.420

D	Windshield wipers	P.230
	Precautions for winter season.....	P.413
	To prevent freezing (windshield wiper de-icer).....	P.423
	Precautions for car wash (vehicles with rain-sensing windshield wipers)*	P.467
E	Back window	P.172
F	Fuel filler door	P.234
	Refueling method.....	P.234
	Fuel type/fuel tank capacity	P.569
G	Tires	P.490
	Tire size/inflation pressure	P.574
	Winter tires/tire chains	P.413
	Checking/rotation/tire pressure warning system	P.490
	Coping with flat tires.....	P.541
H	Hood	P.480
	Opening	P.480
	Engine oil	P.570
	Coping with overheating	P.561

Light bulbs of the exterior lights for driving

(Replacing method: P.515, Watts: P.575)

I	Headlights	P.223
J	Parking lights	P.223
K	Turn signal lights	P.216
	Daytime running lights	P.223
L	Head lights/daytime running lights	P.223
M	Turn signal lights	P.216
	Parking lights	P.223
N	Side marker lights*/rear tailgate markers*	P.223

O	Fog lights *	P.226
P	Tail lights	P.223
	Turn signal lights	P.216
	Stop lights	
Q	Back-up lights	
	Changing the shift position to R	P.212
	license plate lights	P.223
R	Turn signal lights	P.216
S	Light bar *	P.230

* : If equipped

■ Instrument panel

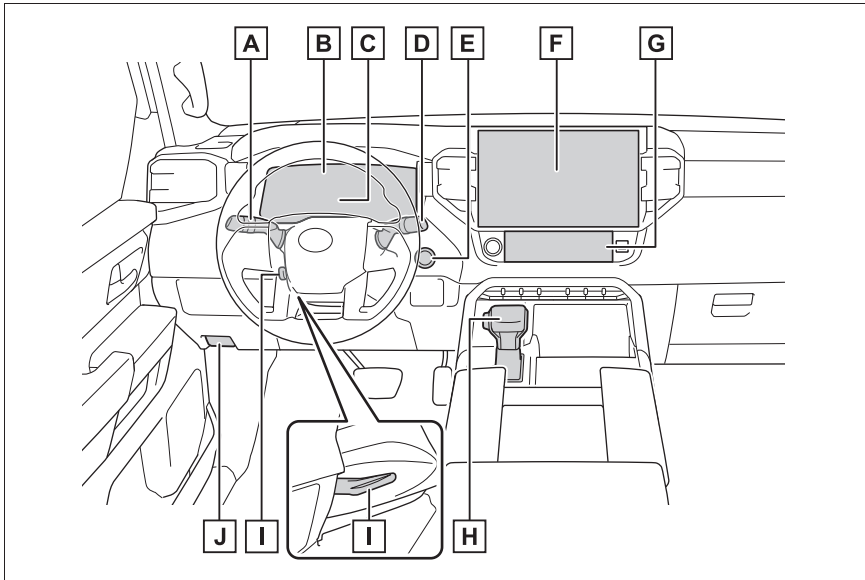

A	Turn signal lever	P.216
	Headlight switch	P.223
	Headlights/parking lights/tail lights/license plate lights/ daytime running lights/rear tailgate markers * ¹	P.223
	Fog lights * ¹	P.226
B	Multi-information display	P.95
	Display	P.95
	When a warning message is displayed	P.537
C	Meters	P.91
	Reading the meters/ adjusting the instrument panel light	P.91
	Warning lights/indicator lights	P.86
	When a warning light turns on	P.527

D	Windshield wiper and washer switch	P.230
	Usage.....	P.230
	Adding washer fluid.....	P.487
	Warning messages	P.537
E	Power switch	P.207
	Starting the hybrid system/changing the modes	P.207
	Emergency stop of the hybrid system	P.520
	When the hybrid system will not start	P.551
	Warning messages	P.537
F	Multimedia system ^{*2}	
G	Air conditioning system	P.418
	Usage.....	P.418
	Back window defogger.....	P.420
H	Shift lever	P.212
	Changing the shift position.....	P.213
	Precautions for towing	P.523
	When the shift lever does not move.....	P.213
I	Tilt and telescopic steering control switch ^{*1} / tilt and telescopic steering lock release lever ^{*1}	P.151
	Adjustment	P.151
	Driving position memory ^{*1}	P.144
J	Hood lock release lever	P.480

^{*1}: If equipped

^{*2}: Refer to "MULTIMEDIA OWNER'S MANUAL".

Switches

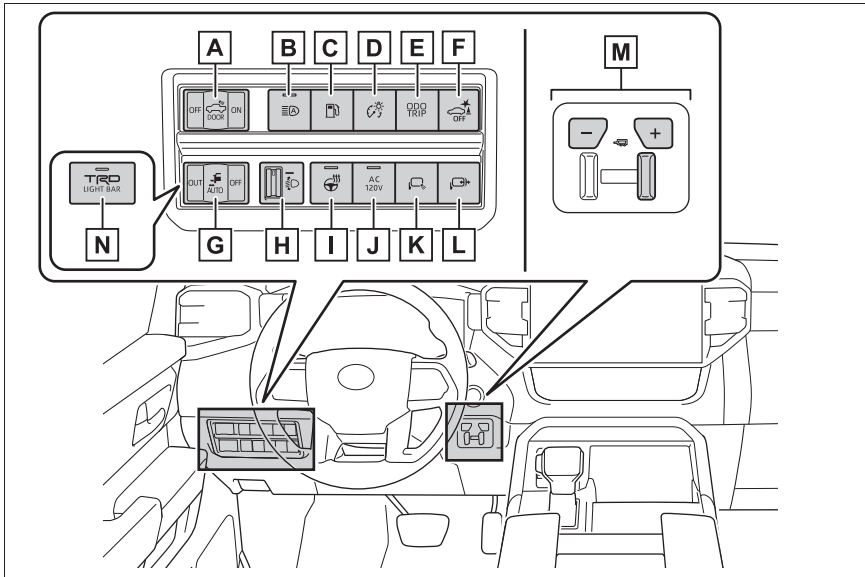

A	Cargo lamp main switch	P.430
B	Automatic High Beam switch	P.226
C	Fuel lid opener switch	P.235
D	Instrument panel light control switch	P.94
E	“ODO TRIP” switch	P.93
F	PKSB OFF switch	P.303
G	Power steps switch	
	Power running boards *	P.117
	Power bed step *	P.129
H	Headlight leveling dial *	P.225
I	Heated steering wheel switch *	P.425
J	AC 120V switch *	P.451
K	Outer mirror lamp switch *	P.168

L Outer mirror extend switch * P.167

M Trailer brake control switch P.398

N Light bar switch * P.230

*: If equipped

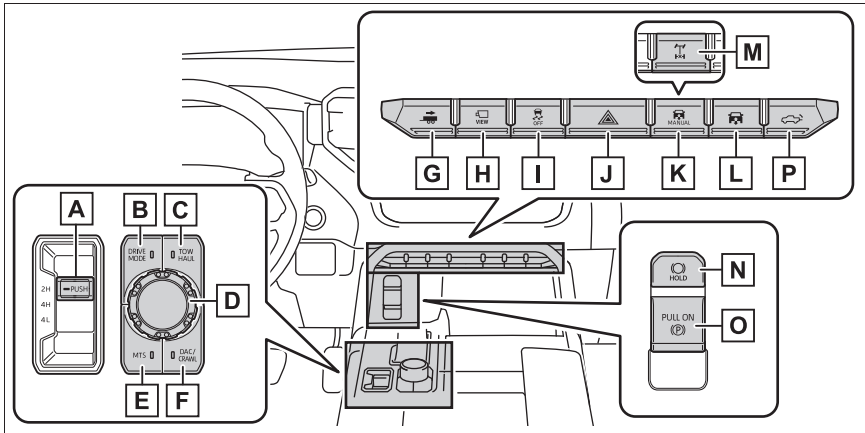

A Front-wheel drive control switch * P.379

B “DRIVE MODE” switch * P.376

C “TOW HAUL” switch * P.215

D Mode select switch * P.215, 376, 383, 387

E “MTS” switch * P.387

F “DAC/CRAWL” switch * P.383

G Trailer Backup Guide switch * P.402

H Camera switch * P.326

I VSC OFF switch P.394

J Emergency flasher switch P.520

K Height control mode select switch * P.373

L Height control switch * P.373

M Rear differential lock switch * P.382

N Brake hold switch P.220

O Parking brake switch P.217
 Applying/releasing the parking brake P.217
 Precautions for winter season P.414
 Warning buzzer/messages P.219, 532

P Power tailgate opener switch P.121

*: If equipped

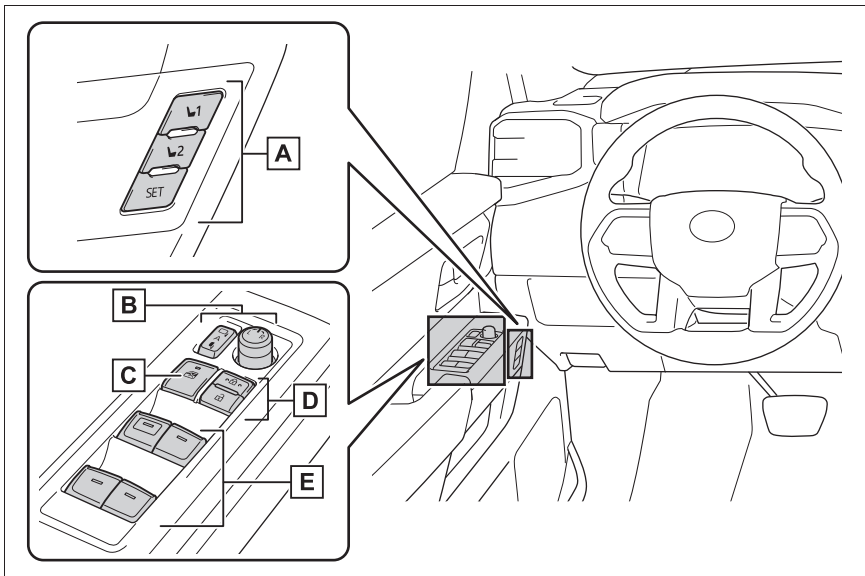

A Driving position memory switches P.144

B Outside rear view mirror switches P.164

C Window lock switch P.171

D Door lock switches P.116

E Power window switches P.169

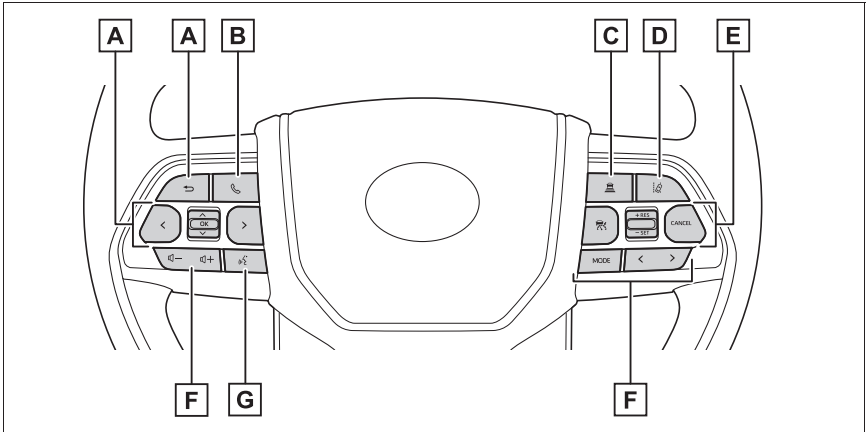

- A** Meter control switches P.96
- B** Phone switch *
- C** Vehicle-to-vehicle distance switch P.275
- D** LTA (Lane Tracing Assist) switch P.254
- E** Cruise control switches
 - Dynamic radar cruise control with full-speed range P.268
- F** Audio remote control switches *
- G** Talk switch *

*: Refer to "MULTIMEDIA OWNER'S MANUAL".

Interior

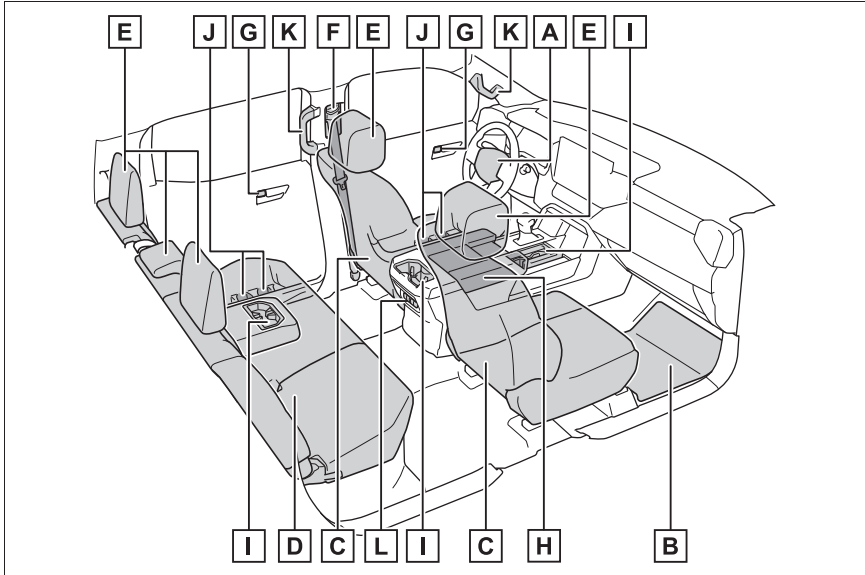

A	SRS airbags	P.36
B	Floor mats	P.26
C	Front seats	P.136
D	Rear seats	P.141
E	Head restraints	P.148
F	Seat belts	P.29
G	Inside lock buttons	P.116
H	Console box	P.434
I	Cup holders	P.432
J	Bottle holders	P.433
K	Assist grip	P.449
L	Rear seat heaters/seat ventilators control switch *	P.426

* : if equipped

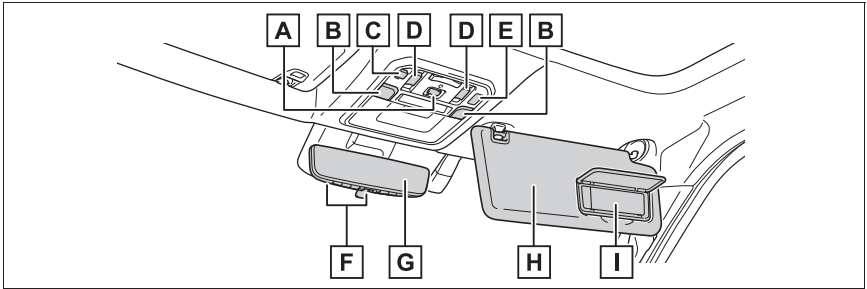

A	“SOS” button *	P.68
B	Personal/interior lights		P.429
C	Power back window switch		P.172
D	Panoramic moon roof switches *		P.173
E	“MOOD” switch *		P.429
F	Garage door opener buttons		P.457
G	Inside rear view mirror *		P.153
	Digital Rear-view Mirror *		P.154
H	Sun visors		P.455
I	Vanity mirrors		P.456

* : If equipped

For safety and security

1

1-1. For safe use

- Before driving 26
- For safe driving 27
- Seat belts 29
- SRS airbags 36
- Front passenger occupant
classification system 46
- Exhaust gas precautions 51

1-2. Child safety

- Riding with children 52
- Child restraint systems... 53

1-3. Emergency assistance

- Safety Connect 68

1-4. Hybrid system

- Hybrid system features .. 73
- Hybrid system precautions
..... 77

1-5. Theft deterrent system

- Immobilizer system 82
- Alarm..... 83

Before driving

Observe the following before starting off in the vehicle to ensure safety of driving.

Installing floor mats

Use only floor mats designed specifically for vehicles of the same model and model year as your vehicle. Fix them securely in place onto the carpet.

- 1 Insert the retaining hooks (clips) into the floor mat eyelets.

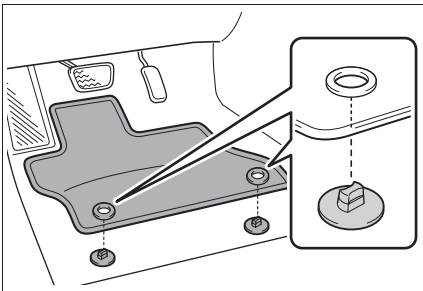

- 2 Turn the upper knob of each retaining hook (clip) to secure the floor mats in place.

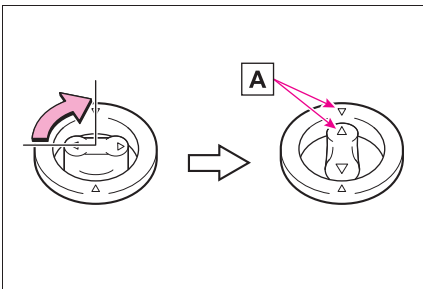

Always align the \triangle marks **A**.

The shape of the retaining hooks (clips) may differ from that shown in the illustration.

! WARNING

Observe the following precautions.

Failure to do so may cause the driver's floor mat to slip, possibly interfering with the pedals while driving. An unexpectedly high speed may result or it may become difficult to stop the vehicle. This could lead to an accident, resulting in death or serious injury.

■ When installing the driver's floor mat

- Do not use floor mats designed for other models or different model year vehicles, even if they are Toyota Genuine floor mats.
- Only use floor mats designed for the driver's seat.
- Always install the floor mat securely using the retaining hooks (clips) provided.
- Do not use two or more floor mats on top of each other.
- Do not place the floor mat bottom-side up or upside-down.

⚠ WARNING

■ Before driving

- Check that the floor mat is securely fixed in the correct place with all the provided retaining hooks (clips). Be especially careful to perform this check after cleaning the floor.

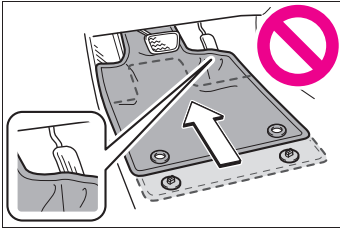

- With the hybrid system stopped and the shift lever in P, fully depress each pedal to the floor to make sure it does not interfere with the floor mat.

For safe driving

For safe driving, adjust the seat and mirror to an appropriate position before driving.

Correct driving posture

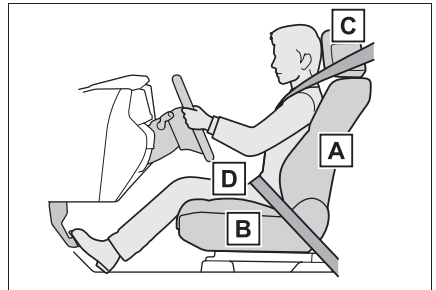

- A** Adjust the angle of the seatback so that you are sitting straight up and so that you do not have to lean forward to steer. (→P.136)
- B** Adjust the seat so that you can depress the pedals fully and so that your arms bend slightly at the elbow when gripping the steering wheel. (→P.136)
- C** Lock the head restraint in place with the center of the head restraint closest to the top of your ears. (→P.148)
- D** Wear the seat belt correctly. (→P.29)

**WARNING****■ For safe driving**

Observe the following precautions.

Failure to do so may result in death or serious injury.

- Do not adjust the position of the driver's seat while driving. Doing so could cause the driver to lose control of the vehicle.
- Do not place a cushion between the driver or passenger and the seatback. A cushion may prevent correct posture from being achieved, and reduce the effectiveness of the seat belt and head restraint.
- Do not place anything under the front seats. Objects placed under the front seats may become jammed in the seat tracks and stop the seat from locking in place. This may lead to an accident and the adjustment mechanism may also be damaged.
- Always observe the legal speed limit when driving on public roads.
- When driving over long distances, take regular breaks before you start to feel tired. Also, if you feel tired or sleepy while driving, do not force yourself to continue driving and take a break immediately.

child becomes large enough to properly wear the vehicle's seat belt. (→P.53)

Adjusting the mirrors

Make sure that you can see rear of the vehicle clearly by adjusting the inside rear view mirror (if equipped), Digital Rear-view Mirror (if equipped) and outside rear view mirrors properly. (→P.153, 154, 164)

Correct use of the seat belts

Make sure that all occupants are wearing their seat belts before driving the vehicle. (→P.29)

Use a child restraint system appropriate for the child until the

Seat belts

Make sure that all occupants are wearing their seat belts before driving the vehicle.

WARNING

Observe the following precautions to reduce the risk of injury in the event of sudden braking, sudden swerving or an accident. Failure to do so may cause death or serious injury.

■ Wearing a seat belt

- Ensure that all passengers wear a seat belt.
- Always wear a seat belt properly.
- Each seat belt should be used by one person only. Do not use a seat belt for more than one person at once, including children.
- Toyota recommends that children be seated in the rear seat and always use a seat belt and/or an appropriate child restraint system.
- To achieve a proper seating position, do not recline the seat more than necessary. The seat belt is most effective when the occupants are sitting up straight and well back in the seats.
- Do not wear the shoulder belt under your arm.
- Always wear your seat belt low and snug across your hips.

■ Pregnant women

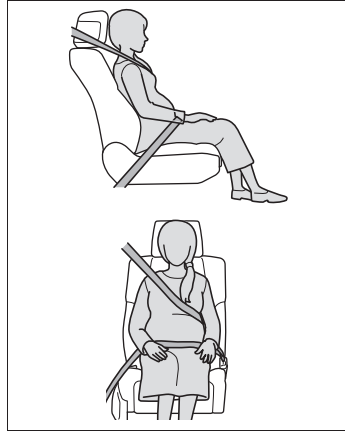

Obtain medical advice and wear the seat belt in the proper way. (→P.30)

Women who are pregnant should position the lap belt as low as possible over the hips in the same manner as other occupants, extending the shoulder belt completely over the shoulder and avoiding belt contact with the rounding of the abdominal area.

If the seat belt is not worn properly, not only the pregnant woman, but also the fetus could suffer death or serious injury as a result of sudden braking or a collision.

■ People suffering illness

Obtain medical advice and wear the seat belt in the proper way. (→P.30)

■ When children are in the vehicle

→P.66

■ Seat belt damage and wear

- Do not damage the seat belts by allowing the belt, plate, or buckle to be jammed in the door.

⚠ WARNING

- Inspect the seat belt system periodically. Check for cuts, fraying, and loose parts. Do not use a damaged seat belt until it is replaced. Damaged seat belts cannot protect an occupant from death or serious injury.
- Ensure that the belt and plate are locked and the belt is not twisted.
If the seat belt does not function correctly, immediately contact your Toyota dealer.
- Replace the seat assembly, including the belts, if your vehicle has been involved in a serious accident, even if there is no obvious damage.
- Do not attempt to install, remove, modify, disassemble or dispose of the seat belts. Have any necessary repairs carried out by your Toyota dealer. Inappropriate handling may lead to incorrect operation.

Correct use of the seat belts



- Extend the shoulder belt so that it comes fully over the shoulder, but does not come into contact with the neck or slide off the shoulder.

- Position the lap belt as low as possible over the hips.
- Adjust the position of the seatback. Sit up straight and well back in the seat.
- Do not twist the seat belt.

■ Child seat belt usage

The seat belts of your vehicle were principally designed for persons of adult size.

- Use a child restraint system appropriate for the child, until the child becomes large enough to properly wear the vehicle's seat belt. (→P.53)
- When the child becomes large enough to properly wear the vehicle's seat belt, follow the instructions regarding seat belt usage. (→P.29)

■ Seat belt extender

If your seat belts cannot be fastened securely because they are not long enough, a personalized seat belt extender is available from your Toyota dealer free of charge.

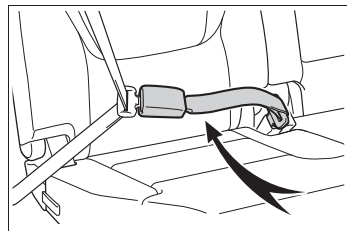

⚠ WARNING

■ Using a seat belt extender

Observe the following precautions to reduce the risk of injury in the event of sudden braking, sudden swerving or an accident. Failure to do so may cause death or serious injury.

⚠ WARNING

- Do not wear the seat belt extender if you can fasten the seat belt without the extender.
- Do not use the seat belt extender when installing a child restraint system because the belt will not securely hold the child restraint system, increasing the risk of death or serious injury in the event of an accident.
- The personalized extender may not be safe on another vehicle, when used by another person, or at a different seating position other than the one originally intended.

⚠ NOTICE

■ When using a seat belt extender

When releasing the seat belt, press on the buckle release button on the extender, not on the seat belt.

This helps prevent damage to the vehicle interior and the extender itself.

Fastening and releasing the seat belt (except for the rear center seat)

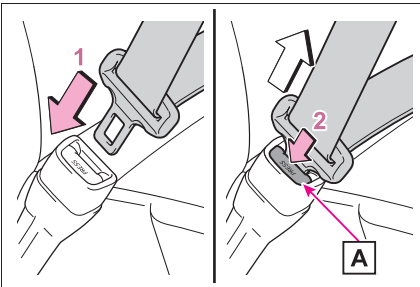

- 1 To fasten the seat belt, push

the plate into the buckle until a click sound is heard.

- 2 To release the seat belt, press the release button **A**.

If the seat belt cannot be pulled out of the retractor, firmly pull the belt and release it.

■ Emergency locking retractor (ELR)

The retractor will lock the belt during a sudden stop or on impact. It may also lock if you lean forward too quickly. A slow, easy motion will allow the belt to extend so that you can move around fully.

■ Automatic locking retractor (ALR)

When a passenger's shoulder belt is completely extended and then retracted even slightly, the belt is locked in that position and cannot be extended. This feature is used to hold the child restraint system (CRS) firmly. To free the belt again, fully retract the belt and then pull the belt out once more. (→P.53)

■ After using the seat belts on the outboard rear seats

Stow the seat belt buckles in their respective pockets.



Fastening the seat belt (for the rear center seat)

- 1 Take out the plate.

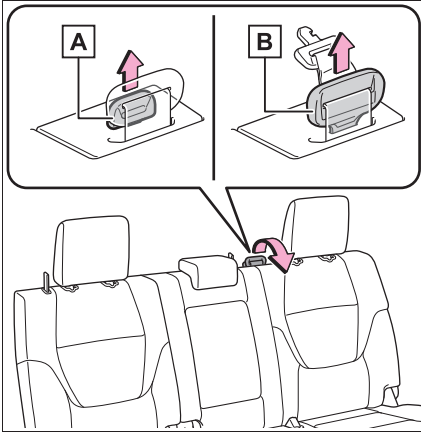

A Plate A

B Plate B

- 2 When fixing the belt, in the order of plate A and then plate B, insert the plate into the buckle until a clicking sound is heard.

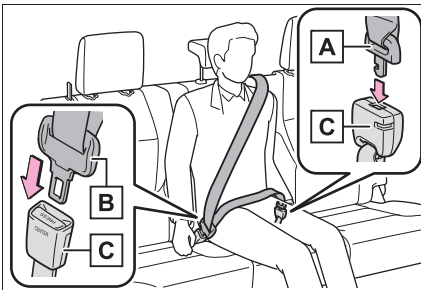

A Plate A

B Plate B

C Buckle

⚠ WARNING

- When using the rear center seat belt

Do not use the rear center seat belt with either buckle released. Fastening only one of the buckles may result in death or serious injury in case of sudden braking or a collision.

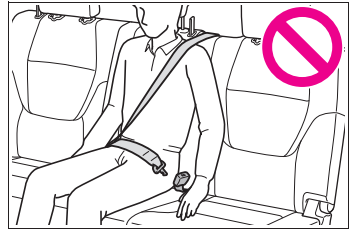

Releasing and stowing the seat belt (for the rear center seat)

- 1 To release the hooked buckle, push the buckle release button **A**.

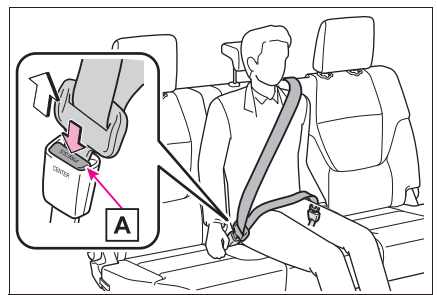

- 2** Insert the mechanical key (→P.110) or plate B into the notch of buckle and remove the belt.

Retract the belt slowly when releasing and stowing the seat belt.

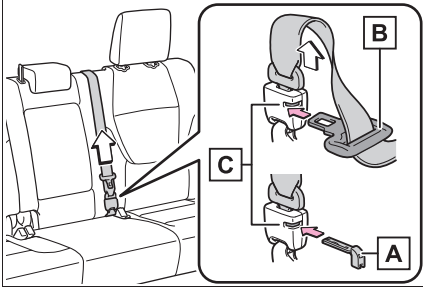

A Mechanical key

B Plate B

C Buckle

- 3** Stow in the holder in the order of plate B and then plate A.

In order to securely fix it, firmly insert it to the back.

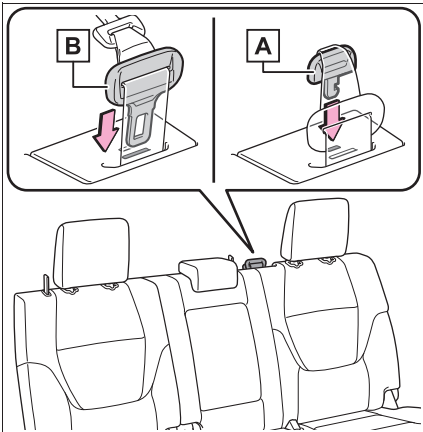

A Plate A

B Plate B

- 4** Stow the seat belt buckle in the pocket.

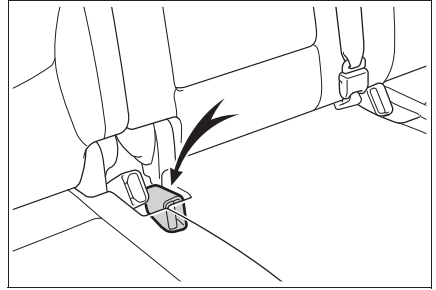

■ Emergency locking retractor (ELR)

The retractor will lock the belt during a sudden stop or on impact. It may also lock if you lean forward too quickly. A slow, easy motion will allow the belt to extend so that you can move around fully.

■ Automatic locking retractor (ALR)

When a passenger's shoulder belt is completely extended and then retracted even slightly, the belt is locked in that position and cannot be extended. This feature is used to hold the child restraint system (CRS) firmly. To free the belt again, fully retract the belt and then pull the belt out once more. (→P.53)

Adjusting the seat belt shoulder anchor height (front seats)

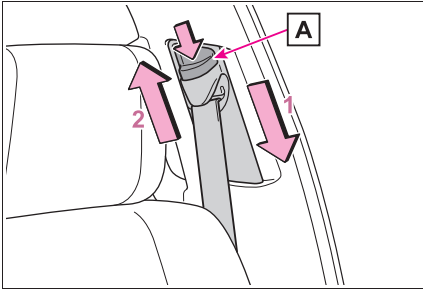

- 1 Push the seat belt shoulder anchor down while pressing the release button **A**.
- 2 Push the seat belt shoulder anchor up while pressing the release button **A**.

Move the height adjuster up and down as needed until you hear a click.

! WARNING

■ Adjustable shoulder anchor

Always make sure the shoulder belt is positioned across the center of your shoulder. The belt should be kept away from your neck, but not falling off your shoulder. Failure to do so could reduce the amount of protection in an accident and cause death or serious injuries in the event of a sudden stop, sudden swerve or accident.

Seat belt pretensioners (front and outboard rear seats)

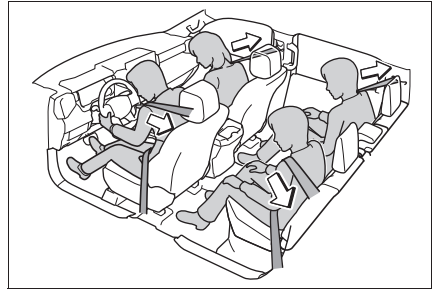

The pretensioners help the seat belts to quickly restrain the occupants by retracting the seat belts when the vehicle is subjected to certain types of severe frontal or side collision or a vehicle rollover.

The pretensioners do not activate in the event of a minor frontal impact, a minor side impact or a rear impact.

■ Replacing the belt after the pretensioner has been activated

If the vehicle is involved in multiple collisions, the pretensioner will activate for the first collision, but will not activate for the second or subsequent collisions.

■ PCS-linked seat belt pretensioner control

If the PCS (Pre-Collision System) determines that the possibility of a collision with a vehicle is high, the seat belt pretensioners will be prepared to operate.

**WARNING****■ Seat belt pretensioners**

Observe the following precautions to reduce the risk of injury in the event of sudden braking, sudden swerving or an accident.

Failure to do so may cause death or serious injury.

- Do not place anything, such as a cushion, on the front passenger's seat. Doing so will disperse the passenger's weight, which prevents the sensor from detecting the passenger's weight properly. As a result, the seat belt pretensioner for the front passenger's seat may not activate in the event of a collision.
- If the pretensioner has activated, the SRS warning light will come on. In that case, the seat belt cannot be used again and must be replaced at your Toyota dealer.

SRS airbags

The SRS airbags inflate when the vehicle is subjected to certain types of severe impacts that may cause significant injury to the occupants. They work together with the seat belts to help reduce the risk of death or serious injury.

SRS airbag system

■ Location of the SRS airbags

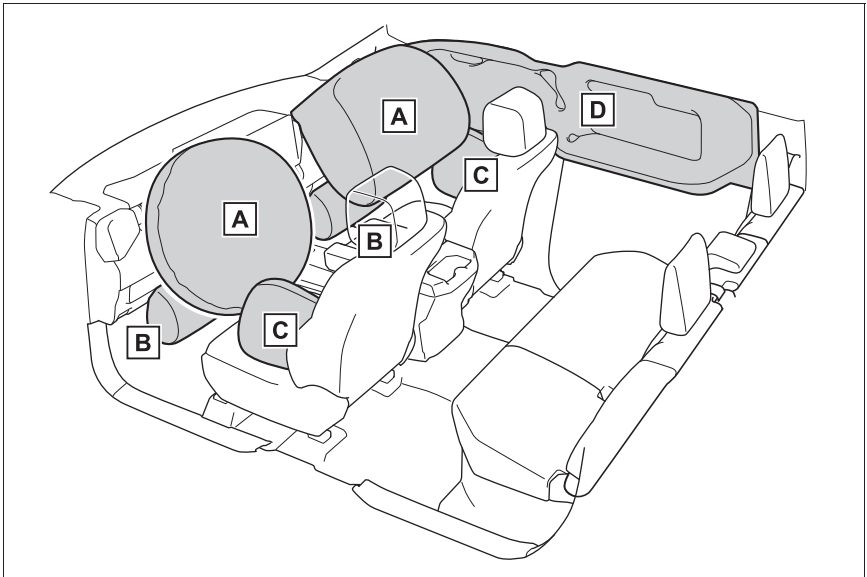

▶ SRS front airbags

A SRS driver airbag/front passenger airbag

Can help protect the head and chest of the driver and front passenger from impact with interior components

B SRS knee airbags

Can help provide driver and front passenger protection

▶ SRS side and curtain shield airbags

C SRS front side airbags

Can help protect the torso of the front seat occupants

D SRS curtain shield airbags

- Can help protect primarily the head of occupants in the outer seats
- Can help prevent the occupants from being thrown from the vehicle in the event of vehicle rollover

■ SRS airbag system components

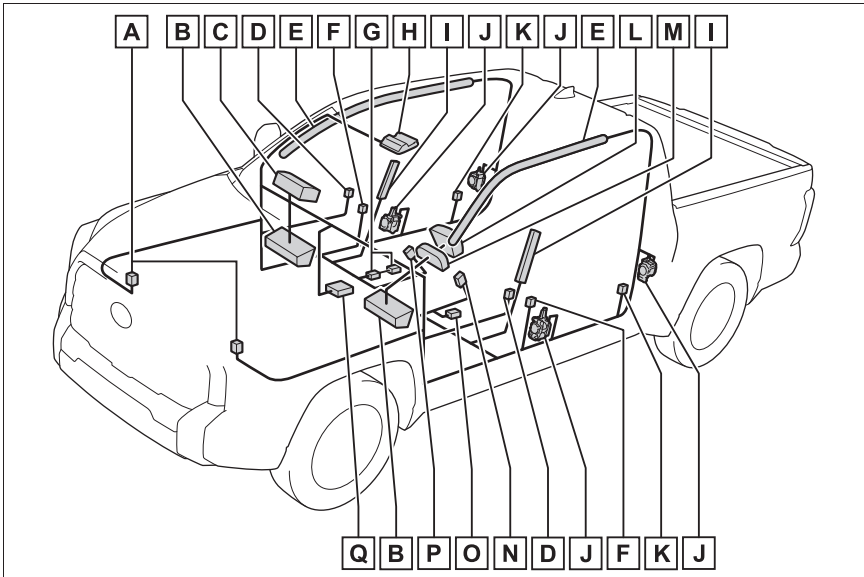

- A** Front impact sensors
- B** Knee airbags
- C** Front passenger airbag
- D** Side impact sensors (front)
- E** Curtain shield airbags
- F** Side impact sensors (front door)
- G** Front passenger occupant classification sensors
- H** “AIR BAG ON” and “AIR BAG OFF” indicator lights
- I** Side airbags
- J** Seat belt pretensioners and force limiters
- K** Side impact sensors (rear)
- L** Driver airbag
- M** SRS warning light

- N** Driver's seat belt buckle switch
- O** Driver's seat position sensor
- P** Front passenger's seat belt buckle switch
- Q** Airbag sensor assembly

Your vehicle is equipped with ADVANCED AIRBAGS designed based on the US motor vehicle safety standards (FMVSS208). The airbag sensor assembly (ECU) controls airbag deployment based on information obtained from the sensors etc. shown in the system components diagram above. This information includes crash severity and occupant information. As the airbags deploy, a chemical reaction in the inflators quickly fills the airbags with non-toxic gas to help restrain the motion of the occupants.

■ If the SRS airbags deploy (inflate)

- Slight abrasions, burns, bruising, etc., may be sustained from SRS airbags, due to the extremely high speed deployment (inflation) by hot gases.
- A loud noise and white powder will be emitted.
- Parts of the airbag module (steering wheel hub, airbag cover and inflator) as well as the front seats, parts of the front and rear pillars, and roof side rails, may be hot for several minutes. The airbag itself may also be hot.
- The windshield may crack.
- The hybrid system will be stopped and fuel supply to the engine will be stopped. (→P.80)
- All of the doors will be unlocked. (→P.114)
- The brakes and stop lights will be controlled automatically. (→P.394)
- The interior lights will turn on automatically. (→P.430)
- The emergency flashers will turn on automatically. (→P.520)
- For Safety Connect subscribers, if any of the following situations

occur, the system is designed to send an emergency call to the response center, notifying them of the vehicle's location (without needing to push the "SOS" button) and an agent will attempt to speak with the occupants to ascertain the level of emergency and assistance required. If the occupants are unable to communicate, the agent automatically treats the call as an emergency and helps to dispatch the necessary emergency services. (→P.68)

- An SRS airbag is deployed.
- A seat belt pretensioner is activated.
- The vehicle is involved in a severe rear-end collision.

■ SRS airbag deployment conditions (SRS front airbags)

- The SRS front airbags will deploy in the event of an impact that exceeds the set threshold level (the level of force corresponding to an approximately 12 - 18 mph [20 - 30 km/h] frontal collision with a fixed wall that does not move or deform).

However, this threshold velocity will be considerably higher in the following situations:

- If the vehicle strikes an object,

such as a parked vehicle or sign pole, which can move or deform on impact

- If the vehicle is involved in an underride collision, such as a collision in which the front of the vehicle underrides, or goes under, the bed of a truck
- Depending on the type of collision, it is possible that only the seat belt pretensioners and knee airbags will activate.
- The SRS front airbags for the front passenger will not activate if there is no passenger sitting in the front passenger seat. However, the SRS front airbags for the front passenger may deploy if luggage is put in the seat, even if the seat is unoccupied.

■ SRS airbag deployment conditions (SRS side and curtain shield airbags)

- The SRS side and curtain shield airbags will deploy in the event of an impact that exceeds the set threshold level (the level of force corresponding to the impact force produced by an approximately 3300 lb. [1500 kg] vehicle colliding with the vehicle cabin from a direction perpendicular to the vehicle orientation at an approximate speed of 12 - 18 mph [20 - 30 km/h]).
- Both SRS curtain shield airbags may deploy in the event of a severe side collision.
- Both SRS curtain shield airbags will deploy in the event of vehicle rollover.
- Both SRS curtain shield airbags may also deploy in the event of a severe frontal collision.

■ Conditions under which the SRS airbags may deploy (inflate), other than a collision

The SRS front airbags and SRS side and curtain shield airbags may also deploy if a serious impact

occurs to the underside of your vehicle. Some examples are shown in the illustration.

- Hitting a curb, edge of pavement or hard surface
- Falling into or jumping over a deep hole
- Landing hard or falling

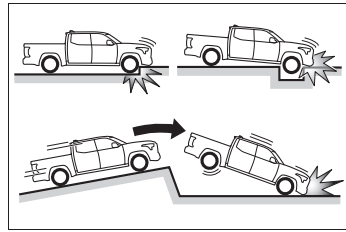

The SRS curtain shield airbags may also deploy under the situations shown in the illustration.

- The angle of vehicle tip-up is marginal.
- The vehicle skids and hits a curb stone.

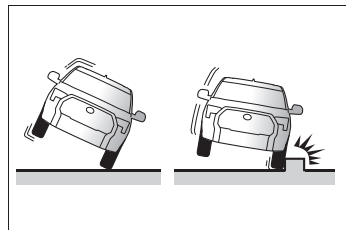

■ **Types of collisions that may not deploy the SRS airbags (SRS front airbags)**

The SRS front airbags do not generally inflate if the vehicle is involved in a side or rear collision, if it rolls over, or if it is involved in a low-speed frontal collision. But, whenever a collision of any type causes sufficient forward deceleration of the vehicle, deployment of the SRS front airbags may occur.

- Collision from the side
- Collision from the rear
- Vehicle rollover

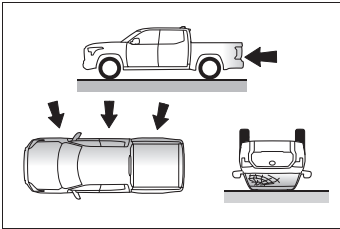

■ **Types of collisions that may not deploy the SRS airbags (SRS side and curtain shield airbags)**

The SRS side and curtain shield airbags may not activate if the vehicle is subjected to a collision from the side at certain angles, or a collision to the side of the vehicle body other than the passenger compartment.

- Collision from the side to the vehicle body other than the passenger compartment
- Collision from the side at an angle

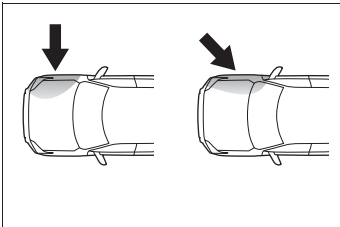

The SRS side airbags do not generally inflate if the vehicle is involved in a frontal or rear collision, if it rolls over, or if it is involved in a low-

speed side collision.

- Collision from the front
- Collision from the rear
- Vehicle rollover

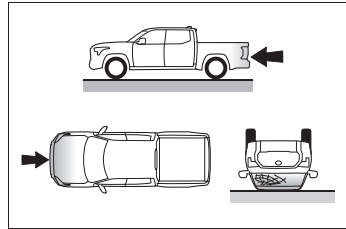

The SRS curtain shield airbags do not generally inflate if the vehicle is involved in a rear collision, if it pitches end over end, or if it is involved in a low-speed side or low-speed frontal collision.

- Collision from the rear
- Pitching end over end

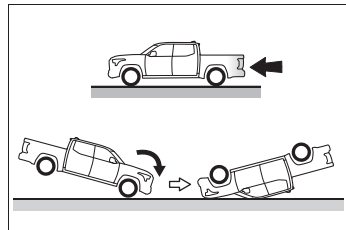

■ When to contact your Toyota dealer

In the following cases, the vehicle will require inspection and/or repair. Contact your Toyota dealer as soon as possible.

- Any of the SRS airbags have been inflated.
- The front of the vehicle is damaged or deformed, or was involved in an accident that was not severe enough to cause the SRS front airbags to inflate.

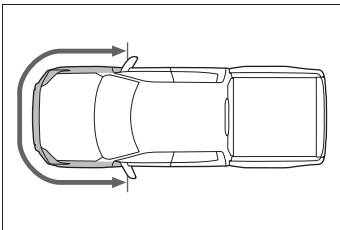

- A portion of a door or its surrounding area is damaged, deformed or has had a hole made in it, or the vehicle was involved in an accident that was not severe enough to cause the SRS side and curtain shield airbags to inflate.

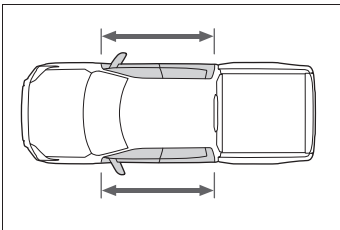

- The pad section of the steering wheel, dashboard near the front passenger airbag or lower portion of the instrument panel is scratched, cracked, or otherwise damaged.

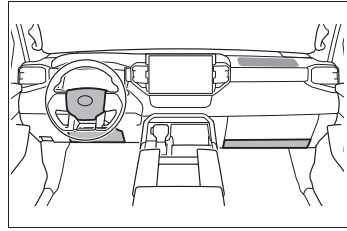

- The surface of the seats with the side airbag is scratched, cracked, or otherwise damaged.

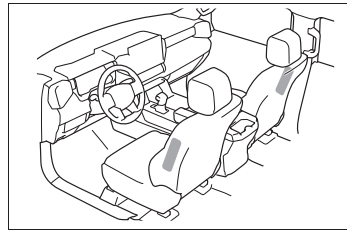

- The portion of the front pillars, rear pillars or roof side rail garnishes (padding) containing the SRS curtain shield airbags inside, is scratched, cracked, or otherwise damaged.

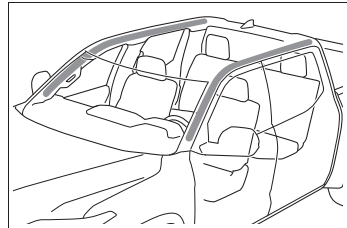

⚠ WARNING

■ SRS airbag precautions

Observe the following precautions regarding the SRS airbags. Failure to do so may cause death or serious injury.

- The driver and all passengers in the vehicle must wear their seat belts properly. The SRS airbags are supplemental devices to be used with the seat belts.

⚠ WARNING

- The SRS driver airbag deploys with considerable force, and can cause death or serious injury especially if the driver is very close to the airbag.

The National Highway Traffic Safety Administration (NHTSA) advises: Since the risk zone for the driver's airbag is the first 2 - 3 in. (50 - 75 mm) of inflation, placing yourself 10 in. (250 mm) from your driver airbag provides you with a clear margin of safety. This distance is measured from the center of the steering wheel to your breastbone. If you sit less than 10 in. (250 mm) away now, you can change your driving position in several ways:

- Move your seat to the rear as far as you can while still reaching the pedals comfortably.
- Slightly recline the back of the seat. Although vehicle designs vary, many drivers can achieve the 10 in. (250 mm) distance, even with the driver seat all the way forward, simply by reclining the back of the seat somewhat. If reclining the back of your seat makes it hard to see the road, raise yourself by using a firm, non-slippery cushion, or raise the seat if your vehicle has that feature.
- If your steering wheel is adjustable, tilt it downward. This points the airbag toward your chest instead of your head and neck.

The seat should be adjusted as recommended by NHTSA above, while still maintaining control of the foot pedals, steering wheel, and your view of the instrument panel controls.

- If the seat belt extender has been connected to the front seat belt buckles but the seat belt extender has not also been fastened to the latch plate of the seat belt, the SRS front airbags will judge that the driver and front passenger are wearing the seat belt even though the seat belt has not been connected. In this case, the SRS front airbags may not activate correctly in a collision, resulting in death or serious injury in the event of a collision. Be sure to wear the seat belt with the seat belt extender.

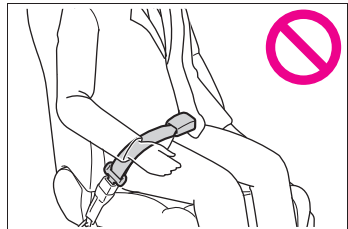

- The SRS front passenger airbag also deploys with considerable force, and can cause death or serious injury especially if the front passenger is very close to the airbag. The front passenger seat should be as far from the airbag as possible with the seatback adjusted, so the front passenger sits upright.

⚠ WARNING

- Improperly seated and/or restrained infants and children can be killed or seriously injured by a deploying airbag. An infant or child who is too small to use a seat belt should be properly secured using a child restraint system. Toyota strongly recommends that all infants and children be placed in the rear seats of the vehicle and properly restrained. The rear seats are safer for infants and children than the front passenger seat. (→P.53)
- Do not sit on the edge of the seat or lean against the dashboard.

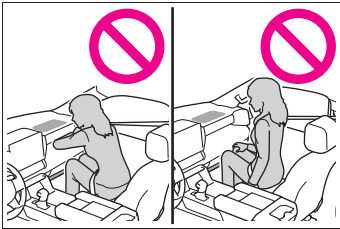

- Do not allow a child to stand in front of the SRS front passenger airbag unit or sit on the knees of a front passenger.

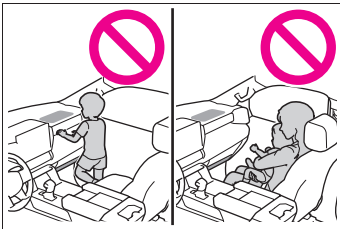

- Do not allow the front seat occupants to hold items on their knees.

- Do not lean against the door, the roof side rail or the front, side and rear pillars.



- Do not allow anyone to kneel on the passenger seats toward the door or put their head or hands outside the vehicle.

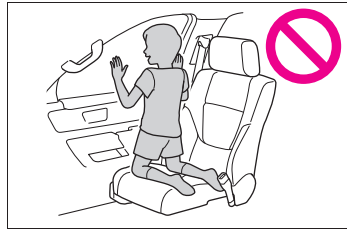

- Do not attach anything to or lean anything against areas such as the dashboard, steering wheel pad and lower portion of the instrument panel. These items can become projectiles when the SRS driver, front passenger and knee airbags deploy.

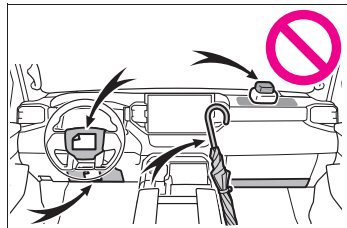

! WARNING

- Do not attach anything to areas such as a door, windshield, side windows, front or rear pillar, roof side rail and assist grip.

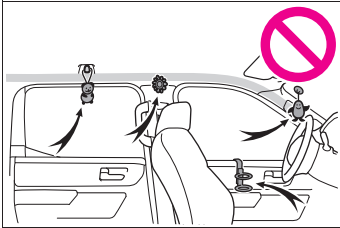

- Do not hang coat hangers or hard objects on the coat hooks. All of these items could become projectiles and may cause death or serious injury, should the SRS curtain shield airbags deploy.
- If a vinyl cover is put on the area where the SRS knee airbag will deploy, be sure to remove it.
- Do not use seat accessories which cover the parts where the SRS side airbags inflate as they may interfere with inflation of the SRS airbags. Such accessories may prevent the SRS side airbags from activating correctly, disable the system or cause the SRS side airbags to inflate accidentally, resulting in death or serious injury.
- Do not strike or apply significant levels of force to the area of the SRS airbag components or the front doors. Doing so can cause the SRS airbags to malfunction.
- Do not touch any of the component parts immediately after the SRS airbags have deployed (inflated) as they may be hot.

- If breathing becomes difficult after the SRS airbags have deployed, open a door or window to allow fresh air in, or leave the vehicle if it is safe to do so. Wash off any residue as soon as possible to prevent skin irritation.

- If the areas where the SRS airbags are stored, such as the steering wheel pad and front and rear pillar garnishes are damaged or cracked, have them replaced by your Toyota dealer.

- Do not place anything, such as a cushion, on the front passenger's seat. Doing so will disperse the passenger's weight, which prevents the sensor from detecting the passenger's weight properly. As a result, the SRS front airbags for the front passenger may not deploy in the event of a collision.

■ Modification and disposal of SRS airbag system components

Do not dispose of your vehicle or perform any of the following modifications without consulting your Toyota dealer. The SRS airbags may malfunction or deploy (inflate) accidentally, causing death or serious injury.

- Installation, removal, disassembly and repair of the SRS airbags
- Repairs, modifications, removal or replacement of the steering wheel, instrument panel, dashboard, seats or seat upholstery, front, side and rear pillars, roof side rails, front door panels, front door trims or front door speakers

**WARNING**

- Modifications to the front door panel (such as making a hole in it)
- Repairs or modifications of the front fender, front bumper, or side of the occupant compartment
- Installation of a grille guard (bull bars, kangaroo bar, etc.), snow plows, winches or roof luggage carrier
- Modifications to the vehicle's suspension system
- Installation of electronic devices such as mobile two-way radios and CD players
- Modifications to your vehicle for a person with a physical disability

Front passenger occupant classification system

Your vehicle is equipped with a front passenger occupant classification system. This system detects the conditions of the front passenger seat and activates or deactivates the front passenger airbag and front passenger knee airbag.

System components

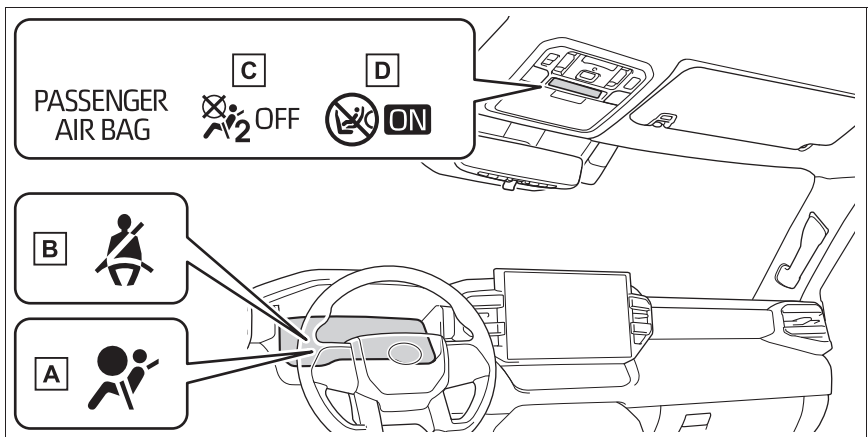

- A** SRS warning light
- B** Driver's and front passenger's seat belt reminder light
- C** "AIR BAG OFF" indicator light
- D** "AIR BAG ON" indicator light

**WARNING****■ Front passenger occupant classification system precautions**

Observe the following precautions regarding the front passenger occupant classification system. Failure to do so may cause death or serious injury.

- Wear the seat belt properly.
- Make sure the front passenger's seat belt plate has not been left inserted into the buckle before someone sits in the front passenger seat.
- Make sure the "AIR BAG OFF" indicator light is not illuminated when using the seat belt extender for the front passenger seat. If the "AIR BAG OFF" indicator light is illuminated, disconnect the extender tongue from the seat belt buckle, and reconnect the seat belt. Reconnect the seat belt extender after making sure the "AIR BAG ON" indicator light is illuminated. If you use the seat belt extender while the "AIR BAG OFF" indicator light is illuminated, the SRS airbags for the front passenger will not activate, which could cause death or serious injury in the event of a collision.
- Do not apply a heavy load to the front passenger seat or equipment (e.g. seatback pocket).
- Do not put weight on the front passenger seat by putting your hands or feet on the front passenger seat seatback from the rear passenger seat.
- Do not let a rear passenger lift the front passenger seat with their feet or press on the seatback with their legs.

- Do not put objects under the front passenger seat.
- Do not recline the front passenger seatback so far that it touches a rear seat. This may cause the "AIR BAG OFF" indicator light to be illuminated, which indicates that the SRS airbags for the front passenger will not activate in the event of a severe accident. If the seatback touches the rear seat, return the seatback to a position where it does not touch the rear seat. Keep the front passenger seatback as upright as possible when the vehicle is moving. Reclining the seatback excessively may lessen the effectiveness of the seat belt system.
- If an adult sits in the front passenger seat, the "AIR BAG ON" indicator light is illuminated. If the "AIR BAG OFF" indicator is illuminated, ask the passenger to sit up straight, well back in the seat, feet on the floor, and with the seat belt worn correctly. If the "AIR BAG OFF" indicator still remains illuminated, either ask the passenger to move to the rear seat, or if that is not possible, move the front passenger seat fully rearward.
- When it is unavoidable to install a forward-facing child restraint system on the front passenger seat, install the child restraint system on the front passenger seat in the proper order. (→P.55)
- Do not modify or remove the front seats.

**WARNING**

- Do not kick the front passenger seat or subject it to severe impact. Otherwise, the SRS warning light may come on to indicate a malfunction of the front passenger occupant classification system. In this case, contact your Toyota dealer immediately.
- Child restraint systems installed on the rear seat should not contact the front seatbacks.
- Do not use a seat accessory, such as a cushion and seat cover, that covers the seat cushion surface.
- Do not modify or replace the upholstery of the front seat.

Condition and operation in the front passenger occupant classification system

■ Adult*1

Indicators/warning lights	“AIR BAG ON” and “AIR BAG OFF” indicator lights	“AIR BAG ON”
	SRS warning light	Off
	Driver’s and front passenger’s seat belt reminder light	Off*2 or flashing*3
Devices	Front passenger airbag	Activated
	Front passenger knee airbag	

■ Child*⁴

Indicators/warning lights	“AIR BAG ON” and “AIR BAG OFF” indicator lights	“AIR BAG OFF” or “AIR BAG ON” ^{*4}
	SRS warning light	Off
	Driver’s and front passenger’s seat belt reminder light	Off ^{*2} or flashing ^{*3}
Devices	Front passenger airbag	Deactivated or activated ^{*4}
	Front passenger knee airbag	

■ Child restraint system with infant*⁵

Indicators/warning lights	“AIR BAG ON” and “AIR BAG OFF” indicator lights	“AIR BAG OFF” ^{*6}
	SRS warning light	Off
	Driver’s and front passenger’s seat belt reminder light	Off ^{*2} or flashing ^{*3}
Devices	Front passenger airbag	Deactivated
	Front passenger knee airbag	

■ Unoccupied

Indicators/warning lights	“AIR BAG ON” and “AIR BAG OFF” indicator lights	“AIR BAG OFF”
	SRS warning light	Off
	Driver’s and front passenger’s seat belt reminder light	
Devices	Front passenger airbag	Deactivated
	Front passenger knee airbag	

■ There is a malfunction in the system

Indicators/warning lights	“AIR BAG ON” and “AIR BAG OFF” indicator lights	“AIR BAG OFF”
	SRS warning light	On
	Driver’s and front passenger’s seat belt reminder light	
Devices	Front passenger airbag	Deactivated
	Front passenger knee airbag	

*1: The system judges a person of adult size as an adult. When a smaller adult sits in the front passenger seat, the system may not recognize him/her as an adult depending on his/her physique and posture.

*2: In the event the front passenger is wearing a seat belt

*3: In the event the front passenger does not wear a seat belt

*4: For some children, child in seat, child in booster seat or child in convertible seat, the system may not recognize him/her as a child. Factors which may affect this can be the physique or posture.

*5: Never install a rear-facing child restraint system on the front passenger seat. A forward-facing child restraint system should only be installed on the front passenger seat when it is unavoidable. (→P.53)

*6: In case the indicator light is not illuminated, consult this manual on how to install the child restraint system properly. (→P.55)

Exhaust gas precautions

Harmful substance to the human body is included in exhaust gases if inhaled.



WARNING

Exhaust gases contain harmful carbon monoxide (CO), which is colorless and odorless. Observe the following precautions. Failure to do so may cause exhaust gases to enter the vehicle and may lead to an accident caused by light-headedness, or may lead to death or a serious health hazard.

■ Important points while driving

- Keep the back window closed.
- If you smell exhaust gases in the vehicle even when the back window is closed, open the windows and have the vehicle inspected at your Toyota dealer as soon as possible.

■ When parking

- If the vehicle is in a poorly ventilated area or a closed area, such as a garage, stop the hybrid system.
- Do not leave the vehicle with the hybrid system operating for a long time. If such a situation cannot be avoided, park the vehicle in an open space and ensure that exhaust fumes do not enter the vehicle interior.

- Do not leave the hybrid system operating in an area with snow build-up, or where it is snowing. If snowbanks build up around the vehicle while the hybrid system operating, exhaust gases may collect and enter the vehicle.

■ Exhaust pipe

The exhaust system needs to be checked periodically. If there is a hole or crack caused by corrosion, damage to a joint or abnormal exhaust noise, be sure to have the vehicle inspected and repaired by your Toyota dealer.

Riding with children

Observe the following precautions when children are in the vehicle.

Use a child restraint system appropriate for the child, until the child becomes large enough to properly wear the vehicle's seat belt.

- It is recommended that children sit in the rear seats to avoid accidental contact with the shift lever, wiper switch, etc.
- Use the rear door child-protector lock or the window lock switch to avoid children opening the door while driving or operating the power window accidentally.
(→P.116, 171)
- Do not let small children operate equipment which may catch or pinch body parts, such as the power window, hood, tailgate, seats, etc.



WARNING

■ When children are in the vehicle

Never leave children unattended in the vehicle, and never allow children to have or use the key.

Children may be able to start the vehicle or shift the vehicle into neutral. There is also a danger that children may injure themselves by playing with the windows or other features of the vehicle. In addition, heat build-up or extremely cold temperatures inside the vehicle can be fatal to children.

Child restraint systems

Before installing a child restraint system in the vehicle, there are precautions that need to be observed, different types of child restraint systems, as well as installation methods, etc., written in this manual.

Use a child restraint system when riding with a small child that cannot properly use a seat belt. For the child's safety, install the child restraint system to a rear seat. Be sure to follow the installation method that is in the operation manual enclosed with the restraint system.

Table of contents

Points to remember: P.53

Child restraint system: P.55

When using a child restraint system: P.56

Child restraint system installation method

- Using an anchor bracket (for top tether strap): P.58
- Fixed with a child restraint LATCH anchor: P.60
- Fixed with a seat belt: P.63

Points to remember

The laws of all 50 states of the U.S.A. as well as Canada now require the use of child restraint systems.

- Prioritize and observe the warnings, as well as the laws and regulations for child restraint systems.
- Use a child restraint system until the child becomes large enough to properly wear the vehicle's seat belt.
- Choose a child restraint system that suits your vehicle and is appropriate to the age and size of the child.

WARNING

■ When a child is riding

Observe the following precautions.

Failure to do so may result in death or serious injury.

- For effective protection in automobile accidents and sudden stops, a child must be properly restrained, using a seat belt or child restraint system which is correctly installed. For installation details, refer to the operation manual enclosed with the child restraint system. General installation instruction is provided in this manual.

**WARNING**

- Toyota strongly urges the use of a proper child restraint system that conforms to the weight and size of the child, installed on the rear seat. According to accident statistics, the child is safer when properly restrained in the rear seat than in the front seat.
- Holding a child in your or someone else's arms is not a substitute for a child restraint system. In an accident, the child can be crushed against the windshield or between the holder and the interior of the vehicle.

■ Handling the child restraint system

If the child restraint system is not properly fixed in place, the child or other passengers may be seriously injured or even killed in the event of sudden braking, sudden swerving, or an accident.

- If the vehicle were to receive a strong impact from an accident, etc., it is possible that the child restraint system has damage that is not readily visible. In such cases, do not reuse the restraint system.
- Make sure you have complied with all installation instructions provided with the child restraint system manufacturer and that the system is properly secured.
- Keep the child restraint system properly secured on the seat even if it is not in use. Do not store the child restraint system unsecured in the passenger compartment.
- If it is necessary to detach the child restraint system, remove it from the vehicle.

Child restraint system

■ Types of child restraint system installation methods

Confirm with the operation manual enclosed with the child restraint system about the installation of the child restraint system.

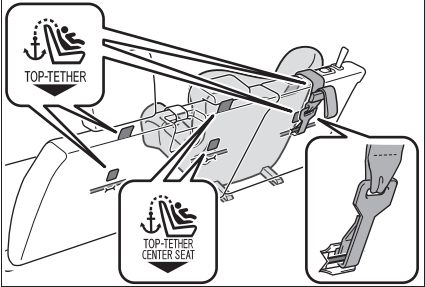
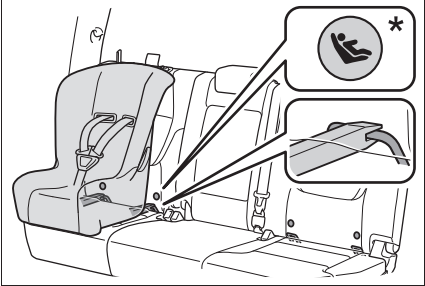
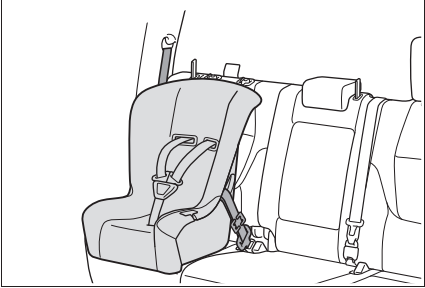
Installation method	Page
<p>Anchor brackets (for top tether strap) attachment</p>	 <p>P.58</p>
<p>Child restraint LATCH anchors attachment</p>	 <p>P.60</p>
<p>Seat belt attachment</p>	 <p>P.63</p>

*: If equipped

When using a child restraint system

■ When installing a child restraint system to a front passenger seat

For the safety of a child, install child restraint systems to a rear seats. When installing child restraint system to a front passenger seat is unavoidable, adjust the seat as follows and install the child restraint system.

- Move the front seat fully rearward.
- Adjust the seatback angle to the most upright position.

When installing a forward-facing child seat, if there is a gap between the child seat and the seatback, adjust the seatback angle until good contact is achieved.

- If the head restraint interferes with the child restraint system installation and the head restraint can be removed, remove the head restraint. Otherwise, put the head restraint in the upper most position.

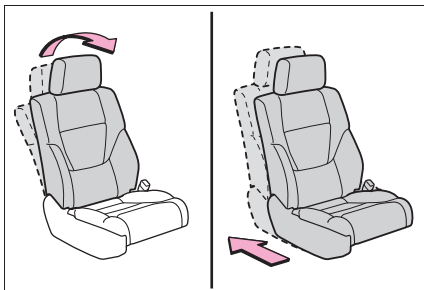

⚠ WARNING

■ When using a child restraint system

Observe the following precautions.

Failure to do so may result in death or serious injury.

- Never install a rear-facing child restraint system on the front passenger seat even if the "AIR BAG OFF" indicator light is illuminated. In the event of an accident, the force of the rapid inflation of the front passenger airbag can cause death or serious injury to the child if the rear-facing child restraint system is installed on the front passenger seat.
- A forward-facing child restraint system may be installed on the front passenger seat only when it is unavoidable. A child restraint system that requires a top tether strap should not be used in the front passenger seat since there is no top tether strap anchor for the front passenger seat.

⚠ WARNING

- A forward-facing child restraint system may be installed on the front passenger seat only when it is unavoidable. When installing a forward-facing child restraint system on the front passenger seat, adjust the seatback angle to the most upright position, move the seat to the rearmost position, and raise the seat to the upper most position, even if the "AIR BAG OFF" indicator light is illuminated.

If the head restraint interferes with the child restraint system installation and the head restraint can be removed, remove the head restraint. If the head restraint cannot be removed, raise it to the uppermost position.

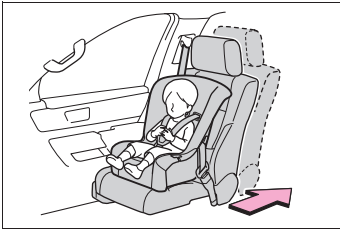

- Do not allow the child to lean his/her head or any part of his/her body against the door or the area of the seat, front or rear pillars, or roof side rails from which the SRS side airbags or SRS curtain shield airbags deploy even if the child is seated in the child restraint system. It is dangerous if the SRS side and curtain shield airbags inflate, and the impact could cause death or serious injury to the child.

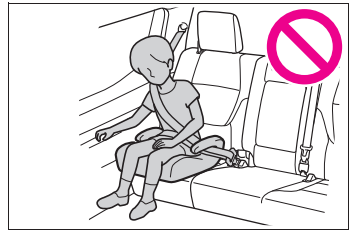

- When a booster seat is installed, always ensure that the shoulder belt is positioned across the center of the child's shoulder. The belt should be kept away from the child's neck, but not so that it could fall off the child's shoulder.
- Use child restraint system suitable to the age and size of the child and install it to the rear seat.
- If the driver's seat interferes with the child restraint system and prevents it from being attached correctly, attach the child restraint system to the right-hand rear seat.

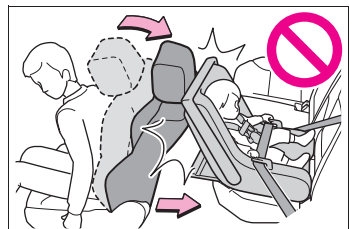

⚠ WARNING

- Adjust the front passenger seat so that it does not interfere with the child restraint system.

Using an anchor bracket (for top tether strap)

■ Anchor brackets (for top tether strap)

Anchor brackets are provided for each rear seat.

Use anchor brackets when fixing the top tether strap.

▶ Outboard rear seats

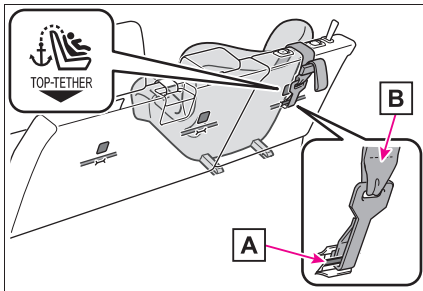

A Anchor brackets

B Top tether strap

▶ Rear center seat

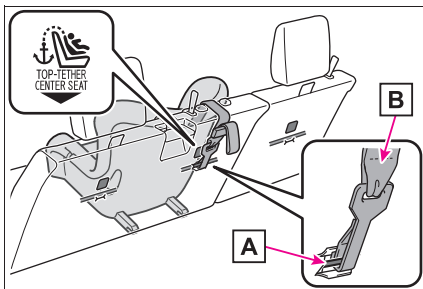

A Anchor bracket

B Top tether strap

■ Fixing the top tether strap to the anchor bracket

Install the child restraint system in accordance to the operation manual enclosed with the child restraint system.

▶ Outboard rear seats

- 1 Remove the head restraint. (→P.149)

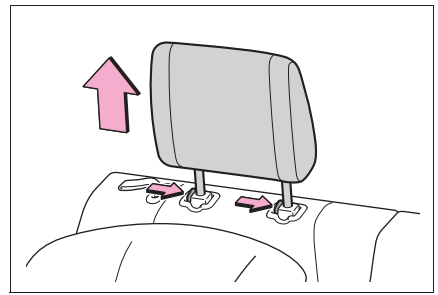

- 2 Place the child restraint system on the seat facing the front of the vehicle.
- 3 Latch the hook onto the anchor bracket.

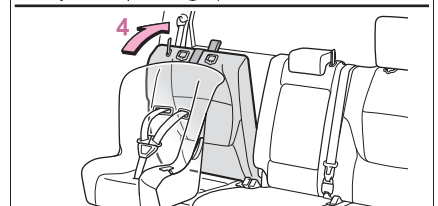
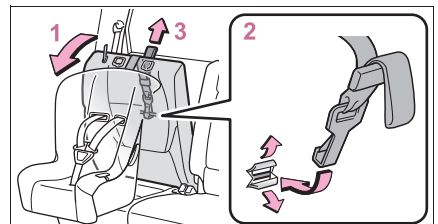

- 1 Swing the seatback forward slightly. (→P.141)
- 2 Latch the hook onto the

anchor bracket.

- 3 Fix the top tether strap so that there is no slack.
- 4 Return the seatback.
- 4 Secure the child restraint system using the seat belt (→P.64) or the lower anchors (→P.60), and then tighten the top tether strap.

Make sure the top tether strap is securely latched.

- 5 If the head restraint does not interfere with the child restraint system installation, install the head restraint.

- 2 Place the child restraint system on the seat facing the front of the vehicle.
- 3 Latch the hook onto the anchor bracket.

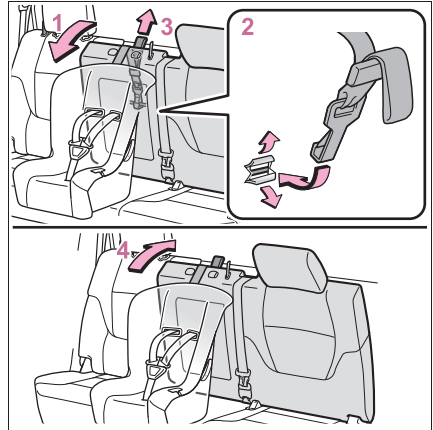

- 1 Swing the seatback forward slightly. (→P.141)
- 2 Latch the hook onto the anchor bracket.
- 3 Fix the top tether strap so that there is no slack.
- 4 Return the seatback.
- 4 Secure the child restraint system using the seat belt (→P.64) or the lower anchors (→P.60), and then tighten the top tether strap.

Make sure the top tether strap is securely latched.

When installing the child restraint system with the head restraint being raised, be sure to have the top tether strap pass underneath the head restraint.

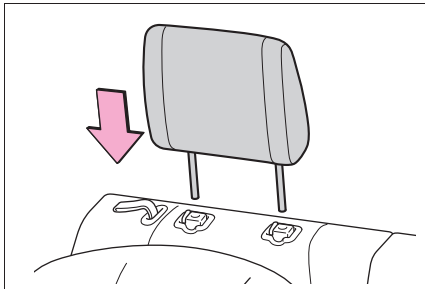

► Rear center seat

- 1 Adjust the head restraint to the upmost position.

If the head restraint interferes with the child restraint system installation and the head restraint can be removed, remove the head restraint. (→P.149)

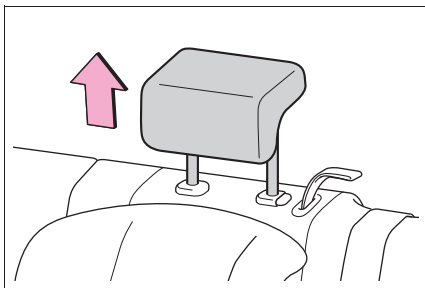

- 5 If the head restraint does not interfere with the child restraint system installation, install the head restraint.

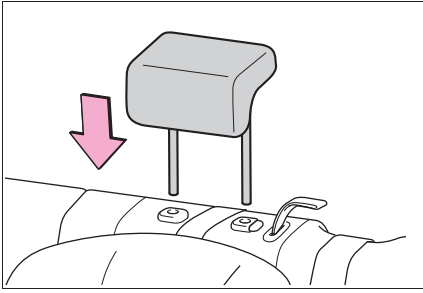

■ Laws and regulations pertaining to anchors

The LATCH system conforms to FMVSS225 or CMVSS210.2. Child restraint systems conforming to FMVSS213 or CMVSS213 specifications can be used. This vehicle is designed to conform to SAE J1819.

⚠ WARNING

■ When installing a child restraint system

Observe the following precautions.

Failure to do so may result in death or serious injury.

- Firmly attach the top tether strap and make sure that the belt is not twisted.
- Do not attach the top tether strap to anything other than the anchor bracket.
- Follow all installation instructions provided by the child restraint system manufacturer.

- Rear center seat: When installing the child restraint system with the head restraint being raised, after the head restraint has been raised and then the anchor bracket has been fixed, do not lower the head restraint.
- If the seat is adjusted, reconfirm the security of the child restraint system.

Child restraint system fixed with a child restraint LATCH anchor

■ Child restraint LATCH anchors

LATCH anchors are provided for the outboard rear seat.

(Buttons displaying the location of the anchors are attached to the seats.) [If equipped]

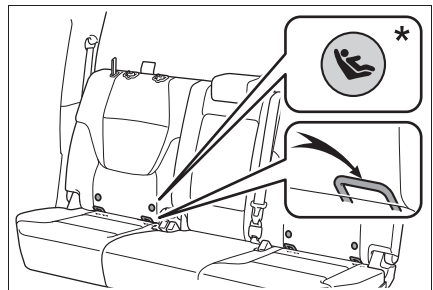

* : If equipped

■ When installing in the rear outboard seats

Install the child restraint system in accordance to the operation manual enclosed with the child restraint system.

If the child restraint has a top tether strap, install the top tether strap before installing the child

restraint system, and then install the child restraint system.

(→P.58)

- 1 If the head restraint interferes with the child restraint system installation and the head restraint can be removed, remove the head restraint. (→P.149)

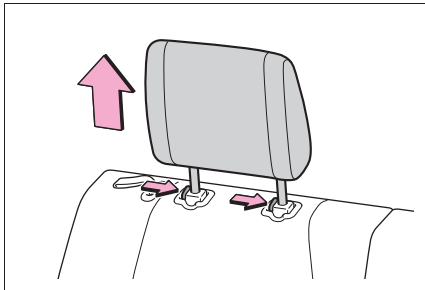

- 2 Widen the gap between the seat cushion and seatback slightly.

- ▶ With flexible lower attachments

- 3 Latch the hooks of the lower attachments onto the LATCH anchors.

For owners in Canada:

The symbol on a child restraint system indicates **A** the presence of a lower connector system.

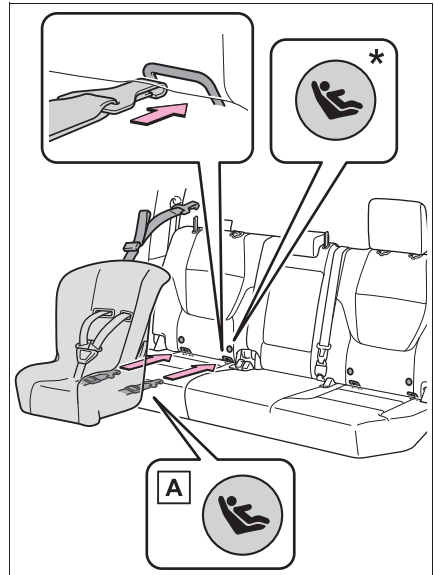

A Canada only

*: If equipped

▶ With rigid lower attachments

3 Latch the buckles onto the LATCH anchors.

For owners in Canada:

The symbol on a child restraint system indicates **A** the presence of a lower connector system.

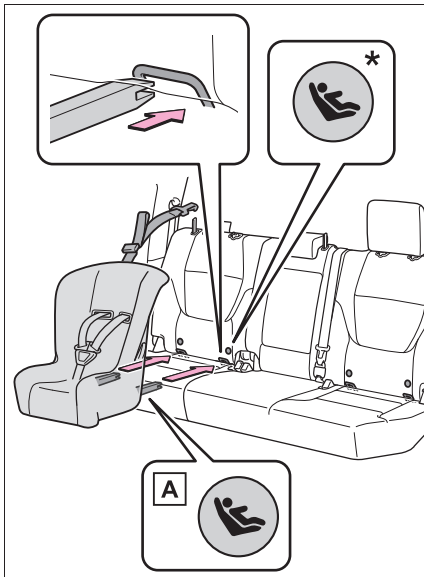

A Canada only

*: If equipped

4 If the child restraint has a top tether strap, tighten the top tether strap. (→P.58)

5 After installing the child restraint system, rock it back and forth to ensure that it is installed securely. (→P.66)

■ Laws and regulations pertaining to anchors

The LATCH system conforms to

FMVSS225 or CMVSS210.2.

Child restraint systems conforming to FMVSS213 or CMVSS213 specifications can be used.

This vehicle is designed to conform to SAE J1819.

⚠ WARNING

■ When installing a child restraint system

Observe the following precautions.

Failure to do so may result in death or serious injury.

- When using the LATCH anchors, be sure that there are no foreign objects around the anchors and that the seat belt is not caught behind the child restraint system.
- Follow all installation instructions provided by the child restraint system manufacturer.
- Child restraint systems cannot be installed in the rear center seat. Do not install the child restraint system in the rear center seat using the LATCH anchors.
- When securing some types of child restraint systems in rear seats, it may not be possible to properly use the seat belts in positions next to the child restraint without interfering with it or affecting seat belt effectiveness. Be sure your seat belt fits snugly across your shoulder and low on your hips. If it does not, or if it interferes with the child restraint, move to a different position. Failure to do so may result in death or serious injury.
- If the seat is adjusted, reconfirm the security of the child restraint system.

Child restraint system fixed with a seat belt

A child restraint system for a small child or baby must itself be properly restrained on the seat with the lap portion of the lap/shoulder belt.

■ Installing child restraint system using a seat belt (child restraint lock function belt)

Install the child restraint system in accordance to the operation manual enclosed with the child restraint system.

■ Rear-facing — Infant seat/convertible seat

- 1 Place the child restraint system on the rear seat facing the rear of the vehicle.

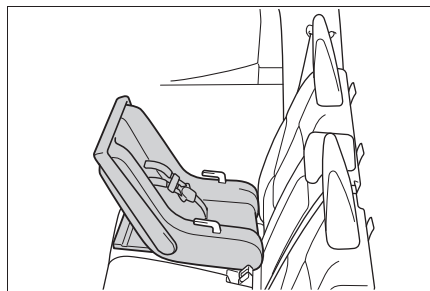

- 2 Run the seat belt through the child restraint system and insert the plate into the buckle. Make sure that the belt is not twisted.

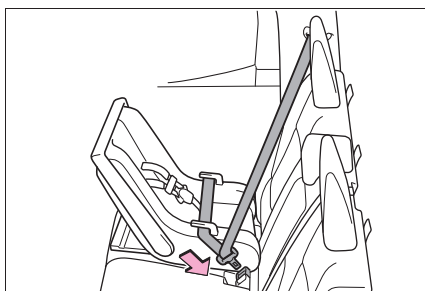

- 3 Fully extend the shoulder belt and allow it to retract to put it in lock mode. In lock mode, the belt cannot be extended.

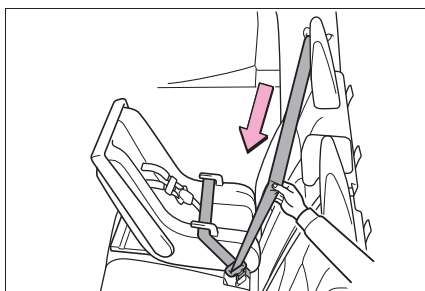

- 4 While pushing the child restraint system down into the rear seat, allow the shoulder belt to retract until the child restraint system is securely in place.

After the shoulder belt has retracted to a point where there is no slack in the belt, pull the belt to check that it cannot be extended.

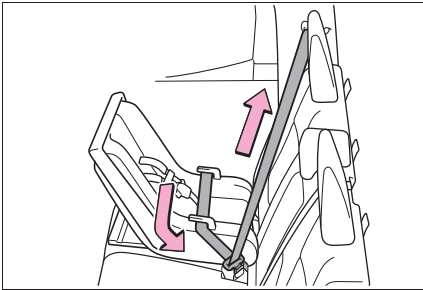

- 5 After installing the child restraint system, rock it back and forth to ensure that it is installed securely. (→P.66)

■ Forward-facing — Convertible seat

Before installing the child restraint to the rear seat:

If the child restraint has a top tether strap, install the top tether strap, and then install the child restraint system. (→P.58) Also, follow the child restraint manufacturer's operation manual regarding the installation.

1 Adjust the seat

When using the front passenger seat: If installing the child restraint system to the front passenger seat is unavoidable, refer to P.56 for front passenger seat adjustment.

- 2 If the head restraint interferes with the child restraint system installation and the head restraint can be removed, remove the head restraint. (→P.149)

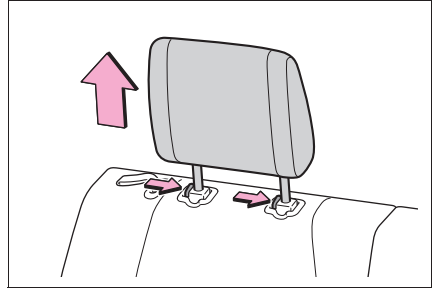

- 3 Place the child restraint system on the seat facing the front of the vehicle.

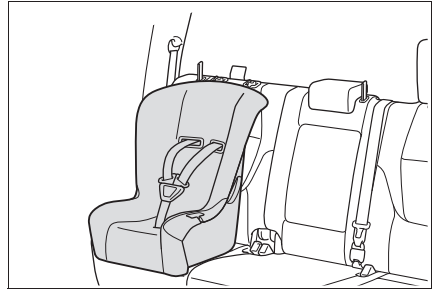

- 4 Run the seat belt through the child restraint system and insert the plate into the buckle. Make sure that the belt is not twisted.

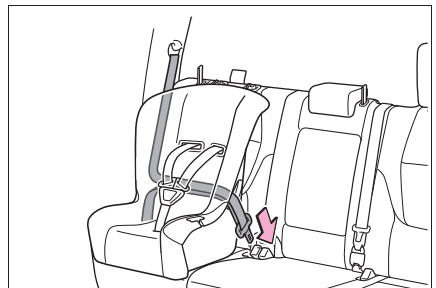

- 5** Fully extend the shoulder belt and allow it to retract to put it in lock mode. In lock mode, the belt cannot be extended.

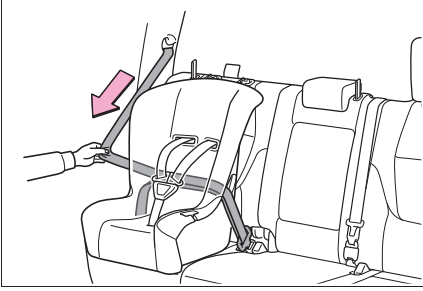

- 6** While pushing the child restraint system into the rear seat, allow the shoulder belt to retract until the child restraint system is securely in place.

After the shoulder belt has retracted to a point where there is no slack in the belt, pull the belt to check that it cannot be extended.

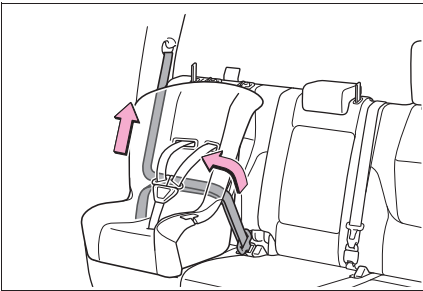

- 7** If the child restraint has a top tether strap, tighten the top tether strap. (→P.58)
- 8** After installing the child restraint system, rock it back and forth to ensure that it is installed securely. (→P.66)

■ Booster seat

- 1** If installing the child restraint system to the front passenger seat is unavoidable, refer to P.56 for front passenger seat adjustment.
- 2** High back type: If the head restraint interferes with your child restraint system, and the head restraint can be removed, remove the head restraint. (→P.149)

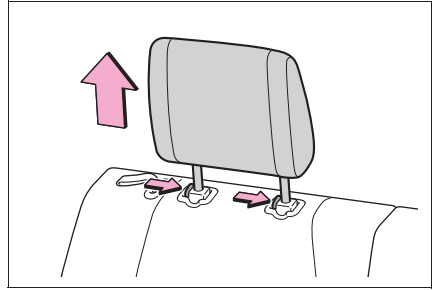

- 3** Place the child restraint system on the seat facing the front of the vehicle.

▶ Booster type

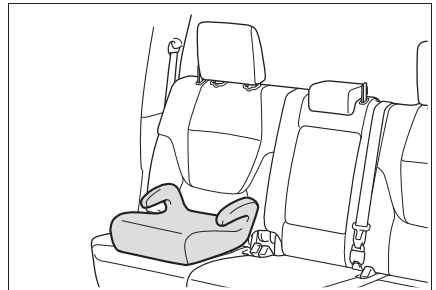

▶ High back type

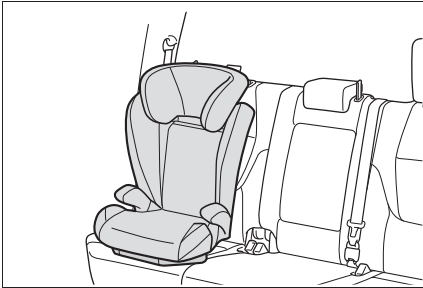

- 4 Sit the child in the child restraint system. Fit the seat belt to the child restraint system according to the manufacturer's instructions and insert the plate into the buckle. Make sure that the belt is not twisted.

Check that the shoulder belt is correctly positioned over the child's shoulder and that the lap belt is as low as possible. (→P.29)



■ Removing a child restraint system installed with a seat belt

Press the buckle release button and fully retract the seat belt.

When releasing the buckle, the child restraint system may spring up due to the rebound of the seat cushion. Release the buckle while holding down the child restraint

system.

Since the seat belt automatically reels itself, slowly return it to the stowing position.

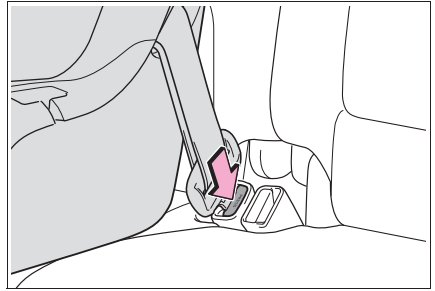

⚠ WARNING

■ When installing a child restraint system

Observe the following precautions.

Failure to do so may result in death or serious injury.

- Do not allow children to play with the seat belt. If the seat belt becomes twisted around a child's neck, it may lead to choking or other serious injuries that could result in death. If this occurs and the buckle cannot be unfastened, scissors should be used to cut the belt.
- Ensure that the belt and plate are securely locked and the seat belt is not twisted.
- Shake the child restraint system left and right, and forward and backward to ensure that it has been securely installed.
- When a booster seat is installed, always ensure that the shoulder belt is positioned across the center of the child's shoulder. The belt should be kept away from the child's neck, but not so that it could fall off the child's shoulder.

**WARNING**

- Follow all installation instructions provided by the child restraint system manufacturer.
- When securing some types of child restraint systems in rear seats, it may not be possible to properly use the seat belts in positions next to the child restraint without interfering with it or affecting seat belt effectiveness. Be sure your seat belt fits snugly across your shoulder and low on your hips. If it does not, or if it interferes with the child restraint, move to a different position. Failure to do so may result in death or serious injury.
- When installing a child restraint system in the rear center seat, adjust both seat cushions to the same position and align both seatbacks at the same angle. Otherwise, the child restraint system cannot be securely restrained and this may cause death or serious injuries in the event of sudden braking, sudden swerving or an accident.
- If the seat is adjusted, reconfirm the security of the child restraint system.

■ When installing a booster seat

To prevent the belt from going into ALR lock mode, do not fully extend the shoulder belt. ALR mode causes the belt to tighten only. This could cause injury or discomfort to the child. (→P.31, 33)

■ Do not use a seat belt extender

If a seat belt extender is used when installing a child restraint system, the seat belt will not securely hold the child restraint system, which could cause death or serious injury to the child or other passengers in the event of sudden braking, sudden swerving or an accident.

Safety Connect*

*: If equipped

Safety Connect is a subscription-based telematics service that uses Global Positioning System (GPS) data and embedded cellular technology to provide safety and security features to subscribers. Safety Connect is supported by Toyota's designated response center, which operates 24 hours per day, 7 days per week.

Safety Connect service is available by subscription on select, telematics hardware-equipped vehicles.

By using the Safety Connect service, you are agreeing to be bound by the Telematics Subscription Service Agreement and its Terms and Conditions, as in effect and amended from time to time, a current copy of which is available at Toyota.com. All use of the Safety Connect service is subject to such then-applicable Terms and Conditions.

System components

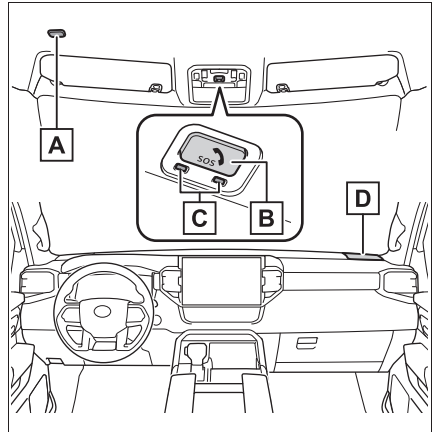

- A** Microphone
- B** "SOS" button
- C** LED light indicators
- D** Speaker

■ Certification

→P.638

Services

Subscribers have the following Safety Connect services available:

- Automatic Collision Notification*

Helps drivers receive necessary response from emergency service providers. (→P.70)

*: U.S. Patent No. 7,508,298 B2

- Stolen Vehicle Location

Helps drivers in the event of vehicle theft. (→P.70)

- **Emergency Assistance Button (“SOS”)**

Connects drivers to response-center support. (→P.70)

- **Enhanced Roadside Assistance**

Provides drivers various on-road assistance. (→P.70)

Subscription

After you have signed the Telematics Subscription Service Agreement and are enrolled, you can begin receiving services.

A variety of subscription terms is available for purchase. Contact your Toyota dealer, call the following or push the “SOS” button in your vehicle for further subscription details.

- **The United States**

1-800-331-4331

- **Canada**

1-888-869-6828

- **Puerto Rico**

1-877-855-8377

■ Safety Connect Services Information

- Phone calls using the vehicles Bluetooth® technology will not be possible during Safety Connect.
- Safety Connect is available beginning Fall 2009 on select Toyota models (in the contiguous United States only). Contact with the Safety Connect response center is dependent upon the telematics

device being in operative condition, cellular connection availability, and GPS satellite signal reception, which can limit the ability to reach the response center or receive emergency service support. Enrollment and Telematics Subscription Service Agreement required. A variety of subscription terms is available; charges vary by subscription term selected and location.

- **Automatic Collision Notification, Emergency Assistance and Stolen Vehicle Location** will function in the United States, including Hawaii and Alaska, Puerto Rico and in Canada, and Enhanced Roadside Assistance will function in the United States, Puerto Rico and in Canada.
- **Automatic Collision Notification, Emergency Assistance, Stolen Vehicle and Enhanced Road Assistance** will not function in the United States Virgin Islands. For vehicles first sold in the USVI, no Safety Connect services will function in and outside the United States Virgin Islands.
- Safety Connect services are not subject to section 255 of the Telecommunications Act and the device is not TTY compatible.

■ Languages

The Safety Connect response center will offer support in multiple languages. The Safety Connect system will offer voice prompts in English, Spanish, and French. Please indicate your language of choice when enrolling.

■ When contacting the response center

You may be unable to contact the response center if the network is busy.

Safety Connect LED light Indicators

When the power switch is turned to ON, the red indicator light comes on for 2 seconds then turns off. Afterward, the green indicator light comes on, indicating that the service is active.

The following indicator light patterns indicate specific system usage conditions:

- Green indicator light on = Active service
- Green indicator light flashing = Safety Connect call in process
- Red indicator light (except at vehicle start-up) = System malfunction (contact your Toyota dealer)
- No indicator light (off) = Safety Connect service not active

Safety Connect services

■ Automatic Collision Notification

In case of either airbag deployment or severe rear-end collision, the system is designed to automatically call the response center. The responding agent receives the vehicle's location and attempts to speak with the vehicle occupants to assess the level of emergency. If the occu-

pants are unable to communicate, the agent automatically treats the call as an emergency, contacts the nearest emergency services provider to describe the situation, and requests that assistance be sent to the location.

■ Stolen Vehicle Location

If your vehicle is stolen, Safety Connect can work with local authorities to assist them in locating and recovering the vehicle. After filing a police report, call the Safety Connect response center at 1-800-331-4331 in the United States, 1-877-855-8377 in Puerto Rico or 1-888-869-6828 in Canada, and follow the prompts for Safety Connect to initiate this service.

In addition to assisting law enforcement with recovery of a stolen vehicle, Safety-Connect-equipped vehicle location data may, under certain circumstances, be shared with third parties to locate your vehicle. Further information is available at Toyota.com.

■ Emergency Assistance Button ("SOS")

In the event of an emergency on the road, push the "SOS" button to reach the Safety Connect response center. The answering agent will determine your vehicle's location, assess the emergency, and dispatch the

necessary assistance required.

If you accidentally press the “SOS” button, tell the response-center agent that you are not experiencing an emergency.

■ **Enhanced Roadside Assistance**

Enhanced Roadside Assistance adds GPS data to the already included warranty-based Toyota roadside service.

Subscribers can press the “SOS” button to reach a Safety Connect response-center agent, who can help with a wide range of needs, such as: towing, flat tire, fuel delivery, etc. For a description of the Roadside Assistance services and their limitations, please see the Safety Connect Terms and Conditions, which are available at Toyota.com.

Safety information for Safety Connect

Important! Read this information about exposure to radio frequency signals before using Safety Connect;

The Safety Connect system installed in your vehicle is a low-power radio transmitter and receiver. It receives and also sends out radio frequency (RF) signals.

In August 1996, the Federal Communications Commission

(FCC) adopted RF exposure guidelines with safety levels for mobile wireless phones. Those guidelines are consistent with the safety standards previously set by the following U.S. and international standards bodies.

- ANSI (American National Standards Institute) C95.1 [1992]
- NCRP (National Council on Radiation Protection and Measurement) Report 86 [1986]
- ICNIRP (International Commission on Non-Ionizing Radiation Protection) [1996]

Those standards were based on comprehensive and periodic evaluations of the relevant scientific literature. Over 120 scientists, engineers, and physicians from universities, and government health agencies and industries reviewed the available body of research to develop the ANSI Standard (C95.1).

The design of Safety Connect complies with the FCC guidelines in addition to those standards.

■ Free /Open Source Software Information

This product contains Free/Open Source Software (FOSS). The License information and/or the source code of such FOSS can be found at the following

<https://www.denso.com/global/en/opensource/dcm/toyota/>

Hybrid system features

Your vehicle is a Hybrid Electric Vehicle. It has characteristics different from conventional vehicles. Be sure you are closely familiar with the characteristics of your vehicle, and operate it with care.

The hybrid system combines the use of a gasoline engine and an electric motor (traction motor) according to driving conditions, improving fuel efficiency and reducing exhaust emissions.

System components

■ System components

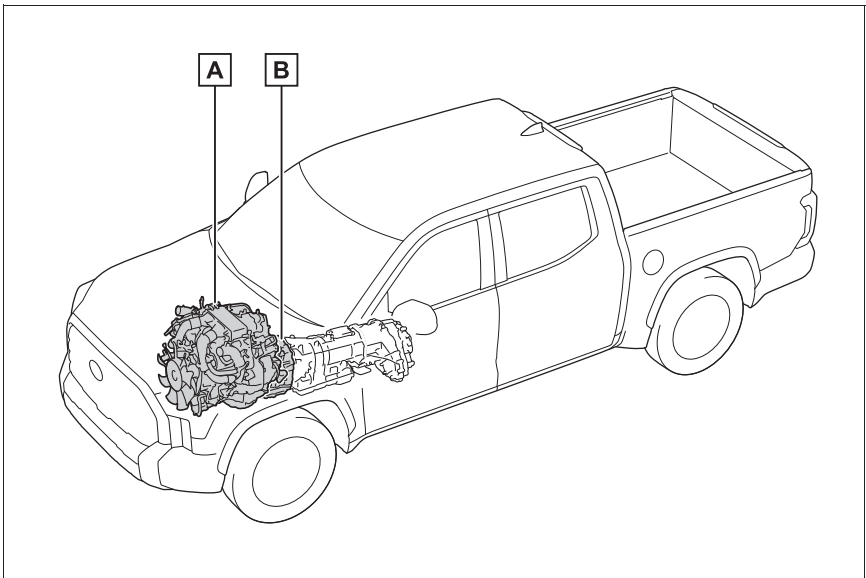

The illustration is an example for explanation and may differ from the actual item.

- A** Gasoline engine
- B** Electric motor (traction motor)

■ When stopped/during start off

The gasoline engine stops* when the vehicle is stopped. During start off, the electric motor (traction motor) drives the vehicle. At slow speeds or when traveling down a gentle slope, the engine is stopped* and the electric motor (traction motor) is used.

*: When the hybrid battery (traction battery) requires charging or the engine is warming up, etc., the gasoline engine will not automatically stop. (→P.74)

■ During normal driving

The gasoline engine is predominantly used. The electric motor (traction motor) charges the hybrid battery (traction battery) as necessary.

■ When accelerating sharply

When the accelerator pedal is depressed heavily, the power of the hybrid battery (traction battery) is added to that of the gasoline engine via the electric motor (traction motor).

■ When braking (regenerative braking)

The wheels operate the electric motor (traction motor) as a power generator, and the hybrid battery (traction battery) is charged.

■ Regenerative braking

- In the following situations, kinetic energy is converted to electric energy and deceleration force can be obtained in conjunction with the recharging of the hybrid battery (traction battery).
- The accelerator pedal is released while driving with the shift lever in D or S.
- The brake pedal is depressed while driving with the shift lever in D or S.

■ Conditions in which the gasoline engine may not stop

The gasoline engine starts and stops automatically. However, in any of the following situations, it may not stop automatically, possibly reducing fuel economy*:

- During gasoline engine warm-up
- During hybrid battery (traction battery) charging
- When the temperature of the hybrid battery (traction battery) is high or low
- When the heater is switched on
- When repeatedly accelerating/decelerating rapidly
- When repeatedly operating the hybrid system for a long time
- When driving down a long slope
- When the "TOW HAUL" switch is on
- When the "MTS" switch is on
- When the front-wheel drive control switch is in "4H" or "4L"
- When the hood is opened during "READY" indicator is illuminated
- When the shift lever is shifted to S

*: Depending on the circumstances, the gasoline engine may also not stop automatically in other situations.

■ Charging the hybrid battery (traction battery)

As the gasoline engine charges the hybrid battery (traction battery), the battery does not need to be charged from an outside source. However, if the vehicle is left parked for a long time the hybrid battery (traction battery) will slowly discharge. For this reason, be sure to drive the vehicle at least once every few months for at least 30 minutes or 10 miles (16 km). If the hybrid battery (traction battery) becomes fully discharged and you are unable to start the hybrid system, contact your Toyota dealer.

■ Charging the 12-volt battery

→P.558

■ After the 12-volt battery has discharged or when the terminal has been removed and installed during exchange, etc.

The gasoline engine may not stop even if the vehicle is being driven by the hybrid battery (traction battery). If this continues for a few days, contact your Toyota dealer.

■ Sounds and vibrations specific to a Hybrid Electric Vehicle

There may be no engine sound or vibration even though the vehicle is able to move with the “READY” indicator is illuminated. For safety, apply the parking brake and make sure to shift the shift lever to P when parked.

The following sounds or vibrations may occur when the hybrid system is operating and are not a malfunction:

- Motor sounds may be heard from the engine compartment.
- Sounds may be heard from the hybrid battery (traction battery) under the rear seats when the hybrid system starts or stops.
- Relay operating sounds such as a snap or soft clank will be emitted

from the hybrid battery (traction battery), under the rear seats, when the hybrid system is started or stopped.

- Sounds may be heard from the transmission when the gasoline engine starts or stops, when driving at low speeds, or during idling.
 - Engine sounds may be heard when accelerating sharply.
 - Sounds may be heard due to regenerative braking when the brake pedal is depressed or as the accelerator pedal is released.
 - Vibration may be felt when the gasoline engine starts or stops.
 - Cooling fan sounds may be heard from the air intake vents on the side of the lower part of the rear seat.
- **Maintenance, repair, recycling, and disposal**

Contact your Toyota dealer regarding maintenance, repair, recycling and disposal. Do not dispose of the vehicle yourself.

Acoustic vehicle alerting system

When the gasoline engine is off while driving, a sound is produced to warn pedestrians, people riding bicycles or other people and vehicles in the surrounding area that the vehicle is approaching. The pitch of the sound adjusts according to vehicle speed. When vehicle speed is approximately 22 mph (35 km/h) or more, the warning system turns off.

■ Acoustic vehicle alerting system

In the following cases, the acoustic vehicle alerting system sound may be difficult for pedestrians, people riding bicycles or other people and vehicles in the surrounding area to hear:

- When there is a lot of noise in the vicinity
- When it is raining or during strong winds

Hybrid system precautions

Take care when handling the hybrid system, as it is a high voltage system (about 288 V at maximum) as well as contains parts that become extremely hot when the hybrid system is operating. Read the following descriptions carefully before using the hybrid system, and handle the hybrid system correctly. Note that warning labels with a ⚠ mark are attached to the high voltage components, to remind you of careful handling required.

System components

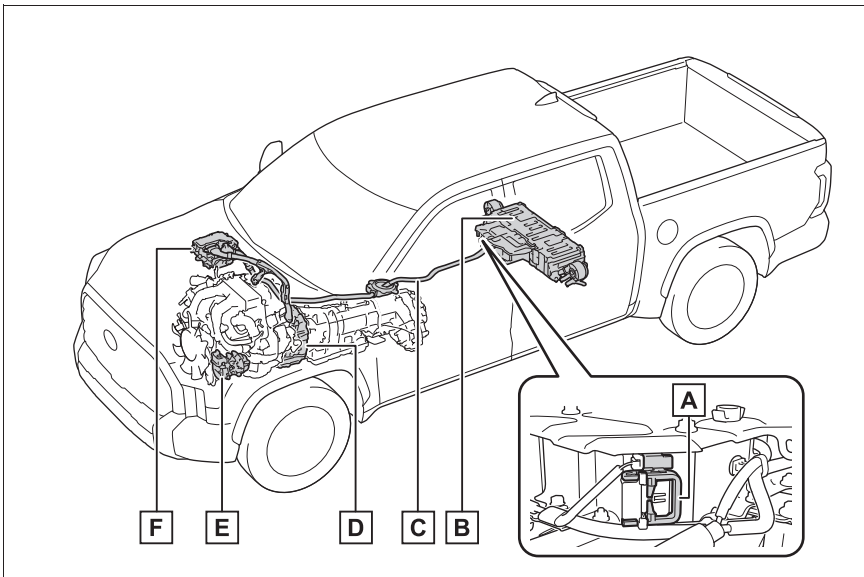

The illustration is an example for explanation and may differ from the actual item.

- A** Service plug
- B** Hybrid battery (traction battery)
- C** High voltage cables (orange)
- D** Electric motor (traction motor)

E Air conditioning compressor

F Power control unit

■ Running out of fuel

When the vehicle has run out of fuel and the hybrid system cannot be started, refuel the vehicle with at least enough gasoline to make the low fuel level warning light (→P.533) go off. If there is only a small amount of fuel, the hybrid system may not be able to start. (The standard amount of fuel is about 5.8 gal. [21.9 L, 4.8 Imp. gal.] when the vehicle is on a level surface. This value may vary when the vehicle is on a slope. Add extra fuel when the vehicle is inclined.)

■ Electromagnetic waves

- High voltage parts and cables on Hybrid Electric Vehicles incorporate electromagnetic shielding, and therefore emit approximately the same amount of electromagnetic waves as conventional gasoline powered vehicles or home electronic appliances.
- Your vehicle may cause sound interference in some third party-produced radio parts.

■ Hybrid battery (traction battery)

The hybrid battery (traction battery) has a limited service life. The lifespan of the hybrid battery (traction battery) can change in accordance with driving style and driving conditions.

■ Starting the hybrid system in an extremely cold environment

When the hybrid battery (traction battery) is extremely cold (below approximately -31°F [-35°C]) under the influence of the outside temperature, it may not be possible to start the hybrid system. In this case, try to start the hybrid system again after the temperature of the hybrid battery increases due to the outside

temperature increase etc.

⚠ WARNING

■ High voltage precautions

This vehicle has high voltage DC and AC systems as well as a 12-volt system. DC and AC high voltage is very dangerous and can cause severe burns and electric shock that may result in death or serious injury.

- Never touch, disassemble, remove or replace the high voltage parts, cables or their connectors.
- Do not touch the high voltage components. They are extremely hot, especially after driving.
- Never try to open the service plug access hole located under the right side of the rear seat. The service plug is used only when the vehicle is serviced and is subject to high voltage.

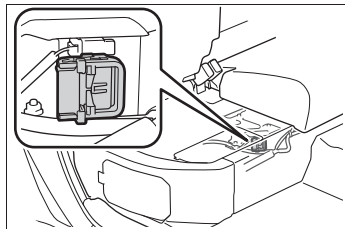

■ Road accident cautions

Observe the following precautions to reduce the risk of death or serious injury:

⚠ WARNING

- Stop the vehicle in a safe place to prevent subsequent accidents. While depressing the brake pedal, apply the parking brake and shift the shift lever to P to stop the hybrid system. Then, slowly release the brake pedal
- Do not touch the high voltage parts, cables and connectors.
- If electric wires are exposed inside or outside your vehicle, an electric shock may occur. Never touch exposed electric wires.
- If a fire occurs in the Hybrid Electric Vehicle, leave the vehicle as soon as possible. Never use a fire extinguisher that is not meant for electric fires. Using even a small amount of water may be dangerous.
- If your vehicle needs to be towed, do so with the rear wheels raised. If the wheels connected to the electric motor (traction motor) are on the ground when towing, the motor may continue to generate electricity. This may cause a fire. (→P.523)
- Carefully inspect the ground under the vehicle. If you find that liquid has leaked onto the ground, the fuel system may have been damaged. Leave the vehicle as soon as possible.
- If a fluid leak occurs, do not touch the fluid as it may be strong alkaline electrolyte from the hybrid battery (traction battery). If it comes into contact with your skin or eyes, wash it off immediately with a large amount of water or, if possible, boric acid solution. Seek immediate medical attention.

■ Hybrid battery (traction battery)

- Never resell, hand over or modify the hybrid battery. To prevent accidents, hybrid batteries that have been removed from a disposed vehicle are collected through your Toyota dealer. Do not dispose of the battery yourself.

Unless the battery is properly collected, the following may occur, resulting in death or serious injury:

- The hybrid battery may be illegally disposed of or dumped, and it is hazardous to the environment or someone may touch a high voltage part, resulting in an electric shock.
- The hybrid battery is intended to be used exclusively with your Hybrid Electric Vehicle. If the hybrid battery is used outside of your vehicle or modified in any way, accidents such as electric shock, heat generation, smoke generation, an explosion and electrolyte leakage may occur.

When reselling or handing over your vehicle, the possibility of an accident is extremely high because the person receiving the vehicle may not be aware of these dangers.

- If your vehicle is disposed of without the hybrid battery having been removed, there is a danger of serious electric shock if high voltage parts, cables and their connectors are touched. In the event that your vehicle must be disposed of, the hybrid battery must be disposed of by your Toyota dealer. If the hybrid battery is not disposed of properly, it may cause electric shock that can result in death or serious injury.



NOTICE

Hybrid battery (traction battery)

Do not carry large amounts of water such as water cooler bottles in the vehicle. If water spills onto the hybrid battery (traction battery), the battery may be damaged. Have the vehicle inspected by your Toyota dealer.

Hybrid battery (traction battery) air intake vents

There are air intake vents under the rear seat for the purpose of cooling the hybrid battery (traction battery).

If the vents are blocked, it may interfere with the cooling of the hybrid battery (traction battery).

If input/output of the hybrid battery (traction battery) becomes limited and the distance that the vehicle can be driven using the electric motor (traction motor) is reduced, the fuel economy may be reduced.

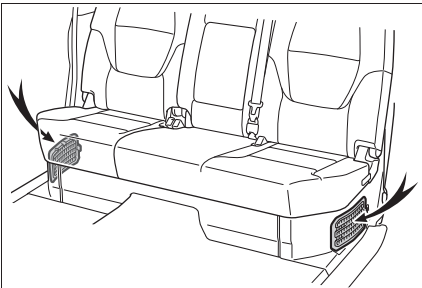

NOTICE

Hybrid battery (traction battery) air intake vents

- Make sure not to block the air intake vents with anything, such as a seat cover, plastic cover, or luggage.
The input/output of the hybrid battery (traction battery) may be restricted, leading to a reduction in hybrid battery (traction battery) output and a malfunction.
- Periodically clean the air intake vents to prevent them from clogging. (→P.506)
- Do not get water or foreign materials in the air intake vents as this may cause a short circuit and damage the hybrid battery (traction battery).

Emergency shut off system

When a certain level of impact is detected by the impact sensor, the emergency shut off system blocks the high voltage current and stops the fuel pump to minimize the risk of electrocution and fuel leakage. If the emergency shut off system activates, your vehicle will not restart. To restart the hybrid system, contact your Toyota dealer.

Hybrid warning message

A message is automatically displayed when a malfunction occurs in the hybrid system or an improper operation is attempted.

If a warning message is shown on the multi-information display, read the message and follow the instructions.

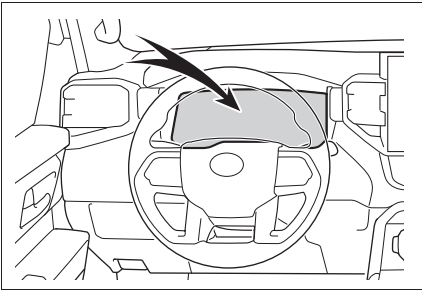

- **If a warning light comes on, a warning message is displayed, or the 12-volt battery is disconnected**

The hybrid system may not start. In this case, try to start the system again. If the “READY” indicator does not come on, contact your Toyota dealer.

Immobilizer system

The vehicle's keys have built-in transponder chips that prevent the hybrid system from starting if a key has not been previously registered in the vehicle's on-board computer.

Never leave the keys inside the vehicle when you leave the vehicle.

This system is designed to help prevent vehicle theft but does not guarantee absolute security against all vehicle thefts.

Operating the system

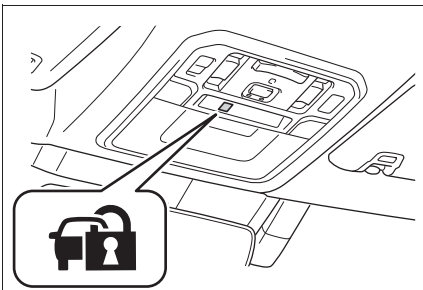

The indicator light flashes after the power switch has been turned off to indicate that the system is operating.

The indicator light stops flashing after the power switch has been turned to ACC or ON to indicate that the system has been canceled.

System maintenance

The vehicle has a maintenance-free type immobilizer system.

Conditions that may cause the system to malfunction

- If the grip portion of the key is in contact with a metallic object
- If the key is in close proximity to or touching a key to the security system (key with a built-in transponder chip) of another vehicle

Certification

→P.639

NOTICE

To ensure the system operates correctly

Do not modify or remove the system. If modified or removed, the proper operation of the system cannot be guaranteed.

Alarm

The alarm uses light and sound to give an alert when an intrusion is detected. The alarm is triggered in the following situations when the alarm is set:

- A locked door or tailgate is unlocked or opened in any way other than using the entry function or wireless remote control. (The doors will lock again automatically.)
- The hood is opened.

Setting/deactivating/stopping the alarm system

■ Items to check before locking the vehicle

To prevent unexpected triggering of the alarm and vehicle theft, make sure of the following:

- Nobody is in the vehicle.
- The windows and the panoramic moon roof (if equipped) are closed before the alarm is set.
- No valuables or other personal items are left in the vehicle.

■ Setting

Close the doors and hood, and lock all the doors using the entry function or wireless remote con-

trol. The system will be set automatically after 30 seconds.

The indicator light changes from being on to flashing when the system is set.

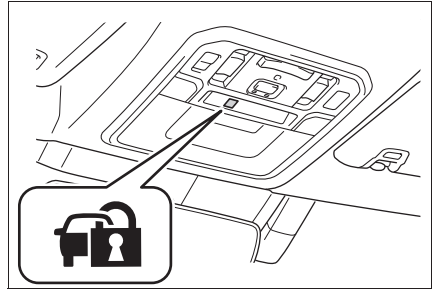

■ Deactivating or stopping

Do one of the following to deactivate or stop the alarms:

- Unlock the doors and tailgate using the entry function or wireless remote control.
- Turn the power switch to ACC or ON, or start the hybrid system. (The alarm will be deactivated or stopped after a few seconds.)

■ System maintenance

The vehicle has a maintenance-free type alarm system.

■ Triggering of the alarm

The alarm may be triggered in the following situations:
(Stopping the alarm deactivates the alarm system.)

- The doors are unlocked using the mechanical key.

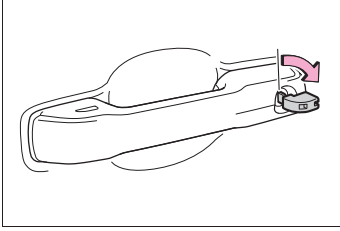

- A person inside the vehicle opens a door, hood or power tailgate or unlocks the vehicle.



- The 12-volt battery is recharged or replaced when the vehicle is locked. (→P.558)

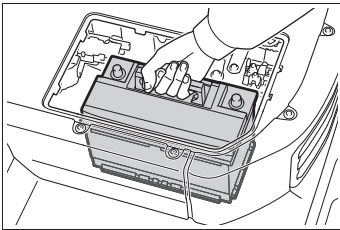

■ Alarm-operated door lock

In the following cases, depending on the situation, the door may automatically lock to prevent improper entry into the vehicle:

- When a person remaining in the vehicle unlocks the door and the alarm is activated.
- While the alarm is activated, a person remaining in the vehicle

unlocks the door.

- When recharging or replacing the 12-volt battery.

⚠ NOTICE

■ To ensure the system operates correctly

Do not modify or remove the system. If modified or removed, the proper operation of the system cannot be guaranteed.

Vehicle status information and indicators

2

2-1. Instrument cluster

Warning lights and indicators	86
Gauges and meters	91
Multi-information display	95
Head-up display	102
Fuel consumption information	107

Warning lights and indicators

The warning lights and indicators on the instrument cluster, overhead console and outside rear view mirrors inform the driver of the status of the vehicle's various systems.

Instrument cluster

For the purpose of explanation, the following illustrations display all warning lights and indicators illuminated.

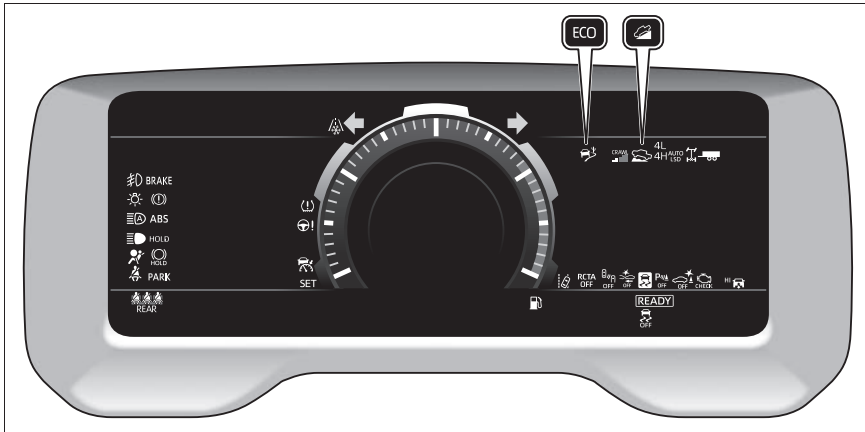

The units used on the meters and some indicators may differ depending on the target region.

Warning lights

Warning lights inform the driver of malfunctions in the indicated vehicle's systems.



Brake system warning light^{*1} (→P.527)



Brake system warning light^{*1} (→P.527)



Brake system warning light^{*1} (→P.527)



High coolant temperature warning light^{*2} (→P.527)



Charging system warning light^{*2} (→P.528)



Low engine oil pressure warning light^{*2} (→P.528)



Malfunction indicator lamp^{*1} (→P.528)



Malfunction indicator lamp^{*1} (→P.528)



SRS warning light^{*1} (→P.528)



ABS warning light^{*1} (→P.529)



ABS warning light^{*1} (→P.529)



Electric power steering system warning light^{*1} (→P.529)



Electric power steering system warning light^{*1} (→P.529)



PCS warning light^{*1} (→P.529)



LTA indicator (→P.530)



Intuitive parking assist OFF indicator^{*3} (→P.530)



PKSB OFF indicator^{*1} (→P.530)



“RCTA OFF” indicator^{*1} (→P.531)



Slip indicator light^{*1} (→P.531)



Inappropriate pedal operation warning light^{*2} (→P.531)



Brake hold operated indicator^{*1} (→P.532)

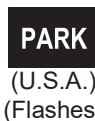

Parking brake indicator (→P.532)



Parking brake indicator (→P.532)



(Flashes)

Rear differential lock indicator (if equipped) (→P.532)



Tire pressure warning light*¹ (→P.532)



Low fuel level warning light (→P.533)



Driver's and front passenger's seat belt reminder light (→P.533)



Rear passengers' seat belt reminder lights (→P.533)



Air suspension malfunction indicator (if equipped) (→P.534)



Trailer brake warning light (→P.534)

*¹: These lights turn on when the power switch is turned to ON to indicate that a system check is being performed. They will turn off after the hybrid system is started, or after a few seconds. There may be a malfunction in a system if the light does not come on, or turn off. Have the vehicle inspected by your Toyota dealer.

*²: This light illuminates on the multi-information display with a message.

*³: Intuitive parking assist OFF indicator turns on when the power switch is turned to ON while the Intuitive parking assist function is on. It will turn off after a few seconds.































WARNING



















■ If a safety system warning light does not come on

Should a safety system light such as the ABS and SRS warning light not come on when you start the hybrid system, this could mean that these systems are not available to help protect you in an accident, which could result in death or serious injury. Have the vehicle inspected by your Toyota dealer immediately if this occurs.

Indicators

The indicators inform the driver of the operating state of the vehicle's various systems.

	Turn signal indicator (→P.216)		Slip indicator light ^{*5} (→P.394)
	Headlight indicator (→P.223) (U.S.A.)		VSC OFF indicator ^{*3, 5} (→P.394)
	Tail light indicator (→P.223) (Canada)		PCS warning light ^{*3, 5} (→P.246)
	Headlight high beam indicator (→P.225)		BSM outside rear view mirror indicators ^{*5, 6} (→P.281, 296)
	Automatic High Beam indicator (→P.226)		BSM OFF indicator ^{*3, 5} (→P.283)
	Front fog light indicator (if equipped) (→P.226)		RCTA OFF indicator ^{*3, 5} (→P.296)
	Smart key system indica- tor ^{*1} (→P.207)		Brake hold standby indi- cator ^{*5} (→P.220)
	“READY” indicator (→P.207)		Brake hold operated indi- cator ^{*5} (→P.220)
	Cruise control indicator (→P.268)		Security indicator ^{*7} (→P.82, 83)
	Dynamic radar cruise control indicator (→P.268)		Low outside temperature indicator ^{*8} (→P.92)
	Cruise control “SET” indi- cator (→P.268)		Parking brake indicator (→P.217) (U.S.A.)
	LTA indicator (→P.243, 260) (*2)		Parking brake indicator (→P.217) (Canada)
	Intuitive parking assist OFF indicator ^{*3, 4} (→P.289)		“ECO” mode indicator (→P.376)
	PKSB OFF indicator ^{*3, 5} (→P.303)		“SPORT” mode indicator (if equipped) (→P.376)
			“SPORT S” mode indica- tor (if equipped) (→P.376)
			“SPORT S+” mode indi- cator (if equipped) (→P.376)

	“COMFORT” mode indicator (if equipped) (→P.376)		“TOW+” indicator (→P.215)
	“CUSTOM” mode indicator (if equipped) (→P.376)		“AIR BAG ON/OFF” indicator* ^{3, 7} (→P.46)
	Downhill assist control system indicator* ⁵ (if equipped) (→P.390)		
	Air suspension indicator (if equipped) (→P.373)		
	“4H” indicator (if equipped) (→P.379)		
	“4L” indicator (if equipped) (→P.379)		
	“AUTO LSD” indicator* ⁵ (if equipped) (→P.381)		
	Rear differential lock indicator (if equipped) (→P.382)		
	Crawl Control indicator* ⁵ (if equipped) (→P.383)		
	Crawl Control speed level indicator (if equipped) (→P.383)		
	AUTO mode indicator (if equipped) (→P.387)		
	DIRT mode indicator (if equipped) (→P.387)		
	SAND mode indicator (if equipped) (→P.387)		
	MUD mode indicator (if equipped) (→P.387)		
	DEEP SNOW mode indicator (if equipped) (→P.387)		
	ROCK mode indicator (if equipped) (→P.387)		
	“TOW HAUL” indicator (→P.215)		

*¹: This light illuminates on the multi-information display with a message.

*²: Depending on the operating conditions of the system, the color and state (illuminated/blinking) of the indicator change.

*³: The light comes on when the system is turned off.

*⁴: Intuitive parking assist OFF indicator turns on when the power switch is turned to ON while the Intuitive parking assist function is on. It will turn off after a few seconds.

*⁵: These lights turn on when the power switch is turned to ON to indicate that a system check is being performed. They will turn off after the hybrid system is started, or after a few seconds. There may be a malfunction in a system if the lights do not turn on, or turn off. Have the vehicle inspected by your Toyota dealer.

*⁶: This light illuminates on the outside rear view mirrors.

*⁷: This light illuminates on the overhead console.

*⁸: When the outside temperature is approximately 37°F (3°C) or lower, the indicator will flash for approximately 10 seconds, then stay on.

Gauges and meters

The meters display various drive information.

Meter display

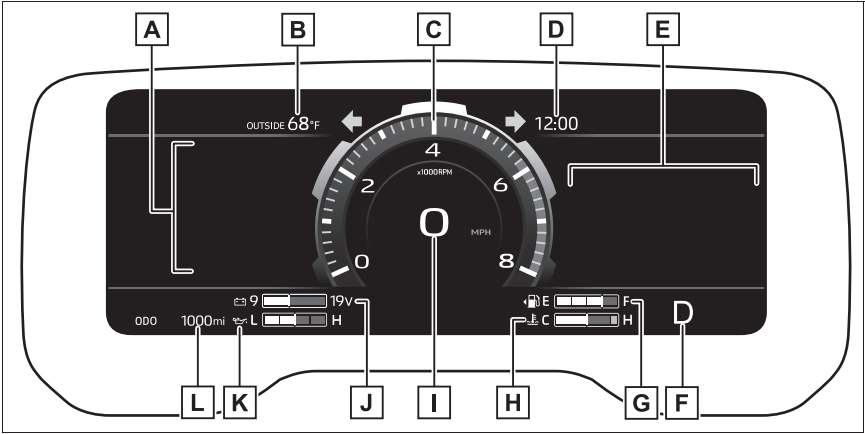

The units used on the meter and display may differ depending on the target region.

A Multi-information display

Presents the driver with a variety of driving-related data (→P.95)

Displays warning messages if a malfunction occurs (→P.537)

B Outside temperature (→P.92)

C Tachometer

Displays the engine speed in revolutions per minute

D Clock (→P.92)

Time displayed is linked to the multimedia system. For details, refer to "MULTIMEDIA OWNER'S MANUAL".

E Right Side Gauges

Presents the driver with a variety of vehicle states data (→P.94)

F Shift position and shift range display

Displays the selected shift position or selected shift range (→P.212)

G Fuel gauge

Displays the quantity of fuel remaining in the tank

[H] Engine coolant temperature gauge

Displays the engine coolant temperature

[I] Speedometer

Displays the vehicle speed

[J] Voltmeter

Displays the charge state

[K] Engine oil pressure gauge

Displays the engine oil pressure

[L] Odometer and trip meter (→P.93)

■ The meters and display illuminate when

The power switch is in ON.

■ Tachometer needle feature

The tachometer needle will fade in or out during the engine starting or stopping, respectively.

The needle is completely visible after the engine is turned on or turned off.

■ Clock settings screen

If clock setting item is displayed when  is selected on the multi-information display, the system may be malfunctioning. Have the vehicle inspected by your Toyota dealer.

■ Outside temperature display

- In the following situations, the correct outside temperature may not be displayed, or the display may take longer than normal to change.
 - When stopped, or driving at low speeds (less than 12 mph [20 km/h])
 - When the outside temperature has changed suddenly (at the entrance/exit of a garage, tunnel, etc.)
 - When “--” or “E” is displayed, the system may be malfunctioning. Take your vehicle to your Toyota dealer.

- Displays the outside temperature within the range of -40°F (-40°C) to 122°F (50°C).

- When the outside temperature is approximately 37°F (3°C) or lower, the indicator  will flash for approximately 10 seconds, then stay on.

■ Liquid crystal display

→P.96

■ Customization

Settings (e. g. meter display) can be changed on  screen of the multi-information display. (→P.99)

 **WARNING**

■ The information display at low temperatures

Allow the interior of the vehicle to warm up before using the liquid crystal information display. At extremely low temperatures, the information display monitor may respond slowly, and display changes may be delayed.

**WARNING**

For example, there is a lag between the driver's shifting and the new gear number appearing on the display. This lag could cause the driver to downshift again, causing rapid and excessive engine braking and possibly an accident resulting in death or injury.

**NOTICE****■ To prevent damage to the engine and its components**

- Do not let the indicator needle of the tachometer enter the red zone, which indicates the maximum engine speed.
- The engine may be overheating if the engine coolant temperature gauge is in the red zone (H). In this case, immediately stop the vehicle in a safe place, and check the engine after it has cooled completely. (→P.561)

■ Voltmeter

When the voltmeter indicates 19 V or higher or 9 V or lower while the hybrid system is operating, there may be a 12-volt battery or charging system malfunction. Have the vehicle inspected at your Toyota dealer.

■ Engine oil pressure gauge

When the value of the engine oil pressure gauge drops while the engine is running, stop the vehicle in a safe place immediately and check the amount of engine oil. (→P.482)

When the oil pressure drops even though the engine oil amount has not decreased, or if the oil pressure does not increase when engine oil is added, contact your Toyota dealer, as there may be a problem with the lubrication system.

Odometer and trip meter display**■ Display items****● Odometer**

Displays the total distance the vehicle has been driven.

● Trip meter A/Trip meter B

Displays the distance the vehicle has been driven since the meter was last reset. Trip meters A and B can be used to record and display different distances independently.

● Distance until next engine oil change

Displays the distance the vehicle can be driven until an oil change is necessary.

■ Changing the display

Each time the “ODO TRIP” switch is pressed, the displayed item will be changed. When the trip meter is displayed, pressing and holding the switch will reset the trip meter.

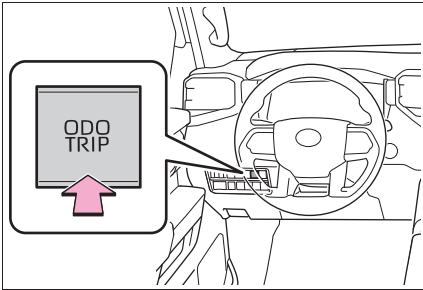

■ Pop-up display

In some situations the following will be temporarily displayed:

Distance until next engine oil change

Displays the distance until the next engine oil change. This display will be displayed in the following situations:

- When the power switch is turned to ON.
- When a warning message indicating that oil maintenance should be performed soon or is required is displayed.

Instrument panel light control

The brightness of the instrument panel lights can be adjusted.

Pressing the button will adjust

brightness of the instrument panel light.

The brightness of the instrument panel lights can be adjusted by pressing the button.

Short press: 1 step change of brightness level.

Long press: continues change of brightness level until released.

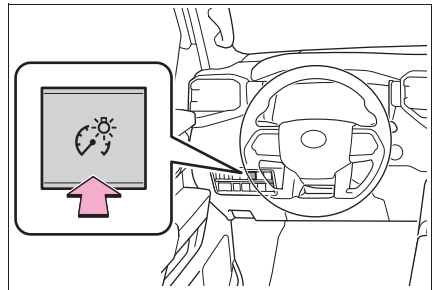

■ Instrument cluster brightness adjustment

The instrument cluster brightness levels when the tail lights are on and off can be adjusted individually. However, when the surroundings are bright (daytime, etc.), turning on the tail lights will not change the instrument cluster brightness.

Right Side Gauges

Displays the various types of vehicle information.

■ Display items

- Boost and Hybrid Power Meters

Displays the engine turbo boost and traction motor output power.

- Pitch and roll gauges

Displays the longitudinal and lateral inclination of the vehicle

- Tow gauges

Displays the engine turbo boost and traction motor output power, engine oil temperature, transmission fluid temperature

- Off

Select to turn the display off

■ Changing the display items

- 1 Press < or > to select .
- 2 Press ^ or v to select “Customize Right Side”, and then press and hold OK.
- 3 Select the item and then press OK.

Multi-information display

The multi-information display is used to display fuel efficiency related information and various types of driving-related information. The multi-information display can also be used to change the display settings and other settings.

Display and menu icons

■ Display

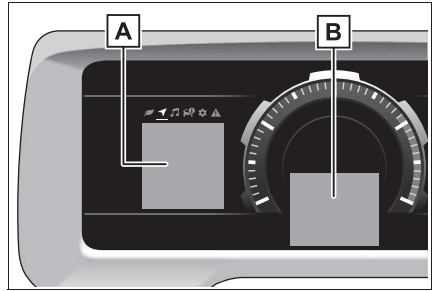

A Content display area

By selecting menu icons on the multi-information display, a variety of driving-related information can be displayed. The multi-information display can also be used to change display settings and other vehicle settings.

Warning or advice pop-up displays are also displayed in certain situations.







B Driving support system status display area

- LTA (Lane Tracing Assist)
(→P.254)

- Dynamic radar cruise control with full-speed range (→P.268)
- RSA (Road Sign Assist) (if equipped) (→P.265)

■ Menu icons

The menu icons will be displayed by pressing the < or > meter control switch.

-  Driving information display (→P.97)
-  Navigation system-linked display (→P.98)
-  Audio system-linked display (→P.98)
-  Vehicle information display (→P.98)
-  Settings display (→P.99)
-  Warning message display (→P.101)

■ Liquid crystal display

Small spots or light spots may appear on the display. This phenomenon is characteristic of liquid crystal displays, and there is no problem continuing to use the display.

Changing the display

The multi-information display is operated using the meter control switches.

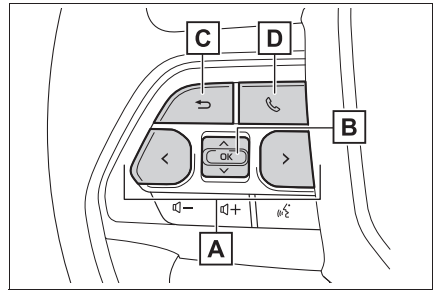

- A** Scroll the screen^{*}/switch the display^{*}/move the cursor
- B** Press: Enter/Set
Press and hold: Reset/Display customizable items
- C** Return to the previous screen
- D** Call sending/receiving and history display

Linked with the hands-free system, sending or receiving call is displayed. For details regarding the hands-free system, refer to the “MULTIMEDIA OWNER’S MANUAL”.

^{*}: On screens where the screen can be scrolled and the display can be switched, a scroll bar or a round icon that shows the number of registered screens is displayed.

⚠ WARNING**■ Caution for use while driving**

For safety, avoid operating the meter control switch while driving as much as possible, and do not look continuously at the multi-information display while driving. Stop the vehicle and operate the meter control switch. Failure to do so may cause a steering wheel operation error, resulting in an unexpected accident.

Content of driving information

Select to display fuel consumption data in various forms.

■ Fuel economy

Use the displayed values as a reference only.

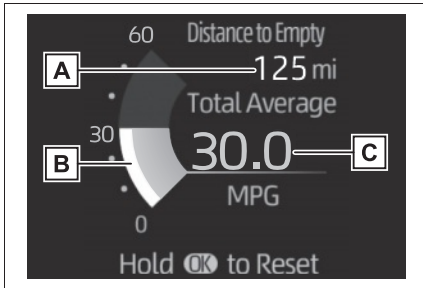
**A** Distance to empty

Displays the driving range with remaining fuel. (→P.98)

B Current fuel consumption

Displays instantaneous current fuel consumption.

C Average fuel economy (after reset)

To reset the average fuel economy display, press and hold the **OK**

meter control switch.

The average fuel economy display can be changed in .

(→P.99)

- Average fuel economy (after start)

Displays the average fuel consumption since hybrid system start.

- Average fuel economy (after refuel)

Displays the average fuel consumption since the vehicle was refueled.

■ Hybrid System Indicator/Distance to empty

- Hybrid System Indicator

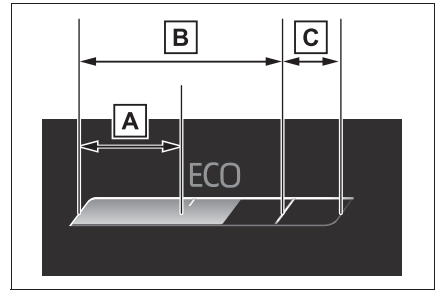
**A** Hybrid Eco area

Shows that gasoline engine power is not being used very often.

The gasoline engine will automatically stop and restart under various conditions.

B Eco area

Shows that the vehicle is being driven in an Eco-friendly manner.

By keeping the indicator needle within the Eco area, more Eco-friendly driving can be achieved.

C Power area

Shows that an Eco-friendly driving range is being exceeded (during full power driving, etc.)

- Distance to empty

Displays the driving range with remaining fuel. (→P.98)

Distance to empty

- This distance is computed based on your average fuel consumption. As a result, the actual distance that can be driven may differ from that displayed.
- When only a small amount of fuel is added to the tank, the display may not be updated. When refueling, turn the power switch to OFF. If the vehicle is refueled without turning the power switch to OFF, the display may not be updated.
- When “Refuel” is displayed, the remaining fuel amount is low and the distance that can be driven with the remaining fuel cannot be calculated. Refuel immediately.

Hybrid System Indicator

The Hybrid System Indicator will not operate in the following situations:

- The “READY” indicator is not illuminated.
- The shift lever is in a range other than D or S.

Navigation system-linked display

Select to display the following navigation system-linked information:

- Route guidance to destination
- Compass display (heading-up display)

Audio system-linked display

The operating conditions of the audio system can be displayed on the multi-information display.

Vehicle information display**Trailer brake**

Displays trailer brake control status (→P.398) and trailer type*.

*: To select the trailer, press and hold the OK meter control switch. (→P.100)

Trailer Mode BSM

Displays trailer length* and trailer blind spot status (→P.281).

*: To select the trailer, press and hold the OK meter control switch. (→P.100)

Drive information

2 items that are selected using the “Drive Info Items” setting (average speed, distance and total time) can be displayed vertically.

The displayed information changes according to the “Drive Info Type” setting (since the system was started or between resets). (→P.99)

Use the displayed information as a reference only.

Following items will be displayed.

- “Trip”
 - “Average Speed”: Displays the average vehicle speed since hybrid system start*
 - “Distance”: Displays the distance driven since hybrid system start*
 - “Total Time”: Displays the elapsed time since hybrid system start*
- *: These items are reset each time the hybrid system stops.
- “Total”
 - “Average Speed”: Displays the average vehicle speed since the display was reset*
 - “Distance”: Displays the distance driven since the display was reset*
 - “Total Time”: Displays the elapsed time since the display was reset*

*: To reset, display the desired item and press and hold the OK meter control switch.

■ Tire inflation pressure

Displays inflation pressure of each tire.

Settings display

■ Meter display settings that can be changed

● Language

Select to change the language displayed.

● Units

Select to change the units of measure displayed.

● Meter Type

Select to change the main dial type to speedometer or tachometer.

● (Driving information display settings)

• Fuel economy display

Select to change the average fuel consumption display between after start/after reset/after refuel. (→P.97)

● (Audio settings)

Select to display/not display the audio system linked display.

● (Vehicle information display settings)

Select to change the displayed content of the following:

• Drive information type

Select to change the drive information type display between after start/after reset.

100 2-1. Instrument cluster

- Drive information items

Select to set the first and second items of the drive information display to any of the following: average vehicle speed/distance/elapsed time.

- Pop-up display

Select to enable/disable pop-up displays for each relevant system.

- Multi-information display off

Select to turn the multi-information display off.

To turn the multi-information display on again, press any of the meter control switches.

- Default setting

Select to reset the meter display settings to the default setting.

■ Changing settings of the trailer type

- Trailer settings screen

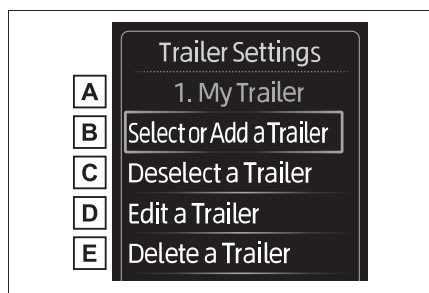

A Displays the name of the currently selected trailer or “No Trailer Selected” if a trailer has not yet been selected

B Add a new trailer or select an existing saved trailer

- Maximum of 10 trailers can be saved.

- Select the trailer name, length, hitch type, brake type and number of axles.
- The parameters which can be set depend on which of the trailer systems are installed on the vehicle. (Trailer Brake Controller, Trailer Backup Guide and Trailer Mode BSM)

C Deselect the currently selected trailer

- Used when a 4-pin trailer connector has been disconnected. (4-pin trailer connector disconnection cannot be automatically detected by Trailer Brake Controller)

D Edit the parameters of a saved trailer (name, length, hitch type, brake type and number of axles)

- The parameters which can be edited depend on which of the trailer systems are installed on the vehicle (Trailer Brake Controller, Trailer Backup Guide and Trailer Mode BSM)

E Delete a saved trailer

- Trailer detail screen

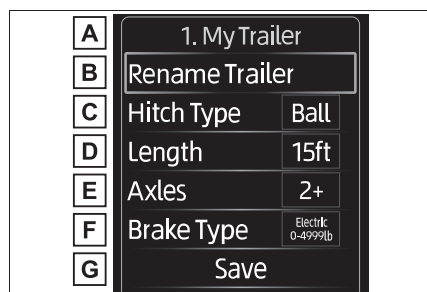

A Displays the name of the current trailer which is being added or edited.

- B** Change the name of the trailer.
- C** Change the hitch type of the trailer between ball hitch (conventional), gooseneck or fifth wheel. Note that gooseneck and fifth wheel trailers are not supported for some features (Trailer Backup Guide and Trailer Mode BSM)
- D** Change the length of the trailer. If the exact length is not listed, round up the actual length of the trailer to the closest available value. "Auto" length detection can also be selected.
- E** Change the number of axles.
- F** Change the brake type (electric or electric over hydraulic) and weight of the trailer, or turn trailer brakes off for that trailer.
- G** Save the trailer information
If there are any errors with the trailer values, re-select the value or delete and re-save the trailer. If the error continues, contact your Toyota dealer.

■ Vehicle functions and settings that can be changed

→P.588

■ Suspension of the settings display

- Some settings cannot be changed while driving. When changing settings, park the vehicle in a safe place.
- If a warning message is displayed, operation of the settings display will be suspended.



WARNING

■ Cautions during setting up the display

If the hybrid system is operating when changing the display settings, ensure that the vehicle is parked in a place with adequate ventilation. In a closed area such as a garage, exhaust gases including harmful carbon monoxide (CO) may collect and enter the vehicle. This may lead to death or a serious health hazard.



NOTICE

■ During setting up the display

To prevent 12-volt battery discharge, ensure that the hybrid system is operating while setting up the display features.

Warning message display

Select to display warning messages and measures to be taken if a malfunction is detected. (→P.537)

Head-up display *

*: If equipped

The head-up display projects a variety of driving-related information and the operating state of the driving support systems on the windshield.

System components

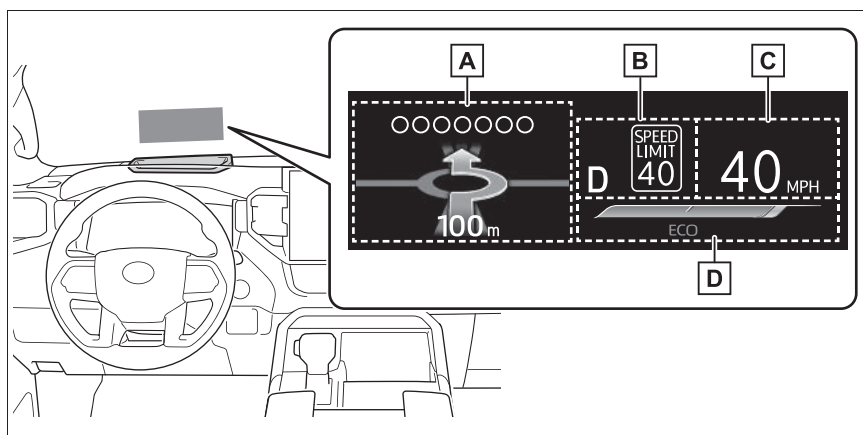

Illustrations used in this text are intended as examples, and may differ from the image that is actually displayed by the head-up display.

- A** Driving support system status/navigation system-linked display area (→P.104)
- B** Shift position display/RSA (Road Sign Assist) (if equipped) display area (→P.212, 265)
- C** Vehicle speed display
- D** Hybrid System Indicator/Outside temperature display area (→P.106)

■ Head-up display will operate when

The power switch is in ON.

■ When using the head-up display

The head-up display may seem dark or hard to see when viewed through sunglasses, especially polarized sunglasses. Adjust the brightness of the head-up display or remove your sunglasses.

■ Street name display

Only street names which are included in the map data will be displayed.

⚠ WARNING

■ When using the head-up display

- Check that the position and brightness of the head-up display image does not interfere with safe driving. Incorrect adjustment of the image's position or brightness may obstruct the driver's view and lead to an accident, resulting in death or serious injury.
- Do not continuously look at the head-up display while driving as you may fail to see pedestrians, objects on the road, etc., ahead of the vehicle.

⚠ NOTICE

■ Head-up display projector

- Do not place any drinks near the head-up display projector. If the projector gets wet, electrical malfunctions may result.

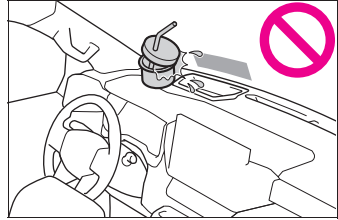

- Do not place anything on or put stickers onto the head-up display projector. Doing so could interrupt head-up display indications.
- Do not touch the inside of the head-up display projector or thrust sharp edges or the like into the projector. Doing so could cause mechanical malfunctions.

Using the head-up display

Select  on the multi-information display (→P.590) and then “HUD Main”.

■ Enabling/disabling the head-up display

Press the OK meter control switch to enable/disable the head-up display.

■ Changing the head-up display settings

Press and hold the OK meter control switch to change the following settings:

- Brightness and vertical position of the head-up display

Select to adjust the brightness or vertical position of the head-up display.

- Display content

Select to change the display between the following:

- No content
- Hybrid System Indicator
- Select to enable/disable the following items:
 - Route guidance to destination
 - Driving support system display
 - Compass (heading-up display)
 - Audio system operation status
- Display angle

Select to adjust the angle of the head-up display.

■ Enabling/disabling of the head-up display

If the head-up display is disabled, it will remain disabled when the power switch is turned off then back to ON.

■ Display brightness

The brightness of the head-up display can be adjusted on  of the multi-information display. Also, it is automatically adjusted according to the ambient brightness.

WARNING

■ Caution for changing settings of the head-up display

If the hybrid system is operating when changing the display settings, ensure that the vehicle is parked in a place with adequate ventilation. In a closed area such as a garage, exhaust gases including harmful carbon monoxide (CO) may collect and enter the vehicle. This may lead to death or a serious health hazard.

NOTICE

■ When changing the settings of the head-up display

To prevent 12-volt battery discharge, ensure that the hybrid system is operating while changing the settings of the head-up display.

Driving support system status/navigation system-linked display area

■ Driving support system status display

Displays the operational status of the following systems:

- LTA (Lane Tracing Assist) (→P.254)
- Dynamic radar cruise control with full-speed range (→P.268)

Details of content displayed on the head-up display may differ from that displayed on the multi-information display. For details, refer to the explanation of each system.

■ Navigation system-linked display area

Displays the following items which are linked to the navigation system:

- Street name
- Route guidance to destination
- Compass (heading-up display)

Pop-up display

Pop-up displays for the following systems will be displayed when necessary:

■ Driving support systems

Displays a warning/suggestion/advice message or the operating state of a relevant system.

- PCS (Pre-Collision System) (→P.242)
- LTA (Lane Tracing Assist) (→P.254)
- PKSB (Parking Support Brake) (→P.301)
- Brake Override System (→P.182)
- Drive-Start Control (→P.187)

Details of content displayed on the head-up display may differ from that displayed on the multi-information display. For details, refer to the explanation of each system.

■ / icons

These icons are linked to the multi-information display

 : Master warning icon

Displayed when a warning message is displayed on the multi-information display. (→P.537)

 : Information icon

Displayed when an advice pop-up display is displayed on the multi-information display.

■ Warning message

Some warning messages are displayed when necessary, according to certain conditions.

Details of content displayed on the head-up display may differ from that displayed on the multi-information display.

■ Audio system operation status

Displayed when an audio remote control switch on the steering wheel is operated.

■ Hands-free system status

Displayed when the hands-free system is operated.

■ When a pop-up display is displayed

When a pop-up display is displayed, a current display may no longer be displayed. In this case, the display will return after the pop-up display disappears.

Hybrid System Indicator/Outside temperature display

■ Hybrid System Indicator

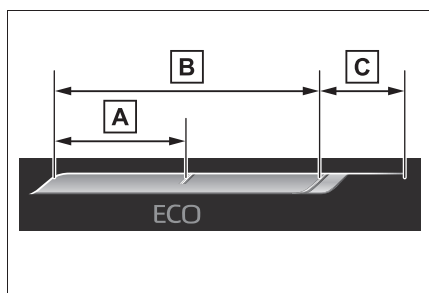

A Hybrid Eco area

B Eco area

C Power area

Displayed content is the same as that displayed on the multi-information display (Hybrid System Indicator). For details, refer to P.97.

■ Outside temperature display

Displayed when the power switch is turned to ON or when the low outside temperature indicator is flashing.

■ Outside temperature display

- When the ambient temperature is approximately 37°F (3°C) or lower, the low outside temperature indicator will flash for approximately 10 seconds and the outside temperature display will turn off. In this case, the display will be displayed again when the outside temperature becomes approximately 41°F (5°C) or higher.
- In the following situations, the correct outside temperature may not

be displayed, or the display may take longer than normal to change:

- When stopped, or driving at low speeds (less than 16 mph [25 km/h])
- When the outside temperature has changed suddenly (at the entrance/exit of a garage, tunnel, etc.)
- When "--" is displayed, the system may be malfunctioning. Take your vehicle to your Toyota dealer.

Fuel consumption information

Fuel consumption information can be displayed on the multimedia system.

Consumption

■ Current fuel consumption screen

- 1 Select  on the main menu.

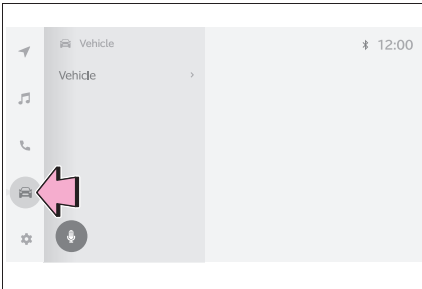

- 2 Select "Trip information".

If a screen other than "Current" is displayed, select "Current".

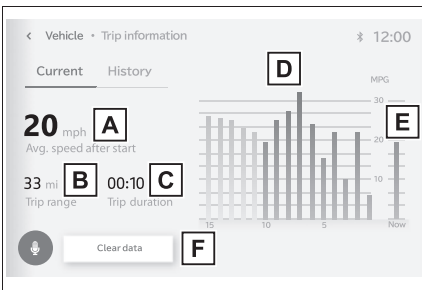

- A** Average vehicle speed since the hybrid system was started.
- B** Trip range

- C** Elapsed time since the hybrid system was started
- D** Fuel consumption in the past 15 minutes
- E** Current fuel consumption
- F** Resetting the consumption data

Use the displayed average fuel consumption as a reference. The image is an example only, and may vary slightly from actual conditions.

■ History fuel consumption screen

- 1 Select  on the main menu.

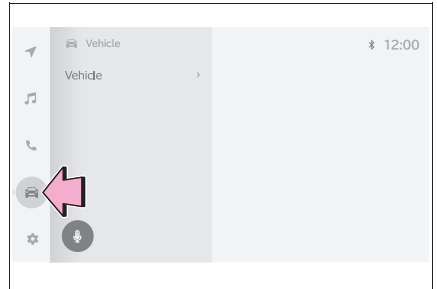

2 Select “Trip information”.

If a screen other than “History” is displayed, select “History”.

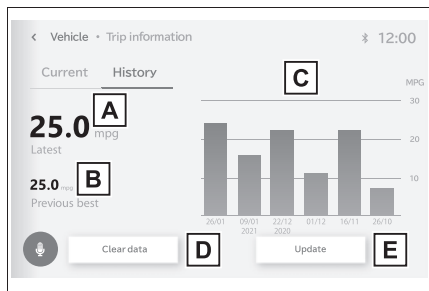

- A Latest fuel consumption
- B Best recorded fuel consumption
- C Previous fuel consumption record
- D Resetting the history data
- E Updating the latest fuel consumption data

Use the displayed average fuel consumption as a reference. The image is an example only, and may vary slightly from actual conditions.

■ **Updating the history data**

Update the average fuel consumption by selecting “Update” to measure the current fuel consumption again.

■ **Resetting the data**

The fuel consumption data can be deleted by selecting “Clear data”.

■ **Trip range**

Displays the estimated maximum distance that can be driven with the quantity of fuel remaining.

As a result, the actual distance that can be driven may differ from that displayed.

Before driving**3****3-1. Key information**

Keys **110**

3-2. Opening, closing and locking the doors and tailgate

Side doors **113**

Power running boards. **117**

Tailgate..... **120**

Power bed step **129**

Smart key system **131**

3-3. Adjusting the seats

Front seats **136**

Rear seats..... **141**

Driving position memory
..... **144**

Head restraints..... **148**

3-4. Adjusting the steering wheel and mirrors

Steering wheel **151**

Inside rear view mirror **153**

Digital Rear-view Mirror**154**

Outside rear view mirrors
..... **164**

3-5. Opening, closing the windows and moon roof

Power windows **169**

Power back window **172**

Panoramic moon roof.. **173**

Keys

The keys

The following keys are provided with the vehicle.

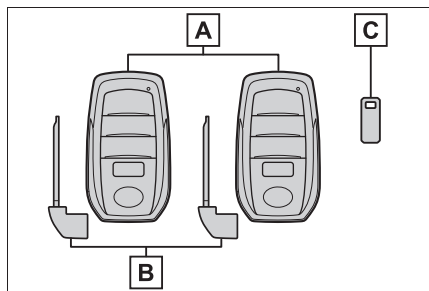

A Electronic keys

- Operating the smart key system (→P.131)
- Operating the wireless remote control function (→P.111)

B Mechanical keys

C Key number plate

■ When riding in an aircraft

When bringing an electronic key onto an aircraft, make sure you do not press any buttons on the electronic key while inside the aircraft cabin. If you are carrying an electronic key in your bag, etc., ensure that the buttons are not likely to be pressed accidentally. Pressing a button may cause the electronic key to emit radio waves that could interfere with the operation of the aircraft.

■ Electronic key battery depletion

- The standard battery life is 1 to 2 years.
- If the battery becomes low, an alarm will sound in the cabin and a message will be shown on the multi-information display when the

hybrid system is stopped.

- To reduce key battery depletion when the electronic key is to not be used for long periods of time, set the electronic key to the battery-saving mode. (→P.132)
- As the electronic key always receives radio waves, the battery will become depleted even if the electronic key is not used. The following symptoms indicate that the electronic key battery may be depleted. Replace the battery when necessary.
 - The smart key system or the wireless remote control does not operate.
 - The detection area becomes smaller.
 - The LED indicator on the key surface does not turn on.
- To avoid serious deterioration, do not leave the electronic key within 3 ft. (1 m) of the following electrical appliances that produce a magnetic field:
 - TVs
 - Personal computers
 - Cellular phones, cordless phones and battery chargers
 - Recharging cellular phones or cordless phones
 - Table lamps
 - Induction cookers

■ Replacing the battery

→P.510

■ Confirmation of the number of registered keys

The number of keys already registered to the vehicle can be confirmed. Ask your Toyota dealer for details.

■ If “A New Key has been Registered Contact Your Dealer for Details” is shown on the multi-information display

This message will be displayed each time the driver’s door is opened when the doors are unlocked from the outside for

approximately 10 days after a new electronic key has been registered. If this message is displayed but you have not had a new electronic key registered, ask your Toyota dealer to check if an unknown electronic key (other than those in your possession) has been registered.



NOTICE

■ To prevent key damage

- Do not drop the keys, subject them to strong shocks, or bend them.
- Do not expose the keys to high temperatures for a long period of time.
- Do not get the keys wet or wash them in an ultrasonic washer, etc.
- Do not attach metallic or magnetic materials to the keys or place the keys close to such materials.
- Do not disassemble the keys.
- Do not attach a sticker or anything else to the surface of the electronic key.
- Do not place the keys near objects that produce magnetic fields, such as TVs, audio systems and induction cookers, or medical electrical equipment, such as low-frequency therapy equipment.

■ Carrying the electronic key on your person

Carry the electronic key 3.9 in. (10 cm) or more away from electric appliances that are turned on. Radio waves emitted from electric appliances within 3.9 in. (10 cm) of the electronic key may interfere with the key, causing the key to not function properly.

■ In case of a smart key system malfunction or other key-related problems

→P.553

■ When an electronic key is lost

→P.553

Wireless remote control

The electronic keys are equipped with the following wireless remote control:

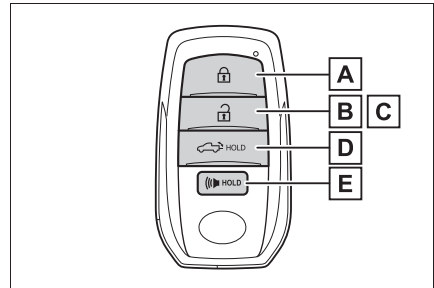

- A** Locks the doors and the tailgate (→P.113)
- B** Unlocks the doors and the tailgate (→P.113)
- C** Opens the windows^{*1} and the panoramic moon roof^{*1, 2} (→P.113)
- D** Opens/closes the power tailgate and deploys power bed step^{*1, 2}. (→P.121, 130)
- E** Sounds the alarm

^{*1}: This setting must be customized at your Toyota dealer.

^{*2}: If equipped

■ **Theft deterrent panic mode**

When (🔊) **HOLD** is pressed for longer than about one second, an alarm will sound intermittently and the vehicle lights will flash to deter any person from trying to break into or damage your vehicle.

To stop the alarm, press any button on the electronic key.

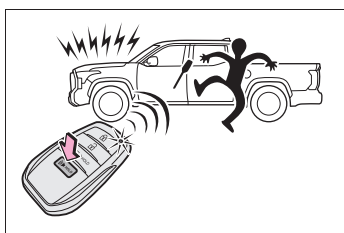

Using the mechanical key

To take out the mechanical key, slide the release lever **A** and take the key out.

The mechanical key can only be inserted in one direction, as the key only has grooves on one side. If the key cannot be inserted in a lock cylinder, turn it over and re-attempt to insert it.

After using the mechanical key, store it in the electronic key. Carry the mechanical key together with the electronic key. If the electronic key battery is depleted or the entry function does not operate properly, you will need the mechanical key. (→P.553)

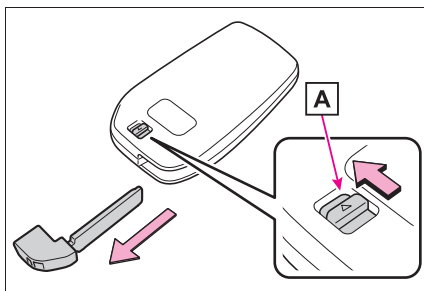

■ **When required to leave the vehicle's key with a parking attendant**

Remove the mechanical key for your own use and provide the attendant with the electronic key only.

■ **If you lose your mechanical keys**

→P.553

■ **If a wrong key is used**

The key cylinder rotates freely, isolated from the internal mechanism.

Side doors

Unlocking and locking the doors from the outside

Smart key system (entry function)

Carry the electronic key to enable this function.

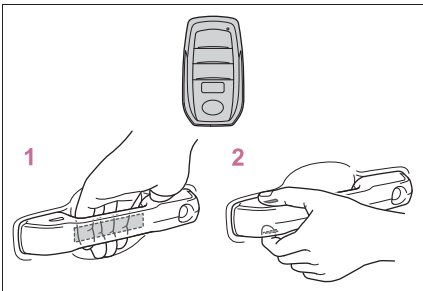

- 1** Grip the driver's door handle to unlock the door. Holding the driver's door handle for approximately 2 seconds unlocks all the doors. Grip front passenger door handle to unlock all the doors.*

Make sure to touch the sensor on the back of the handle.

The doors cannot be unlocked for 3 seconds after the doors are locked.

- 2** Touch the lock sensor (indentation on the upper part or lower part of the handle) to lock all the doors.

Check that the door is securely locked.

*: The door unlock settings can be changed.

Wireless remote control

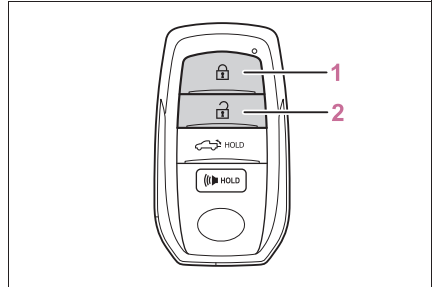

- 1** Locks all the doors and the tailgate

Check that the doors and the tailgate are securely locked.

- 2** Unlocks all the doors and the tailgate

Pressing the button unlocks the driver's door. Pressing the button again within 5 seconds unlocks the other door.

Press and hold to open the windows*1 and the panoramic moon roof*1, 2

*1: This setting must be customized at your Toyota dealer.

*2: If equipped

Switching the door unlock function



It is possible to set which doors the entry function unlocks using the wireless remote control.

- 1** Turn the power switch off.
- 2** When the indicator light on the key surface is not on, press and hold , HOLD or HOLD for approximately 5 seconds while pressing and holding .

The setting changes each time an operation is performed, as shown below. (When changing the setting

114 3-2. Opening, closing and locking the doors and tailgate

continuously, release the buttons, wait for at least 5 seconds, and repeat step 2.)

Multi-information display/Beep	Unlocking function
 <p>Exterior: Beeps 3 times Interior: Pings once</p>	<p>Holding the driver's door handle unlocks only the driver's door.</p>
	<p>Holding the front passenger door handles unlocks all the doors and tailgate.</p>
 <p>Exterior: Beeps twice Interior: Pings once</p>	<p>Holding either front door handle unlocks all the doors and tailgate.</p>

To prevent unintended triggering of the alarm, unlock the doors using the wireless remote control and open and close a door once after the settings have been changed. (If a door is not opened within 60 seconds after  is pressed, the doors will be locked again and the alarm will automatically be set.)

In a case that the alarm is triggered, immediately stop the alarm. (→P.83)

■ Impact detection door lock release system

In the event that the vehicle is subject to a strong impact, all the doors are unlocked. Depending on the force of the impact or the type of accident, however, the system may not operate.

■ Operation signals

A buzzer sounds and the emergency flashers flash to indicate that the doors have been locked/unlocked. (Locked: once; Unlocked: twice)

A buzzer sounds to indicate that the windows are operating.

■ Security feature

If a door is not opened within approximately 60 seconds after the vehicle is unlocked, the security feature automatically locks the vehicle again.

■ When the doors cannot be locked by the lock sensor on the upper part of the door handle

If the door will not lock even when the topside sensor area is touched, try touching both the topside and underside sensor areas at the same time.

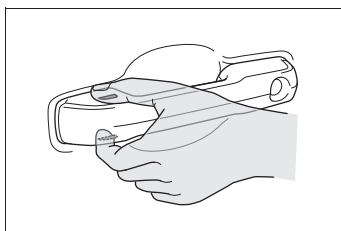

■ Open door warning buzzer

If an attempt to lock the doors is made when a door is not fully closed, a buzzer sounds continuously for 5 seconds. Fully close the door to stop the buzzer, and lock the vehicle once more.

■ Setting the alarm

Locking the doors will set the alarm system. (→P.83)

■ Conditions affecting the operation of the smart key system or wireless remote control

→P.133

■ If the smart key system or the wireless remote control does not operate properly

Use the mechanical key to lock and unlock the doors. (→P.554)
Replace the key battery with a new one if it is depleted. (→P.510)

■ If the 12-volt battery is discharged

The doors cannot be locked and unlocked using the smart key system or wireless remote control. Lock or unlock the doors using the mechanical key. (→P.554)

■ Rear seat reminder function

- In order to remind you not to forget luggage, etc., in the rear seat, when the power switch is turned to OFF after any of the following conditions are met, a buzzer will sound and a message will be displayed on the multi-information display for approximately 6 seconds.
- The hybrid system is started within 10 minutes after opening and closing a rear door.
- A rear door has been opened and closed after the hybrid system was started.

However, if a rear door is opened and then closed within approximately 2 seconds, the rear seat reminder function may not operate.

- The rear seat reminder function determines that luggage, etc., has been placed in a rear seat based on opening and closing of a rear door. Therefore, depending on the situation, the rear seat reminder function may not operate and you may still forget luggage, etc., in the rear seat, or it may operate unnecessarily.
- The rear seat reminder function can be enabled/disabled. (→P.588)

■ Customization

Some functions can be customized. (→P.588)

WARNING

■ To prevent an accident

Observe the following precautions while driving the vehicle. Failure to do so may result in a door opening and an occupant falling out of the vehicle, resulting in death or serious injury.

- Ensure that all doors are properly closed and locked.
- Do not pull the inside handle of the doors while driving.
Be especially careful for the front doors, as the doors may be opened even if the inside lock buttons are in locked position.
- Set the rear door child-protector locks when children are seated in the rear seats.

■ When opening or closing a door

Check the surroundings of the vehicle such as whether the vehicle is on an incline, whether there is enough space for a door to open and whether a strong wind is blowing. When opening or closing the door, hold the door handle tightly to prepare for any unpredictable movement.

Unlocking and locking the doors from the inside

■ Door lock switches (to lock/unlock)

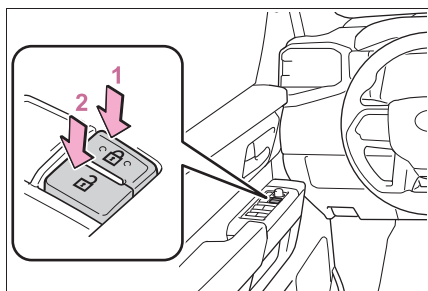

- 1 Locks all the doors
- 2 Unlocks all the doors

■ Inside lock buttons

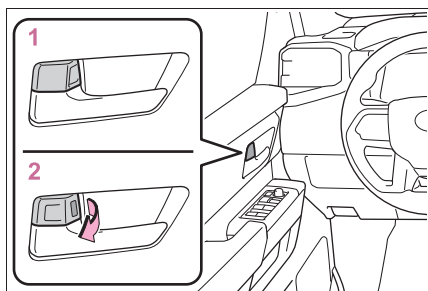

- 1 Locks the door
- 2 Unlocks the door

The front doors can be opened by pulling the inside handle even if the lock buttons are in the lock position.

■ Locking the front doors from the outside without a key

- 1 Move the inside lock button to the lock position.
- 2 Close the door.

The door cannot be locked if the power switch is in ACC or ON, or the electronic key is left inside the vehicle. However, the key may not be detected correctly and the door

may be locked.

■ Open door warning buzzer

If a door is not fully closed, a buzzer will sound when the vehicle speed reaches 3 mph (5 km/h). The open door(s) is indicated on the multi-information display.

Rear door child-protector lock

The door cannot be opened from inside the vehicle when the lock is set.

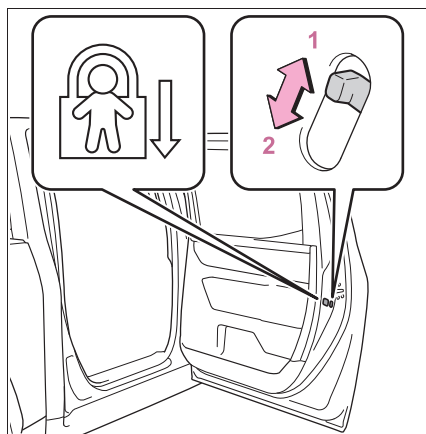

- 1 Unlock
- 2 Lock

These locks can be set to prevent children from opening the rear doors. Push down on each rear door switch to lock both rear doors.

Automatic door locking and unlocking systems

The following functions can be set or canceled:

For instructions on customizing, refer to P.588.

Function	Operation
Speed linked door locking function	All doors are automatically locked when vehicle speed is approximately 12 mph (20 km/h) or higher.
Shift position linked door locking function	All doors are automatically locked when the shift position is shifted to a position other than P.
Shift position linked door unlocking function	All doors are automatically unlocked when the shift position is shifted to P.
Driver's door linked door unlocking function	All doors are automatically unlocked when driver's door is opened within approximately 45 seconds after turning the power switch off.

Power running boards*

*: If equipped

The power running boards deploy when opening a door or by using the switch inside the vehicle.

The power running boards stow by closing a door, operating the switch inside the vehicle, or by driving 3 mph (5 km/h) or higher.

⚠ WARNING

■ Cautions regarding the power running boards

Observe the following precautions. Failure to do so may cause serious injury.

- Check to make sure that all passengers and people in the vehicle's surrounding area do not have a hand on the boards or any part of their body in a position where it could be caught between the boards and the vehicle when the power running boards is being operated.
- Confirm that the boards have completely deployed or stowed before getting in or out of the vehicle. If someone gets in or out of the vehicle during the power running boards operation, the boards may stop deploying or stowing.
- Take care when pressing the power steps switch. The boards will deploy or stow and may hit other people or objects.

⚠ WARNING

- Always check that the power steps switch is turned off when cleaning the boards, before jacking up or placing any object under the vehicle, or if boards are not operating correctly.
- Do not allow children to operate the power running boards. Operating the power running boards so that the boards contacts someone can cause serious injury, and in some instances, even death.

■ Jam protection function

Observe the following precautions.

Failure to do so may cause serious injury.

Do not place any body part between the boards and vehicle.

The jam protection function may not work depending on the shape of the object that is caught.

Side door linked operation

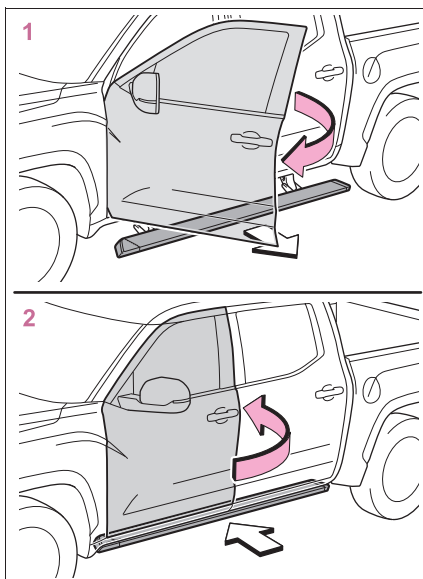

- 1 Opening a door: The appropriate board deploys.
- 2 Closing a door: The appropriate board stows.

■ Jam protection function

If a board contacts an obstacle when deploying, it will stow. If an obstacle gets caught between a board and the vehicle when stowing, the board will deploy.

If an obstacle is detected 3 times in a row during power running board operation, the board will stop at the position it contacts the obstacle. When the side door on the same side as the board is opened and closed, or switch is operated once the obstacle is cleared, the board will attempt to stow or deploy again.

■ Automatic stowing function

The boards will be automatically stowed, for safety, under the following conditions:

- A board is not completely stowed
- Vehicle speed is approximately 3 mph (5 km/h) or higher

The boards will not automatically deploy again when vehicle speed returns to less than 3 mph (5 km/h).

■ **If “Running Board Unable to Deploy” is displayed on the multi-Information display**

The board may not be completely deployed.

Close and open the door once more or use the switch inside the vehicle (→P.119) and completely deploy the board.

■ **If “Power Steps Unable to Retract” is displayed on the multi-Information display**

The boards may not be completely stowed.

Check that nothing is caught between the boards and the vehicle.

■ **If “Power Steps System Malfunction See Owner’s Manual” is displayed on the multi-information display**

The system may be malfunctioning. Have the vehicle inspected by Toyota dealer.

■ **When snow or mud is attached to the boards or the boards are frozen**

The power running boards may not operate correctly. Before stepping on a board, check that it is completely deployed. If the power running boards are not operating correctly, turn the power steps switch off and refrain from use.

■ **After recharging/reconnecting the 12-volt battery**

If the power running boards have not completely deployed or stowed, the boards may not move in the intended direction the first time they are operated. However, from the second time onwards, the boards will resume normal operation.

■ **When getting in and out of the vehicle**

Take care because clothes and shoes may become dirty due to contact with the lower part of the vehicle body.

Deploying and stowing the power running boards from inside

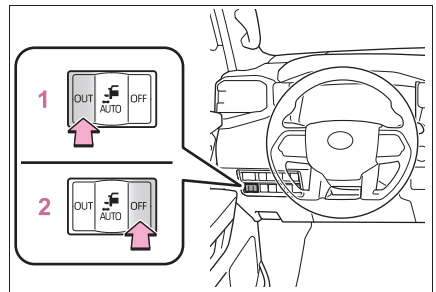

- 1 Deploys the running boards on both sides.
- 2 Stows the running boards on both sides.

The power bed step is also linked with switch operations. (→P.129)

Putting the switch in the neutral position sets the power running boards to AUTO mode. AUTO mode allows the deploying/stowing of the boards to be linked to opening/closing of the side doors.

Both power running boards and power bed step are deployed when “OUT” position is selected. Operation only if steps are not already deployed.

Both power running boards and power bed step are stowed when “OFF” position is selected. Operation only if steps are not already stowed.

■ Automatic stowing function

The boards will be automatically stowed, for safety, under the following condition:

- Vehicle speed is approximately 3 mph (5 km/h) or higher

Tailgate

The tailgate can be locked/unlocked and opened/closed by the following procedures.

⚠ WARNING

■ Caution while driving

Observe the following precautions. Failure to do so may result in death or serious personal injury.

- Do not drive with the tailgate open.
- Do not allow anyone to get on the rear step bumper.

Locking/unlocking the tailgate

■ Smart key system (entry function)

Carry the electronic key to enable this function.

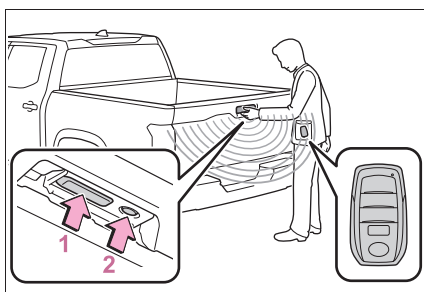

1 Opens/closes the tailgate

The tailgate cannot be unlocked for 3 seconds after the tailgate is locked.

2 Locks all the doors and the tailgate

Check that the tailgate is securely locked.

■ **Using the wireless remote control**

→P.111

Opening/closing the tailgate

■ **Using the wireless remote control**

Press and hold the switch.

The power tailgate automatically opens/closes.

Pressing the switch while the power tailgate is opening/closing reverses the operation, after two presses the switch the function is stopped.

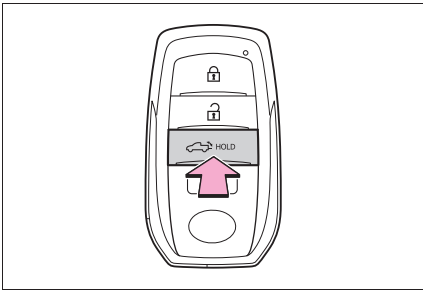

■ **Opening/closing the tailgate from the inside**

Press and hold the switch.

The power tailgate automatically opens/closes.

Pressing the switch while the power tailgate is opening/closing reverses the operation, after twice press the switch the function is stopped.

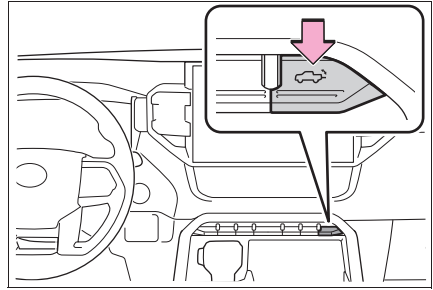

■ **Opening the tailgate**

When the tailgate is unlocked:
Press the tailgate opener switch.

When the tailgate is locked: While carrying the electronic key on your person, press the tailgate opener switch.

The power tailgate automatically opens.

Pressing the switch while the power tailgate is opening/closing reverses the operation. After two additional reverse operations, the switch function is stopped. To reactivate switch, manually close tailgate.

The support cables will hold the tailgate horizontal.

122 3-2. Opening, closing and locking the doors and tailgate

- ▶ Tailgate opener switch on tail lamp

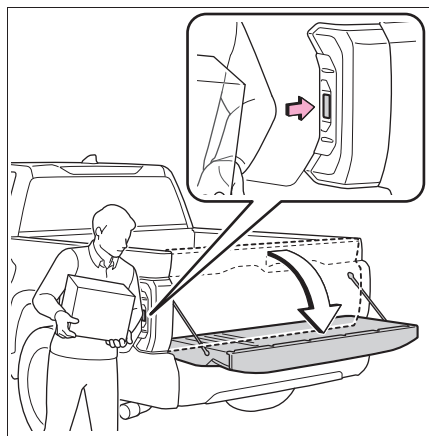

- ▶ Tailgate opener switch on tailgate handle

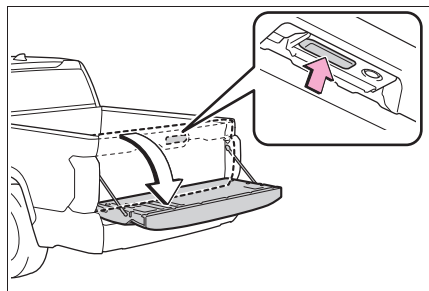

■ Closing the tailgate

- ▶ Using the tailgate opener switch on tail lamp

Press the switch.

The power tailgate automatically closes.

Pressing the switch while the power tailgate is opening/closing reverses tailgate operation. After two presses of the switch, the tailgate is stopped.

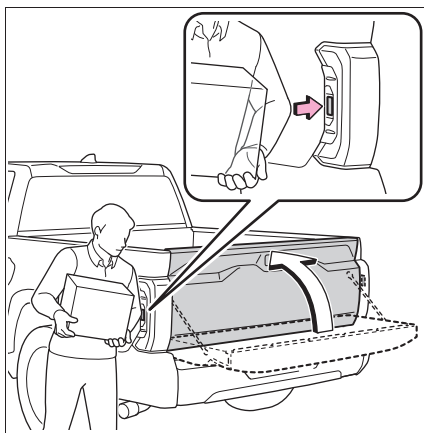

- ▶ Close assist

Lift the tailgate from the full-open position to at least 0.8 in. (2 cm) using hands or knee.

The tailgate closing assist will be activated, and the power tailgate will fully close automatically.

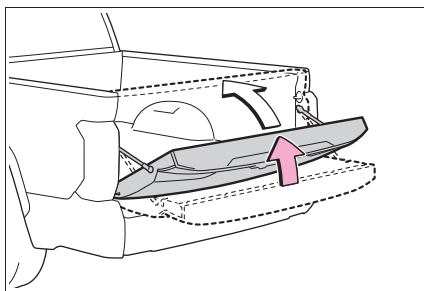

■ Changing the setting of tailgate open alert

When the tailgate is left open, a warning message is displayed on the multi-information display.

Settings can be changed on “ Settings” screen of the multi-information display.

Select the “ Alert” and change the settings. (→P.593)

■ Tailgate closer

In the event that the tailgate is left partially latched, the tailgate closer will automatically close it to the fully closed position.

Whatever the state of the power switch, the tailgate closer operates.

■ Battery saving function

When the power switch is off and the tailgate is open for more than 8 hours, the close assist may not be activated.

If you unlock the doors, or open a door with the electronic key on your person, (→P.131) any of these things will wake the system and close assist will activate.

■ Power tailgate operating conditions

The power tailgate can automatically open and close under the following conditions:

- When the power tailgate system is enabled. (→P.125)
- When the tailgate is unlocked.

However, if the tailgate opener switch on the tailgate handle or the tail lamps is pressed while carrying the electronic key on your person, the power tailgate will be operated even if the tailgate is locked. (→P.121)

- Vehicle speed is below approximately 2 mph (3 km/h).

■ Operation of the power tailgate

- The emergency flashers twice flash to indicate that the tailgate is opening/closing.
- While carrying the electronic key on your person, the tailgate can be operated when the other doors are locked.
- When the power tailgate system is disabled, the power tailgate does not operate but it can be opened and closed by hand by pressing

the tailgate open switch on the tailgate handle or the tail lamp.

- When the power tailgate automatically opens, if an abnormality due to people or objects is detected, operation will stop.
- Cargo pushing on, or leaning on the tailgate may cause it to open quickly. Lift or reposition cargo to prevent this risk prior to operating power tailgate. Also, if customer pushes down on the tailgate with more than 99 lbf (441 N, 45 kgf) force, the clutch in the spindle will slip and the tailgate will open more quickly than normal.

■ Jam protection function

The motor has detection function to detect jam, there also are sensors on each side of the tailgate. If something obstructs the power tailgate while it is closing, the tailgate will automatically stop.

After jam protection function operate, power tailgate system is disabled. The power tailgate system is re-enabled when the tailgate is fully closed manually. (→P.540)

■ Initializing the power tailgate

If the tailgate is reattached or the battery is reinstalled, it must be initialized by manually closing the tailgate fully.

■ Manual mode

The power tailgate changes to manual mode under the following conditions:

- Jam protection function operates.
- The power tailgate system is turned off on the multi-information display.
- When the power tailgate system has an internal failure.
- When the tailgate has been removed and re-attached (and the wire harness connectors re-attached) but the tailgate has not

124 3-2. Opening, closing and locking the doors and tailgate

been fully closed yet.

- When the battery has been disconnected and re-attached while the tailgate is open but the tailgate has not been fully closed yet.

■ Customization

Some functions can be customized.
(Customizable features: →P.588)

⚠ WARNING

■ Tailgate closer

- In the event that the tailgate is left partially latched, the tailgate closer will automatically close it to the fully closed position. It takes several seconds before the tailgate closer begins to operate. Be careful not to get fingers or anything else caught in the path of the power tailgate or tailgate hinges, as this may cause bone fractures or other serious injuries.

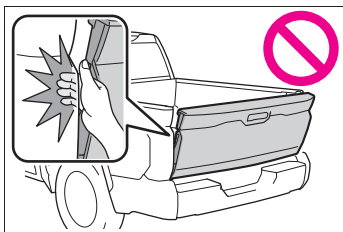

- Use caution when using the tailgate closer as it still operates when the power tailgate system is canceled.

■ Power tailgate

Observe the following precautions when operating the power tailgate.

Failure to do so may cause death or serious injury.

- Check the safety of the surrounding area to make sure there are no obstacles or anything that could cause any of your belongings to get caught.

- If anyone is in the vicinity, make sure they are safely away from the tailgate so they will not be contacted by the tailgate or by cargo during opening and let them know that the tailgate is about to open or close.

- If the power tailgate system is turned off while the tailgate is operating automatically, the automatic operation is stopped. The tailgate then has to be operated manually. Take extra care when on upward inclines, as the tailgate may open unexpectedly.

- If the operating conditions of the power tailgate are no longer met, a buzzer may sound and the tailgate may stop opening or closing. The tailgate then has to be operated manually. Take extra care when on upward inclines, as the tailgate may open abruptly.

- Do not apply a large load to the edge of the tailgate during the operation of the tailgate opening. Take extra care as the tailgate may open abruptly.

- In the following situations, the power tailgate may detect an abnormality and automatic operation may be stopped. In this case, the tailgate has to be operated manually. Take extra care when on upward inclines, as the tailgate may open abruptly.

- When the tailgate contacts an obstacle

- When the battery voltage suddenly drops, such as when the power switch is turned to ON or the hybrid system is started during automatic operation

⚠ WARNING

■ Jam protection function

Observe the following precautions. Failure to do so may cause death or serious injury.

- Never use any part of your body to intentionally activate the jam protection function.
- The jam protection function may not work if something gets caught just before the tailgate fully closes. Be careful to not get fingers or anything else caught.
- The jam protection function may not work depending on the shape of the object that is caught. Be careful to not get fingers or anything else caught.

- Take care not to damage the sensors (installed on the right and left edges of the power tailgate) with a knife or other sharp object. If the sensor is disconnected, the power tailgate will not close automatically.

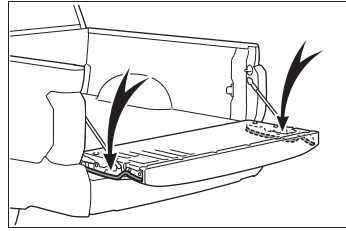

Changing settings of the power tailgate system

The settings of the power tailgate system can be changed by displaying the “⚙ Settings” -



screen from the setting screen of the multi-information display.

The changed power tailgate settings are not reset by turning the power switch to OFF. In order to restore the original settings, they need to be changed back on the setting screen of the multi-information display.

⚠ NOTICE

■ To prevent tailgate closer malfunction

Do not apply excessive force to the tailgate while the tailgate closer is operating. Applying excessive force may cause the tailgate closer to malfunction.

■ To prevent damage to the power tailgate

- Make sure that there is no ice between the tailgate and frame that would prevent movement of the tailgate. Operating the power tailgate when excessive load is present on the tailgate may cause a malfunction.

Removing the tailgate

■ Before removing the tailgate

Turn the tailgate open alert and power tailgate system (if equipped) off before removing the tailgate. (→P.121, 122)

These connector covers* are used when removing the tailgate, to prevent the wire harness connectors from being contaminated.

*: Contact a Toyota dealer to inquire about connector covers.

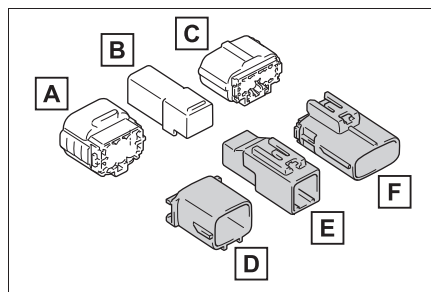

A Connector cover (Type A)

B Connector cover (Type B)

C Connector cover (Type C)

D Connector cover (Type D)

E Connector cover (Type E)

F Connector cover (Type F)

Store the connector covers in the glove box in a plastic bag when not using.

1 Open the tailgate.

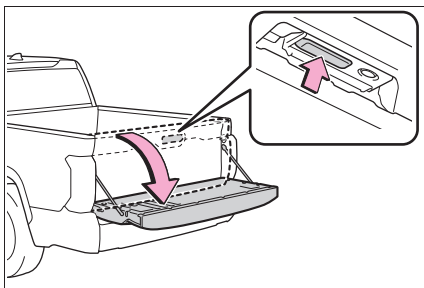

2 Disconnect the wire harness connectors.

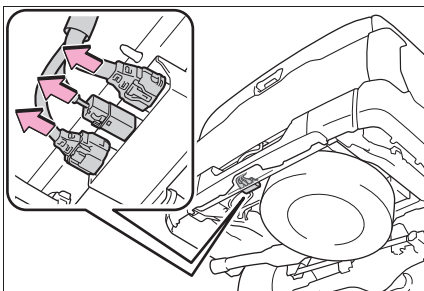

3 Install the connector cover (Type A, B, and C) to the wire harness connector of the vehicle body frame.

The shape of each connector differs. Install connector cover to the corresponding connector.

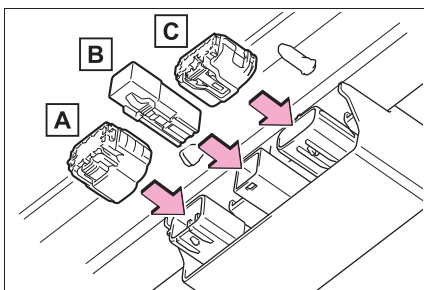

A Connector cover (Type A)

B Connector cover (Type B)

C Connector cover (Type C)

- 4 Pull out the plastic wire protector located in the vehicle bed by pressing the tabs and pulling the protector.

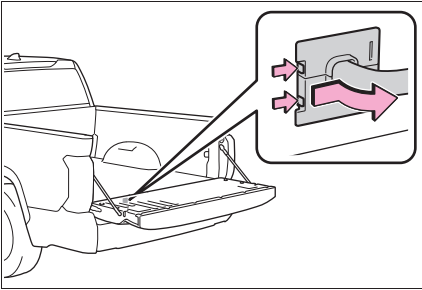

- 5 Pull out the wire harness from the vehicle bed.

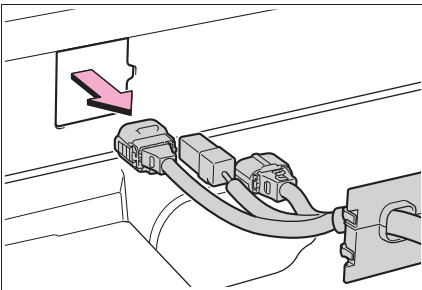

- 6 Install the connector cover (Type D, E, and F) to the wire harness connector of the tailgate.

The shape of each connector differs. Install connector cover to the corresponding connector.

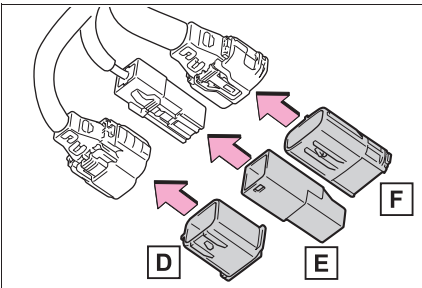

- D Connector cover (Type D)

- E Connector cover (Type E)

- F Connector cover (Type F)

■ Removing the tailgate

- 1 Open the tailgate to the angle where you can release the brackets on the support cables from the lugs on both sides.
Lift the support cable bracket up and slide it off.

To unhook the support cable bracket, keep pulling up the clip on the bracket and unhook the bracket.

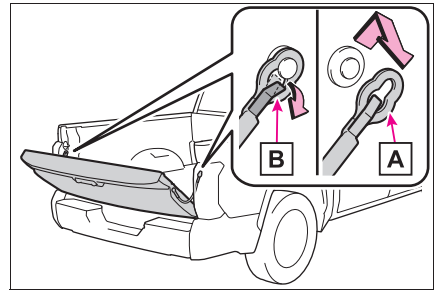

- A Support cable bracket

- B Clip

- 2 Tilt the tailgate to about 45° from vertical and pull up the right side of the tailgate to unhook the right side.

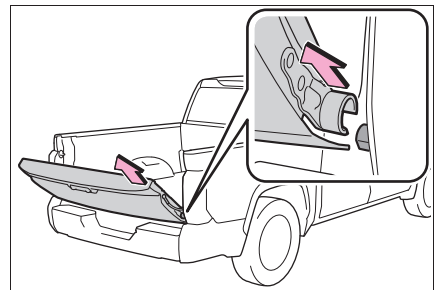

128 3-2. Opening, closing and locking the doors and tailgate

3 Tilt the tailgate up to 15°.

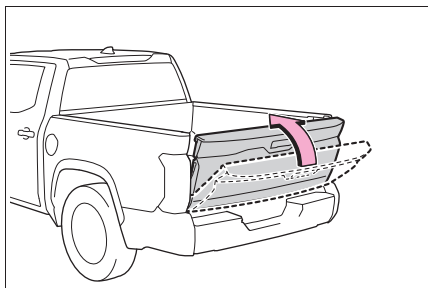

4 Slide the tailgate a little to the right to unhook the left side.

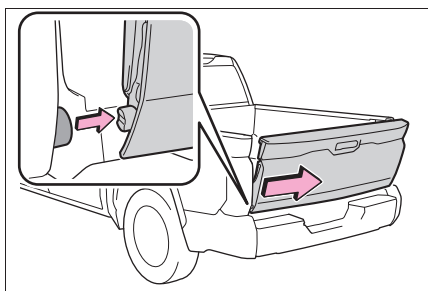

To attach the tailgate, follow the removal procedure in reverse order.

WARNING

■ Before removing the tailgate

Disconnect the wire harness between the back-up camera and the vehicle.

Failure to do so may result in serious personal injury or damage to the vehicle components.

NOTICE

■ To prevent damage to the tailgate wire harness

Do not pull out all of the tailgate wire harness before opening the tailgate.

■ To prevent damage to the camera lens

Store the removed tailgate with the back-up camera lens facing upward.

■ After removing the tailgate

While the tailgate is removed, an open tailgate icon is displayed each time the power switch is turned ON.

This icon is removed by pressing  on meter control switches or customize (→P.122).

■ Initializing the power tailgate

→P.123

Rear step bumper

For rear end protection and easier step-up loading.

To get on the rear step bumper, use the shaded area in the illustration.

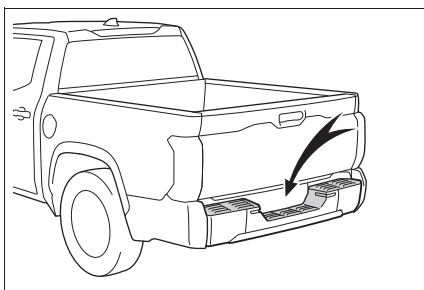

NOTICE

■ To prevent damage to the rear step bumper

Do not allow more than one person to get on the rear step bumper at a time.

Power bed step*

* : If equipped

The power bed step deploys when opening the tailgate, operating the wireless remote control, or by using the switch inside the vehicle.

The power bed step stows by closing the tailgate, operating the switch inside the vehicle, or by driving above 3 mph (5 km/h).

■ Automatic stowing function

The step will be automatically retracted, for safety, under the following condition:

- Vehicle speed is approximately 3 mph (5 km/h) or higher

■ If “Power Steps Unable to Retract” is displayed on the multi-Information display

The step may not be completely stowed.

Check that nothing is caught between the step and the vehicle.

■ If “Power Steps System Malfunction See Owner’s Manual” is displayed on the multi-information display

The system may be malfunctioning. Have the vehicle inspected by Toyota dealer.



WARNING

■ Cautions regarding the power bed step

Observe the following precautions. Failure to do so may cause serious injury.

- Check to make sure that all passengers and people in the vehicle’s surrounding area do not have a hand on the step or any part of their body in a position where it could be caught between the step and the vehicle when the power bed step is being operated.
- Confirm that the step has completely deployed or stowed before getting in or out of the vehicle. If someone gets in or out of the vehicle during power bed step operation, the step may stop deploying or stowing.
- Take care when pressing the power steps switch. The step will deploy or stow and may hit other people or objects.
- Always check that the power steps switch is turned off when cleaning the step, before jacking up or placing any object under the vehicle, or if the step is not operating correctly.
- Do not allow children to operate the power bed step. Operating power bed step so that a step contacts someone can cause serious injury, and in some instances, even death.
- **Jam protection function**
Observe the following precautions. Failure to do so may cause serious injury.
Do not place any body part between the power bed step and vehicle. The jam protection function may not work depending on the shape of the object that is caught.

Deploying and stowing the power bed step with wireless remote control

Press the switch.

The power bed step automatically deploys with the tailgate or stows.

Before pressing the button, make sure the power steps switch is in “AUTO” position.

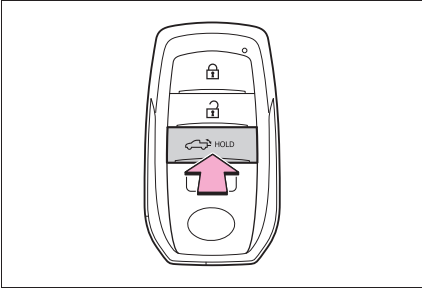

Deploying and stowing the power bed step from inside

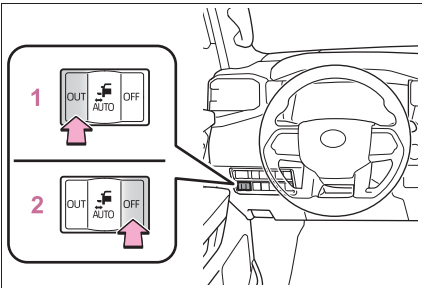

1 Deploys the bed step.

2 Stows the bed step.

Putting the switch in the neutral position sets the power bed step to AUTO mode. AUTO mode allows the deploying and stow-

ing of the step to be linked to opening/closing the tailgate.

Both power running boards and power bed step are deployed when “OUT” position is selected. Operate only if the steps are not already deployed and if the vehicle speed is 3 mph (5 km/h) or less.

Both power running boards and power bed step are stowed when “OFF” position is selected. Operate only if the step is not already stowed.

Tailgate linked operation

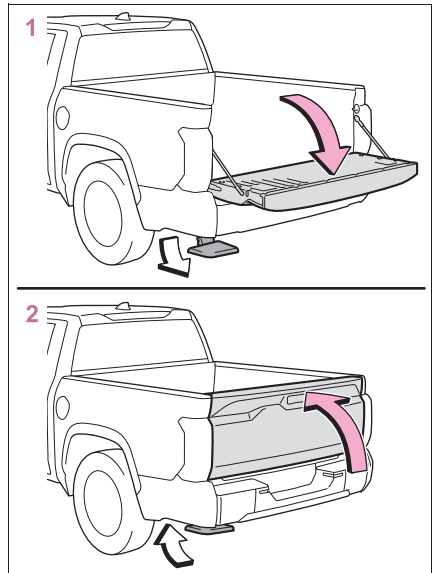

1 Opening the tailgate: The step deploys.

2 Closing the tailgate: The step stows.

Smart key system

The following operations can be performed simply by carrying the electronic key on your person, for example in your pocket. The driver should always carry the electronic key.

- Locks and unlocks the doors (→P.113)
- Locks and unlocks the tailgate (→P.120)
- Starts the hybrid system (→P.207)

Antenna location

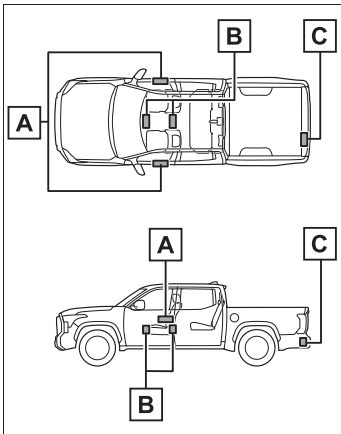

- A** Antennas outside the cabin
- B** Antennas inside the cabin
- C** Antenna inside rear bumper

Effective range (areas within which the electronic key is detected)

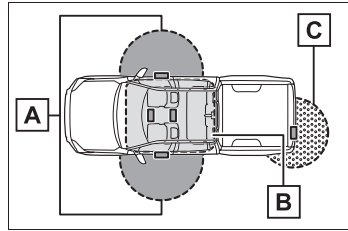

- A** When locking or unlocking the doors

The system can be operated when the electronic key is within about 2.3 ft. (0.7 m) of an outside door handle. (Only the doors detecting the key can be operated.)

- B** When starting the hybrid system or changing power switch modes

The system can be operated when the electronic key is inside the vehicle.

- C** When opening/closing the power tailgate

The system can be operated when the electronic key is within about 2.3 ft. (0.7 m) of the tailgate release button.

Alarms and warning messages

An alarm sounds and warning messages are displayed on the multi-information display to protect against unexpected accidents or theft of the vehicle resulting from erroneous operation. When a warning message is displayed, take appropriate measures based on the displayed message. (→P.537)

When only an alarm sounds, circumstances and correction procedures are as follows.

132 3-2. Opening, closing and locking the doors and tailgate

- When an exterior alarm sounds once for 5 seconds

Situation	Correction procedure
An attempt was made to lock the vehicle while a door was open.	Close all of the doors and lock the doors again.

- When an interior alarm sounds continuously

Situation	Correction procedure
The power switch was turned to ACC while the driver's door was open (The driver's door was opened when the power switch was in ACC).	Turn the power switch off and close the driver's door.
The power switch was turned off while the driver's door was open.	Close the driver's door.

■ If “Smart Key System Malfunction See Owner’s Manual” is displayed on the multi-information display

The system may be malfunctioning. Have the vehicle inspected by Toyota dealer immediately.

■ If “Key Detected in Vehicle” is shown on the multi-information display

An attempt was made to lock the doors using the smart key system while the electronic key was still inside the vehicle. Retrieve the electronic key from the vehicle and lock the doors again.

■ Battery-saving function



The battery-saving function will be activated in order to prevent the

electronic key battery and the 12-volt battery from being discharged while the vehicle is not in operation for a long time.

- In the following situations, the smart key system may take some time to unlock the doors.
 - The electronic key has been left in an area of approximately 6 ft. (2 m) of the outside of the vehicle for 10 minutes or longer.
 - The smart key system has not been used for 5 days or longer.
 - If the smart key system has not been used for 14 days or longer, the doors cannot be unlocked at any doors except the driver's door. In this case, take hold of the driver's door handle, or use the wireless remote control or the mechanical key, to unlock the doors.

■ Turning an electronic key to battery-saving mode

- When battery-saving mode is set, battery depletion is minimized by stopping the electronic key from receiving radio waves.

Press  twice while pressing and holding . Confirm that the electronic key indicator flashes 4 times. While the battery-saving mode is set, the smart key system cannot be used. To cancel the function, press any of the electronic key buttons.

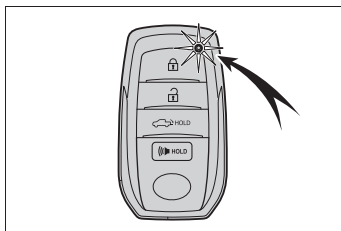

- Electronic keys that will not be used for long periods of time can be set to the battery-saving mode in advance.

■ Conditions affecting operation

The smart key system uses weak radio waves. In the following situations, the communication between the electronic key and the vehicle may be affected, preventing the smart key system, wireless remote control and immobilizer system from operating properly. (Ways of coping: →P.553)

- When the electronic key battery is depleted
- Near a TV tower, electric power plant, gas station, radio station, large display, airport or other facility that generates strong radio waves or electrical noise
- When carrying a portable radio, cellular phone, cordless phone or other wireless communication device
- When the electronic key is in contact with, or is covered by the following metallic objects
 - Cards to which aluminum foil is attached
 - Cigarette boxes that have aluminum foil inside
 - Metallic wallets or bags
 - Coins
 - Hand warmers made of metal
 - Media such as CDs and DVDs
- When other wireless keys (that emit radio waves) are being used nearby
- When carrying the electronic key together with the following devices that emit radio waves
 - Another electronic key or a wireless key that emits radio waves
 - Personal computers or personal digital assistants (PDAs)
 - Digital audio players
 - Portable game systems
- If window tint with a metallic content or metallic objects are attached to the rear window
- When the electronic key is placed near a battery charger or electronic devices
- When the vehicle is parked in a pay parking spot where radio waves are emitted.

■ Note for the entry function

- Even when the electronic key is within the effective range (detection areas), the system may not operate properly in the following cases:
 - The electronic key is too close to the window or outside door handle, near the ground, or in a high place when the doors are locked or unlocked.
 - The electronic key is near the ground or in a high place, or too close to the center of the rear bumper.
 - The electronic key is on the instrument panel, or floor, or in the door pockets or glove box when the hybrid system is started or power switch modes are changed.
- Do not leave the electronic key on top of the instrument panel or near the door pockets when exiting the vehicle. Depending on the radio wave reception conditions, it may be detected by the antenna outside the cabin and the doors will become lockable from the outside, possibly trapping the electronic key inside the vehicle.
- As long as the electronic key is within the effective range, the doors may be locked or unlocked by anyone. However, only the doors detecting the electronic key can be used to unlock the vehicle.
- Even if the electronic key is not inside the vehicle, it may be possible to start the hybrid system if the electronic key is near the window.
- The doors may unlock or lock if a large amount of water splashes on the door handle, such as in the rain or in a car wash, when the electronic key is within the effective range. (The doors will automatically be locked after approximately 60 seconds if the

134 3-2. Opening, closing and locking the doors and tailgate

doors are not opened and closed.)

- If the wireless remote control is used to lock the doors when the electronic key is near the vehicle, there is a possibility that the door may not be unlocked by the entry function. (Use the wireless remote control to unlock the doors.)
- Touching the door lock sensor while wearing gloves may delay or prevent lock operation.
- When the lock operation is performed using the lock sensor, recognition signals will be shown up to two consecutive times. After this, no recognition signals will be given.
- If the door handle becomes wet while the electronic key is within the effective range, the door may lock and unlock repeatedly. In this case, follow the following correction procedures to wash the vehicle:
 - Place the electronic key in a location 6 ft. (2 m) or more away from the vehicle. (Take care to ensure that the key is not stolen.)
 - Set the electronic key to battery-saving mode to disable the smart key system. (→P.132)
- If the electronic key is inside the vehicle and a door handle becomes wet during a car wash, a message may be shown on the multi-information display and a buzzer will sound outside the vehicle. To turn off the alarm, lock all the doors.
- The lock sensor may not work properly if it comes into contact with ice, snow, mud, etc. Clean the lock sensor and attempt to operate it again.
- A sudden approach to the effective range or door handle may prevent the doors from being unlocked. In this case, return the door handle to the original position and check that the doors unlock before pulling the door handle

again.

- If there is another electronic key in the detection area, it may take slightly longer to unlock the doors after the door handle is gripped.

■ When the vehicle is not driven for extended periods

- To prevent theft of the vehicle, do not leave the electronic key within 6 ft. (2 m) of the vehicle.
- The smart key system can be deactivated in advance.
- Setting the electronic key to battery-saving mode helps to reduce key battery depletion. (→P.132)

■ To operate the system properly

- Make sure to carry the electronic key when operating the system. Do not get the electronic key too close to the vehicle when operating the system from the outside of the vehicle.

Depending on the position and holding condition of the electronic key, the key may not be detected correctly and the system may not operate properly. (The alarm may go off accidentally, or the door lock prevention function may not operate.)

■ If the smart key system does not operate properly

- Locking and unlocking the doors and tailgate: →P.554
- Starting the hybrid system: →P.554

■ Customization

Some functions can be customized. (→P.588)

■ If the smart key system has been deactivated in a customized setting

- Locking and unlocking the doors and opening the tailgate: Use the wireless remote control or mechanical key. (→P.113, 121, 554)

- Starting the hybrid system and changing power switch modes:
→P.554
- Stopping the hybrid system:
→P.209
- **Certification**
→P.639

**WARNING****■ Caution regarding interference with electronic devices**

- People with implantable cardiac pacemakers, cardiac resynchronization therapy-pacemakers or implantable cardioverter defibrillators should keep away from the smart key system antennas. (→P.131)
The radio waves may affect the operation of such devices. If necessary, the entry function can be disabled. Ask your Toyota dealer for details, such as the frequency of radio waves and timing of the emitted radio waves. Then, consult your doctor to see if you should disable the entry function.
- Users of any electrical medical device other than implantable cardiac pacemakers, cardiac resynchronization therapy-pacemakers or implantable cardioverter defibrillators should consult the manufacturer of the device for information about its operation under the influence of radio waves.
Radio waves could have unexpected effects on the operation of such medical devices.

Ask your Toyota dealer for details on disabling the entry function.

Front seats

The seats can be adjusted (longitudinally, vertically, etc.). Adjust the seat to ensure the correct driving posture.

Adjustment procedure

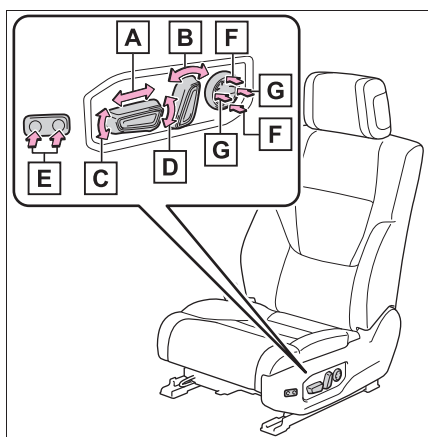

- A** Seat position adjustment
- B** Seatback angle adjustment
- C** Seat cushion (front) angle adjustment
- D** Vertical height adjustment
- E** Seat cushion length adjustment (if equipped)
- F** Lumbar support height adjustment (if equipped)
- G** Lumbar support adjustment

■ When adjusting the seat

- Make sure that any surrounding passengers or objects are not

contact the seat.

- Take care when adjusting the seat so that the head restraint does not touch the ceiling.
- **Power easy access system (if equipped)**

The driver's seat and steering wheel move in accordance with power switch mode and the driver's seat belt condition. (→P.144)

⚠ WARNING

■ When adjusting the seat position

- Take care when adjusting the seat position to ensure that other passengers are not injured by the moving seat.
- Do not put your hands under the seat or near the moving parts to avoid injury. Fingers or hands may become jammed in the seat mechanism.
- Make sure to leave enough space around the feet so they do not get stuck.

■ Seat adjustment

To reduce the risk of sliding under the lap belt during a collision, do not recline the seat more than necessary.

If the seat is too reclined, the lap belt may slide past the hips and apply restraint forces directly to the abdomen, or your neck may contact the shoulder belt, increasing the risk of death or serious injury in the event of an accident. Adjustments should not be made while driving as the seat may unexpectedly move and cause the driver to lose control of the vehicle.

Front seat refresh system (if equipped)

Pneumatic chambers built into the front seat apply pressure to the occupant's body at different modes and intensities.

1 Touch  on the main menu of the multimedia system, then touch "Seat controls" on the sub menu.

2 Touch "Massage".

3 Select driver's seat or front passenger's seat.

4 Select the desired mode.

● "Centripetal"

Applies pressure sequentially from the front of the seat cushion to top of the seatback

● "Centrifugal"

Applies pressure sequentially from the top of the seatback to the front of the seat cushion

● "Upper body"

Applies pressure sequentially from the bottom to the top of the seatback

● "Lower body"

Applies pressure sequentially from the front to the back of the seat cushion

● "Lumbar"

Applies pressure sequentially from the bottom to the top of the lumbar area of the seatback

5 Select the desired intensity and then select  (on).

The intensity can be adjusted in 5 steps.

To stop the operation, select  (off).

If a seat is not occupied, do not operate the front seat refresh system for that seat.

■ Operating conditions

- The power switch is in ON.
- For the front passenger's seat: The weight of an occupant is detected on the front passenger's seat.

Once weight is detected on the seat, the seat will be judged as occupied until the front passenger's door is opened then closed or the power switch is turned off.

■ Automatic stop function

The operation will be canceled automatically after approximately 15 minutes.

WARNING

■ Important points while driving

Do not adjust the driver's seat refresh system while driving.

Using it may affect your ability to control the vehicle, possibly leading to an accident resulting in death or serious injury.

■ Using the refresh system

- Those who are pregnant, have recently given birth, or suffer from ailments requiring rest (heart disease etc.) should consult a doctor before use.
- Do not allow children to use the refresh function.

⚠ WARNING

- Do not use immediately after consuming a meal or alcohol, or for an extended period of time.
- If you feel sick while using the refresh function, immediately discontinue use.

IsoDynamic Performance seat (If equipped)

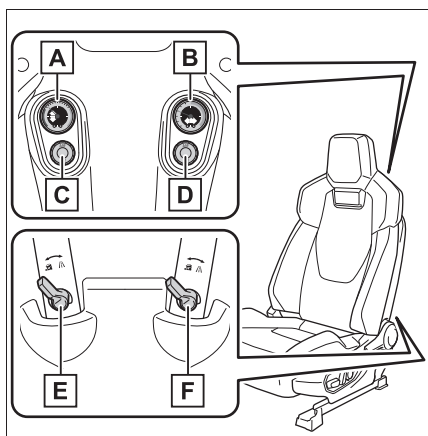

- A** Vertical shock absorber air pressure gauge
- B** Horizontal shock absorber air pressure gauge
- C** Vertical adjust air valve
- D** Horizontal adjust air valve
- E** Vertical shock absorber lock lever
- F** Horizontal shock absorber lock lever

■ **Using the Vertical and Horizontal shock absorber**

- 1 Take out the air pump from the glove box. (→P.432)
- 2 Turn the lever on the IsoDynamic Performance seat to the unlock .

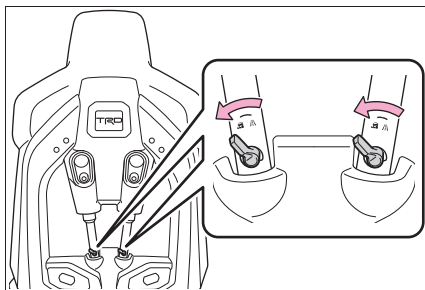

- 3 Remove the valve cap by turning it counterclockwise.

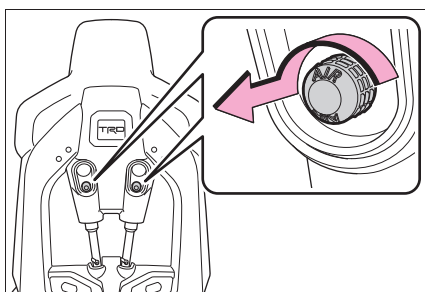

- 4 Attach the air pump nozzle clockwise to the horizontal adjust air valve or vertical adjust air valve.

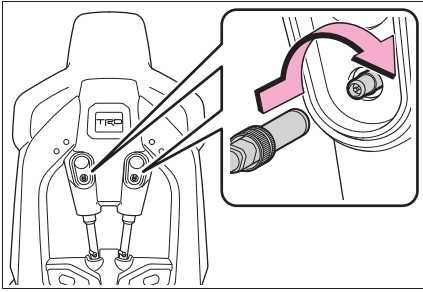

- 5 Adjust the air pressure inside the shock absorber using the air pump, referring to the table below.

Horizontal shock absorber air pressure air gauge

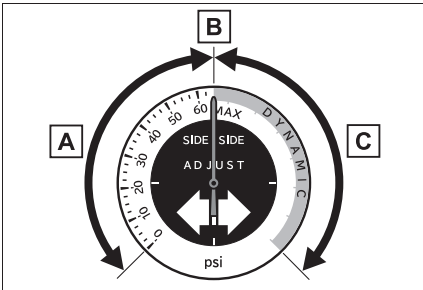

- A** Customer should keep pressure in this area
- B** "MAX"
- C** "DYNAMIC" area

Vertical shock absorber air pres-

sure air gauge

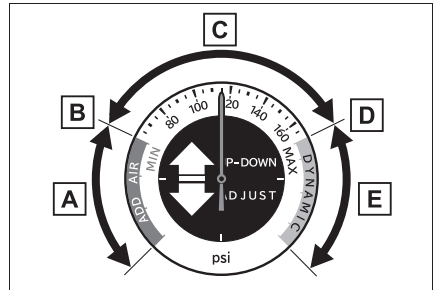

- A** "ADD AIR" area
- B** "MIN"
- C** Customer should keep pressure in this area
- D** "MAX"
- E** "DYNAMIC" area

- If pressure drops into the "ADD AIR" area add air until it is out of this area.
- Pressure may drop into "ADD AIR" area due to temperature or occupant mass fluctuation. If this happens air should be added to the system. If the pressure continually drops into "ADD AIR" area for no reason customer should bring the vehicle to the dealer for inspection.

140 3-3. Adjusting the seats

- If systems are filled to or near the “MAX” the needle may move into the “DYNAMIC” area while driving over rough terrain. This will cause no damage to the shock systems but pressurizing the systems into the “DYNAMIC” area will lead to the shocks being too stiff to see any benefit from the systems. The systems are also equipped with a max pressure relief valve to ensure no damage is done due to over pressurizing.

Horizontal shock absorber air pressure

Occupant Weight lb. (kg)	Low-Speed Off-Road psi (kPa, kgf/cm ² or bar)	Hi-Speed Off-Road psi (kPa, kgf/cm ² or bar)
Below 140 (Below 63.5)	15 (103, 1.03)	20 (138, 1.38)
140 to 170 (63.5 to 77.1)	18 (124, 1.24)	25 (172, 1.72)
170 to 200 (77.1 to 90.1)	20 (138, 1.38)	30 (207, 2.07)
200 to 230 (90.1 to 104)	20 (138, 1.38)	40 (276, 2.76)
230 to 250 (104 to 113)	20 (138, 1.38)	40 (276, 2.76)

Occupant Weight lb. (kg)	Low-Speed Off-Road psi (kPa, kgf/cm ² or bar)	Hi-Speed Off-Road psi (kPa, kgf/cm ² or bar)
250 to 270 (113 to 144)	20 (138, 1.38)	45 (310, 3.10)
270 or more (144 or more)	20 (138, 1.38)	50 (345, 3.45)

Vertical shock absorber air pressure

Occupant Weight lb. (kg)	Low-Speed Off-Road psi (kPa, kgf/cm ² or bar)	Hi-Speed Off-Road psi (kPa, kgf/cm ² or bar)
Below 140 (Below 63.5)	60 (414, 4.14)	70 (483, 4.83)
140 to 170 (63.5 to 77.1)	60 (414, 4.14)	75 (517, 5.17)
170 to 200 (77.1 to 90.1)	65 (448, 4.48)	80 (551, 5.51)
200 to 230 (90.1 to 104)	70 (483, 4.83)	85 (586, 5.86)
230 to 250 (104 to 113)	75 (517, 5.17)	90 (621, 6.21)

Occupant Weight lb. (kg)	Low-Speed Off-Road psi (kPa, kgf/cm ² or bar)	Hi-Speed Off-Road psi (kPa, kgf/cm ² or bar)
250 to 270 (113 to 144)	75 (517, 5.17)	105 (724, 7.24)
270 or more (144 or more)	80 (551, 5.51)	120 (827, 8.27)

- 6 Remove the air pump.
- 7 Install the valve caps.
- 8 After using, turn the shock absorber lock lever to the lock side .

Seats are equipped with shock stroke indicators. These can be used to see how much stroke the shocks are seeing to help decide the necessary pressure for the vertical or horizontal shock systems based on occupant size and terrain.

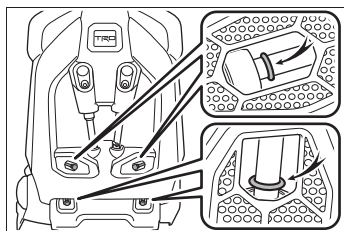

Rear seats

The seatbacks of the rear seats can be folded down. The bottom cushion can be raised.

Folding down and returning the rear seatbacks

- **Folding down the rear seatbacks**
 - 1 Move the front seats forward. (→P.136)
 - 2 Stow the rear armrest. (→P.449)
 - 3 Stow the rear seat belt buckles and the rear center seat belt. (→P.31, 32)
 - 4 Use the seat belt hangers to prevent the belts from being tangled.

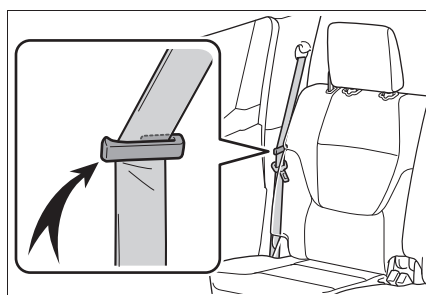

- 5 Lower the head restraint on the rear center seat to the lowest position and fold the head restraints on the rear outboard seats. (→P.148)

142 3-3. Adjusting the seats

- 6 Pull the seatback lock release strap and fold the seatback down.

Each seatback may be folded separately.

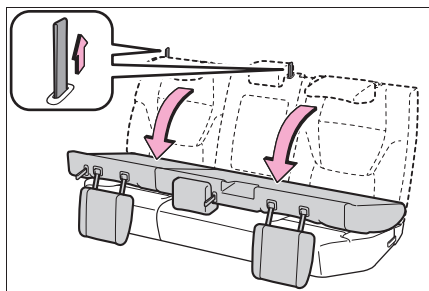

■ Returning the rear seatbacks

- 1 Raise the rear seatback until it locks.

Check that the seat belts are not twisted or caught in the seatback.

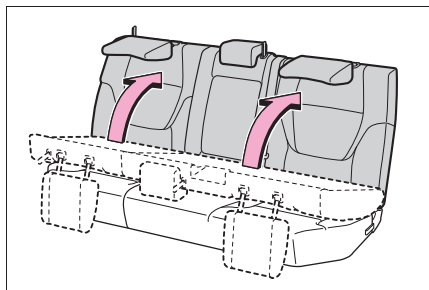

- 2 Returning the head restraints on the rear outboard seats to the original position. (→P.148)

▲ WARNING

Observe the following precautions. Failure to do so may result in death or serious injury.

■ When folding the rear seatbacks down

- Do not fold the seatbacks down while driving.
- Stop the vehicle on level ground, set the parking brake and shift the shift lever to P.
- Do not allow anyone to sit on a folded seatback while driving.
- Do not allow anyone to sit on the rear center seat if the rear right seat is folded down, as the seat belt buckle for the rear center seat belt is then concealed under the folded seat and cannot be used.
- Be careful not to get your hand caught when folding the rear seatbacks.
- Adjust the position of the front seats before folding down the rear seatbacks so that the front seats do not interfere with the rear seatbacks when folding down the rear seatbacks.

■ After returning the rear seatback to the upright position

- Make sure that the seatback is securely locked in position by lightly pushing it back and forth. If the seatback is not securely locked, the red marking will be visible on the seatback lock release strap. Make sure that the red mark is not visible.

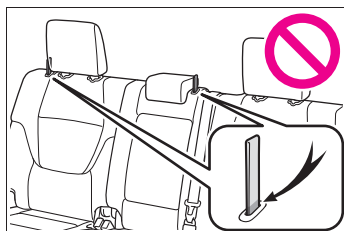

⚠ WARNING

- Check that the seat belts are not twisted or caught in the seatback.

Raising and returning the bottom cushions**■ Raising the bottom cushions**

- 1 Move the front seats forward. (→P.136)
- 2 Stow the rear armrest. (→P.449)
- 3 Stow the rear seat belt buckles.

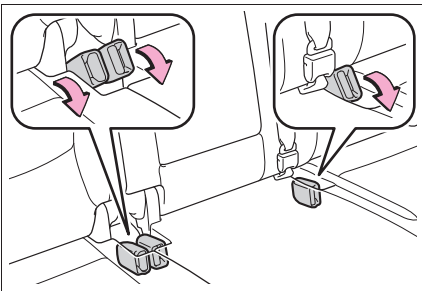

- 4 Use the seat belt hangers to prevent the belts from being tangled.

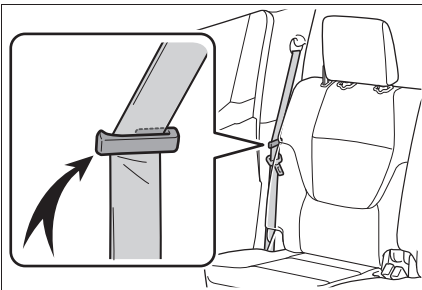

- 5 Raise the bottom cushion until it locks.

Each bottom cushion may be raised separately.

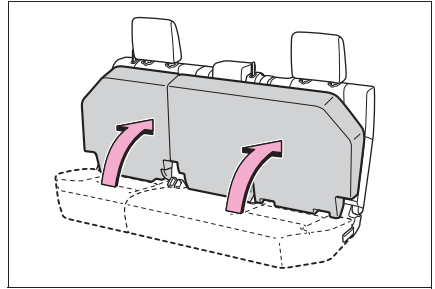
**■ Returning the bottom cushions**

Pull and release the strap, then carefully lower the bottom cushion using your other hand.

Check that the seat belts are not twisted or caught in the seatback.

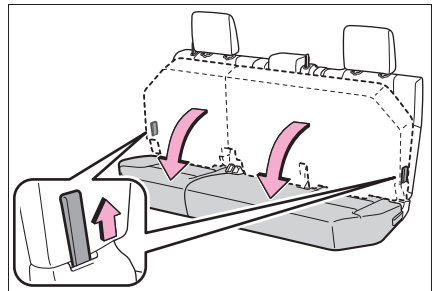
**⚠ WARNING**

Observe the following precautions. Failure to do so may result in death or serious injury.

■ When raising the bottom cushion

- Do not raise the bottom cushion while driving.
- Stop the vehicle on level ground, set the parking brake and shift the shift lever to P.
- Do not allow anyone to sit on the hybrid battery (traction battery) cover while driving.

! WARNING

- Do not allow anyone to sit on the rear center seat if the rear right seat is raised, as the seat belt buckle for the rear center seat belt is then concealed on the bottom cushion and cannot be used.
- Adjust the position of the front seats before raising the bottom cushions so that the front seats do not interfere with the bottom cushion when raising the bottom cushion.
- **When returning the bottom cushions**
- Be careful not to get your hands or feet pinched in the seat.
- Check that the seat belts are not twisted or caught in the bottom cushions.

Driving position memory

This feature automatically adjusts the positions of the driver's seat, steering wheel (power adjustment type) and outside rear view mirrors to make entering and exiting the vehicle easier or to suit your preferences.

Two different driving positions can be recorded.

Each electronic key can be registered to recall your preferred driving position.

Enabling easier driver entry and exit (power easy access system)

The driver's seat and steering wheel (power adjustment type) are automatically adjusted to allow the driver to enter and exit the vehicle easily.

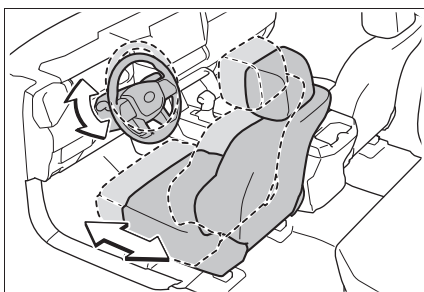

When all of the following have been performed, the driver's seat and steering wheel (power adjustment type) are automati-

cally adjusted to a position that allows driver to enter and exit the vehicle easily.

- The shift lever has been shifted to P.
- The power switch has been turned off.
- The driver's seat belt has been unfastened.

When any of the following has been performed, the driver's seat and steering wheel (power adjustment type) automatically return to their original positions.

- The power switch has been turned to ACC or ON.
- The driver's seat belt has been fastened.

■ Operation of the power easy access system

When exiting the vehicle, the power easy access system may not operate if the seat is already close to the rearmost position, etc.

■ Customization

Some functions can be customized. (→P.588)

Recording/recalling a driving position

■ Recording procedure

- 1 Check that the shift lever is in P.
- 2 Turn the power switch to ON.
- 3 Adjust the driver's seat, steering wheel (power adjustment type) and outside rear

view mirrors to the desired positions.

- 4 While pressing the "SET" button, or within 3 seconds after the "SET" button is pressed, press button "1" or "2" until the buzzer sounds.

If the selected button has already been preset, the previously recorded position will be overwritten.

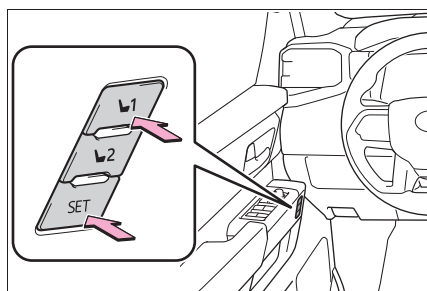

■ Recall procedure

- 1 Check that the shift lever is in P.
- 2 Turn the power switch to ON.
- 3 Press one of the buttons for the driving position you want to recall until the buzzer sounds.

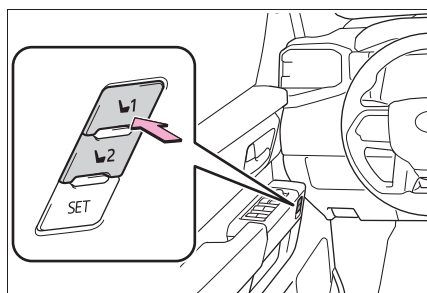

■ **To stop the position recall operation part-way through**

Perform any of the following operations:

- Press the “SET” button.
- Press button “1” or “2”.
- Operate any of the seat adjustment switches (only cancels seat position recall).
- Operate the tilt and telescopic steering control switch (only cancels steering wheel position recall).

■ **Seat positions that can be memorized (→P.136)**

The positions adjusted by the following procedure can be recorded:

- Seat position adjustment
- Seatback angle adjustment
- Seat cushion (front) angle adjustment
- Vertical height adjustment
- Seat cushion length adjustment (if equipped)

■ **Operating the driving position memory after turning the power switch off**

Recorded seat positions can be activated up to 180 seconds after the driver’s door is opened and another 60 seconds after it is closed again.

■ **In order to correctly use the driving position memory function**

If a seat position is already in the furthest possible position and the seat is operated in the same direction, the recorded position may be slightly different when it is recalled.

■ **When recalling the driving position**

Take care when recalling the driving position so that the head restraint does not touch the ceiling.

■ **When the recorded seat position cannot be recalled**

The seat position may not be recalled in some situations when the seat position is recorded in a certain range. For details, contact your Toyota dealer.

 **WARNING**

■ **Seat adjustment caution**

Take care during seat adjustment so that the seat does not strike the rear passenger or squeeze your body against the steering wheel.

Registering/recall/canceling a driving position to an electronic key (memory recall function)

■ **Registering procedure**

Record your driving position to button “1” or “2” before performing the following:

Carry only the key you want to register, and then close the driver’s door.

If 2 or more keys are in the vehicle, the driving position cannot be recorded properly.

- 1 Check that the shift lever is in P.
- 2 Turn the power switch to ON.
- 3 Recall the driving position that you want to record.
- 4 While pressing the recalled button, press and hold the door lock switch (either lock or unlock) until the buzzer sounds.

If the driving position could not be registered, the buzzer sounds continuously for approximately 3 seconds.

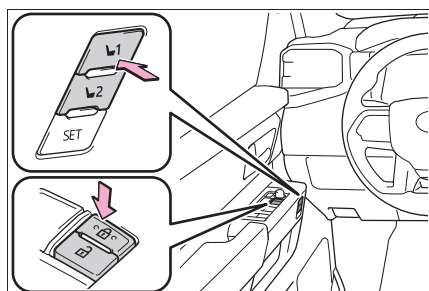

■ Recall procedure

- 1 Make sure that the doors are locked before recalling the driving position. Carry the electronic key that has been registered to the driving position, and then unlock and open the driver's door using the smart key system wireless remote control.

The driving position will move to the recorded position (not including the steering wheel). However, the seat will move to a position slightly behind the recorded position in order to make entering the vehicle easier.

If the driving position is in a position that has already been recorded, the seat and outside rear view mirrors will not move.

- 2 Turn the power switch to ACC or ON, or fasten a seat belt.

The seat and steering wheel will move to the recorded position.

■ Cancellation procedure

Carry only the key you want to cancel and then close the driver's door.

If 2 or more keys are in the vehicle, the driving position cannot be canceled properly.

- 1 Check that the shift lever is in P.
- 2 Turn the power switch to ON.
- 3 While pressing the "SET" button, press and hold the door lock switch (either lock or unlock) until the buzzer sounds twice.

If the driving position could not be canceled, the buzzer sounds continuously for approximately 3 seconds.

■ Recalling the driving position using the memory recall function

- Different driving positions can be registered for each electronic key. Therefore, the driving position that is recalled may be different depending on the key being carried.
- If a door other than the driver's door is unlocked with the smart key system, the driving position cannot be recalled. In this case, press the driving position button which has been set.

■ Customization

Some functions can be customized. (→P.588)

Head restraints

Head restraints are provided for all seats.

⚠ WARNING

■ Head restraint precautions

Observe the following precautions regarding the head restraints. Failure to do so may result in death or serious injury.

- Use the head restraints designed for each respective seat.
- Adjust the head restraints to the correct position at all times.
- After adjusting the head restraints, push down on them and make sure they are locked in position.
- Do not drive with the head restraints removed.

Adjusting a head restraint

■ Front seats

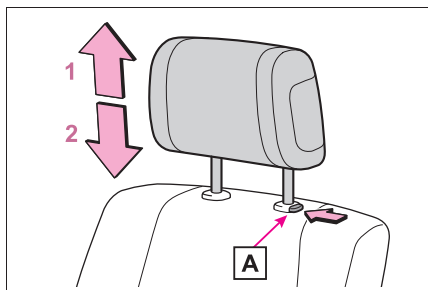

1 Up

Pull the head restraints up.

2 Down

Push the head restraint down while pressing the lock release button **A**.

■ Rear seats

► Center

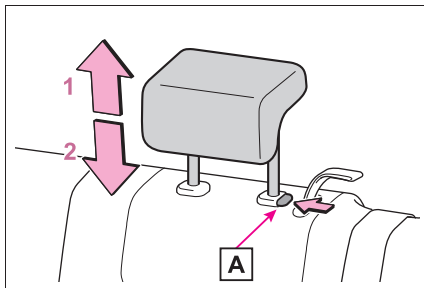

1 Up

Pull the head restraints up.

2 Down

Push the head restraint down while pressing the lock release button **A**.

► Outer

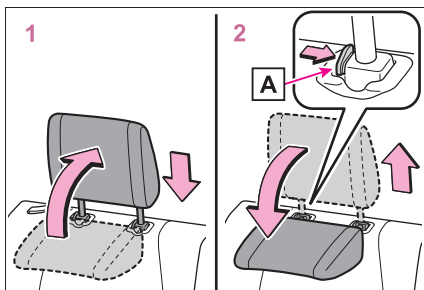

1 To use

Lift up the head restraint back to the neutral position and then push the head restraint down.

2 To fold

Lift up the head restraint while pressing the right lock release button **A**, and fold it forward.

■ Adjusting the height of the head restraints (front seat)

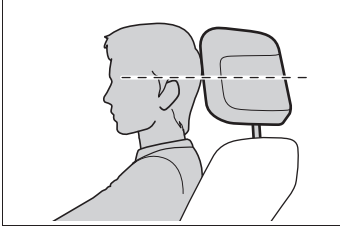

Make sure that the head restraints are adjusted so that the center of the head restraint is closest to the top of your ears.

■ Adjusting the rear center seat head restraint

Always raise the head restraint one level from the stowed position when using.

Removing the head restraints

■ Front seats

Pull the head restraint up while pressing the lock release button

A.

If the head restraint touches the ceiling, making the removal difficult, change the seat height or angle. (→P.136)

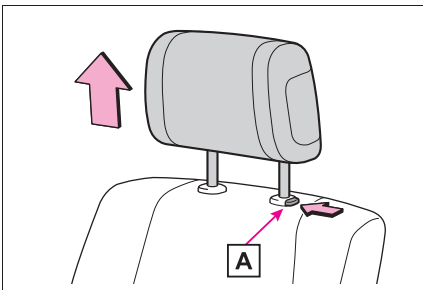

■ Rear seats

▶ Center

Pull the head restraint up while pressing the lock release button

A.

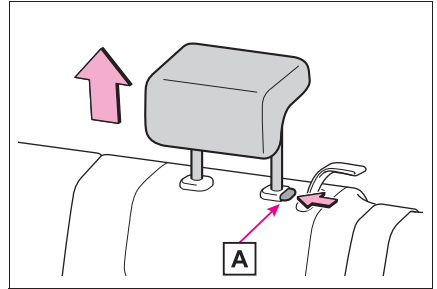

▶ Outer

Pull the head restraint up while pressing both lock release buttons

A.

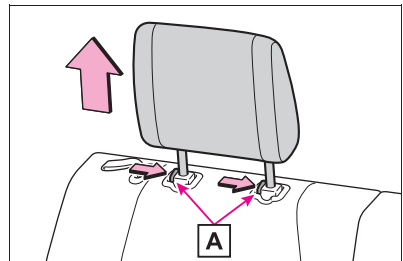

Installing the head restraints

■ Front seats

Align the head restraint with the installation holes and push it down to the lock position.

Press and hold the lock release button **A** when lowering the head restraint.

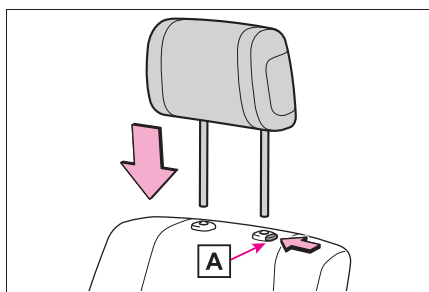

■ Rear seats

► Center

Align the head restraint with the installation holes and push it down to the lock position.

Press and hold the lock release button **A** when lowering the head restraint.

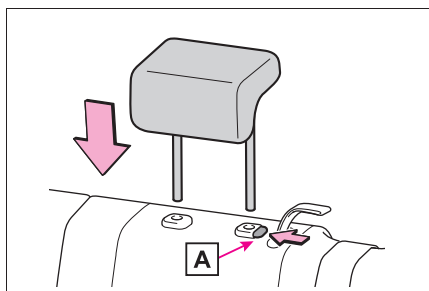

► Outer

Align the head restraint with the installation holes and push it down to the lock position.

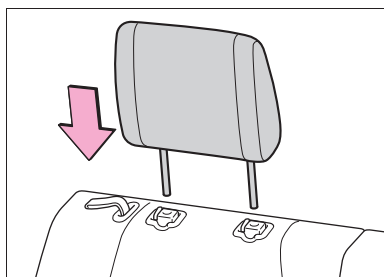

Steering wheel

Adjustment procedure

▶ Manual adjustment type

- 1 Hold the steering wheel and push the lever down.

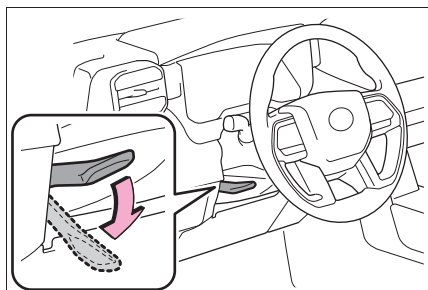

- 2 Adjust to the ideal position by moving the steering wheel horizontally and vertically.

After adjustment, pull the lever up to secure the steering wheel.

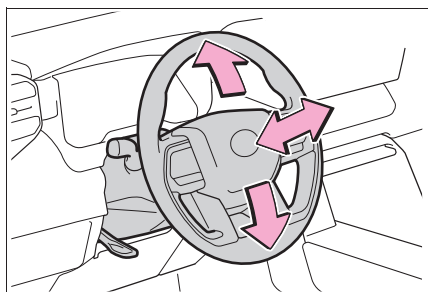

▶ Power adjustment type

Operating the switch moves the steering wheel in the following directions:

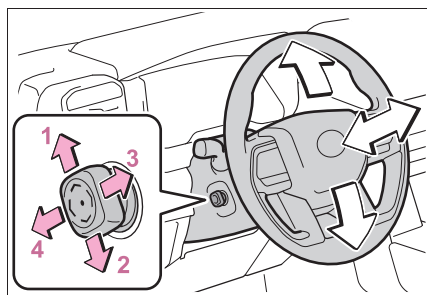

- 1 Up
- 2 Down
- 3 Toward the driver
- 4 Away from the driver

■ The steering wheel can be adjusted when (power adjustment type)

The power switch is in ACC or ON*.

*: If the driver's seat belt is fastened, the steering wheel can be adjusted regardless of power switch mode.

■ **Automatic tilt-away & returning function (if equipped)**

When the power switch is turned off, the steering wheel is automatically adjusted to a position that allows driver to enter and exit the vehicle easily.

When the power switch has been turned ACC or ON, the steering wheel automatically returns to the original position.

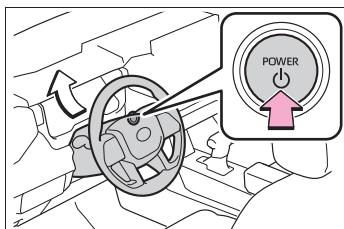

■ **Automatic adjustment of the steering position (if equipped)**

A desired steering position can be entered to memory and recalled automatically by the driving position memory system. (→P.144)

■ **Power easy access system (if equipped)**

The steering wheel and driver's seat move in accordance with power switch mode and the driver's seat belt condition. (→P.144)

■ **After adjusting the steering wheel (manual adjustment type)**

Make sure that the steering wheel is securely locked.

The horn may not sound if the steering wheel is not securely locked.

■ **Customization**

Some functions can be customized. (→P.588)

! WARNING

■ **Caution while driving**

Do not adjust the steering wheel while driving.

Doing so may cause the driver to mishandle the vehicle and cause an accident, resulting in death or serious injury.

■ **After adjusting the steering wheel (manual adjustment type)**

Make sure that the steering wheel is securely locked. Otherwise, the steering wheel may move suddenly, possibly causing an accident, resulting in death or serious injury.

Sounding the horn

Press on or close to the  mark.

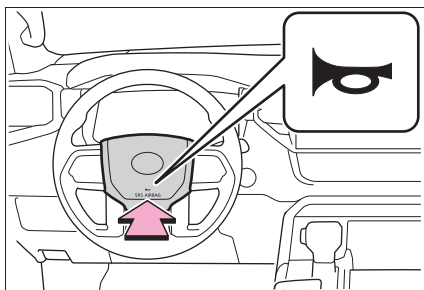

Inside rear view mirror*

*: If equipped

The rear view mirror's position can be adjusted to enable sufficient confirmation of the rear view.

Adjusting the height of rear view mirror

The height of the rear view mirror can be adjusted to suit your driving posture.

Adjust the height of the rear view mirror by moving it up and down.

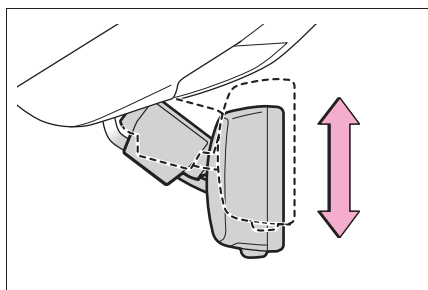

⚠ WARNING

■ Caution while driving

Do not adjust the position of the mirror while driving. Doing so may lead to mishandling of the vehicle and cause an accident, resulting in death or serious injury.

Anti-glare function

Responding to the level of brightness of the headlights of vehicles behind, the reflected light is automatically reduced.

Turn the automatic anti-glare function mode on/off

When the automatic anti-glare function is in ON mode, the indicator **A** illuminates.

The function will set to ON mode each time the power switch is turned to ON.

Pressing the button turns the function to OFF mode. (The indicator **A** also turns off.)

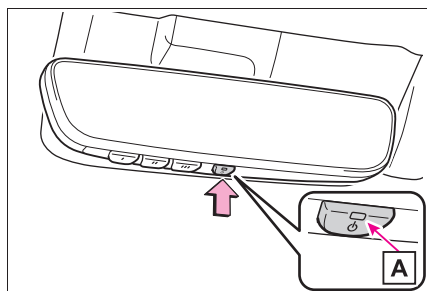

■ To prevent sensor error

To ensure that the sensors operate properly, do not touch or cover them.

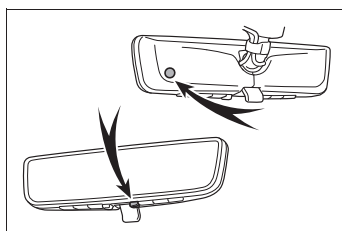

Digital Rear-view Mirror*

*: If equipped

The Digital Rear-view Mirror is a system that uses the camera on the rear of the vehicle and displays its image on the display of the Digital Rear-view Mirror.

The Digital Rear-view Mirror can be changed between optical mirror mode and digital mirror mode by operating the lever.

The Digital Rear-view Mirror allows the driver to see the rear view despite obstructions, such as the head restraints or luggage, ensuring rear visibility. Also, the rear seats are not displayed and privacy of the passengers is enhanced.

WARNING

Observe the following precautions. Failure to do so may result in death or serious injury.

■ Before using the Digital Rear-view Mirror

- Make sure to adjust the mirror before driving. (→P.156)
- Change to optical mirror mode and adjust the position of the Digital Rear-view Mirror so that the area behind your vehicle can be viewed properly.

- Change to digital mirror mode and adjust the display settings.
- As the range of the image displayed by the Digital Rear-view Mirror is different from that of the optical mirror, make sure to check this difference before driving.

System components

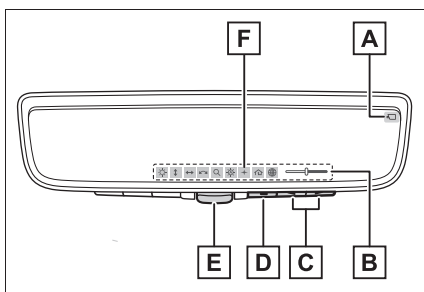

- A** Camera indicator
Indicates that the camera is operating normally.
- B** Icon display area
Displays icons, adjusting gauge, etc. (→P.156)
- C** Select/adjust button
Press to change the setting of the item you want to adjust.
- D** Menu button
Press to display the icon display area and select the item you want to adjust.
- E** Lever
Operate to change between digital mirror mode and optical mirror mode.
- F** Digital anti-glare mode indicator

In digital mirror mode, this indicates that the anti-glare function is on. (→P.156)

Changing modes

Operate the lever to change between digital mirror mode and optical mirror mode.

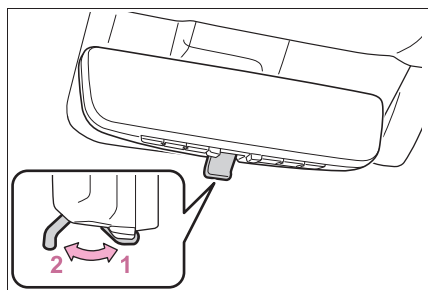

1 Digital mirror mode

Displays an image of the area behind the vehicle.

 will illuminate in this mode.

2 Optical mirror mode

Turns off the display of the Digital Rear-view Mirror allows it to be used as an optical mirror.

■ Digital mirror mode operating condition

The power switch is turned to ON. When the power switch is changed from ON to OFF or ACC, the image will disappear after several seconds.

■ When using the Digital Rear-view Mirror in digital mirror mode

- If it is difficult to see the displayed image due to light reflected off the Digital Rear-view Mirror, the camera being dirty, or if lights of a vehicle behind your vehicle or the displayed image are bothering you, change to optical mirror

mode.

- If the display is difficult to see due to reflected light, close the electronic sunshade for the panoramic moon roof (if equipped).
- Any of the following conditions may occur when driving in the dark, such as at night. None of them indicates that a malfunction has occurred.
 - Colors of objects in the displayed image may differ from their actual color.
 - Depending on the height of the lights of the vehicle behind, the area around the vehicle may appear white and blurry.
 - Automatic image adjustment for brighter surrounding image may cause flickering.

If it is difficult to see the displayed image or flickering bothers you, change to optical mirror mode.

- The Digital Rear-view Mirror may become hot while it is in digital mirror mode. This is not a malfunction.
- Depending on your physical condition or age, it may take longer than usual to focus on the displayed image. In this case, change to optical mirror mode.
- Do not let passengers stare at the displayed image when the vehicle is being driven, as doing so may cause motion sickness.

■ **When the system malfunctions**

If the symbol shown in the illustration is displayed when using the Digital Rear-view Mirror in digital mirror mode, the system may be malfunctioning. The symbol will disappear in a few seconds. Operate the lever, change to optical mirror mode and have the vehicle inspected by your Toyota dealer.

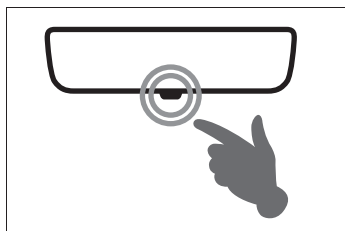

Adjusting the mirror

■ **Adjusting the mirror height**

The height of the rear view mirror can be adjusted to suit your driving posture.

Change to optical mirror mode, adjusting the height of the rear view mirror by moving it up and down.

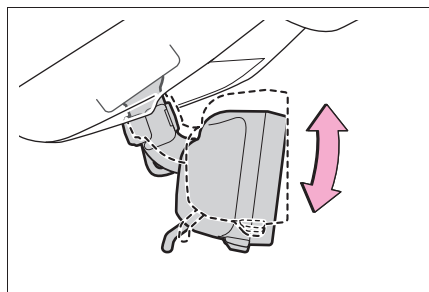

■ **Display settings (digital mirror mode)**



Settings of the display in the digital mirror mode, on/off operation of the automatic anti-glare function, etc. can be changed.

1 Press the menu button.

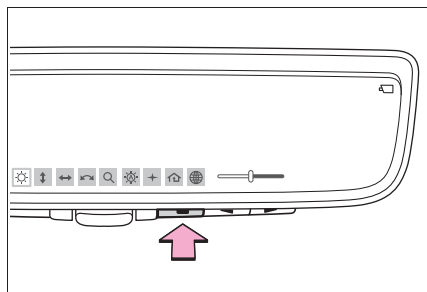



The icons will be displayed.







2 Press the menu button repeatedly and select the item you want to adjust.

3 Press  or  to change the setting.

The icons will disappear if a button is not operated for approximately 5 seconds or more.

Icons	Settings
	Select to adjust the brightness of the display.
	Select to adjust the area displayed up/down.
	Select to adjust the area displayed to the left/right.
	Select to adjust the angle of the displayed image.
	Select to zoom in/out the displayed image.

Icons	Settings
	<p>Select to enable/disable the automatic anti-glare function.*</p> <p>Responding to the brightness of the headlights of vehicles behind, the reflected light is automatically adjusted.</p> <p>The automatic anti-glare function is enabled each time the power switch is changed to ON.</p>
	<p>Select to display HomeLink® Training Tutorial to assist customers to train their Garage Door Opener System. (→P.457)</p>
	<p>The digital anti-glare mode can be turned on and off. When enabled, the brightness of the display is reduced at night to reduce headlight glare from vehicles to the rear.</p>
	<p>Select to change the language of the HomeLink® Training Tutorial.</p>

*: This is a function for the optical mirror mode, however, the setting can also be changed while using the digital mirror mode.

■ Enabling/disabling the automatic anti-glare function (optical mirror mode)

The automatic anti-glare function in the optical mirror mode can be enabled/disabled. The setting can be changed in both

the digital mirror mode and the optical mirror mode.

▶ When using the digital mirror mode

→P.156

▶ When using the optical mirror mode



1 Press the menu button.

The icons will be displayed.

2 Press the menu button repeatedly and select .

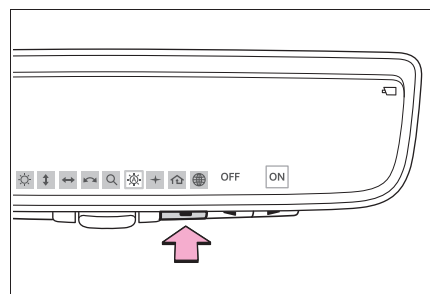
The setting display will be displayed.



3 Press  or  to enable ("ON")/disable ("OFF") the automatic anti-glare function.

The icons will disappear if a button is not operated for approximately 5 seconds or more.

■ Adjusting the display (digital mirror mode)

- If the displayed image is adjusted, it may appear distorted. This is not a malfunction.
- If the brightness of the Digital Rear-view Mirror is set too high, it may cause eye strain. Adjust the Digital Rear-view Mirror to an appropriate brightness. If your

eyes become tired, change to optical mirror mode.

- The brightness of the Digital Rear-view Mirror will change automatically according to the brightness of the area in front of your vehicle.
- The digital anti-glare mode operates only in locations where the surroundings are dark. Depending on the surrounding illumination environment, the image may not darken and it may not be possible to reduce headlight glare from vehicles to the rear.

■ **To prevent the light sensors from malfunctioning**

To prevent the light sensors from malfunctioning, do not touch or cover them.

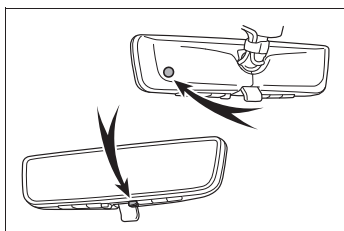

⚠ WARNING

Observe the following precautions.

Failure to do so may result in death or serious injury.

■ **While driving**

- Do not adjust the position of the Digital Rear-view Mirror or adjust the display settings while driving.

Stop the vehicle and operate the Digital Rear-view Mirror control switches.

Failure to do so may cause a steering wheel operation error, resulting in an unexpected accident.

- Always pay attention to the vehicle's surroundings.

The size of the vehicles and other objects may look different when in digital mirror mode and optical mirror mode.

When backing up, make sure to directly check the safety of the area around your vehicle, especially behind the vehicle.

Additionally, if a vehicle approaches from the rear in the dark, such as at night, the surrounding area may appear dim.

■ **To prevent causes of fire**

If the driver continues using the Digital Rear-view Mirror while smoke or odor comes from the mirror, it may result in fire. Stop using the system immediately and contact your Toyota dealer.

Cleaning the Digital Rear-view Mirror

■ **Cleaning the mirror surface**

If the mirror surface is dirty, the image on the display may be difficult to see.

Clean the mirror surface gently using a soft dry cloth.

■ **Cleaning the camera**

If the camera lens is dirty or covered with foreign matter, such as water droplets, snow, mud, etc., the displayed image may not be clear. In this case, rinse the camera lens with a large quantity of water and then wipe it clean with a soft cloth dampened with water.

■ The camera

The camera for the Digital Rear-view Mirror is located as shown.

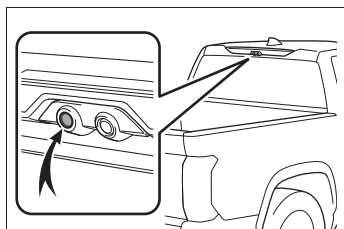

⚠ NOTICE

■ To prevent the Digital Rear-view Mirror from malfunctioning

- Do not use detergents, such as thinner, benzene, and alcohol to clean the mirror. They may discolor, deteriorate or damage the mirror surface.
- Do not smoke, use matches, use cigarette lighters or allow open flames near the mirror. It may damage the mirror or cause a fire.
- Do not remove, disassemble or modify the mirror.

■ To prevent the camera from malfunctioning

- Observe the following precautions, otherwise the Digital Rear-view Mirror may not operate properly.
 - Do not strike or hit the camera or subject it to a strong impact, as the camera installation position and angle may be changed.
 - Do not remove, disassemble or modify the camera.

- When washing the camera, rinse it with a large quantity of water and then wipe it clean with a soft cloth dampened with water. Do not strongly rub the camera lens, as it may be scratched and will not be able to transmit a clear image.
- Do not allow organic solvent, car wax, window cleaner or glass coat to adhere to the camera cover. If this happens, wipe it off as soon as possible.
- Do not apply hot water to the camera in cold weather, as the sudden change of temperature may cause the camera to not operate properly.
- When using a high pressure washer to wash the vehicle, do not directly spray the camera and its surrounding area, as doing so may cause the camera to not operate properly.
- Do not subject the camera to a strong impact as this could cause a malfunction. If this happens, have the vehicle inspected by your Toyota dealer as soon as possible.
- Do not block the vent holes of the mirror. Otherwise, the mirror may be hot, leading to a malfunction or a fire.

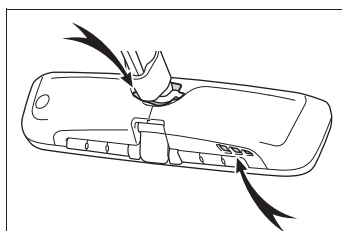





If you notice any symptoms

If you notice any of the following symptoms, refer to the following table for the likely cause and the solution.

If the symptom is not resolved by the solution, have the vehicle inspected by your Toyota dealer.

Symptom	Likely cause	Solution
The image is difficult to see.	The mirror surface is dirty.	Clean the mirror surface gently, using a soft dry cloth.
	Sunlight or headlights are shining directly into the Digital Rear-view Mirror.	Change to optical mirror mode. (If the light is coming through the electronic sunshade for panoramic moon roof [if equipped], close the electronic sunshade.)
	<ul style="list-style-type: none"> • The vehicle is in a dark area. • The vehicle is near a TV tower, broadcasting station, electric power plant, or other location where strong radio waves or electrical noise may be present. • The temperature around the camera is extremely high/low. • The ambient temperature is extremely low. • It is raining or humid. • Sunlight or headlights are shining directly into the camera lens. • The vehicle is under fluorescent lights, sodium lights, mercury lights, etc. • Water vapor from the tailpipe is obstructing the camera. 	Change to optical mirror mode. (Change back to digital mirror mode when the conditions have improved.)

Symptom	Likely cause	Solution
The image is difficult to see.	Foreign matters (such as water droplets, snow, mud, etc.) is on the camera lens.	<ul style="list-style-type: none"> • Change to optical mirror mode. • Rinse the camera with a large quantity of water, wipe it clean with a soft cloth dampened with water, and then change back to digital mirror mode.
The image is out of alignment.	The camera or its surrounding area has received a strong impact.	Change to optical mirror mode and have the vehicle inspected by your Toyota dealer.
The display is dim and  is displayed.	The system may be malfunctioning.	Change to optical mirror mode and have the vehicle inspected by your Toyota dealer.
 goes off.		

Symptom	Likely cause	Solution
 is displayed.	The Digital Rear-view Mirror is extremely hot. (The display will gradually become more dim. If the temperature continues to increase, the Digital Rear-view Mirror will turn off.)	Reducing the cabin temperature is recommended to reduce the temperature of the mirror. ( will disappear when the mirror becomes cool.) If  does not disappear even though the mirror is cool, have the vehicle inspected by your Toyota dealer.
The lever cannot be operated properly.	The lever may be malfunctioning.	Change to optical mirror mode and have the vehicle inspected by your Toyota dealer. (To change to optical mirror mode, press and hold the menu button for approximately 10 seconds.)

Outside rear view mirrors

The rear view mirror's position can be adjusted to change the rear view.

When using the outside rear view mirrors in a cold weather

When it is cold and the outside rear view mirrors are frozen, it may not be possible to fold/extend them or adjust the mirror surface. Remove the ice, snow, etc. covering the outside rear view mirrors.

WARNING

Important points while driving

Observe the following precautions while driving.

Failure to do so may result in loss of control of the vehicle and cause an accident, resulting in death or serious injury.

- Do not adjust the mirrors while driving.
- Do not drive with the mirrors folded.
- Both the driver and passenger side mirrors must be unfolded and properly adjusted before driving.

Adjustment procedure

- ▶ Type A
- 1 To select a mirror to adjust, turn the switch.

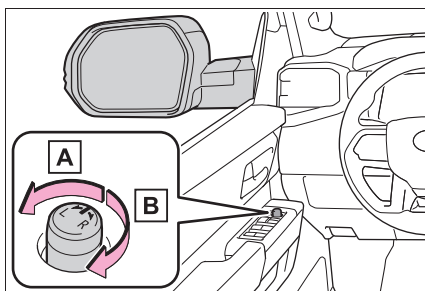

A Left

B Right

- 2 To adjust the mirror, operate the switch.

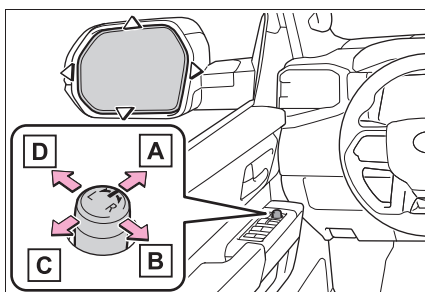

A Up

B Right

C Down

D Left

- ▶ Type B

Upper part mirror:

- 1 To select a mirror to adjust, turn the switch.

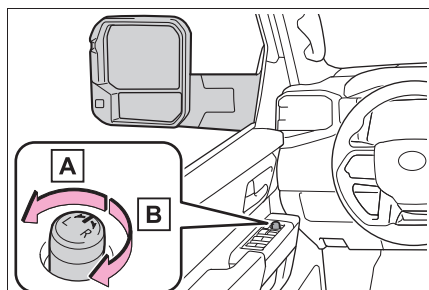

- A** Left
B Right

- 2 To adjust the mirror, operate the switch.

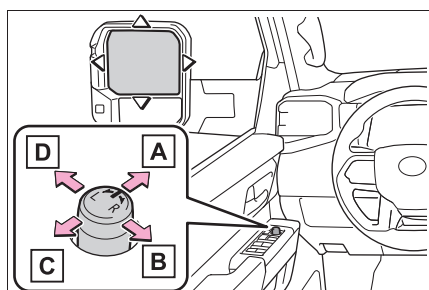

- A** Up
B Right
C Down
D Left

Lower part mirror:

Adjust the mirror up and down, in or

out by pushing the mirror surface.

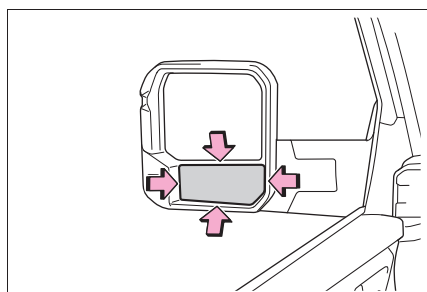

■ **Mirror angle can be adjusted when**

The power switch is in ACC or ON.

■ **Defogging the mirrors**

The outside rear view mirrors can be cleared using the mirror defoggers. Turn on the rear window defogger to turn on the outside rear view mirror defoggers. (→P.420)

■ **Automatic adjustment of the mirror angle**

A desired mirror face angle can be entered to memory and recalled automatically by the driving position memory. (→P.144)

■ **Auto anti-glare function* (if equipped)**

*: Standard type mirror has auto anti-glare function (left side only). Extending type mirrors have auto anti-glare function (left and right side).

When the anti-glare inside rear view mirror is set to automatic mode, the outside rear view mirrors will activate in conjunction with the anti-glare inside rear view mirror to reduce reflected light. (→P.153)

! WARNING

■ When the mirror defoggers are operating

Do not touch the rear view mirror surfaces, as they can become very hot and burn you.

Folding and unfolding the mirrors

► From outside

Push the mirror back in the direction of the vehicle's rear.

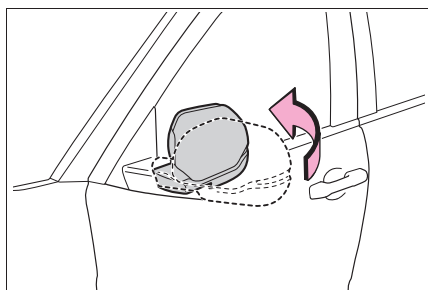

► From inside

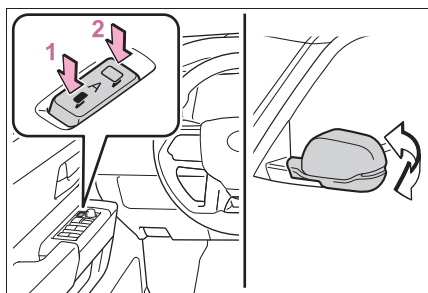

1 Folds the mirrors

2 Unfolds the mirrors

Putting the switch in the neutral position sets the mirrors to automatic mode. Automatic mode allows the folding or unfolding of the mirrors to be linked to locking/unlocking of the doors.

■ Using automatic mode in cold weather

When automatic mode is used in cold weather, the door mirror could freeze up and automatic stowing and return may not be possible. In this case, remove any ice and snow from the door mirror, then either operate the mirror using manual mode or move the mirror by hand.

■ Customization

Some functions can be customized. (→P.588)

! WARNING

■ When a mirror is moving

To avoid personal injury and mirror malfunction, be careful not to get your hand caught by the moving mirror.

Extending the mirrors (if equipped)

The mirror can be deployed to the outer side in order to improve rear visibility when towing a wide trailer.

Press the switch and extend the mirror.

Press the switch again to return the mirror to the original position.

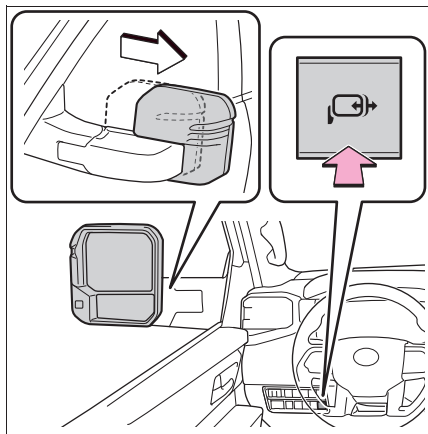

Using the extending mirrors in cold weather

The door mirror extending & retracting functions could freeze up and extending or retracting may not be possible. In this case, remove any ice and snow from the mirror, then either operate the mirror by pressing the extend or retract switch or move the mirror by hand.

Recommended mirror angle when towing a trailer (vehicles with extending mirrors)

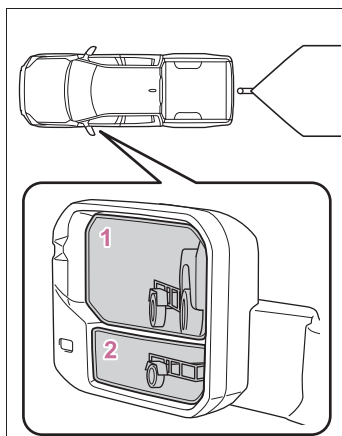

- 1 Power adjust the upper part of the mirror until an appropriate view is obtained. It is recommended that the outer 2/3 of the upper mirror be filled with images other than the vehicle and trailer.
- 2 Manually adjust the lower part of the mirror until an appropriate view of the towed object is obtained. It is recommended that the outer 2/3 of the lower mirror be filled with images other than the trailer.

Linked mirror function when reversing (if equipped)

When either “L” or “R” of the mirror select switch is selected, the outside rear view mirrors will automatically angle downwards when the vehicle is reversing in order to give a better view of the ground.

To disable this function, select neither “L” nor “R”.

■ Adjusting the mirror angle when the vehicle is reversing

With the shift lever in R, adjust the mirror angle at a desired position.

The adjusted angle will be memorized and the mirror will automatically tilt to the memorized angle whenever the shift lever is shifted to R from next time.

The memorized downward tilt position of the mirror is linked to the normal position (angle adjusted with the shift position in other than R). Therefore, if the normal position is changed after adjustment, the tilt position will also change.

When the normal position is changed, readjust the angle in reversing.

Trailer light (if equipped)

Improves reverse operation for trailer parking by turning on the outer mirror lights at night.

These lights can be used as work lights.

When the shift lever is in P or R, press the switch.

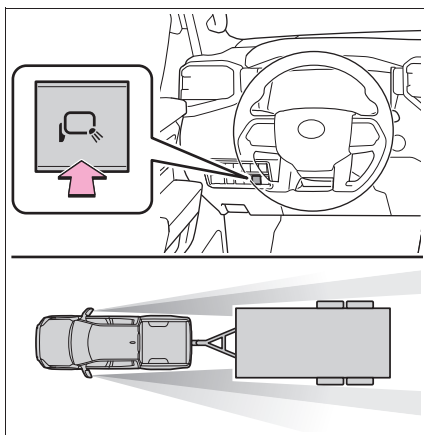

■ Automatic light off system

The lights will automatically turn off when any of the following conditions are satisfied:

- When the shift lever is in N or D
- When the outer mirror is folded (→P.166)

Power windows

Opening and closing the power windows

The power windows can be opened and closed using the switches.

Operating the switch moves the windows as follows:

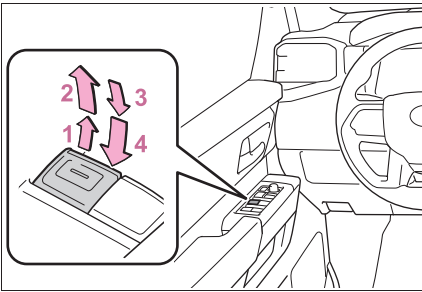

- 1 Closing
- 2 One-touch closing *
- 3 Opening
- 4 One-touch opening *

*: To stop the window partway, operate the switch in the opposite direction.

■ The power windows can be operated when

The power switch is in ON

■ Operating the power windows after turning the hybrid system off

The power windows can be operated for approximately 45 seconds even after the power switch is turned to ACC or turned off. They cannot, however, be operated once either front door is opened.

■ Jam protection function

If an object becomes jammed

between the window and the window frame while the window is closing, window movement is stopped and the window is opened slightly.

■ Catch protection function

If an object becomes caught between the door and window while the window is opening, window movement is stopped.

■ When the side window cannot be opened or closed

When the jam protection function or catch protection function operates unusually and the side window cannot be opened or closed, perform the following operations with the power window switch of that door.

- Stop the vehicle. With the power switch in ON, within 4 seconds of the jam protection function or catch protection function activating, continuously operate the power window switch in the one-touch closing direction or one-touch opening direction so that the side window can be opened and closed.
- If the side window cannot be opened and closed even when performing the above operations, perform the following procedure for function initialization.
 - 1 Turn the power switch to ON.
 - 2 Pull and hold the power window switch in the one-touch closing direction and completely close the side window.
 - 3 Release the power window switch for a moment, resume pulling the switch in the one-touch closing direction, and hold it there for approximately 6 seconds or more.
 - 4 Press and hold the power window switch in the one-touch opening direction. After the side window is completely opened, continue holding the switch for an additional 1 second or more.

- 5 Release the power window switch for a moment, resume pushing the switch in the one-touch opening direction, and hold it there for approximately 4 seconds or more.
- 6 Pull and hold the power window switch in the one-touch closing direction again. After the side window is completely closed, continue holding the switch for a further 1 second or more.

If you release the switch while the window is moving, start again from the beginning.

If the window reverses and cannot be fully closed or opened, have the vehicle inspected by your Toyota dealer.

■ Door lock linked window operation

- The power windows can be opened and closed using the mechanical key.* (→P.554)
- The power windows can be opened using the wireless remote control.* (→P.113)

*: These settings must be customized at your Toyota dealer.

■ Power windows open warning buzzer

A buzzer sounds and a message is shown on the multi-information display in the instrument cluster when the power switch is turned off and the driver's door is opened with the power windows open.

■ Customization

Some functions can be customized. (→P.588)

WARNING

Observe the following precautions. Failure to do so may result in death or serious injury.

■ Closing the windows

- The driver is responsible for all the power window operations, including the operation for the passengers. In order to prevent accidental operation, especially by a child, do not let a child operate the power windows. It is possible for children and other passengers to have body parts caught in the power window. Also, when riding with a child, it is recommended to use the window lock switch. (→P.171)
- Check to make sure that all passengers do not have any part of their body in a position where it could be caught when a window is being operated.

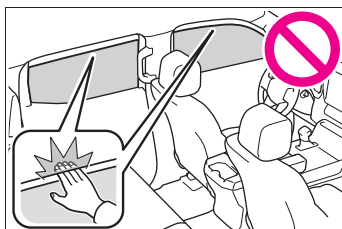

- When using the wireless remote control or mechanical key and operating the power windows, operate the power window after checking to make sure that there is no possibility of any passenger having any of their body parts caught in the window. Also do not let a child operate window by the wireless remote control or mechanical key. It is possible for children and other passengers to get caught in the power window.
- When exiting the vehicle, turn the power switch off, carry the key and exit the vehicle along with the child. There may be accidental operation, due to mischief, etc., that may possibly lead to an accident.

WARNING

■ Jam protection function

- Never use any part of your body to intentionally activate the jam protection function.
- The jam protection function may not work if something gets jammed just before the window is fully closed. Be careful not to get any part of your body jammed in the window.

■ Catch protection function

- Never use any part of your body or clothing to intentionally activate the catch protection function.
- The catch protection function may not work if something gets caught just before the window is fully opened. Be careful not to get any part of your body or clothing caught in the window.

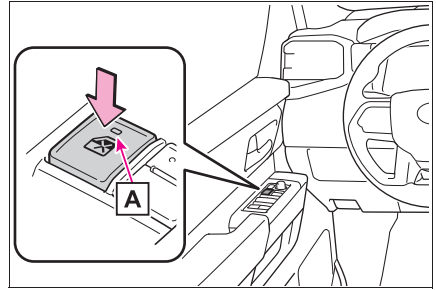

■ The power windows can be operated when

The power switch is in ON.

■ When the 12-volt battery is disconnected

The window lock switch is disabled. If necessary, press the window lock switch after reconnecting the 12-volt battery.

Preventing accidental operation (window lock switch)

This function can be used to prevent children from accidentally opening or closing a passenger window.

Press the switch.

The indicator **A** will come on and the passenger windows will be locked.

The passenger windows can still be opened and closed using the driver's switch even if the lock switch is on.

Power back window

WARNING

■ Caution while driving

Keep the back window closed.

This not only keeps personal belongings from being thrown out, but also prevents exhaust gases from entering the vehicle.

Opening and closing the power back windows

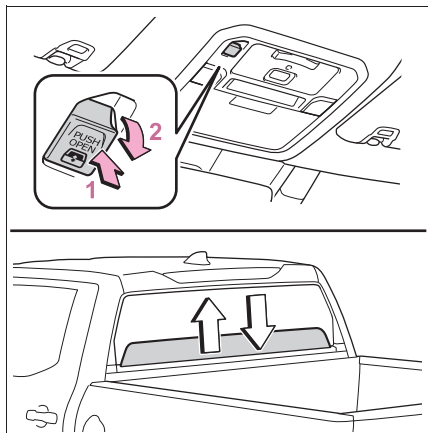

1 Opening

2 Closing

■ The power back window can be operated when

The power switch is in ON.

■ Operating the power back windows after turning the hybrid system off

The power back windows can be operated for approximately 43 seconds after the power switch is turned to ACC or off. They cannot, however, be operated once either front door is opened.

WARNING

■ Closing the back window

Observe the following precautions.

Failure to do so may result in death or serious injury.

- The driver is responsible for all the power back window operations, including the operation for the passengers. In order to prevent accidental operation, especially by a child, do not let a child operate the power back window. It is possible for children and other passengers to have body parts caught in the power back window.
- Check to make sure that all passengers do not have any part of their body in a position where it could be caught when a window is being operated.
- When exiting the vehicle, turn the power switch off, carry the key and exit the vehicle along with the child. There may be accidental operation, due to mischief, etc., that may possibly lead to an accident.

Panoramic moon roof*

*: If equipped

Use the overhead switches to operate the panoramic moon roof and electronic sunshade.

Operating the electronic sunshade and panoramic moon roof

■ Opening and closing the electronic sunshade

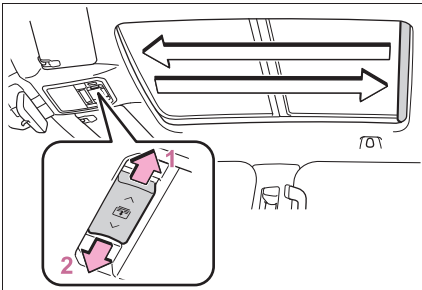

1 Opens the electronic sunshade*

Slide and hold the  switch backward momentary and the sunshade will automatically open. The electronic sunshade will fully open automatically.

2 Closes the electronic sunshade*

Slide and hold the  switch forward. The electronic sunshade will fully close automatically.

If the panoramic moon roof is not fully closed, it will close fully before the electronic sunshade closes.

*: Quickly slide and release the  switch in either direction to stop the electronic sunshade partway.

■ Tilting the panoramic moon roof up and down

Press the ROOF switch to tilt the panoramic moon roof up.*

When the panoramic moon roof is tilted up, the electronic sunshade will open to the half-open position of the roof.

*: Lightly press the ROOF switch again to stop the panoramic moon roof partway.

Press and hold the ROOF switch to tilt the panoramic moon roof down.

The panoramic moon roof can be tilted down only when it is in the tilt-up position.

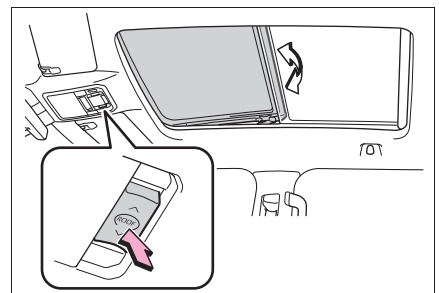

■ **Opening and closing the panoramic moon roof**

Opens the panoramic moon roof*

Slide and hold the ^{ROOF} switch backward. The panoramic moon roof and electronic sunshade will open automatically.

The panoramic moon roof can be opened from the tilt-up position.

*: Quickly slide and release the ^{ROOF} switch in either direction to stop the panoramic moon roof part-way.

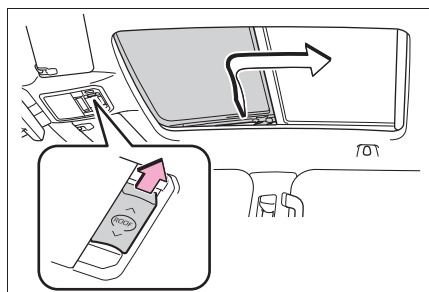

Closes the panoramic moon roof

Slide and hold the ^{ROOF} switch forward. The panoramic moon roof will fully close automatically.

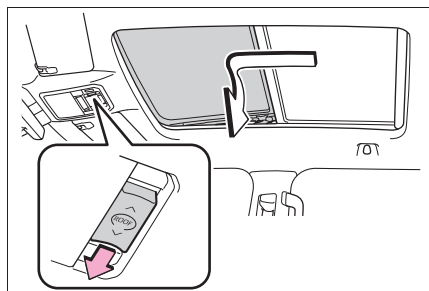

■ **The panoramic moon roof can be operated when**

The power switch is in ON.

■ **Operating the panoramic moon roof after turning the hybrid system off**

The panoramic moon roof and electronic sunshade can be operated for approximately 45 seconds after the power switch is turned to ACC or OFF. They cannot, however, be operated once either front door is opened.

■ **Jam protection function**

If an object is detected between the panoramic moon roof and the frame in the following situations, travel is stopped and the panoramic moon roof opens slightly.

- The panoramic moon roof is closing or tilting down.
- The electronic sunshade is closing.

■ **Closing both the panoramic moon roof and electronic sunshade**

Slide the  switch forward.

The electronic sunshade will close to the half-open position and pause. The panoramic moon roof will then fully close. Then the electronic sunshade will fully close.

■ Door lock linked panoramic moon roof operation

- The panoramic moon roof can be opened and closed using the mechanical key.* (→P.554)
- The panoramic moon roof can be opened using the wireless remote control.* (→P.111)
- The alarm may be triggered if the alarm is set and the panoramic moon roof is closed using the door lock linked panoramic moon roof operation function. (→P.83)

*: These settings must be customized at your Toyota dealer.

■ When the panoramic moon roof does not close normally

Perform the following procedure:

- 1 Stop the vehicle.
- 2 Operate the ^{ROOF} switch forward to close the panoramic moon roof.
- 3 Slide the ^{ROOF} switch forward and hold it for 15 seconds. After about 10 seconds the glass should move forward toward the hard stops and stall, then reverse to close position.
- 4 Within 5 seconds, Slide and hold the  switch forward again.

The sunshade will go to fully open position and stop. The moon roof will then follow, to fully open then close. The sunshade will then close.

If the panoramic moon roof does not fully close even after performing the above procedure correctly, have the vehicle inspected by your Toyota dealer.

■ Panoramic moon roof open reminder function

A buzzer sounds and a message is shown on the multi-information display when the power switch is turned to OFF and the driver's door is opened with the panoramic moon roof open.

■ Customization

Some functions can be customized. (→P.588)

⚠ WARNING

Observe the following precautions.

Failure to do so may result in death or serious injury.

■ Opening and closing the electronic sunshade

- Check to make sure that all passengers do not have any part of their body in a position where it could be caught when the electronic sunshade is being operated.

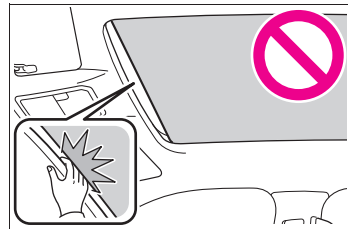

- Do not let a child operate the electronic sunshade. Closing the electronic sunshade on someone can cause death or serious injury.

■ Opening the panoramic moon roof

- Do not allow any passengers to put their hands or head outside the vehicle while it is moving.
- Do not sit on top of the panoramic moon roof.

WARNING

■ Opening and closing the panoramic moon roof

- The driver is responsible for panoramic moon roof opening and closing operations. In order to prevent accidental operation, especially by a child, do not let a child operate the panoramic moon roof. It is possible for children and other passengers to have body parts caught in the panoramic moon roof.
- Check to make sure that all passengers do not have any part of their body in a position where it could be caught when the panoramic moon roof is being operated.

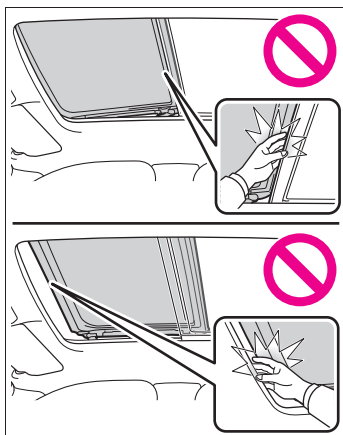

- When using the wireless remote control or mechanical key and operating the panoramic moon roof, operate the panoramic moon roof after checking to make sure that there is no possibility of any passenger having any of their body parts caught in the panoramic moon roof. Also, do not let a child operate panoramic moon roof by the wireless remote control or mechanical key. It is possible for children and other passengers to get caught in the panoramic moon roof.

- When exiting the vehicle, turn the power switch to OFF, carry the key and exit the vehicle along with the child. There may be accidental operation, due to mischief, etc., that may possibly lead to an accident.

■ Jam protection function

- Never use any part of your body to intentionally activate the jam protection function.
- The jam protection function may not work if something gets caught just before the panoramic moon roof or electronic sunshade is fully closed. Also, the jam protection function is not designed to operate while the switch is being pressed. Take care so that your fingers, etc. do not get caught.

■ To prevent burns or injuries

Do not touch the area between the underside of the panoramic moon roof and the electronic sunshade. Your hand may get caught and you could injure yourself. Also, if the vehicle is left in direct sunlight for a long time, the underside of the panoramic moon roof could become very hot and could cause burns.



NOTICE

■ To prevent damage to the panoramic moon roof

- Before opening the panoramic moon roof, make sure that there are no foreign objects, such as stones or ice, around the opening.
- Do not hit the surface or edge of the panoramic moon roof with hard objects.
- The panoramic moon roof opens outside the vehicle, thereby increasing the height of the vehicle. Please use caution when opening or driving with the panoramic moon roof open (pulling into low garages, etc.)

■ After the vehicle has been washed or rained on

Before opening the panoramic moon roof, wipe any water off the panoramic moon roof. Otherwise, water may enter the cabin when the panoramic moon roof is opened.

4-1. Before driving

- Driving the vehicle..... **181**
- Cargo and luggage **188**
- Vehicle load limits **190**
- Trailer towing..... **191**
- Dinghy towing **206**

4-2. Driving procedures

- Power (ignition) switch **207**
- Automatic transmission **212**
- Turn signal lever..... **216**
- Parking brake **217**
- Brake Hold **220**

4-3. Operating the lights and wipers

- Headlight switch **223**
- Fog light switch **226**
- AHB (Automatic High Beam)..... **226**
- Light bar **230**
- Windshield wipers and washer..... **230**

4-4. Refueling

- Opening the fuel tank cap **234**

4-5. Using the driving support systems

- Toyota Safety Sense 2.5 **237**
- PCS (Pre-Collision System) **242**
- LTA (Lane Tracing Assist) **254**
- RSA (Road Sign Assist) **265**
- Dynamic radar cruise control with full-speed range **268**
- BSM (Blind Spot Monitor) **281**
- Intuitive parking assist. **288**
- RCTA (Rear Cross Traffic Alert)..... **295**
- PKSB (Parking Support Brake)..... **301**
- Parking Support Brake function (static objects) **306**
- Parking Support Brake function (rear-crossing vehicles)..... **309**
- Toyota parking assist monitor **311**
- Panoramic view monitor **324**
- Multi-terrain Monitor **361**
- Electronically modulated air suspension **373**

Driving mode select switch **376**

Four-wheel drive system **379**

AUTO LSD system..... **381**

Rear differential lock system **382**

Crawl Control **383**

Multi-terrain Select **387**

Downhill assist control system **390**

Driving assist systems **393**

Trailer brake controller **398**

Trailer Backup Guide .. **401**

Active front spoiler **406**

4-6. Driving tips

Hybrid Electric Vehicle driving tips..... **408**

Off-road precautions ... **410**

Winter driving tips **413**

Driving the vehicle

The following procedures should be observed to ensure safe driving:

Driving procedure**■ Starting the hybrid system**

→P.207

■ Driving

- 1 With the brake pedal depressed, shift the shift lever to D.
- 2 If the parking brake is set, release the parking brake. (→P.217)

If the parking brake is in automatic mode, the parking brake is release automatically when shifting the shift lever to any position other than P. (→P.218)

- 3 Gradually release the brake pedal and gently depress the accelerator pedal to accelerate the vehicle.

■ Stopping

- 1 With the shift lever in D, depress the brake pedal.
- 2 If necessary, set the parking brake.

If the vehicle is to be stopped for an extended period of time, shift the shift lever to P. (→P.212)

■ Parking the vehicle

- 1 With the shift lever in D, depress the brake pedal to stop the vehicle completely.

- 2 Set the parking brake (→P.217), and shift the shift lever to P. (→P.212)

Check the parking brake indicator is illuminated.

Do not press the shift release button after shifting the shift position to P.

- 3 Turn the power switch to OFF to stop the hybrid system.
- 4 Lock the door, making sure that you have the electronic key on your person.

If parking on a hill, block the wheels as needed.

■ Starting off on a steep uphill

- 1 With the brake pedal depressed, shift the shift lever to D.

The hill-start assist control will be activated.

- 2 Pull the parking brake switch and parking brake is set manually. (→P.217)
- 3 Release the brake pedal and gently depress the accelerator pedal to accelerate the vehicle.
- 4 Press the parking brake switch and parking brake is released manually. (→P.217)

Parking brake automatic release function. (→P.219)

■ For fuel-efficient driving

Keep in mind that Hybrid Electric Vehicle are similar to conventional vehicles, and it is necessary to

182 4-1. Before driving

refrain from activities such as sudden acceleration. (→P.408)

■ Driving in the rain

- Drive carefully when it is raining, because visibility will be reduced, the windows may become fogged-up, and the road will be slippery.
- Drive carefully when it starts to rain, because the road surface will be especially slippery.
- Refrain from high speeds when driving on an expressway in the rain, because there may be a layer of water between the tires and the road surface, preventing the steering and brakes from operating properly.

■ Engine speed while driving

In the following conditions, the engine speed may become high while driving.

This is due to automatic up-shifting control or down-shifting implementation to meet driving conditions. It does not indicate sudden acceleration.

- The vehicle is judged to be driving uphill or downhill
- When the accelerator pedal is released
- When the brake pedal is depressed while “TOW HAUL” mode or “TOW+” mode is selected (if equipped)

■ Restraining the hybrid system output (Brake Override System)

- When the accelerator and brake pedals are depressed at the same time, the hybrid system output may be restrained.
- A warning message is displayed on the multi-information display while the system is operating.

■ Breaking in your new Toyota

To extend the life of the vehicle, observing the following precautions is recommended:

- For the first 200 miles (300 km):
Avoid sudden stops.

- For the first 500 miles (800 km):
Do not tow a trailer.

- For the first 1000 miles (1600 km):
 - Do not drive at extremely high speeds.
 - Avoid sudden acceleration.
 - Do not drive continuously in low gears.
 - Do not drive at a constant speed for extended periods.

■ Operating your vehicle in a foreign country

Comply with the relevant vehicle registration laws and confirm the availability of the correct fuel. (→P.569)

WARNING

Observe the following precautions. Failure to do so may result in death or serious injury.

■ When starting the vehicle

Always keep your foot on the brake pedal while stopped with the “READY” indicator is illuminated. This prevents the vehicle from creeping.

■ When driving the vehicle

- Do not drive if you are unfamiliar with the location of the brake and accelerator pedals to avoid depressing the wrong pedal.
- Accidentally depressing the accelerator pedal instead of the brake pedal will result in sudden acceleration that may lead to an accident.
- When backing up, you may twist your body around, leading to difficulty in operating the pedals. Make sure to operate the pedals properly.

⚠ WARNING

- Make sure to keep a correct driving posture even when moving the vehicle only slightly. This allows you to depress the brake and accelerator pedals properly.
- Depress the brake pedal using your right foot. Depressing the brake pedal using your left foot may delay response in an emergency, resulting in an accident.
- The driver should pay extra attention to pedestrians when the vehicle is powered only by the electric motor (traction motor). As there is no engine noise, the pedestrians may misjudge the vehicle's movement. Even though the vehicle is equipped with the acoustic vehicle alerting system, drive with care as pedestrians in the vicinity may still not notice the vehicle if the surrounding area is noisy.
- Do not drive the vehicle over or stop the vehicle near flammable materials. The exhaust system and exhaust gases can be extremely hot. These hot parts may cause a fire if there is any flammable material nearby.
- During normal driving, do not turn off the hybrid system. Turning the hybrid system off while driving will not cause loss of steering or braking control, however, power assist to the steering will be lost. This will make it more difficult to steer smoothly, so you should pull over and stop the vehicle as soon as it is safe to do so. In the event of an emergency, such as if it becomes impossible to stop the vehicle in the normal way: →P.520

- Use engine braking (downshift) to maintain a safe speed when driving down a steep hill. Using the brakes continuously may cause the brakes to overheat and lose effectiveness. (→P.212)
- Do not adjust the positions of the steering wheel, the seat, or the inside or outside rear view mirrors while driving. Doing so may result in a loss of vehicle control.
- Always check that all passengers' arms, heads or other parts of their body are not outside the vehicle.
- Do not drive in excess of the speed limit. Even if the legal speed limit permits it, do not drive over 85 mph (140 km/h) unless your vehicle has high-speed capability tires. Driving over 85 mph (140 km/h) may result in tire failure, loss of control and possible injury. Be sure to consult a tire dealer to determine whether the tires on your vehicle are high-speed capability tires or not before driving at such speeds.
- On vehicles with electronically modulated air suspension, if you drive through deep water over about 20 in. (500 mm) in depth, put the vehicle height in the "HI" mode using the height control switch and then change to manual mode by pushing the height control mode select switch. Drive your vehicle at 18 mph (30 km/h) or less. Do not stop in the water to prevent water from entering within the vehicle. Do not drive through water deeper than about 28 in. (700 mm) even if the vehicle height is in "HI" mode. (→P.373)

 **WARNING**

■ **When driving on slippery road surfaces**

- Sudden braking, acceleration and steering may cause tire slippage and reduce your ability to control the vehicle.
- Sudden acceleration, engine braking due to shifting, or changes in engine speed could cause the vehicle to skid.
- After driving through a puddle, lightly depress the brake pedal to make sure that the brakes are functioning properly. Wet brake pads may prevent the brakes from functioning properly. If the brakes on only one side are wet and not functioning properly, steering control may be affected.

■ **When shifting the shift lever**

- Do not let the vehicle roll backward while a forward driving position is selected, or roll forward while the shift lever is in R. Doing so may result in an accident or damage to the vehicle.
- Do not shift the shift lever to P while the vehicle is moving. Doing so can damage the transmission and may result in a loss of vehicle control.
- Do not shift the shift lever to R while the vehicle is moving forward. Doing so can damage the transmission and may result in a loss of vehicle control.
- Do not shift the shift lever to a driving position while the vehicle is moving backward. Doing so can damage the transmission and may result in a loss of vehicle control.

- Moving the shift lever to N while the vehicle is moving will disengage the hybrid system. Engine braking is not available with the hybrid system disengaged.

- Be careful not to shift the shift lever with the accelerator pedal depressed. Shifting the shift lever to any positions other than P or N may lead to unexpected rapid acceleration of the vehicle that may cause an accident and result in death or serious injury.

■ **If you hear a squealing or scraping noise (brake pad wear indicators)**

Have the brake pads checked and replaced by your Toyota dealer, or any reliable repairer as soon as possible.

Rotor damage may result if the pads are not replaced when needed.

It is dangerous to drive the vehicle when the wear limits of the brake pads and/or those of the brake discs are exceeded.

■ **When the vehicle is stopped**

- Do not depress the accelerator pedal unnecessarily. If the shift lever is any position other than P or N, the vehicle may accelerate suddenly and unexpectedly, causing an accident.
- In order to prevent accidents due to the vehicle rolling away, always keep depressing the brake pedal while stopped with the "READY" indicator is illuminated, and apply the parking brake as necessary.

**WARNING**

- If the vehicle is stopped on an incline, in order to prevent accidents caused by the vehicle rolling forward or backward, always depress the brake pedal and securely apply the parking brake as needed.
 - Avoid revving or racing the engine.
Running the engine at high speed while the vehicle is stopped may cause the exhaust system to overheat, which could result in a fire if combustible material is nearby.
- When the vehicle is parked**
- Do not leave glasses, cigarette lighters, spray cans, or soft drink cans in the vehicle when it is in the sun.
Doing so may result in the following:
 - Gas may leak from a cigarette lighter or spray can, and may lead to a fire.
 - The temperature inside the vehicle may cause the plastic lenses and plastic material of glasses to deform or crack.
 - Soft drink cans may fracture, causing the contents to spray over the interior of the vehicle, and may also cause a short circuit in the vehicle's electrical components.
 - Do not leave cigarette lighters in the vehicle. If a cigarette lighter is in a place such as the glove box or on the floor, it may be lit accidentally when luggage is loaded or the seat is adjusted, causing a fire.

- Do not attach adhesive discs to the windshield or windows. Do not place containers such as air fresheners on the instrument panel or dashboard. Adhesive discs or containers may act as lenses, causing a fire in the vehicle.
- Do not leave a door or window open if the curved glass is coated with a metallized film such as a silver-colored one. Reflected sunlight may cause the glass to act as a lens, causing a fire.
- Always apply the parking brake, shift the shift lever to P, stop the hybrid system and lock the vehicle. Do not leave the vehicle unattended while the hybrid system is operating.
If the vehicle is parked with the shift lever in P but the parking brake is not set, the vehicle may start to move, possibly leading to an accident.
- Do not touch the exhaust pipes while the "READY" indicator is illuminated or immediately after turning the hybrid system off.
Doing so may cause burns.
- 4WD models: If the shift lever is moved before the "4L" indicator turns on/off, the transfer mode may not be shifted completely. The transfer mode disengages both the front and rear driveshafts from the powertrain and allows the vehicle to move regardless of the shift position. (At this time, the indicator blinks and the buzzer sounds.)
Therefore, the vehicle is free to roll even if the automatic transmission is in P. You or someone else could be seriously injured. You must complete the shifting of the transfer mode. (→P.379)

**WARNING****■ When taking a nap in the vehicle**

Always turn the hybrid system off. Otherwise, if you accidentally move the shift lever or depress the accelerator pedal, this could cause an accident or fire due to hybrid system overheating. Additionally, if the vehicle is parked in a poorly ventilated area, exhaust gases may collect and enter the vehicle, leading to death or a serious health hazard.

■ When braking

- When the brakes are wet, drive more cautiously. Braking distance increases when the brakes are wet, and this may cause one side of the vehicle to brake differently than the other side. Also, the parking brake may not securely hold the vehicle.
- If the electronically controlled brake does not operate, do not follow other vehicles closely and avoid hills or sharp turns that require braking. In this case, braking is still possible, but the brake pedal should be depressed more firmly than usual. Also, the braking distance will increase. Have your brakes fixed immediately.
- The brake system consists of 2 or more individual hydraulic systems; if one of the systems fails, the other will still operate. In this case, the brake pedal should be depressed more firmly than usual and the braking distance will increase. Have your brakes fixed immediately.

■ If the vehicle becomes stuck

Do not spin the wheels excessively when a driven wheel is up in the air, or the vehicle is stuck in sand, mud, etc. This may damage the driveline components or propel the vehicle forward or backward, causing an accident.

**NOTICE****■ When driving the vehicle**

- Do not depress the accelerator and brake pedals at the same time during driving, as this may restrain the hybrid system output.
- Do not use the accelerator pedal or depress the accelerator and brake pedals at the same time to hold the vehicle on a hill.

■ When parking the vehicle

Always set the parking brake and shift the shift lever to P. Failure to do so may cause the vehicle to move or the vehicle may accelerate suddenly if the accelerator pedal is accidentally depressed.

■ Avoiding damage to vehicle parts

- Do not turn the steering wheel fully in either direction and hold it there for an extended period of time. Doing so may damage the power steering.
- When driving over bumps in the road, drive as slowly as possible to avoid damaging the wheels, underside of the vehicle, etc.



NOTICE

■ If you get a flat tire while driving

A flat or damaged tire may cause the following situations. Hold the steering wheel firmly and gradually depress the brake pedal to slow down the vehicle.

- It may be difficult to control your vehicle.
- The vehicle will make abnormal sounds or vibrations.
- The vehicle will lean abnormally.

Information on what to do in case of a flat tire (→P.541)

■ When encountering flooded roads

Do not drive on a road that has flooded after heavy rain, etc. Doing so may cause the following serious damage to the vehicle:

- Engine stalling
- Short in electrical components
- Engine damage caused by water immersion

In the event that you drive on a flooded road and the vehicle becomes flooded or stuck in mud or sand, be sure to have your Toyota dealer check the following:

- Brake function
- Changes in quantity and quality of oil and fluid used for the engine, transmission, transfer (4WD vehicles), differential, etc.
- Lubricant condition for the propeller shaft, bearings and suspension joints (where possible), and the function of all joints, bearings, etc.

Sudden start restraint control (Drive-Start Control [DSC])

When the following unusual operation is performed with the accelerator pedal depressed, the hybrid system output may be restrained.

- When the shift lever is shifted to R*.
- When the shift lever is shifted from P or R to forward drive shift position such as D*.

When the system operates, a message appears on the multi-information display. Read the message and follow the instruction.

*: Depending on the situation, the shift position may not be changed.

■ Drive-Start Control (DSC)

When the TRAC is turned off (→P.394), sudden start restraint control also does not operate. If your vehicle have trouble escaping from the mud or fresh snow due to sudden start restraint operation, deactivate TRAC (→P.394) so that the vehicle may become able to escape from the mud or fresh snow.

Also, sudden start restraint control will not operate in the following conditions:

- When the front-wheel drive control switch is in “4H” or “4L” position. (4WD models only)
- When AUTO LSD mode, the drive start control does not operate. (if equipped)
- When Multi-terrain Select is selected. (if equipped)

Cargo and luggage

Take notice of the following information about storage precautions, cargo capacity and load:

Capacity and distribution

Cargo capacity depends on the total weight of the occupants.

(Cargo capacity) = (Total load capacity) — (Total weight of occupants)

Steps for Determining Correct Load Limit —

(1) Locate the statement “The combined weight of occupants and cargo should never exceed XXX kg or XXX lbs.” on your vehicle’s placard.

(2) Determine the combined weight of the driver and passengers that will be riding in your vehicle.

(3) Subtract the combined weight of the driver and passengers from XXX kg or XXX lbs.

(4) The resulting figure equals the available amount of cargo and luggage load capacity.

For example, if the “XXX” amount equals 1400 lbs. and there will be five 150 lb passengers in your vehicle, the amount of available cargo and luggage load capacity is 650 lbs. (1400 –

750 (5 × 150) = 650 lbs.)

(5) Determine the combined weight of luggage and cargo being loaded on the vehicle. That weight may not safely exceed the available cargo and luggage load capacity calculated in Step 4.

(6) If your vehicle will be towing a trailer, load from your trailer will be transferred to your vehicle. Consult this manual to determine how this reduces the available cargo and luggage load capacity of your vehicle. (→P.190)

Calculation formula for your vehicle

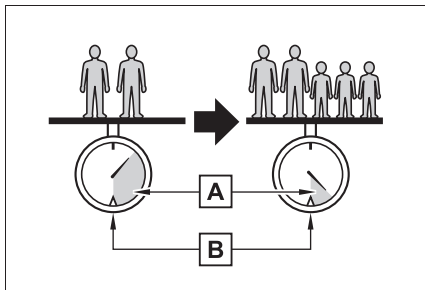

A Cargo capacity

B Total load capacity (vehicle capacity weight) (→P.567)

When 2 people with the combined weight of A lb. (kg) are riding in your vehicle, which has a total load capacity (vehicle capacity weight) of B lb. (kg), the available amount of cargo and luggage load capacity will

be C lb. (kg) as follows:

$$B^{*2} \text{ lb. (kg)} - A^{*1} \text{ lb. (kg)} = C^{*3} \text{ lb. (kg)}$$

*1: A = Weight of people

*2: B = Total load capacity

*3: C = Available cargo and luggage load

In this condition, if 3 more passengers with the combined weight of D lb. (kg) get on, the available cargo and luggage load will be reduced E lb. (kg) as follows:

$$C \text{ lb. (kg)} - D^{*4} \text{ lb. (kg)} = E^{*5} \text{ lb. (kg)}$$

*4: D = Additional weight of people

*5: E = Available cargo and luggage load

As shown in the example above, if the number of occupants increases, the cargo and luggage load will be reduced by an amount that equals the increased weight due to the additional occupants. In other words, if an increase in the number of occupants causes an excess of the total load capacity (combined weight of occupants plus cargo and luggage load), you must reduce the cargo and luggage on your vehicle.



WARNING

■ Things that must not be carried in the luggage compartment

The following things may cause a fire if loaded in the luggage compartment:

- Receptacles containing gasoline

- Aerosol cans

■ Storage precautions

Observe the following precautions.

Failure to do so may prevent the pedals from being depressed properly, may block the driver's vision, or may result in items hitting the driver or passengers, possibly causing an accident.

- Do not stack anything behind the front seats higher than the seatbacks.

- Do not place cargo or luggage in or on the following locations.

- At the feet of the driver

- On the front passenger or rear seats (when stacking items)

- On the instrument panel

- On the dashboard

- On the auxiliary box or tray that has no lid

- Secure all items in the occupant compartment.

- Never allow anyone to ride in the rear deck. It is not designed for passengers. They should ride in their seats with their seat belts properly fastened. Otherwise, they are much more likely to suffer death or serious bodily injury, in the event of sudden braking, sudden swerving or an accident.

■ Capacity and distribution

- Do not exceed the maximum axle weight rating or the total vehicle weight rating.

**WARNING**

- Even if the total load of occupant's weight and the cargo load is less than the total load capacity, do not apply the load unevenly. Improper loading may cause deterioration of steering or braking control which may cause death or serious injury.

Vehicle load limits

Vehicle load limits include total load capacity, seating capacity, TWR (Trailer Weight Rating) and cargo capacity.

- Total load capacity (vehicle capacity weight): →P.567

Total load capacity means the combined weight of occupants, cargo and luggage.

- Seating capacity: →P.567

Seating capacity means the maximum number of occupants whose estimated average weight is 150 lb. (68 kg) per person.

Even if the number of occupants are within the seating capacity, do not exceed the total load capacity.

- TWR (Trailer Weight Rating): →P.197

TWR means the maximum gross trailer weight (trailer weight plus its cargo weight) that your vehicle is able to tow.

- Cargo capacity

Cargo capacity may increase or decrease depending on the weight and the number of occupants.

■ Total load capacity and seating capacity

These details are also described on the tire and loading information label. (→P.574)



WARNING

■ Overloading the vehicle

Do not overload the vehicle. It may not only cause damage to the tires, but also degrade steering and braking ability, resulting in an accident.

Trailer towing

Your vehicle is designed primarily as a passenger-and-load-carrying vehicle. Towing a trailer can have an adverse impact on handling, performance, braking, durability, and fuel consumption. For your safety and the safety of others, you must not overload your vehicle or trailer. You must also ensure that you are using appropriate towing equipment, that the towing equipment has been installed correctly and used properly, and that you employ the requisite driving habits.

Vehicle-trailer stability and braking performance are affected by trailer stability, brake performance and setting, trailer brakes, the hitch and hitch systems.

To tow a trailer safely, use extreme care and drive the vehicle in accordance with your trailer's characteristics and operating conditions.

Toyota warranties do not apply to damage or malfunction caused by towing a trailer for commercial purposes.

Contact your Toyota dealer for further information about additional requirements such as a towing kit, etc.

■ **Trailer brake controller**

→P.398

■ **Before towing**

Check that the following conditions are met:

- Ensure that your vehicle's tires are properly inflated. (→P.574)
- Trailer tires are inflated according to the trailer manufacturer's recommendation.
- All trailer lights work as required by law.
- All lights work each time you connect them.
- The trailer ball is set at the proper height for the coupler on the trailer.
- The trailer is level when it is hitched. Do not drive if the trailer is not level, and check for improper tongue weight, overloading, worn suspension, or other possible causes.
- The trailer cargo is securely loaded.
- The rear view mirrors conform to all applicable federal, state/provincial or local regulations. If they do not, install rear view mirrors appropriate for towing purposes.

 **WARNING**

■ **Trailer towing precautions**

To tow a trailer safely, use extreme care and drive the vehicle in accordance with the trailer's characteristics and operating conditions. Failure to do so could cause an accident resulting in death or serious injury. Vehicle stability and braking performance are affected by trailer stability, brake setting and performance, and the hitch. Your vehicle will handle differently when towing a trailer.

■ **To avoid accident or injury**

- Do not exceed the TWR, unbraked TWR, GCWR, GVWR or GAWR.
- If the gross trailer weight is over 2000 lb. (900 kg), a sway control device with sufficient capacity is required.
- If the gross trailer weight is over 5000 lb. (2200 kg), a weight distributing hitch with sufficient capacity is required.
- Adjust the tongue weight within the appropriate range. Place heavier loads as close to the trailer axle as possible.
- Do not exceed 65 mph (104 km/h), the posted towing speed limit or the speed limit for your trailer as set forth in your trailer owner's manual, whichever is lowest. Slow down sufficiently before making a turn, in cross winds, on wet or slippery surface, etc., to help avoid an accident. If you experience a vehicle-trailer instability from reducing a certain speed, slow down and make sure you keep your vehicle speed under the speed of which you experience the instability.

**WARNING**

- Do not make jerky, abrupt or sharp turns.
- Do not apply the brakes suddenly as you may skid, resulting in jackknifing and loss of vehicle control. This is especially true on wet or slippery surfaces.
- Do not exceed the trailer hitch assembly weight, gross vehicle weight, gross axle weight and trailer tongue weight capacities.
- Do not use the following systems when your vehicle is towing a trailer or another vehicle.
 - PCS (Pre-Collision System)
 - Dynamic radar cruise control with full-speed range

Except when the following conditions are all met,

- LTA (Lane Tracing Assist)

If the vehicle detects that a trailer is being towed, the lane centering function of LTA is automatically turned off.

- When the other vehicle is a trailer properly attached and connected to Toyota's official TBC ECU.
- When the vehicle is not being driven on a slippery surface such as an icy road or a very wet road.
- Slow down and downshift before descending steep or long downhill grades. Do not make sudden downshifts while descending steep or long downhill grades.

- Vehicle-trailer instability is more likely on steep long downhills. Before descending steep or long downhill grades, slow down and downshift. Do not make sudden downshifts when descending steep or long downhill grades. Avoid holding the brake pedal down too long or applying the brakes too frequently. This could cause the brakes to overheat and result in reduced braking efficiency.
- Do not tow a trailer when the temporary spare tire is installed on your vehicle.

■ When towing a trailer

Toyota recommends trailers with brakes that conform to any applicable federal and state/provincial regulations.

- If the gross trailer weight exceeds unbraked TWR, trailer brakes are required. Toyota recommends trailers with brakes that conform to all applicable federal and state/provincial regulations.
- Never tap into your vehicle's hydraulic system, as this will lower the vehicle's braking effectiveness.
- Never tow a trailer without using a safety chain securely attached to both the trailer and the vehicle. If damage occurs to the coupling unit or hitch ball, there is danger of the trailer wandering into another lane.

Towing related terms

■ GCWR (Gross Combination Weight Rating)

The maximum allowable gross combination weight. The gross combination weight is the sum of the total vehicle weight (including the occupants, cargo and any optional equipment installed on the vehicle) and the weight of the trailer being towed (including the cargo in the trailer).

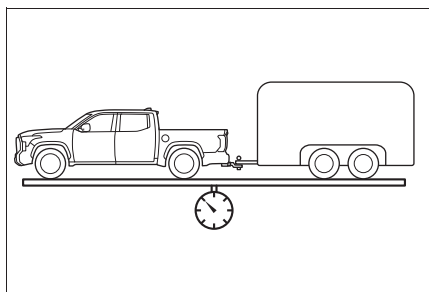

■ GVWR (Gross Vehicle Weight Rating)

The maximum allowable gross vehicle weight. The gross vehicle weight is the total weight of the vehicle. When towing a trailer, it is the sum of the vehicle weight (including the occupants, cargo and any optional equipment installed on the vehicle) and the tongue weight.

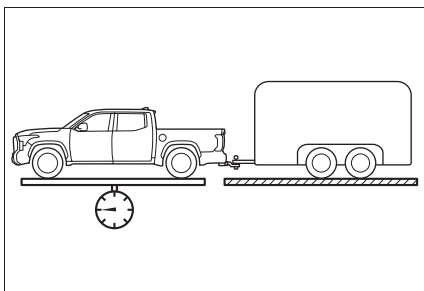

■ GAWR (Gross Axle Weight Rating)

The maximum allowable gross axle weight. The gross axle weight is the load placed on each axle (front and rear).

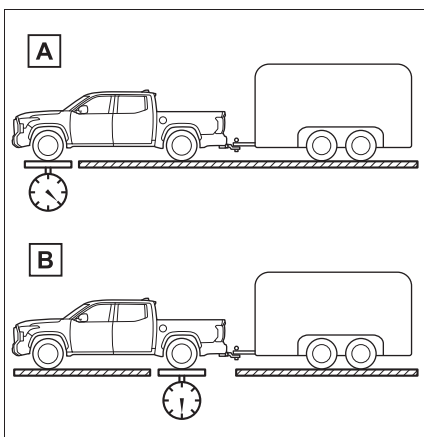

A Front GAWR

B Rear GAWR

■ **TWR (Trailer Weight Rating)**

The maximum allowable gross trailer weight. The gross trailer weight is the sum of the trailer weight and the weight of the cargo in the trailer.

TWR is calculated assuming base vehicle with one driver, one front passenger, towing package (if available), hitch and hitch systems (if required).

Additional optional equipment, passengers and cargo in the vehicle will reduce the trailer weight rating so as not to exceed GCWR, GVWR and GAWR.

If the gross trailer weight exceeds 3000 lb. (1360 kg), it is recommended to use a trailer with 2 or more axles.

■ **Unbraked TWR (Unbraked Trailer Weight Rating)**

The trailer weight rating for towing a trailer without a trailer service brake system.

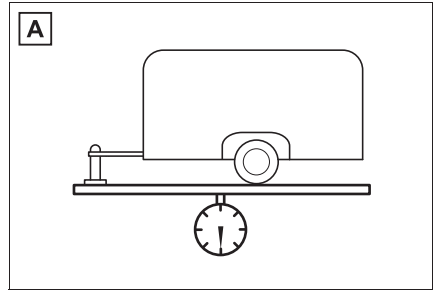

A Without brakes

■ **Tongue Weight**

The load placed on the trailer hitch ball. (→P.198)

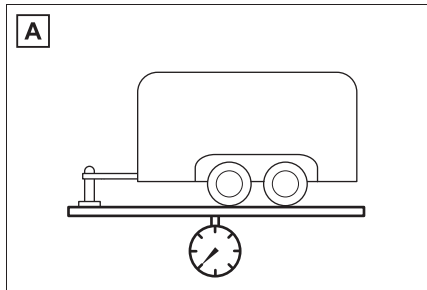
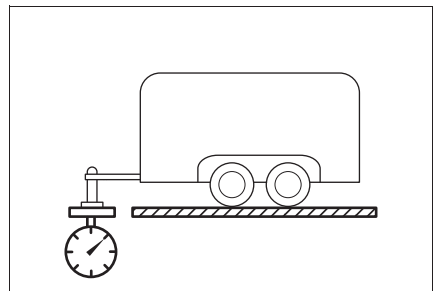

A With brakes

■ **Kingpin Weight**

The load placed on the 5th wheel mount or the gooseneck ball. (→P.198)

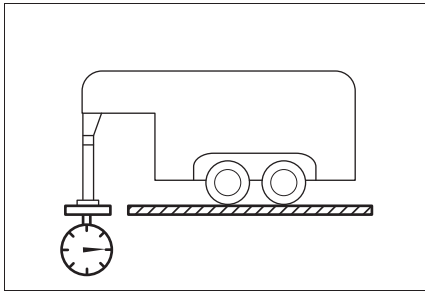

Weight limits

- The gross trailer weight must never exceed the TWR described in the table. (→P.197)
- The gross combination weight must never exceed the GCWR described in the table. (→P.197)
- The gross vehicle weight must never exceed the GVWR indicated on the Certification Label. (→P.568)
- The gross axle weight on each axle must never exceed the GAWR indicated on the Certification Label. (→P.568)
- If the gross trailer weight is over the unbraked TWR, trailer service brakes are required.
- If the gross trailer weight is over 2000 lb. (907 kg), a sway control device with sufficient

capacity is required.

- If the gross trailer weight is over 5000 lb. (2268 kg), a weight distributing hitch with sufficient capacity is required.

GCWR, TWR, Unbraked TWR, Fifth wheel and Goose-neck towing TWR

Confirm that the gross trailer weight, gross combination weight, gross vehicle weight, gross axle weight and tongue weight are all within the limits.

■ GCWR* and TWR*

Model code ^{*1}	GCWR	TWR
VXKH70L-PSVLZA	17700 lb. (8030 kg)	11450 lb. (5190 kg)
VXKH70L-PSVZZA	17700 lb. (8030 kg)	11380 lb. (5160 kg)
VXKH71L-PRVLZA	17700 lb. (8030 kg)	11350 lb. (5145 kg)
VXKH75L-PSVLZA	17700 lb. (8030 kg)	11130 lb. (5045 kg)
VXKH75L-PSVUZA	17000 lb. (7710 kg)	10290 lb. (4665 kg)
VXKH75L-PSVZZA	17600 lb. (7980 kg)	10990 lb. (4980 kg)
VXKH76L-PRVLZA	17700 lb. (8030 kg)	11060 lb. (5015 kg)
VXKH76L-PRVZZA	17700 lb. (8030 kg)	10960 lb. (4970 kg)

*1: The model code is indicated on the Certification Label. (→P.568)

■ Unbraked TWR*

1000 lb. (453 kg)

*: These models meet the tow-vehicle trailering requirement of SAE International per SAE J2807.

Trailer Tongue Weight and Trailer Kingpin Weight

- A recommended tongue weight or kingpin weight varies in accordance with the types of trailers or towing as described below.
- To ensure the recommended values shown below, the trailer must be loaded by referring to the following instructions.

1. Conventional Towing

The gross trailer weight should be distributed so that the tongue weight is 9% to 11%. (Tongue Weight/Gross trailer weight x 100 = 9% to 11%)

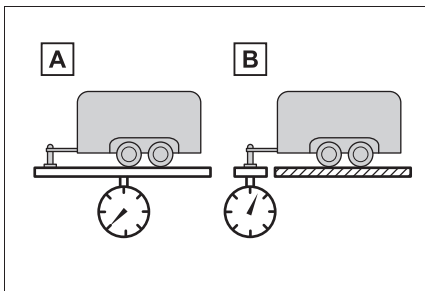

A Gross trailer weight

B Tongue Weight

If using a weight distributing hitch when towing, return the front axle to the same weight as before the trailer connection.

If front axle weight cannot be measured directly, measure the front fender height above the front axle before connection. Adjust weight

distributing hitch torque until front fender is returned to the same height as before connection.

Do not reduce front fender height below original measurement.

The gross trailer weight, gross axle weight and tongue weight can be measured with platform scales found at a highway weighing station, building supply company, trucking company, junk yard, etc.

2. Fifth wheel Towing or Goose-neck Towing

The gross trailer weight should be distributed so that the kingpin weight is 14% to 16%. (Kingpin weight/Gross trailer weight x 100 = 14% to 16%)

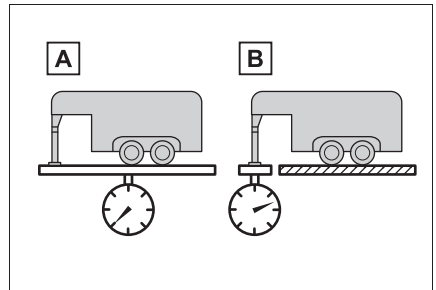

A Gross trailer weight

B Kingpin weight

The gross trailer weight and kingpin weight can be measured with platform scales found at a highway weighing station, building supply company, trucking company, junk yard, etc.

Current fifth wheel trailer designs are not compatible with short bed.

NOTICE**When towing a fifth wheel trailer**

Be careful not to hit the cabin or bed with the trailer while making a sharp turn.

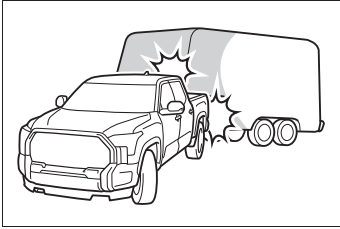
**Hitch**

Trailer hitch assemblies have different weight capacities. Toyota recommends the use of Toyota hitch/bracket for your vehicle. For details, contact your Toyota dealer.

- If you wish to install a trailer hitch, contact your Toyota dealer.
- Use only a hitch that conforms to the gross trailer weight requirement of your vehicle.
- Follow the directions supplied by the hitch manufacturer.
- Lubricate the hitch ball and kingpin with a light coating of grease.
- Remove the hitch ball whenever you are not towing a trailer. Remove the trailer hitch if you do not need it. After removing the hitch, seal

any mounting holes in the vehicle body to prevent entry of any substances into the vehicle.

WARNING**Hitch**

Trailer hitch assemblies have different weight capacities established by the hitch manufacturer. Even though the vehicle may be physically capable of towing a higher weight, the operator must determine the maximum weight rating of the particular hitch assembly and never exceed the maximum weight rating specified for the trailer-hitch. Exceeding the maximum weight rating set by the trailer-hitch manufacturer can cause an accident resulting in death or serious personal injuries.

NOTICE**When installing a trailer hitch**

Use only the position recommended by your Toyota dealer. Do not install the trailer hitch on the bumper; this may cause body damage.

Selecting trailer ball

Use the correct trailer ball for your application.

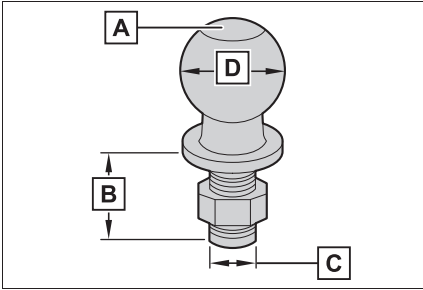

A Trailer ball load rating

Matches or exceeds the gross trailer weight rating of the trailer.

B Shank length

Protrudes beyond the bottom of the lock washer and nut at least 2 threads.

C Shank diameter

Matches the ball mount hole diameter size.

D Ball diameter

Matches the size of the trailer coupler. Most couplers are stamped with the required trailer ball size.

Trailer class	Typical trailer ball size
IV	2 5/16 in.
II and III	2 in.
I	1 7/8 in.

Positions for towing hitch receiver

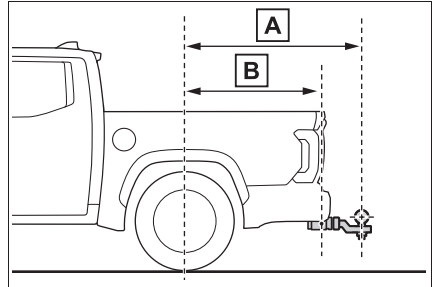

A Weight carrying ball position: 58.3 in. (1481 mm)

B Hitch receiver pin hole position: 46.4 in. (1178.9 mm)

Matching trailer ball height to trailer coupler height

No matter which class of tow hitch applies, for a more safer trailer hookup, the trailer ball setup must be the proper height for the coupler on the trailer.

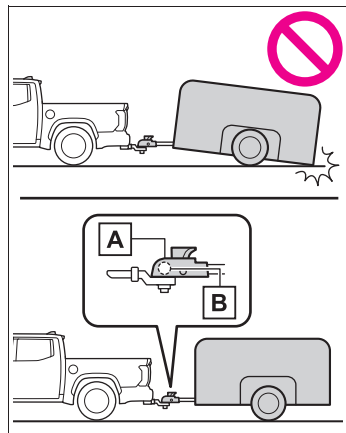

A Coupler

B Trailer ball

Connecting trailer lights

Use the wire harness located in the rear end of the vehicle.

The tow lighting system is designed for 64 watts/5 amps of electrical current per side (right and left) for the trailer brake/turn light functions.

Please contact your Toyota dealer with any questions or concerns.

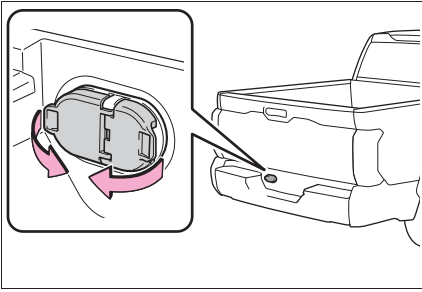

■ Auto current cut-off function

In case of over current, the auto cut-off function stops the power flowing to the trailer lights to prevent damage to the vehicle's electrical system.

This function is activated when the rated current of any of the following trailer light circuit components is exceeded:

- Stop/turn signal light (right): maximum 5 A
- Stop/turn signal light (left): maximum 5 A

■ When the auto current cut function is activated

If a trailer light does not come on due to the activation of the auto current cut function, the light system will need to be reset.

Follow the reset procedure shown

below.

- If a tail light does not come on, turn off the headlight switch.
- If the right-side stop/turn signal light does not come on, put the turn signal in the off position or remove foot from the brake pedal.
- If the left-side stop/turn signal light does not come on, put the turn signal in the off position or remove foot from the brake pedal.

If the emergency flashers do not operate, press the emergency flasher switch to turn them off.

After the light system is reset, operate the light switches again to see if the lights operate normally.

If the lights do not operate normally, have the vehicle inspected by your Toyota dealer.

■ Trailer lights operation check function

Use the meter control switches to start the function. (→P.96)

- 1 Press < or > to select .
- 2 Press ^ or v to select "Trailer Light Check", and then press **OK**.
- 3 Press **OK** to start the trailer light check.

The light check operates in the cycle of Brake lights → Left turn lights → Right turn lights.

■ The trailer light check is operational when

The trailer light check operates when all of the following conditions are met:

- The vehicle is stopped.
- The shift lever is shifted to P.



NOTICE

Do not directly splice trailer lights

Do not directly splice trailer lights. Directly splicing trailer lights may damage your vehicle's electrical system and cause a malfunction.

Connecting and disconnecting a trailer (vehicles with electronically modulated air suspension)

If a height control system is installed in your vehicle, you have to connect and disconnect your trailer more carefully.

- Connecting

- 1 Set the height control of electronically modulated air suspension system to "N" mode.
- 2 Turn off the hybrid system, or set the electronically modulated air suspension system to manual mode. (→P.373)
- 3 Connect the trailer.
- 4 Restart the hybrid system.
- 5 Press the height control mode select switch to cancel the manual mode condition that was set on step 2.
- 6 Check that the "MAN." indicator turns off. Set the height control of electronically modulated air suspension system to "N" mode.

- Disconnecting

- 1 Set the height control of electronically modulated air suspension system to "N" mode.
- 2 Set the electronically modulated air suspension system to manual mode.
- 3 Turn off the hybrid system.
- 4 Set the supporting leg of the trailer on the ground and raise the hitch by 4 in. (100 mm).
- 5 Restart the hybrid system.
- 6 Press the height control mode select switch to cancel the manual mode condition that was set on step 2. Check that the "MAN." indicator turns off.
- 7 Wait until vehicle height is stabilized.
- 8 Make sure the hitch is disconnected. If the hitch does not disconnect, raise the hitch higher and repeat steps 2 through 7. Move the vehicle forward in "LO" mode where the hitch does not touch anything in "N" mode. Set the height control of electronically modulated air suspension system to "N" mode.

Trailer towing tips

Your vehicle will handle differently when towing a trailer. To help avoid an accident, death or serious injury, keep the following

in mind when towing:

- Speed limits for towing a trailer vary by state or province. Do not exceed the posted towing speed limit.
- Toyota recommends that the vehicle-trailer speed limit is 65 mph (104 km/h) on a flat, straight, dry road. Do not exceed this limit, the posted towing speed limit or the speed limit for your trailer as set forth in your trailer owner's manual, whichever is lowest. Instability of the towing vehicle-trailer combination (trailer sway) increases as speed increases. Exceeding speed limits may cause loss of control.
- Before starting out, check the trailer lights, tires and the vehicle-trailer connections. Recheck after driving a short distance.
- Practice turning, stopping and reversing with the trailer attached in an area away from traffic until you become accustomed to the feel of the vehicle-trailer combination.
- Reversing with a trailer attached is difficult and requires practice. Grip the bottom of the steering wheel and move your hand to the left to move the trailer to the left. Move your hand to the right to move the trailer to the right. (This is generally opposite to reversing without a trailer attached.) Avoid sharp or prolonged turning. Have someone guide you when reversing to reduce the risk of an accident.
- As stopping distance is increased when towing a trailer, vehicle-to-vehicle distance should be increased. For each 10 mph (16 km/h) of speed, allow at least one vehicle and trailer length.
- Avoid sudden braking as you may skid, resulting in the trailer jackknifing and a loss of vehicle control. This is especially true on wet or slippery surfaces.
- Avoid jerky starts or sudden acceleration.
- Avoid jerky steering and sharp turns, and slow down before making a turn.
- Note that when making a turn, the trailer wheels will be closer than the vehicle wheels to the inside of the turn. Compensate by making a wider than normal turning radius.
- Slow down before making a turn, in crosswinds, on wet or slippery surfaces, etc. Increasing vehicle speed can destabilize the trailer.
- Take care when passing other vehicles. Passing requires

considerable distance. After passing a vehicle, do not forget the length of your trailer, and be sure you have plenty of room before changing lanes.

- Instability happens more frequently when descending steep or long downhill grades. Before descending, slow down and downshift. Do not make sudden downshifts while descending steep or long downhill grades.
- Avoid holding the brake pedal down too long or applying the brakes too frequently. This could cause the brakes to overheat and result in reduced braking efficiency.
- Due to the added load of the trailer, your vehicle's hybrid system may overheat on hot days (at temperatures over 85°F [30°C]) when driving up a long or steep grade. If the engine coolant temperature gauge indicates overheating, immediately turn off the air conditioning (if in use), pull your vehicle off the road and stop in a safe spot. (→P.561)
- Always place wheel blocks under both the vehicle's and the trailer's wheels when parking. Apply the parking brake firmly, and put the transmission in P. Avoid parking on a slope, but if unavoid-

able, do so only after performing the following:

- 1 Apply the brakes and keep them applied.
 - 2 Have someone place wheel blocks under both the vehicle's and trailer's wheels.
 - 3 When the wheel blocks are in place, release the brakes slowly until the blocks absorb the load.
 - 4 Apply the parking brake firmly.
 - 5 Shift into P and turn off the hybrid system.
- When restarting after parking on a slope:
 - 1 With the transmission in P, start the hybrid system. Be sure to keep the brake pedal pressed.
 - 2 Shift into a forward gear. If reversing, shift into R.
 - 3 If the parking brake is in manual mode, release the parking brake. (→P.217)
 - 4 Release the brake pedal, and slowly pull or back away from the wheel blocks. Stop and apply the brakes.
 - 5 Have someone retrieve the blocks.

■ Break-in schedule

If your vehicle is new or equipped with any new power train components (such as an engine, transmission, transfer [4WD models], rear

differential or wheel bearing), Toyota recommends that you do not tow a trailer until the vehicle has been driven for over 500 miles (800 km).

After the vehicle has been driven for over 500 miles (800 km), you can start towing. However, for the next 500 miles (800 km), drive the vehicle at a speed of less than 50 mph (80 km/h) when towing a trailer, and avoid full throttle acceleration.

■ Maintenance

- If you tow a trailer, your vehicle will require more frequent maintenance due to the additional load. (See “Owner’s Warranty Information Booklet” or “Scheduled Maintenance Guide” / “Owner’s Manual Supplement”.)
- Retighten the fixing bolts of the towing ball and bracket after approximately 600 miles (1000 km) of trailer towing.

■ If trailer sway occurs

One or more factors (crosswinds, passing vehicles, rough roads, etc.) can adversely affect handling of your vehicle and trailer, causing instability.

- If trailer swaying occurs:
 - Firmly grip the steering wheel. Steer straight ahead. Do not try to control trailer swaying by turning the steering wheel.
 - Begin releasing the accelerator pedal immediately but very gradually to reduce speed. Do not increase speed. Do not apply vehicle brakes.

If you make no extreme correction with the steering or brakes, your vehicle and trailer should stabilize. (if enabled, Trailer Sway Control can also help to stabilize the vehicle and trailer.)

- After the trailer swaying has stopped:
 - Stop in a safe place. Get all occupants out of the vehicle.

- Check the tires of the vehicle and the trailer.
- Check the load in the trailer. Make sure the load has not shifted. Make sure the tongue weight is appropriate, if possible.
- Check the load in the vehicle. Make sure the vehicle is not overloaded after occupants get in.

If you cannot find any problems, the speed at which trailer swaying occurred is beyond the limit of your particular vehicle-trailer combination. Drive at a lower speed to prevent instability. Remember that swaying of the towing vehicle-trailer increases as speed increases.

Dinghy towing

Your vehicle is not designed to be dinghy towed (with 4 wheels on the ground) behind a motor home.

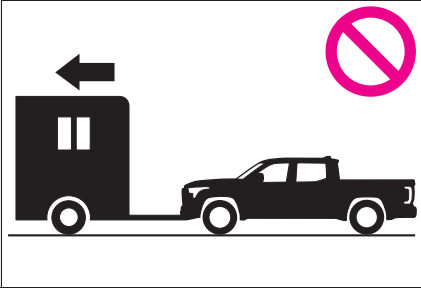

NOTICE

■ **To avoid serious damage to your vehicle**

Do not tow your vehicle with the four wheels on the ground.

Power (ignition) switch

Performing the following operations when carrying the electronic key on your person starts the hybrid system or changes power switch modes.

Starting the hybrid system

- 1 Pull the parking brake switch to check that the parking brake is set. (→P.217)

The parking brake indicator will come on.

- 2 Check that the shift lever is in P.
- 3 Firmly depress the brake pedal.

 and a message will be displayed on the multi-information display.

If it is not displayed, the hybrid system cannot be started.

- 4 Press the power switch shortly and firmly.

When operating the power switch, one short, firm press is enough. It is not necessary to press and hold the switch.

If the “READY” indicator turns on, the hybrid system will operate normally.

Continue depressing the brake pedal until the “READY” indicator is illuminated.

The hybrid system can be started

from any power switch mode.

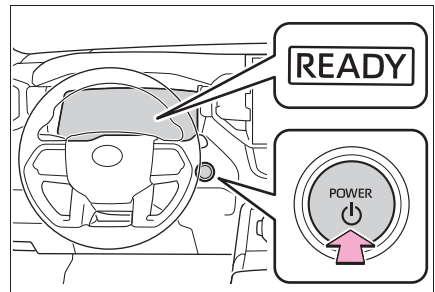

- 5 Check that the “READY” indicator is illuminated.

The vehicle cannot be driven if the “READY” indicator is off.

■ If the hybrid system does not start

- The immobilizer system may not have been deactivated. (→P.82) Contact your Toyota dealer.
- If a message related to start-up is shown on the multi-information display, read the message and follow the instructions.

■ When the ambient temperature is low, such as during winter driving conditions

- When starting the hybrid system, the flashing time of the “READY” indicator may be long. Leave the vehicle as it is until the “READY” indicator is steady on, as steady means the vehicle is able to move.
- When the hybrid battery (traction battery) is extremely cold (below approximately -31°F [-35°C]) under the influence of the outside temperature, it may not be possible to start the hybrid system. In this case, try to start the hybrid system again after the temperature of the hybrid battery increases due to the outside temperature increase, etc.
- When the outside temperature is extremely cold, the hybrid system may be started by starter motor.

■ **Starting the hybrid system by starter motor**

- When the fuel lid is opened and closed (such as re-fueling)
- When the outside temperature is extremely cold (the hybrid system may be started by starter motor)

■ **Sounds and vibrations specific to a Hybrid Electric Vehicle**

→P.75

■ **If the 12-volt battery is discharged**

The hybrid system cannot be started using the smart key system. Refer to P.555 to restart the hybrid system.

■ **Electronic key battery depletion**

→P.110

■ **Conditions affecting operation**

→P.133

■ **Notes for the entry function**

→P.133

■ **If “Smart Key System Malfunction See Owner’s Manual” is displayed on the multi-information display**

The system may be malfunctioning. Have the vehicle inspected by your Toyota dealer immediately.

■ **When “Check Fuel Cap” is displayed on the multi-information display**

→P.235

■ **If the “READY” indicator does not come on**

In the event that the “READY” indicator does not come on even after performing the proper procedures for starting the vehicle, contact your Toyota dealer immediately.

■ **If the hybrid system is malfunctioning**

→P.537

■ **Electronic key battery**

→P.510

■ **Operation of the power switch**

- If the switch is not pressed shortly and firmly, the power switch mode may not change or the hybrid system may not start.
- If attempting to restart the hybrid system immediately after turning the power switch to OFF, the hybrid system may not start in some cases. After turning the power switch to OFF, please wait a few seconds before restarting the hybrid system.

■ **Customization**

If the smart key system has been deactivated in a customized setting, refer to P.553.



WARNING

■ **When starting the hybrid system**

Always start the hybrid system while sitting in the driver’s seat. Do not depress the accelerator pedal while starting the hybrid system under any circumstances. Doing so may cause an accident resulting in death or serious injury.



NOTICE

■ **When starting the hybrid system**

If the hybrid system becomes difficult to start, have your vehicle checked by your Toyota dealer immediately.

**NOTICE****■ Symptoms indicating a malfunction with the power switch**

If the power switch seems to be operating somewhat differently than usual, such as the switch sticking slightly, there may be a malfunction. Contact your Toyota dealer immediately.

Stopping the hybrid system

- 1 Stop the vehicle completely.
- 2 Set the parking brake (→P.217), and shift the shift lever to P.

Check the parking brake indicator is illuminated.

Do not press the shift release button after shifting the shift position to P.

- 3 Press the power switch shortly and firmly.

The hybrid system will stop, and the meter display will be extinguished.

- 4 Release the brake pedal and check that “ACCESSORY” or “IGNITION ON” is not shown on the meter.

■ Automatic hybrid system shut off feature

- The vehicle is equipped with a feature that automatically shuts off the hybrid system when the shift lever is in P with the hybrid system operating for an extended period.
- The hybrid system will automatically shut off after approximately 1 hour if it has been left running while the shift lever is in P.

- The timer for the automatic hybrid system shut off feature will reset if the brake pedal is depressed or if the shift lever is in a position other than P.
- After the vehicle is parked, if the door is locked with the door lock switch (→P.116) from the inside or the mechanical key (→P.112) from the outside, the automatic hybrid system shut off feature will be disabled. The timer for the automatic hybrid system shut off feature will be re-enabled if the driver's door is opened.

**WARNING****■ Stopping the hybrid system in an emergency**

- If you want to stop the hybrid system in an emergency while driving the vehicle, press and hold the power switch for more than 2 seconds, or press it briefly 3 times or more in succession. (→P.520)
However, do not touch the power switch while driving except in an emergency. Turning the hybrid system off while driving will not cause loss of steering or braking control, however, power assist to the steering will be lost. This will make it more difficult to steer smoothly, so you should pull over and stop the vehicle as soon as it is safe to do so.
- If the power switch is operated while the vehicle is running, a warning message will be shown on the multi-information display and a buzzer sounds.
- To restart the hybrid system after performing an emergency shutdown, shift the shift lever to N and then press the power switch.

⚠ WARNING

■ When parking

Exhaust gases include harmful carbon monoxide (CO), which is colorless and odorless. Observe the following precautions.

Failure to do so may cause exhaust gases to enter the vehicle and may lead to an accident caused by light-headedness, or may lead to death or a serious health hazard.

- If the vehicle is in a poorly ventilated area or a closed area, such as a garage, stop the hybrid system.
- Do not leave the vehicle with the hybrid system operating for a long time. If such a situation cannot be avoided, park the vehicle in an open space and ensure that exhaust fumes do not enter the vehicle interior.
- Do not leave the hybrid system operating in an area with snow build-up, or where it is snowing. If snowbanks build up around the vehicle while the hybrid system is operating, exhaust gases may collect and enter the vehicle.

Changing power switch modes

Modes can be changed by pressing the power switch with the brake pedal released. (The mode changes each time the switch is pressed.)

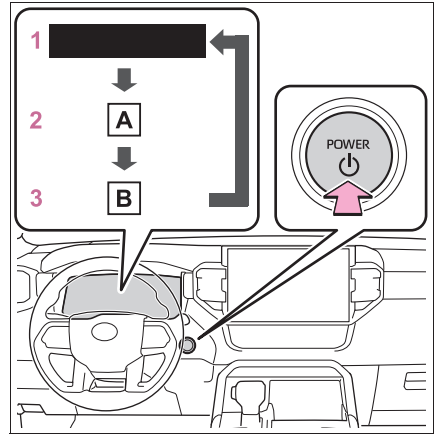

A “ACCESSORY”

B “IGNITION ON”

1 OFF*

The emergency flashers can be used.

The multi-information display will not be displayed.

2 ACC

Some electrical components such as the audio system can be used.

“ACCESSORY” will be displayed on the meter.

3 ON

All electrical components can be used.

“IGNITION ON” will be displayed on the meter.

* : If the shift lever is in a position

other than P or the shift release button is pressed when turning off the hybrid system, the power switch will be remained to ON, not to OFF.

■ Auto power off function

If the vehicle is left in ACC for more than 20 minutes or ON (the hybrid system is not operating) for more than an hour with the shift lever is in P or the shift release button is not pressed, the power switch will automatically turn to OFF. However, this function cannot entirely prevent the 12-volt battery discharge. Do not leave the vehicle with the power switch in ACC or ON for long periods of time when the hybrid system is not operating.



NOTICE

■ To prevent 12-volt battery discharge

- Do not leave the power switch in ACC or ON for long periods of time without the hybrid system on.
- If “ACCESSORY” or “IGNITION ON” is displayed on the meter, the power switch is not off. Exit the vehicle after turning the power switch off.

When stopping the hybrid system with the shift lever in a position other than P

If the hybrid system is stopped when the shift lever is in a position other than P or the shift release button is pressed, the power switch will not be turned to OFF. Perform the following procedure to turn the switch to OFF:

- 1 Check that the parking brake is set.
- 2 Shift the shift lever to P.

Do not press the shift release button after shifting the shift position to P.

- 3 Check that “IGNITION ON” is displayed on the multi-information display and press the power switch shortly and firmly.
- 4 Check that “ACCESSORY” or “IGNITION ON” on the multi-information display is off.



NOTICE

■ To prevent 12-volt battery discharge

Do not stop the hybrid system with the shift lever in a position other than P or the shift release button pressed. If the hybrid system is stopped with the shift lever in a position other than P or the shift release button pressed, the power switch will not be turned OFF and remained to ON. If the vehicle is left in ON, 12-volt battery discharge may occur.

Automatic transmission

Select the shift position depending on your purpose and situation.

Shift position purpose and functions

Shift position	Objective or function
P	Parking the vehicle/starting the hybrid system
R	Reversing
N	Neutral (Condition in which the power is not transmitted)
D	Normal driving*1
S	S mode driving*2 (→P.214)

*1: Shifting to the D position allows the system to select a gear suitable for the driving conditions. Setting the shift lever to the D position is recommended for normal driving.

*2: Selecting shift ranges using S mode restricts the upper limit of the possible gear ranges, controls engine braking force, and prevents unnecessary upshifting.

Driving on a downhill

On declines, there may be case where the vehicle shifts down automatically to obtain engine braking. As a result of the downshifting, the

engine speed may increase.

To protect the automatic transmission

● If the tires spin continually when the vehicle becomes stuck in mud, dirt or snow, or if the accelerator pedal is depressed and released repeatedly while driving, the automatic transmission temperature may become too high and the automatic transmission may be damaged.

To avoid damaging the automatic transmission, the system may temporarily lock the gear. If the automatic transmission temperature falls, the gear locking is canceled and the automatic transmission is returned to the normal operation.

● If the automatic transmission fluid temperature is high, “Transmission Oil Temp. High Stop in a Safe Place and See Owner’s Manual” will be displayed on the multi-information display. Immediately stop the vehicle in a safe place, shift the shift lever to P and wait until the warning message go off. If the warning message go off, you may start the vehicle again. If the warning message do not go off, contact your Toyota dealer.

When driving with dynamic radar cruise control with full-speed range activated

Even when performing the following actions with the intent of enabling engine braking, engine braking will not activate because dynamic radar cruise control with full-speed range will not be canceled.

● While driving in S mode, downshifting to 9, 8, 7, 6, 5 or 4. (→P.214)

Restraining sudden start (Drive-Start Control)

→P.187

■ **AI-SHIFT**

The AI-SHIFT automatically selects the suitable gear according to driver operation and driving conditions. AI-SHIFT automatically operates when the shift lever is in D or S.

! WARNING

■ **When driving on slippery road surfaces**

Do not accelerate or shift gears suddenly. Sudden changes in engine braking may cause the vehicle to spin or skid, resulting in an accident.

Shifting the shift lever

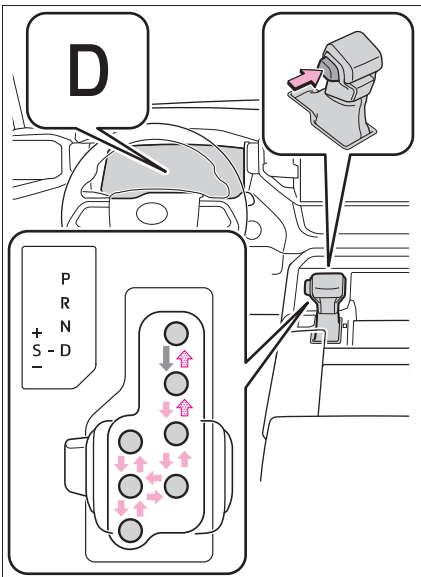

← While the power switch is in ON and the brake pedal depressed*, shift the shift lever while pushing the shift release button on the shift knob.

← Shift the shift lever while

pushing the shift release button on the shift knob.

← Shift the shift lever normally.

When shifting the shift lever between P and D, make sure that the vehicle is completely stopped.

*: For the vehicle to be able to be shifted from P, the brake pedal must be depressed before the shift release button is pushed. If the shift release button is pushed first, the shift lock will not be released.

■ **Shift lock system**

The shift lock system is a system to prevent accidental operation of the shift lever in starting. The shift lever can be shifted from P only when the power switch is in ON, the brake pedal is depressed and the shift release is pushed.

■ **If the shift lever cannot be shifted from P**

First, check whether the brake pedal is being depressed. If the shift lever cannot be shifted even though the brake pedal is depressed and the shift release button is pushed, there may be a problem with the shift lock system. Have the vehicle inspected by your Toyota dealer immediately. The following steps may be used as an emergency measure to ensure that the shift lever can be shifted.

Releasing the shift lock:

- 1 Set the parking brake.
- 2 Turn the power switch off.
- 3 Depress the brake pedal.

- 4 Pry the cover up with a flathead screwdriver or equivalent tool. To prevent damage to the cover, cover the tip of the screwdriver with a rag.

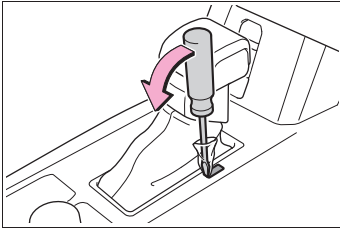

- 5 Press and hold the shift lock override button and then push the button on the shift knob. The shift lever can be shifted while both buttons are pressed.

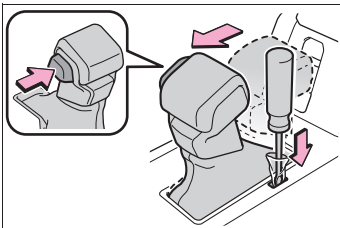

⚠ WARNING

■ To prevent an accident when releasing the shift lock

Before pressing the shift lock override button, make sure to set the parking brake and depress the brake pedal.
If the accelerator pedal is accidentally depressed instead of the brake pedal when the shift lock override button is pressed and the shift lever is shifted out of P, the vehicle may suddenly start, possibly leading to an accident resulting in death or serious injury.

Selecting the driving mode

■ Drive mode

→P.376

Changing shift ranges in S mode

When the shift lever is in the S position, the shift lever can be operated as follows:

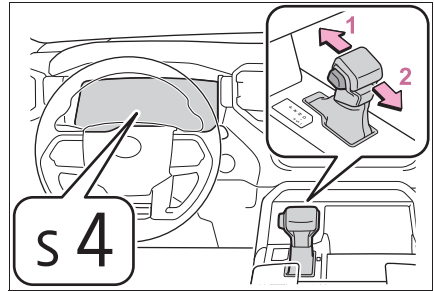

- 1 Upshifting
- 2 Downshifting

The selected shift range, from S1 to S10 will be displayed on the multi-information display.

The initial shift range in S mode is set automatically to 4, 5, 6, 7 or 8 according to vehicle speed.

However, the initial shift range may be set to 4 if AI-SHIFT has operated while the shift lever was in the D position. (→P.213)

■ S mode

- You can choose from 10 levels of accelerating force and engine braking force.
- A lower shift range will provide greater accelerating force and engine braking force than a higher shift range, and the engine revolutions will also increase.
- To prevent the engine from over-revving, upshifting may automatically occur.
- To protect the automatic transmission, a function is adopted that automatically selects a higher shift

range when the fluid temperature is high.

- When the shift range is 9 or lower, holding the shift lever toward “+” sets the shift range to 10.

■ Downshifting restriction warning buzzer

To help ensure safety and driving performance, downshifting operation may sometimes be restricted. In some circumstances, downshifting may not be possible even when the shift lever is operated. (A buzzer will sound twice.)

■ If the S indicator does not come on even after shifting the shift lever to S

This may indicate a malfunction in the automatic transmission system. Have the vehicle inspected by your Toyota dealer immediately.

“TOW HAUL” switch (if equipped)

Use “TOW HAUL” or “TOW+” mode when pulling a trailer or hauling a heavy load. Activating “TOW HAUL” or “TOW+” mode changes engine, transmission, and steering to be more suitable when pulling a trailer.

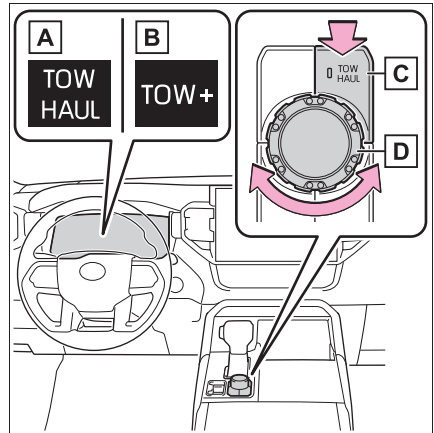

- A** “TOW HAUL” indicator
- B** “TOW+” indicator
- C** “TOW HAUL” switch
- D** Mode select switch

- 1** Press the “TOW HAUL” switch

The “TOW HAUL” indicator will come on.

Press the switch once more to cancel the mode.

- 2** Turn the mode select switch to change between “TOW HAUL” or “TOW+” modes.

When more towing power is needed than is available in “TOW HAUL” mode, use “TOW+” mode.

216 4-2. Driving procedures

(→P.216)

The “TOW+” indicator will come on.

■ Automatic deactivation of “TOW HAUL” and “TOW+” mode

“TOW HAUL” and “TOW+” mode is deactivated the following conditions:

- When the front-wheel drive control switch is in “4L”
- When driving mode select or Multi-terrain Select (if equipped) is selected

■ Differences with “TOW HAUL” mode and “TOW+” mode

It is recommended to use each mode according to the weight of the trailer to be towed.

- “TOW HAUL” mode is used when towing trailers that weigh less than 5000 lb. (2268 kg).
- “TOW+” mode is used when towing trailers that weigh more than 5000 lb. (2268 kg).

Turn signal lever

Operating instructions

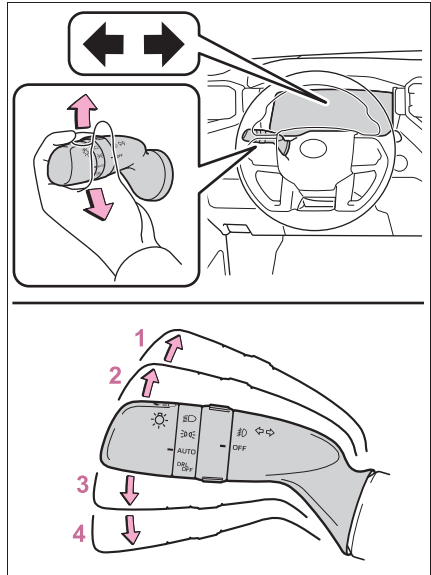

- 1 Right turn
- 2 Lane change to the right (move the lever partway and release it)

The right hand signals will flash 3 times.

- 3 Lane change to the left (move the lever partway and release it)

The left hand signals will flash 3 times.

- 4 Left turn

■ Turn signals can be operated when

The power switch is in ON.

■ If the indicator flashes faster than usual

Check that the front or rear turn signal lights has not burned out.

- If the turn signals stop flashing before a lane change has been performed

Operate the lever again.

■ Customization

Some functions can be customized.
(→P.588)

Parking brake

The parking brake can be set or released automatically or manually. In automatic mode, the parking brake can be set or released automatically according to shift lever operation.

Also, even in automatic mode, the parking brake can be set or released manually.

Operating instructions

■ Using the manual mode

The parking brake can be set and released manually.

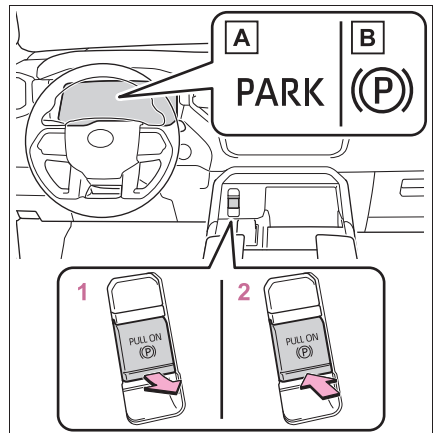

A U.S.A.

B Canada

- 1** Pull the switch to set the parking brake.

The parking brake indicator light will turn on.

Pull and hold the parking brake

switch if an emergency occurs and it is necessary to operate the parking brake while driving.

2 Push the switch to release the parking brake.

- Operate the parking brake switch while depressing the brake pedal or the accelerator pedal. When using this function, slowly depress the accelerator pedal.
- Parking brake automatic release function (→P.219)

Make sure that the parking brake indicator light turn off.

If the parking brake indicator light flashes, operate the switch again. (→P.532)

■ Turning the automatic mode on

While the vehicle is stopped, pull and hold the parking brake switch until a buzzer sounds and message is displayed on the multi-information display.

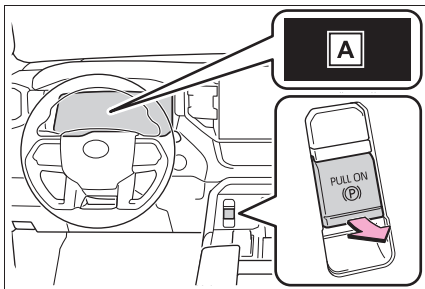

A “EPB Shift Interlock Function Activated”

When the automatic mode is turned on, the parking brake operates as follows.

- When the shift lever is shifted

from P, the parking brake will be released, and the parking brake indicator light will turn off.

- When the shift lever is shifted to P, the parking brake will be set, and the parking brake indicator light will turn on.

Operate the shift lever with the vehicle stopped and the brake pedal depressed.

■ Turning the automatic mode off

While the vehicle is stopped and depressing the brake pedal, press and hold the parking brake switch until a buzzer sounds and message is displayed on the multi-information display.

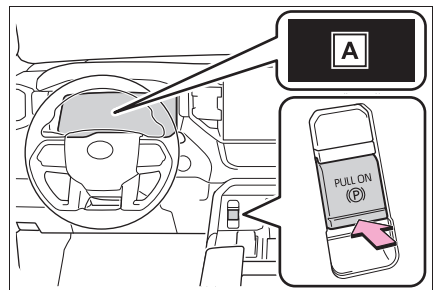

A “EPB Shift Interlock Function Deactivated”

■ Parking brake operation

- When the power switch is not in ON, the parking brake cannot be released using the parking brake switch.
- When the power switch is not in ON, automatic mode (automatic brake setting and releasing) is not

available.

■ Parking brake automatic release function

The parking brake will be released automatically when the accelerator pedal is slowly depressed under the following conditions:

- The driver's door is closed
- The driver is wearing the seat belt
- The shift lever is in a forward or reverse position.
- The malfunction indicator lamp or brake system warning light is not illuminated

If the automatic release function does not operate, release the parking brake manually.

■ Parking brake automatic lock function

The parking brake will be set automatically under the following conditions:

- The driver does not operate the brake pedal
- The driver's door is not closed
- The driver is not wearing the seat belt
- The shift lever position is not in P or N
- The malfunction indicator lamp or brake system warning light is not illuminated

■ If "Parking Brake Temporarily Unavailable" is displayed on the multi-information display

If the parking brake is operated repeatedly over a short period of time, the system may restrict operation to prevent overheating. If this happens, refrain from operating the parking brake. Normal operation will return after about 1 minute.

■ If "Parking Brake Unavailable" is displayed on the multi-information display

Operate the parking brake switch. If

the message does not disappear after operating the switch several times, the system may be malfunctioning. Have the vehicle inspected by your Toyota dealer.

■ Parking brake operation sound

When the parking brake operates, a motor sound (whirring sound) may be heard. This does not indicate a malfunction.

■ Parking brake indicator light

- Depending on the power switch mode, the parking brake indicator light will turn on and stay on as described below:
ON: Comes on until the parking brake is released.
Not in ON: Stays on for approximately 15 seconds.
- When the power switch is turned to OFF with the parking brake set, the parking brake indicator light will stay on for about 15 seconds. This does not indicate a malfunction.

■ When the parking brake switch malfunctions

Automatic mode (automatic brake setting and releasing) will be turned on automatically.

■ Parking the vehicle

→P.181

■ Parking brake engaged warning buzzer

A buzzer will sound if the vehicle is driven with the parking brake engaged. "Parking Brake ON" is displayed on the multi-information display (with the vehicle reaching a speed of 3 mph [5 km/h]).

■ If the brake system warning light comes on

→P.527

■ Usage in winter time

→P.414

**WARNING****■ When parking the vehicle**

Do not leave a child in the vehicle alone. The parking brake may be released unintentionally by a child and there is the danger of the vehicle moving that may lead to an accident resulting in death or serious injury.

■ Parking brake switch

Do not set any objects near the parking brake switch. Objects may interfere with the switch and may lead the parking brake to unexpectedly operate.

**NOTICE****■ When parking the vehicle**

Before you leave the vehicle, shift the shift lever to P, set the parking brake and make sure that the vehicle does not move.

■ When the system malfunctions

Stop the vehicle in a safe place and check the warning messages.

■ When the parking brake cannot be released due to a malfunction

Driving the vehicle with the parking brake set will lead to brake components overheating, which may affect braking performance and increase brake wear. Have the vehicle inspected by your Toyota dealer immediately if this occurs.

Brake Hold

The brake hold system keeps the brake applied when the shift lever is in D, S or N with the system on and the brake pedal has been depressed to stop the vehicle. The system releases the brake when the accelerator pedal is depressed with the shift lever in D or S to allow smooth start off.

Enabling the system

Turns the brake hold system on. The brake hold standby indicator (green) **A** comes on. While the system is holding the brake, the brake hold operated indicator (yellow) **B** comes on.

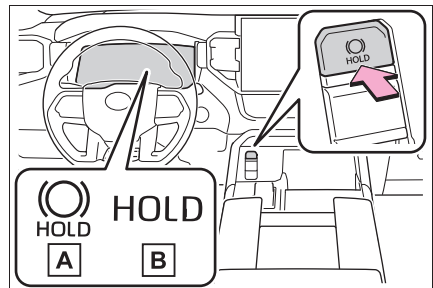
**■ Brake hold system operating conditions**

The brake hold system cannot be turned on in the following conditions:

- The driver's door is not closed.
- The driver is not wearing the seat

belt.

- The parking brake is engaged.

If any of the conditions above are detected when the brake hold system is enabled, the system will turn off and the brake hold standby indicator light will go off. In addition, if any of the conditions are detected while the system is holding the brake, a warning buzzer will sound and a message will be shown on the multi-information display. The parking brake will then be set automatically.

■ Brake hold function

- If the brake pedal is left released for a period of about 3 minutes after the system has started holding the brake, the parking brake will be set automatically. In this case, a warning buzzer sounds and a message is shown on the multi-information display.
- To turn the system off while the system is holding the brake, firmly depress the brake pedal and press the button again.
- The brake hold function may not hold the vehicle when the vehicle is on a steep incline. In this situation, it may be necessary for the driver to apply the brakes. A warning buzzer will sound and the multi-information display will inform the driver of this situation. If a warning message is shown on the multi-information display, read the message and follow the instructions.

■ When the parking brake is set automatically while the system is holding the brakes

Perform any of the following operations to release the parking brake:

- Depress the accelerator pedal. (The parking brake is not released if the seat belt is not fastened, door is open, and/or the shift lever is in P or N.)
- Operate the parking brake switch

with the brake pedal depressed.

Make sure that the parking brake indicator light goes off. (→P.217)

■ When an inspection at your Toyota dealer is necessary

When the brake hold standby indicator (green) does not illuminate even when the brake hold switch is pressed with the brake hold system operating conditions met, the system may be malfunctioning. Have the vehicle inspected at your Toyota dealer.

■ If “Brake Hold Malfunction Press Brake to Deactivate Visit Your Dealer” or “Brake Hold Malfunction Visit Your Dealer” is displayed on the multi-information display

The system may be malfunctioning. Have the vehicle inspected by your Toyota dealer.

■ Warning messages and buzzers

Warning messages and buzzers are used to indicate a system malfunction or to inform the driver of the need for caution. If a warning message is shown on the multi-information display, read the message and follow the instructions.

■ When another control activates with the brake hold system

A message is displayed on the multi-information display in any of the following cases.

- “Brake Hold Unavailable, See the Owner’s Manual”
 - When the brake hold switch is pressed while the downhill assist control system is activated.
 - When the brake hold switch is pressed while the front-wheel drive control switch is turned to “4L” mode.
- “Brake Hold Unavailable, Press Brake to Deactivate.”
- When the “DAC/CRAWL” switch is operated while the brake hold system is activated.

222 4-2. Driving procedures

- When the four-wheel drive control switch is turned to “4L” mode while the brake hold system is activated.

The brake hold system and downhill assist control system or transfer “4L” mode cannot be activated at the same time.

Please press the brake hold switch with the brake pedal depressed to turn off the brake hold system.

■ If the brake hold operated indicator flashes

→P.532



WARNING

■ When the vehicle is on a steep incline

Take care when using the brake hold system on a steep incline, exercise caution. The brake hold function may not hold brakes in such situations.

Also, the system may not activate depending on the angle of the slope.

■ When stopped on a slippery road

The system cannot stop the vehicle when the gripping ability of the tires has been exceeded. Do not use the system when stopped on a slippery road.



NOTICE

■ When parking the vehicle

The brake hold system is not designed for use when parking the vehicle for a long period of time. Turning the power switch off while the system is holding the brake may release the brake, which would cause the vehicle to move. When operating the power switch, depress the brake pedal, shift the shift lever to P and set the parking brake.

Headlight switch

The headlights can be operated manually or automatically.

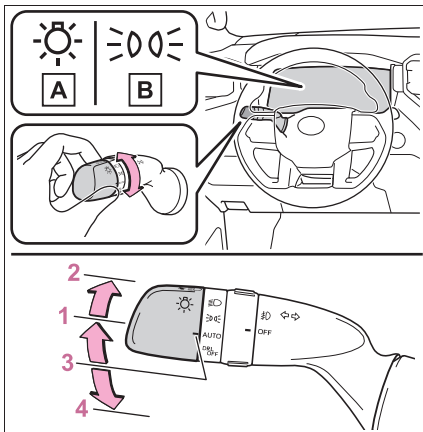

Operating instructions

Operating the  switch turns on the lights as follows:



A U.S.A.

B Canada

- 1**  The side marker, rear tailgate markers (if equipped), parking, tail, license plate, instrument panel lights, and daytime running lights (→P.223) turn on.
- 2**  The headlights and all lights listed above (except daytime running lights) turn on.
- 3** AUTO The headlights, day-

time running lights (→P.223) and all the lights listed above turn on and off automatically.

- 4**  (if equipped) Off

■ AUTO mode can be used when

The power switch is in ON.

■ Daytime running light system

- On some models: The daytime running lights illuminate using the same lights as the headlights but at a lower intensity.
- To make your vehicle more visible to other drivers during daytime driving, the daytime running lights turn on automatically when all of the following conditions are met. (The daytime running lights are not designed for use at night.)
 - The hybrid system is started
 - The parking brake is released
 - The headlight switch is in the  or AUTO* position

*: When the surroundings are bright

- The daytime running lights remain on after they illuminate, even if the parking brake is set again.
- For the U.S.A.: Daytime running lights can be turned off by operating the switch.

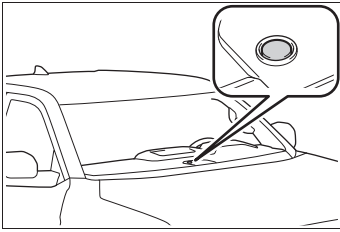

■ Headlight control sensor



The sensor may not function properly if an object is placed on the sensor, or anything that blocks the sensor is affixed to the windshield. Doing so interferes with the sensor detecting the level of ambient light and may cause the automatic headlight system to malfunction.

■ Automatic light off system

- When the headlights are on: The headlights and tail lights turn off 30 seconds after the driver's door is opened and closed if the power switch is turned to ACC or off. (The lights turn off immediately if  on the key is pressed after all the doors are closed.)
- When only the tail lights are on: The tail lights turn off automatically if the power switch is turned to ACC or OFF and the driver's door is opened.

To turn the lights on again, turn the power switch to ON, or turn the light switch off once and then back to  or .

■ Light reminder buzzer

A buzzer sounds when the power switch is turned to ACC or OFF and the driver's door is opened while the lights are turned on.

■ When unlock the doors (welcome lamp) (If equipped)

When the doors are unlocked using the entry function or wireless remote control, the front parking lights, rear tailgate markers and tail lights turn

on automatically.

When the light switch is in the AUTO position and the surrounding area is dark, this function will operate.

■ Automatic headlight leveling system (if equipped)

The level of the headlights is automatically adjusted according to the number of passengers and the loading condition of the vehicle to ensure that the headlights do not interfere with other road users.

■ Windshield wiper linked headlight illumination

When driving during daytime with the headlight switch turned to AUTO, if the windshield wipers are used, the headlights will turn on automatically after several seconds to help enhance the visibility of your vehicle.

■ 12-volt battery-saving function

In order to prevent the 12-volt battery of the vehicle from discharging, if the headlights and/or tail lights are on when the power switch is turned to OFF the 12-volt battery-saving function will operate and automatically turn off all the lights after approximately 20 minutes. When the power switch is turned to ON, the 12-volt battery-saving function will be disabled.

When any of the following are performed, the 12-volt battery-saving function is canceled once and then reactivated. All the lights will turn off automatically 20 minutes after the 12-volt battery-saving function has been reactivated:

- When the headlight switch is operated
- When a door is opened or closed

■ Customization

Some functions can be customized. (→P.588)

 NOTICE

■ To prevent 12-volt battery discharge

Do not leave the lights on longer than necessary when the hybrid system is not operating.

Turning on the high beam headlights

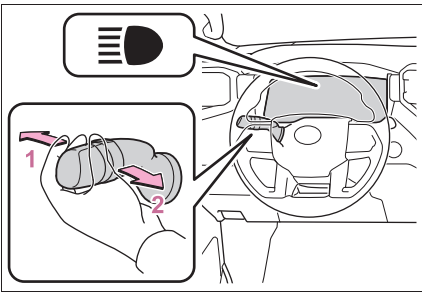

- 1 With the headlights on, push the lever away from you to turn on the high beams.

Pull the lever toward you to the center position to turn the high beams off.

- 2 Pull the lever toward you and release it to flash the high beams once.

You can flash the high beams with the headlights on or off.

Manual headlight leveling dial (if equipped)

The vehicle is equipped with manual leveling of the headlamps. The aim of the headlamps can be adjusted by adjusting the dial settings based on your vehicle loading condition.

It is recommended that the headlamps remain adjusted as close to “0” position for unloaded vehicle. Adjust to larger number as loading condition increases so not to interfere with other road users.

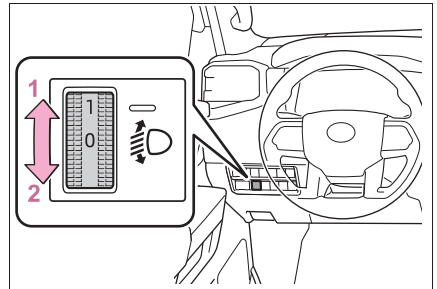

- 1 Raises the level of the headlights
- 2 Lowers the level of the headlights

Fog light switch *

*: If equipped

The fog lights secure excellent visibility in difficult driving conditions, such as in rain and fog.

Operating instructions

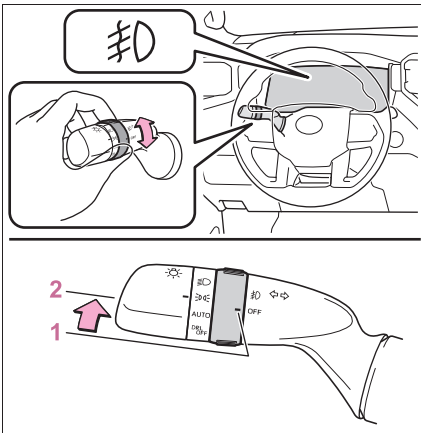

- 1 OFF *1 or ○ *2 Turns the front fog lights off
- 2 D Turns the front fog lights on

*1: U.S.A.

*2: Canada

■ Fog lights can be used when

The parking lights are on or the headlights are on in low beam.

AHB (Automatic High Beam)

The Automatic High Beam uses an in-vehicle front camera to assess the brightness of streetlights, the lights of vehicles ahead etc., and automatically turns the high beam on or off as necessary.

⚠ WARNING

■ Limitations of the Automatic High Beam

Do not overly rely on the Automatic High Beam. Always drive safely, taking care to observe your surroundings and turning the high beams on or off manually if necessary.

■ To prevent incorrect operation of the Automatic High Beam system

Do not overload the vehicle.

Activating the Automatic High Beam

- 1 Press the Automatic High Beam switch.

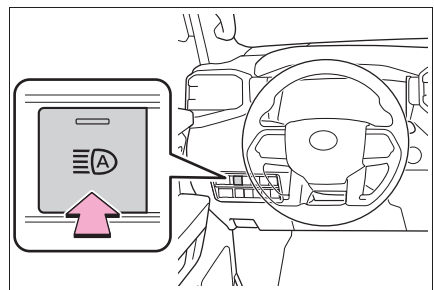

- 2 Turn the headlight switch to the  or AUTO position.

When the headlight switch lever is in the low beam position, the AHB system will be enabled and the AHB indicator will illuminate.

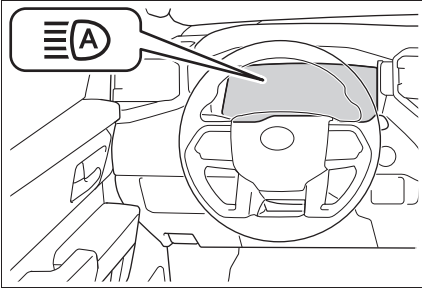

■ High beam automatic turning on or off conditions

- When all of the following conditions are fulfilled, the high beam will be automatically turned on (after approximately 1 second):
 - Vehicle speed is above approximately 21 mph (34 km/h) or more.
 - The area ahead of the vehicle is dark.
 - There are no vehicles ahead with headlights or tail lights turned on.
 - There are few streetlights on the road ahead.
- If any of the following conditions are fulfilled, the high beam will be automatically turned off:
 - Vehicle speed drops below approximately 17 mph (27 km/h).
 - The area ahead of the vehicle is not dark.
 - Vehicles ahead have headlights or tail lights turned on.
 - There are many streetlights on the road ahead.

■ Front camera detection information

- The high beam may not be automatically turned off in the following situations:
 - When oncoming vehicles sud-

- denly appear from a curve
- When the vehicle is cut in front of by another vehicle
- When vehicles ahead are hidden from sight due to repeated curves, road dividers or roadside trees
- When vehicles ahead appear from the faraway lane on a wide road
- When vehicles ahead have no lights
- The high beam may be turned off if a vehicle ahead that is using fog lights without using the headlights is detected.
- House lights, street lights, traffic signals, and illuminated billboards or signs may cause the high beam to switch to the low beams, or the low beams to remain on.
- The following factors may affect the amount of time taken to turn the high beam on or off:
 - The brightness of headlights, fog lights, and tail lights of vehicles ahead
 - The movement and direction of vehicles ahead
 - When a vehicle ahead only has operational lights on one side
 - When a vehicle ahead is a two-wheeled vehicle
 - The condition of the road (gradient, curve, condition of the road surface etc.)
 - The number of passengers and amount of luggage
- The high beam may be turned on or off when the driver does not expect it.
- Bicycles or similar objects may not be detected.
- In the situations shown below, the system may not be able to accurately detect surrounding brightness levels. This may cause the low beams to remain on or the high beams to cause problems for pedestrians, vehicles ahead or other parties. In these cases, manually switch between the high and low beams.
- In bad weather (rain, snow, fog,

- sandstorms, etc.)
- The windshield is obscured by fog, mist, ice, dirt, etc.
 - The windshield is cracked or damaged
 - The front camera is deformed or dirty
 - When the temperature of the front camera is extremely high
 - Surrounding brightness levels are equal to those of headlights, tail lights or fog lights
 - When headlights or tail lights of vehicles ahead are turned off, dirty, changing color, or not aimed properly
 - When the vehicle is hit by water, snow, dust, etc. from a preceding vehicle
 - When driving through an area of intermittently changing brightness and darkness
 - When frequently and repeatedly driving ascending/descending roads, or roads with rough, bumpy or uneven surfaces (such as stone-paved roads, gravel roads, etc.)
 - When frequently and repeatedly taking curves or driving on a winding road
 - There is a highly reflective object ahead of the vehicle, such as a sign or mirror
 - The back of a vehicle ahead is highly reflective, such as a container on a truck
 - The vehicle's headlights are damaged or dirty, or are not aimed properly
 - The vehicle is listing or titling due to a flat tire, a trailer being towed, etc.
 - The high beam and low beam are repeatedly being switched between in an abnormal manner
 - The driver believes that the high beam may be causing problems or distress to other drivers or pedestrians nearby

■ Temporarily lowering sensor sensitivity

The sensitivity of the sensor can be

temporarily lowered.

- 1 Turn the power switch off while the following conditions are met.
 - The headlight switch is in  or AUTO.
 - The headlight switch lever is in low beam position.
 - Automatic High Beam switch is on.
- 2 Turn the power switch to ON.
- 3 Within 60 seconds after step 2, repeat pushing the headlight switch lever to the high beam position then pulling it to the original position quickly 10 times, then leave the lever in the original position.
- 4 If the sensitivity is changed, the AHB indicator is turn on and off 3 times.

Automatic High Beam (headlights) may turn on even when the vehicle is stopped.

Turning the high beams on/off manually

■ Switching to the high beams

Push the lever away from you.

The AHB indicator will turn off and the high beam indicator will turn on.

Pull the lever to its original position to activate the Automatic High Beam system.

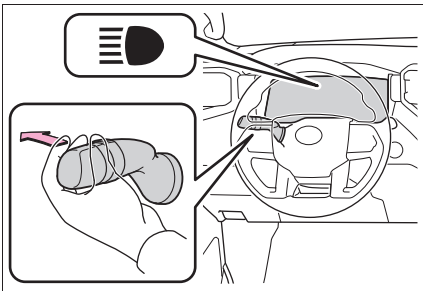

■ Switching to the low beams

Press the Automatic High Beam switch.

The AHB indicator will turn off.

Press the switch to activate the Automatic High Beam system again.

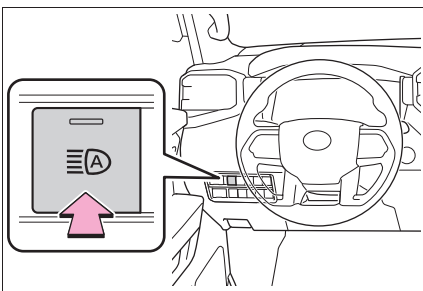

■ Temporarily switching to the low beams

Pull the lever toward you and

then return it to its original position.

The high beams are on while the lever is pulled toward you. However, after the lever is returned to its original position, the low beams remain on for a certain period of time. Afterwards, the Automatic High Beam system will be activated again.

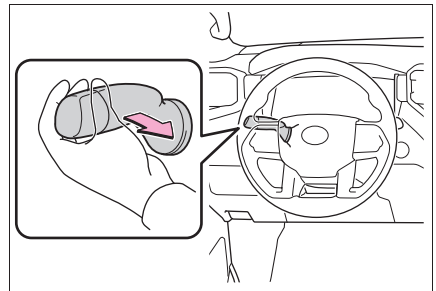

■ Temporarily switching to the low beams

It is recommended to switch to the low beams when the high beam may cause problems or distress to other drivers or pedestrians nearby.

Light bar*

*: If equipped

Turning the light bar on/off

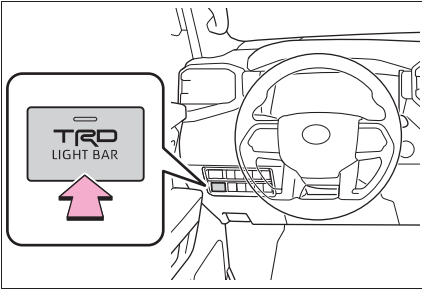

Press the switch.

■ Light bar operating condition

When the following conditions are met, the light bar will turn on:

- The high beam headlights are on.
- The light bar switch is pressed.
- The power switch is in ON.

■ If the indicator blinks twice when the switch is pressed

Light bar will not turn on. Check that the high beam headlights are turned on.

■ If the indicator blinks slowly when the switch is pressed

Light bar will not turn on. Check that the power switch is in ON, or that the "READY" indicator is illuminated.

Windshield wipers and washer

Operating the lever can switch between automatic operation and manual operation, or can use the washer.

⚠ NOTICE

■ When the windshield is dry

Do not use the wipers, as they may damage the windshield.

Operating the wiper lever

Operating the  lever operates the wipers or washer as follows:

- ▶ Intermittent windshield wipers with interval adjuster

When intermittent windshield wiper operation is selected, the wiper interval can be also adjusted.

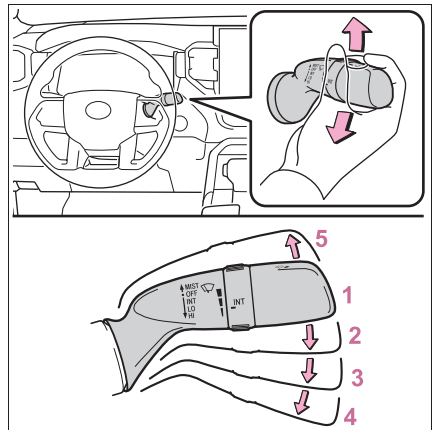

1 OFF *1 or ○ *2
Off

2 INT *1 or ☒ *2
Intermittent operation

3 LO *1 or ▼ *2
Low speed wiper operation

4 HI *1 or ▼ *2
High speed wiper operation

5 MIST *1 or ▲ *2
Temporary operation

Wiper intervals can be adjusted when intermittent operation is selected.

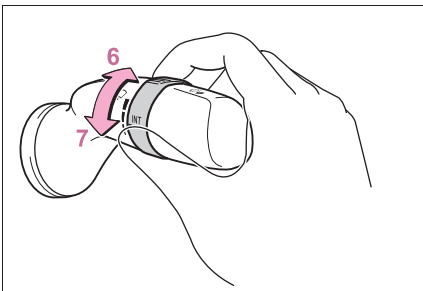

6 Increases the intermittent windshield wiper frequency

7 Decreases the intermittent windshield wiper frequency

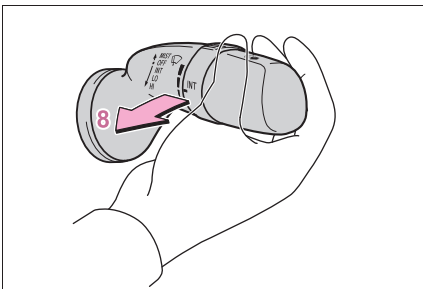

8 Washer/wiper dual operation

ation

Pulling the lever operates the wipers and washer.

(After operating several times, the wipers operate once more time after a short delay to prevent dripping. However, the dripping prevention does not operate while the vehicle is moving.)

*1: U.S.A.

*2: Canada

► Rain-sensing windshield wipers

When AUTO is selected, the wipers will operate automatically when the sensor detects falling rain. The system automatically adjusts wiper timing in accordance with rain volume and vehicle speed.

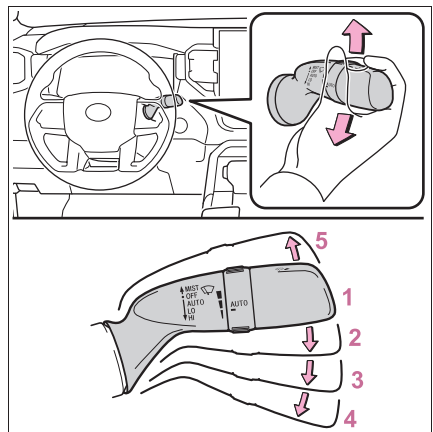

1 OFF *1 or ○ *2
Off

2 AUTO Rain-sensing wiper operation

232 4-3. Operating the lights and wipers

The wipers will operate automatically when the sensor detects falling rain. The system automatically adjusts wiper timing in accordance with rain volume and vehicle speed.

3 LO *1 or ▼ *2

Low speed wiper operation

4 HI *1 or ▼▼ *2

High speed wiper operation

5 MIST *1 or ▲ *2

Temporary operation

When AUTO is selected, the sensor sensitivity can be adjusted by turning the switch ring.

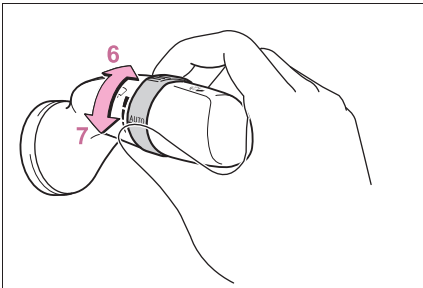

6 Increases the sensitivity

7 Decreases the sensitivity

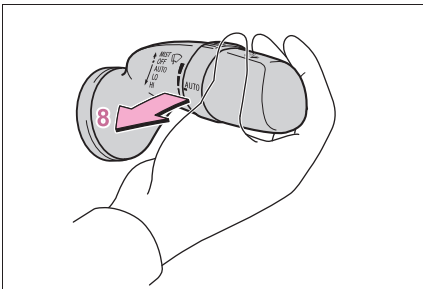

8  Washer/wiper dual operation

Pulling the lever operates the wipers and washer.

(After operating several times, the wipers operate once more time after a short delay to prevent dripping. However, the dripping prevention does not operate while the vehicle is moving.)

*1: U.S.A.

*2: Canada

■ The windshield wiper and washer can be operated when

The power switch is in ON.

■ Effects of vehicle speed on wiper operation (vehicles with rain-sensing windshield wipers)

Even when the wipers are not in AUTO mode, vehicle speed affects the time until the drip prevention wiper sweep occurs.

With low speed windshield wiper operation selected, wiper operation will be switched from low speed to intermittent wiper operation only when the vehicle is stationary. (However, when the sensor sensitivity is adjusted to the highest level, the mode cannot be switched.)

■ Raindrop sensor (vehicles with rain-sensing windshield wipers)

- The raindrop sensor judges the amount of raindrops. An optical sensor is adopted. It may not operate properly when sunlight from the rising or setting of the sun intermittently strikes the windshield, or if bugs, etc., are present on the windshield.

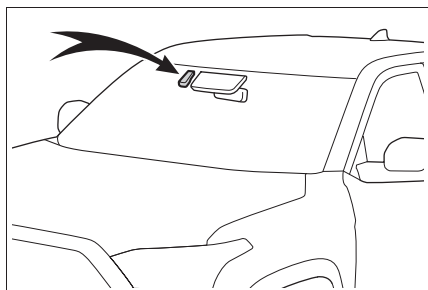

- If the wiper is turned to AUTO mode while the power switch is in ON, the wipers will operate once to show that AUTO mode is activated.
 - If the temperature of the raindrop sensor is 185°F (85°C) or higher, or 5°F (-15°C) or lower, automatic operation may not occur. In this case, operate the wipers in any mode other than AUTO mode.
- ### ■ If no windshield washer fluid sprays

Check that the washer nozzles are not blocked if there is washer fluid in the windshield washer fluid reservoir.

⚠ WARNING

■ Caution regarding the use of windshield wipers in AUTO mode (vehicles with rain-sensing windshield wipers)

The windshield wipers may operate unexpectedly if the sensor is touched or the windshield is subject to vibration in AUTO mode. Take care that your fingers or anything else do not become caught in the windshield wipers.

■ Caution regarding the use of washer fluid

When it is cold, do not use the washer fluid until the windshield becomes warm. The fluid may freeze on the windshield and cause low visibility. This may lead to an accident, resulting in death or serious injury.

⚠ NOTICE

■ When there is no washer fluid spray from the nozzle

Damage to the washer fluid pump may be caused if the lever is pulled toward you and held continually.

■ When a nozzle becomes blocked

In this case, contact your Toyota dealer. Do not try to clear it with a pin or other object. The nozzle will be damaged.

■ To prevent 12-volt battery discharge

Do not leave the wipers on longer than necessary when the hybrid system is off.

Opening the fuel tank cap

The fuel tank of your vehicle has a special structure, which requires a reduction in fuel tank pressure before refueling. After the opener switch has been pressed, it will take several seconds until the vehicle is ready for refueling.

Before refueling the vehicle

- Turn the power switch off and ensure that all the doors and windows are closed.
- Confirm the type of fuel.

■ Fuel types

→P.569

■ Fuel tank opening for unleaded gasoline

To help prevent incorrect fueling, your vehicle has a fuel tank opening that only accommodates the special nozzle on unleaded fuel pumps.



WARNING

■ When refueling the vehicle

Observe the following precautions while refueling the vehicle. Failure to do so may result in death or serious injury.

- After exiting the vehicle and before opening the fuel door, touch an unpainted metal surface to discharge any static electricity. It is important to discharge static electricity before refueling because sparks resulting from static electricity can cause fuel vapors to ignite while refueling.
- Always hold the grips on the fuel tank cap and turn it slowly to remove it. A whooshing sound may be heard when the fuel tank cap is loosened. Wait until the sound cannot be heard before fully removing the cap. In hot weather, pressurized fuel may spray out of the filler neck and cause injury.
- Do not allow anyone that has not discharged static electricity from their body to come close to an open fuel tank.
- Do not inhale vaporized fuel. Fuel contains substances that are harmful if inhaled.
- Do not smoke while refueling the vehicle. Doing so may cause the fuel to ignite and cause a fire.
- Do not return to the vehicle or touch any person or object that is statically charged. This may cause static electricity to build up, resulting in a possible ignition hazard.
- **When refueling**
Observe the following precautions to prevent fuel overflowing from the fuel tank:
 - Securely insert the fuel nozzle into the fuel filler neck.
 - Stop filling the tank after the fuel nozzle automatically clicks off.

⚠ WARNING

- Do not top off the fuel tank.

⚠ NOTICE**■ Refueling**

- Finish refueling within 30 minutes. If more than 30 minutes passes, the internal valve closes. In this condition, fuel may overflow during the refueling process. Press the fuel filler door opener switch again.
- Make sure that the fuel filler door lock is not pushed by the fuel nozzle boot, etc. If the lock is held, the internal valve closes and fuel may overflow. To prevent it, press the fuel filler door opener switch again.

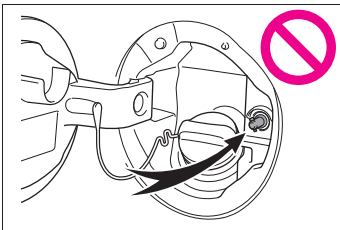

- Do not spill fuel during refueling. Doing so may damage the vehicle, such as causing the emission control system to operate abnormally or damaging fuel system components or the vehicle's painted surface.

Opening the fuel tank cap

- 1 Press the opener switch.

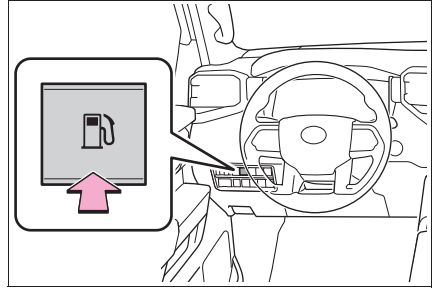

- 2 Turn the fuel tank cap slowly to open it and put it into the holder on the fuel filler door.

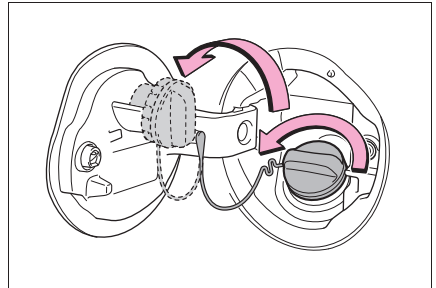
**Closing the fuel tank cap**

After refueling, turn the fuel tank cap until you hear a click. Once the cap is released, it will turn slightly in the opposite direction.

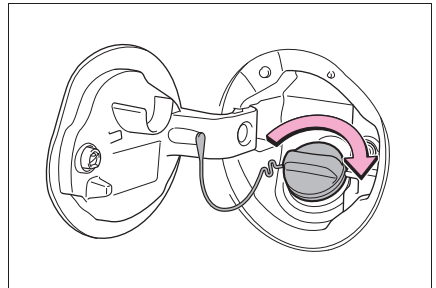

■ **When “Check Fuel Cap” is displayed on the multi-information display**

The fuel tank cap may be unfastened or loose. Turn the power switch to OFF, check the cap and tighten it securely. If the message remains, wait a few seconds and then turn the power switch to OFF once again.

■ **If the fuel filler door cannot be opened**

Consult your Toyota dealer.



WARNING

■ **When replacing the fuel tank cap**

Do not use anything but a genuine Toyota fuel tank cap designed for your vehicle. Doing so may cause a fire or other incident which may result in death or serious injury.

■ **When Opening the fuel tank cap**

Depending on the driving conditions of the vehicle before refueling, it may take some time to reduce the pressure in the tank. Unless there is an actual emergency, do not use the emergency release lever to open the fuel door and then open the fuel tank cap. Doing so may cause fuel to spray out from the fuel filler opening.

Toyota Safety Sense 2.5

The Toyota Safety Sense 2.5 consists of the following drive assist systems and contributes to a safe and comfortable driving experience:

Driving assist system

■ PCS (Pre-Collision System)

→P.242

■ LTA (Lane Tracing Assist)

→P.254

■ AHB (Automatic High Beam)

→P.226

■ RSA (Road Sign Assist)*

→P.265

*: If equipped

■ Dynamic radar cruise control with full-speed range

→P.268

! WARNING

■ Toyota Safety Sense 2.5

The Toyota Safety Sense 2.5 is designed to operate under the assumption that the driver will drive safely, and is designed to help reduce the impact to the occupants and the vehicle in the case of a collision or assist the driver in normal driving conditions.

As there is a limit to the degree of recognition accuracy and control performance that this system can provide, do not overly rely on this system. The driver is always responsible for paying attention to the vehicle's surroundings and driving safely.

Sensors

Two types of sensors, located behind the front grille and windshield, detect information necessary to operate the drive assist systems.

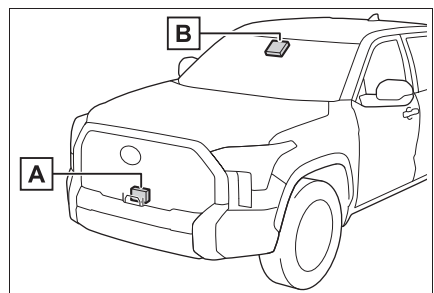

A Radar sensor

B Front camera

WARNING

■ To avoid malfunction of the radar sensor

Observe the following precautions.

Otherwise, the radar sensor may not operate properly, possibly leading to an accident resulting in death or serious injury.

- Keep the radar sensor and the radar sensor cover clean at all times.

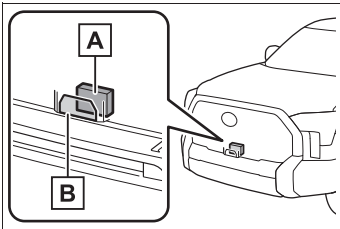

A Radar sensor

B Radar sensor cover

If the front of the radar sensor or the front or back of the radar sensor cover is dirty or covered with water droplets, snow, etc., clean it.

Clean the radar sensor and radar sensor cover with a soft cloth to avoid damaging them.

- Do not attach accessories, stickers (including transparent stickers) or other items to the radar sensor, radar sensor cover or surrounding area.
- Do not subject the radar sensor or its surrounding area to a strong impact.
If the radar sensor, front grille, or front bumper has been subjected to a strong impact, have the vehicle inspected by your Toyota dealer.

- Do not disassemble the radar sensor.
- Do not modify or paint the radar sensor or radar sensor cover.
- In the following cases, the radar sensor must be recalibrated. Contact your Toyota dealer for details.
 - When the radar sensor or front grille are removed and installed, or replaced
 - When the front bumper is replaced

■ To avoid malfunction of the front camera

Observe the following precautions.

Otherwise, the front camera may not operate properly, possibly leading to an accident resulting in death or serious injury.

- Keep the windshield clean at all times.
 - If the windshield is dirty or covered with an oily film, water droplets, snow, etc., clean the windshield.
 - If a glass coating agent is applied to the windshield, it will still be necessary to use the windshield wipers to remove water droplets, etc., from the area of the windshield in front of the front camera.
 - If the inner side of the windshield where the front camera is installed is dirty, contact your Toyota dealer.

⚠ WARNING

- Do not attach objects, such as stickers, transparent stickers, etc., to the outer side of the windshield in front of the front camera (shaded area in the illustration).

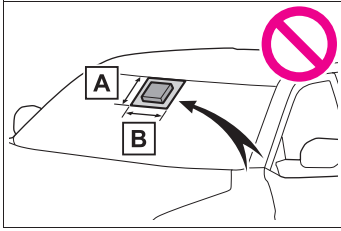

- A** From the top of the windshield to approximately 0.4 in. (1 cm) below the bottom of the front camera
- B** Approximately 7.9 in. (20 cm) (Approximately 4.0 in. [10 cm] to the right and left from the center of the front camera)
- If the part of the windshield in front of the front camera is fogged up or covered with condensation or ice, use the windshield defogger to remove the fog, condensation or ice. (→P.419)
 - If water droplets cannot be properly removed from the area of the windshield in front of the front camera by the windshield wipers, replace the wiper insert or wiper blade.
 - Do not attach window tint to the windshield.

- Replace the windshield if it is damaged or cracked. After replacing the windshield, the front camera must be recalibrated. Contact your Toyota dealer for details.
- Do not allow liquids to contact the front camera.
- Do not allow bright lights to shine into the front camera.
- Do not dirty or damage the front camera. When cleaning the inside of the windshield, do not allow glass cleaner to contact the lens of the front camera. Also, do not touch the lens. If the lens is dirty or damaged, contact your Toyota dealer.
- Do not subject the front camera to a strong impact.
- Do not change the installation position or direction of the front camera or remove it.
- Do not disassemble the front camera.
- Do not modify any components of the vehicle around the front camera (inside rear view mirror, etc.) or ceiling.
- Do not attach any accessories to the hood, front grille or front bumper that may obstruct the front camera. Contact your Toyota dealer for details.
- If a surfboard or other long object is to be mounted on the roof, make sure that it will not obstruct the front camera.
- Do not modify the headlights or other lights.

■ Certification

→P.640

240 4-5. Using the driving support systems

■ If a warning message is displayed on the multi-information display

A system may be temporarily unavailable or there may be a malfunction in the system.

- In the following situations, perform the actions specified in the table. When the normal operating conditions are detected, the message will disappear and the system will become operational.

If the message does not disappear, contact your Toyota dealer.

Situation	Actions
When the area around a camera is covered with dirt, moisture (fogged up, covered with condensation, ice, etc.), or other foreign matter	Using the wiper and A/C function, remove the dirt and other attached matter. (→P.419)
When the temperature around the front camera is outside of the operational range, such as when the vehicle is in the sun or in an extremely cold environment	If the front camera is hot, such as after the vehicle had been parked in the sun, use the air conditioning system to decrease the temperature around the front camera. If a sunshade was used when the vehicle was parked, depending on its type, the sunlight reflected from the surface of the sunshade may cause the temperature of the front camera to become excessively high.
	If the front camera is cold, such after the vehicle is parked in an extremely cold environment, use the air conditioning system to increase the temperature around the front camera.
The area in front of the front camera is obstructed, such as when the hood is open or a sticker is attached to the part of the windshield in front of the front camera.	Close the hood, remove the sticker, etc., to clear the obstruction.
When “Pre-Collision System Radar In Self Calibration Unavailable See Owner’s Manual” is displayed.	Check whether there is attached materials on the radar sensor and radar sensor cover, and if there is, remove it.

- In the following situations, if the situation has changed (or the vehicle has been driven for some time) and the normal operating conditions are detected, the message will disappear and the system will become operational.

If the message does not disappear, contact your Toyota dealer.

- When the temperature around the radar sensor is outside of the operational range, such as when the vehicle is in the sun or in an extremely cold environment
- When the front camera cannot detect objects in front of the vehicle, such as when driving in the dark, snow, or fog, or when bright lights are shining into the front camera
- Depending on the conditions in the vicinity of the vehicle, the radar may judge the surrounding environment can not be properly recognized. In that case, “Pre-Collision System Unavailable See Owner’s Manual” is displayed.

PCS (Pre-Collision System)

The pre-collision system uses a radar sensor and front camera to detect objects (→P.242) in front of the vehicle. When the system determines that the possibility of a frontal collision with an object is high, a warning operates to urge the driver to take evasive action and the potential brake pressure is increased to help the driver avoid the collision. If the system determines that the possibility of a frontal collision with an object is extremely high, the brakes are automatically applied to help avoid the collision or help reduce the impact of the collision.

The pre-collision system can be disabled/enabled and the warning timing can be changed. (→P.246)

Detectable objects

The system can detect the following (The detectable objects differs depending on the function.):

- Vehicles
- Bicyclists

- Pedestrians

System functions

■ Pre-collision warning

When the system determines that the possibility of a frontal collision is high, a buzzer will sound and a warning message will be displayed on the multi-information display to urge the driver to take evasive action.

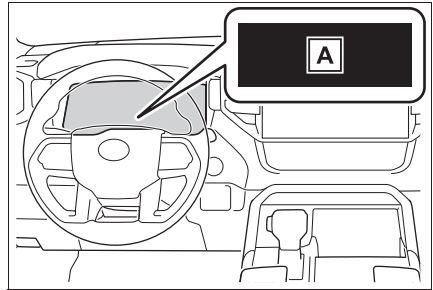

A "BRAKE!"

■ Pre-collision brake assist

When the system determines that the possibility of a frontal collision is high, the system applies greater braking force in relation to how strongly the brake pedal is depressed.

■ Pre-collision braking

If the system determines that the possibility of a frontal collision is extremely high, the brakes are automatically applied to help avoid the collision or reduce the impact of the collision.

■ Emergency steering assist

If the system determines that the possibility of a collision with a pedestrian is high and that there is sufficient space for the vehicle to be steered into within its lane, and the driver has begun evasive maneuver or steering, emergency steering assist will assist the steering movements to help enhance the vehicle stability and for lane departure prevention. During operation, the indicator will illuminate in green.

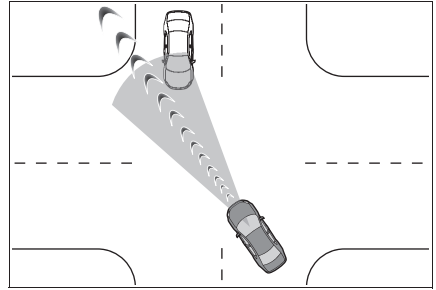

- When you turn right/left, pedestrian is detected in the forward direction and estimated to enter your vehicle's path (bicyclists are not detected.)

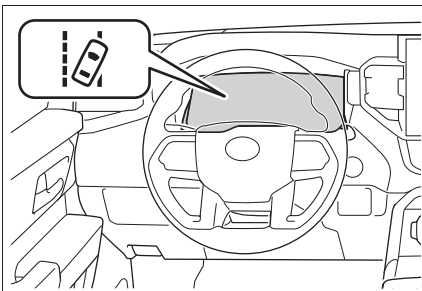

■ Intersection right/left turn assistance

If the system determines that there is a high possibility of a collision in the following situations, it will assist with Pre-collision warning and, if necessary Pre-collision braking.

Depending on the configuration of the intersection, it may not be possible to support.

- When you turn right/left at an intersection and cross the path of an oncoming vehicle

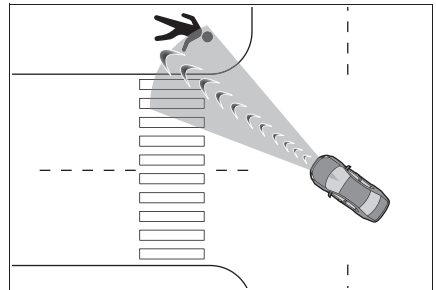

■ Suspension control (vehicles with Adaptive Variable Suspension System)

When the system determines that the possibility of a frontal collision is high, the Adaptive Variable Suspension System (→P.393) will control the damping force of the shock absorbers to help maintain an appropriate vehicle posture.

**WARNING**

■ Limitations of the pre-collision system

- The driver is solely responsible for safe driving. Always drive safely, taking care to observe your surroundings. Do not use the pre-collision system instead of normal braking operations under any circumstances. This system will not prevent collisions or lessen collision damage or injury in every situation. Do not overly rely on this system. Failure to do so may lead to an accident, resulting in death or serious injury.
- Although this system is designed to help avoid a collision or help reduce the impact of the collision, its effectiveness may change according to various conditions, therefore the system may not always be able to achieve the same level of performance. Read the following conditions carefully. Do not overly rely on this system and always drive carefully.
- Conditions under which the system may operate even if there is no possibility of a collision: →P.249
- Conditions under which the system may not operate properly: →P.251
- Do not attempt to test the operation of the pre-collision system yourself. Depending on the objects used for testing (dummies, cardboard objects imitating detectable objects, etc.), the system may not operate properly, possibly leading to an accident.

■ Pre-collision braking

- When the pre-collision braking function is operating, a large amount of braking force will be applied.
 - If the vehicle is stopped by the operation of the pre-collision braking function, the pre-collision braking function operation will be canceled after approximately 2 seconds. Depress the brake pedal as necessary.
 - The pre-collision braking function may not operate if certain operations are performed by the driver. If the accelerator pedal is being depressed strongly or the steering wheel is being turned, the system may determine that the driver is taking evasive action and possibly prevent the pre-collision braking function from operating.
 - In some situations, while the pre-collision braking function is operating, operation of the function may be canceled if the accelerator pedal is depressed strongly or the steering wheel is turned and the system determines that the driver is taking evasive action.
 - If the brake pedal is being depressed, the system may determine that the driver is taking evasive action and possibly delay the operation timing of the pre-collision braking function.
- ### ■ Emergency steering assist
- As emergency steering assist operation will be canceled when the system determines that lane departure prevention function has been completed.

**WARNING**

- Emergency steering assist may not operate or may be cancel in the following cases as the system may determine the driver is taking actions.
 - If the accelerator pedal is being depressed strongly, the steering wheel is being operated sharply, the brake pedal is being depressed or the turn signal lever is being operated. In this case, the system may determine that the driver is taking evasive action and the emergency steering assist may not operate.
 - The emergency steering assist will be disabled automatically when the system judges that a trailer is connected.
 - In some situations, while the emergency steering assist is operating, operation of the function may be canceled if the accelerator pedal is depressed strongly, the steering wheel is operated sharply or the brake pedal is being depressed and the system determines that the driver is taking evasive action.
 - When the emergency steering assist is operating, if the steering wheel is held firmly or is operated in the opposite direction to that which the system is generating torque, the function may be canceled.
- **When to disable the pre-collision system**
- In the following situations, disable the system, as it may not operate properly, possibly leading to an accident resulting in death or serious injury:
- When the vehicle is being towed

- When your vehicles is towing a trailer or another vehicle, except when the following conditions are all met
 - When the other vehicle is a trailer properly attached and connected to Toyota's official TBC ECU. (→P.191)
 - When the vehicle is not being driven on a slippery surface such as an icy road or a very wet road.
- When transporting the vehicle via truck, boat, train or similar means of transportation
- When the vehicle is raised on a lift with the hybrid system on and the tires are allowed to rotate freely
- When inspecting the vehicle using a drum tester such as a chassis dynamometer or speedometer tester, or when using an on vehicle wheel balancer
- When a strong impact is applied to the front bumper or front grille, due to an accident or other reasons
- If the vehicle cannot be driven in a stable manner, such as when the vehicle has been in an accident or is malfunctioning
- When the vehicle is driven in a sporty manner or off-road
- When the tires are not properly inflated
- When the tires are very worn
- When tires of a size other than specified are installed
- When tire chains are installed
- When a compact spare tire or an emergency tire puncture repair kit is used

⚠ WARNING

- If equipment (snow plow, etc.) that may obstruct the radar sensor or front camera is temporarily installed to the vehicle
- When the vehicle is lifted up, except in the following cases
 - When using a Toyota official lift kit up to 4 in. (101 mm), including tire height. Aftermarket lift kits may degrade system performance.

Changing settings of the pre-collision system

■ Enabling/disabling the pre-collision system

The pre-collision system can be enabled/disabled on  (→P.595) of the multi-information display.

The system is automatically enabled each time the power switch is turned to ON.

If the system is disabled, the PCS warning light will turn on and a message will be displayed on the multi-information display.

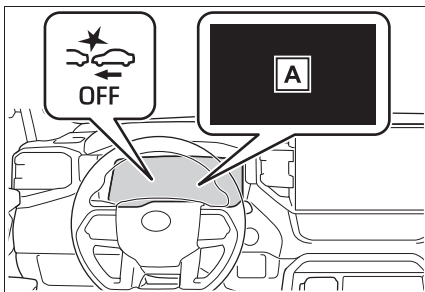

A "Pre-Collision System OFF"

■ Changing the pre-collision warning timing

The pre-collision warning timing can be changed on  (→P.595) of the multi-information display.

The warning timing setting is retained when the power switch is turned off. However, if the pre-collision system is disabled and re-enabled, the operation timing will return to the default setting (middle).

If the pre-collision warning timing is changed, emergency steering assist timing will also be changed accordingly.

If late is selected, emergency steering assist would not operate in case of an emergency.

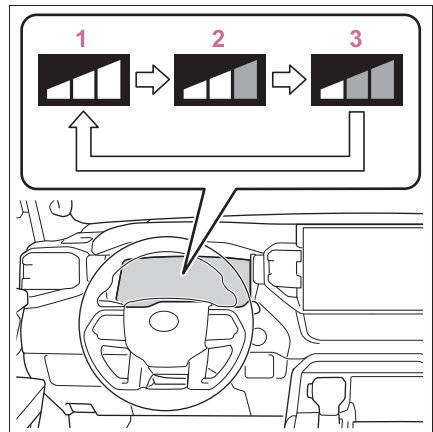

1 Early

2 Middle

This is the default setting.

3 Late

■ Operational conditions for each pre-collision function

The pre-collision system is enabled and the system determines that the possibility of a frontal collision with a detected object is high.

The system may not operate in the following situations:

- If a 12-volt battery terminal has been disconnected and reconnected and then the vehicle has not been driven for a certain amount of time
- If the shift lever is in R
- When the VSC OFF indicator is illuminated (only the pre-collision warning function will be operational)

The operation speeds and operation cancelation for each function is listed below.

● Pre-collision warning

Detectable objects	Vehicle speed	Relative speed between your vehicle and object
Vehicles	Approx. 7 to 110 mph (10 to 180 km/h)	Approx. 7 to 110 mph (10 to 180 km/h)
Bicyclists and pedestrians	Approx. 7 to 50 mph (10 to 80 km/h)	Approx. 7 to 50 mph (10 to 80 km/h)

While the pre-collision warning function is operating, if the steering wheel is operated heavily or suddenly, the pre-collision warning may be canceled.

● Pre-collision brake assist

Detectable objects	Vehicle speed	Relative speed between your vehicle and object
Vehicles	Approx. 20 to 110 mph (30 to 180 km/h)	Approx. 20 to 110 mph (30 to 180 km/h)
Bicyclists and pedestrians	Approx. 20 to 50 mph (30 to 80 km/h)	Approx. 20 to 50 mph (30 to 80 km/h)

248 4-5. Using the driving support systems

● Pre-collision braking

Detectable objects	Vehicle speed	Relative speed between your vehicle and object
Vehicles	Approx. 7 to 110 mph (10 to 180 km/h)	Approx. 7 to 110 mph (10 to 180 km/h)
Bicyclists and pedestrians	Approx. 7 to 50 mph (10 to 80 km/h)	Approx. 7 to 50 mph (10 to 80 km/h)

If either of the following occur while the pre-collision braking function is operating, it will be canceled:

- The accelerator pedal is depressed strongly.
- The steering wheel is turned sharply or abruptly.

● Emergency steering assist

When the turn signal lights are flashing, emergency steering assist will not operate in case of an emergency.

The emergency steering assist will be disabled automatically when the system judges that a trailer is connected.

Detectable objects	Vehicle speed	Relative speed between your vehicle and object
Pedestrians	Approx. 31 to 50 mph (50 to 80 km/h)	Approx. 31 to 50 mph (50 to 80 km/h)

If any of the following occur while the emergency steering assist function is operating, it will be canceled:

- The accelerator pedal is depressed strongly.
- The steering wheel is turned sharply or abruptly.
- The brake pedal is depressed.

● Intersection right/left turn assistance (pre-collision warning)

When the turn signal lights are not flashing, support for turning left or right at an intersection which targets oncoming vehicles does not work.

When the system judges that a trailer is detected, intersection support is disabled for vehicles and pedestrians.

Detectable objects	Vehicle speed	Oncoming vehicle speed	Relative speed between your vehicle and object
Vehicles	Approx. 7 to 15 mph (10 to 25 km/h)	Approx. 20 to 35 mph (30 to 55 km/h)	Approx. 25 to 50 mph (40 to 80 km/h)
Pedestrians	Approx. 7 to 15 mph (10 to 25 km/h)	-	Approx. 7 to 15 mph (10 to 25 km/h)

● Intersection right/left turn assistance (pre-collision braking)

When the turn signal lights are not flashing, support for turning left or right at an intersection which targets oncoming vehicles does not work.

When the system judges that a trailer is detected, intersection support is disabled for vehicles and pedestrians.

Detectable objects	Vehicle speed	Oncoming vehicle speed	Relative speed between your vehicle and object
Vehicles	Approx. 10 to 15 mph (15 to 25 km/h)	Approx. 20 to 28 mph (30 to 45 km/h)	Approx. 28 to 43 mph (45 to 70 km/h)
Pedestrians	Approx. 7 to 15 mph (10 to 25 km/h)	-	Approx. 7 to 15 mph (10 to 25 km/h)

■ Object detection function

The system detects objects based on their size, profile, motion, etc. However, an object may not be detected depending on the surrounding brightness and the motion, posture, and angle of the detected object, preventing the system from operating properly. (→P.251)
The illustration shows an image of detectable objects.

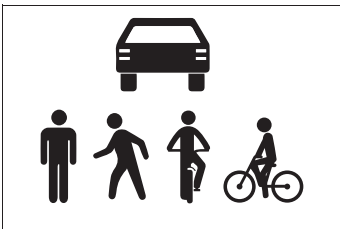

■ Conditions under which the system may operate even if there is no possibility of a collision

- In some situations such as the following, the system may determine that there is a possibility of a frontal collision and operate.
 - When passing a detectable object, etc.
 - When changing lanes while overtaking a detectable object, etc.
 - When approaching a detectable object in an adjacent lane or on the roadside, such as when

changing the course of travel or driving on a winding road

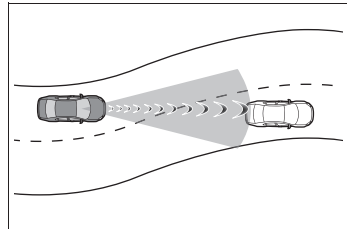

- When rapidly closing on a detectable object, etc.
- When approaching objects on the roadside, such as detectable objects, guardrails, utility poles, trees, or walls
- When there is a detectable object or other object by the roadside at the entrance of a curve

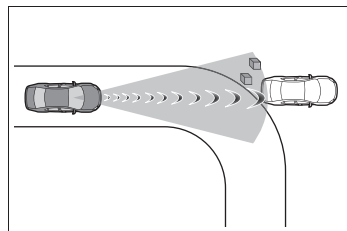

- When there are patterns or paint in front of your vehicle that may be mistaken for a detectable object
- When the front of your vehicle is hit by water, snow, dust, etc.
- When overtaking a detectable object that is changing lanes or making a right/left turn

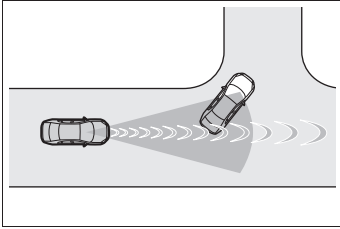

- When passing a detectable object in an oncoming lane that is stopped to make a right/left turn

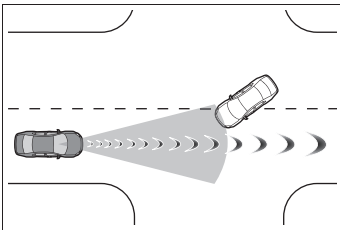

- When a detectable object approaches very close and then stops before entering the path of your vehicle
- If the front of your vehicle is raised or lowered, such as when on an uneven or undulating road surface
- When driving on a road surrounded by a structure, such as in a tunnel or on an iron bridge
- When there is a metal object (manhole cover, steel plate, etc.), steps, or a protrusion in front of your vehicle
- When passing under an object (road sign, billboard, etc.)

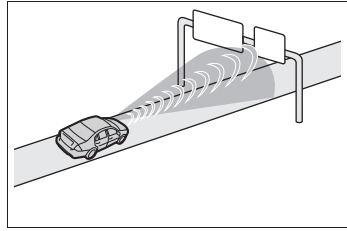

- When approaching an electric toll gate barrier, parking area barrier, or other barrier that opens and closes
- When using an automatic car wash
- When driving through or under objects that may contact your vehicle, such as thick grass, tree branches, or a banner

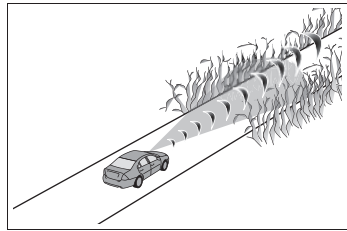

- When driving through steam or smoke
- When driving near an object that reflects radio waves, such as a large truck or guardrail
- When driving near a TV tower, broadcasting station, electric power plant, radar equipped vehicles, etc., or other location where strong radio waves or electrical noise may be present
- When there are many things which can reflect the radio waves of the radar in the vicinity (tunnels, truss bridges, gravel roads, snow covered road that have tracks, etc.)
- While making a right/left turn, when an oncoming vehicle or a crossing pedestrian has already exited the path of your vehicle
- While making a right/left turn, closely in front of an oncoming vehicle or a crossing pedestrian.
- While making a right/left turn,

when an oncoming vehicle or a crossing pedestrian stops before entering the path of your vehicle

- While making a right/left turn, when an oncoming vehicle turns right/left in front of your vehicle

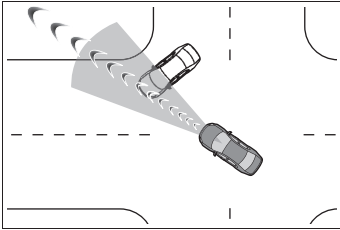

- While steering into the direction of oncoming traffic
- When the vehicle is lifted up using an aftermarket lift kit
- When the vehicle is lifted up more than 4 in. (101 mm)

■ Situations in which the system may not operate properly

- In some situations such as the following, an object may not be detected by the radar sensor and front camera, preventing the system from operating properly:
 - When a detectable object is approaching your vehicle
 - When your vehicle or a detectable object is wobbling
 - If a detectable object makes an abrupt maneuver (such as sudden swerving, acceleration or deceleration)
 - When your vehicle approaches a detectable object rapidly
 - When a detectable object is not directly in front of your vehicle

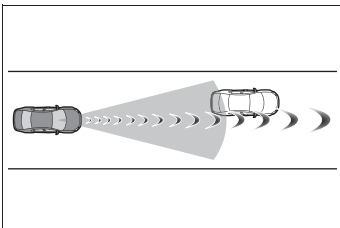

- When a detectable object is near a wall, fence, guardrail, manhole cover, vehicle, steel plate on the

road, etc.

- When a detectable object is under a structure
- When part of a detectable object is hidden by an object, such as large baggage, an umbrella, or guardrail
- When there are many things which can reflect the radio waves of the radar in the vicinity (tunnels, truss bridges, gravel roads, snow covered road that have tracks, etc.)
- When there is an effect on the radio waves to the radar that is installed on another vehicle
- When multiple detectable objects are close together
- If the sun or other light is shining directly on a detectable object
- When a detectable object is a shade of white and looks extremely bright
- When a detectable object appears to be nearly the same color or brightness as its surroundings
- If a detectable object cuts or suddenly emerges in front of your vehicle
- When the front of your vehicle is hit by water, snow, dust, etc.
- When a very bright light ahead, such as the sun or the headlights of oncoming traffic, shines directly into the front camera
- When approaching the side or front of a vehicle ahead
- If a vehicle ahead is a motorcycle
- If a vehicle ahead is narrow, such as a personal mobility vehicle
- If a preceding vehicle has a small rear end, such as an unloaded truck
- If a preceding vehicle has a low rear end, such as a low bed trailer

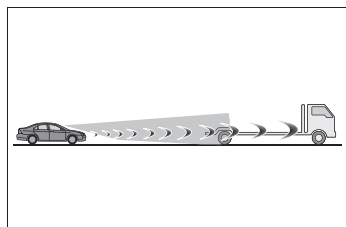

- If a vehicle ahead has extremely high ground clearance

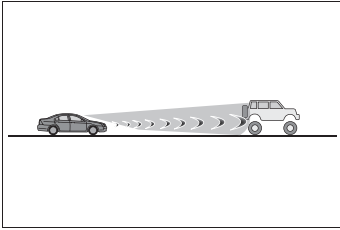

- If a vehicle ahead is carrying a load which protrudes past its rear bumper
- If a vehicle ahead is irregularly shaped, such as a tractor or side car
- If a vehicle ahead is a child sized bicycle, a bicycle that is carrying a large load, a bicycle ridden by more than one person, or a uniquely shaped bicycle (bicycle with a child seat, tandem bicycle, etc.)
- If a pedestrian/or the riding height of a bicyclist ahead is shorter than approximately 3.2 ft. (1 m) or taller than approximately 6.5 ft. (2 m)
- If a pedestrian/bicyclist is wearing oversized clothing (a rain coat, long skirt, etc.), making their silhouette obscure
- If a pedestrian is bending forward or squatting or bicyclist is bending forward
- If a pedestrian/bicyclist is moving fast
- If a pedestrian is pushing a stroller, wheelchair, bicycle or other vehicle
- When driving in inclement weather such as heavy rain, fog, snow or a sandstorm
- When driving through steam or smoke
- When the surrounding area is dim, such as at dawn or dusk, or while at night or in a tunnel, making a detectable object appear to be nearly the same color as its surroundings
- When driving in a place where the surrounding brightness changes

suddenly, such as at the entrance or exit of a tunnel

- After the hybrid system has started the vehicle has not been driven for a certain amount of time
- While making a left/right turn and for a few seconds after making a left/right turn
- While driving on a curve and for a few seconds after driving on a curve
- If your vehicle is skidding
- If the front of the vehicle is raised or lowered

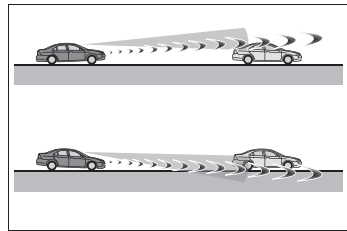

- If the wheels are misaligned
- If a wiper blade is blocking the front camera
- The vehicle is being driven at extremely high speeds
- When driving on a hill
- If the radar sensor or front camera is misaligned
- When driving in a traffic lane separated by more than one lane where oncoming vehicles are driving while making a right/left turn
- When largely out of place with the opposite facing targeted oncoming vehicle during a right/left turn

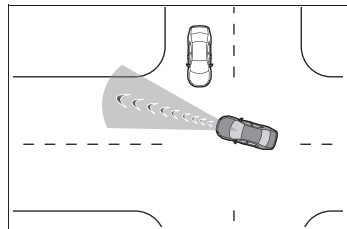

- While making a right/left turn, when a pedestrian approaches from behind or side of your vehicle

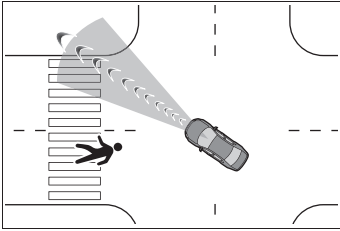

- When the vehicle is lifted up using an aftermarket lift kit
- When the vehicle is lifted up more than 4 in. (101 mm)
- In addition to the above, in some situations, such as the following, the emergency steering assist may not operate.
- When the white (yellow) lane lines are difficult to see, such as when they are faint, diverging/merging, or a shadow is cast upon them
- When the lane is wider or narrower than normal
- When there is a light and dark pattern on the road surface, such as due to road repairs
- When a pedestrian is detected near the centerline of the vehicle
- When the target is too close
- When there is insufficient safe or unobstructed space for the vehicle to be steered into
- If oncoming vehicle is present
- If VSC function is operating
- In some situations such as the following, sufficient braking force or steering force may not be obtained, preventing the system from performing properly:
 - If the braking functions cannot operate to their full extent, such as when the brake parts are extremely cold, extremely hot, or wet
 - If the vehicle is not properly maintained (brakes or tires are excessively worn, improper tire inflation pressure, etc.)
 - When the vehicle is being driven on a gravel road or other slippery

surface

- When the road surface has deep wheel tracks
- When driving on a hill road
- When driving on a road that has inclines to the left or right
- When your vehicles is towing a trailer or another vehicle
- When your vehicle is lifted up

■ If VSC is disabled

- If VSC is disabled (→P.394), the pre-collision brake assist and pre-collision braking functions are also disabled.
- The PCS warning light will turn on and “VSC Turned OFF Pre-Collision Brake System Unavailable” will be displayed on the multi-information display.

LTA (Lane Tracing Assist)

Summary of functions

While driving on a road with clear white (yellow) lane lines, the LTA system warns the driver if the vehicle may deviate from the current lane*, and also can slightly operate the steering wheel to help avoid deviation from the lane. Also, while the dynamic radar cruise control with full-speed range is operating, this system will operate the steering wheel to maintain the vehicle's lane position.

The LTA system recognizes white (yellow) lane lines* using the front camera. Additionally, it detects preceding vehicles using the front camera and radar.

*: May recognize the boundaries between the asphalt and the side of the road, such as grass, soil, or the curb, to be road lanes

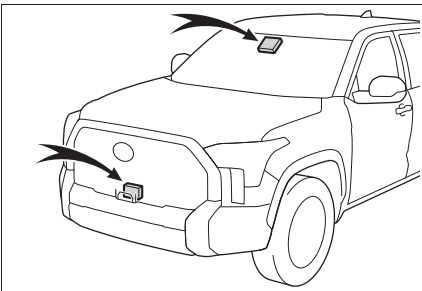

⚠ WARNING

■ Before using LTA system

- Do not rely solely upon the LTA system. The LTA system does not automatically drive the vehicle or reduce the amount of attention that must be paid to the area in front of the vehicle. The driver must always assume full responsibility for driving safely by paying careful attention to the surrounding conditions and operating the steering wheel to correct the path of the vehicle. Also, the driver must take adequate breaks when fatigued, such as from driving for a long period of time.
- Failure to perform appropriate driving operations and pay careful attention may lead to an accident, resulting in death or serious injury.
- When connecting a trailer which can be connected with Toyota's official TBC ECU, the lane centering function will be disabled automatically when LTA detects a trailer connection. When other trailer is connected, turn off the lane centering function if a trailer is connected and it is not automatically disabled. After trailer disconnect and power switch is turned off, lane centering function can be turned on.

**WARNING**

- This vehicle has Automatic Trailer Detection feature that can detect certain trailers under certain conditions. After trailer is detected, lane centering function will be disabled. In certain conditions, there is a possibility of falsely detecting trailer when there is no actual trailer. In that case, lane centering function will be disabled. To activate lane centering function, turn power switch to off and then turn it on again.
 - Following scenes has possibility of false detection of trailer: Crowded environments such as parking lots or camping grounds, closely following vehicles such traffic jam, drive through, parallel parking, etc.
 - Do not use the lane centering system and steering assist function when the vehicle is lifted unless using a Toyota official lift up kit up to 4 in. (101 mm), including tire height. Aftermarket lift kits may degrade system performance.
- Situations unsuitable for LTA system**
- In the following situations, use the LTA switch to turn the system off. Failure to do so may lead to an accident, resulting in death or serious injury.
- Vehicle is driven on a road surface which is slippery due to rainy weather, fallen snow, freezing, etc.
 - Vehicle is driven on a snow-covered road.
 - White (yellow) lines are difficult to see due to rain, snow, fog, dust, etc.

- Vehicle is driven in a temporary lane or restricted lane due to construction work.
 - Vehicle is driven in a construction zone.
 - A spare tire, tire chains, etc., are equipped.
 - When the tires have been excessively worn, or when the tire inflation pressure is low.
 - When your vehicles is towing a trailer or another vehicle, except when the following condition is met.
 - When the other vehicle is a trailer properly attached and connected to Toyota's official TBC ECU. (→P.191)
 - When the vehicle is lifted up, except in the following cases.
 - When using a Toyota official lift kit up to 4 in. (101 mm), including tire height. Aftermarket lift kits may degrade system performance.
- Preventing LTA system malfunctions and operations performed by mistake**
- Do not modify the headlights or place stickers, etc., on the surface of the lights.
 - Do not modify the suspension, etc. If the suspension, etc., needs to be replaced, contact your Toyota dealer.
 - Do not install or place anything on the hood or grille. Also, do not install a grille guard (bull bars, kangaroo bar, etc.).
 - If your windshield needs repairs, contact your Toyota dealer.

⚠ WARNING

■ Conditions in which functions may not operate properly

In the following situations, the functions may not operate properly and the vehicle may depart from its lane. Drive safely by always paying careful attention to your surroundings and operate the steering wheel to correct the path of the vehicle without relying solely on the functions.

- When the follow-up cruising display is displayed (→P.260) and the preceding vehicle changes lanes. (Your vehicle may follow the preceding vehicle and also change lanes.)

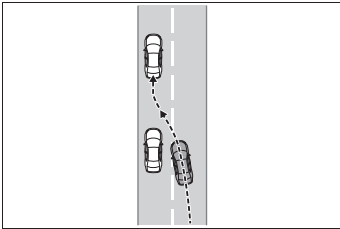

- When the follow-up cruising display is displayed (→P.260) and the preceding vehicle is swaying. (Your vehicle may sway accordingly and depart from the lane.)
- When the follow-up cruising display is displayed (→P.260) and the preceding vehicle departs from its lane. (Your vehicle may follow the preceding vehicle and depart from the lane.)
- When the follow-up cruising display is displayed (→P.260) and the preceding vehicle is being driven extremely close to the left/right lane line. (Your vehicle may follow the preceding vehicle and depart from the lane.)
- Vehicle is being driven around a sharp curve.

- Objects or patterns that could be mistaken for white (yellow) lines are present on the side of the road (guardrails, reflective poles, etc.).

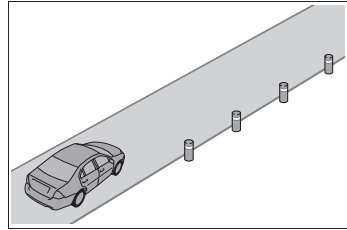

- Vehicle is driven where the road diverges, merges, etc.

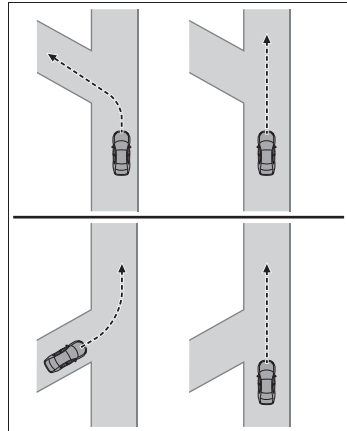

- Repair marks of asphalt, white (yellow) lines, etc., are present due to road repair.

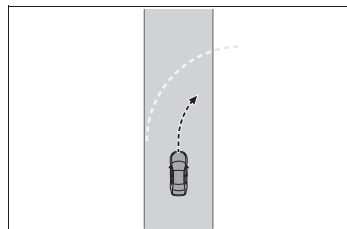

- There are shadows on the road that run parallel with, or cover, the white (yellow) lines.

**WARNING**

- The vehicle is driven in an area without white (yellow) lines, such as in front of a tollgate or checkpoint, or at an intersection, etc.
- The white (yellow) lines are cracked, “Botts’ dots”, “Raised pavement marker” or stones are present.
- The white (yellow) lines cannot be seen or are difficult to see due to sand, etc.
- The vehicle is driven on a road surface that is wet due to rain, puddles, etc.
- The traffic lines are yellow (which may be more difficult to recognize than lines that are white).
- The white (yellow) lines cross over a curb, etc.
- The vehicle is driven on a bright surface, such as concrete.
- The vehicle is driven on a surface that is bright due to reflected light, etc.
- The vehicle is driven in an area where the brightness changes suddenly, such as at the entrances and exits of tunnels, etc.
- Light from the headlights of an oncoming vehicle, the sun, etc., enters the camera.
- The vehicle is driven on a slope.
- The vehicle is driven on a road which tilts left or right, or a winding road.
- The vehicle is driven on an unpaved or rough road.
- The traffic lane is excessively narrow or wide.
- The vehicle is extremely tilted due to carrying heavy luggage or having improper tire pressure.
- The distance to the preceding vehicle is extremely short.
- The vehicle is moving up and down a large amount due to road conditions during driving (poor roads or road seams).
- When driving in a tunnel or at night with the headlights off or when a headlight is dim due to its lens being dirty or it being misaligned.
- The vehicle is struck by a crosswind.
- The vehicle is affected by wind from a vehicle driven in a nearby lane.
- The vehicle has just changed lanes or crossed an intersection.
- Tires which differ by structure, manufacturer, brand or tread pattern are used.
- When tires of a size other than specified are installed.
- Snow tires, etc., are equipped.
- The vehicle is being driven at extremely high speeds.
- When your vehicles is towing a trailer or another vehicle, except when the following condition is met.
 - When the other vehicle is a trailer properly attached and connected to Toyota's official TBC ECU. (→P.191)

⚠ WARNING

- When the vehicle is lifted up, except in the following cases.
 - When using a Toyota official lift kit up to 4 in. (101 mm), including tire height. Aftermarket lift kits may degrade system performance.

Functions included in LTA system

■ Lane departure alert function

When the system determines that the vehicle might depart from its lane*, a warning is displayed on the multi-information display, and either a warning buzzer will sound or the steering wheel will vibrate to alert the driver.

When the warning buzzer sounds or the steering wheel vibrates, check the area around your vehicle and carefully operate the steering wheel to move the vehicle back to the center of the lane.

When the system determines that the vehicle might depart from its lane and that the possibility of a collision with an overtaking vehicle in the adjacent lane is high, the lane departure alert will operate even if the turn signals are operating.

*: May recognize the boundaries between the asphalt and the side of the road, such as grass, soil, or the curb, to be road lanes

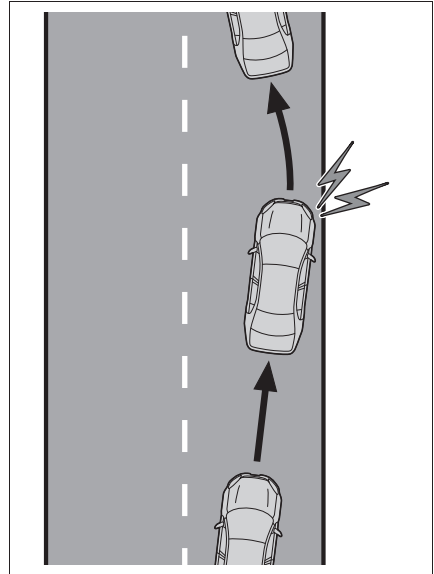

■ Steering assist function

When the system determines that the vehicle might depart from its lane, the system provides assistance as necessary by operating the steering wheel in small amounts for a short period of time to keep the vehicle in its lane.

When the system determines that the vehicle might depart from its lane and that the possibility of a collision with an overtaking vehicle in the adjacent lane is high, the steering assist function will operate even if the turn signals are operating.

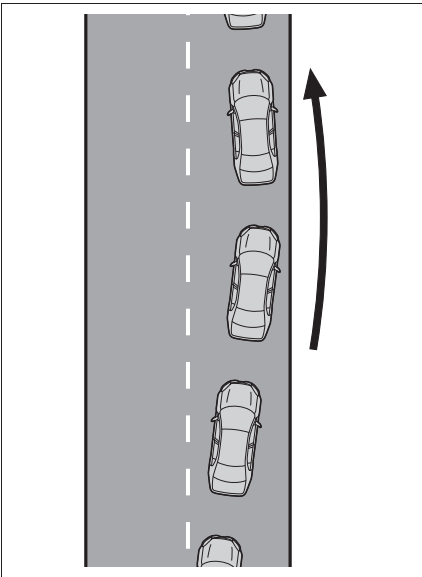

■ Vehicle sway warning function

When the vehicle is swaying within a lane, the warning buzzer will sound and a message will be displayed on the multi-information display to alert the driver.

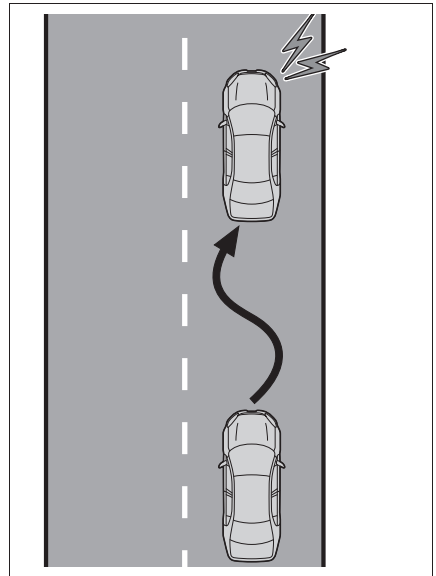

■ Lane centering function

This function is linked with dynamic radar cruise control with full-speed range and provides the required assistance by operating the steering wheel to keep the vehicle in its current lane.

When dynamic radar cruise control with full-speed range is not operating, the lane centering function does not operate.

In situations where the white (yellow) lane lines are difficult to see or are not visible, such as when in a traffic jam, this function will operate to help follow a preceding vehicle by monitoring the position of the preceding vehicle.

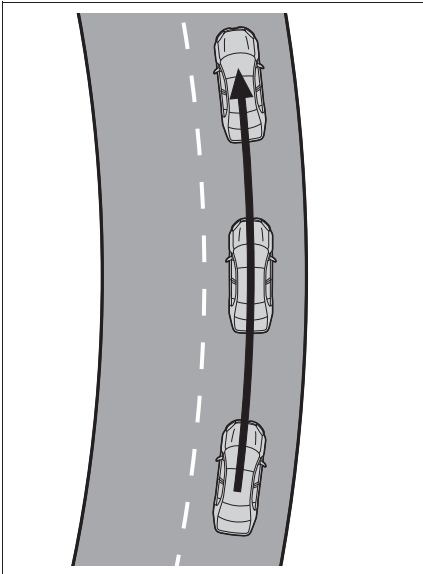

Turning LTA system on

Press the LTA switch to turn the LTA system on

The LTA indicator illuminates and a message is displayed on the multi-information display.

Press the LTA switch again to turn the LTA system off.

When the LTA system is turned on or off, operation of the LTA system continues in the same condition the next time the hybrid system started.

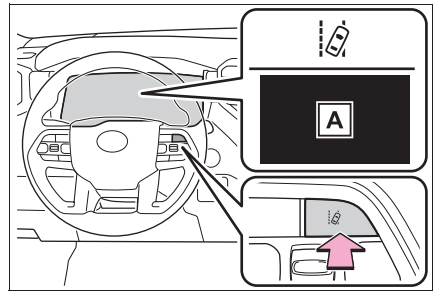

A “LTA Steering Assist Active
Lane Centering Active”

Indications on multi-information display

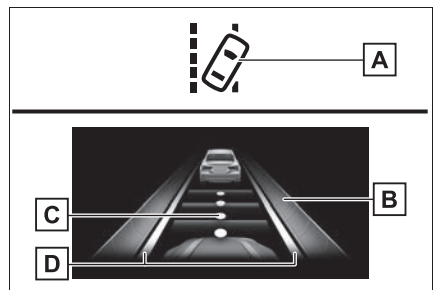

A LTA indicator

The illumination condition of the indicator informs the driver of the

system operation status.

Illuminated in white: LTA system is operating.

Illuminated in green: Steering wheel assistance of the steering assist function or lane centering function is operating.

Flashing in orange: Lane departure alert function is operating.

B Operation display of steering wheel operation support

Displayed when the multi-information display is switched to the driving support system information screen.

Indicates that steering wheel assistance of the steering assist function or lane centering function is operating.

Both outer sides of the lane are displayed: Indicates that steering wheel assist of the lane centering function is operating.

One outer side of the lane is displayed: Indicates that steering wheel assist of the steering assist function is operating.

Both outer sides of the lane are flashing: Alerts the driver that their input is necessary to stay in the center of the lane (lane centering function).

C Follow-up cruising display

Displayed when the multi-information display is switched to the driving support system information screen.

Indicates that steering assist of the lane centering function is operating by monitoring the position of a preceding vehicle.

When the follow-up cruising display

is displayed, if the preceding vehicle moves, your vehicle may move in the same way. Always pay careful attention to your surroundings and operate the steering wheel as necessary to correct the path of the vehicle and ensure safety.

D Lane departure alert function display

Displayed when the multi-information display is switched to the driving support system information screen.

► Inside of displayed lines is white



Indicates that the system is recognizing white (yellow) lines*. When the vehicle departs from its lane, the white line displayed on the side the vehicle departs from flashes orange.

- ▶ Inside of displayed lines is black



Indicates that the system is not able to recognize white (yellow) lines* or is temporarily canceled.

*: May recognize the boundaries between the asphalt and the side of the road, such as grass, soil, or the curb, to be road lanes

■ Operation conditions of each function

● Lane departure alert function

This function operates when all of the following conditions are met.

- LTA is turned on.
- Vehicle speed is approximately 32 mph (50 km/h) or more.*¹
- System recognizes white (yellow) lane lines*². (When a white [yellow] line*² is recognized on only one side, the system will operate only for the recognized side.)
- Width of traffic lane is approximately 9.8 ft. (3 m) or more.
- Turn signal lever is not operated. (Except when another vehicle is in the lane on the side where the turn signal was operated)
- Vehicle is not being driven around a sharp curve.
- No system malfunctions are detected. (→P.265)

*¹: The function operates even if the vehicle speed is less than approximately 32 mph (50 km/h)

when the lane centering function is operating.

*²: May recognize the boundaries between the asphalt and the side of the road, such as grass, soil, or the curb, to be road lanes

● Steering assist function

This function operates when all of the following conditions are met in addition to the operation conditions for the lane departure alert function.

- Vehicle is not accelerated or decelerated by a fixed amount or more.
- Steering wheel is not operated with a steering force level suitable for changing lanes.
- ABS, VSC, TRAC and PCS are not operating.
- TRAC or VSC is not turned off.
- Hands off steering wheel warning is not displayed. (→P.264)

● Vehicle sway warning function

This function operates when all of the following conditions are met.

- Setting for “Sway Warning” in  of the multi-information display is set to “ON”. (→P.596)
- Vehicle speed is approximately 32 mph (50 km/h) or more.
- Width of traffic lane is approximately 9.8 ft. (3 m) or more.
- No system malfunctions are detected. (→P.265)

● Lane centering function

This function operates when all of the following conditions are met.

- LTA is turned on.
- Setting for “Lane Center” in  of the multi-information display is set to “ON”. (→P.596)
- This function recognizes white (yellow) lane lines or the position of a preceding vehicle (except when the preceding vehicle is small, such as a motorcycle).

- The dynamic radar cruise control with full-speed range is operating in vehicle-to-vehicle distance control mode.
- Width of traffic lane is approximately 10 to 13 ft. (3 to 4 m).
- Turn signal lever is not operated.
- Vehicle is not being driven around a sharp curve.
- No system malfunctions are detected. (→P.265)
- Vehicle does not accelerate or decelerate by a fixed amount or more.
- Steering wheel is not operated with a steering force level suitable for changing lanes.
- ABS, VSC, TRAC and PCS are not operating.
- TRAC or VSC is not turned off.
- Hands off steering wheel warning is not displayed. (→P.264)
- The vehicle is being driven in the center of a lane.
- Steering assist function is not operating.
- When your vehicle is not towing a trailer or during emergency towing.

■ Temporary cancelation of functions

- When operation conditions are no longer met, a function may be temporarily canceled. However, when the operation conditions are met again, operation of the function is automatically restored. (→P.262)
- If the operation conditions (→P.262) are no longer met while the lane centering function is operating, the steering wheel may vibrate and the buzzer may sound to indicate that the function has been temporarily canceled. However, if the “Alert” customization setting is set to , the system will notify the driver by vibrating the steering wheel instead of sounding the buzzer.

■ Steering assist function/lane centering function

- Depending on the vehicle speed, lane departure situation, road conditions, etc., the driver may not feel the function is operating or the function may not operate at all.
- The steering control of the function is overridden by the driver's steering wheel operation.
- Do not attempt to test the operation of the steering assist function.

■ Lane departure alert function

- The warning buzzer may be difficult to hear due to external noise, audio playback, etc. Also, it may be difficult to feel steering wheel vibrations due to the road conditions, etc.
- It may not be possible for the system to determine if there is a danger of a collision with a vehicle in an adjacent lane.
- Do not attempt to test the operation of the lane departure alert function.

■ Hands off steering wheel warning

In the following situations, a warning message urging the driver to hold the steering wheel and the symbol shown in the illustration are displayed on the multi-information display to warn the driver. The warning stops when the system determines that the driver holds the steering wheel. Always keep your hands on the steering wheel when using this system, regardless of warnings.

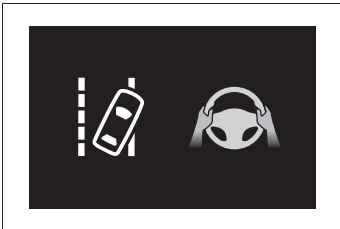

- When the system determines that the driver is driving without holding the steering wheel while the system is operating

If the driver continues to keep their hands off of the steering wheel, the buzzer sounds, the driver is warned and the function is temporarily canceled. This warning also operates in the same way when the driver continuously operates the steering wheel only a small amount.

The buzzer also sounds even if the alert type is set to .

- When the system determines that the vehicle may deviate from the lane while driving around a curve while the lane centering function is operating.

Depending on the vehicle condition and road conditions, the warning may not operate. Also, if the system determines that the vehicle is driving around a curve, warnings will occur earlier than during straight-

lane driving.

- When the system determines that the driver is driving without holding the steering wheel while the steering wheel assist of the steering assist function is operating.

If the driver continues to keep their hands off of the steering wheel and the steering wheel assist is operating, the buzzer sounds and the driver is warned. Each time the buzzer sounds, the continuing time of the buzzer becomes longer.

The buzzer also sounds even if the alert type is set to .

■ Vehicle sway warning function

When the system determines that the vehicle is swaying while the vehicle sway warning function is operating, a buzzer sounds and a warning message urging the driver to rest and the symbol shown in the illustration are simultaneously displayed on the multi-information display.



Depending on the vehicle and road conditions, the warning may not operate.

■ Warning message

If the following warning message is displayed on the multi-information display and the LTA indicator illuminates in orange, follow the appropriate troubleshooting procedure. Also, if a different warning message is displayed, follow the instructions displayed on the screen.

- “LTA Malfunction Visit Your Dealer”

The system may not be operating properly. Have the vehicle inspected by your Toyota dealer.

- “LTA Unavailable”

The system is temporarily canceled due to a malfunction in a sensor other than the front camera. Turn the LTA system off, wait for a little while, and then turn the LTA system back on.

- “LTA Unavailable at Current Speed”

The function cannot be used as the vehicle speed exceeds the LTA operation range. Drive slower.

■ Customization

Function settings can be changed. (Customizable features: →P.596)

RSA (Road Sign Assist)*

*: If equipped

Summary of function

The RSA system recognizes specific road signs using the front camera and/or navigation system (when speed limit information is available) to provide information to the driver via the display.

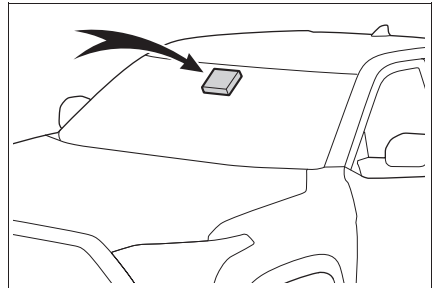

If the system judges that the vehicle is being driven over the speed limit, performing prohibited actions, etc., according to the recognized road signs, it notifies the driver through a visual notification and notification buzzer.

⚠ WARNING

■ Before using the RSA

Do not rely solely upon the RSA system. RSA is a system which supports the driver by providing information, but it is not a replacement for a driver's own vision and awareness. Drive safely by always paying careful attention to the traffic rules.

Indication on the multi-information display

When the front camera recognizes a sign and/or information of a sign is available from the navigation system, the sign will be displayed on the multi-information display.

- When the driving support system information is selected, a maximum of 3 signs can be displayed. (→P.95)

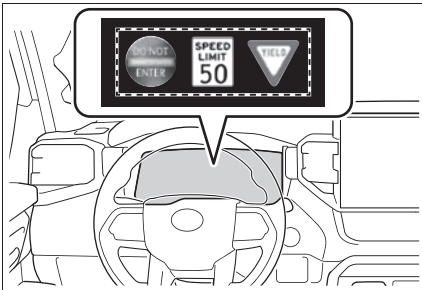

- When a tab other than the driving support system information is selected, the following types of road signs will be displayed. (→P.95)
- Speed limit sign
- Do Not Enter sign (when notification is necessary)

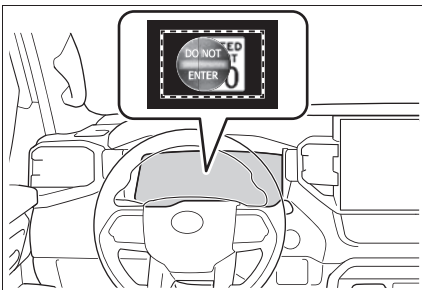

If signs other than speed limit signs

are recognized, they will be displayed in an overlapping stack under the current speed limit sign.

Supported types of road signs

The following types of road signs, including electronic signs and blinking signs, are recognized.

A non-official or a recently introduced traffic sign may not be recognized.



Speed limit



Do Not Enter



Stop



Yield

Notification function



In the following situations, the RSA system will notify the driver.

- When the vehicle speed exceeds the speed notification threshold of the speed limit sign displayed, the sign display will be emphasized and a buzzer will sound.
- When the RSA system recognizes a do not enter sign and

determines that your vehicle has entered a no-entry area, the displayed sign will flash and a buzzer will sound.

Depending on the situation, a notification function may not operate properly.

■ Setting procedure

- 1 Press < or > of the meter control switches and select  .
- 2 Press ^ or v of the meter control switches and select  RSA, then press OK.

■ Automatic turn-off of RSA sign display

In the following situations, a displayed speed limit sign and/or do not enter sign will stop being displayed automatically:

- No sign has been recognized for a certain distance.
- The road changes due to a left or right turn, etc.

In the following situations, stop and yield signs will stop being displayed automatically:

- The system determines that your vehicle has passed the sign.
- The road changes due to a left or right turn, etc.

■ Conditions in which the function may not operate or detect correctly

In the following situations, RSA does not operate normally and may not recognize signs, display the incorrect sign, etc. However, this does not indicate a malfunction.

- The front camera is misaligned due to a strong impact being applied to the sensor, etc.
- Dirt, snow, stickers, etc., are on

the windshield near the front camera.

- In inclement weather such as heavy rain, fog, snow or sand storms
- Light from an oncoming vehicle, the sun, etc., enters the front camera.
- The sign is dirty, faded, tilted or bent.
- The contrast of electronic sign is low.
- All or part of the sign is hidden by the leaves of a tree, a pole, etc.
- The sign is only visible to the front camera for a short amount of time.
- The driving scene (turning, lane change, etc.) is judged incorrectly.
- If a sign not appropriate for the currently traveled lane, but the sign exists directly after a freeway branches, or in an adjacent lane just before merging.
- Stickers are attached to the rear of the preceding vehicle.
- A sign resembling a system compatible sign is recognized.
- Side road speed signs may be detected and displayed (if positioned in sight of the front camera) while the vehicle is traveling on the main road.
- Roundabout exit road speed signs may be detected and displayed (if positioned in sight of the front camera) while traveling on a roundabout.
- The front of the vehicle is raised or lowered due to the carried load.
- The surrounding brightness is not sufficient or changes suddenly.
- When a sign intended for trucks, etc., is recognized.
- The navigation system map data is outdated.
- The navigation system is not operating.

- The speed information displayed on the meter and on the navigation system may be different due to the navigation system using map data.

■ Speed limit sign display

If the power switch was last turned off while a speed limit sign was displayed on the multi-information display, the same sign displays again when the power switch is turned to ON.

■ If “RSA Malfunction Visit Your Dealer” is shown

The system may be malfunctioning. Have the vehicle inspected by your Toyota dealer.

■ Customization

Some functions can be customized. (Customizable features: →P.596)

Dynamic radar cruise control with full-speed range

Summary of functions

In vehicle-to-vehicle distance control mode, the vehicle automatically accelerates, decelerates and stops to match the speed changes of the preceding vehicle even if the accelerator pedal is not depressed. In constant speed control mode, the vehicle runs at a fixed speed.

Use the dynamic radar cruise control with full-speed range on freeways and highways.

- Vehicle-to-vehicle distance control mode (→P.272)
- Constant speed control mode (→P.277)

System Components

■ Meter display

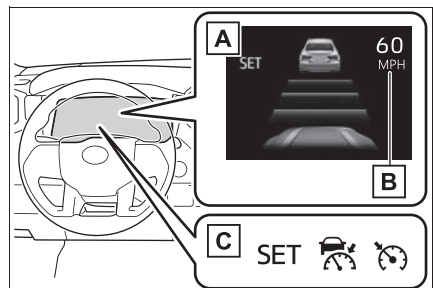

A Multi-information display

B Set speed

C Indicators

■ Operation switches

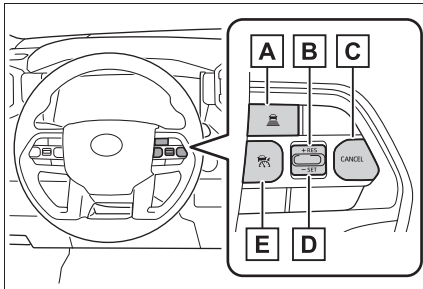

- A** Vehicle-to-vehicle distance switch
- B** “+RES” switch
- C** Cancel switch
- D** “-SET” switch
- E** Cruise control main switch

⚠ WARNING

■ Before using dynamic radar cruise control with full-speed range

- Driving safely is the sole responsibility of the driver. Do not rely solely on the system, and drive safely by always paying careful attention to your surroundings.
- The dynamic radar cruise control with full-speed range provides driving assistance to reduce the driver's burden. However, there are limitations to the assistance provided. Read the following conditions carefully. Do not overly rely on this system and always drive carefully.

- When the sensor may not be correctly detecting the vehicle ahead: →P.279
- Conditions under which the vehicle-to-vehicle distance control mode may not function correctly: →P.280
- Set the speed appropriately depending on the speed limit, traffic flow, road conditions, weather conditions, etc. The driver is responsible for checking the set speed.
- Even when the system is functioning normally, the condition of the preceding vehicle as detected by the system may differ from the condition observed by the driver. Therefore, the driver must always remain alert, assess the danger of each situation and drive safely. Relying solely on this system or assuming the system ensures safety while driving can lead to an accident, resulting in death or serious injury.

- Switch the dynamic radar cruise control with full-speed range setting to off, using the cruise control main switch when not in use.

■ Cautions regarding the driving assist systems

Observe the following precautions, as there are limitations to the assistance provided by the system. Failure to do so may cause an accident resulting in death or serious injury.

**WARNING**

- Assisting the driver to measure following distance

The dynamic radar cruise control with full-speed range is only intended to help the driver in determining the following distance between the driver's own vehicle and a designated vehicle traveling ahead. It is not a mechanism that allows careless or inattentive driving, and it is not a system that can assist the driver in low-visibility conditions.

It is still necessary for driver to pay close attention to the vehicle's surroundings.

- Assisting the driver to judge proper following distance

The dynamic radar cruise control with full-speed range determines whether the following distance between the driver's own vehicle and a designated vehicle traveling ahead is within a set range. It is not capable of making any other type of judgement. Therefore, it is absolutely necessary for the driver to remain vigilant and to determine whether or not there is a possibility of danger in any given situation.

- Assisting the driver to operate the vehicle

The dynamic radar cruise control with full-speed range does not include functions which will prevent or avoid collisions with vehicles ahead of your vehicle.

Therefore, if there is ever any possibility of danger, the driver must take immediate and direct control of the vehicle and act appropriately in order to ensure the safety of all involved.

- **Situations unsuitable for dynamic radar cruise control with full-speed range**

Do not use dynamic radar cruise control with full-speed range in any of the following situations. Doing so may result in inappropriate speed control and could cause an accident resulting in death or serious injury.

- Roads where there are pedestrians, cyclists, etc.
- In heavy traffic
- On roads with sharp bends
- On winding roads

**WARNING**

- On slippery roads, such as those covered with rain, ice or snow
- On steep downhill, or where there are sudden changes between sharp up and down gradients
Vehicle speed may exceed the set speed when driving down a steep hill.
- At entrances to freeways and highways
- When weather conditions are bad enough that they may prevent the sensors from detecting correctly (fog, snow, sandstorm, heavy rain, etc.)
- When there is rain, snow, etc., on the front surface of the radar or front camera
- In traffic conditions that require frequent repeated acceleration and deceleration
- When your vehicle is towing a trailer or another vehicle, except when the following condition is met.
 - When the other vehicle is a trailer properly attached and connected to Toyota's official TBC ECU. (→P.191)
- When an approach warning buzzer is heard often
- When the vehicle is lifted up, except in the following cases.
 - When using a Toyota official lift kit up to 4 in. (101 mm), including tire height. Aftermarket lift kits may degrade system performance.

Driving in vehicle-to-vehicle distance control mode

This mode employs a radar to detect the presence of vehicles up to approximately 328 ft. (100 m) ahead, determines the current vehicle-to-vehicle following distance, and operates to maintain a suitable following distance from the vehicle ahead. The desired vehicle-to-vehicle distance can also be set by operating the vehicle-to-vehicle distance switch.

When driving on downhill slopes, the vehicle-to-vehicle distance may become shorter.

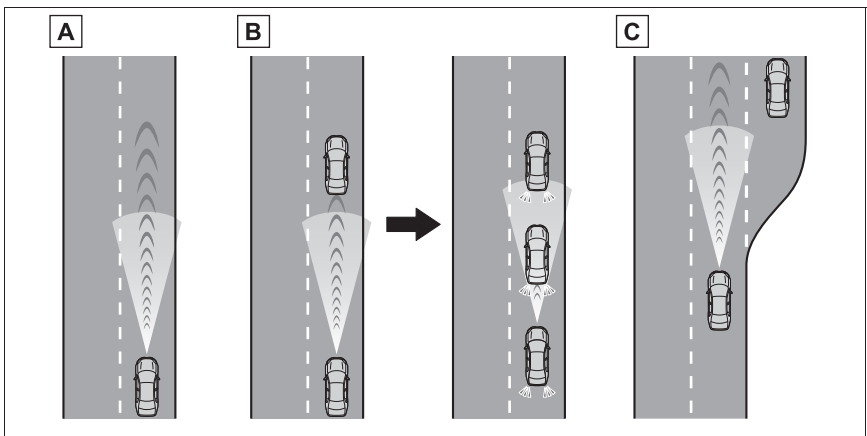

A Example of constant speed cruising

When there are no vehicles ahead

The vehicle travels at the speed set by the driver.

B Example of deceleration cruising and follow-up cruising

When a preceding vehicle driving slower than the set speed appears

When a vehicle is detected running ahead of you, the system automatically decelerates your vehicle. When a greater reduction in vehicle speed is necessary, the system applies the brakes (the stop lights will come on at this time). The system will respond to changes in the speed of the vehicle ahead in order to maintain the vehicle-to-vehicle distance set by the driver. Approach warning warns you when the system cannot decelerate sufficiently to prevent your vehicle from closing in on the vehicle ahead.

When the vehicle ahead of you stops, your vehicle will also stop (vehicle is stopped by system control). After the vehicle ahead starts off, pressing the “+RES” switch or depressing the accelerator pedal (start-off operation) will resume follow-up cruising. If the start-off operation is not performed, system

control continues to keep your vehicle stopped.

When the turn signal lever is operated and your vehicle moves to an overtaking lane while driving at 50 mph (80 km/h) or more, the vehicle will accelerate to help to overtake a passing vehicle.

The system's identification of what is an overtaking lane may be determined solely based on the location of the steering wheel in the vehicle (left side driver position versus right side driver position.) If the vehicle is driven to a region where the overtaking lane is on a different side from where the vehicle is normally driven, the vehicle may accelerate when the turn signal lever is operated in the opposite direction to the overtaking lane (e.g., if the driver normally operates the vehicle in a region where the overtaking lane is to the right but then drives to a region where the overtaking lane is to the left, the vehicle may accelerate when the right turn signal is activated).

C Example of acceleration

When there are no longer any preceding vehicles driving slower than the set speed

The system accelerates until the set speed is reached. The system then returns to constant speed cruising.

Setting the vehicle speed (vehicle-to-vehicle distance control mode)

- 1 Press the cruise control main switch to activate the cruise control.

Dynamic radar cruise control indicator will come on and a message will be displayed on the multi-information display. Press the switch again to deactivate the cruise control.

If the cruise control main switch is pressed and held for 1.5 seconds or more, the system turns on in constant speed control mode. (→P.277)

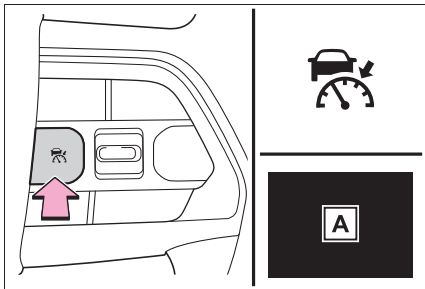

A “Radar Ready”

- 2 Accelerate or decelerate, with accelerator pedal operation, to the desired vehicle speed (at or above approximately 20 mph [30 km/h]) and press the “-SET” switch to set the speed.

Cruise control “SET” indicator will come on.

The vehicle speed at the moment the switch is released becomes the

set speed.

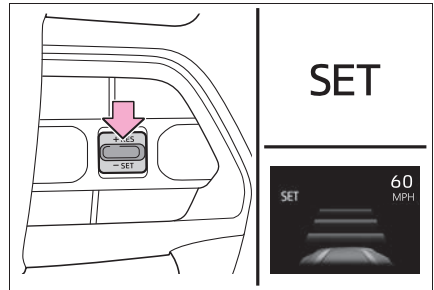

Adjusting the set speed

- Adjusting the set speed by the switch

To change the set speed, press the “+RES” or “-SET” switch until the desired set speed is displayed.

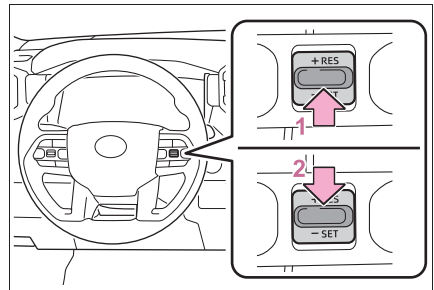

- 1 Increases the speed (Except when the vehicle has been stopped by system control in vehicle-to-vehicle distance control mode)
- 2 Decreases the speed

Fine adjustment: Press the switch.

Large adjustment: Press and hold the switch to change the speed, and release when the desired speed is reached.

In the vehicle-to-vehicle distance control mode, the set

speed will be increased or decreased as follows:

► For the U.S. mainland, Hawaii

Fine adjustment: By 1 mph (1.6 km/h)^{*1} or 1 km/h (0.6mph)^{*2} each time the switch is pressed

Large adjustment: Increases or decreases in 1mph (1.6 km/h)^{*1} or 1 km/h (0.6 mph)^{*2} increments for as long as the switch is held

► Except for the U.S. mainland and Hawaii

Fine adjustment: By 1 mph (1.6 km/h)^{*1} or 1 km/h (0.6mph)^{*2} each time the switch is pressed

Large adjustment: Increases or decreases in 5 mph (8 km/h)^{*1} or 5 km/h (3.1 mph)^{*2} increments for as long as the switch is held

In the constant speed control mode (→P.277), the set speed will be increased or decreased as follows:

Fine adjustment: By 1 mph (1.6 km/h)^{*1} or 1 km/h (0.6 mph)^{*2} each time the switch is pressed

Large adjustment: The speed will continue to change while the switch is held.

*1: When the set speed is shown in “MPH”

*2: When the set speed is shown in “km/h”

■ Increasing the set speed by the accelerator pedal

1 Accelerate with accelerator pedal operation to the desired vehicle speed

2 Press the “-SET” switch

Changing the vehicle-to-vehicle distance (vehicle-to-vehicle distance control mode)

Pressing the switch changes the vehicle-to-vehicle distance as follows:

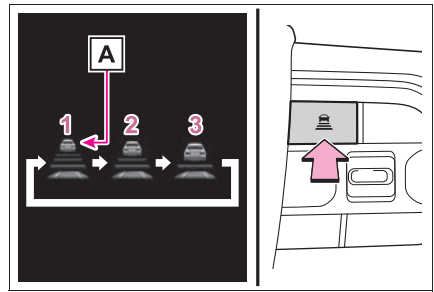

1 Long

2 Medium

3 Short

If a vehicle is running ahead of you, the preceding vehicle mark **A** will also be displayed.

Vehicle-to-vehicle distance settings (vehicle-to-vehicle distance control mode)

Select a distance from the table below. Note that the distances shown correspond to a vehicle speed of 50 mph (80 km/h). Vehicle-to-vehicle distance increases/decreases in accordance with vehicle speed. When the vehicle is stopped by system control, the vehicle stops at a certain vehicle-to-vehicle distance depending on the situation.

Distance options	Vehicle-to-vehicle distance
Long	Approximately 160 ft. (50 m)
Medium	Approximately 130 ft. (40 m)
Short	Approximately 100 ft. (30 m)

Resuming follow-up cruising when the vehicle has been stopped by system control (vehicle-to-vehicle distance control mode)

After the vehicle ahead of you starts off, press the “+RES” switch.

Your vehicle will also resume follow-up cruising if the acceler-

ator pedal is depressed after the vehicle ahead of you starts off.

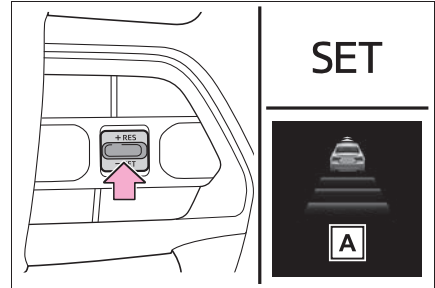

- A** “Operate Cruise switch or Accelerator Pedal to Resume”

Canceling and resuming the speed control

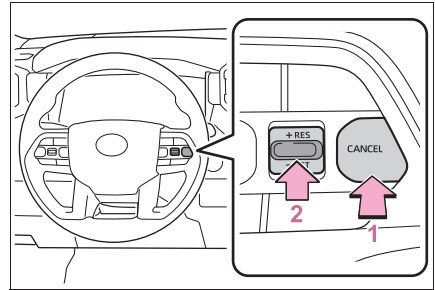

- 1** Pressing the cancel switch cancels the speed control.

The speed control is also canceled when the brake pedal is depressed. (When the vehicle has been stopped by system control, depressing the brake pedal does not cancel the setting.)

- 2** Pressing the “+RES” switch resumes the cruise control and returns vehicle speed to the set speed.

Approach warning (vehicle-to-vehicle distance control mode)

When your vehicle is too close to a vehicle ahead, and sufficient automatic deceleration via the cruise control is not possible, the display will flash and the buzzer will sound to alert the driver. An example of this would be if another driver cuts in front of you while you are following a vehicle. Depress the brake pedal to ensure an appropriate vehicle-to-vehicle distance.

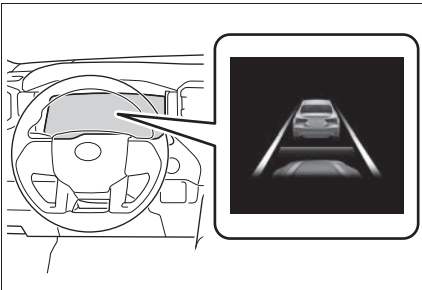

■ Warnings may not occur when

In the following instances, warnings may not occur even when the vehicle-to-vehicle distance is small.

- When the speed of the preceding vehicle matches or exceeds your vehicle speed
- When the preceding vehicle is traveling at an extremely slow speed
- Immediately after the cruise control speed was set

- When depressing the accelerator pedal

Selecting constant speed control mode

When constant speed control mode is selected, your vehicle will maintain a set speed without controlling the vehicle-to-vehicle distance. Select this mode only when vehicle-to-vehicle distance control mode does not function correctly due to a dirty radar, etc.

- 1 With the cruise control off, press and hold the cruise control main switch for 1.5 seconds or more.

Immediately after the switch is pressed, the dynamic radar cruise control indicator will come on. Afterwards, it switches to the cruise control indicator.

Switching to constant speed control mode is only possible when operating the switch with the cruise control off.

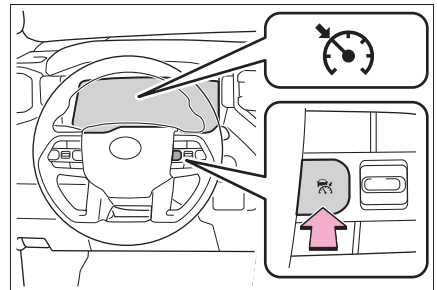

- 2 Accelerate or decelerate, with accelerator pedal operation, to the desired vehicle speed (at or above approximately 20 mph [30 km/h])

278 4-5. Using the driving support systems

and press the “-SET” switch to set the speed.

Cruise control “SET” indicator will come on.

The vehicle speed at the moment the switch is released becomes the set speed.

Adjusting the speed setting:
→P.274

Canceling and resuming the speed setting: →P.276

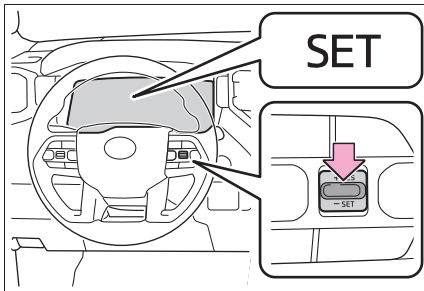

■ Dynamic radar cruise control with full-speed range can be set when

- The shift lever is in D.
- The desired set speed can be set when the vehicle speed is approximately 20 mph (30 km/h) or more. (However, when the vehicle speed is set while driving at below approximately 20 mph [30 km/h], the set speed will be set to approximately 20 mph [30 km/h].)

■ Accelerating after setting the vehicle speed

The vehicle can accelerate by operating the accelerator pedal. After accelerating, the set speed resumes. However, during vehicle-to-vehicle distance control mode, the vehicle speed may decrease below the set speed in order to maintain the distance to the preceding vehicle.

■ When the vehicle stops while follow-up cruising

- Pressing the “+RES” switch while the vehicle ahead stops will resume follow-up cruising if the vehicle ahead starts off within approximately 3 seconds after the switch is pressed.
- If the vehicle ahead starts off within 3 seconds after your vehicle stops, follow-up cruising will be resumed.

■ Automatic cancelation of vehicle-to-vehicle distance control mode

Vehicle-to-vehicle distance control mode is automatically canceled in the following situations.

- VSC is activated.
- TRAC is activated for a period of time.
- When the VSC or TRAC system is turned off.
- The sensor cannot detect correctly because it is covered in some way.
- When the brake control or output restriction control of a driving support system operates. (For example: Pre-Collision System, Drive-Start Control)
- The center differential lock/unlock is not completed within 5 seconds while the cruise control system is on.
- The parking brake is operated.
- The vehicle is stopped by system control on a steep incline.
- The following are detected when the vehicle has been stopped by system control:
 - The driver is not wearing a seat belt.
 - The driver's door is opened.
 - The vehicle has been stopped for about 3 minutes.

If vehicle-to-vehicle distance control mode is automatically canceled for

any reasons other than the above, there may be a malfunction in the system. Contact your Toyota dealer.

■ Automatic cancelation of constant speed control mode

Constant speed control mode is automatically canceled in the following situations:

- Actual vehicle speed is more than approximately 10 mph (16 km/h) below the set vehicle speed.
- Actual vehicle speed falls below approximately 20 mph (30 km/h).
- VSC is activated.
- TRAC is activated for a period of time.
- When the VSC or TRAC system is turned off.
- When the brake control or output restriction control of a driving support system operates. (For example: Pre-Collision System, Drive-Start Control)
- The center differential lock/unlock is not completed within 5 seconds while the cruise control system is on.
- The parking brake is operated.

If constant speed control mode is automatically canceled for any reasons other than the above, there may be a malfunction in the system. Contact your Toyota dealer.

■ Brake operation

A brake operation sound may be heard and the brake pedal response may change, but these are not malfunctions.

■ Warning messages and buzzers for dynamic radar cruise control with full-speed range

Warning messages and buzzers are used to indicate a system malfunction or to inform the driver of the need for caution while driving. If a warning message is shown on the multi-information display, read the message and follow the instructions.

(→P.240, 537)

■ When the sensor may not be correctly detecting the vehicle ahead

In the case of the following and depending on the conditions, operate the brake pedal when deceleration of the system is insufficient or operate the accelerator pedal when acceleration is required.

As the sensor may not be able to correctly detect these types of vehicles, the approach warning (→P.277) may not be activated.

- Vehicles that cut in suddenly
- Vehicles traveling at low speeds
- Vehicles that are not moving in the same lane
- Vehicles with small rear ends (trailers with no load on board, etc.)

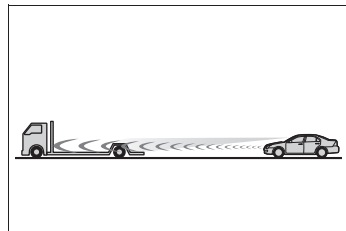

- Motorcycles traveling in the same lane
- When water or snow thrown up by the surrounding vehicles hinders the detecting of the sensor
- When your vehicle is pointing upwards (caused by a heavy load in the luggage compartment, etc.)

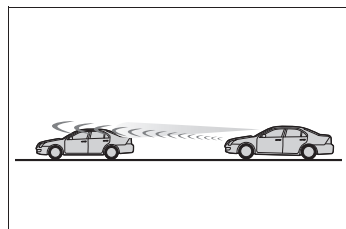

- Preceding vehicle has an extremely high ground clearance

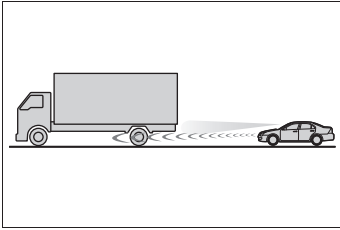

- When the vehicle is towing a trailer or during emergency towing.
 - When the vehicle is lifted up, except in the following cases.
 - When using a Toyota official lift kit up to 4 in. (101 mm), including tire height. Aftermarket lift kits may degrade system performance.
- **Conditions under which the vehicle-to-vehicle distance control mode may not function correctly**

In the case of the following conditions, operate the brake pedal (or accelerator pedal, depending on the situation) as necessary.

As the sensor may not be able to correctly detect vehicles ahead, the system may not operate properly.

- When the road curves or when the lanes are narrow

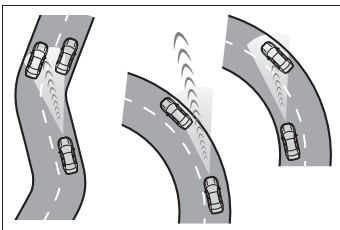

- When steering wheel operation or your position in the lane is unstable

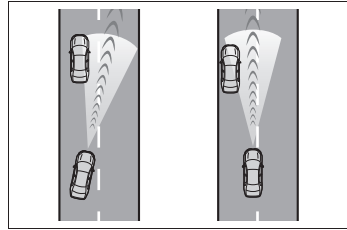

- When the vehicle ahead of you decelerates suddenly
- When driving on a road surrounded by a structure, such as in a tunnel or on a bridge
- While the vehicle speed is decreasing to the set speed after the vehicle accelerates by depressing the accelerator pedal
- When your vehicles is towing a trailer or another vehicle, except when the following condition is met.
 - When the other vehicle is a trailer properly attached and connected to Toyota's official TBC ECU. (→P.191)
- When the vehicle is lifted up, except in the following cases.
 - When using a Toyota official lift kit up to 4 in. (101 mm), including tire height. Aftermarket lift kits may degrade system performance.

BSM (Blind Spot Monitor)

The Blind Spot Monitor is a system that uses rear side radar sensors installed on the inner side of the rear bumper on the left and right side to assist the driver for lane changing decision.

WARNING

■ Cautions regarding the use of the system

- The driver is solely responsible for safe driving. Always drive safely, taking care to observe your surroundings.

The Blind Spot Monitor is a supplementary function which alerts the driver that a vehicle is in a blind spot of the outside rear view mirrors or is approaching rapidly from behind into a blind spot. Do not overly rely on the Blind Spot Monitor. As the function cannot judge if it is safe to change lanes, over reliance could lead to an accident resulting in death or serious injury.

As the system may not function correctly under certain conditions, the driver's own visual confirmation of safety is necessary.

- When the vehicle is lifted up, except in the following cases.
 - When using a Toyota official lift kit up to 4 in. (101 mm), including tire height. Aftermarket lift kits may degrade system performance.

System components

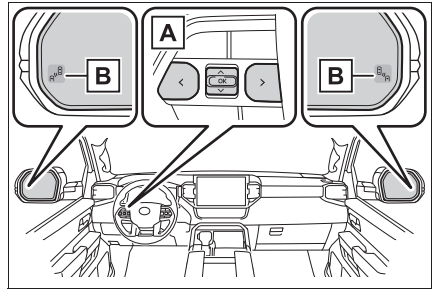

A Meter control switches

Turning the Blind Spot Monitor on/off.

B Outside rear view mirror indicators

When a vehicle is detected in a blind spot of the outside rear view mirrors or approaching rapidly from behind into a blind spot, the outside rear view mirror indicator on the detected side will illuminate. If the turn signal lever is operated toward the detected side, the outside rear view mirror indicator flashes.

■ Outside rear view mirror indicator visibility

In strong sunlight, the outside rear view mirror indicator may be difficult to see.

■ When “Blind Spot Monitor Unavailable” is shown on the multi-information display

Ice, snow, mud, etc., may be attached to the rear bumper around the sensors. (→P.282) The system should return to normal operation after removing the ice, snow, mud, etc., from the rear bumper. Additionally, the sensors may not operate normally when driving in extremely hot or cold environments.

■ **When “Blind Spot Monitor Malfunction Visit Your Dealer” is shown on the multi-information display**

There may be a sensor malfunction or misaligned. Have the vehicle inspected by your Toyota dealer.

■ **Customization**

Some functions can be customized. (→P.597)

■ **Certification**

→P.642

! WARNING

■ **To ensure the system can operate properly**

Blind Spot Monitor sensors are installed behind the left and right sides of the rear bumper respectively. Observe the following to ensure the Blind Spot Monitor can operate correctly.

- Keep the sensors and the surrounding areas on the rear bumper clean at all times.

If a sensor or its surrounding area on the rear bumper is dirty or covered with snow, the Blind Spot Monitor may not operate and a warning message (→P.281) will be displayed. In this situation, clear off the dirt or snow and drive the vehicle with the operation conditions of the BSM function (→P.286) satisfied for approximately 10 minutes. If the warning message does not disappear, have the vehicle inspected by your Toyota dealer.

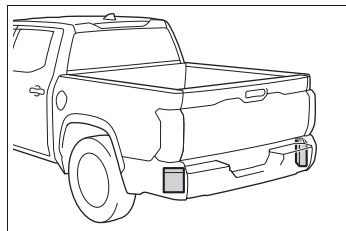



- Do not attach accessories, stickers (including transparent stickers), aluminum tape, etc., to a sensor or its surrounding area on the rear bumper.

⚠ WARNING

- Do not subject a sensor or its surrounding area on the rear bumper to a strong impact. If a sensor is moved even slightly off position, the system may malfunction and vehicles may not be detected correctly. In the following situations, have your vehicle inspected by your Toyota dealer.
 - A sensor or its surrounding area is subject to a strong impact.
 - If the surrounding area of a sensor is scratched or dented, or part of them has become disconnected.
- Do not disassemble the sensor.
- Do not modify the sensor or surrounding area on the rear bumper.
- If a sensor or the rear bumper needs to be removed/installed or replaced, contact your Toyota dealer.
- Do not paint the rear bumper any color other than an official Toyota color.

Changing settings of the Blind Spot Monitor**■ Turning the Blind Spot Monitor on/off**

Use the meter control switches to turn on/off the function. (→P.96)

- 1 Press < or > to select .
- 2 Press ^ or v to select “ BSM” and then press OK.

When the BSM function is disabled, the BSM OFF indicator (→P.89) illuminates. (Each time the power switch is turned off then changed to ON, the Blind Spot Monitor will be enabled automatically.)

■ Setting the trailer type

Use the meter control switches to select the trailer type. (→P.96)

- 1 Press < or > to select .
- 2 Press ^ or v to select “Trailer Settings” and then press and hold OK.
- 3 According to the display, select the desired setting and then press OK. (→P.100)

■ Auto Trailer Detection (ATD)

Auto Trailer Detection (ATD) detects if a trailer is attached by using the Trailer Brake Controller (TBC) or the Blind Spot Monitor (BSM) sensors.

- Trailers that use TBC can be detected by using the 7-pin trailer brake connectors.
- Other types of trailers can be detected using the BSM sensors.
- When a trailer is detected via BSM or TBC, RCTA function will be disabled.
- As soon as the trailer is detected, the detection area will be extended to a maximum length of approximately 16 ft. (15 m) from the rear bumper of the truck.
- If the trailer does not have a 7-pin connector, or the 7-pin connector is not engaged, the trailer is detected via the BSM sensor. In this case PKSB and Intuitive parking assist functions will not be dis-

abled.

- For trailer auto detection without engagement of 7-pin connector, the vehicle should be moving forward at speed of above 0.6 mph (1 km/h) for at least 10 seconds.
- ATD function is triggered at every power switch on/off cycle or if the vehicle is stopped in shift the shift lever is in P or N for more than 90 seconds.
- Trailer detection vis BSM sensors may be delayed if the vehicle is in a crowded environment such as busy parking lot, area surrounded with trees (camping ground) or in an environment with objects in the immediate environment that prevent sensors from sufficiently detecting the trailer.

■ **Trailer Length Detection (TLD)**

- Once a trailer is detected and if the trailer length in the meter is selected as “Auto”, the TLD function will estimate the trailer length using the Blind Spot Monitor sensors.
- In order to estimate the trailer length with TLD function and detection area, make at least two 90 degree turns.
- If the trailer length is entered manually via multi-information display input, the detection area is also adjusted to exceed the length of the trailer.
- Depending on some trailer types and the dimensions of the trailer TMW performance may be degraded.

Blind Spot Monitor operation

■ **Vehicles that can be detected by the Blind Spot Monitor**

The Blind Spot Monitor uses rear side radar sensors to detect the following vehicles traveling in adjacent lanes and advises the driver of the presence of such vehicles via the indicators on the outside rear view mirrors.

- When not towing a trailer

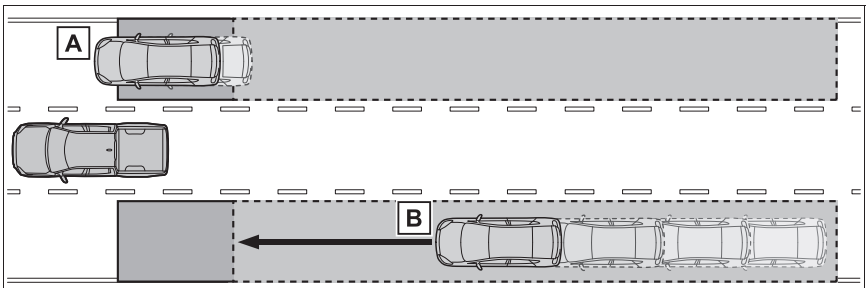

- A** Vehicles approaching in adjacent lanes that may not be visible using the outside rear view mirrors (the blind spots)
- B** Vehicles that are approaching rapidly in adjacent lanes that are not visible using the outside rear view mirrors (the blind spots)

- When towing a trailer

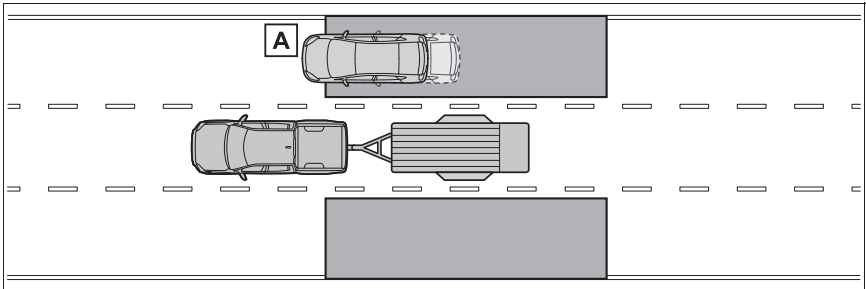

- A** Vehicles approaching in adjacent lanes that may not be visible using the outside rear view mirrors (the blind spots)

■ The Blind Spot Monitor detection areas

The areas that vehicles can be detected in are outlined below.

- When not towing a trailer

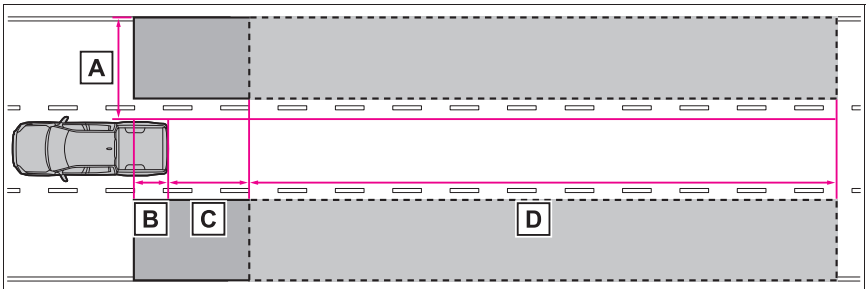

The range of each detection area is:

- A** Approximately 1.6 ft. (0.5 m) to 11.5 ft. (3.5 m) from either side of the vehicle ^{*1}
- B** Approximately 3.3 ft. (1 m) forward of the rear bumper
- C** Approximately 9.8 ft. (3 m) from the rear bumper
- D** Approximately 9.8 ft. (3 m) to 197 ft. (60 m) from the rear bumper ^{*2}

● When towing a trailer

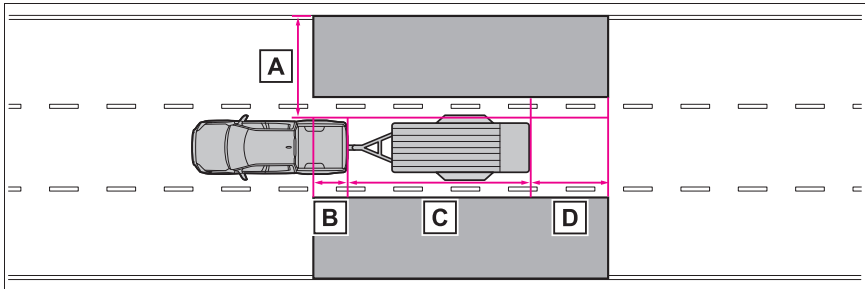

The range of each detection area is:

- A** Approximately 1.6 ft. (0.5 m) to 11.5 ft. (3.5 m) from either side of the vehicle^{*1}
- B** Approximately 3.3 ft. (1 m) forward of the rear bumper
- C** Trailer overall length^{*3}
- D** Approximately 9.8 ft. (3 m) from the rear end of trailer^{*3}

^{*1}: The area between the side of the vehicle and 1.6 ft. (0.5 m) from the side of the vehicle cannot be detected.

^{*2}: The outer mirror indicator warning may be delayed. The delay increases in proportion to the speed differential with vehicles approaching in the adjacent lane.

^{*3}: The system does not support trailers wider than 8.5 ft. (2.59 m) and/or longer than 39 ft. (12.0 m). For box trailers and certain other trailer types that are up to 8.5 ft. (2.59 m) wide and/or 39 ft. (12.0 m) long, the indicator warning in the outer mirror may be delayed if the vehicle in the adjacent lane overtakes your vehicle at a high-speed differential.

■ **The Blind Spot Monitor is operational when**

The Blind Spot Monitor is operational when all of the following conditions are met:

- The Blind Spot Monitor is on.
- The shift position is in a position other than R.
- The vehicle speed is greater than approximately 6 mph (10 km/h).

■ **The Blind Spot Monitor will detect a vehicle when**

The Blind Spot Monitor will detect a

vehicle present in the detection area in the following situations:

- A vehicle in an adjacent lane overtakes your vehicle.
- You overtake a vehicle in an adjacent lane slowly.
- Another vehicle enters the detection area when it changes lanes.

■ **Conditions under which the system will not detect a vehicle**

The Blind Spot Monitor is not designed to detect the following types of vehicles and/or objects:

- Small motorcycles, bicycles, pedestrians, etc.*
- Vehicles traveling in the opposite direction
- Guardrails, walls, signs, parked vehicles and similar stationary objects*
- Following vehicles that are in the same lane*
- Vehicles traveling 2 lanes away from your vehicle*
- Vehicles which are being overtaken rapidly by your vehicle*

*: Depending on the conditions, detection of a vehicle and/or object may occur.

■ Conditions under which the system may not function correctly

- The Blind Spot Monitor may not detect vehicles correctly in the following situations:
 - When the sensor is misaligned due to a strong impact to the sensor or its surrounding area
 - When mud, snow, ice, a sticker, etc., is covering the sensor or surrounding area on the rear bumper
 - When driving on a road surface that is wet with standing water during bad weather, such as heavy rain, snow, or fog
 - When multiple vehicles are approaching with only a small gap between each vehicle
 - When the distance between your vehicle and a following vehicle is short
 - When there is a significant difference in speed between your vehicle and the vehicle that enters the detection area
 - When the difference in speed between your vehicle and another vehicle is changing
 - When a vehicle enters a detection area traveling at about the same speed as your vehicle
 - As your vehicle starts from a stop, a vehicle remains in the detection area
- When driving up and down consecutive steep inclines, such as hills, dips in the road, etc.
- When driving on roads with sharp bends, consecutive curves, or uneven surfaces
- When vehicle lanes are wide, or when driving on the edge of a lane, and the vehicle in an adjacent lane is far away from your vehicle
- When an accessory (such as a bicycle carrier) is installed to the rear of the vehicle
- When driving with tailgate in the open position or when cargo (such as lumber) is loaded on the open tailgate.
- When there is a significant difference in height between your vehicle and the vehicle that enters the detection area
- Immediately after the Blind Spot Monitor is turned on
- Instances of the Blind Spot Monitor unnecessarily detecting a vehicle and/or object may increase in the following situations:
 - When the sensor is misaligned due to a strong impact to the sensor or its surrounding area
 - When the distance between your vehicle and a guardrail, wall, etc., that enters the detection area is short
 - When driving up and down consecutive steep inclines, such as hills, dips in the road, etc.
 - When vehicle lanes are narrow, or when driving on the edge of a lane, and a vehicle traveling in a lane other than the adjacent lanes enters the detection area
 - When driving on roads with sharp bends, consecutive curves, or uneven surfaces
 - When the tires are slipping or spinning
 - When the distance between your vehicle and a following vehicle is short
 - When an accessory (such as a

bicycle carrier) is installed to the rear of the vehicle

- When turning at an intersection with a trailer is being towed and an adjacent vehicle continues traveling straight

Intuitive parking assist

The distance from your vehicle to objects, such as a wall, when parallel parking or maneuvering into a garage is measured by the sensors and communicated via the multi-information display and/or multimedia display and a buzzer. Always check the surrounding area when using this system.

System components

■ Types of sensors

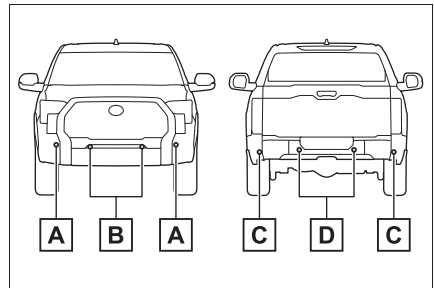

- A** Front corner sensors
- B** Front center sensors
- C** Rear corner sensors
- D** Rear center sensors

■ Display

When the sensors detect an object, such as a wall, a graphic is shown on the multi-information display and/or multimedia display depending on the position and distance to the object. (As the distance to the object becomes short, the distance segments may blink.)

▶ Multi-information display

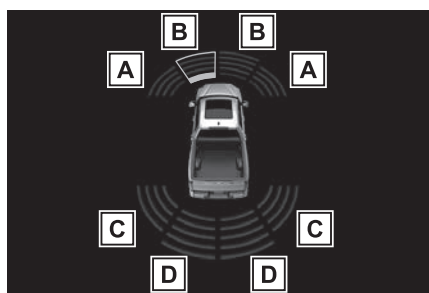

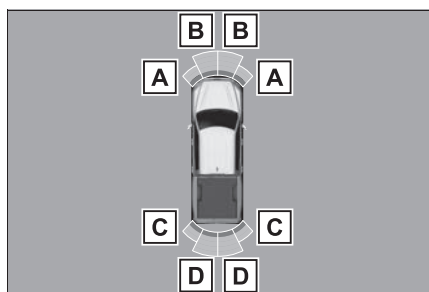

▶ Multimedia display





- A**] Front corner sensor detection
- B**] Front center sensor detection
- C**] Rear corner sensor detection
- D**] Rear center sensor detection

Turning intuitive parking assist on/off

Use the meter control switches to enable/disable the intuitive parking assist. (→P.96)

- 1 Press < or > to select .
- 2 Press ^ or v to select  and then press OK.

When the intuitive parking assist function is disabled, the intuitive parking assist OFF indicator (→P.89) illuminates.

To re-enable the system when it was disabled, select  on the multi-information display, select  and then On. If disabled using this method, the system will not be re-enabled by turning the power switch off and then to ON.

■ When towing a trailer

When the 7-pin connector is connected and Auto Trailer Detection (ATD) (→P.283) is activated, the rear sensor automatically turns off.

WARNING

■ Cautions regarding the use of the system

There is a limit to the degree of recognition accuracy and control performance that this system can provide, do not overly rely on this system. The driver is always responsible for paying attention to the vehicle's surroundings and driving safely.

**WARNING****■ To ensure the system can operate properly**

Observe the following precautions.

Failing to do so may result in the vehicle being unable to be driven safely and possibly cause an accident.

- Do not damage the sensors, and always keep them clean.
- Do not attach a sticker or install an electronic component, such as a backlit license plate (especially fluorescent type), fog lights, fender pole or wireless antenna near a radar sensor.
- Do not subject the surrounding area of the sensor to a strong impact. If subjected to an impact, have the vehicle inspected by your Toyota dealer. If the front or rear bumper needs to be removed/installed or replaced, contact your Toyota dealer.
- Do not modify, disassemble or paint the sensors.
- Do not attach a license plate cover.
- Keep your tires properly inflated.

■ When to disable the function

In the following situations, disable the function as it may operate even though there is no possibility of a collision.

- Failing to observe the warnings above.
- A non-genuine Toyota suspension (lowered suspension, etc.) is installed.

■ Notes when washing the vehicle

Do not apply intensive bursts of water or steam to the sensor area.

Doing so may result in the sensor malfunctioning.

- When using a high pressure washer to wash the vehicle, do not spray the sensors directly, as doing so may cause a sensor to malfunction.
- When using steam to clean the vehicle, do not direct steam too close to the sensors as doing so may cause a sensor to malfunction.

■ The system can be operated when

- The power switch is in ON.
- Intuitive parking assist function is on.
- The vehicle speed is less than about 6 mph (10 km/h).
- A shift position other than P is selected.

■ If “Parking Assist Unavailable Clean Parking Assist Sensor” is displayed on the multi-information display

A sensor may be covered with water drops, ice, snow, dirt, etc. Remove the water drops, ice, snow, dirt, etc., from the sensor to return the system to normal.

Also, due to ice forming on a sensor at low temperatures, a warning message may be displayed or the sensor may not be able to detect an object. Once the ice melts, the system will return to normal.

If a warning message is displayed even if the sensor is clean, there may be a sensor malfunction. Have the vehicle inspected by your Toyota dealer.

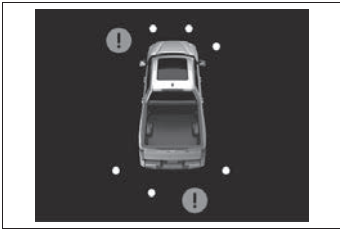

■ If “Parking Assist Unavailable” is displayed on the multi-information display

Water may be continuously flowing over the sensor surface, such as in a heavy rain. When the system determines that it is normal, the system will return to normal.

■ Sensor detection information

- The sensor’s detection areas are limited to the areas around the vehicle’s front and rear bumpers.
- The following situations may occur during use.
 - Depending on the shape of the object and other factors, the detection distance may shorten, or detection may be impossible.
 - Detection may be impossible if static objects draw too close to the sensor.

- There will be a short delay between static object detection and display (warning buzzer sounds). Even at low speeds, there is a possibility that the object will come within 11.9 in. (30 cm) before the display is shown and the warning buzzer sounds.
- It might be difficult to hear the buzzer due to the volume of the audio system or air flow noise of the air conditioning system.
- It may be difficult to hear the sound of this system due to the buzzers of other systems.

■ Objects which the system may not be properly detected

The shape of the object may prevent the sensor from detecting it. Pay particular attention to the following objects:

- Wires, fences, ropes, etc.
- Cotton, snow and other materials that absorb sound waves
- Sharply-angled objects
- Low objects
- Tall objects with upper sections projecting outwards in the direction of your vehicle

■ Situations in which the system may not operate properly

Certain vehicle conditions and the surrounding environment may affect the ability of a sensor to correctly detect objects. Particular instances where this may occur are listed below.

- There is dirt, snow, water drops or ice on a sensor. (Cleaning the sensors will resolve this problem.)
- A sensor is frozen. (Thawing the area will resolve this problem.) In especially cold weather, if a sensor is frozen the sensor display may be displayed abnormally, or objects, such as a wall, may not be detected.

- When a sensor or the area around a sensor is extremely hot or cold.

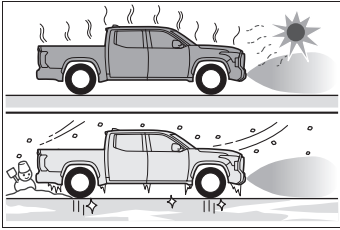

- On an extremely bumpy road, on an incline, on gravel, or on grass.
- When vehicle horns, vehicle detectors, motorcycle engines, air brakes of large vehicles, the clearance sonar of other vehicles or other devices which produce ultrasonic waves are near the vehicle
- A sensor is coated with a sheet of spray or heavy rain.
- If objects draw too close to the sensor.
- When a pedestrian is wearing clothing that does not reflect ultrasonic waves (ex. skirts with gathers or frills).
- When objects that are not perpendicular to the ground, not perpendicular to the vehicle traveling direction, uneven, or waving are in the detection range.
- Strong wind is blowing
- When driving in inclement weather such as fog, snow or a sandstorm
- When an object that cannot be detected is between the vehicle and a detected object
- If an object such as a vehicle, motorcycle, bicycle or pedestrian cuts in front of the vehicle or runs out from the side of the vehicle
- If the orientation of a sensor has been changed due to a collision or other impact
- When equipment that may obstruct a sensor is installed, such as a towing eyelet, bumper protector (an additional trim strip,

etc.), bicycle carrier, or snow plow

- If the front of the vehicle is raised or lowered due to the carried load
- If the vehicle cannot be driven in a stable manner, such as when the vehicle has been in an accident or is malfunctioning
- When a tire chains, compact spare tire or an emergency tire puncture repair kit is used
- When the tailgate is opened

■ Situations in which the system may operate even if there is no possibility of a collision

In some situations, such as the following, the system may operate even though there is no possibility of a collision.

- When driving on a narrow road

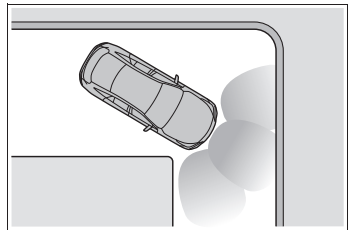

- When driving toward a banner, flag, low-hanging branch or boom barrier (such as those used at railroad crossings, toll gates and parking lots)
- When there is a rut or hole in the surface of the road
- When driving on a metal cover (grating), such as those used for drainage ditches
- When driving up or down a steep slope
- If a sensor is hit by a large amount of water, such as when driving on a flooded road
- There is dirt, snow, water drops or ice on a sensor. (Cleaning the sensors will resolve this problem.)
- A sensor is coated with a sheet of spray or heavy rain

- When driving in inclement weather such as fog, snow or a sandstorm
- When strong winds are blowing

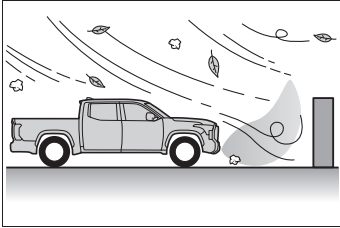

- When vehicle horns, vehicle detectors, motorcycle engines, air brakes of large vehicles, the clearance sonar of other vehicles or other devices which produce ultrasonic waves are near the vehicle
- If the front of the vehicle is raised or lowered due to the carried load
- If the orientation of a sensor has been changed due to a collision or other impact
- The vehicle is approaching a tall or curved curb
- Driving close to columns (H-shaped steel beams, etc.) in multi-story parking garages, construction sites, etc.
- If the vehicle cannot be driven in a stable manner, such as when the vehicle has been in an accident or is malfunctioning
- On an extremely bumpy road, on an incline, on gravel, or on grass

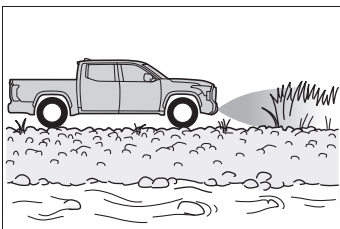

- When a tire chains, compact spare tire or an emergency tire puncture repair kit is used

■ When towing a trailer

Rear sensors turn off when the trailer connection is detected.

When reversing, the rear sensors turn off, but the front corner sensors operate.

■ Certification

→P.643

Sensor detection display, object distance

■ Detection range of the sensors

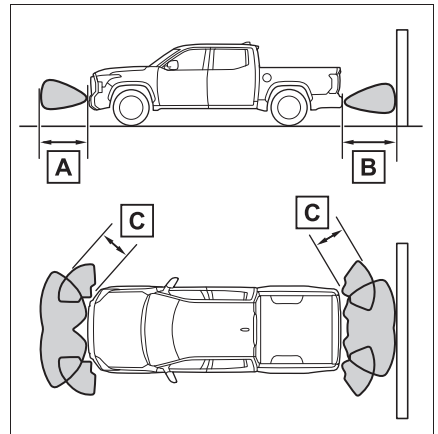

A Approximately 3.3 ft. (100 cm)

B Approximately 4.9 ft. (150 cm)

C Approximately 2.0 ft. (60 cm)

The diagram shows the detection range of the sensors. Note that the sensors cannot detect objects that are extremely close to the vehicle.

The range of the sensors may change depending on the shape of the object, etc.

■ **The distance and buzzer**

Approximate distance to obstacle	Buzzer
Front sensor: 3.3 ft. to 2.0 ft. (100 cm to 60 cm)* Rear sensor: 4.9 ft. to 2.0 ft. (150 cm to 60 cm)*	Slow
2.0 ft. to 1.5 ft. (60 cm to 45 cm)*	Medium
1.5 ft. to 1.0 ft. (45 cm to 30 cm)*	Fast
1.0 ft. to 0.5 ft. (30 cm to 15 cm)	Continuous
Less than 0.5 ft. (15 cm)	

* : Automatic buzzer mute function is enabled. (→P.294)

■ **Buzzer operation and distance to an object**

A buzzer sounds when the sensors are operating.



- The buzzer beeps faster as the vehicle approaches an object.
When the vehicle comes within approximately 1.0 ft. (30 cm) of the object, the buzzer sounds continuously.
- When 2 or more sensors simultaneously detect a static object, the buzzer sounds for the nearest object.
- Even when the sensors are operating, the buzzer will be muted in some situations. (automatic buzzer mute function)

■ **Adjusting the buzzer volume**

The buzzer volume can be

adjusted on the multi-information display.

Use the meter control switches to change settings. (→P.96)

- 1 Press < or > of the meter control switch to select .
- 2 Press ^ or v of the meter control switch to select  and then press and hold OK.
- 3 Select the volume and then press OK.

Each time the switch is pressed, the volume level will change between 1, 2, and 3.

■ Muting a buzzer

A mute button will be displayed on the multi-information display when an object is detected. To mute the buzzer, press **OK**.

The buzzers for the intuitive parking assist and RCTA function (if equipped) will be muted simultaneously.

Mute will be canceled automatically in the following situations:

- When the shift position is changed.
- When the vehicle speed exceeds a certain speed.
- When there is a malfunction in a sensor or the system is temporarily unavailable.
- When the operating function is disabled manually.
- When the power switch is turned off.

RCTA (Rear Cross Traffic Alert)

The RCTA function uses the BSM rear side radar sensors installed behind the rear bumper. This function is intended to assist the driver in checking areas that are not easily visible when backing up.

WARNING

■ Cautions regarding the use of the system

- There is a limit to the degree of recognition accuracy and control performance that this system can provide, do not overly rely on this system. The driver is always responsible for paying attention to the vehicle's surroundings and driving safely. (→P.281)
- When the vehicle is lifted up, except in the following cases.
 - When using a Toyota official lift kit up to 4 in. (101 mm), including tire height. Aftermarket lift kits may degrade system performance.

■ To ensure the system can operate properly

→P.282

System components

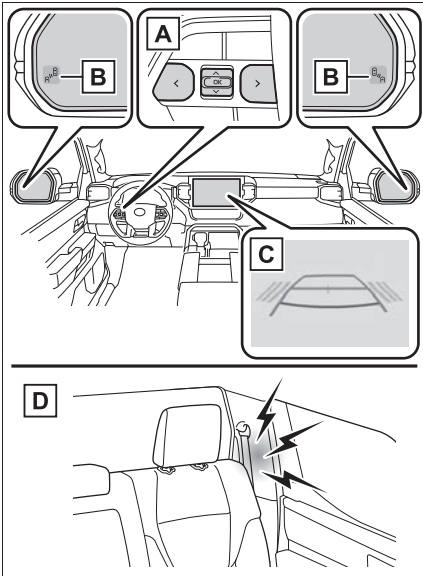

A Meter control switches

Turning the RCTA function on/off.

B Outside rear view mirror indicators

When a vehicle approaching from the right or left at the rear of the vehicle is detected, both outside rear view mirror indicators will flash.

C Multimedia display

If a vehicle approaching from the right or left at the rear of the vehicle is detected, the RCTA icon (→P.297) for the detected side will be displayed on the multimedia display. This illustration shows an example of a vehicle approaching from both sides of the vehicle.

D RCTA buzzer

If a vehicle approaching from the right or left at the rear of the vehicle is detected, a buzzer will sound.

The buzzer also sounds for approximately 1 second immediately after the RCTA function is turned on.

Turning the RCTA function on/off

Use the meter control switches to enable/disable the RCTA function. (→P.96)

- 1 Press < or > to select .
- 2 Press ^ or v to select “RCTA” and then press OK.

When the RCTA function is disabled, the “RCTA OFF” indicator (→P.89) illuminates. (Each time the power switch is turned off then changed to ON, the RCTA function will be enabled automatically.)

■ When towing a trailer

When Auto Trailer Detection (ATD) (→P.283) is activated, the function automatically turns off.

■ Outside rear view mirror indicator visibility

In strong sunlight, the outside rear view mirror indicator may be difficult to see.

■ Hearing the RCTA buzzer

The RCTA buzzer may be difficult to hear over loud noises, such as high audio volume.

■ When “Rear Cross Traffic Alert Unavailable” is shown on the multi-information display

The sensor voltage has become abnormal, or water, snow, mud, etc., may be built up in the vicinity of the sensor area of the rear bumper. (→P.282)

Removing the water, snow, mud, etc., from the vicinity of the sensor

area should return it to normal. Also, the sensor may not function normally when used in extremely hot or cold weather.

■ **When “Rear Cross Traffic Alert Malfunction Visit Your Dealer” is shown on the multi-information display**

There may be a sensor malfunction or misaligned. Have the vehicle inspected at your Toyota dealer.

■ **Radar sensors**

→P.282

RCTA function

■ **Operation of the RCTA function**

The RCTA function uses radar sensors to detect vehicles approaching from the right or left at the rear of the vehicle and alerts the driver of the presence of such vehicles by flashing the outside rear view mirror indicators and sounding a buzzer.

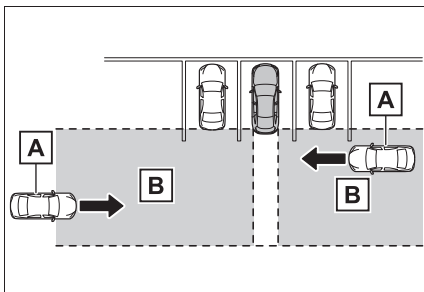

A Approaching vehicles

B Detection areas of approaching vehicles

■ **RCTA icon display**

When a vehicle approaching from the right or left at the rear of the vehicle is detected, the following will be displayed on the multimedia display.

This illustration shows an example of a vehicle approaching from both sides of the vehicle.

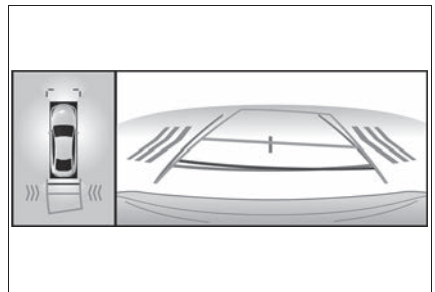

■ **RCTA function detection areas**

The areas that vehicles can be detected in are outlined below.

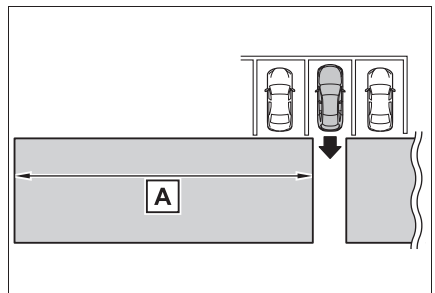

The buzzer can alert for faster vehicles approaching from farther away.

Example:

Approaching vehicle	Speed	Approximate alert distance A
Fast	17 mph (28 km/h)	66 ft. (20 m)
Slow	5 mph (8 km/h)	18 ft. (5.5 m)

■ The RCTA function is operational when

The RCTA function operates when all of the following conditions are met:

- The power switch is in ON.
- The RCTA function is on.
- The shift position is in R.
- The vehicle speed is less than approximately 5 mph (8 km/h).
- The approaching vehicle speed is between approximately 5 mph (8 km/h) and 17 mph (28 km/h).
- The 7-pin connector for Trailer Brake controller is not engaged.

■ Adjusting the buzzer volume

The buzzer volume can be adjusted on the multi-information display.

Use the meter control switches to change settings. (→P.96)

- 1 Press **<** or **>** of the meter control switch to select .
- 2 Press **^** or **v** of the meter control switch to select "RCTA" and then press and hold **OK**.

- 3 Press **OK** to select the volume.

Each time the switch is pressed, the volume level will change between 1, 2, and 3.

■ Muting a buzzer temporarily

A mute button will be displayed on the multi-information display when a vehicles or an object is detected. To mute the buzzer, press **OK**.

The buzzers for the RCTA function and intuitive parking assist will be muted simultaneously.

Mute will be canceled automatically in the following situations:

- When the shift lever is changed.
- When the vehicle speed exceeds a certain speed.
- When there is a malfunction in a sensor or the system is temporarily unavailable.
- When the operating function is disabled manually.
- When the power switch is turned off.

■ Conditions under which the system will not detect a vehicle

The RCTA function is not designed to detect the following types of vehicles and/or objects:

- Vehicles approaching from directly behind
- Vehicles backing up in a parking space next to your vehicle
- Vehicles that the sensors cannot detect due to obstructions

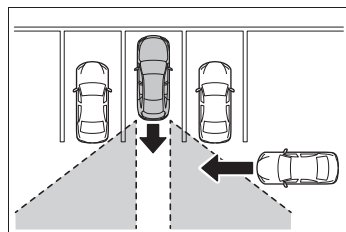

- Guardrails, walls, signs, parked vehicles and similar stationary objects*
- Small motorcycles, bicycles, pedestrians, etc.*
- Vehicles moving away from your vehicle
- Vehicles approaching from the parking spaces next to your vehicle*
- The distance between the sensor and approaching vehicle gets too close

*: Depending on the conditions, detection of a vehicle and/or object may occur.

■ **Situations in which the system may not operate properly**

The RCTA function may not detect vehicles correctly in the following situations:

- When the sensor is misaligned due to a strong impact to the sensor or its surrounding area
- When mud, snow, ice, a sticker, etc., is covering the sensor or surrounding area on the position above the rear bumper
- When driving on a road surface that is wet with standing water during bad weather, such as heavy rain, snow, or fog
- When multiple vehicles are approaching with only a small gap between each vehicle
- When a vehicle is approaching at high speed
- When equipment that may obstruct a sensor is installed, such as a towing eyelet, bumper protector (an additional trim strip, etc.), bicycle carrier, or snow plow

- When backing up on a slope with a sharp change in grade

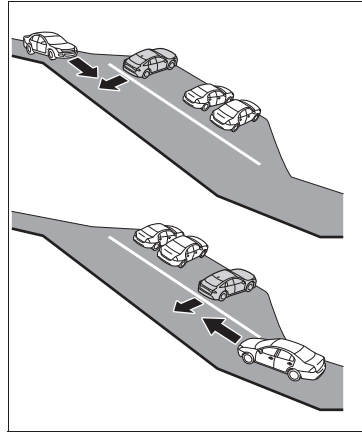

- When backing out of a sharp angle parking spot

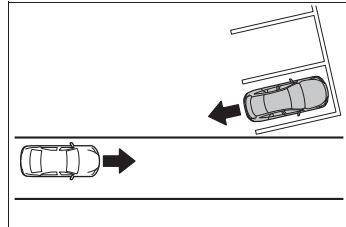

- Immediately after the RCTA function is turned on
- Immediately after the hybrid system is started with the RCTA function on
- When there is a significant difference in height between your vehicle and the vehicle that enters the detection area
- When a sensor or the area around a sensor is extremely hot or cold
- If the suspension has been modified or tires of a size other than specified are installed
- If the front of the vehicle is raised or lowered due to the carried load

- When turning while backing up

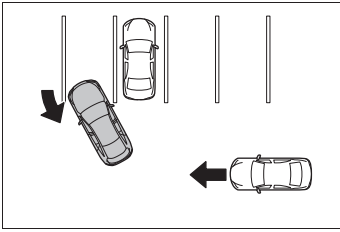

- When a vehicle turns into the detection area

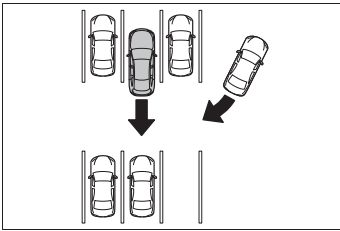

■ Situations in which the system may operate even if there is no possibility of a collision

Instances of the RCTA function unnecessary detecting a vehicle and/or object may increase in the following situations:

- When the parking space faces a street and vehicles are being driven on the street

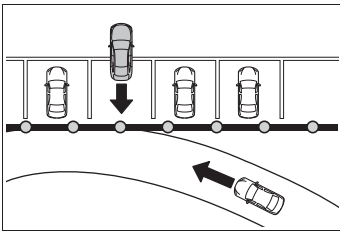

- When the distance between your vehicle and metal objects, such as a guardrail, wall, sign, or parked vehicle, which may reflect electrical waves toward the rear of the vehicle, is short

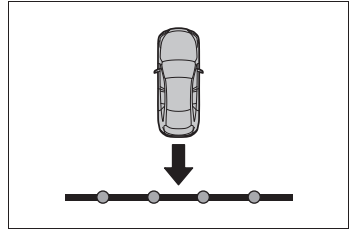

- When equipment that may obstruct a sensor is installed, such as a towing eyelet, bumper protector (an additional trim strip, etc.), bicycle carrier, or snow plow
- When a vehicle passes by the side of your vehicle

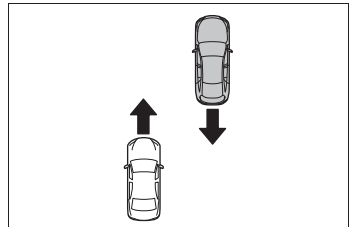

- When a detected vehicle turns while approaching the vehicle

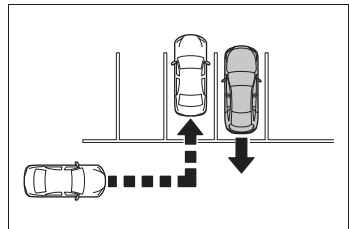

- When there are spinning objects near your vehicle such as the fan of an air conditioning unit
- When water is splashed or sprayed toward the rear bumper, such as from a sprinkler
- Moving objects (flags, exhaust fumes, large rain droplets or snowflakes, rain water on the road)

surface, etc.)

- When the distance between your vehicle and a guardrail, wall, etc., that enters the detection area is short
- Gratings and gutters
- When a sensor or the area around a sensor is extremely hot or cold
- If the suspension has been modified or tires of a size other than specified are installed
- If the front of the vehicle is raised or lowered due to the carried load

PKSB (Parking Support Brake)

The Parking Support Brake system consists of the following functions that operate when driving at a low speed or backing up, such as when parking. When the system determines that the probability of a collision with a detected object or pedestrian is high, a warning operates to urge the driver to take evasive action. If the system determines that the possibility of a collision with a detected object or pedestrian is extremely high, the brakes are automatically applied to help avoid the collision or help reduce the impact of the collision.

PKSB (Parking Support Brake) system

- Parking Support Brake function (static objects)
→P.306
- Parking Support Brake function (rear-crossing vehicles)
→P.309

**WARNING****■ Cautions regarding the use of the system**

Do not overly rely on the system, as doing so may lead to an accident.

Always drive while checking the safety of the surroundings of the vehicle.

Depending on the vehicle and road conditions, weather, etc., the system may not operate.

The detection capabilities of sensors and radars are limited.

Always drive while checking the safety of the surroundings of the vehicle.

- The driver is solely responsible for safe driving. Always drive carefully, taking care to observe your surroundings. The Parking Support Brake system is designed to provide support to lessen the severity of collisions. However, it may not operate in some situations.
- The Parking Support Brake system is not designed to stop the vehicle completely. Additionally, even if the system has stopped the vehicle, it is necessary to depress the brake pedal immediately as brake control will be canceled after approximately 2 seconds.
- It is extremely dangerous to check the system operations by intentionally driving the vehicle into the direction of a wall, etc. Never attempt such actions.

■ When to disable the Parking Support Brake

In the following situations, disable the Parking Support Brake as the system may operate even though there is no possibility of a collision.

- When inspecting the vehicle using a chassis roller, chassis dynamo or free roller
- When loading the vehicle onto a boat, truck or other transport vessel
- If the suspension has been modified or tires of a size other than specified are installed
- If the front of the vehicle is raised or lowered due to the carried load
- When equipment that may obstruct a sensor is installed, such as a towing eyelet, bumper protector (an additional trim strip, etc.), bicycle carrier, or snow plow
- When using automatic car washing devices
- If the vehicle cannot be driven in a stable manner, such as when the vehicle has been in an accident or is malfunctioning
- When the vehicle is driven in a sporty manner or off-road
- When the tires are not properly inflated
- When the tires are very worn
- When a tire chains, compact spare tire or an emergency tire puncture repair kit is used

 NOTICE

■ If “PKSB Unavailable” is displayed on the multi-information display and the PKSB OFF indicator is on

If this message is displayed immediately after the power switch is changed to ON, operate the vehicle carefully, paying attention to your surroundings. It may be necessary to drive the vehicle for a certain amount of time before the system returns to normal. (If the system does not return to normal after driving for a while, clean the sensors and their surrounding area on the bumpers.)

Enabling/Disabling the Parking Support Brake

Press the switch to enable/disable the parking support brake.

All of the Parking Support Brake functions (static objects and rear-crossing vehicles) are enabled/disabled simultaneously.

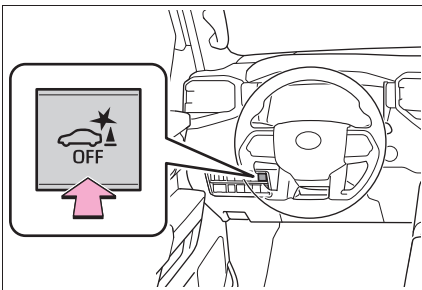

When the Parking Support Brake is disabled, the PKSB OFF indicator (→P.89) illuminates.

To enable the system, press the switch again. If disabled using this method, the system will not be re-

enabled by turning the power switch off and then to ON.

■ When towing a trailer

When the 7-pin connector is connected and Auto Trailer Detection (ATD) (→P.283) is activated, the function automatically turns off.

■ When “4L” mode selected (4WD models)

The parking support brake is automatically disabled.

Display and buzzer for hybrid system output restriction control and brake control

If the hybrid system output restriction control or brake control operates, a buzzer will sound and a message will be displayed on the multi-information display and head-up display (if equipped), multimedia display, to alert the driver.

Depending on the situation, hybrid system output restriction control will operate to either limit acceleration or restrict output as much as possible.

- Hybrid system output restriction control is operating (acceleration restriction)

Acceleration greater than a certain amount is restricted by the system.

Multi-information display: “Object Detected Acceleration Reduced”

Multimedia display and head-up display (if equipped): No warning displayed

PKSB OFF indicator: Not illuminated

Buzzer: Does not sound

- Hybrid system output restriction control is operating (output restricted as much as possible)

The system has determined that stronger-than-normal brake operation is necessary.

Multimedia display: "BRAKE!"

Multi-information display and head-up display (if equipped): "BRAKE!"

PKSB OFF indicator: Not illuminated

Buzzer: Short beep

- Brake control is operating

The system determined that emergency braking is necessary.

Multimedia display: "BRAKE!"

Multi-information display and head-up display (if equipped): "BRAKE!"

PKSB OFF indicator: Not illuminated

Buzzer: Short beep

- Vehicle stopped by system operation

The vehicle has been stopped by brake control operation.

Multimedia display: "Press Brake Pedal"

Multi-information display and head-up display (if equipped): "Switch to Brake" (If the accelerator pedal is not depressed, "Press Brake Pedal" will be displayed.)

PKSB OFF indicator: Illuminated

Buzzer: Short beep

System overview

If the Parking Support Brake determines that a collision with a detected object is possible, the hybrid system output will be restricted to restrain any increase in the vehicle speed. (Hybrid system output restriction control: See figure 2.)

Additionally, if the accelerator pedal continues to be depressed, the brakes will be applied automatically to reduce the vehicle speed. (Brake control: See figure 3.)

- Figure 1 When the PKSB (Parking Support Brake) is not operating

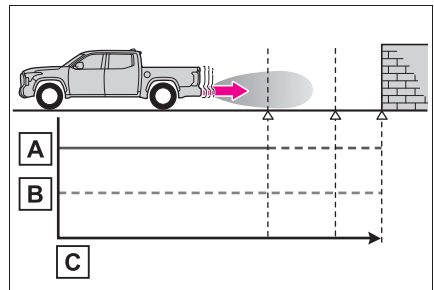

A Hybrid system output

B Braking force

C Time

- Figure 2 When hybrid system output restriction control operates

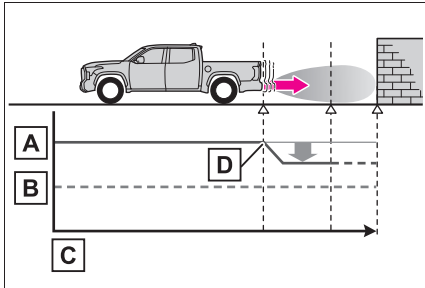

- A** Hybrid system output
- B** Braking force
- C** Time
- D** Hybrid system output restriction control begins operating (System determines that possibility of collision with detected object is high)

- Figure 3 When hybrid system output restriction control and brake control operates

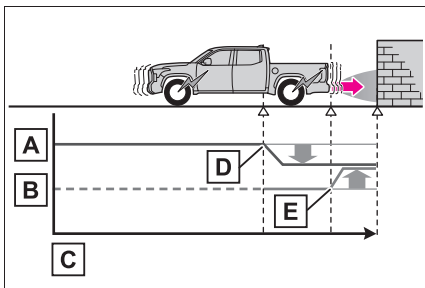

- A** Hybrid system output
- B** Braking force
- C** Time
- D** Hybrid system output restric-

tion control begins operating (System determines that possibility of collision with detected object is high)

- E** Brake control begins operating (System determines that possibility of collision with detected object is extremely high)

■ **If the Parking Support Brake has operated**

If the vehicle is stopped due to operation of the Parking Support Brake, the Parking Support Brake will be disabled and the PKSB OFF indicator will illuminate. If the Parking Support Brake operates unnecessarily, brake control can be canceled by depressing the brake pedal or waiting for approximately 2 seconds for it to automatically be canceled. Then, the vehicle can be operated by depressing the accelerator pedal.

■ **Re-enabling the Parking Support Brake**

To re-enable the Parking Support Brake when it has been disabled due to operation of the Parking Support Brake, either enable the system again (→P.303), or turn the power switch off and then back to ON.

Additionally, if any of the following conditions are met, the system will be re-enabled automatically and the PKSB OFF indicator will turn off:

- The P shift position is selected
- The object is no longer detected in the traveling direction of the vehicle
- The traveling direction of the vehicle changes

- If “PKSB Unavailable” is displayed on the multi-information display and the PKSB OFF indicator is on

If the vehicle is stopped due to operation of the Parking Support Brake, the Parking Support Brake will be disabled and the PKSB OFF indicator will illuminate.

- A sensor may be covered with water drops, ice, snow, dirt, etc. Remove the water drops, ice, snow, dirt, etc., from the sensor to return the system to normal. Also, due to ice forming on a sensor at low temperatures, a warning message may be displayed or the sensor may not be able to detect an object. Once the ice melts, the system will return to normal.
- If this message continues to be displayed even after cleaning the sensor, or is displayed even though the sensor is clean, have the vehicle inspected by your Toyota dealer.
- If a 12-volt battery terminal has been disconnected and reconnected

The system needs to be initialized. To initialize the system, drive the vehicle straight ahead for 5 seconds or more at a speed of approximately 22 mph (35 km/h) or more.

Parking Support Brake function (static objects)

If the sensors detect a static object, such as a wall, in the traveling direction of the vehicle and the system determines that a collision may occur due to the vehicle suddenly moving forward due to an accidental accelerator pedal operation, the vehicle moving the unintended direction due to the wrong shift position being selected, or while parking or traveling at low speeds, the system will operate to lessen the impact with the detected static object and reduce the resulting damage.

Examples of function operation

This function will operate in situations such as the following if an object is detected in the traveling direction of the vehicle.

- When traveling at a low speed and the brake pedal is not depressed, or is depressed late

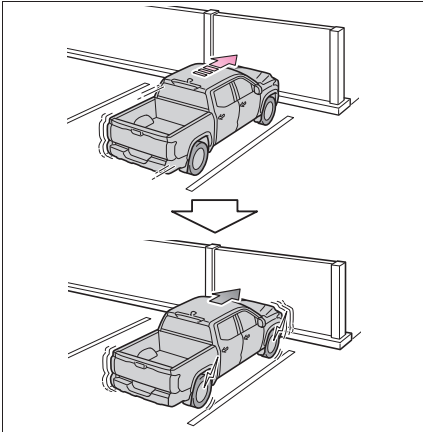

- When the accelerator pedal is depressed excessively

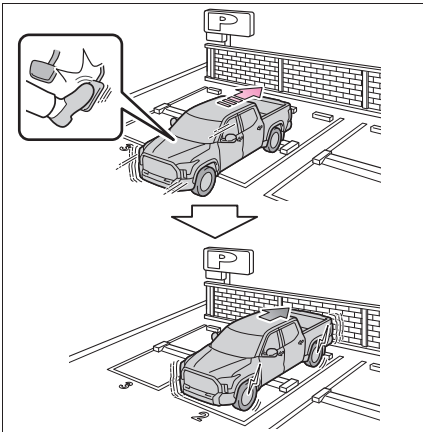

- When the vehicle moves in the unintended direction due to the wrong shift position being selected

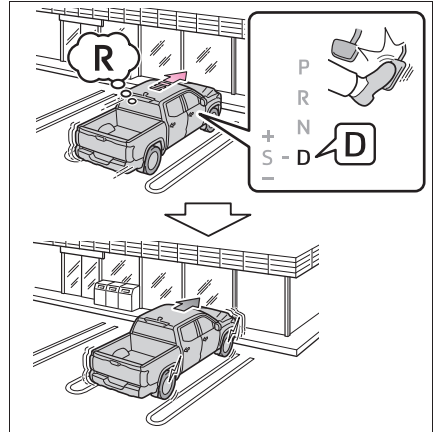

Types of sensors

→P.288

▲ WARNING

- To ensure the system can operate properly

Observe the following precautions.

Failing to do so may result in the vehicle being unable to be driven safely and possibly cause an accident.

- Do not damage the sensors, and always keep them clean.
- Do not attach a sticker or install an electronic component, such as a backlit license plate (especially fluorescent type), fog lights, fender pole or wireless antenna near a radar sensor.

**WARNING**

- Do not subject the surrounding area of the sensor to a strong impact. If subjected to an impact, have the vehicle inspected by your Toyota dealer. If the front or rear bumper needs to be removed/installed or replaced, contact your Toyota dealer.
- Do not modify, disassemble or paint the sensors.
- Do not attach a license plate cover.
- Keep your tires properly inflated.

■ Handling the suspension

Do not modify the suspension, as changes to the height or inclination of the vehicle may prevent the sensors from detecting objects correctly or cause the system to not operate or operate unnecessarily.

■ If the Parking Support Brake function (static objects) operates unnecessarily, such as at a railroad crossing

In the event that the Parking Support Brake function (static objects) operates unnecessarily, such as at a railroad crossing, brake control will be canceled after approximately 2 seconds, allowing you to proceed forward and leave the area, brake control can also be canceled by depressing the brake pedal. Depressing the accelerator pedal after brake control is canceled will allow you to proceed forward and leave the area.

■ Notes when washing the vehicle

Do not apply intensive bursts of water or steam to the sensor area.

Doing so may result in the sensor malfunctioning.

- When using a high pressure washer to wash the vehicle, do not spray the sensors directly, as doing so may cause a sensor to malfunction.
- When using steam to clean the vehicle, do not direct steam too close to the sensors as doing so may cause a sensor to malfunction.

■ The Parking Support Brake function (static object) will operate when

The function will operate when the PKSB OFF indicator is not illuminated or flashing (→P.89, 530) and all of the following conditions are met:

- Hybrid system output restriction control
 - The Parking Support Brake is enabled.
 - The vehicle speed is approximately 9 mph (15 km/h) or less.
 - There is a static object in the traveling direction of the vehicle and approximately 6 to 13 ft. (2 to 4 m) away.
 - The Parking Support Brake determines that a stronger-than-normal brake operation is necessary to avoid a collision.
- Brake control
 - Hybrid system output restriction control is operating.
 - The Parking Support Brake determines that an immediate brake operation is necessary to avoid a collision.

■ The Parking Support Brake function (static objects) will stop operating when

The function will stop operating if any of the following conditions are met:

- Hybrid system output restriction control
- The Parking Support Brake is disabled.
- The system determines that the collision has become avoidable with normal brake operation.
- The static object is no longer approximately 6 to 13 ft. (2 to 4 m) away from the vehicle or in the traveling direction of the vehicle.
- Brake control
- The Parking Support Brake is disabled.
- Approximately 2 seconds have elapsed since the vehicle was stopped by brake control.
- The brake pedal is depressed after the vehicle is stopped by brake control.
- The static object is no longer approximately 6 to 13 ft. (2 to 4 m) away from the vehicle or in the traveling direction of the vehicle.

■ Detection range of the Parking Support Brake function (static objects)

The detection range of the Parking Support Brake function (static objects) differs from the detection range of the intuitive parking assist. (→P.293) Therefore, even if the intuitive parking assist detects an object and provides a warning, the Parking Support Brake function (static objects) may not start operating.

■ Situations in which the system may not operate properly

→P.291

■ Situations in which the system may operate even if there is no possibility of a collision

→P.292

Parking Support Brake function (rear-crossing vehicles)

If a rear radar sensor detects a vehicle approaching from the right or left at the rear of the vehicle and the system determines that the possibility of a collision is high, this function will perform brake control to reduce the likelihood of an impact with the approaching vehicle.

Examples of function operation

This function will operate in situations such as the following if a vehicle is detected in the traveling direction of the vehicle.

- **When reversing, a vehicle is approaching and the brake pedal is not depressed, or is depressed late**

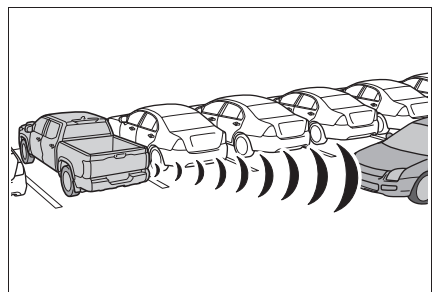

Types of sensors

→P.282

**WARNING**
■ To ensure the system can operate properly

Observe the following precautions regarding the rear radar sensors (→P.282). Failure to do so may cause a sensor to not operate properly, and may cause an accident.

- Do not modify, disassemble or paint the sensors.
- Do not replace a rear radar sensor with a part other than a genuine part.
- Do not damage the rear radar sensors, and always keep the radar sensors and their surrounding area on the bumper clean.
- If the area around a rear radar sensor is subjected to an impact, the system may not operate properly due to a sensor malfunction. Have the vehicle inspected by your Toyota dealer.
- Observe the rear radar sensor handling precautions. (→P.282)

■ The Parking Support Brake function (rear-crossing vehicles) will operate when

The function will operate when the PKSB OFF indicator is not illuminated or flashing (→P.89, 530) and all of the following conditions are met:

- Hybrid system output restriction control
- The Parking Support Brake is enabled.
- The vehicle speed is approximately 9 mph (15 km/h) or less.
- Vehicles are approaching from the right or left at the rear of the vehicle at a traveling speed of approx-

- imately 5 mph (8 km/h) or more.
- The shift position is in R.
- The Parking Support Brake determines that a stronger than normal brake operation is necessary to avoid a collision with an approaching vehicle.
- Brake control
- Hybrid system output restriction control is operating.
- The Parking Support Brake determines that an emergency brake operation is necessary to avoid a collision with an approaching vehicle.

■ The Parking Support Brake function (rear-crossing vehicles) will stop operating when

The function will stop operating if any of the following conditions are met:

- Hybrid system output restriction control
- The Parking Support Brake is disabled.
- The collision becomes avoidable with normal brake operation.
- A vehicle is no longer approaching from the right or left at the rear of the vehicle.
- Brake control
- The Parking Support Brake is disabled.
- Approximately 2 seconds have elapsed since the vehicle was stopped by brake control.
- The brake pedal is depressed after the vehicle is stopped by brake control.
- A vehicle is no longer approaching from the right or left at the rear of the vehicle.

■ Detection area of the Parking Support Brake function (rear-crossing vehicles)

The detection area of the Parking Support Brake function (rear-crossing vehicles) differs from the detection area of the RCTA function (→P.297). Therefore, even if the RCTA function detects a vehicle and

provides an alert, the Parking Support Brake function (rear-crossing vehicles) may not start operating.

■ **Situations in which the system may not operate properly**

→P.299

■ **Situations in which the system may operate even if there is no possibility of a collision**

→P.300

Toyota parking assist monitor*

*: If equipped

The parking assist monitor assists the driver by displaying an image of the view behind the vehicle while backing up, for example while parking.

When the display is changed to the wide rear view mode, a wider lateral view behind the vehicle will be displayed.

The screen illustrations used in this text are intended as examples, and may differ from the image that is actually displayed on the screen.

Driving precautions

The parking assist monitor is a supplemental device intended to assist the driver when backing up. When backing up, be sure to visually check all around the vehicle both directly and using the mirrors before proceeding. If you do not, you may hit another vehicle, and could possibly cause an accident.

Pay attention to the following precautions when using the parking assist monitor.

**WARNING**

- Never depend on the parking assist monitor entirely when backing up. The image and the position of the guide lines displayed on the screen may differ from the actual state. Use caution, just as you would when backing up any vehicle.
- Be sure to back up slowly, depressing the brake pedal to control vehicle speed.
- If you seem likely to hit nearby vehicles, obstacles, people or mount the shoulder, depress the brake pedal to stop the vehicle.
- The instructions given are only guidelines. When and how much to turn the steering wheel will vary according to traffic conditions, road surface conditions, vehicle condition, etc., when parking. It is necessary to be fully aware of this before using the parking assist system.
- When parking, be sure to check that the parking space will accommodate your vehicle before maneuvering into it.
- Do not use the parking assist monitor in the following cases:
 - On icy or slick road surfaces, or in snow
 - When using tire chains or emergency tires
 - When the tailgate is not closed completely
 - On roads that are not flat or straight, such as curves or slopes
 - If the suspension has been modified or tires of a size other than specified are installed
- In low temperatures, the screen may darken or the image may become faint. The image could distort when the vehicle is moving, or you may become unable to see the image on the screen. Be sure to visually check all around the vehicle both directly and using the mirrors before proceeding.
- If the tire sizes are changed, the position of the guide lines displayed on the screen may change.
- The camera uses a special lens. The distances between objects and pedestrians that appear in the image displayed on the screen will differ from the actual distances. (→P.319)

Screen display

The parking assist monitor screen will be displayed if the shift lever is shifted to R while the power switch is in ON.

Each time the display mode switching button is selected, the mode will change as follows:

Rear view: Displays the rear view of the vehicle.

Wide rear view: Displays a near 180° image from the rear view camera.

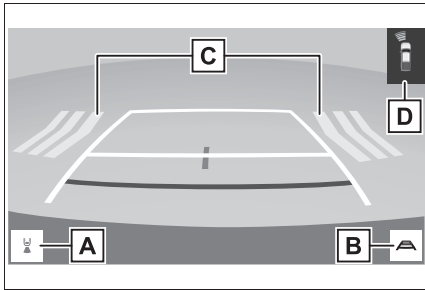

A Display mode switching button

Each time the button is selected, the rear view mode and the wide rear view mode are switched.

B Guide line switching button

Select to switch the guide line mode. (→P.314)

- Each time the button is selected, the display mode changes in the following order:

Estimated course line display mode
 → Parking assist guide line display mode
 → Distance guide line display mode
 → Center guide line display mode.

C Rear Cross Traffic Alert*

When a sensor detects a vehicle approaching from the rear, the direction of the vehicle approaching from the rear is displayed and the buzzer sounds.

D Intuitive parking assist*

When a sensor detects a stationary object, the direction of and the approximate distance to the a stationary object are displayed and the buzzer sounds.

*: If equipped

For details about the Rear Cross Traffic Alert function (→P.295) and intuitive parking assist. (→P.288)

! WARNING

As the Rear Cross Traffic Alert display is displayed over the camera view, it may be difficult to see the Rear Cross Traffic Alert display depending on the color and brightness of the surrounding area.

Canceling Toyota parking assist monitor

The parking assist monitor is canceled when the shift lever is shifted into any position other than R.

Using the system

Use any of the following modes.

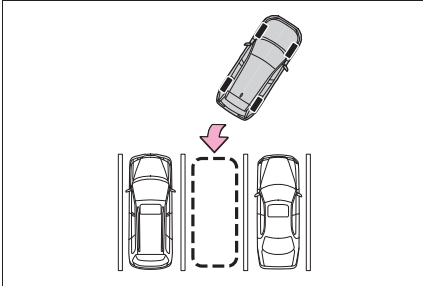

- ▶ Estimated course line display mode (→P.315)

Estimated course lines are displayed which move in accordance with the operation of the steering wheel.

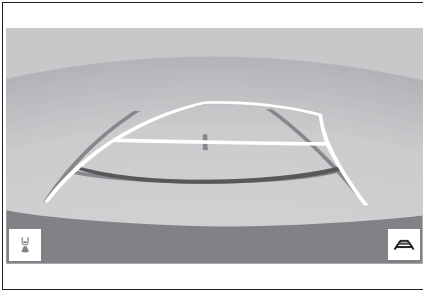

- ▶ Parking assist guide line display mode (→P.316)

The steering wheel return points (parking assist guide lines) are displayed.

This mode is recommended for those who are comfortable with parking the vehicle without the aid of the estimated course lines.

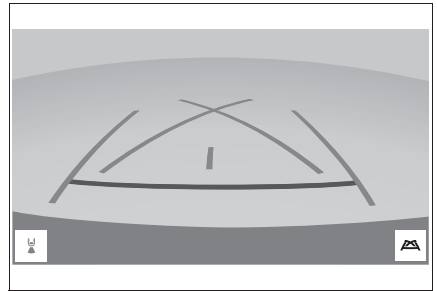

- ▶ Distance guide line display mode (→P.316)

Distance guide lines only are displayed.

This mode is recommended for those who are comfortable with parking the vehicle without the aid of the guide lines.

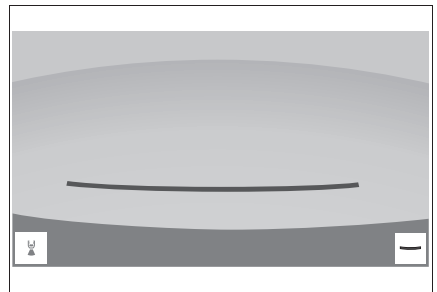

▶ Center guide line display mode (→P.316)

Estimated course lines and vehicle center line are displayed which move in accordance with the operation of the steering wheel.

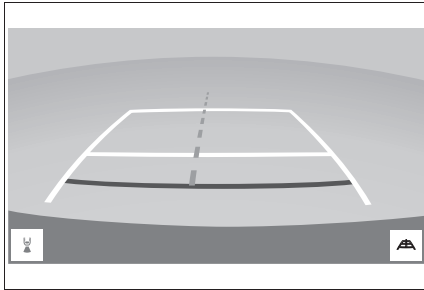

Estimated course line display mode

Screen description

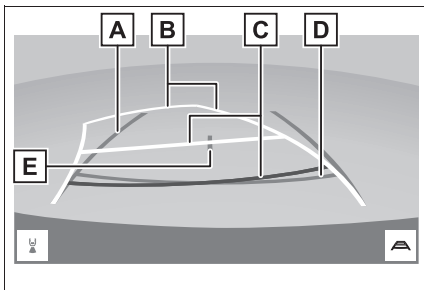

A Vehicle width guide line

Displays a guide path when the vehicle is being backed straight up.

B Estimated course lines

Show an estimated course when the steering wheel is turned.

C Distance guide lines

Show distance behind the vehicle when the steering wheel is turned.

- The guide lines move in conjunction with the estimated course lines.
- The guide lines display points approximately 1.5 ft. (0.5 m) (red) and approximately 3 ft. (1 m) (yellow) from the center of the edge of the bumper.

D Distance guide line

Shows distance behind the vehicle.

- Displays a point approximately 1.5 ft. (0.5 m) (blue) from the edge of the bumper.

E Vehicle center guide line

Indicates the estimated vehicle center on the ground.

! WARNING

If the steering wheel is straight and the vehicle width guide lines and the estimated course lines are not in alignment, have the vehicle inspected by your Toyota dealer.

Parking assist guide line display mode

Screen description

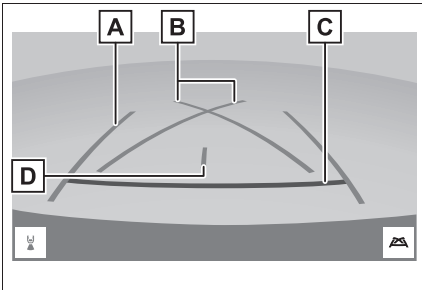

A Vehicle width guide line

Displays a guide path when the vehicle is being backed straight up.

- The displayed width is wider than the actual vehicle width.

B Parking assist guide lines

Show the path of the smallest turn possible behind the vehicle.

C Distance guide line

Shows distance behind the vehicle.

- Displays points approximately 1.5 ft. (0.5 m) (red) from the edge of the bumper.

D Vehicle center guide line

Indicates the estimated vehicle center on the ground.

Distance guide line display mode

Screen description

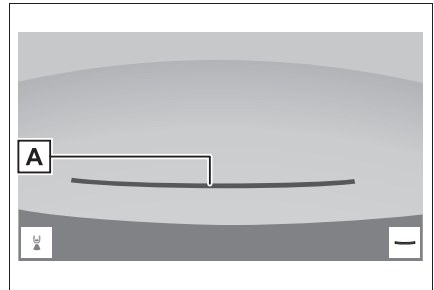

A Distance guide line

Shows distance behind the vehicle.

- Displays points approximately 1.5 ft. (0.5 m) (red) from the edge of the bumper.

Center guide line display mode

Screen description

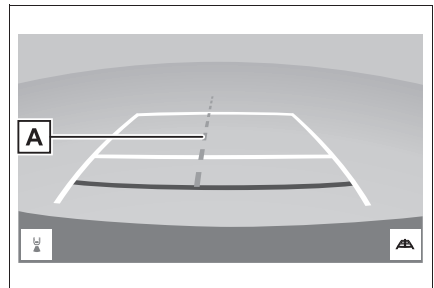

A Center guide line

Indicates the estimated vehicle center.

Toyota parking assist monitor precautions

Area displayed on screen

The parking assist monitor displays an image of the view from the bumper of the rear area of the vehicle.

► Rear view

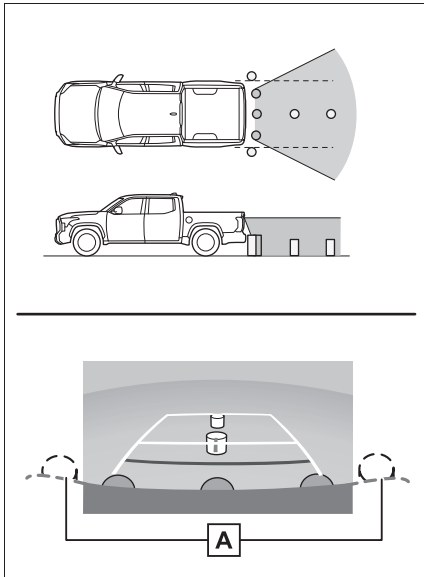

A Corners of bumper

- The area around both corners of the bumper will not be displayed.
- Wide rear view

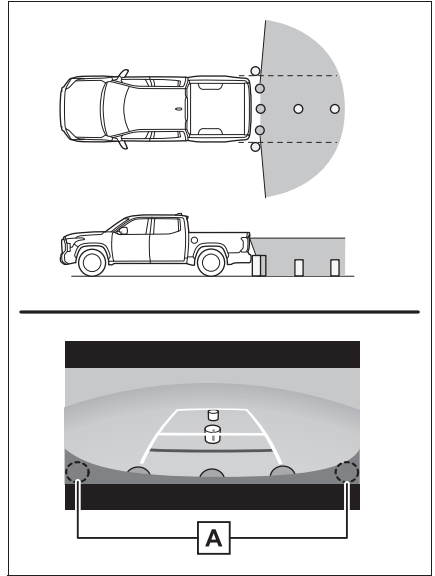

A Corners of bumper

- The area around both corners of the bumper will not be displayed.
- The image adjustment procedure for the parking assist monitor screen is the same as the procedure for adjusting the screen display. (Refer to the "MULTIMEDIA OWNER'S MANUAL".)
- The area displayed on the screen may vary according to vehicle orientation conditions.
- Objects which are close to either corner of the bumper or under the bumper cannot be displayed.
- The camera uses a special lens. The distance of the image that appears on the screen differs from the actual distance.
- Items which are located higher than the camera may not be displayed on the monitor.

The camera

The camera for the parking assist monitor is located as shown in the illustration.

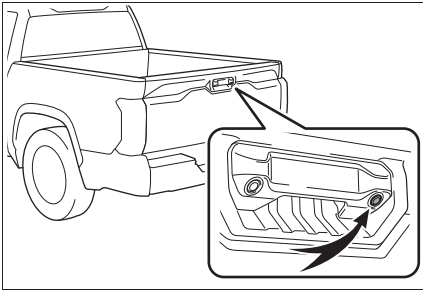

Using the camera

If dirt or foreign matter (such as water droplets, snow, mud, etc.) is adhering to the camera, it cannot transmit a clear image. In this case, flush it with a large quantity of water and wipe the camera lens clean with a soft and wet cloth.



NOTICE

- The parking assist monitor may not operate properly in the following cases.
- If the back of the vehicle is hit, the position and mounting angle of the camera may change.

- As the camera has a water proof construction, do not detach, disassemble or modify it. This may cause incorrect operation.
- When cleaning the camera lens, flush the camera with a large quantity of water and wipe it with a soft and wet cloth. Strongly rubbing the camera lens may cause the camera lens to be scratched and unable to transmit a clear image.
- Do not allow organic solvent, car wax, window cleaner or a glass coating to adhere to the camera. If this happens, wipe it off as soon as possible.
- If the temperature changes rapidly, such as when hot water is poured on the vehicle in cold weather, the system may not operate normally.
- When washing the vehicle, do not apply intensive bursts of water to the camera or camera area. Doing so may result in the camera malfunctioning.
- Do not expose the camera to strong impact as this could cause a malfunction. If this happens, have the vehicle inspected by your Toyota dealer as soon as possible.

Differences between the screen and the actual road

- The distance guide lines and the vehicle width guide lines may not actually be parallel with the dividing lines of the parking space, even when they appear to be so. Be sure to check visually.
- The distances between the vehicle width guide lines and the left and right dividing lines of the parking space may not be equal, even when they appear to be so. Be sure to check visually.
- The distance guide lines give a distance guide for flat road surfaces. In any of the following situations, there is a margin of error between the guide lines on the screen and the actual distance/course on the road.

■ When the ground behind the vehicle slopes up sharply

The distance guidelines are projected on a horizontal surface, distances on an upward sloping surface appear farther from the vehicle than the actual distance. Because of this, objects will appear to be farther away than they actually are. In the same way, there will be a margin of error between the guidelines and the actual distance/course on the road.

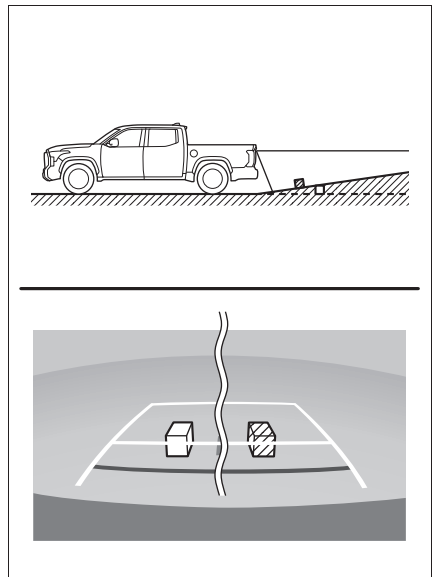

■ When the ground behind the vehicle slopes down sharply

The distance guidelines are projected on a horizontal surface, distances on an downward sloping surface appear closer to the vehicle than the actual distance. Because of this, objects will appear to be closer than they actually are. In the same way, there will be a margin of error between the guidelines and the actual distance/course on the road.

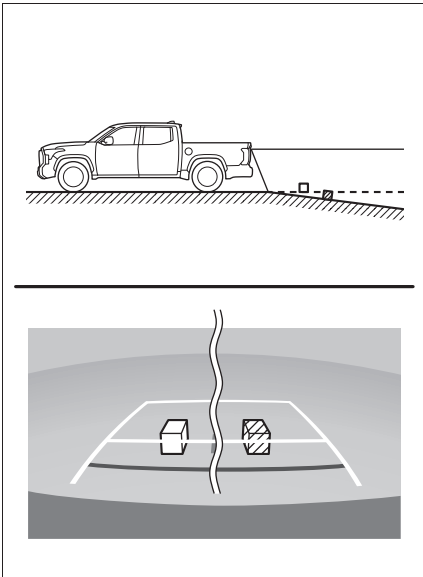

■ When any part of the vehicle sags

When the vehicle posture tilts due to the number of passengers or the distribution of the load, there is a margin of error between the guide lines on the screen and the actual distance/course on the road.

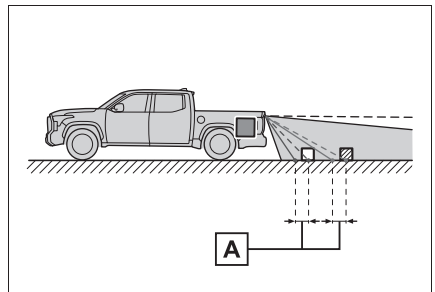

A A margin of error

When approaching three-dimensional objects

The estimated course lines target flat surfaced objects (such as the road). It is not possible to determine the position of three-dimensional objects (such as vehicles) using the estimated course lines and distance guide lines. When approaching a three-dimensional object that extends outward (such as the flatbed of a truck), be careful of the following.

Estimated course lines

Visually check the surroundings and the area behind the vehicle. In the case shown below, the truck appears to be outside of the estimated course lines and the vehicle does not look as if it hits the truck. However, the rear body of the truck may actually cross over the estimated course lines. In reality if you back up as guided by the estimated course lines, the vehicle may hit the truck.

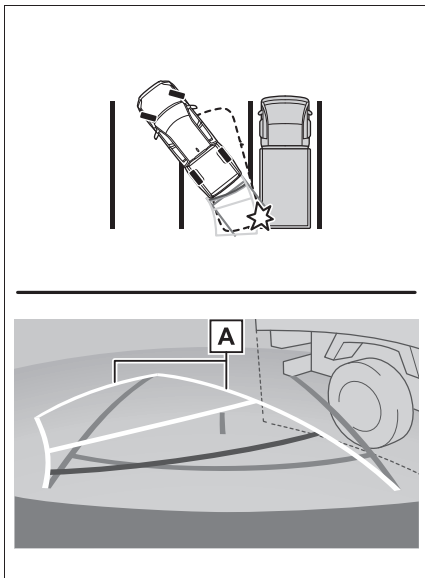

A Estimated course lines

Distance guide lines

Visually check the surroundings and the area behind the vehicle. On the screen, it appears that a truck is parking at point **B**.

However, in reality if you back up to point **A**, you will hit the truck. On the screen, it appears that **A** is closest and **C** is farthest away. However, in reality, the distance to **A** and **C** is the same, and **B** is farther than **A** and **C**.

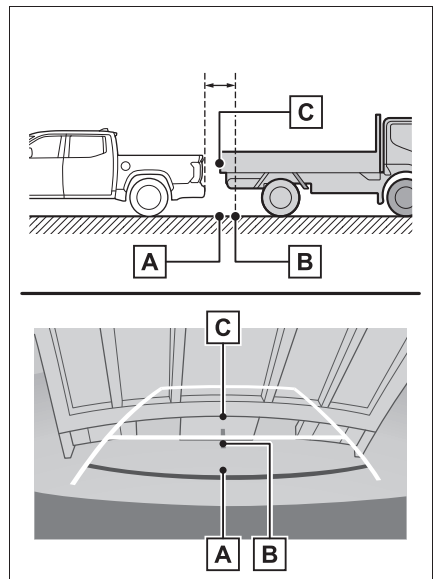

Things you should know

If you notice any symptoms

If you notice any of the following symptoms, refer to the likely cause and the solution, and re-check.

If the symptom is not resolved by the solution, have the vehicle inspected by your Toyota dealer.

Symptom	Likely cause	Solution
The image is difficult to see	<ul style="list-style-type: none"> • The vehicle is in a dark area • The temperature around the lens is either high or low • The outside temperature is low • There are water droplets on the camera • It is raining or humid • Foreign matter (mud, etc.) is adhering to the camera • Sunlight or headlights are shining directly into the camera • The vehicle is under fluorescent lights, sodium lights, mercury lights, etc. 	<p>Back up while visually checking the vehicle's surroundings. (Use the monitor again once conditions have been improved.)</p> <p>The procedure for adjusting the picture quality of the parking assist monitor is the same as the procedure for adjusting the screen display. (Refer to the "MULTIMEDIA OWNER'S MANUAL".)</p>
The image is blurry	Dirt or foreign matter (such as water droplets, snow, mud, etc.) is adhering to the camera.	Flush the camera with a large quantity of water and wipe the camera lens clean with a soft and wet cloth.
The image is out of alignment	The camera or surrounding area has received a strong impact.	Have the vehicle inspected by your Toyota dealer.

Symptom	Likely cause	Solution
The guide lines are very far out of alignment	The camera position is out of alignment.	Have the vehicle inspected by your Toyota dealer.
	<ul style="list-style-type: none"> • The vehicle is tilted (there is a heavy load on the vehicle, tire pressure is low due to a tire puncture, etc.) • The vehicle is used on an incline. 	<p>If this happens due to these causes, it does not indicate a malfunction.</p> <p>Back up while visually checking the vehicle's surroundings.</p>
The estimated course lines move even though the steering wheel is straight	There is a malfunction in the signals being output by the steering sensor.	Have the vehicle inspected by your Toyota dealer.
Guide lines are not displayed	The tailgate is open.	<p>Close the tailgate.</p> <p>If this does not resolve the symptom, have the vehicle inspected by your Toyota dealer.</p>
 is displayed	<ul style="list-style-type: none"> • 12-volt battery has been reinstalled. • The steering wheel has been moved while the 12-volt battery was being reinstalled. • 12-volt battery power is low. • The steering sensor has been reinstalled. • There is a malfunction in the signals being output by the steering sensor. 	<p>Stop the vehicle, and turn the steering wheel as far as it will go to the left and right.</p> <p>If this does not resolve the symptom, have the vehicle inspected by your Toyota dealer.</p>

Panoramic view monitor^{*}

*: If equipped

Panoramic view monitor assists the driver in viewing the surroundings, when operating at low speeds, by combining the front, side and rear cameras and displaying a complete vehicle overhead image on the screen.

When you press the camera switch or shift the shift lever to R while the power switch is in ON, the panoramic view monitor operates.

The monitor displays various views of the position and surroundings of the vehicle.

The screen illustrations used in this text are intended as examples, and may differ from the image that is actually displayed on the screen.

Driving precautions

The panoramic view monitor is a supplemental device intended to assist the driver when checking around the vehicle. When using, be sure to visually check all around the vehicle both directly and using the mirrors before proceeding. If you do not, you may hit another vehicle or possi-

bly cause an accident.

Pay attention to the following precautions when using the panoramic view monitor.

WARNING

- Never depend on the panoramic view monitor entirely. The image and the position of the guide lines displayed on the screen may differ from the actual state. Use caution just as you would when driving any other vehicle.
- Always make sure to check all around the vehicle with your own eyes when driving.
- Never drive while looking only at the screen as the image on the screen is different from actual conditions. If you are driving while looking only at the screen, you may hit a person or an object, resulting in an accident. When driving, be sure to check the vehicle's surroundings with your own eyes and the vehicle's mirrors.
- Depending on the circumstances of the vehicle (number of passengers, amount of luggage, etc.), the position of the guide lines displayed on the screen may change. Be sure to check visually around the vehicle before proceeding.
- Do not use the panoramic view monitor system in the following cases:
 - On icy or slick road surfaces, or in snow
 - When using tire chains or emergency tires
 - When the front door or the tail-gate is not closed completely

**WARNING**

- On roads that are not flat or straight, such as curves or slopes
- If the suspension has been modified or tires of a size other than specified are installed
- In low temperatures, the screen may darken or the image may become faint. The image could distort when the vehicle is moving, or you may become unable to see the image on the screen. Be sure to visually check all around the vehicle both directly and using the mirrors before proceeding.
- If the tire sizes are changed, the position of the guide lines displayed on the screen may change.
- The camera uses a special lens. The distances between objects and pedestrians that appear in the image displayed on the screen will differ from the actual distances. (→P.353)
- When an aftermarket part is installed in the display area of the screen.

**NOTICE**

- In panoramic view/moving view/see-through view, the system combines images taken from the front, back, left and right side cameras into a single image. There are limits to the range and content that can be displayed. Familiarize yourself with the characteristics of the panoramic view monitor system before using it.

- Image clarity may decline at the four corners of the panoramic view/moving view/see-through view. However, this is not a malfunction, as these are the regions along the border of each camera image where the images are combined.
- Depending on lighting conditions near each of the cameras, bright and dark patches may appear on the panoramic view/moving view/see-through view.
- The panoramic view/moving view/see-through view display does not extend higher than the installation position and image capture range of each camera.
- There are blind spots around the vehicle. Accordingly, there are regions not displayed in panoramic view.
- Three-dimensional objects displayed in wide front view, rear view or side view may not be displayed in panoramic view/moving view/see-through view.
- People and other three-dimensional obstacles may appear differently when displayed on the panoramic view monitor. (These differences include, among others, cases in which displayed objects appear to have fallen over, disappear near image processing areas, appear from image processing areas, or when the actual distance to an object differs from the displayed position.)

**NOTICE**

- When the tailgate, which is equipped with the back camera, or front doors, which are equipped with door mirrors that have built-in side cameras, are open, images will not be displayed properly on the panoramic view monitor.
- The vehicle icon displayed in panoramic view/moving view/see-through view is a computer generated image. Accordingly, properties such as the color, shape and size will differ from the actual vehicle. For this reason, nearby three-dimensional objects may appear to be touching the vehicle, and actual distances to three-dimensional objects may differ from those displayed.

Camera switch

The camera switch is located as shown in the illustration.

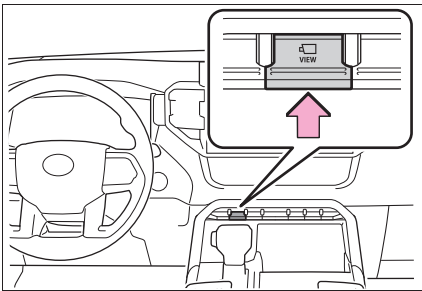

Menu button

The screens which are displayed from the following buttons can be selected. Also, the display can be changed to various screens from button combinations.

The button display changes due to the situation of the vehicle, such as the screen and speed being displayed, shift position, vehicle equipment, etc.

The menu button is displayed when the shift lever is in D, N, or R.

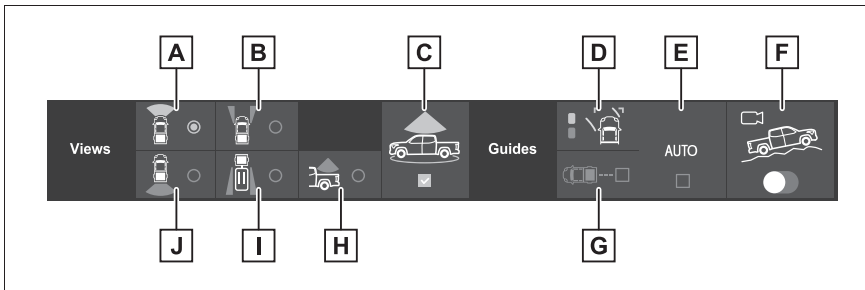

- A** Front view button
- B** Front split view button
- C** Panoramic view on/off button
- D** Guide line select button (→P.334, 339)
- E** Auto mode on/off button (→P.336)
- F** Multi-terrain Monitor on/off button (→P.361)
- G** Center guide line on/off button (→P.339)
- H** Bed view button (→P.346)
- I** Rear split view button
- J** Rear view button

Display

Checking around the vehicle

When the shift lever is in P.

▶ Moving view

Press .

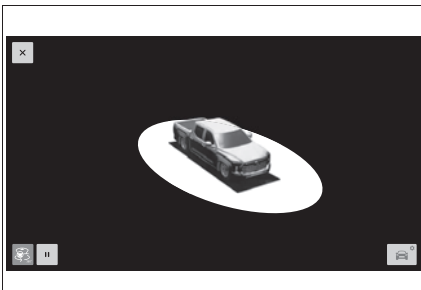

▶ See-through view

Press .

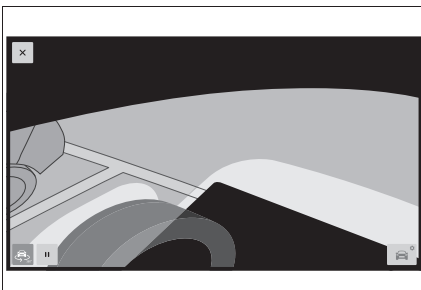

Checking the front and around the vehicle

When the shift lever is in a position other than P.

▶ Panoramic view & front view

Select the front view button and then turn ON the panoramic view button.

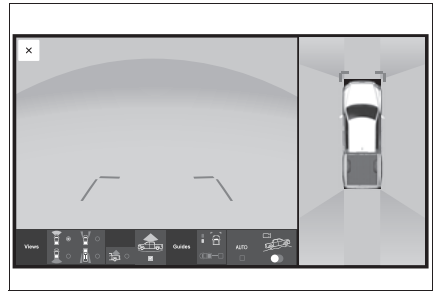

▶ Wide front view

Select the front view button and then turn OFF the panoramic view button.

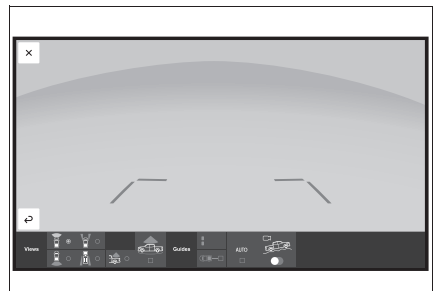

▶ Front split view

Select the front split view button.

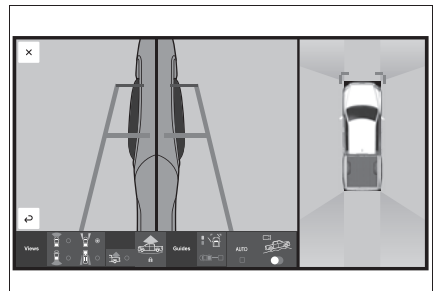

Checking the rear and around the vehicle

When the shift lever is in a position other than P.

► Panoramic view & rear view

Select the rear view button and then turn ON the panoramic view button.

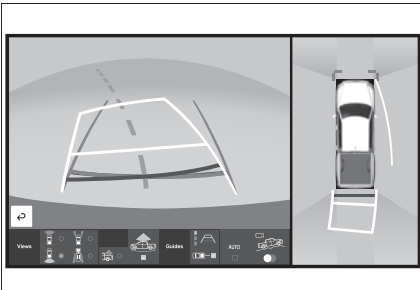

► Wide rear view

Select the rear view button and then turn OFF the panoramic view button.

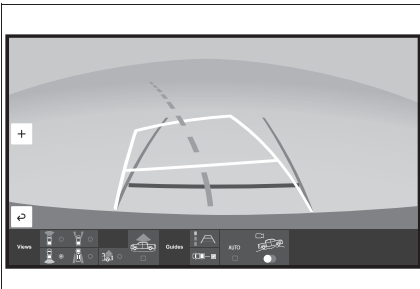

► Rear split view

Select the rear split view button.

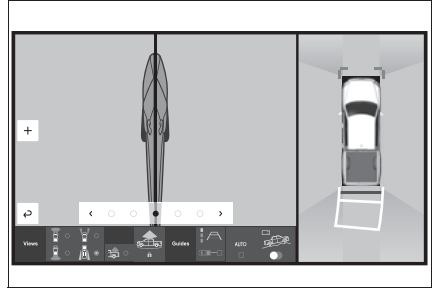

Checking the bed

Select the bed view button.

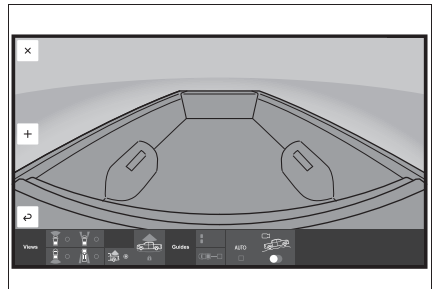

Checking around the vehicle

The moving view screen and the see-through view screen provide support when checking the areas of around the vehicle while parking. These screens display an image of the vicinity of the vehicle combined from the 4 cameras. The screen will display a 360° view around the vehicle from either inside the vehicle or from a birds-eye view at an angle.

To display the moving view/see-

330 4-5. Using the driving support systems

through view screen, press  when the shift lever is in P and the intuitive parking assist is enabled.

Screen display

► Moving view



► See-through view

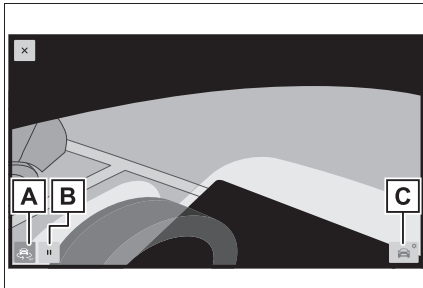

A Display mode switching button

Select to change the display mode between the moving view and the see-through view.

B Rotation pause switch



Select to pause the rotation of the screen.

To resume rotation, select .

C Body color setting switch

Select to display the body color set-

ting screen and change the color of the vehicle displayed on the panoramic view monitor. (→P.347)

Pressing  on the screen or  again changes the screen back to the previously displayed screen, such as the navigation screen.

Checking the front and around the vehicle

The panoramic view & front view/wide front view/front split view screen provides support when checking the areas in front of the vehicle and around the vehicle when taking-off at T-intersections or other intersections during poor visibility.

To display the screen, press  when the shift lever is in D or N with the vehicle moving approximately 10 mph (16 km/h) or less.

This screen will be displayed if the intuitive parking assist detects an object in front of your vehicle (intuitive parking assist linked display).

Screen display

Each time the display mode switching button is selected, the mode will change as follows:

► Panoramic view & front view

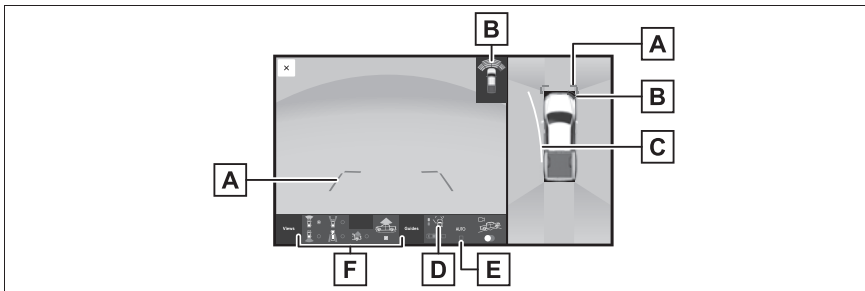

A Distance guide lines

Shows distance in front of the vehicle.

- Display points approximately 3 ft. (1 m) from the edge of the bumper.

B Intuitive parking assist

When a sensor detects an obstacle, the direction of and the approximate distance to the obstacle are displayed and the buzzer sounds.

C Estimated course lines

Shows an estimated course when the steering wheel is turned.

- This line will be displayed when the steering wheel is turned by 90° or more from the center (straight-line) position.

D Guide line switching button

Select to change the guide line mode between the distance guide line mode and the estimated course line mode. (→P.334)

332 4-5. Using the driving support systems

E Automatic display button

Select to turn automatic display mode on/off. (→P.336)

F Display mode switching buttons

The display can be changed to various screens from button combinations.

▶ Wide front view

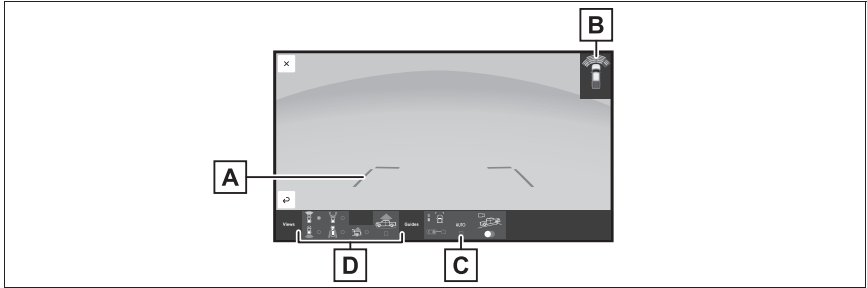

A Distance guide lines

Shows distance in front of the vehicle.

- Display points approximately 3 ft. (1 m) from the edge of the bumper.

B Intuitive parking assist

When a sensor detects an obstacle, the direction of and the approximate distance to the obstacle are displayed and the buzzer sounds.

C Automatic display button

Select to turn automatic display mode on/off. (→P.336)

D Display mode switching buttons

The display can be changed to various screens from button combinations.

▶ Front split view

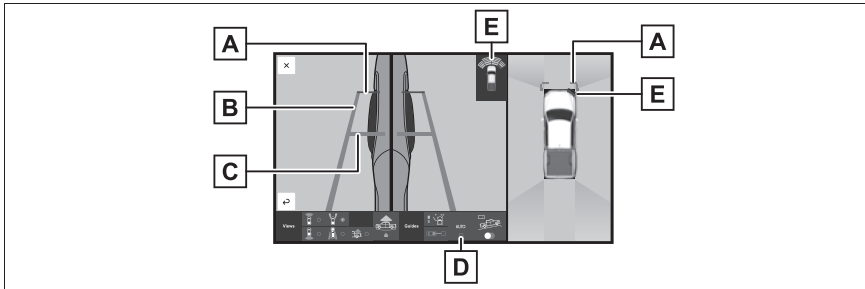
**A** Distance guide lines

Shows distance in front of the vehicle.

- Split view: Display points approximately 1.5 ft. (0.5 m) from the edge of the bumper.
- Panoramic view: Display points approximately 3 ft. (1 m) from the edge of the bumper.

B Vehicle width guide lines

Shows guide lines of the vehicle's width including the outside rear view mirrors.

C Front tire guide lines

Shows guide lines of where the front tire touches the ground.

D Automatic display button

Select to turn automatic display mode on/off. (→P.336)

E Intuitive parking assist

When a sensor detects an obstacle, the direction of and the approximate distance to the obstacle are displayed and the buzzer sounds.

-
- Pressing **x** on the screen or  changes the screen to the previously displayed screen, such as the navigation screen.
 - For details about the intuitive parking assist (→P.288).
 - The display position of the intuitive parking assist and the position of obstacles displayed in the camera image do not match.

⚠ WARNING

- When a sensor indicator on the intuitive parking assist display illuminates in red or a buzzer sounds continuously, be sure to check the area around the vehicle immediately and do not proceed any further until safety has been ensured, otherwise an unexpected accident may occur.
- As the intuitive parking assist display is displayed over the camera view, it may be difficult to see the intuitive parking assist display depending on the color and brightness of the surrounding area.

Switching the guide line mode (panoramic view & front view mode)

Each time the guide line switching button is selected, the mode will change as follows:

▶ Distance guide line

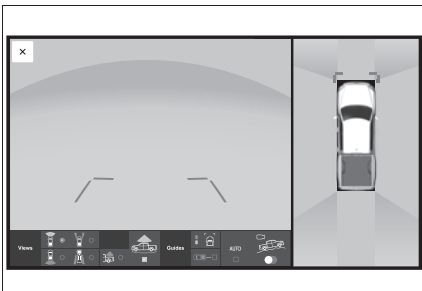

Only the distance guide lines are displayed.

▶ Estimated course line

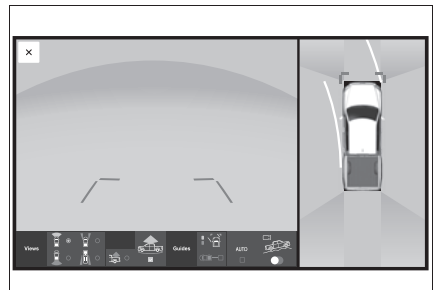

Estimated course lines will be added to the distance guide lines.

Using the vehicle width guide line (front split view mode)

The front split view screen displays images from the cameras installed on each outside rear view mirror. This screen is designed to support the driver in safe driving in situations such as when driving on a narrow road, by allowing them to check the areas around the sides of the vehicle.

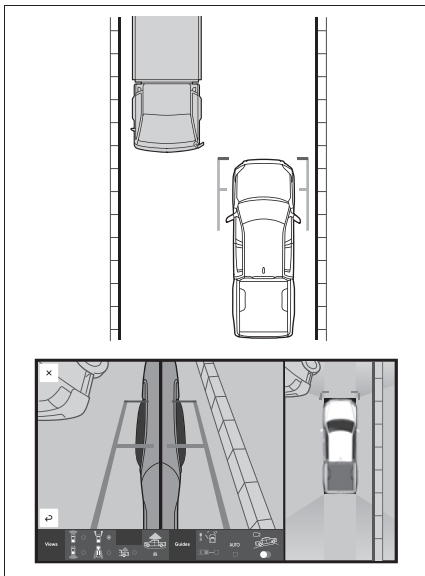

- Check the positions and distance between the vehicle width guide line and a target object such as the obstacle or curb of the road.

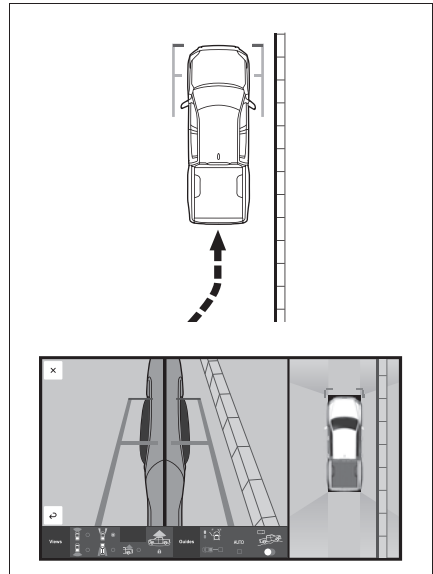

- Pull over to the curb as shown in the illustration above, taking care not to let the vehicle width guide line overlap the target object.
- Ensure that the vehicle width guide line is parallel to the target object.

Automatic display mode

In addition to screen switching by operating , automatic display mode is available. In this mode, the screen is switched automatically in response to vehicle speed.

Each time the “AUTO” button is selected, automatic display

mode is enabled/disabled.

In automatic display mode, the monitor will automatically display images in the following situations:

- When the shift lever is shifted to D or N.
- When vehicle speed is reduced to approximately 10 mph (16 km/h) or less.

Checking the rear and around the vehicle

The panoramic view & rear view/wide rear view/rear split view screen provide support when checking the areas of behind the vehicle and around the vehicle while backing up, for example while parking.

The screens will be displayed when the shift lever is in R.

Screen display

Each time the display mode switching button is selected, the mode will change as follows:

- ▶ Panoramic view & rear view

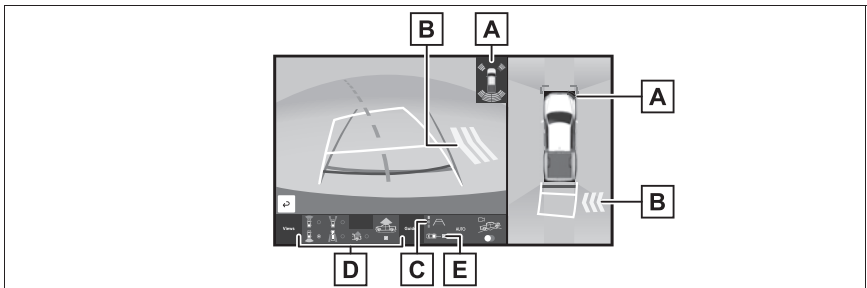

A Intuitive parking assist

When a sensor detects an obstacle, the direction of and the approximate distance to the obstacle are displayed and the buzzer sounds.

B Rear Cross Traffic Alert

When a sensor detects an obstacle, the direction of obstacle is displayed

and the buzzer sounds.

C Guide line switching button

Select to switch the guide line mode. (→P.339)

D Display mode switching buttons

The display can be changed to various screens from button combinations.

E Center guide line on/off button

Select to on/off the center guide line. (→P.339)

► Wide rear view

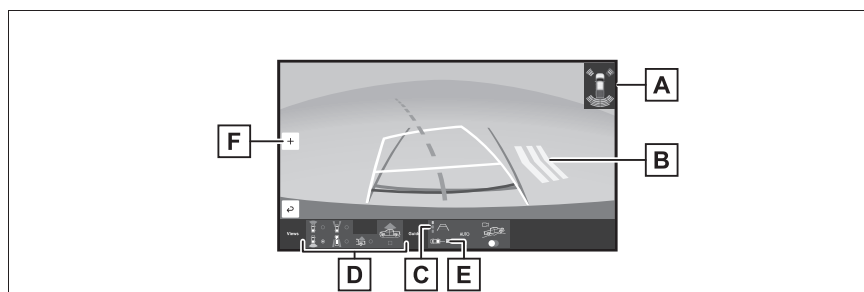

A Intuitive parking assist

When a sensor detects an obstacle, the direction of and the approximate distance to the obstacle are displayed and the buzzer sounds.

B Rear Cross Traffic Alert

When a sensor detects an obstacle, the direction of obstacle is displayed and the buzzer sounds.

C Guide line switching button

Select to switch the guide line mode. (→P.339)

D Display mode switching buttons

The display can be changed to various screens from button combinations.

E Center guide line on/off button

Select to on/off the center guide line. (→P.339)

F Zoom button

Each time press the button, the mode will change between the wide rear view mode, narrow rear view mode and hitch view mode. (→P.342)

▶ Rear split view

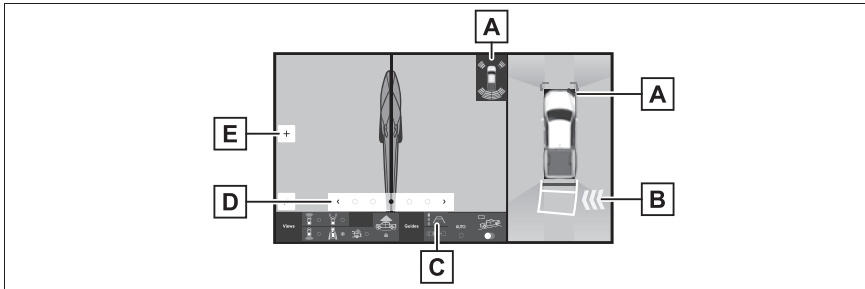

A Intuitive parking assist

When a sensor detects an obstacle, the direction of and the approximate distance to the obstacle are displayed and the buzzer sounds.

B Rear Cross Traffic Alert

When a sensor detects an obstacle, the direction of obstacle is displayed and the buzzer sounds.

C Guide line switching button

Select to switch the guide line mode. (→P.339)

D Camera angle adjustment (→P.343)

E Zoom button (→P.343)

- The monitor is canceled when the shift lever is shifted into any position other than R.
- For details about the intuitive parking assist (→P.288) and Rear Cross Traffic Alert function. (→P.295)
- The display position of the intuitive parking assist and the position of obstacles displayed in the camera image do not match.

⚠ WARNING

- When a sensor indicator on the intuitive parking assist display illuminates in red or a buzzer sounds continuously, be sure to check the area around the vehicle immediately and do not proceed any further until safety has been ensured, otherwise an unexpected accident may occur.
- As the intuitive parking assist display and Rear Cross Traffic Alert display are displayed over the camera view, it may be difficult to see the intuitive parking assist display and Rear Cross Traffic Alert display depending on the color and brightness of the surrounding area.

Guide lines displayed on the screen

Each time the guide line switching button is selected, the mode will change as follows:

► Estimated course line

Estimated course lines are displayed which move in accordance with the operation of the steering wheel.

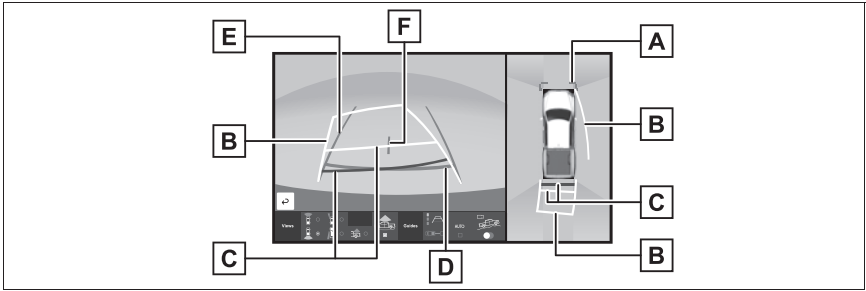

A Distance guide lines

Shows distance in front of the vehicle.

- Display points approximately 3 ft. (1 m) from the edge of the bumper.

B Estimated course lines

Shows an estimated course when the steering wheel is turned.

C Distance guide lines

Shows the distance behind the vehicle when the steering wheel is turned.

- The guide lines move in conjunction with the estimated course lines.
- The guide lines display points approximately 1.5 ft. (0.5 m) (red) and approximately 3 ft. (1 m) (yellow) from the center of the edge of the bumper.

D Distance guide line

Shows the distance behind the vehicle.

- Displays a point approximately 1.5 ft. (0.5 m) (blue) from the edge of the bumper.

E Vehicle width guide lines

Displays a guide path when the vehicle is being backed straight up.

F Vehicle center guide line

Indicates the estimated vehicle center on the ground.

340 4-5. Using the driving support systems

► Parking assist guide line

The steering wheel return points (parking assist guide lines) are displayed.

This mode is recommended for those who are comfortable with parking the vehicle without the aid of the estimated course lines.

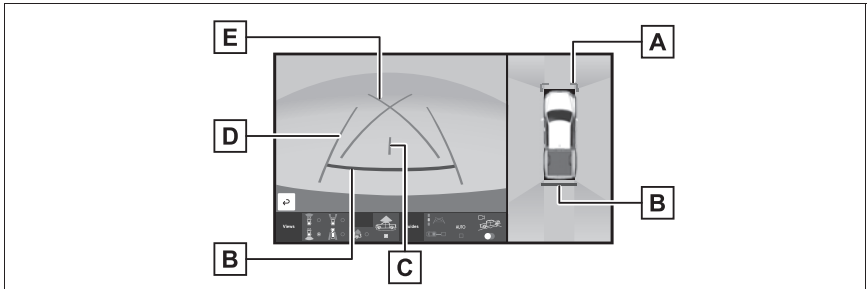

A Distance guide lines

Shows distance in front of the vehicle.

- Display points approximately 3 ft. (1 m) from the edge of the bumper.

B Distance guide line

Shows the distance behind the vehicle.

- Displays a point approximately 1.5 ft. (0.5 m) (red) from the edge of the bumper.

C Vehicle center guide line

Indicates the estimated vehicle center on the ground.

D Vehicle width guide lines

Displays a guide path when the vehicle is being backed straight up.

E Parking assist guide lines

Shows the path of the smallest turn possible behind the vehicle.

▶ Distance guide line

Only distance guide line is displayed.

This mode is recommended for those who are comfortable with parking the vehicle without the aid of the guide lines.

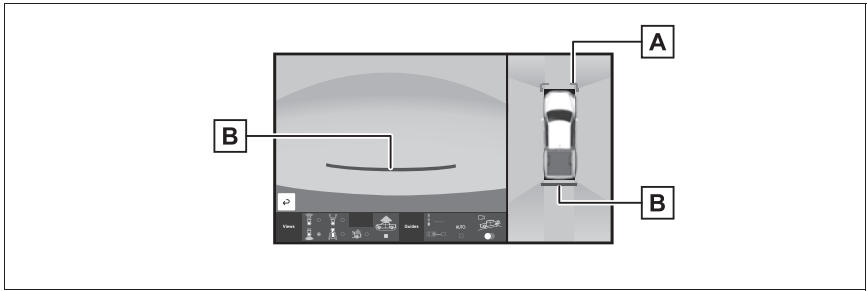

A Distance guide lines

Shows distance in front of the vehicle.

- Display points approximately 3 ft. (1 m) from the edge of the bumper.

B Distance guide line

Shows the distance behind the vehicle.

- Displays a point approximately 1.5 ft. (0.5 m) (red) from the edge of the bumper.

▶ Center guide line

When the display is turned ON, the center guide line simultaneously displays the each of the guide lines for the estimated course line, parking assist guide line or distance guide line.

Vehicle center line is displayed which move in accordance with the operation of the steering wheel.

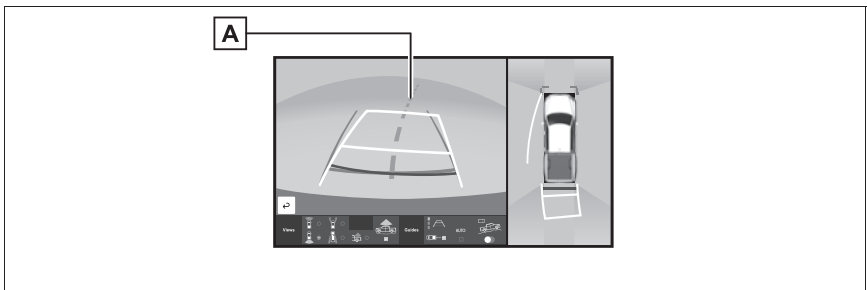

A Vehicle center guide line

Indicates the estimated vehicle center on the ground.

342 4-5. Using the driving support systems

The display position of the intuitive parking assist and the position of obstacles displayed in the camera image do not match.

WARNING

- Depending on the circumstances of the vehicle (number of passengers, amount of luggage, etc.), the position of the guide lines displayed on the screen may change. Be sure to check visually around the vehicle before proceeding.
- If the steering wheel is straight and the vehicle width guide lines and the estimated course lines are not in alignment, have the vehicle inspected by your Toyota dealer.
- Do not use the system if the display is incorrect due to an uneven (hilly) road or a non-straight (curvy) road.

Changing the rear view mode

Each time press the zoom button, the mode will change as follows:

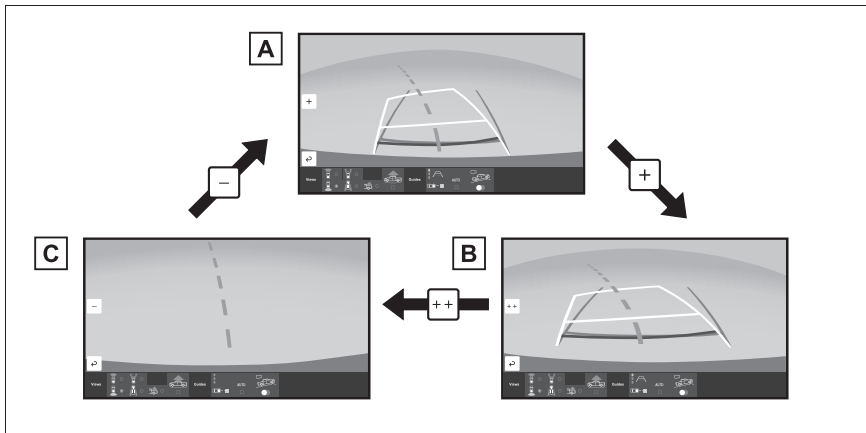

- A** Wide rear view
- B** Narrow rear view
- C** Hitch zoom view

- The hitch zoom view can be displayed for a certain time when  is pressed while the driving at speeds of 10 mph (16 km/h) or more.
- The hitch zoom view and bed zoom view (→P.346) can be switched when the switch is pressed while the displaying the screen.

Using the rear split view

If towing a trailer, magnify the difficult to see section of the vehicle rear or change the screen display and use when checking.

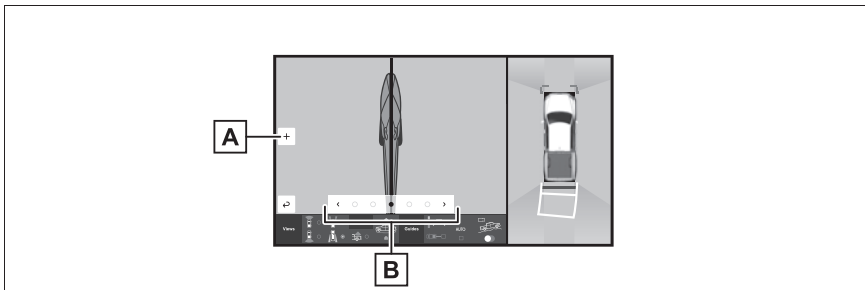

A Zoom button

The rear split view, which is currently displayed, can be magnified.

B Camera angle adjustment button

The direction of the camera can be changed from left to right in 5 stages.

Parking

Using the estimated course line

When parking in a space which is in the reverse direction to the space described in the procedure below, the steering directions will be reversed.

- 1 Shift the shift lever to R.
- 2 Turn the steering wheel so that the estimated course lines are within the parking space, and back up slowly.

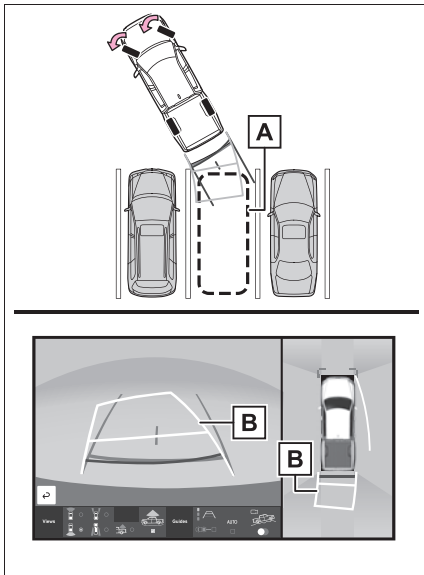

A Parking space

B Estimated course lines

- 3 When the rear position of the vehicle has entered the parking space, turn the steering wheel so that the vehicle

width guide lines are within the left and right dividing lines of the parking space.

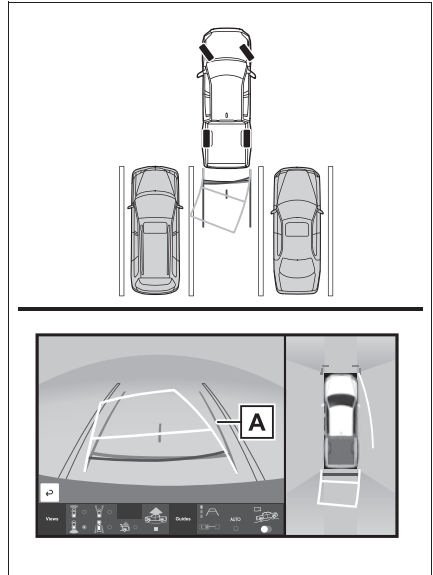

A Vehicle width guide line

- 4 Once the vehicle width guide lines and the parking space lines are parallel, straighten the steering wheel and back up slowly until the vehicle has completely entered the parking space.
- 5 Stop the vehicle in an appropriate place, and finish parking.

Using parking assist guide line

When parking in a space which is in the reverse direction to the space described in the procedure below, the steering directions will be reversed.

- 1 Shift the shift lever to R.
- 2 Back up until the parking assist guide line meets the edge of the dividing line of the parking space.

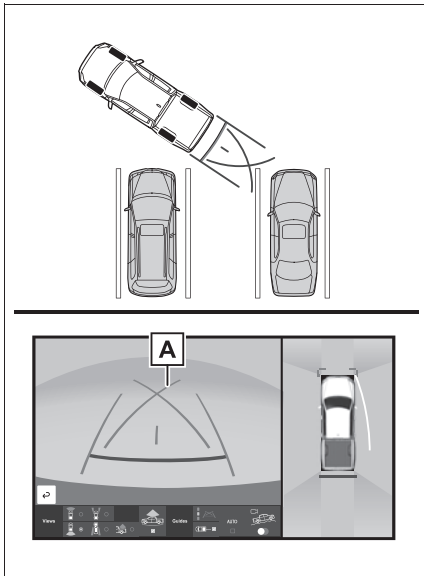

A Parking assist guide line

- 3 Turn the steering wheel all the way to the left, and back up slowly.
- 4 Once the vehicle is parallel with the parking space, straighten the steering wheel and back up slowly until the

vehicle has completely entered the parking space.

- 5 Stop the vehicle in an appropriate place, and finish parking.

Checking the bed

Use to check the state of the load in the carrier bed.

Screen display

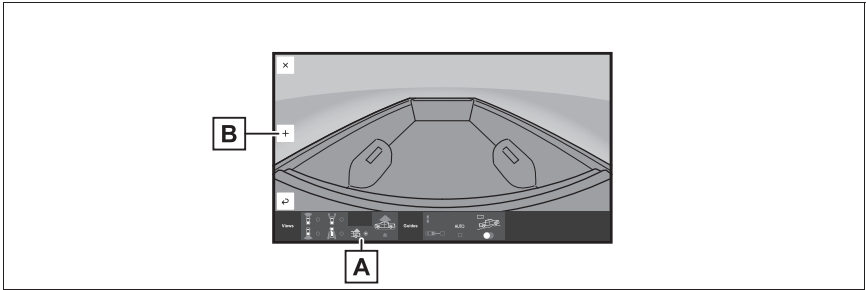

A Bed view button

B Zoom button

- The bed zoom view can be displayed for a certain time when  is pressed while the driving at speeds of 9 mph (16 km/h) or more.
- The bed zoom view and hitch zoom view (→P.342) can be switched when the switch is pressed while the displaying the screen.

Magnifying function

If displayed objects are too small to see clearly when the panoramic view is displayed, the area around any of the 4 corners of the vehicle can be magnified.

Magnifying the display

- 1 Turn the intuitive parking assist on.
- 2 Select the area on the panoramic view display you wish to magnify.

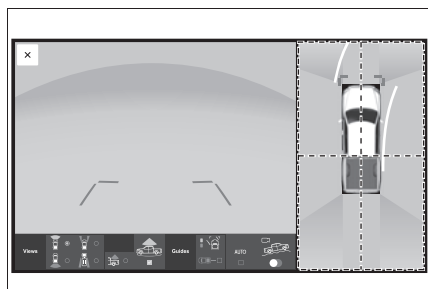

- Touching one of the 4 areas within the dotted lines will magnify that area. (Dotted lines are not displayed on the actual display.)
 - To return to the normal view, touch the panoramic view display again.
-
- The magnifying function is enabled when all of the following conditions are met:
 - The panoramic view & front view or the panoramic view & rear view is displayed.
 - The vehicle speed is below approximately 10 mph (16 km/h).

- The intuitive parking assist is available.
- In the following situations, the magnified display will be canceled automatically:
 - The vehicle speed is approximately 10 mph (16 km/h) or higher.
 - The intuitive parking assist is unavailable.
- When the display is magnified, the guide lines will not be displayed.

Customizing the panoramic view monitor

The color of the vehicle displayed on the panoramic view monitor can be changed.

Changing the body color displayed in the panoramic view monitor

- 1 Display the moving view/see-through view screen. (→P.329)
- 2 Select .
- 3 Select the desired color.

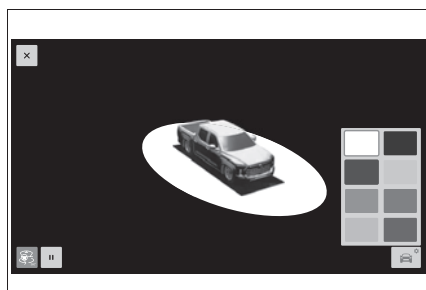

Panoramic view monitor precautions

Area displayed on screen

Area of image of panoramic view

The panoramic view monitor displays an image of the surrounding view of the vehicle.

Since the panoramic view processes and displays images based on flat road surfaces, it cannot depict the position of three-dimension objects (such as vehicle bumpers, etc.) that are in positions higher than the surface of the road. Even if there is room between the bumpers of the vehicles and it seems not likely to collide in the image, in reality, the both vehicles are on a collision course.

Check the safety of the surroundings directly.

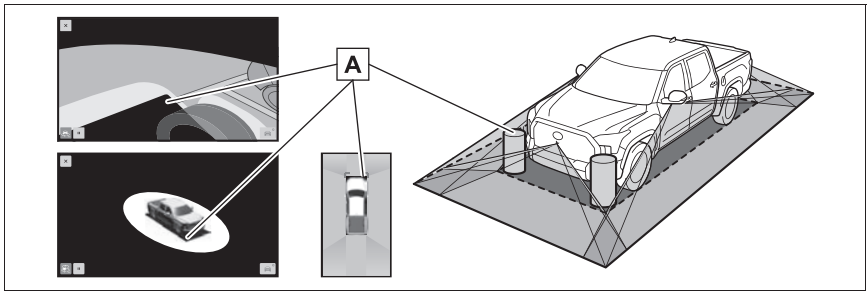

- A** Objects located in the shaded areas will not be displayed on the screen.

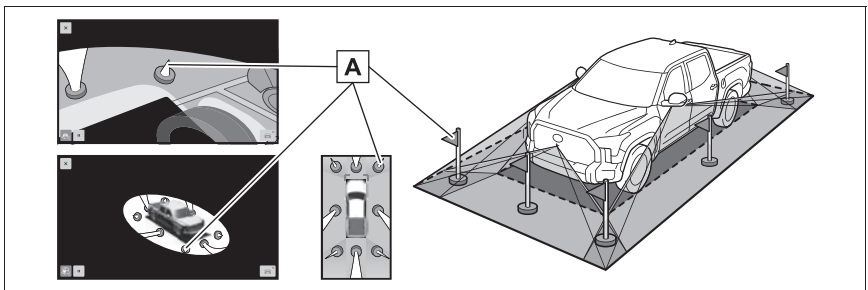

- A** Parts of objects which extend above a certain height cannot be displayed on the screen.

- As the images obtained from four cameras are processed and displayed on the standard of a flat road surface; the panoramic view/moving view/see through view may be displayed as follows.
- Objects may look collapsed; thinner or bigger than usual.
- An object with a higher position than the road surface may look farther away than it actually is or may not appear at all.
- Tall objects may appear protruding from the non-displayed areas of the image.
- Variations in the brightness of the image may appear for every camera.
- The displayed image may be shifted by inclination of the vehicle body, change in vehicle height, etc., depending on the number of passengers, amount of luggage, fuel quantity, etc.
- If the front doors or tailgate are not completely closed; neither the image nor the guide lines are displayed.
- The position relations of the vehicle icon and the road surface or obstacle may differ from the actual positions.
- The black areas of the vicinity of the vehicle icon are areas that are not captured by the camera.
- Images like the following are combined, thus some areas may be difficult to view.

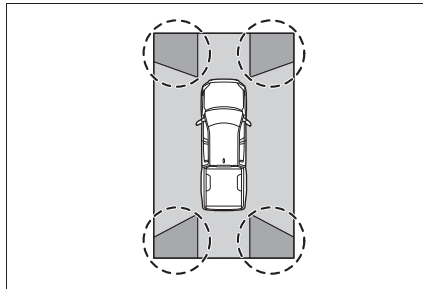
**⚠ WARNING**

When a sensor indicator on the intuitive parking assist display illuminates in red or a buzzer sounds continuously, be sure to check the area around the vehicle immediately and do not proceed any further until safety has been ensured, otherwise an unexpected accident may occur.

Area of the image captured by the camera

▶ Panoramic view & front view

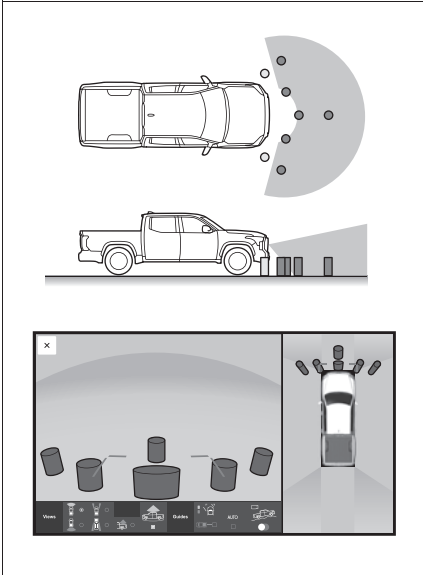

▶ Front split view

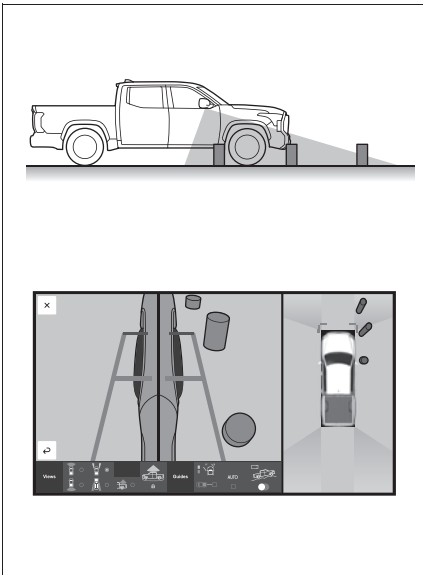

▶ Panoramic view & rear view

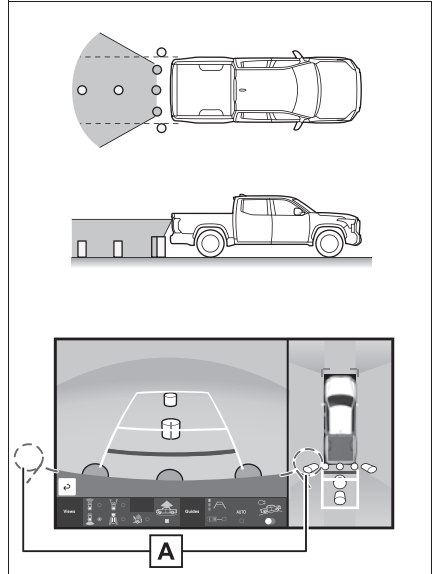

A The area around both corners of the bumper will not be displayed.

► Wide rear view

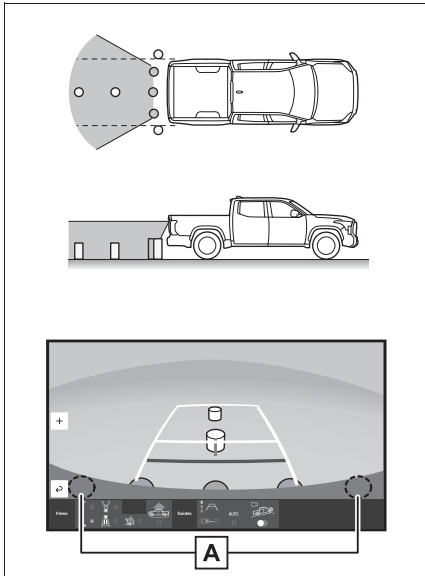

A The area around both corners of the bumper will not be displayed.

► Rear split view

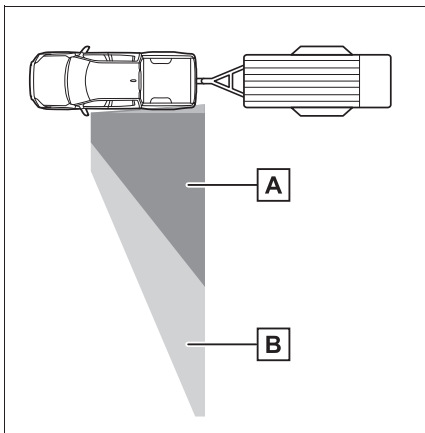

The area able to be seen changes depending on the camera angle adjustments.

A When the camera angle is in

the middle (Left: 50%/Right: 50%)

B When the camera angle is at the MAX on the left side (Left: 100%)

► Hitch zoom view

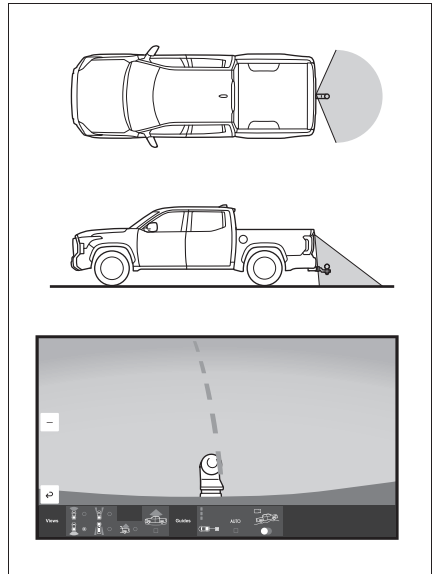

► Bed view

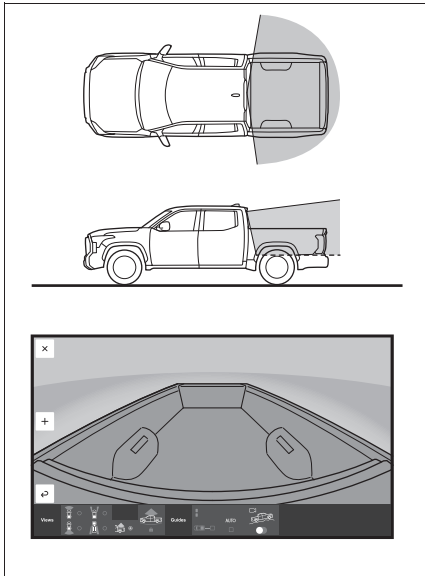

- The area covered by the camera is limited. Objects which are close to either corner of the bumper or under the bumper cannot be seen on the screen.
- The area displayed on the screen may vary depending on vehicle orientation or road conditions.
- The camera uses a special lens. The distance in the image displayed on the screen will differ from the actual distance.
- In the rear split view, there is a blind spot due to the size (length and height) of the trailer.
- In the hitch zoom view, if a backlit license plate is equipped it may be reflected in the screen.
- In the bed zoom view, the section near the cabin is a blind spot.

The camera

The cameras for the panoramic view monitor are located as

shown in the illustrations.

► Front camera

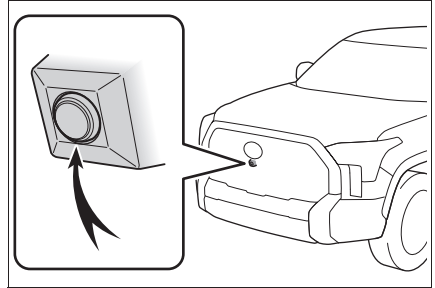

► Side cameras

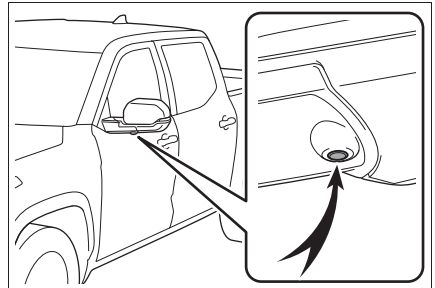

► Rear camera

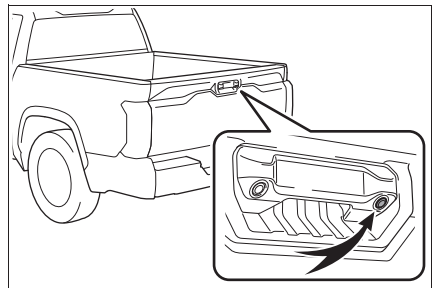

► Bed camera

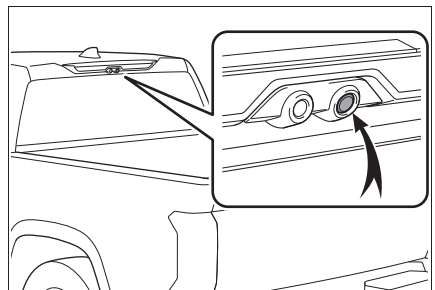

Using the camera

If dirt or foreign matter (such as water droplets, snow, mud, etc.) is adhering to the camera, it cannot transmit a clear image. In this case, flush it with a large quantity of water and wipe the camera lens clean with a soft and wet cloth.



NOTICE

- The panoramic view monitor may not operate properly in the following cases.
 - If the camera is hit, the position and mounting angle of the camera may change.
 - As the camera has a water proof construction, do not detach, disassemble or modify it. This may cause incorrect operation.
 - When cleaning the camera lens, flush the camera with a large quantity of water and wipe it with a soft and wet cloth. Strongly rubbing the camera lens may cause the camera lens to be scratched and unable to transmit a clear image.
 - Do not allow an organic solvent, car wax, window cleaner or a glass coating to adhere to the camera. If this happens, wipe it off as soon as possible.
 - If the temperature changes rapidly, such as when hot water is poured on the vehicle in cold weather, the system may not operate normally.

- When washing the vehicle, do not apply intensive bursts of water to the camera or camera area. Doing so may result in the camera malfunctioning.
- Do not expose the camera to strong impacts as this could cause a malfunction. If this happens, have the vehicle inspected by your Toyota dealer as soon as possible.

Difference between the screen and the actual road

- The distance guide lines and the vehicle width guide lines may not actually be parallel with the dividing lines of the parking space, even when they appear to be so. Be sure to check visually.
- The distances between the vehicle width guide lines and the left and right dividing lines of the parking space may not be equal, even when they appear to be so. Be sure to check visually.
- The distance guide lines give a distance guide for flat road surfaces. In any of the following situations, there is a margin of error between the guide lines on the screen and the actual distance/course on the road.

When the ground behind the vehicle slopes up sharply

The distance guidelines are projected on a horizontal surface, distances on an upward sloping surface appear farther from the vehicle than the actual distance. Because of this, objects will appear to be farther away than they actually are. In the same way, there will be a margin of error between the guidelines and the actual distance/course on the road.

Because of this, objects will appear to be closer than they actually are. In the same way, there will be a margin of error between the guidelines and the actual distance/course on the road.

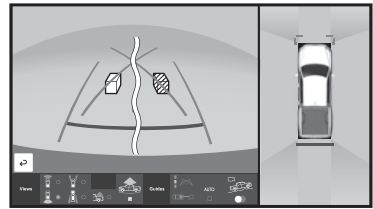
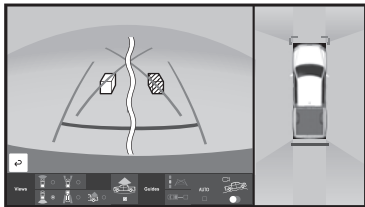
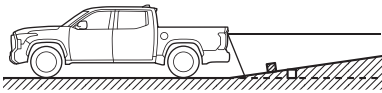
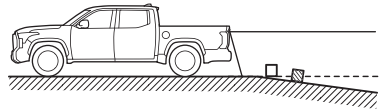

When the ground behind the vehicle slopes down sharply

The distance guidelines are projected on a horizontal surface, distances on an downward sloping surface appear closer to the vehicle than the actual distance.

When any part of the vehicle sags

When the vehicle posture tilts due to the number of passengers or the distribution of the load, there is a margin of error between the guide lines on the screen and the actual distance/course on the road.

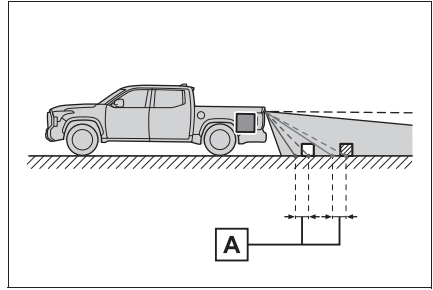

A A margin of error

Distortion of three-dimensional objects on the screen

When there are three-dimensional objects (such as vehicle bumpers, etc.) nearby in positions higher than the surface of the road, take extra care when using the following.

Panoramic view display (including magnified display)

Since the panoramic view processes and displays images based on flat road surfaces, it cannot depict the position of three-dimension objects (such as vehicle bumpers, etc.) that are in positions higher than the surface of the road. For example, even though it appears that there is space between the bumpers of the two vehicles in the illustration below and they are not likely to collide, in reality, a collision is about to occur.

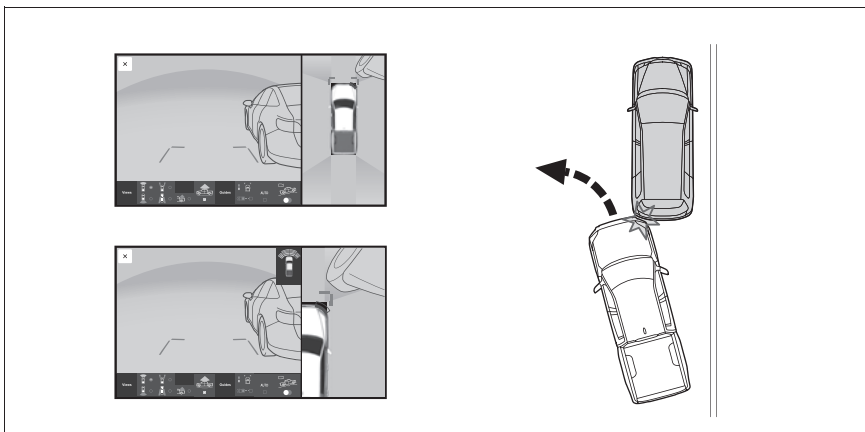

! WARNING

When a sensor indicator on the intuitive parking assist display illuminates in red or a buzzer sounds continuously, be sure to check the area around the vehicle immediately and do not proceed any further until safety has been ensured, otherwise an unexpected accident may occur.

When approaching three-dimensional objects

The estimated course lines target flat surfaced objects (such as the road). It is not possible to determine the position of three-dimensional objects (such as vehicles) using the estimated course lines and distance guide lines. When approaching a three-dimensional object that extends outward (such as the flatbed of a truck), be careful of the following.

! WARNING

When a sensor indicator on the intuitive parking assist display illuminates in red or a buzzer sounds continuously, be sure to check the area around the vehicle immediately and do not proceed any further until safety has been ensured, otherwise an unexpected accident may occur.

Estimated course lines

Since the estimated course line is displayed for a flat road surface, it cannot depict the position of three-dimensional objects (such as vehicle bumpers, etc.) that are in positions higher than the surface of the road. Even if the bumpers of the vehicle is on the outside of the estimated course line in the image, in reality, the vehicles are on a collision course.

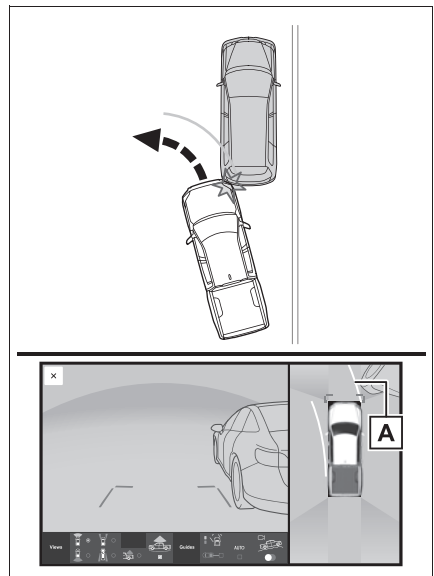

A Estimated course line

Three-dimensional objects (such as the overhang of a wall or loading platform of a truck) in high positions may not be projected on the screen. Check the safety of the surroundings directly.

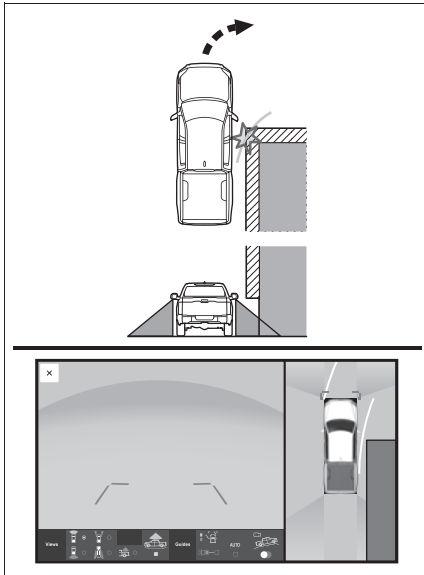

The pillar that is diagonal to the parking spot may be displayed perpendicular on the screen. Even if it seems like there will not be a collision, the pillar is diagonal, so there may be collision with the upper part of the pillar.

Check the safety of the surroundings directly.

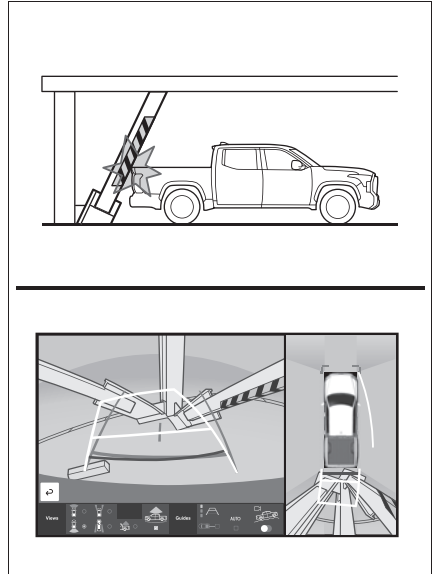

358 4-5. Using the driving support systems

Visually check the surroundings and the area behind the vehicle. In the case shown below, the truck appears to be outside of the estimated course lines and the vehicle does not look as if it hits the truck. However, the rear body of the truck may actually cross over the estimated course lines. In reality if you back up as guided by the estimated course lines, the vehicle may hit the truck.

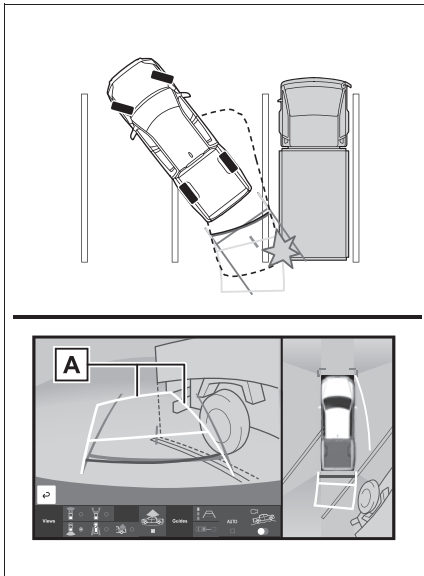

A Estimated course lines

Distance guide lines

Visually check the surroundings and the area behind the vehicle. On the screen, it appears that a truck is parking at point **B**. However, in reality if you back

up to point **A**, you will hit the truck. On the screen, it appears that **A** is closest and **C** is farthest away. However, in reality, the distance to **A** and **C** is the same, and **B** is farther than **A** and **C**.

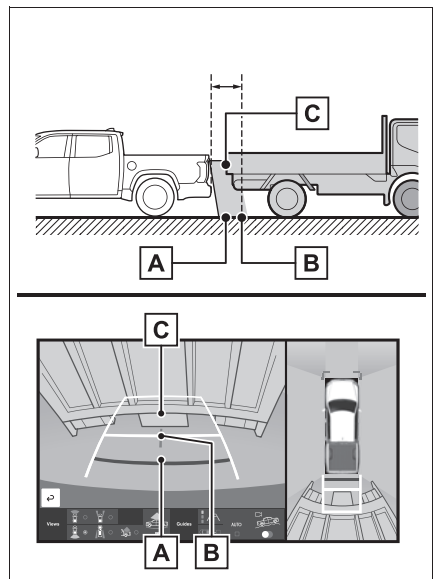

Things you should know

If you notice any symptoms

If you notice any of the following symptoms, refer to the likely cause and the solution, and re-check.

If the symptom is not resolved by the solution, have the vehicle inspected by your Toyota dealer.

Symptom	Likely cause	Solution
The image is difficult to see	<ul style="list-style-type: none"> • The vehicle is in a dark area • The temperature around the lens is either high or low • The outside temperature is low • There are water droplets on the camera • It is raining or humid • Foreign matter (mud, etc.) is adhering to the camera • Sunlight or headlights are shining directly into the camera • The vehicle is under fluorescent lights, sodium lights, mercury lights, etc. 	<p>Back up while visually checking the vehicle's surroundings. (Use the monitor again once conditions have been improved.)</p> <p>The procedure for adjusting the picture quality of the panoramic view monitor system is the same as the procedure for adjusting the screen display. (Refer to the "MULTIMEDIA OWNER'S MANUAL".)</p>
The image is blurry	Dirt or foreign matter (such as water droplets, snow, mud, etc.) is adhering to the camera.	Flush the camera with a large quantity of water and wipe the camera lens clean with a soft and wet cloth.
The image is out of alignment	The camera or surrounding area has received a strong impact.	Have the vehicle inspected by your Toyota dealer.

Symptom	Likely cause	Solution
The guide lines are very far out of alignment	The camera position is out of alignment.	Have the vehicle inspected by your Toyota dealer.
	<ul style="list-style-type: none"> • The vehicle is tilted. (There is a heavy load on the vehicle, tire pressure is low due to a tire puncture, etc.) • The vehicle is used on an incline. 	If this happens due to these causes, it does not indicate a malfunction. Back up while visually checking the vehicle's surroundings.
The estimated course lines move even though the steering wheel is straight	There is a malfunction in the signals being output by the steering sensor.	Have the vehicle inspected by your Toyota dealer.
Guide lines are not displayed	The tailgate is open.	Close the tailgate. If this does not resolve the symptom, have the vehicle inspected by your Toyota dealer.
 is displayed	<ul style="list-style-type: none"> • 12-volt battery has been reinstalled. • The steering wheel has been moved while the 12-volt battery was being reinstalled. • 12-volt battery power is low. • The steering sensor has been reinstalled. • There is a malfunction in the signals being output by the steering sensor. 	Have the vehicle inspected by your Toyota dealer.
The panoramic view display cannot be magnified	The intuitive parking assist may be malfunctioning or dirty.	Follow the correction procedures for malfunctions of the intuitive parking assist. (→P.288)
The see-through view/moving view cannot be displayed		

Multi-terrain Monitor*

*: If equipped

The Multi-terrain Monitor helps the driver to check the vehicle surroundings. It assists in determining the conditions around the driver in a variety of situations, such as when judging conditions during off-road driving or checking for obstacles when parking.

WARNING

Observe the following precautions to avoid an accident that could result in death or serious injuries.

■ When using the Multi-terrain Monitor system

- Never rely solely on the Multi-terrain Monitor. As with unequipped vehicles, drive carefully while directly confirming the safety of your surroundings and the area to the rear of the vehicle. Take particular care to avoid parked cars and other obstacles.
- Due to the characteristics of the camera lens, the actual position and distance of people and other obstacles will differ from those shown on the Multi-terrain Monitor screen. Directly confirm the safety of your surroundings before driving.
- Do not drive while only looking at the screen. When driving, make sure to directly confirm the safety of your surroundings, such as by visually checking the area and using the vehicle's mirrors.

- In low temperatures, the screen may darken or the images may become faint. Images of moving objects in particular may distort or disappear from the screen. Therefore, make sure to drive carefully while directly visually confirming the safety of your surroundings.
- Do not use the Multi-terrain Monitor system in the following cases:
 - On icy or slick road surfaces, or in snow
 - When using tire chains or emergency tires
 - When the front door or the tail-gate is not closed completely
 - If the suspension has been modified or tires of a size other than specified are installed

Camera switch

The camera switch is located as shown in the illustration.

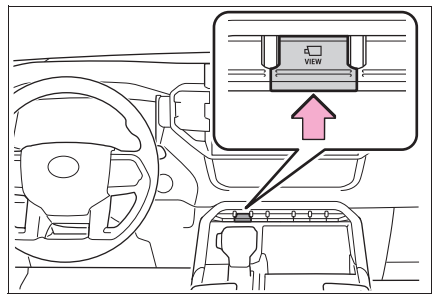

The Multi-terrain Monitor is displayed by operating  when vehicle speed is approximately 10 mph (16 km/h) or less. If the vehicle speed exceeds approximately 10 mph (16 km/h), the Multi-terrain Monitor display is canceled.

Menu button

The screens that are displayed can be selected by the following buttons.

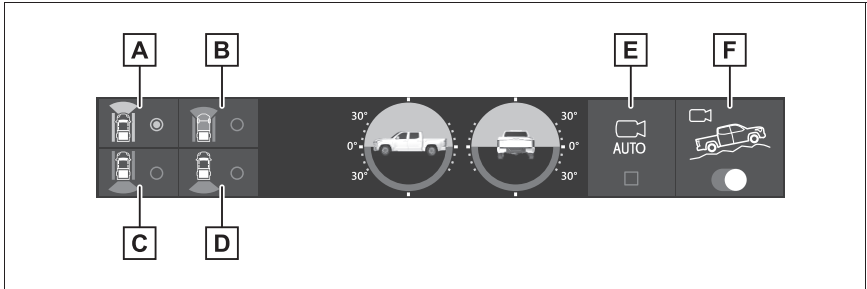

- A** Front view & dual side view
- B** Under vehicle terrain view & dual side view
- C** Rear view & dual side view
- D** Wide rear view
- E** Auto mode on/off button (→P.364)
- F** Multi-terrain Monitor on/off button

Panoramic View Monitor is displayed when the Multi-terrain Monitor is turned OFF. (→P.324)

When the front-wheel drive control switch is in “4L”, or “4H” and Multi-terrain select is ON

confirming the obstacle in the flank of tire neighborhood and the vehicle with a side screen

The Multi-terrain Monitor is display a screen suitable for off-road.

- The driver can drive while confirming the following guidelines with a front view
- Distance with the obstacle in the front
- Estimated course line
- The driver can drive while

Checking the area to the front and sides of the vehicle

- ▶ Front view & dual side view

Select the front view & dual side view button.

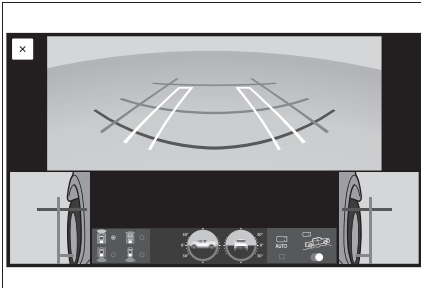

When the front view and side view screens are touched, each of the display sizes can be changed.

Checking the condition of the road surface under the vehicle

- ▶ Under vehicle terrain view & dual side view

Select the under vehicle terrain view & dual side view button.

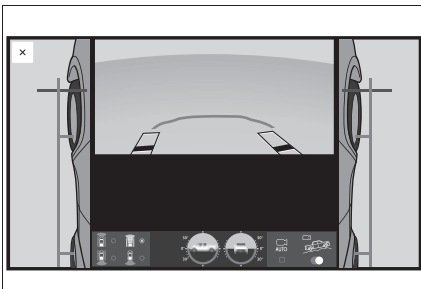

- ▶ Under vehicle terrain view & dual side view (front magnified)

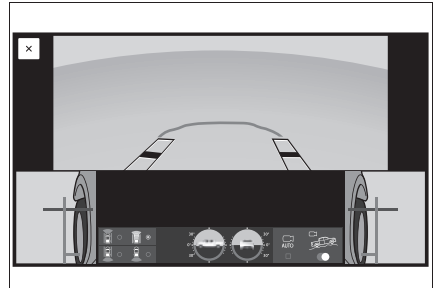

When the under vehicle terrain view and side view screens are touched, each of the display sizes can be changed.

Checking the area to the rear of the vehicle

- ▶ Rear view & dual side view

Select the rear view & dual side view button.

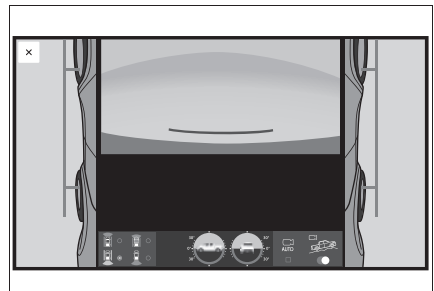

364 4-5. Using the driving support systems

▶ Wide rear view

Select the wide rear view button.



The rear view & dual side view and the wide rear displays can be switched by touching the screen.

When the front-wheel drive control switch is in “2H”, or “4H” and Multi-terrain select is OFF

The panoramic view monitor is displayed. (→P.324)

Automatic display mode

When automatic display mode is turned on, the Multi-terrain Monitor screen is displayed in the following conditions, even if  has not been operated.

- When the shift lever is shifted to D or N.
- When vehicle speed is reduced to approximately 10 mph (16 km/h) or less.

time  is selected. When automatic display mode is on, an indicator illuminates on the icon.

- Even when automatic display mode is on, the display can still be switched by pressing .

-
- The automatic display mode switches between on and off each

Screen display and functions

The front-wheel drive control switch in the case of “4L”, or “4H” and Multi-terrain select is ON, the Multi-terrain Monitor can display a screen suitable for off-road.

Front view & dual side view

Front view & dual side view can be used to check the area around the front of the vehicle.

- In addition to an image of the front of the vehicle, guide lines are displayed in a composite view to provide reference for when deciding a direction to move forward in.
- If the steering wheel is turned 270° or more, guide lines and other features to support turning are automatically displayed.

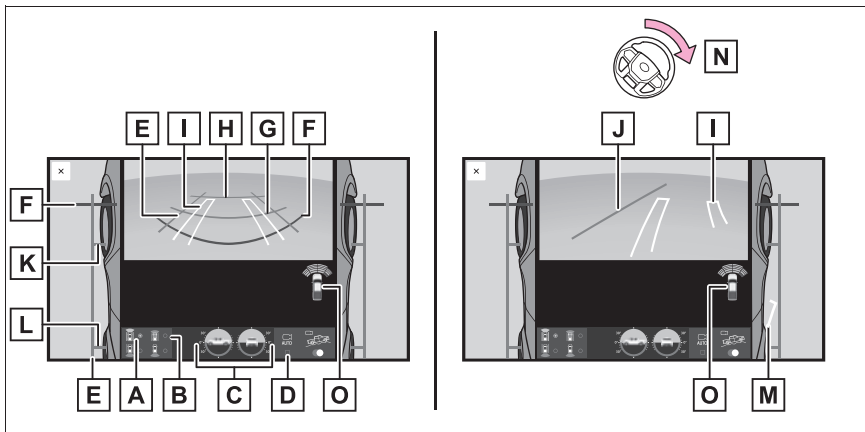

A Front view & dual side view button

B Under vehicle terrain view & dual side view button (→P.368)

C Clinometer/slip display

Displays the vehicle's estimated degree of incline or indicates a tire slip-page. (→P.367, 368)

D Automatic display button

Select to turn automatic display mode on/off. (→P.364)

E Vehicle width lines (blue)

Shows guide lines of the vehicle's width including the outside rear view mirrors.

F 1.5 ft. (0.5 m) distance guide line (red)

Show distance in front of the vehicle.

- Display points approximately 1.5 ft. (0.5 m) from the edge of the bumper.

G 3 ft. (1 m) distance guide line (blue)

H 6 ft. (2 m) distance guide line (blue)

I Front tire course line (yellow)

Shows the estimated course of the front tires according to steering wheel position.

J Forward movement guide line (blue)

Shows the estimated tire course of the tightest possible turn.

K Front tire contact line (blue)

Shows guide lines of where the front tire touches the ground.

L Rear tire contact line (blue)

Shows guide lines of where the rear tire touches the ground.

M Rear tire course line (yellow)

Shows the estimated course of the rear tires.

N When the steering wheel is turned by 270° or more

O Intuitive parking assist

When a sensor detects an obstacle, the direction of and the approximate distance to the obstacle are displayed and the buzzer sounds.

-
- The screen can be displayed when the shift lever is in a position other than R.
 - When the intuitive parking assist detects an obstacle or another vehicle, a warning message pops up in the clinometer/slip display area.

Clinometer

Clinometer displays the vehicle inclination to the front, rear, left and right within a range of 0° to approximately 30° .

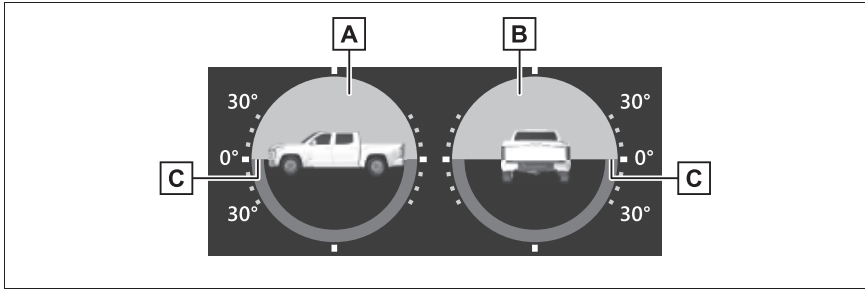

A Degree markers of incline to the front and rear

Indicates the vehicle inclination in degrees in the front and rear directions.

B Degree markers of incline to the left and right

Indicates the vehicle inclination in degrees in the left and right directions.

C Pointer

Indicates the degree of the vehicle inclination in comparison to a parallel line.

- The display indicates the incline of the vehicle in degrees shown by the movement of the pointer and the rotation of the vehicle image.
- The color of the degree markers of incline to the front, rear, left and right changes according to the current incline of the vehicle.
- After the power switch is in ON, the degree of incline is not displayed until such information is determined.
- The degree of incline showed on the clinometer is only an approximate indication, and may differ from the degree of incline measured using other equipment.

Slip display

When tire slippage is detected, the clinometer display area is automatically switched to the slip display.

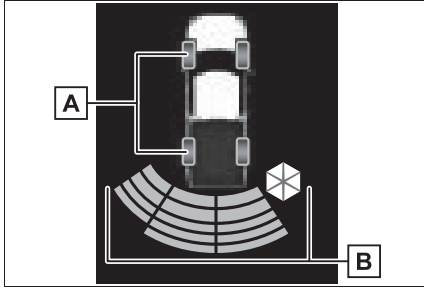
**A Tire display**

Indicates the position of freely spinning tires in yellow if the tire spins. (During Crawl Control is operating, all of the tires are indicated in yellow.)

B Pop-up display of the intuitive parking assist

Displayed if an obstacle is detected while the intuitive parking assist is turned on.

Under vehicle terrain view & dual side view

Lines indicating current vehicle and tire position are displayed in a composite view on an image taken approximately 32 ft. (10m) behind the current vehicle position and assists the driver to check conditions underneath the vehicle or determine the position of the front tires.

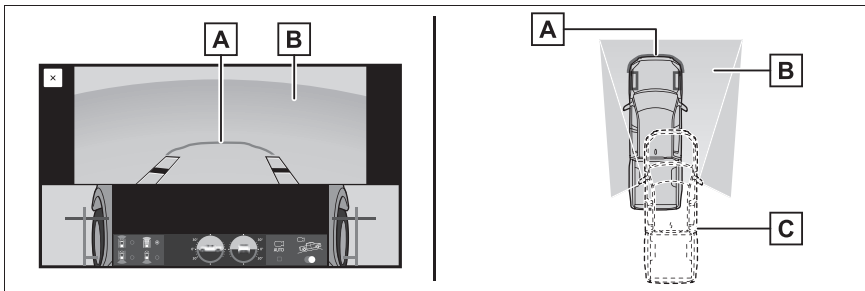

A Current vehicle position

B Image displayed in the under vehicle terrain view (image taken approximately 32 ft. (10m) behind the current vehicle position)

C Vehicle position at the time the image was taken (approximately 32 ft. (10m) behind the current vehicle position)

Displaying the under vehicle terrain view

- Under vehicle terrain view & dual side view

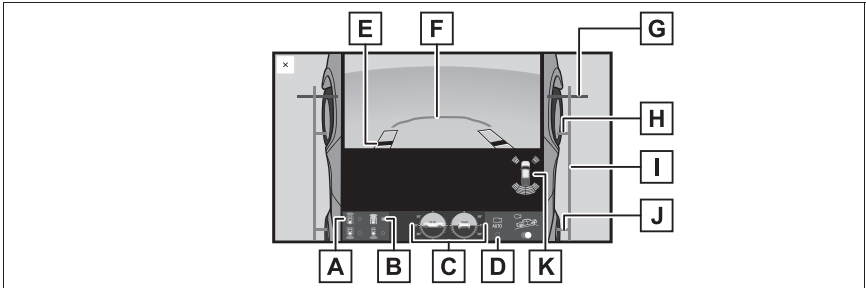

- Under vehicle terrain view & dual side view (front magnified)

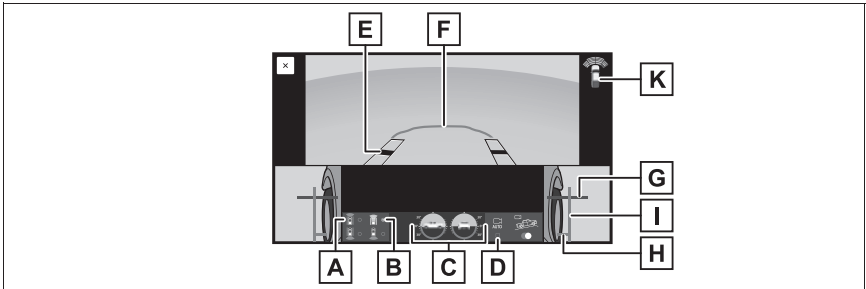

A Front view & dual side view button (→P.365)

B Under vehicle terrain view & dual side view button

C Clinometer/slip display

Displays the vehicle's estimated degree of incline or indicates a tire slip-page. (→P.367, 368)

D Automatic display button

Select to turn automatic display mode on/off. (→P.364)

E Tire position indicator lines (black or white)

Indicates the estimated position of the front tires.

F Vehicle position indicator lines (blue)

Indicates the estimated position of the vehicle.

G 1.5 ft. (0.5 m) distance guide line (red or black)

Show distance in front of the vehicle.

- Display points approximately 1.5 ft. (0.5 m) from the edge of the bumper.

H Front tire contact line (blue)

370 4-5. Using the driving support systems

Shows guide lines of where the front tire touches the ground.

I Vehicle width lines (blue)

Shows guide lines of the vehicle's width including the outside rear view mirrors.

J Rear tire contact line (blue)

Shows guide lines of where the rear tire touches the ground.

K Intuitive parking assist

When a sensor detects an obstacle, the direction of and the approximate distance to the obstacle are displayed and the buzzer sounds.

-
- The screen can be displayed when the shift lever is in a position other than R.
 - While the under vehicle terrain view is displayed, if the vehicle speed reaches or exceeds approximately 3 mph (5 km/h), the screen automatically returns to the front view display.
 - In the following situations, the under vehicle terrain view selection button cannot be operated.
 - The vehicle is not completely stopped
 - After the hybrid system starts, a fixed distance or more has not been driven
 - After the front-wheel drive control switch is shifted to "4L", a fixed distance or more has not been driven
 - In the following situations, the system may not operate normally, or it may not be possible to switch to the under vehicle terrain view.
 - The road is covered with snow
 - It is nighttime and the road has no illumination
 - Dirt or foreign matter is adhering to the camera lens
 - There is water in front of the vehicle (a river, puddle, sea water, etc.)



WARNING

- The tire position indicator lines and vehicle position indicator lines may differ from actual vehicle positions depending on the number of passengers, cargo weight, road grade, road surface conditions, brightness of the surrounding environment, etc. Always drive the vehicle while confirming the safety of your surroundings.
- The image displayed is one that was previously taken at a point approximately 32 ft. (10m) behind the current vehicle position. In cases such as when objects move after the image is taken, the image displayed on the screen may differ from the actual state.

Rear view & dual side view/wide rear view

The rear view & dual side view/wide rear view screen provide support when checking the areas of behind the vehicle and around the vehicle while backing up, for example while parking.

The screens will be displayed when the shift lever is in R.

► Rear view & dual side view

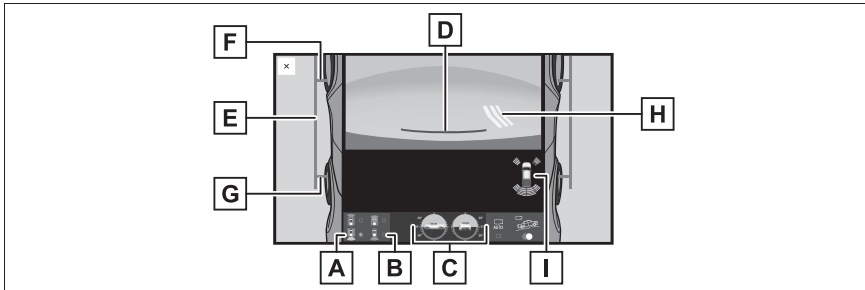

► Wide rear view

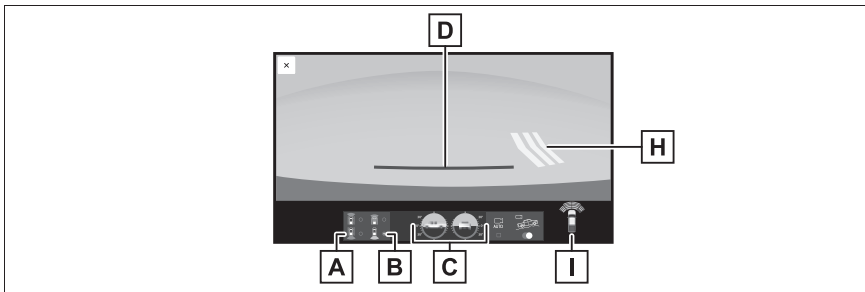

A Rear view & dual side view

B Wide rear view button

C Clinometer/slip display

Displays the vehicle's estimated degree of incline or indicates a tire slip-page. (→P.367, 368)

D 1.5 ft. (0.5 m) distance guide line (red)

Show distance in rear of the vehicle.

- Display points approximately 1.5 ft. (0.5 m) from the edge of the bumper.

E Vehicle width guide lines (blue)

Displays a guide path when the vehicle is being backed straight up.

F Front tire contact line (blue)

372 4-5. Using the driving support systems

Shows guide lines of where the front tire touches the ground.

G Rear tire contact line (blue)

Shows guide lines of where the rear tire touches the ground.

H Rear Cross Traffic Alert

When a sensor detects a vehicle approaching from the rear, the direction of the vehicle approaching from the rear is displayed and the buzzer sounds.

I Intuitive parking assist

When a sensor detects an obstacle, the direction of and the approximate distance to the obstacle are displayed and the buzzer sounds.

-
- The screen can be displayed when the shift lever is in R.
 - For details about the Rear Cross Traffic Alert function. (→P.295)
 - If the tailgate is not closed, guide lines will not be displayed. If the guide lines do not display even when the tailgate is closed, have the vehicle inspected at your Toyota dealer.



WARNING

The tire position indicator lines and vehicle position indicator lines may differ from actual vehicle positions depending on the number of passengers, cargo weight, road grade, road surface conditions, brightness of the surrounding environment, etc. Always drive the vehicle while confirming the safety of your surroundings.

Multi-terrain Monitor precautions

→P.348

Things you should know

→P.359

Electronically modulated air suspension *

*: If equipped

The electronically modulated air suspension allows the driver to control the vehicle's height in order to adjust for driving conditions.

Select the desired height with the height control switch.

Height control switch

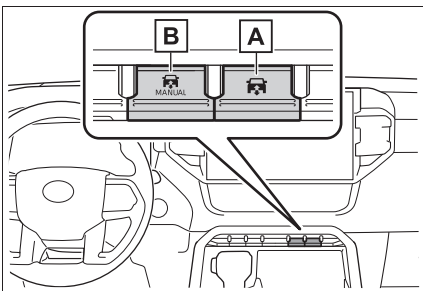

- A** Height control switch
- B** Height control mode select switch

Selecting vehicle height

Operating the switch changes vehicle rear height as follows:

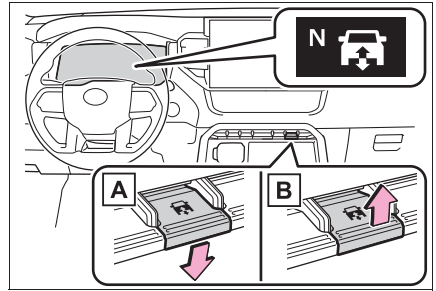

- A** Lower
- B** Higher

Vehicle height can be adjusted only when the hybrid system is operating.

The selected height mode will be shown on the electronically modulated air suspension display.

The selected mode will flash while the height mode is being changed.

■ Height modes

- “N” mode (normal mode): For ordinary driving

Normal height

- “HI” mode (high mode): For driving on bumpy roads 1.6 in. (40 mm) higher than the normal height

The “HI” mode is unavailable when the vehicle's speed exceeds 18 mph (30 km/h).

When the vehicle's speed exceeds

374 4-5. Using the driving support systems

18 mph (30 km/h), the height will be adjusted to the normal height automatically.

- “LO” mode (low mode): For the ease of egress/ingress and loading luggage

1.2 in. (30 mm) lower than the normal height

The “LO” mode is unavailable when the vehicle’s speed exceeds 8 mph (12 km/h).

When the vehicle’s speed exceeds 8 mph (12 km/h), the height will be adjusted to the normal height automatically.

Disabling the height control

When the height control mode select switch is pressed, the vehicle height is fixed at the current height.

The “MAN.” indicator is displayed on the multi-information display and the automatic leveling function turned off.

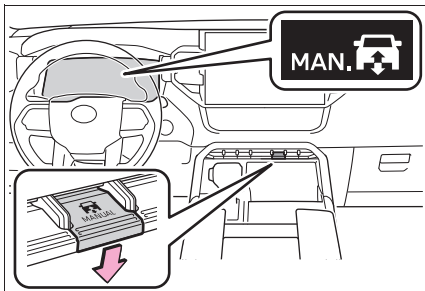

The height can be adjusted by pressing the height control switch.

Press the switch again or when the

vehicle’s speed exceeds 18 mph (30 km/h), the height will be adjusted to the normal height automatically.

■ Automatic leveling function

Regardless of the number of occupants or the luggage load, vehicle height in any mode is always adjusted to a fixed height by the automatic leveling function.

■ When “HI” mode is selected

The vehicle height will change to “N” mode when driving at the speeds of 18 mph (30 km/h).

■ When “LO” mode is selected

- The vehicle height will change to “N” mode when vehicle speed exceeds 8 mph (12 km/h).
- This mode allows for easy access to the vehicle (getting in and out) and easy loading and unloading.

■ The electronically modulated air suspension will not operate in the following cases:

- The underbody of the vehicle is touching the surface of the road.
- The area around the suspension is covered with ice.

The height control indicators will blink, turn off and then turn on continuously to indicate that the electronically modulated air suspension is not operational.

To re-enable operation, turn off the hybrid system and then restart it.

■ Even if you hear an operating noise

This does not indicate a problem in the electronically modulated air suspension.

■ The electronically modulated air suspension failure warning

The warning message is displayed on the multi-information display, and the electronically modulated air suspension cannot be activated until

the malfunction is corrected. Stop the hybrid system and start again. If the warning message turns off, the system operating correctly. If the warning message continues to be displayed, have your vehicle inspected by your Toyota dealer as soon as possible.

■ When the indicator turns on

Indicates a malfunction in the air suspension system. Have the vehicle inspected by your Toyota dealer immediately. (→P.87, 534)



WARNING

■ The electronically modulated air suspension must be turned off in the following circumstances:

Otherwise, the automatic leveling function may cause the vehicle's height to change, and you may catch part of your body in the vehicle, resulting in an unexpected accident or injury:

- When driving through water such as shallow streams (Put the vehicle height in "HI" mode and turn off the electronically modulated air suspension. Drive at 18 mph [30 km/h] or slower.)
- When jacking up the vehicle, installing tire chains or tying the vehicle with chains/wires for transportation via flat bed truck (Turn the system to the manual mode and stop the hybrid system.)
- When the vehicle must be towed (Put the vehicle height in "N" mode and turn the system to the manual mode.)
- When the vehicle gets stuck (Turn the system to the manual mode.)

- When disconnecting a trailer (Put the vehicle height in "N" mode and turn the system to the manual mode.)

■ Selecting the correct height mode

Observe the following precautions to prevent accidents or injury. Failure to do so may cause damage to parts of the vehicle, as well as dangerous handling characteristics, which may lead to fatal or injury accidents.

- Before you lower the vehicle's height, check under the vehicle to make sure that no one is there.
- "HI" mode should only be used when driving on rough roads, for example when driving off-road. Because the vehicle's center of gravity will become higher when in the mode, the vehicle may become unstable when turning abruptly, resulting in an accident.
- Do not select "HI" mode when you load cargo on the roof luggage carrier. Because the vehicle's center of gravity will become higher when in the mode, the vehicle may become unstable when turning abruptly, resulting in an accident.



NOTICE

■ **Be careful in any place where overhead space is limited.**

When changing to a higher mode or after unloading, the vehicle height will rise. This may cause damage to the vehicle.

■ **Do not select “LO” mode when driving on bumpy roads.**

If the underbody of the vehicle touches a rugged road surface, the vehicle may be damaged.

■ **Do not change the vehicle height frequently.**

The compressor might overheat and cause the operation to stop.

■ **When on the extremely uneven roads with rocks**

Sometimes the vehicle height is not adjusted because it is judged as uneven road driving.

Driving mode select switch *

*: If equipped

The driving modes can be selected to suit driving condition.

System components

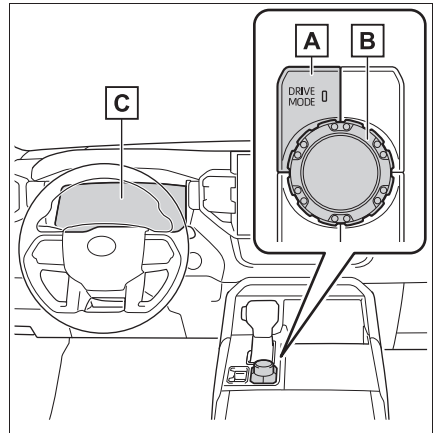

- A** “DRIVE MODE” switch
- B** Mode select switch
- C** Multi-information display
(→P.95)

Selecting the driving mode

- 1 Press the “DRIVE MODE” switch.

The indicator **A** on the switch will turn on.

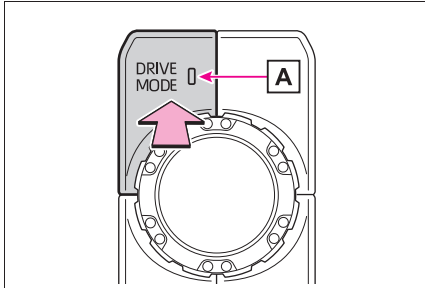

- 2 Select the driving modes on the multi-information display while turning the mode select switch left and right.

- ▶ Vehicles without Adaptive Variable Suspension system

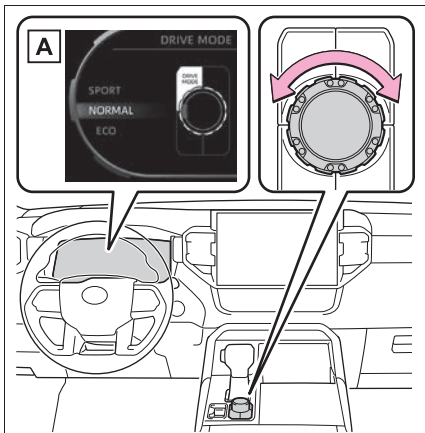

A Multi-information display

- “NORMAL” mode

Provides an optimal balance of fuel economy, quietness, and dynamic

performance. Suitable for city driving.

- “ECO” mode

Helps the driver accelerate in an eco-friendly manner and improve fuel economy through moderate throttle characteristics and by controlling the operation of the air conditioning system (heating/cooling). The “ECO” indicator comes on.

- “SPORT” mode

Assists acceleration response by controlling the transmission, engine and steering. Suitable for when precise handling is desirable, for example when driving on mountain roads. The “SPORT” indicator comes on.

- ▶ Vehicles with Adaptive Variable Suspension system

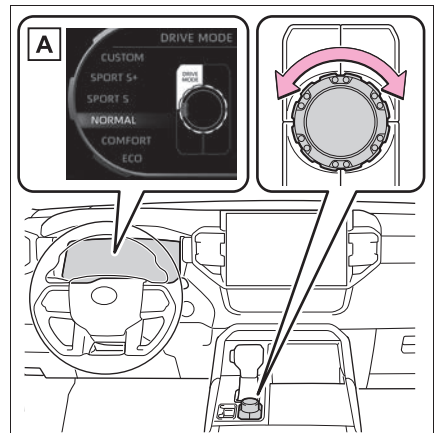

A Multi-information display

- “NORMAL” mode

Provides an optimal balance of fuel economy, quietness, and dynamic performance. Suitable for city driving.

- “COMFORT” mode

By controlling the suspension, riding comfort is further enhanced. Suitable for city driving. The “COMFORT” indicator comes on.

- “ECO” mode

Helps the driver accelerate in an eco-friendly manner and improve fuel economy through moderate throttle characteristics and by controlling the operation of the air conditioning system (heating/cooling). The “ECO” indicator comes on.

- “SPORT S” mode

Assists acceleration response by controlling the transmission, engine and steering. Suitable for when precise handling is desirable, for example when driving on mountain roads. The “SPORT S” indicator comes on.

- “SPORT S+” mode

Helps to ensure the controllability and stability of the vehicle by integrally controlling the steering wheel and suspensions as well as the transmission and engine, making it suitable for sporty driving. The “SPORT S+” indicator comes on.

- “CUSTOM” mode

Allows you to drive with the power train, chassis and air conditioning system functions set to your preferred settings. Custom mode settings can only be changed on the drive mode customization display of multimedia system. The “CUSTOM” indicator comes on.

is in “2H” and “4H”.

■ **Operation of the air conditioning system in Eco mode**

Eco mode controls the heating/cooling operations and fan speed of the air conditioning system to enhance fuel efficiency. To improve air conditioning performance, perform the following operations:

- Adjust the fan speed (→P.419)
- Turn off Eco drive mode (→P.377)

■ **Automatic deactivation of driving modes:**

Driving mode is deactivated or the driving mode will be changed to normal mode in the following conditions:

- After turning the power switch off and then turning it to on
- When the front-wheel drive control switch is in “4L” (4WD models only)
- When the Multi-terrain Select is turned on (if equipped)
- When the Downhill assist control system is turned on (if equipped)
- When the “TOW HAUL” mode or “TOW+” mode is turned on (if equipped)

■ **Customization**

The Custom mode can be changed. (Customizable features: →P.598)

■ **The driving mode select switch can be operated when**

The front-wheel drive control switch

Four-wheel drive system*

*: If equipped

Use the front-wheel drive control switch to select the following transfer modes:

Front-wheel drive control switch

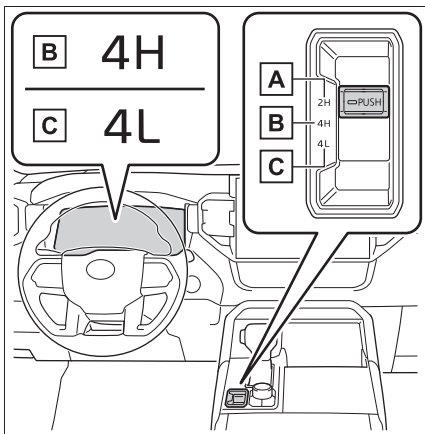

A “2H” (high speed position, two-wheel drive)

Use this for normal driving on dry hard-surfaced roads. This position gives greater economy, quietest ride and least wear.

B “4H” (high speed position, four-wheel drive)

Use this for driving only on tracks that permit the tires slide, like off-road, icy or snow-covered roads. This position provides greater traction than two-wheel drive.

The “4H” indicator will come on.

C “4L” (low speed position,

four-wheel drive)

Use this for maximum power and traction. Use “4L” for climbing or descending steep hills, off-road driving, and hard pulling in sand, mud or deep snow.

The “4L” indicator will come on.

Shifting between “2H” and “4H”

■ Shifting from “2H” to “4H”

- 1 Reduce vehicle speed to less than 62 mph (100 km/h).
- 2 Push and shift the front-wheel drive control switch to “4H”.

The “4H” indicator will come on.

■ Shifting from “4H” to “2H”

- 1 Reduce vehicle speed to less than 62 mph (100 km/h).
- 2 Push and shift the front-wheel drive control switch to “2H”.

The “4H” indicator will go off.

Shifting between “4H” and “4L”

■ Shifting from “4H” to “4L”

- 1 Stop the vehicle completely and continue to depress the brake pedal.
- 2 Shift the shift lever to N.
- 3 Push and shift the front-wheel drive control switch to “4L”.

The “4L” indicator will come on.

■ Shifting from “4L” to “4H”

- 1 Stop the vehicle completely and continue to depress the brake pedal.
- 2 Shift the shift lever to N.
- 3 Push and shift the front-wheel drive control switch to “4H”.

The “4L” indicator will go off.

■ When the front-wheel drive control switch is shifted to “4L”

VSC is automatically turned off.

■ If the “4H” indicator flashes

The transfer mode may not successfully change. Drive straight ahead while accelerating or decelerating, or drive in reverse.

■ If the “4H” indicator is ON and the “4L” indicator continues to flash

A message will be displayed in the multi-information display. Follow a message, shift the shift lever to D or R and drive the vehicle slowly, then stop.

■ If the “4H” indicator continues to flash and the “4L” indicator is ON

A message will be displayed in the multi-information display. Follow a message, shift the shift lever to D or R and drive the vehicle slowly, then stop.

■ If the “4H” indicator is ON and the “4L” indicator continues to flash and a buzzer sounds

The shift lever is not in N and/or the vehicle is moving. Stop the vehicle completely, shift the shift lever to N and make sure that the indicator stops flashing.

■ If the “4H” indicator continues to flash and the “4L” indicator is ON and a buzzer sounds

The shift lever is not in N and/or the vehicle is moving. Stop the vehicle completely, shift the shift lever to N and make sure that the indicator stops flashing

■ If the “4H” and “4L” indicator flashes rapidly

There may be a malfunction in the four-wheel drive system. Have the vehicle inspected by your Toyota dealer immediately.

■ Four-wheel drive usage frequency

You should drive in four-wheel drive for at least 10 miles (16 km) each month. This will assure that the front drive components are lubricated.



WARNING

■ Shifting the front-wheel drive control switch from “2H” to “4H” while driving

Never operate the front-wheel drive control switch if the wheels are slipping. Stop the slipping or spinning before shifting.

■ When the vehicle is parked

If the shift lever is moved before the “4L” indicator turns on/off, the transfer mode may not be shifted completely. The transfer mode disengages both the front and rear driveshafts from the powertrain and allows the vehicle to move regardless of the shift position. (At this time, the indicator blinks and the buzzer sounds.) Therefore, the vehicle is free to roll even if the automatic transmission is in P. You or someone else could be seriously injured. You must complete the shifting of the transfer mode before placing transmission in P.

AUTO LSD system*

*: If equipped

The AUTO LSD system aids traction by using the traction control system to control hybrid system performance and braking when one of the drive wheels begins to spin. The system should be used only when one of the drive wheels spinning occurs in a ditch or rough surface.

System operation

The system can be used only on 2WD models. The system is activated when driving at a speed under 62 mph (100 km/h). The AUTO LSD system will be activated with the following two procedures.

To turn the AUTO LSD system on, quickly press and release



The “AUTO LSD” indicator light will come on.

Press  again to turn the system off.

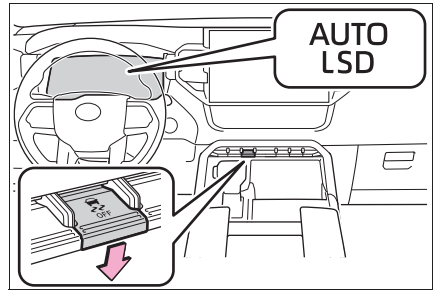

■ If the brake system overheats

The system will cease operation and a buzzer will alert the driver. At this time, the “Traction Control Turned OFF” displayed in the multi-information display. Stop the vehicle in a safe place. (There is no problem with continuing normal driving.) The system will be automatically restored after a short time.

▲ WARNING

■ To avoid an accident

- Do not use the AUTO LSD system in conditions other than when one of the drive wheels spinning occurs in a ditch or rough surface.
- Do not drive with the AUTO LSD system continuously turned on.

Failure to do so, a much greater steering effort and more careful cornering control will be required.

▲ NOTICE

■ Activating while driving

Do not activate the AUTO LSD system if the wheel is slipping. Stop the slipping or spinning before activating.

Rear differential lock system*

*: If equipped

Use the rear differential lock system only when wheel spinning occurs in a ditch or on a slippery or ragged surface. This system is effective in case one of the rear wheels is spinning.

Rear differential lock switch

Press the switch to turn the system on/off.

At this time, the rear differential lock indicator and indicator in the differential lock/unlock display will blink. Wait a few seconds for the system to complete operation. After the rear differential is locked, the indicators will stop blinking and remain on.

To unlock the rear differential, push the switch again.

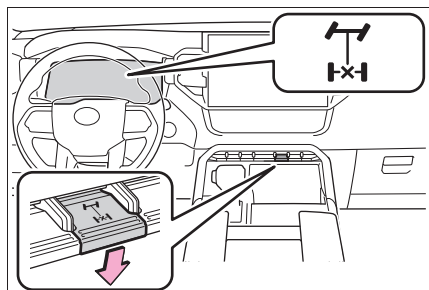

■ Operating tips

- Be sure to stop the wheels before locking the differential.
- Unlock the differential as soon as

the vehicle moves out.

■ Unlocking the rear differential

If the rear differential lock indicator still flashes even after unlocking the rear differential, check the safety of the surrounding area and slightly turn the steering wheel in either direction while the vehicle is in motion.

■ Automatic unlocking feature

The rear differential lock is also unlocked in any of the following situations:

- When the front-wheel drive control switch is turned to “2H” or “4H”
- When the power switch is turned off

■ After unlocking the rear differential

Check that the indicators go off.

■ The rear differential lock indicator and indicator in the differential lock/unlock display

- The indicators blink while locking/unlocking the rear differential.
- If the indicators continue to blink when you operate the rear differential lock switch, stop the vehicle completely and operate the switch again.

If the indicators continue to blink even if doing so, have the vehicle inspected by your Toyota dealer as soon as possible. There may be a trouble in the four-wheel drive system.

■ Locking the rear differential

The following systems do not operate when the rear differential is locked.

- ABS
- Brake assist system
- VSC
- Downhill assist control system (if equipped)
- TRAC

**WARNING****■ When using the rear differential lock system**

Failure to observe the following precautions may result in an accident.

- Do not lock the rear differential in the conditions other than above.
- Do not lock the rear differential until the wheels have stopped spinning.
- Do not drive over 5 mph (8 km/h) when the differential is locked.
- Do not keep driving with the rear differential lock state

Crawl Control*

*: If equipped

Allows travel on extremely rough off-road surfaces at a fixed low speed without pressing the accelerator or brake pedal. Minimizes loss of traction or vehicle slip when driving on slippery road surfaces, allowing for stable driving.

**WARNING****■ When using Crawl Control function**

Do not rely solely on the Crawl Control function. This function does not extend the vehicle's performance limitations. Always thoroughly check the road conditions, and drive safely.

■ These conditions may cause the system not to operate properly

When driving on the following surfaces, the system may not be able to maintain a fixed low speed, which may result in an accident:

- Extremely steep inclines.
- Extremely uneven surfaces.
- Snow-covered roads, or other slippery surfaces.

System components

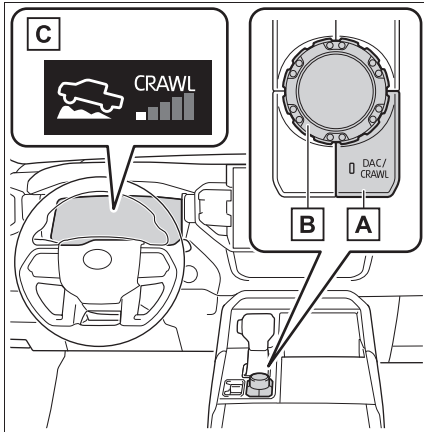

- A** “DAC/CRAWL” switch
- B** Mode select switch
- C** Indicators (→P.89)

Turning Crawl Control on

- 1 Press the “DAC/CRAWL” switch.

The indicator light **A** and the Crawl Control indicator on the multi-information display will come on, and the slip indicator will flash.

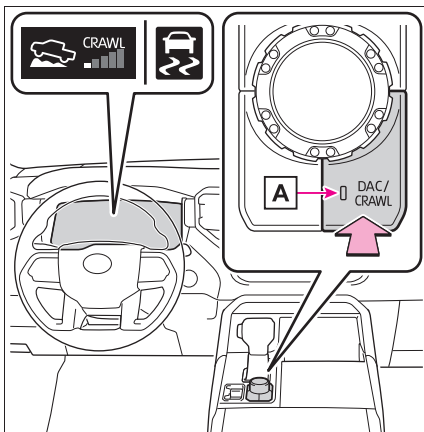

- 2 Turn the mode select switch left or right to select a mode on the multi-information display.

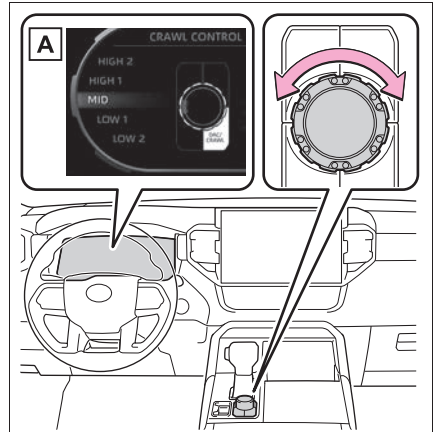

- A** Multi-information display

Selectable modes

A mode which matches the road conditions can be selected from among the following 5 modes.

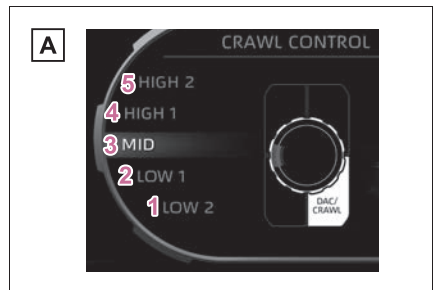

- A** Multi-information display

- 1 “LOW 2”

Suitable for driving on rocky roads or decline

- 2 “LOW 1”

Suitable for driving on rocky roads, decline or bumpy incline

3 “MID”

Suitable for driving on bumpy inclines

4 “HIGH 1”

Suitable for driving on bumpy inclines, debris roads, snow-covered roads, muddy roads, gravel roads and grass roads

5 “HIGH 2”

Suitable for driving on bumpy inclines, debris roads, snow-covered roads, muddy roads, gravel roads and grass roads

Turning Crawl Control off

- ▶ When the “DAC/CRAWL” switch indicator illuminates

Press the “DAC/CRAWL” switch again.

- ▶ When the “DAC/CRAWL” switch indicator does not illuminate

Press the “DAC/CRAWL” switch to turn the indicator on. Press the “DAC/CRAWL” switch again with the indicator turned on.

If Crawl Control is turned off, the Crawl Control indicator and the slip indicator will go off and a message, stating that Crawl Control has been turned off will be displayed on the multi-information display for several seconds.

When turning off Crawl Control while driving, drive extremely carefully.

■ Operating tips

Crawl Control can be used with Multi-terrain Select (if equipped) ON or OFF. (→P.387)

■ Operation conditions of the Crawl Control

- The hybrid system is operating.
- The shift lever is in any gear other than P or N.
- The front-wheel drive control switch is in “4L”.
- The driver’s door is closed.

■ Automatic system cancelation of Crawl Control

In the following situations, the buzzer will sound intermittently and the Crawl Control will be canceled automatically. In this event, the Crawl Control indicator will flash and then go off, and a message stating that Crawl Control has been turned off will be displayed on the multi-information display for several seconds.

- When the shift lever is moved to P or N.
- When the front-wheel drive control switch is in “4H”.
- When the driver’s door is opened.

■ Function limitations of Crawl Control

- On vehicles with rear differential lock system, in the following situations, brake control can be used to drive downhill at a constant speed. However, hybrid system control is not available when driving uphill at a constant speed.
- When the vehicle speed exceeds approximately 6 mph (10 km/h).

- In the following situation, hybrid system control and brake control will stop temporarily. In this event, the Crawl Control indicator will flash.
- With the rear differential is locked: when the vehicle speed exceeds approximately 6 mph (10 km/h).
- With the rear differential is unlocked: when the vehicle speed exceeds approximately 15 mph (25 km/h).

■ When the Crawl Control system is operated continuously

- If Crawl Control is used continuously for a long time, the brake system overheats. In this case, a buzzer will sound, a message stating a malfunction will be displayed on the multi-information display, and the Crawl Control indicator will flash and then go off. In this event, as Crawl Control will be temporarily inoperable, stop the vehicle immediately in a safe place, and allow the brake system to cool down sufficiently until the message goes off. (In the meantime, normal driving is possible.)
- If Crawl Control is used continuously for a long time, the automatic transmission overheats. In this case, a buzzer will sound, the system will be temporarily canceled, and a message stating a malfunction may be displayed on the multi-information display. In this event, stop the vehicle in a safe place until the message goes off.

■ Sounds and vibrations caused by the Crawl Control system

- A sound may be heard from the hybrid system compartment when the hybrid system is started or just after the vehicle begins to move. This sound does not indicate that a malfunction has occurred in Crawl Control system.
- Either of the following conditions may occur when the Crawl Control

system is operating. None of these are indicators that a malfunction has occurred.

- Vibrations may be felt through the vehicle body and steering.
- A motor sound may be heard after the vehicle comes to a stop.

■ When there is a malfunction in the system

Warning lights and/or warning messages will turn on. (→P.527, 537)

Multi-terrain Select*

*: If equipped

Multi-terrain Select is a system that improves drivability in off-road situations.

Select a mode that most closely matches the type of terrain on which you are driving from several modes.

Brake control, steering feel and drive force control can be optimized in accordance with the selected mode.

WARNING

■ When using the Multi-terrain Select

Observe the following precautions to avoid an accident that could result in death or serious injuries:

- Check that the selected mode indicators are illuminated before driving. Multi-terrain Select will not operate when the indicators are off.
- The road conditions listed (→P.388) are for reference only. There is a chance that the function may not be the most appropriate in terms of road conditions such as pitch, slipperiness, undulation, etc. Thoroughly check the road conditions before driving.
- Multi-terrain Select is not intended to expand the limits of the vehicle. Check the road conditions thoroughly beforehand, and drive safely and carefully.

NOTICE

■ Precaution for use

The Multi-terrain Select is intended for use during off-road driving. Do not use the system at any other time.

System components

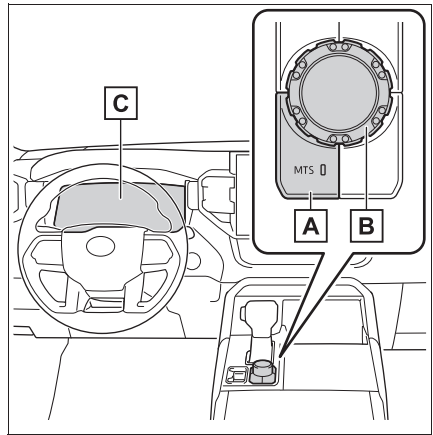

A “MTS” switch

B Mode select switch

C Multi-information display

Selected mode is displayed.

Switching modes

- 1 Press the “MTS” switch.

The indicator **A** on the switch will turn on.

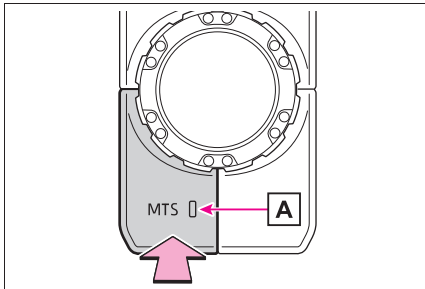



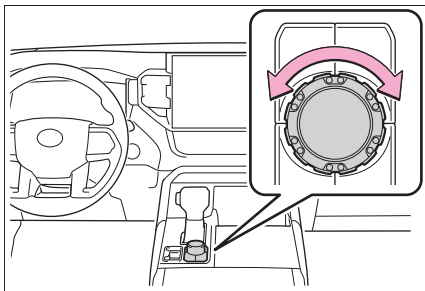

- 2 Select the Multi-terrain Select modes on the multi-information display while turning the mode select switch left and right.

Depending on the positions of the front-wheel drive control switch, a mode can be selected from among the following modes.







- ▶ Front-wheel drive control switch is in “4L”

Mode	Road Conditions
 “AUTO”	Suitable for the road conditions
 “SAND”	Suitable for sandy roads and other slippery conditions
 “MUD”	Suitable for muddy roads and other slippery conditions
 “ROCK”	Suitable for rocky terrain

If the brake control has activated, the slip indicator light will flash.

- ▶ Front-wheel drive control switch is in “4H”

Mode	Road Conditions
 “AUTO”	Suitable for the road conditions
 “DIRT”	Suitable for bumpy road conditions, such as dirt roads
 “SAND”	Suitable for sandy roads and other slippery conditions

Mode		Road Conditions
	“MUD”	Suitable for muddy roads and other slippery conditions
	“DEEP SNOW”	Suitable for deep snow roads

If the brake control has activated, the slip indicator light will flash.

When the vehicle is in “SAND”, “MUD” or “DEEP SNOW” mode, VSC is automatically turned off. (VSC OFF indicator light come on.)

■ Multi-terrain Select

Multi-terrain Select controls the vehicle so that it can maximize the drive force and improve drivability on rough roads. As a result, fuel efficiency may diminish when compared to driving in normal mode.

■ Automatic system cancelation

In the following situations, Multi-terrain Select will be canceled automatically.

- When the power switch is turned off
- When the front-wheel drive control switch is in “2H”
- When “TOW HAUL” mode and “TOW+” mode is selected while the front-wheel drive control switch is in “4H”
- When drive mode select is selected while the front-wheel drive control switch is in “4H”

■ Turning off Multi-terrain Select

Performing the following turns Multi-terrain Select off, and then the display on the multi-information display will disappear.

- ▶ When the “MTS” switch indicator is illuminated

Press the “MTS” switch while the system is in operation.

- ▶ When the “MTS” switch indicator is not illuminated

Press the “MTS” switch to turn the indicator on.

Press the “MTS” switch again with the Multi-terrain Select indicator illuminated.

■ When the vehicle is stuck

Switching the transfer and differential functions, refer to the following pages. (If equipped)

- Four-wheel drive system (→P.379)
- Rear differential lock (→P.382)

■ Driving in Multi-terrain Select

The following types of situations may occur, but they are not malfunctions.

- Vibrations may be felt throughout the vehicle or steering wheel.
- Operating noise may be heard from the hybrid system compartment.

■ When an inspection at your Toyota dealer is necessary

In the following situations, the system may be malfunctioning. Have the vehicle inspected by your Toyota dealer immediately.

- When the slip indicator light illuminates.
- When the indicator for each mode does not illuminate on the multi-information display even though Multi-terrain Select is selected.

Downhill assist control system*

*: If equipped

The downhill assist control system helps to prevent excessive speed on steep downhill slopes. The system will operate when the vehicle is traveling under 18 mph (30 km/h) and transfer mode is in “4H”.

⚠ WARNING

■ When using downhill assist control system

Do not rely overmuch on the downhill assist control system. This function does not extend the vehicle's performance limitations. Always thoroughly check the road conditions, and drive safely.

System components

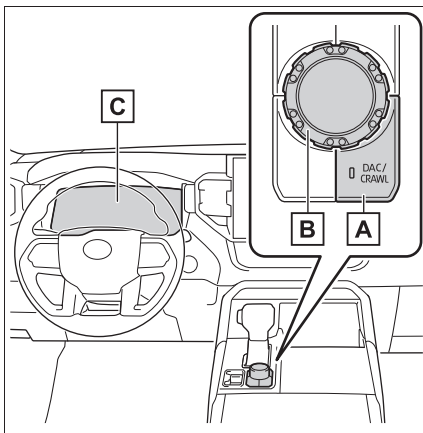

A “DAC/CRAWL” switch

B Mode select switch

C Multi-information display

System operation

Press the “DAC/CRAWL” switch.

The downhill assist control system indicator will come on and the system will operate.

When the system is in operation, the slip indicator will flash, and the stop lights/high mounted stop lights will be lit. A sound may also occur during the operation. This does not indicate a malfunction.

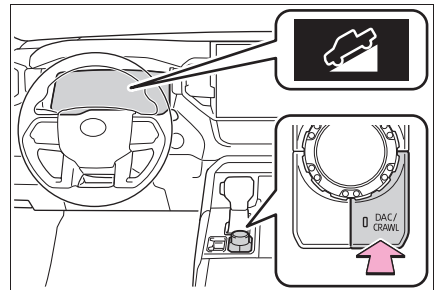

Setting the speed of the downhill assist control system

Turn the mode select switch to set the desired speed (approx. 3 mph [4 km/h] to 18 mph [30 km/h]). The set speed is displayed on the multi-information display.

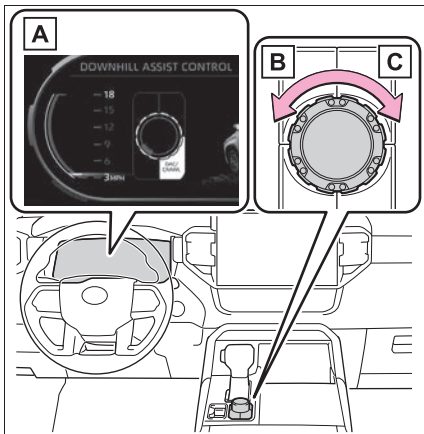

- A** Multi-information display
- B** Decreases the speed
- C** Increases the speed

Turning off the system

- ▶ When the “DAC/CRAWL” switch indicator illuminates

Press the “DAC/CRAWL” switch again.

- ▶ When the “DAC/CRAWL” switch indicator does not illuminate

Press the “DAC/CRAWL” switch to turn the indicator on.

Press the “DAC/CRAWL” switch again with the indicator turned on.

The downhill assist control system indicator will flash as the system gradually ceases operation, and will turn off when the system is fully off.

Press the “DAC/CRAWL” switch while the downhill assist control system indicator is flashing to start the system again.

Operating tips

- Downhill assist control system can be used with “TOW HAUL” mode and “TOW+” mode, drive mode select, or Multi-terrain Select ON or OFF.
- The system will operate when the shift lever is in a position other than P, however to make effective use of the system it is recommended to select a lower shift range.
- **If the downhill assist control system indicator flashes**

- In the following situations, the indicator flashes and the system will not operate:
 - The front-wheel drive control switch is changed to a position other than “4H”.
 - The shift lever is in P.
 - The vehicle speed exceeds approximately 18 mph (30 km/h).
 - The brake system overheats.
- In the following situations, the indicator flashes to alert the driver, but the system will operate:
 - The shift lever is in N.
 - The “DAC/CRAWL” switch is pressed while the “DAC/CRAWL” switch indicator illuminates.

The system will gradually cease operation. The indicator will flash during operation, and then go off when the system is fully off.

■ When the downhill assist control system is operated continuously

If the downhill assist control system is operated for a long period of time, the brake system may abnormally overheat. To prevent that, a buzzer will sound and the function is temporarily stopped. In this case, the downhill assist control system indicator will flash. (The vehicle can be driven normally during this time) When the downhill assist control system indicator switches to steadily illuminated after a short while and the system will become available.

■ Sounds and vibrations caused by the downhill assist control system

- A sound may be heard from the hybrid system compartment when the hybrid system is started or just after the vehicle begins to move. This sound does not indicate that a malfunction has occurred in downhill assist control system.
- Either of the following conditions may occur when the downhill assist control system is operating. None of these are indicators that a malfunction has occurred.
 - Vibrations may be felt through the vehicle body and steering.
 - A motor sound may be heard after the vehicle comes to a stop.

■ System malfunction

In the following cases, have your vehicle checked by your Toyota dealer.

- The downhill assist control system indicator does not come on when the “DAC/CRAWL” switch is pressed.
- The slip indicator light comes on.

WARNING

- **The system may not operate on the following surfaces, which may lead to an accident causing death or serious injury**
 - Slippery surfaces such as wet or muddy roads
 - Icy surface
 - Very bumpy and rough roads

Driving assist systems

To keep driving safety and performance, the following systems operate automatically in response to various driving situations. Be aware, however, that these systems are supplementary and should not be relied upon too heavily when operating the vehicle.

Summary of the driving assist systems

■ ECB (Electronically Controlled Brake System)

The electronically controlled system generates braking force corresponding to the brake operation

■ ABS (Anti-lock Brake System)

Helps to prevent wheel lock when the brakes are applied suddenly, or if the brakes are applied while driving on a slippery road surface, or in off-road conditions (such as rough roads, sand and mud)

The ABS operates in synchronization with the Multi-terrain Select

■ Brake assist

Generates an increased level of braking force after the brake pedal is depressed when the

system detects a panic stop situation

■ Enhanced VSC (Enhanced Vehicle Stability Control)

Provides cooperative control of the ABS, TRAC, VSC and EPS.

Helps to maintain directional stability when swerving on slippery road surfaces by controlling steering performance.

■ Trailer Sway Control

Helps the driver to control trailer sway by selectively applying brake pressure for individual wheels and reducing driving torque when trailer sway is detected.

■ TRAC (Traction Control)

Helps to maintain drive power and prevent the drive wheels from spinning when starting the vehicle or accelerating on slippery roads

■ Hill-start assist control

Helps to reduce the backward movement of the vehicle when starting on an uphill

■ AVS (Adaptive Variable Suspension System) (if equipped)

The damping force of the shock absorbers are independently controlled for the 4 wheels according to factors including the road surface conditions and driving operation, contributing toward enhancing smooth driv-

ing comfort and superior stability, and helping to maintain vehicle posture.

In addition, the damping force can be changed by selecting the drive mode with the driving mode select (→P.376), and driving comfort can be ensured during off-road driving by setting the front-wheel drive control switch to “4L”. (→P.379)

■ **EPS (Electric Power Steering)**

Employs an electric motor to reduce the amount of effort needed to turn the steering wheel.

■ **The Secondary Collision Brake**

When the SRS airbag sensor detects a collision and the system operates, the brakes and brake lights are automatically controlled to reduce the vehicle speed and help reduce the possibility of further damage due to a secondary collision.

■ **When the TRAC/VSC/ABS/Trailer Sway Control systems are operating**

The slip indicator light will flash while the TRAC/VSC/ABS/Trailer Sway Control systems are operating.

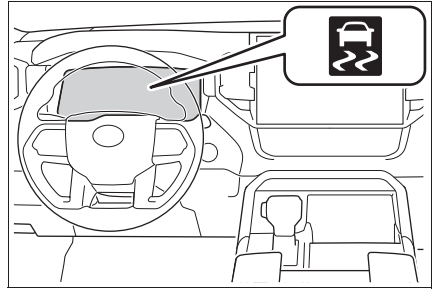

■ **Disabling the TRAC system**

If the vehicle gets stuck in mud, dirt or snow, the TRAC system may reduce power from the hybrid system to the wheels. Pressing  to turn the system off may make it easier for you to rock the vehicle in order to free it.

To turn the TRAC system off, quickly press and release .

“Traction Control Turned OFF” is displayed in the multi-information display.

Press  again to turn the system back on.

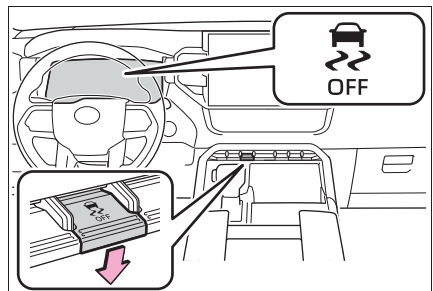

■ **Turning off the TRAC/VSC/Trailer Sway Control systems**

To turn the TRAC, VSC and Trailer Sway Control systems off, press and hold  for more than 3 seconds while the vehicle is stopped. The “Traction Control Turned OFF”

is displayed in the multi-information display and the VSC OFF indicator light will come on.*

Press  again to turn the system back on.

*: PCS will also be disabled (only Pre-Collision warning is available). The PCS warning light will come on and a message will be displayed on the multi-information display. (→P.253, 529)

■ **When the message is displayed on the multi-information display showing that TRAC has been disabled even if  has not been pressed**

- TRAC is temporary deactivated. If the information continues to show, contact your Toyota dealer.
- When using Multi-terrain Select, the “VSC OFF” indicator will turn on depending on the mode, even if the VSC OFF switch has not been pressed.

■ **Operating conditions of hill-start assist control**

When the following five conditions are met, the hill-start assist control will operate:

- The shift lever is in a position other than P or N (when stating off forward/backward on an upward incline)
- The vehicle is stopped
- The accelerator pedal is not depressed
- The parking brake is not engaged
- The power switch is turned to ON

■ **Automatic system cancelation of hill-start assist control**

The hill-start assist control will turn off in any of the following situations:

- The shift lever is shifted to P or N

- The accelerator pedal is depressed
- The parking brake is engaged
- A maximum of 2 seconds have elapsed after the brake pedal is released
- The power switch is turned to OFF

■ **Sounds and vibrations caused by the ABS, brake assist, VSC, Trailer Sway Control, TRAC and hill-start assist control systems**

- A sound may be heard from the hybrid system compartment when the brake pedal is depressed repeatedly, when the hybrid system is started or just after the vehicle begins to move. This sound does not indicate that a malfunction has occurred in any of these systems.
- Any of the following conditions may occur when the above systems are operating. None of these indicates that a malfunction has occurred.
 - Vibrations may be felt through the vehicle body and steering.
 - A motor sound may be heard also after the vehicle comes to a stop.

■ **ECB operating sound**

ECB operating sound may be heard in the following cases, but it does not indicate that a malfunction has occurred.

- Operating sound heard from the engine compartment when the brake pedal is operated.
- Motor sound of the brake system heard from the front part of the vehicle when the driver' door is opened.
- Operating sound heard from the engine compartment when one or two minutes passed after the stop of the hybrid system.

■ Automatic reactivation of TRAC, Trailer Sway Control and VSC systems

After turning the TRAC, Trailer Sway Control and VSC systems off, the systems will be automatically re-enabled in the following situations:

- When the power switch is turned off
- If only the TRAC system is turned off, the TRAC will turn on when vehicle speed increases
- If both the TRAC and VSC systems are turned off, automatic re-enabling will not occur when vehicle speed increases.

■ Reduced effectiveness of the EPS system

The effectiveness of the EPS system is reduced to prevent the system from overheating when there is frequent steering input over an extended period of time. The steering wheel may feel heavy as a result. Should this occur, refrain from excessive steering input or stop the vehicle and turn the hybrid system off. The EPS system should return to normal within 10 minutes.

■ Secondary Collision Brake operating conditions

The system operates when the SRS airbag sensor detects a collision while the vehicle is in motion. However, the system does not operate when the components are damaged.

■ Secondary Collision Brake automatic cancelation

The system is automatically canceled in any of the following situations.

- The vehicle speed drops to approximately 0 mph (0 km/h).
- A certain amount of time elapses during operation
- The accelerator pedal is depressed a large amount

WARNING

■ The ABS does not operate effectively when

- The limits of tire gripping performance have been exceeded (such as excessively worn tires on a snow covered road).
- The vehicle hydroplanes while driving at high speed on wet or slick roads.

■ Stopping distance when the ABS is operating may exceed that of normal conditions

The ABS is not designed to shorten the vehicle's stopping distance. Always maintain a safe distance from the vehicle in front of you, especially in the following situations:

- When driving on dirt, gravel or snow-covered roads
- When driving with tire chains
- When driving over bumps in the road
- When driving over roads with potholes or uneven surfaces

■ TRAC/VSC may not operate effectively when

Directional control and power may not be achievable while driving on slippery road surfaces, even if the TRAC/VSC system is operating. Drive the vehicle carefully in conditions where stability and power may be lost.

■ Hill-start assist control does not operate effectively when

- Do not overly rely on hill-start assist control. Hill-start assist control may not operate effectively on steep inclines and roads covered with ice.

**WARNING**

- Unlike the parking brake, hill-start assist control is not intended to hold the vehicle stationary for an extended period of time. Do not attempt to use hill-start assist control to hold the vehicle on an incline, as doing so may lead to an accident.

■ When the TRAC/VSC/Trailer Sway Control is activated

The slip indicator light flashes. Always drive carefully. Reckless driving may cause an accident. Exercise particular care when the indicator light flashes.

■ When the TRAC/VSC/Trailer Sway Control systems are turned off

Be especially careful and drive at a speed appropriate to the road conditions. As these are the systems to help ensure vehicle stability and driving force, do not turn the TRAC/VSC/Trailer Sway Control systems off unless necessary.

Trailer Sway Control is part of the VSC system and will not operate if VSC is turned off or experiences a malfunction.

■ Replacing tires

Make sure that all tires are of the specified size, brand, tread pattern and total load capacity. In addition, make sure that the tires are inflated to the recommended tire inflation pressure level.

The ABS, TRAC, Trailer Sway Control and VSC systems will not function correctly if different tires are installed on the vehicle. Contact your Toyota dealer for further information when replacing tires or wheels.

■ Handling of tires and the suspension

Using tires with any kind of problem or modifying the suspension will affect the driving assist systems, and may cause a system to malfunction.

■ Trailer Sway Control precaution

The Trailer Sway Control system is not able to reduce trailer sway in all situations. Depending on many factors such as the conditions of the vehicle, trailer, road surface and driving environment, the Trailer Sway Control system may not be effective. Refer to your trailer owner's manual for information on how to tow your trailer properly.

■ If trailer sway occurs

Observe the following precautions.

Failing to do so may cause death or serious injury.

- Firmly grip the steering wheel. Steer straight ahead. Do not try to control trailer sway by turning the steering wheel.
- Begin releasing the accelerator pedal immediately but very gradually to reduce speed. Do not increase speed. Do not apply vehicle brakes.

If you make no extreme correction with the steering or brakes, your vehicle and trailer should stabilize. (→P.191)

**WARNING****■ Secondary Collision Brake**

Do not rely solely upon the Secondary Collision Brake. This system is designed to help reduce the possibility of further damage due to a secondary collision, however, that effect changes according to various conditions. Overly relying on the system may result in death or serious injury.

Trailer brake controller

The trailer brakes can be controlled by the Trailer brake controller via the 7-pin connector. By selecting the type of brakes that are being used on the trailer (electric or electric-over-hydraulic) and setting the “gain” for the controller, the manual brake slider is used to slow just the trailer. The vehicle brake pedal will also slow down as well as stop the trailer when applied, also via the same connector. “Gain” values, manual brake outputs, trailer brake types, and the trailer connection status are displayed in the multi-information display.

This vehicle comes equipped with a Toyota Genuine Trailer Brake Controller. Use of a third-party trailer brake controller along with the Toyota Genuine Trailer Brake Controller may have unexpected effects on the system. Toyota does not recommend the use of a third-party brake controller with this vehicle.

⚠ WARNING**■ When driving on slippery road surfaces**

When stopping with ABS activated, output to the trailer might be reduced in order to reduce the likelihood of trailer wheels to lock. The trailer is not equipped with ABS. Drive safely on slippery road surfaces.

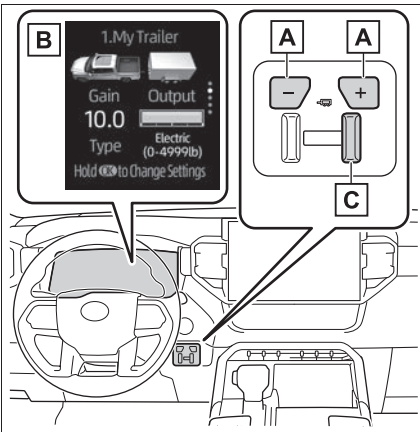
System operation**A** “GAIN” (+/-) selection button

Pressing the “GAIN” (+/-) buttons will adjust the amount of power that can be outputted to the trailer brakes. The “gain” can be adjusted from 0 (no trailer braking) to 10 (maximum output) in 0.5 increments. Each press of the button will increase or decrease the “gain” setting by one step. The “gain” value will appear in the multi-information display.

B Trailer brake type

Trailer brake type can be selected by using the multi-information. The combination meter will show which

trailer brake type is selected in the multi-information display.

C Manual brake slider

Adjusting this slider position will engage the trailer’s brakes only. If the manual brake slider is used while the vehicle brake is applied, the greater of the two outputs will be sent to the trailer brakes.

Changing settings of the trailer brake type

Select the item desired to be setup and select as follows on the multi-information screen (→P.100):

- 1 Press **<** or **>** on the meter control switch and then select .
- 2 Press **^** or **v** on the meter control switch, select “Trailer Settings”, and then press and hold **OK** on the meter control switch.
- 3 According to the display, select the desired setting and then press **OK**.

Changing trailer brake type or trailer ID will cause the current “gain” setting to reset to zero. Make sure to set the “gain” as described in the following section.

Setting the “Gain”

“Gain” setting on trailer brake controller should be set for a specific towing condition. “Gain” setting should be adjusted each time the vehicle load, trailer load, road conditions, or weather changes. Setting the “gain” value to 0 will disable the trailer brake controller output.

- 1 Make sure the trailer brakes are in good working condition and functioning normally. See trailer dealer if necessary.
- 2 Hook up the trailer and make proper electrical connections.
- 3 Select the correct type of trailer brakes that are equipped on the trailer by using the multi-information display.
- 4 Drive vehicle with trailer attached on a level road surface similar to towing condition and in traffic-free environment. Driving speed should be approximately 20 - 25 mph [35 - 40 km/h].

- 5 Using the “GAIN” (+/-) selection buttons, set a starting “gain” of 5.0.

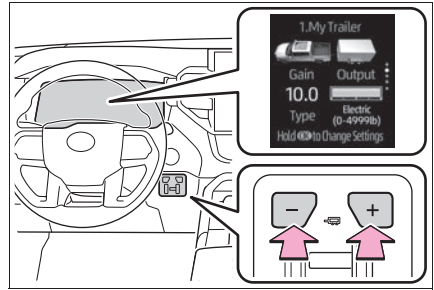

- 6 While driving 20 - 25 mph [35 - 40 km/h], fully apply the manual brake slider.
- 7 Adjust the “gain” setting, using the “GAIN” (+/-) selection buttons, to either increase or decrease to just below the point of trailer wheel lock-up.
- 8 For confirmation, repeat steps 6 and 7 until desired “gain” setting is reached (just below point of trailer wheel lock-up).

■ When setting the “gain”

Wheel lock-up occurs when the trailer wheel squeals or tire smoke occurs. Trailer wheels may not lock-up while driving heavily loaded trailer. During this case, adjust the Trailer “gain” to the highest allowable setting for the towing condition.

■ When disconnecting and reconnecting 12-volt battery terminals

The “gain” setting data will be reset.

■ Trailer Sway Control Function

Helps suppress trailer sway at an early stage by using the trailer brake

control system to operate the trailer brakes.

■ **If the Trailer brake warning light comes on**

Indicates a malfunction in the Trailer brake control system or Trailer connector circuit.

Have the vehicle inspected by your Toyota dealer immediately.

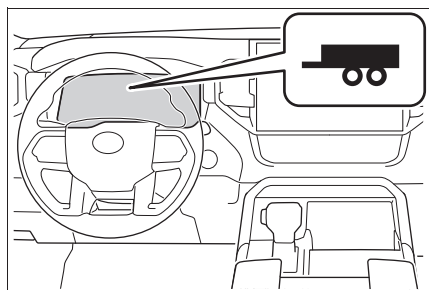

⚠ WARNING

■ **Trailer brake type setting**

It is the responsibility of the driver to make sure the trailer brakes are functioning normally and adjusted appropriately. Failure to check and maintain trailer brakes may result in loss of vehicle control, crash, or serious injury.

Trailer brake control system will work with most electric and electric-overhydraulic trailer braking systems up to 3 axles (24 A output to trailer brakes). Please be sure to test compatibility with the system at low speeds and in a safe area. If a warning message appears in the multi-information display (→P.537), have the vehicle inspected by your Toyota dealer immediately. Some electric-over-hydraulic trailer brakes will take some minimum output to activate. Trailer brake control system will not work with trailer hydraulic surge brakes.

Trailer Backup Guide*

*: If equipped

Trailer Backup Guide is a system to assist when backing up a trailer by providing either (1) steering control to assist backing up straight (Straight Path Assist) or (2) guidance for manual steering backup (Guidance mode).

Trailer Backup Guide uses the rear camera to detect the trailer and a trailer hitch light, which allows the driver to use the system at night time.

The system calculates the trailer angle by image processing from the rear camera and calculates trailer length and hitch length during the trailer setup (calibration) maneuver.

Procedure

- 1 Select “Trailer Settings” from  (→P.96) on the multi-information display and add a trailer according to the display.
- 2 Press the switch to turn the system ON.

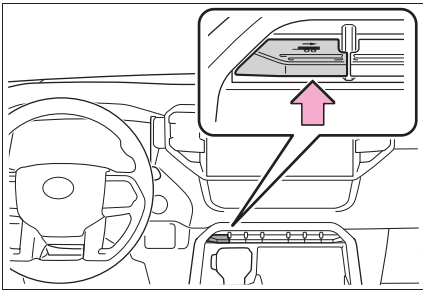

- 3 Continue or reselect the trailer in the message displayed on the multi-information display.

When the selected trailer is being used for the first time, setup (calibration) is necessary (→P.403).

Once calibration is completed, it is retained for future use and the system will automatically detect the trailer.

The driver needs to change the trailer selection when using a different trailer. The system does not automatically recognize the trailer from the saved trailers list.

- 4 Once trailer is detected, shift the shift lever to R to activate Guidance mode.

- 5 Touch the switch at the bottom right on multimedia to activate Straight Path Assist.

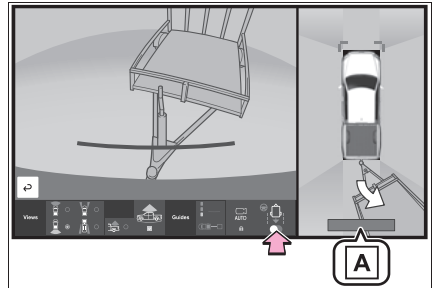





A “Trailer Direction”

When using Straight Path Assist, the driver can override the system using the steering wheel to adjust the trailer direction. Upon release of the steering wheel, Straight Path Assist re-activates with a revised straight back target direction.

■ When adding the trailer

Use the meter control switches to select the trailer type. (→P.96)

- 1 Press  or  to select .
- 2 Press  or  to select “Trailer Settings” and then press and hold **OK**.
- 3 According to the display, select the desired setting and then press **OK**. (→P.100)

Trailer Settings are not available while Trailer Backup Guide system is active.

The system is designed to support trailers with single or multi-axles using a ball hitch. The system does not support fifth wheel or gooseneck trailers.

Setup (Calibration)

Bring the vehicle and trailer to a large open space like an empty parking lot. Activate Trailer Backup Guide system and follow the instructions displayed on the multi-information display/multimedia.

For best calibration results, do not exceed 5 mph (8 km/h).

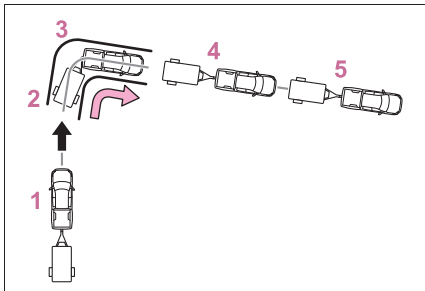

- 1** Drive straight forward slowly (5 mph [8 km/h] or less) while holding the steering wheel straight.
- 2** Stop vehicle with trailer straight and confirm blue line is aligned with trailer center in Camera view.
- 3** Drive forward slowly making a left or right turn that changes vehicle direction 90 degrees or more.
- 4** After completing the turn, continue straight forward slowly to align trailer.
- 5** Stop vehicle to complete calibration.

■ When calibrating the system

- Please check whether the blue line appropriately aligns with the center of the trailer in the camera view, such as in the following diagram, with regards to procedure **2**.

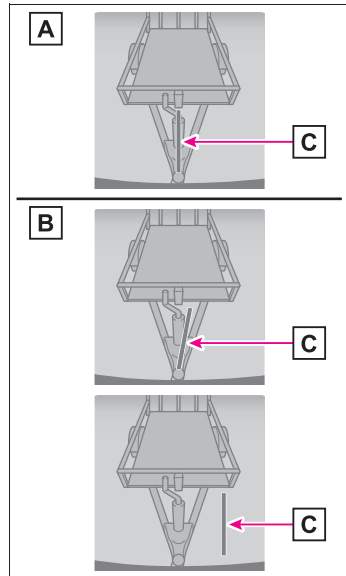

- A** State where the blue line aligns with the center of the trailer. (Select “Yes” in the multi-information display)
- B** State where the blue line does not align with the center of the trailer. (Select “No” in the multi-information display)
- C** Blue line

404 4-5. Using the driving support systems

- The system is designed to support most trailers 6.6 ft. (2 m) to 26.2 ft. (8 m) in length (length is defined from the coupler center point for the ball to the wheel axle [single axle] or center of the wheel axles [2 or more axles]) with ball mount lengths between 4.5 in. (114.3 mm) and 18.5 in. (469.9 mm). Do not attempt to use trailers or ball mounts that have a length outside of this range as the system performance degrades and could cause improper system function.

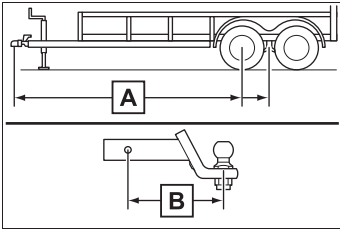

A Trailer length

B Ball mount length

- For best calibration results, calibrate in daytime on a smooth and level road.
- It may be necessary at times to recalibrate the trailer to improve performance.
- The system is designed to be used with the same trailer connection every time. If the ball mount position is changed or reconfigured or items are added to the trailer tongue after calibration, recalibration may be required.

Using Guidance mode

Guidance mode provides a “Trailer Direction” arrow that indicates the direction the trailer will swing, based on calculations from the steering wheel angle information. Guidance mode

provides a “BRAKE Extreme Trailer Angle” (jackknife) warning with warning buzzer to alert the driver that the trailer angle is near the jackknife condition.

Using Straight Path Assist

Touch the switch at the bottom right on multimedia to activate Straight Path Assist. Straight Path Assist controls steering to back up the trailer in a straight-line. The system can be overridden by using steering wheel to adjust trailer direction.

The driver is always responsible for paying attention to the vehicle’s surroundings and driving safely. This system does not control braking. Driver needs to control vehicle speed, control braking, and stop the vehicle to avoid any collision.

For best results, reverse slowly when using Straight Path Assist.

Canceling the system

- Trailer Backup Guide system is canceled when the trailer cannot be detected (e.g. dirty camera lens, insufficient lighting condition, obstruction of the trailer in the rear camera view, incorrectly selected trailer, etc.)
- Guidance mode is canceled

when any of the following occurs:

- Press the Trailer Backup Guide switch*
- Press the Camera switch*
- Vehicle speed is greater than approximately 4.7 mph (7.6 km/h)
- VSC or ABS is operated*
- Tailgate is opened*
- Trailer tracking is lost
- Shift the shift lever out of R
- There is a system malfunction*

*: Includes Trailer Backup Guide system cancel

- Straight Path Assist is canceled when any of the following occurs:
 - Any of the events, above, that cancel Guidance mode occur
 - Press the Straight Path Assist switch on the multimedia screen
 - The system temperature preservation function operates (to prevent power steering equipment from overheating)

Trailer hitch light

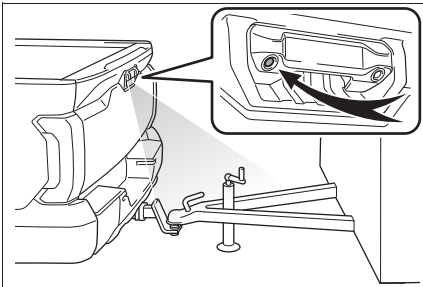

This light's usage for Trailer

Backup Guide is controlled by the Trailer Backup Guide system and the driver does not need to activate the light separately.

For other usage: →P.430

WARNING

■ Cautions regarding the use of the system

In order for this system to perform as designed, the vehicle must be driven safely and the driver must control the speed to keep it within operating parameters and to avoid a collision.

As there is a limit to the degree of control performance that this system can provide, do not overly rely on this system. The driver is always responsible for paying attention to the vehicle's surroundings and driving safely. This system does not control braking (or steering when in Guidance mode). Driver needs to control vehicle speed, control braking, (and steering when in Guidance mode,) and stop the vehicle to avoid any collision. Failure to follow this warning could result in property damage, serious injury or death.

■ When using the Trailer Backup Guide

For proper system performance, observe the following precautions. Failure to do so may lead to an accident resulting in property damage, serious injury, or death.

- Keep the tailgate fully latched.
- Keep the rear camera clean at all times.
- Do not change the installation position or direction of the rear camera or remove it.

**WARNING**

- Do not modify the trailer hitch light. (→P.405)
- Make sure nothing can obstruct the rear camera view of the trailer.

The system is designed to operate in various weather and lighting conditions and on different ground surfaces (asphalt, grass, gravel, etc.), however performance can still be affected by various environmental factors (e.g. shadow passing over the trailer or diminished contrast between trailer and the ground leading to trailer detection being lost, etc.) so always drive carefully, remain alert and aware of your surroundings, and do not overly rely on the system.

Active front spoiler*

*: If equipped

The equipped active front spoiler operates automatically while the vehicle is being driven. This active front spoiler enhances aerodynamic performance especially at high speeds, contributing to a more stable ride.

■ Automatic operating conditions

- The active front spoiler will activate automatically as follows according:

Conditions	Speed mph (km/h)
Deploy	Over 37 (60)
Retract	Under 25 (40)

Always observe the legal speed limit when driving on public roads.

- Automatically operates when the outside temperature is 40°F (5°C) and above.
- Automatically stows when in Tow mode.
- Automatically stows when in “4H” mode or “4L” mode. (If equipped)

When there is a malfunction in the system, avoid high speed driving and have the vehicle inspected by your Toyota dealer.

**NOTICE****■ To prevent system damage**

- Do not attach any accessories or other foreign objects to the active front spoiler.

 NOTICE

- Do not modify or disassemble the active front spoiler.
- Do not subject the active front spoiler to severe impacts.

Manually deploying the active front spoiler

It is necessary to deploy the Active front spoiler to remove the engine under cover for maintenance.

■ Lowering the active front spoiler to the service position

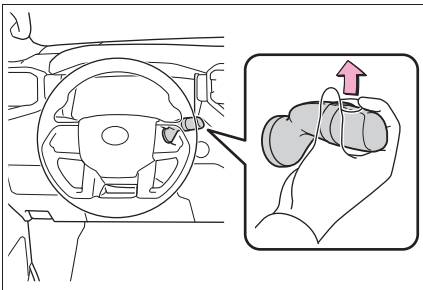

Within approximately 45 seconds of turning the power switch off, move the wiper lever to the **MIST** ^{*1} or **△** ^{*2} position and hold it for approximately 2 seconds or more.

The active front spoiler will move to the service position.

^{*1}: U.S.A.

^{*2}: Canada

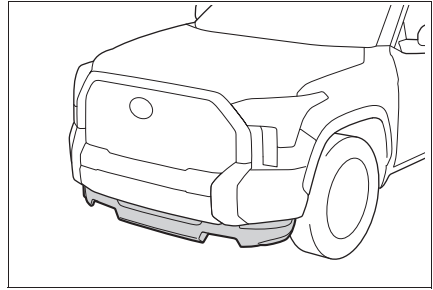

■ Raising the active front spoiler to the retracted position

Turn the power switch to ON, and when the shift lever is put in R or D, the active front spoiler will retract to the stowed position.

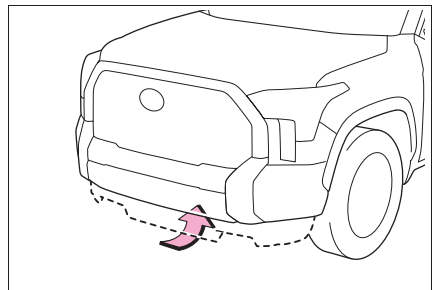

 NOTICE

■ To prevent damage to the active front spoiler

Before manually deploying or stowing the active front spoiler, make sure there are no obstacles or foreign objects in the surrounding area.

Hybrid Electric Vehicle driving tips

For economical and ecological driving, pay attention to the following points:

Using Eco drive mode

When using Eco drive mode, the torque corresponding to the accelerator pedal depression amount can be generated more smoothly than it is in normal conditions. In addition, the operation of the air conditioning system (heating/cooling) will be minimized, improving the fuel economy. (→P.376)

Use of Hybrid System Indicator

The Eco-friendly driving is possible by keeping the indicate of Hybrid System Indicator within Eco area. (→P.97)

Shift lever operation

Shift the shift lever to D when stopped at a traffic light, or driving in heavy traffic etc. Shift the shift lever to P when parking. When using the N, there is no positive effect on fuel consumption. When using the air conditioning system, etc., the hybrid battery (traction battery) power is consumed.

Accelerator pedal/brake pedal operation

- Drive your vehicle smoothly. Avoid abrupt acceleration and deceleration. Gradual acceleration and deceleration will make more effective use of the electric motor (traction motor) without having to use gasoline engine power.
- Avoid repeated acceleration. Repeated acceleration consumes hybrid battery (traction battery) power, resulting in poor fuel consumption. Battery power can be restored by driving with the accelerator pedal slightly released.

When braking

Make sure to operate the brakes gently and in a timely manner. A greater amount of electrical energy can be regenerated when slowing down.

Delays

Repeated acceleration and deceleration, as well as long waits at traffic lights, will lead to bad fuel economy. Check traffic reports before leaving and avoid delays as much as possible. When driving in a traffic jam, gently release the brake pedal to allow the vehicle to move forward slightly while avoiding

overuse of the accelerator pedal. Doing so can help control excessive gasoline consumption.

Highway driving

Control and maintain the vehicle at a constant speed. Before stopping at a toll booth or similar, allow plenty of time to release the accelerator and gently apply the brakes. A greater amount of electrical energy can be regenerated when slowing down.

Air conditioning

Use the air conditioning only when necessary. Doing so can help reduce excessive gasoline consumption.

In summer: When the ambient temperature is high, use the recirculated air mode. Doing so will help to reduce the burden on the air conditioning system and reduce fuel consumption as well.

In winter: Because the gasoline engine will not automatically cut out until it and the interior of the vehicle are warm, it will consume fuel. Also, fuel consumption can be improved by avoiding overuse of the heater.

Checking tire inflation pressure

Make sure to check the tire inflation pressure frequently. Improper tire inflation pressure can cause poor fuel economy. Also, as snow tires can cause large amounts of friction, their use on dry roads can lead to poor fuel economy. Use tires that are appropriate for the season.

Luggage

Carrying heavy luggage will lead to poor fuel economy. Avoid carrying unnecessary luggage. Installing a large roof rack will also cause poor fuel economy.

Warming up before driving

Since the gasoline engine starts up and cuts out automatically when cold, warming up the engine is unnecessary. Moreover, frequently driving short distances will cause the engine to repeatedly warm up, which can lead to excess fuel consumption.

Off-road precautions

This vehicle belongs to the utility vehicle class, which has higher ground clearance and narrower tread in relation to the height of its center of gravity to make it capable of performing in a wide variety of off-road applications.

Off-road vehicle features

- Specific design characteristics give it a higher center of gravity than ordinary passenger cars. This vehicle design feature causes this type of vehicle to be more likely to rollover. And, utility vehicles have a significantly higher rollover rate than other types of vehicles.
- An advantage of the higher ground clearance is a better view of the road allowing you to anticipate problems.
- It is not designed for cornering at the same speeds as ordinary passenger cars any more than low-slung sports cars are designed to perform satisfactorily under off-road conditions. Therefore, sharp turns at excessive speeds may cause the vehicle to roll over.

WARNING

■ Off-road vehicle precautions

Always observe the following precautions to minimize the risk of death, serious injury or damage to your vehicle:

- In a rollover crash, an unbelted person is significantly more likely to die than a person wearing a seat belt. Therefore, the driver and all passengers should always fasten their seat belts.
- Avoid sharp turns or abrupt maneuvers, if at all possible. Failure to operate this vehicle correctly may result in loss of control or vehicle rollover causing death or serious injury.
- Avoid loading any items on the roof that will raise the vehicle's center of gravity.
- Always slow down in gusty crosswinds. Because of its profile and higher center of gravity, your vehicle is more sensitive to side winds than an ordinary passenger car. Slowing down will allow you to have better control.
- Do not drive horizontally across steep slopes. Driving straight up or straight down is preferred. Your vehicle (or any similar off-road vehicle) can tip over sideways much more easily than forward or backward.

Off-road driving

When driving your vehicle off-road, please observe the following precautions to ensure your driving enjoyment and to help prevent the closure of areas to off-road vehicles:

- Drive your vehicle only in areas where off-road vehicles are permitted to travel.
- Respect private property. Get owner's permission before entering private property.
- Do not enter areas that are closed. Honor gates, barriers and signs that restrict travel.
- Stay on established roads. When conditions are wet, driving techniques should be changed or travel delayed to prevent damage to roads.

■ Additional information for off-road driving

- ▶ For owners in U.S. mainland, Hawaii and Puerto Rico:

To obtain additional information pertaining to driving your vehicle off-road, consult the following organizations.

- State and Local Parks and Recreation Departments
- State Motor Vehicle Bureau
- Recreational Vehicle Clubs
- U.S. Forest Service and Bureau of Land Management

WARNING

■ Off-road driving precautions

Always observe the following precautions to minimize the risk of death, serious injury or damage to your vehicle:

- Drive carefully when off the road. Do not take unnecessary risks by driving in dangerous places.
- Do not grip the steering wheel spokes when driving off-road. A bad bump could jerk the wheel and injure your hands. Keep both hands and especially your thumbs on the outside of the rim.
- Always check your brakes for effectiveness immediately after driving in sand, mud, water or snow.
- After driving through tall grass, mud, rock, sand, rivers, etc., check that there is no grass, bush, paper, rags, stone, sand, etc. adhering or trapped on the underbody. Clear off any such matter from the underbody. If the vehicle is used with these materials trapped or adhering to the underbody, a breakdown or fire could occur.
- In a rollover crash, an unbelted person is significantly more likely to die than a person wearing a seat belt. Therefore, the driver and all passengers should fasten their seat belts whenever the vehicle is moving.



WARNING

- When driving off-road or in rugged terrain, do not drive at excessive speeds, jump, make sharp turns, strike objects, etc. This may cause loss of control or vehicle rollover causing death or serious injury. You are also risking expensive damage to your vehicle's suspension and chassis.



NOTICE

■ **To prevent water damage**

Take all necessary safety measures to ensure that water damage to the engine, hybrid system or other components does not occur.

- Water entering the engine air intake will cause severe engine damage.
- Water entering the automatic transmission will cause deterioration in shift quality, locking up of your transmission accompanied by vibration, and ultimately damage.
- Water can wash the grease from wheel bearings, causing rusting and premature failure, and may also enter the differentials, transmission and transfer case, reducing the gear oil's lubricating qualities.

■ **When you drive through water**

- If driving through water, such as when crossing shallow streams, first check the depth of the water and the bottom of the riverbed for firmness. Drive slowly and avoid deep water.

- When crossing a river or a puddle, be sure to cross it without stopping midway. If you stop or drive at extremely low speeds in water, water may enter the vehicle and damage the hybrid battery making the vehicle unable to be driven.

■ **Inspection after off-road driving**

- Sand and mud that has accumulated around brake discs may affect braking efficiency and may damage brake system components.
- Always perform a maintenance inspection after each day of off-road driving that has taken you through rough terrain, sand, mud, or water. For scheduled maintenance information, refer to the "Scheduled Maintenance Guide" or "Owner's Manual Supplement".

Winter driving tips

Carry out the necessary preparations and inspections before driving the vehicle in winter. Always drive the vehicle in a manner appropriate to the prevailing weather conditions.

Preparation for winter

- Use fluids that are appropriate to the prevailing outside temperatures.
- Engine oil
- Engine/power control unit coolant
- Washer fluid
- Have a service technician inspect the condition of the 12-volt battery.
- Have the vehicle fitted with four snow tires or purchase a set of tire chains for the rear tires*.

*: Tire chains cannot be mounted on 285/65R18 tires.

Ensure that all tires are the same size and brand, and that chains match the size of the tires.

**WARNING****■ Driving with snow tires**

Observe the following precautions to reduce the risk of accidents. Failure to do so may result in a loss of vehicle control and cause death or serious injury.

- Use tires of the specified size.

- Maintain the recommended level of air pressure.
- Do not drive in excess of 75 mph (120 km/h), regardless of the type of snow tires being used.
- Use snow tires on all, not just some wheels.
- 4WD models: Do not mix tires of different makes, models, tread patterns or treadwear.

■ Driving with tire chains (vehicles without 285/65R18 tires)

Observe the following precautions to reduce the risk of accidents. Failure to do so may result in the vehicle being unable to be driven safely, and may cause death or serious injury.

- Do not drive in excess of the speed limit specified for the tire chains being used, or 30 mph (50 km/h), whichever is lower.
- Avoid driving on bumpy road surfaces or over potholes.
- Avoid sudden acceleration, abrupt steering, sudden braking and shifting operations that cause sudden engine braking.
- Slow down sufficiently before entering a curve to ensure that vehicle control is maintained.
- Do not use LTA (Lane Tracing Assist) system.



NOTICE

■ **Repairing or replacing snow tires**

Request repairs or replacement of snow tires from Toyota dealers or legitimate tire retailers.

This is because the removal and attachment of snow tires affects the operation of the tire pressure warning valves and transmitters.

Before driving the vehicle

Perform the following according to the driving conditions:

- Do not try to forcibly open a window or move a wiper that is frozen. Pour warm water over the frozen area to melt the ice. Wipe away the water immediately to prevent it from freezing.
- To ensure proper operation of the climate control system fan, remove any snow that has accumulated on the air inlet vents in front of the windshield.
- Check for and remove any excess ice or snow that may have accumulated on the exterior lights, outside rear view mirrors, windows, vehicle's roof, chassis, around the tires or on the brakes.
- Remove any snow or mud from the bottom of your shoes before getting in the vehicle.

When driving the vehicle

Accelerate the vehicle slowly, keep a safe distance between you and the vehicle ahead, and drive at a reduced speed suitable to road conditions.

When parking the vehicle

- Park the vehicle and move the shift lever to P without setting the parking brake. The parking brake may freeze up, preventing it from being released. If the vehicle is parked without setting the parking brake, make sure to block the wheels. Failure to do so may be dangerous because it may cause the vehicle to move unexpectedly, possibly leading to an accident.

When the parking brake is in automatic mode, release the parking brake after shifting the shift lever to P. (→P.218)

- If the vehicle is parked without setting the parking brake, confirm that the shift lever cannot be moved out of P*.

*: The shift lever will be locked if it is attempted to be shifted from P to any other position without depressing the brake pedal. If the shift lever can be shifted from P, there may be a problem with the shift lock system. Have the vehicle inspected by your Toyota

dealer immediately.

⚠ WARNING

■ When parking the vehicle

When parking the vehicle without applying the parking brake, make sure to chock the wheels. If you do not chock the wheels, the vehicle may move unexpectedly, possibly resulting in an accident.

Selecting tire chains

▶ Vehicles without 285/65R18 tires

Use the correct tire chain size when mounting the tire chains. Chain size is regulated for each tire size.

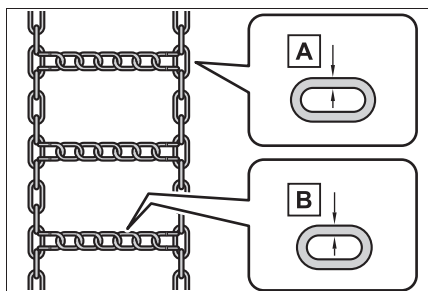

A Side chain (0.2 in. [5 mm] in diameter)

B Cross chain (0.25 in. [6.3 mm] in diameter)

▶ Vehicles with 285/65R18 tires

Tire chains cannot be mounted as the space between the tire and body is too narrow.

Snow tires should be used instead.

Regulations on the use of tire chains (vehicles without 285/65R18 tires)

Regulations regarding the use of tire chains vary depending on location and type of road.

Always check local regulations before installing chains.

■ Tire chain installation

Observe the following precautions when installing and removing chains:

- Install and remove tire chains in a safe location.
- Install tire chains on the rear tires. Do not install tire chains on the front tires.
- Install tire chains on the rear tires as tightly as possible. Retighten chains after driving 1/4 - 1/2 mile (0.5 - 1.0 km).
- Install tire chains following the instructions provided with the tire chains.

⚠ NOTICE

■ Fitting tire chains

The tire pressure warning valves and transmitters may not function correctly when tire chains are fitted.

Interior features**5****5-1. Using the air conditioning system and defogger**

Automatic air conditioning system..... **418**

Heated steering wheel/seat heaters/seat ventilators **425**

5-2. Using the interior lights

Interior lights list **428**

5-3. Using the storage features

List of storage features **431**

Luggage compartment features **435**

5-4. Using the other interior features

Other interior features . **440**

Garage door opener.... **457**

Automatic air conditioning system

Air outlets and fan speed are automatically adjusted according to the temperature setting.

Air conditioning controls

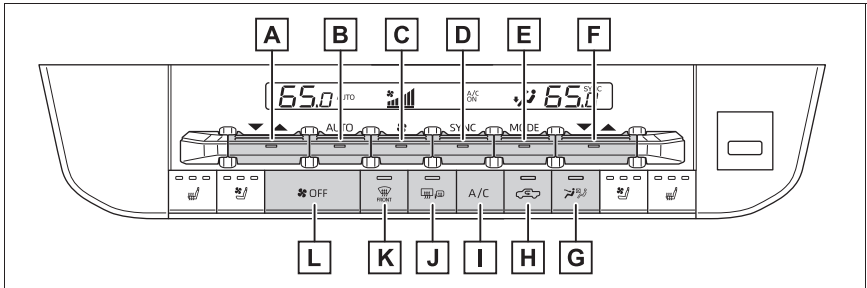

- A** Left-hand side temperature control toggle
- B** “AUTO” toggle
- C** Fan speed control toggle
- D** “SYNC” toggle
- E** Air flow mode control toggle
- F** Right-hand side temperature control toggle
- G** “S-FLOW” switch
- H** Outside/recirculated air mode switch
- I** “A/C” switch
- J** Rear window and outside rear view mirror defoggers switch
- K** Windshield defogger switch
- L** “OFF” switch

■ Adjusting the temperature setting

Operate the temperature control toggle upwards to increase the temperature and downwards to decrease the temperature.

If the “A/C” switch is not pressed, the system will blow ambient temperature air or heated air.

■ Setting the fan speed

Operate the fan speed control toggle upwards to increase the fan speed and downwards to decrease the fan speed.

Press the “OFF” switch to turn the fan off.

■ Change the airflow mode

Operate the air flow mode control toggle.

The airflow mode changes as follows each time the toggle is operate.

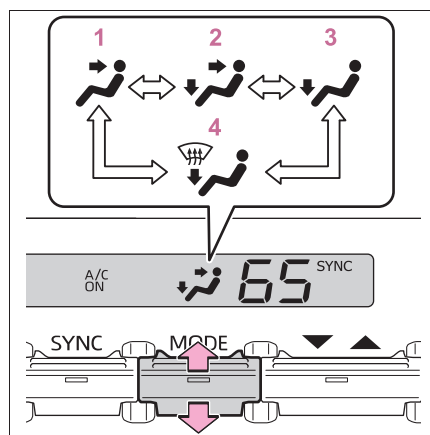

- 1 Air flows to the upper body.
- 2 Air flows to the upper body and feet.

3 Air flows to the feet.

4 Air flows to the feet and the windshield defogger operates.

■ Switching between outside air and recirculated air modes

Press the outside/recirculated air mode switch.

The mode switches between outside air mode and recirculated air mode each time the switch is operated.

When recirculated air mode is selected, the indicator illuminates on the outside/recirculated air mode switch.

■ Set cooling and dehumidification function

Press the “A/C” switch.

When the function is on, “A/C ON” indicator will illuminate. When the function is off, “A/C OFF” indicator will illuminate.

■ Defogging the windshield

Defoggers are used to defog the windshield and front side windows.

Press the windshield defogger switch.

Press the outside air mode switch if the recirculated air mode is used. (It may switch automatically.)

To defog the windshield and the side windows quickly, turn the air flow and temperature up.

To return to the previous mode,

press the windshield defogger switch again when the windshield is defogged.

When the windshield defogger switch is on, the indicator illuminates on the windshield defogger switch.

■ Defogging the rear window and outside rear view mirrors

Defoggers are used to defog the rear window and to remove raindrops, dew and frost from the outside rear view mirrors.

Press the rear window and outside rear view mirror defoggers switch.

The defoggers will automatically turn off after 15 minutes.

When the rear window and outside rear view mirror defoggers switch is on, the indicator illuminates on the rear window and outside rear view mirror defoggers switch.

■ When the outside temperature exceeds 75°F (24°C) and the air conditioning system is on

- In order to reduce the air conditioning power consumption, the air conditioning system may switch to recirculated air mode automatically. This may also reduce fuel consumption.
- Recirculated air mode is selected as a default mode when the power switch is turned to ON.

It is possible to switch to outside air mode at any time by pressing the outside air mode switch.

■ Fogging up of the windows

- The windows will easily fog up

when the humidity in the vehicle is high. Turning the cooling and dehumidification function on will dehumidify the air from the outlets and defog the windshield effectively.

- If you turn the cooling and dehumidification function off, the windows may fog up more easily.
- The windows may fog up if the recirculated air mode is used.

■ When driving on dusty roads

Close all windows. If dust thrown up by the vehicle is still drawn into the vehicle after closing the windows, it is recommended that the air intake mode be set to outside air mode and the fan speed to any setting except off.

■ Outside/recirculated air mode

- Setting to the recirculated air mode temporarily is recommended in preventing dirty air from entering the vehicle interior and helping to cool the vehicle when the outside air temperature is high.
- Outside/recirculated air mode may automatically switch depending on the temperature setting or the inside temperature.

■ When the outside temperature falls to nearly 32°F (0°C)

The dehumidification function may not operate even when "A/C" switch is pressed.

■ Ventilation and air conditioning odors

- To let fresh air in, set the air conditioning system to the outside air mode.
- During use, various odors from inside and outside the vehicle may enter into and accumulate in the air conditioning system. This may then cause odor to be emitted from the vents.
- In order to suppress odors that

occur when the air conditioning system starts, the air flow mode may change to blow air to the feet or air may stop blowing for a short period of time immediately after the air conditioning system is started in automatic mode.

- When parking, the system automatically switches to outside air mode to encourage better air circulation throughout the vehicle, helping to reduce odors that occur when starting the vehicle.

■ **Air conditioning filter**

→P.505

■ **Air conditioning system refrigerant**

- A label regarding the refrigerant of the air conditioning system is attached to the hood at the location shown in the following illustration.

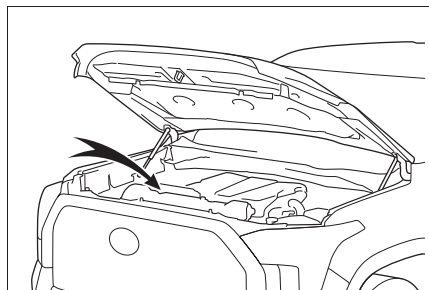

- The meaning of each symbol on the label are as follows:

	Caution
	Air conditioning system
	Air conditioning system lubricant type

	Requires registered technician to service air conditioning system
	Flammable refrigerant

■ **Customization**

Some functions can be customized. (Customizable features: →P.597)

! WARNING

■ **To prevent the windshield from fogging up**

Do not use the windshield defogger switch during cool air operation in extremely humid weather. The difference between the temperature of the outside air and that of the windshield can cause the outer surface of the windshield to fog up, blocking your vision.

■ **When the outside rear view mirror defoggers are operating**

Do not touch the rear view mirror surfaces when the outside rear view mirror defoggers are on.

! NOTICE

■ **To prevent 12-volt battery discharge**

Do not leave the air conditioning system on longer than necessary when the hybrid system is off.

■ **When repairing/replacing parts of the air conditioning system**

Have repair/replacement performed by your Toyota dealer. When a part of the air conditioning system, such as the evaporator, is to be replaced, it must be replaced with a new one.

Using automatic mode

- 1 Operate the “AUTO” toggle.
- 2 Adjust the temperature setting.
- 3 To stop the operation, press the “OFF” switch.

If the fan speed setting or air flow modes are operated, the automatic mode indicator goes off. However, automatic mode for functions other than that operated is maintained.

■ Using automatic mode

Fan speed is adjusted automatically according to the temperature setting and the ambient conditions.

Therefore, the fan may stop for a while until warm or cool air is ready to flow immediately after the automatic mode switch is pressed.

Front seat concentrated airflow mode (S-FLOW)

This function automatically controls the air conditioning airflow so that priority is given to the front seats. Unnecessary air conditioning is suppressed, contributing to increased fuel efficiency.

Front seat concentrated airflow mode operates in the following situations.

- No passengers are detected in the rear seats
- The windshield defogger is not operating

While operating,  illuminates.

■ Manually turning front seat concentrated airflow mode on/off

In front seat concentrated airflow mode, directing airflow to the front seats only and to all seats can be switched via switch operation. When the mode has been switched manually, automatic airflow control stops operating.

Press  on the air conditioning operation panel and switch the airflow.

- Indicator illuminated: Airflow to the front seats only
- Indicator off: Airflow to the all seats

■ Operation of automatic airflow control

- In order to maintain a comfortable interior, airflow may be directed to seats without passengers immediately after the hybrid system is started and at other times depending on the outside temperature.
- After the hybrid system is started, if passengers move around inside or enter/exit the vehicle, the system cannot accurately detect the presence of passengers and automatic airflow control will not operate.

■ Operation of manual airflow control

Even if the function is manually switched to directing airflow to only the front seats, when a rear seat is occupied, it may automatically direct airflow to all seats.

■ To return to automatic airflow control

- 1 With the indicator off, turn the power switch off.
- 2 After 60 minutes or more elapse, turn the power switch to ON.

Adjusting the temperature for driver and front passenger seats simultaneously (“SYNC” mode)

To turn on the “SYNC” mode, operate the “SYNC” toggle upwards or downwards.

The driver’s side temperature control toggle can be used to adjust the temperature for the driver’s and front passenger’s side. To enter individual mode, operate the front passenger’s side temperature control toggle or press the “SYNC” toggle again.

When the “SYNC” mode is on, the “SYNC” indicator is illuminate.

Windshield wiper de-icer

This feature is used to prevent ice from building up on the windshield and wiper blades.

Press the rear window and outside rear view mirror defoggers switch.

The windshield wiper de-icer will automatically turn off after 15 minutes.

Turning the rear window and outside rear view mirror defoggers on will turn the windshield wiper de-icer on.

When the rear window and outside rear view mirror defoggers switch is on, the indicator illuminates on the rear window and outside rear view mirror defoggers switch.

⚠ WARNING

■ To prevent burns

Do not touch the glass at lower part of the windshield or to the side of the front pillars when the windshield wiper de-icer is on.

Air outlet layout and operations

■ Location of air outlets

The air outlets and air volume change according to the selected air flow mode.

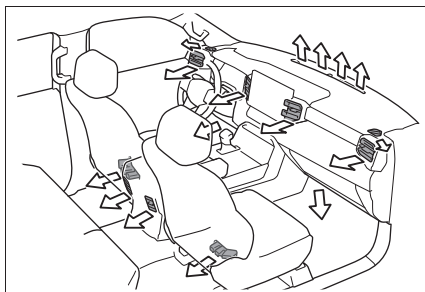

■ Adjusting the air flow direction and opening/closing the air outlets

► Front

Direct air flow to the left or right, up or down.

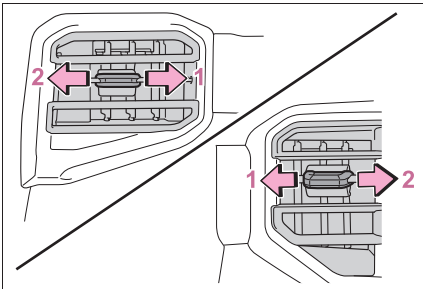
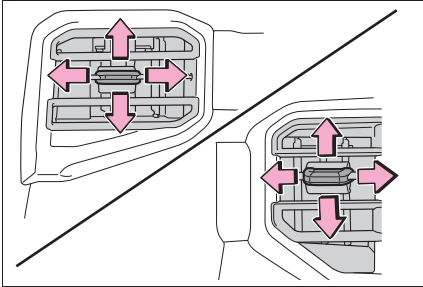

- 1 Open the vent
- 2 Close the vent

► Rear

Direct air flow to the left or right, up or down.

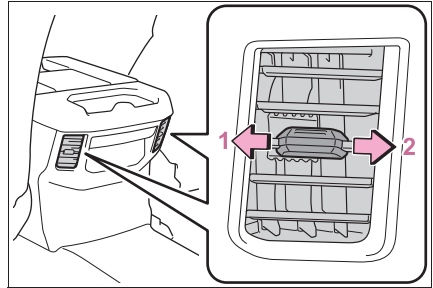
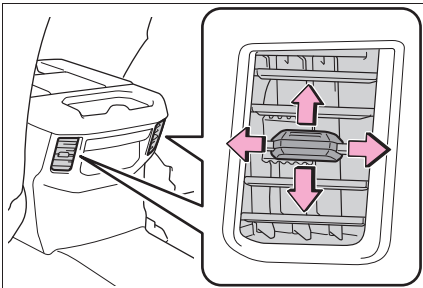

- 1 Open the vent
- 2 Close the vent

⚠ WARNING

- To not interrupt the windshield defogger from operating

Do not place anything on the instrument panel which may cover the air outlets. Otherwise, air flow may be obstructed, preventing the windshield defoggers from defogging.

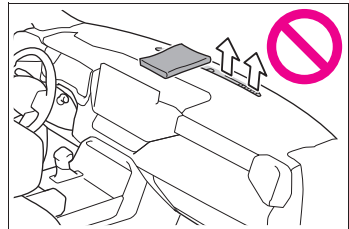

Heated steering wheel* /seat heaters/seat ventilators

*: If equipped

● Heated steering wheel

Warms up the grip of the steering wheel

● Front seat heaters/Rear seat heaters

Warm up the seat upholstery

● Front seat ventilators/Rear seat ventilators

Maintain good ventilation by pulling air through the seat upholstery



WARNING

■ To prevent minor burn injuries

Care should be taken if anyone in the following categories comes in contact with the steering wheel or seats when the heater is on:

- Babies, small children, the elderly, the sick and the physically challenged
- Persons with sensitive skin
- Persons who are fatigued
- Persons who have taken alcohol or drugs that induce sleep (sleeping drugs, cold remedies, etc.)



NOTICE

■ To prevent damage to the seat heaters and seat ventilators

Do not put heavy objects that have an uneven surface on the seat and do not stick sharp objects (needles, nails, etc.) into the seat.

■ To prevent 12-volt battery discharge

Do not use the functions when the hybrid system is off.

Operating instructions

■ Heated steering wheel (if equipped)

Turns heated steering wheel on/off

When the heated steering wheel is on, the indicator illuminates on the heated steering wheel switch.

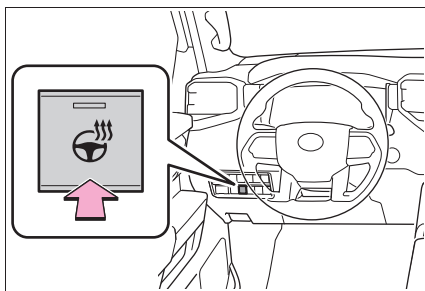

■ Front seat heaters/seat ventilators

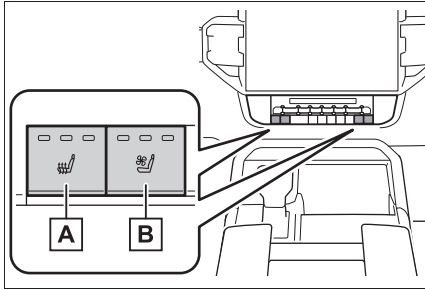

A Adjust the front seat heater temperature level

Each time the switch is pressed, the operation condition changes as follows.

Hi (3 segments lit) → Mid (2 segments lit) → Lo (1 segment lit) → Off

The level indicator (red) light up during operation.

B Adjust the front seat ventilator fan speed level

Each time the switch is pressed, the operation condition changes as follows.

Hi (3 segments lit) → Mid (2 segments lit) → Lo (1 segment lit) → Off

The level indicator (blue) light up during operation.

■ Rear seat heaters (if equipped)/seat ventilators (if equipped)

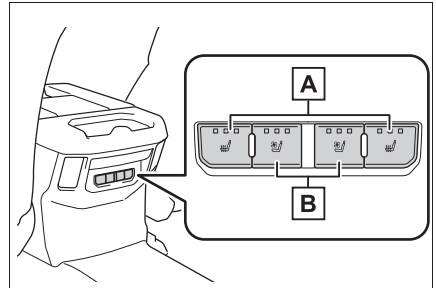

A Adjust the rear seat heater temperature level

Each time the switch is pressed, the operation condition changes as follows.

Hi (3 segments lit) → Mid (2 segments lit) → Lo (1 segment lit) → Off

The level indicator (red) light up during operation.

B Adjust the rear seat ventilator fan speed level

Each time the switch is pressed, the operation condition changes as follows.

Hi (3 segments lit) → Mid (2 segments lit) → Lo (1 segment lit) → Off

The level indicator (blue) light up during operation.

■ The heated steering wheel, seat heaters and seat ventilators can be used when

The power switch is in ON.

**WARNING****■ To prevent overheating and minor burn injuries**

Observe the following precautions when using the seat heaters.

- Do not cover the seat with a blanket or cushion when using the seat heater.
- Do not use seat heater more than necessary.

Interior lights list

Location of the interior lights

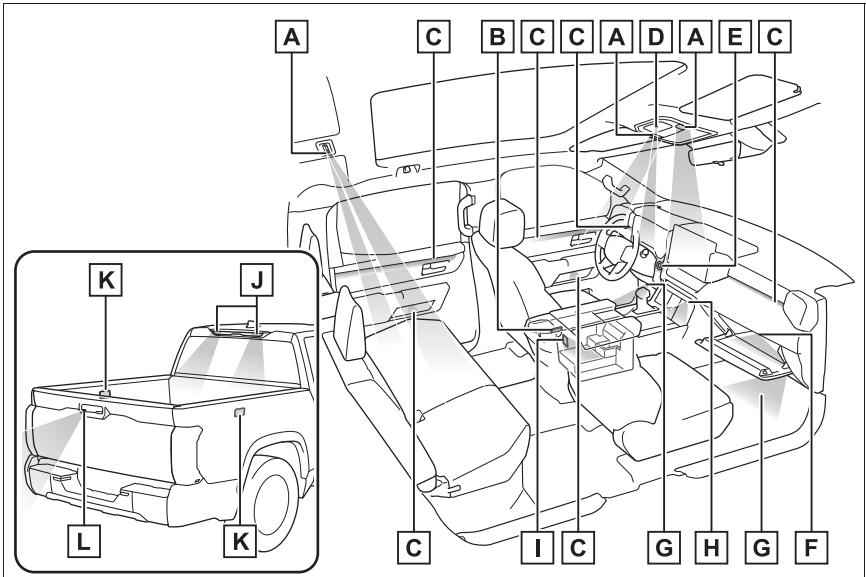

- A** Personal/interior lights (→P.429)
- B** Door courtesy lights
- C** Ambient lights (if equipped) (→P.429)
- D** Shift lever light (if equipped)
- E** Power switch light
- F** Glove box light
- G** Footwell lights (if equipped)
- H** Front tray light
- I** Console box light (if equipped)
- J** Cargo lamp (→P.430)
- K** Bed lamp (if equipped) (→P.430)
- L** Trailer hitch light (→P.405, 430)

Personal/interior lights main switch

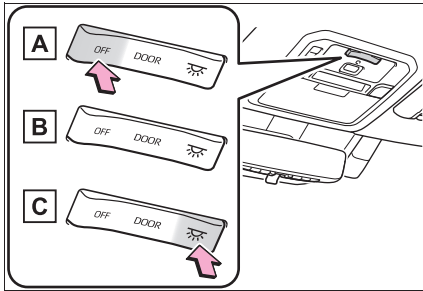

A "OFF"

The personal/interior lights can be individually turned on or off.

B "DOOR"

The personal/interior lights come on when a door is opened. They turn off when the doors are closed.

C On

The personal/interior lights cannot be individually turned off.

Operating the personal/interior lights

► Front

Turns the lights on/off

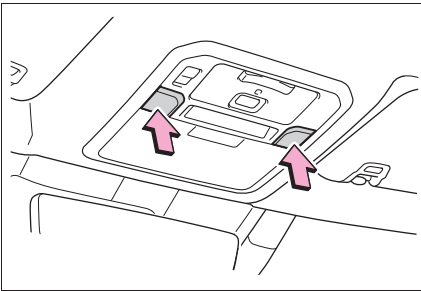

► Rear

Turns the lights on/off

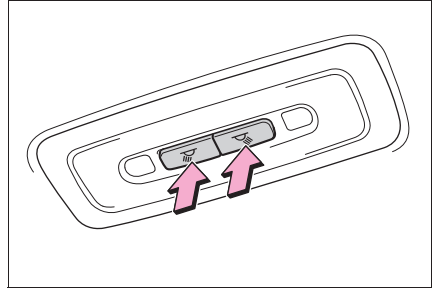

Ambient lights (if equipped)

Each time the "MOOD" switch is pressed, the brightness level changes.

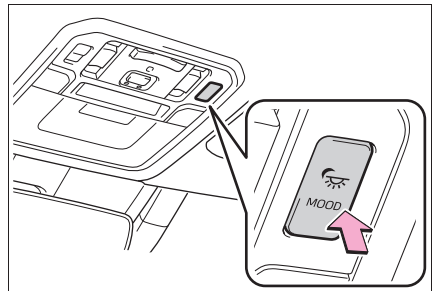

Cargo lamp main switch

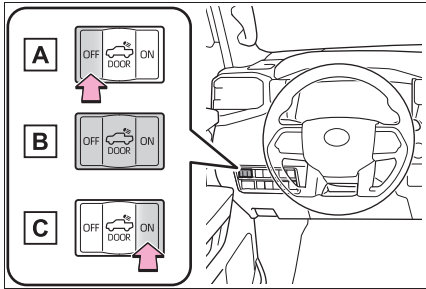

A “OFF”

Turns the lights off

B “DOOR”

The cargo lamp and bed lamp turns on/off when the door or tailgate is opened or closed while the shift lever is in P, D or R.

The trailer hitch light turns on when the door or tailgate is opened or closed while the shift lever is in P or R. trailer hitch light will turn off when shift lever in D.

C “ON”

The cargo lamp, bed lamp, trailer hitch light turns on while the shift lever is in P or R. Only cargo lamp and bed lamp turns on while shift lever is in D.

■ Illuminated entry system

The lights automatically turn on/off according to the power switch mode, the presence of the electronic key, whether the doors are locked/unlocked, and whether the doors are open/closed.

■ To prevent the 12-volt battery from being discharged

If the following lights remain on when the door is not fully closed and the main switch is in the “DOOR” position, the lights will go off auto-

matically after 20 minutes:

- Personal/interior lights
- Cargo lamp
- Bed lamp
- Trailer hitch light

■ The personal/interior lights may turn on automatically when

If any of the SRS airbags deploy (inflate) or in the event of a strong rear impact, the personal/interior lights will turn on automatically.

The personal/interior lights will turn off automatically after approximately 20minutes.

The personal/interior lights can be turned off manually. However, in order to help prevent further collisions, it is recommended that they be left on until safety can be ensured.

(The personal/interior lights may not turn on automatically depending on the force of the impact and conditions of the collision.)

■ Customization

Some functions can be customized. (→P.588)

⚠ NOTICE

■ To prevent 12-volt battery discharge

Do not leave the lights on longer than necessary when the hybrid system is off.

■ Removing light lenses

Never remove the lens for the personal/interior lights. Otherwise, the lights will be damaged. If a lens needs to be removed, contact your Toyota dealer.

List of storage features

Location of the storage features

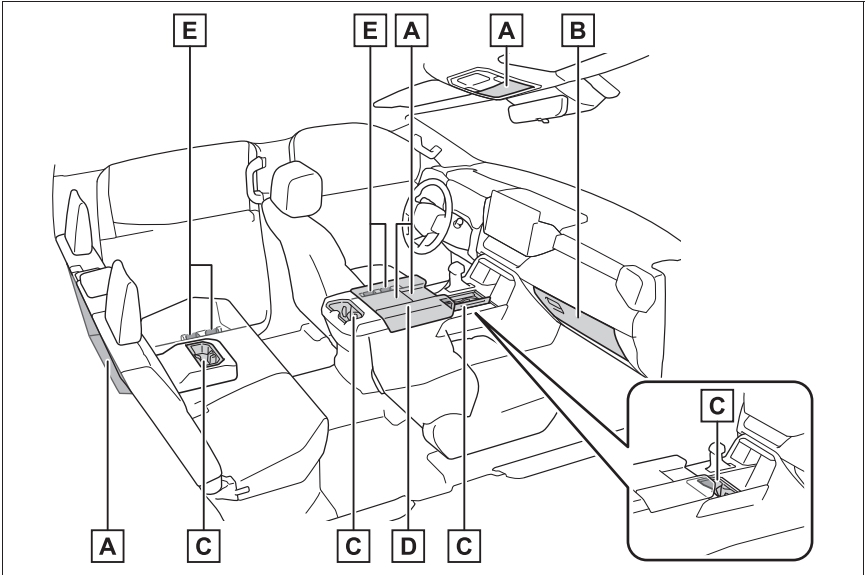

- A** Auxiliary boxes
- B** Glove box
- C** Cup holders
- D** Console box
- E** Bottle holders

⚠ WARNING

■ Items that should not be left in the storage spaces

Do not leave glasses, lighters or spray cans in the storage spaces, as this may cause the following when cabin temperature becomes high:

- Glasses may be deformed by heat or cracked if they come into contact with other stored items.

- Lighters or spray cans may explode. If they come into contact with other stored items, the lighter may catch fire or the spray can may release gas, causing a fire hazard.

Glove box

Pull up the lever to open.

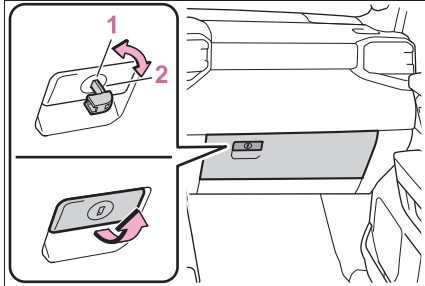

- 1 Unlock with the mechanical key
- 2 Lock with the mechanical key

Tray within glove box

The tray can be removed by lifting the tray and then sliding it out.

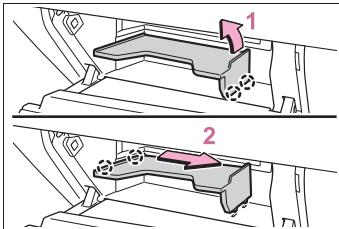

- 1 Lift the tray to disengage the clips.
- 2 Slide to remove the tabs from the holes.

⚠ WARNING

■ Caution while driving

Keep the glove box closed. In the event of sudden braking or sudden swerving, an accident may occur due to an occupant being struck by the open glove box or the items stored inside.

Cup holders

► Front (Type A)

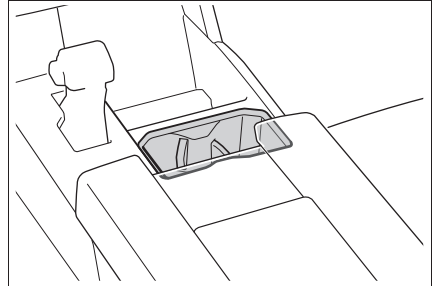

► Front (Type B)

Press in and release the button.

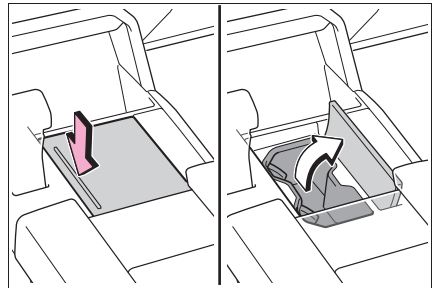

► Rear (Type A)

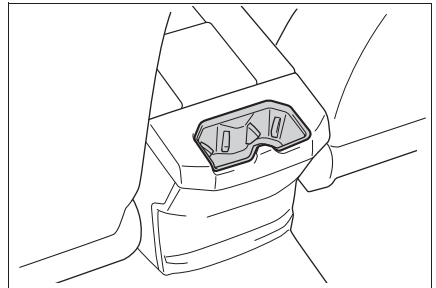

▶ Rear (Type B)

Pull the armrest down for use.

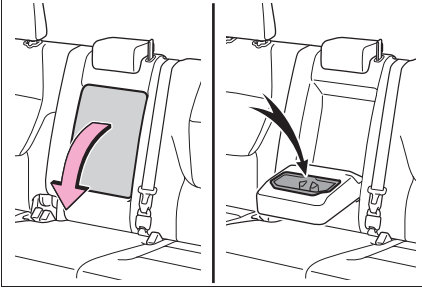

⚠ WARNING

■ **Items unsuitable for the cup holder**

Do not place anything other than cups or beverage cans in the cup holders.

Inappropriate items must not be stored in the cup holders even if the lid is closed.

Other items may be thrown out of the holders in the event of an accident or sudden braking and cause injury. If possible, cover hot drinks to prevent burns.

■ **When not in use**

Keep the cup holders closed. Injuries may result in the event of an accident or sudden braking.

Bottle holders

▶ Front

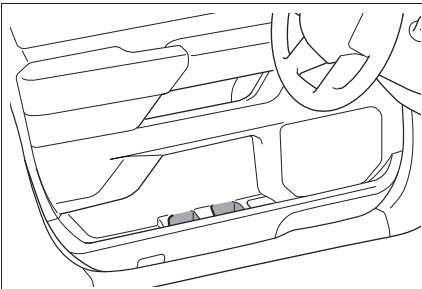

▶ Rear (if equipped)

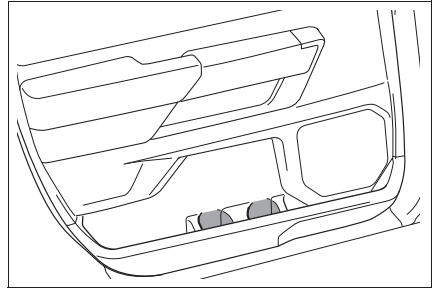
■ **Bottle holders**

- When storing a bottle, close the cap.
- The bottle may not be stored depending on its size or shape.

⚠ WARNING

■ **Items unsuitable for the bottle holders**

Do not place anything other than a bottle in the bottle holders. Other items may be thrown out of the holders in the event of an accident or sudden braking and cause injury.

⚠ NOTICE

■ **Items that should not be stowed in the bottle holders**

Put the cap on before stowing a bottle. Do not place open bottles in the bottle holders, or glasses and paper cups containing liquid. The contents may spill and glasses may break.

Console box

Press either button to open the console box.

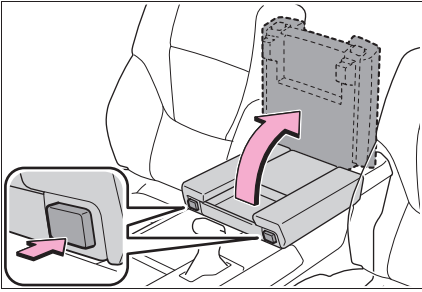

■ Console box

When the auxiliary box is slid, the console box can be accessed.

■ Console box partition

The partition of the console box can be removed.

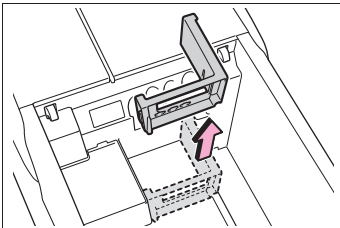

The removed partition can be stowed in the position as shown in the illustration.

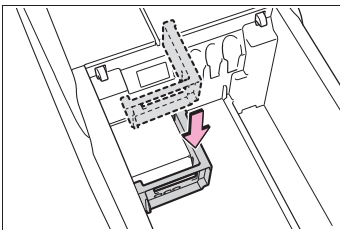

⚠ WARNING

■ Caution while driving

Keep the console box closed. Injuries may result in the event of an accident or sudden braking.

Auxiliary boxes

► Type A

Push in and release the auxiliary box.

This box is useful for temporarily storing the small items.

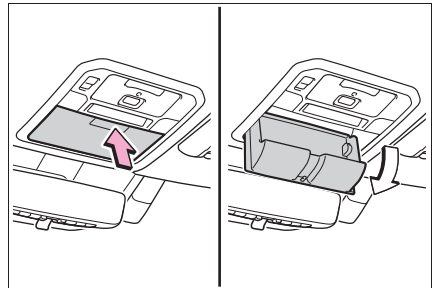

► Type B

Pull the auxiliary box out.

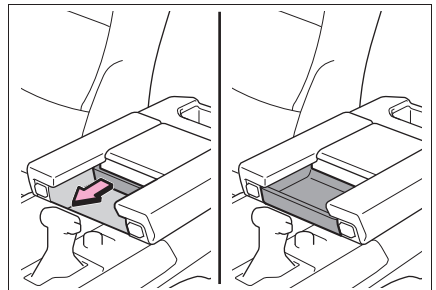

- ▶ Type C (if equipped)

Pull the lid to open.

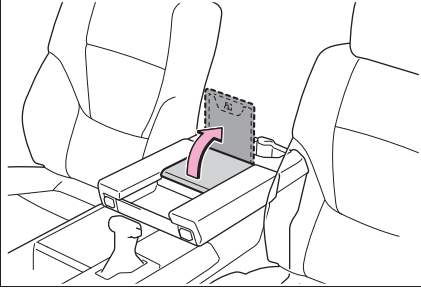

- ▶ Type D (if equipped)

Folding down the rear seat-backs. (→P.141)

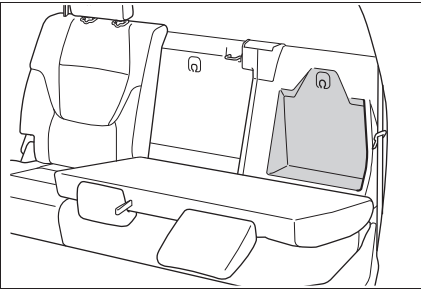

WARNING

■ Caution while driving

Do not leave the auxiliary box open while driving. Items may fall out and cause death or serious injury in case of an accident or sudden stop.

■ Items unsuitable for storing (type A)

Do not store items heavier than 0.4 lb. (0.2 kg). Doing so may cause the auxiliary box to open and the items inside may fall out, resulting in an accident.

Luggage compartment features

Bed hooks

Bed hooks are provided for securing loose items.

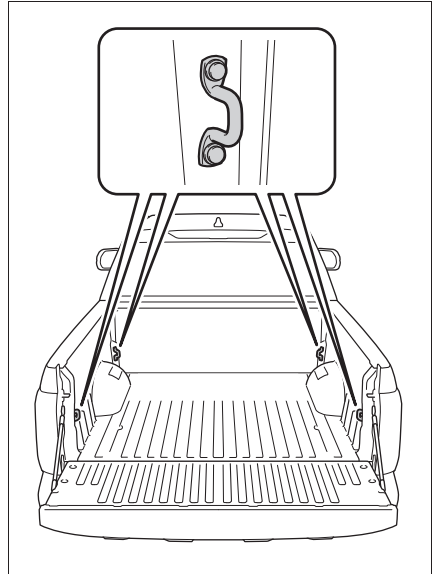

Deck

■ Tie-down cleats

The deck rail system enables you to insert and move tie-down cleats to their best location along deck rails to secure a load.

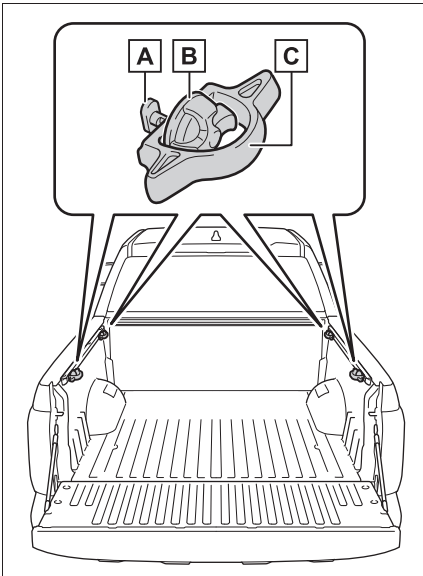

- A** Locking plate
- B** Thumb wheel
- C** Tie-down cleat

● Installing the tie-down cleat

- 1** Loosen the thumb wheel in a counterclockwise motion, and depress the wheel so

that the locking plate maintains 0.5 in. (12.7 mm) gap.

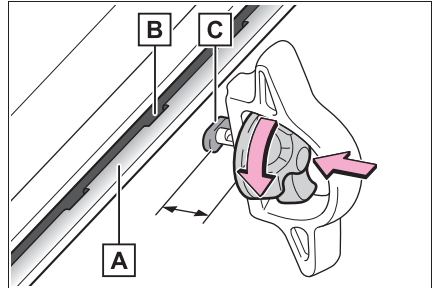

- A** Deck rail
- B** Detent
- C** Locking plate

- 2** Insert the locking plate into the deck rail, rotate the tie-down cleat 90°, and release the thumb wheel.

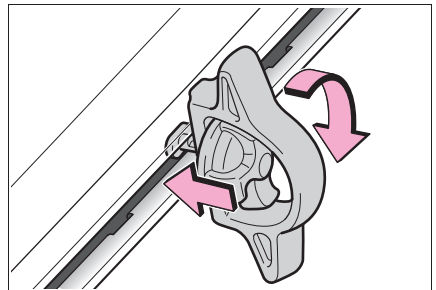

- 3** Slide the cleat to the closest detent in the rail system. You will feel that the locking plate snaps into a detent.

When using a tonneau cover, confirm the cleat position will not interfere with its proper closing and latching.

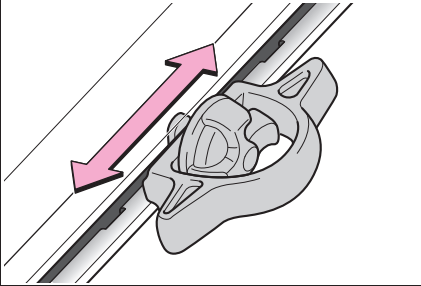

- 4** Tighten the thumb wheel in a clockwise motion until the clutch mechanism ratchets.

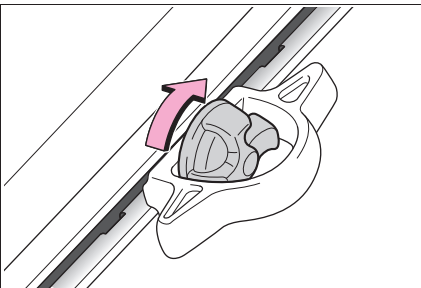

- 5** Check the tie-down cleat to confirm that it is locked into a detent and securely mounted to the deck rail system.

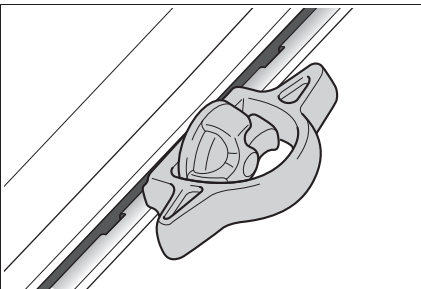

! WARNING

■ Tie-down cleat precautions

- Properly install and tighten the tie-down cleats into the deck rail system. Failure to properly install and tighten the tie-down cleats can cause cargo to become unsecured. Unsecured cargo can cause injury when the vehicle is in motion.
- Applying loads at an angle to the bed cleat greater than 45 degrees from horizontal or loads greater than 220 lbs (100 kg) may cause damage to the bed, bed rail system, bed cleat as well as the cargo. This can cause cargo to become unsecured. Unsecured cargo can cause injury when the vehicle is in motion.
- Properly secure all cargo to prevent shifting or sliding during driving. Failure to properly secure cargo can cause injury when the vehicle is in motion.
- When using a tonneau cover, confirm the cleat position will not interfere with its proper closing and latching. Failure to confirm proper closing and latching can lead to tonneau cover coming off while driving and cause injury.

Deck divider

■ Vertical position

The plank can be inserted in the deck side groove.

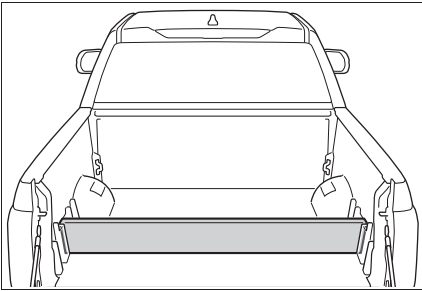

Insertion position:

► Type A

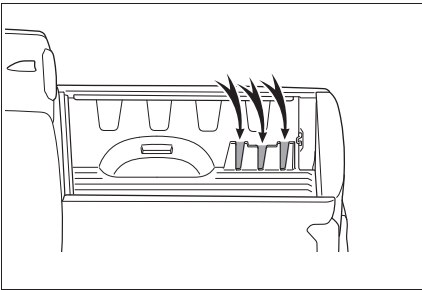

► Type B

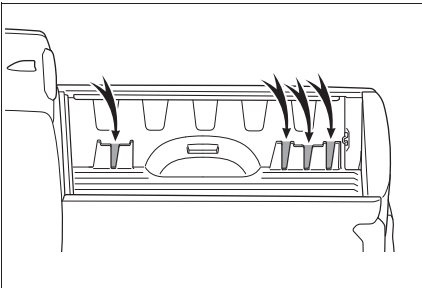

Dimensions of the wood that is prepared:

Prepare a 2×8 wood plank with the following dimensions.

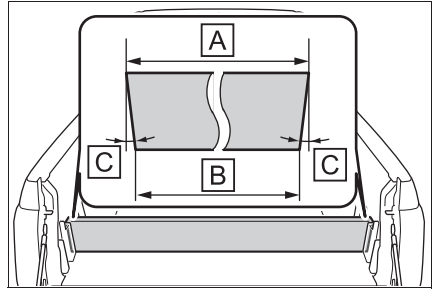

A 62.2 in (1580 mm)

B 60.7 in (1541 mm)

C 6 degree

Measure dimension **A** and **B** on your vehicle to ensure accurate length based on vehicle variation.

■ Horizontal position

A 2×8 wood plank can be placed in the deck board grooves.

Prepare the board by measuring the length with the actual vehicle according to the position it is to be placed.

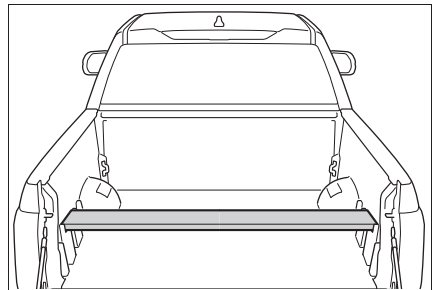

Insertion position:

▶ Type A

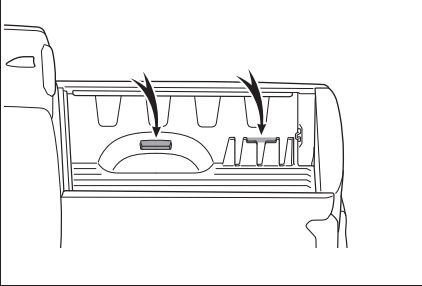

▶ Type B

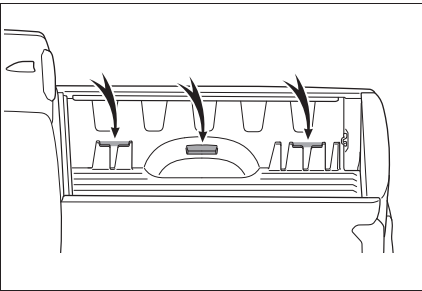

Dimensions:

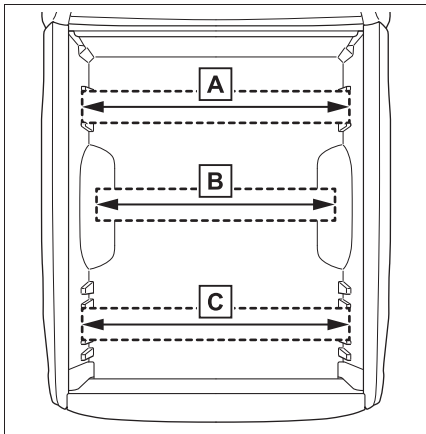

A Width 61.9 in. (1573 mm)

B Width 55.5 in. (1409 mm)

C Width 61.9 in. (1573 mm)

Measure dimension **A**, **B** and **C** on your vehicle to ensure accurate

length based on vehicle variation.

! WARNING

■ When using and operating the deck divider

- Do not use deck divider boards when off-roading or crossing rough terrain. The boards could come out of the cargo bed area, causing damage to other vehicles or causing injury or death.
- Ensure that deck divider boards are prepared to the proper dimensions, including the edge angle. Failure to do so could cause the boards to come out of the cargo bed area, causing damage to other vehicles or causing injury or death.

! NOTICE

■ When using the deck divider

- Boards in board slots alone may not guarantee that the cargo be held sufficiently, other means may be necessary.
- Board dimensions are for reference due to variations in bed size manufacturing. The board size may require minor adjustment due to variation. If board is forced into slot, it could result in damage to bed.

Other interior features

USB charging ports

The USB charging ports are used to supply 2.5 A (USB Type-A) or 3.0 A (USB Type-C) of electricity at 5 V to external devices.

Use the appropriate terminal for each charging port type.

The USB charging ports are for charging only. They are not designed for data transfer or other purposes.

Depending on the external device, it may not charge properly. Refer to the manual included with the device before using a USB charging port.

■ Using the USB charging ports

- ▶ In the console box

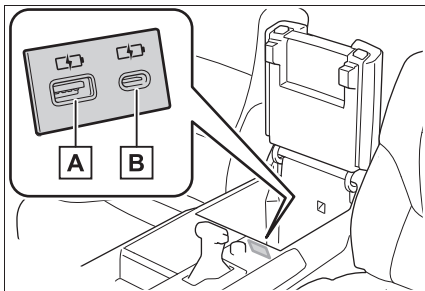

- A** USB Type-A
- B** USB Type-C

- ▶ Rear of console box

Open the lid.

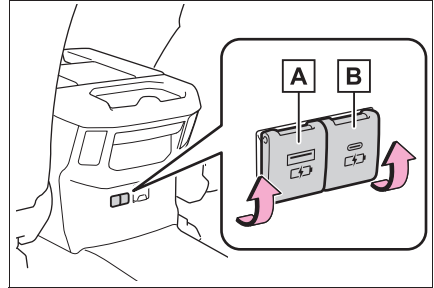

- A** USB Type-A
- B** USB Type-C

■ The USB charging ports can be used when

The power switch is in ACC or ON.

■ Situations in which the USB charging ports may not operate correctly

- USB Type-A: If a device which consumes more than 2.5 A at 5 V is connected
- USB Type-C: If a device which consumes more than 3.0 A at 5 V is connected
- If a device designed to communicate with a personal computer, such as a USB memory device, is connected
- If the connected external device is turned off (depending on device)
- If the temperature inside the vehicle is high, such as after the vehicle has been parked in the sun

■ About connected external devices

Depending on the connected external device, charging may occasionally be suspended and then start again. This is not a malfunction.

**NOTICE****■ To prevent damage to the USB charging ports**

- Do not insert foreign objects into the ports.
- Do not spill water or other liquids into the ports.
- Rear of console box: When the USB charging ports are not in use, close the lids. If a foreign object or liquid enters a port may cause a short circuit.
- Do not apply excessive force to or impact the USB charging ports.
- Do not disassemble or modify the USB charging ports.

■ To prevent damage to external devices

- Do not leave external devices in the vehicle. The temperature inside the vehicle may become high, resulting in damage to an external device.
- Do not push down on or apply unnecessary force to an external device or the cable of an external device while it is connected.

■ To prevent 12-volt battery discharge

Do not use the USB charging ports for a long period of time with the hybrid system is off.

such as smartphones and mobile batteries, etc., on the charge area.

The compatible portable devices can be found on the following Wireless Power Consortium website.

<https://www.wirelesspowerconsortium.com/>

[wirelesspowerconsortium.com/](https://www.wirelesspowerconsortium.com/)

This function cannot be used with portable devices that are larger than the charging tray. Also, depending on the portable device, it may not operate as normal. Please read the operation manual for portable devices to be used.

■ The “Qi” logo

The “Qi” logo is a trademark of the Wireless Power Consortium.

Qi ID: 11277

**Wireless charger (if equipped)**

A portable device can be charged by just placing Qi standard wireless charge compatible portable devices according to the Wireless Power Consortium,

■ Name for all parts

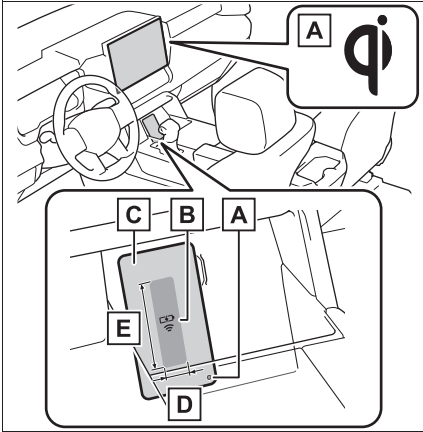

- A** Operation indicator light
- B** Charging area*
- C** Charging tray
- D** Approximately 1.0 in. (2.5 cm)
- E** Approximately 3.9 in. (10 cm)

*: Compatible portable devices and the wireless charger contain charging coils. The charging coil in the wireless charger can be moved within the charge area up to the position of the charging coil inside a portable device. Charging is possible if the center of the coil of the portable device is placed within the charge area. If 2 or more portable devices are placed on the charging tray, their charging coils may not be properly detected and they may not be charged.

■ Using the wireless charger

Place the portable device on the charging tray.

Place the charging side of the portable device down with the center of the device in the center of the charge area.

When charging, the operation indicator light (orange) comes on.

If charging is not occurring, refer to “Situations in which the function may not operate normally” (→P.447).

When charging is complete, the operation indicator light (green) comes on.

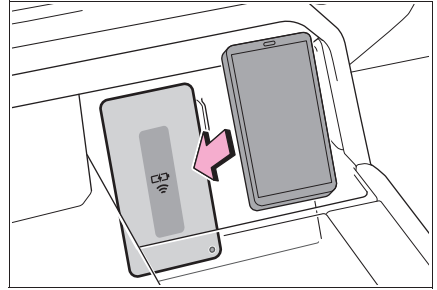

■ Recharging function

- When charging is complete and after a fixed time in the charge suspension state, charging restarts.
- When a portable device is moved significantly in the charge area, the charging coil is disconnected and charging is stopped momentarily. However, if there is a charging coil in the charge area, the charging coil inside the wireless charger will move toward it and then charging restarts.

■ Rapid charging function

- The following portable devices support rapid charging.
- Portable devices compliant with WPC Ver1.3.2 and compatible with rapid charging
- iPhone's with an iOS version that supports 7.5 W charging (iPhone

8 and later models)

- Portable devices compatible with Galaxy original rapid charging standard.
- When a portable device that supports rapid charging is charged, charging automatically switches to the rapid charging function.

■ Lighting conditions of operation indicator light

Operation indicator light		Conditions
Charging tray side	Multimedia system screen side	
Turning off	Disappear	When the Multimedia power supply is off or power switch is off
Green (comes on)	Gray	On Standby (charging possible state) ^{*1}
		When charging is complete ^{*2}
Orange (comes on)	Blue	Charging

^{*1}: Charging power will not be output during standby. A metallic object will not be heated, if it is placed on the charging tray in this state.

^{*2}: Depending on the portable device, there are cases where the operation indicator light will continue being lit up orange even after the charging is complete.

■ The wireless charger is not working properly

The following are situations in which the wireless charger does not work properly and how to deal with the possible causes.

Operation indicator light	Multimedia system screen	Suspected causes/Handling method
Orange (Flashing repeatedly once every second)	Gray	<p>Vehicle to wireless charger communication failure → If the hybrid system is operating, stop and then restart the hybrid system.</p> <p>If the power switch is in ACC, start the hybrid system. (→P.207)</p>
Green (Flashing repeatedly once every second)	Disappear	<p>Wireless charger and multimedia system communication failure → If the hybrid system is operating, stop and then restart the hybrid system.</p> <p>If the power switch is in ACC, start the hybrid system. (→P.207)</p>
Green (comes on)	Blue	<p>AM radio stations are being automatically selected → Wait until the system has completed the automatic selection of AM radio stations. In the case that automatic selection cannot be completed, stop automatic selection.</p>
		<p>The smart key system is detecting the key → Wait until the key detection is complete.</p>

Operation indicator light	Multimedia system screen	Suspected causes/Handling method
Green (comes on)	Gray	<p>Foreign substance detection: A metallic foreign substance is in the charge area, and so the abnormal heating prevention function of the metallic foreign substance operated → Remove the foreign substance from the charge area.</p>
		<p>Portable device misaligned/distanced from charging surface: The charging coil in the portable device moved outside of the charging area, or lens convex is large, or case is thick so the abnormal heating prevention function operated → Remove the portable device from the wireless charger, after 5 seconds, then place the portable device so that it is near the center of the wireless charger. Also, if a case or cover is installed to the portable device, remove it.</p>
		<p>Battery protection function of portable device: Before full charging, battery protection function of portable device operated → Confirm the setting of portable device.</p>

Operation indicator light	Multimedia system screen	Suspected causes/Handling method
Orange (Repeatedly flashes 4 times continuously)	Gray	<p>Safety shutdown resulting when the temperature within the wireless charger exceeded the set value</p> <p>→ Stop charging, remove the portable device from the charging tray, wait for the temperature to drop, and then start charging again.</p>

■ The wireless charger can be operated when

The power switch is in ACC or ON.

■ Usable portable devices

- Devices compatible with wireless charging Qi standards can be used. However, compatibility with portable devices that comply with Qi Ver. 1.0, 1.3.2 and later versions is not guaranteed.
- Starting with mobile phones and smartphones, it is aimed for low power electrically supplied portable devices of no more than 5 W.
- However, charging exceeding 5 W is supported by the following portable devices.
 - Charging at 7.5 W or less is supported by iPhone's that support 7.5 W charging.
 - Devices that comply with independent Galaxy charging standards support rapid charging. Check the specifications of each portable device for the charging electricity.
 - Charging at 15 W or less is supported by portable devices compliant with EPP output as defined by WPC standard Ver1.3.2.

■ Using the smart key system

If the smart key system detects the electronic key while a device is being charged, charging will be temporarily stopped. When the electronic key is detected, charging will

automatically start again.

■ When covers and accessories are attached to portable devices

Do not charge in situations where cover and accessories not able to handle Qi are attached to the portable device. Depending on the type of cover (including for certain genuine manufacturer parts) and accessory, it may not be possible to charge.

When charging is not performed even with the portable device placed on the charge area, remove the cover and accessories.

■ AM radio cooperation function during charging

- During charging, if noise occurs when listening to the AM radio, the charging frequency is automatically changed to reduce the noise.
- When automatically seeking AM radio stations, charging will be suspended to prevent charging noise from being detected as a radio station. Charging will resume automatically when seek tuning is stopped.

■ Important points of the wireless charger

- If the electronic key cannot be detected within the vehicle interior, charging can not be done. When the door is opened and closed, charging may be tempo-

rarily suspended.

- When charging, the wireless charging device and portable device will get warmer, however this is not a malfunction. When a portable device gets warm while charging, charging may stop due to the protection function on the portable device side. In this case, when the temperature of the portable drops significantly, charge again.

The fan may start operating to lower the temperature inside the wireless charger, however this is not a malfunction.

■ Operation sounds

A buzzing noise may be heard when pressing the power switch to turn to ACC or ON or when detecting a portable device. However, this is not a malfunction.

■ Cleaning the wireless charger

→P.470

■ Situations in which the function may not operate normally

Devices may not be charged normally in the following situations.

- The portable device is fully charged
- The portable device is being charged with a cable connected
- There is foreign matter between the charge area and portable device
- Charging has caused the portable device to heat up
- The temperature around the charging tray is 95°F (35°C) or higher, such as in extreme heat
- The portable device is placed with its charging surface facing up
- The small portable device such as foldable type is placed in an area misaligned from the charge area
- The portable device is larger than the charging tray
- The camera lens protrudes 0.12 in (3 mm) or more from the surface of the portal device
- The vehicle is in an area where strong electrical waves or noise are emitted, such as near a television tower, power plant, gasoline station, broadcasting station, large display, airport, etc.
- The electronic key is not inside the vehicle
- Any of the following objects is stuck or installed between the charging side of the portable device and the charge area.
 - Thick cases or covers
 - A case or cover attached with an uneven or tilted surface, so that the charging side is not flat
 - Thick decorations
 - Accessories, such as finger rings, straps, etc.
- When there is a gap between the charging side of the portable device and the charge area due to a protrusion such as a camera on the charging side of the portable device.
- When the portable device is in contact with, or is covered by any of the following metallic objects:
 - A card that has metal on it, such as aluminum foil, etc.
 - A pack of cigarettes that includes aluminum foil
 - A wallet or bag that is made of metal
 - Coins
 - A heating pad
 - CDs, DVDs or other media
 - A metal accessory
 - A case or cover made of metal
 - A flip type case with a magnet on the charging side of the portable device
- Electric wave type wireless remote controls are being used nearby
- 2 or more portable devices are placed on the charging tray at the same time

- If you use a device with a built-in S-Pen (Galaxy Note series, etc.) and the device with the S-Pen inserted is on the tray.

If charging is abnormal or the operation indicator light continues to flash for any other reason, the wireless charger may be malfunctioning. Contact your Toyota dealer.

■ If the smartphone OS has been updated

If the smartphone OS has been updated to a newer version, its charging specifications may have changed significantly. For details, check the information on the manufacturer's website.

■ Trademark information

- iPhone is a trademark of Apple Inc., registered in the U.S. and other countries.
- "Galaxy" is a trademark or registered trademark of Samsung Electronics Co., Ltd.

■ Certification

→P.644



WARNING

■ Caution while driving

When charging a portable device, for safety reasons, the driver should not operate the main part of the portable device while driving.

■ Caution while in motion

Do not charge lightweight devices such as wireless headphones while in motion. These devices are very light and may be ejected from the charging tray, which may lead to unforeseen accidents.

■ Caution regarding interference with electronic devices

People with implantable cardiac pacemakers, cardiac resynchronization therapy-pacemakers or implantable cardioverters, as well as any other electrical medical device, should consult their physician about the usage of the wireless charger.

■ To prevent malfunctions or burns

Observe the following precautions. Failure to do so may result in a equipment failure and damage, catch fire, burns due to overheat or electric shock.

- Do not insert any metallic objects between the charge area and the portable device while charging
- Do not attach an aluminum sticker or other metallic object to the charge area
- Do not attach an aluminum sticker or other metallic object to the side of the portable device (or to its case or cover) that touches the charge area
- Do not use the charging tray as a small storage space
- Do not subject to a strong force or impact
- Do not disassemble, modify or remove
- Do not charge devices other than specified portable devices
- Keep away from magnetic items
- Do not perform charging if the charging area is dirty
- Do not cover with a cloth or similar material

 NOTICE

■ **To prevent malfunctions and data corruptions**

- When charging, bringing a credit, or other magnetic card, or magnetic storage media close to the charge area may clear any stored data due to magnetic influence. Also, do not bring a wristwatch or other precision instrument close to the charge area since doing so may cause it to malfunction.
- Do not charge with a non-contact IC card such as a transportation system IC card inserted between the charging side of a portable device and the charge area. The IC chip may become extremely hot and damage the portable device or IC card. Be especially careful not to charge a portable device inside a case or cover with a non-contact IC card attached.
- Do not leave portable devices inside the vehicle. The inside of the vehicle can become hot in extreme heat, which could cause a malfunction.

■ **To prevent battery discharge**

Do not use the wireless charger for a long period of time when the hybrid system is stopped.

Armrest

Pull the armrest down for use.

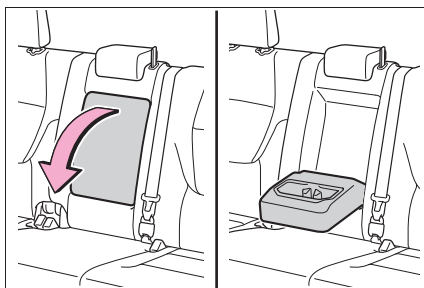

 NOTICE

■ **To prevent damage to the armrest**

Do not place too much strain on the armrest.

Assist grips

An assist grip installed on the pillar can be used when getting in or out of the vehicle and others.

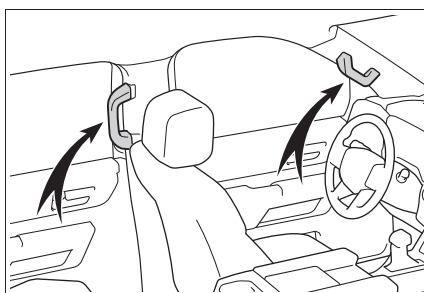

 NOTICE

■ **To prevent damage to the assist grip**

Do not hang any heavy object or put a heavy load on the assist grip.

Coat hooks

▶ Type A

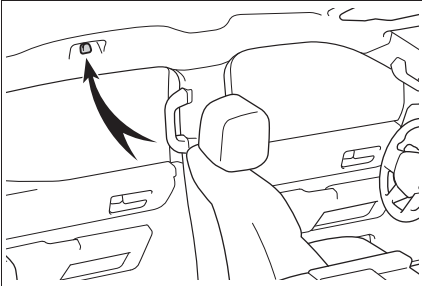

▶ Type B

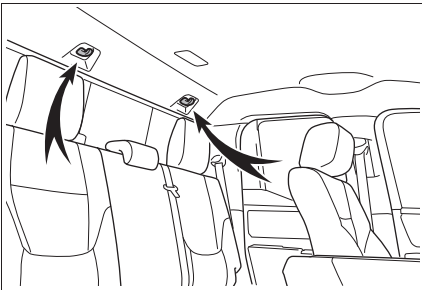

⚠ WARNING

■ Items that must not be hung on the hook

Do not hang a coat hanger or other hard or sharp object on the hook. If the SRS curtain shield airbags deploy, these items may become projectiles that cause death or serious injury.

Power outlet (12 VDC)

The power outlet can be used for 12 V accessories that run on less than 10 A.

Open the lid.

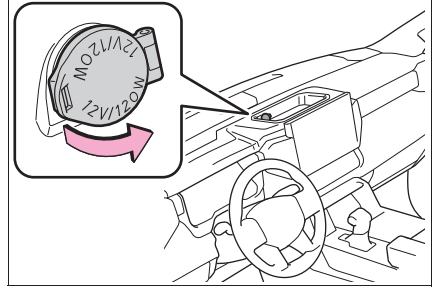

■ The power outlet can be used when

The power switch is in ACC or ON.

■ When stopping the hybrid system

Disconnect electrical devices with charging functions, such as mobile battery packs. If such devices are left connected, the hybrid system may not stop normally.

⚠ NOTICE

■ To avoid damaging the power outlet

Close the power outlet lid when the power outlet is not in use. Foreign objects or liquids that enter the power outlet may cause a short circuit.

■ To prevent the fuse from being blown

Do not use an accessory that uses more than 12 V 10 A.

■ To prevent 12-volt battery discharge

Do not use the power outlet longer than necessary when the hybrid system is off.

Power outlets (120 VAC) (if equipped)

Please use as a power supply for electronic devices that use less than 120 VAC.

■ Using the power outlets

- ▶ Rear of the console box

Open the lid.

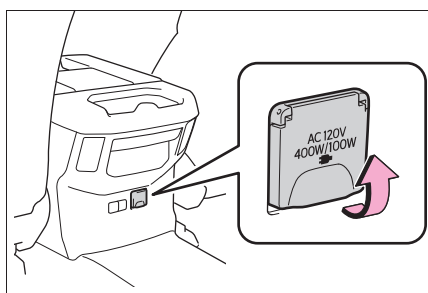

- ▶ Bed

Open the lid.

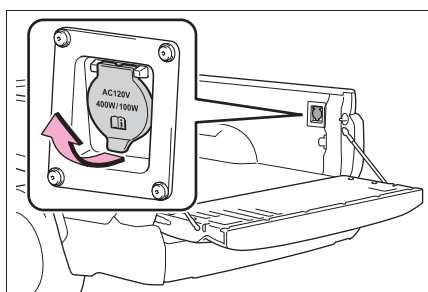

■ When turning the power outlets on

Press the “AC120V” switch.

The power outlets can be used when the indicator on the “AC120V” switch is illuminated.

The power outlets are turned off/on each time the “AC120V” switch is pressed.

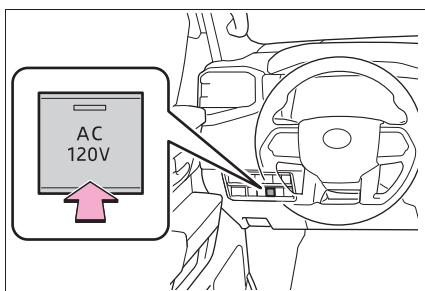

■ Maximum available capacity of the power outlet

- While the vehicle is being driven

The maximum capacity of the power outlet is always 120 V AC/100 W.

- When the vehicle is stationary
 - The maximum capacity is restricted to 120 V AC/100 W when the shift lever is moved to any positions other than P or N.
 - The maximum capacity is 120 V AC/400 W when the shift lever is in P or N.

The maximum capacity of 400 W can only be restored by turning the power outlet main switch off and then on again under condition described above.

■ **When connecting a device**

Open the lid, and fully and securely insert the plug of the device into the power outlet.

▶ **Rear of the console box**

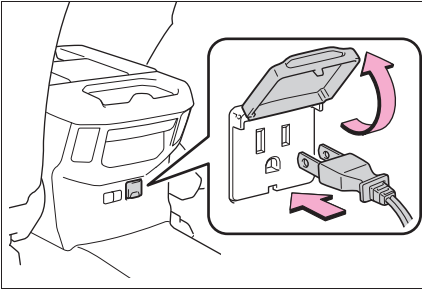

▶ **Bed**

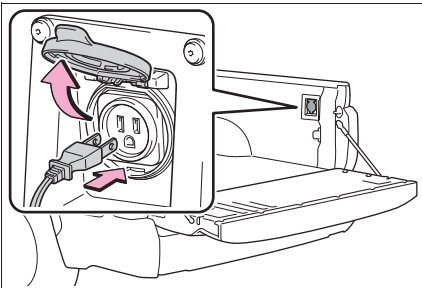

■ **When turning the power outlets off**

- 1 Turn the connected devices off.
- 2 Press the “AC120V” switch to turn the power outlets off.
- 3 Disconnect each plug from the power outlets.
- 4 Close the lid of each power outlet.

■ **The power outlet can be used when**

The hybrid system is operating.

■ **Electronic devices that can be connected to the power outlets**

Use electronic devices that can be connected to the 120 VAC power outlets. Depending on the devices being used, the current flow may become high and the electric power for a moment may exceed the regulated capacity. If the regulated capacity is exceeded by the electronic devices being used, the protection function of the power outlet may operate and power outlet may not be able to be used, but this is not a malfunction. However, observe the following precautions:

- Depending on the devices used, it may cause interference with TV and radio broadcasts.
- Observe the precautions that are stated in the instruction manuals for each of the electronic devices.
- It is assumed that many typical general electronic devices will not be used within the vehicle. The following problems may occur when using electronic devices within the vehicle.
 - Electronic device malfunction due to vibrations while driving.
 - Electronic device malfunction or poor operations due to temperature changes* within the vehicle.
 - The installation is unstable and may not operate normally as the compartment within the vehicle is not flat.

*: Depending on the weather, season, usage environment, etc., the vehicle compartment may undergo extreme high or low temperatures.

■ **Power outlet**

The power outlet on the console box is a device in order to use electronic devices within the vehicle.

■ **Devices which may not operate correctly**

The following 120 VAC devices may

not operate properly:

- Devices with high initial peak wattage
- Measuring devices that process precise data
- Devices that require an extremely stable power supply
- Devices that require a constant power supply from the power outlet, such as a device with a timer.

■ **When the power supply function cannot be used**

If the “AC120V” switch is pressed but the switch indicator does not illuminate, the protection circuit may have operated.

In this case, perform the appropriate procedures as follows.

- Disconnect the plug of each device from the power outlets, check that the total power consumption of all devices to be connected to the power outlets, reconnect the devices and then press the “AC120V” switch again.
- Disconnect the plug of each device from the power outlets, check that the devices are not malfunctioning, reconnect the devices and then press the “AC120V” switch again.
- If the temperature inside the vehicle is high, such as after the vehicle has been parked under the sun, move the vehicle to a shaded area, use the air conditioning system to sufficiently cool the interior, and then press the “AC120V” switch again.

If the power outlets cannot be used even after performing the appropriate procedures above, have the vehicle inspected by your Toyota dealer.

- If any electrical device has malfunctioned, park the vehicle in a safe location and turn the “AC120V” switch off.
- If the protection function activates

and power is cut, perform the following procedure.

- 1 Stop the vehicle in a safe place and set the parking brake.
- 2 Ensure that the shift lever is in P or N.
- 3 Check that the power consumed by the electrical devices is within 400 W and any device has not malfunctioned.
- 4 Press the “AC120V” switch.

If the inside of the vehicle is hot, open the windows to lower the temperature and turn the switch back on once the inside of the vehicle reaches a normal temperature. If following the procedure above does not restore power, have the vehicle inspected at your Toyota dealer.



WARNING

■ **For safe use**

Observe the following precautions.

Failure to do so may lead to an accident, resulting in death or serious injury.

- Do not use devices such as the following when driving:
 - Devices which cannot be properly secured within the vehicle.
 - Devices which may distract the driver and be a hindrance to safe driving, such as a TV, DVD player, etc.
 - Unsecured devices which generate heat, such as a toaster, microwave, electric heater, electric kettle, coffee maker, etc., as they may cause burns or a fire in the case of sudden braking or an accident.

**WARNING**

- Devices which may fall under the pedals and prevent the brake pedal from being depressed.
- Do not use devices which produce steam while the windows are closed. Doing so may cause the windows to fog up, reducing visibility and making it difficult to drive safely. Also, the steam may damage or negatively affect other devices. If the device must be used, stop the vehicle and open the windows before use.
- Do not use damaged electronic devices. The power supply function may not be able to be used.
- Do not disconnect the plug of a device while your hands are wet or insert a pin or other object into the power outlet. Also, if a liquid or snow is on the power outlet, dry the outlet before using it.
- Do not attempt to modify, disassemble or repair a power outlet. For information on repairs, contact your Toyota dealer.
- Do not let children touch the power outlets.
- Keep the power outlets free of dust and foreign matter. Also, regularly clean the power outlet.
- If the plug of a device fits loosely in a power outlet, even though it is fully inserted, replace the power outlet. For information on replacement, contact your Toyota dealer.

■ Using the power outlets while parked or stopped

Observe the following precautions.

Failure to do so may lead to an accident, possibly resulting in death or serious injury.

- Do not leave the vehicle unattended while the hybrid system is operating and a device is connected to a power outlet.
- Do not place luggage or get near the vicinity of the tailpipe.
- Make sure that the hood is closed. Do not put your head or hands anywhere inside the engine room, as the cooling fans may operate suddenly. If too close, hands and clothing (especially a tie, scarf, etc.) may get caught in a fan.
- Do not stop the vehicle near objects which burn easily.
- Install and use appropriately related devices to make air supply and exhaust ventilation possible in places where ventilation is bad, such as within garages, and places where the vehicle is surrounded (places where snow accumulates).
- Do not use in places where ventilation is bad, such as within garages where there are no air supply and exhaust ventilation devices, and places where the vehicle is surrounded (places where snow accumulates, etc.).
- Do not use the power outlets if the vehicle has a vehicle cover installed.
- Do not sleep in the vehicle while using devices such as an electric heater.

⚠ WARNING**■ Devices to be connected**

- Read the instruction manual included with the electronic device being used and observe the precautions that are stated regarding the product.
- Do not use when the power plug or electronic device are damaged.
- Malfunctions or poor operations may occur when the outside temperatures are particularly high or low.
- Normal operations may not be possible for electronic devices that require level installation.
- Excluding electronic devices with waterproof specifications, do not use in places where it can be covered by rain or water, or places with lots of humidity.
- Do not use medical equipment as the power supply function may temporarily stop depending the conditions of the vehicle.

⚠ NOTICE

Observe the following precautions.

Failure to do so may lead to the power outlets not operating correctly or damage to the vehicle or a connected device.

■ To avoid short circuit or malfunction

- Do not set a device which generates heat near the interior components or on a seat. Heat may cause these parts to melt or burn.

- Do not use devices which are sensitive to vibration or heat in the vehicle.
These devices may malfunction due to vibration while driving or heat while the vehicle is parked in the sun.
- When not using a power outlet, make sure to close the cover. If foreign matter or a liquid enters the power outlet, it may cause a malfunction or short circuit.
- Do not use a multi-point outlet adapter as doing so may overload the power outlet.
- Immediately stop using if there is an unusual amount of heat being felt from the power outlet.

■ When the ambient temperature is high

If the temperature inside the vehicle is high, such as after the vehicle has been parked under the sun, move the vehicle to a shaded area, use the air conditioning system to sufficiently cool the interior, and then press the "AC120V" switch again.

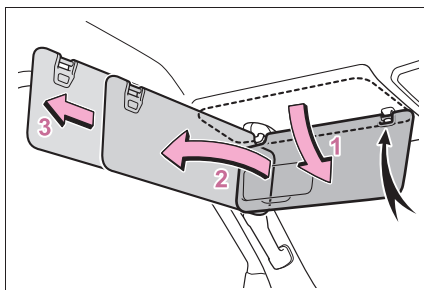
Sun visors

- 1 To set the visor in the forward position, flip it down.
- 2 To set the visor in the side position, flip down, unhook,

and swing it to the side.

- 3 To use the side extender, place the visor in the side position, then slide it backward.

Vanity mirrors

Open the cover.

The vanity light turns on.

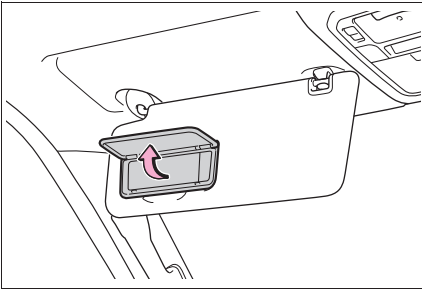

■ To prevent 12-volt battery discharge

If the vanity lights remain on when the power switch is turned off, the lights will go off automatically after 20 minutes.

⚠ NOTICE

■ To prevent the 12-volt battery from being discharged

Do not leave the vanity lights on for extended periods while the hybrid system is off.

Rear door sunshades (if equipped)

Pull up the tab of the sunshade and hook the shade on using the anchors.

To retract the sunshade, unhook the sunshade and retract it slowly.

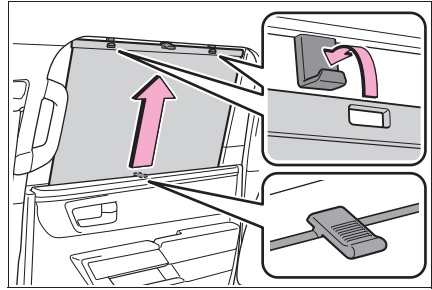

⚠ NOTICE

■ To ensure normal operation of the sunshades

Observe the following precautions:

- Do not place anything where it may hinder the opening/closing of the rear door sunshades.
- Do not attach items to the rear door sunshades.
- Do not apply excessive load to the rear door sunshades while they are hanging from the hooks.
- Do not operate the rear door sunshade while the rear door is opening/closing.
- Do not store the rear door sunshade in a tilted position. If stored in a tilted position, the rear door sunshade screen may become creased.

■ To prevent damage to the rear door sunshade

Observe the following precautions:

- Do not use the rear door sunshade when either hook is detached. When the rear door is opened/closed, the rear door sunshade may be damaged.
- Do not pull on the screen while the hooks are attached. The screen may be damaged.

Garage door opener

The garage door opener can be programmed using the HomeLink® to operate garage doors, gates, entry doors, door locks, home lighting systems, security systems, and other devices.

■ HomeLink® programming procedure

The programming procedures can also be found at the following URL. Website: www.homelink.com/toyota



For support, contact customer support at the following.

Help Line: 1-800-355-3515

System components

The HomeLink® wireless control system in your vehicle has 3 buttons which can be programmed to operate 3 different devices. Refer to the programming methods on the following pages to determine the method which is appropriate for the device.

- ▶ Vehicles with auto anti-glare inside rear view mirror

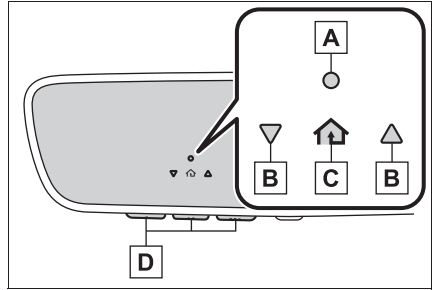

- A** HomeLink® indicator light
- B** Garage door operation indicators
- C** HomeLink® icon

Illuminates while HomeLink® is operating.

- D** Buttons

- ▶ Vehicles with Digital Rear-view Mirror

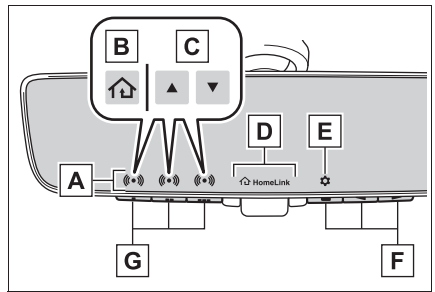

- A** HomeLink® indicator light
Illuminates above each button selected.
- B** HomeLink® icon
- C** Garage door operation indicators

- D** HomeLink® logo

Appears while HomeLink[®] is operating. When the menu button (→P.154) is pressed, the logo disappears even while the HomeLink[®] is operating.

E Setting icon

Press the menu button to change the setting.

F Menu buttons

G HomeLink[®] buttons

■ **Codes stored in the HomeLink[®] memory**

- The registered codes are not erased even if the 12-volt battery cable is disconnected.
- If learning failed when registering a different code to a HomeLink[®] button that already has a code registered to it, the already registered code will not be erased.

■ **Certification**

→P.646

 **WARNING**

■ **When programming a garage door or other remote control device**

The garage door or other device may operate, so ensure people and objects are out of danger to prevent potential harm.

■ **Conforming to federal safety standards**

Do not use the HomeLink[®] compatible transceiver with any garage door opener or device that lacks safety stop and reverse features as required by federal safety standards.

This includes any garage door that cannot detect an interfering object. A door or device without these features increases the risk of death or serious injury.

■ **When operating or programming HomeLink[®]**

Never allow a child to operate or play with the HomeLink[®] buttons.

Programming the HomeLink[®]

■ **Before programming HomeLink[®]**

- During programming, it is possible that garage doors, gates, or other devices may operate. For this reason, make sure that people and objects are clear of the garage door or other devices to prevent injury or other potential harm.
- It is recommended that a new battery be placed in the remote control transmitter for more accurate programming.
- Garage door opener motors manufactured after 1995 may be equipped with rolling code protection. If this is the case,

you may need a stepladder or other sturdy, safe device to reach the “Learn” or “Smart” button on the garage door opener motor.

■ Programming HomeLink®

Steps **2** through **4** must be performed within 60 seconds, otherwise the indicator light will stop flashing and programming will not be successfully completed.

- 1** Vehicles with Digital Rear-view Mirror: Press the HomeLink® button or menu button. When the HomeLink® button is pressed: HomeLink® Training Tutorial will be displayed to assist you programming the HomeLink®.

When the menu button is pressed: Press the menu button  and select the “SET UP”. HomeLink® Training Tutorial will be displayed to assist you programming the HomeLink®.

- 2** Press and release the HomeLink® button you want to program and check that the HomeLink® indicator light flashes (orange).
- 3** Point the remote control transmitter for the device at the rear view mirror, 1 to 3 in. (25 to 75 mm) from the HomeLink® buttons.

Keep the HomeLink® indicator light in view while programming.

- ▶ Vehicles with auto anti-glare inside rear view mirror

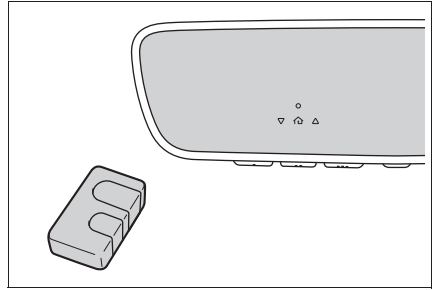

- ▶ Vehicles with Digital Rear-view Mirror

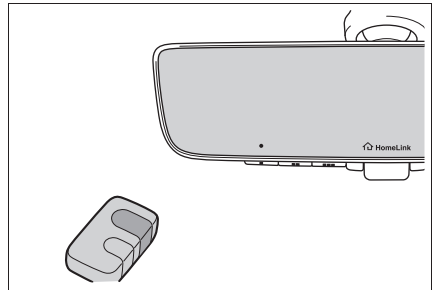

- 4** Program a device.

- ▶ Vehicles with auto anti-glare inside rear view mirror

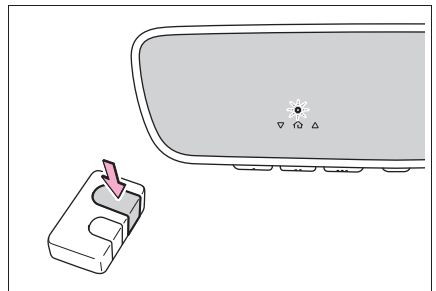

- ▶ Vehicles with Digital Rear-view Mirror

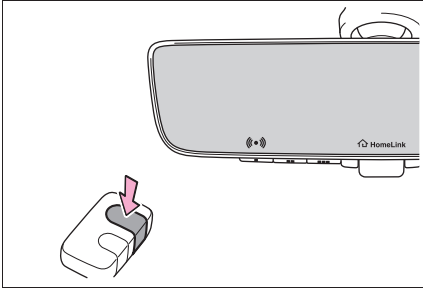

- ▶ Programming a device other than an entry gate (for U.S.A. owners)

Press and hold the remote control transmitter button until the HomeLink[®] indicator light changes from slowly flashing orange to rapidly flashing green (rolling code) or continuously lit green (fixed code), then release the button.

- ▶ Programming an entry gate (for U.S.A. owners)/Programming a device in the Canadian market

Press and release the remote control transmitter button at 2 second intervals, repeatedly, until the HomeLink[®] indicator light changes from slowly flashing (orange) to rapidly flashing (green) (rolling code) or continuously lit (green) (fixed code).

- 5 Test the HomeLink[®] operation by pressing the newly programmed button and observing the indicator light:

- HomeLink[®] indicator light illuminates: Programming of a fixed code device has com-

pleted. The garage door or other device should operate when a HomeLink[®] button is pressed and released.

- HomeLink[®] indicator light flashes rapidly: The garage door opener motor or other device is equipped with a rolling code. To complete programming, firmly press and hold the HomeLink[®] button for 2 seconds then release it.
- If the garage door or other device does not operate, proceed to "Programming a rolling code system".
- 6 Repeat the steps above to program another device for any of the remaining HomeLink[®] buttons.

■ Programming a rolling code system

Two or more people may be necessary to complete rolling code programming.

- 1 Locate the “Learn” or “Smart” button on the garage door opener motor in the garage.

This button can usually be found where the hanging antenna wire is attached to the unit. The name and color of the button may vary by manufacturer. Refer to the owner’s manual supplied with the garage door opener motor for details.

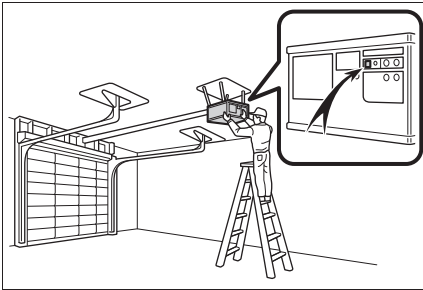

- 2 Press and release the “Learn” or “Smart” button.

Perform 3 within 30 seconds after performing 2.

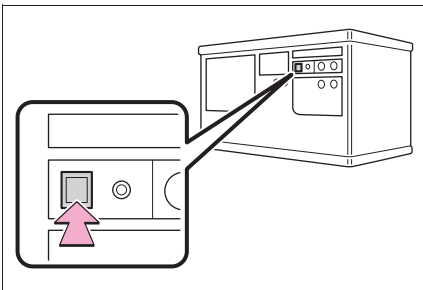

- 3 Press and hold the desired HomeLink® button (inside the vehicle) for 2 seconds and release it. Repeat this

sequence (press/hold/release) up to 3 times to complete programming.

If the garage door opener motor operates when the HomeLink® button is pressed, the garage door opener motor recognizes the HomeLink® signal.

- ▶ Vehicles with auto anti-glare inside rear view mirror

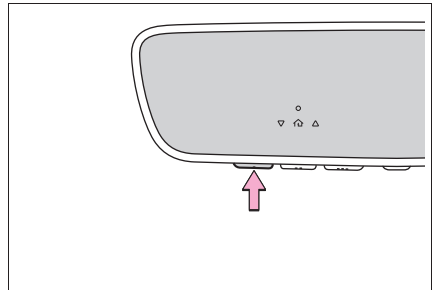

- ▶ Vehicles with Digital Rear-view Mirror

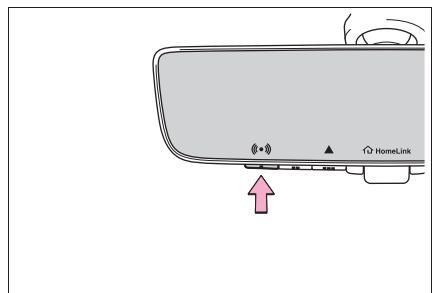

■ Enabling 2-way communication with a garage door (only available for compatible devices)

When enabled, 2-way communication allows you to check the status of the opening and closing of a garage door through indicators in your vehicle.

2-way communication is only available if the garage door opener motor used is a compatible device. (To check device compatibility, refer to www.homelink.com.)

- 1 Within 5 seconds after programming the garage door opener has been completed, if the garage door opener motor is trained to HomeLink[®], both garage door operation indicators will flash rapidly (green) and the light on the garage door opener motor will blink twice, indicating that 2-way communication is enabled.

If the indicators do not flash, perform **2** and **3** within the first 10 presses of the HomeLink[®] button after programming has been completed.

- 2 Press a programmed HomeLink[®] button to operate a garage door.
- 3 Within 1 minute of pressing the HomeLink[®] button, after the garage door operation has stopped, press the

“Learn” or “Smart” button on the garage door opener motor. Within 5 seconds of the establishment of 2-way communication with the garage door opener, both garage door operation indicators in the vehicle will flash rapidly (green) and the light on the garage door opener motor will blink twice, indicating that 2-way communication is enabled.

■ Reprogramming a single HomeLink[®] button

When the following procedure is performed, buttons which already have devices registered to them can be overwritten:

- 1 Press and hold the desired HomeLink[®] button.
- 2 When the HomeLink[®] indicator starts flashing orange, release the HomeLink[®] button and perform “Programming HomeLink[®]” **1** (it takes 20 seconds for the HomeLink[®] indicator to start flashing).

■ Before programming

- Install a new battery in the transmitter.
- The battery side of the transmitter must be pointed away from the HomeLink[®] buttons.

Operating HomeLink®

Press the appropriate HomeLink® button. The HomeLink® indicator light should turn on.

The status of the opening and closing of a garage door is shown by the garage door opener indicators.

- ▶ Vehicles with auto anti-glare inside rear view mirror

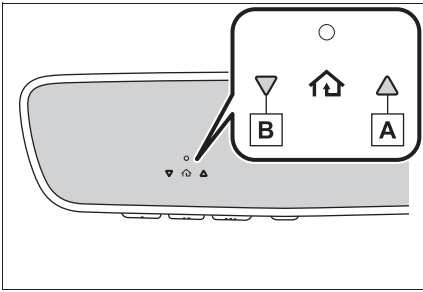

A Opening

B Closing

- ▶ Vehicles with Digital Rear-view Mirror

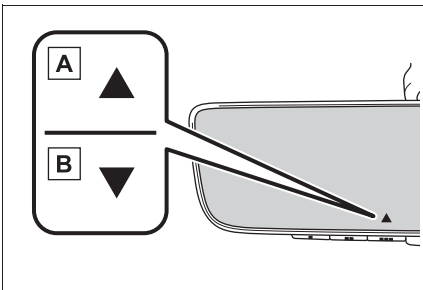

A Opening







B Closing

This function is only available if the garage door opener motor used is a compatible device. (To check

device compatibility, refer to www.homelink.com.)

Color	Status
Orange (flashing)	Currently opening/closing
Green	Opening/closing has completed
Red (flashing)	Feedback signals cannot be received

The indicators can operate within approximately 820 ft. (250 m) of the garage door. However, if there are obstructions between the garage door and the vehicle, such as houses and trees, feedback signals from the garage door may not be received.

To recall the previous door operation status, press and release either HomeLink® buttons  and  or  and  (vehicles with auto anti-glare inside rear view mirror),  and  (vehicles with Digital Rear-view Mirror), simultaneously. The last recorded status will be displayed for 3 seconds.

Erasing the entire Home-Link[®] memory (all three codes)

Press and hold the 2 outside buttons for 10 seconds until the HomeLink[®] indicator light changes from continuously lit (orange) to rapidly flashing (green).

If you sell your vehicle, be sure to erase the programs stored in the HomeLink[®] memory.

- ▶ Vehicles with auto anti-glare inside rear view mirror

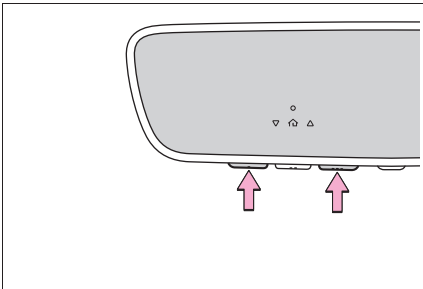

- ▶ Vehicles with Digital Rear-view Mirror

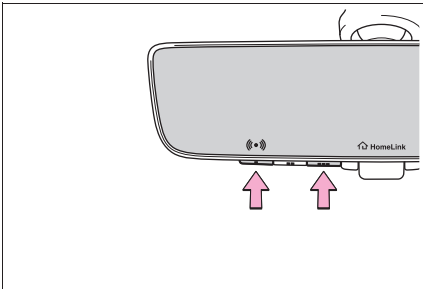

Maintenance and care

6

6-1. Maintenance and care

Cleaning and protecting the vehicle exterior **466**

Cleaning and protecting the vehicle interior **469**

6-2. Maintenance

Maintenance requirements **472**

General maintenance.. **473**

Emission inspection and maintenance (I/M) programs **476**

6-3. Do-it-yourself maintenance

Do-it-yourself service precautions..... **478**

Hood **480**

Engine compartment... **481**

12-volt battery **488**

Tires **490**

Tire inflation pressure.. **501**

Wheels **503**

Air conditioning filter.... **505**

Cleaning the hybrid battery (traction battery) air intake vents..... **506**

Electronic key battery.. **510**

Checking and replacing fuses..... **512**

Light bulbs..... **515**

Cleaning and protecting the vehicle exterior

Perform cleaning in a manner appropriate to each component and its material.

Cleaning instructions

- Working from top to bottom, liberally apply water to the vehicle body, wheel wells and underside of the vehicle to remove any dirt and dust.
- Wash the vehicle body using a sponge or soft cloth, such as a chamois.
- For hard-to-remove marks, use car wash soap and rinse thoroughly with water.
- Wipe away any water.
- Wax the vehicle when the waterproof coating deteriorates.

If water does not bead on a clean surface, apply wax when the vehicle body is cool.

■ Automatic car washes

- Fold the mirrors before washing the vehicle.

Start washing from the front of the vehicle. Extend the mirrors before driving.

- Brushes used in automatic car washes may scratch the vehicle surface, parts (wheel, etc.) and harm your vehicle's paint.

■ High pressure car washes

As water may enter the cabin, do not bring the nozzle tip near the gaps around the doors or perimeter of the windows, or spray these areas continuously.

■ When using a car wash

If the door handle becomes wet while the electronic key is within the effective range, the door may lock and unlock repeatedly. In that case, follow the following correction procedures to wash the vehicle:

- Place the key in a position 6 ft. (2 m) or more separate from the vehicle while the vehicle is being washed. (Take care to ensure that the key is not stolen.)
- Set the electronic key to battery-saving mode to disable the Smart key system. (→P.132)

■ Wheels and wheel ornaments

- Remove any dirt immediately by using a neutral detergent.
- Wash detergent off with water immediately after use.
- To protect the paint from damage, make sure to observe the following precautions.
 - Do not use acidic, alkaline or abrasive detergent
 - Do not use hard brushes
 - Do not use detergent on the wheels when they are hot, such as after driving or parking in hot weather

■ Brake pads and calipers

Rust may form if the vehicle is parked with wet brake pads or disc rotors, causing them to stick. Before parking the vehicle after it is washed, drive slowly and apply the brakes several times to dry the parts.

■ Bumpers and wheel arch moldings

Do not scrub with abrasive cleaners.

■ Plated portions

If dirt cannot be removed, clean the parts as follows:

- Use a soft cloth dampened with an approximately 5% solution of neutral detergent and water to clean the dirt off.
- Wipe the surface with a dry, soft cloth to remove any remaining moisture.
- To remove oily deposits, use alcohol wet wipes or a similar product.



WARNING

■ When washing the vehicle

Do not apply water to the inside of the engine compartment. Doing so may cause the electrical components, etc. to catch fire.

■ Precautions regarding the exhaust pipe

Exhaust gases cause the exhaust pipe to become quite hot. When washing the vehicle, be careful not to touch the pipe until it has cooled sufficiently, as touching hot exhaust pipe can cause burns.

■ When cleaning the windshield (vehicles with rain-sensing windshield wipers)

Set the wiper switch to off. If the wiper switch is in “AUTO”, the wipers may operate unexpectedly in the following situations, and may result in hands being caught or other serious injuries and cause damage to the wiper blades.

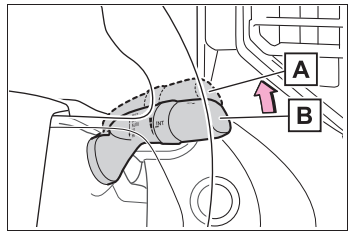

A Off

B “AUTO”

- When the upper part of the windshield where the raindrop sensor is located is touched by hand
- When a wet rag or similar is held close to the raindrop sensor
- If something bumps against the windshield
- If you directly touch the raindrop sensor body or if something bumps into the raindrop sensor

■ Precaution regarding the rear bumper with Blind Spot Monitor (vehicles with painted rear bumper)

If the paint of the rear bumper is chipped or scratched, the following systems may not function correctly. If this occurs, consult your Toyota dealer.

- BSM
- RCTA

**WARNING**

- PKSB

**NOTICE**

■ **To prevent paint deterioration and corrosion on the body and components (aluminum wheels, etc.)**

- Wash the vehicle immediately in the following cases:
 - After driving near the sea coast
 - After driving on salted roads
 - If coal tar or tree sap is present on the paint surface
 - If dead insects, insect droppings or bird droppings are present on the paint surface
 - After driving in an area contaminated with soot, oily smoke, mine dust, iron powder or chemical substances
 - If the vehicle becomes heavily soiled with dust or mud
 - If liquids such as benzene and gasoline are spilled on the paint surface
 - If the paint is chipped or scratched, have it repaired immediately.
 - To prevent the wheels from corroding, remove any dirt and store in a place with low humidity when storing the wheels.
- **Cleaning the exterior lights**
- Wash carefully. Do not use organic substances or scrub with a hard brush. This may damage the surfaces of the lights.

- Do not apply wax to the surfaces of the lights. Wax may cause damage to the lenses.

■ **When using an automatic car wash (vehicles with rain-sensing windshield wipers)**

Set the wiper switch to the off position.

If the wiper switch is in "AUTO", the wipers may operate and the wiper blades may be damaged.

■ **When using a high pressure car wash**

- When washing the vehicle, do not spray the camera or its surrounding area directly with a high pressure washer. Shock applied from high pressure water may cause the device to not operate normally.
- Do not spray water directly on the radar which is equipped behind the grill. Otherwise it may cause the device to be damaged.
- Do not bring the nozzle tip close to boots (rubber or resin manufactured cover), connectors or the following parts. The parts may be damaged if they come into contact with high-pressure water.
 - Traction related parts
 - Steering parts
 - Suspension parts
 - Brake parts
- Keep the cleaning nozzle at least 11.9 in. (30 cm) away from the vehicle body. Otherwise resin section, such as moldings and bumpers, may be deformed and damaged.

Also, do not continuously hold the nozzle in the same place.

 NOTICE

- Do not spray the lower part of the windshield continuously.

If water enters the air conditioning system intake located near the lower part of the windshield, the air conditioning system may not operate correctly.

- Do not wash the underside of the vehicle using a high pressure car washer.

■ **When raising the windshield wiper arms**

Make sure to hold the hook parts of the wiper arms to raise them. Do not hold only the wiper blades when raising them, or it may cause deformation of the wiper blades.

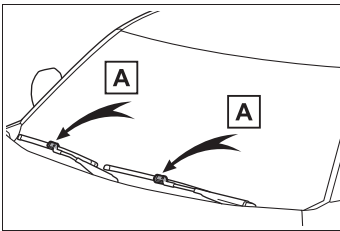

A Hook parts

■ **Cleaning the high mounted spotlight and cargo lamps**

When using high-pressured car washers, the tip of the nozzle should be at least 20 in. (50 cm) from the car body. Water can seep lamp housing or the vehicle cabin if the nozzle is closer to the car body.

Cleaning and protecting the vehicle interior

Perform cleaning in a manner appropriate to each component and its material.

Protecting the vehicle interior

- Remove dirt and dust using a vacuum cleaner. Wipe dirty surfaces with a cloth dampened with lukewarm water.
- If dirt cannot be removed, wipe it off with a soft cloth dampened with neutral detergent diluted to approximately 1%.
Wring out any excess water from the cloth and thoroughly wipe off remaining traces of detergent and water.

■ Shampooing the carpets

There are several commercial foaming-type cleaners available. Use a sponge or brush to apply the foam. Rub in overlapping circles. Do not use water. Wipe dirty surfaces and let them dry. Excellent results are obtained by keeping the carpet as dry as possible.

■ Handling the seat belts

Clean with mild soap and lukewarm water using a cloth or sponge. Also check the belts periodically for excessive wear, fraying or cuts.

**WARNING****Water in the vehicle**

Do not get any of the SRS components or wiring in the vehicle interior wet. (→P.36)

An electrical malfunction may cause the airbags to deploy or not function properly, resulting in death or serious injury.

Cleaning the interior (especially instrument panel)

Do not use a polish wax or polish cleaner. The instrument panel may reflect off the windshield, obstructing the driver's view and leading to an accident, resulting in death or serious injury.

**NOTICE****Cleaning detergents**

- Do not use the following types of detergent, as they may discolor the vehicle interior or cause streaks or damage to painted surfaces:
 - Areas other than the seats and steering wheel: Organic substances such as benzene or gasoline, alkaline or acidic solutions, dye, and bleach
 - Seats: Alkaline or acidic solutions, such as thinner, benzene, and alcohol
 - Steering wheel: Organic substances, such as thinner, and cleaner that contains alcohol
- Do not use a polish wax or polish cleaner. The instrument panel's or other interior part's painted surface may be damaged.

Preventing damage to leather surfaces

Observe the following precautions to avoid damage to and deterioration of leather surfaces:

- Remove any dust or dirt from leather surfaces immediately.
- Do not expose the vehicle to direct sunlight for extended periods of time. Park the vehicle in the shade, especially during summer.
- Do not place items made of vinyl, plastic, or containing wax on the upholstery, as they may stick to the leather surface if the vehicle interior heats up significantly.
- Do not leave excess moisture on leather surfaces, as prolonged exposure may cause damage.

Water on the floor

Do not wash the vehicle floor with water.

Vehicle systems such as the audio system may be damaged if water comes into contact with electrical components such as the audio system above or under the floor of the vehicle. Water may also cause the body to rust.

When cleaning the inside of the windshield

Do not allow glass cleaner to contact the lens. Also, do not touch the lens. (→P.237)

**NOTICE****■ Cleaning the inside of the back window**

- Do not use a glass cleaner to clean the back window, as this may cause damage to the back window defogger heater wires or antenna. Use a cloth dampened with lukewarm water to gently wipe the window clean. Wipe the window in strokes running parallel to the heater wires or antenna.
- Be careful not to scratch or damage the heater wires or antenna.

Cleaning the areas with satin-finish metal accents

- Remove dirt using a water-dampened soft cloth or synthetic chamois.
- Wipe the surface with a dry, soft cloth to remove any remaining moisture.

■ Cleaning the areas with satin-finish metal accents

The metal areas use a layer of real metal for the surface. It is necessary to clean them regularly. If dirty areas are left uncleaned for long periods of time, they may be difficult to clean.

Cleaning the leather areas

- Remove dirt and dust using a vacuum cleaner.
- Wipe off any excess dirt and dust with a soft cloth dampened with diluted detergent.

Use a diluted water solution of approximately 5% neutral wool detergent.

- Wring out any excess water from the cloth and thoroughly wipe off all remaining traces of detergent.
- Wipe the surface with a dry, soft cloth to remove any remaining moisture. Allow the leather to dry in a shaded and ventilated area.

■ Caring for leather areas

Toyota recommends cleaning the interior of the vehicle at least twice a year to maintain the quality of the vehicle's interior.

Cleaning the synthetic leather areas

- Remove dirt and dust using a vacuum cleaner.
- Wipe it off with a soft cloth dampened with neutral detergent diluted to approximately 1%.
- Wring out any excess water from the cloth and thoroughly wipe off remaining traces of detergent and water.

Maintenance requirements

To ensure safe and economical driving, day-to-day care and regular maintenance are essential. It is the owner's responsibility to perform regular checks. Toyota recommends the maintenance below.

■ Repair and replacement

It is recommended that genuine Toyota parts be used for repairs to ensure performance of each system. If non-Toyota parts are used in replacement or if a repair shop other than a Toyota dealer performs repairs, confirm the warranty coverage.

■ Allow inspection and repairs to be performed by a Toyota dealer

- Toyota technicians are well-trained specialists and are kept up to date with the latest service information. They are well informed about the operation of all systems on your vehicle.
- Keep a copy of the repair order. It proves that the maintenance that has been performed is under warranty coverage. If any problem should arise while your vehicle is under warranty, your Toyota dealer will promptly take care of it.



WARNING

■ If your vehicle is not properly maintained

Improper maintenance could result in serious damage to the vehicle and possible death or serious injury.

■ Handling of the 12-volt battery

- Engine exhaust, some of its constituents, and a wide variety of automobile components contain or emit chemicals known to the State of California to cause cancer and birth defects and other reproductive harm. Work in a well ventilated area.
- Oils, fuels and fluids contained in vehicles as well as waste produced by component wear contain or emit chemicals known to the State of California to cause cancer and birth defects or other reproductive harm. Avoid exposure and wash any affected area immediately.
- 12-volt battery posts, terminals and related accessories contain lead and lead compounds which are known to cause brain damage. Wash your hands after handling. (→P.488)

General maintenance

General maintenance should be performed on a daily basis. This can be done by yourself or by a Toyota dealer.

Scheduled maintenance

Scheduled maintenance should be performed at specified intervals according to the maintenance schedule.

For details about maintenance items and schedules, refer to the "Scheduled Maintenance Guide" or "Owner's Manual Supplement".

■ Resetting the message indicating maintenance is required

After the required maintenance is performed according to the maintenance schedule, please reset the message.

To reset the message, follow the procedure described below:

- 1 Press **<** or **>** of meter control switches and select  on the multi-information display.
- 2 Press **^** or **v** of meter control switches and select “Vehicle Settings”, and then press and hold **OK**.
- 3 Press **^** or **v** of meter control switches and select “Scheduled Maintenance”, and then press **OK**.
- 4 Select the “Yes” and press **OK**.

Do-it-yourself maintenance

You can perform some maintenance procedures by yourself. Please be aware that do-it-yourself maintenance may affect warranty coverage.

The use of Toyota repair manuals is recommended.

For details about warranty coverage, refer to the separate “Owner’s Warranty Information Booklet” or “Owner’s Manual Supplement”.

General maintenance

Listed below are the general maintenance items that should be performed at the intervals specified in the “Owner’s Warranty Information Booklet” or “Owner’s Manual Supplement/Scheduled Maintenance Guide”. It is recommended that any problem you notice should be brought to the attention of your Toyota dealer or qualified service shop for advice.

 WARNING**■ If the hybrid system is operating**

Turn the hybrid system off and ensure that there is adequate ventilation before performing maintenance checks.

Engine compartment

Items	Check points
Brake fluid	Is the brake fluid at the correct level? (→P.486)
Engine/inter-cooler/power control unit coolant	Is the engine/inter-cooler/power control unit coolant at the correct level? (→P.484)
Engine oil	Is the engine oil at the correct level? (→P.482)
Exhaust system	There should not be any fumes or strange sounds.
Radiator/condenser/inter-cooler	The radiator, condenser and inter-cooler should be free from foreign objects. (→P.486)
Washer fluid	Is there sufficient washer fluid? (→P.487)

Vehicle interior

Items	Check points
12-volt battery	Check the connections. (→P.488)
Accelerator pedal	<ul style="list-style-type: none"> The accelerator pedal should move smoothly (without uneven pedal effort or catching).

Items	Check points
Automatic transmission "Park" mechanism	<ul style="list-style-type: none"> When parked on a slope and the shift lever is in P, is the vehicle securely stopped?
Brake pedal	<ul style="list-style-type: none"> Does the brake pedal move smoothly? Does the brake pedal have appropriate clearance from the floor? Does the brake pedal have the correct amount of free play?
Brakes	<ul style="list-style-type: none"> The vehicle should not pull to one side when the brakes are applied. The brakes should work effectively. The brake pedal should not feel spongy. The brake pedal should not get too close to the floor when the brakes are applied.
Head restraints	<ul style="list-style-type: none"> Do the head restraints move smoothly and lock securely?

Items	Check points
Indicators/buzzers	<ul style="list-style-type: none"> Do the indicators and buzzers function properly?
Parking brake	<ul style="list-style-type: none"> Does the parking brake operate normally? When parked on a slope and the parking brake is on, is the vehicle securely stopped?
Seat belts	<ul style="list-style-type: none"> Do the seat belts operate smoothly? The seat belts should not be damaged.
Seats	<ul style="list-style-type: none"> Do the seat controls operate properly?
Steering wheel	<ul style="list-style-type: none"> Does the steering wheel rotate smoothly? Does the steering wheel have the correct amount of free play? There should not be any strange sounds coming from the steering wheel.

Vehicle exterior

Items	Check points
Doors	<ul style="list-style-type: none"> Do the doors operate smoothly?
Engine hood	<ul style="list-style-type: none"> Does the hood lock system work properly?
Fluid leaks	<ul style="list-style-type: none"> There should not be any signs of fluid leakage after the vehicle has been parked.
Lights	<ul style="list-style-type: none"> Do all the lights come on?

Items	Check points
Tires	<ul style="list-style-type: none"> • Is the tire inflation pressure correct? • The tires should not be damaged or excessively worn. • Have the tires been rotated according to the maintenance schedule? • The wheel nuts should not be loose.
Windshield wipers	<ul style="list-style-type: none"> • The wiper blades should not show any signs of cracking, splitting, wear, contamination or deformation. • The wiper blades should clear the windshield without streaking or skipping.

Emission inspection and maintenance (I/M) programs

Some states have vehicle emission inspection programs which include OBD (On Board Diagnostics) checks. The OBD system monitors the operation of the emission control system.

If the malfunction indicator lamp comes on

The OBD system determines that a problem exists somewhere in the emission control system. Your vehicle may not pass the I/M test and may need to be repaired. Contact your Toyota dealer to service the vehicle.

Your vehicle may not pass the I/M test in the following situations:

- When the 12-volt battery is disconnected or discharged Readiness codes that are set during ordinary driving are erased. Also, depending on your driving habits, the readiness codes may not be completely set.

- When the fuel tank cap is loose
The malfunction indicator lamp comes on indicating a temporary malfunction and your vehicle may not pass the I/M test.

When the malfunction indicator lamp still remains on after several driving trips

The error code in the OBD system will not be cleared unless the vehicle is driven 40 or more times.

If your vehicle does not pass the I/M test

Contact your Toyota dealer to prepare the vehicle for re-testing.

Do-it-yourself service precautions

If you perform maintenance by yourself, be sure to follow the correct procedure as given in these sections.

Maintenance

Items	Parts and tools
12-volt battery condition (→P.488)	<ul style="list-style-type: none"> • Grease • Warm water • Baking soda • Distilled water • Flat-head screw-driver or mechanical key (→P.110) • Conventional wrench (for terminal clamp bolts)
Brake fluid level (→P.486)	<ul style="list-style-type: none"> • FMVSS No.116 DOT 3 or SAE J1703 brake fluid • FMVSS No.116 DOT 4 or SAE J1704 brake fluid • Rag or paper towel • Funnel (used only for adding brake fluid)

Items	Parts and tools
Engine/inter-cooler/power control unit coolant level (→P.484)	<ul style="list-style-type: none"> • “Toyota Super Long Life Coolant” or a similar high quality ethylene glycol-based non-silicate, nonamine, non-nitrite and non-borate coolant with long-life hybrid organic acid technolog
	For the U.S.A.: “Toyota Super Long Life Coolant” is pre-mixed with 50% coolant and 50% deionized water.
	For Canada: “Toyota Super Long Life Coolant” is pre-mixed with 55% coolant and 45% deionized water. <ul style="list-style-type: none"> • Funnel (used only for adding coolant)
Engine oil level (→P.482)	<ul style="list-style-type: none"> • “Toyota Genuine Motor Oil” or equivalent • Rag or paper towel • Funnel (used only for adding engine oil)
Fuses (→P.512)	<ul style="list-style-type: none"> • Fuse with same amperage rating as original

Items	Parts and tools
Light bulbs (→P.517)	<ul style="list-style-type: none"> • Bulb with same number and wattage rating as original • Phillips-head screwdriver • Wrench
Radiator and condenser (→P.486)	—
Tire inflation pressure (→P.501)	<ul style="list-style-type: none"> • Tire pressure gauge • Compressed air source
Washer fluid (→P.487)	<ul style="list-style-type: none"> • Water or washer fluid containing antifreeze (for winter use) • Funnel (used only for adding water or washer fluid)

**WARNING**

The engine compartment contains many mechanisms and fluids that may move suddenly, become hot, or become electrically energized. To avoid death or serious injury, observe the following precautions.

■ **When working on the engine compartment**

- Make sure that the “ACCESSORY” or “IGNITION ON” on the multi-information display and the “READY” indicator are both off.
- Keep hands, clothing and tools away from the moving fan and engine.

- Be careful not to touch the engine, inverter, radiator, exhaust manifold, etc., right after driving as they may be hot. Oil and other fluids may also be hot.

- Do not leave anything that may burn easily, such as paper and rags, in the engine compartment.

- Do not smoke, cause sparks or expose an open flame to fuel. Gasoline and battery fumes are flammable.

■ **When working near the electric cooling fan or radiator grille**

Be sure the power switch is off. With the power switch in ON, the electric cooling fan may automatically start to run if the air conditioning is on and/or the coolant temperature is high. (→P.486)

■ **Safety glasses**

Wear safety glasses to prevent flying or falling material, fluid spray, etc., from getting in your eyes.

**NOTICE**

■ **If you remove the air cleaner filter**

Driving with the air cleaner filter removed may cause excessive engine wear due to dirt in the air.

Hood

Opening the hood

- 1 Pull the hood lock release lever.

The hood will pop up slightly.

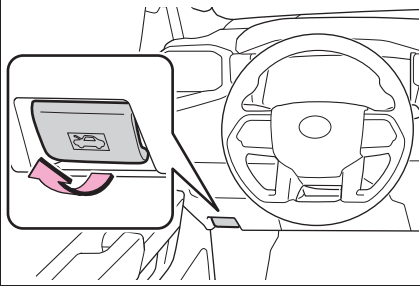

- 2 Pull up the auxiliary catch lever and lift the hood.

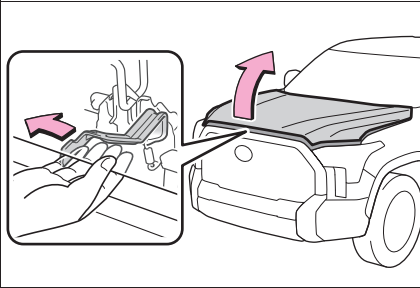

■ 12-volt battery

→P.488

⚠ WARNING

■ Pre-driving check

Check that the hood is fully closed and locked.

If the hood is not locked properly, it may open while the vehicle is in motion and cause an accident, which may result in death or serious injury.

Engine compartment

Components

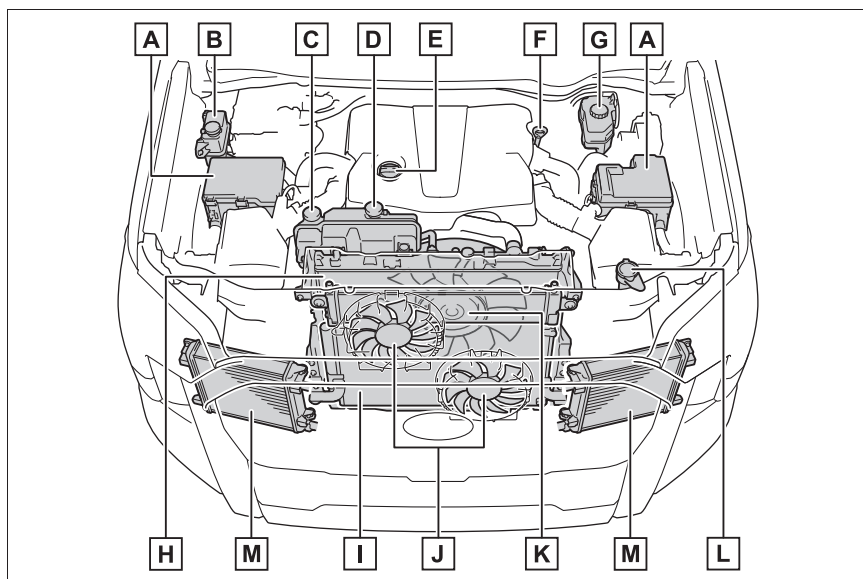

- A** Fuse boxes (→P.512)
- B** Power control unit coolant reservoir (→P.484)
- C** Intercooler coolant reservoir (→P.484)
- D** Engine coolant reservoir (→P.484)
- E** Engine oil filler cap (→P.482)
- F** Engine oil level dipstick (→P.482)
- G** Brake fluid reservoir (→P.486)
- H** Engine radiator (→P.486)
- I** Condenser (→P.486)
- J** Electric cooling fans
- K** Radiator cooling fan (→P.484)
- L** Washer fluid tank (→P.487)
- M** Intercooler radiators (→P.484)

Checking the engine oil

With the engine at operating temperature and turned off, check the oil level on the dipstick.

- 1 Park the vehicle on level ground. After warming up the engine and turning off the engine, wait about 5 minutes for the oil to drain back into the bottom of the engine.
- 2 Holding a rag under the end, pull the dipstick out.

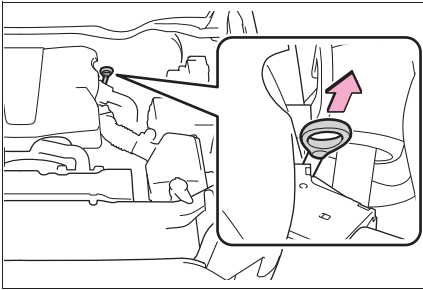

- 3 Wipe the dipstick clean.
- 4 Reinsert the dipstick fully with its protruding areas (A in the illustration) pointing towards engine.

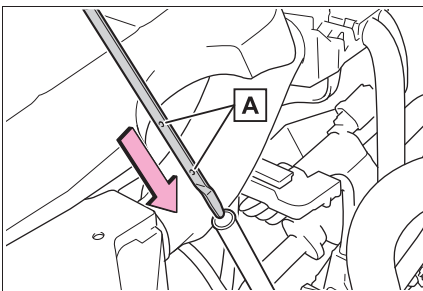

- 5 Holding a rag under the end, pull the dipstick out and

check whether the oil level is above low level mark.

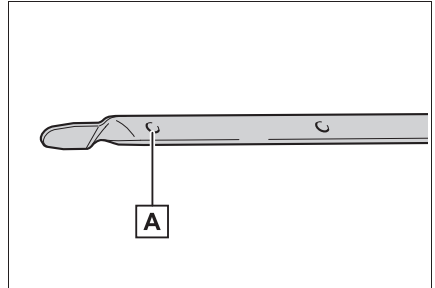

A Low level mark

The shape of the dipstick may differ depending on the type of vehicle or engine.

- 6 Wipe the dipstick and reinsert it fully.

⚠ NOTICE

■ To prevent serious engine damage

Check the oil level on a regular basis.

■ Engine oil consumption

A certain amount of engine oil will be consumed while driving. In the following situations, oil consumption may increase, and engine oil may need to be refilled in between oil maintenance intervals.

- When the engine is new, for example directly after purchasing the vehicle or after replacing the engine
- If low quality oil or oil of an inappropriate viscosity is used
- When driving at high engine speeds or with a heavy load, when towing, or when driving while accelerating or decelerating frequently

- When leaving the engine idling for a long time, or when driving frequently through heavy traffic

■ Engine oil level rise

If the vehicle is repeatedly driven without the engine warmed up, moisture caused by dew condensation inside the engine or fuel which did not burn mixes into the engine oil, resulting in a rise in engine oil level.

However, this is not a malfunction.

For example, the engine become difficult to be warmed up in the following situations.

- When driving a short distance
- When driving at a low speed
- When the outside temperature is low

When checking the engine oil, make sure that the engine is warmed up. If the engine oil level exceeds the refill upper limit mark, contact your Toyota dealer.

Adding engine oil

■ Checking the oil type and preparing the items needed

Make sure to check the oil type and prepare the items needed before adding oil.

- Engine oil selection

→P.570

- Oil quantity (Low level mark
→ Refill upper limit mark)

1.6 qt. (1.5 L, 1.3 Imp.qt.)

- Items

Clean funnel

■ Adding engine oil

If the oil level is below or near the low level mark, add engine oil of the same type as that already in the engine.

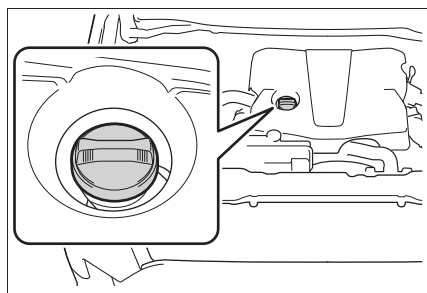

- 1 Remove the oil filler cap by turning it counterclockwise.
- 2 Add engine oil slowly, checking the dipstick.

Make sure that the oil level does not exceed the refill upper limit mark and is between the low level mark and refill upper limit mark.

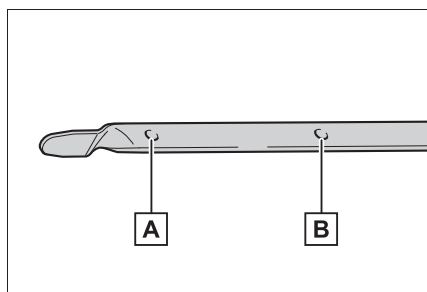

- A** Low level mark
- B** Refill upper limit mark

The shape of the dipstick may differ depending on the type of vehicle or engine.

- 3 Install the oil filler cap by turning it clockwise.

■ **After changing the engine oil**

The engine oil maintenance data should be reset. Perform the following procedures:

- 1 Press < or > of the meter control switches and select .
- 2 Press ^ or v of the meter control switches, select the “Vehicle Settings” and then press OK.
- 3 Press ^ or v of the meter control switches, select the “Oil Maintenance” and then press OK.
- 4 Select the “Yes” and push OK. “Reset Complete” is displayed on the multi-information display.

 **WARNING**

■ **Used engine oil**

- Used engine oil contains potentially harmful contaminants which may cause skin disorders such as inflammation and skin cancer, so care should be taken to avoid prolonged and repeated contact. To remove used engine oil from your skin, wash thoroughly with soap and water.
- Dispose of used oil and filters only in a safe and acceptable manner. Do not dispose of used oil and filters in household trash, in sewers or onto the ground. Call your Toyota dealer, service station or auto parts store for information concerning recycling or disposal.
- Do not leave used engine oil within the reach of children.

 **NOTICE**

■ **When replacing the engine oil**

- Be careful not to spill engine oil on the vehicle components.
- Avoid overfilling, or the engine could be damaged.
- Check the oil level on the dipstick every time you refill the vehicle.
- Be sure the engine oil filler cap is properly tightened.

■ **If oil is spilled on the engine cover**

To prevent the engine cover from being damaged, remove any engine oil from the engine cover as soon as possible using a neutral detergent. Do not use an organic solvent such as brake cleaner.

Checking the coolant

The coolant level is satisfactory if it is between the “F” and “L” lines on the reservoir when the hybrid system is cold.

► **Engine coolant**

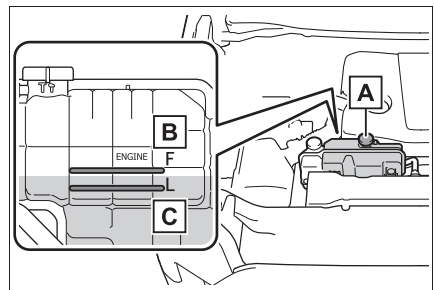

A Engine coolant reservoir cap

B “F” line

C “L” line

If the level is on or below the “L” line, add coolant up to the “F” line.
(→P.561)

► Intercooler coolant

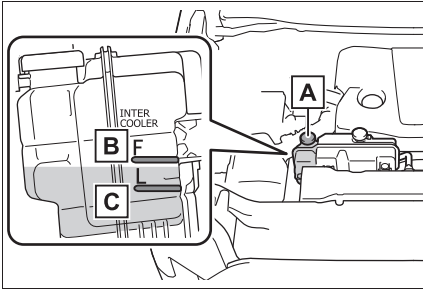

A Intercooler coolant reservoir cap

B “F” line

C “L” line

If the level is on or below the “L” line, add coolant up to the “F” line.
(→P.561)

► Power control unit coolant

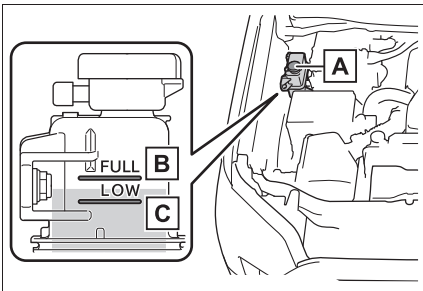

A Power control unit coolant reservoir cap

B “FULL” line

C “LOW” line

If the level is on or below the “LOW” line, add coolant up to the “FULL” line.
(→P.561)

■ Coolant selection

Only use “Toyota Super Long Life Coolant” or a similar high quality ethylene glycol based non-silicate, non-amine, non-nitrite, and non-borate coolant with long-life hybrid organic acid technology.

U.S.A.: “Toyota Super Long Life Coolant” is a mixture of 50% coolant and 50% deionized water.

(Minimum temperature: -31°F [-35°C])

Canada: “Toyota Super Long Life Coolant” is a mixture of 55% coolant and 45% deionized water.

(Minimum temperature: -44°F [-42°C])

For more details about coolant, contact your Toyota dealer.

■ If the coolant level drops within a short time of replenishing

Visually check the radiator, hoses, engine coolant reservoir cap, intercooler coolant reservoir cap, drain cock and water pump.

If you cannot find a leak, have your Toyota dealer test the cap and check for leaks in the cooling system.

⚠ WARNING

■ When the hybrid system is hot

Do not remove the coolant reservoir cap.

The cooling system may be under pressure and may spray hot coolant if the cap is removed, causing serious injuries, such as burns.

**NOTICE**

■ When adding coolant

Coolant is neither plain water nor straight antifreeze. The correct mixture of water and antifreeze must be used to provide proper lubrication, corrosion protection and cooling. Be sure to read the antifreeze or coolant label.

■ If you spill coolant

Be sure to wash it off with water to prevent it from damaging parts or paint.

Checking the radiator, condenser and inter-cooler radiators

Check the radiator, condenser and intercooler radiators and clear away any foreign objects. If either of the above parts is extremely dirty or you are not sure of their condition, have your vehicle inspected by your Toyota dealer.

**WARNING**

■ When the hybrid system is hot

Do not touch the radiator, condenser or intercooler radiators or condenser as they may be hot and cause serious injuries, such as burns.

Checking and adding the brake fluid

■ Checking fluid level

The brake fluid level should be between the “MAX” and “MIN” lines on the tank.

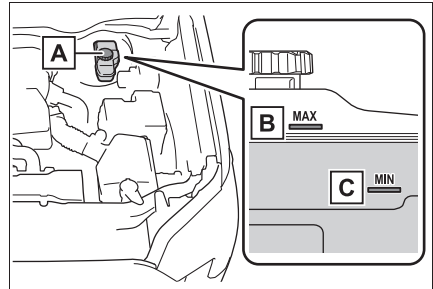

A Brake fluid reservoir cap

B “MAX” line

C “MIN” line

■ Adding fluid

Make sure to check the fluid type and prepare the necessary item.

● Fluid type

FMVSS No.116 DOT 3 or SAE J1703 brake fluid

FMVSS No.116 DOT 4 or SAE J1704 brake fluid

● Item

Clean funnel

■ Brake fluid can absorb moisture from the air

Excess moisture in the brake fluid can cause a dangerous loss of braking efficiency. Use only newly opened brake fluid.

⚠ WARNING**■ When filling the reservoir**

Take care as brake fluid can harm your hands and eyes and damage painted surfaces.

If fluid gets on your hands or in your eyes, flush the affected area with clean water immediately.

If you still experience discomfort, see a doctor.

⚠ WARNING**■ When adding washer fluid**

Do not add washer fluid when the hybrid system is hot or operating as washer fluid contains alcohol and may catch fire if spilled on the hybrid system, etc.

⚠ NOTICE**■ If the fluid level is low or high**

It is normal for the brake fluid level to go down slightly as the brake pads wear out or when the fluid level in the accumulator is high. If the reservoir needs frequent refilling, there may be a serious problem.

⚠ NOTICE**■ Do not use any fluid other than washer fluid**

Do not use soapy water or anti-freeze instead of washer fluid. Doing so may cause streaking on the vehicle's painted surfaces, as well as damaging the pump leading to problems of the washer fluid not spraying.

Adding the washer fluid

If the washers do not work or the "Windshield Washer Fluid Low" appears on the multi-information display, the washer tank may be empty.

Add washer fluid.

■ Diluting washer fluid

Dilute washer fluid with water as necessary. Refer to the freezing temperatures listed on the label of the washer fluid bottle.

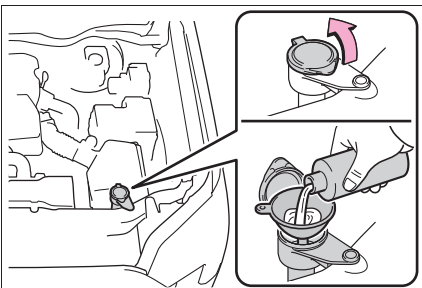

12-volt battery

Location

The 12-volt battery is located in the left-hand side of the rear seat under.

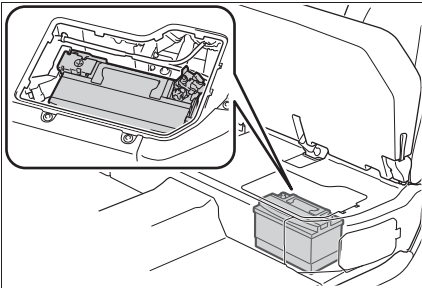

Removing the 12-volt battery cover

1 Raising the bottom cushion.
(→P.143)

2 Remove the battery cover.

Use the flat-head screwdriver or mechanical key (→P.110).

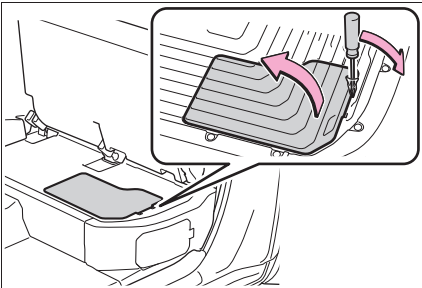

Before recharging

When recharging, the 12-volt battery produces hydrogen gas which is flammable and explosive. Therefore, observe the following precautions before recharging:

- If recharging with the 12-volt battery installed on the vehicle, be sure to disconnect the ground cable.

- Make sure the power switch on charger is off when connecting and disconnecting the charger cables to the 12-volt battery.

After recharging/reconnecting the 12-volt battery

- Unlocking the doors using the smart key system may not be possible immediately after reconnecting the 12-volt battery. If this happens, use the wireless remote control or the mechanical key to lock/unlock the doors.

- Start the hybrid system with the power switch in ACC. The hybrid system may not start with the power switch turned off. However, the hybrid system will operate normally from the second attempt.

- The power switch mode is recorded by the vehicle. If the 12-volt battery is reconnected, the vehicle will return the power switch mode to the status it was in before the 12-volt battery was disconnected. Make sure to turn off the power switch before disconnecting the 12-volt battery. Take extra care when connecting the 12-volt battery if the power switch mode prior to discharge is unknown.

- When the 12-volt battery is reconnected, start the hybrid system, depress the brake pedal, and confirm that it is possible to shift into each shift position.

If the system will not start even after multiple attempts, contact your Toyota dealer.

**WARNING****Chemicals in the 12-volt battery**

The 12-volt battery contains poisonous and corrosive sulfuric acid and may produce hydrogen gas which is flammable and explosive. To reduce the risk of death or serious injury, take the following precautions while working on or near the 12-volt battery:

- Do not cause sparks by touching the 12-volt battery terminals with tools.
- Do not smoke or light a match near the 12-volt battery.
- Avoid contact with eyes, skin and clothes.
- Never inhale or swallow electrolyte.
- Wear protective safety glasses when working near the 12-volt battery.
- Keep children away from the 12-volt battery.

Where to safely charge the 12-volt battery

Always charge the 12-volt battery in an open area. Do not charge the 12-volt battery in a garage or closed room where there is insufficient ventilation.

Emergency measures regarding electrolyte

- If electrolyte gets in your eyes
Flush your eyes with clean water for at least 15 minutes and get immediate medical attention. If possible, continue to apply water with a sponge or cloth while traveling to the nearest medical facility.

- If electrolyte gets on your skin
Wash the affected area thoroughly. If you feel pain or burning, get medical attention immediately.

- If electrolyte gets on your clothes
It can soak through clothing on to your skin. Immediately take off the clothing and follow the procedure above if necessary.

- If you accidentally swallow electrolyte
Drink a large quantity of water or milk. Get emergency medical attention immediately.

When replacing the 12-volt battery

Use a 12-volt battery designed for this vehicle. Failure to do so may cause gas (hydrogen) to enter the passenger compartment, causing a fire or explosion.

For replacement of the 12-volt battery, contact your Toyota dealer.

**NOTICE****When recharging the 12-volt battery**

Never recharge the 12-volt battery while the hybrid system is operating. Also, be sure all accessories are turned off.

Exterior

Make sure that the 12-volt battery terminals are not corroded and that there are no loose connections, cracks, or loose clamps.

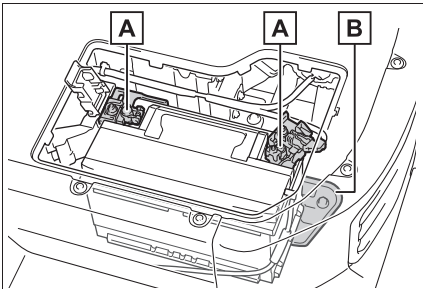

A Terminals

B Hold-down clamp

Tires

Replace or rotate tires in accordance with maintenance schedules and treadwear.

Checking tires

Check if the treadwear indicators are showing on the tires. Also check the tires for uneven wear, such as excessive wear on one side of the tread.

Check the spare tire condition and pressure if not rotated.

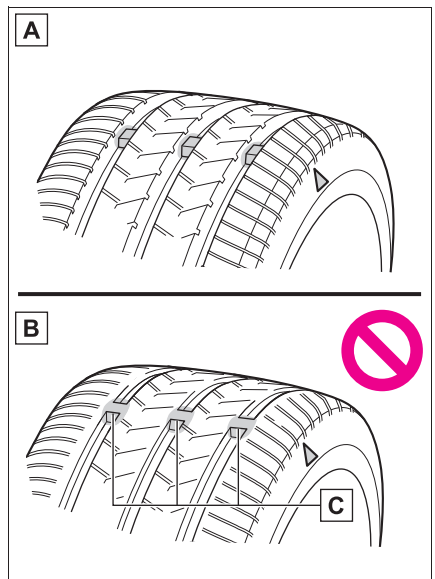

A New tread

B Worn tread

C Treadwear indicator

The location of treadwear indicators

is shown by a “TWI” or “ Δ ” mark, etc., molded into the sidewall of each tire.

Replace the tires if the treadwear indicators are showing on a tire.

■ When to replace your vehicle's tires

Tires should be replaced if:

- The treadwear indicators are showing on a tire.
- You have tire damage such as cuts, splits, cracks deep enough to expose the fabric, and bulges indicating internal damage
- A tire goes flat repeatedly or cannot be properly repaired due to the size or location of a cut or other damage

If you are not sure, consult with your Toyota dealer.

■ Tire life

Any tire over 6 years old must be checked by a qualified technician even if it has seldom or never been used, or damage is not obvious.

■ Maximum load of tire

Check that the number given by dividing the maximum load by 1.10 of the replacement tire is greater than 1/2 of the Gross Axle Weight Ratings (GAWR) of either the front axle or the rear axle, whichever is greater.

For the GAWR, see the Certification Label.

For the maximum load of the tire, see the load limit at maximum cold tire inflation pressure mentioned on the sidewall of the tire. (→P.578)

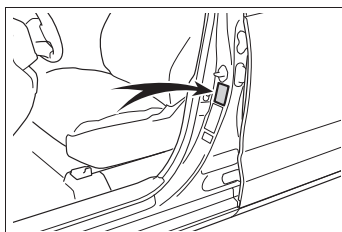

■ Tire types

● Summer tires

Summer tires are high-speed performance tires best suited to highway driving under dry conditions. Since summer tires do not have the same traction performance as snow tires, summer tires are inadequate for driving on snow-covered or icy roads. For driving on snow-covered roads or icy roads, the use of snow tires is recommended. When installing snow tires, be sure to replace all four tires.

● All season tires

All season tires are designed to provide better traction in snow and to be adequate for driving in most winter conditions as well as for use year-round. All season tires, however, do not have adequate traction performance compared with snow tires in heavy or loose snow. Also, all season tires fall short in acceleration and handling performance compared with summer tires in highway driving.

● Snow tires

For driving on snow-covered roads or icy roads, we recommend using snow tires. If you need snow tires, select tires of the same size, construction and load capacity as the originally installed tires. Since your vehicle has radial tires as original equipment, make sure your snow tires also have radial construction. Do not install studded tires without first checking local regulations for possible restrictions. Snow tires should be installed on all wheels. (→P.413)

■ If the tread on snow tires wears down below 0.16 in. (4 mm)

The effectiveness of the tires as snow tires is lost.

⚠ WARNING

■ When inspecting or replacing tires

Observe the following precautions to prevent accidents. Failure to do so may cause damage to parts of the drive train as well as dangerous handling characteristics, which may lead to an accident resulting in death or serious injury.

- Do not mix tires of different makes, models or tread patterns. Also, do not mix tires of remarkably different treadwear.
- Do not use tire sizes other than those recommended by Toyota.
- Do not mix differently constructed tires (radial, bias-belted or bias-ply tires).
- Do not mix summer, all season and snow tires.

- Do not use tires that have been used on another vehicle. Do not use tires if you do not know how they were used previously.
- Do not use tires with different load rating and/ or speed symbol than what is specified on tire pressure label or in owner's manual.

⚠ NOTICE

■ Driving on rough roads

Take particular care when driving on roads with loose surfaces or potholes. These conditions may cause losses in tire inflation pressure, reducing the cushioning ability of the tires. In addition, driving on rough roads may cause damage to the tires themselves, as well as the vehicle's wheels and body.

Tire rotation

Rotate the tires in the order shown.

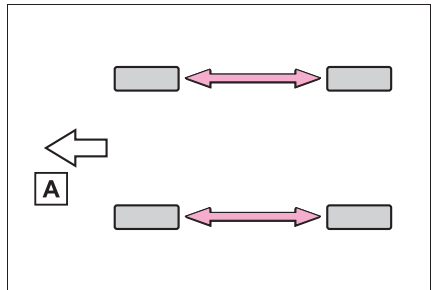

A Front

To equalize tire wear and extend tire life, Toyota recommends that tire rotation is carried out at the same interval as tire inspection.

Do not fail to initialize the tire pres-

sure warning system after tire rotation.

Tire pressure warning system

Your vehicle is equipped with a tire pressure warning system that uses tire pressure warning valves and transmitters to detect low tire inflation pressure before serious problems arise.

The tire pressure warning system of this vehicle adopts a 2-type warning system

- When “Adjust Pressure” is displayed (Normal Warning)

The tire pressure warning light comes on and a buzzer sounds when the tire inflation pressure becomes low due to natural air leakage or outside temperature. (Ways of coping: →P.535, 574)

- When “Immediately Check tire when Safe” is displayed (Emergency Warning)

The tire pressure warning light comes on and a buzzer sounds when the tire inflation pressure becomes low suddenly due to a blowout. (Ways of coping: →P.541) However, the system may not be able to detect sudden tire ruptures (bursting, etc.).

The tire pressure detected by the tire pressure warning system can be displayed on the multi-information display.

The unit can be changed.

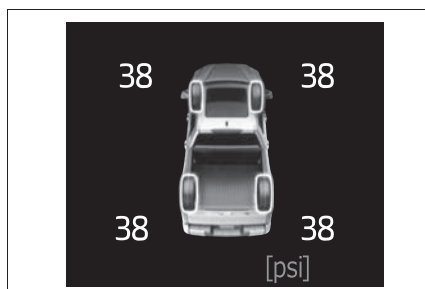

■ How to change the unit

- 1 Park the vehicle in a safe place and turn the power switch off.
- 2 Turn the power switch to ON.
- 3 Press < or > of the meter control switch to select .
- 4 Press ^ or v to select “Vehicle Settings” and then press and hold OK.
- 5 Press ^ or v to select “TPWS” and then press OK.
- 6 Press ^ or v to select “Set Unit” and then press OK.
- 7 Press ^ or v to select the desired unit and then press OK.

■ **Routine tire inflation pressure checks**

The tire pressure warning system does not replace routine tire inflation pressure checks. Make sure to check tire inflation pressure as part of your routine of daily vehicle checks.

■ **Tire inflation pressure**

● It may take a few minutes to display the tire inflation pressure after the power switch is turned to ON. It may also take a few minutes to display the tire inflation pressure after inflation pressure has been adjusted.

● Tire inflation pressure changes with temperature. The displayed values may also be different from the values measured using a tire pressure gauge.

■ **Situations in which the tire pressure warning system may not operate properly**

- In the following cases, the tire pressure warning system may not operate properly.
- If non-genuine Toyota wheels are used.
- A tire has been replaced with a tire that is not an OE (Original Equipment) tire.
- A tire has been replaced with a tire that is not of the specified size.
- Tire chains, etc., are equipped.
- An auxiliary-supported run-flat tire is equipped.
- If a window tint that affects the radio wave signals is installed.
- If there is a lot of snow or ice on the vehicle, particularly around the wheels or wheel housings.
- If the tire inflation pressure is extremely higher than the specified level.
- If wheels without tire pressure warning valves and transmitters are used.
- If the ID code on the tire pressure warning valves and transmitters is

not registered in the tire pressure warning computer.

- Performance may be affected in the following situations.
- Near a TV tower, electric power plant, gas station, radio station, large display, airport or other facility that generates strong radio waves or electrical noise
- When carrying a portable radio, cellular phone, cordless phone or other wireless communication device

If tire position information is not correctly displayed due to the radio wave conditions, the display may be corrected by driving and changing the radio wave conditions may change.

- When the vehicle is parked, the time taken for the warning to start or go off could be extended.
- When tire inflation pressure declines rapidly for example when a tire has burst, the warning may not function.

■ **Warning performance of the tire pressure warning system**

The warning of the tire pressure warning system will change in accordance with the conditions under which it was initialized. For this reason, the system may give a warning even if the tire pressure does not reach a low enough level, or if the pressure is higher than the pressure that was adjusted to when the system was initialized.

■ **Certification**

→P.647

Installing tire pressure warning valves and transmitters

When replacing tires or wheels, tire pressure warning valves and transmitters must also be installed.

When new tire pressure warning valves and transmitters are installed, new ID codes must be registered in the tire pressure warning computer and the tire pressure warning system must be initialized. (→P.498)

■ When replacing the tires and wheels

If the ID code of the tire pressure warning valve and transmitter is not registered, the tire pressure warning system will not work properly. After driving for about 20 minutes, the tire pressure warning light blinks for 1 minute and stays on to indicate a system malfunction.



NOTICE

■ Repairing or replacing tires, wheels, tire pressure warning valves, transmitters and tire valve caps

- When removing or fitting the wheels, tires or the tire pressure warning valves and transmitters, contact your Toyota dealer as the tire pressure warning valves and transmitters may be damaged if not handled correctly.

- Make sure to install the tire valve caps. If the tire valve caps are not installed, water could enter the tire pressure warning valves, corrode the valves and the tire pressure warning valves could be bound.

- When replacing tire valve caps, do not use tire valve caps other than those specified. The cap may become stuck.

Initializing the tire pressure warning system

■ The tire pressure warning system must be initialized in the following circumstances:

- When rotating the tires.
- When changing the tires.
- After registering the ID codes. (→P.498)
- When changing between two registered wheel sets.

When the tire pressure warning system is initialized, the current tire inflation pressure is set as the benchmark pressure.

■ How to initialize the tire pressure warning system

- 1 Park the vehicle in a safe place, turn the power switch off and wait 20 minutes or more.

Initialization cannot be performed while the vehicle is moving.

- 2 Adjust the tire inflation pressure to the specified cold tire inflation pressure level.

Make sure to adjust the tire pressure to the specified cold tire inflation pressure level. The tire pressure warning system will operate based on this pressure level.

- 3 Start the hybrid system.
- 4 Press **<** or **>** of the meter control switch to select .
- 5 Press **^** or **v** to select "Vehicle Settings" and then press and hold **OK**.
- 6 Press **^** or **v** to select "TPWS" and then press **OK**.
- 7 Press **^** or **v** to select "Set Pressure". Then press and hold **OK**.
"Set Pressure Accepted" will be displayed on the multi-information display and the tire pressure warning light will blink 3 times.
When the message disap-

pears, initialization is complete.

A message is displayed on the multi-information display. Also, "--" is displayed for inflation pressure of each tire on the multi-information display while the tire pressure warning system determines the position.

- 8 Drive straight (with occasional left and right turns) at approximately 25 mph (40 km/h) or more for approximately 10 to 30 minutes.

When initialization is complete, the inflation pressure of each tire will be displayed on the multi-information display.

Even if the vehicle is not driven at approximately 25 mph (40 km/h) or more, initialization can be completed by driving for a long time. However, if initialization does not complete after driving for 1 hour or more, park the vehicle in a safe place for approximately 20 minutes and then drive the vehicle again.

■ When initializing

- Initialization is performed while driving at a vehicle speed of approximately 25 mph (40 km/h) or more.
- Make sure to carry out initialization after adjusting the tire inflation pressure. Also, make sure the tires are cold before carrying out initialization or tire inflation pressure adjustment.
- The tire pressure warning system can be initialized by yourself, but depending on the driving conditions and driving environment, initialization may take some time to complete.

■ The initialization operation

- If you have accidentally turned the power switch off during initialization, it is not necessary to restart the initialization again as initialization will restart when the power switch has been turned to ON for the next time.
- If you accidentally perform initialization when initialization is not necessary, adjust the tire inflation pressure to the specified level when the tires are cold, and conduct initialization again.
- While the position of each tire is being determined and the inflation pressures are not being displayed on the multi-information display, if the inflation pressure of a tire drops, the tire pressure warning light will come on.

■ If the tire pressure warning system is not initialized properly

- In the following situations, initialization may take longer than usual to be completed or may not be possible. Normally, initialization completes within approximately 30 minutes.
 - Vehicle is not driven at approximately 25 mph (40 km/h) or more
 - Vehicle is driven on unpaved roads
 - Vehicle is driven near other vehicles and system cannot recognize tire pressure warning valve and transmitters of your vehicle over those of other vehicles
 - If the vehicle is driven in heavy traffic or another situation where other vehicles are driven close by, it may take time for the system to recognize the tire pressure warning valve and transmitters of your vehicle over those of other vehicles.
- If initialization does not complete after driving for 1 hour or more, park the vehicle in a safe place for approximately 20 minutes and then drive the vehicle again.

- If the vehicle is reversed during initialization, the data up to that point is reset, so perform the initialization procedure again from the beginning.
- In the following situations, initialization will not be started or was not completed properly and the system will not operate properly. Perform the initialization procedure again.
 - If, when attempting to start initialization, the tire pressure warning light does not blink 3 times.
 - If, when the vehicle has been driven for about 20 minutes after performing initialization, the tire pressure warning light blinks for approximately 1 minute and then illuminates.

If initialization cannot be completed after performing the above procedure, contact your Toyota dealer.



WARNING

■ When initializing the tire pressure warning system

Do not initialize tire pressure without first adjusting the tire inflation pressure to the specified level. Otherwise, the tire pressure warning light may not come on even if the tire inflation pressure is low, or it may come on when the tire inflation pressure is actually normal.

Registering ID codes

Every tire pressure warning valve and transmitter has a unique ID code. When replacing a tire pressure warning valve and transmitter, it is necessary to register the ID code. When registering the ID codes, perform the following procedure.

- 1 Park the vehicle in a safe place, wait for approximately 20 minutes, and then start the hybrid system.
- 2 Press < or > of the meter control switch to select .
- 3 Press ^ or v to select “Vehicle Settings” and then press and hold OK.
- 4 Press ^ or v to select “TPWS” and then press OK.
- 5 Press ^ or v to select “Change Wheel”. Then press and hold OK until the tire pressure warning light blinks slowly 3 times.

The change wheel set mode is activated and registration is started.

Then a message will be displayed on the multi-information display.

When registration is being performed, the tire pressure warning light will blink for approximately 1 minute then illuminate and “--” will be displayed for the inflation pressure of each tire on the multi-infor-

mation display.

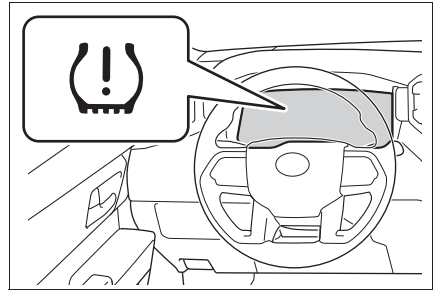

- 6 Drive straight (with occasional left and right turns) at approximately 25 mph (40 km/h) or more for approximately 10 to 30 minutes.

When registration is completed, the tire pressure warning light will go off and the inflation pressure of each tire will be displayed on the multi-information display.

Even if the vehicle is not driven at approximately 25 mph (40 km/h) or more, registration can be completed by driving for a long time. However, if registration does not complete after driving for 1 hour or more, perform the procedure again from the beginning.

- 7 Initialize the tire pressure warning system. (→P.495)

■ When registering ID codes

- ID code registration is performed while driving at a vehicle speed of approximately 25 mph (40 km/h) or more.
- Before performing ID code registration, make sure that no wheels with tire pressure warning valve and transmitters installed are near the vehicle.
- Make sure to initialize the tire pressure warning system after registering the ID codes. If the system is initialized before registering the ID codes, the initialized

values will be invalid.

- ID codes can be registered by yourself, but depending on the driving conditions and driving environment, registration may take some time to complete.
- As the tires will be warm when registration is completed, make sure to allow the tires to cool before performing initialization.

■ **Canceling ID code registration**

- To cancel ID code registration after it has been started, select “Change Wheel” on the multi-information display and press and hold again.
- If ID code registration has been canceled, the tire pressure warning light will blink for approximately 1 minute when the power switch is turned to ON and then illuminate. The tire pressure warning system will be operational when the tire pressure warning light turns off.
- If the warning light does not turn off even after several minutes have elapsed, ID code registration may not have been canceled correctly. To cancel registration, perform the ID code registration start procedure again and then turn the power switch off before driving.

■ **If ID codes are not registered properly**

- In the following situations, ID code registration may take longer than usual to be completed or may not be possible. Normally, registration completes within approximately 30 minutes.
If ID code registration is not complete after driving for approximately 30 minutes, continue driving for a while.
- Vehicle is not parked for approximately 20 minutes or more before driving
- Vehicle is not driven at approximately 25 mph (40 km/h) or more
- Vehicle is driven on unpaved

roads

- Vehicle is driven near other vehicles and system cannot recognize tire pressure warning valve and transmitters of your vehicle over those of other vehicles
- Wheel with tire pressure warning valve and transmitter installed is inside or near the vehicle

If registration does not complete after driving for 1 hour or more, perform the ID code registration procedure again from the beginning.

- If the vehicle is reversed during registration, the data up to that point is reset, so perform the registration procedure again from the beginning.
- In the following situations, ID code registration will not be started or was not completed properly and the system will not operate properly. Perform the ID code registration procedure again.
- If, when attempting to start ID code registration, the tire pressure warning light does not blink slowly 3 times.
- If, when the vehicle has been driven for about 20 minutes after performing ID code registration, the tire pressure warning light blinks for approximately 1 minute and then illuminates.
- If ID code registration cannot be completed after performing the above procedure, contact your Toyota dealer.

Selecting wheel set

Your vehicle is equipped with tire pressure warning system with the function to have ID codes registered for a second wheel set, for example a winter set. You can register a second wheel set by yourself or your Toyota dealer.

After registration of a second wheel set, either of these two wheel sets can be selected for usage with the tire pressure warning system.

■ Operating conditions for the function

- This function will perform the change of wheel set only if a second wheel set has been registered. If no second wheel set has been registered, no change will be made when selecting this function in the menu.
- Only a change between both registered wheel set is possible, mixing between these wheel sets is not supported.

■ How to change between wheel sets

- 1 Have the vehicle fitted with the preferred wheel set.
- 2 Press < or > of the meter control switches on the steering wheel and select .

- 3 Press ^ or v of the meter control switches and select "Vehicle Settings", and then press and hold OK.
- 4 Press ^ or v of the meter control switches and select "TPWS", and then press OK.
- 5 Press ^ or v of the meter control switches and select "Change Wheel". Then press and hold OK until the tire pressure warning light starts slowly blinking 3 times.

Afterward, the tire pressure warning light turns on after flashing for 1 minute.

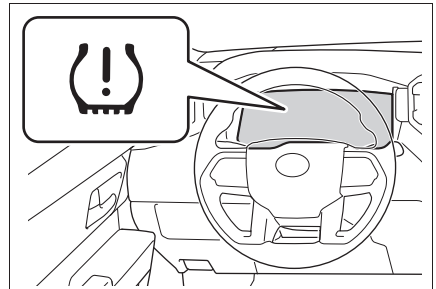

After 2 minutes, registration of a second wheel set is being performed. The tire pressure warning light will turn off and "--" will be displayed for the inflation pressure of each tire on the multi-information display.

- 6 Initialize the tire pressure warning system. (→P.496)

If the tire inflation pressure settings for the installed tires change, initialization operations are required, but if the tire inflation pressure settings are the same, initialization is not

required.

- 7 Drive straight (with occasional left and right turns) at approximately 25 mph (40 km/h) or more for approximately 10 to 30 minutes.

Registration of a second wheel set is complete when the tire pressure warning light turns off and the inflation pressure of each tire is displayed on the multi-information display.

Tire inflation pressure

Checking the specified tire inflation pressure

The recommended cold tire inflation pressure and tire size are displayed on the tire and loading information label. (→P.574)

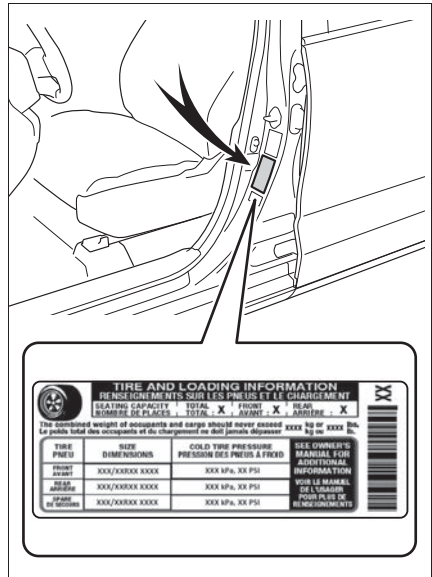

Inspection and adjustment procedure

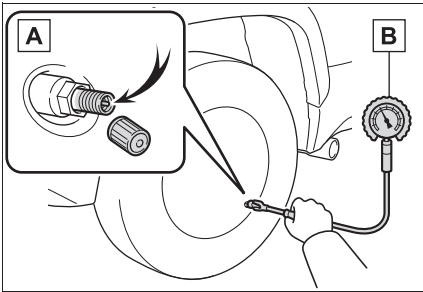

A Tire valve

B Tire pressure gauge

- 1 Remove the tire valve cap.
- 2 Press the tip of the tire pressure gauge onto the tire valve.
- 3 Read the pressure using the gauge gradations.
- 4 If the tire inflation pressure is not at the recommended level, adjust the pressure. If you add too much air, press the center of the valve to deflate.
- 5 After completing the tire inflation pressure measurement and adjustment, apply soapy water to the valve and check for leakage.
- 6 Put the tire valve cap back on.

■ Tire inflation pressure check interval

You should check tire inflation pressure every two weeks, or at least once a month. Do not forget to

check the spare.

■ Effects of incorrect tire inflation pressure

Driving with incorrect tire inflation pressure may result in the following:

- Reduced fuel economy
- Reduced driving comfort and poor handling
- Reduced tire life due to wear
- Reduced safety
- Damage to the drive train

If a tire needs frequent inflating, have it checked by your Toyota dealer.

■ Instructions for checking tire inflation pressure

When checking tire inflation pressure, observe the following:

- Check only when the tires are cold. If your vehicle has been parked for at least 3 hours or has not been driven for more than 1 mile or 1.5 km, you will get an accurate cold tire inflation pressure reading.
- Always use a tire pressure gauge. It is difficult to judge if a tire is properly inflated based only on its appearance.
- It is normal for the tire inflation pressure to be higher after driving as heat is generated in the tire. Do not reduce tire inflation pressure after driving.
- Never exceed the vehicle capacity weight. Passengers and luggage weight should be placed so that the vehicle is balanced.

**WARNING****■ Proper inflation is critical to save tire performance**

Keep your tires properly inflated. If the tires are not properly inflated, the following conditions may occur which could lead to an accident resulting in death or serious injury:

- Excessive wear
- Uneven wear
- Poor handling
- Possibility of blowouts resulting from overheated tires
- Air leaking from between tire and wheel
- Wheel deformation and/or tire damage
- Greater possibility of tire damage while driving (due to road hazards, expansion joints, sharp edges in the road, etc.)

**NOTICE****■ When inspecting and adjusting tire inflation pressure**

Be sure to put the tire valve caps back on.

If a valve cap is not installed, dirt or moisture may get into the valve and cause an air leak, resulting in decreased tire inflation pressure.

Wheels

If a wheel is bent, cracked or heavily corroded, it should be replaced. Otherwise, the tire may separate from the wheel or cause a loss of handling control.

Wheel selection

When replacing wheels, care should be taken to ensure that they are equivalent to those removed in load capacity, diameter, rim width and inset*.

Replacement wheels are available at your Toyota dealer.

*: Conventionally referred to as offset.

Toyota does not recommend using the following:

- Wheels of different sizes or types
- Used wheels
- Bent wheels that have been straightened

■ When replacing wheels

The wheels of your vehicle are equipped with tire pressure warning valves and transmitters that allow the tire pressure warning system to provide advance warning in the event of a loss in tire inflation pressure. Whenever wheels are replaced, the tire pressure warning valves and transmitters must be installed. (→P.495)

**WARNING****■ When replacing wheels**

- Do not use wheels that are a different size from those recommended in the Owner's Manual or certification label, as this may result in a loss of handling control.
- Never use an inner tube in a leaking wheel which is designed for a tubeless tire. Doing so may result in an accident, causing death or serious injury.

■ When installing the wheel nuts

Never use oil or grease on the wheel bolts or wheel nuts. Oil and grease may cause the wheel nuts to be excessively tightened, leading to bolt or disc wheel damage. In addition, the oil or grease can cause the wheel nuts to loosen and the wheel may fall off, causing an accident and resulting in death or serious injury. Remove any oil or grease from the wheel bolts or wheel nuts.

■ Use of defective wheels prohibited

Do not use cracked or deformed wheels. Doing so could cause the tire to leak air during driving, possibly causing an accident.

**NOTICE****■ Replacing tire pressure warning valves and transmitters**

- Because tire repair or replacement may affect the tire pressure warning valves and transmitters, make sure to have tires serviced by your Toyota dealer or other qualified service shop. In addition, make sure to purchase your tire pressure warning valves and transmitters at your Toyota dealer.
- Ensure that only genuine Toyota wheels are used on your vehicle. Tire pressure warning valves and transmitters may not work properly with non-genuine wheels.

Aluminum wheel precautions

- Use only Toyota wheel nuts and wheel nut wrenches designed for use with your aluminum wheels.
- When rotating, repairing or changing your tires, check that the wheel nuts are still tight after driving 1000 miles (1600 km).
- Be careful not to damage the aluminum wheels when using tire chains.
- Use only Toyota genuine balance weights or equivalent and a plastic or rubber hammer when balancing your wheels.

Air conditioning filter

The air conditioning filter must be changed regularly to maintain air conditioning efficiency.

Removing the air conditioning filter

- 1 Turn the power switch off.
- 2 Open the glove box.

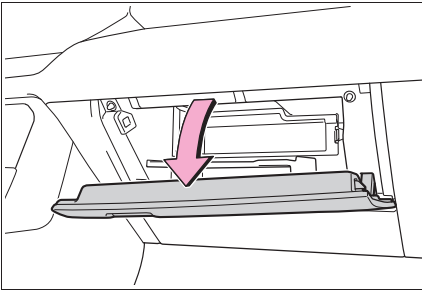

- 3 Remove the panel.

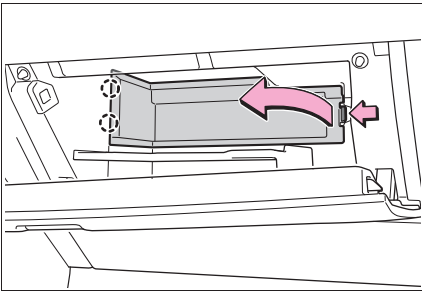

- 4 Unlock the filter cover (A), pull the filter cover out of the claws (B), and remove the filter cover.

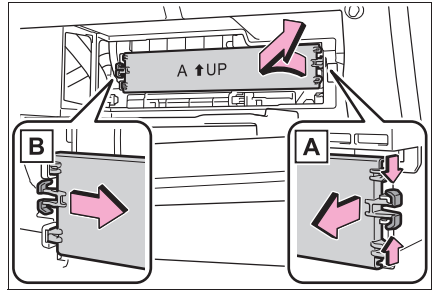

- 5 Remove the filter case.

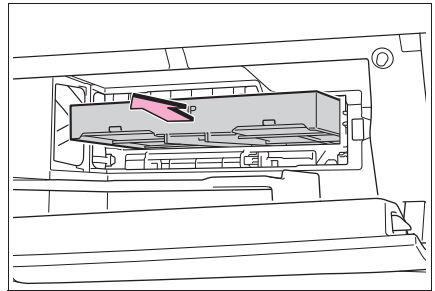

- 6 Remove the air conditioning filter from the filter case and replace it with a new one.

The “↑ UP” marks shown on the filter and the filter case should be pointing up.

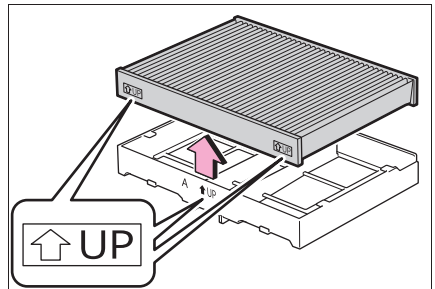

■ Checking interval

Inspect and replace the air conditioning filter according to the maintenance schedule. In dusty areas or areas with heavy traffic flow, early replacement may be required. (For scheduled maintenance information, please refer to the “Owner’s Manual Supplement” or “Scheduled Maintenance Guide”.)

■ If air flow from the vents decreases dramatically

The filter may be clogged. Check the filter and replace if necessary.



NOTICE

■ When using the air conditioning system

Make sure that a filter is always installed.

Using the air conditioning system without a filter may cause damage to the system.

■ To prevent damage to the filter cover

When moving the filter cover in the direction of arrow to release the fitting, pay attention not to apply excessive force to the claws. Otherwise, the claws may be damaged.

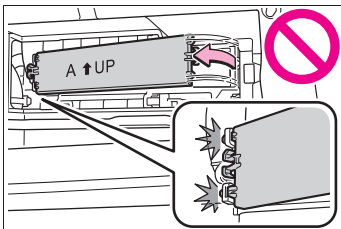

Cleaning the hybrid battery (traction battery) air intake vents

To prevent the fuel economy from being affected, visually inspect the hybrid battery (traction battery) air intake vents periodically for clogs. If it is dusty or clogged or if “Maintenance Required for Traction Battery Cooling Parts See Owner’s Manual” is displayed on the multi-information display, clean the air intake vents using the following procedures:

■ Scheduled maintenance of the air intake vents is necessary when

In some situations such as when the vehicle is used frequently or in heavy traffic or dusty areas, the air intake vents may need to be cleaned more regularly.

For details, refer to the “Owner’s Warranty Information Booklet” or “Owner’s Manual Supplement”.

■ Cleaning the air intake vents

Improper handling of the air intake vent cover and filter may result in damage to them. If you have any concerns about cleaning the filter, contact your Toyota dealer.

 NOTICE

■ If “Maintenance Required for Traction Battery Cooling Parts See Owner’s Manual” is displayed on the multi-information display

Clean the air intake vents immediately.

If the vehicle is continuously driven with the warning message displayed, it may cause a malfunction or output restriction of the hybrid battery (traction battery).

Cleaning procedure

- 1 Turn the power switch off.
- 2 Remove the air intake vent cover.

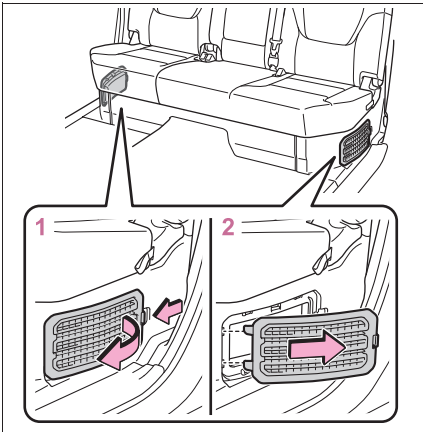

- 1 Pull the cover as shown in the illustration to disengage the 2 claws.
- 2 Pull the cover toward the side of the vehicle to remove it.
- 3 Remove the filter from the air intake vent cover.

If dust has accumulated on the air intake vent cover, remove the dust

with a vacuum cleaner, etc.

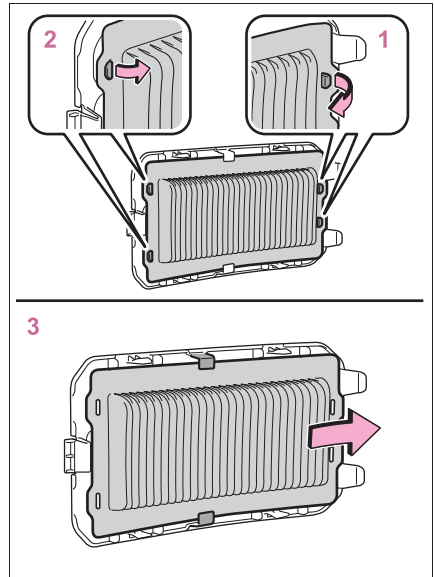

- 1 Disengage the claw as shown in the illustration.
- 2 Disengage the claw as shown in the illustration.
- 3 Remove the filter from the cover.
- 4 Remove the dust and sand from the filter.

Using a vacuum cleaner, etc., absorb dust and sand from the filter by profiling the nozzle lightly along the fold.

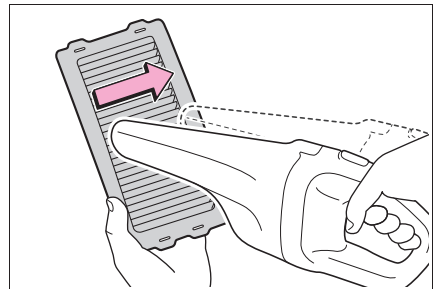

508 6-3. Do-it-yourself maintenance

- 5 Hold the filter to the light and check if it is not clogged.

If the dust or sand cannot be removed completely, contact your Toyota dealer.

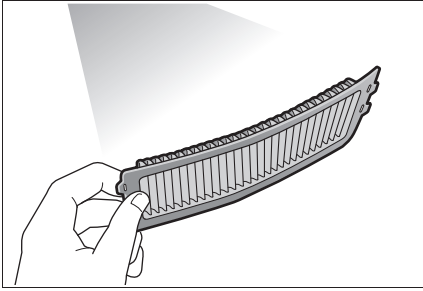

- 6 Reinstall the filter to the cover.

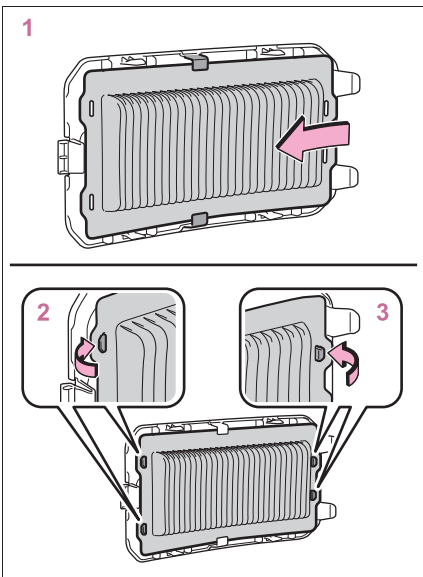

- 1 Installing the filter to the as shown in the illustration.
- 2 Engage the filter to the 2 claws as shown in the illustration.
- 3 Engage the filter to the 2 claws as shown in the illustration.

Make sure that the filter is not crooked or deformed when installing it.

- 7 Install the air intake vent cover.

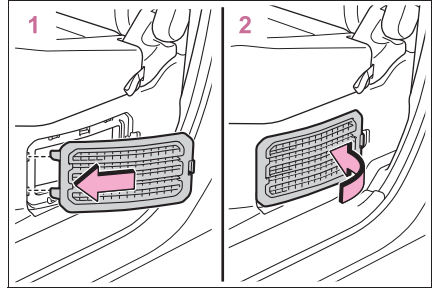

- 1 Insert the tab of the cover as shown in the illustration.

- 2 Push the cover to engage the 2 claws.

► If “Maintenance Required for Traction Battery Cooling Parts See Owner’s Manual” was displayed on the multi-information display

- 8 Start the hybrid system and check that the warning message is no longer displayed.

It may take approximately 20 minutes after the hybrid system is started until the warning message disappears.

If the warning message does not disappear after some time, have the vehicle inspected by your Toyota dealer.

■ If the dust or sand on the filter cannot be removed

It is recommended to use a vacuum cleaner with plastic brushes.

 **WARNING**
■ When cleaning the air intake vents

- Do not use water or other liquids to clean the air intake vents. If water is applied to the hybrid battery (traction battery) or other components, a malfunction or fire may occur.
- Before cleaning the air intake vents, make sure to turn the power switch off to stop the hybrid system.
- Do not put a hand or leg in the air intake vents. If it is caught in a cooling fan, or if it touches a high voltage part that results in an electric shock, death or serious injuries may result.
- Do not touch the service plug located near the air intake vents. (→P.78)

 **NOTICE**
■ When cleaning the air intake vents

Do not use an air blow gun, etc. Dust may be blown out, possibly causing a malfunction or output restriction of the hybrid battery (traction battery).

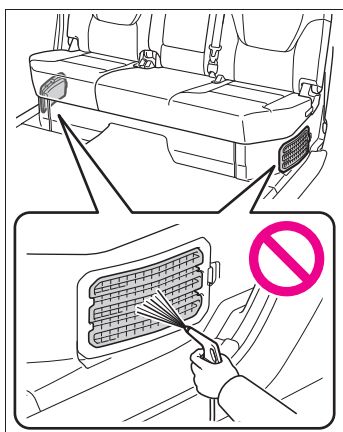
■ To prevent damage to the vehicle

Observe the following precautions:

- Do not allow water or foreign matter to enter the air intake vents.
- Make sure to reinstall the filter and cover to their original positions after cleaning.
- Do not install anything to the air intake vents other than the exclusive filter for this vehicle or use the vehicle without the filter installed.

■ To prevent damage to the filter

Observe the following precautions.

If the filter is damaged, have it replaced with a new filter by your Toyota dealer.

- Do not use an air blow gun, etc.
- Do not press hard a vacuum cleaner, etc. against the filter.
- Do not use a hard brush, such as a metal brush.
- Do not break the fold of the filter.

Electronic key battery

Replace the battery with a new one if it is depleted. As the key may be damaged if the following procedure is not performed properly, it is recommended that key battery replacement be performed by your Toyota dealer.

■ If the electronic key battery is depleted

The following symptoms may occur:

- The smart key system and wireless remote control will not function properly.
- The operational range will be reduced.

Items to prepare

- Flathead screwdriver
- Small flathead screwdriver
- Lithium battery CR2450

■ Use a CR2450 lithium battery

- Batteries can be purchased at your Toyota dealer, local electrical appliance shops or camera stores.
- Replace only with the same or equivalent type recommended by the manufacturer.
- Dispose of used batteries according to local laws.

Replacing the battery

- 1 Take out the mechanical key.

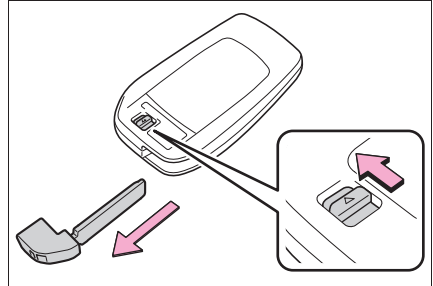

- 2 Remove the cover.

To prevent damage to the key, cover the tip of the flathead screwdriver with a tape.

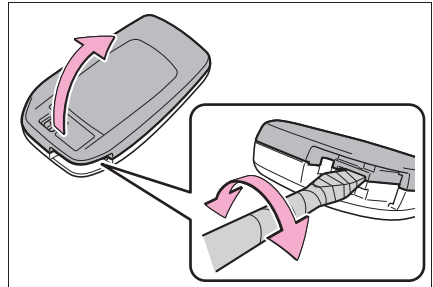

- 3 Remove the depleted battery.

Insert a new battery with the "+" terminal facing up.

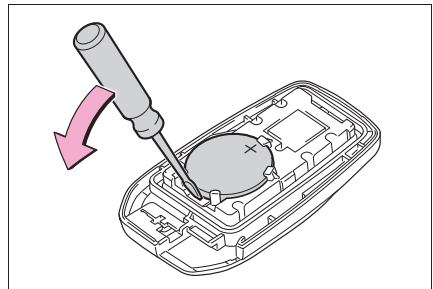

**WARNING****■ Removed battery and other parts**

These parts are small and if swallowed by a child, they can cause choking. Keep away from children. Failure to do so could result in death or serious injury.

■ Battery precautions

Observe the following precautions.

Failure to do so may result in death or serious injury.

- Do not swallow the battery. Doing so may cause chemical burns.
- A coin battery or button battery is used in the electronic key. If a battery is swallowed, it may cause severe chemical burns in as little as 2 hours and may result in death or serious injury.
- Keep away new and removed batteries from children.
- If the cover cannot be firmly closed, stop using the electronic key and stow the key in the place where children cannot reach, and then contact your Toyota dealer.
- If you accidentally swallow a battery or put a battery into a part of your body, get emergency medical attention immediately.

■ To prevent battery explosion or leakage of flammable liquid or gas

- Replace the battery with a new battery of the same type. If a wrong type of battery is used, it may explode.

- Do not expose batteries to extremely low pressure due to high altitude or extremely high temperatures.

- Do not burn, break or cut a battery.

**NOTICE****■ When replacing the battery**

Use a flathead screwdriver of appropriate size. Applying excessive force may deform or damage the cover.

■ For normal operation after replacing the battery

Observe the following precautions to prevent accidents:

- Always work with dry hands. Moisture may cause the battery to rust.
- Do not touch or move any other component inside the remote control.
- Do not bend either of the battery terminals.

Checking and replacing fuses

If any of the electrical components do not operate, a fuse may have blown. If this happens, check and replace the fuses as necessary.

Checking and replacing fuses

- 1 Turn the power switch off.
 - 2 Open the fuse box cover.
- Engine compartment: type A fuse box

Push the tabs in and lift the lid off.

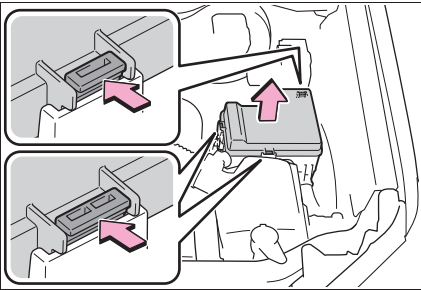

- Engine compartment: type B fuse box

Push the tabs in and lift the lid off.

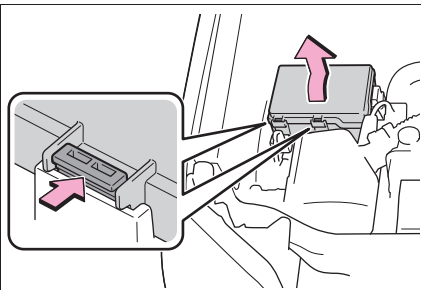

- Passenger' side instrument panel

Remove the cover.

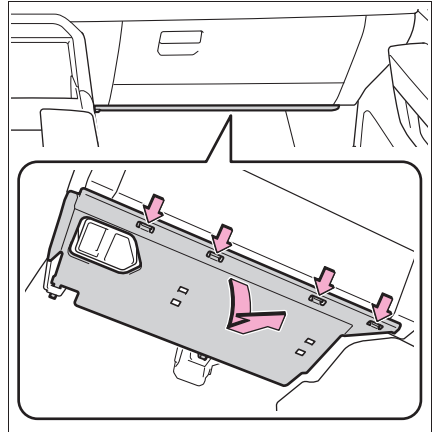

Vehicles with footwell lights:
Remove the footwell lights connector.

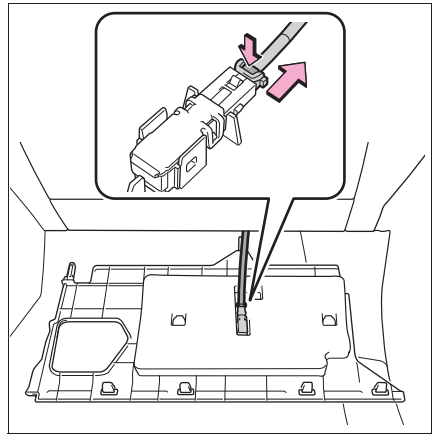

Remove the lid.

Make sure to push the claw when removing/installing the lid.

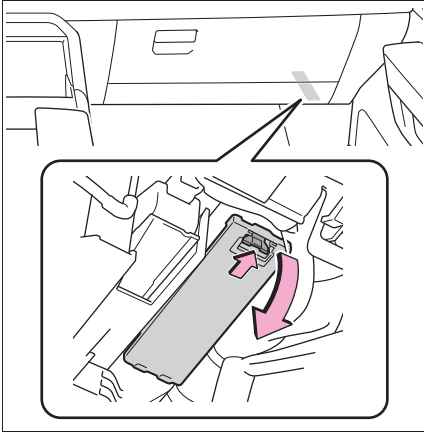

- ▶ Under the right-hand rear seat
- Lift the rear seat cushion. (→P.143)
- Remove the cover.

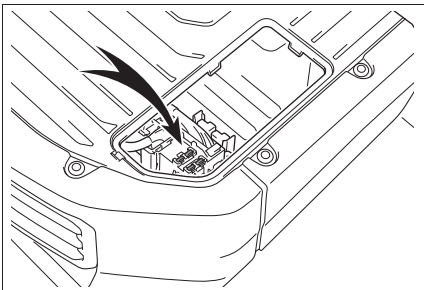
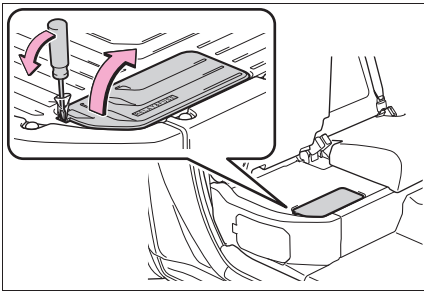

- 3 Remove the fuse with the pullout tool. Only type A fuse can be removed using the pullout tool.

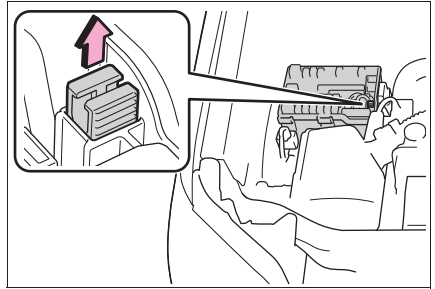

- 4 Check if the fuse is blown.

Type A and B:
Replace the blown fuse with a new fuse of an appropriate amperage rating. The amperage rating can be found on the fuse box lid.

Type C and D:
Contact your Toyota dealer.

- ▶ Type A

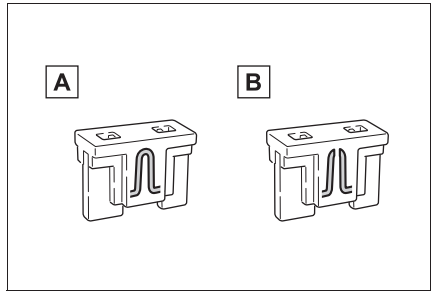

A Normal fuse

B Blown fuse

▶ Type B

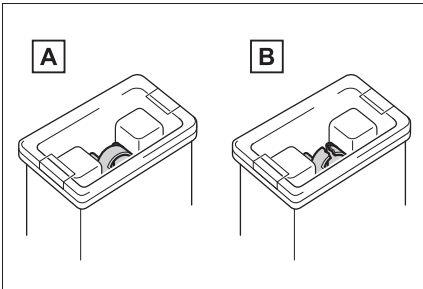

A Normal fuse

B Blown fuse

▶ Type C

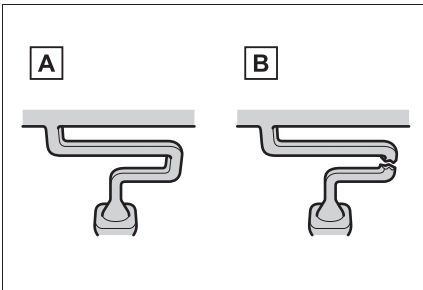

A Normal fuse

B Blown fuse

▶ Type D

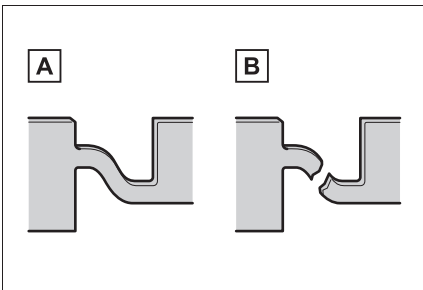

A Normal fuse

B Blown fuse

■ **After a fuse is replaced**

- When installing the lid, make sure that the tab is installed securely.
- If the lights do not turn on even after the fuse has been replaced, a bulb may need replacement.
- If the replaced fuse blows again, have the vehicle inspected by your Toyota dealer.

■ **If there is an overload in a circuit**

The fuses are designed to blow, protecting the wiring harness from damage.

■ **When replacing light bulbs**

Toyota recommends that you use genuine Toyota products designed for this vehicle. Because certain bulbs are connected to circuits designed to prevent overload, non-genuine parts or parts not designed for this vehicle may be unusable.

! WARNING

■ **To prevent system breakdowns and vehicle fire**

Observe the following precautions.

Failure to do so may cause damage to the vehicle, and possibly a fire or injury.

- Never use a fuse of a higher amperage rating than that indicated, or use any other object in place of a fuse.
- Always use a genuine Toyota fuse or equivalent. Never replace a fuse with a wire, even as a temporary fix.
- Do not modify the fuses or fuse boxes.



NOTICE

■ Before replacing fuses

Have the cause of electrical overload determined and repaired by your Toyota dealer as soon as possible.

Light bulbs

You may replace the following bulb by yourself. If necessary bulb replacement seems difficult to perform, contact your Toyota dealer. For more information about replacing other lights, contact your Toyota dealer.

Preparing for light bulb replacement

Check the wattage of the light bulb to be replaced. (→P.575)

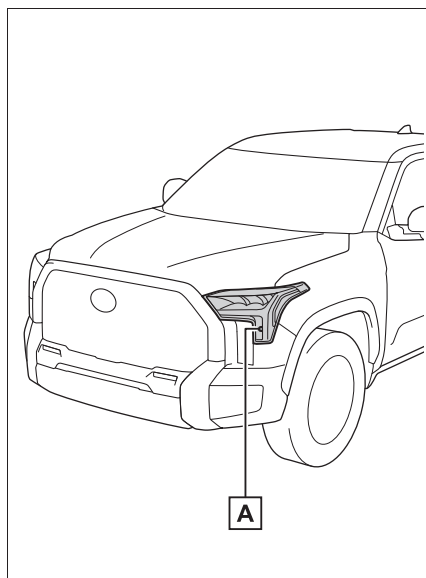
Bulb location

A Front turn signal/parking lights (bulb type)

■ **Lights that need to be replaced by your Toyota dealer**

- Headlights
- Daytime running lights
- Front turn signal/parking lights (LED type)
- Front fog lights (if equipped)
- Side marker lights
- Rear tailgate markers (if equipped)
- Side turn signal lights
- Trailering light (if equipped)
- Tail lights
- Stop lights
- Back-up light
- Rear turn signal lights
- High mounted stoplight/cargo lamp
- Trailer hitch light (if equipped)
- Bed lamp (if equipped)
- Auxiliary lights (if equipped)
- Light bar (if equipped)
- Arch molding marker lights (if equipped)

■ **When replacing the light bulbs**

Confirm that they are properly engaged with the bulb base and that there is no light leakage.

■ **LED Lights**

The lights other than front turn signal/parking lights (bulb type) consist of a number of LEDs. If any of the LEDs burn out, take your vehicle to your Toyota dealer to have the

light replaced.

■ **Condensation build-up on the inside of the lens**

Temporary condensation build-up on the inside of the headlight lens does not indicate a malfunction. Contact your Toyota dealer for more information in the following situations:

- Large drops of water have built up on the inside of the lens.
- Water has built up inside the headlight.

■ **When replacing light bulbs**

→P.514

Replacing light bulb

■ Front turn signal/parking lights (bulb type)

- 1 To allow enough working space, turn the steering wheel to the opposite side of the bulb to be replaced. Remove the screws, and remove the fender liner.

Turn the steering wheel to the left when replacing the right side light bulb, and turn the steering wheel to the right when replacing the left side light bulb.

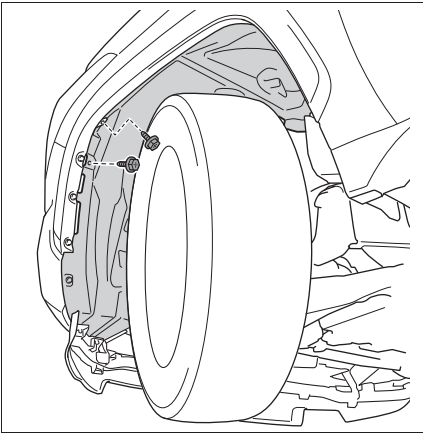

- 2 Open the fender liner and turn the bulb base counter-clockwise.

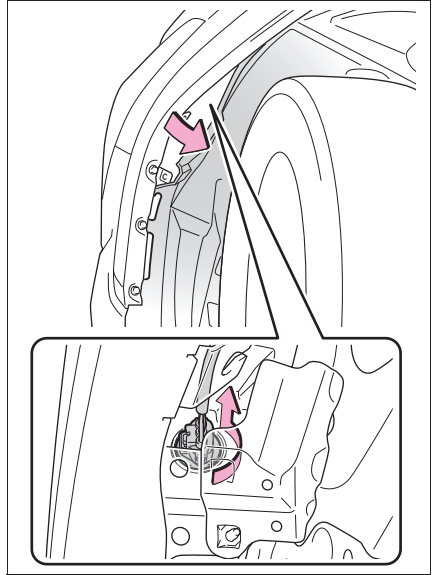

- 3 Remove the light bulb.

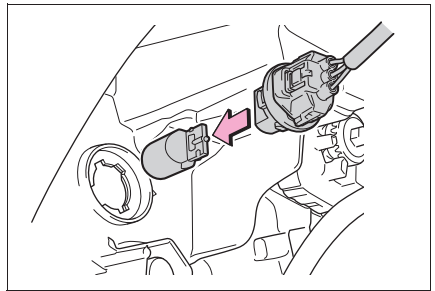

- 4 Install a new light bulb and turn the bulb base clockwise.

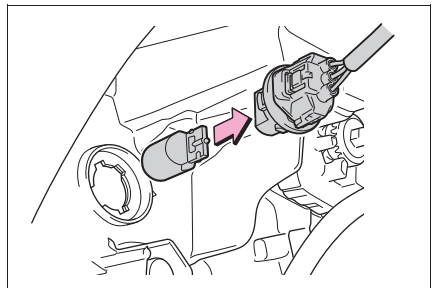

- 5 Reinstall the fender liner and install the screws.

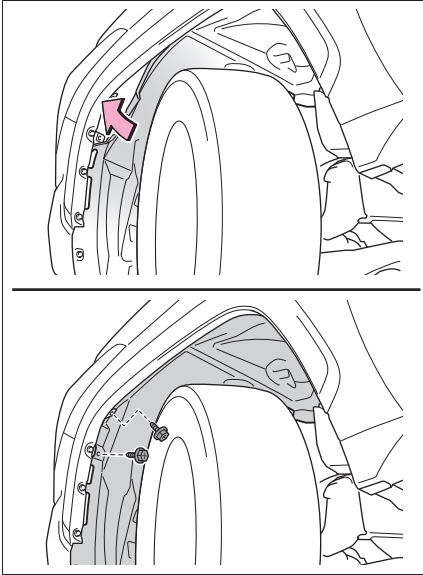

● Do not attempt to repair or disassemble light bulbs, connectors, electric circuits or component parts. Doing so may result in death or serious injury due to electric shock.

■ **To prevent damage or fire**
Make sure bulbs are fully seated and locked.

⚠ WARNING

■ **Replacing light bulbs**

- Turn off the lights. Do not attempt to replace the bulb immediately after turning off the lights. The bulbs become very hot and may cause burns.
- Do not touch the glass portion of the light bulb with bare hands. When it is unavoidable to hold the glass portion, use and hold with a clean dry cloth to avoid getting moisture and oils on the bulb. Also, if the bulb is scratched or dropped, it may blow out or crack.
- Fully install light bulbs and any parts used to secure them. Failure to do so may result in heat damage, fire, or water entering the light unit. This may damage the lights or cause condensation to build up on the lens.

When trouble arises

7

7-1. Essential information

Emergency flashers **520**

If your vehicle has to be stopped in an emergency **520**

If the vehicle is submerged or water on the road is rising **521**

7-2. Steps to take in an emergency

If your vehicle needs to be towed..... **523**

If you think something is wrong **525**

If a warning light turns on or a warning buzzer sounds **527**

If a warning message is displayed..... **537**

If you have a flat tire.... **541**

If the hybrid system will not start **551**

If you lose your keys ... **553**

If the electronic key does not operate properly.. **553**

If the vehicle 12-volt battery is discharged **555**

If your vehicle overheats **561**

If the vehicle becomes stuck **564**

Emergency flashers

The emergency flashers are used to warn other drivers when the vehicle has to be stopped on the road due to a breakdown, etc.

Operating instructions

Press the switch to flash all of the turn signal lights.

To turn them off, press the switch once again.

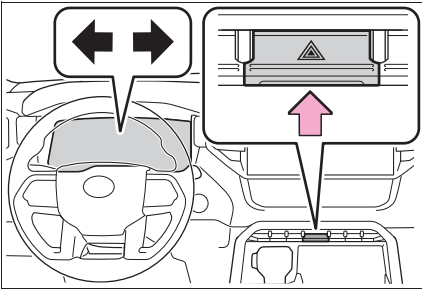

Emergency flashers

- If the emergency flashers are used for a long time while the hybrid system is not operating, the 12-volt battery may discharge.
- If any of the SRS airbags deploy (inflate) or in the event of a strong rear impact, the emergency flashers will turn on automatically. The emergency flashers will turn off automatically after operating for approximately 20 minutes. To manually turn the emergency flashers off, press the switch twice.
(The emergency flashers may not turn on automatically depending on the force of the impact and conditions of the collision.)

If your vehicle has to be stopped in an emergency

Only in an emergency, such as if it becomes impossible to stop the vehicle in the normal way, stop the vehicle using the following procedure:

Stopping the vehicle

- 1 Steadily step on the brake pedal with both feet and firmly depress it.
Do not pump the brake pedal repeatedly as this will increase the effort required to slow the vehicle.
- 2 Shift the shift lever to N.
 - ▶ If the shift lever is shifted to N
- 3 After slowing down, stop the vehicle in a safe place by the road.
- 4 Stop the hybrid system.
 - ▶ If the shift lever cannot be shifted to N
- 3 Keep depressing the brake pedal with both feet to reduce vehicle speed as much as possible.

- 4 To stop the hybrid system, press and hold the power switch for 2 consecutive seconds or more, or press it briefly 3 times or more in succession.

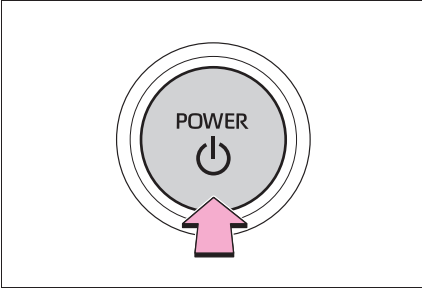

- 5 Stop the vehicle in a safe place by the road.

! WARNING

■ If the hybrid system has to be turned off while driving

Power assist for the steering wheel will be lost, making the steering wheel heavier to turn. Decelerate as much as possible before turning off the hybrid system.

If the vehicle is submerged or water on the road is rising

This vehicle is not designed to be able to drive on roads that are deeply flooded with water. Do not drive on roads where the roads may be submerged or the water may be rising. It is dangerous to remain in the vehicle, if it is anticipated that the vehicle will be flooded or set adrift. Remain calm and follow the following.

- If the door can be opened, open the door and exit the vehicle.
- If the door cannot be opened, open the window using the power window switch and ensure an escape route.
- If the window can be opened, exit the vehicle through the window.
- If the door and window cannot be opened due to the rising water, remain calm, wait until the water level inside the vehicle rises to the point that the water pressure inside of the vehicle equals the water pressure outside of the vehicle and then open the door after waiting for the rising water to enter the vehicle, and exit the vehicle.

When the outside water level exceeds half the height of the door, the door cannot be opened from the inside due to water pressure.

■ **Water level exceeds the floor**

When the water level exceeds the floor and time has passed, the electrical equipment will get damaged, the power windows will not operate, the engine and motor stop, and the vehicle may not be able to get moving.

■ **Using an emergency escape hammer*1**

Laminated glass*2 is used in the windshield and the windows on this vehicle.

Laminated glass cannot be shattered with an emergency hammer*1.

*1: Contact your Toyota dealer or aftermarket accessory manufacturer for further information about an emergency hammer.

*2: If equipped

■ **How to distinguish laminated glass**

When looking from the cross-sectional view point, laminated glass is two sheets of glass pasted together.

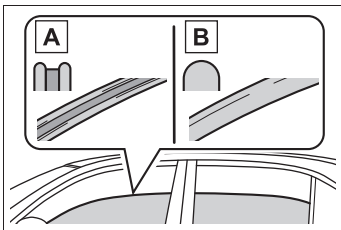

A Laminated glass

B Tempered glass

! WARNING

■ **Caution while driving**

Do not drive on roads where the roads may be submerged or the water may be rising. Otherwise the vehicle may be damaged and cannot move, as well as become flooded and set adrift, which may lead to death.

If your vehicle needs to be towed

If towing is necessary, we recommend having your vehicle towed by your Toyota dealer or commercial towing service, using a wheel-lift type truck or flat-bed truck.

Use a safety chain system for all towing, and abide by all state/provincial and local laws.

Situations when it is necessary to contact dealers before towing

The following may indicate a problem with your transmission. Contact your Toyota dealer or commercial towing service before towing.

- The hybrid system warning message is shown on the multi-information display and the vehicle does not move.
- The vehicle makes an abnormal sound.

Towing with a wheel-lift type truck

- ▶ From the front

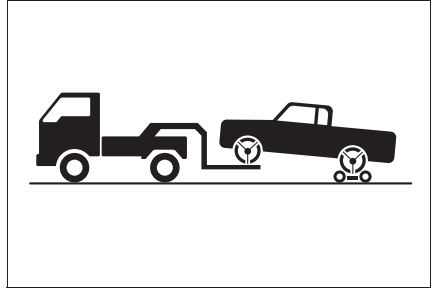

Use a towing dolly under the rear wheels.

- ▶ From the rear

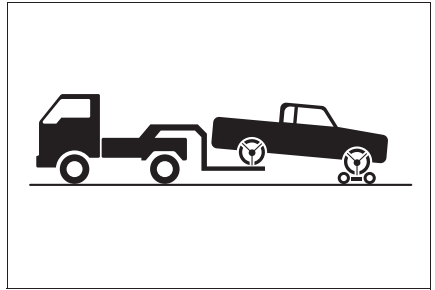

Use a towing dolly under the front wheels.

⚠ WARNING

Observe the following precautions.

Failure to do so may result in death or serious injury.

■ When towing the vehicle**▶ 2WD models**

Be sure to transport the vehicle with all four wheels raised off the ground. If the vehicle is towed with the tires contacting the ground, the drivetrain and related parts may be damaged, an accident may occur due to a change in direction of the vehicle or electricity generated by the operation of the motor may cause a fire to occur depending on the nature of the damage or malfunction.

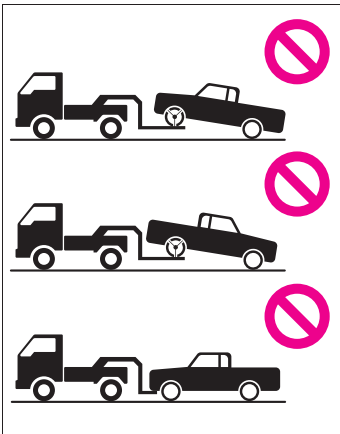
**▶ 4WD models**

Be sure to transport the vehicle with all four wheels raised off the ground. If the vehicle is towed with the tires contacting the ground, the drivetrain or related parts may be damaged, the vehicle may fly off the truck, or electricity generated by the operation of the motor may cause a fire to occur depending on the nature of the damage or malfunction.

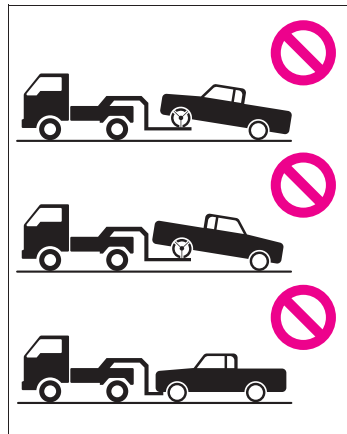
**⚠ NOTICE****■ To prevent damage to the vehicle when towing using a wheel-lift type truck**

- Do not tow the vehicle from the rear when the power switch is off.
- When raising the vehicle, ensure adequate ground clearance for towing at the opposite end of the raised vehicle. Without adequate clearance, the vehicle could be damaged while being towed.



NOTICE

■ Towing with a sling-type truck

Do not tow with a sling-type truck to prevent body damage.

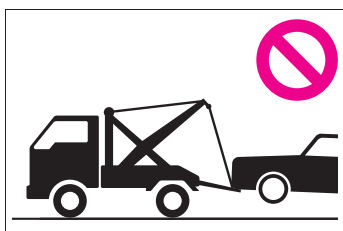

Using a flatbed truck

When using a flat-bed truck to transport the vehicle, use tire strapping belts. Refer to the owner's manual of the flat-bed truck for the tire strapping method.

In order to suppress vehicle movement during transportation, set the parking brake and turn the power switch off.

Emergency towing

Your vehicle has not towing hook. If towing is necessary, we recommend having your vehicle towed by your Toyota dealer or commercial towing service.

If you think something is wrong

If you notice any of the following symptoms, your vehicle probably needs adjustment or repair. Contact your Toyota dealer as soon as possible.

Visible symptoms

- Fluid leaks under the vehicle. (Water dripping from the air conditioning after use is normal.)
- Flat-looking tires or uneven tire wear
- Engine coolant temperature gauge needle continually points higher than normal.
- Voltmeter continually points higher or lower than normal.
- Engine oil pressure gauge continually points lower than normal.
- Automatic transmission fluid temperature warning message is displayed

Audible symptoms

- Changes in exhaust sound
- Excessive tire squeal when cornering
- Strange noises related to the suspension system
- Pinging or other noises related to the engine

Operational symptoms



- Engine misses, stumbling or running roughly
- Appreciable loss of power
- Vehicle pulls heavily to one side when braking
- Vehicle pulls heavily to one side when driving on a level road
- Loss of brake effectiveness, spongy feeling, pedal almost touches the floor

If a warning light turns on or a warning buzzer sounds



Calmly perform the following actions if any of the warning lights comes on or flashes. If a light comes on or flashes, but then goes off, this does not necessarily indicate a malfunction in the system. However, if this continues to occur, have the vehicle inspected by your Toyota dealer.

Actions to the warning lights or warning buzzers

■ Brake system warning light (warning buzzer)

Warning light	Details/Actions
 <p>BRAKE (U.S.A.) or  (Red) (Canada)</p>	<p>Indicates that:</p> <ul style="list-style-type: none"> ● The brake fluid level is low; or ● The brake system is malfunctioning <p>→ Immediately stop the vehicle in a safe place and contact your Toyota dealer. Continuing to drive the vehicle may be dangerous.</p>

■ Brake system warning light (warning buzzer)

Warning light	Details/Actions
 <p> (Yellow)</p>	<p>Indicates a malfunction in:</p> <ul style="list-style-type: none"> ● The parking brake system; ● The regenerative braking system; or ● The electronically controlled brake system <p>→ Have the vehicle inspected by your Toyota dealer immediately.</p>

■ High coolant temperature warning light*

Warning light	Details/Actions
	<p>Indicates that the engine is overheating</p> <p>→ Immediately stop the vehicle in a safe place. Handling method (→P.561)</p>

*: This light illuminates on the multi-information display with a message.

■ Charging system warning light* (warning buzzer)

Warning light	Details/Actions
	Indicates a malfunction in the vehicle's charging system → Immediately stop the vehicle in a safe place and contact your Toyota dealer.



*: This light illuminates on the multi-information display with a message.

■ Low engine oil pressure warning light* (warning buzzer)

Warning light	Details/Actions
	Indicates that the engine oil pressure is excessively low → Immediately stop the vehicle in a safe place and contact your Toyota dealer.

*: This light illuminates on the multi-information display with a message.



■ Malfunction indicator lamp

Warning light	Details/Actions
 (U.S.A.) or  (Canada)	Indicates a malfunction in: <ul style="list-style-type: none"> ● The hybrid system; ● The electronic engine control system; or ● The electronic throttle control system → Have the vehicle inspected by your Toyota dealer immediately.



■ SRS warning light

Warning light	Details/Actions
	Indicates a malfunction in: <ul style="list-style-type: none"> ● The SRS airbag system; ● The front passenger occupant classification system; or ● The seat belt pretensioner system → Have the vehicle inspected by your Toyota dealer immediately.

■ ABS warning light

Warning light	Details/Actions
 (U.S.A.) or  (Canada)	<p>Indicates a malfunction in:</p> <ul style="list-style-type: none"> ● The ABS; or ● The brake assist system <p>→ Have the vehicle inspected by your Toyota dealer immediately.</p>

■ Electric power steering system warning light (warning buzzer)

Warning light	Details/Actions
 (Red) or  (Yellow)	<p>Indicates a malfunction in the EPS (Electric Power Steering) system</p> <p>→ Have the vehicle inspected by your Toyota dealer immediately.</p>

■ PCS warning light

Warning light	Details/Actions
 (Flashes or illuminates)	<p>When a buzzer sounds simultaneously:</p> <p>Indicates a malfunction has occurred in the PCS (Pre-Collision System).</p> <p>→ Have the vehicle inspected by your Toyota dealer immediately.</p> <p>When a buzzer does not sound:</p> <p>The PCS (Pre-Collision System) has become temporarily unavailable, corrective action may be necessary.</p> <p>→ Follow the instructions displayed on the multi-information display. (→P.240, 537)</p> <p>If the PCS (Pre-Collision System) or VSC (Vehicle Stability Control) system is disabled, the PCS warning light will illuminate.</p> <p>→ P.394</p>

■ **LTA indicator (warning buzzer)**

Warning light	Details/Actions
 <p>(Orange)</p>	<p>Indicates a malfunction in the LTA (Lane Tracing Assist) → Follow the instructions displayed on the multi-information display. (→P.265)</p>

■ **Intuitive parking assist OFF indicator (warning buzzer)**

Warning light	Details/Actions
 <p>(Flashes)</p>	<p>Indicates a malfunction in the intuitive parking assist function → Have the vehicle inspected by your Toyota dealer immediately.</p> <p>Indicates that the system is temporarily unavailable, possibly due to a sensor being dirty or covered with ice, etc. → Follow the instructions displayed on the multi-information display. (→P.291)</p>

■ **PKSB OFF indicator (warning buzzer)**

Warning light	Details/Actions
 <p>(Flashes)</p>	<p>When a buzzer sounds: Indicates a malfunction in the PKSB (Parking Support Brake) system → Have the vehicle inspected by your Toyota dealer immediately.</p> <p>When a buzzer does not sound: Indicates that the system is temporarily unavailable, possibly due to a sensor being dirty or covered with ice, etc. → Follow the instructions displayed on the multi-information display. (→P.306)</p>

■ “RCTA OFF” indicator (warning buzzer)

Warning light	Details/Actions
 <p>RCTA OFF (Flashes)</p>	<p>Indicates a malfunction in the RCTA (Rear Cross Traffic Alert) function</p> <p>→ Have the vehicle inspected by your Toyota dealer immediately.</p> <p>Indicates that the rear bumper around the radar sensor is covered with dirt, etc. (→P.282)</p> <p>→ Follow the instructions displayed on the multi-information display. (→P.296)</p>

■ Slip indicator light

Warning light	Details/Actions
	<p>Indicates a malfunction in:</p> <ul style="list-style-type: none"> ● The VSC/Trailer Sway Control system; ● The TRAC system; ● The hill-start assist control system; ● Multi-terrain Select brake control (if equipped); ● Crawl Control (if equipped); or ● The downhill assist control system (if equipped) <p>→ Have the vehicle inspected by your Toyota dealer immediately.</p>

■ Inappropriate pedal operation warning light* (warning buzzer)



Warning light	Details/Actions
	<p>When a buzzer sounds:</p> <ul style="list-style-type: none"> ● Brake Override System is malfunctioning ● Drive-Start Control is malfunctioning ● Drive-Start Control is operating <p>→ Follow the instructions displayed on the multi-information display.</p> <p>When a buzzer does not sound: Brake Override System is operating.</p> <p>→ Release the accelerator pedal and depress the brake pedal.</p>

*: This light illuminates on the multi-information display with a message.

■ Brake hold operated indicator (warning buzzer)

Warning light	Details/Actions
 (Flashes)	Indicates a malfunction in the brake hold system → Have the vehicle inspected by your Toyota dealer immediately.

■ Parking brake indicator (warning buzzer)

Warning light	Details/Actions
 (Flashes) (U.S.A.) or  (Flashes) (Canada)	It is possible that the parking brake is not fully engaged or released → Operate the parking brake switch once again. This light comes on when the parking brake is not released. If the light turns off after the parking brake is fully released, the system is operating normally.

■ Rear differential lock indicator

Warning light	Details/Actions
 (Flashes) (If equipped)	Indicates a malfunction in the rear differential lock system → Have the vehicle inspected by your Toyota dealer immediately.

■ Tire pressure warning light

Warning light	Details/Actions
	When the light comes on after blinking for approximately 1 minute: Malfunction in the tire pressure warning system → Have the system checked by your Toyota dealer. When the light comes on: Low tire inflation pressure such as <ul style="list-style-type: none"> ● Natural causes ● Flat tire → Immediately stop the vehicle in a safe place. Handling method (→P.534)

■ Low fuel level warning light

Warning light	Details/Actions
	Indicates that remaining fuel is approximately 3.4 gal. (13.0 L, 2.8 Imp. gal.) or less → Refuel the vehicle.

■ Driver's and front passenger's seat belt reminder light (warning buzzer)*

Warning light	Details/Actions
	Warns the driver and/or front passenger to fasten their seat belts → Fasten the seat belt. If the front passenger's seat is occupied, the front passenger's seat belt also needs to be fastened to make the warning light (warning buzzer) turn off.

* Driver's seat belt warning buzzer:

The driver's seat belt warning buzzer sounds to alert the driver that his or her seat belt is not fastened. Once the power switch is turned to ON, the buzzer sounds. If the seat belt is still unfastened, the buzzer sounds intermittently for a certain period of time after the vehicle reaches a certain speed.

Front passenger's seat belt warning buzzer:

The front passenger's seat belt warning buzzer sounds to alert the front passenger that his or her seat belt is not fastened. If the seat belt is unfastened, the buzzer sounds intermittently for a certain period of time after the vehicle reaches a certain speed.

■ Rear passengers' seat belt reminder lights (warning buzzer)*

Warning light	Details/Actions
	Warns the rear passengers to fasten their seat belts → Fasten the seat belt.

* Rear passengers' seat belt warning buzzer:

The rear passengers' seat belt warning buzzer sounds to alert the rear passenger that his or her seat belt is not fastened. If the seat belt is unfastened, the buzzer sounds intermittently for a certain period of time, after the seat belt is fastened and unfastened and the vehicle reaches a certain speed.

■ **Air suspension malfunction indicator**

Warning light	Details/Actions
 <p>(If equipped)</p>	<p>Indicates a malfunction in the air suspension system → Have the vehicle inspected by your Toyota dealer immediately.</p>

■ **Trailer brake warning light**

Warning light	Details/Actions
	<p>Indicates a malfunction in: ● Trailer brake control system; or ● Trailer connector circuit → Have the vehicle inspected by your Toyota dealer immediately.</p>

■ **Warning buzzer**

In some cases, the buzzer may not be heard due to being in a noisy location or audio sound.

■ **Front passenger detection sensor, seat belt reminder and warning buzzer**

- If luggage is placed on the front passenger seat, the front passenger detection sensor may cause the warning light to flash and the warning buzzer to sound even if a passenger is not sitting in the seat.
- If a cushion is placed on the seat, the sensor may not detect a passenger, and the warning light may not operate properly.

■ **SRS warning light**

This warning light system monitors the airbag sensor assembly, front impact sensors, side impact sensors (front door), side impact sensors (front), side impact sensors (rear), driver's seat position sensor, driver's seat belt buckle switch, front passenger occupant classification sensors, "AIR BAG ON" indicator light, "AIR BAG OFF" indicator light, front passenger's seat belt buckle switch, seat belt pretensioners, air-

bags, interconnecting wiring and power sources. (→P.37)

■ **If the malfunction indicator lamp comes on while driving**

First check the following:

- Is the fuel tank empty?
If it is, fill the fuel tank immediately.
- Is the fuel tank cap loose?
If it is, tighten it securely.
The light will go off after several driving trips.
If the light does not go off even after several trips, contact your Toyota dealer as soon as possible.

■ **Electric power steering system warning light (warning buzzer)**

When the 12-volt battery charge becomes insufficient or the voltage temporarily drops, the electric power steering system warning light may come on and the warning buzzer may sound.

■ **When the tire pressure warning light comes on**

Inspect the tires to check if a tire is punctured.

If a tire is punctured: →P.541

If none of the tires are punctured:

Turn the power switch off then turn it to ON. Check if the tire pressure warning light comes on or blinks.

- ▶ If the tire pressure warning light blinks for approximately 1 minute then stays on

There may be a malfunction in the tire pressure warning system. Have the vehicle inspected by your Toyota dealer immediately.

- ▶ If the tire pressure warning light comes on
 - 1 After the temperature of the tires has lowered sufficiently, check the inflation pressure of each tire and adjust them to the specified level.
 - 2 If the warning light does not turn off even after several minutes have elapsed, check that the inflation pressure of each tire is at the specified level and perform initialization. (→P.496)

■ The tire pressure warning light may come on due to natural causes

The tire pressure warning light may come on due to natural causes such as natural air leaks and tire inflation pressure changes caused by temperature. In this case, adjusting the tire inflation pressure will turn off the warning light (after a few minutes).

■ When a tire is replaced with a spare tire

The temporary spare tire is not equipped with the tire pressure warning valve and transmitter. If a tire goes flat, the tire pressure warning light will not turn off even though the flat tire is replaced with the temporary spare tire.

Replace the temporary spare tire with the repaired tire and adjust the proper tire inflation pressure. The tire pressure warning light will turn off after several minutes.

■ Conditions that the tire pressure warning system may not function properly

→P.494

WARNING

■ If both the ABS and the brake system warning lights remain on

Stop your vehicle in a safe place immediately and contact your Toyota dealer. The vehicle will become extremely unstable during braking, and the ABS system may fail, which could cause an accident resulting in death or serious injury.

■ When the electric power steering system warning light comes on

When the light comes on yellow, the assist to the power steering is restricted. When the light comes on red, the assist to the power steering is lost and handling operations of the steering wheel become extremely heavy. When steering wheel operations are heavier than usual, grip the steering wheel firmly and operate it using more force than usual.

■ If the tire pressure warning light comes on

Be sure to observe the following precautions.

Failure to do so could cause a loss of vehicle control and result in death or serious injury.

- Stop your vehicle in a safe place as soon as possible. Adjust the tire inflation pressure immediately.

**WARNING**

- If the tire pressure warning light comes on even after tire inflation pressure adjustment, it is probable that you have a flat tire. Check the tires. If a tire is flat, change it with the spare tire and have the flat tire repaired by the nearest Toyota dealer.
- Avoid abrupt maneuvering and braking.
If the vehicle tires deteriorate, you could lose control of the steering wheel or the brakes.
- **If a blowout or sudden air leakage should occur**

The tire pressure warning system may not activate immediately.

■ Maintenance of the tires

Each tire, including the spare (if provided), should be checked monthly when cold and inflated to the inflation pressure recommended by the vehicle manufacturer on the vehicle placard or tire inflation pressure label (tire and load information label). (If your vehicle has tires of a different size than the size indicated on the vehicle placard or tire inflation pressure label [tire and load information label], you should determine the proper tire inflation pressure for those tires.)

As an added safety feature, your vehicle has been equipped with a tire pressure monitoring system (TPMS-tire pressure warning system) that illuminates a low tire pressure telltale (tire pressure warning light) when one or more of your tires is significantly under-inflated. Accordingly, when the low tire pressure telltale (tire pressure warning light) illuminates, you should stop and check your tires as soon as possible, and inflate them to the proper pressure. Driving on a significantly under-inflated tire causes the tire to overheat and can lead to tire failure. Under-inflation also reduces fuel efficiency and tire tread life, and may affect the vehicle's handling and stopping ability.

Please note that the TPMS (tire pressure warning system) is not a substitute for proper tire maintenance, and it is the driver's responsibility to maintain correct tire pressure, even if under-inflation has not reached the level to trigger illumination of the TPMS low tire pressure telltale (tire pressure warning light).

Your vehicle has also been equipped with a TPMS (tire pressure warning system) malfunction indicator to indicate when the system is not operating properly. The TPMS (tire pressure warning system) malfunction indicator is combined with the low tire pressure telltale (tire pressure warning light). When the system detects a malfunction, the telltale will flash for approximately one minute and then remain continuously illuminated. This sequence will continue upon subsequent vehicle start-ups as long as the malfunction exists. When the malfunction indicator is illuminated, the system may not be able to detect or signal low tire pressure as intended.

**WARNING**

TPMS (tire pressure warning system) malfunctions may occur for a variety of reasons, including the installation of replacement or alternate tires or wheels on the vehicle that prevent the TPMS (tire pressure warning system) from functioning properly. Always check the TPMS (tire pressure warning system) malfunction tell-tale after replacing one or more tires or wheels on your vehicle to ensure that the replacement or alternate tires and wheels allow the TPMS (tire pressure warning system) to continue to function properly.

**NOTICE****■ To ensure the tire pressure warning system operates properly**

Do not install tires with different specifications or manufactures as the tire pressure warning system may not operate properly.

If a warning message is displayed

The multi-information display shows warnings of system malfunctions, incorrectly performed operations, and messages that indicate a need for maintenance. When a message is shown, perform the correction procedure appropriate to the message.

Additionally, if a warning light comes on or flashes at the same time that a warning message is displayed, take the appropriate corrective action for the warning light. (→P.527)

If a warning message is displayed again after the appropriate actions have been performed, contact your Toyota dealer.

■ Warning messages

The warning messages explained below may differ from the actual messages according to operation conditions and vehicle specifications.

■ If a message about an operation is displayed

- If a message about an operation of the accelerator pedal or brake pedal is displayed

A warning message about an operation of the brake pedal may be shown while the driving assist systems such as PCS (Pre-Collision system) or the dynamic radar cruise control with full-speed range is operating. If a warning message is shown, be sure to decelerate the vehicle or follow an instruction shown on the multi-information display.

A warning message is shown when Brake Override System operates. (→P.182)

A warning message is shown when Drive-Start Control (→P.187) or Parking Support Brake (→P.301) operates. Follow the instructions on the multi-information display.

- If a message about an operation of the power switch is displayed

An instruction for operation of the power switch is shown when the incorrect procedure for starting the hybrid system is performed or the power switch is operated incorrectly. Follow the instructions shown on the multi-information display to operate the power switch again.

- If a message about a shift lever operation is displayed

To prevent the shift lever from being

operated incorrectly or the vehicle from moving unexpectedly, a message that requires shifting the shift lever may be shown on the multi-information display. In that case, follow the instruction of the message and shift the shift lever.

- If a message or image about an open/close state of a part or replenishment of a consumable is displayed

Confirm the part indicated by the multi-information display or a warning light, and then perform the coping method such as closing the open door or replenishing a consumable.

■ If a message that indicates the need for visiting your Toyota dealer is displayed

The system or part shown on the multi-information display is malfunctioning. Have the vehicle inspected by your Toyota dealer immediately.

■ If a message that indicates the need for referring to Owner's Manual is displayed

- If "Engine Coolant Temp High Stop in a Safe Place See Owner's Manual" is shown, follow the instructions (→P.561).

- If the following messages are shown, there may be a malfunction.

Immediately stop the vehicle in a safe place and contact your Toyota dealer. Continuing to drive the vehicle may be dangerous.

- "Hybrid System Malfunction"
- "Check Engine"
- "Traction battery system malfunction"
- "Accelerator System Malfunction"
- "Hybrid System Stopped"
- "Smart Key System Malfunction See Owner's Manual"
- If the following messages are shown, there may be a malfunction

tion.

Immediately have the vehicle inspected by your Toyota dealer.

- “Oil Pressure Low Stop in a Safe Place See Owner’s Manual”
- “Braking Power Low Stop in a Safe Place See Owner’s Manual”
- If “Maintenance Required for Traction Battery Cooling Parts See Owner’s Manual” is shown, the filter may be clogged, the air intake vents may be blocked, or there may be a gap in the duct. Therefore, perform the following correction procedure.

Cleaning the hybrid battery (traction battery) air intake vents (→P.506)

If the warning message is shown even if the vents are cleaned, have the vehicle inspected by your Toyota dealer.

■ If “Shift to P Before Exiting Vehicle” or “Shift to P when Parked” is displayed

Message is displayed when the driver’s door is opened without turning the power switch to OFF with the shift lever in any position other than P.

Shift the shift lever to P.

■ If “Shift is in N Release Accelerator Before Shifting” is shown

Message is displayed when the accelerator pedal has been depressed and the shift lever is in N. Release the accelerator pedal and shift the shift lever to D, S or R.

■ If “Auto Power OFF to Conserve Battery” is displayed

Power was turned off due to the automatic power off function.

Next time when starting the hybrid system, increase the hybrid system speed slightly and maintain that level for approximately 5 minutes to recharge the 12-volt battery.

■ If “Headlight System Malfunction Visit Your Dealer” is displayed

The following systems may be malfunctioning. Have the vehicle inspected by your Toyota dealer immediately.

- The LED headlight system
- The automatic headlight leveling system (if equipped)
- Automatic High Beam

■ If “Engine Oil Level Low Add or Replace” is displayed

The engine oil level may be low. Check the level of the engine oil, and add engine oil if necessary (→P.482). This message may be displayed if the vehicle is stopped on a slope. Move the vehicle to a level surface and check if the message disappears.

■ If “Hybrid System Stopped Steering Power Low” is displayed

This message is displayed if the hybrid system is stopped while driving.

When steering wheel operations are heavier than usual, grip the steering wheel firmly and operate it using more force than usual.

■ If “Maintenance Required Soon” is displayed

Indicates that all maintenance according to the driven distance on the maintenance schedule* should be performed soon.

Comes on approximately 4500 miles (7200 km) after the message has been reset.

If necessary, perform maintenance. Please reset the message after the maintenance is performed. (→P.473)

*: Refer to the separate “Scheduled Maintenance Guide” or “Owner’s Manual Supplement” for the main-

tenance interval applicable to your vehicle.

■ **If “Maintenance Required Visit Your Dealer” is displayed**

Indicates that all maintenance is required to correspond to the driven distance on the maintenance schedule*.

Comes on approximately 5000 miles (8000 km) after the message has been reset. (The indicator will not work properly unless the message has been reset.)

Perform the necessary maintenance. Please reset the message after the maintenance is performed. (→P.473)

*: Refer to the separate “Scheduled Maintenance Guide” or “Owner’s Manual Supplement” for the maintenance interval applicable to your vehicle.

■ **If “Engine Maintenance Required Visit Your Dealer” is shown**

The engine or an engine component is malfunctioning. Have the vehicle inspected by your Toyota dealer immediately.

■ **If “Oil Maintenance Required Soon” is displayed**

Indicates that the engine oil should be scheduled to be changed.

Check the engine oil and change it if necessary. After changing the engine oil, make sure to reset the message. (→P.484)

■ **If “Oil Maintenance Required” is displayed**

Indicates that the engine oil should be changed.

Check and change the engine oil, and oil filter by your Toyota dealer. After changing the engine oil, make sure to reset the message. (→P.484)

■ **If a message that indicates the malfunction of front camera is displayed**

The following systems may be suspended until the problem shown in the message is resolved. (→P.240, 527)

- PCS (Pre-Collision System)
- LTA (Lane Tracing Assist)
- Automatic High Beam
- RSA (Road Sign Assist) (if equipped)
- Dynamic radar cruise control with full-speed range

■ **If a message that indicates the malfunction of radar sensor is displayed**

The following systems may be suspended until the problem shown in the message is resolved. (→P.240, 527)

- PCS (Pre-Collision System)
- LTA (Lane Tracing Assist)
- Dynamic radar cruise control with full-speed range

■ **If “Radar Cruise Control Unavailable See Owner’s Manual” is displayed**

The dynamic radar cruise control with full-speed range system is suspended temporarily or until the problem shown in the message is resolved. (causes and coping methods: →P.240)

■ **If “Radar Cruise Control Unavailable” is displayed**

The dynamic radar cruise control with full-speed range system cannot be used temporarily. Use the system when it becomes available again.

■ **If “Power Tailgate Unavailable Fully Close Tailgate Manually to Re-Activate Power Tailgate” is displayed**

If the following message is displayed after pressing the Tailgate opener switch, the power tailgate

requires re-initialization. To re-initialize the power tailgate, manually fully close and latch the tailgate.

The power tailgate may require re-initialization when the following has occurred.

- Jam detection has occurred and the tailgate is not fully closed.
- The tailgate has been unplugged and reconnected, and the tailgate has not been fully closed.
- The power tailgate main switch was pressed while the tailgate is not fully closed.
- The 12-volt battery has been reconnected while the tailgate is not fully closed.

When the tailgate is fully closed and latched, the system will re-initialize and the message will disappear.

■ If “Power Tailgate Unavailable/Malfunction Visit Your Dealer” is displayed

When the following message is displayed, it is an indication that there is a malfunction in the system.

Have the vehicle inspected by your Toyota dealer.

■ Warning buzzer

→P.538

If you have a flat tire

Your vehicle is equipped with a spare tire. The flat tire can be replaced with the spare tire.

For details about tires: P.490



WARNING

■ If you have a flat tire

Do not continue driving with a flat tire.

Driving even a short distance with a flat tire can damage the tire and the wheel beyond repair, which could result in an accident.

Before repairing the tire

- Stop the vehicle in a safe place on a hard, flat surface.
- Set the parking brake.
- Shift the shift lever to P.
- Stop the hybrid system.
- Turn on the emergency flashers. (→P.520)
- For models with electronically modulated air suspension: Press the height control mode select switch to set the height control system to manual mode. (→P.373)

Location of the spare tire, jack and tools

■ Spare tire

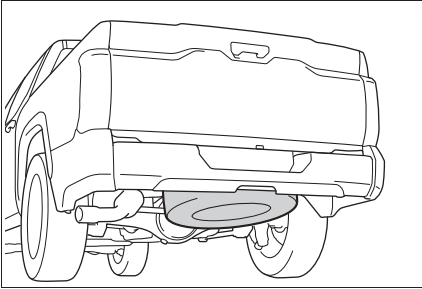

■ Jack and tools

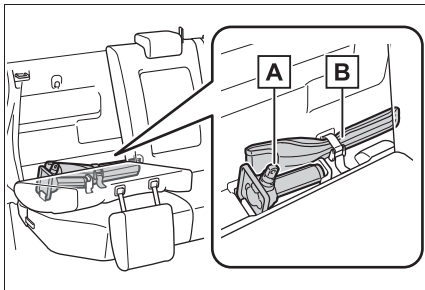

A Jack

B Tool bag

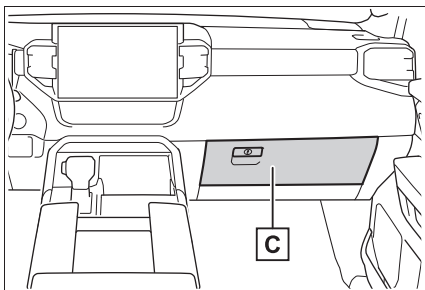

C Wheel lock key (if equipped)

⚠ WARNING

■ Using the tire jack

Observe the following precautions.

Improper use of the tire jack may cause the vehicle to suddenly fall off the jack, leading to death or serious injury.

- Do not use the tire jack for any purpose other than replacing tires or installing and removing tire chains.
- Only use the tire jack that comes with this vehicle for replacing a flat tire. Do not use it on other vehicles, and do not use other tire jacks for replacing tires on this vehicle.
- Put the jack properly in its jack point.
- Do not put any part of your body under the vehicle while it is supported by the jack.
- Do not start the hybrid system or drive the vehicle while the vehicle is supported by the jack.
- Do not raise the vehicle while someone is inside.
- When raising the vehicle, do not put an object on or under the jack.
- Do not raise the vehicle to a height greater than that required to replace the tire.
- Use a jack stand if it is necessary to get under the vehicle.

**WARNING**

● When lowering the vehicle, make sure that there is no-one near the vehicle. If there are people nearby, warn them vocally before lowering.

■ Using the jack handle

Insert the square head securely until you hear a click to prevent the extension parts from coming apart unexpectedly.

Wheel lock nut (if equipped)

When replacing tires on a vehicle with wheel lock nuts, use the following procedures to remove and install the wheel lock nuts.

The wheel lock key is stored in the glove box. Always return the wheel lock key to its original position after use, so that it does not get lost. (→P.542)

■ Removal

For ease of removal, the wheel lock nut should always be the first one loosened.

- 1 Place the wheel lock key on top of the wheel lock nut, turning until the wheel lock key and wheel lock nut patterns engage.
- 2 Place the wheel nut wrench on the wheel lock key, and while applying pressure on the wheel lock key, loosen the wheel lock nut.

■ Installation

For ease of installation, the wheel lock nut should always be the last one tightened.

- 1 By hand, install a wheel lock nut on each wheel.
- 2 Place the wheel lock key on top of the wheel lock nut, turning until the wheel lock key and wheel lock nut patterns engage.
- 3 Place the wheel nut wrench on the wheel lock key, and while applying pressure on the wheel lock key, tighten the wheel lock nut to the recommended torque.

**NOTICE****■ When using a wheel lock key (if equipped)**

Do not use an impact wrench. Using an impact wrench may cause permanent damage to wheel lock nut and wheel lock key. If in doubt about wheel lock application, contact your Toyota dealer.

544 7-2. Steps to take in an emergency

Taking out the jack and tool bag

- 1 Fold the head restraint (→P.148), and then pull the strap and then fold down the seatback.

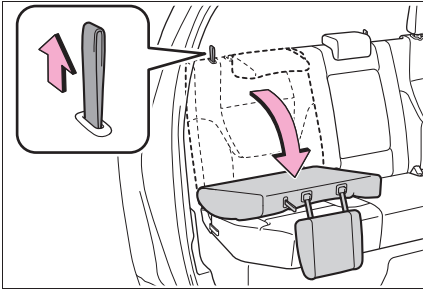

- 2 Loosen and remove the jack.

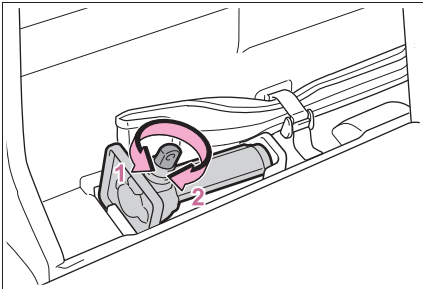

- 1 Loosen
- 2 Tighten

After using the jack, install the jack in the exact reverse order from which they were removed.

- 3 Unhook the tightening strap and take out the tool bag.

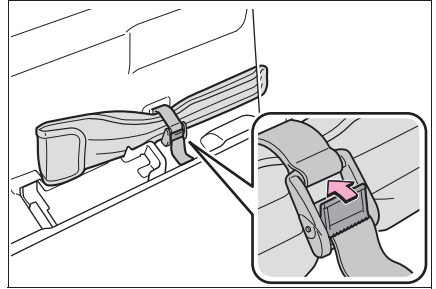

Taking out the spare tire

- 1 Assemble the jack handle extension as shown.

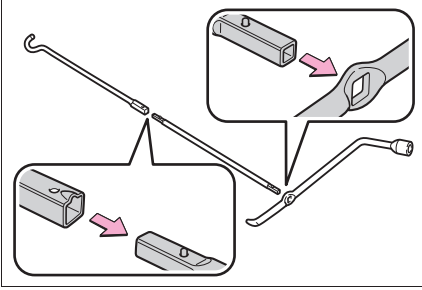

- 2 Insert the end of the jack handle extension into the lowering screw and turn it counterclockwise.

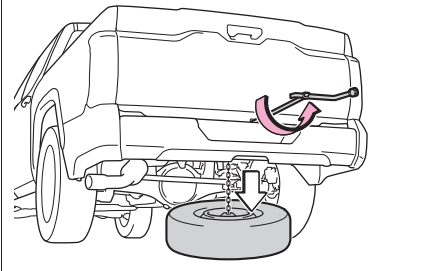
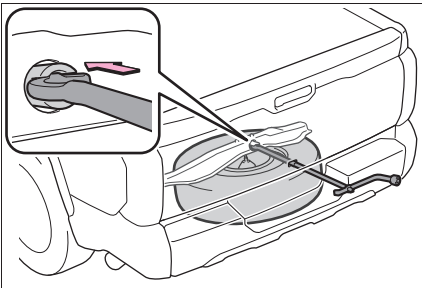

- 3 After the tire is lowered completely to the ground, remove the holding bracket.

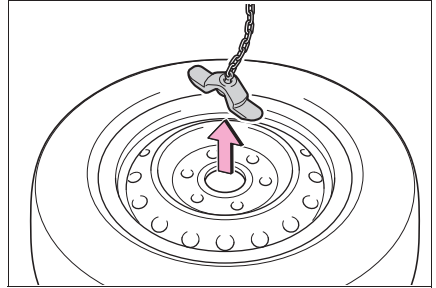

Replacing a flat tire

- 1 Chock the tires.

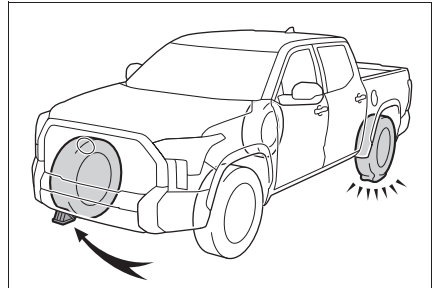

Tire	Wheel chock positions
Front left-hand side	Behind the rear right-hand side tire
Front right-hand side	Behind the rear left-hand side tire
Rear left-hand side	In front of the front right-hand side tire
Rear right-hand side	In front of the front left-hand side tire

546 7-2. Steps to take in an emergency

- 2 Slightly loosen the wheel nuts (one turn).

Vehicles with wheel locks: Use the wheel lock key to loosen the wheel lock.

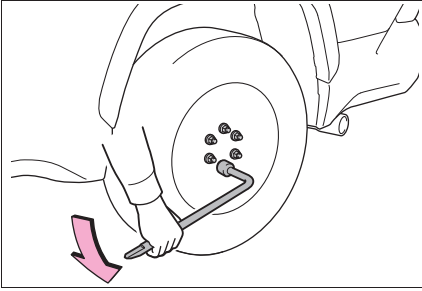

- 3 Assemble the jack handle extension as shown.

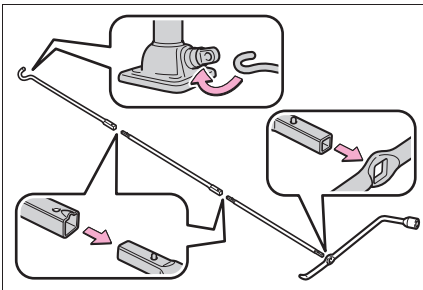

- 4 Position the jack at the correct jack point as shown.

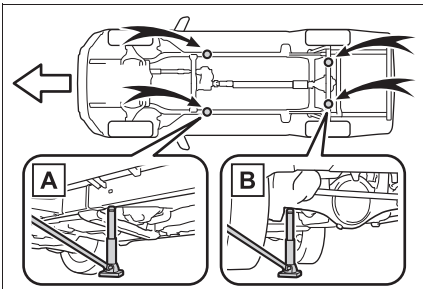

A Front

B Rear

Make sure the jack is positioned on a level and solid place.

- 5 Raise the vehicle until the tire is slightly raised off the ground.

When positioning the jack under the rear axle housing, make sure the groove on the top of the jack fits with the rear axle housing.

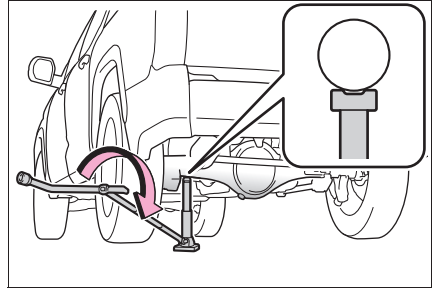

- 6 Remove all the wheel nuts and the tire.

When resting the tire on the ground, place the tire so that the wheel design faces up to avoid scratching the wheel surface.

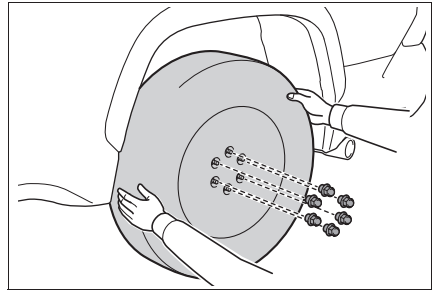

⚠ WARNING

■ Replacing a flat tire

- Observe the following precautions.

Failure to do so may result in serious injury:

- Lower the spare tire completely to the ground before removing it from under the vehicle.

- Do not try to remove the wheel ornament by hand. Take due care in handling the ornament to avoid unexpected personal injury.
- Do not touch the disc wheels or the area around the brakes immediately after the vehicle has been driven.

After the vehicle has been driven the disc wheels and the area around the brakes will be extremely hot. Touching these areas with hands, feet or other body parts while changing a tire, etc., may result in burns.

- Failure to follow these precautions could cause the wheel nuts to loosen and the tire to fall off, resulting in death or serious injury.
- After replacing a tire, check the tightening torque as soon as possible.

Steel wheel: 154 ft•lbf (209 N•m, 21.3 kgf•m)
 Aluminum wheel: 97 ft•lbf (131 N•m, 13.4 kgf•m)
- When installing a tire, only use wheel nuts that have been specifically designed for that wheel.
- Retighten the wheel nuts within 100 miles (160 km) of driving.
- If there are any cracks or deformations in the bolt screws, nut threads or bolt holes of the wheel, have the vehicle inspected by your Toyota dealer.
- Do not attach a heavily damaged wheel ornament, as it may fly off the wheel while the vehicle is moving.
- When installing the wheel nuts, be sure to install them with the tapered ends facing inward.

Installing the spare tire

- 1 Remove any dirt or foreign matter from the wheel contact surface.

If foreign matter is on the wheel contact surface, the wheel nuts may loosen while the vehicle is in motion, causing the tire to come off.

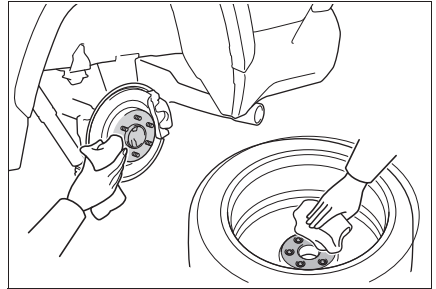

- 2 Install the spare tire and loosely tighten each wheel nut by hand by approximately the same amount.

When replacing a steel wheel with a steel wheel (including a compact spare tire), tighten the wheel nuts until the tapered portion **A** comes into loose contact with the disc wheel seat **B**.

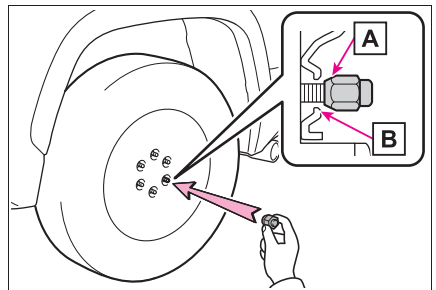

548 7-2. Steps to take in an emergency

When replacing an aluminum wheel with a steel wheel (including a compact spare tire), tighten the wheel nuts until the tapered portion **A** comes into loose contact with the disc wheel seat **B**.

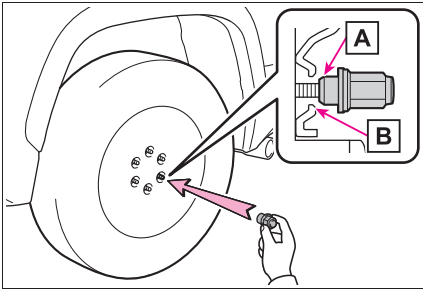

3 Lower the vehicle.

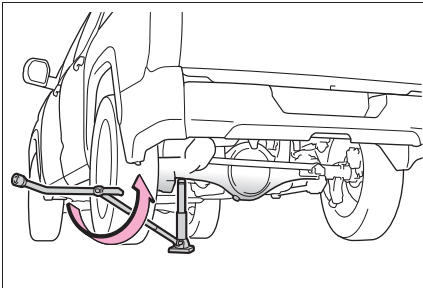

4 Securely tighten the wheel nuts two or three times in the order shown in the illustration using a wheel nut wrench.

Vehicles with wheel locks:
Tighten the wheel lock using the wheel lock key after tightening the other wheel nuts.

Tightening torque:

154 ft•lbf (209 N•m, 21.3 kgf•m)

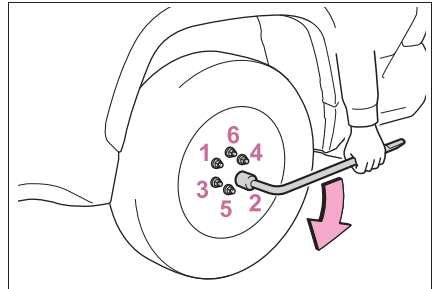

! WARNING

■ Stowing the flat tire

Failure to follow steps listed under stowing the tire may result in damage to the spare tire carrier and loss of the tire, which could result in serious injury or death.

Stowing the flat tire, jack and all tools

- 1** Remove the center wheel ornament by pushing from the reverse side.
- 2** Lay down the tire with the valve stem facing up and install the holding bracket. Turn the jack handle extension clockwise to take up slack in the chain.

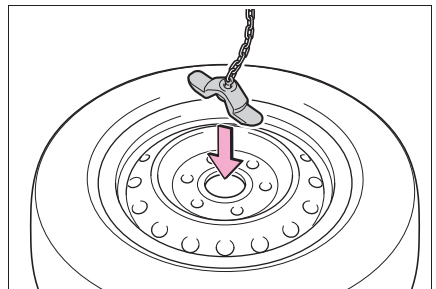

- 3** Check to ensure the holding bracket is centered in the wheel hub.

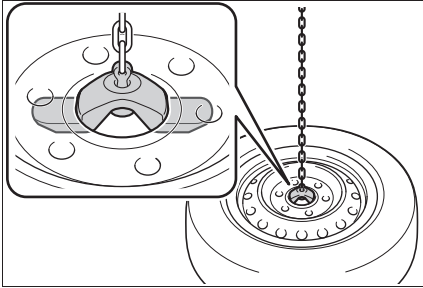

- 4** While raising, secure the tire, taking care that the tire goes straight up without catching on any surrounding part, to prevent it from flying forward during a collision or sudden braking.

Tightening torque:

34.7 ft•lbf (46.6 N•m, 4.8 kgf•m)

- 5** Confirm it is not loose after tightening:

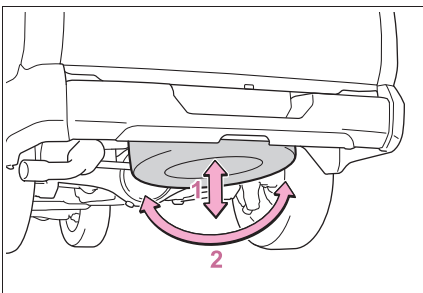

- 1** Push and pull the tire
2 Try rotating

Visually check to ensure tire is not hung on surrounding parts.

If looseness or misassembly exists, repeat step **2** and step **4**.

- 6** Repeat step **5**, any time the tire is lowered or disturbed.
7 Stow the tools and jack securely.

■ **The temporary spare tire**

- The temporary spare tire is identified by the “TEMPORARY USE ONLY” marking on the disc wheel and/or tire sidewall. Use the temporary spare tire temporarily, and only in an emergency.

- Make sure to check the tire inflation pressure of the temporary spare tire. (→P.574)

■ **When using the temporary spare tire**

As the temporary spare tire is not equipped with the tire pressure warning valve and transmitter, low inflation pressure of the spare tire will not be indicated by the tire pressure warning system. Also, if you replace the temporary spare tire after the tire pressure warning light comes on, the light remains on.

■ **If you have a flat rear tire on a road covered with snow or ice**

Install the temporary spare tire on one of the front wheels of the vehicle. Perform the following steps and fit tire chains to the rear tires:

- 1** Replace a front tire with the temporary spare tire.
- 2** Replace the flat rear tire with the tire removed from the front of the vehicle.
- 3** Fit tire chains to the rear tires.

**WARNING****■ When using the temporary spare tire**

- Remember that the temporary spare tire provided is specifically designed for use with your vehicle. Do not use your temporary spare tire on another vehicle.
- Do not use more than one temporary spare tires simultaneously.
- Replace the temporary spare tire with a standard tire as soon as possible.
- Avoid sudden acceleration, abrupt steering, sudden braking and shifting operations that cause sudden engine braking.

■ When the spare tire is attached

The vehicle speed may not be correctly detected, and the following systems may not operate correctly:

- ABS & Brake assist
- VSC
- TRAC
- AUTO LSD (if equipped)
- PCS (Pre-Collision System)
- AHB (Automatic High Beam)
- LTA (Lane Tracing Assist)
- Dynamic radar cruise control with full-speed range
- EPS
- Trailer Sway Control
- Tire pressure warning system
- BSM (Blind Spot Monitor)

- Panoramic view monitor (if equipped)
- Multi-terrain Monitor (if equipped)
- Toyota parking assist monitor (if equipped)
- Intuitive parking assist
- PKSB (Parking Support Brake)
- Navigation system (if equipped)

Also, not only can the following system not be utilized fully, but it may even negatively affect the drive-train components:

- 4WD system (if equipped)

■ Speed limit when using the temporary spare tire

Do not drive at speeds in excess of 50 mph (80 km/h) when a temporary spare tire is installed on the vehicle.

The temporary spare tire is not designed for driving at high speeds. Failure to observe this precaution may lead to an accident causing death or serious injury.

**NOTICE****■ Do not drive the vehicle with a flat tire**

Do not continue driving with a flat tire.

Driving even a short distance with a flat tire can damage the tire and the wheel beyond repair.

■ Driving with tire chains and the temporary spare tire

Do not fit tire chains to the temporary spare tire.

Tire chains may damage the vehicle body and adversely affect driving performance.



NOTICE

■ When stowing the flat tire

Ensure that there is no object caught between the tire and the vehicle underbody.

■ When replacing the tires

When removing or fitting the wheels, tires or the tire pressure warning valve and transmitter, contact your Toyota dealer as the tire pressure warning valve and transmitter may be damaged if not handled correctly.

■ To avoid damage to the tire pressure warning valves and transmitters

When a tire is repaired with liquid sealants, the tire pressure warning valve and transmitter may not operate properly. If a liquid sealant is used, contact your Toyota dealer or other qualified service shop as soon as possible. Make sure to replace the tire pressure warning valve and transmitter when replacing the tire. (→P.495)

If the hybrid system will not start

Reasons for the hybrid system not starting vary depending on the situation. Check the following and perform the appropriate procedure:

The hybrid system will not start even though the correct starting procedure is being followed. (→P.207)

One of the following may be the cause of the problem:

- The electronic key may not be functioning properly. (→P.553)
- There may not be sufficient fuel in the vehicle's tank. Refuel the vehicle.
- There may be a malfunction in the immobilizer system. (→P.82)
- The hybrid system may be malfunctioning due to an electrical problem such as electronic key battery depletion or a blown fuse. However, depending on the type of malfunction, an interim measure is available to start the hybrid system. (→P.552)
- The temperature of the hybrid battery (traction battery) may be extremely low (below

552 7-2. Steps to take in an emergency

approximately -31°F [-35°C]).
(→P.207)

The interior lights and headlights are dim, or the horn does not sound or sounds at a low volume.

One of the following may be the cause of the problem:

- The 12-volt battery may be discharged. (→P.555)
- The 12-volt battery terminal connections may be loose or corroded. (→P.488)

The interior lights and headlights do not turn on, or the horn does not sound.

One of the following may be the cause of the problem:

- The 12-volt battery may be discharged. (→P.555)
- One or both of the 12-volt battery terminals may be disconnected. (→P.488)

Contact your Toyota dealer if the problem cannot be repaired, or if repair procedures are unknown.

Emergency start function

When the hybrid system does not start, the following steps can be used as an interim measure to start the hybrid system if the power switch is functioning nor-

mally.

Do not use this starting procedure except in case of emergency.

- 1 Pull the parking brake switch to check that the parking brake is set. (→P.217)

Parking brake indicator will come on.

- 2 Shift the shift lever to P.

- 3 Turn the power switch to ACC.

- 4 Press and hold the power switch for about 15 seconds while depressing the brake pedal firmly.

Even if the hybrid system can be started using the above steps, the system may be malfunctioning. Have the vehicle inspected by your Toyota dealer.

If you lose your keys

New genuine keys can be made by your Toyota dealer using other key and the key number stamped on your key number plate.

Keep the plate in a safe place such as your wallet, not in the vehicle.



NOTICE

■ When an electronic key is lost

If the electronic key remains lost, the risk of vehicle theft increases significantly. Visit your Toyota dealer immediately with all remaining electronic keys that were provided with your vehicle.

If the electronic key does not operate properly

If communication between the electronic key and vehicle is interrupted (→P.133) or the electronic key cannot be used because the battery is depleted, the smart key system and wireless remote control cannot be used. In such cases, the doors can be opened and the hybrid system can be started by following the procedure below.

■ When the electronic key does not work properly

- Make sure that the smart key system has not been deactivated in the customization setting. If it is off, turn the function on. (Customizable features: →P.588)
- Check if battery-saving mode is set. If it is set, cancel the function. (→P.132)



NOTICE

■ In case of a smart key system malfunction or other key-related problems

Take your vehicle with all the electronic keys provided with your vehicle to your Toyota dealer.

Locking and unlocking the doors

Use the mechanical key (→P.112) in order to perform the following operations:

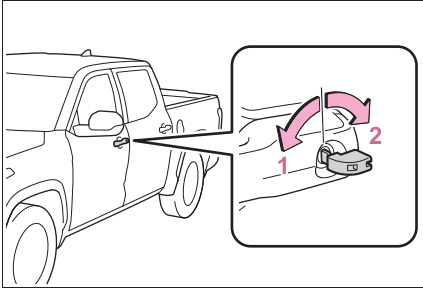

- 1 Locks all the doors
- 2 Unlocks all the doors

Turning the key unlocks the driver's door. Turning the key again unlocks the other doors.

Key linked functions

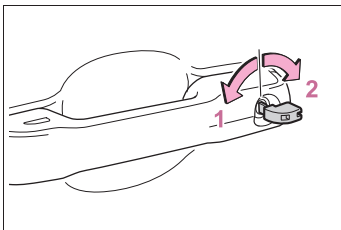

- 1 Closes the windows. (turn and hold)
- 2 Opens the windows and the panoramic moon roof*. (turn and hold)

These settings must be customized at your Toyota dealer.

*: If equipped

⚠ WARNING

■ When using the mechanical key and operating the power windows and the panoramic moon roof (if equipped)

Operate the power window or the panoramic moon roof after checking to make sure that there is no possibility of any passenger having any of their body parts caught in the window or the panoramic moon roof.

Also, do not allow children to operate the mechanical key. It is possible for children and other passengers to get caught in the power window or the panoramic moon roof.

Starting the hybrid system

- 1 Ensure that the shift lever is in P and depress the brake pedal.
- 2 Touch the Toyota emblem side of the electronic key to the power switch.

When the electronic key is detected, a buzzer sounds and the power switch will turn to ON.

When the smart key system is deactivated in customization setting, the power switch will turn to ACC.

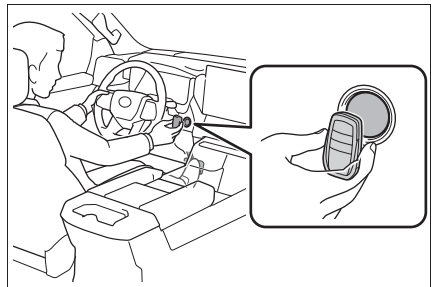

- 3 Firmly depress the brake pedal and check that  is shown on the multi-information display.
- 4 Press the power switch shortly and firmly.

In the event that the hybrid system still cannot be started, contact your Toyota dealer.

■ Stopping the hybrid system

Shift the shift lever to P, set the parking brake, shift the shift lever to P and press the power switch as you normally do when stopping the hybrid system.

■ Electronic key battery

As the above procedure is a temporary measure, it is recommended that the electronic key battery be replaced immediately when the battery is depleted. (→P.510)

■ Alarm

Using the mechanical key to lock the doors will not set the alarm system. If a door is unlocked using the mechanical key when the alarm system is set, the alarm may be triggered. (→P.83)

■ Changing power switch modes

Release the brake pedal and press the power switch in step 3 above. The hybrid system does not start and modes will be changed each time the switch is pressed. (→P.210)

If the vehicle 12-volt battery is discharged

The following procedures may be used to start the hybrid system if the vehicle's 12-volt battery is discharged.

You can also call your Toyota dealer or a qualified repair shop.

Restarting the hybrid system

If you have a set of jumper (or booster) cables and a second vehicle with a 12-volt battery, you can jump start your vehicle by following the steps below.

- 1 Confirm that the electronic key is being carried.

When connecting the jumper (or booster) cables, depending on the situation, the alarm may activate and doors locked. (→P.84)

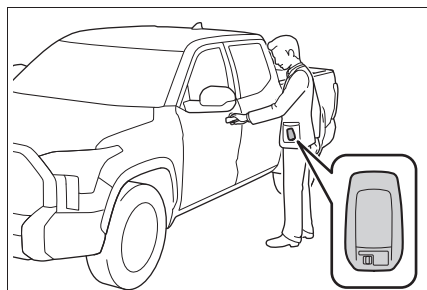

556 7-2. Steps to take in an emergency

- 2 Open the hood (→P.480) and fuse box cover.

Push claw to completely release the lock, and then lift up the cover.

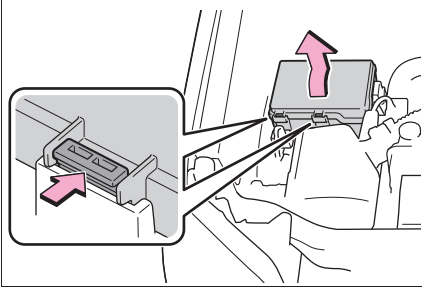

- 3 Open the exclusive jump starting terminal cover.

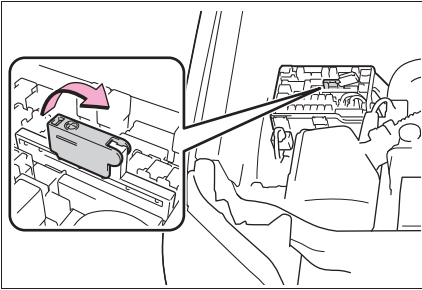

- 4 Remove the engine cover.

Lift the edge of the cover to disengage the fixed pins, and then pull the cover towards you to remove it.

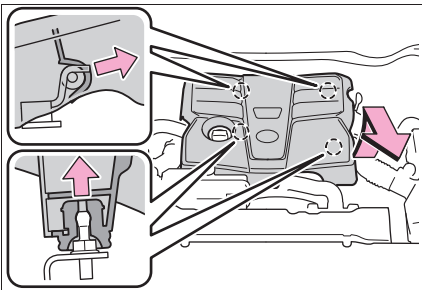

- 5 Connect a positive jumper cable clamp to **A** on your vehicle and connect the clamp on the other end of the positive cable to **B** on the second vehicle. Then, connect a negative cable clamp to **C** on the second vehicle and connect the clamp at the other end of the negative cable to **D**.

Use jumper cables that can reach the specified terminals and connecting point.

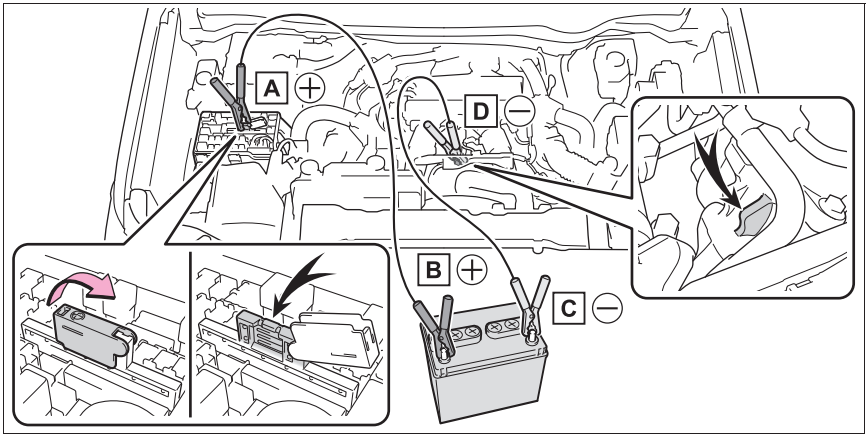

- A** Exclusive jump starting terminal (your vehicle)
- B** Positive (+) battery terminal (second vehicle)
- C** Negative (-) battery terminal (second vehicle)
- D** Metallic point shown in the illustration

- 6 Start the engine of the second vehicle. Increase the engine speed slightly and maintain at that level for approximately 5 minutes to recharge the 12-volt battery of your vehicle.

- 7 Open and close any of the doors of your vehicle with the power switch OFF.

- 8 Maintain the engine speed of the second vehicle and start

the hybrid system of your vehicle by turning the power switch to ON.

- 9 Once the vehicle's hybrid system has started, remove the jumper cables in the exact reverse order from which they were connected.
- 10 When the engine cover installing, reverse the step removed.

558 7-2. Steps to take in an emergency

11 Close the exclusive jump starting terminal cover, and reinstall the fuse box cover to its original position.

Once the engine starts, have the vehicle inspected at your Toyota dealer as soon as possible.

■ Starting the hybrid system when the battery is discharged

The hybrid system cannot be started by push-starting.

■ To prevent 12-volt battery discharge

- Turn off the headlights and the audio system while the hybrid system is off.
- Turn off any unnecessary electrical components when the vehicle is running at a low speed for an extended period, such as in heavy traffic.

■ When the 12-volt battery is removed or discharged

- Information stored in the ECU is cleared. When the 12-volt battery is depleted, have the vehicle inspected at your Toyota dealer.
- Some systems may require initialization. (→P.600)

■ When removing the 12-volt battery terminals

When the 12-volt battery terminals are removed, the information stored in the ECU is cleared. Before removing the 12-volt battery terminals, contact your Toyota dealer.

■ Charging the 12-volt battery

The electricity stored in the 12-volt battery will discharge gradually even when the vehicle is not in use, due to natural discharge and the draining effects of certain electrical appliances. If the vehicle is left for a long time, the 12-volt battery may discharge, and the hybrid system may

be unable to start. (The 12-volt battery recharges automatically while the hybrid system is operating.)

■ When recharging or replacing the 12-volt battery

- In some cases, it may not be possible to unlock the doors using the smart key system when the 12-volt battery is discharged. Use the wireless remote control or the mechanical key to lock or unlock the doors.
 - The hybrid system may not start on the first attempt after reinstalling the 12-volt battery. In that case, start the hybrid system in the same manner as when the electronic key does not operate properly (→P.554). This is not a malfunction, as the hybrid system will start normally on the second attempt.
 - The power switch mode is memorized by the vehicle. When the 12-volt battery is reconnected, the system will return to the mode it was in before the 12-volt battery was discharged. Before disconnecting the 12-volt battery, turn the power switch off. If you are unsure what mode the power switch was in before the 12-volt battery discharged, be especially careful when reconnecting the 12-volt battery.
 - Some systems may require initialization. (→P.600)
- ### ■ When replacing the 12-volt battery
- Use a 12-volt battery that conforms to European regulations.
 - Use a battery that the case size is same as the previous one (LN4), 20 hours rate capacity (20HR) is equivalent (80Ah) or greater, and performance rating (CCA) is equivalent (689A) or greater.
 - If the sizes differ, the 12-volt battery cannot be properly secured.
 - If the 20 hour rate capacity is low, even if the time period where the

vehicle is not used in a short time, the 12-volt battery may discharge and hybrid system may not be able to start.

- Use a ventilation type calcium battery
- Use a 12-volt battery with a handle. If a 12-volt battery without a handle is used, removal is more difficult.
- When removing the 12-volt battery: →P.488
- After replacing, firmly attach the following items to the exhaust hole of the 12-volt battery.
 - Use the exhaust hose that was attached to the 12-volt battery before replacing and confirm that it is firmly connected to the hole section of the vehicle.
 - Use the exhaust hole plug included with the 12-volt battery replaced or the one installed on the battery prior to the replaced. (Depending on the 12-volt battery to be replaced, the exhaust hole may be plugged.)

For details, consult your Toyota dealer.

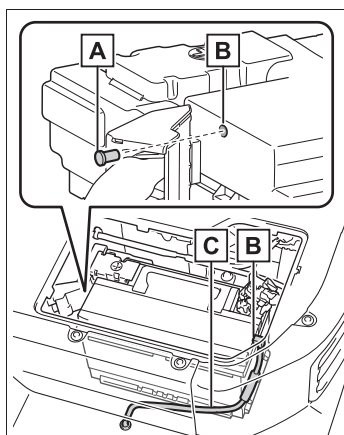

- A** Exhaust hole cap
- B** Exhaust hole
- C** Exhaust hose

⚠ WARNING

■ When removing the 12-volt battery terminals

Always remove the negative (-) terminal first. If the positive (+) terminal contacts any metal in the surrounding area when the positive (+) terminal is removed, a spark may occur, leading to a fire in addition to electrical shocks and death or serious injury.

■ Avoiding 12-volt battery fires or explosions

Observe the following precautions to prevent accidentally igniting the flammable gas that may be emitted from the 12-volt battery:

- Make sure each jumper cable is connected to the correct terminal and that it is not unintentionally in contact with any other than the intended terminal.
- Do not allow the other end of the jumper cable connected to the "+" terminal to come into contact with any other parts or metal surfaces in the area, such as brackets or unpainted metal.
- Do not allow the + and - clamps of the jumper cables to come into contact with each other.
- Do not smoke, use matches, cigarette lighters or allow open flame near the 12-volt battery.

■ 12-volt battery precautions

The 12-volt battery contains poisonous and corrosive acidic electrolyte, while related parts contain lead and lead compounds. Observe the following precautions when handling the 12-volt battery:

⚠ WARNING

- When working with the 12-volt battery, always wear safety glasses and take care not to allow any 12-volt battery fluids (acid) to come into contact with skin, clothing or the vehicle body.
- Do not lean over the 12-volt battery.
- In the event that 12-volt battery fluid comes into contact with the skin or eyes, immediately wash the affected area with water and seek medical attention. Place a wet sponge or cloth over the affected area until medical attention can be received.
- Always wash your hands after handling the 12-volt battery support, terminals, and other battery-related parts.
- Do not allow children near the 12-volt battery.

■ After recharging the 12-volt battery

Have the 12-volt battery inspected at your Toyota dealer as soon as possible. If the 12-volt battery is deteriorating, continued use may cause the 12-volt battery to emit a malodorous gas, which may be detrimental to the health of passengers.

■ When replacing the 12-volt battery

- For information regarding 12-volt battery replacement, contact your Toyota dealer.
- After replacing, securely attach the exhaust hose and exhaust hole plug to the exhaust hole of the replaced 12-volt battery. If not properly installed, gases (hydrogen) may leak into the vehicle interior, and there is the possible danger of the gas igniting and exploding.

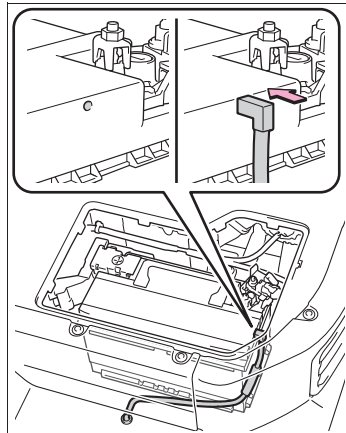

⚠ NOTICE

■ When handling jumper cables

When connecting the jumper cables, ensure that they do not become entangled in the cooling fan.

■ When connecting jumper cables

Make sure to connect jumper cables to the specified terminals and connecting point. Failure to do so may adversely affect the electronic devices or damage to them.

If your vehicle overheats

The following may indicate that your vehicle is overheating.

- The needle of the engine coolant temperature gauge (→P.91) enters the red zone or a loss of engine (hybrid system) power is experienced. (For example, the vehicle speed does not increase.)
- “Engine Coolant Temp High Stop in a Safe Place See Owner’s Manual” is shown on the multi-information display.
- Steam comes out from under the hood.

Correction procedures

- If the engine coolant temperature gauge enters the red zone or “Engine Coolant Temp High Stop in a Safe Place See Owner’s Manual” is shown on the multi-information display

- 1 Stop the vehicle in a safe place and turn off the air conditioning system, and then stop the hybrid system.
- 2 If you see steam:
Carefully lift the hood after the steam subsides.
If you do not see steam:
Carefully lift the hood.
- 3 After the hybrid system has cooled down sufficiently, inspect the hoses, engine radiator core (radiator) and intercooler radiator core (radiator) for any leaks.

If a large amount of coolant leaks, immediately contact your Toyota

dealer.

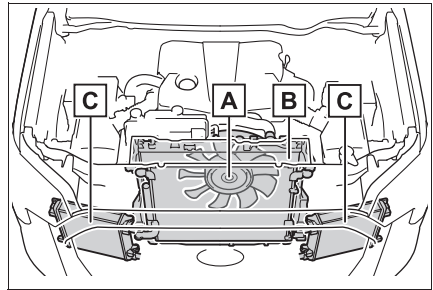

- A** Cooling fan
- B** Engine radiator
- C** Intercooler radiators

562 7-2. Steps to take in an emergency

- 4 The coolant level is satisfactory if it is between the “F” or “FULL” and “L” or “LOW” lines on the reservoir.

► Engine

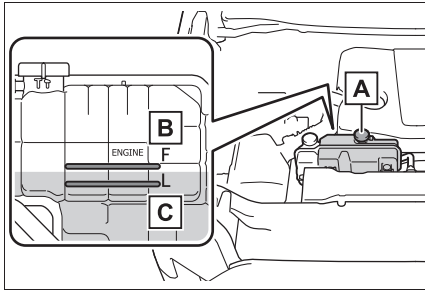

A Reservoir

B “F” line

C “L” line

► Intercooler radiator

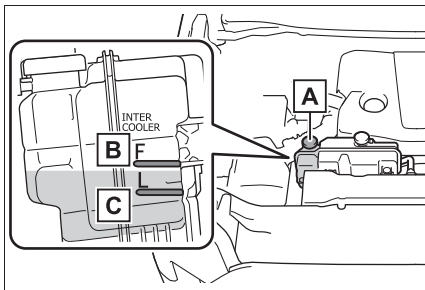

A Reservoir

B “F” line

C “L” line

► Power control unit

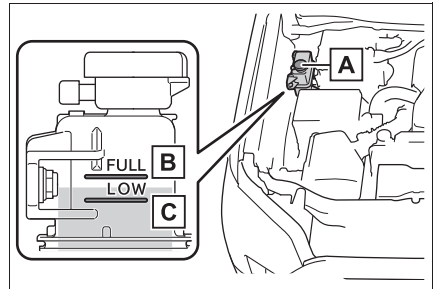

A Reservoir

B “FULL” line

C “LOW” line

- 5 Add coolant if necessary.

Water can be used in an emergency if coolant is unavailable.

If water was added in an emergency, have the vehicle inspected at your Toyota dealer as soon as possible.

► Engine

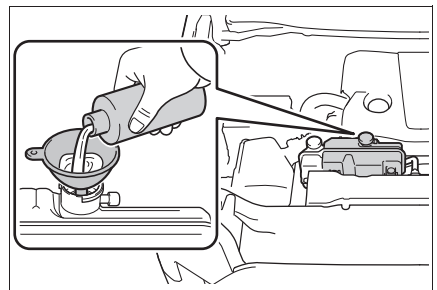

► Intercooler radiator

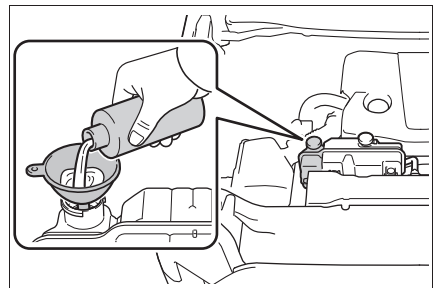

▶ Power control unit

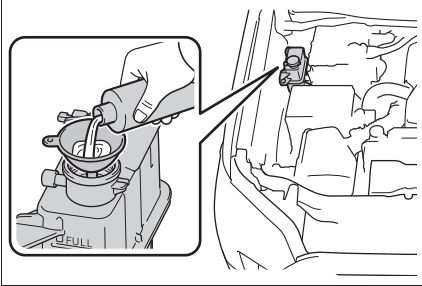

- 6 Start the hybrid system to check that the radiator cooling fan operates and to check for coolant leaks from the radiator or hoses.
- 7 If the fan is not operating: Stop the hybrid system immediately and contact your Toyota dealer.
If the fan is operating: Have the vehicle inspected at the nearest Toyota dealer.
- 8 Check if “Engine Coolant Temp High Stop in a Safe Place See Owner’s Manual” is shown on the multi-information display.

If the message does not disappear: Stop the hybrid system and contact your Toyota dealer.

If the message is not displayed: Have the vehicle inspected at the nearest Toyota dealer.

⚠ WARNING

■ **When inspecting under the hood of your vehicle**

Observe the following precautions.
Failure to do so may result in serious injury such as burns.

- If steam is seen coming from under the hood, do not open the hood until the steam has subsided. The engine compartment may be very hot.
- After the hybrid system has been turned off, check that the “READY” indicator is off. When the hybrid system is operating, the gasoline engine may automatically start, or the cooling fan may suddenly operate even if the gasoline engine stops. Do not touch or approach rotating parts such as the fan, which may lead to fingers or clothing (especially a tie, a scarf or a muffler) getting caught, resulting in serious injury.
- Do not loosen the coolant reservoir caps, while the hybrid system and radiator are hot. High temperature steam or coolant could spray out.

⚠ NOTICE

■ **When adding coolant**

Add coolant slowly after the hybrid system has cooled down sufficiently. Adding cool coolant to a hot hybrid system too quickly can cause damage to the hybrid system.

■ **To prevent damage to the cooling system**

Observe the following precautions:

- Avoid contaminating the coolant with foreign matter (such as sand or dust, etc.).
- Do not use any coolant additive.

If the vehicle becomes stuck

Carry out the following procedures if the tires spin or the vehicle becomes stuck in mud, dirt or snow:

Recovering procedure

- 1 Stop the hybrid system. Set the parking brake and shift the shift lever to P.

Do not press the shift release button after shifting the shift position to P.

- 2 Remove the mud, snow or sand from around the rear wheels.
- 3 Place wood, stones or some other material under the rear wheels to help provide traction.
- 4 Restart the hybrid system.
- 5 Shift the shift lever to D or R and release the parking brake. Then, while exercising caution, depress the accelerator pedal.

■ When it is difficult to free the vehicle

Try the followings.

- Turn off the TRAC (→P.394)
- Using the rear differential lock* (→P.382)
- Switching the front-wheel drive control switch* (→P.379)

- Using Crawl Control* (→P.383)

- Using Multi-terrain Select* (→P.387)

*: If equipped

WARNING

■ When attempting to free a stuck vehicle

If you choose to push the vehicle back and forth to free it, make sure the surrounding area is clear to avoid striking other vehicles, objects or people. The vehicle may also lunge forward or lunge back suddenly as it becomes free. Use extreme caution.

■ When shifting the shift lever

Be careful not to shift the shift lever with the accelerator pedal depressed. This may lead to unexpected rapid acceleration of the vehicle that may cause an accident resulting in death or serious injury.

NOTICE

■ To avoid damaging the transmission and other components

- Avoid spinning the rear wheels and depressing the accelerator pedal more than necessary.
- If the vehicle remains stuck even after these procedures are performed, the vehicle may require towing to be freed.

Vehicle specifications

8

8-1. Specifications

Maintenance data (fuel, oil level, etc.)..... **566**

Fuel information **576**

Tire information **578**

8-2. Customization

Customizable features **588**

8-3. Initialization

Items to initialize **600**

Maintenance data (fuel, oil level, etc.)

Dimensions and weight

Overall length		233.6 in. (5932 mm) ^{*2} 245.6 in. (6237 mm) ^{*3}
Overall width		80.0 in. (2031 mm)
Overall height ^{*1}	2WD	77.1 in. (1957 mm) ^{*2, 4}
		77.0 in. (1955 mm) ^{*2, 5}
		76.9 in. (1954 mm) ^{*3, 4}
		76.9 in. (1953 mm) ^{*3, 5}
	4WD [*] 9	77.3 in. (1964 mm) ^{*2, 7}
		77.7 in. (1974 mm) ^{*2, 4}
77.7 in. (1973 mm) ^{*2, 5}		
4WD [*] 8	77.6 in. (1970 mm) ^{*3, 4}	
	77.5 in. (1969 mm) ^{*3, 5}	
	78.1 in. (1983 mm) ^{*2, 6}	
	79.9 in. (2028 mm) ^{*2, 4}	
4WD [*] 8	80.0 in. (2031 mm) ^{*2, 5}	
	79.9 in. (2029 mm) ^{*3, 4}	
	79.8 in. (2027 mm) ^{*3, 5}	
	79.8 in. (2027 mm) ^{*3, 5}	
Wheelbase		145.7 in. (3700 mm) ^{*2} 157.7 in. (4005 mm) ^{*3}
Front tread	2WD	68.4 in. (1737 mm)
	4WD	68.1 in. (1729 mm) ^{*4, 5, 7} 68.5 in. (1739 mm) ^{*6}
Rear tread		68.4 in. (1737 mm)

^{*1}: Unladen vehicles

^{*2}: Short Bed type

*3: Standard Bed type

*4: 265/70R18 tires

*5: 265/60R20 tires

*6: 285/65R18 tires

*7: 265/50R22 tires

*8: Vehicles with Toyota official lift kit

*9: Vehicles without Toyota official lift kit

Vehicle capacity weight

Model code ^{*1}	Driving system	Bed type	Vehicle capacity weight (Occupants + luggage)
VXKH70L-PSVLZA	2WD	Short	1390 lb. (630 kg)
VXKH70L-PSVZZA			1365 lb. (620 kg)
VXKH71L-PRVLZA		Standard	1420 lb. (645 kg)
VXKH75L-PSVLZA	4WD	Short	1380 lb. (625 kg) ^{*2}
			1345 lb. (610 kg) ^{*3}
VXKH75L-PSVUZA			1335 lb. (605 kg)
VXKH75L-PSVZZA		1290 lb. (585 kg)	
VXKH76L-PRVLZA		Standard	1390 lb. (630 kg)
VXKH76L-PRVZZA			1325 lb. (600 kg)

*1: The model code is indicated on the Certification Label. (→P.568)

*2: TRD Pro models

*3: Except TRD Pro models

Seating capacity

Seating capacity	5 (Front 2, Rear 3)
------------------	---------------------

Vehicle identification

■ Vehicle identification number

The vehicle identification number (VIN) is the legal identifier for your vehicle. This is the primary identification number for your Toyota. It is used in registering the ownership of your vehicle.

This number is stamped on the front left frame.

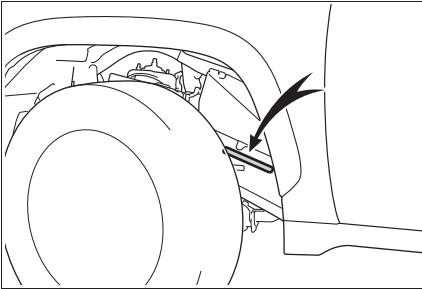

This number is also on the top left of the instrument panel.

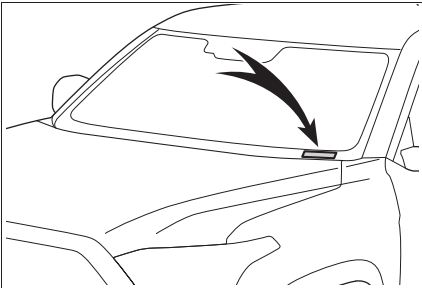

This number is also on the Certification Label.

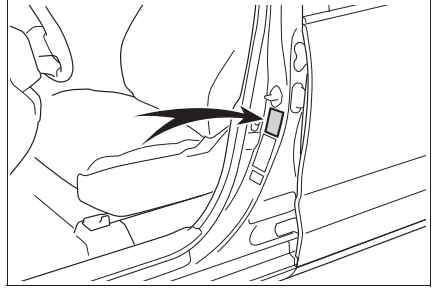

The engine number is stamped on the engine block as shown.

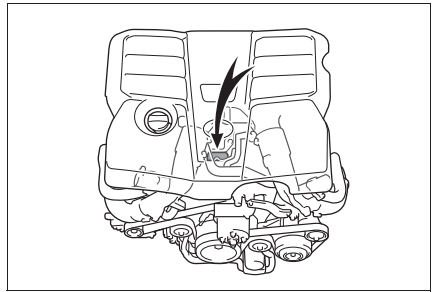

Engine

Model	V35A-FTS
Type	6-cylinder V type, 4-cycle, gasoline (with turbocharger)
Bore and stroke	3.37 × 3.94 in. (85.5 × 100.0 mm)
Displacement	210.2 cu.in. (3445 cm ³)
Valve clearance	Automatic adjustment
Drive belt tension	Automatic adjustment

Fuel

Fuel type	Unleaded gasoline only
Research Octane Number	87 (Research Octane Number 91) or higher
Fuel tank capacity (Reference)	32.2 gal. (122.0 L, 26.8 Imp.gal.)

Electric motor (traction motor)

Type	Permanent magnet synchronous motor
Maximum output	36 kW
Maximum torque	184 ft•lbf (250 N•m, 25.5 kgf•m)

Hybrid battery (traction battery)

Type	Nickel-Metal hydride battery
Voltage	7.2 V/module
Capacity	6.5 Ah
Quantity	40 modules
Nominal voltage	288 V

Lubrication system

■ **Oil capacity (Drain and refill [Reference*])**

With filter	7.7 qt. (7.3 L, 6.4 Imp. qt.)
Without filter	7.4 qt. (7.0 L, 6.2 Imp. qt.)

*: The engine oil capacity is a reference quantity to be used when changing the engine oil. When actually adding the engine oil, make sure that the oil level does not exceed the refill upper limit mark and is between the low level mark and refill upper limit mark (→P.482). Warm up and turn off the engine, wait about 8 minutes, and check the oil level on the dipstick.

■ **Engine oil selection**

“Toyota Genuine Motor Oil” is used in your Toyota vehicle. Use Toyota approved “Toyota Genuine Motor Oil” or equivalent to satisfy the following grade and viscosity.

Oil grade:

ILSAC GF-6A multigrade engine oil

Recommended viscosity: SAE 0W-20

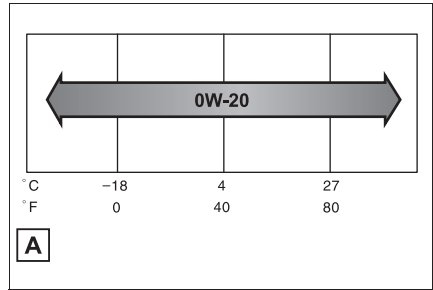

A Outside temperature

SAE 0W-20 is the best choice for good fuel economy and good starting in cold weather.

If SAE 0W-20 is not available, SAE 5W-20 oil may be used.

However, it must be replaced with SAE 0W-20 at the next oil change.

Oil viscosity (0W-20 is explained here as an example):

- The 0W in 0W-20 indicates the characteristic of the oil which allows cold startability. Oils with a lower value before the W allow for easier starting of the engine in cold weather.
- The 20 in 0W-20 indicates the viscosity characteristic of the oil when the oil is at high temperature.

How to read oil container label:

The International Lubricant Specification Advisory Committee (ILSAC) Certification Mark is added to some oil containers to help you select the oil you should use.



Cooling system

Capacity *	Gasoline engine	13.1 qt. (12.4 L, 10.9 Imp.qt.)
	Intercooler	4.6 qt. (4.4 L, 3.9 Imp.qt.)
	Power control unit	2.2 qt. (2.1 L, 1.8 Imp.qt.)
Coolant type	Use either of the following: <ul style="list-style-type: none"> • “Toyota Super Long Life Coolant” • Similar high-quality ethylene glycol-based non-silicate, non-amine, non-nitrite, and non-borate coolant with long-life hybrid organic acid technology Do not use plain water alone.	

*: The fluid capacity is a reference quantity.
If replacement is necessary, contact your Toyota dealer.

Ignition system (spark plug)

Make	DENSO EC22HPR-D7
Gap	0.027 in. (0.7 mm)



NOTICE

■ Iridium-tipped spark plugs

Use only iridium-tipped spark plugs. Do not adjust the spark plug gap.

Electrical system

Open voltage at 68°F (20°C):	12.0 V or higher (Turn the power switch off and turn on the high beam headlights for 30 seconds.)
Charging rates	5 A max.

Automatic transmission

Fluid capacity*	12.4 qt. (11.7 L, 10.3 Imp.qt.)
Fluid type	Toyota Genuine ATF WS

*: The fluid capacity is a reference quantity.
If replacement is necessary, contact your Toyota dealer.



NOTICE

■ Automatic transmission fluid type

Using transmission fluid other than the above type may cause abnormal noise or vibration, or damage the transmission of your vehicle.

Transfer (4WD models)

Oil capacity	2.17 qt. (2.05 L, 1.80 Imp.qt.)
Oil type and viscosity	Toyota Genuine ATF WS

Your Toyota vehicle is filled with “Toyota Genuine ATF WS” at the factory.

Use Toyota approved “Toyota Genuine ATF WS” or an equivalent of matching quality to satisfy the above specification. Please contact your Toyota dealer for further details.

Differential

Oil capacity	Front (4WD models)	1.4 qt. (1.29 L, 1.1 Imp.qt.)
	Rear	<ul style="list-style-type: none"> ▶ Without rear differential lock system 6.0 qt. (5.73 L, 5.0 Imp.qt.) ▶ With rear differential lock system 5.8 qt. (5.51 L, 4.8 Imp.qt.)
Oil type and viscosity		Toyota Genuine Differential Gear Oil LT 75W-85 GL-5 or equivalent

Your Toyota vehicle is filled with “Toyota Genuine Differential Gear Oil” at the factory.

Use Toyota approved “Toyota Genuine Differential Gear Oil” or an equivalent oil of matching quality to satisfy the above specification. Please contact your Toyota dealer for further details.

Brakes

Pedal clearance ^{*1}	3.6 in. (90.8 mm) Min.
Pedal free play	0.04 — 0.24 in. (1 — 6 mm)
Brake pad wear limit	0.04 in. (1 mm)
Parking brake indicator ^{*2}	<p>When pulling the parking brake switch for 1 to 2 seconds: comes on</p> <p>When pushing the parking brake switch for 1 to 2 seconds: turns off</p>
Fluid type	<ul style="list-style-type: none"> • FMVSS No.116 DOT 3 or SAE J1703 • FMVSS No.116 DOT 4 or SAE J1704

^{*1}: Minimum pedal clearance when depressed with a force of 110 lbf (490 N, 50 kgf) while the hybrid system is running.

^{*2}: Make sure to confirm that the brake warning light (yellow) does not illuminate. (If the brake warning light illuminates, refer to P.527.)

Steering

Free play	Less than 1.2 in. (30 mm)
-----------	---------------------------

Tires and wheels

► 18-inch tires (type A)

Tire size	265/70R18 116T, 265/70R18 116T (spare)
Tire inflation pressure (Recommended cold tire inflation pressure)	35 psi (240 kPa, 2.4 kgf/cm ² or bar)
Wheel size	18 × 7 1/2 J, 18 × 7J (spare)
Wheel nut torque	Steel wheels: 154 ft•lbf (209 N•m, 21.3 kgf•m) Aluminum wheels: 97 ft•lbf (131 N•m, 13.4 kgf•m)

► 18-inch tires (type B)

Tire size	285/65R18 116T, 265/70R18 116T (spare)
Tire inflation pressure (Recommended cold tire inflation pressure)	35 psi (240 kPa, 2.4 kgf/cm ² or bar)
Wheel size	18 × 8 1/2 J, 18 × 7J (spare)
Wheel nut torque	Steel wheels: 154 ft•lbf (209 N•m, 21.3 kgf•m) Aluminum wheels: 97 ft•lbf (131 N•m, 13.4 kgf•m)

► 20-inch tires (type A)

Tire size	265/60R20 112H, 245/75R18 112T (spare)
Tire inflation pressure (Recommended cold tire inflation pressure)	35 psi (240 kPa, 2.4 kgf/cm ² or bar) 36 psi (250 kPa, 2.5 kgf/cm ² or bar) (spare)
Wheel size	20 × 8J, 18 × 7J (spare)
Wheel nut torque	Steel wheels: 154 ft•lbf (209 N•m, 21.3 kgf•m) Aluminum wheels: 97 ft•lbf (131 N•m, 13.4 kgf•m)

► 20-inch tires (type B)

Tire size	265/60R20 112H, 265/70R18 116T (spare)
Tire inflation pressure (Recommended cold tire inflation pressure)	35 psi (240 kPa, 2.4 kgf/cm ² or bar)
Wheel size	20 × 8 1/2 J, 18 × 7J (spare)
Wheel nut torque	Steel wheels: 154 ft•lbf (209 N•m, 21.3 kgf•m) Aluminum wheels: 97 ft•lbf (131 N•m, 13.4 kgf•m)

► 22-inch tires

Tire size	265/50R22 112H, 245/75R18 112T (spare)
Tire inflation pressure (Recommended cold tire inflation pressure)	38 psi (260 kPa, 2.6 kgf/cm ² or bar) 36 psi (250 kPa, 2.5 kgf/cm ² or bar) (spare)
Wheel size	22 × 8J, 18 × 7J (spare)
Wheel nut torque	Steel wheels: 154 ft•lbf (209 N•m, 21.3 kgf•m) Aluminum wheels: 97 ft•lbf (131 N•m, 13.4 kgf•m)

Light bulbs

	Light bulbs	Bulb No.	W	Type
Exterior	Front turn signal/parking lights	7444NA	28/8	A

A: Wedge base bulbs (amber)

Fuel information

You must only use unleaded gasoline. Select octane rating 87 (Research Octane Number 91) or higher. Use of unleaded gasoline with an octane rating lower than 87 may result in engine knocking. Persistent knocking can lead to engine damage.

At minimum, the gasoline you use should meet the specifications of ASTM D4814 in the U.S.A.

Gasoline quality

In very few cases, driveability problems may be caused by the brand of gasoline you are using. If driveability problems persist, try changing the brand of gasoline. If this does not correct the problem, consult your Toyota dealer.

Recommendation of the use of gasoline containing detergent additives

- Toyota recommends the use of gasoline that contains detergent additives to avoid build-up of engine deposits.
- All gasoline sold in the U.S.A. contains minimum detergent additives to clean and/or keep clean intake systems, per EPA's lowest additives concentration program.
- Toyota strongly recommends the use of Top Tier Detergent Gasoline. For more information on Top Tier Detergent Gasoline and a list of marketers, please go to the official website www.toptiergas.com.

Recommendation of the use of low emissions gasoline

Gasolines containing oxygenates such as ethers and ethanol, as well as reformulated gasolines, are available in some cities. These fuels are typically acceptable for use, providing they meet other fuel requirements.

Toyota recommends these fuels, since the formulations allow for reduced vehicle emissions.

Non-recommendation of the use of blended gasoline

- Use only gasoline containing up to 15% ethanol.
DO NOT use any flex-fuel or gasoline that could contain more than 15% ethanol, including from any pump labeled E30 (30% ethanol **A**), E50 (50% ethanol **B**), E85 (85% ethanol **C**) (which are only some examples of fuel containing more than 15% ethanol).

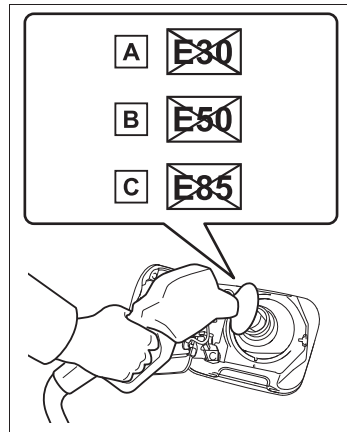

- If you use gasohol in your vehicle, be sure that it has an octane rating no lower than 87.
- Toyota does not recommend the use of gasoline containing methanol.

■ Non-recommendation of the use of gasoline containing MMT

Some gasoline contains an octane enhancing additive called MMT (Methylcyclopentadienyl Manganese Tricarbonyl).

Toyota does not recommend the use of gasoline that contains MMT. If fuel containing MMT is used, your emission control system may be adversely affected.

The malfunction indicator lamp on the instrument cluster may come on. If this happens, contact your Toyota dealer for service.

■ If your engine knocks

- Consult your Toyota dealer.
- You may occasionally notice light knocking for a short time while accelerating or driving uphill. This is normal and there is no need for concern.

■ Fuel-related poor driveability

If poor driveability (poor hot starting, vaporization, engine knocking, etc.) is encountered after using a different type of fuel, discontinue the use of that type of fuel.

■ When refueling with gasohol

Take care not to spill gasohol. It can damage your vehicle's paint.



NOTICE

■ Notice on fuel quality

- Do not use improper fuels. If improper fuels are used, the engine will be damaged.
- Do not use leaded gasoline. Leaded gasoline can cause damage to your vehicle's three-way catalytic converters causing the emission control system to malfunction.
- Do not use gasohol other than the type previously stated. Other gasohol may cause fuel system damage or vehicle performance problems.
- Using unleaded gasoline with an octane number or rating lower than the level previously stated will cause persistent heavy knocking. At worst, this will lead to engine damage.

Tire information

Typical tire symbols

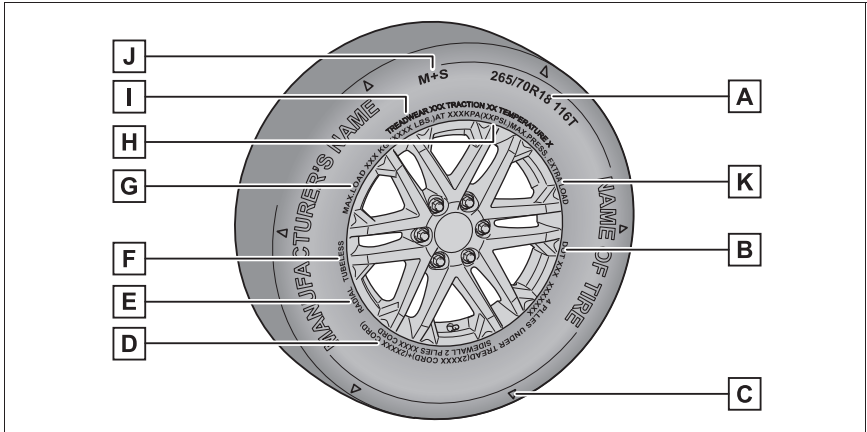

A Tire size (→P.580)

B DOT and Tire Identification Number (TIN) (→P.579)

C Location of treadwear indicators (→P.490)

D Tire ply composition and materials

Plyes are layers of rubber-coated parallel cords. Cords are the strands which form the plyes in a tire.

E Radial tires or bias-ply tires

A radial tire has “RADIAL” on the sidewall. A tire not marked “RADIAL” is a bias-ply tire.

F TUBELESS or TUBE TYPE

A tubeless tire does not have a tube and air is directly put into the tire. A tube type tire has a tube inside the tire and the tube maintains the air pressure.

G Load limit at maximum cold tire inflation pressure (→P.491)

H Maximum cold tire inflation pressure (→P.574)

This means the pressure to which a tire may be inflated.

I Uniform tire quality grading

For details, see “Uniform Tire Quality Grading” that follows.

J Summer tires or all season tires (→P.491)

An all season tire has “M+S” on the sidewall. A tire not marked “M+S” is a summer tire.

K Extra load tire (if equipped)

A tire designed to operate at higher loads and higher inflation pressure than the corresponding standard tire.

Typical DOT and Tire Identification Number (TIN)

► Type A

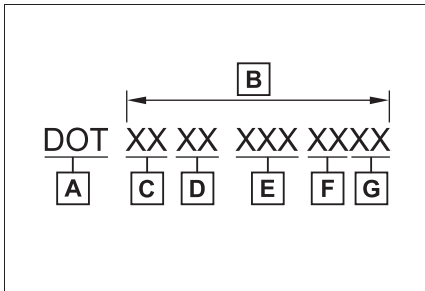

- A** DOT symbol*
- B** Tire Identification Number (TIN)
- C** Tire size code
- D** Manufacturer’s optional tire type code (3 or 4 letters)
- E** Tire manufacturer’s identification mark
- F** Manufacturing week
- G** Manufacturing year

*: The DOT symbol certifies that the tire conforms to applicable Federal Motor Vehicle Safety Standards.

► Type B

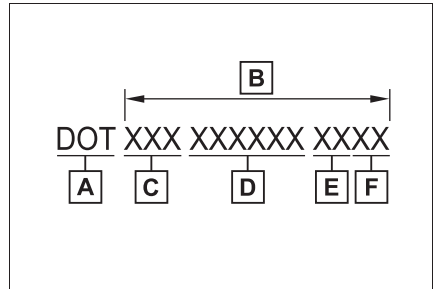

- A** DOT symbol*
- B** Tire Identification Number (TIN)
- C** Tire manufacturer’s identification mark
- D** Manufacturer’s code
- E** Manufacturing week
- F** Manufacturing year

*: The DOT symbol certifies that the tire conforms to applicable Federal Motor Vehicle Safety Standards.

Tire size

■ **Typical tire size information**

The illustration indicates typical tire size.

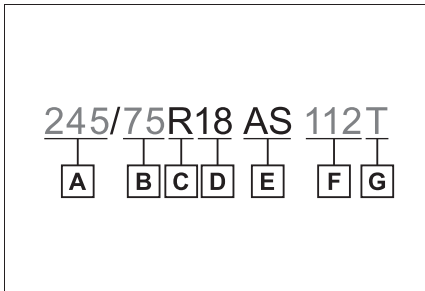

- A** Section width (millimeters)
- B** Aspect ratio (tire height to section width)
- C** Tire construction code (R = Radial, D = Diagonal)
- D** Wheel diameter (inches)
- E** Speed category (alphabet with one letter)
- F** Load index (2 digits or 3 digits)
- G** Speed symbol (alphabet with one letter)

■ **Tire dimensions**

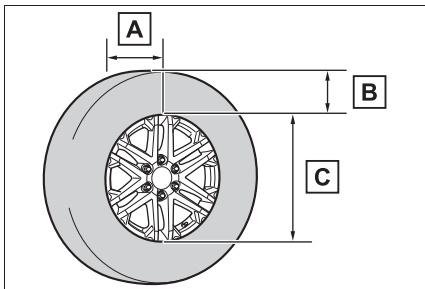

- A** Section width
- B** Tire height
- C** Wheel diameter

Tire section names

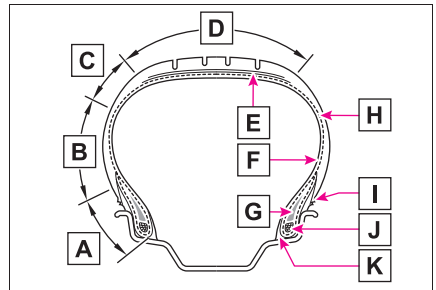

- A** Bead
- B** Sidewall
- C** Shoulder
- D** Tread
- E** Belt
- F** Inner liner
- G** Reinforcing rubber
- H** Carcass
- I** Rim lines
- J** Bead wires
- K** Chafer

Uniform Tire Quality Grading

This information has been prepared in accordance with regulations issued by the National Highway Traffic Safety Administration of the U.S. Department of Transportation.

It provides the purchasers and/or prospective purchasers of Toyota vehicles with information on uniform tire quality grading.

Your Toyota dealer will help answer any questions you may have as you read this information.

■ DOT quality grades

All passenger vehicle tires must conform to Federal Safety Requirements in addition to these grades. Quality grades can be found where applicable on the tire sidewall between tread shoulder and maximum section width.

For example: Treadwear 200 Traction AA Temperature A

■ Treadwear

The treadwear grade is a comparative rating based on the wear rate of the tire when tested under controlled conditions on a specified government test course.

For example, a tire graded 150 would wear one and a half (1 - 1/2) times as well on the government course as a tire graded 100.

The relative performance of tires depends upon the actual conditions of their use. Performance may differ significantly from the norm due to variations in driving habits, service practices and differences in road characteristics and climate.

■ Traction AA, A, B, C

The traction grades, from highest to lowest, are AA, A, B and C, and they represent the tire's ability to stop on wet pavement as measured under controlled conditions on specified government test surfaces of asphalt and concrete.

A tire marked C may have poor traction performance.

Warning: The traction grade assigned to this tire is based on braking (straight ahead) traction tests and does not include cornering (turning) traction.

■ Temperature A, B, C

The temperature grades are A (the highest), B, and C, representing the tire's resistance to the generation of heat and its ability to dissipate heat when tested under controlled conditions on a specified indoor laboratory test wheel.

Sustained high temperature can cause the material of the tire to degenerate and reduce tire life, and excessive temperature can lead to sudden tire failure.

Grade C corresponds to a level of performance which all passenger car tires must meet under the Fed-

582 8-1. Specifications

eral Motor Vehicle Safety Standard No. 109.

Grades B and A represent higher levels of performance on the laboratory test wheel than the minimum required by law.

Warning: The temperature grades

of a tire assume that it is properly inflated and not overloaded.

Excessive speed, underinflation, or excessive loading, either separately or in combination, can cause heat buildup and possible tire failure.

Glossary of tire terminology

Tire related term	Meaning
Cold tire inflation pressure	Tire pressure when the vehicle has been parked for three hours or more, or has not been driven more than 1 mile or 1.5 km under that condition
Maximum inflation pressure	The maximum cold inflated pressure to which a tire may be inflated, shown on the sidewall of the tire
Recommended inflation pressure	Cold tire inflation pressure recommended by a manufacturer
Accessory weight	The combined weight (in excess of those standard items which may be replaced) of automatic transmission, power steering, power brakes, power windows, power seats, radio and heater, to the extent that these items are available as factory-installed equipment (whether installed or not)
Curb weight	The weight of a motor vehicle with standard equipment, including the maximum capacity of fuel, oil and coolant, and if so equipped, air conditioning and additional weight optional engine
Maximum loaded vehicle weight	The sum of: (a) Curb weight (b) Accessory weight (c) Vehicle capacity weight (d) Production options weight

Tire related term	Meaning
Normal occupant weight	150 lb. (68 kg) times the number of occupants specified in the second column of Table 1* that follows
Occupant distribution	Distribution of occupants in a vehicle as specified in the third column of Table 1* below
Production options weight	The combined weight of installed regular production options weighing over 5 lb. (2.3 kg) in excess of the standard items which they replace, not previously considered in curb weight or accessory weight, including heavy duty brakes, ride levelers, roof rack, heavy duty battery, and special trim
Rim	A metal support for a tire or a tire and tube assembly upon which the tire beads are seated
Rim diameter (Wheel diameter)	Nominal diameter of the bead seat
Rim size designation	Rim diameter and width
Rim type designation	The industry manufacturer's designation for a rim by style or code
Rim width	Nominal distance between rim flanges
Vehicle capacity weight (Total load capacity)	The rated cargo and luggage load plus 150 lb. (68 kg) times the vehicle's designated seating capacity
Vehicle maximum load on the tire	The load on an individual tire that is determined by distributing to each axle its share of the maximum loaded vehicle weight, and dividing by two
Vehicle normal load on the tire	The load on an individual tire that is determined by distributing to each axle its share of curb weight, accessory weight, and normal occupant weight (distributed in accordance with Table 1* below), and dividing by two
Weather side	The surface area of the rim not covered by the inflated tire

Tire related term	Meaning
Bead	The part of the tire that is made of steel wires, wrapped or reinforced by ply cords and that is shaped to fit the rim
Bead separation	A breakdown of the bond between components in the bead
Bias ply tire	A pneumatic tire in which the ply cords that extend to the beads are laid at alternate angles substantially less than 90 degrees to the centerline of the tread
Carcass	The tire structure, except tread and sidewall rubber which, when inflated, bears the load
Chunking	The breaking away of pieces of the tread or sidewall
Cord	The strands forming the plies in the tire
Cord separation	The parting of cords from adjacent rubber compounds
Cracking	Any parting within the tread, sidewall, or innerliner of the tire extending to cord material
CT	A pneumatic tire with an inverted flange tire and rim system in which the rim is designed with rim flanges pointed radially inward and the tire is designed to fit on the underside of the rim in a manner that encloses the rim flanges inside the air cavity of the tire
Extra load tire	A tire designed to operate at higher loads and at higher inflation pressures than the corresponding standard tire
Groove	The space between two adjacent tread ribs
Innerliner	The layer(s) forming the inside surface of a tubeless tire that contains the inflating medium within the tire
Innerliner separation	The parting of the innerliner from cord material in the carcass

Tire related term	Meaning
Intended outboard sidewall	(a) The sidewall that contains a whitewall, bears white lettering, or bears manufacturer, brand, and/or model name molding that is higher or deeper than the same molding on the other sidewall of the tire, or (b) The outward facing sidewall of an asymmetrical tire that has a particular side that must always face outward when mounted on a vehicle
Light truck (LT) tire	A tire designated by its manufacturer as primarily intended for use on lightweight trucks or multipurpose passenger vehicles
Load rating	The maximum load that a tire is rated to carry for a given inflation pressure
Maximum load rating	The load rating for a tire at the maximum permissible inflation pressure for that tire
Maximum permissible inflation pressure	The maximum cold inflation pressure to which a tire may be inflated
Measuring rim	The rim on which a tire is fitted for physical dimension requirements
Open splice	Any parting at any junction of tread, sidewall, or innerliner that extends to cord material
Outer diameter	The overall diameter of an inflated new tire
Overall width	The linear distance between the exteriors of the sidewalls of an inflated tire, including elevations due to labeling, decorations, or protective bands or ribs
Passenger car tire	A tire intended for use on passenger cars, multipurpose passenger vehicles, and trucks, that have a gross vehicle weight rating (GVWR) of 10,000 lb. or less.
Ply	A layer of rubber-coated parallel cords
Ply separation	A parting of rubber compound between adjacent plies

Tire related term	Meaning
Pneumatic tire	A mechanical device made of rubber, chemicals, fabric and steel or other materials, that, when mounted on an automotive wheel, provides the traction and contains the gas or fluid that sustains the load
Radial ply tire	A pneumatic tire in which the ply cords that extend to the beads are laid at substantially 90 degrees to the centerline of the tread
Reinforced tire	A tire designed to operate at higher loads and at higher inflation pressures than the corresponding standard tire
Section width	The linear distance between the exteriors of the sidewalls of an inflated tire, excluding elevations due to labeling, decoration, or protective bands
Sidewall	That portion of a tire between the tread and bead
Sidewall separation	The parting of the rubber compound from the cord material in the sidewall
Snow tire	A tire that attains a traction index equal to or greater than 110, compared to the ASTM E-1136 Standard Reference Test Tire, when using the snow traction test as described in ASTM F-1805-00, Standard Test Method for Single Wheel Driving Traction in a Straight Line on Snow-and Ice-Covered Surfaces, and which is marked with an Alpine Symbol () on at least one sidewall
Test rim	The rim on which a tire is fitted for testing, and may be any rim listed as appropriate for use with that tire
Tread	That portion of a tire that comes into contact with the road

Tire related term	Meaning
Tread rib	A tread section running circumferentially around a tire
Tread separation	Pulling away of the tread from the tire carcass
Treadwear indicators (TWI)	The projections within the principal grooves designed to give a visual indication of the degrees of wear of the tread
Wheel-holding fixture	The fixture used to hold the wheel and tire assembly securely during testing

*: Table 1 -Occupant loading and distribution for vehicle normal load for various designated seating capacities

Designated seating capacity, Number of occupants	Vehicle normal load, Number of occupants	Occupant distribution in a normally loaded vehicle
2 through 4	2	2 in front
5 through 10	3	2 in front, 1 in second seat
11 through 15	5	2 in front, 1 in second seat, 1 in third seat, 1 in fourth seat
16 through 20	7	2 in front, 2 in second seat, 2 in third seat, 1 in fourth seat

Customizable features

Your vehicle includes a variety of electronic features that can be personalized to your preferences. The settings of these features can be changed by using the multi-information display, the multimedia system or at your Toyota dealer.

Customizing vehicle features

■ Changing by using the meter control switches

- 1 Press < or > to select .
- 2 Operate the meter control switches to select the desired item to be customized.
- 3 According to the display, select the desired setting and then press OK.

To go back to the previous screen or exit the customize mode, press .

■ Changing by using the multimedia system

- 1 Select  on the main menu
- 2 Select "Vehicle customize".
- 3 According to the display, select the desired setting.

Various setting can be changed. Refer to the list of settings that can be changed for details.

WARNING

■ During customization

As the hybrid system needs to be operating during customization, ensure that the vehicle is parked in a place with adequate ventilation. In a closed area such as a garage, exhaust gases including harmful carbon monoxide (CO) may collect and enter the vehicle. This may lead to death or a serious health hazard.

NOTICE

■ During customization

To prevent 12-volt battery discharge, ensure that the hybrid system is operating while customizing features.

Customizable features

Some function settings are changed simultaneously with other functions being customized. Contact your Toyota dealer for further details.

A Settings that can be changed using the multimedia system

B Settings that can be changed using the multi-information display

C Settings that can be changed by your Toyota dealer

Definition of symbols: O = Available, — = Not available

■ Gauges, meters and multi-information display (→P.91, 95)

Function ^{*1}	Customized setting	A	B	C
Language ^{*2}	<ul style="list-style-type: none"> •English •French •Spanish 	—	O	—
Units ^{*2}	<ul style="list-style-type: none"> •miles (MPG US) •km (km/L) •km (L/100 km) •miles (MPG Imperial) 	—	O	—
Speedometer display	<ul style="list-style-type: none"> •Digital •Analog •Digital & Analog 	—	O	—
Fuel economy display	<ul style="list-style-type: none"> •Total average (Average fuel consumption [after reset]) •Trip average (Average fuel consumption [after start]) •Tank average (Average fuel consumption [after refuel]) 	—	O	—
Audio system linked display	<ul style="list-style-type: none"> •On •Off 	—	O	—
Drive information type	<ul style="list-style-type: none"> •Trip (after start) •Total (after reset) 	—	O	—
Drive information items (First item)	<ul style="list-style-type: none"> •Distance •Average vehicle speed •Elapsed time 	—	O	—

Function ^{*1}	Customized setting	A	B	C
Drive information items (Second item)	<ul style="list-style-type: none"> •Distance •Average vehicle speed •Elapsed time 	—	O	—
Pop-up display	<ul style="list-style-type: none"> •On •Off 	—	O	—

*1: For details about each function: →P.99

*2: The default setting varies according to country.

■ Head-up Display* (→P.102)

Function	Customized setting	A	B	C
Head-up display	<ul style="list-style-type: none"> •On •Off 	—	O	—
Hybrid System Indicator	<ul style="list-style-type: none"> •On •Off 	—	O	—
Route guidance to destination/street name	<ul style="list-style-type: none"> •On •Off 	—	O	—
Driving support system display	<ul style="list-style-type: none"> •On •Off 	—	O	—
Compass	<ul style="list-style-type: none"> •On •Off 	—	O	—
Audio system operation status	<ul style="list-style-type: none"> •On •Off 	—	O	—

*: If equipped

■ Door lock (→P.113, 120, 553)

Function	Customized setting	A	B	C
Unlocking using a mechanical key	<ul style="list-style-type: none"> •Driver's door unlocked in one step, all doors unlocked in two step •All doors unlocked in one step 	—	—	O
Automatic door locking function	<ul style="list-style-type: none"> •Shift position linked door locking operation •Speed linked door locking operation •Off 	O	—	O
Automatic door unlocking function	<ul style="list-style-type: none"> •Shift position linked door unlocking operation •Driver's door linked door unlocking operation •Off 	O	—	O

■ Smart key system and wireless remote control (→P.113, 120, 131)

Function	Customized setting	A	B	C
Operating signal (Buzzers)	<ul style="list-style-type: none"> •Off •1 ~ 7 	O	—	O
Operation signal (Emergency flashers)	<ul style="list-style-type: none"> •On •Off 	O	—	O
Time elapsed before automatic door lock function is activated if door is not opened after being unlocked	<ul style="list-style-type: none"> •30 seconds •60 seconds •120 seconds 	O	—	O
Open door warning buzzer (When locking the vehicle)	<ul style="list-style-type: none"> •On •Off 	—	—	O

■ **Smart key system (→P.113, 120, 131)**

Function	Customized setting	A	B	C
Smart key system	<ul style="list-style-type: none"> •On •Off 	—	—	○
Smart door unlocking	<ul style="list-style-type: none"> •Driver's door •All the doors 	○	—	○
Time elapsed before unlocking all the door when gripping and holding the driver's door handle	<ul style="list-style-type: none"> •Off •1.5 seconds •2 seconds •2.5 seconds 	—	—	○
Number of consecutive door lock operations	<ul style="list-style-type: none"> •2 times •As many as desired 	—	—	○

■ **Wireless remote control (→P.111, 113, 121)**

Function	Customized setting	A	B	C
Wireless remote control	<ul style="list-style-type: none"> •On •Off 	—	—	○
Unlocking operation	<ul style="list-style-type: none"> •Driver's door unlocked in one step, all doors unlocked in two step •All doors unlocked in one step 	○	—	○
Tailgate opening operation	<ul style="list-style-type: none"> •One short press •Push twice •Press and hold (short) •Press and hold (long) •Off 	—	—	○
Power tailgate opening operation	<ul style="list-style-type: none"> •Single press •Double press •Press and hold •Off 	—	—	○
Theft deterrent panic mode	<ul style="list-style-type: none"> •On •Off 	—	—	○
Locking operation when door opened	<ul style="list-style-type: none"> •On •Off 	○	—	○

■ Rear seat reminder (→P.115)

Function	Customized setting	A	B	C
Indication to prevent mis- placement in the rear seat	<ul style="list-style-type: none"> •On •Off 	—	O	—

■ Tailgate open alert (→P.122)

Function	Customized setting	A	B	C
Tailgate open alert	<ul style="list-style-type: none"> •On •Off 	—	O	—

■ Power tailgate (→P.121)

Function	Customized setting	A	B	C
Power tailgate operations	<ul style="list-style-type: none"> •On •Off 	—	O	—
Close Assist	<ul style="list-style-type: none"> •On •Off 	—	—	O
Power tailgate operation by tailgate opener switch on tail lamp and tailgate handle	<ul style="list-style-type: none"> •On •Off (latch release only) 	—	—	O
Operating signal (Buzzers)	<ul style="list-style-type: none"> •On •Off 	—	—	O
Power tailgate buzzer vol- ume	<ul style="list-style-type: none"> •Low •Medium •High 	—	O	—

■ Driving position memory (→P.144)

Function	Customized setting	A	B	C
Selecting doors linked to the memory recall function	<ul style="list-style-type: none"> •Driver's door •All doors 	—	—	O
Driver's seat slide movement when exiting the vehicle	<ul style="list-style-type: none"> •Full •Partial •Off 	O	—	O
Steering wheel movement	<ul style="list-style-type: none"> •Tilt only •Telescopic only •Tilt and telescopic •Off 	O	—	O

■ Outside rear view mirrors (→P.164)

Function	Customized setting	A	B	C
Automatic mirror folding and extending operation	<ul style="list-style-type: none"> •Linked to the locking/unlocking of the doors •Linked to operation of the power switch •Off 	—	—	○

■ Power windows and panoramic moon roof* (→P.169, 173)

Function	Customized setting	A	B	C
Mechanical key linked operation	<ul style="list-style-type: none"> •On •Off 	—	—	○
Wireless remote control linked operation	<ul style="list-style-type: none"> •On (open only) •Off 	—	—	○
Wireless remote control linked operation signal (buzzer)	<ul style="list-style-type: none"> •On •Off 	—	—	○
Side windows open warning function	<ul style="list-style-type: none"> •On •Off 	—	—	○
Sliding roof open warning function	<ul style="list-style-type: none"> •On •Off 	—	—	○

* : If equipped

■ Turn signal lever (→P.216)

Function	Customized setting	A	B	C
Times of flashing of the lane change signal flashers	<ul style="list-style-type: none"> •Off •3 ~ 7 	—	—	○

■ Automatic light control system (→P.223)

Function	Customized setting	A	B	C
Light sensor sensitivity	•-2 ~ 2	○	—	○
Time elapsed before headlights automatically turn off after doors are closed	•Off •30 seconds •60 seconds •90 seconds	○	—	○
Windshield wiper linked headlight illumination	•On •Off	—	—	○

■ Lights (→P.223)

Function	Customized setting	A	B	C
Daytime running lights*	•On •Off	○	—	○
Welcome lamp (if equipped)	•On •Off	—	—	○

*: Except for Canada

■ PCS (Pre-Collision System) (→P.242)

Function	Customized setting	A	B	C
PCS (Pre-Collision System)*	•On •Off	—	○	—
Adjust alert timing	•Late •Middle •Early	—	○	—

*: The system is automatically enabled each time the power switch is turned to ON.

■ LTA (Lane Tracing Assist) (→P.254)

Function	Customized setting	A	B	C
Lane centering function	<ul style="list-style-type: none"> •On •Off 	—	○	—
Alert type	<ul style="list-style-type: none"> •Steering wheel vibration •Buzzer 	—	○	—
Alert sensitivity	<ul style="list-style-type: none"> •Standard •High 	—	○	—
Vehicle sway warning function	<ul style="list-style-type: none"> •On •Off 	—	○	—
Vehicle sway warning sensitivity	<ul style="list-style-type: none"> •Low •Standard •High 	—	○	—

■ RSA (Road Sign Assist)* (→P.265)

Function	Customized setting	A	B	C
RSA (Road Sign Assist)	<ul style="list-style-type: none"> •On •Off 	—	○	—
Excess speed notification method	<ul style="list-style-type: none"> •No notification •Display only •Display and buzzer 	—	○	—
Excess speed notification level	<ul style="list-style-type: none"> •1 mph (2 km/h) •3 mph (5 km/h) •5 mph (10 km/h) 	—	○	—
Other notifications method (No-entry notification)	<ul style="list-style-type: none"> •No notification •Display only •Display and buzzer 	—	○	—

* : If equipped

■ BSM (Blind Spot Monitor) (→P.281)

Function	Customized setting	A	B	C
BSM (Blind Spot Monitor)	<ul style="list-style-type: none"> •On •Off 	—	○	—
Outside rear view mirror indicator brightness	<ul style="list-style-type: none"> •Bright •Dim 	—	○	—
Alert timing for presence of approaching vehicle (sensitivity)	<ul style="list-style-type: none"> •Late •Intermediate •Early •Only when vehicle detected in blind spot 	—	○	—

■ Intuitive parking assist (→P.288)

Function	Customized setting	A	B	C
Intuitive parking assist	<ul style="list-style-type: none"> •On •Off 	—	○	—
Buzzer volume	•Level 1 ~ Level 3	—	○	—

■ RCTA (Rear Cross Traffic Alert) (→P.295)

Function	Customized setting	A	B	C
RCTA (Rear Cross Traffic Alert)	<ul style="list-style-type: none"> •On •Off 	—	○	—
Buzzer volume	•Level 1 ~ Level 3	—	○	—

■ Automatic air conditioning system (→P.418)

Function	Customized setting	A	B	C
A/C mode with auto	<ul style="list-style-type: none"> •On •Off 	○	—	○

■ **Illumination** (→P.428)

Function	Customized setting	A	B	C
Time elapsed before the interior lights and cargo lamp turn off	<ul style="list-style-type: none"> •Off •7.5 seconds •15 seconds •30 seconds 	O	—	O
Operation of the personal/interior lights after the power switch is turned off	<ul style="list-style-type: none"> •On •Off 	—	—	O
Operation of the personal/interior lights when the doors are unlocked	<ul style="list-style-type: none"> •On •Off 	—	—	O
Operation of the personal/interior lights when you approach the vehicle with the electronic key on your person	<ul style="list-style-type: none"> •On •Off 	—	—	O
Ambient lights*	<ul style="list-style-type: none"> •On •Off 	—	—	O

*: If equipped

■ **Driving mode select switch*** (→P.376)

Function	Customized setting	A	B	C
Powertrain control in Custom mode*	<ul style="list-style-type: none"> •Eco •Normal •Power 	O	—	—
Suspension control in Custom mode*	<ul style="list-style-type: none"> •Comfort •Normal •Sport 	O	—	—
Steering control in Custom mode*	<ul style="list-style-type: none"> •Normal •Sport 	O	—	—

*: If equipped

■ Vehicle customization

- When the smart key system is off, the entry unlock function cannot be customized.
- When the doors remain closed after unlocking the doors and the timer activated automatic door lock function activates, signals will be generated in accordance with the operation buzzer volume and operational signal (Emergency flashers) function settings.
- Some settings can be changed using a switch or the multimedia system. If a setting is changed using a switch, the changed setting will not be reflected on the multimedia system until the power switch is turned off and then to ON.

Items to initialize

The following items must be initialized for normal system operation after such cases as the 12-volt battery being reconnected, or maintenance being performed on the vehicle:

List of items to initialize

Item	When to initialize	Reference
PKSB (Parking Support Brake)	<ul style="list-style-type: none"> After reconnecting or changing the 12-volt battery 	P.306
Maintenance required reminder message	<ul style="list-style-type: none"> After the maintenance is performed 	P.473, 484
Tire pressure warning system	<ul style="list-style-type: none"> When the tire inflation pressure is changed, such as when changing traveling speed or load weight. When the tire inflation pressure is changed, such as when the tire size is changed. When rotating the tires. After performing the transmitter ID code registration procedure. 	P.495
Toyota parking assist monitor*	<ul style="list-style-type: none"> 12-volt battery has been reinstalled. 	P.322, 359, 372
Panoramic view monitor*	<ul style="list-style-type: none"> The steering wheel has been moved while the 12-volt battery was being reinstalled. 	
Multi-terrain Monitor*	<ul style="list-style-type: none"> 12-volt battery power is low. 	
Power tailgate	<ul style="list-style-type: none"> When the tailgate is reattached. Battery has been reinstalled. After jam protection function operate. After turn on the power tailgate system using the meter control switch. 	P.123, 540

*: If equipped

9-1. For owners

- Reporting safety defects for
U.S. owners..... **602**
- Reporting safety defects for
Canadian owners **602**
- Seat belt instructions for
Canadian owners (in
French)..... **603**
- SRS airbag instructions for
Canadian owners (in
French)..... **605**
- Camper information **613**

Reporting safety defects for U.S. owners

If you believe that your vehicle has a defect which could cause a crash or could cause injury or death, you should immediately inform the National Highway Traffic Safety Administration (NHTSA) in addition to notifying Toyota Motor Sales, U.S.A., Inc. (Toll-free: 1-800-331-4331).

If NHTSA receives similar complaints, it may open an investigation, and if it finds that a safety defect exists in a group of vehicles, it may order a recall and remedy campaign. However, NHTSA cannot become involved in individual problems between you, your dealer, or Toyota Motor Sales, U.S.A., Inc.

To contact NHTSA, you may call the Vehicle Safety Hotline toll-free at 1-888-327-4236 (TTY: 1-800-424-9153); go to <http://www.safercar.gov>; or write to: Administrator, NHTSA, 1200 New Jersey Ave. SE., Washington, DC 20590. You can also obtain other information about motor vehicle safety from <http://www.safercar.gov>.

Reporting safety defects for Canadian owners

Canadian customers who wish to report a safety-related defect to Transport Canada, Defects Investigations and Recalls, may telephone the toll-free hotline 1-800-333-0510, mail Transport Canada - ASFAD, 330 Sparks Street, Ottawa, ON, K1A 0N5, or complete the online form at <https://www.tc.gc.ca/recalls>.

Les clients canadiens désireux de rendre compte d'un défaut lié à la sécurité auprès de Transport Canada, Enquêtes sur les défauts et rappels, peuvent appeler gratuitement l'assistance téléphonique au 1-800-333-0510, écrire un courriel à Transports Canada - ASFAD, 330 Sparks Street, Ottawa, ON, K1A 0N5, ou remplir la déclaration en ligne à l'adresse <https://www.tc.gc.ca/rappels>.

Seat belt instructions for Canadian owners (in French)

The following is a French explanation of seat belt instructions extracted from the seat belt section in this manual.

See the seat belt section for more detailed seat belt instructions in English.

Utilisation correcte des ceintures de sécurité



- Déroulez la sangle diagonale de telle sorte qu'elle passe bien sur l'épaule, sans pour autant être en contact avec le cou ou glisser de l'épaule.
- Placez la sangle abdominale le plus bas possible sur les hanches.
- Réglez la position du dossier de siège. Asseyez-vous le dos le plus droit possible et calez-vous bien dans le siège.
- Ne pas vriller la ceinture de

sécurité.

⚠ AVERTISSEMENT

■ Lorsque vous utilisez la ceinture de sécurité du siège central arrière

Ne pas utiliser la ceinture de sécurité du siège central arrière avec une de ses deux boucles déverrouillée. Si une seule des boucles est verrouillée, tout freinage brusque ou collision peut entraîner des blessures graves, voire mortelles.

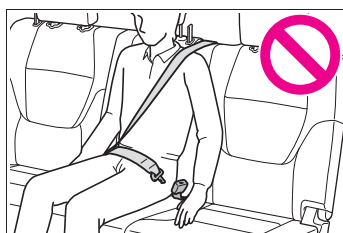

Entretien et nettoyage

■ Manipulation des ceintures de sécurité

Avec un chiffon ou une éponge, nettoyez à l'aide d'un savon doux et de l'eau tiède. Vérifiez aussi les ceintures régulièrement pour vous assurer qu'elles ne présentent pas d'usure excessive, d'effilochage ou de coupures.

**AVERTISSEMENT****■ État et usure des ceintures de sécurité**

Inspectez les ceintures de sécurité périodiquement. Contrôlez qu'elles ne sont pas entaillées, effilochées, et que leurs ancrages ne sont pas desserrés. Ne pas utiliser une ceinture de sécurité défectueuse avant qu'elle ne soit remplacée. Une ceinture de sécurité défectueuse n'apporte aucune garantie de protection de l'occupant contre des blessures graves, voire mortelles.

SRS airbag instructions for Canadian owners (in French)

The following is a French explanation of SRS airbag instructions extracted from the SRS airbag section in this manual.

See the SRS airbag section for more detailed SRS airbag instructions in English.

Système de coussins gonflables SRS

■ Emplacement des coussins gonflables SRS

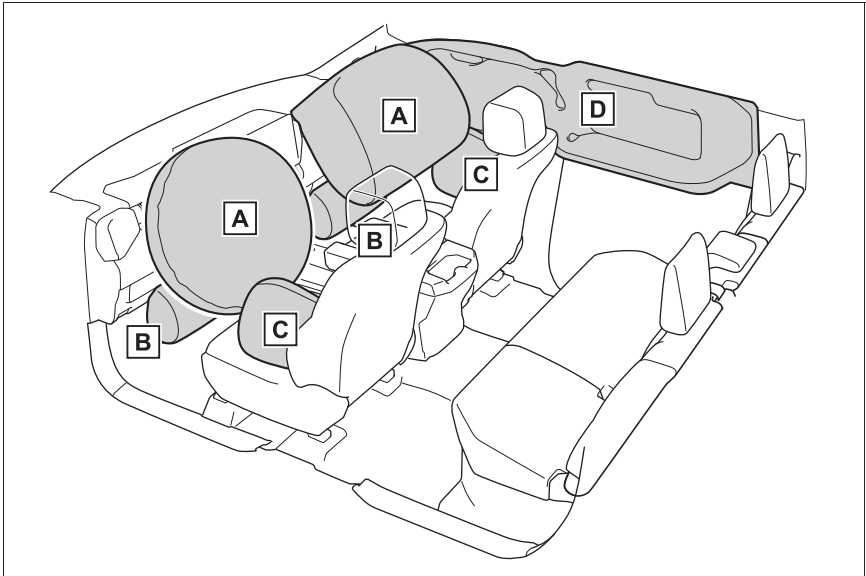

► Coussins gonflables SRS frontaux

A Coussin gonflable SRS conducteur/passager avant

Participent à la protection de la tête et du thorax du conducteur et du passager avant contre les chocs avec les éléments de l'habitacle

B Coussins gonflables SRS de genoux

Participe à la protection du conducteur et du passager avant

► Coussins gonflables SRS latéraux et rideau

C Coussins gonflables SRS latéraux avant

Participent à la protection du haut du corps des occupants aux places avant

D Coussins gonflables SRS rideau

- Participent principalement à la protection de la tête des occupants assis dans les sièges des places extérieures
- Participent à empêcher les occupants d'être éjectés du véhicule en cas de retournement de celui-ci

■ **Composition du système de coussins gonflables SRS**

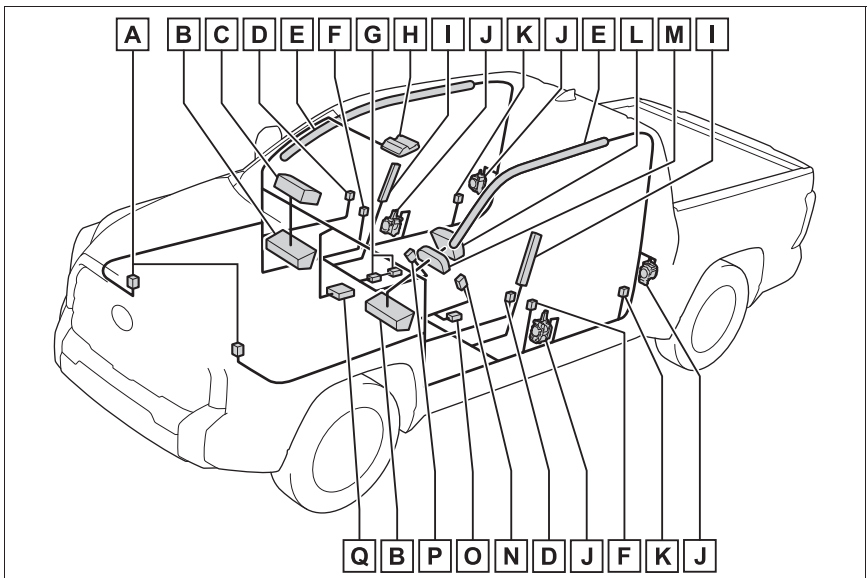

A Capteurs d'impact avant

B Coussins gonflables de genoux

C Coussin gonflable passager avant

D Capteurs d'impact latéral (avant)

E Coussins gonflables rideau

F Capteurs d'impact latéral (porte avant)

G Capteurs de classification d'occupant du siège passager avant

H Témoins indicateurs "AIR BAG ON" et "AIR BAG OFF"

- I** Coussins gonflables latéraux
- J** Prétensionneurs et limiteurs d'effort de ceinture de sécurité
- K** Capteurs d'impact latéral (arrière)
- L** Coussin gonflable conducteur
- M** Témoin d'alerte SRS
- N** Contacteur de boucle de ceinture de sécurité conducteur
- O** Capteur de position du siège conducteur
- P** Contacteur de boucle de ceinture de sécurité passager avant
- Q** Boîtier électronique de coussins gonflables

Votre véhicule est équipé de COUSSINS GONFLABLES INTELLIGENTS (ADVANCED AIRBAGS) conçus selon les normes de sécurité américaines applicables aux véhicules à moteur (FMVSS208). Le boîtier électronique de coussins gonflables (ECU) utilise les informations reçues des capteurs, etc. détaillés dans le schéma ci-dessus de composition du système pour commander le déploiement des coussins gonflables. Ces informations comprennent des informations sur la gravité de la collision et les occupants. Le déploiement rapide des coussins gonflables est obtenu au moyen d'une réaction chimique dans les dispositifs pyrotechniques, qui produit un gaz inoffensif permettant d'amortir le mouvement des occupants.



AVERTISSEMENT

■ Précautions avec les coussins gonflables SRS

Respectez les précautions suivantes concernant les coussins gonflables SRS.

À défaut, des blessures graves, voire mortelles, pourraient s'ensuivre.

- Le conducteur et tous les passagers à bord du véhicule doivent porter leur ceinture de sécurité correctement. Les coussins gonflables SRS sont des dispositifs de protection complémentaires aux ceintures de sécurité.

**AVERTISSEMENT**

- Le coussin gonflable SRS conducteur se déploie avec une puissance considérable et peut occasionner des blessures graves, voire mortelles, notamment lorsque le conducteur se trouve très près du coussin gonflable.

L'autorité fédérale chargée de la sécurité routière aux États-Unis, la NHTSA (National Highway Traffic Safety Administration) conseille: Sachant que la zone de danger pour le coussin gonflable conducteur se trouve dans les premiers 2 à 3 in. (50 à 75 mm) du déploiement, placez-vous à 10 in. (250 mm) du coussin gonflable conducteur pour garantir une marge de sécurité suffisante. Cette distance est à mesurer entre le moyeu du volant de direction et le sternum. Si vous êtes assis à moins de 10 in. (250 mm), vous pouvez changer votre position de conduite de plusieurs façons:

- Reculez votre siège le plus possible, tout en continuant à pouvoir atteindre confortablement les pédales.

- Inclinez légèrement le dossier du siège.
Bien que les véhicules soient différents les uns des autres, la plupart des conducteurs peuvent s'asseoir à une distance de 10 in. (250 mm), même avec le siège conducteur complètement avancé, simplement en inclinant un peu le dossier de siège. Si vous avez des difficultés à voir la route après avoir incliné votre siège, utilisez un coussin ferme et antidérapant pour vous rehausser ou, si votre véhicule est équipé du réglage en hauteur du siège, remontez-le.
- Si votre volant de direction est réglable, inclinez-le vers le bas. Cela vous permet d'orienter le coussin gonflable vers votre buste plutôt que vers la tête et le cou.

Le siège doit être réglé selon les recommandations de la NHTSA ci-dessus, tout en conservant le contrôle des pédales et du volant, et la vue des commandes au tableau de bord.

⚠ AVERTISSEMENT

- Si vous attachez une rallonge de ceinture de sécurité aux boucles des ceintures de sièges avant, mais pas au pêne de la ceinture de sécurité proprement dite, les coussins gonflables SRS frontaux déterminent que le conducteur et le passager avant portent leur ceinture de sécurité, alors même qu'elle n'est pas attachée. Dans ce cas, les coussins gonflables SRS frontaux risquent de ne pas se déployer correctement en cas de collision, causant des blessures graves, voire mortelles. Veillez à porter la ceinture de sécurité avec la rallonge de ceinture de sécurité.

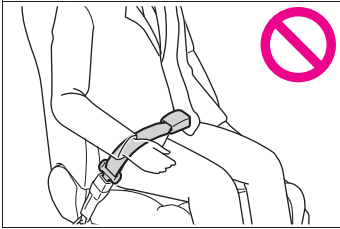

- Le coussin gonflable SRS passager avant se déploie également avec une puissance considérable et peut occasionner des blessures graves, voire mortelles, notamment lorsque le passager avant se trouve très près du coussin gonflable. Le siège du passager avant doit se trouver le plus loin possible du coussin gonflable et le dossier doit être réglé de manière à ce que le passager avant soit assis bien droit.

- Le déploiement d'un coussin gonflable peut infliger des blessures graves, voire mortelles, aux nourrissons et aux enfants mal assis et/ou mal attachés. Installez dans un siège de sécurité enfant les enfants trop jeunes pour pouvoir utiliser la ceinture de sécurité. Toyota recommande vivement que tous les nourrissons et enfants soient installés dans les sièges arrière du véhicule et convenablement attachés. Les sièges arrière sont plus sûrs pour les nourrissons et les enfants que le siège passager avant.
- Ne jamais installer un siège de sécurité enfant type dos à la route sur le siège passager avant, même si le témoin indicateur "AIR BAG OFF" est allumé. En cas d'accident, la force exercée par le déploiement rapide du coussin gonflable passager avant peut causer des blessures graves, voire mortelles à un enfant, si le siège de sécurité enfant type dos à la route est installé sur le siège passager avant.
- Ne pas s'asseoir sur le bord du siège et ne pas s'appuyer contre la planche de bord.

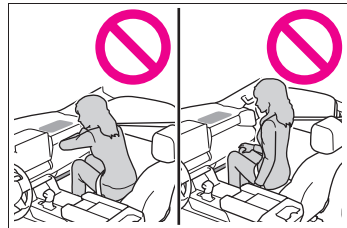

⚠ AVERTISSEMENT

- Ne pas laisser un enfant rester debout devant le coussin gonflable SRS passager avant ni assis sur les genoux du passager avant.

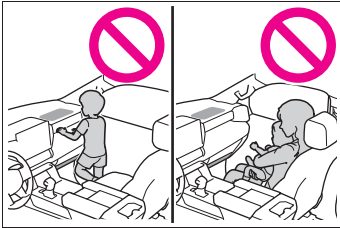

- Ne pas laisser les occupants des sièges avant voyager avec un objet sur les genoux.
- Ne pas s'appuyer contre la porte, contre le rail latéral de toit ou contre les montants avant, latéraux et arrière.



- Ne laissez personne s'agenouiller face à la portière sur les sièges du passager ou sortir la tête ou les mains à l'extérieur du véhicule.

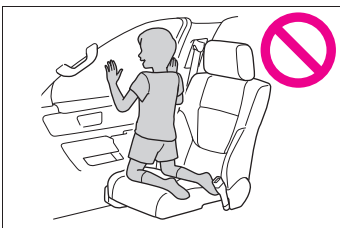

- Ne rien fixer ou disposer sur la planche de bord, la garniture centrale du moyeu de volant de direction et la partie inférieure du tableau de bord. Lors du déploiement des coussins gonflables SRS conducteur, passager avant et de genoux, tout objet risque de se transformer en projectile.

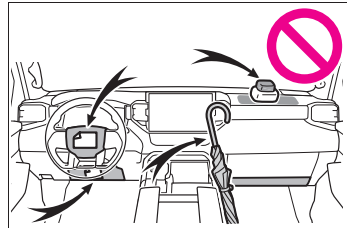

- Ne rien fixer sur les parties telles que les portes, la vitre de pare-brise, les vitres latérales, les montants avant et arrière, les rails latéraux de toit et les poignées de maintien.

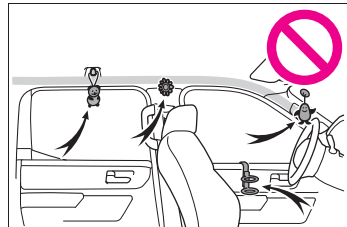

- Ne pas suspendre aux crochets à vêtements un cintre nu ni aucun autre objet dur ou tranchant. En cas de déploiement des coussins gonflables SRS rideau, tous ces objets pourraient se transformer en projectiles et causer des blessures graves, voire mortelles.
- Si une housse en vinyle recouvre la partie où le coussin gonflable SRS de genoux se déploie, veillez à l'enlever.



AVERTISSEMENT

- N'utilisez pour les sièges aucun accessoire venant recouvrir les parties où se déploient les coussins gonflables SRS latéraux, car il risquerait d'en gêner le déploiement. De tels accessoires peuvent empêcher les coussins gonflables SRS latéraux de s'activer correctement, neutraliser le système ou provoquer le déploiement accidentel des coussins gonflables SRS latéraux, provoquant ainsi des blessures graves, voire mortelles.
- Ne pas faire subir de chocs violents ni des pressions excessives aux parties renfermant les composants des coussins gonflables SRS, ni aux portes avant. En effet, cela pourrait entraîner un mauvais fonctionnement des coussins gonflables SRS.
- Ne touchez aucun composant du système immédiatement après le déclenchement (déploiement) des coussins gonflables SRS, car ils sont alors encore très chauds.
- Si vous avez des difficultés à respirer après le déploiement des coussins gonflables SRS, ouvrez une porte ou une vitre pour faire entrer de l'air frais, ou bien descendez du véhicule si cela ne présente pas de danger. Retirez tout résidu dès que possible afin d'éviter d'éventuelles irritations de la peau.

- Si les parties renfermant les coussins gonflables SRS, telles que la garniture centrale du volant de direction et les garnitures de montants avant et arrière, apparaissent abîmées ou craquelées, faites-les remplacer par votre concessionnaire Toyota.

- Ne rien poser sur le siège du passager avant, comme un coussin par exemple. Cela a pour conséquence de répartir le poids du passager sur toute la surface du siège, ce qui empêche le capteur de détecter normalement le poids du passager. En conséquence, les coussins gonflables SRS frontaux du passager avant peuvent ne pas se déployer en cas de collision.

■ Modification et élimination en fin de vie des éléments du système de coussins gonflables SRS

Ne mettez pas à la casse votre véhicule et ne lui apportez aucune des modifications suivantes sans consulter votre concessionnaire Toyota. Les coussins gonflables SRS peuvent ne pas fonctionner correctement ou se déployer (se gonfler) accidentellement, provoquant ainsi des blessures graves, voire mortelles.

- Installation, dépose, démontage et réparations des coussins gonflables SRS

- Réparations, modifications, démontage ou remplacement du volant de direction, du tableau de bord, de la planche de bord, des sièges ou de leur garnissage, des montants avant, latéraux et arrière, des rails latéraux de toit, des panneaux de portes avant, des garnitures de portes avant ou des haut-parleurs de portes avant

**AVERTISSEMENT**

- Modifications du panneau de porte avant (percer un trou dedans, par exemple)
- Réparation ou modification des ailes avant, du bouclier avant, ou des flancs de l'habitacle
- Installation d'un équipement de protection sur la calandre (pare-buffle, pare-kangourou, etc.), d'un chasse-neige, de treuils ou d'une galerie de toit
- Modification des suspensions du véhicule
- Installation d'appareils électroniques, tels qu'un émetteur/récepteur radio ou lecteur de CD
- Aménagements du véhicule visant à permettre sa conduite par une personne atteinte d'un handicap physique

Camper information

This information has been prepared in accordance with regulation issued by the National Highway Traffic Safety Administration of the U.S. Department of Transportation. It provides the purchasers and/or prospective purchasers of Toyota vehicles with information on truck-camper loading. Your Toyota dealer will help answer any questions you may have as you read this information.

Center of gravity location

The figures given in the illustration indicate the recommended center of gravity zone.

- 1 Recommended location for cargo center of gravity for cargo weight rating
- 2 Rear end of truck bed

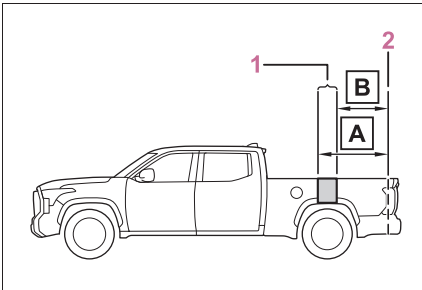

A	B
48.0 in. (1220 mm)	41.0 in. (1040 mm)

WARNING

■ Loading precaution

If a load is too far back, it can cause dangerous handling. If it is too far forward, the front axle may be overloaded.

Cargo weight rating and proper matching

When the truck is used to carry a slide-in camper, the total cargo load of the truck consists of the manufacturer's camper weight figure, the weight of installed additional camper equipment not included in the manufacturer's camper weight figure, the weight of camper cargo, and the weight of passengers in the camper. The total cargo load should not exceed the truck's cargo weight rating and the camper's center of gravity should fall within the truck's recommended center of gravity zone when installed.

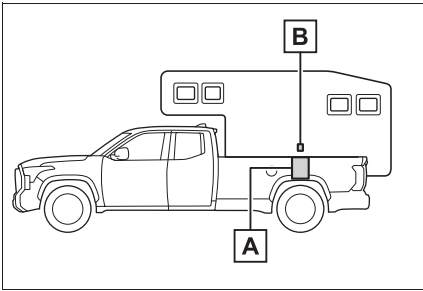

- A** Recommended center of gravity location zone
- B** Camper center of gravity

■ Cargo weight rating

No.	Model code *	Cab	Drive	Bed	Grade	Pas- sen- ger	Cargo Weight Rating	
							lbs	kg
1	VXKH70L- PSVLZA	CrewMax	2WD	Short	Limited	5	640	290
2	VXKH70L- PSVZZA				Platinum		615	280
3	VXKH71L- PRVLZA			Standard	Limited		670	305
4	VXKH75L- PSVLZA		4WD	Short	Limited		595	270
5	VXKH75L- PSVUZA				Capstone		585	265
6	VXKH75L- PSVZZA				Platinum		540	245
7	VXKH76L- PRVLZA			Standard	Limited		640	290
8	VXKH76L- PRVZZA				Platinum		575	260

*: The model code is indicated on the Certification Label. (→P.568)



WARNING

■ Overloading

Be careful — overloading can cause dangerous braking and handling problems, and can damage your vehicle and its tires.

Gross axle and vehicle weight ratings

Secure loose items to prevent weight shifts that could affect the balance of your vehicle. When the truck camper is loaded, drive to a scale and weigh on the front and on the rear wheels separately to determine axle loads. Individual axle loads should not exceed either of the Gross Axle Weight Ratings (GAWR). The total of the axle loads should not exceed the Gross Vehicle Weight Rating (GVWR). These ratings are given on the vehicle certification label which is located on the door latch post on the left side of the vehicle. (→P.568) If weight ratings are exceeded, move or remove items to bring all weights below the ratings.

► Gross axle weight rating

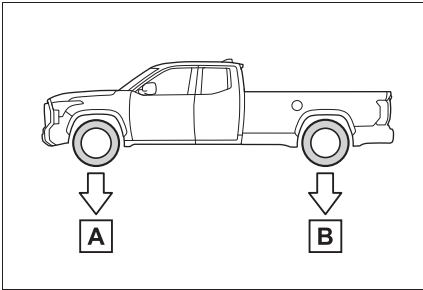

A Front GAWR

B Rear GAWR

► Gross vehicle weight rating

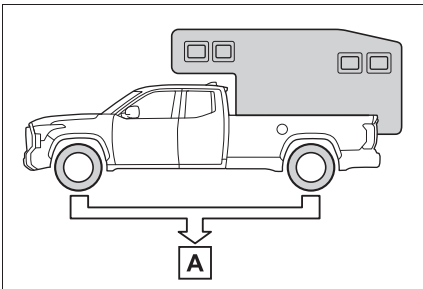

A Not exceed GVWR

■ GAWR and GVWR

Model code *1	Engine	Driving system	Bed type	GAWR		GVWR
				Front	Rear	
VXKH70L -PSVLZA	V35A- FTS	2WD	Short	4080 lb. (1850 kg)	4080 lb. (1850 kg)	7375 lb. (3345 kg)
VXKH70L -PSVZZA						7430 lb. (3370 kg)
VXKH71L -PRVLZA			7465 lb. (3385 kg)			
VXKH75L -PSVLZA		4WD	Short			7630 lb. (3460 kg) ^{*2}
VXKH75L -PSVUZA						7605 lb. (3450 kg) ^{*3}
VXKH75L -PSVZZA						7650 lb. (3470 kg)
VXKH75L -PSVZZA						7630 lb. (3460 kg)
VXKH76L -PRVLZA						Standard
VXKH76L -PRVZZA		7780 lb. (3530 kg)				

*1: The model code is indicated on the Certification Label. (→P.568)

*2: TRD Pro models

*3: Except TRD Pro models

Index

What to do if... (Trouble-shooting) **620**
Alphabetical Index..... **623**

What to do if... (Troubleshooting)

If you have a problem, check the following before contacting your Toyota dealer.

The doors cannot be locked, unlocked, opened or closed



You lose your keys

- If you lose your keys, new keys can be made by your Toyota dealer. (→P.553)
- If you lose your electronic keys, the risk of vehicle theft increases significantly. Contact your Toyota dealer immediately. (→P.553)



The electronic key does not operate properly

- Is the electronic key battery weak or depleted? (→P.510)



The doors cannot be locked or unlocked

- Is the power switch in ON?

When locking the doors, turn the power switch off. (→P.210)

- Is the electronic key left inside the vehicle?

When locking the doors, make sure that you have the electronic key on

your person.

- The function may not operate properly due to the condition of the radio wave. (→P.133)



The rear door cannot be opened

- Is the child-protector lock set?

The rear door cannot be opened from inside the vehicle when the lock is set. Open the rear door from outside and then unlock the child-protector lock. (→P.116)

If you think something is wrong



The hybrid system does not start

- Did you press the power switch while firmly depressing the brake pedal? (→P.207)
- Is the shift lever in P? (→P.207)
- Is the electronic key anywhere detectable inside the vehicle? (→P.131)
- Is the electronic key battery weak or depleted?

In this case, the hybrid system can be started in a temporary way. (→P.554)

- Is the 12-volt battery discharged? (→P.555)



The shift lever cannot be shifted from P even if you depress the brake pedal

- Is the power switch in ON?

If you cannot release the shift lever by depressing the brake pedal with the power switch in ON. (→P.213)



The windows do not open or close by operating the power window switches

- Is the window lock switch pressed?

The power window except for the one at the driver's seat cannot be operated if the window lock switch is pressed. (→P.171)



The power switch is turned off automatically

- The auto power off function will be operated if the vehicle is left in ACC or ON (the hybrid system is not operating) for a period of time. (→P.211)



A warning buzzer sounds during driving

- The seat belt reminder light is flashing

Are the driver and the front passenger wearing the seat belts? (→P.533)

- The parking brake indicator is on

Is the parking brake released? (→P.217)

Depending on the situation, other types of warning buzzer may also sound. (→P.527, 537)



An alarm is activated and the horn sounds

- Did anyone inside the vehicle open a door during setting the alarm?

The sensor detects it and the alarm sounds. (→P.83)

Do one of the following to deactivate or stop the alarms:

- Unlock the doors using the entry function or wireless remote control.
- Turn the power switch to ACC or ON, or start the hybrid system. (The alarm will be deactivated or stopped after a few seconds.)



A warning buzzer sounds when leaving the vehicle

- Is the message displayed on the multi-information display?

Check the message on the multi-information display. (→P.527)



**A warning light turns on
or a warning message is
displayed**

- When a warning light turns on or a warning message is displayed, refer to P.527, 537.

**When a problem has
occurred**



If you have a flat tire

- Stop the vehicle in a safe place and replace the flat tire with the spare tire. (→P.541)



**The vehicle becomes
stuck**

- Try the procedure for when the vehicle becomes stuck in mud, dirt, or snow. (→P.564)

Alphabetical Index

A

- A/C** 418
- Air conditioning filter 505
- Automatic air conditioning system 418
- Front seat concentrated airflow mode (S-FLOW) 422
- ABS (Anti-lock Brake System)** 393
- Warning light 529
- Acoustic vehicle alerting system** 75
- Active front spoiler** 406
- Adaptive Variable Suspension System (AVS)** 393
- AHB (Automatic High Beam)** 226
- AI-SHIFT** 213
- Air conditioning filter** 505
- Air conditioning system** 418
- Air conditioning filter 505
- Automatic air conditioning system 418
- Front seat concentrated airflow mode (S-FLOW) 422
- Air suspension** 373
- Airbags** 36
- Airbag operating conditions 38
- Airbag precautions for your child 41
- Correct driving posture 27
- Curtain shield airbag operating conditions 39
- Curtain shield airbag precautions 41
- Front passenger occupant classification system 46
- General airbag precautions 41
- Locations of airbags 36
- Modification and disposal of airbags 44
- Side airbag operating conditions 39
- Side airbag precautions 41
- Side and curtain shield airbags operating conditions 39
- Side and curtain shield airbags precautions 41
- SRS airbags 36
- SRS warning light 528
- Alarm** 83
- Warning buzzer 527
- Ambient lights** 428
- Anchor brackets** 55, 58
- Antennas (smart key system)** 131
- Anti-lock Brake System (ABS)** 393
- Warning light 529
- Approach warning** 277
- Armrest** 449
- Assist grips** 449
- Audio system-linked display** ... 98
- AUTO LSD system** 381
- Automatic air conditioning system** 418
- Automatic headlight leveling system** 224
- Automatic High Beam** 226
- Automatic light control system** 224
- Automatic transmission** 212
- If the shift lever cannot be shifted from P 213
- S mode 214
- TOW HAUL switch 212
- Auxiliary boxes** 434
- Average fuel economy** 97
- Average vehicle speed** 98
- AVS (Adaptive Variable Suspension System)** 393

B

Back window
 Power back window 172

Back-up lights
 Replacing light bulbs 516

Battery (12-volt battery) 488
 Battery checking 488
 If the 12-volt battery is dis-
 charged 555
 Preparing and checking before
 winter 413
 Warning light 528

Battery (traction battery) 77

Bed hooks 435

Bed lamp 428
 Replacing light bulbs 516

Blind Spot Monitor (BSM) 281
 Enabling/disabling the system
 283
 Trailer settings 100

Boost Meter 94

Bottle holders 433

Brake
 Brake hold 220
 Fluid 486, 573
 Parking brake 217
 Regenerative braking 74
 Warning light 527

Brake assist 393

Brake hold 220

Brake Override System 182

Break-in tips 182

Brightness control
 Instrument panel light control . 94

BSM (Blind Spot Monitor) 281
 Enabling/disabling the system
 283
 Trailer settings 100

C

Camper information 613

Care 466, 469
 Aluminum wheel ornaments . 466
 Aluminum wheels 466
 Exterior 466
 Hybrid battery (traction battery)
 air intake vents 506
 Interior 469
 Seat belts 469

Cargo and luggage 188

Cargo capacity 190

Cargo lamp 428
 Replacing light bulbs 516

Chains 415

Child restraint system 53
 Fixed with a LATCH system ... 60
 Fixed with a seat belt 63
 Front passenger occupant clas-
 sification system 46
 Points to remember 53
 Riding with children 52
 Types of child restraint system
 installation method 55
 Using an anchor bracket 58

Child safety 52
 12-volt battery precautions ... 489
 Airbag precautions 41
 Battery precautions 559
 Child restraint system 55
 Heated steering wheel and seat
 heater precautions 425
 How your child should wear the
 seat belt 30
 Panoramic moon roof 175
 Power back window 172
 Power window lock switch 171
 Power window precautions ... 170
 Rear door child-protectors ... 116
 Removed electronic key battery
 precautions 511

Seat belt extender precautions
..... 30

Seat belt precautions 52

Child-protectors 116

Cleaning 466, 469

Aluminum wheel ornaments 466

Aluminum wheels 466

Exterior 466

Interior 469

Radar sensor 238

Seat belts 469

Clock 91

Coat hooks 450

Condenser 486

Console box 434

Console box light 428

Consumption screen 107

Coolant 484

Checking 484

Cooling system 484

Engine overheating 561

Coussins gonflables

Modification et élimination en fin
de vie des coussins gonflables
..... 611

Crawl Control 383

Cruise control

Dynamic radar cruise control
with full-speed range 268

Cup holders 432

Current fuel consumption 97

Curtain shield airbags 36

Customizable features 588

D

DAC 390

Daytime running light system 223

Daytime running lights

Replacing light bulbs 516

Deck divider 436, 438

Defogger

Outside rear view mirrors 420

Rear window 420

Windshield 419

Differential 573

Digital Rear-view Mirror 154

Dimension 566

Dinghy towing 206

Display

Dynamic radar cruise control
with full-speed range 268

Head-up display 102

Intuitive parking assist 289

LTA (Lane Tracing Assist) 260

Multi-information display 95

Warning messages 537

Display change button 94

**Distance until next engine oil
change 93**

Do-it-yourself maintenance ... 473

Door courtesy lights 428

Door lock

Side doors 113

Smart key system 131

Wireless remote control 111

Doors

Automatic door locking and
unlocking system 117

Door glasses 169

Door lock 113

Open door warning buzzer . 114,
116

Outside rear view mirrors 164

Rear door child-protectors 116

Side doors 113

**Downhill assist control system
..... 390**

Drive distance 98

Drive information 98

Drive-start control 187

Driving **181**
 Break-in tips 182
 Correct driving posture 27
 Hybrid Electric Vehicle driving tips 408
 Procedures 181
 Winter drive tips 413
Driving information display **97**
Driving mode select switch ... **376**
Driving position memory **144**
 Memory recall function 146
 Power easy access system .. 144
Driving range **97**
Dynamic radar cruise control with full-speed range **268**
 Approach warning 277
 Warning message 279

E

ECB (Electronically Controlled Brake System) **393**
 Warning light 527
EDR (Event data recorder) **9**
Elapsed time **98**
Electric motor (traction motor) **73**
Electric Power Steering (EPS) **394**
 Warning light 529
Electronic key **110**
 Battery-saving function 132
 If the electronic key does not operate properly 553
 Replacing the battery 510
Electronic sunshade **173**
Electronically Controlled Brake System (ECB) **393**
 Warning light 527
Electronically modulated air suspension **373**
Emergency flashers **520**
Emergency tire puncture **541**

Emergency, in case of
 If a warning buzzer sounds ..527
 If a warning light turns on527
 If a warning message is displayed537
 If the 12-volt battery is discharged555
 If the electronic key does not operate properly553
 If the hybrid system will not start551
 If the vehicle is submerged or water on the road is rising ..521
 If you have a flat tire541
 If you lose your keys553
 If you think something is wrong525
 If your vehicle becomes stuck564
 If your vehicle has to be stopped in an emergency520
 If your vehicle needs to be towed523
 If your vehicle overheats561
Engine..... **569**
 ACC210
 Compartment481
 How to start the hybrid system207
 If the hybrid system will not start551
 If your vehicle has to be stopped in an emergency520
 Overheating561
 Power switch207
Engine coolant..... **484**
 Capacity571
 Checking484
 Preparing and checking before winter413
Engine coolant temperature gauge **91**

Engine oil	
Capacity	570
Checking	482
Warning light	528
Engine oil pressure gauge	91
Engine switch (power switch)	207
Auto power off function	211
Changing the power switch modes	210
If your vehicle has to be stopped in an emergency.....	520
Starting the hybrid system....	207
Enhanced Vehicle Stability Control (Enhanced VSC)	393
Enhanced VSC (Enhanced Vehicle Stability Control)	393
EPS (Electric Power Steering)	394
Warning light	529
Event data recorder (EDR).....	9

F

Flat tire	541
Tire pressure warning system	493
Floor mats	26
Fluid	
Automatic transmission	572
Brake	573
Washer	487
Fog light	
Replacing light bulbs	516
Switch.....	226
Footwell lights	428
Four-wheel drive system	379
Front fog light	
Replacing light bulbs	516
Front passenger occupant classification system	46
Front seat	
Refresh system	137

Front seats	136
Adjustment	136
Cleaning	469
Correct driving posture	27
Driving position memory	144
Head restraints	148
IsoDynamic Performance seat	138
Memory recall function	146
Power easy access system ..	144
Seat heaters	425
Seat position memory.....	144
Seat ventilators.....	425
Front tray light	428
Front turn signal lights	216
Turn signal lever	216
Front turn signal/parking lights	
Replacing light bulbs	516, 517
Wattage	575
Fuel	
Capacity	569
Fuel gauge	91
Information	576
Opening the fuel tank cap	234
Type.....	569
Warning light.....	533
Fuel consumption	
Average fuel economy.....	97
Current fuel consumption	97
Fuel economy	97
Fuel gauge.....	91
Fuses	512

G

Garage door opener	457
Gauges	91
Glove box	432
Glove box light.....	428

H

Head restraints 148

Head-up display 102

 Driving support system display area 104

 HUD (Head-up display) switch 103

 Hybrid System Indicator 106

 Navigation system-linked display area 104

 Outside temperature 102

 Pop-up display 105

 Settings 104

Headlights

 Automatic High Beam system 226

 Light switch 223

 Replacing light bulbs 516

Heated steering wheel 425

Heaters

 Automatic air conditioning system 418

 Heated steering wheel 425

 Outside rear view mirrors 420

 Seat heaters 425

High mounted stoplight

 Replacing light bulbs 516

High-voltage components 77

Hill-start assist control 393

Hood 480

 Open 480

Hooks

 Coat hooks 450

 Retaining hooks (floor mat) 26

Horn 152

HUD (Head-up display) switch 103

Hybrid battery (traction battery)

 Location 77

 Warning message 81

Hybrid battery (traction battery) air intake vents 80

 Cleaning 506

Hybrid Electric Vehicle driving tips 408

Hybrid Power Meter 94

Hybrid system 73

 Acoustic vehicle alerting system 75

 Emergency shut off system 80

 High voltage components 77

 Hybrid system precautions 77

 If the hybrid system will not start 551

 Power (ignition) switch 207

 Regenerative braking 74

 Starting the hybrid system 207

 Warning lights 528

Hybrid System Indicator .. 97, 106

I

Identification

 Vehicle 568

Ignition switch (power switch) 207

 Auto power off function 211

 Changing the power switch modes 210

 If your vehicle has to be stopped in an emergency 520

 Starting the hybrid system 207

Immobilizer system 82

Indicators 89

Initialization

 Items to initialize 600

 Parking Support Brake 306

 Power windows 169

 Tire pressure warning system 495

Inside rear view mirror 153

Instrument panel light control .. 94

Intercooler 486

Intercooler coolant	484
Capacity	571
Checking	484
Interior lights	428
Wattage	575
Interior lights list	428
Intuitive parking assist	288
Enabling/disabling the system	
.....	289
Function	288
Warning lights.....	530
Warning message	291

J

Jam protection function	
Electronic sunshade	174
Panoramic moon roof.....	174
Power running boards	118
Power tailgate	123
Power windows	169

K

Keyless entry	
Smart key system.....	131
Wireless remote control	111
Keys	110
Battery-saving function.....	132
Electronic key.....	110
If the electronic key does not	
operate properly	553
If you lose your keys	553
Key number plate	110
Keyless entry.....	113, 120, 131
Mechanical key	110
Power switch	207
Replacing the battery	510
Warning buzzer	131
Wireless remote control	111
Knee airbags	36

L

Lane Tracing Assist (LTA)	254
Operation.....	254
Warning lights.....	530
Warning messages.....	265
Language (multi-information display)	99
LATCH anchors	60
Lever	
Auxiliary catch lever	480
Hood lock release lever	480
Shift lever	213
Turn signal lever	216
Wiper lever	230
License plate lights	
Light switch.....	223
Replacing light bulbs	516
Light bulbs	
Replacing	515
Lights	
Ambient lights	429
Automatic High Beam system	
.....	226
Cargo lamp.....	430
Fog light switch.....	226
Headlight switch	223
Interior lights	428, 429
Personal lights.....	429
Replacing light bulbs	516
Trailing light	168
Turn signal lever	216
Vanity lights	456
Wattage	575
LTA (Lane Tracing Assist)	254
Operation.....	254
Warning lights.....	530
Warning messages.....	265
Luggage compartment features	
.....	435
Bed hooks	435
Deck divider.....	436, 438

M

Maintenance

- Do-it-yourself maintenance .. 478
- General maintenance 473
- Maintenance data 566
- Maintenance requirements... 472

Malfunction indicator lamp.... 528

Manual headlight leveling dial
..... **225**

Menu icons 96

Meter

- Boost Meter 94
- Clock 91
- Engine oil pressure gauge 91
- Hybrid Power Meter 94
- Indicators 89
- Instrument panel light control . 94
- Meter control switches 96
- Meters 91
- Multi-information display 95
- Pitch and roll gauges 94
- Settings 99
- Tow gauges 94
- Voltmeter 91
- Warning lights 87, 527
- Warning messages 537

Meter control switches 96

Mirrors

- Digital Rear-view Mirror 154
- Inside rear view mirror 153
- Outside rear view mirror defog-
gers 420
- Outside rear view mirrors 164
- Vanity mirrors 456

Mode select switch

- TOW HAUL switch 215

Multi-information display 95

- Audio system-linked display ... 98
- Changing the display 96
- Driving information display 97
- Dynamic radar cruise control
with full-speed range 268
- Fuel economy 97
- Hybrid System Indicator 97
- Intuitive parking assist 289
- LTA (Lane Tracing Assist) 260
- Menu icons 96
- Meter control switches 96
- Navigation system-linked display
..... 98
- Settings 99
- Tire pressure 493
- Trailer settings 100
- Vehicle information display 98
- Warning messages 537

Multi-terrain Monitor 361

- Automatic display mode 364
- Camera switch 361
- Function 362
- Menu button 362
- Multi-terrain Monitor precautions
..... 372
- Screen display and functions 365
- Things you should know 372

Multi-terrain Select 387

N

Navigation system-linked display

- **98, 102**

O

Odometer 93

Odometer and trip meter display

- Display change button 94
- Display items 93

Off-road precautions 410

Oil
 Differential oil 573
 Engine oil 570
 Transfer oil 572

Opener
 Hood..... 480
 Opening the fuel tank cap 234

Outside rear view mirrors
 Adjustment 164
 BSM (Blind Spot Monitor)..... 281
 Folding 166
 Mirror position memory 144
 Outside rear view mirror defog-
 gers 420
 RCTA (Rear Cross Traffic Alert)
 295

Outside temperature 91, 106

Overheating 561

P

Panic mode 112

Panoramic moon roof 173

Panoramic view monitor 324
 Camera switch 326
 Checking around the vehicle 329
 Checking the bed 346
 Checking the front and around
 the vehicle 331
 Checking the rear and around
 the vehicle 336
 Customizing the panoramic view
 monitor 347
 Display 328
 Driving precautions 324
 Magnifying function 347
 Menu button 327
 Panoramic view monitor precau-
 tions..... 348
 Things you should know..... 359

**Parking assist sensors (intuitive
 parking assist)..... 288**

Parking brake.....217
 Brake system warning light ..527
 Parking brake engaged warning
 buzzer.....219
 Warning light.....532
 Warning message.....219

Parking lights
 Light switch.....223

Parking Support Brake (PKSB)
301
 Enabling/disabling the system
303
 Parking Support Brake function
 (rear-crossing vehicles)309
 Parking Support Brake function
 (static objects)306
 Warning lights.....530
 Warning message.....306

PCS (Pre-Collision System)...242
 Enabling/disabling the system
246
 Function.....242
 Warning light.....529

Personal lights.....428

Pitch and roll gauges 94

PKSB (Parking Support Brake)
301
 Enabling/disabling the system
303
 Parking Support Brake function
 (rear-crossing vehicles)309
 Parking Support Brake function
 (static objects)306
 Warning lights.....530
 Warning message.....306

Power back window172

Power bed step129

Power control unit.....77

Power control unit coolant484
 Capacity571
 Checking484

Power easy access system ...144

Power outlet.....450, 451
Power running boards 117
Power steering (Electric power steering system)
 Warning light 529
Power switch207
 Auto power off function 211
 Changing the power switch modes 210
 If your vehicle has to be stopped in an emergency..... 520
 Starting the hybrid system.... 207
Power switch light..... 428
Power tailgate
 Wireless remote control 121
Power tailgate opener switch 121
Power windows
 Door lock linked window operation 170
 Jam protection function 169
 Operation 169
 Window lock switch 171
Pre-Collision System (PCS)... 242
 Enabling/disabling the system 246
 Function 242
 Warning light 529

R

Radar cruise control (dynamic radar cruise control with full-speed range).....268
Radiator.....486
RCTA (Rear Cross Traffic Alert)
 295
 Enabling/disabling the system 296
 Warning lights..... 531
 Warning message 296

Rear Cross Traffic Alert (RCTA)
 295
 Enabling/disabling the system 296
 Warning lights..... 531
 Warning message..... 296
Rear differential lock system.....382
Rear door sunshades.....456
Rear seats141
 Cleaning 469
 Head restraints 148
 Seat heaters 425
 Seat ventilators..... 425
Rear turn signal lights.....216
 Replacing light bulbs 516
 Turn signal lever 216
Rear view mirror
 Digital Rear-view Mirror 154
 Inside rear view mirror 153
 Outside rear view mirrors 164
Rear window defogger420
Refueling234
 Capacity 569
 Fuel types 569
 Opening the fuel tank cap 234
Regenerative braking 74
 Warning lights..... 527

Replacing
 Electronic key battery 510
 Fuses..... 512
 Light bulbs 515
Road accident cautions 78
Road Sign Assist265
RSA (Road Sign Assist)265

S

Safety Connect 68
Seat
 Front seat refresh system..... 137
Seat belt reminder light.....533

Seat belts29

- Adjusting the seat belt shoulder anchor height34
- Automatic Locking Retractor ..31
- Child restraint system installation55
- Cleaning and maintaining the seat belt..... 469
- Emergency Locking Retractor 31
- How to wear your seat belt..... 30
- How your child should wear the seat belt.....30
- Pregnant women, proper seat belt use..... 29
- Reminder light and buzzer ...533
- Seat belt extender 30
- Seat belt pretensioners 34
- SRS warning light..... 528

Seat heaters425**Seat position memory 144****Seat ventilators425****Seating capacity 190, 567****Seats 136, 141**

- Adjustment 136
- Adjustment precautions136, 142, 143
- Child seats/child restraint system installation 53
- Cleaning 469
- Driving position memory..... 144
- Folding down and returning the rear seatbacks..... 141
- Head restraints..... 148
- IsoDynamic Performance seat 138
- Power easy access system .. 144
- Properly sitting in the seat..... 27
- Seat heaters..... 425
- Seat position memory 144
- Seat ventilators 425

Sensor

- Automatic headlight system .224
- Automatic High Beam system226
- BSM (Blind Spot Monitor).....282
- Dynamic radar cruise control with full-speed range237
- Inside rear view mirror.....153
- Intuitive parking assist288
- LTA (Lane Tracing Assist).....254
- Parking Support Brake function (rear-crossing vehicles)282
- Parking Support Brake function (static objects)288
- PCS (Pre-Collision System) .237
- Radar sensor237
- Rain-sensing windshield wipers233
- RCTA (Rear Cross Traffic Alert)282

Service plug77**Shift lever213**

- Automatic transmission212
- If the shift lever cannot be shifted from P.....213

Shift lever light.....428**Shift lock system213****Side airbags36****Side marker lights**

- Light switch.....223
- Replacing light bulbs516

Side mirrors

- Adjustment 164
- BSM (Blind Spot Monitor).....281
- Folding.....166
- Heaters.....420
- Mirror position memory.....144
- RCTA (Rear Cross Traffic Alert)295

Side turn signal lights216

- Replacing light bulbs516
- Turn signal lever216

Side windows	169
Smart key system	131
Antenna location	131
Entry functions	113, 120
Starting the hybrid system....	207
Snow tires	413
Spare tire	
Inflation pressure.....	574
Storage location	542
Spark plug	571
Specifications	566
Speedometer	91
Steering wheel	
Adjustment	151
Heated steering wheel	425
Meter control switches	96
Power easy access system..	144
Steering wheel position memory	144
Stop lights	
Replacing light bulbs	516
Storage features	431
Stuck	
If the vehicle becomes stuck	564
Sun visors	455
Switches	
Activating the Automatic High Beam.....	226
Automatic High Beam system	226
Brake Hold switch	220
DAC/CRAWL switch.....	383, 390
Display change button.....	94
Door lock switches	116
DRIVE MODE switch	376
Driving position memory switches	144
Dynamic radar cruise control with full-speed range switch	269
Emergency flashers switch ..	520
Fog light switch	226
Front-wheel drive control switch	379
Garage door opener switches	457
Heated steering wheel switch	425
Height control mode select switch	373
Height control switch	373
HUD (Head-up display) switch	103
Light bar	230
Light switches.....	223
LTA (Lane Tracing Assist) switch	260
Meter control switches.....	96
Mode select switch	376, 383, 387, 390
MTS switch.....	387
Outer mirror extend switch ..	167
Outside rear view mirror switches.....	164
Panoramic moon roof switches	173
Parking brake switch	217
PKSB (Parking Support Brake)	303
Power door lock switch.....	116
Power steps switch.....	119, 130
Power switch	207
Power tailgate opener switch	121
Power window switches	169
Rear differential lock system	382
Rear window and outside rear view mirror defoggers switch	420
Seat heater switches	425
Seat ventilator switches.....	425
“SOS” button	68
Tilt and telescopic steering control switch	151

Tire pressure warning reset switch 496
 TOW HAUL switch 215
 Trailer brake control switch .. 398
 Trailering light switch..... 168
 Vehicle-to-vehicle distance switch 269
 VSC OFF switch..... 394
 Window lock switch 171
 Windshield defogger switch . 419
 Windshield wiper and washer switch 230
 Windshield wiper de-icer switch 423

T

Tail lights

Light switch 223
 Replacing light bulbs 516

Tailgate 120

Power tailgate 121
 Removing the tailgate 126

The Secondary Collision Brake 394

Theft deterrent system

Alarm 83
 Immobilizer system 82

Tire inflation pressure..... 501

Maintenance data..... 574
 Tire inflation pressure display function..... 493
 Warning light 532

Tire information 578

Glossary 582
 Size 580
 Tire identification number 579
 Uniform Tire Quality Grading 581

Tire pressure display 493

Tire pressure warning system

..... 493
 Function 493
 Initializing 495

Installing tire pressure warning valves and transmitters 495
 Registering ID codes 498
 Selecting wheel set 500
 Warning light..... 532

Tires 490

Chains 415
 Checking 490
 If you have a flat tire 541
 Inflation pressure 501
 Information 578
 Replacing 541
 Rotating tires 492
 Size 574
 Snow tires..... 413
 Tire inflation pressure display function..... 493
 Tire pressure warning system 493
 Warning light..... 532

Tools 542

Top tether strap 58

Tow gauges 94

TOW HAUL switch 215

Towing

Dinghy towing..... 206
 Emergency towing 523
 Trailer Backup Guide..... 401
 Trailer settings 100
 Trailer towing 191

Toyota parking assist monitor

..... 311
 Distance guide line display mode 316
 Driving precautions..... 311
 Estimated course line display mode 315
 Parking assist guide line display mode 316
 Screen display 313
 Things you should know 322

Toyota parking assist monitor
 precautions.....317
 Using the system.....314
Toyota Safety Sense 2.5**237**
 AHB (Automatic High Beam) 226
 Dynamic radar cruise control
 with full-speed range 268
 LTA (Lane Tracing Assist).....254
 PCS (Pre-Collision System) .242
 RSA (Road Sign Assist)265
TRAC (Traction Control)**393**
Traction battery (hybrid battery)
**77**
 Hybrid battery (traction battery)
 air intake vents 80
 Location.....77
 Specification.....569
 Warning message 81
Traction Control (TRAC)**393**
Traction motor (electric motor)**73**
 Specification.....569
Trailer Backup Guide**401**
 Canceling the system.....404
 Precautions405
 Procedure.....402
 Setup (Calibration)403
 Trailer hitch light.....405
 Using Guidance mode.....404
 Using Straight Path Assist....404
Trailer brake**398**
Trailer brake controller**398**
 Trailer settings.....100
Trailer hitch light**405, 428**
 Replacing light bulbs516
Trailer settings.....**100**
Trailer Sway Control**393**
Trailer towing.....**191**
 Trailer Backup Guide.....401
 Trailer settings.....100
Trailer light
 Replacing light bulbs516
Transfer**572**

Transmission
 Automatic transmission212
Trip meters**93**
Turn signal lights.....**216**
 Replacing light bulbs516
 Turn signal lever216

U

USB charging ports.....**440**

V

Vanity lights**456**
Vanity mirrors**456**
Vehicle capacity weight**567**
Vehicle data recording**7**
Vehicle identification number**568**
Vehicle information display**98**
Ventilators (seat ventilators) .**425**
Voltmeter**91**

W

Warning buzzers
 Approach warning277
 Brake hold532
 Brake Override System531
 Brake system.....527
 Charging system528
 Downshifting215
 Drive-Start Control.....531
 Electric power steering529
 Engine528
 Hands off steering wheel warn-
 ing (LTA)264
 Hybrid system.....528
 Intuitive parking assist ..294, 530
 Low engine oil pressure528
 LTA (Lane Tracing Assist) ...254,
 258, 530
 Open door114, 116
 Open window.....170

- PCS (Pre-Collision System)529
 PKSB (Parking Support Brake)
 530
 Pre-collision braking 242
 Pre-collision warning 242
 RCTA (Rear Cross Traffic Alert)
 296, 531
 Seat belt 533
 SRS airbag 528
 Vehicle sway warning function
 (LTA)..... 264
Warning label 77
Warning lights 87, 527
 ABS 529
 Air suspension malfunction indi-
 cator 534
 Brake hold operated indicator
 532
 Brake Override System 531
 Brake system 527
 Charging system 528
 Drive-Start Control 531
 Electric power steering 529
 High coolant temperature 527
 Hybrid system 528
 Intuitive parking assist OFF indi-
 cator 530
 Low engine oil pressure 528
 Low fuel level 533
 LTA indicator 530
 Malfunction indicator lamp ... 528
 Parking brake indicator 532
 PKSB OFF indicator 530
 Pre-collision system 529
 RCTA OFF indicator 531
 Rear differential lock indicator
 532
 Seat belt reminder light 533
 Slip indicator 531
 SRS airbag 528
 Tire pressure 532
 Trailer brake warning light 534
Warning messages 537
Washer 230
 Adding 487
 Preparing and checking before
 winter 413
 Switch 230
Washing and waxing 466
Weight
 Cargo capacity 190
 Load limits 190
Wheel lock nut 543
Wheels 503
 Replacing 503
 Size 574
 Wheel lock nut 543
Window lock switch 171
Windows
 Power back window 172
 Power windows 169
 Rear window defogger 420
 Washer 230
Windshield defogger 419
Windshield wipers 230
 Rain-sensing windshield wipers
 230
Winter driving tips 413
Wireless charger 441
Wireless remote control 111
 Battery-Saving Function 132
 Locking/Unlocking 111
 Replacing the battery 510
-
- For information regarding
 the equipment listed
 below, refer to the “MUL-
 TIMEDIA OWNER’S MAN-
 UAL”.**
 - Navigation system
 - Audio/visual system

Certifications

Safety Connect

FCC ID: JOYCW1011

NOTE

This device complies with part 15 of the FCC Rules. Operation is subject to the following two conditions: (1) This device may not cause harmful interference, and (2) this device must accept any interference received, including interference that may cause undesired operation.

FCC WARNING

Changes or modifications not expressly approved by the party responsible for compliance could void the user's authority to operate the equipment.

Co-location: This transmitter must not be co-located or operated in conjunction with any other antenna or transmitter.

CAUTION : Radio Frequency Radiation Exposure

This equipment complies with FCC radiation exposure limits set forth for an uncontrolled environment and meets the FCC radio frequency (RF) Exposure Guidelines. This equipment should be installed and operated keeping the radiator at least 20cm or more away from person's body.

IC: 574B-CW1011

NOTE

This device contains licence-exempt transmitter(s)/receiver(s) that comply with Innovation, Science and Economic Development Canada's licence-exempt RSS(s). Operation is subject to the following two conditions:

(1) This device may not cause interference.

(2) This device must accept any interference, including interference that may cause undesired operation of the device.

The antenna cannot be removed (and changed) by user.

Co-location: This transmitter must not be co-located or operated in conjunction with any other antenna or transmitter.

CAUTION: Radio Frequency Radiation Exposure

This equipment complies with ISED radiation exposure limits set forth for an uncontrolled environment and meets RSS-102 of the ISED radio frequency (RF) Exposure rules. This equipment should be installed and operated keeping the radiator at least 20 cm or more away from person's body.

NOTE

L'émetteur/récepteur exempt de licence contenu dans le présent appareil est conforme aux CNR d'Innovation, Sciences et Développement économique Canada applicables aux appareils radio exempts de licence. L'exploitation est autorisée aux deux conditions suivantes :

- (1) L'appareil ne doit pas produire de brouillage;
- (2) L'appareil doit accepter tout brouillage radioélectrique subi, même si le brouillage est susceptible d'en compromettre le fonctionnement.

L'utilisateur n'est pas autorisé à retirer (ou modifier) l'antenne.

Emplacement: Cet émetteur ne doit pas être installé ou utilisé conjointement avec d'autres antennes ou émetteurs.

ATTENTION : exposition aux radiofréquences

Cet équipement est conforme aux limites d'exposition aux rayonnements ISDE établies pour un environnement non contrôlé et satisfait à la norme CNR-102 de la réglementation ISDE sur l'exposition aux radiofréquences (RF). Cet équipement doit être installé et utilisé avec un minimum de 20 cm de distance entre la source de rayonnement et le corps.

Smart key system and immobilizer system

- For vehicles sold in U.S.A.

FCC ID:NI4TMLF19D-1

FCC ID:HYQ14FBX

This device complies with part 15 of the FCC Rules. Operation is subject to the following two conditions: (1) This device may not cause harmful interference, and (2) this device must accept any interference received, including interference that may cause undesired operation.

Changes or modifications not expressly approved by the party responsible for compliance could void the user's authority to operate the equipment.

- ▶ For vehicles sold in Canada

IC: 2842A-TMLF1901

IC: 1551A-14FBX

This device complies with Industry Canada's licence-exempt RSSs. Operation is subject to the following two conditions: (1) This device may not cause interference; and (2) This device must accept any interference, including interference that may cause undesired operation of the device.

Le présent appareil est conforme aux CNR d'Industrie Canada applicables aux appareils radio exempts de licence. L'exploitation est autorisée aux deux conditions suivantes : 1) l'appareil ne doit pas produire de brouillage; 2) l'utilisateur de l'appareil doit accepter tout brouillage radioélectrique subi, même si le brouillage est susceptible d'en compromettre le fonctionnement.

Toyota Safety Sense 2.5

- ▶ For vehicles sold in the U.S.A., Hawaii, Guam, Puerto Rico and Saipan

Radiofrequency radiation exposure Information:

This equipment complies with FCC radiation exposure limits set forth for an uncontrolled environment. This equipment should be installed and operated with minimum distance of 20 cm between the radiator and your body.

This transmitter must not be co-located or operating in conjunction with any other antenna or transmitter.

FCC Notice

Changes or modifications not expressly approved by the party responsible for compliance could void the user's authority to operate the equipment.

► For vehicles sold in Canada

This device contains licence-exempt transmitter(s)/receiver(s) that comply with Innovation, Science and Economic Development Canada's licence-exempt RSS(s). Operation is subject to the following two conditions:

- (1) This device may not cause interference.
- (2) This device must accept any interference, including interference that may cause undesired operation of the device.

Radiofrequency radiation exposure information:

This equipment complies with radiation exposure limits set forth for an uncontrolled environment. This equipment should be installed and operated with minimum distance of 20 cm between the radiator and your body.

L'émetteur/récepteur exempt de licence contenu dans le présent appareil est conforme aux CNR d'Innovation, Sciences et Développement économique Canada applicables aux appareils radio exempts de licence. L'exploitation est autorisée aux deux conditions suivantes :

- (1) L'appareil ne doit pas produire de brouillage;
- (2) L'appareil doit accepter tout brouillage radioélectrique subi, même si le brouillage est susceptible d'en compromettre le fonctionnement.

Informations sur l'exposition aux rayonnements radiofréquences:

Cet équipement est conforme aux limites d'exposition aux rayonnements définies pour un environnement non contrôlé. Cet équipement doit être installé et utilisé avec un minimum de 20 cm de distance entre la source de rayonnement et votre corps.

BSM (Blind Spot Monitor)

- ▶ For vehicles sold in the U.S.A., Hawaii, Guam, Puerto Rico and Saipan

FCC ID : OAYSRR3A

This device complies with part 15 of the FCC Rules. Operation is subject to the following two conditions:

- (1) This device may not cause harmful interference, and
- (2) this device must accept any interference received, including interference that may cause undesired operation.

FCC Warning

Changes or modifications not expressly approved by the party responsible for compliance could void the user's authority to operate the equipment.

- ▶ For vehicles sold in Canada

This device contains licence-exempt transmitter(s)/receiver(s) that comply with Innovation, Science and Economic Development Canada's licence-exempt RSS(s). Operation is subject to the following two conditions:

1. This device may not cause interference.
2. This device must accept any interference, including interference that may cause undesired operation of the device.

Radiofrequency radiation exposure information:

This equipment complies with radiation exposure limits set forth for an uncontrolled environment. This equipment should be installed and operated with minimum distance of 20 cm between the radiator and your body.

L'émetteur/récepteur exempt de licence contenu dans le présent appareil est conforme aux CNR d'Innovation, Sciences et Développement économique Canada applicables aux appareils radio exempts de licence. L'exploitation est autorisée aux deux conditions suivantes:

1. L'appareil ne doit pas produire de brouillage;
2. L'appareil doit accepter tout brouillage radioélectrique subi, même si le brouillage est susceptible d'en compromettre le fonctionnement.

Informations sur l'exposition aux rayonnements radiofréquences:
Cet équipement est conforme aux limites d'exposition aux rayonnements définies pour un environnement non contrôlé. Cet équipement doit être installé et utilisé avec un minimum de 20 cm de distance entre la source de rayonnement et votre corps.

Intuitive parking assist

- ▶ For vehicles sold in the U.S.A., Hawaii, Guam, Puerto Rico and Saipan

Product name : Intuitive parking assist

Compliance statement : This device complies with part 18 of the FCC Rules.

Responsible Party : DENSO International America, Inc.

24777 Denso Drive, P.O. Box 5047, Southfield,

Michigan 48033-5244, U.S.A.

<https://www.denso.com/us-ca/en/about-us/company-information/diam/>

- ▶ For vehicles sold in Canada

This ISM device complies with Canadian ICES-001.

Cet appareil ISM est conforme à la norme NMB-001 du Canada.

Wireless charger

- For vehicles sold in the U.S.A., Hawaii, Guam, Puerto Rico and Saipan

FCC ID:ACJ932AT2501

NOTE:

This device complies with part 15 and part 18 of the FCC Rules. Operation is subject to the following two conditions: (1) This device may not cause harmful interference, and (2) this device must accept any interference received, including interference that may cause undesired operation.

FCC CAUTION

Changes or modifications not expressly approved by the party responsible for compliance could void the user's authority to operate the equipment. This equipment has been tested and found to comply with the limits for a wireless power charger, pursuant to part 18 of the FCC Rules. This equipment generates, uses and can radiate radio frequency energy and, if not installed and used in accordance with the instructions, may cause harmful interference to radio communications. However, there is no guarantee that interference will not occur in a particular installation. If this equipment does cause harmful interference to radio communications, which can be determined by turning the equipment off and on, the user is encouraged to try to correct the interference by one or more of the following measures:

- Reorient or relocate the receiving antenna.
- Increase the separation between the equipment and receiver.
- Connect the equipment into an outlet on a circuit different from that to which the receiver is connected.

The available scientific evidence does not show that any health problems are associated with using low power wireless devices. There is no proof, however, that these low power wireless devices are absolutely safe. Low power wireless devices emit low levels of radio frequency energy (RF) in the microwave range while being used. Whereas high levels of RF can produce health effects (by heating tissue), exposure of low-level RF that does not produce heating effects causes no known adverse health effects. Many studies of low-level RF exposures have not found any biological effects. Some studies have suggested that some biological effects might occur, but such findings have not been confirmed by additional research.

AT2501 has been tested and found to comply with FCC radiation exposure limits set forth for an uncontrolled environment and meets the FCC radio frequency (RF) Exposure Guidelines.

The contact information for maintenance is described in the car manual by the manufacturer of the car in which this wireless charger is installed.

FCC ID : ACJ932AT2301

NOTE:

This device complies with part 15 and part 18 of the FCC Rules. Operation is subject to the following two conditions: (1) This device may not cause harmful interference, and (2) this device must accept any interference received, including interference that may cause undesired operation.

FCC CAUTION

Changes or modifications not expressly approved by the party responsible for compliance could void the user's authority to operate the equipment. This equipment has been tested and found to comply with the limits for a wireless power charger, pursuant to part 18 of the FCC Rules. This equipment generates, uses and can radiate radio frequency energy and,

if not installed and used in accordance with the instructions, may cause harmful interference to radio communications. However, there is no guarantee that interference will not occur in a particular installation. If this equipment does cause harmful interference to radio communications, which can be determined by turning the equipment off and on, the user is encouraged to try to correct the interference by one or more of the following measures:

- Reorient or relocate the receiving antenna.
- Increase the separation between the equipment and receiver.
- Connect the equipment into an outlet on a circuit different from that to which the receiver is connected.

This equipment complies with FCC radiation exposure limits set forth for an uncontrolled environment and meets the FCC radio frequency (RF) Exposure Guidelines. This equipment should be installed and operated keeping the radiator at least 20cm or more away from person's body.

► **For vehicles sold in Canada**

NOTE:

This device contains licence-exempt transmitter(s)/receiver(s) that comply with Innovation, Science and Economic Development Canada's licence-exempt RSS(s). Operation is subject to the following two conditions: (1) This device may not cause interference. (2) This device must accept any interference, including interference that may cause undesired operation of the device.

L'émetteur/récepteur exempt de licence contenu dans le présent appareil est conforme aux CNR d'Innovation, Sciences et Développement économique Canada applicables aux appareils radio exempts de licence. L'exploitation est autorisée aux deux conditions suivantes :

- 1) L'appareil ne doit pas produire de brouillage;
- 2) L'appareil doit accepter tout brouillage radioélectrique subi, même si le brouillage est susceptible d'en compromettre le fonctionnement.

CAUTION:

This equipment complies with ISED radiation exposure limits set forth for an uncontrolled environment and meets RSS-102 of the ISED radio frequency (RF) Exposure rules. This equipment should be installed and operated keeping the radiator at least 20cm or more away from person's body.

Cet équipement est conforme aux limites d'exposition aux rayonnements énoncées pour un environnement non contrôlé et respecte les règles d'exposition aux fréquences radioélectriques (RF) CNR-102 de l'ISDE.

Cet équipement doit être installé et utilisé en gardant une distance de 20 cm ou plus entre le radiateur et le corps humain.

Garage door opener

- For vehicles sold in the U.S.A. and Hawaii

FCC ID: NZLUAHL5E & NZLAECHL5

This device complies with FCC rules part 15 and Innovation, Science, and Economic Development Canada RSS-210. Operation is subject to the following two conditions: (1) This device may not cause harmful interference, and (2) This device must accept any interference that may be received including interference that may cause undesired operation. **WARNING:** The transmitter has been tested and complies with FCC and ISED rules. Changes or modifications not expressly approved by the party responsible for compliance could void the user's authority to operate the device.

This equipment complies with FCC and ISED radiation exposure limits set forth for an uncontrolled environment. End Users must follow the specific operating instructions for satisfying RF exposure compliance. This transmitter must be at least 20 cm from the user and must not be co-located or operating in conjunction with any other antenna or transmitter.

- For vehicles sold in Canada

This device complies with FCC rules part 15 and Innovation, Science, and Economic Development Canada RSS-210. Operation is subject to the following two conditions: (1) This device may not cause harmful interference, and (2) This device must accept any interference that may be received including interference that may cause undesired operation. **WARNING:** The transmitter has been tested and complies with FCC and ISED rules. Changes or modifications not expressly approved by the party responsible for compliance could void the user's authority to operate the device.

This equipment complies with FCC and ISED radiation exposure limits set forth for an uncontrolled environment. End Users must follow the specific operating instructions for satisfying RF exposure compliance. This transmitter must be at least 20 cm from the user and must not be co-located or operating in conjunction with any other antenna or transmitter.

Cet appareil est conforme aux règlements de la FCC, section 15, et au CNR-210 d'Innovation, Sciences et Développement économique Canada. Le fonctionnement est assujéti aux deux conditions suivantes : (1) cet appareil ne doit pas causer d'interférences nuisibles et (2) cet appareil doit accepter toute interférence reçue, y compris celle qui pourrait entraîner un dysfonctionnement. **MISE EN GARDE :** L'émetteur a subi des tests et est conforme aux règlements de la FCC et d'ISDE. Les changements ou modifications non approuvés explicitement par la partie responsable de la conformité pourraient rendre caduque l'autorisation de l'utilisateur de se servir du dispositif.

Cet appareil est conforme aux limites d'exposition aux radiations de la FCC et d'ISDE établies pour un environnement non contrôlé. Les utilisateurs finaux doivent respecter les instructions d'utilisation spécifiques pour satisfaire aux exigences de conformité aux expositions de RF. L'émetteur doit se trouver à 20 cm au minimum de l'utilisateur et ne doit pas être situé au même endroit que tout autre émetteur ou antenne ni fonctionner avec un autre émetteur ou antenne.

Tire pressure warning system

“Perchlorate Material – special handling may apply, See www.dtsc.ca.gov/hazardouswaste/perchlorate.”

- ▶ For vehicles sold in the U.S.A., Hawaii, Guam, Puerto Rico and Saipan

FCC ID: PAXPMVE005

NOTE

This device complies with part 15 of the FCC Rules.

Operation is subject to the following two conditions:

- (1) This device may not cause harmful interference, and
- (2) this device must accept any interference received, including interference that may cause undesired operation.

FCC WARNING

Changes or modifications not expressly approved by the party responsible for compliance could void the user's authority to operate the equipment.

- ▶ For vehicles sold in Canada

NOTE

This device contains licence-exempt transmitter(s)/ receiver(s) that comply with Innovation, Science and Economic Development Canada's licence-exempt RSS(s).

Operation is subject to the following two conditions:

- (1) This device may not cause interference.
- (2) This device must accept any interference, including interference that may cause undesired operation of the device.

NOTE

L'émetteur/récepteur exempt de licence contenu dans le présent appareil est conforme aux CNR d'Innovation, Sciences et Développement économique Canada applicables aux appareils radio exempts de licence.

L'exploitation est autorisée aux deux conditions suivantes :

- (1) L'appareil ne doit pas produire de brouillage;
- (2) L'appareil doit accepter tout brouillage radioélectrique subi, même si le brouillage est susceptible d'en compromettre le fonctionnement.

GAS STATION INFORMATION

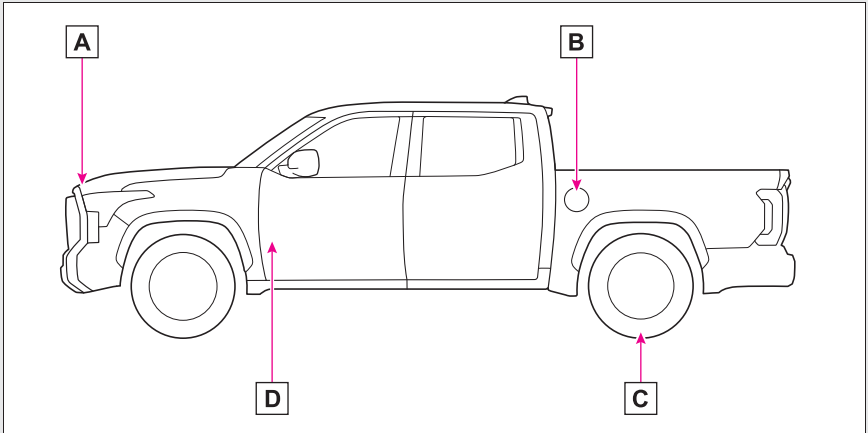

- A** Auxiliary catch lever (→P.480)
- B** Fuel filler door (→P.235)
- C** Tire inflation pressure (→P.574)
- D** Hood lock release lever (→P.480)

Fuel tank capacity (Reference)	P.569
Fuel type	P.569
Cold tire inflation pressure	P.574
Engine oil capacity (Drain and refill — reference)	P.570
Engine oil type	P.570

