

# Owner's Manual

**2024 PASSPORT**

## California Proposition 65 Warning

 **WARNING:** Operating, servicing and maintaining a passenger vehicle or off-highway motor vehicle can expose you to chemicals including engine exhaust, carbon monoxide, phthalates, and lead, which are known to the State of California to cause cancer and birth defects or other reproductive harm.

To minimize exposure, avoid breathing exhaust, do not idle the engine except as necessary, service your vehicle in a well-ventilated area and wear gloves or wash your hands frequently when servicing your vehicle. For more information go to [www.P65Warnings.ca.gov/passenger-vehicle](http://www.P65Warnings.ca.gov/passenger-vehicle).

### Event Data Recorders

**This vehicle is equipped with an event data recorder (EDR).**

The main purpose of an EDR is to record, in certain crash or near crash-like situations, such as an air bag deployment or hitting a road obstacle, data that will assist in understanding how a vehicle's systems performed. **The EDR is designed to record data related to vehicle dynamics and safety systems for a short period of time, typically 30 seconds or less.** The EDR in this vehicle is designed to record such data as:

- How various systems in your vehicle were operating;
- Whether or not the driver and passenger safety belts were buckled/fastened;
- How far (if at all) the driver was depressing the accelerator and/or brake pedal; and,
- How fast the vehicle was traveling.

These data can help provide a better understanding of the circumstances in which crashes and injuries occur. NOTE: EDR data are recorded by your vehicle only if a non-trivial crash situation occurs; no data are recorded by the EDR under normal driving conditions and no personal data (e.g., name, gender, age, and crash location) are recorded. However, other parties, such as law enforcement, could combine the EDR data with the type of personally identifying data routinely acquired during a crash investigation.

To read data recorded by an EDR, special equipment is required, and access to the vehicle or the EDR is needed. In addition to the vehicle manufacturer, other parties, such as law enforcement, that have the special equipment, can read the information if they have access to the vehicle or the EDR.

The data belongs to the vehicle owner and may not be accessed by anyone else except as legally required or with the permission of the vehicle owner.

## **Service Diagnostic Recorders**

This vehicle is equipped with service-related devices that record information about powertrain performance. The data can be used to verify emissions law requirements and/or help technicians diagnose and solve service problems. It may also be combined with data from other sources for research purposes, but it remains confidential. Some diagnostic and maintenance information is uploaded to Honda upon vehicle start up.

## **California Perchlorate Contamination Prevention Act**

The airbags, seat belt tensioners, and CR type batteries in this vehicle may contain perchlorate materials - special handling may apply. See [www.dtsc.ca.gov/hazardouswaste/perchlorate/](http://www.dtsc.ca.gov/hazardouswaste/perchlorate/)

As you read this manual, you will find information that is preceded by a **NOTICE** symbol. This information is intended to help you avoid damage to your vehicle, other property, or the environment.

## System Updates Terms and Conditions\*

### General

Your vehicle has an application that allows your 8-in. Color Touchscreen to automatically search for Honda software updates that are specific to your 8-in. Color Touchscreen and its connected devices (initially every one (1) week via Wi-Fi or every four (4) weeks via Telematics Control Unit (TCU)\*, queries may occur more or less frequently due to internet outages, retries, direct user action, WAP push from the server or a change in query policy on the Honda servers). This application periodically transmits to our servers a limited amount of vehicle and device information (Vehicle Identification Number (VIN), the Model Type (MT) Identification Number, Hardware and Software Part Number, Serial Number, Software Version, preferred language, Internet Protocol (IP) address, Transaction Log (alert or update viewing, update download and installation, software status), etc.). When the application finds an update from the server, the application initially asks permission to download and install the update. Where available, in your settings menu you may elect to automatically download and install these updates or you may elect to manually update the system.

When your 8-in. Color Touchscreen searches our servers for updates or alerts, we will automatically provide you with the opportunity to update your devices or transmit the update or alert directly to your 8-in. Color Touchscreen. We will also maintain on our servers a log of the updates or alerts that are installed.

### Your Personal Data

Should the aforementioned information transmitted to Honda constitute personal information in your region, please note that this information will be treated in strict accordance with the rules and regulations outlined in this notice as well as applicable data protection law.

\* Not available on all models

The terms of our privacy notice are incorporated into these terms by reference and your use of system updates will be subject to the privacy notice. Our privacy notice sets out information about how we and any named third parties will process any personal data we collect from you or that you provide to us, via the application.

For further details, see Honda's connected product privacy notice at: U.S.: [www.honda.com](http://www.honda.com)

Canada: [www.honda.ca/privacy/vehicledata](http://www.honda.ca/privacy/vehicledata)

Honda collects, uses and stores your personal data for the reasons set out below:

- to deliver the system updates and related services to you;
- to allow us to improve and optimize the system updates products and services;
- to respond to user questions and complaints; and for internal record keeping.
- where necessary for Honda's legitimate interests, as listed below, and where our interests are not overridden by your data protection rights.

Protecting our legitimate business interests and legal rights includes, but is not limited to, use in connection with compliance, regulatory, auditing, legal claims (including disclosure of such information in connection with legal process or litigation) and other ethics and compliance reporting requirements.

Honda will also convert personal data into anonymous data and use it (normally on an aggregated statistical basis) for uses such as market research and analysis, to improve the system updates, to analyze trends, and to assess the success of software update releases. Aggregated personal information does not personally identify you or any other use of the system updates.

Honda may share this data with Honda's worldwide support organization or affiliated Honda companies or other third parties engaged by Honda for the purposes of rendering support services in connection with system support.



## **Software End User License Agreement**

Your vehicle comes equipped with software, which is governed by the End User License Agreement in this Owner's Manual, and which contains a binding arbitration clause. Please refer to the End User License Agreement for the terms and conditions governing your use of the installed software, as well as the applications, services, functions, and content provided through the software. Your use of the installed software will serve as your consent to the terms and conditions of the End User License Agreement. You may opt out within 30 days of your initial use of the Software by sending a signed, written notice to HONDA at American Honda Motor Co., Inc. Honda Automobile Customer Service Mail Stop CHI-5, 1919 Torrance Blvd. Torrance, CA 90501-2746.

## **Privacy Notice**

This vehicle may share location and usage information. To manage this setting, visit [www.hondalink.com/vehicle-data-choices](http://www.hondalink.com/vehicle-data-choices).

**To learn more about how we collect and use Personal Information including precise geolocation data, please read our Privacy Notice and Vehicle Data Privacy Notice, accessible at [www.honda.com](http://www.honda.com).**

## A Few Words About Safety

---

Your safety, and the safety of others, is very important. And operating this vehicle safely is an important responsibility.

To help you make informed decisions about safety, we have provided operating procedures and other information on labels and in this manual. This information alerts you to potential hazards that could hurt you or others.

Of course, it is not practical or possible to warn you about all the hazards associated with operating or maintaining your vehicle. You must use your own good judgment.

You will find this important safety information in a variety of forms, including:

- **Safety Labels** - on the vehicle.
- **Safety Messages** - preceded by a safety alert symbol  and one of three signal words: **DANGER**, **WARNING**, or **CAUTION**. These signal words mean:

 **DANGER**

You **WILL** be **KILLED** or **SERIOUSLY HURT** if you don't follow instructions.

 **WARNING**

You **CAN** be **KILLED** or **SERIOUSLY HURT** if you don't follow instructions.

 **CAUTION**

You **CAN** be **HURT** if you don't follow instructions.

- **Safety Headings** - such as Important Safety Precautions.
- **Safety Section** - such as Safe Driving.
- **Instructions** - how to use this vehicle correctly and safely.

This entire book is filled with important safety information - please read it carefully.

This owner's manual should be considered a permanent part of the vehicle and should remain with the vehicle when it is sold.

The Navigation Manual is available online at *mygarage.honda.com* (U.S.) or *honda.ca* (Canada). **If you are the first registered owner of your vehicle, you may request a complimentary printed copy of the Navigation Manual within the first six months of vehicle purchase.** To request a copy, visit *mygarage.honda.com*. In Canada, please request a copy from your Honda dealer.

This owner's manual covers all models of your vehicle. You may find descriptions of equipment and features that are not on your particular model.

The images throughout this owner's manual (including the front cover) that depict features, equipment, and Audio/Information screen, Meter screens are only examples and may not be representative of your particular model.

This owner's manual is for vehicles sold in the United States and Canada.

The information and specifications included in this publication were in effect at the time of approval for printing. Honda Motor Co., Ltd. reserves the right, however, to discontinue or change specifications or design at any time without notice and without incurring any obligation.

## ➤ Safe Driving P. 33

For Safe Driving P. 34      Seat Belts P. 39      Airbags P. 49

## ➤ Instrument Panel P. 81

Indicators P. 82      Gauges and Displays P. 109

## ➤ Controls P. 125

Clock P. 126      Locking and Unlocking the Doors P. 128  
Windows P. 155      Moonroof P. 158  
Seats P. 182

## ➤ Features P. 221

Audio System P. 222  
General Information on the Audio System P. 305  
*Bluetooth*® *HandsFreeLink*® P. 343

## ➤ Driving P. 369

Before Driving P. 370      Towing a Trailer P. 376  
Parking Your Vehicle P. 471      Multi-View Rear Camera P. 482

## ➤ Maintenance P. 489

Before Performing Maintenance P. 490      Maintenance Minder™ P. 494  
Checking and Maintaining Wiper Blades P. 518  
Remote Transmitter Care P. 533  
Accessories and Modifications P. 541

## ➤ Handling the Unexpected P. 543

Tools P. 544      If a Tire Goes Flat P. 545  
Indicator Coming On/Blinking P. 562      Fuses P. 567  
Refueling P. 574      If You Cannot Open the Tailgate P. 575

## ➤ Information P. 577

Specifications P. 578      Identification Numbers P. 580  
Emissions Testing P. 583      Warranty Coverages P. 585

# Contents

Child Safety P. 64	Exhaust Gas Hazard P. 79	Safety Labels P. 80
Tailgate P. 143	Security System P. 152	
Operating the Switches Around the Steering Wheel P. 159	Mirrors P. 180	
Interior Convenience Items P. 193	Climate Control System P. 213	
Audio System Basic Operation P. 228	Audio Error Messages P. 302	
Customized Features P. 327	HomeLink® Universal Transceiver* P. 340	
Off-Highway Driving Guidelines P. 386	When Driving P. 388	Honda Sensing® P. 422
Refueling P. 484	Fuel Economy and CO <sub>2</sub> Emissions P. 487	Braking P. 467
Maintenance Under the Hood P. 500	Replacing Light Bulbs P. 512	
Checking and Maintaining Tires P. 522	Battery P. 531	
Climate Control System Maintenance P. 534	Cleaning P. 536	
Engine Does Not Start P. 553	If the Battery Is Dead P. 557	Overheating P. 560
Emergency Towing P. 572	If You Cannot Unlock the Fuel Fill Door P. 573	
Devices that Emit Radio Waves P. 581	Reporting Safety Defects P. 582	
Authorized Manuals P. 588	Customer Service Information P. 589	

Quick Reference Guide P. 8

Safe Driving P. 33

Instrument Panel P. 81

Controls P. 125

Features P. 221

Driving P. 369

Maintenance P. 489

Handling the Unexpected P. 543

Information P. 577

Index P. 591

# Visual Index

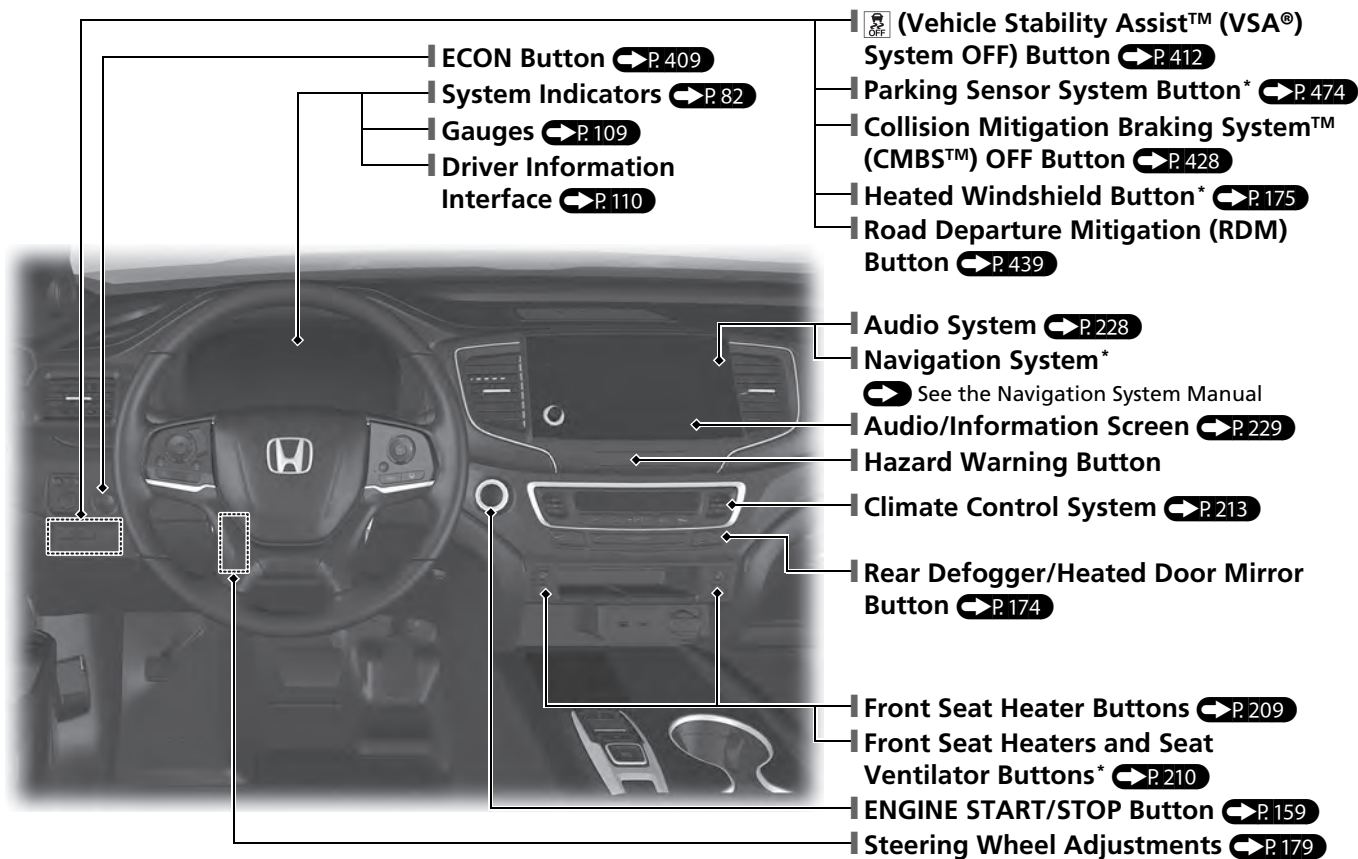

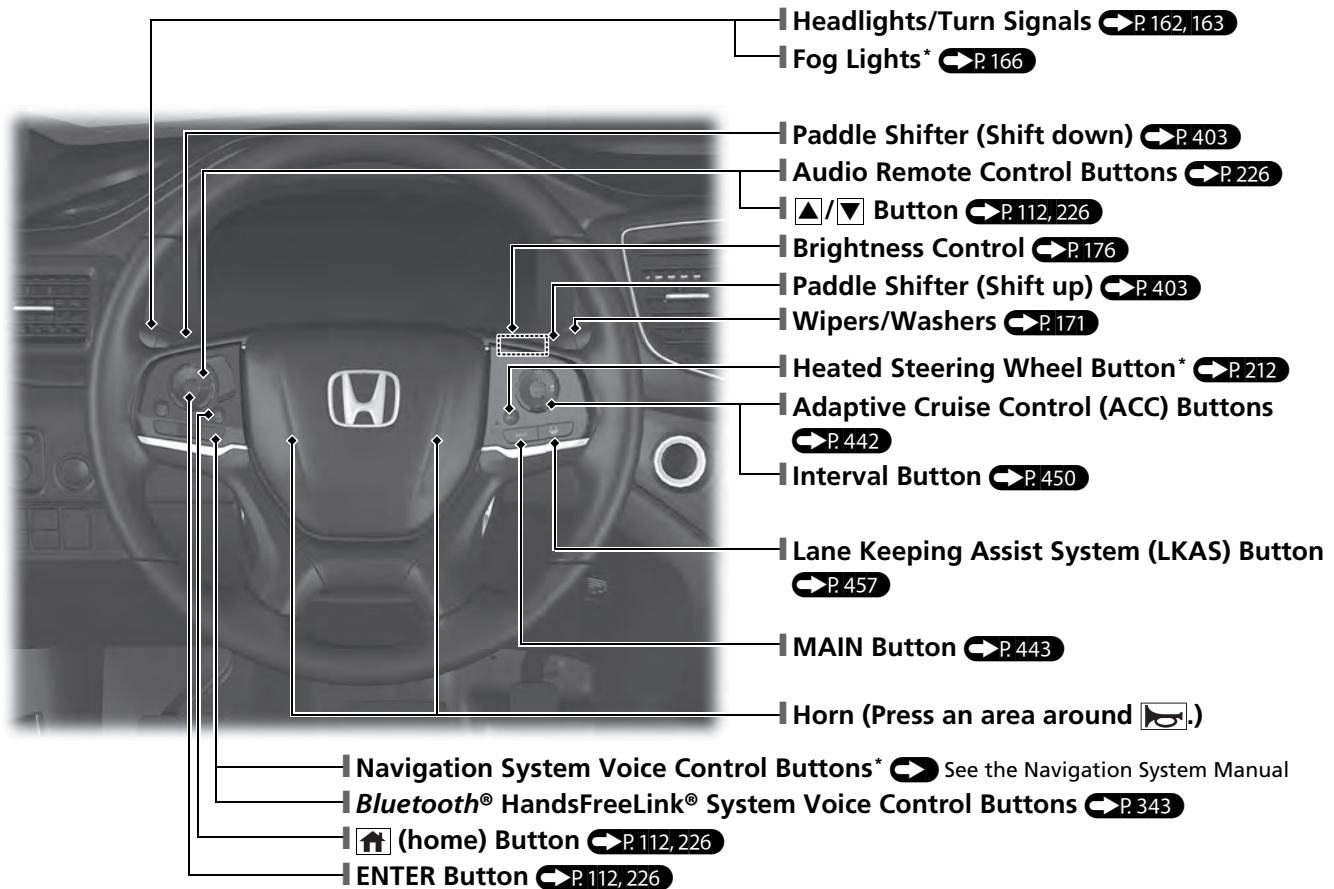

# Visual Index

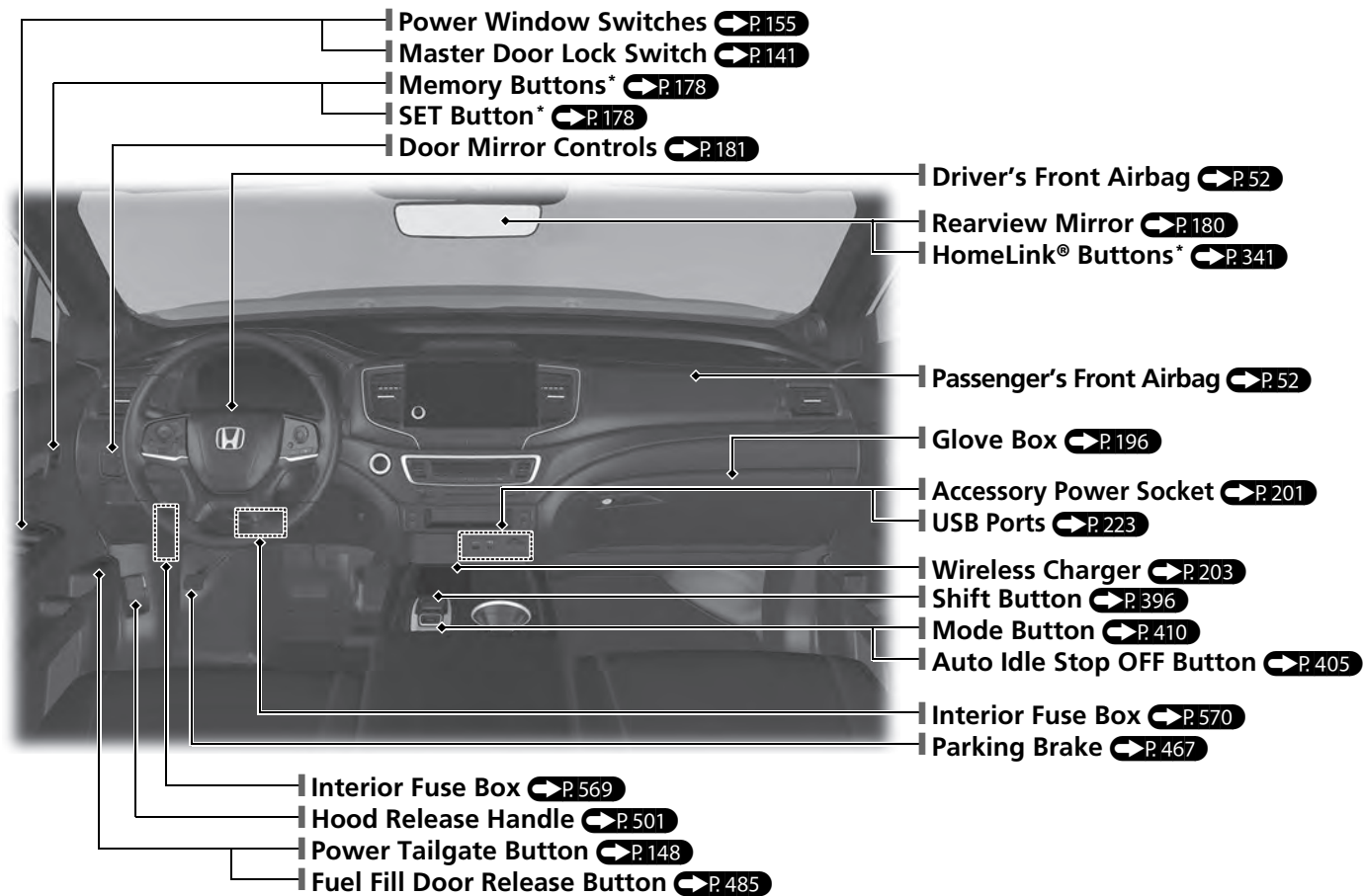

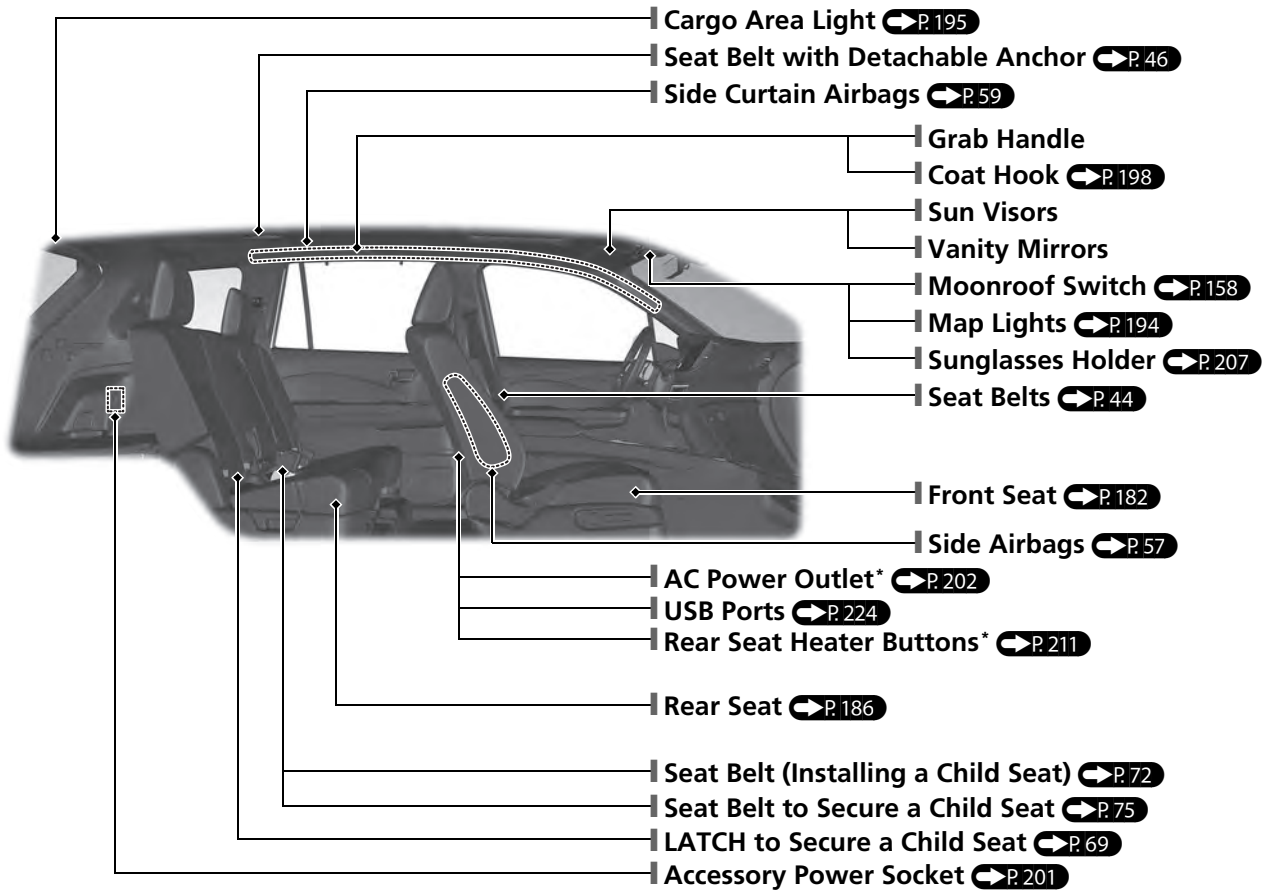



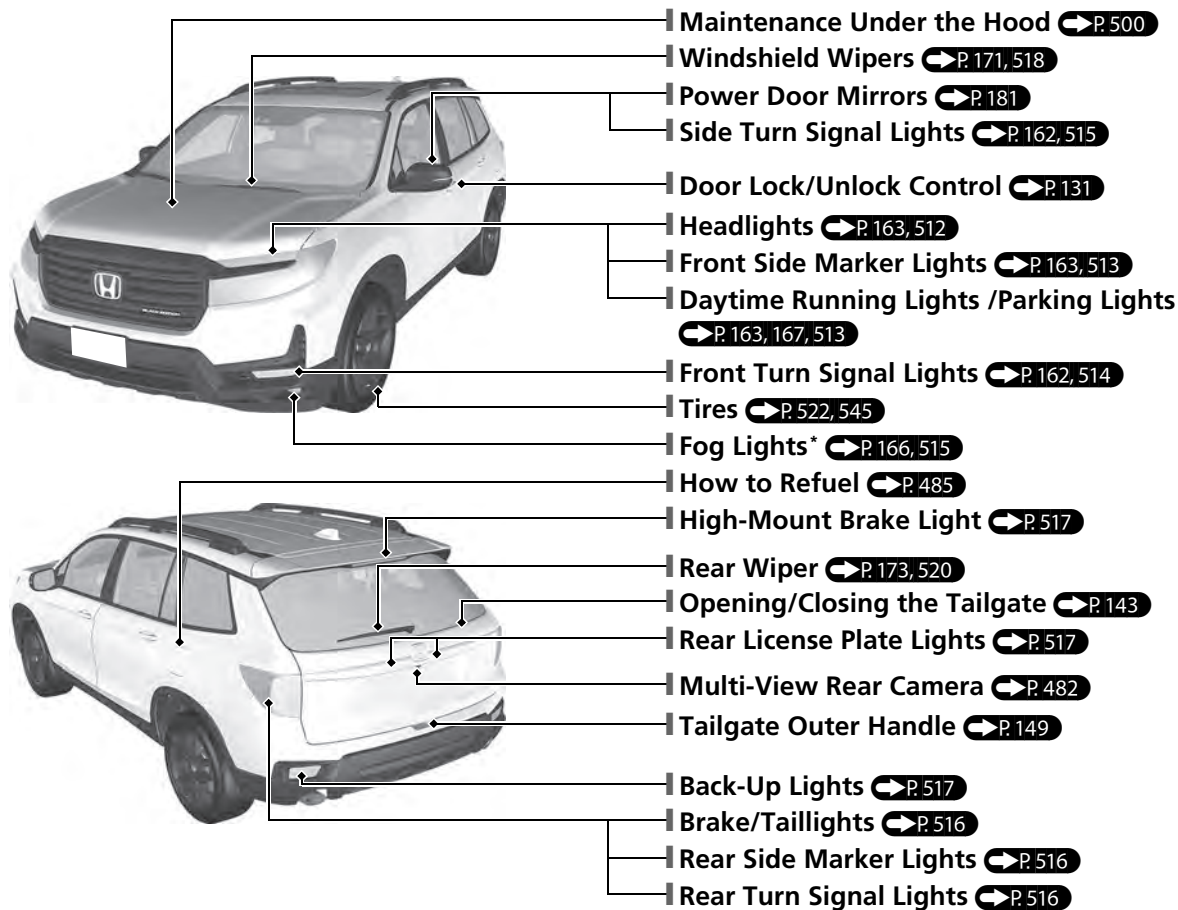

# Visual Index

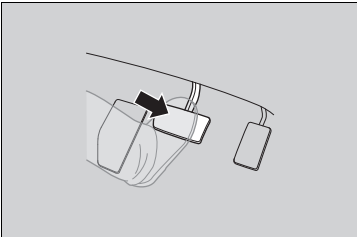
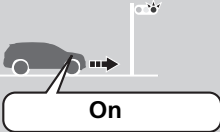

# Auto Idle Stop Function

To improve fuel economy, the engine stops and then restarts as detailed below. When Auto Idle Stop is on, the Auto Idle Stop indicator (green) comes on. P. 404

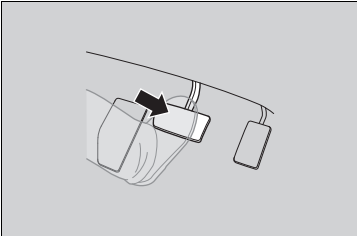
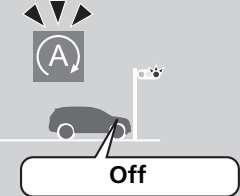
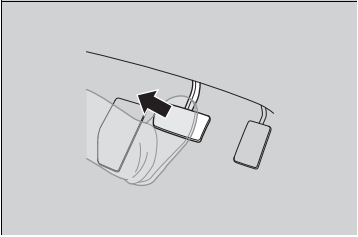
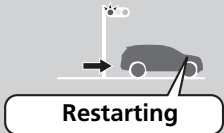
At	Automatic transmission	Engine status
Deceleration  	 <p>Stop the vehicle and depress the brake pedal.</p>	 <p><b>On</b></p>
Stop  	 <p>Keep the brake pedal depressed.</p>	 <p><b>Off</b></p>
Start-up	 <p>Release the brake pedal.</p>	 <p><b>Restarting</b></p>

# Eco Assist® System

## Ambient Meter

- The color of the ambient meter changes to green to indicate that the vehicle is being driven in a fuel-efficient manner.



**ECON Button** ➔ P. 409

Helps maximize fuel economy.

**ECON Mode Indicator** ➔ P. 90

Comes on when the ECON button is pressed.

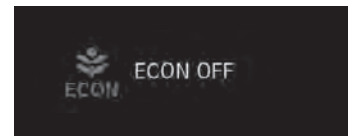

The message is displayed for a few seconds when the ECON button is pressed.

# Safe Driving P.33

## Airbags P.49

- Your vehicle is fitted with airbags to help protect you and your passengers during a moderate-to-severe collision.

## Child Safety P.64

- All children 12 and younger should be seated in the rear seat.
- Smaller children should be properly restrained in a forward-facing child seat.
- Infants must be properly restrained in a rear-facing child seat.

## Exhaust Gas Hazard P.79

- Your vehicle emits dangerous exhaust gases that contain carbon monoxide. Do not run the engine in confined spaces where carbon monoxide gas can accumulate.

## Seat Belts P.39

- Fasten your seat belt and sit upright well back in the seat.
- Check that your passengers are wearing their seat belts correctly.

## Before Driving Checklist P.370

- Before driving, check that the front seats, head restraints, steering wheel, and mirrors have been properly adjusted.

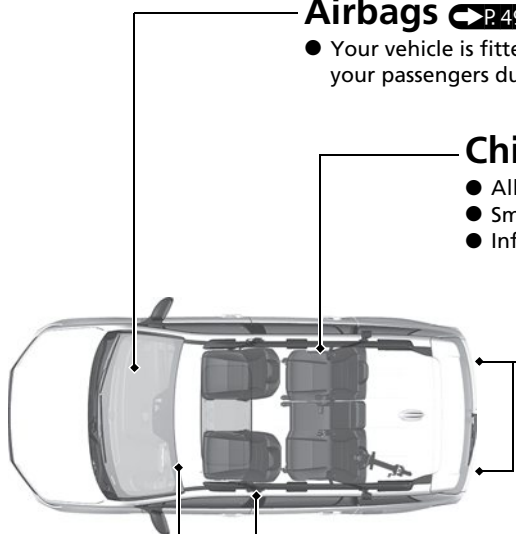











Fasten your lap belt as low as possible.

# Instrument Panel P.81



## Indicators P.82 / Gauges P.109 / Driver Information Interface P.110

### System Indicators

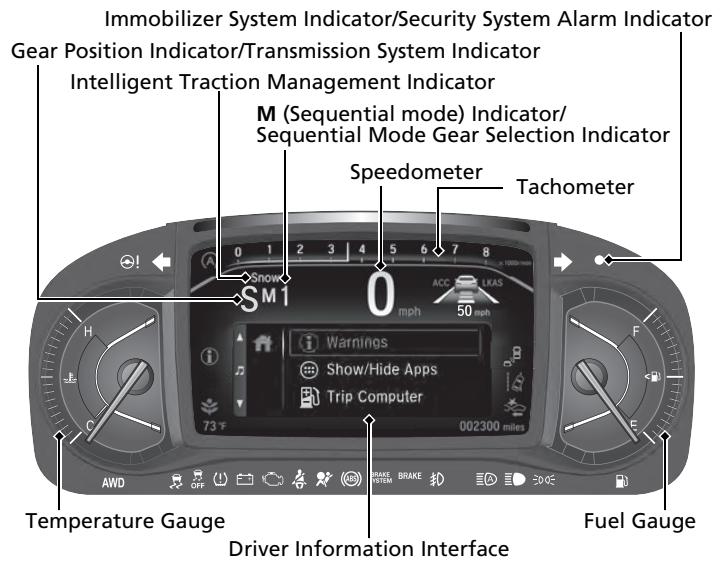



-  Malfunction Indicator Lamp
-  Charging System Indicator
-  Electric Power Steering (EPS) System Indicator
-  Low Fuel Indicator
-  Vehicle Stability Assist™ (VSA®) System Indicator
-  VSA® OFF Indicator
-  **BRAKE**  
U.S.  
Canada  
Parking Brake and Brake System Indicator (Amber)
-  **(ABS)**  
Anti-lock Brake System (ABS) Indicator
-  Blind spot information System Indicator
-  **ACC**  
Adaptive Cruise Control (ACC) Indicator (Green/Amber)
-  **LKAS**  
Lane Keeping Assist System (LKAS) Indicator (Green/Amber)













### System Indicators

-  Road Departure Mitigation (RDM) Indicator
-  Collision Mitigation Braking System™ (CMBS™) Indicator

### Lights Indicators

-  Lights On Indicator
-  High Beam Indicator
-  Auto High-Beam Indicator
-  Fog Light Indicator\*

### System Indicators

-  Turn Signal and Hazard Warning Indicators
-  Low Tire Pressure/TPMS Indicator
-  **BRAKE**  
U.S.  
Canada  
Parking Brake and Brake System Indicator (Red)
-  Seat Belt Reminder Indicator
-  Supplemental Restraint System Indicator
-  ECON Mode Indicator
-  **(A)**  
Auto Idle Stop System Indicator (Amber)/Auto Idle Stop Indicator (Green)
-  **(A)**  
OFF  
Auto Idle Stop OFF Indicator
-  Auto Idle Stop Suspend Indicator
-  **(i)**  
System Message Indicator
-  **AWD**  
All-wheel drive system (AWD) Indicator

# Controls P.125

## Clock P.126



To adjust time



To adjust date



- 1 Select , then select **Settings**.
- 2 Select **System**, then **Date & Time**.
- 3 Select **Set Date & Time**.
- 4 Select **Automatic Date & Time**, then select **OFF**.
- 5 Select **Set Date** or **Set Time**.

6 Adjust the dates, hours, and minutes by selecting /.

7 Select **Save** to set the time.

### Models with navigation system

The navigation system receives signals from GPS satellites, updating the clock automatically.

## ENGINE START/STOP Button P.159

Press the button to change the vehicle's power mode.



## Turn Signals P.162

Turn Signal Control Lever

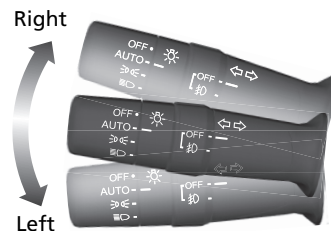

## Lights P.163

Light Control Switches

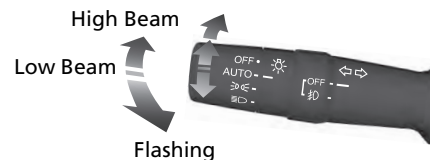

## Wipers and Washers

➔ P.171

Wiper/Washer Control Lever

**MIST**

**OFF**

**AUTO**\*1: Wiper speed varies automatically

**INT**\*2: Low speed with intermittent

**LO**: Low speed wipe

**HI**: High speed wipe

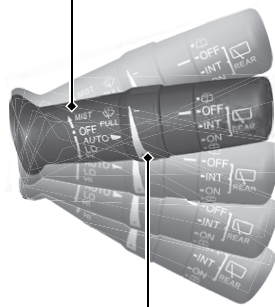

Pull toward you to spray washer fluid.

Adjustment Ring

☐: Low Sensitivity\*1

☐↙: Lower speed, fewer sweeps\*2

☐↗: High Sensitivity\*1

☐↖↗: Higher speed, more sweeps\*2

\*1: Models with automatic intermittent operation

\*2: Models with manual intermittent operation

Models with automatic intermittent wipers

**AUTO** should always be turned **OFF** before the following situations in order to prevent severe damage to the wiper system:

- Cleaning the windshield
- Driving through a car wash
- No rain present

## Steering Wheel ➔ P.179

- To adjust, push the adjustment lever down, adjust to the desired position, then pull up the lever back in place.

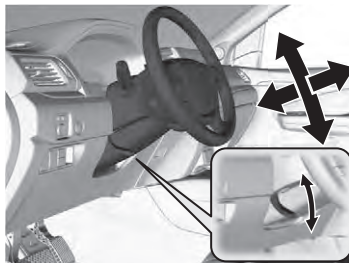

## Unlocking the Front Doors from the Inside

➔ P.140

- Pull either front door inner handle to unlock and open it at the same time.



## Tailgate P.143

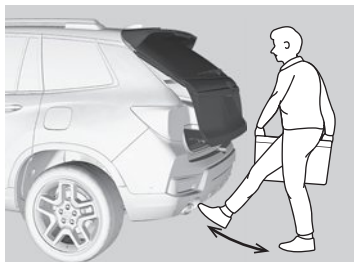

### Models with Hands Free Access

Use a forward and back kicking motion under the center of the rear bumper to open or close the power tailgate while carrying the keyless remote.

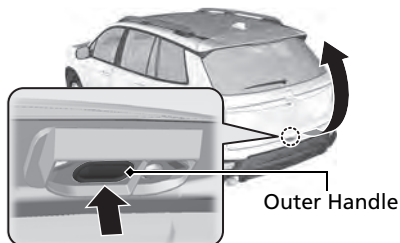
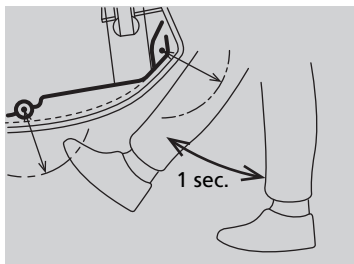

- Press the tailgate outer handle to unlock and open the tailgate when you carry the keyless remote.
- Press the power tailgate button on the driver's door or the remote transmitter to open and close the power tailgate.

## Power Door Mirrors

### P.181

- With the power mode in ON, move the selector switch to L or R.
- Push the appropriate edge of the adjustment switch to adjust the mirror.
- Press the folding button\* to fold in and out the door mirrors.

Folding Button\*      Selector Switch

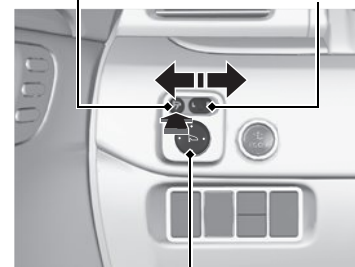

Adjustment Switch

\* Not available on all models



## Power Windows P.155

- With the power mode in ON, open and close the power windows.
- If the power window lock button is in the off position, each passenger's window can be opened and closed with its own switch.
- If the power window lock button is in the on position (indicator is on), each passenger's window switch is disabled.

Power Window Lock Button      Indicator

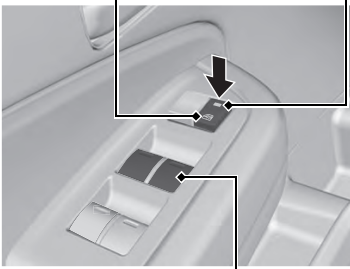

Window Switch

# Climate Control System P.213

- Press the **AUTO** button to activate the climate control system.
- Press the button to turn the system on or off.
- Press the button to defrost the windshield.

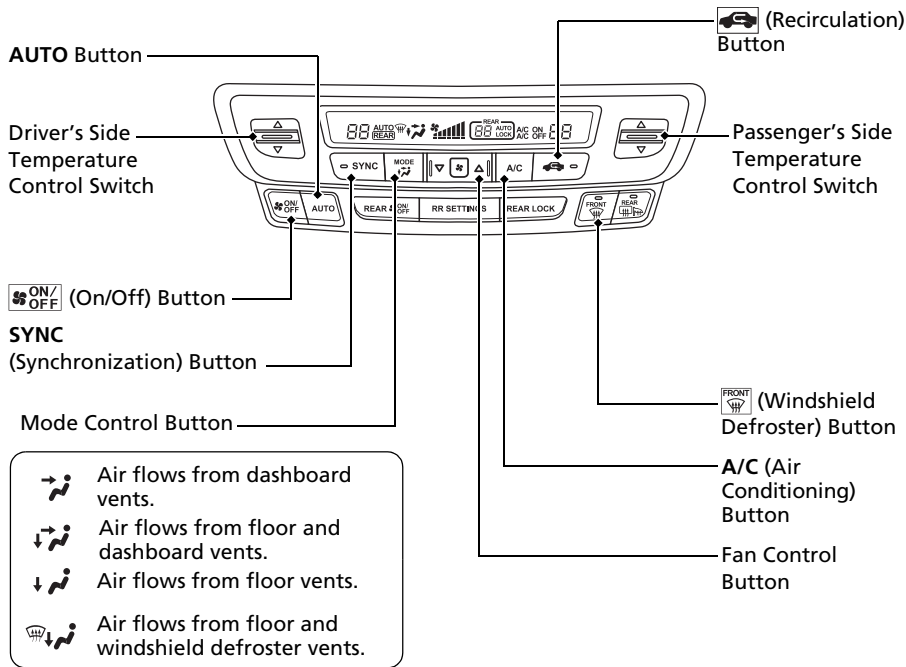

# Rear Climate Control\* P.218

- Press the **AUTO** button to activate the rear climate control system.
- Press the button to turn the system on or off.

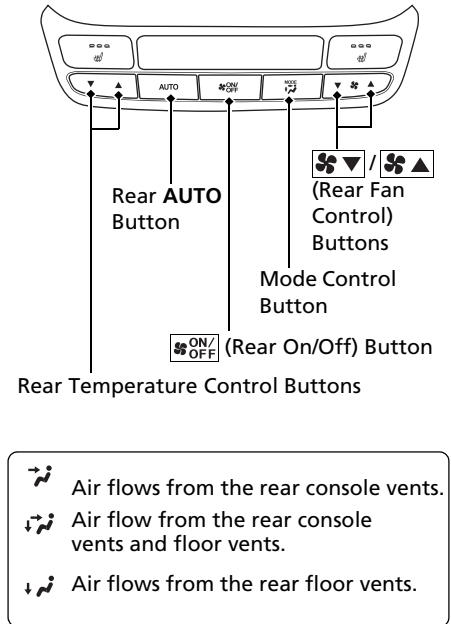

\* Not available on all models

# Features P.221

## Audio System P.222

For navigation system operation  See the Navigation System Manual

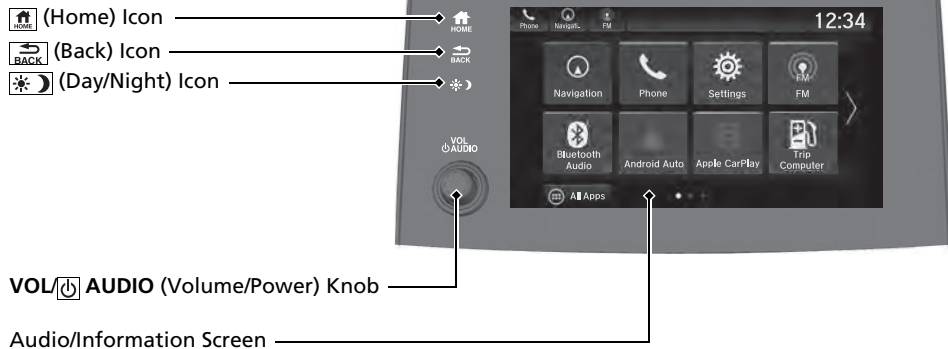

# Audio Remote Controls

➔ P. 226

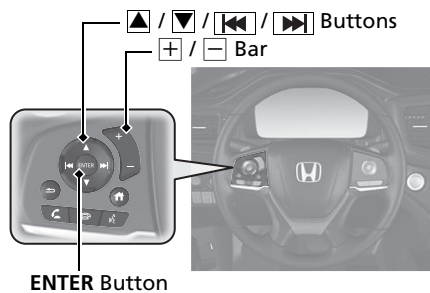

- + / - Bar  
Press to adjust the volume up/down.
- ▲ / ▼ / ⏮ / ⏭ / ENTER Buttons  
Press ▲ or ▼ to select **Now Playing** on the home screen of the driver information interface, and then press the **ENTER** button.

Press ▲ or ▼ to cycle through the audio mode as follows:

Android Auto/Apple CarPlay/SiriusXM®\*/  
AM/Bluetooth® Audio/Social Playlist/FM/  
My Honda Music/USB/iPod

Radio: Press ⏮ / ⏭ to change the preset station.

USB device/My Honda Music/Bluetooth®

Audio:

Press ⏮ / ⏭ to skip to the beginning of the next song or return to the beginning of the current song.

# Driving ↔ P. 369

## Automatic Transmission ↔ P. 396

- Select **P** and depress the brake pedal when starting the engine.
- **Gear selection**

### Gear Position Indicator

The gear position indicator and the shift button indicator indicate the current gear selection.



Gear Position Indicator

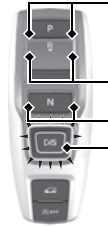

Shift Button Indicator

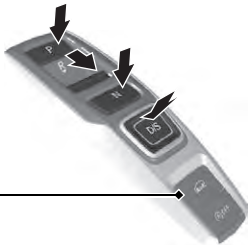

Intelligent Traction Management Button

**P**

### Park

Press the **P** button.  
Used when parking or before turning off or starting the engine.  
Transmission is locked.

**R**

### Reverse

Pull back the **R** button.  
Used when reversing.

**N**

### Neutral

Press the **N** button.  
Transmission is not locked.

**D/S**

### Drive/S Position

Each time you press the **D/S** button, the mode switches between Drive and S position mode.  
Used for:

#### Drive

- Normal driving (gears change between 1st and 9th automatically)
- Temporarily driving in the sequential mode

#### S Position

- Automatically changing gears between 1st and 8th (8th gear is used only at high speed)
- Driving in the sequential mode

## Paddle Shifters P. 403

- Paddle shifters allow you to shift gears much like a manual transmission (1st through 9th). This is useful for engine braking.

Gear Position Indicator

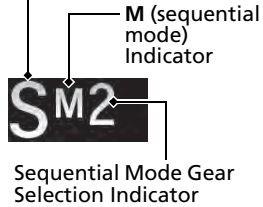

**When the transmission is in **

- The transmission will shift back to automatic mode once the system detects that the vehicle is cruising.

**When the transmission is in **

- Holds the selected gear, and the **M** (sequential mode) indicator comes on.
- The sequential mode gear selection is shown in the instrument panel.

Shift Down   
Paddle Shifter



Shift Up   
Paddle Shifter



## VSA® On and Off P. 412

- The Vehicle Stability Assist™ (VSA®) system helps stabilize the vehicle during cornering and helps maintain traction while accelerating on loose or slippery road surfaces.
- VSA® comes on automatically every time you start the engine.
- To partially disable or fully restore VSA® function, press and hold the  (VSA® OFF) button until you hear a beep.

## CMBS™ On and Off

 P. 428

- When a possible frontal collision is likely unavoidable, the CMBS™ can reduce the vehicle speed and the severity of the collision.
- The CMBS™ is turned on every time you start the engine.
- To turn the CMBS™ on or off, press and hold the button until you hear a beep.

## Tire Pressure Monitoring System (TPMS) with Tire Fill Assist P. 418, 565

- The TPMS monitors tire pressure.
- TPMS is turned on automatically every time you start the engine.
- TPMS fill assist provides audible and visual guidance during tire pressure adjustment.

## Refueling P. 484

**Fuel recommendation: Unleaded gasoline, pump octane number 87 or higher**

**Fuel tank capacity: 19.5 US gal (73.8 L)**

- 1 Press the fuel fill door release button.



- 2 After filling, wait about five seconds before removing the filler nozzle.

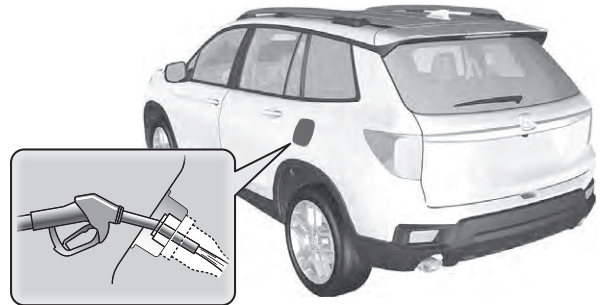

# Honda Sensing®

Assists with functions such as acceleration, braking, and steering in order to reduce the burden on the driver, as well as help avoid or reduce the severity of collisions.

Honda Sensing® has the following functions.

## Collision Mitigation Braking System™ (CMBS™)

↔ P. 425

The system can assist you when it determines there is a possibility of your vehicle colliding with a vehicle or a pedestrian detected in front of your vehicle. The CMBS™ is designed to alert you when the potential for a collision is determined, as well as to reduce your vehicle speed to help minimize collision severity when a collision is deemed unavoidable.

## Road Departure Mitigation (RDM) System

↔ P. 437

Alerts and helps to assist you when the system detects a possibility of your vehicle unintentionally crossing over detected lane markings and/or leaving the roadway altogether.

↔ P. 422

## Adaptive Cruise Control (ACC)

↔ P. 442

Helps maintain a constant vehicle speed and a set following-interval behind a vehicle detected ahead of yours, without you having to keep your foot on the brake or the accelerator.

## Lane Keeping Assist System (LKAS)

↔ P. 455

Provides steering input to help keep the vehicle in the middle of a detected lane and provides tactile and visual alerts if the vehicle is detected drifting out of its lane.

## Auto High-Beam

↔ P. 168

The front sensor camera detects the light sources ahead of the vehicle such as the lights of a preceding or oncoming vehicle, or street lights. When you are driving at night, the system automatically switches the headlights between low beam and high beam depending on the situation.

## Blind spot information System

↔ P. 414

Is designed to detect vehicles in specified alert zones adjacent to your vehicle, particularly in harder to see areas commonly known as “blind spots”. When the system detects vehicles approaching from behind in adjacent lanes, the appropriate indicator comes on for a few seconds, providing assistance when you change lanes.

## Cross Traffic Monitor

↔ P. 478

Monitors the rear corner areas using the radar sensors when reversing, and alerts you if a vehicle approaching from a rear corner is detected. The system is convenient when you are backing out of a parking space.

## Parking Sensor System\*

↔ P. 473

The corner and center sensors monitor obstacles near your vehicle, and the beeper and audio/information screen let you know the approximate distance between your vehicle and the obstacle.



# Maintenance P.489

## Under the Hood P.500

- Check engine oil, engine coolant, and windshield washer fluid. Add when necessary.
- Check brake fluid.
- Check the battery condition monthly.

- 1 Pull the hood release handle under the corner of the dashboard.



- 2 Locate the hood latch lever, pull it up, and then raise the hood. Once you have raised the hood slightly, you can release the lever.



- 3 When finished, close the hood and make sure it is firmly locked in place.

## Wiper Blades P.518

- Replace blades if they leave streaks across the windshield or become noisy.



## Tires P.522

- Inspect tires and wheels regularly.
- Check tire pressures regularly.
- Install snow tires for winter driving.

## Lights P.512

- Inspect all lights regularly.

# Handling the Unexpected P.543

## Flat Tire P.545

- Park in a safe location and replace the flat tire with the compact spare tire located in the cargo area.



## Engine Won't Start P.553

- If the battery is dead, jump start using a booster battery.

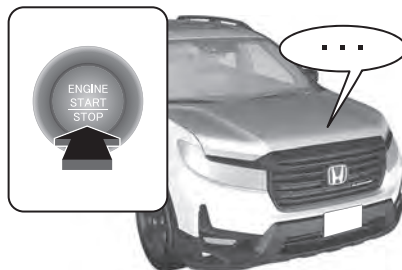

## Overheating P.560

- Park in a safe location. If you do not see steam under the hood, open the hood, and let the engine cool down.



## Indicators Come On P.562

- Identify the indicator and consult the owner's manual.

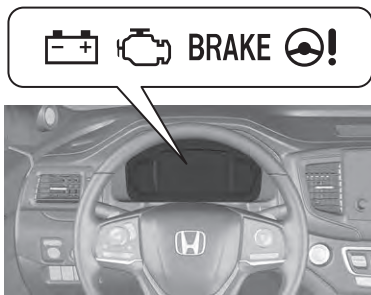

## Blown Fuse P.567

- Check for a blown fuse if an electrical device does not operate.

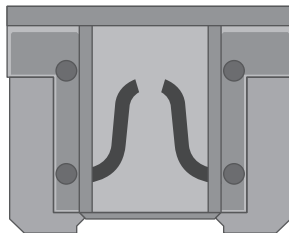

## Emergency Towing P.572

- Call a professional towing service if you need to tow your vehicle.



# What to Do If

**Q** **Canadian models**  
The power mode does not change from VEHICLE OFF (LOCK) to ACCESSORY. Why?

**A**

- The steering wheel may be locked.
- Move the steering wheel left and right after pressing the **ENGINE START/STOP** button.



**Q** Why does the brake pedal pulsate slightly when applying the brakes?

**A** This can occur when the ABS activates and does not indicate a problem. Apply firm, steady pressure on the brake pedal. Never pump the brake pedal.

▶ Anti-lock Brake System (ABS) P. 469

**Q** The rear door cannot be opened from inside the vehicle. Why?

**A** Check if the childproof lock is in the lock position. If so, open the rear door with the outside door handle. To cancel this function, slide the lever up to the unlock position.



---

**Q** Why do the doors lock after I unlocked the doors?

**A** If you do not open the doors within 30 seconds, the doors are relocked automatically for security.

---

**Q** Why does the beeper sound when I open the driver's door?

**A** The beeper sounds when:

- The power mode is in ACCESSORY.
- The exterior lights are left on.
- The Auto Idle Stop is in operation.

---

**Q** Why does a beeper sound when I walk away from the vehicle after I close the door?

**A** The beeper sounds if you move outside the walk away auto lock operating range before the door completely closes.

- ▶ Locking the doors and tailgate (Walk away auto lock®)

**➔ P.134**

---

**Q** Why does the beeper sound when I start driving?

**A** The beeper sounds when:

- Driver and/or front passenger are not wearing their seat belts.
- The parking brake pedal is not fully released.

---

**Q** Why do I hear a screeching sound when I apply the brake pedal?

**A** The brake pads may need to be replaced. Have your vehicle inspected by a dealer.

---



Why does the gear position automatically change to **P** when I open the driver's door to check for parking space lines when reversing?



- Fasten the driver's seat belt.
- Close the driver's door and manually change the gear position.
  - ▶ When opening the driver's door **P. 399**



I'm seeing an amber indicator of a tire with an exclamation point. What is that?



- The Tire Pressure Monitoring System (TPMS) needs attention. Check tire pressure.
- ▶ If the Low Tire Pressure/Tire Pressure Monitoring System (TPMS) Indicator Comes On or Blinks **P. 565**

# Safe Driving

You can find many safety recommendations throughout this chapter, and throughout this manual.

## **For Safe Driving**

Important Safety Precautions.....	34
Important Handling Information.....	36
Your Vehicle's Safety Features.....	37
Safety Checklist .....	38

## **Seat Belts**

About Your Seat Belts .....	39
Fastening a Seat Belt .....	44
Seat Belt Inspection.....	48

## **Airbags**

Airbag System Components.....	49
Types of Airbags .....	52
Front Airbags (SRS) .....	52
Side Airbags.....	57
Side Curtain Airbags .....	59
Airbag System Indicators.....	60
Airbag Care .....	63

## **Child Safety**

Protecting Child Passengers .....	64
Safety of Infants and Small Children ..	66
Safety of Larger Children .....	77

## **Exhaust Gas Hazard**

Carbon Monoxide Gas.....	79
--------------------------	----

## **Safety Labels**

Label Locations .....	80
-----------------------	----

The following pages explain your vehicle's safety features and how to use them properly. The safety precautions below are ones that we consider to be among the most important.

## Important Safety Precautions

---

### ■ Always wear your seat belt

A seat belt is your best protection in all types of collisions. Airbags are designed to supplement seat belts, not replace them. So even though your vehicle is equipped with airbags, make sure you and your passengers always wear your seat belts, and wear them properly.

### ■ Restrain all children

Children ages 12 and under should ride properly restrained in a back seat, not the front seat. Infants and small children should be restrained in a child seat. Larger children should use a booster seat and a lap/shoulder seat belt until they can use the belt properly without a booster seat.

### ■ Be aware of airbag hazards

While airbags can save lives, they can cause serious or fatal injuries to occupants who sit too close to them, or are not properly restrained. Infants, young children, and short adults are at the greatest risk. Be sure to follow all instructions and warnings in this manual.

### ■ Don't drink and drive

Alcohol and driving don't mix. Even one drink can reduce your ability to respond to changing conditions, and your reaction time gets worse with every additional drink. So don't drink and drive, and don't let your friends drink and drive, either.

### ▣ Important Safety Precautions

---

Some states, provinces and territories prohibit the use of cell phones other than hands-free devices by the driver while driving.

**■ Pay appropriate attention to the task of driving safely**

Engaging in cell phone conversation or other activities that keep you from paying close attention to the road, other vehicles, and pedestrians could lead to a crash. Remember, situations can change quickly, and only you can decide when it is safe to divert some attention away from driving.

**■ Control your speed**

Excessive speed is a major factor in crash injuries and deaths. Generally, the higher the speed, the greater the risk, but serious injuries can also occur at lower speeds. Never drive faster than is safe for current conditions, regardless of the maximum speed posted.

**■ Keep your vehicle in safe condition**

Having a tire blowout or a mechanical failure can be extremely hazardous. To reduce the possibility of such problems, check your tire pressures and condition frequently, and perform all regularly scheduled maintenance.

**■ Do not leave children unattended in the vehicle**

Children, pets, and people needing assistance left unattended in the vehicle may be injured if they activate one or more of the vehicle controls. They may also cause the vehicle to move, resulting in a crash in which they and/or another person(s) can be injured or killed. Also, depending on the ambient temperature, the temperature of the interior may reach extreme levels, which can result in harm or death. Even if the climate control system is on, never leave them in the vehicle unattended as the climate control system can shut off at any time.



## Important Handling Information

Your vehicle has higher ground clearance than a passenger vehicle designed for use only on pavement. Higher ground clearance has many advantages for off-highway driving. It allows you to travel over bumps, obstacles, and rough terrain. It also provides good visibility so you can anticipate problems earlier.

These advantages come at some cost. Because your vehicle is taller and rides higher off the ground, it has a higher center gravity making it more susceptible to tipping or rollover if you make abrupt turns. Utility vehicles have a significantly higher rollover rate than other types of vehicles. In a rollover crash, an unbelted person is significantly more likely to die than a person wearing a seat belt. As a reminder, make sure you and your passengers always wear seat belts.

### ► Important Handling Information

For information on how to reduce the risk of rollover, read:

► **Driving Guidelines for Your Utility Vehicle**  
P. 394

► **Off-Highway Driving Guidelines** P. 386  
Failure to operate your vehicle correctly might result in a crash or a rollover.

## Your Vehicle's Safety Features

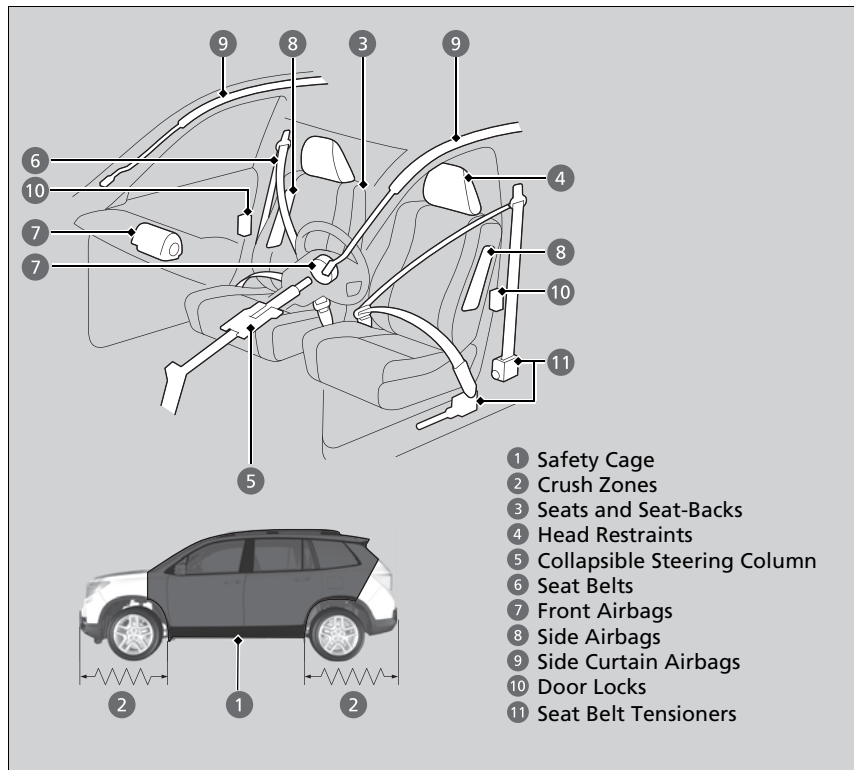

The following checklist will help you take an active role in protecting yourself and your passengers.

### ▣ Your Vehicle's Safety Features

Your vehicle is equipped with many features that work together to help protect you and your passengers during a crash.

Some features do not require any action on your part. These include a strong steel framework that forms a safety cage around the passenger compartment, front and rear crush zones, a collapsible steering column, and tensioners that tighten the front seat belts in a sufficient crash.

However, you and your passengers cannot take full advantage of these features unless you remain seated in the correct position and always wear your seat belts. In fact, some safety features can contribute to injuries if they are not used properly.

## Safety Checklist

For the safety of you and your passengers, make a habit of checking these items each time before you drive.

- After everyone has entered the vehicle, be sure all doors and the tailgate are closed and locked. Locking the doors and the tailgate helps prevent an occupant from being ejected and an outsider from unexpectedly opening a door or the tailgate.
  - **Locking/Unlocking the Doors from the Inside** P. 139
- Adjust your seat to a position suitable for driving. Be sure the front seats are adjusted as far to the rear as possible while allowing the driver to control the vehicle. Sitting too close to a front airbag can result in serious or fatal injury in a crash.
  - **Seats** P. 182
- Adjust head restraints to the proper position. Head restraints are most effective when the center of the head restraint aligns with the center of your head. Taller persons should adjust their head restraint to the highest position.
  - **Adjusting the Front and Rear Outer Seat Head Restraint Positions** P. 189
- Always wear your seat belt, and make sure you wear it properly. Confirm that any passengers are properly belted as well.
  - **Fastening a Seat Belt** P. 44
- Protect children by using seat belts or child seats according to a child's age, height, and weight.
  - **Child Safety** P. 64

### ☒ Safety Checklist

If the door and/or tailgate open message appears on the driver information interface, a door and/or the tailgate is not completely closed. Close all doors and the tailgate tightly until the message disappears.

#### ➤ **Driver Information Interface Warning and Information Messages** P. 98



## About Your Seat Belts

Seat belts are the single most effective safety device because they keep you connected to the vehicle so that you can take advantage of many built-in safety features. They also help keep you from being thrown against the inside of the vehicle, against any passengers, or out of the vehicle. When worn properly, seat belts also keep your body properly positioned in a crash so that you can take full advantage of the additional protection provided by the airbags.

In addition, seat belts help protect you in almost every type of crash, including:

- frontal impacts
- side impacts
- rear impacts
- rollovers

### ■ Lap/shoulder seat belts

All five seating positions are equipped with lap/shoulder seat belts with emergency locking retractors. In normal driving, the retractor lets you move freely while keeping some tension on the belt. During a collision or sudden stop, the retractor locks to restrain your body.

The front passenger's and rear seat belts also have a lockable retractor for use with child seats.

➤ **Installing a Child Seat with a Lap/Shoulder Seat Belt** P. 72

### ⓘ About Your Seat Belts

## ⚠ WARNING

**Not wearing a seat belt properly increases the chance of serious injury or death in a crash, even though your vehicle has airbags.**

**Be sure you and your passengers always wear seat belts and wear them properly.**

Seat belts cannot completely protect you in every crash. But in most cases, seat belts can reduce your risk of serious injury.

Most states and all Canadian provinces and territories require you to wear seat belts.

If you extend the seat belt too quickly, it will lock in place. If this happens, slightly retract the seat belt, then extend it slowly.

### ■ Proper use of seat belts

Follow these guidelines for proper use:

- All occupants should sit upright, well back in the seat, and remain in that position for the duration of the trip. Slouching and leaning reduce the effectiveness of the belt and can increase the chance of serious injury in a crash.
- Never place the shoulder part of a lap/shoulder seat belt under your arm or behind your back. This could cause very serious injuries in a crash.
- Two people should never use the same seat belt. If they do, they could be very seriously injured in a crash.
- Do not put any accessories on the seat belts. Devices intended to improve comfort or reposition the shoulder part of a seat belt can reduce the protective capability and increase the chance of serious injury in a crash.

### 🔍 About Your Seat Belts

If a rear seat passenger moves around and extends the seat belt, the lockable retractor may activate. If this happens, release the retractor by unfastening the seat belt and allow the belt to retract completely. Then, refasten the belt.

## Seat Belt Reminder



### ■ Front seats

The seat belt system includes an indicator on the instrument panel to remind the driver or a front passenger or both to fasten their seat belts.

If you set the power mode to ON and a seat belt is not fastened, a beeper will sound, and the indicator will blink. After a few seconds, the beeper will stop and the indicator will come on and remain illuminated until the seat belt is fastened.

The beeper will periodically sound and the indicator will blink while the vehicle is moving until the seat belt is fastened.

### ⊞ Seat Belt Reminder

The indicator will also come on if a front passenger does not fasten their seat belt within six seconds after the power mode is set to ON.

When no one is sitting in the front passenger's seat, the indicator will not come on and the beeper will not sound.

The indicator also may not come on and the beeper may not sound when the occupant is not heavy enough to trigger the weight sensor. Such occupants (e.g., infants and smaller children) should be moved to the rear seat as a deploying front airbag likely will injure or kill them.

#### ➤ Protecting Child Passengers P. 64

The driver information interface uses colors to aid the driver in checking the status of the passengers.

For the front seating positions:

- Green indicates the seat belt is fastened.
- An unfastened gray graphic indicates the seat belt is not fastened and an occupant has not been detected.
- An unfastened red graphic indicates the seat belt is unfastened and an occupant has been detected.



### ■ Rear seats

Your vehicle monitors rear seat belt use. The driver information interface notifies you if any of the rear seat belts are unfastened after they were previously fastened.

In order to encourage the driver to evaluate rear seat belt usage, the display appears when:

- Any of the rear passenger seat belts are unfastened when the power mode is set to ON.
- A rear door is opened and then closed.
- Any of the rear passengers fasten or unfasten their seat belt.

The seat belt reminder indicator blinks and the beeper sounds if any rear passenger seat belts are unfastened while driving.

To see the display:

- ▶ **Accessing Content** P. 112

### ▶▶ Seat Belt Reminder

The system will not detect a passenger in the rear seats who has not fastened the seat belt.

The driver should check the status of the rear passengers' seat belts at the start of each trip and each time a passenger is seated in the rear seats, using the driver information interface as an aid.

An alert will sound if a passenger in the rear seats unfastens the seat belt while the vehicle is in motion or if motion resumes while the graphic is red.

The driver information interface uses colors to aid the driver in checking the status of the passengers.

For the rear seating positions:

- Green indicates the seat belt is fastened.
- An unfastened gray graphic indicates the seat belt has not been fastened recently.
- An unfastened red graphic indicates the seat belt was unfastened recently.

The system does not monitor harnesses that are part of a child seat, the anchors of the LATCH system, or the anchor buckle of the second row center seat belt. While the system can inform you that a seat belt buckle is fastened, it cannot determine whether the second row center seat belt anchor buckle is in use or if a child seat is properly installed or used.

- ▶▶ **Protecting Child Passengers** P. 64

## Automatic Seat Belt Tensioners

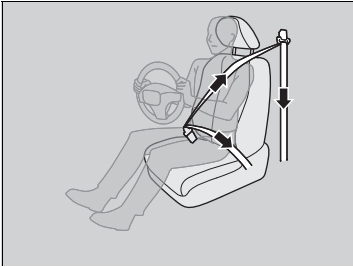

The front seats are equipped with automatic seat belt tensioners to enhance safety.

The tensioners automatically tighten the front seat belts during a moderate-to-severe frontal collision, sometimes even if the collision is not severe enough to inflate the front airbags.

### Automatic Seat Belt Tensioners

The seat belt tensioners can only operate once. If a tensioner is activated, the SRS indicator will come on. Have a dealer replace the tensioner and thoroughly inspect the seat belt system as it may not offer protection in a subsequent crash.

During a moderate-to-severe side impact, the tensioner on that side of the vehicle also activates.



## Fastening a Seat Belt

After adjusting a front seat to the proper position, and while sitting upright and well back in the seat:

➤ **Seats** P. 182

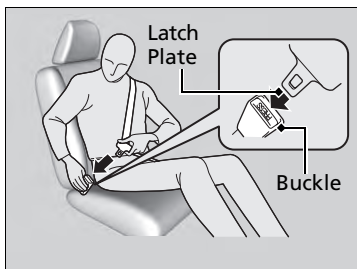
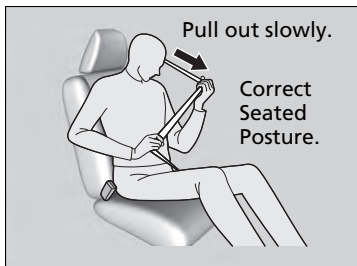

1. Pull the seat belt out slowly.

2. Insert the latch plate into the buckle, then tug on the belt to make sure the buckle is secure.

▶ Make sure that the belt is not twisted or caught on anything.

### Fastening a Seat Belt

No one should sit in a seat with an inoperative seat belt or one that does not appear to be working correctly. Using a seat belt that is not working properly may not protect the occupant in a crash. Have a dealer check the belt as soon as possible.

Never insert any foreign objects into the buckle or retractor mechanism.

If the seat belt appears to be locked in a fully retracted position, firmly pull out on the shoulder belt once, then push it back in.

Then, smoothly pull it out of the retractor and fasten. If you are unable to release the seat belt from a fully retracted position, do not allow anyone to sit in the seat, and take your vehicle to a dealer for repair.

➤ **About Your Seat Belts** P. 39

➤ **Seat Belt Inspection** P. 48

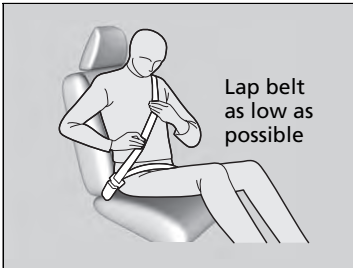

3. Position the lap part of the belt as low as possible across your hips, then pull up on the shoulder part of the belt so the lap part fits snugly. This lets your strong pelvic bones take the force of a crash and reduces the chance of internal injuries.
4. If necessary, pull up on the belt again to remove any slack, then check that the belt rests across the center of your chest and over your shoulder. This spreads the forces of a crash over the strongest bones in your upper body.

## ■ Adjusting the Shoulder Anchor

The front seats have adjustable shoulder anchors to accommodate taller and shorter occupants.

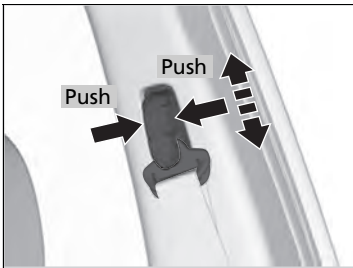

1. Move the anchor up and down while holding the release button.
2. Position the anchor so that the belt rests across the center of your chest and over your shoulder.

## ▶▶ Fastening a Seat Belt

### ⚠ WARNING

Improperly positioning the seat belts can cause serious injury or death in a crash.

Make sure all seat belts are properly positioned before driving.

To release the belt, push the red **PRESS** button and then guide the belt by hand until it has retracted completely.

When exiting the vehicle, be sure the belt is properly stowed so that it will not get caught in the closing door.

## ▶▶ Adjusting the Shoulder Anchor

The shoulder anchor height can be adjusted to four levels. If the belt contacts your neck, lower the height one level at a time.

After an adjustment, make sure that the shoulder anchor position is secure.

## ■ Seat Belt with Detachable Anchor

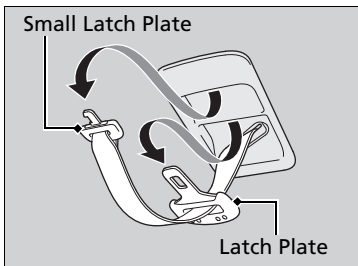

1. Pull out the seat belt's small latch plate and the latch plate from each holding slot in the ceiling.

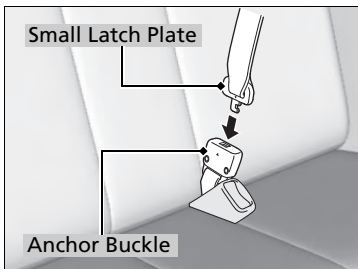

2. Line up the triangle marks on the small latch plate and anchor buckle. Make sure the seat belt is not twisted. Attach the belt to the anchor buckle.

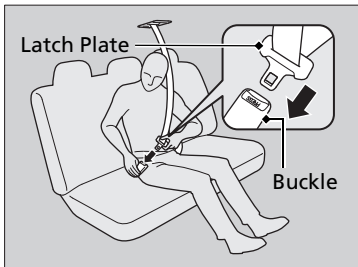

3. Insert the latch plate into the buckle. Properly fasten the seat belt the same way you fasten the lap/shoulder seat belt.

## ▶▶ Seat Belt with Detachable Anchor

### ⚠ WARNING

Using the seat belt with the detachable anchor unfastened increases the chance of serious injury or death in a crash.

Before using the seat belt, make sure the detachable anchor is correctly fastened.

To unlatch the detachable anchor, insert the latch plate into the slot on the side of the anchor buckle.

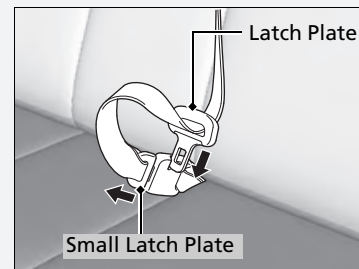

## Advice for Pregnant Women

If you are pregnant, the best way to protect yourself and your unborn child when driving or riding in a vehicle is to always wear a seat belt and keep the lap part of the belt as low as possible across the hips.

Wear the shoulder belt across the chest avoiding the abdomen.



Wear the lap part of the belt as low as possible across the hips.

## Advice for Pregnant Women

Each time you have a checkup, ask your doctor if it is okay for you to drive.

To reduce the risk of injuries to both you and your unborn child that can be caused by an inflating front airbag:

- When driving, sit upright and adjust the seat as far back as possible while allowing full control of the vehicle.
- When sitting in the front passenger's seat, adjust the seat as far back as possible.

## Seat Belt Inspection

Regularly check the condition of your seat belts as follows:

- Pull each belt out fully, and look for frays, cuts, burns, and wear.
- Check that the latch plates and buckles work smoothly, and the belts retract easily.
  - ▶ If a belt does not retract easily, cleaning the belt may correct the problem. Only use a mild soap and warm water. Do not use bleach or cleaning solvents. Make sure the belt is completely dry before allowing it to retract.

Any belt that is not in good condition or working properly will not provide proper protection and should be replaced as soon as possible.

A belt that has been worn during a crash may not provide the same level of protection in a subsequent crash. Have your seat belts inspected by a dealer after any collision.

### ▶▶ Seat Belt Inspection

#### **WARNING**

Not checking or maintaining seat belts can result in serious injury or death if the seat belts do not work properly when needed.

Check your seat belts regularly and have any problem corrected as soon as possible.

## Airbag System Components

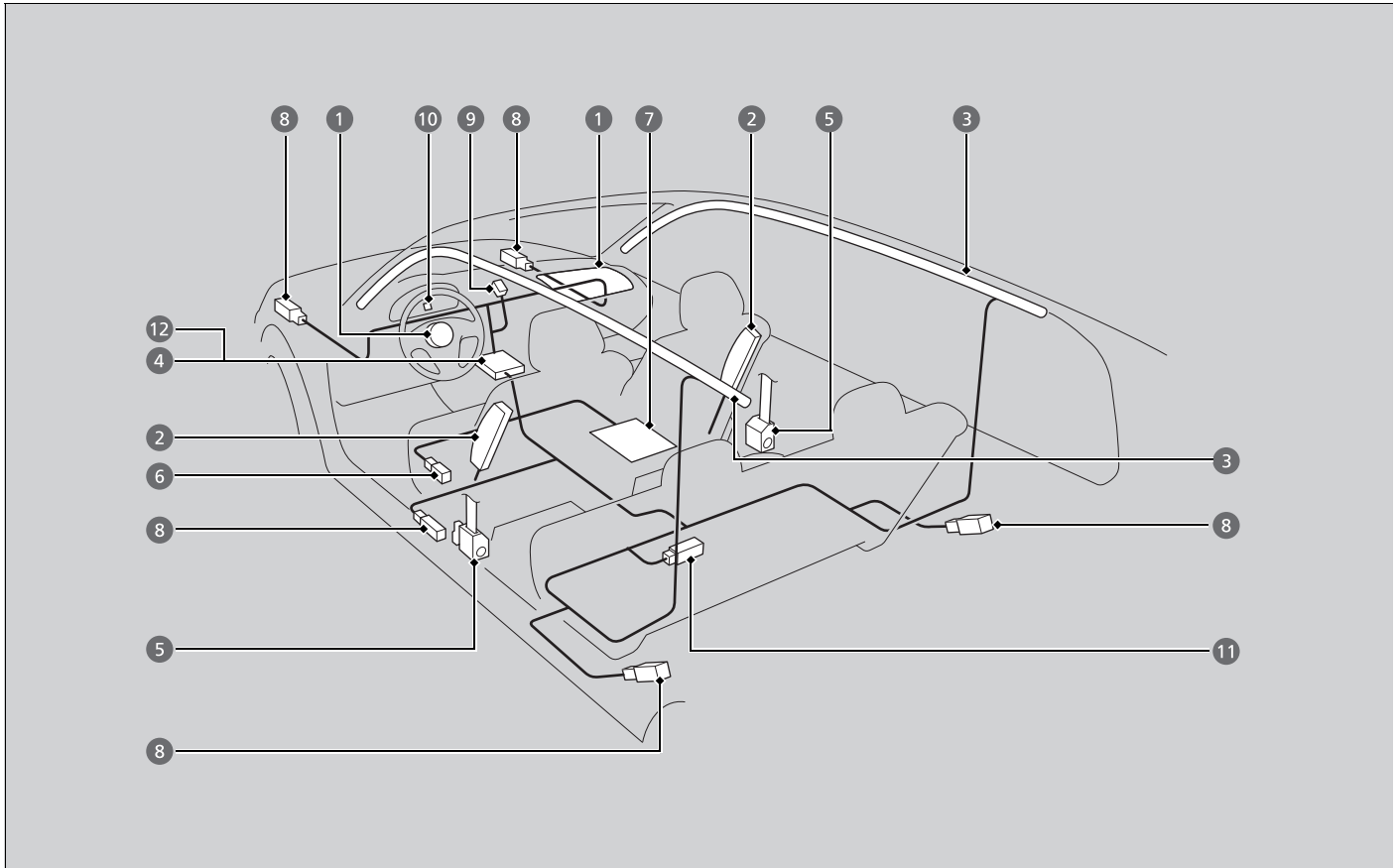

The front, side, and side curtain airbags are deployed according to the direction and severity of impact. Both side curtain airbags are deployed in a rollover. The airbag system includes:

- ❶ Two SRS (Supplemental Restraint System) front airbags. The driver's airbag is stored in the center of the steering wheel; the front passenger's airbag is stored in the dashboard. Both are marked **SRS AIRBAG**.
- ❷ Two side airbags, one for the driver and one for a front passenger. The airbags are stored in the outer edges of the seat-backs. Both are marked **SIDE AIRBAG**.
- ❸ Two side curtain airbags, one for each side of the vehicle. The airbags are stored in the ceiling, above the side windows. The front and rear pillars are marked **SIDE CURTAIN AIRBAG**.
- ❹ An electronic control unit that, when the power mode is in ON, continually monitors information about the various impact sensors, seat and buckle sensors, rollover sensor, airbag activators, seat belt tensioners and other vehicle information. During a crash event the unit can record such information.
- ❺ Automatic front seat belt tensioners. In addition, the driver's and front passenger's seat belt buckles incorporate sensors that detect whether or not the belts are fastened.
- ❻ Driver's seat position sensor. This sensor detects the driver's seat slide position to help determine the optimal deployment of the driver's airbag.
- ❼ Weight sensors in the front passenger's seat. The sensors are used for occupant classification to activate or deactivate the front passenger's airbag.
- ❽ Impact sensors that can detect a moderate-to-severe front or side impact.
- ❾ An indicator on the dashboard that alerts you that the front passenger's front airbag has been turned off.
- ❿ An indicator on the instrument panel that alerts you to a possible problem with your airbag system or seat belt tensioners.
- ⓫ Safing Sensor
- ⓬ A rollover sensor that can detect if your vehicle is about to roll over and signal the control unit to deploy both side curtain airbags.

## ■ Important Facts About Your Airbags

Airbags can pose serious hazards. To do their job, airbags must inflate with tremendous force. So, while airbags help save lives, they can cause burns, bruises, and other minor injuries, sometimes even fatal ones if occupants are not wearing their seat belts properly and sitting correctly.

**What you should do:** Always wear your seat belt properly and sit upright and as far back from the steering wheel as possible while allowing full control of the vehicle. A front passenger should move their seat as far back from the dashboard as possible.

Remember, however, that no safety system can prevent all injuries or deaths that can occur in a severe crash, even when seat belts are properly worn and the airbags deploy.

**Do not place hard or sharp objects between yourself and a front airbag.**

Carrying hard or sharp objects on your lap, or driving with a pipe or other sharp object in your mouth, can result in injuries if your front airbag inflates.

**Do not attach or place objects on the front airbag covers.** Objects on the covers marked **SRS AIRBAG** could interfere with the proper operation of the airbags or be propelled inside the vehicle and hurt someone if the airbags inflate.

## ▣ Important Facts About Your Airbags

Do not attempt to deactivate your airbags. Together, airbags and seat belts provide the best protection.

When driving, keep hands and arms out of the deployment path of the front airbag by holding each side of the steering wheel. Do not cross an arm over the airbag cover.



## Types of Airbags

Your vehicle is equipped with three types of airbags:

- **Front airbags:** Airbags in front of the driver's and front passenger's seats.
- **Side airbags:** Airbags in the driver's and front passenger's seat-backs.
- **Side curtain airbags:** Airbags above the side windows.

Each is discussed in the following pages.

## Front Airbags (SRS)

The front SRS airbags inflate in a moderate-to-severe frontal collision to help protect the head and chest of the driver and/or front passenger.

**SRS** (Supplemental Restraint System) indicates that the airbags are designed to supplement seat belts, not replace them. Seat belts are the occupant's primary restraint system.

### ■ Housing Locations

The front airbags are housed in the center of the steering wheel for the driver, and in the dashboard for the front passenger. Both airbags are marked **SRS AIRBAG**.

### ☒ Types of Airbags

The airbags can inflate whenever the power mode is in ON.

After an airbag inflates in a crash, you may see a small amount of smoke. This is from the combustion process of the inflator material and is not harmful. People with respiratory problems may experience some temporary discomfort. If this occurs, get out of the vehicle as soon as it is safe to do so.

### ☒ Front Airbags (SRS)

During a frontal crash severe enough to cause one or both front airbags to deploy, the airbags can inflate at different rates, depending on the severity of the crash, whether or not the seat belts are latched, and/or other factors. Frontal airbags are designed to supplement the seat belts to help reduce the likelihood of head and chest injuries in frontal crashes.

## ■ Operation

Front airbags are designed to inflate during moderate-to-severe frontal collisions. When the vehicle decelerates suddenly, the sensors send information to the control unit which signals one or both front airbags to inflate.

A frontal collision can be either head-on or angled between two vehicles, or when a vehicle crashes into a stationary object, such as a concrete wall.

## ■ How the Front Airbags Work

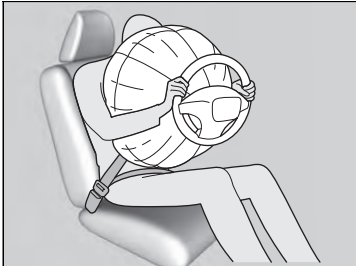

While your seat belt restrains your torso, the front airbag provides supplemental protection for your head and chest. The front airbags deflate immediately so that they won't interfere with the driver's visibility or the ability to steer or operate other controls.

The total time for inflation and deflation is so fast that most occupants are not aware that the airbags deployed until they see them lying in front of them.

## ⊠ How the Front Airbags Work

Although the driver's and front passenger's airbags normally inflate within a split second of each other, it is possible for only one airbag to deploy. This can happen if the severity of a collision is at the margin, or threshold that determines whether or not the airbags will deploy. In such cases, the seat belt will provide sufficient protection, and the supplemental protection offered by the airbag would be minimal.

### ■ When front airbags should not deploy

**Minor frontal crashes:** Front airbags were designed to supplement seat belts and help save lives, not to prevent minor scrapes, or even broken bones that might occur during a less than moderate-to-severe frontal crash.

**Side impacts:** Front airbags can provide protection when a sudden deceleration causes a driver or front passenger to move toward the front of the vehicle. Side airbags and side curtain airbags have been specifically designed to help reduce the severity of injuries that can occur during a moderate-to-severe side impact which can cause the driver or passenger to move toward the side of the vehicle.

**Rear impacts:** Head restraints and seat belts are your best protection during a rear impact. Front airbags cannot provide any significant protection and are not designed to deploy in such collisions.

**Rollovers:** In a rollover, your best form of protection is a seat belt or, if your vehicle is equipped with a rollover sensor, both a seat belt and a side curtain airbag. Front airbags, however, are not designed to deploy in a rollover as they would provide little if any protection.

### ■ When front airbags deploy with little or no visible damage

Because the airbag system senses sudden deceleration, a strong impact to the vehicle framework or suspension might cause one or more of the airbags to deploy. Examples include running into a curb, the edge of a hole, or other low fixed object that causes a sudden deceleration in the vehicle chassis. Since the impact is underneath the vehicle, damage may not be readily apparent.

### ■ When front airbags may not deploy, even though exterior damage appears severe

Since crushable body parts absorb crash energy during an impact, the amount of visible damage does not always indicate proper airbag operation. In fact, some collisions can result in severe damage but no airbag deployment because the airbags would not have been needed or would not have provided protection even if they had deployed.

## Advanced Airbags

The airbags have advanced features to help reduce the likelihood of airbag related injuries to smaller occupants.

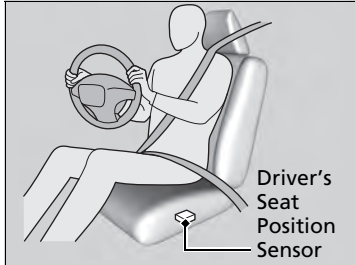

The driver's advanced airbag system includes a seat position sensor.

Based on information from this sensor and the severity of the impact, the advanced airbag system determines the optimal deployment of the driver's airbag.

### Advanced Airbags

If there is a problem with the driver's seat position sensor or the passenger's seat weight sensors, the SRS indicator will come on, and in the event of a crash, the airbag will deploy (regardless of the driver's seating position or passenger's occupant classification) with a force corresponding to the severity of the impact.

#### Supplemental Restraint System (SRS) Indicator P. 60

For the advanced front airbags to work properly, confirm that:

- The occupant is sitting in an upright position, wearing the seat belt properly and the seat-back is not excessively reclined.
- The occupant is not leaning against the door or center console.
- The occupant's feet are placed on the floor in front of them.
- There are no objects hanging from the front passenger's seat.
- Only small, lightweight objects are in the seat-back pocket.
- The steering wheel and passenger's side dashboard are not obstructed by any object.
- No liquid has been spilled on or under the seat.
- There is no child seat or other object pressing against the rear of the seat or seat-back.
- There is no rear passenger pushing or pulling on the back of the front passenger's seat.

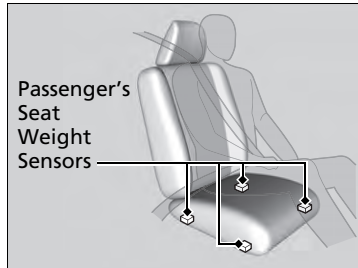

The front passenger's advanced airbag system has weight sensors. The sensors are used for occupant classification to activate or deactivate the front passenger's airbag.

For adult size occupants, the system will automatically activate the front passenger's airbag. If a small adult sits in the front passenger seat and the system does not recognize him/her as an adult, see

▶ **Passenger Airbag Off Indicator** P. 61

We advise against allowing a child age 12 or under to ride in the front passenger's seat. However, if you do allow a small child or infant to ride in the front passenger's seat, the system is designed to automatically deactivate the front passenger's airbag. Do not let a small child or infant ride in the front passenger's seat if the airbag does not automatically deactivate.

#### ▶▶ Advanced Airbags

- There are no objects placed under or beside the front passenger's seat. Improperly positioned objects can interfere with the advanced airbag sensors.
- The head restraint is not contacting the roof.  
▶ **Passenger Airbag Off Indicator** P. 61
- The floor mat behind the front passenger's seat is hooked to the floor mat anchor. An improperly placed mat can interfere with the advanced airbag sensors.  
▶ **Floor Mats** P. 537

## Side Airbags

The side airbags help protect the torso and pelvis of the driver or a front passenger during a moderate-to-severe side impact.

### Housing Locations

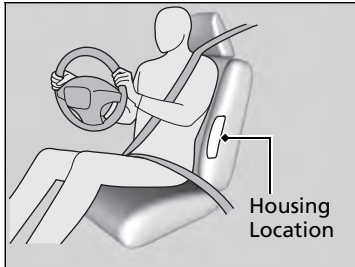

The side airbags are housed in the outside edge of the driver's and passenger's seat-backs.

Both are marked **SIDE AIRBAG**.

### Operation

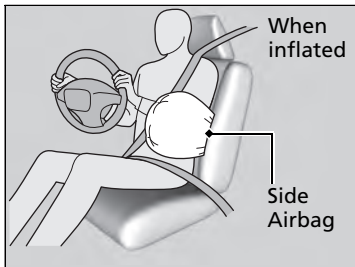

When the sensors detect a moderate-to-severe side impact, the control unit signals the side airbag on the impact side to immediately inflate.

### Side Airbags

Make sure you and your front seat passenger always sit upright. Leaning into the path of a side airbag can prevent the airbag from deploying properly and increases your risk of serious injury.

Do not attach accessories on or near the side airbags. They can interfere with the proper operation of the airbags, or hurt someone if an airbag inflates.

Do not cover or replace the front seat-back covers without consulting a dealer. Improperly replacing or covering front seat-back covers can prevent your side airbags from properly deploying during a side impact.

■ **When a side airbag deploys with little or no visible damage**

Because the airbag system senses sudden acceleration, a strong impact to the side of the vehicle's framework can cause a side airbag to deploy. In such cases, there may be little or no damage, but the side impact sensors detected a severe enough impact to deploy the airbag.

■ **When a side airbag may not deploy, even though visible damage appears severe**

It is possible for a side airbag not to deploy during an impact that results in apparently severe damage. This can occur when the point of impact was toward the far front or rear of the vehicle, or when the vehicle's crushable body parts absorbed most of the crash energy. In either case, the side airbag would not have been needed nor provided protection even if it had deployed.

## Side Curtain Airbags

The side curtain airbags help protect the heads of the driver and passengers in the outer seating positions during a moderate-to-severe side impact. The side curtain airbags equipped in this vehicle are also designed to help reduce the likelihood of partial and complete ejection of vehicle occupants through side windows in crashes, particularly rollover crashes.

### ■ Housing Locations

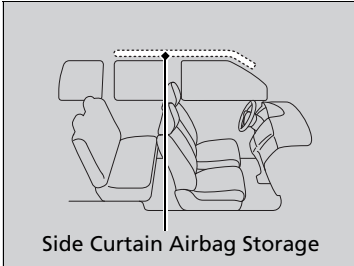

The side curtain airbags are located in the ceiling above the side windows on both sides of the vehicle.

### ■ Operation

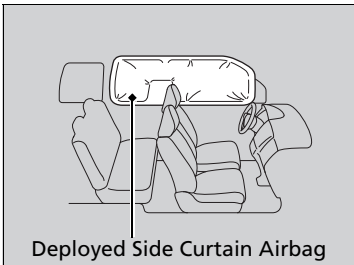

The side curtain airbag is designed to deploy in a rollover or a moderate-to-severe side impact.

### ▣ Side Curtain Airbags

To get the best protection from the side curtain airbags, occupants should wear their seat belts properly and sit upright and well back in their seats.

Do not attach any objects to the side windows or roof pillars as they can interfere with the proper operation of the side curtain airbags.

If the SRS control unit senses that your vehicle is about to rollover, it immediately deploys both side curtain airbags and activates both front seat belt tensioners.

If the impact is on the passenger's side, the passenger's side curtain airbag deploys even if there are no occupants on that side of the vehicle.



### ■ When side curtain airbags deploy in a frontal collision

One or both side curtain airbags may also inflate in a moderate-to-severe angled frontal collision.

## Airbag System Indicators

If a problem occurs in the airbag system, the SRS indicator will come on and a message appears on the driver information interface.

### ■ Supplemental Restraint System (SRS) Indicator



#### ■ When the power mode is set to ON

The indicator comes on for a few seconds, then goes off. This tells you the system is working properly.

If the indicator comes on at any other time, or does not come on at all, have the system checked by a dealer as soon as possible. If you don't, your airbags and seat belt tensioners may not work properly when they are needed.

### ⌘ Supplemental Restraint System (SRS) Indicator

## ⚠ WARNING

Ignoring the SRS indicator can result in serious injury or death if the airbag systems or tensioners do not work properly.

Have your vehicle checked by a dealer as soon as possible if the SRS indicator alerts you to a possible problem.

## Passenger Airbag Off Indicator

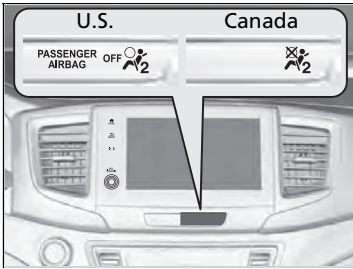

### ■ When the passenger airbag off indicator comes on

The indicator comes on to alert you that the passenger's airbag has been turned off. This occurs when the weight sensors determine that a small child or infant is on the passenger seat.

Children age 12 or under should always ride properly restrained in a back seat.

#### 🚗 Child Safety P. 64

Objects placed on the seat can also cause the indicator to come on. If the indicator is on, in the event of a crash the passenger's airbag will not deploy. If your vehicle is equipped with a passenger's knee airbag, this airbag will not deploy either.

If the passenger's seat is empty, the passenger's airbag will not deploy and the indicator will not come on. When you set the power mode to ON, the indicator comes on and goes off a few seconds later to indicate that system checks are being performed. After that, the indicator comes on or off depending on the passenger's occupant classification.

### 🚗 Passenger Airbag Off Indicator

To ensure the passenger is detected properly, confirm that:

- The occupant is sitting in an upright position, wearing the seat belt properly and the seat-back is not excessively reclined.
- The occupant is not leaning against the door or center console.
- The occupant's feet are placed on the floor in front of them.
- There are no objects hanging from the front passenger's seat.
- Only small, lightweight objects are in the seat-back pocket.
- No liquid has been spilled on or under the seat.
- There is no child seat or other object pressing against the rear of the seat or seat-back.
- There is no rear passenger pushing or pulling on the back of the front passenger's seat.
- There are no objects placed under or beside the front passenger's seat. Improperly positioned objects can interfere with the advanced airbag sensors.
- The floor mat behind the front passenger's seat is hooked to the floor mat anchor. An improperly placed mat can interfere with the advanced airbag sensors.
- The head restraint is not contacting the roof.

#### ✘ Passenger Airbag Off Indicator

The passenger airbag off indicator may come on and go off periodically if the total weight on the seat is near the airbag cutoff threshold. For a small adult, depending on physique and posture, the system may not recognize him/her as an adult and thus deactivate the passenger's airbag.

If this occurs, please confirm that the conditions set forth in the above bullet points on the previous page are met.

Have your vehicle checked by a dealer as soon as possible if:

- All of the above conditions are met, and the indicator comes on with an adult seated in the front passenger seat.
- The seat is empty and the indicator is on.
- The indicator does not come on and go off after setting the power mode to ON as described.

Do not allow an adult passenger to ride in the front seat when the indicator is on.

## Airbag Care

---

You do not need to, and should not, perform any maintenance on or replace any airbag system components yourself. However, you should have your vehicle inspected by a dealer in the following situations:

### ■ When the airbags have deployed

If an airbag has inflated, the control unit and other related parts must be replaced. Similarly, once an automatic seat belt tensioner has been activated, it must be replaced.

### ■ When the vehicle has been in a moderate-to-severe collision

Even if the airbags did not inflate, have your dealer inspect the following: the driver's seat position sensor, weight sensors in the passenger's seat, front seat belt tensioners, and each seat belt that was worn during the crash.

### ■ Do not remove or modify a front seat without consulting a dealer

This would likely disable or affect the proper operation of the driver's seat position sensor or the weight sensors in the passenger's seat. If it is necessary to remove or modify a front seat to accommodate a person with disabilities, contact a Honda dealer, or for U.S. vehicles, American Honda Automobile Customer Service at 1-800-999-1009 and for Canadian vehicles, Honda Canada Customer Relations at 1-888-9-HONDA-9.

#### ✘ Airbag Care

We recommend against the use of salvaged airbag system components, including the airbag, tensioners, sensors, and control unit.

## Protecting Child Passengers

Each year, many children are injured or killed in vehicle crashes because they are either unrestrained or not properly restrained. In fact, vehicle crashes are the number one cause of death of children ages 12 and under.

To reduce the number of child deaths and injuries, every state, Canadian province and territory requires that infants and children be properly restrained when they ride in a vehicle.

**Children should sit properly restrained in a rear seat.** This is because:

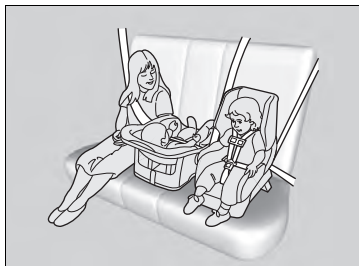

- An inflating front airbag can injure or kill a child sitting in the front seat.
- A child in the front seat is more likely to interfere with the driver's ability to safely control the vehicle.
- Statistics show that children of all sizes and ages are safer when they are properly restrained in a rear seat.

### Protecting Child Passengers

#### **WARNING**

**Children who are unrestrained or improperly restrained can be seriously injured or killed in a crash.**

**Any child too small for a seat belt should be properly restrained in a child seat. A larger child should be properly restrained with a seat belt, using a booster seat if necessary.**

The National Highway Traffic Safety Administration and Transport Canada recommend that all children ages 12 and under be properly restrained in a rear seat. Some states or provinces/territories have laws restricting where children may ride.

- Never hold a child on your lap because it is impossible to protect them in the event of a collision.
- Never put a seat belt over yourself and a child. During a crash, the belt would likely press deep into the child and cause serious or fatal injuries.
- Never let two children use the same seat belt. Both children could be very seriously injured in a crash.
- Any child who is too small to wear a seat belt correctly must be restrained in an approved child seat that is properly secured to the vehicle using either the seat belt or the lower anchors of the LATCH system.
- Do not allow children to operate the doors, windows, or seat adjustments.
- Do not leave children in the vehicle unattended, especially in hot weather when the inside of the vehicle can get hot enough to kill them. They could also activate vehicle controls causing it to move unexpectedly.

#### ▶▶ Protecting Child Passengers

### **⚠ WARNING**

**Allowing a child to play with a seat belt or wrap one around their neck can result in serious injury or death.**

**Instruct children not to play with any seat belt and make sure any unused seat belt a child can reach is buckled, fully retracted, and locked.**

To deactivate a lockable retractor, release the buckle and allow the seat belt to wind up all the way.

To remind you of the passenger's front airbag hazards and child safety, your vehicle has warning labels on the dashboard (U.S. models) and on the front visors. Please read and follow the instructions on these labels.

**▶▶ Safety Labels P. 80**

## Safety of Infants and Small Children

### ■ Protecting Infants

An infant must be properly restrained in a rear-facing child seat until the infant reaches the seat manufacturer's weight or height limit for the seat.

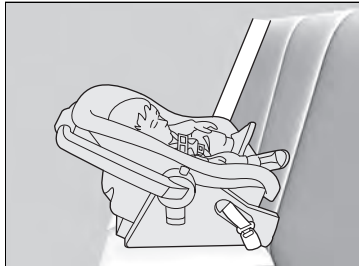

#### ■ Positioning a rear-facing child seat

Child seats must be placed and secured in a rear seating position.

When properly installed, a rear-facing child seat may prevent the driver or a front passenger from moving their seat all the way back, or from locking their seat-back in the desired position. Make sure that there is no contact between the child seat and the seat in front of it.

It can also interfere with proper operation of the passenger's advanced front airbag system.

➤ **Airbags** P. 49

If this occurs, we recommend that you install the child seat directly behind the front passenger's seat, move the seat as far forward as needed, and leave it unoccupied. Or, you may wish to get a smaller rear-facing child seat.

### ⓘ Protecting Infants

## ⚠ WARNING

Placing a rear-facing child seat in the front seat can result in serious injury or death during a crash.

Always place a rear-facing child seat in the rear seat, not the front.

Experts recommend use of a rear-facing seat for a child so long as the child's height and weight are appropriate for a rear-facing seat.

Infants should never be seated in a forward-facing position.

Always refer to the child seat manufacturer's instructions before installation.

Do not allow a front seat to rest against a child seat installed in a rear seating position. The weight sensor in the front seat may not correctly detect the actual weight of the occupant.

## ■ Protecting Smaller Children

If a child has exceeded the weight and height limitations of a rearward-facing child seat, the child should be properly restrained in a firmly secured forward-facing child seat until they exceed the weight and height limitations for the forward-facing child seat.

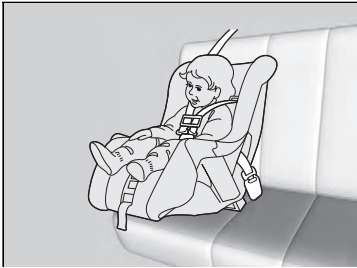

### ■ Forward-facing child seat placement

We strongly recommend placing a forward-facing child seat in a rear seating position.

Placing a forward-facing child seat in the front seat can be hazardous, even with advanced front airbags that automatically turn the passenger's front airbag off. A rear seat is the safest place for a child.

## ⚠ Protecting Smaller Children

### ⚠ WARNING

Placing a forward-facing child seat in the front seat can result in serious injury or death if the front airbag inflates.

If you must place a forward-facing child seat in front, move the vehicle seat as far back as possible, and properly restrain the child.

Educate yourself about the laws and regulations regarding child seat use where you are driving, and follow the child seat manufacturer's instructions.



## ■ Selecting a Child Seat

Most child seats are LATCH-compatible (Lower Anchors and Tethers for Children). Some have a rigid-type connector while others have a flexible-type connector. Both are equally easy to use. Some existing and previously owned child seats can only be installed using the seat belt. Whichever type you choose, follow the child seat manufacturer's use and care instructions including recommended expiration dates as well as the instructions in this manual. Proper installation is key to maximizing your child's safety.

In seating positions and vehicles not equipped with LATCH, a LATCH-compatible child seat can be installed using the seat belt and a top tether for added security. This is because all child seats are required to be designed so that they can be secured with a lap belt or the lap part of a lap/shoulder belt. In addition, the child seat manufacturer may advise that a seat belt be used to attach a LATCH-compatible seat once a child reaches a specified weight. Please read the child seat owner's manual for proper installation instructions.

### ■ Important consideration when selecting a child seat

Make sure the child seat meets the following three requirements:

- The child seat is the correct type and size for the child.
- The child seat is the correct type for the seating position.
- The child seat is compliant with Federal Motor Vehicle Safety Standard 213 or Canadian Motor Vehicle Safety Standard 213.

## ▶▶ Selecting a Child Seat

Installation of a LATCH-compatible child seat is simple.

LATCH-compatible child seats have been developed to simplify the installation process and reduce the likelihood of injuries caused by incorrect installation.

## ■ Installing a LATCH-Compatible Child Seat

A LATCH-compatible child seat can be installed in the rear seats. A child seat is attached to the lower anchors with either the rigid or flexible type of connectors.

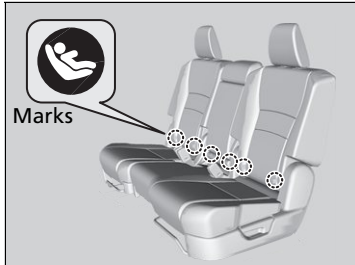

1. Locate the lower anchors under the marks.

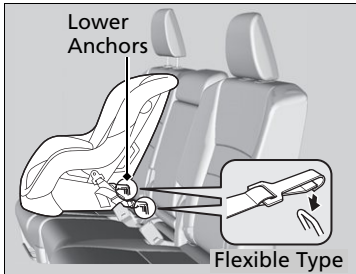
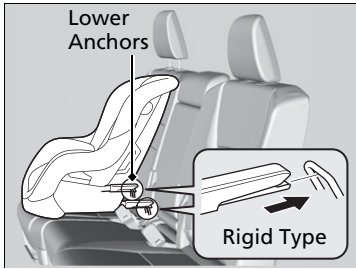

2. Place the child seat on the vehicle seat, then attach the child seat to the lower anchors according to the instructions that came with the child seat.

- ▶ When installing the child seat, make sure that the lower anchors are not obstructed by the seat belt or any other object.

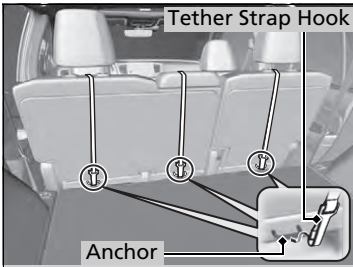

**Outer positions**

3. Slide the seat forward.
4. Put the outer head restraint to its uppermost position, then route the tether strap between the head restraint legs, and secure the tether strap hook onto the anchor.  
Make sure the strap is not twisted.

**Center position**

3. Slide the seat forward.
4. Put the center head restraint to its lowest position, then route the tether strap over the top of the head restraint and secure the tether strap hook onto the anchor.  
Make sure the strap is not twisted.

**All positions**

5. Tighten the tether strap as instructed by the child seat manufacturer.
6. Slide the seat backward.
7. Make sure the child seat is firmly secured by rocking it forward and back and side to side; little movement should be felt.
8. Make sure any unused seat belt that a child can reach is buckled, the lockable retractor is activated, and the belt is fully retracted and locked.

▶ **Protecting Child Passengers** P. 64



▶▶ Installing a LATCH-Compatible Child Seat

**⚠ WARNING**

Never attach two child seats to the same anchor. In a collision, one anchor may not be strong enough to hold two child seat attachments and may break, causing serious injury or death.

For your child's safety, when using a child seat installed using the LATCH system, make sure that the child seat is properly secured to the vehicle. A child seat that is not properly secured will not adequately protect a child in a crash and may cause injury to the child or other vehicle occupants.

## ■ Installing a Child Seat with a Lap/Shoulder Seat Belt

A child seat can be installed with a lap/shoulder belt in any rear seat or, if absolutely necessary, the front passenger seat.



1. Place the child seat on the vehicle seat.

### Outer positions

2. Slide the seat forward.
3. Put the outer head restraint to its uppermost position, then route the tether strap between the head restraint legs, and secure the tether strap hook onto the anchor.

Make sure the strap is not twisted.

### Center position

2. Slide the seat forward.
3. Put the center head restraint to its lowest position, then route the tether strap over the top of the head restraint and secure the tether strap hook onto the anchor.

Make sure the strap is not twisted.

### All positions

4. Tighten the tether strap as instructed by the child seat manufacturer.

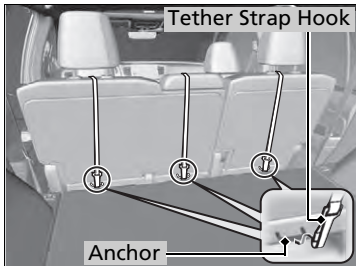

## ▶▶ Installing a Child Seat with a Lap/Shoulder Seat Belt

A child seat that is not properly secured will not adequately protect a child in a crash and may cause injury to the child or other vehicle occupants.

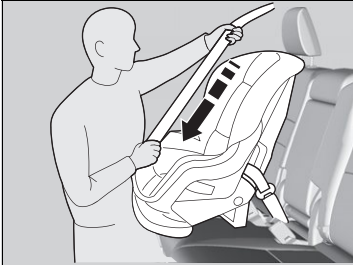
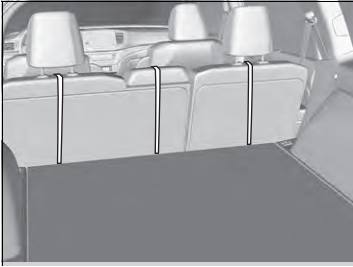

5. Slide the seat backward.
6. Route the seat belt through the child seat according to the seat manufacturer's instructions, and insert the latch plate into the buckle.
  - Insert the latch plate fully until it clicks.
7. Slowly pull the shoulder part of the belt all the way out until it stops. This activates the lockable retractor.
8. Let the seat belt retract a few inches and check that the retractor has switched modes by pulling on the webbing. It should not pull out again until it is reset by removing the latch plate from the buckle.
  - If you are able to pull the shoulder belt out, the lockable retractor is not activated. Slowly pull the seat belt all the way out, and repeat steps 7-8.

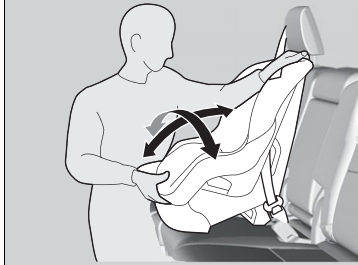

**9.** Grab the shoulder part of the seat belt near the buckle, and pull up to remove any slack from the lap part of the belt.

▶ When doing this, place your weight on the child seat and push it into the vehicle seat.

**10.** Make sure the child seat is firmly secured by rocking it forward and back and side to side; less than one inch of movement should occur near the seat belt.

**11.** Make sure any unused seat belt that a child can reach is buckled, the lockable retractor is activated, and the belt is fully retracted and locked.

📖 **Protecting Child Passengers** P. 64

📖 **Installing a Child Seat with a Lap/Shoulder Seat Belt**

To deactivate a lockable retractor, release the buckle and allow the seat belt to wind up all the way.

## ■ Adding Security with a Tether

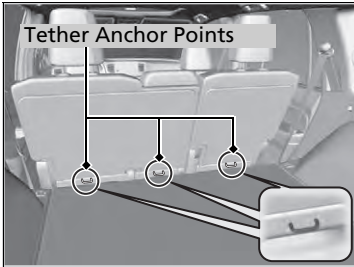

A tether anchor point is provided behind each rear seating position. If you have a child seat that comes with a tether but can be installed with a seat belt, the tether may be used for additional security.

## ▣ Adding Security with a Tether

Always use a tether for forward facing child seats whether using the seat belt or lower anchors.



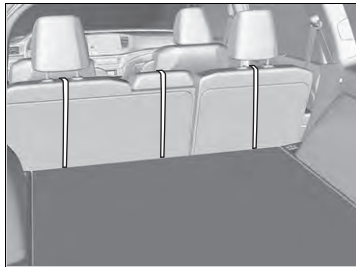
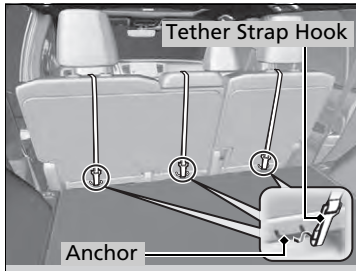

### ■ Using an outer anchor

1. Slide the seat forward.
2. Put the head restraint to its upper-most position, then route the tether strap through the head restraint legs. Make sure the strap is not twisted.
3. Secure the tether strap hook to the anchor.
4. Tighten the tether strap as instructed by the child seat manufacturer.
5. Slide the seat backward, then confirm that the tether strap is not loose.

### ■ Using the center anchor

1. Slide the seat forward.
2. Lower the head restraint to its lowest position.
3. Route the tether strap over the head restraint. Make sure the strap is not twisted.
4. Secure the tether strap hook to the anchor.
5. Tighten the tether strap as instructed by the child seat manufacturer.
6. Slide the seat backward, then confirm that the tether strap is not loose.

## Safety of Larger Children

### ■ Protecting Larger Children

The following pages give instructions on how to check proper seat belt fit, what kind of booster seat to use if one is needed, and important precautions for a child who must sit in front.

### ■ Checking Seat Belt Fit

When a child is too big for a child seat, secure the child in a rear seat using the lap/shoulder seat belt. Have the child sit upright and all the way back, then answer the following questions.



#### ■ Checklist

- Do the child's knees bend comfortably over the edge of the seat?
- Does the shoulder belt cross between the child's neck and arm?
- Is the lap part of the seat belt as low as possible, touching the child's thighs?
- Will the child be able to stay seated like this for the whole trip?

If you answer yes to all these questions, the child is ready to wear the lap/shoulder seat belt correctly. If you answer no to any question, the child needs to ride on a booster seat until the seat belt fits properly without a booster seat.

### ▶▶ Safety of Larger Children

## ⚠ WARNING

Allowing a child age 12 or under to sit in front can result in injury or death if the passenger's front airbag inflates.

If a larger child must ride in front, move the vehicle seat as far to the rear as possible, have the child sit up properly and wear the seat belt properly, using a booster seat if needed.

## ■ Booster Seats



If a lap/shoulder seat belt cannot be used properly, position the child in a booster seat in the rear seat. For the child's safety, check that the child meets the booster seat manufacturer's recommendations.

## ▣ Booster Seats

When installing a booster seat, make sure to read the instructions that came with it, and install the seat accordingly.

There are high- and low-type booster seats. Choose a booster seat that allows the child to wear the seat belt correctly.

Some U.S. states and Canadian provinces and territories require children to use a booster seat until they reach a given age or weight (e.g. 6 years or 60 lbs). Be sure to check current laws in the state or province, or territory where you intend to drive.

## ■ Protecting Larger Children - Final Checks

Your vehicle has a rear seat where children can be properly restrained. If you ever have to carry a group of children, and a child must ride in front:

- Make sure you read and fully understand the instructions and safety information in this manual.
- Move the front passenger seat as far back as possible.
- Have the child sit upright and well back in the seat.
- Check that the seat belt is properly positioned so that the child is secure in the seat.

## ■ Monitoring child passengers

We strongly recommend that you keep an eye on child passengers. Even older, more mature children sometimes need to be reminded to fasten their seat belts and sit up properly.

## Carbon Monoxide Gas

The engine exhaust from this vehicle contains carbon monoxide, a colorless, odorless, and highly toxic gas. As long as you properly maintain your vehicle, carbon monoxide gas will not get into the interior.

### ■ Have the exhaust system inspected for leaks whenever

- The exhaust system is making an unusual noise.
- The exhaust system may have been damaged.
- The vehicle is raised for an oil change.

When you operate a vehicle with the tailgate open, airflow can pull exhaust gas into the interior and create a hazardous condition. If you must drive with the tailgate open, open all the windows and set the climate control system as shown below.

1. Select the fresh air mode.
2. Select the  mode.
3. Set the fan speed to high.
4. Set the temperature control to a comfortable setting.

Adjust the climate control system in the same manner if you sit in your parked vehicle with the engine running.

### ☒ Carbon Monoxide Gas

## WARNING

Carbon monoxide gas is toxic. Breathing it can cause unconsciousness and even kill you.

Avoid any enclosed areas or activities that expose you to carbon monoxide.

An enclosed area such as a garage can quickly fill up with carbon monoxide gas. Do not run the engine with the garage door closed. Even when the garage door is open, drive out of the garage immediately after starting the engine.

## Label Locations

These labels are in the locations shown. They warn you of potential hazards that can cause serious injury or death. Read these labels carefully.

If a label comes off or becomes hard to read (except for the U.S. dashboard label which may be removed by the owner), contact a dealer for a replacement.

### Sun Visor U.S. models

**⚠️ WARNING**

**EVEN WITH ADVANCED AIR BAGS**

Children can be killed or seriously injured by the air bag.

- The back seat is the safest place for children.
- Never put a rear-facing child seat in the front.
- Always use seat belts and child restraints.
- See owner's manual for more information about air bags.

### Canadian models

⚠️ WARNING	⚠️ ATTENTION
<b>To avoid serious injury</b> <ul style="list-style-type: none"> <li>• For maximum safety protection in all types of crashes, you must always wear your safety belt.</li> <li>• Do not install rearward-facing child seats in any front passenger seat position.</li> <li>• Do not sit or lean unnecessarily close to the air bag.</li> <li>• Do not place any objects over the air bag or between the air bag and yourself.</li> <li>• See the owner's manual for further information and explanations.</li> </ul>	<b>Pour éviter des blessures graves</b> <ul style="list-style-type: none"> <li>• Pour profiter d'une protection maximale lors d'une collision bouchez toujours votre ceinture de sécurité.</li> <li>• N'installez jamais un siège pour enfants faisant face à l'arrière sur le siège du passager avant.</li> <li>• Ne vous appuyez pas et ne vous assoyez pas près du coussin gonflable.</li> <li>• Ne déposez aucun objet sur le coussin gonflable ou entre le coussin gonflable et vous.</li> <li>• Lisez le guide utilisateur pour de plus amples renseignements.</li> </ul>

### Sun Visor U.S. models only

**⚠️ WARNING: HIGHER ROLLOVER RISK**

Avoid Abrupt Maneuvers and Excessive Speed.

Always Buckle Up.

See Owner's Manual For Further Information.

### Dashboard U.S. models only

This Vehicle is Equipped with Advanced Air Bags

Even with Advanced Air Bags

Children can be killed or seriously injured by the air bag.

The back seat is the safest place for children.

Never put a rear-facing child seat in the front.

Always use seat belts and child restraints.

See owner's manual for more information about air bags.

For more information see page 108&P9.

### Radiator Cap

**DANGER WARNING**

**危険 危険**

NEVER OPEN WHEN HOT. Hot coolant will scald you.

NEVER REFRIGERANT PAS QUAND CHAUD. NE PAS OUVRIRE LE RÉSERVOIR MOTORISÉ. 必ずしも熱い時に開かないでください。必ず安全に開かしてください。 108&P9

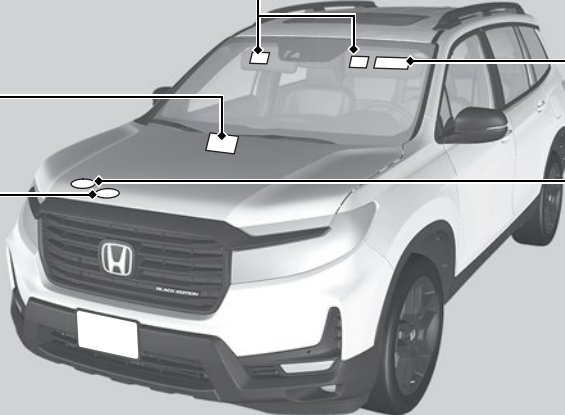

### Air Conditioner System U.S. models

**⚠️ WARNING**

Refrigerant-Performance

AIR CONDITIONER SYSTEM CONTAINS REFRIGERANT R-1234YF UNDER HIGH PRESSURE. TO BE SERVICED ONLY BY QUALIFIED PERSONNEL. (Check restrictions in this service manual.)

**AIR CONDITIONER SYSTEM**

REFRIGERANT: R-1234YF (SAE J1030, ASHRAE 34) (A1)

REC. CHARGE: MAX 0,655 kg MIN 0,605 kg

OIL TYPE: RBD05V-01 OIL (POE)

TYR Honda Motor Co., Ltd.

### Canadian models

**⚠️** **🔥** **🚰**







**R-1234yf**





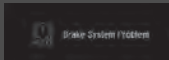



# Instrument Panel

This chapter describes the buttons, indicators, and gauges that are used while driving.











<b>Indicators</b> .....	82
Driver Information Interface Warning and Information Messages.....	98
<b>Gauges and Displays</b>	
Gauges.....	109
Driver Information Interface .....	110





Indicator	Name	On/Blinking	Explanation	Message
<p><b>U.S.</b> <b>BRAKE</b></p> <p><b>Canada</b></p>  <p>(Red)</p>	Parking Brake and Brake System Indicator (Red)	<ul style="list-style-type: none"> <li>Comes on for a few seconds when you set the power mode to ON, then goes off if the parking brake has been released.</li> <li>Comes on when the parking brake is applied, and goes off when it is released.</li> <li>Comes on when the brake fluid level is low.</li> <li>Comes on if there is a problem with the brake system.</li> <li>The beeper sounds and the indicator comes on if you drive with the parking brake not fully released.</li> </ul>	<ul style="list-style-type: none"> <li><b>Comes on while driving</b> - Make sure the parking brake is released. Check the brake fluid level.                             <ul style="list-style-type: none"> <li>➤ <b>What to do when the indicator comes on while driving</b> P. 564</li> </ul> </li> <li><b>Comes on along with the ABS indicator</b> - Have your vehicle checked by a dealer.                             <ul style="list-style-type: none"> <li>➤ <b>If the Brake System Indicator (Red) Comes On</b> P. 564</li> </ul> </li> </ul>	  
<p><b>U.S.</b> <b>BRAKE SYSTEM</b></p> <p><b>Canada</b></p>  <p>(Amber)</p>	Parking Brake and Brake System Indicator (Amber)	<ul style="list-style-type: none"> <li>Comes on for a few seconds when you set the power mode to ON, then goes off.</li> <li>Comes on if there is a problem with a system related to braking other than the conventional brake system.</li> </ul>	<ul style="list-style-type: none"> <li><b>Comes on while driving</b> - Have your vehicle checked by a dealer.</li> <li>With this indicator on, your vehicle still has normal braking ability.</li> </ul>	<p><b>U.S.</b></p>  <p><b>Canada</b></p> 

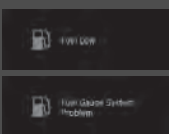





Indicator	Name	On/Blinking	Explanation	Message
	Malfunction Indicator Lamp	<ul style="list-style-type: none"> <li>• Comes on when you set the power mode to ON, and goes off when the engine starts, or after several seconds if the engine did not start. If “readiness codes” have not been set, it blinks five times before it goes off.</li> <li>• Comes on if there is a problem with the emissions control system.</li> <li>• Blinks when a misfire in the engine’s cylinders is detected.</li> </ul>	<ul style="list-style-type: none"> <li>• Readiness codes are part of the on-board diagnostics for the emissions control systems.                             <ul style="list-style-type: none"> <li>► <b>Testing of Readiness Codes</b> P. 583</li> </ul> </li> <li>• <b>Comes on while driving</b> - Have your vehicle checked by a dealer.</li> <li>• <b>Blinks while driving</b> - Stop in a safe place where there are no flammable objects. Stop the engine for 10 minutes or more, and wait for it to cool down. Then, take your vehicle to a dealer.                             <ul style="list-style-type: none"> <li>► <b>If the Malfunction Indicator Lamp Comes On or Blinks</b> P. 563</li> </ul> </li> </ul>	
	Charging System Indicator	<ul style="list-style-type: none"> <li>• Comes on when you set the power mode to ON, and goes off when the engine starts.</li> <li>• Comes on when there is a problem with the charging system.</li> </ul>	<ul style="list-style-type: none"> <li>• <b>Comes on while driving</b> - Turn off the climate control system and rear defogger in order to reduce electricity consumption.                             <ul style="list-style-type: none"> <li>► <b>If the Charging System Indicator Comes On</b> P. 563</li> </ul> </li> </ul>	
	Gear Position Indicator	<ul style="list-style-type: none"> <li>• Indicates the current gear selection.</li> </ul>	<ul style="list-style-type: none"> <li>► <b>Shifting</b> P. 396</li> </ul>	
	M (sequential mode) Indicator/ Sequential Mode Gear Selection Indicator	<ul style="list-style-type: none"> <li>• Comes on when the manual sequential shift mode is applied.</li> </ul>	<ul style="list-style-type: none"> <li>► <b>Sequential Mode</b> P. 402</li> </ul>	

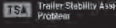









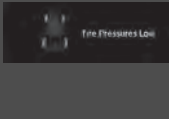

Indicator	Name	On/Blinking	Explanation	Message
	Transmission System Indicator	<ul style="list-style-type: none"> <li>The indicated current gear selection blinks if there is a problem with the transmission system.</li> </ul>	<ul style="list-style-type: none"> <li>Avoid sudden starts and acceleration, and stop in a safe place immediately. Have your vehicle checked by a dealer.</li> </ul>	
		<ul style="list-style-type: none"> <li>All the gear positions may light for several seconds, and go off.</li> </ul>	<ul style="list-style-type: none"> <li>When all the gear positions light, immediately stop your vehicle in a safe place.</li> <li>Indicators go off if there is no problem. However, even if they go off, take your vehicle to a dealer for inspection.</li> </ul>	
		<ul style="list-style-type: none"> <li>The indicated current gear selection or all the gear positions blink if there is a problem with the transmission system, and the vehicle no longer moves.</li> </ul>	<ul style="list-style-type: none"> <li>Immediately stop in a safe place.                             <ul style="list-style-type: none"> <li>➤ <b>Emergency Towing</b> P. 572</li> </ul> </li> <li>Have your vehicle checked by a dealer.</li> </ul>	
		<ul style="list-style-type: none"> <li>The indicated current gear selection or all the gear positions blink if you cannot select <b>P</b> due to the transmission system failure.</li> </ul>	<ul style="list-style-type: none"> <li>The engine can be activated as a temporary measure.                             <ul style="list-style-type: none"> <li>➤ <b>If the Transmission Indicator Blinks along with the Warning Message</b> P. 566</li> </ul> </li> <li>Set the parking brake when parking.</li> <li>Have your vehicle checked by a dealer immediately.</li> </ul>	

Indicator	Name	On/Blinking	Explanation	Message
	Seat Belt Reminder Indicator	<ul style="list-style-type: none"> <li>• Blinks and the beeper sounds for a few seconds if you are not wearing a seat belt when you set the power mode to ON, then the indicator comes on.</li> <li>• If the front passenger is not wearing a seat belt, the indicator comes on a few seconds later.</li> <li>• Comes on for a while when the rear seat belt is unfastened while the power mode in ON.</li> <li>• Blinks while driving if you and/or any passenger has not fastened a seat belt. The beeper sounds and the indicator blinks at regular intervals.</li> </ul>	<ul style="list-style-type: none"> <li>• The beeper stops and the indicator goes off when you and the passengers fasten their seat belts.</li> <li>• <b>Stays on after you and/or the passengers have fastened the seat belt(s)</b> - A detection error may have occurred in the sensor. Have your vehicle checked by a dealer. <ul style="list-style-type: none"> <li>➤ <b>Seat Belt Reminder</b> P. 41</li> </ul> </li> </ul>	
	Low Fuel Indicator	<ul style="list-style-type: none"> <li>• Comes on when the fuel reserve is running low (approximately 2.5 U.S. gal./9.5 Liter left).</li> <li>• Blinks if there is a problem with the fuel gauge.</li> </ul>	<ul style="list-style-type: none"> <li>• <b>Comes on</b> - Refuel your vehicle as soon as possible.</li> <li>• <b>Blinks</b> - Have your vehicle checked by a dealer.</li> </ul>	
	Anti-lock Brake System (ABS) Indicator	<ul style="list-style-type: none"> <li>• Comes on for a few seconds when you set the power mode to ON, then goes off.</li> <li>• If it comes on at any other time, there is a problem with the ABS.</li> </ul>	<ul style="list-style-type: none"> <li>• <b>Stays on constantly</b> - Have your vehicle checked by a dealer. With this indicator on, your vehicle still has normal braking ability but no anti-lock function. <ul style="list-style-type: none"> <li>➤ <b>Anti-lock Brake System (ABS)</b> P. 469</li> </ul> </li> </ul>	

Indicator	Name	On/Blinking	Explanation	Message
	Supplemental Restraint System Indicator	<ul style="list-style-type: none"> <li>• Comes on for a few seconds when you set the power mode to ON, then goes off.</li> <li>• Comes on if a problem with any of the following is detected:                             <ul style="list-style-type: none"> <li>- Supplemental Restraint System</li> <li>- Side airbag system</li> <li>- Side curtain airbag system</li> <li>- Seat belt tensioner</li> </ul> </li> </ul>	<ul style="list-style-type: none"> <li>• <b>Stays on constantly or does not come on at all</b> - Have your vehicle checked by a dealer.</li> </ul>	
	Vehicle Stability Assist™ (VSA®) System Indicator	<ul style="list-style-type: none"> <li>• Comes on for a few seconds when you set the power mode to ON, then goes off.</li> <li>• Blinks when VSA® or trailer stability assist is active.</li> <li>• Comes on if there is a problem with the VSA®, hill start assist, trailer stability assist or brake lighting system.</li> </ul>	<ul style="list-style-type: none"> <li>• <b>Stays on constantly</b> - Have your vehicle checked by a dealer.                             <ul style="list-style-type: none"> <li>▣ <b>Vehicle Stability Assist™ (VSA®), aka Electronic Stability Control (ESC), System</b> P. 411</li> <li>▣ <b>Trailer Stability Assist</b> P. 383</li> <li>▣ <b>Hill start assist system</b> P. 393</li> </ul> </li> <li>• When <b>Trailer Stability Assist Problem</b> is displayed on the Driver Information Interface, the VSA® does not activate.</li> </ul>	  





Indicator	Name	On/Blinking	Explanation	Message
	Vehicle Stability Assist™ (VSA®) OFF Indicator	<ul style="list-style-type: none"> <li>Comes on for a few seconds when you set the power mode to ON, then goes off.</li> </ul>	—	—
		<ul style="list-style-type: none"> <li>Comes on when VSA® OFF switch is pressed.</li> </ul>	<ul style="list-style-type: none"> <li>Appears when Normal or Snow mode is selected.                             <ul style="list-style-type: none"> <li>► <b>VSA® On and Off</b> P. 412</li> </ul> </li> </ul>	
		<ul style="list-style-type: none"> <li>Comes on when Mud/Sand mode is selected by pressing Intelligent Traction Management System switch.</li> </ul>	<ul style="list-style-type: none"> <li>Appears when Mud mode is selected.                             <ul style="list-style-type: none"> <li>► <b>Intelligent Traction Management</b> P. 410</li> </ul> </li> </ul>	
			<ul style="list-style-type: none"> <li>Appears when Sand mode is selected.                             <ul style="list-style-type: none"> <li>► <b>Intelligent Traction Management</b> P. 410</li> </ul> </li> </ul>	
		<ul style="list-style-type: none"> <li>Comes on when VSA® OFF switch is pressed.</li> </ul>	<ul style="list-style-type: none"> <li>Appears when Mud or Sand mode is selected.                             <ul style="list-style-type: none"> <li>► <b>VSA® On and Off</b> P. 412</li> </ul> </li> </ul>	
	Electric Power Steering (EPS) System Indicator	<ul style="list-style-type: none"> <li>Comes on when you set the power mode to ON, and goes off when the engine starts.</li> <li>Comes on if there is a problem with the EPS system.</li> </ul>	<ul style="list-style-type: none"> <li><b>Stays on constantly or does not come on at all</b> - Have your vehicle checked by a dealer.                             <ul style="list-style-type: none"> <li>► <b>If the Electric Power Steering (EPS) System Indicator Comes On</b> P. 564</li> </ul> </li> </ul>	





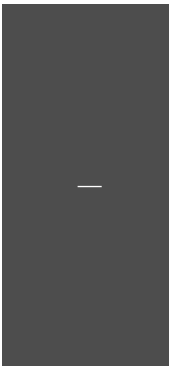

Indicator	Name	On/Blinking	Explanation	Message
	Low Tire Pressure/TPMS Indicator	<ul style="list-style-type: none"> <li>• Comes on for a few seconds when you set the power mode to ON, then goes off.</li> <li>• Comes on if the tire pressure of any of the tires becomes significantly low.</li> </ul>	<ul style="list-style-type: none"> <li>• <b>Comes on while driving</b> - Stop in a safe place, check tire pressures, and inflate the tire(s) if necessary.</li> </ul>	
		<ul style="list-style-type: none"> <li>• Blinks for about one minute, and then stays on if there is a problem with the TPMS with Tire Fill Assist, or when a compact spare tire is temporarily installed.</li> </ul>	<ul style="list-style-type: none"> <li>• <b>Blinks and remains on</b> - Have your vehicle checked by a dealer. If the vehicle is fitted with a compact spare, get your regular tire repaired or replaced and put back on your vehicle as soon as you can.</li> </ul>	
	Turn Signal and Hazard Warning Indicators	<ul style="list-style-type: none"> <li>• Blinks when you operate the turn signal lever.</li> <li>• Blinks along with all turn signals when you press the hazard warning button.</li> </ul>	<ul style="list-style-type: none"> <li>• <b>Does not blink or blinks rapidly</b>   <b>Replacing Light Bulbs</b> P. 514, 516</li> </ul>	—
	Lights On Indicator	<ul style="list-style-type: none"> <li>• Comes on whenever the light switch is on, or in <b>AUTO</b> when the exterior lights are on.</li> </ul>	<ul style="list-style-type: none"> <li>• If you set the power mode to ACCESSORY or VEHICLE OFF while the exterior lights are on, a chime sounds when the driver's door is opened.</li> </ul>	—
	High Beam Indicator	<ul style="list-style-type: none"> <li>• Comes on when the high beam headlights are on.</li> </ul>	—	—

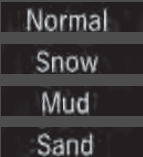
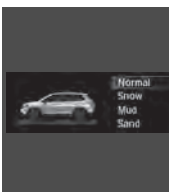
Indicator	Name	On/Blinking	Explanation	Message
	Auto High-Beam Indicator	<ul style="list-style-type: none"> <li>• Comes on for a few seconds when you set the power mode to ON, then goes off.</li> <li>• Comes on when all the operating conditions of the auto high-beam are met.</li> </ul>	<p>🚩 <b>Auto High-Beam</b> P. 168</p>	—
	Fog Light Indicator*	<ul style="list-style-type: none"> <li>• Comes on when the fog lights are on.</li> </ul>	—	—
<p>Indicator</p> 	Immobilizer System Indicator	<ul style="list-style-type: none"> <li>• Comes on briefly when you set the power mode to ON, then goes off.</li> <li>• Blinks if the immobilizer system cannot recognize the key information.</li> </ul>	<ul style="list-style-type: none"> <li>• <b>Blinks</b> - You cannot start the engine. Set the power mode to VEHICLE OFF*<sup>1</sup>, then select the ON mode again.</li> <li>• <b>Repeatedly blinks</b> - The system may be malfunctioning. Have your vehicle checked by a dealer.</li> <li>• Do not attempt to alter this system or add other devices to it. Electrical problems can occur.</li> </ul>	—
<p>Indicator</p> 	Security System Alarm Indicator	<ul style="list-style-type: none"> <li>• Comes on briefly when you set the power mode to ON, then goes off.</li> <li>• Blinks when the security system alarm has been set.</li> </ul>	<p>🚩 <b>Security System Alarm</b> P. 152</p>	—









\*1:Canadian models only: Apply and hold the brake pedal before selecting the ON mode.





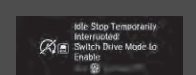

\* Not available on all models





Indicator	Name	On/Blinking	Explanation	Message
	System Message Indicator	<ul style="list-style-type: none"> <li>Comes on along with a beep when a problem is detected. A system message on the driver information interface appears at the same time.</li> </ul>	<ul style="list-style-type: none"> <li>While the indicator is on, press the  (home) button, select <b>Warnings</b>, then press the <b>ENTER</b> button to see the message again.</li> <li>Refer to the Indicators information in this chapter when a system message appears on the driver information interface. Take the appropriate action for the message.</li> <li>The driver information interface does not return to the normal screen unless the warning is canceled, or the <b>ENTER</b> button is pressed repeatedly.</li> </ul>	
	ECON Mode Indicator	<ul style="list-style-type: none"> <li>Comes on when the ECON mode is on.</li> </ul>	<p>➤ <b>ECON Mode</b> P. 409</p>	
	Intelligent Traction Management Indicator	<ul style="list-style-type: none"> <li>Comes on when pressing the Intelligent Traction Management button.</li> </ul>	<p>➤ <b>Intelligent Traction Management</b> P. 410</p>	

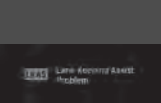





Indicator	Name	On/Blinking	Explanation	Message
	Auto Idle Stop Indicator (Green)	<ul style="list-style-type: none"> <li>Comes on when Auto Idle Stop is in operation. The engine automatically shuts off.</li> </ul>	<ul style="list-style-type: none"> <li>➤ <b>Auto Idle Stop</b> P. 404</li> </ul>	—
	Auto Idle Stop <b>OFF</b> Indicator	<ul style="list-style-type: none"> <li>Comes on when the Auto Idle Stop system has been turned off by the Auto Idle Stop system <b>OFF</b> button.</li> </ul>	<ul style="list-style-type: none"> <li>➤ <b>Auto Idle Stop System ON/OFF</b> P. 405</li> </ul>	
	Auto Idle Stop System Indicator (Amber)	<ul style="list-style-type: none"> <li>Comes on for a few seconds when you set the power mode to ON, then goes off.</li> </ul>	—	—
		<ul style="list-style-type: none"> <li>Blinks if there is a problem with the Auto Idle Stop system.</li> </ul>	<ul style="list-style-type: none"> <li>Have your vehicle checked by a dealer.</li> </ul>	
	Auto Idle Stop Suspend Indicator	<ul style="list-style-type: none"> <li>Comes on while Auto Idle Stop is temporarily suspended in the following situations.</li> </ul>	—	—
		<ul style="list-style-type: none"> <li>- Brake pedal is not fully pressed.</li> </ul>	<ul style="list-style-type: none"> <li>Depress the brake pedal firmly.</li> </ul>	













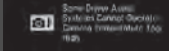



Indicator	Name	On/Blinking	Explanation	Message
	Auto Idle Stop Suspend Indicator	- The transmission is in a position other than <b>D</b> .	<p style="text-align: center;">➤ <b>Auto Idle Stop</b> P. 404</p> <ul style="list-style-type: none"> <li>If you press and hold the Auto Idle Stop <b>OFF</b> button, you can select whether to display the status messages or not.</li> </ul>	
		- System charging is prioritized.		
		- Climate control system is prioritized. -  is ON (indicator on).		
		- Engine coolant temperature is not in operating range.		
		- The Intelligent Traction Management is set to <b>Snow</b> , <b>Mud</b> , or <b>Sand</b> .		
		- The battery temperature is too low. - Auto Idle Stop does not activate for some reason.		
		<p style="text-align: center;">—</p>		

Indicator	Name	On/Blinking	Explanation	Message
	All-wheel drive ( <b>AWD</b> ) Indicator	<ul style="list-style-type: none"> <li>• Comes on for a few seconds when you set the power mode to ON, then goes off.</li> <li>• Comes on if there is a problem with the AWD system.</li> <li>• Blinks when the differential temperature is too high.</li> </ul>	<ul style="list-style-type: none"> <li>• <b>Stays on constantly</b> - The engine drives the front wheels only in this state. Have your vehicle checked by a dealer.</li> </ul>	
			<ul style="list-style-type: none"> <li>• <b>Blinks while driving</b> - Stop in a safe place, change to <b>P</b>, and idle the engine until the indicator goes off. If the indicator does not stop blinking, take your vehicle to a dealer.                             <ul style="list-style-type: none"> <li>➤ <b>Intelligent Variable Torque Management (i-VTM4™) AWD System</b> P. 417</li> </ul> </li> </ul>	
	Lane Keeping Assist System ( <b>LKAS</b> ) Indicator (Amber)	<ul style="list-style-type: none"> <li>• Comes on for a few seconds when you set the power mode to ON, then goes off.</li> <li>• Comes on if there is a problem with the LKAS.</li> </ul>	<ul style="list-style-type: none"> <li>• <b>Stays on constantly</b> - Have your vehicle checked by a dealer.</li> </ul>	
	Lane Keeping Assist System ( <b>LKAS</b> ) Indicator (Green)	<ul style="list-style-type: none"> <li>• Comes on when you press the <b>MAIN</b> button.</li> </ul>	<ul style="list-style-type: none"> <li>➤ <b>Lane Keeping Assist System (LKAS)</b> P. 455</li> </ul>	

Indicator	Name	On/Blinking	Explanation	Message
	Road Departure Mitigation (RDM) Indicator	<ul style="list-style-type: none"> <li>• Comes on for a few seconds when you change the power mode to ON, then goes off.</li> <li>• Comes on if there is a problem with the RDM system.</li> </ul>	<ul style="list-style-type: none"> <li>• <b>Stays on constantly</b> - Have your vehicle checked by a dealer.</li> </ul>	
		<ul style="list-style-type: none"> <li>• Comes on when the RDM system shuts itself off.</li> </ul>	<ul style="list-style-type: none"> <li>• <b>Stays on</b> - The temperature inside the camera is too high. Use the climate control system to cool down the camera. The system activates when the temperature inside the camera cools down.                      📄 <b>Front Sensor Camera</b> P. 464</li> </ul>	
			<ul style="list-style-type: none"> <li>• <b>Stays on</b> - The area around the camera is blocked by dirt, mud, etc. Stop your vehicle in a safe place, and wipe it off with a soft cloth.</li> <li>• Have your vehicle checked by a dealer if the indicator and message come back on after you cleaned the area around the camera.                      📄 <b>Front Sensor Camera</b> P. 464</li> </ul>	









Indicator	Name	On/Blinking	Explanation	Message
	Adaptive Cruise Control (ACC) Indicator (Amber)	<ul style="list-style-type: none"> <li>• Comes on for a few seconds when you set the power mode to ON, then goes off.</li> <li>• Comes on if there is a problem with ACC.</li> </ul>	<ul style="list-style-type: none"> <li>• <b>Comes on while driving</b> - Have your vehicle checked by a dealer.</li> </ul>	
	Adaptive Cruise Control (ACC) Indicator (Green)	<ul style="list-style-type: none"> <li>• Comes on when you press the <b>MAIN</b> button.</li> </ul>	<ul style="list-style-type: none"> <li>➤ <b>Adaptive Cruise Control (ACC)</b> P. 442</li> </ul>	
	Collision Mitigation Braking System™ (CMBS™) Indicator	<ul style="list-style-type: none"> <li>• Comes on for a few seconds when you change the power mode to ON, then goes off.</li> <li>• Comes on when you deactivate the CMBS™. A driver information interface message appears for five seconds.</li> <li>• Comes on if there is a problem with the CMBS™.</li> </ul>	<ul style="list-style-type: none"> <li>• <b>Stays on constantly without the CMBS™ off</b> - Have your vehicle checked by a dealer.</li> <li>➤ <b>Collision Mitigation Braking System™ (CMBS™)</b> P. 425</li> </ul>	 



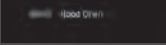

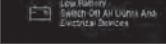

Indicator	Name	On/Blinking	Explanation	Message
	Collision Mitigation Braking System™ (CMBS™) Indicator	<ul style="list-style-type: none"> <li>Comes on when the CMBS™ shuts itself off.</li> </ul>	<ul style="list-style-type: none"> <li><b>Stays on</b> - The temperature inside the camera is too high. Use the climate control system to cool down the camera. The system activates when the temperature inside the camera cools down.   <b>Front Sensor Camera</b> P. 464</li> </ul>	
		<ul style="list-style-type: none"> <li>Comes on when the area around the camera is blocked by dirt, mud, etc. Stop your vehicle in a safe place, and wipe it off with a soft cloth.</li> <li>Have your vehicle checked by a dealer if the indicator does not go off even after you cleaned the camera.   <b>Front Sensor Camera</b> P. 464</li> </ul>	<ul style="list-style-type: none"> <li><b>Stays on</b> - The area around the camera is blocked by dirt, mud, etc. Stop your vehicle in a safe place, and wipe it off with a soft cloth.</li> <li>Have your vehicle checked by a dealer if the indicator does not go off even after you cleaned the camera.   <b>Front Sensor Camera</b> P. 464</li> </ul>	
		<ul style="list-style-type: none"> <li>Comes on when the radar sensor gets dirty, stop your vehicle in a safe place, and wipe off dirt using a soft cloth. Indicator may take some time to go off after the radar sensor is cleaned.</li> <li>Have your vehicle checked by a dealer if the indicator does not go off even after you clean the sensor cover.   <b>Radar Sensor</b> P. 466</li> </ul>	<ul style="list-style-type: none"> <li>When the radar sensor gets dirty, stop your vehicle in a safe place, and wipe off dirt using a soft cloth. Indicator may take some time to go off after the radar sensor is cleaned.</li> <li>Have your vehicle checked by a dealer if the indicator does not go off even after you clean the sensor cover.   <b>Radar Sensor</b> P. 466</li> </ul>	

Indicator	Name	On/Blinking	Explanation	Message
	Blind spot information System Indicator	<ul style="list-style-type: none"> <li>• Stays on while blind spot information system is turned off.</li> </ul>	—	
		<ul style="list-style-type: none"> <li>• Comes on when mud, snow, or ice accumulates in the vicinity of sensor.</li> </ul>	<ul style="list-style-type: none"> <li>• <b>Comes on while driving</b> - Remove the obstacle in the vicinity of the sensor.   <b>Blind spot information System</b>                      P. 414</li> </ul>	
		<ul style="list-style-type: none"> <li>• Comes on if there is a problem with the system.</li> </ul>	<ul style="list-style-type: none"> <li>• <b>Comes on while driving</b> - Have your vehicle checked by a dealer.</li> </ul>	

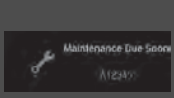

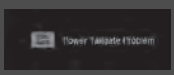





## Driver Information Interface Warning and Information Messages



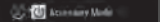



The following messages appear only on the driver information interface. Press the  (home) button, select **Warnings**, then press the **ENTER** button to see the message again with the system message indicator on.





Message	Condition	Explanation
 Door Open  Tailgate Open  Door And Tailgate Open	<ul style="list-style-type: none"> <li>Appears if any door or the tailgate is not completely closed.</li> </ul>	<ul style="list-style-type: none"> <li>Goes off when all doors and the tailgate are closed.</li> </ul>
 Hood Open	<ul style="list-style-type: none"> <li>Appears when the hood is opened.</li> </ul>	<ul style="list-style-type: none"> <li>Close the hood.</li> </ul>
 Engine Oil Low	<ul style="list-style-type: none"> <li>Appears when the engine oil pressure is low.</li> </ul>	<ul style="list-style-type: none"> <li><b>Appears while driving</b> - Immediately stop in a safe place.   <b>If the Engine Oil Low Warning Appears</b> P. 562</li> </ul>
 Washer Fluid Low	<ul style="list-style-type: none"> <li>Appears when the washer fluid is low.</li> </ul>	<ul style="list-style-type: none"> <li>Refill the washer fluid.   <b>Refilling Window Washer Fluid</b> P. 511</li> </ul>
 Transmission Temperature Too High TRANSMISSION TEMP. TOO HIGH MULTIMEDIA, MUSIC, AIRCLIMATE	<ul style="list-style-type: none"> <li>Appears when the temperature of the transmission is starting to get too hot.</li> <li>The performance of the vehicle may be reduced.</li> </ul>	<ul style="list-style-type: none"> <li>Until the message disappears, reduce your speed and allow the system to cool down.</li> </ul>
 Low Battery SWITCH OFF ALL LIGHTS AND ELECTRICAL SERVICES	<ul style="list-style-type: none"> <li>Appears if the battery charge becomes low.</li> </ul>	<ul style="list-style-type: none"> <li>Charge the battery.</li> </ul>

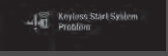

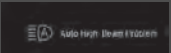

Message	Condition	Explanation
	<ul style="list-style-type: none"> <li>Appears when there is a problem with the sensor on the battery.</li> </ul>	<ul style="list-style-type: none"> <li>Have your vehicle checked by a dealer.                             <ul style="list-style-type: none"> <li>► <b>Checking the Battery</b> P. 531</li> </ul> </li> </ul>
	<ul style="list-style-type: none"> <li>Appears when the scheduled maintenance is due soon.</li> <li>Consequently, <b>Maintenance Due Now</b> and <b>Maintenance Past Due</b> follow.</li> </ul>	<ul style="list-style-type: none"> <li>► <b>Maintenance Minder Messages on the Driver Information Interface</b> P. 496</li> </ul>
	<ul style="list-style-type: none"> <li>Appears when the engine coolant temperature gets abnormally high.</li> </ul>	<ul style="list-style-type: none"> <li>► <b>Overheating</b> P. 560</li> </ul>
<div style="border: 1px solid black; padding: 2px; width: fit-content; margin-bottom: 5px;">U.S.</div>  <div style="border: 1px solid black; padding: 2px; width: fit-content; margin-bottom: 5px;">Canada</div> 	<ul style="list-style-type: none"> <li>Appears when there is a problem with the power tailgate system.</li> </ul>	<ul style="list-style-type: none"> <li>Manually open or close the power tailgate.</li> <li>Have your vehicle checked by a dealer.</li> </ul>
<div style="border: 1px solid black; padding: 2px; width: fit-content; margin-bottom: 5px;">U.S.</div>  <div style="border: 1px solid black; padding: 2px; width: fit-content; margin-bottom: 5px;">Canada</div> 	<ul style="list-style-type: none"> <li>Appears when the starter system has a problem.</li> </ul>	<ul style="list-style-type: none"> <li>As a temporary measure, press and hold the <b>ENGINE START/STOP</b> button for up to 15 seconds while pressing the brake pedal and manually start the engine.</li> <li>Have your vehicle checked by a dealer.</li> </ul>

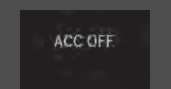







Message	Condition	Explanation
 	<ul style="list-style-type: none"> <li>Appears when the steering wheel is locked.</li> </ul>	<ul style="list-style-type: none"> <li>Move the steering wheel left and right while pressing the <b>ENGINE START/STOP</b> button.</li> </ul>
	<ul style="list-style-type: none"> <li>Appears when the power mode is in ACCESSORY.</li> </ul>	—
	<ul style="list-style-type: none"> <li>Appears after the driver's door is opened when the power mode is in ACCESSORY.</li> </ul>	<ul style="list-style-type: none"> <li>Change the power mode to VEHICLE OFF.                             <ul style="list-style-type: none"> <li>➤ <b>ENGINE START/STOP Button</b> P. 159</li> </ul> </li> </ul>
	<ul style="list-style-type: none"> <li>Appears when you close the door with the power mode in ON without the remote inside the vehicle.</li> </ul>	<ul style="list-style-type: none"> <li>Disappears when you bring the remote back inside the vehicle and close the door.                             <ul style="list-style-type: none"> <li>➤ <b>Keyless Remote Reminder</b> P. 161</li> </ul> </li> </ul>
	<ul style="list-style-type: none"> <li>Appears when the remote battery becomes weak.</li> </ul>	<ul style="list-style-type: none"> <li>Replace the battery as soon as possible.                             <ul style="list-style-type: none"> <li>➤ <b>Replacing the Remote Battery</b> P. 533</li> </ul> </li> </ul>
	<ul style="list-style-type: none"> <li>Appears if the remote battery is too weak to start the engine or the key is not within operating range to start the engine. A beeper sounds six times.</li> </ul>	<ul style="list-style-type: none"> <li>Bring the remote in front of the <b>ENGINE START/STOP</b> button to be touched with.                             <ul style="list-style-type: none"> <li>➤ <b>If the Keyless Remote Battery is Weak</b> P. 555</li> </ul> </li> </ul>
	<ul style="list-style-type: none"> <li>Appears three seconds after the <b>To Start, Hold Remote Near Start Button</b>, then <b>To Start Engine</b> messages appeared sequentially.</li> </ul>	<ul style="list-style-type: none"> <li>Unless you bring the keyless remote in front of the <b>ENGINE START/STOP</b> button, this message does not appear.                             <ul style="list-style-type: none"> <li>➤ <b>If the Keyless Remote Battery is Weak</b> P. 555</li> </ul> </li> </ul>





Message	Condition	Explanation
	<ul style="list-style-type: none"> <li>Appears if there is a problem with the cooling system.</li> </ul>	<ul style="list-style-type: none"> <li>Drive slowly to prevent overheating and have your vehicle checked by a dealer as soon as possible.</li> </ul>
	<ul style="list-style-type: none"> <li>Appears if there is a problem with the headlights.</li> </ul>	<ul style="list-style-type: none"> <li><b>Appears while driving</b> - The headlights may not be on. When conditions allow you to drive safely, have your vehicle checked by a dealer as soon as possible.</li> </ul>
	<p><b>Models with parking sensor system</b></p> <ul style="list-style-type: none"> <li>Appears if there is a problem with the parking sensor system.</li> </ul>	<ul style="list-style-type: none"> <li>Check if the area around the sensor(s) is covered with mud, ice, snow, etc. If the indicator(s) stays on or the beeper does not stop even after you clean the area, have the system checked by a dealer.</li> </ul>
	<p><b>Models with parking sensor system</b></p> <ul style="list-style-type: none"> <li>Appears if there are obstacles around the sensors.</li> </ul>	<ul style="list-style-type: none"> <li>Check for obstacles near your vehicle to make sure it is safe to park.</li> </ul>
	<ul style="list-style-type: none"> <li>Appears as soon as a problem is detected in the keyless access system.</li> </ul>	<ul style="list-style-type: none"> <li><b>Appears constantly</b> - Have your vehicle checked by a dealer.</li> </ul>
	<ul style="list-style-type: none"> <li>Appears as soon as a problem is detected in the push button starting system.</li> </ul>	<ul style="list-style-type: none"> <li><b>Appears constantly</b> - Have your vehicle checked by a dealer.</li> </ul>
	<ul style="list-style-type: none"> <li>Appears if you press the <b>ENGINE START/STOP</b> button while the vehicle is moving.</li> </ul>	<p> <b>Emergency Engine Stop</b> P. 556</p>







Message	Condition	Explanation
	<ul style="list-style-type: none"> <li>Appears if there is a problem with the Auto high-beam.</li> </ul>	<ul style="list-style-type: none"> <li>Manually operate the headlight switch.</li> <li>If you are driving with the high-beam headlights when this happens, the headlights are changed to low beams.</li> </ul>
	<ul style="list-style-type: none"> <li>Appears when the area around the camera is blocked by dirt, mud, etc. Stop your vehicle in a safe place, and wipe it off with a soft cloth.</li> <li>May appear when driving in bad weather (rain, snow, fog, etc.)</li> </ul>	<ul style="list-style-type: none"> <li>Have your vehicle checked by a dealer if the message comes back on after you cleaned the area around the camera.</li> </ul>
	<ul style="list-style-type: none"> <li>Flashes when the system senses a likely collision with a vehicle in front of you.</li> </ul>	<ul style="list-style-type: none"> <li>Take the appropriate means to prevent a collision (apply the brakes, change lanes, etc.)                             <ul style="list-style-type: none"> <li>► <b>Collision Mitigation Braking System™ (CMBS™)</b> P. 425</li> <li>► <b>Adaptive Cruise Control (ACC)</b> P. 442</li> </ul> </li> </ul>
	<ul style="list-style-type: none"> <li>Appears when ACC has been automatically canceled.</li> </ul>	<ul style="list-style-type: none"> <li>You can resume the set speed after the condition that caused ACC to cancel improves. Press the <b>RES/+</b> button.                             <ul style="list-style-type: none"> <li>► <b>Adaptive Cruise Control (ACC)</b> P. 442</li> </ul> </li> </ul>
	<ul style="list-style-type: none"> <li>Appears when pressing the <b>-/SET</b> button while the vehicle is moving, and the brake pedal is depressed.</li> </ul>	<ul style="list-style-type: none"> <li>ACC cannot be set.                             <ul style="list-style-type: none"> <li>► <b>Adaptive Cruise Control (ACC)</b> P. 442</li> </ul> </li> </ul>
	<ul style="list-style-type: none"> <li>Appears if the VSA® or traction control function operates while ACC is in operation.</li> </ul>	<ul style="list-style-type: none"> <li>ACC has been automatically canceled.                             <ul style="list-style-type: none"> <li>► <b>Adaptive Cruise Control (ACC)</b> P. 442</li> </ul> </li> </ul>

Message	Condition	Explanation
	<ul style="list-style-type: none"> <li>Appears when the speed of the vehicle is too high for you to set ACC.</li> </ul>	<ul style="list-style-type: none"> <li>Reduce the speed, then set ACC.                             <ul style="list-style-type: none"> <li>▶ <b>Adaptive Cruise Control (ACC)</b> P. 442</li> </ul> </li> </ul>
	<ul style="list-style-type: none"> <li>Appears when ACC is canceled due to excessive vehicle speed.</li> </ul>	<ul style="list-style-type: none"> <li>Reduce the speed, then reset ACC.                             <ul style="list-style-type: none"> <li>▶ <b>Adaptive Cruise Control (ACC)</b> P. 442</li> </ul> </li> </ul>
	<ul style="list-style-type: none"> <li>Appears when the speed of the vehicle is too low for you to set ACC.</li> </ul>	<ul style="list-style-type: none"> <li>Raise the speed, then set ACC.                             <ul style="list-style-type: none"> <li>▶ <b>Adaptive Cruise Control (ACC)</b> P. 442</li> </ul> </li> </ul>
	<ul style="list-style-type: none"> <li>Appears when ACC is canceled due to excessive low vehicle speed.</li> </ul>	<ul style="list-style-type: none"> <li>Raise the speed, then reset ACC.                             <ul style="list-style-type: none"> <li>▶ <b>Adaptive Cruise Control (ACC)</b> P. 442</li> </ul> </li> </ul>







Message	Condition	Explanation
	<p><b>Lane Keeping Assist System (LKAS)</b></p> <ul style="list-style-type: none"> <li>• Appears when the vehicle is driving out of a detected lane. The steering wheel vibrates rapidly.</li> </ul> <p><b>Road Departure Mitigation (RDM) System</b></p> <ul style="list-style-type: none"> <li>• Appears when the vehicle is driving out of a detected lane.</li> </ul> <p><b>When you selected Warning Only</b></p> <ul style="list-style-type: none"> <li>- The steering wheel vibrates rapidly when the vehicle is drifting out of a detected lane.</li> </ul> <p><b>When you selected Normal or Wide</b></p> <ul style="list-style-type: none"> <li>- The steering wheel vibrates rapidly when the vehicle is drifting out of a detected line. The system also steers the vehicle to help you remain within your driving lane.</li> </ul>	<ul style="list-style-type: none"> <li>• Keep the vehicle within the lane you are driving. <ul style="list-style-type: none"> <li>➤ <b>Lane Keeping Assist System (LKAS)</b> P. 455</li> </ul> </li> <li>• Keep the vehicle within the lane you are driving. <ul style="list-style-type: none"> <li>➤ <b>Road Departure Mitigation (RDM) System</b> P. 437</li> </ul> </li> <li>• You can change the setting for the road departure mitigation system. <b>Normal, Wide, and Warning Only</b> can be selected. <ul style="list-style-type: none"> <li>➤ <b>Customized Features</b> P. 327</li> </ul> </li> </ul>
	<ul style="list-style-type: none"> <li>• Blinks when you fail to steer the vehicle. The beeper sounds simultaneously.</li> </ul>	<ul style="list-style-type: none"> <li>• Operate the steering wheel to resume the LKAS.</li> </ul>
	<ul style="list-style-type: none"> <li>• Appears when the LKAS is in operation, or the LKAS button is pressed, but there is a problem with a system related to the LKAS. The LKAS cancels automatically. The beeper sounds simultaneously if selected by customization.</li> </ul>	<ul style="list-style-type: none"> <li>• If any other system indicators come on, such as the VSA®, ABS and brake system, take appropriate action. <ul style="list-style-type: none"> <li>➤ <b>Indicators</b> P. 82</li> </ul> </li> </ul>

Message	Condition	Explanation
	<ul style="list-style-type: none"> <li>Appears if the temperature inside the camera is too high and some driver assist systems cannot be activated.</li> </ul>	<ul style="list-style-type: none"> <li>Use the climate control system to cool down the camera.</li> <li><b>Disappears</b> - The camera has been cooled down and the systems are activated normally.                             <ul style="list-style-type: none"> <li>➤ <b>Front Sensor Camera</b> P. 464</li> </ul> </li> </ul>
	<ul style="list-style-type: none"> <li>Appears if the area around the front sensor camera is blocked by dirt, mud, etc. and be prevented from detecting a vehicle in front.</li> <li>May appear when driving in bad weather (rain, snow, fog, etc.)</li> </ul>	<ul style="list-style-type: none"> <li>When the front window gets dirty, stop your vehicle in a safe place, and wipe it off with a soft cloth.</li> <li>Have your vehicle checked by a dealer if the message does not disappear even after you cleaned the area around the camera.                             <ul style="list-style-type: none"> <li>➤ <b>Front Sensor Camera</b> P. 464</li> </ul> </li> </ul>
	<ul style="list-style-type: none"> <li>Appears if anything covers the radar sensor cover and prevents the sensor from detecting a vehicle in front.</li> <li>May appear when driving in bad weather (rain, snow, fog, etc.)</li> </ul>	<ul style="list-style-type: none"> <li>When the radar sensor gets dirty, stop your vehicle in a safe place, and wipe off dirt using a soft cloth. The message may take some time to go off.</li> <li>Have your vehicle checked by a dealer if the message does not disappear even after you clean the sensor cover.                             <ul style="list-style-type: none"> <li>➤ <b>Radar Sensor</b> P. 466</li> </ul> </li> </ul>
	<ul style="list-style-type: none"> <li>Appears when the transmission system temperature is too high. The vehicle does not operate properly.</li> </ul>	<ul style="list-style-type: none"> <li>Stop in a safe place in <b>P</b>.</li> <li>Let the engine idle until the message disappears.</li> </ul>

Message	Condition	Explanation
	<ul style="list-style-type: none"> <li>Appears when you set the power mode to ACCESSORY or ON.</li> </ul>	<ul style="list-style-type: none"> <li>➤ <b>Starting the Engine</b> P. 388</li> </ul>
	<ul style="list-style-type: none"> <li>Appears when the engine does not restart automatically due to the following reason:                             <ul style="list-style-type: none"> <li>The hood is open.</li> <li>There is a problem in the system that disables Auto Idle Stop.</li> </ul> </li> </ul>	<ul style="list-style-type: none"> <li>Follow the normal procedure to start the engine.                             <ul style="list-style-type: none"> <li>➤ <b>Starting the Engine</b> P. 388</li> </ul> </li> </ul>
	<ul style="list-style-type: none"> <li>Appears when you attempt to change to another gear position with the transmission in <b>P</b> and the engine OFF.</li> </ul>	<ul style="list-style-type: none"> <li>To select another gear position while in <b>P</b>, the engine must be ON.</li> </ul>
	<ul style="list-style-type: none"> <li>Appears when you set the power mode to OFF while driving.</li> </ul>	<ul style="list-style-type: none"> <li>Immediately stop in a safe place, set the parking brake, then restart the engine. If the message disappears, continue driving.</li> </ul>
	<ul style="list-style-type: none"> <li>Appears when you try to change the gear position after the position has automatically been changed to <b>P</b> with the driver's door open and the driver's seat belt unfastened.</li> </ul>	<ul style="list-style-type: none"> <li>Press the park button if you leave the vehicle.</li> </ul>

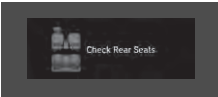
Message	Condition	Explanation
	<ul style="list-style-type: none"> <li>Appears if the vehicle is stationary and the transmission is put into <b>[N]</b>, the driver's seatbelt is unfastened, and the brake pedal is released, as there is a risk that the vehicle might roll unexpectedly.</li> </ul>	<ul style="list-style-type: none"> <li>Press the <b>[P]</b> button before releasing the brake pedal when idling, parking or exiting the vehicle.                             <ul style="list-style-type: none"> <li>► <b>Shift Operation</b> P. 398</li> </ul> </li> </ul>
	<ul style="list-style-type: none"> <li>Appears when the engine stops without the transmission in <b>[P]</b>, and does not restart automatically.</li> <li>Appears if you open the hood while Auto Idle Stop activates.</li> </ul>	<ul style="list-style-type: none"> <li>If you want to set the power mode to ON, change the gear position to <b>[P]</b>.</li> <li>If you want to start the engine, follow the normal procedure.                             <ul style="list-style-type: none"> <li>► <b>Starting the Engine</b> P. 388</li> </ul> </li> </ul>
	<ul style="list-style-type: none"> <li>Appears when you change to <b>[N]</b>, then release the <b>[N]</b> button.</li> </ul>	<ul style="list-style-type: none"> <li>► <b>If you want to keep the transmission in [N] position [car wash mode]</b> P. 400</li> </ul>
	<ul style="list-style-type: none"> <li>Appears when you press and hold <b>[N]</b> button for more than two seconds.</li> </ul>	<ul style="list-style-type: none"> <li>Disappears when you set the gear position to other than <b>[N]</b>.                             <ul style="list-style-type: none"> <li>► <b>If you want to keep the transmission in [N] position [car wash mode]</b> P. 400</li> </ul> </li> </ul>
	<ul style="list-style-type: none"> <li>Appears when car wash mode is not available due to hot transmission.</li> </ul>	<ul style="list-style-type: none"> <li>When transmission is too hot, car wash mode may not be available. Let the engine idle and cool down transmission.                             <ul style="list-style-type: none"> <li>► <b>If you want to keep the transmission in [N] position [car wash mode]</b> P. 400</li> </ul> </li> </ul>
	<ul style="list-style-type: none"> <li>Appears when you try to change the gear position without depressing the brake pedal.</li> </ul>	<ul style="list-style-type: none"> <li>Depress the brake pedal, then select a shift button.</li> </ul>



Message	Condition	Explanation
	<ul style="list-style-type: none"> <li>Appears when you try to change the gear position without releasing your foot off the accelerator pedal.</li> </ul>	<ul style="list-style-type: none"> <li>Release your foot off the accelerator pedal, then select a shift button.</li> </ul>
	<ul style="list-style-type: none"> <li>Appears when the <b>P</b> button is pressed while the vehicle is moving.</li> <li>Appears if you change the gear position to <b>R</b> while the vehicle is moving forward, or to <b>D</b> while the vehicle is reversing.</li> </ul>	<ul style="list-style-type: none"> <li>Make sure that the vehicle comes to a stop before operating the select button.</li> </ul>
	<ul style="list-style-type: none"> <li>Appears when you set the power mode to VEHICLE OFF, if the rear doors were opened shortly before or after the vehicle was powered on.</li> </ul>	<ul style="list-style-type: none"> <li>Check the rear seat for passengers or items before exiting the vehicle.                             <ul style="list-style-type: none"> <li>➤ <b>Rear Seat Reminder</b> P. 188</li> </ul> </li> </ul>
	<ul style="list-style-type: none"> <li>Appears when you press the <b>P</b> button but it is not engaged due to low ATF temperature.</li> </ul>	<ul style="list-style-type: none"> <li>Depress the brake pedal until this message disappears.</li> </ul>
	<ul style="list-style-type: none"> <li>Appears when depressing the accelerator pedal while the gear position is in <b>N</b>.</li> </ul>	<ul style="list-style-type: none"> <li>Remove your foot from the accelerator pedal. When driving, depress the brake pedal and change the gear position.</li> </ul>
	<ul style="list-style-type: none"> <li>Appears when you unlock and open the driver's door while the engine is running by remote engine start.</li> </ul>	<ul style="list-style-type: none"> <li>➤ <b>Remote Engine Start</b> P. 390</li> </ul>

## Gauges

Gauges include the fuel gauge, temperature gauge, and related indicators. They are displayed when the power mode is set to ON.

### Fuel Gauge

Displays the amount of fuel left in the fuel tank.

### Temperature Gauge

Displays the temperature of the engine coolant.

#### » Fuel Gauge

##### NOTICE

You should refuel when the reading approaches **[E]**. Running out of fuel can cause the engine to misfire, damaging the catalytic converter.

The actual amount of remaining fuel may differ from the fuel gauge reading.

#### » Temperature Gauge

##### NOTICE

Driving with the temperature gauge reading in the upper zone can cause serious engine damage. Pull safely to the side of the road and allow engine temperature to return to normal.

➔ **Overheating** P. 560

## Driver Information Interface

---

The driver information interface displays the speedometer, tachometer, odometer, trip computer, outside temperature, and other gauges. It also displays important messages such as warnings and other helpful information.

### ■ Speedometer

Displays your driving speed in mph or km/h.

### ■ Tachometer

Shows the number of engine revolutions per minute.

#### ⌘ Speedometer

---

You can set the speedometer and the displayed measurements to read in either mph or km/h.

➤ **Units** P. 119

#### ⌘ Tachometer

---

You can turn on or off the tachometer display.

➤ **Show Tachometer** P. 123

## ■ Odometer

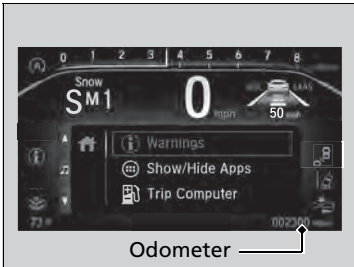

Shows the total number of miles or kilometers that your vehicle has accumulated.

## ■ Outside Temperature

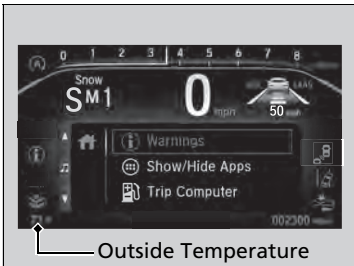

Shows the outside temperature in Fahrenheit (U.S.) or Celsius (Canada).

### ■ Adjusting the outside temperature display

Adjust the temperature reading by up to  $\pm 5^{\circ}\text{F}$  or  $\pm 3^{\circ}\text{C}$  if the temperature reading seems incorrect.

Use the audio/information screen to correct the temperature.



▶ **Customized Features** P. 327

### ⊗ Outside Temperature

The temperature sensor is in the front bumper. Road heat and exhaust from another vehicle can affect the temperature reading when your vehicle speed is less than 19 mph (30 km/h).

It may take several minutes for the display to be updated after the temperature reading has stabilized.

## ■ Accessing Content

Press the  (home) button, then press the  button to scroll to the content you want to see. Press the **ENTER** button to see detailed information.

## ▣ Accessing Content

To go back to the previous screen, press the  (back) button.

You can edit, add, or delete the meter contents using the driver information interface.

▣ **Arrange Apps** P. 122

▣ **Show/Hide Apps** P. 121

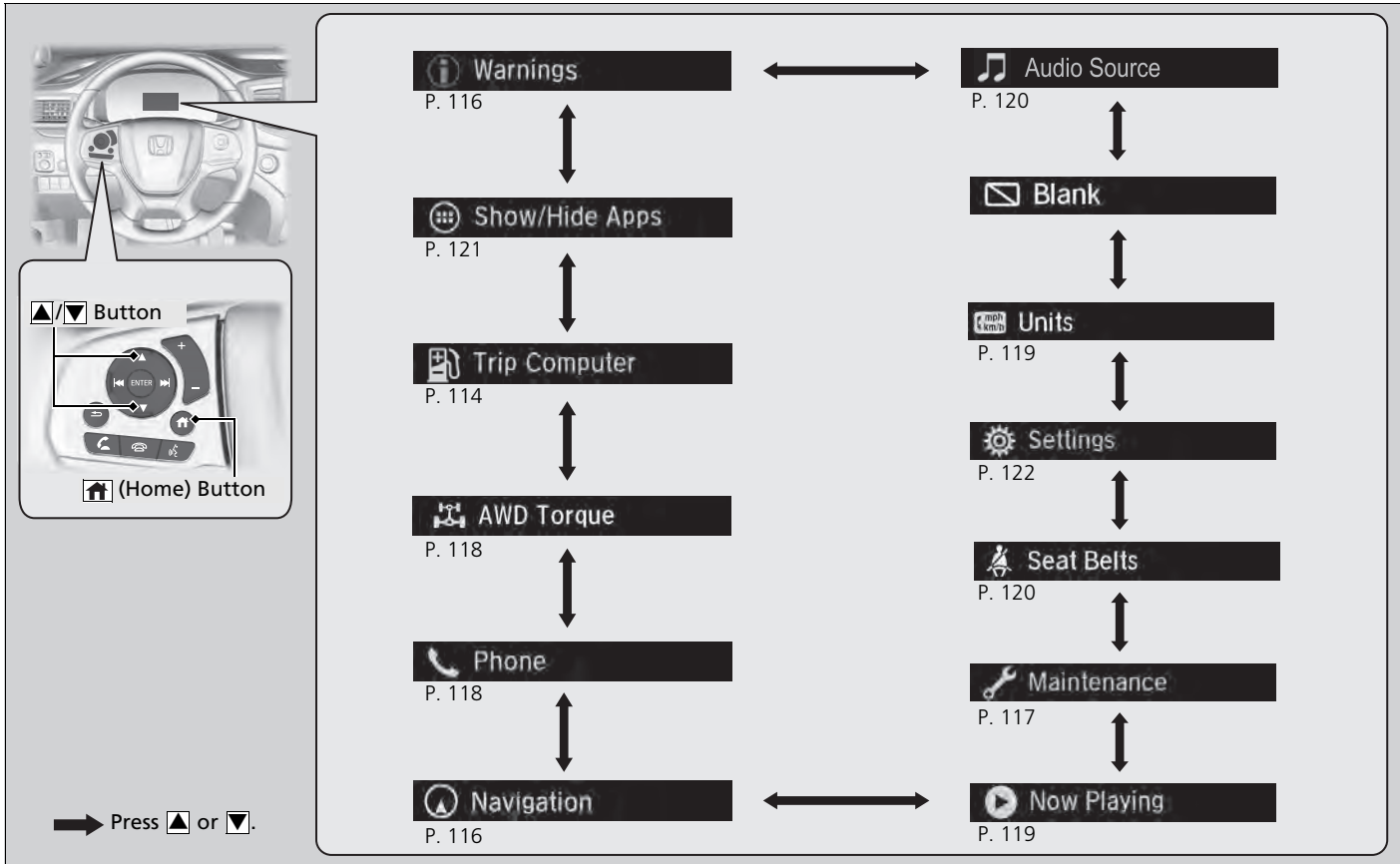

Instrument Panel

## ■ Trip Computer

Press the **ENTER** button to switch between trip computer A and trip computer B.

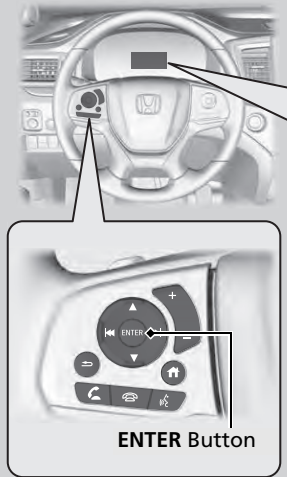

Trip Computer A



Distance

Average Fuel Economy

Range

Instant Fuel Economy

ENTER

Trip Computer B



**■ Distance**

Shows the total number of miles or kilometers driven since the last reset. Meters A and B can be used to measure two separate trips.

**Resetting distance**

To reset the **Distance**, display it and then press and hold the **ENTER** button until the **Distance** is reset to **0.0**.

**■ Average fuel economy (Avg. Fuel)**

Shows the estimated average fuel economy of each **Distance** in mpg or l/100 km. The display is updated at set intervals. When a **Distance** is reset, the average fuel economy is also reset.

**■ Instant fuel economy**

Shows the instant fuel economy as a bar graph in mpg or l/100 km.

**■ Range**

Shows the estimated distance you can travel on the remaining fuel. This estimated distance is based on the vehicle's current fuel economy.

**Distance**

Switch between **Distance A** and **Distance B** by pressing the **ENTER** button.

**Average fuel economy (Avg. Fuel)**

You can change when to reset the average fuel economy.

➤ **Customized Features P. 327**

**Range**

The driving range displayed is only an estimate and may differ from the actual distance the vehicle can travel.



## Navigation



Turn-By-Turn Driving Directions



Compass

Display Audio shows you turn-by-turn directions to your destination.

### Models with navigation system

When the navigation system is not providing driving guidance, an image of a compass appears in the driver information interface.

➤ Refer to the navigation system

## Navigation

Turn-by-turn directions will be shown on the driver information interface only when your android phone is connected to Android Auto™.

You can select whether to have the turn-by-turn display come on or not during the route guidance.

➤ **Customized Features** P. 327

## Warnings

➤ **Driver Information Interface Warning and Information Messages** P. 98

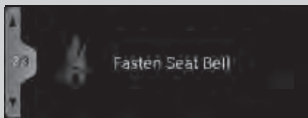

(Example)

The **Warnings** app is dynamic and will only appear when there are active warnings. If there are no Warnings, this app will not be shown.

## Maintenance



Shows the current condition of the tire pressure and the remaining oil life.



### ■ Tire Pressure

Shows the tire pressure of each tire.

- ▶ **Tire Pressure Monitoring System (TPMS) with Tire Fill Assist** P. 418



### ■ Oil Life

Shows the remaining oil life and Maintenance Minder™.

- ▶ **Maintenance Minder™** P. 494

## ■ AWD Torque



The indicators on the display show the amount of torque being transferred to the right front, left front, right rear, and left rear wheels.

▶ **Intelligent Variable Torque Management (i-VTM4™) AWD System** P. 417

## ■ Phone

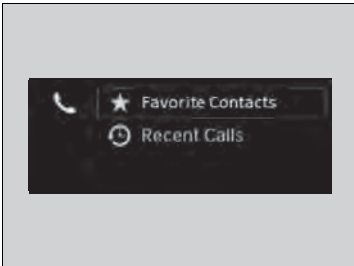

Shows the current phone information.

▶ **Bluetooth® HandsFreeLink®** P. 343

## Units

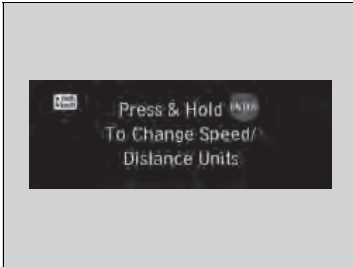

Enables you to set the speedometer and the displayed measurements to read in either mph or km/h.

Press and hold the **ENTER** button. Each time you do this, the unit will change from mph to km/h or vice versa. After this, a confirmation screen will appear for a few seconds.

## Now Playing

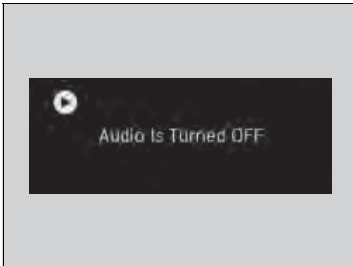

Shows the current audio information.

▶ **Audio System Basic Operation** P. 228

## ■ Audio Source

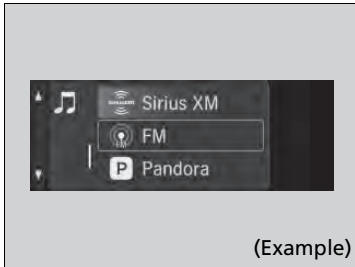

Shows the current audio source.

▶ **Audio System Basic Operation** P. 228

## ■ Seat Belts

Occurs, under specified conditions, when seat belts are latched or unlatched.

▶ **Seat Belt Reminder** P. 41

## Show/Hide Apps

You can show or hide the meter contents.

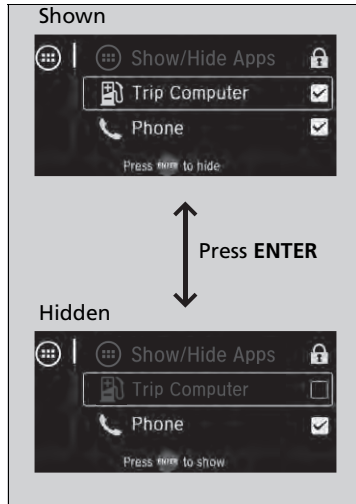

Select the content you wish to show or hide, then press the **ENTER** button.

- ▶ Repeat it if you want to show or hide more than one app.

### Show/Hide Apps

You cannot hide apps with the  icon on the right side.

You can also add the **Android Auto**, **Apple CarPlay**, **Sirius XM**, **My Honda Music**, **USB**, **AM**, **FM**, **Bluetooth Audio**, and **Social Playlist** apps.

\* Not available on all models

## ■ Settings

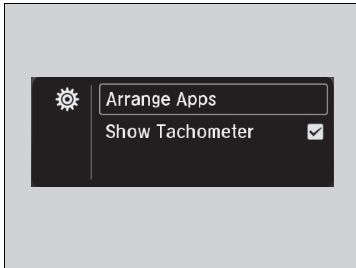

Change the settings to your liking.

## ■ Arrange Apps

You can change the order of the apps on the home screen.

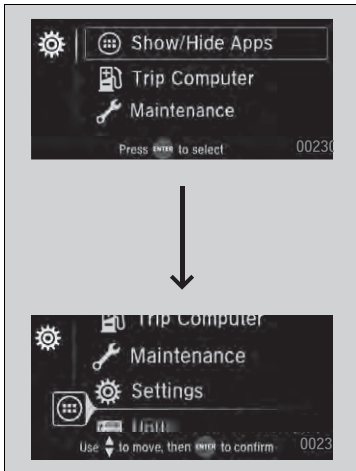



1. Press the ▲/▼ button to select **Arrange Apps**, then press the **ENTER** button.
2. Press the ▲/▼ button to select the icon you want to move, then press the **ENTER** button.
3. Press the ▲/▼ button repeatedly to move the icon to your desired position, then press the **ENTER** button.

## ■ Show Tachometer

You can show or hide the tachometer.



Press the / button to select **Show Tachometer**, then press the **ENTER** button.

- ▶ The tachometer appears when the check box is checked.



This page intentionally left blank.

# Controls

This chapter explains how to operate the various controls necessary for driving.

<b>Clock</b> .....	126	<b>Moonroof</b> .....	158	Adjusting the Steering Wheel .....	179
<b>Locking and Unlocking the Doors</b>		<b>Operating the Switches Around the</b>		<b>Mirrors</b>	
Key Types and Functions .....	128	<b>Steering Wheel</b>		Interior Rearview Mirror .....	180
Low Keyless Remote Signal Strength ....	130	ENGINE START/STOP Button.....	159	Power Door Mirrors .....	181
Locking/Unlocking the Doors from the		Turn Signals .....	162	<b>Seats</b>	
Outside .....	131	Light Switches.....	163	Front Seats .....	182
Locking/Unlocking the Doors from the		Fog Lights* .....	166	Rear Seats.....	186
Inside .....	139	Daytime Running Lights .....	167	Armrest .....	192
Childproof Door Locks .....	141	Auto High-Beam .....	168	<b>Interior Convenience Items</b>	
Auto Door Locking/Unlocking .....	142	Wipers and Washers .....	171	Interior Lights .....	193
<b>Tailgate</b> .....	143	Rear Defogger/Heated Door Mirror		Storage Items .....	196
<b>Security System</b> .....	152	Button.....	174	Other Interior Convenience Items.....	201
<b>Windows</b> .....	155	Brightness Control .....	176	<b>Climate Control System</b> .....	213
		Driving Position Memory System* ....	177		

\* Not available on all models

## Adjusting the Clock

### Models without navigation system

You can adjust the time manually in the audio/information screen, with the power mode in ON.





### Adjusting the Time



#### Using the Settings menu on the audio/information screen

1. Select , then select **Settings**.
2. Select **System**.
3. Select **Date & Time**.
4. Select **Set Date & Time**.
5. Select **Automatic Date & Time**, then select **OFF**.

#### To adjust time:

6. Select **Set Time**.
7. Selecting /.
  - ▶ AM/PM icon can be switched to each other either by selecting /, or by directly touching the icon.
  - ▶ When you customize the clock display to 24 hour clock, AM/PM icon is not displayed.
8. Select **Save** to set the time.

 **Customized Features** P. 327



### Clock

#### Models with navigation system

The clock is automatically updated through the navigation system, so the time does not need to be adjusted.

#### Using the Settings menu on the audio/information screen

You can also adjust the clock by touching the clock displayed on the upper right corner of the display or the **Clock** icon on the home screen.

1. Touch the clock on the display.
  - The clock screen of the select face-type appears.
2. Select **Settings**.
3. Select **Date & Time Settings**.
4. Select **Set Date & Time**.
5. Select **Automatic Date & Time**, then select **OFF**.
6. Select **Set Date** or **Set Time**.
7. Adjusting the dates, hours and minutes by selecting /.
8. Select **Save** to set the time.

You can customize the clock display to show the 12 hour clock or 24 hour clock.

 **Customized Features** P. 327

**To adjust date:**

- 6.** Select **Set Date**.
- 7.** Selecting ▲/▼.
- 8.** Select **Save** to set the date.

## Key Types and Functions

This vehicle comes with the following keys:

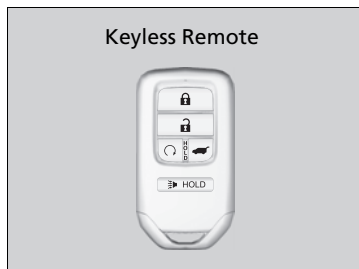

Use the keys to start and stop the engine, and to lock and unlock all the doors and tailgate.

### Key Types and Functions

All the keys have an immobilizer system. The immobilizer system helps to protect against vehicle theft.

**Immobilizer System** P. 152

Follow the advice below to prevent damage to the keys:

- Do not leave the keys in direct sunlight, or in locations with high temperature or high humidity.
- Do not drop the keys or set heavy objects on them.
- Keep the keys away from liquids, dust and sand.
- Do not take the keys apart except for replacing the battery.

If the circuits in the keys are damaged, the engine may not start, and the remote transmitter may not work.

If the keys do not work properly, have them inspected by a dealer.

You can remotely start the engine using the keyless remote.

**Remote Engine Start** P. 390

### Built-in Key

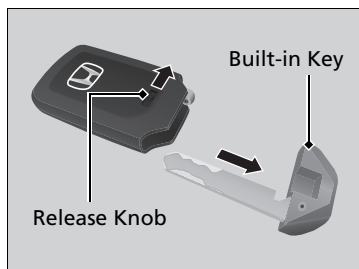

The built-in key can be used to lock/unlock the doors when the keyless remote battery becomes weak and the power door lock/unlock operation is disabled.

To remove the built-in key, slide the release knob and then pull out the key. To reinstall the built-in key, push the built-in key into the keyless remote until it clicks.

## ■ Key Number Tag

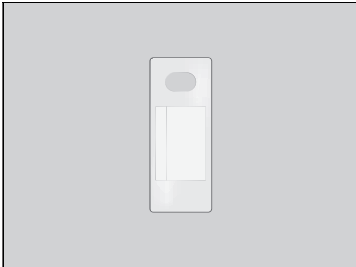

Contains a number that you will need if you purchase a replacement key.

## ▣ Key Number Tag

Keep the key number tag separate from the key in a safe place outside of your vehicle.  
If you wish to purchase an additional key, contact a dealer.

If you lose your key and you cannot start the engine, contact a dealer.

## Low Keyless Remote Signal Strength

The vehicle transmits radio waves to locate the keyless remote when locking/unlocking the doors and tailgate, or to start the engine.

In the following cases, locking/unlocking the doors and tailgate, or starting the engine may be inhibited or operation may be unstable:

- Strong radio waves are being transmitted by nearby equipment.
- You are carrying the keyless remote together with telecommunications equipment, laptop computers, cell phones, or wireless devices.
- A metallic object is touching or covering the keyless remote.

### ⓘ Low Keyless Remote Signal Strength

Communication between the keyless remote and the vehicle consumes the keyless remote's battery. Battery life is about two years, but this varies depending on regularity of use.

The battery is consumed whenever the keyless remote is receiving strong radio waves. Avoid placing it near electrical appliances such as televisions and personal computers.

## Locking/Unlocking the Doors from the Outside

### ■ Using the Keyless Access System

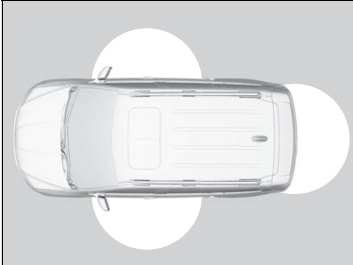

When you carry the keyless remote, you can lock/unlock the doors and the tailgate.

You can lock/unlock the doors and the tailgate within a radius of about 32 inches (80 cm) of the outside door handle or tailgate outer handle.

### ▣ Locking/Unlocking the Doors from the Outside

If the interior light switch is in the door activated position, the interior lights come on when you unlock the doors and tailgate.

No doors opened: The lights fade out after 30 seconds.

Doors and tailgate relocked: The lights go off immediately.

➤ **Interior Lights** P. 193

### ▣ Using the Keyless Access System

If you do not open a door or the tailgate within 30 seconds of unlocking the vehicle with the keyless access system, the doors and tailgate will automatically relock.

You can lock or unlock doors using the keyless access system only when the power mode is in VEHICLE OFF.

*Continued*



## ■ Locking the doors and tailgate

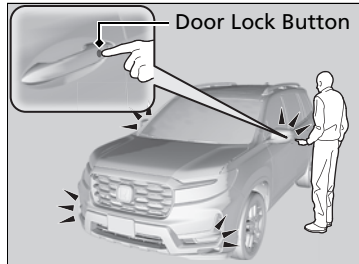

Press the door lock button on a front door or the tailgate.

- ▶ Some exterior lights flash; the beeper sounds; all the doors and tailgate lock; and the security system sets.

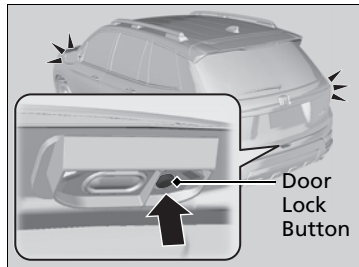

## ⊗ Using the Keyless Access System

- Do not leave the keyless remote in the vehicle when you get out. Carry it with you.
- Even if you are not carrying the keyless remote, you can lock/unlock the doors and tailgate while someone else with the remote is within range.
- The door may be unlocked if the door handle is covered with water in heavy rain or in a car wash if the keyless remote is within range.
- If you grip a door handle wearing gloves, the door sensor may be slow to respond or may not respond by unlocking the doors.
- After locking the door, you have up to 2 seconds during which you can pull the door handle to confirm whether the door is locked. If you need to unlock the door immediately after locking it, wait at least 2 seconds before gripping the handle, otherwise the door will not unlock.
- The door might not open if you pull it immediately after gripping the door handle. Grip the handle again and confirm that the door is unlocked before pulling the handle.
- Even within the 32 inches (80 cm) radius, you may not be able to lock/unlock the doors with the keyless remote if it is above or below the outside handle.
- The keyless remote may not operate if it is too close to the door and door glass.

## ■ Unlocking the doors and tailgate

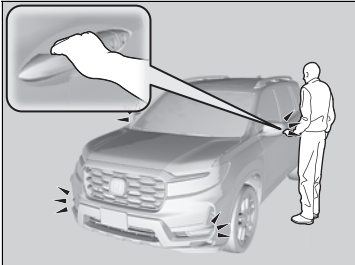

Grab the driver's door handle:

- ▶ The driver's door unlocks.
- ▶ Some exterior lights flash twice and the beeper sounds twice.

Grab the front passenger's door handle:

- ▶ All doors and the tailgate unlock.
- ▶ Some exterior lights flash twice and the beeper sounds twice.

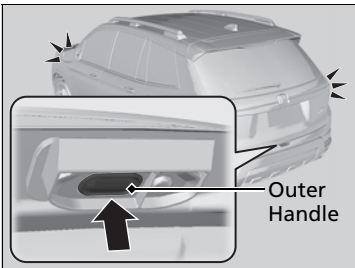

Press the tailgate outer handle:

- ▶ The tailgate unlocks and opens.
- ▶ Some exterior lights flash twice and the beeper sounds twice.

▶ **Using the Tailgate Outer Handle** P. 149

## ▶▶ Using the Keyless Access System

The light flash, beeper, and unlock settings can be customized using the audio/information screen.

▶ **Customized Features** P. 327

You can also unlock and open with the power tailgate.

▶ **Using the Tailgate Outer Handle** P. 149

■ Locking the doors and tailgate (Walk away auto lock®)

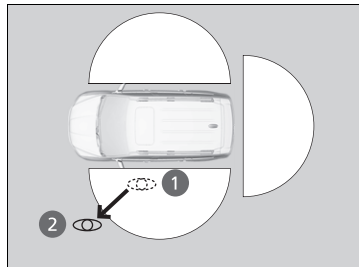
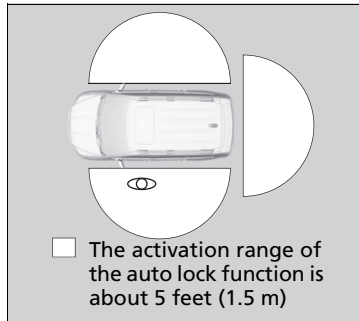

When you walk away from the vehicle with all doors and tailgate closed while carrying the keyless remote, the doors will automatically lock.

The auto lock function activates when all doors and tailgate are closed, and the keyless remote is within about 5 feet (1.5 m) radius of the outside door handle or tailgate outer handle.

Exit vehicle while carrying keyless remote and close door(s) and tailgate.

1. While within about 5 feet (1.5 m) radius of the vehicle.
  - ▶ The beeper sounds; the auto lock function will be activated.
2. Carry the keyless remote beyond about 5 feet (1.5 m) from the vehicle and remain outside this range for 2 or more seconds.
  - ▶ Some exterior lights flash; the beeper sounds; all doors and tailgate will then lock.

▣ Locking the doors and tailgate (Walk away auto lock®)

The auto lock function is set to OFF as the factory default setting. The auto lock function can be set to ON using the audio/information screen. Turning ON auto lock function using the audio/information screen, shall only activate the function in remote transmitter that was used to unlock the driver's door.

▶ Customized Features P. 327

After the auto lock function has been activated, when you stay within the locking/unlocking operation range, the indicator on the keyless remote will continue to flash until the doors are locked.

When you stay beside the vehicle within the operation range, the doors will automatically lock approximately 30 seconds after the auto lock function activating beeper sounds.

When you open a door after the auto lock function activating beeper sounds, the auto lock function will be delayed until all doors and tailgate are closed.

Under the following circumstances, the auto-lock function will not activate:

- The remote is inside the vehicle.
  - ▶ The buzzer will not sound.
- The remote is taken out of its operational range before all the doors are closed.
  - ▶ The buzzer will sound.

To temporarily deactivate the function:

1. Set the power mode to OFF.
2. Open the driver's door.
3. Using the master door lock switch, operate the lock as follows:  
Lock → Unlock → Lock → Unlock.  
▶ The beeper sounds, and the function is deactivated.

To restore the function:

- Set the power mode to ON.
- Lock the vehicle without using the auto lock function.
- With the keyless remote on you, move out of the auto lock function operation range.
- Open any door.

#### ⊠ Locking the doors and tailgate (Walk away auto lock®)

If equipped, the user must wait until the power tailgate fully closes before the auto lock function will be activated.

The auto lock function does not operate when any of the following conditions are met.

- The keyless remote is inside the vehicle.
- A door or the hood is not closed.
- The power mode is set to any mode other than OFF.
- The keyless remote is not located within a radius of about 5 feet (1.5 m) from the vehicle when you get out of the vehicle and close the doors.

#### **Auto lock function operation stop beeper**

After the auto lock function has been activated, the auto lock operation stop beeper sounds for approximately two seconds in the following cases.

- The keyless remote is put inside the vehicle through a window.
- You are located too close to the vehicle.
- The keyless remote is put inside the tailgate.

If the warning beeper sounds, check that you are carrying the keyless remote. Then, open/close a door and confirm the auto lock activation beeper sounds once.

## ■ Using the Remote Transmitter



### ■ Locking the doors and tailgate

Press the lock button.

#### Once:

- ▶ Some exterior lights flash, all the doors and tailgate lock, and the security system sets.

#### Twice (within five seconds after the first push):

- ▶ The beeper sounds and verifies the security system is set.

### ■ Unlocking the doors and tailgate

Press the unlock button.

#### Once:

- ▶ Some exterior lights flash twice, and the driver's door unlocks.

#### Twice:

- ▶ The remaining doors and tailgate unlock.

### ▶▶ Locking the doors and tailgate (Walk away auto lock®)

In the case that the keyless remote is out of operating range when you close a door or the boot, a beeper will sound to indicate that the auto lock function has been canceled.

### ▶▶ Using the Remote Transmitter

If you do not open a door or the tailgate within 30 seconds of unlocking the vehicle with the remote transmitter, the doors and tailgate will automatically relock.

You can change the relock timer setting.

▶▶ **Customized Features** P. 327

You can lock or unlock doors using the remote transmitter only when the power mode is in VEHICLE OFF.

The remote transmitter uses low-power signals, so the operating range may vary depending on the surroundings.

The remote will not lock the vehicle when a door is open.

If the distance at which the remote transmitter works varies, the battery is probably low.

If the LED does not come on when you press a button, the battery is dead.

▶▶ **Replacing the Remote Battery** P. 533

## ■ Locking/Unlocking the Doors Using a Key

If the lock or unlock button of the keyless remote does not work, use the key instead.

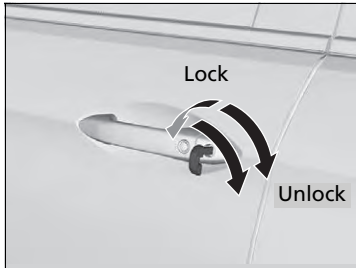

Fully insert the key and turn it.

### ▣ Using the Remote Transmitter

You can customize the door unlock mode setting.

▣ **Customized Features** P. 327

### ▣ Locking/Unlocking the Doors Using a Key

When you lock the driver's door with a key, all the other doors and tailgate lock at the same time. When unlocking, the driver's door unlocks first. Turn the key a second time within a few seconds to unlock the remaining doors and the tailgate.

You can customize the door unlock mode setting.

▣ **Customized Features** P. 327

## ■ Locking a Door Without Using a Key

If you do not have the key on you, or if for some reason you cannot lock a door using the key, you can lock the door without it.

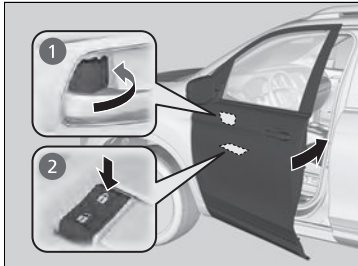

### ■ Locking the front doors

Push the lock tab forward ① or push the master door lock switch in the lock direction ②, and close the door.

### ■ Locking the rear doors

Push the lock tab forward and close the door.

### ■ Lockout prevention system

The doors and tailgate cannot be locked when the keyless remote is inside the vehicle.

## ▶ Locking a Door Without Using a Key

When you lock the driver's door, all the other doors and tailgate lock at the same time.

Before locking a door, make sure that the key is not inside the vehicle.

## Locking/Unlocking the Doors from the Inside

### ■ Using the Lock Tab

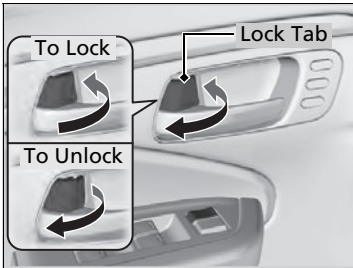

#### ■ Locking a door

Push the lock tab forward.

#### ■ Unlocking a door

Pull the lock tab rearward.

### ☒ Using the Lock Tab

When you lock the door using the lock tab on the driver's door, all of the other doors and the tailgate lock at the same time.

When you unlock the door using the lock tab on the driver's door, only the driver's door will unlock.



## ■ Unlocking Using the Front Door Inner Handle

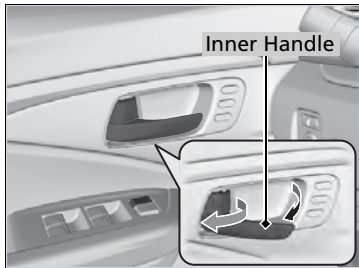

Pull the front door inner handle.

- ▶ The door unlocks and opens in one motion.

Unlocking and opening the driver's door from the inner handle unlocks all the other doors.

To avoid all the doors unlocking, use the lock tab on the driver's door to unlock, then lock again before opening the door.

- ▶ This setting works for one time only. If you do not want all the doors to be unlocked all the time, customize the **Auto Door Unlock** setting to **OFF** using the audio/information screen.
  - ▶ **Customized Features** P. 327

## ▶▶ Unlocking Using the Front Door Inner Handle

The front door inner handles are designed to allow front seat occupants to open the door in one motion. However this feature requires that front seat occupants never pull a front door inner handle while the vehicle is in motion.

Children should always ride in a rear seat where childproof door locks are provided.

- ▶ **Childproof Door Locks** P. 141

### ■ Using the Master Door Lock Switch

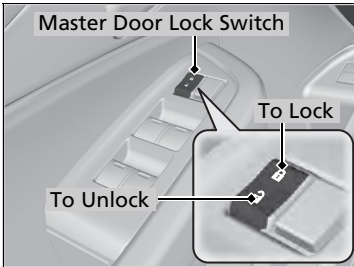

Press the master door lock switch in as shown to lock or unlock all doors and the tailgate.

### Childproof Door Locks

The childproof door locks prevent the rear doors from being opened from the inside regardless of the position of the lock tab.

### ■ Setting the Childproof Door Locks

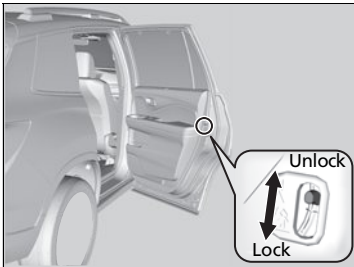

Slide the lever in the rear door to the lock position, and close the door.

#### ■ When opening the door

Open the door using the outside door handle.

### ☒ Using the Master Door Lock Switch

When you lock/unlock either of the front doors using the master door lock switch, all the other doors and the tailgate lock/unlock at the same time.

### ☒ Childproof Door Locks

To open the door from the inside when the childproof door lock is on, put the lock tab in the unlock position, lower the rear window, put your hand out of the window, and pull the outside door handle.

## Auto Door Locking/Unlocking

Your vehicle locks or unlocks all doors automatically when a certain condition is met.

### ■ Auto Door Locking

#### ■ Drive lock mode

All doors and tailgate lock when the vehicle's speed reaches about 10 mph (15 km/h).

### ■ Auto Door Unlocking

#### ■ Driver's door open mode

All doors and tailgate unlock when the driver's door is opened.

### ▶ Auto Door Locking/Unlocking

You can turn off or change to another auto door locking/unlocking setting using the audio/information screen.

▶ **Customized Features** P. 327

## Precautions for Opening/Closing the Tailgate

Always make sure individuals and objects are clear of the tailgate before opening or closing it.

- Open the tailgate all the way.
  - ▶ If it is not fully opened, the tailgate may begin to close under its own weight.
- Be careful when it is windy. The wind may cause the tailgate to close.

Keep the tailgate closed while driving to:

- ▶ Avoid possible damage.
- ▶ Prevent exhaust gas from leaking into the vehicle.
- ▶ **Carbon Monoxide Gas** P. 79

### Precautions for Opening/Closing the Tailgate

#### **⚠ WARNING**

Anyone caught in the path of a tailgate that is being opened or closed can be seriously injured.

**Make sure that all people are clear of the tailgate before opening or closing it.**

Be careful not to hit your head on the tailgate or to put your hands between the tailgate and the cargo area when closing the tailgate.

When you are storing or picking up cargo from the cargo area, or by using a forward and back kicking motion under the center of the rear bumper for hands free access\*, while the engine is idling, do not stand in front of the exhaust pipe. You may get burned.

Do not allow any passenger in the cargo space. They may get hurt during hard braking, a sudden acceleration, or a crash.

\* Not available on all models

## Opening/Closing the Tailgate

### ■ Using the Tailgate Outer Handle

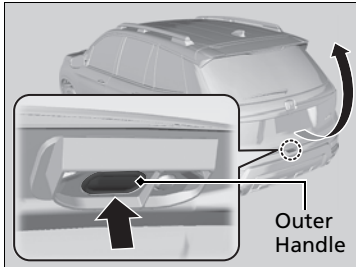

When all the doors are unlocked, the tailgate is unlocked.

Press the outer handle of the tailgate for more than one second, and lift open the tailgate.

If you are carrying the keyless remote, you do not have to unlock the tailgate before opening it.

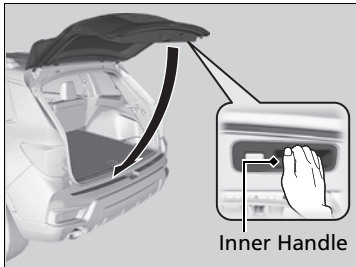

To close the tailgate, grab the inner handle, pull the tailgate down, and push it closed from outside.

### ▣ Using the Tailgate Outer Handle

Do not leave the key, remote transmitter, or keyless remote in the cargo area before closing the tailgate.

Even if you are not carrying the keyless remote, you can lock/unlock the tailgate while someone else with the remote is within range.

## Opening/Closing the Power Tailgate

The power tailgate can be operated by pressing the power tailgate button on the remote transmitter, pressing the power tailgate button in the driver side control panel, pressing the button on the tailgate, or by raising and lowering your foot under the center of the rear bumper for hands free access\*.

The power tailgate can be opened/closed when the transmission is in **P**.

### Opening/Closing the Power Tailgate

#### **⚠ WARNING**

Opening or closing a power tailgate while any part of a passenger is in the tailgate's operating path can cause serious injury.

Make sure all passengers or objects are clear of the tailgate operating range before opening or closing the tailgate.

#### **NOTICE**

Do not push or pull on the power tailgate when it is being automatically opened or closed. Forcibly opening or closing the power tailgate while in operation can deform the tailgate frame.

When operating the power tailgate, make sure there is enough space around your vehicle. People near the tailgate may be seriously hurt if the tailgate hits or closes on their heads. Be especially cautious if children are around.

The power tailgate may not open or close under the following conditions:

- You start the engine while the tailgate is automatically opening or closing.
- The vehicle is parked on a steep hill.
- The vehicle is swayed in a strong wind.
- The tailgate or the roof is covered with snow or ice.

\* Not available on all models

### ■ Using the Hands Free Access\*

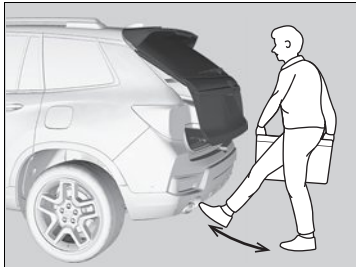

Use a forward and back kicking motion for about 1 second under the center of the rear bumper to open or close the power tailgate while carrying the keyless remote.

- Some exterior lights flash twice and a beeper sounds once, then the tailgate begins to move.

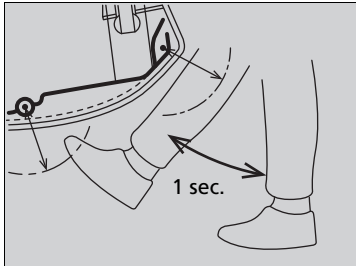

### ▣ Using the Hands Free Access\*

During rain or in other instances when the vehicle becomes wet, the sensor may not properly detect your foot motion.

When performing work on or around the rear section of the vehicle, you may inadvertently open or close the tailgate.

To prevent this from happening, select Customized Features on the audio/information screen and then select OFF for the feature.

► **Customized Features** P. 327

If you hold your foot under the bumper for too long or sweep your foot from side to side, the power tailgate does not open or close.

This function will not operate if you don't have the keyless remote on you. Please make sure you have the keyless remote on you.

## ■ Using the Remote Transmitter

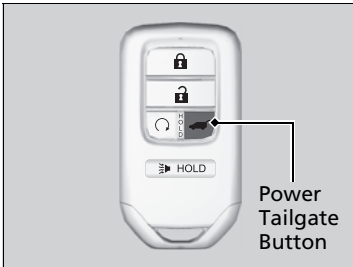

Press the power tailgate button for more than one second to operate when the power mode is in VEHICLE OFF.

- ▶ Some exterior lights flash and the beeper sounds.

If you press the button again while the power tailgate is moving, it will reverse direction.

## ■ Customizing when to open the tailgate

**Anytime:** The power tailgate unlocks and opens at the same time. This is the default setting.

**When Unlocked:** The tailgate opens when all doors are unlocked.

🔧 **Customized Features** P. 327

## 🔧 Opening/Closing the Power Tailgate

If you close the power tailgate when all the doors are locked, the power tailgate locks automatically.

If you replace the battery or the power tailgate fuse while the tailgate is open, the power tailgate may be disabled. The power tailgate resumes once you manually close the tailgate.

Installing aftermarket components other than genuine Honda accessories on the power tailgate may prevent it from fully opening or closing.

Make sure the power tailgate is fully open before you get your cargo in and out.

Make sure the power tailgate is fully closed before you start the vehicle.

The beeper sounds when you start driving while the power tailgate is still open, or closing.



## ■ Using the Power Tailgate Button

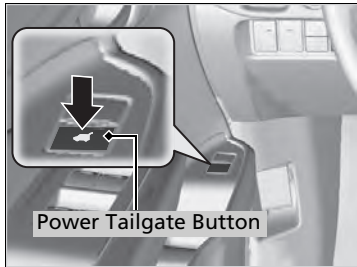

To open or close the power tailgate, press the power tailgate button for about one second.

- Some exterior lights flash and the beeper sounds.

If you press the button again while the power tailgate is moving, it will reverse direction.

## ▣ Opening/Closing the Power Tailgate

If the power tailgate meets resistance while opening or closing, the auto reverse feature reverses the direction. The beeper sounds three times.

The auto reverse function stops sensing when the tailgate is almost closed to make sure that it fully closes.

Do not touch the sensors located on both sides of the tailgate. The power tailgate does not close if you touch either sensor when you are trying to close the tailgate.

Be careful not to scratch the sensors with a sharp object. If scratched, they can be damaged, and the power tailgate closing feature malfunctions.

## ■ Using the Tailgate Outer Handle

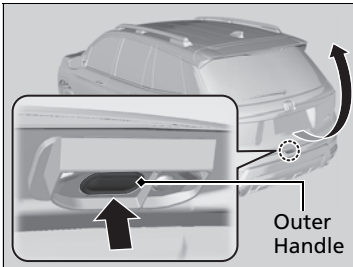

If you press the outer handle of the tailgate for no longer than one second, the tailgate opens automatically.

- ▶ The beeper sounds.
- ▶ If you want to open the tailgate manually, press the button for more than one second.

▶ **Tailgate** P. 143

If you are carrying the keyless remote, you do not have to unlock the tailgate before opening it.

If you press the outer handle again while the power tailgate is moving, it will reverse direction.

## ▶▶ Opening/Closing the Power Tailgate

Do not leave the key, remote transmitter, or keyless remote in the cargo area before closing the tailgate.

Even if you are not carrying the keyless remote, you can lock/unlock the tailgate while someone else with the remote is within range.

You can change the power tailgate operation setting on and off.

▶ **Customized Features** P. 327

## ■ Using the Tailgate Inner Button

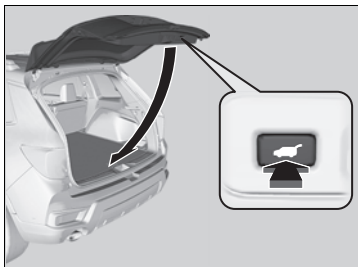

Press the button on the tailgate to close the power tailgate.

- The beeper sounds.

If you press the button again while the power tailgate is moving, it will reverse direction.

## ■ Auto-Closer

If you manually close the power tailgate, it latches automatically.

## ■ Power Tailgate Fall Detection

Automatically lowers the power tailgate when there is a possibility that the fully opened power tailgate can fall down by its own weight (for example, by snow on the tailgate). The beeper sounds while the power tailgate lowers.

### ☒ Auto-Closer

The auto-closer feature does not activate if you press the tailgate outer handle while the power tailgate is closing.

Do not put any force on the tailgate while the power tailgate is latching.

Keep your hands away from the tailgate when you manually close the tailgate and let it latch automatically. It is dangerous to put your hands around the tailgate as it starts to latch itself.

### ☒ Power Tailgate Fall Detection

If you try to manually close the power tailgate immediately after it fully opens, the power tailgate fall detection may be activated.

Once the power tailgate fall detection activates, wait until the power tailgate fully closes. Keep away from the power tailgate when it is in motion.

If the power tailgate fall detection constantly activates, consult at a dealer.

## Immobilizer System

The immobilizer system prevents a key that has not been pre-registered from starting the engine. Each key contains electronic transmitters that use electronic signals to verify the key.

Pay attention to the following when pressing the **ENGINE START/STOP** button:

- Do not allow objects that emit strong radio waves near the **ENGINE START/STOP** button.
- Make sure the key is not covered by or touching a metal object.
- Do not bring a key from another vehicle's immobilizer system near the **ENGINE START/STOP** button.
- Do not put the key near magnetic items. Electronic device, such as televisions and audio systems emit strong magnetic fields. Note that even a key chain can become magnetic.

## Security System Alarm

The security system alarm activates when the tailgate, hood or doors are forcibly opened. The alarm does not activate if the tailgate or doors are opened with the key, remote transmitter or keyless access system.

However, the alarm activates if a door is opened with the key and then the hood is opened before the power mode is set to ON.

### Immobilizer System

#### NOTICE

Leaving the key in the vehicle can result in theft or accidental movement of the vehicle.

Always take the key with you whenever you leave the vehicle unattended.

Do not alter the system or add other devices to it. Doing so may damage the system and make your vehicle inoperable.

### Security System Alarm

Do not alter the system or add other devices to it. Doing so may damage the system and make your vehicle inoperable.

The security alarm continues for a maximum of two minutes until the security system alarm deactivates.

**■ When the security system alarm activates**

The horn sounds intermittently, and some exterior lights flash.

**■ To deactivate the security system alarm**

Unlock the vehicle using the key, remote transmitter or keyless access system. The system, along with the horn and flashing lights, is deactivated.

**■ Setting the security system alarm**

The security system alarm automatically sets when the following conditions have been met:

- The power mode is set to VEHICLE OFF.
- The hood is closed.
- All doors and the tailgate are locked from outside with the key, remote transmitter, or keyless access system.

**■ When the security system alarm sets**

The security system alarm indicator in the instrument panel blinks and the blinking interval changes after about 15 seconds.

**■ To cancel the security system alarm**

The security system alarm is canceled when the vehicle is unlocked using the remote transmitter or keyless access system, or when the power mode is set to ON. The security system alarm indicator goes off at the same time.

**☒ Security System Alarm**

Do not set the security system alarm when someone is in the vehicle or a window is open. The system can accidentally activate when:

- Unlocking the door with the lock tab.
- Opening the hood with the hood release.

If the battery goes dead after you have set the security system alarm, the security alarm may go off once the battery is recharged or replaced.

If this occurs, deactivate the security system alarm by unlocking a door using the key, remote transmitter or keyless access system.

## ■ Panic Mode



### ■ The panic button on the remote transmitter

If you press the panic button for approximately one second, the following will occur for about 30 seconds:

- The horn sounds.
- Some exterior lights flash.

### ■ Canceling panic mode

Press any button on the remote transmitter, or set the power mode to ON.

## Opening/Closing the Power Windows

The power windows can be opened and closed when the power mode is in ON, using the switches on the doors.

The driver's side switches can be used to open and close all the windows. The power window lock button on the driver's side must be switched off (not pushed in, indicator off) to open and close the windows from anywhere other than the driver's seat.

When the power window lock button is pushed in, the indicator comes on and you can only operate the driver's window. Turn the power window lock button on if a child is in the vehicle.

### Opening/Closing Windows with Auto-Open/Close Function

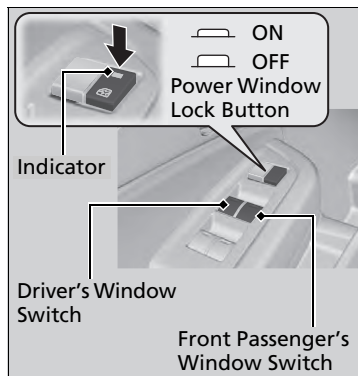

#### Manual operation

**To open:** Push the switch down lightly, and hold it until the desired position is reached.

**To close:** Pull the switch up lightly, and hold it until the desired position is reached.

#### Automatic operation

**To open:** Push the switch down firmly.

**To close:** Pull the switch up firmly.

The window opens or closes completely. To stop the window at any time, push or pull the switch briefly.

### Opening/Closing the Power Windows

#### WARNING

Closing a power window on someone's hands or fingers can cause serious injury.

Make sure your passengers are away from the windows before closing them.

The power windows can be operated for up to 10 minutes after you set the power mode to VEHICLE OFF.

Opening either front door cancels this function.

#### Auto Reverse

If a power window senses resistance when closing automatically, it stops closing and reverses direction.

The driver's window auto reverse function is disabled when you continuously pull up the switch.

The auto reverse function stops sensing when the window is almost closed to ensure that it fully closes.



### ■ Opening/Closing the Windows without Auto-Open/Close Function

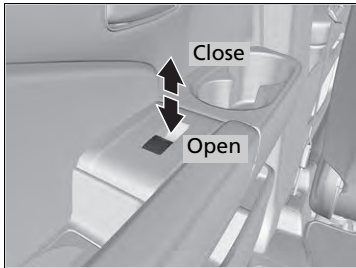

**To open:** Push the switch down.

**To close:** Pull the switch up.

Release the switch when the window reaches the desired position.

### ■ Opening the Windows and the Moonroof with the Remote



**To open:** Press the unlock button, and then within 10 seconds, press it again and hold it.

If the windows and moonroof stop midway, repeat the procedure.

### ▶ Opening/Closing the Power Windows

While driving with any of the windows open, you may hear a booming, throbbing, or helicopter-type noise or pressure. This is called wind buffeting. This is a normal occurrence that can be minimized.

If you hear a wind buffeting noise with any of the windows open, lower all of the other windows slightly or open the moonroof.

## ■ Opening/Closing the Windows and the Moonroof with the Key

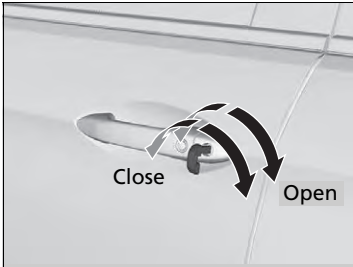

**To open:** Unlock the driver's door with the key. Within 10 seconds of returning the key to the central position, turn the key in the unlock direction and hold it there.

**To close:** Lock the driver's door with the key. Within 10 seconds of returning the key to the central position, turn the key in the lock direction and hold it there.

Release the key to stop the windows/moonroof at the desired position. If you want further adjustment, repeat the same operation.

## Opening and Closing the Moonroof

You can operate the moonroof when the power mode is in ON. Use the switch in the front of the ceiling to open and close the moonroof.

### ■ Using the Moonroof Switch

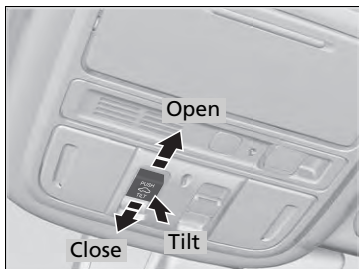

#### ■ Automatic operation

**To open:** Pull the switch back firmly.

**To close:** Push the switch forward firmly.

The moonroof will automatically open or close all the way. To stop the moonroof midway, push the switch briefly.

#### ■ Manual operation

**To open:** Pull the switch back lightly, and hold it until the desired position is reached.

**To close:** Push the switch forward lightly, and hold it until the desired position is reached.

#### ■ Tilting the moonroof up

**To tilt:** Push on the center of the moonroof switch.

**To close:** Push the switch forward firmly, then release.

### ☒ Opening and Closing the Moonroof

## ⚠ WARNING

Opening or closing the moonroof on someone's hands or fingers can cause serious injury.

Make sure all hands and fingers are clear of the moonroof before opening or closing it.

### NOTICE

Opening the moonroof in below freezing temperature or when it is covered with snow or ice can damage the moonroof panel or motor.

The moonroof can be operated for up to 10 minutes after you set the power mode to OFF. Opening either front door cancels this function.

When resistance is detected, the auto reverse function causes the moonroof to change directions, then stop. Auto reverse stops sensing when the moonroof is almost closed to ensure that it fully closes.

You can use the remote transmitter or the key to operate the moonroof.

☒ **Opening the Windows and the Moonroof with the Remote** P. 156

☒ **Opening/Closing the Windows and the Moonroof with the Key** P. 157

## ENGINE START/STOP Button

### ■ Changing the Power Mode

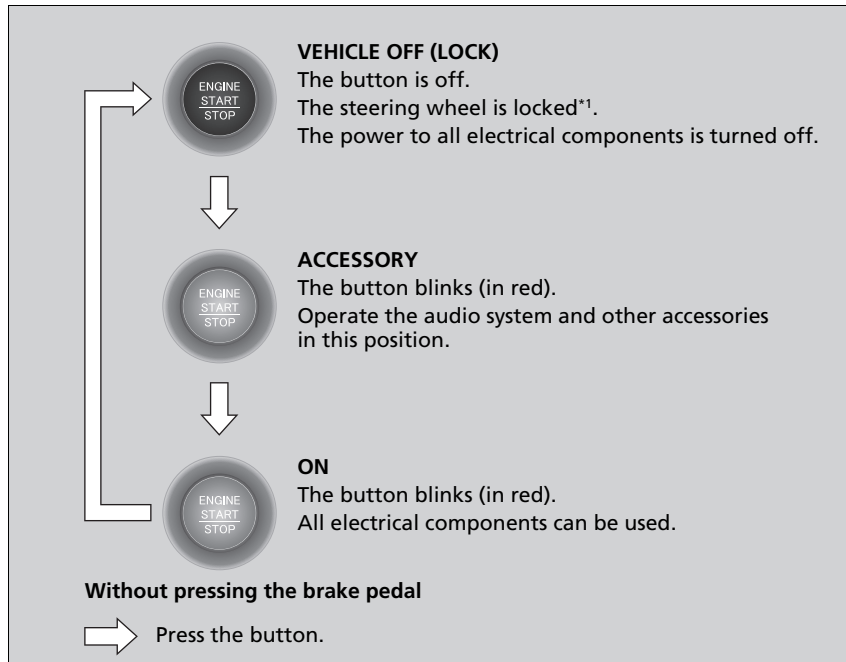

\*1: Canadian models

### ⊞ ENGINE START/STOP Button

**ENGINE START/STOP** Button Operating Range  
You can start the engine when the keyless remote is inside the vehicle.

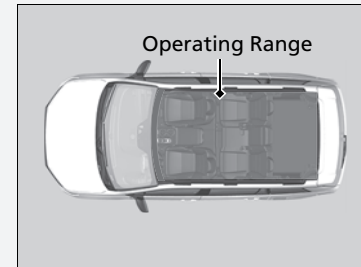

If the battery of the keyless remote is getting low, the engine may not start when you push the **ENGINE START/STOP** button. If the engine does not start, refer to the following link.

➡ **If the Keyless Remote Battery is Weak**  
P. 555

The engine may also run if the keyless remote is close to the door or window, even if it is outside the vehicle.

ON mode:  
The **ENGINE START/STOP** button is on (in red), if the engine is running.

## ■ Automatic Power Off

If you leave the vehicle for 30 to 60 minutes with the transmission in **P** and the power mode in ACCESSORY, the vehicle automatically goes into the mode similar to VEHICLE OFF (LOCK) to avoid draining the battery.

### Canadian models

When in this mode:

The steering wheel does not lock.

You cannot lock or unlock doors with the remote transmitter or the keyless access system.

Press the **ENGINE START/STOP** button to switch the mode to VEHICLE OFF (LOCK).

## ■ Power Mode Reminder

If you open the driver's door when the power mode is set to ACCESSORY, a warning beeper sounds.

## »» ENGINE START/STOP Button

### Canadian models

If the power mode does not change from VEHICLE OFF (LOCK) to ACCESSORY, press the **ENGINE START/STOP** button while moving the steering wheel left and right. The steering wheel will unlock, allowing the mode to change.

Do not leave the power mode in ACCESSORY or ON when you get out.

## ■ Keyless Remote Reminder

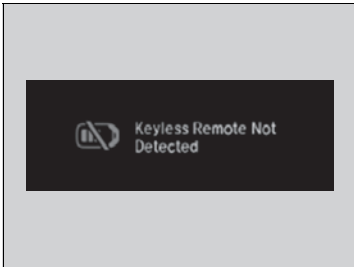

When the power mode is set to any mode other than OFF (LOCK) and you remove the keyless remote from the vehicle and shut the door, an alarm will sound. If the alarm continues to sound, place the keyless remote in another location.

### ■ When the power mode is in ACCESSORY

The alarm will sound from outside the vehicle.

### ■ When the power mode is in ON

An alarm will sound both inside and outside the vehicle. In addition, a warning indicator will appear on the instrument panel.

## ⊞ Keyless Remote Reminder

When the keyless remote is within the system's operational range, and the driver's door is closed, the warning function cancels.

If the keyless remote is taken out of the vehicle after the engine has been started, you can no longer change the **ENGINE START/STOP** button mode or restart the engine. Always make sure if the remote is in your vehicle when you operate the **ENGINE START/STOP** button.

Removing the keyless remote from the vehicle through a window does not activate the warning buzzer.

Do not put the keyless remote on the dashboard or in the glove box. It may cause the warning buzzer to go off. Under some other conditions that can prevent the vehicle from locating the remote, the warning buzzer may also go off even if the remote is within the system's operational range.

## Turn Signals

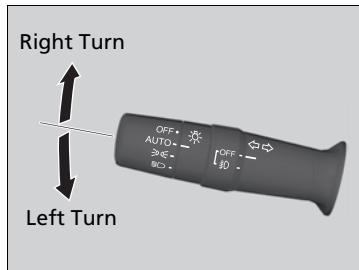

The turn signals can be used when the power mode is in ON.

### ■ One-touch turn signal

When you lightly push up or down and release the turn signal lever, the exterior turn signals and turn signal indicator blink three times. This feature can be used when signaling for a lane change.

# Light Switches

## Manual Operation

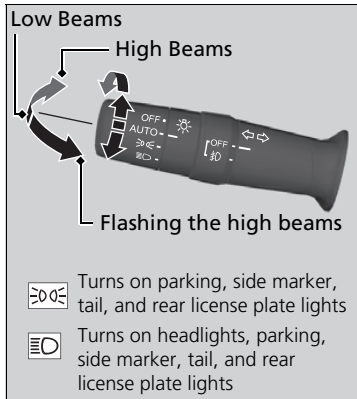

Rotating the light switch turns the lights on and off, regardless of the power mode setting.

### High beams

Push the lever forward until you hear a click.

### Low beams

When in high beams, pull the lever back to return to low beams.

### Flashing the high beams

Pull the lever back, and release it.

### Lights off

Turn the lever to OFF either when:

- The transmission is in **P**.
- The parking brake is applied.

To turn the lights on again, turn the lever to **OFF** to cancel the lights off mode. Even if you do not cancel the lights off mode, the lights come on automatically when:

- The transmission is taken out of **P** and the parking brake is released.
- The vehicle starts to move.

## Light Switches

If you leave the power mode in VEHICLE OFF while the lights are on, a chime sounds when the driver's door is opened.

When the lights are on, the lights on indicator in the instrument panel will be on.

### Lights On Indicator P. 88

Do not leave the lights on when the engine is off because it will cause the battery to discharge.

If you sense that the level of the headlights is abnormal, have your vehicle inspected by a dealer.



## ■ Automatic Operation (automatic lighting control)

Automatic lighting control can be used when the power mode is in ON.

When the light switch is in **AUTO**, the headlights and other exterior lights will switch on and off automatically depending on the ambient brightness.

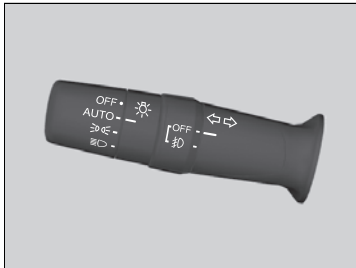

The headlights come on when you unlock a door in dark areas with the headlight switch in **AUTO**.

- ▶ Once you lock the door, the headlights will go off.

## ▶ Automatic Operation (automatic lighting control)

We recommend that you turn on the lights manually when driving at night, in a dense fog, or in dark areas such as long tunnels or parking facilities.

The light sensor is in the location shown below. Do not cover this light sensor with anything; otherwise, the automatic lighting system may not work properly.

### Models with automatic intermittent wipers

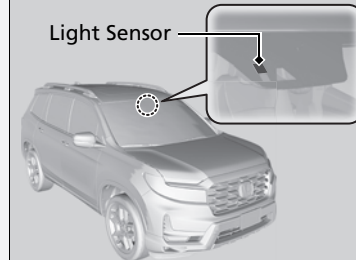

### Models without Automatic Intermittent Wipers

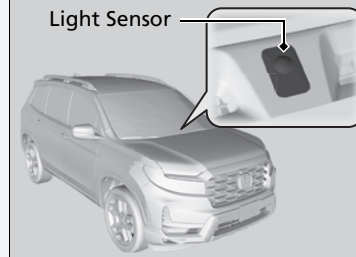

### ■ Headlight Integration with Wipers

The headlights automatically come on when the wipers are used several times within a certain number of intervals with the headlight switch in **AUTO**.  
The headlights automatically go off a few minutes later if the wipers are stopped.

### ■ Automatic Lighting Off Feature

The headlights, all other exterior lights, and the instrument panel lights turn off 15 seconds after you set the power mode to VEHICLE OFF, take the remote with you, and close the driver's door.

If you set the power mode to VEHICLE OFF with the headlight switch on, but do not open the door, the lights turn off after 10 minutes (three minutes, if the switch is in the **AUTO** position).

The lights turn on again when you unlock or open the driver's door. If you unlock the door, but do not open it within 15 seconds, the lights go off. If you open the driver's door, you will hear a reminder chime alerting you that the lights are on.

#### ⌘ Automatic Operation (automatic lighting control)

##### U.S. models

You can adjust the auto light sensitivity as follows:

Setting	The exterior lights come on when the ambient light is at
Max	
High	
Mid	
Low	
Min	

➤ **Customized Features** P. 327

#### ⌘ Headlight Integration with Wipers

This feature activates while the headlights are off in **AUTO**.  
The instrument panel brightness does not change when the headlights come on.

At dark ambient light levels, the automatic lighting control feature turns on the headlights, regardless of the number of wiper sweeps.

#### ⌘ Automatic Lighting Off Feature

You can change the headlight auto off timer setting.  
➤ **Customized Features** P. 327

## Fog Lights\*

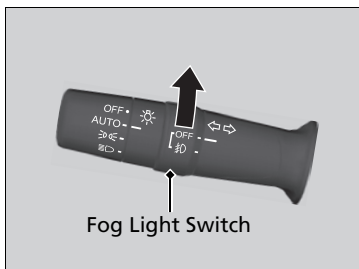

When the parking lights or the headlights are on, turn the fog light switch on to use the fog lights.

## Daytime Running Lights

---

The parking/daytime running lights come on when the following conditions have been met:

### U.S. models

- The power mode is in ON.
- The headlight switch is **AUTO** or **OFF**.
- The parking brake is released.

### Canadian models

- The power mode is in ON.
- The headlight switch is **AUTO**.
- The parking brake is released.

The lights remain on even if you set the parking brake. Setting the power mode to VEHICLE OFF will turn off the daytime running lights.

The daytime running lights are off once the headlight switch is turned on, or when the head light switch is in **AUTO** and it is getting darker outside.

## Auto High-Beam

The front sensor camera detects the light sources ahead of the vehicle such as the lights of a preceding or oncoming vehicle, or street lights. When you are driving at night, the system automatically switches the headlights between low beam and high beam depending on the situation.

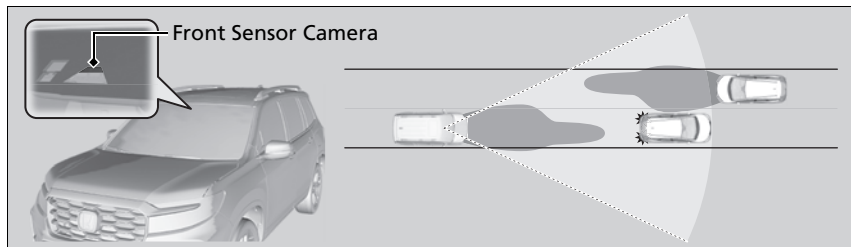

### Auto High-Beam

The auto high-beam system does not always operate in every situation. This system is just for assisting the driver. Always observe your surroundings and switch the headlights between high beam and low beam manually if necessary.

If you find the timing of beam changes inconvenient for driving, change the headlight beams manually.

The range and the distance at which the camera can recognize varies depending on conditions surrounding your vehicle.

Regarding the handling of the camera mounted to the inside of the windshield, refer to the following.

#### Front Sensor Camera P. 464

For the auto high-beam to work properly:

- Do not place an object that reflects light on the dashboard.
- Keep the windshield around the camera clean.
- When cleaning the windshield, be careful not to apply the windshield cleanser to the camera lens.
- Do not attach an object, sticker or film to the area around the camera.
- Do not touch the camera lens.

If the camera receives a strong impact, or repairing of the area near the camera is required, consult a dealer.

### How to Use the Auto High-Beam

When all of the following conditions have been met, the auto high-beam indicator comes on and the auto high-beam is activated.

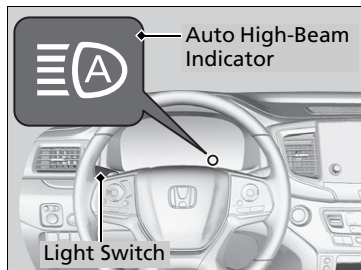

- The power mode is in ON.
- The light switch is in **AUTO**.
- The lever is in the low beam position.
- The headlights have been automatically activated.
- It is dark outside the vehicle.

If the auto high-beam indicator does not come on even when all the conditions have been met, carry out the following procedure and the indicator will come on.

- Pull the lever toward you for flashing the high beams then release it while driving.

### ■ Automatic switching between high-beam and low-beam

When auto high-beam is active, the headlights switch between high beam and low beam based on the following conditions.

#### Switching to high beam:

All of the following conditions must be met before the high beams turn on.

- Your vehicle speed is 45mph (72 km/h) or more.
- There are no preceding or oncoming vehicles with headlights or taillights turned on.
- There are few street lights on the road ahead.



#### Switching to low beam:

One of the following conditions must be met before the low beams turn on.

- Your vehicle speed is 30 mph (48 km/h) or less.
- There is a preceding or oncoming vehicles with headlights or taillights turned on.
- There are many street lights on the road ahead.

### ■ Manual switching between high-beam and low-beam

If you want to manually switch the headlights between high beam and low beam, follow either of the procedures below. Note that when you do this, the auto high-beam indicator will turn off and the auto high-beam will be deactivated.

#### Using the lever:

Pull the lever toward you for flashing the high beams then release it within about one second while driving.

- ▶ To reactivate the auto high-beam, pull the lever toward you for flashing the high beams then release it while driving. The auto high-beam indicator will come on.

#### Using the light switch:

Turn the light switch to .

- ▶ To reactivate the auto high-beam, turn the light switch to **AUTO** when the lever is in the low beam position, the auto high-beam indicator will come on.

#### ⊗ How to Use the Auto High-Beam

In the following cases, the auto high-beam system may not switch the headlights properly or the switching timing may be changed. In case of the automatic switching operation does not fit for your driving habits, please switch the headlights manually.

- The brightness of the lights from the preceding or oncoming vehicle is intense or poor.
- Visibility is poor due to the weather (rain, snow, fog, windshield frost, etc.).
- Surrounding light sources, such as street lights, electric billboards and traffic lights are illuminating the road ahead.
- The brightness level of the road ahead constantly changes.
- The road is bumpy or has many curves.
- A vehicle suddenly appears in front of you, or a vehicle in front of you is not in the preceding or oncoming direction.
- Your vehicle is tilted with a heavy load in the rear.
- A traffic sign, mirror, or other reflective object ahead is reflecting strong light toward the vehicle.
- The oncoming vehicle frequently disappears under roadside trees or behind median barriers.
- The preceding or oncoming vehicle is a motorcycle, bicycle, mobility scooter, or other small vehicle.

The auto high-beam system keeps the headlight low beam when:

- Windshield wipers are operating.
- The camera has detected a dense fog.

## ■ How to Turn Off the Auto High-Beam

You can turn the auto high-beam system off. If you want to turn the system off or on, set the power mode to ON, then carry out the following procedures while the vehicle is stationary.

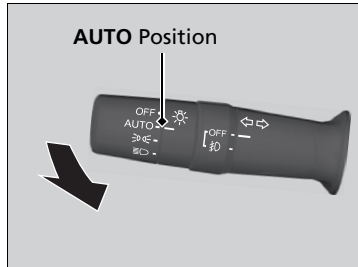

### To turn the system off:

With the light switch is in **AUTO**, pull the lever toward you and hold it for at least 40 seconds. After the auto high-beam indicator light blinks twice, release the lever.

### To turn the system on:

With the light switch is in **AUTO**, pull the lever toward you and hold it for at least 30 seconds. After the auto high-beam indicator light blinks once, release the lever.

## ☒ How to Use the Auto High-Beam

If the **Some Driver Assist Systems Cannot Operate: Camera Temperature Too High** message appears:

- Use the climate control system to cool down the interior and, if necessary, also use defroster mode with the airflow directed toward the camera.
- Start driving the vehicle to lower the windshield temperature, which cools down the area around the camera.

If the **Some Driver Assist Systems Cannot Operate: Clean Front Windshield** or **Auto High-Beam Cannot Operate: Clean Windshield** message appears:

- Park your vehicle in a safe place, and clean the windshield. If the message does not disappear after you have cleaned the windshield and driven for a while, have your vehicle checked by a dealer.

## ☒ How to Turn Off the Auto High-Beam

If you turn the auto high-beam system off, the system does not operate until you turn the system on.

Park in a safe place before turning the system off or on.

# Wipers and Washers

## ■ Windshield Wipers/Washers

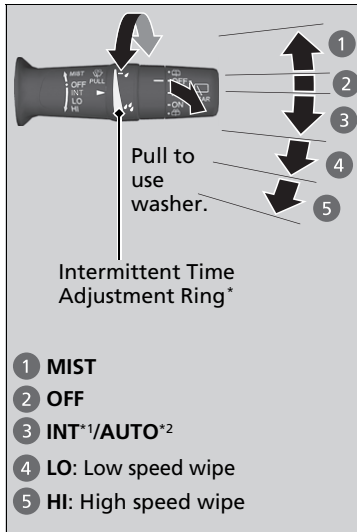

The windshield wipers and washers can be used when the power mode is in ON.

### ■ MIST

The wipers run at high speed until you release the lever.

### ■ Wiper switch (OFF, INT\*<sup>1</sup>/AUTO\*<sup>2</sup>, LO, HI)

Move the lever up or down to change the wiper settings.

### ■ Adjusting wiper operation\*

Turn the adjustment ring to adjust wiper operation.

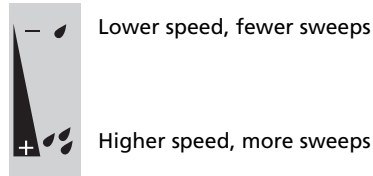

### ■ Washer

Sprays while you pull the lever toward you. When you release the lever for more than one second, the spray stops, the wipers sweep two or three more times to clear the windshield, then stop.

\*1: Models with manual intermittent operation  
\*2: Models with automatic intermittent operation

\* Not available on all models

## ▶▶ Wipers and Washers

### NOTICE

Do not use the wipers when the windshield is dry. The windshield will get scratched, or the rubber blades will get damaged.

Turn the washers off if no washer fluid comes out. The pump may get damaged.

The wiper motor may stop motor operation temporarily to prevent an overload. Wiper operation will return to normal within a few minutes, once the circuit has returned to normal.

### Models with intermittent time adjustment ring

If the vehicle speeds up while the wipers are operating intermittently, the length of the wipe interval shortens.

When the vehicle speeds up, the wiper operation's shortest delay setting (+) and the **LO** setting become the same.

### NOTICE

In cold weather, the blades may freeze to the windshield.

Operating the wipers in this condition may damage the wipers. Use the defogger or heated windshield\* to warm the windshield, then turn the wipers on.



## ■ Automatic Intermittent Wipers\*

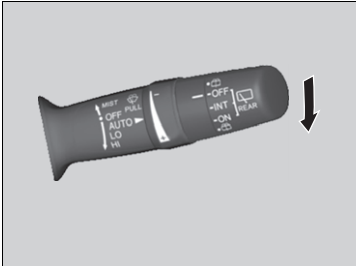

When you push the lever down to **AUTO**, the windshield wipers sweep once, and go into the automatic mode.

The wipers operate intermittently, at low speed, or at high speed and stop in accordance with the amount of rainfall the rainfall sensor detects.

### ■ Auto sensitivity adjustment

When the wiper function is set to **AUTO**, you can adjust the sensitivity of the rainfall sensor (using the adjustment ring) so that wipers will operate in accordance with your preference.

#### Sensor sensitivity



Low sensitivity

High sensitivity

## » Wipers and Washers

If the wipers stop operating due to an obstacle such as the buildup of snow, park the vehicle in a safe place.

Rotate the wiper switch to **OFF**, and set the power mode to ACCESSORY or VEHICLE OFF, then remove the obstacle.

## » Automatic Intermittent Wipers\*

The rainfall sensor is in the location shown below.

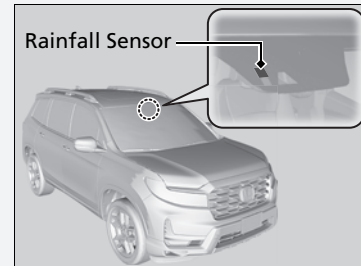

### NOTICE

**AUTO** should always be turned **OFF** before the following situations in order to prevent severe damage to the wiper system:

- Cleaning the windshield
- Driving through a car wash
- No rain present

## ■ Rear Wiper/Washer



- 1 INT: Intermittent
- 2 ON
- 3 OFF
- 4 Washer

The rear wiper and washer can be used when the power mode is in ON.

### ■ Wiper switch (OFF, INT, ON)

Change the wiper switch setting according to the amount of rain.

### ■ Washer (🚿)

Sprays on the rear window while you rotate the switch to this position. Hold it to activate the rear wiper and to spray the washer. Once released, the washer spray will stop and the rear wiper will return to its selected switch setting after a few more sweeps.

### ■ Operating in reverse

When you shift the transmission to **R** with the windshield wiper activated, the rear wiper operates automatically as follows even if its switch is off.

Front Wiper Operation	Rear Wiper Operation
INT (Intermittent)	Intermittent
LO (Low speed wipe) HI (High speed wipe)	Continuous

## Rear Defogger/Heated Door Mirror Button

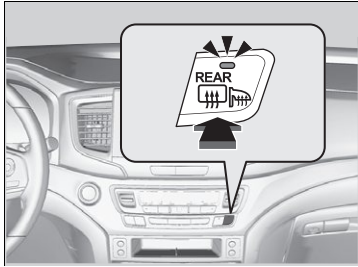

Press the rear defogger and heated door mirror button to defog the rear window and mirrors when the power mode is in ON.

The rear defogger and heated door mirrors automatically switch off after 10-30 minutes depending on the outside temperature.

### ⊠ Rear Defogger/Heated Door Mirror Button

This system consumes a lot of power, so turn it off when the window has been defogged. Also, do not use the system for a long time while the engine is idling. This may weaken the battery, making it difficult to start the engine.

When the power mode is set to ON and the outside temperature is below 41°F (5°C), the heated door mirror may automatically activate for 10 minutes.

## Heated Windshield Button\*

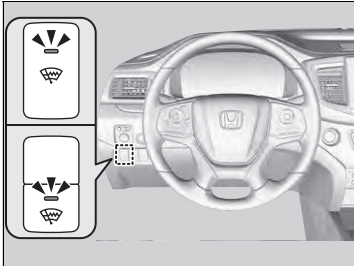

Press the heated windshield button to deice the windshield when the power mode is in ON.

### ⌘ Heated Windshield Button\*

This system consumes a lot of power, so turn it off when the window has been deiced. Also, do not use the system for a long period when the engine is idling. This may weaken the battery, making it difficult to start the engine.

When the outside temperature is below 39°F (4°C), the heated windshield may automatically activate. The system deactivates itself once the outside temperature reaches 43°F (6°C).

\* Not available on all models

## Brightness Control

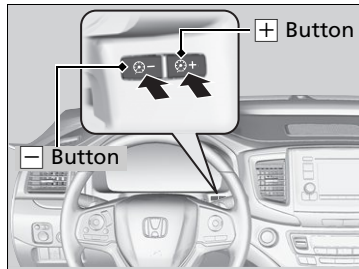

When the power mode is in ON, you can use the **+** or **-** button to adjust instrument panel brightness.

**Brighten:** Press the **+** button.

**Dim:** Press the **-** button.

You will hear a beeper when the brightness reaches minimum or maximum. Several seconds after you have adjusted the brightness, you will be returned to the previous screen.

### ■ Brightness level indicator

The brightness level is shown on the display while you are adjusting it.



### ▶▶ Brightness Control

Instrument panel brightness varies, depending on whether the exterior lights are on or off. The instrument panel dims to reduce glare when they are on.

When it is bright outside and the headlight integration with the wiper is activated, the instrument panel brightness does not change.

To cancel the reduced instrument panel brightness when the exterior lights are on, press the **+** button until the brightness display is up to max, the beeper sounds.

The brightness can be set differently for when the exterior lights are on, and when they are off.

## Driving Position Memory System\*

You can store two driver's seat (except for power lumbar) and outside mirror positions with the driving position memory system.

When you unlock and open the driver's door with a remote transmitter or keyless access system, door mirrors adjust to one of the two preset positions and the seat adjusts to the retracted position of one of the two preset positions automatically.

The seat will move to the stored position when you set the power mode to ACCESSORY.

When you enter the vehicle, the driver information interface briefly shows you which remote transmitter you used to unlock the vehicle.

- **DRIVER 1** transmitter is linked to memory button 1.
- **DRIVER 2** transmitter is linked to memory button 2.



The driver's seat moves rearward depending on the set seating position once you

- Stop the vehicle.
- Put the transmission in **P**.
- Turn the engine off.
- Open the driver's door.

Once the power mode is in the ACCESSORY position, the driver's seat moves to the **DRIVER 1** or **2** preset position.

### ▶▶ Driving Position Memory System\*

Using the audio/information screen, you can disable the automatic seat and door mirrors adjustment function.

▶ **Customized Features** P. 327

The driver's seat easy exit feature can be turned ON/OFF.

▶ **Customized Features** P. 327

### System Operation

The system will not operate if:

- The vehicle speed is above 3 mph (5 km/h).
- Either memory position button is pressed while the seat is in motion.
- The seat position is adjusted while in operation.
- The memory 1 or 2 position is set fully to the rear.

The system may not recognize a key if:

- The key is in close proximity to a cell phone or other wireless device.
- Both keys are in the vehicle at the same time.
- The driving position memory system is disabled in customized features.
- Opening driver's door without fully grabbing door handle.

## ■ Storing a Position in Memory

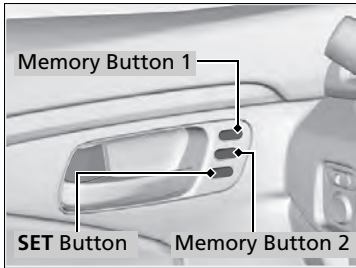

1. Set the power mode to ON. Adjust the driver's seat and the door mirrors to the desired position.
2. Press the **SET** button.
  - ▶ You will hear a beep, and the memory button indicator light will blink.
3. Press and hold memory button **1** or **2** within five seconds of pressing the **SET** button.
  - ▶ You will hear two beeps, and the indicator light on the button you pressed stays on once the seat and the outside mirror positions have been memorized.

## ■ Recalling the Stored Position

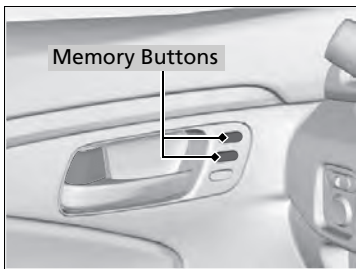

1. Put the transmission into **P**.
2. Apply the parking brake.
3. Press a memory button (**1** or **2**).
  - ▶ You will hear a beep, and the indicator light will blink.

The seat and the door mirrors will automatically move to the memorized positions. When it has finished moving, you will hear the beep, and the indicator light stays on.

## ⌘ Storing a Position in Memory

After you press the **SET** button, the storing operation will be canceled when:

- You do not press the memory button within five seconds.
- You readjust the seat position and door mirror before the double-beep.
- You set the power mode to any position except ON.

## ⌘ Recalling the Stored Position

The seat and the door mirrors will stop moving if you:

- Press the **SET** button or memory button **1** or **2**.
- Adjust the seat position or door mirrors.
- Put the transmission into a position other than **P**.

## Adjusting the Steering Wheel

The steering wheel height and distance from your body can be adjusted so that you can comfortably grip the steering wheel in an appropriate driving posture.

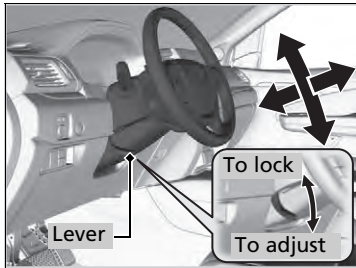

1. Push the steering wheel adjustment lever down.
  - ▶ The steering wheel adjustment lever is under the steering column.
2. Move the steering wheel up or down, and in or out.
  - ▶ Make sure you can see the instrument panel gauges and indicators.
3. Pull the steering wheel adjustment lever up to lock the steering wheel in position.
  - ▶ After adjusting the position, make sure you have securely locked the steering wheel in place by trying to move it up, down, in, and out.

### Adjusting the Steering Wheel

#### **⚠ WARNING**

Adjusting the steering wheel position while driving may cause you to lose control of the vehicle and be seriously injured in a crash.

Adjust the steering wheel only when the vehicle is stopped.



## Interior Rearview Mirror

Adjust the angle of the rearview mirror when you are sitting in the correct driving position.

### ■ Rearview Mirror with Day and Night Positions\*

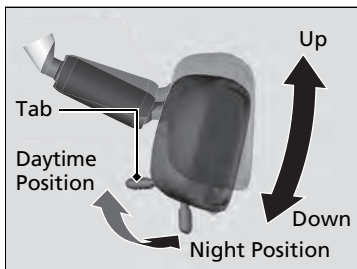

Flip the tab to switch the position. The night position will help to reduce the glare from headlights behind you when driving after dark.

### ■ Automatic Dimming Rearview Mirror\* and Power Door Mirrors\*

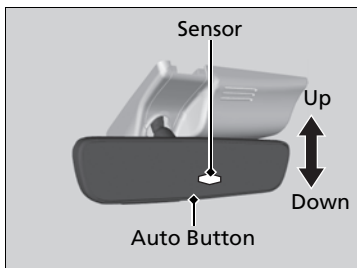

When you are driving after dark, the automatic dimming rearview mirror and power door mirror reduce the glare from headlights behind you. Press the AUTO button to turn this function on and off. When activated, the AUTO indicator comes on.

### ▣ Mirrors

Keep the inside and outside mirrors clean and adjusted for best visibility.

Adjust the mirrors before you start driving.

➤ **Front Seats** P. 182

### ▣ Automatic Dimming Rearview Mirror\* and Power Door Mirrors\*

The auto dimming function cancels when the transmission is in **[R]**.

## Power Door Mirrors

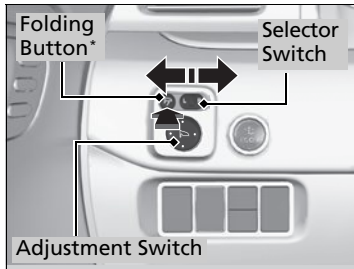

You can adjust the door mirrors when the power mode is in ON.

### ■ Mirror position adjustment

**L/R selector switch:** Select the left or right mirror. After adjusting the mirror, return the switch to the center position.

**Mirror position adjustment switch:** Press the switch left, right, up, or down to move the mirror.

### ■ Folding door mirrors\*

Press the folding button to fold in and out the door mirrors.

### ■ Reverse Tilt Door Mirror\*

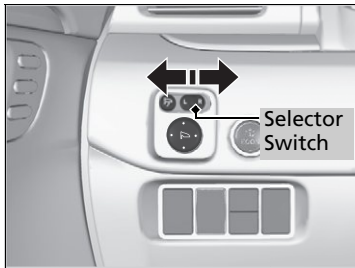

If activated, either side door mirror automatically tilts downward when you put the transmission into **[R]**; this improves close-in visibility on the selected side of the vehicle when backing up. The mirror automatically returns to its original position when you take the transmission out of **[R]**.

To activate this feature, set the power mode to ON, and slide the selector switch to the left or right side.

\* Not available on all models

## Front Seats

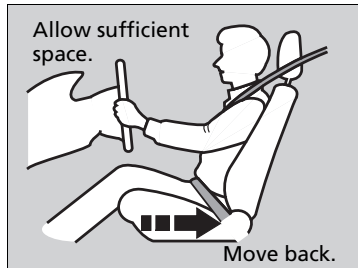

Adjust the driver's seat as far back as possible while allowing you to maintain full control of the vehicle. You should be able to sit upright, well back in the seat and be able to adequately press the pedals without leaning forward, and grip the steering wheel comfortably. The passenger's seat should be adjusted in a similar manner, so that it is as far back from the front airbag in the dashboard as possible.

### Seats

Always make seat adjustments before driving.

### Front Seats

## WARNING

Sitting too close to a front airbag can result in serious injury or death if the front airbags inflate.

Always sit as far back from the front airbags as possible while maintaining control of the vehicle.

The National Highway Traffic Safety Administration and Transport Canada recommend that drivers allow at least 10 inches (25 cm) between the center of the steering wheel and the chest.

## Adjusting the Seat Positions

### Adjusting the front power seats\*

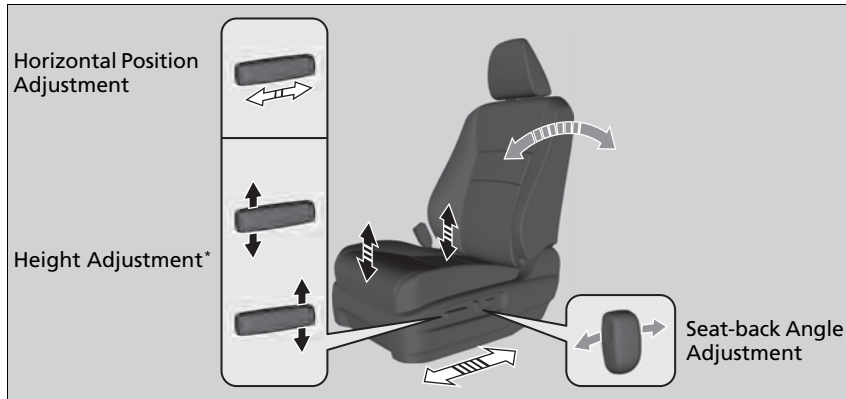

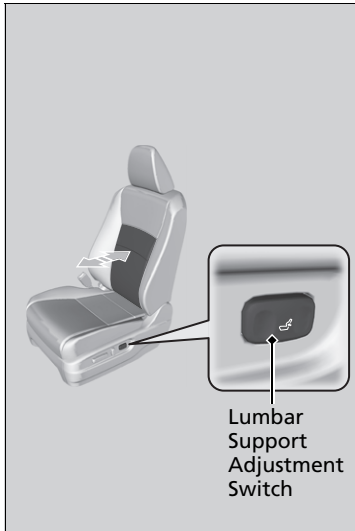

### ■ Lumbar Support Adjustment Switch

**Press the front:** To increase the entire lumbar support.

**Press the rear:** To decrease the entire lumbar support.

## ■ Adjusting the front manual seats\*

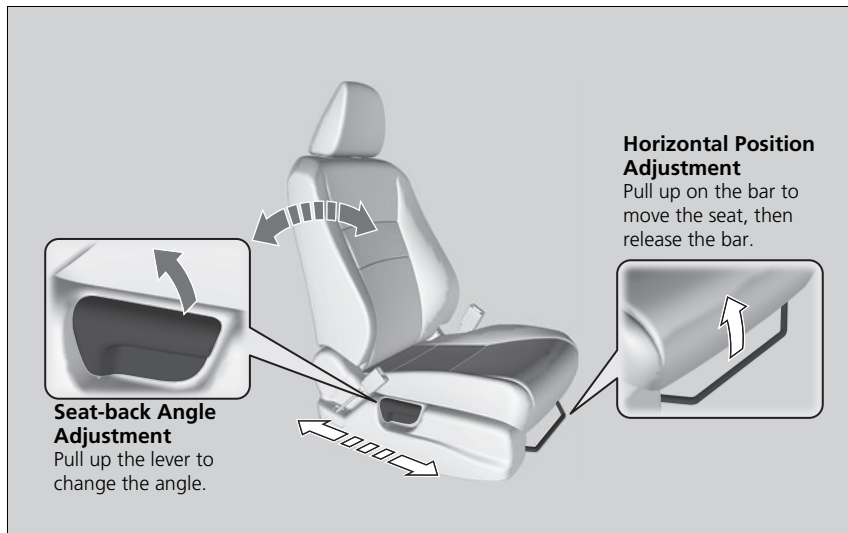

## ▣ Adjusting the front manual seats\*

Once a seat is adjusted correctly, rock it back and forth to make sure it is locked in position.

## ■ Adjusting the Seat-Backs

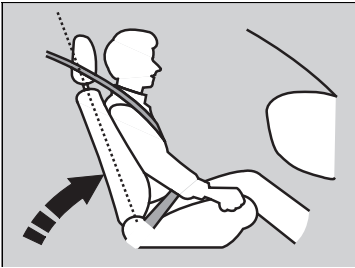

Adjust the driver's seat-back to a comfortable, upright position, leaving ample space between your chest and the airbag cover in the center of the steering wheel.

The front seat passenger should also adjust their seat-back to a comfortable, upright position.

Reclining a seat-back so that the shoulder part of the belt no longer rests against the occupant's chest reduces the protective capability of the belt. It also increases the chance of sliding under the belt in a crash and being seriously injured. The farther a seat-back is reclined, the greater the risk of injury.

## ▣ Adjusting the Seat-Backs

### **⚠ WARNING**

**Reclining the seat-back too far can result in serious injury or death in a crash.**

**Adjust the seat-back to an upright position, and sit well back in the seat.**

Do not put a cushion, or other object, between the seat-back and your back.

Doing so may interfere with proper seat belt or airbag operation.

If you cannot get far enough away from the steering wheel and still reach the controls, we recommend that you investigate whether some type of adaptive equipment may help.

## Rear Seats

### ■ Adjusting the Seat Positions

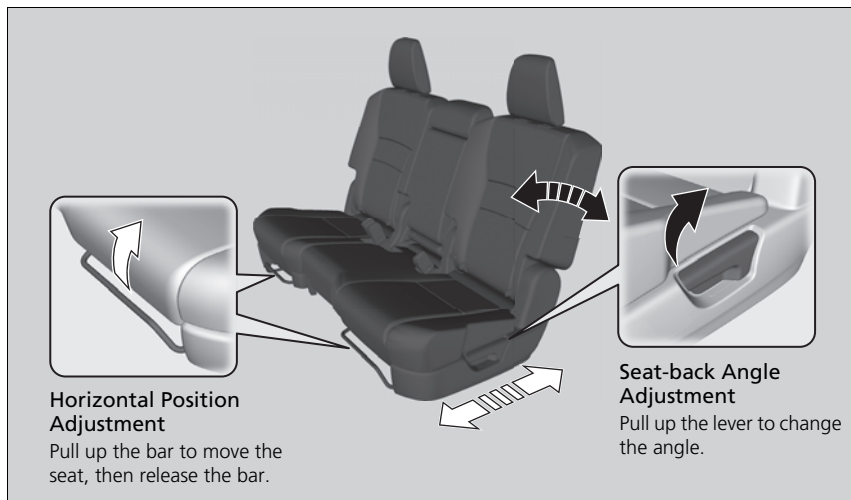

### ► Adjusting the Seat Positions

## **⚠ WARNING**

An unsecured seat or seat-back can move out of position or collapse without warning if there is sudden acceleration or stop or in a crash.

A seat or seat-back that suddenly moves or collapses can result in severe injury or death.

Always make sure all seats and seat-backs are securely locked into position before driving.

## Folding Down the Rear Seat

Separately fold down the left and right halves of the rear seat to make room for cargo.

1. Store the center seat belt first. Insert the latch plate into the slot on the side of the anchor buckle.
2. Retract the seat belt into the holder on the ceiling.
  - **Seat Belt with Detachable Anchor** P. 46
3. Lower the center head restraint to its lowest position. Put the armrest back into the seat-back.

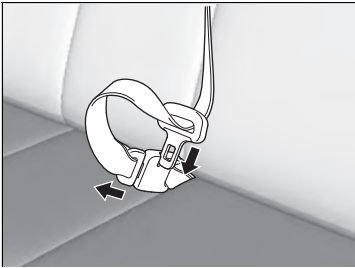

4. Pull up on the seat-back angle adjustment lever.

To return the seat to the original position, pull up the seat-back in the upright position.

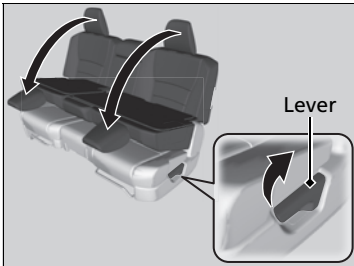

## Folding Down the Rear Seat

Make sure that the folded seat-back does not press against the front passenger seat, as this can cause the weight sensors in the front passenger seat to work improperly.

➤ **Passenger Airbag Off Indicator** P. 61

The front seats must be far enough forward so they do not interfere with the rear seats as they fold down.

To lock the seat-back upright, push it backwards until it locks.

Make sure the seat-back, head restraints and seat cushion are securely latched back into place before driving. Before center occupant use, make sure the center shoulder belt is reinserted into the anchor buckle.



## ■ Rear Seat Reminder

This feature alerts you to the possible presence of passengers or items in the rear seats before you exit the vehicle. It activates when the vehicle is set to VEHICLE OFF if the rear doors were opened shortly before or after the vehicle was set to ON.

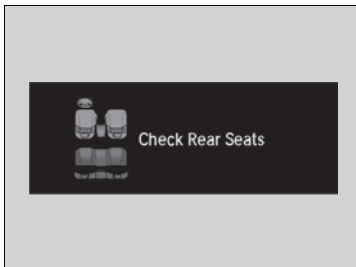

A reminder appears on the driver information interface and an alert will sound when the power mode is set to VEHICLE OFF.

## ▣ Rear Seat Reminder

When the power mode is set to VEHICLE OFF, the reminder comes on briefly, then the function is deactivated.

The reminder will not work if the power mode has not been set to ON within 10 minutes of operating the rear doors.

The system does not detect passengers in the rear seats. Instead, it can detect when a rear door is opened and closed, indicating that there may be something in the rear seats.

You can turn off the notification setting.

▣ **Customized Features** P. 327

## Head Restraints

Your vehicle is equipped with head restraints in all seating positions.

### ■ Adjusting the Front and Rear Outer Seat Head Restraint Positions

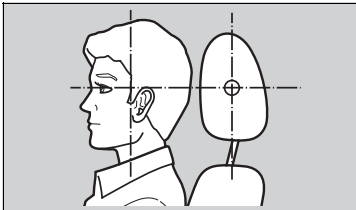

Position head in the center of the head restraint.

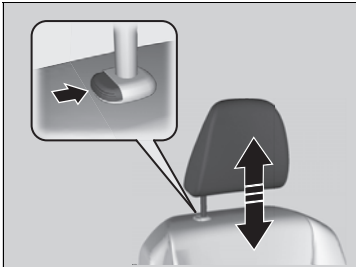

Head restraints are most effective for protection against whiplash and other rear-impact crash injuries when the center of the back of the occupant's head rests against the center of the restraint. The tops of the occupant's ears should be level with the center height of the restraint.

**To raise the head restraint:** Pull it upward.

**To lower the head restraint:** Push it down while pressing the release button.

### ▣ Adjusting the Front and Rear Outer Seat Head Restraint Positions

#### ⚠ WARNING

Improperly positioning head restraints reduces their effectiveness and increases the likelihood of serious injury in a crash.

**Make sure head restraints are in place and positioned properly before driving.**

In order for the head restraint system to work properly:

- Do not hang any items on the head restraints, or from the restraint legs.
- Do not place any objects between an occupant and the seat-back.
- Install each restraint in its proper location.

## ■ Changing the Rear Center Seat Head Restraint Position

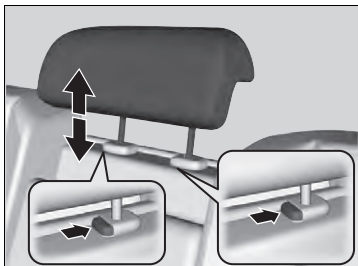

A passenger sitting in the rear center seating position should adjust the height of their head restraint to an appropriate position before the vehicle begins moving.

### To raise the head restraint:

Pull it upward.

### To lower the head restraint:

Push it down while pressing the release button(s).

## ■ Removing and Reinstalling the Head Restraints

Head restraints can be removed for cleaning or repair.

### To remove a head restraint:

#### Front and rear outer seat head restraint

Pull the restraint up as far as it will go. Then, push the release button and pull the restraint up and out.

#### Rear center seat head restraint

Pull the restraint up as far as it will go. Then, push the release buttons which are located on the both legs at the same time, and pull the restraint up and out.

### To reinstall a head restraint:

Insert the legs back in place, then adjust the head restraint to an appropriate height while pressing the release button(s). Pull up on the restraint to make sure it is locked in position.

### ►► Removing and Reinstalling the Head Restraints

## ⚠ WARNING

Failure to reinstall or correctly reinstall, the head restraints can result in severe injury during a crash.

Always replace the head restraints before driving.

## Maintain a Proper Sitting Position

After all occupants have adjusted their seats and head restraints, and put on their seat belts, it is very important that they continue to sit upright, well back in their seats, with their feet on the floor until the vehicle is safely parked and the engine is off.

Sitting improperly can increase the chance of injury during a crash. For example, if an occupant slouches, lies down, turns sideways, sits forward, leans forward or sideways, or puts one or both feet up, the chance of injury during a crash is greatly increased.

In addition, an occupant who is out of position in the front seat can be seriously or fatally injured in a crash by striking interior parts of the vehicle or being struck by an inflating front airbag.

### ▶▶ Maintain a Proper Sitting Position

#### **⚠ WARNING**

**Sitting improperly or out of position can result in serious injury or death in a crash.**

**Always sit upright, well back in the seat, with your feet on the floor.**

## Armrest

### ■ Using the Front Seat Armrest

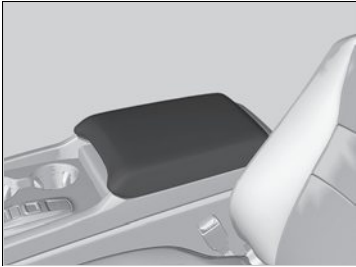

The console compartment can be used as an armrest.

### ■ Using the Rear Seat Armrest



Pull down the armrest of the center backrest.

## Interior Lights

### Interior Light Switches

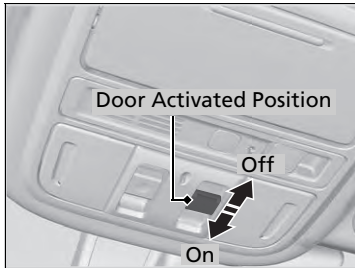

#### ■ ON

The interior lights come on regardless of whether the tailgate and doors are open or closed.

#### ■ Door activated

The interior lights come on in the following situations:

- When tailgate or any doors are opened.
- You unlock the driver's door.
- When the power mode is set to VEHICLE OFF.

#### ■ OFF

The interior lights remain off regardless of whether the tailgate or the doors are open or closed.

### Interior Light Switches

In the door activated position, the interior lights fade out and go off about 30 seconds after the doors are closed.

The lights go off after about 30 seconds in the following situations:

- When you unlock the driver's door but do not open it.
- When you set the power mode to VEHICLE OFF but do not open a door.

You can change the interior lights dimming time.

➤ **Customized Features** P. 327

The interior lights go off immediately in the following situations:

- When you lock the driver's door.
- When you close the driver's door in ACCESSORY mode.
- When you set the power mode to ON.

If you leave the tailgate or doors open in VEHICLE OFF mode, the interior lights go off after about 15 minutes.

To avoid draining the battery, do not leave the interior light on for an extended length of time when the engine or power system is off.

## ■ Map Lights

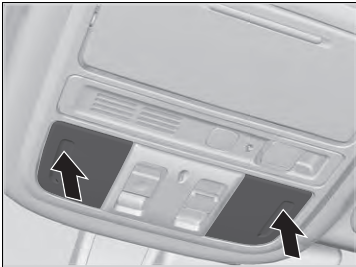

### ■ Front

The map lights can be turned on and off by pressing the lenses.

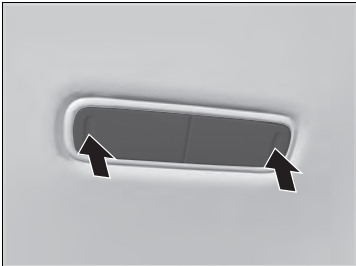

### ■ Rear

The map lights can be turned on and off by pressing the lenses when the front interior light switch is in the door activated position.

## ☞ Map Lights

When the front interior light switch is in the door activated position and any door is open, the map light will not go off when you press the lens.

## ■ Cargo Area Light

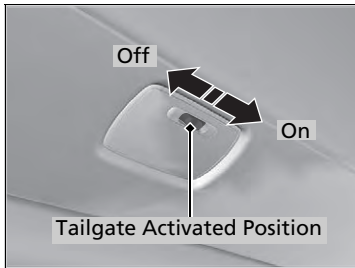

### ■ ON

The light comes on regardless of whether the tailgate is open or closed.

### ■ Tailgate activated

The light comes on when you open the tailgate, and goes off when closed.

### ■ OFF

The light stays off with or without opening the tailgate.



## Storage Items

### ■ Glove Box

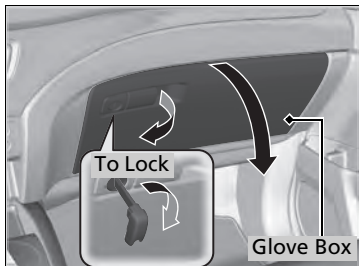

Pull the lever to open the glove box. You can lock the glove box with the built-in key.

### ■ Console Compartment

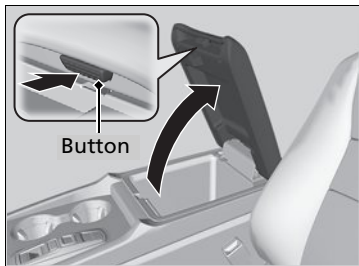

Press the button to open the console compartment.

### » Glove Box

#### **⚠ WARNING**

An open glove box can cause serious injury to your passenger in a crash, even if the passenger is wearing the seat belt.

Always keep the glove box closed while driving.

## ■ Beverage Holders



### ■ Front seat beverage holders

Located in the console between the front seats.

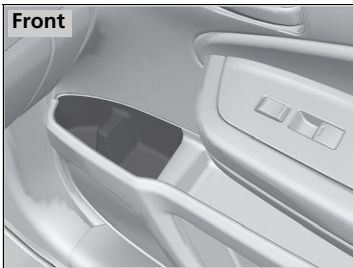

Front

### ■ Door side beverage holders

Located on the both of front and rear door side pockets.

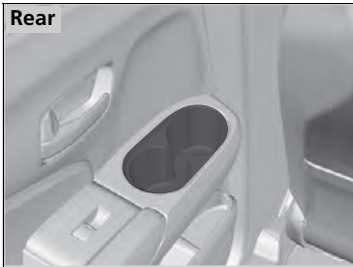

Rear

## » Beverage Holders

### NOTICE

Spilled liquids damage the upholstery, carpeting, and electrical components in the interior.

Be careful when you are using the beverage holders. Hot liquid can scald you.



■ **Rear seat beverage holders**

Fold the armrest down to use the rear seat beverage holders.

■ **Coat Hooks**

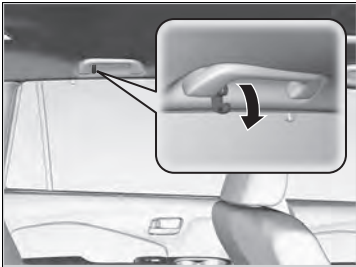

There is a coat hook on the rear grab handle of both sides. Pull it down to use it.

☒ **Coat Hooks**

The coat hooks are not designed for large or heavy items.

## ■ Tie-down Anchors

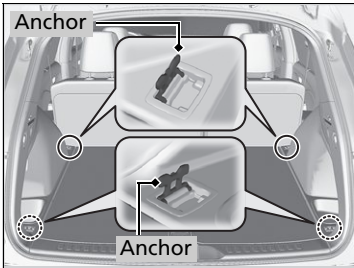

The tie-down anchors on the cargo area floor can be used to install a net for securing items.

## ■ Cargo Hooks

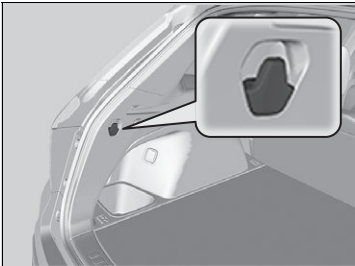

The cargo hooks on both sides of the cargo area can be used to hang a light items.

### ☒ Cargo Hooks

Heavy objects may damage the hook. Make sure any items put on this hook weigh less than 6.6 lbs (3 kg).

Distribute cargo evenly on the floor of the cargo area, placing the heaviest items on the bottom and as far forward as possible.

## ■ Under-floor Storage Area

Pull the handle to open the cargo floor lid.

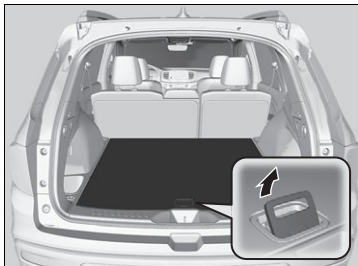

## Other Interior Convenience Items

### ■ Accessory Power Sockets

The accessory power sockets can be used when the power mode is in ACCESSORY or ON.

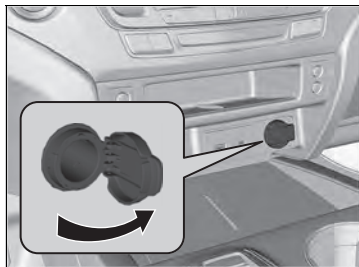

#### ■ Console panel

Open the lid and the cover to use it.

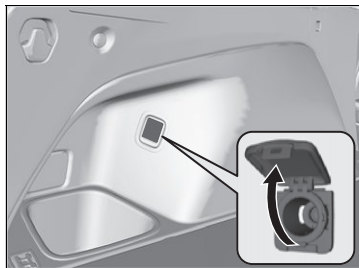

#### ■ Cargo area

Open the cover to use it.

### ⊠ Accessory Power Sockets

Do not insert an automotive type cigarette lighter element.

This can overheat the power socket.

The accessory power socket is designed to supply power for 12-volt DC accessories that are rated 180 watts (15 amps) or less.

To prevent battery drain, only use the power socket with the engine running.

When the accessory power socket is not in use, close the cover to prevent any small foreign objects from getting into the accessory power socket.

## ■ AC Power Outlet\*

The AC power outlet can be used when the engine is running.

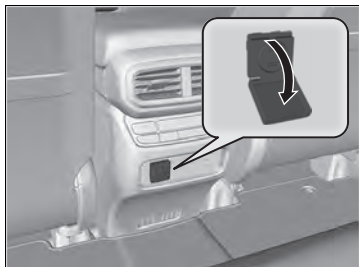

Open the cover to use it. Plug in the appliance slightly, turn it 90° clockwise, then push it all the way.

## ⌘ AC Power Outlet\*

### NOTICE

Do not use the AC power outlet for electric appliances that require high initial peak wattage, such as cathode-ray tube type televisions, refrigerators, electric pumps, etc. It is not suitable for devices that process precise data, such as medical equipment, and that require an extremely stable power supply, such as microcomputer-controlled electric blankets, touch sensor lamps, etc.

The AC power outlet is designed to supply power for up to 115 volt appliances that are rated 150 watts or less.

Continued use of any electric appliance/device exceeding these ratings may result in damage to the appliance/device.

When the AC power outlet is not in use, close the cover to prevent any small foreign objects from getting into the AC power outlet.

## Wireless Charger

To use the wireless charger, the power mode must be in ACCESSORY or ON. Charge any devices compatible with Qi wireless charging on the area indicated by the  mark as follows:

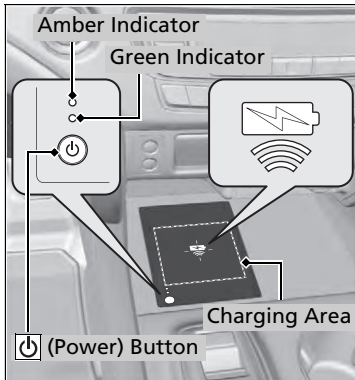

1. To turn the system on and off, press and hold the  (power) button.
  - ▶ When the system is activated, the green indicator light comes on.
2. Place the device you want to charge on the charging area.
  - ▶ The system will automatically start charging the device and the amber indicator light will come on.
  - ▶ Make sure that the device is compatible with the system and placed with the chargeable side in the center of the charging area.
3. When charging is completed, the green indicator light will come on.
  - ▶ Depending on the device, the amber indicator light will stay on.

### Wireless Charger

#### RF Radiation Exposure Statement:

##### U.S. models

This equipment complies with FCC RF Radiation exposure limits set forth for an uncontrolled environment.

This device and its antenna must not be co-located or operating in conjunction with any other antenna or transmitter.

##### Canadian models

This equipment complies with ISED RF Radiation exposure limits set forth for an uncontrolled environment. This device and its antenna must not be co-located or operating in conjunction with any other antenna or transmitter.

In order to use safely:

- Remove any metal objects from the charge pad before charging a device.
- Do not open the charger case.
- Do not use the charger if it malfunctions. Contact your dealer.

If the charger interferes with radio communications, attempt to correct the interference:

- Press and hold the switch on the charger for a few seconds to turn off the charger.



**■ When charging does not start**

Perform one of the solutions in the following table.

Indicator		Cause	Solution
Green & Amber	Blinking simultaneously	There is an obstacle(s) between the charging area and the device.	Remove the obstacle(s).
		The device is not within the charging area.	Pick up and reset the device to the center of the charging area where  is located.
		The temperature of the wireless charger pad increases.	Temporarily suspend charging the device. Wait for the temperature to drop and attempt to charge the device again.
Amber	Blinking	The wireless charger is faulty.	Contact a dealer for repairs.

Controls

Wireless Charger

**⚠ CAUTION**

Metal objects between the charge pad and the device to be charged will get hot and can burn you.

- Always remove foreign objects from the charge pad before charging the device.
- Be sure the surface is clear of dust and other debris before charging.
- Do not spill liquids (i. e. water, drinks, etc.) on the charger and the device.
- Do not use oil, grease, alcohol, benzene or thinner for cleaning the charge pad.
- Do not cover the system with towels, clothing, or other objects while charging etc.
- Avoid spraying aerosols which may come in contact with the charge pad surface.

This system consumes a lot of power. Do not use the system for a long time when the engine is not running. This may weaken the battery, making it difficult to start the engine.

When using the wireless charger, check the user's manual that came with the compatible device you want to charge.

**Wireless Charger**

The wireless charger can support up to 15 W, but the charging rate varies based on the device and other conditions.

**NOTICE**

Do not place any magnetic recording media or precision machines within the charging area while charging.

The data on your cards such as credit cards can be lost because of the magnetic effect. Also, precision machines such as watches can be affected.

“Qi” and  marks are the registered trademarks owned by Wireless Power Consortium (WPC).

In the following cases, charging may stop or not start:

- The device is already fully charged.
- The temperature of the device is extremely high while charging.
- You are at a place that emits strong electromagnetic waves or noises, such as a TV station, electric power plant, or gas station.
- The device has a cover, case or accessories which are not compatible with wireless charging.

A device may not charge if the size or shape of its chargeable side is not appropriate for use with the charging area.

Not all devices are compatible with the system.

#### Wireless Charger

During the charging phase, it is normal for the charging area and device to heat up.

Charging may be briefly interrupted when:

- All the doors and the tailgate are closed
  - to avoid interference with the proper functioning of the keyless access system.
- The position of the device is altered.

Do not charge more than one device at a time on a charging area.

If the device becomes too hot and its battery protection function activates, it may charge extremely slowly or no longer charge. The temperature at which the battery protection function activates depends on the device.

## ■ Sunglasses Holder

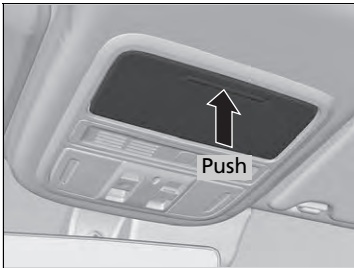

To open the sunglasses holder, push and release the indent. To close, push it again until it latches.

You can store eyeglasses and other small items in this holder.

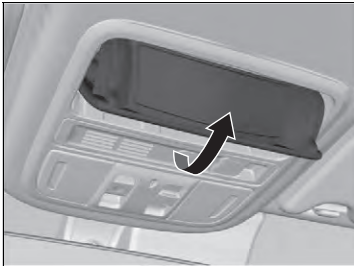

### ■ Conversation mirror\*

The sunglasses holder comes with a mirror. Open the sunglasses holder fully, then push it back to the first detent.

You can use the mirror to view the rear seats.

## ☒ Sunglasses Holder

Keep the holder closed while driving except when accessing stored items.

\* Not available on all models

### ■ Integrated Sunshades\*

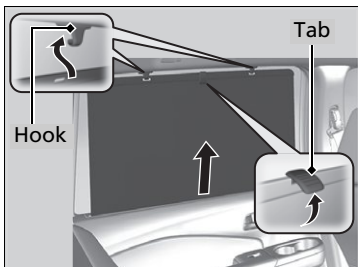

Pull the tab and roll up the sunshade all the way. Use the hooks to hang it.

### ▣ Integrated Sunshades\*

Use the sunshades only when the windows are fully closed. Using the shade while a window is open can unhook and blow off the shade, hitting and hurting anyone sitting near the window.

## ■ Front Seat Heaters\*



The seat heaters can be used when the power mode is in ON.

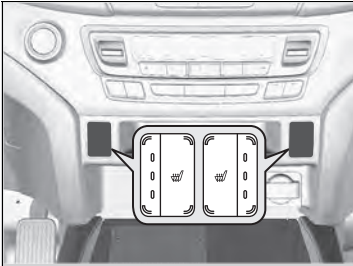

Press the seat heater button:

- Once - The HI setting (three indicators on)
- Twice - The MID setting (two indicators on)
- Three times - The LO setting (one indicator on)
- Four times - The OFF setting (no indicators on)

When the power mode is turned on after it is turned off, the previous setting is maintained.

## ▣ Front Seat Heaters\*

### ⚠ WARNING

Heat induced burns are possible when using seat heaters.

Persons with a diminished ability to sense temperature (e.g., persons with diabetes, lower-limb nerve damage, or paralysis) or with sensitive skin should not use seat heaters.

Do not use the seat heaters even in LO when the engine is off. Under such conditions, the battery may be weakened, making the engine difficult to start.

After a certain period of time, the strength setting for the seat heaters will automatically be reduced by one level at a time until the seat heater shuts off. The elapsed time varies according to the interior environment.

\* Not available on all models

## ■ Front Seat Heaters/Ventilators\*



The seat heaters or ventilators can be used when the power mode is in ON.

The seat heaters: Use them to warm up the seat.

The seat ventilators: Use them when you want to ventilate the surface of the seats.

The lower you set the air conditioning temperature, the more you will feel the effect of the seat ventilation.

Press the seat heater or the seat ventilator button:

Once - The HI setting (three indicators on)

Twice - The MID setting (two indicators on)

Three times - The LO setting (one indicator on)

Four times - The OFF setting (no indicators on)

When the power mode is turned on after it is turned off, the previous setting is maintained.

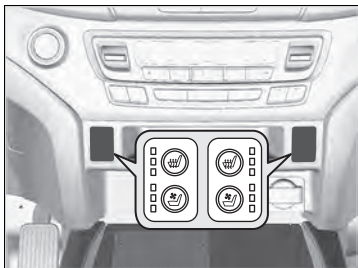

## ▣ Front Seat Heaters/Ventilators\*

### ⚠ WARNING

Heat induced burns are possible when using seat heaters.

Persons with a diminished ability to sense temperature (e.g., persons with diabetes, lower-limb nerve damage, or paralysis) or with sensitive skin should not use seat heaters.

Do not use the seat heaters and the seat ventilation even in LO when the engine is off. Under such conditions, the battery may be weakened, making the engine difficult to start.

After a certain period of time, the strength setting for the seat heaters will automatically be reduced by one level at a time until the seat heater shuts off. The elapsed time varies according to the interior environment.

## ■ Rear Outer Seat Heaters\*

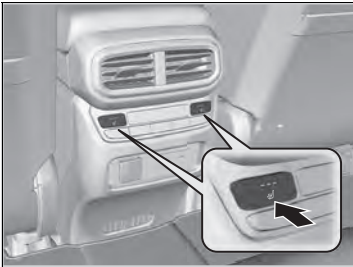

The power mode must be in ON to use the seat heaters.

There is no heater in the rear center seating position.

Press the seat heater button:

Once - The HI setting (three indicators on)

Twice - The MID setting (two indicators on)

Three times - The LO setting (one indicator on)

Four times - The OFF setting (no indicators on)

## ▣ Rear Outer Seat Heaters\*

### ⚠ WARNING

Heat induced burns are possible when using seat heaters.

Persons with a diminished ability to sense temperature (e.g., persons with diabetes, lower-limb nerve damage, or paralysis) or with sensitive skin should not use seat heaters.

Do not use the seat heaters even in LO when the engine is off. Under such conditions, the battery may be weakened, making the engine difficult to start.

After a certain period of time, the strength setting for the rear seat heaters will automatically be reduced by one level at a time until the rear seat heater shuts off. The elapsed time varies according to the interior environment.

\* Not available on all models



## ■ Heated Steering Wheel\*

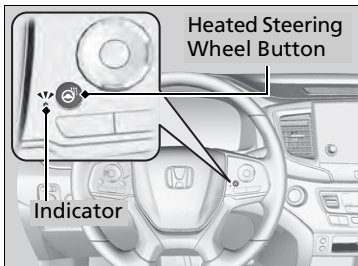

The power mode must be in ON to use the heated steering wheel.

Press the button on the right side of the steering wheel.

When a comfortable temperature is reached, press the button again to turn it off.

The heated steering wheel is turned off every time you start the engine, even if you turned it on the last time you drove the vehicle.

## ▣ Heated Steering Wheel\*

Do not use the heated steering wheel continuously when the engine is off. Under such conditions, the battery may be weakened, making the engine difficult to start.

## Using Automatic Climate Control

The automatic climate control system maintains the interior temperature you select. The system also selects the proper mix of heated or cooled air that will as quickly as possible, raise or lower the interior temperature to your preference.

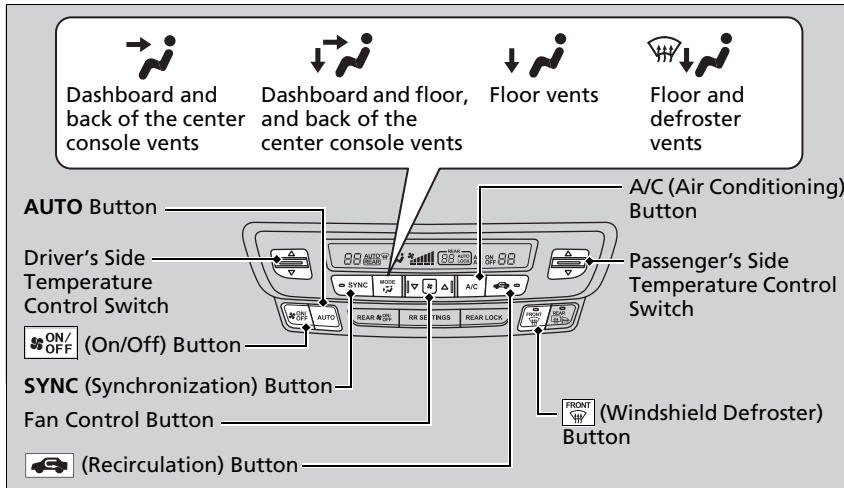

Use the system when the engine is running.

1. Press the **AUTO** button.
2. Adjust the interior temperature using the driver's side or passenger's side temperature control switch.
3. Press the  **ON/OFF** button to cancel.

### Using Automatic Climate Control

If any buttons are pressed while using the climate control system in auto, the function of the button that was pressed will take priority. The **AUTO** indicator will go off, but functions unrelated to the button that was pressed will be controlled automatically.

During Auto Idle Stop, air-conditioning is suspended, and only the blower remains active.

If you do not want air-conditioning suspended, press the Auto Idle Stop **OFF** button to cancel Auto Idle Stop.

To prevent cold air from blowing in from outside, the fan may operate at low speed for a while after the **AUTO** button has been pressed.

While ECON mode is active, the climate control system may have reduced cooling performance.

If the interior is very warm, you can cool it down more rapidly by partially opening the windows, turning the system on auto, and setting the temperature to low. Change the fresh mode to recirculation mode until the temperature cools down.

When you set the temperature to the lower or upper limit, **Lo** or **Hi** is displayed.

### ■ Switching between the recirculation and fresh air modes

Press the  button and switch the mode depending on environmental conditions. Recirculation Mode (indicator on): Recirculates air from the vehicle's interior through the system.

Fresh Air Mode (indicator off): Maintains outside ventilation. Keep the system in fresh air mode in normal situations.

### ■ Defrosting the Windshield and Windows

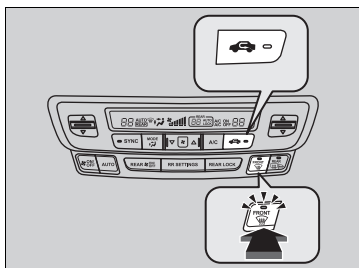

Pressing the  button turns the air conditioner system on and automatically switches the system to fresh air mode.

Press the  button again to turn off, the system returns to the previous settings.

### ►► Using Automatic Climate Control

Pressing the  **ON/OFF** button switches the climate control system between on and off. When turned on, the system returns to your last selection.

### ►► Defrosting the Windshield and Windows

**For your safety, make sure you have a clear view through all the windows before driving.**

Do not set the temperature near the upper or lower limit.

When cold air hits the windshield, the outside of the windshield may fog up.

If you press the  button during Auto Idle Stop, the engine restarts automatically.

If the side windows fog up, adjust the vents so that the air hits the side windows.

■ To rapidly defrost the windows

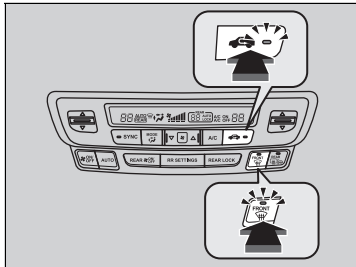

1. Press the  button.
2. Press the  button.

☒ To rapidly defrost the windows

After defrosting or defogging the windows, switch over to fresh air mode. If you keep the system in recirculation mode, the windows may fog up from humidity. This impedes visibility.

## Synchronization Mode

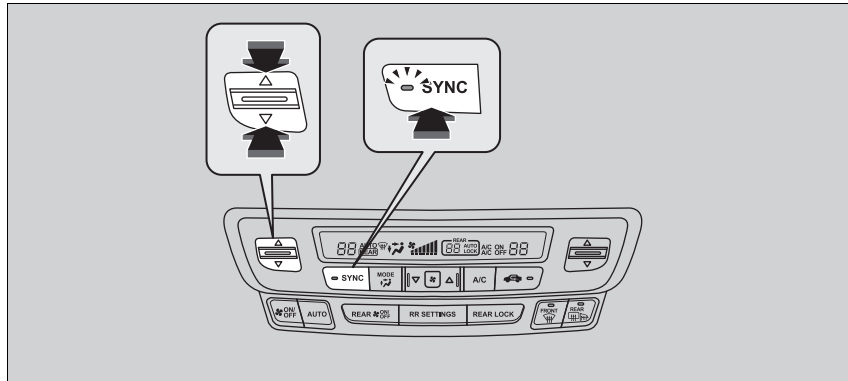

You can set the temperature synchronously for the driver side, front passenger side and rear seats in synchronization mode.

1. Press the **SYNC** button.
  - The system will switch to synchronization mode.
2. Adjust the temperature using driver's side temperature control switch.

Press the **SYNC** button to return to synchronization mode off.

### » Synchronization Mode

When you press the **FRONT \*SE** button, the system changes to synchronization mode.

When the system is in synchronization mode off, the temperature for the driver, front passenger, and rear seats can be set separately.

## Rear Climate Control System

### ■ Using the Rear Climate Control System From the Front Panel

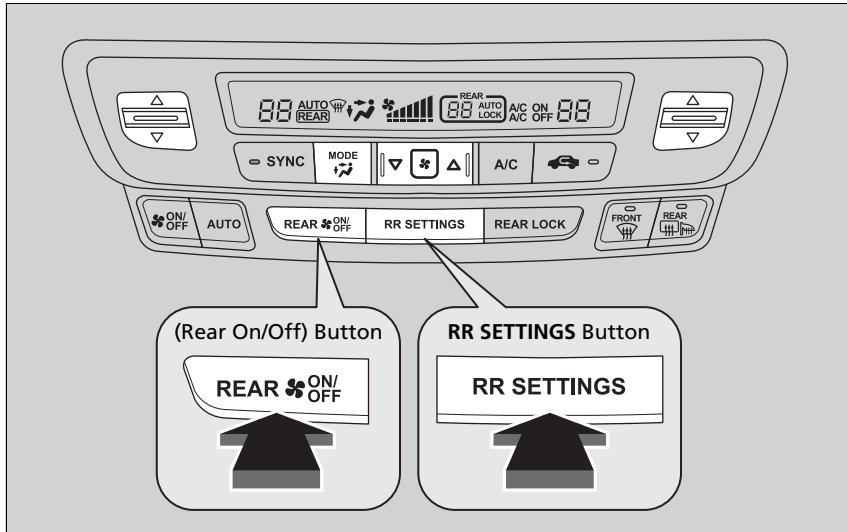

Use the system when the engine is running and the climate control system is operating.

1. Press the **REAR**  (Rear On/Off) button.
2. Press the **RR SETTINGS** button.
  - The system switches to the rear control mode for 10 seconds. The **REAR** indicator appears on the display.

### ►► Rear Climate Control System

#### Models with rear lock button

**LOCK** appears on the rear control panel while the rear lock is on.

If the rear lock is on while in SYNC mode, the rear control panel is disabled. **LOCK SYNC** appears on the rear control panel.

### ►► Using the Rear Climate Control System From the Front Panel

#### Models with rear lock button

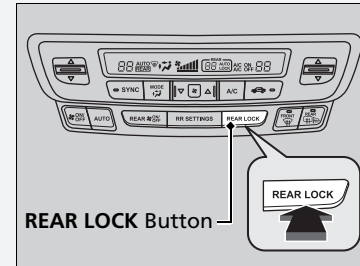

Press the **REAR LOCK** button to turn the rear lock mode on and off. While the rear lock mode is on, the rear control panel is disabled.

- **REAR LOCK** appears on the display.

3. Press the **AUTO** button.
  - The rear system changes to AUTO mode.
  - The system automatically adjusts the fan speed and airflow levels to maintain the set rear temperature. Change the temperature if necessary.
4. To turn off the rear climate control system, press the  (Rear On/Off) button.



### ■ Using the Rear Climate Control System From the Rear Panel\*

#### ▣ Using the Rear Climate Control System From the Rear Panel\*

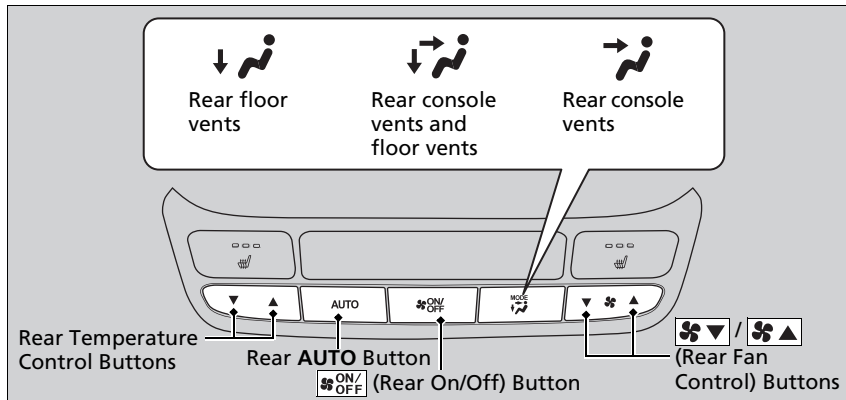
When the **REAR LOCK** button on the front control panel is off, the temperature of the rear passenger compartment can be controlled independently.



Use the system when the engine is running and the climate control system is operating.

1. Press the  (Rear On/Off) button.
2. Press the Rear **AUTO** button.
3. Adjust the interior temperature using the rear temperature control button.
4. To turn off the rear climate control system, press the  button.

## Automatic Climate Control Sensors

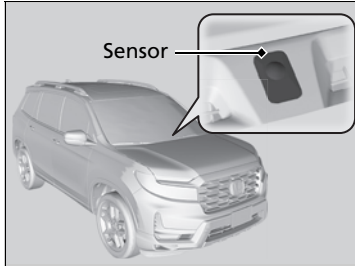

The automatic climate control system is equipped with sensors. Do not cover or spill any liquid on them.

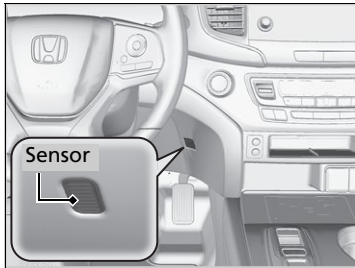



This page intentionally left blank.

# Features

This chapter describes how to operate technology features.

<b>Audio System</b>		
About Your Audio System.....	222	
USB Ports.....	223	
Audio System Theft Protection.....	225	
Audio Remote Controls.....	226	
<b>Audio System Basic Operation</b> .....	228	
<b>Audio Error Messages</b>		
iPod/USB Flash Drive .....	302	
Android/Apps .....	304	
<b>General Information on the Audio System</b>		
SiriusXM® Radio Service* .....	305	
		Compatible iPod, iPad, iPhone, and USB Flash Drives.....
		306
		Honda App License Agreement.....
		307
		Legal Information on Apple CarPlay/ Android Auto.....
		319
		About Open Source Licenses.....
		321
		License Information .....
		322
		<b>Customized Features</b> .....
		327
		<b>HomeLink® Universal Transceiver*</b> ..
		340
		<b>Bluetooth® HandsFreeLink®</b> .....
		343

\* Not available on all models

## About Your Audio System

The audio system features AM/FM radio and SiriusXM® Radio\* service. It can also play USB flash drives, iPod, iPhone, iPad and *Bluetooth*® devices.

You can operate the audio system from the knobs on the panel, the remote controls on the steering wheel, or the icons on the touchscreen interface.

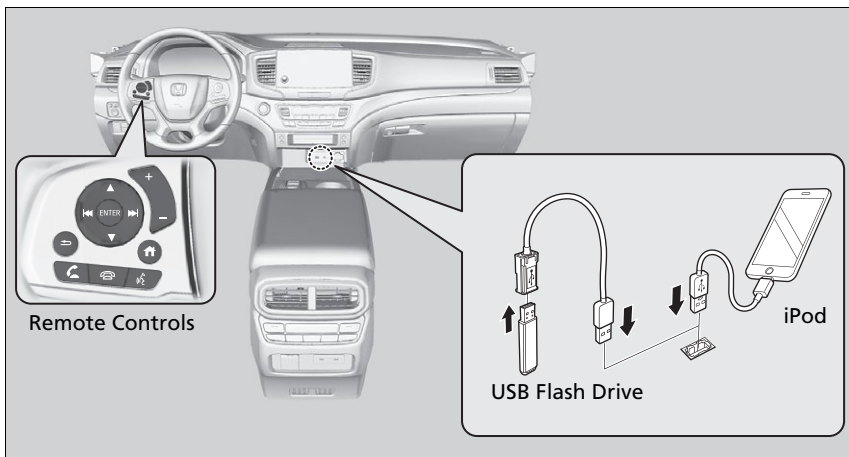

### About Your Audio System

SiriusXM® Radio is available on a subscription basis only. For more information on SiriusXM® Radio, contact a dealer.\*

#### **General Information on the Audio System** P. 305

SiriusXM® Radio is available in the United States and Canada, except Hawaii, Alaska, and Puerto Rico.\*

SiriusXM® is a registered trademark of SiriusXM Radio, Inc.\*

State or local laws may prohibit the operation of handheld electronic devices while operating a vehicle.

After you set the power mode to VEHICLE OFF, you can use the audio system for up to 30 minutes per driving cycle, or until opening the driver's door. However, whether you can continue using the audio system depends on the battery condition. Repeatedly using this feature may drain the battery.

## USB Ports

On the console panel



### ■ On the console panel (🔌)

The USB port (2.5A) is for charging devices, playing audio files and connecting compatible phones with Apple CarPlay or Android Auto.

- ▶ To prevent any potential issues, be sure to use an Apple MFi Certified Lightning Connector for Apple CarPlay, and for Android Auto, the USB cables should be certified by USB-IF to be compliant with USB 2.0 Standard.

### ■ On the front panel (⚡)

The USB port (3.0A) is only for charging devices.

- ▶ You cannot play music even if you have connected music players to it.

### 🔌 USB Ports

- Do not leave the iPod or USB flash drive in the vehicle. Direct sunlight and high temperatures may damage it.
- We recommend that you use a USB cable if you are attaching a USB flash drive to the USB port.
- Do not connect the iPod or USB flash drive using a hub.
- Do not use a device such as a card reader or hard disk drive, as the device or your files may be damaged.
- We recommend backing up your data before using the device in your vehicle.
- Displayed messages may vary depending on the device model and software version.

### USB charge

The USB port can supply up to 2.5A/3.0A of power. It does not output 2.5A/3.0A unless requested by the device.

For amperage details, read the operating manual of the device that needs to be charged.

On the back of the console compartment

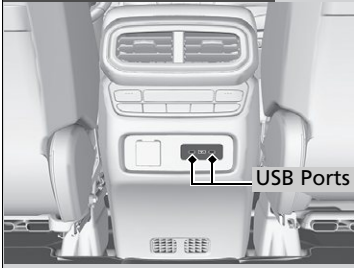

### ■ On the back of the console compartment

The USB ports (3.0A) are only for charging devices.

### » USB Ports

#### On the back of the console compartment

These ports are for battery charge only. You cannot play music even if you have connected a music player to them.

Under certain conditions, a device connected to the port may generate noise in the radio you are listening to.

## Audio System Theft Protection

---

The audio system is disabled when it is disconnected from the power source, such as when the battery is disconnected or goes dead. In certain conditions, the system may display a code entry screen. If this occurs, reactivate the audio system.

### ■ Reactivating the audio system

1. Set the power mode to ON.
2. Turn on the audio system.
3. Press and hold the audio system power button for more than two seconds.
  - ▶ The audio system is reactivated when the audio control unit establishes a connection with the vehicle control unit. If the control unit fails to recognize the audio unit, you must go to a dealer and have the audio unit checked.

## Audio Remote Controls

Allow you to operate the audio system while driving. The information is shown on the driver information interface.

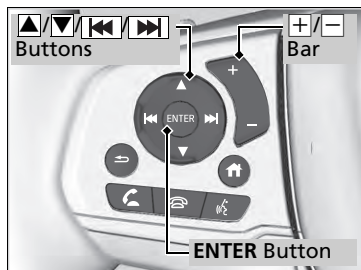

### **(Volume) Bar**

**Press** : To increase the volume.

**Press** : To decrease the volume.

### Audio Remote Controls

Some modes appear only when an appropriate device or medium is used.

Depending on the *Bluetooth*® device you connect, some functions may not be available.

Press the  (back) button to go back to the previous screen or cancel a command.

Press the  (home) button to go back to the home screen of the driver information interface.

You can show or hide the audio mode icons, or change the order of the icons.

 **Show/Hide Apps** P. 121

 **Arrange Apps** P. 122

### ▲/▼/◀◀/▶▶/ENTER Buttons

- When selecting the audio mode  
Press ▲ or ▼ to select **Now Playing** on the home screen of the driver information interface, and then press the **ENTER** button.  
  
**Press ▲ or ▼:** To cycles through the audio modes as follows:  
Android Auto/Apple CarPlay→SiriusXM®\*→AM→*Bluetooth*® Audio→  
Social Playlist→FM→My Honda Music→USB/iPod
- When listening to the radio  
**Press ▶▶:** To select the next preset radio station.  
**Press ◀◀:** To select the previous preset radio station.
- When listening to an iPod, USB flash drive, My Honda Music, or *Bluetooth*® Audio  
**Press ▶▶:** To skip to the next song.  
**Press ◀◀:** To go back to the beginning of the current or previous song.

\* Not available on all models



To use the audio system function, the power mode must be in ACCESSORY or ON.

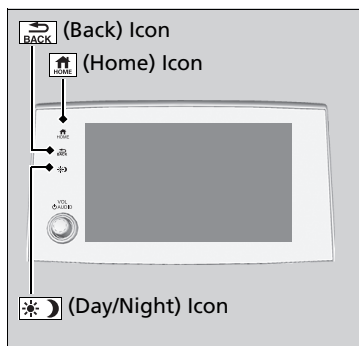

: Select to go to the home screen.

**Switching the Display** P. 229

: Select to go back to the previous display when it is displayed.



: Select to change the audio/information screen brightness.

Select once and select or to make an adjustment.

▶ Each time you select , the mode switches among the daytime mode, nighttime mode and off mode.

## Audio/Information Screen

Displays the audio status and wallpaper. From this display, you can go to various setup options.

### Switching the Display

#### Using the audio/information screen

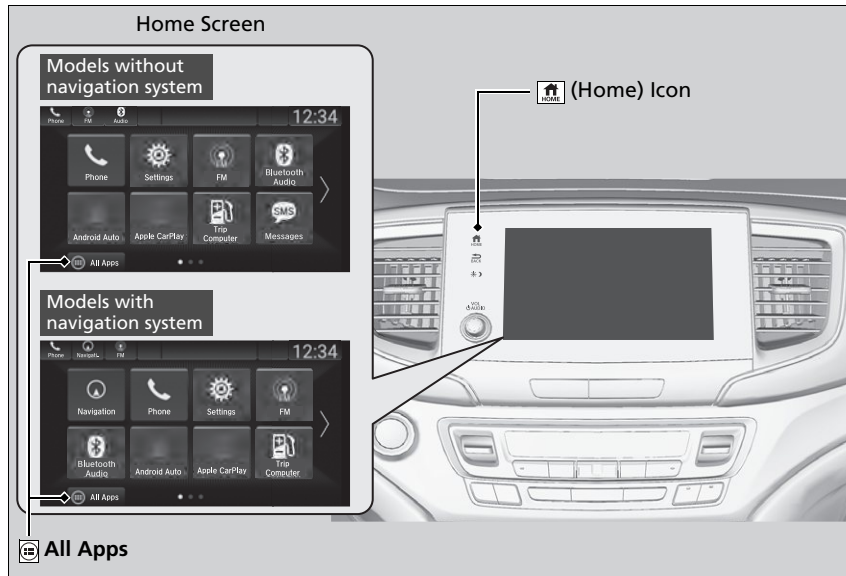

Select  to go to the home screen.

Select the following icons on the home screen or after selecting  **All Apps**.

### Audio/Information Screen

#### Touchscreen Operation

- Use simple gestures - including touching, swiping, and scrolling - to operate certain audio functions.
- Some items may be grayed-out during driving to reduce the potential for distraction.
- You can select them when the vehicle is stopped or use voice commands.
- Wearing gloves may limit or prevent touchscreen response.

You can change the touchscreen sensitivity setting.

 **Customized Features P. 327**

### ■ Phone

Displays the HFL information.

➤ **Bluetooth® HandsFreeLink®** P. 343

### ■ Trip Computer

Displays the trip computer information.

- **Current Drive** tab: Displays the current trip information.
- **Trip A/Trip B** tab: Displays information for the current and three previous drives. The information is stored every time you reset Trip A/B. To reset Trip A/B, select **Reset**. To change the setting of how to reset Trip A/B, select **Settings**, then select **Trip A Reset Method** or **Trip B Reset Method**.

### ■ Clock

Displays the clock.

### ■ System Updates

Updates the software version of the audio system.

➤ **System Updates** P. 242

### ■ FM/AM/Sirius XM\*/USB/Bluetooth Audio/My Honda Music/Social Playlist

Displays the audio information.

### ■ Settings

Enters the customizing menu screen.

➤ **Customized Features** P. 327

## ■ Navigation\*

Displays the navigation screen.

➤ **Refer to the Navigation System Manual**

## ■ HondaLink

Displays the HondaLink® screen.

➤ **HondaLink®** P. 287

## ■ Apple CarPlay/Android Auto

Displays the **Apple CarPlay** or **Android Auto**.

➤ **Apple CarPlay** P. 295

➤ **Android Auto™** P. 298

## ■ Messages

Displays the text message screen.

➤ **Bluetooth® HandsFreeLink®** P. 343

## ■ AT&T Hotspot\*

Displays the AT&T Hotspot screen.

➤ **AT&T Hotspot\*** P. 293

## ■ File Manager

Displays the file manager screen.

➤ **File Manager** P. 248

\* Not available on all models

## ■ Wallpaper Setup

You can change, store, and delete the wallpaper on the audio/information screen.

### ■ Import wallpaper

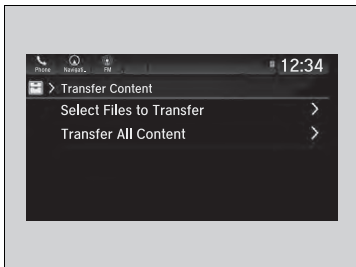

1. Connect the USB flash drive to the front USB port.

▶ **USB Ports** P. 223

2. Select **Clock**.

3. Select **Settings**.

4. Select **Clock Faces**.

5. Select **Add More**.

▶ The **File Manager** screen is displayed.

6. Import a desired picture.

▶ **How to Transfer a File** P. 248

▶ The display will return to the **Clock Faces** screen.

### ▶▶ Wallpaper Setup

The wallpaper you set up on **Clock Faces** cannot be displayed on the driver information interface.

- The file name must be fewer than 255 characters.
- The file format of the image that can be imported is BMP, GIF, JPEG, PNG, or WebP.
- If the USB flash drive does not have any pictures, the **No Data** message appears.

**■ Select wallpaper**

1. Select **Clock**.
2. Select **Settings**.
3. Select **Clock Faces**.
4. Select a desired wallpaper.
  - ▶ The preview is displayed on the screen.
5. Select **Save**.
  - ▶ The display will return to the clock screen.

**■ To view wallpaper once it is set**

1. Select .
2. Select **Clock**.

**■ Delete wallpaper**

1. Select **Clock**.
2. Select **Settings**.
3. Select **Clock Faces**.
4. Select **Delete Photos**.
  - ▶ The **File Manager** screen is displayed.
5. Delete a picture.
  - ▶  **How to Delete a File** P. 251
  - ▶ The display will return to the **Clock Faces** screen.

## ■ Home Screen

### ■ To change to a next screen

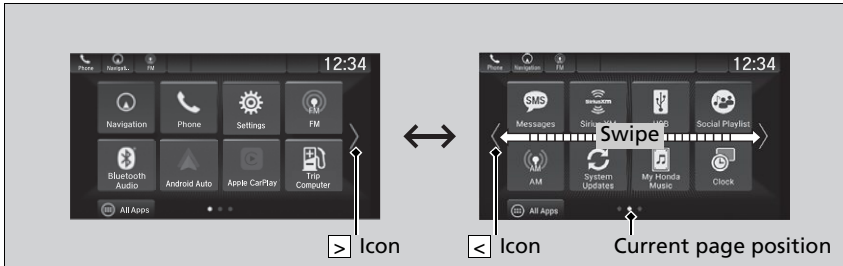

Selecting  or , or swiping the screen left or right changes to the next screen.



## ▶▶ Home Screen

The home screen has 5 pages. You cannot add any more pages.

Select  to go directly back to the first page of the home screen from any page.

## ■ To add app icons on the home screen

App icons can be added on the home screen.

1. Select .
2. Select  **All Apps**.
3. Check the box of the app you want to add.
  - ▶ The app icon will be added on the home screen.

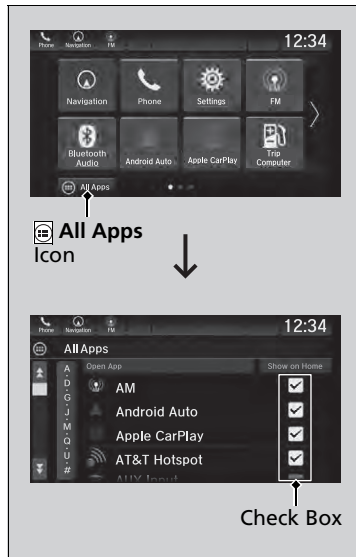

## ▶▶ To add app icons on the home screen

Pre-installed apps may not start up normally. If this occurs, you need to reset the system.

▶ **Defaulting All the Settings** P. 339

If you perform **Factory Data Reset**, it may reset all the settings to their factory default.

▶ **Defaulting All the Settings** P. 339

In case those apps still do not start up normally even after **Factory Data Reset**, contact your dealer.

If a browser shuts down mid-use, the screen will return to the screen viewed prior to the browser startup.



## ■ To move icons on the home screen

You can change location on the home screen.



1. Select and hold an icon.
  - ▶ The screen switches to the customization screen.
2. Drag and drop the icon to where you want it to be.
3. Select **Done**.
  - ▶ The screen will return to the home screen.

## ▶▶ To move icons on the home screen

Select **Tips** to show tips. To hide them, select it again.

## ■ To remove icons on the home screen

You can delete the icons on the home screen.



1. Select and hold an icon.
  - ▶ The screen switches to the customization screen.
2. Drag and drop the icon you want to remove to the **Hide** icon.
  - ▶ The icon is removed from the home screen.
3. Select **Done**.
  - ▶ The screen will return to the home screen.

## ☒ To remove icons on the home screen

Apps will not be deleted by deleting the icon on the home screen.

Select **Tips** to show tips. To hide them, select it again.

### ■ To create shortcuts for apps displayed on the home screen

Three shortcut icons for accessing apps displayed on the home screen are displayed in the upper left area of the screen. You can replace any of these shortcut icons with an icon of your preference.

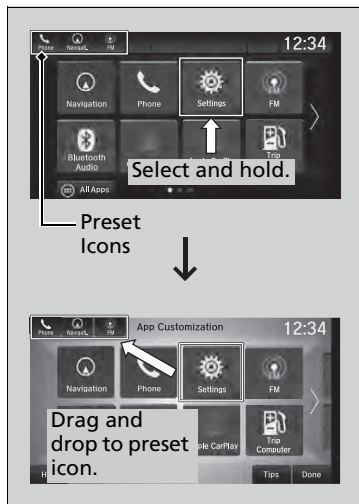

1. From the home screen, select and hold the icon that you want to store in the upper left of the screen.
  - ▶ The screen will switch to the customization screen.
2. Drag the icon over to the upper left of the screen and drop it over the icon that you want to replace.
  - ▶ The new icon will appear in place of the old icon.
3. Select **Done**.
  - ▶ The screen will return to the home screen.

### ▶▶ To create shortcuts for apps displayed on the home screen

Select **Tips** to show tips. To hide them, select it again.

## Status Area



1. Select the system status icon.
  - ▶ The status area appears.
2. Select an item to see the details.
3. Select  or the system status icon to close the area.

## ■ Updating Apps

Some of the audio system's apps can be updated wirelessly when connected via Wi-Fi, or *Bluetooth*® in conjunction with the HondaLink® app installed on a compatible iOS or Android device. If an update is available, a notification is displayed at the top of the screen with the respective app's update icon.

### ■ To update an app:

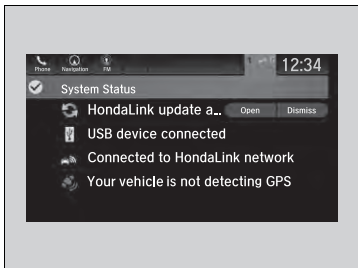
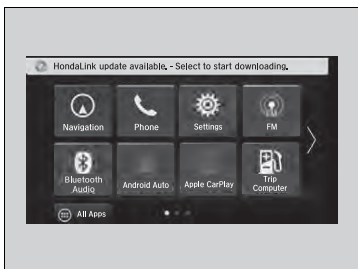

1. A notification appears and notifies you of an update message on the header area.
2. Select the system status icon, and then select the software update notification from the list.

## ▶▶ Updating Apps

The wireless updates are for the apps on the audio system only.

To update compatible apps on your iPhone or Android phone, please visit the App Store or Google Play Store, respectively.

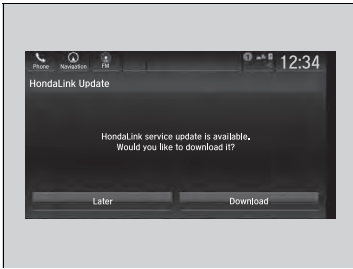

### 3. Select **Download**.

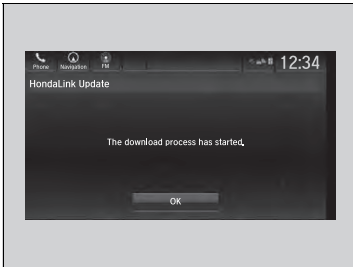

### 4. Select **OK**.

- ▶ A notification appears on the screen if the update is successful. Select **OK**.
- ▶ Restart the engine for the update to be applied.

## System Updates

The audio system's firmware can be updated with a Wi-Fi connection or with a USB device.

### ■ How to Update Wirelessly

#### ■ Wireless connection mode setup

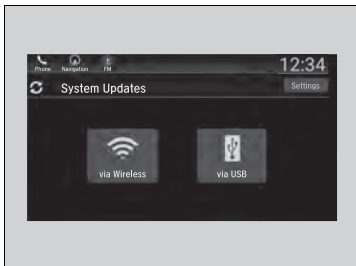

1. Select .
2. Select **System Updates**.
3. Select **Settings**.
4. Select **Connection Setup**.



5. Select **Change Mode**.
6. Select **Network**, then **Save**.
  - ▶ The display returns to the network list.
7. Select an access point from the network list, then **Connect**.
  - ▶ If the audio system requires a password, enter a password.

#### ▶▶ Wireless connection mode setup

If your vehicle has a telematics control unit (TCU), you do not need the wireless connection mode setup.

## ■ How to update

When the audio system update is available, the notification is shown on the audio/information screen. Use the following procedure to update the system.



1. Select .
2. Select **System Updates**.

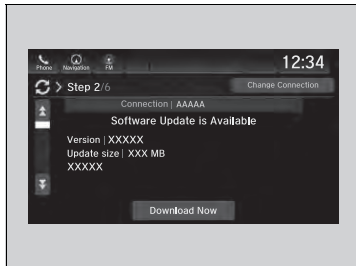

3. Select **via Wireless**.
4. Select **Download Now**.
  - ▶ A notification appears on the screen.



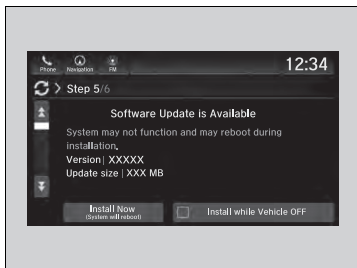

5. Select **Install Now** or **Install while Vehicle OFF**.

- ▶ A notification appears on the screen if the update is successful.

How to update

If **Install while Vehicle OFF** is selected and the user turns the vehicle back on after the update has been completed, for 3 to 5 minutes the system will rebuild the applications, during which time the Honda logo will be displayed.

## ■ Automatic download settings

Use the following procedure to change to the automatic download setting.

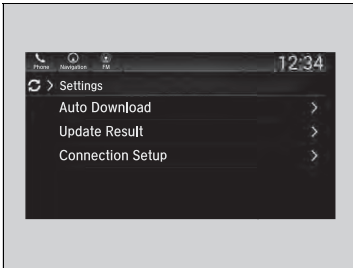

1. Select .
2. Select **System Updates**.
3. Select **Settings**.
4. Select **Auto Download**.
5. Select the access point, then **Allow**.

## ■ View an update result

Use the following procedure to confirm the update result.

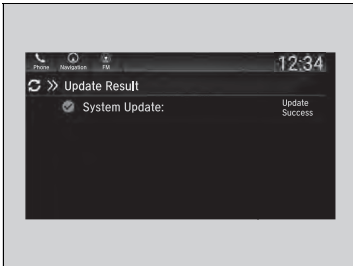



1. Select .
2. Select **System Updates**.
3. Select **Settings**.
4. Select **Update Result**.

## ■ How to Update with a USB Device

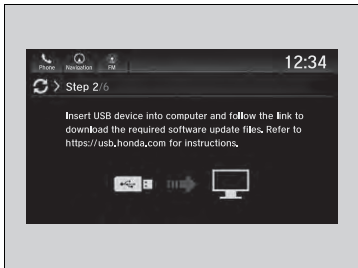
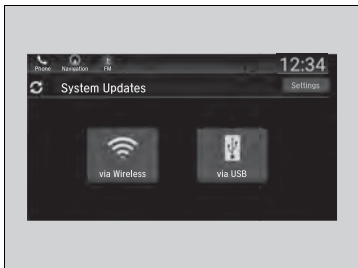
### ■ Download the update files from the server



1. Select .
2. Select **System Updates**.
3. Select **via USB**.
  - ▶ A notification appears on the screen.
4. Connect a USB device into the front USB port.
  - ▶ The inventory data is copied into the USB device.
    - ▶  **USB Ports** P. 223
5. Remove the USB device from the USB port.
6. Connect the USB device into your computer, and then download the update files.
  - ▶ Follow the link to download the required software update files. Refer to <https://usb.honda.com> for instructions.

### ▶▶ How to Update with a USB Device

A USB device with a minimum of 8 GB of free space or more is recommended.

Be sure to delete any previous inventory or update files from the USB before starting the USB update process.

## ■ Update the audio system



1. Select .
2. Select **System Updates**.
3. Select **via USB**.
  - ▶ A notification appears on the screen.
4. Connect the USB device with the update files into the USB port.
  - ▶ A notification appears on the screen.
    - **USB Ports** P. 223
5. Select **Install Now** or **Install while Vehicle OFF**.
  - ▶ A notification appears on the screen if the update is successful.

### Update the audio system

If **Install while Vehicle OFF** is selected and the user turns the vehicle back on after the update has been completed, for 3 to 5 minutes the system will rebuild the applications, during which time the Honda logo will be displayed.

## File Manager

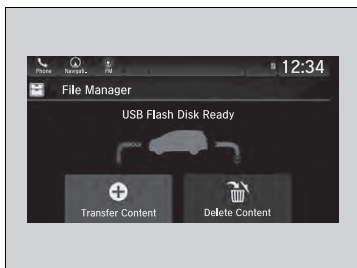

Allows you to transfer image or audio files to the audio system with a USB device.

### ■ How to Transfer a File



1. Connect a USB device into the USB port.

▶ **USB Ports** P. 223

2. Select , then select  **All Apps**.

3. Select **File Manager**.

4. Select **Transfer Content**.

To transfer a selected file:

5. Select **Select Files to Transfer**.

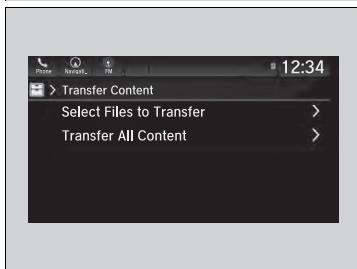

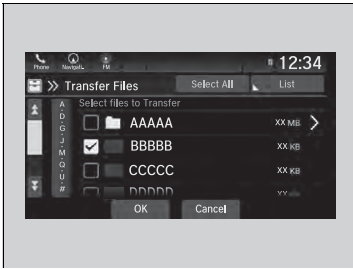

6. Select the file or folder you want to transfer.
7. Select **OK**.

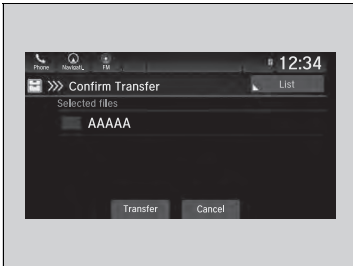

8. Select **Transfer**.
  - ▶ A confirmation message appears on the screen. Select **Continue**.
  - ▶ A notification appears on the screen if the transfer is successful. Then, the display will return to the **File Manager** screen.

#### ▶▶ How to Transfer a File

To switch the view method, select **List** or **Thumbnail** on the upper right of the screen.

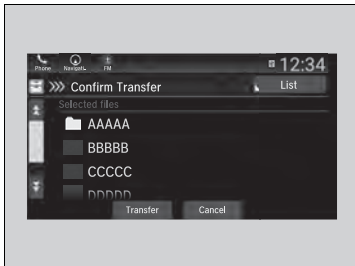
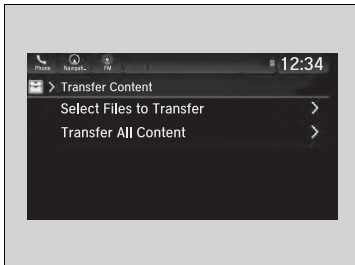

To transfer all files:

**5. Select Transfer All Content.**

**6. Select Transfer.**



- ▶ A confirmation message appears on the screen. Select **Continue**.
- ▶ A notification appears on the screen if the transfer is successful. Then, the display will return to the **File Manager** screen.

▶▶ How to Transfer a File

To switch the view method, select **List** or **Thumbnail** on the upper right of the screen.

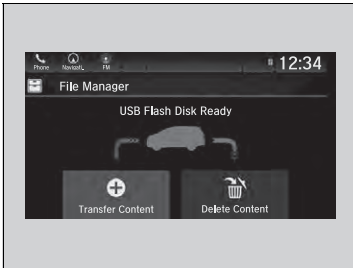
## How to Delete a File



1. Select , then select  **All Apps**.
2. Select **File Manager**.
3. Select **Delete Content**.

To delete a selected file:

4. Select **Select Files to Delete**.

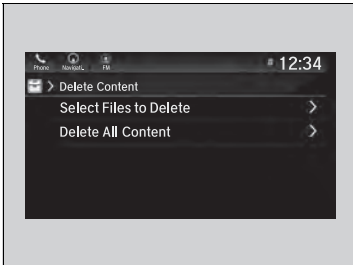



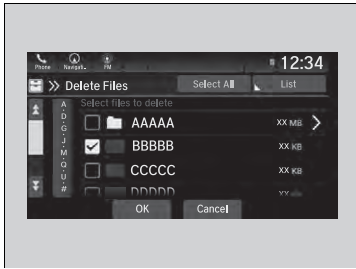

5. Select the file or folder you want to delete.
6. Select **OK**.

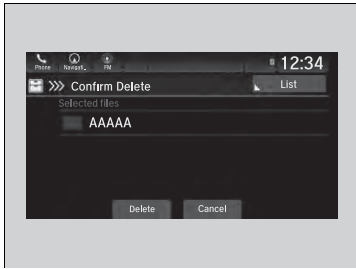

7. Select **Delete**.
  - ▶ A notification appears on the screen if the deletion is successful. Then, the display will return to the **File Manager** screen.

#### ▶▶ How to Transfer a File

To switch the view method, select **List** or **Thumbnail** on the upper right of the screen.

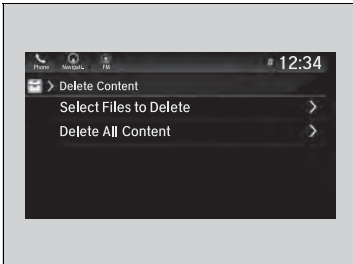

To delete all files:

**4. Select **Delete All Content.****

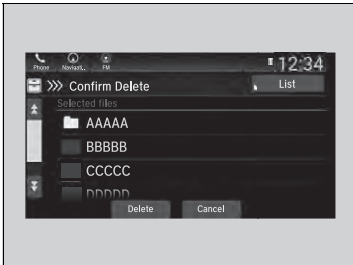

**5. Select **Delete.****

- ▶ A notification appears on the screen if the transfer is successful. Then, the display will return to the **File Manager** screen.

▶▶ How to Transfer a File

To switch the view method, select **List** or **Thumbnail** on the upper right of the screen.

## Adjusting the Sound

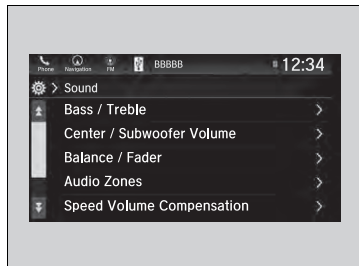
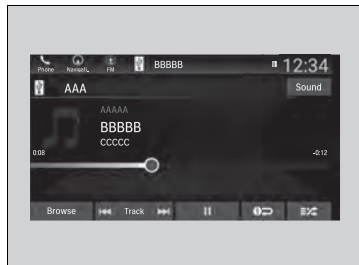

1. Select .
2. Select an audio source icon.
3. Select **Sound**.

Select an item from the following choices:

- **Bass / Treble:** Treble, Midrange, Bass
- **Center / Subwoofer Volume:** Center\*, Subwoofer
- **Balance / Fader:** Balance, Fader
- **Audio Zones\*:** Driver Only, Front Only, Rear Only, Full Vehicle
- **Speed Volume Compensation:** Sets the amount of volume increase.
- **DTS Neural Surround\*:** DTS Neural Surround™

### ▶▶ Adjusting the Sound

The Speed Volume Compensation (SVC) adjusts the volume level based on the vehicle speed. As you go faster, audio volume increases. As you slow down, audio volume decreases.

You can also adjust the sound the following procedure.

1. Select .
2. Select **Settings**.
3. Select **Sound**.

To reset each setting for **Bass / Treble**, **Center / Subwoofer Volume** and **Balance / Fader**, select **Reset**.

## Display Setup

You can change the brightness of the audio/information screen.

### Changing the Screen Brightness



1. Select .
2. Select **Settings**.
3. Select **Display**.
4. Select **Day Mode** or **Night Mode**.
5. Select the setting you want.
6. Select **Save**.

### Changing the Screen Brightness

You can change the **Contrast** and **Black Level** settings in the same manner.

To reset the settings, select **Reset**.

## ■ Selecting an Audio Source

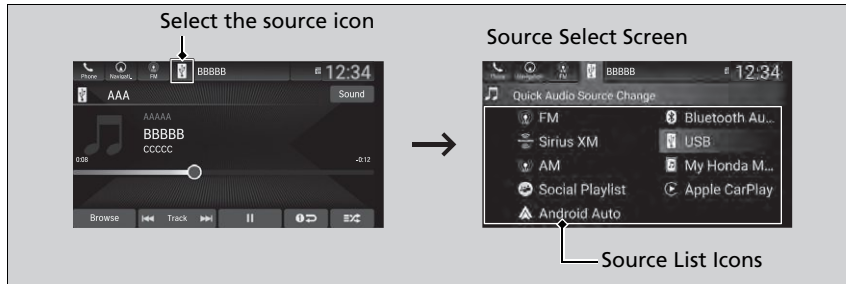



Select the current source icon, then select an icon on the source list to switch the audio source.

## ■ Limitations for Manual Operation

Certain manual functions are disabled or inoperable while the vehicle is in motion. You cannot select a grayed-out option until the vehicle is stopped.

## Voice Control Operation

Your vehicle has a voice control system that allows hands-free operation.

The voice control system uses the  (talk) and  (back) buttons on the steering wheel and a microphone near the map lights on the ceiling.

### Voice Recognition

To achieve optimum voice recognition when using the voice control system:

- Make sure the correct screen is displayed for the voice command that you are using.



The system recognizes only certain commands.

Available voice commands:

 **Voice Portal Screen** P. 258

- Close the windows and moonroof.
- Adjust the dashboard and side vents so air does not blow onto the microphone on the ceiling.
- Speak clearly in a clear, natural speaking voice without pausing between words.
- Reduce any background noise if possible. The system may misinterpret your command if more than one person is speaking at the same time.

#### Voice Control Operation

When you press the  button, a helpful prompt asks what you would like to do. Press and release the  button again to bypass this prompt and give a command.

#### Voice Recognition

The voice control system can only be used from the driver's seat because the microphone unit removes noises from the front passenger's side.

Continued

## ■ Voice Portal Screen

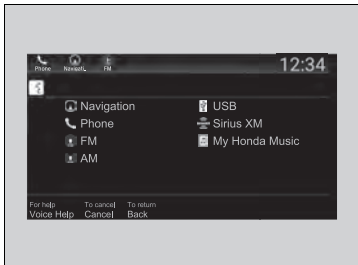

When the  (talk) button is pressed, available voice commands appear on the screen.

For a complete list of commands, say “Voice Help” after the beep.

The system only recognizes the commands on the following pages, at certain screens. Free-form voice commands are not recognized.

\*1: Models with navigation system

\* Not available on all models

## ■ Phone

These commands can only be used when a phone is connected.

When the system recognizes a phone command, the screen will change to the dedicated phone voice recognition screen.

- Call <Your Contact Name>
- Call <Phone Number>
- Call <Category>

Phone commands are not available if using Apple CarPlay.

## ■ Audio

When the system recognizes an audio command, the screen will change to the dedicated audio voice recognition screen.

- FM
- AM
- USB
- Sirius XM\*
- My Honda Music

## ■ Navigation\*1

The screen changes to the navigation screen.

➤ Refer to the Navigation System Manual

## ■ Voice Help

Readout voice guidance for Help on the current screen.

## ■ Phone Commands

The system will accept these commands when on the dedicated phone voice recognition screen.

- *Call <Your Contact Name>*
- *Call <Phone Number>*
- *Call <Category>*

## ■ Audio Commands

The system will accept these commands when on the dedicated audio voice recognition screen.

### ■ FM Commands

- *Tune to <87.7-107.9> FM*

### ■ AM Commands

- *Tune to <530-1710> AM*

### ■ Sirius XM Commands\*

- *Channel <1-999>*
- *Channel <station name>*

### ■ USB/My Honda Music Commands

- *Play Artist*
- *Play Album*
- *Play Genre*
- *Play Playlist*
- *Play Music*
- *Play Song*

\* Not available on all models



## Playing AM/FM Radio

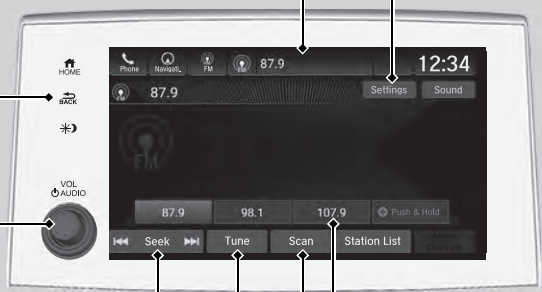

**Audio/Information Screen**

**Settings Icon**  
Select whether to tune to HD Radio™\* automatically.

**BACK (Back) Icon**  
Select to go back to the previous display.

**VOL/AUDIO (Volume/Power) Knob**  
Push to turn the audio system on and off.  
Turn to adjust the volume.

**Seek Icons**  
Select **◀◀** or **▶▶** to search up and down the selected band for a station with a strong signal.

**Tune Icon**  
Select to use the on-screen keyboard for entering the radio frequency directly.

**Scan Icon**  
Select to scan each station with a strong signal.

**Preset Icons**  
Tune the radio frequency for preset memory. Select and hold the preset icon to store that station. Select **>** to display preset 5 onwards.

The diagram shows a central screen with a top status bar (HOME, Phone, Nav, FM, 87.9, 12:34) and a main display area showing a radio frequency (87.9) and a 'Settings' icon. Below the screen is a physical knob labeled 'VOL/AUDIO'. At the bottom of the screen are several touch-sensitive icons: 'Seek' (left and right arrows), 'Tune' (a keyboard icon), 'Scan' (a magnifying glass icon), and 'Station List' (a list icon). Lines connect these elements to their respective text descriptions.

## ■ Preset Memory

To store a station:

1. Tune to the selected station.
2. Select and hold the preset number for the station you want to store.

## ■ Station List

Lists the strongest stations on the selected band.

1. Select **Station List** to display a list.
2. Select the station.

## ■ Manual update



Updates your available station list at any time.

1. Select **Station List** to display a list.
2. Select **Refresh**.

## ▶▶ Preset Memory

The **ST** indicator appears on the display indicating stereo FM broadcasts. Stereo reproduction in AM is not available.

Switching the Audio Mode

Press the  or  button on the steering wheel or select the audio source icon on the screen.

▶▶ **Audio Remote Controls** P. 226

You can store 12 AM/FM stations into preset memory.

## ▶▶ Models with HD Radio™ feature

HD Radio Technology manufactured under license from iBiquity Digital Corporation. U.S. and Foreign Patents. HD Radio™ and the HD, HD Radio, and “Arc” logos are proprietary trademarks of iBiquity Digital Corp.



## ■ Scan

Samples each of the strongest stations on the selected band for 10 seconds. To turn off scan, select **Stop** or .

## ■ Radio Data System (RDS)

Provides text data information related to your selected RDS-capable FM station.

### ■ To find an RDS station from Station List

1. Select **Station List** to display a list while listening to an FM station.
2. Select the station.

### ■ Manual update

Updates your available station list at any time.

1. Select **Station List** to display a list while listening to an FM station.
2. Select **Refresh**.

### Models with HD Radio™ feature

## ■ HD Subchannel

Displays the subchannel list when an HD Radio™ station is selected while listening to an FM station.

1. Select **HD Radio Channels**.
2. Select the channel number.

### ⊗ Radio Data System (RDS)

When you select an RDS-capable FM station, the RDS automatically turns on, and the frequency display changes to the station name. However, when the signals of that station become weak, the display changes from the station name to the frequency.

## Playing SiriusXM® Radio \*

The diagram shows a car stereo unit with a central display screen. The screen displays the SiriusXM interface with the following elements:

- Album Art:** A square image at the top left of the screen.
- Station Art:** A square image at the top center of the screen.
- Audio/Information Screen:** The main display area showing station information like '0 - BBBB', 'BBBBB', and 'AAAAA', along with 'Settings' and 'Sound' buttons.
- Channel Icons:** A row of three 'XX' icons below the station art.
- Category Icons:** A row of three 'XX' icons below the channel icons.
- Preset Icons:** A row of three 'XX' icons at the bottom of the screen.

Physical controls on the left side of the unit include:

- (Back) Icon:** A button with a left-pointing arrow and the word 'BACK'.
- VOL/AUDIO Knob:** A circular knob with a volume icon and the word 'AUDIO'.

Labels with arrows point from these controls and screen elements to their respective descriptions:

- (Back) Icon:** Select to go back to the previous display.
- VOL/AUDIO Knob:** Push to turn the audio system on and off. Turn to adjust the volume.
- Channel Icons:** Select ◀ or ▶ to the previous or next channel. Select and hold to rapidly skip 10 channels at a time.
- Category Icons:** Select ◀ or ▶ to display and select a SiriusXM® Radio category.
- Album Art:** Points to the top-left image on the screen.
- Station Art:** Points to the top-center image on the screen.
- Audio/Information Screen:** Points to the main display area.
- Preset Icons:** Tune the radio frequency for preset memory. Select and hold the preset icon to store that station. Select ▶ to display preset 5 onwards.

\* Not available on all models

## ■ To Change the Tune Mode

1. Select **Settings**.
2. Select **Tune Mode**.
3. Select **All Channels** or **Within Category**.

## ▶▶ Playing SiriusXM® Radio\*

In the channel mode, all available channels are selectable. In the category mode, you can select a channel within a category (Jazz, Rock, Classical, etc.).

There may be instances when SiriusXM® Radio does not broadcast all the data fields (artist name, title). This does not indicate a problem with your audio system.

SiriusXM® Radio stations load in ascending order, which can take about a minute. Once they have loaded you will be able to scroll up or down to make your selections.

### Switching the Audio Mode

Press the ▲ or ▼ button on the steering wheel or select the audio source icon on the screen.

▶▶ **Audio Remote Controls** P. 226

### Tune Start:

When you change to a preset channel, a song being played on that channel restarts from the beginning with this function. This can be turned on or off by the following procedure.

1. Select **Settings**.
2. Select **Tune Start**.
3. Select **ON** or **OFF**.

To change a category, select **Category** icons, or select **More** and then select **Category List**.

## ■ Preset Memory

To store a channel:

1. Tune to the selected channel.
2. Select and hold the preset number for the station you want to store.

## ■ Multi-channel preset (for music channels only)

You can store up to 10 of your preferred music channels per preset.



1. Tune a station.
2. Select and hold the preset number you want to add a music channel.
3. Select **Add to TuneMix** or **Create TuneMix**.

▶ A message appears if there are no available presets.

## ▶▶ Preset Memory

You can store 12 SiriusXM® channels into the preset memory.

## ▶▶ Multi-channel preset (for music channels only)

### TuneMix:

The multi-channel preset function can be turned on or off by the following procedure.

1. Select **Settings**.
2. Select **TuneMix**.
3. Select **ON** or **OFF**.

When you want to replace the channel, select

### Replace Preset.

If you want to delete a channel, select **Edit TuneMix**, and then select the channel you want to delete.

## ■ Listening to Featured Channels

Suggested channel listing received from SiriusXM® can be displayed and selected.

1. Select **Channel List**.
2. Select the featured channel list title you want to listen to.
  - ▶ The selected channel list of the title is displayed.
3. Select the channel.

## ▶▶ Listening to Featured Channels

Up to three featured channels by SiriusXM® can be displayed.



Featured channel lists are at the top of the channel list.

To switch the sorting method, select **Number, Name** or **Category** on the upper right of the screen.

Select **Keypad** to use the on-screen keyboard for entering the channel number directly.

## ■ Replay Function

The system can record up to the last 60 minutes broadcast of your currently tuned channel as well as the last 30 minutes broadcast of preset channels, starting from the moment you turn the vehicle on. If you tuned to preset channel, the system records up to 60 minutes of a broadcast instead of up to 30 minutes. You can rewind and replay the last 30 or 60 minutes of a broadcast.

Move the position you want to replay by selecting  or .

To play or pause on playback mode, select the play/pause icon.

## ■ Returning to real-time broadcast

Select and hold .

## ▶▶ Replay Function

The system starts storing broadcast in memory when the power mode is turned ON. You can go back to the program from that point.

You can no longer replay any program once the power mode is turned off as it erases memory. You can check how long the program has been stored in memory from the audio/information screen.

After 30 or 60 minutes of recording the system will automatically start deleting the oldest data.

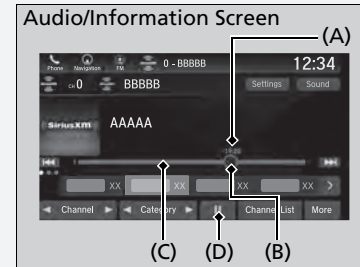

(A): Shows how much time the replayed segment is behind the real-time broadcast

(B): Replayed segment

(C): Length stored in memory

(D): Play/Pause icon



## ■ Live Sports Alert

While listening to other channels, you can receive sports alerts such as scores from your favorite teams.

### ■ To set up a favorite team

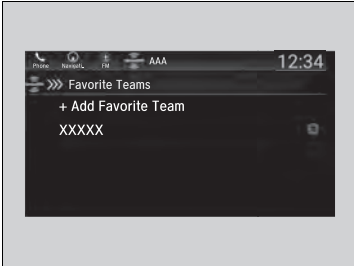

1. Select **Settings**.
2. Select **Sports Notifications Setup**.
3. Select **Favorite Teams**.
4. Select **+ Add Favorite Team**.
5. Select a team.

### ■ To set up an alert message

1. Select **Settings**.
2. Select **Sports Notifications Setup**.
3. Select **Notifications**.
4. Select **Game Notifications** or **SportsFlash Game Play Notifications**.
5. Select **Notifications**.
6. Select **On**.
7. Select a favorite team.

### ▶▶ Live Sports Alert

The sports alert function is active during SiriusXM® mode only.

### ▶▶ To set up a favorite team

Sports alerts cut in only when SiriusXM® mode is on.

## ■ Traffic and Weather Information

You can receive traffic and weather information.

1. Select **Settings**.
2. Select **Traffic & Weather Setup**.
3. Select **Selected City**.
4. Select the region.
  - ▶ When you do not want to receive the information, select **Reset Location**.

### ☒ Traffic and Weather Information

The traffic and weather information function is active during SiriusXM® mode only.

## ■ Channel Schedule

You can view a channel schedule or receive an alert when your favorite program is about to start.

### ■ To view a channel schedule

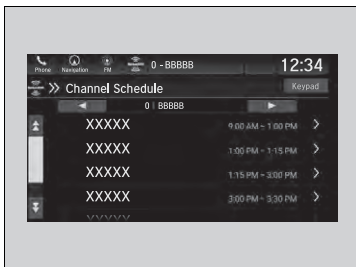

1. Select **More**.
2. Select **Channel Schedule**.

### ■ To set up an alert message

1. Select **More**.
2. Select **Channel Schedule**.
3. Select a program.
4. Select **Set Program Alert**.
5. Select **Just Once** or **Every Time**.

## ▶▶ Channel Schedule

Select **Keypad** to use the on-screen keyboard for entering the channel number directly.

### ▶▶ To set up an alert message

The alert function is active during SiriusXM® mode only.

Selecting **Just Once** disables the alert feature next time you turn the power mode to ON.

If you want to delete the alert, select **Remove Alert**.

## Manage Program Alert

You can change settings for the alert function.

### To enable the alert function

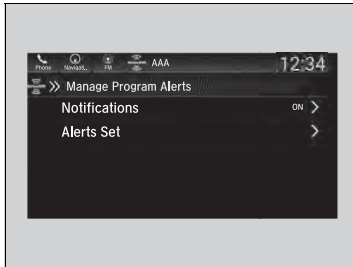

1. Select **Settings**.
2. Select **Manage Program Alerts**.
3. Select **Notifications**.
4. Select **ON** or **OFF**.

### To remove an alert

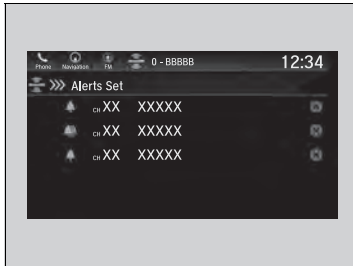

1. Select **Settings**.
2. Select **Manage Program Alerts**.
3. Select **Alerts Set**.
4. Select  on the alert you want to delete.
  - ▶ A confirmation message appears on the screen. Select **Delete**.

## ■ Scan

Sample each channel on the selected mode for 10 seconds.

1. Select **More**.
2. Select **Scan**.

You can change a scan mode by the following procedure.

1. Select **Settings**.
2. Select **Scan Mode**.
3. Select **Channel** or **Preset**.

To turn off scan, select **Stop**.

## ▶▶ Scan

The “Scan Songs in Presets” function is based on TuneScan™ technology of SiriusXM®.

The “Featured Channels” function is based on Featured Favorites™ technology of SiriusXM®.

TuneScan™ and Featured Favorites™ are registered trademarks of SiriusXM® Radio, Inc.

## Playing an iPod

Connect the iPod using your USB connector to the USB port, then select the USB mode.

 **USB Ports** P. 223

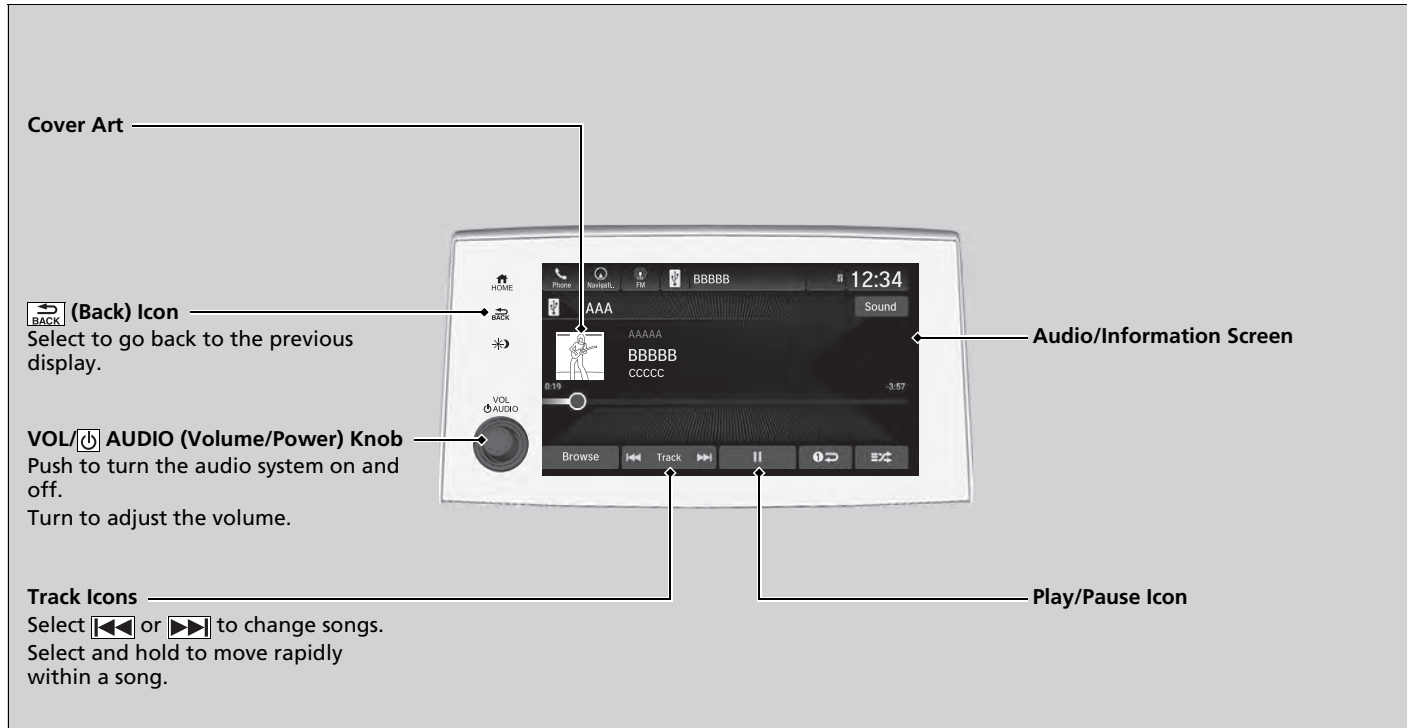

## How to Select a Song from the Music Search List

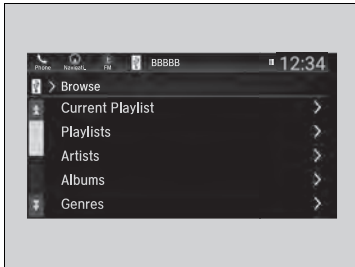

1. Select **Browse**.
2. Select the items on that menu.

## ▶▶ Playing an iPod

Available operating functions vary on models or versions. Some functions may not be available on the vehicle's audio system.

If there is a problem, you may see an error message on the audio/information screen.

▶ **iPod/USB Flash Drive** P. 302

If you operate the music app on your iPhone/iPod while the phone is connected to the audio system, you may no longer be able to operate the same app on the audio/information screen. Reconnect the device if necessary.

If an iPhone is connected via Apple CarPlay, the iPod/USB source will be unavailable and audio files on the phone will be playable only within Apple CarPlay.

## How to Select a Play Mode

You can select shuffle and repeat modes when playing a file.

Select  or .

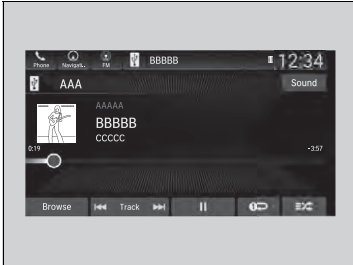

### To turn off a play mode

Select the mode you want to turn off.

## How to Select a Play Mode

Play Mode Menu Items

 **Shuffle All Songs:** Plays all available files in a selected list (playlists, artists, albums, songs, podcasts, genres, composers, or audiobooks) in random order.

 **Repeat Song:** Repeats the current track.



## Playing a USB Flash Drive

Your audio system reads and plays audio files on a USB flash drive in either MP3, WMA, or AAC\*1 format.

Connect your USB flash drive to the USB port, then select the USB mode.

➤ **USB Ports** P. 223

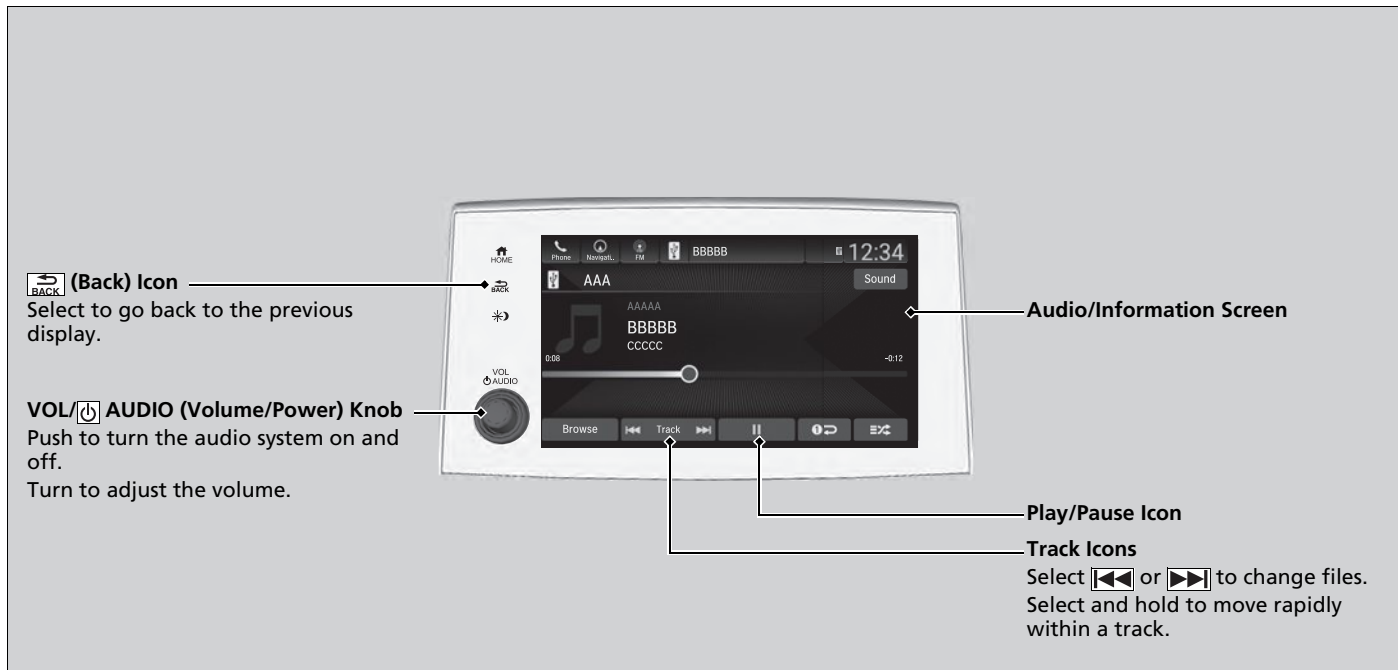

\*1: Only AAC format files recorded with iTunes are playable on this unit.

## How to Select a File from the Music Search List

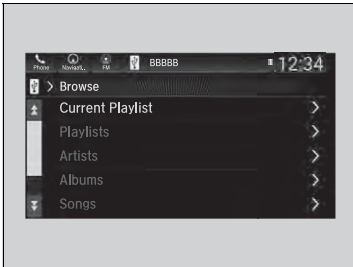

1. Select **Browse**.
2. Select the items on that menu.

## ▶▶ Playing a USB Flash Drive

Use the recommended USB flash drives.

▶ **General Information on the Audio System**  
P. 305

WMA files protected by digital rights management (DRM) cannot be played.

The audio system displays **The selected file cannot be played on this system**, then skips to the next file.

If there is a problem, you may see an error message on the audio/information screen.

▶ **iPod/USB Flash Drive** P. 302

## ■ How to Select a Play Mode

You can select repeat and random modes when playing a file.

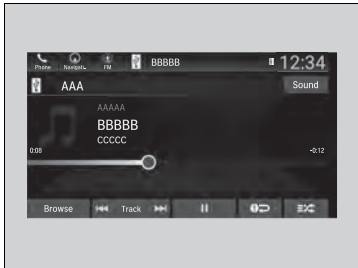

### ■ Random/Repeat

Select  or .

### ■ To turn off a play mode

Select the mode you want to turn off.

## ▶▶ How to Select a Play Mode

Play Mode Menu Items

### Random/Repeat

 **Random in Category:** Plays all files in the current category in random order.

 **Repeat Track:** Repeats the current file.

## Playing My Honda Music

My Honda Music plays audio files that have been imported from a USB flash drive. Your audio system supports audio files in either MP3, WMA, or AAC\*1 format.

📁 **File Manager** P. 248

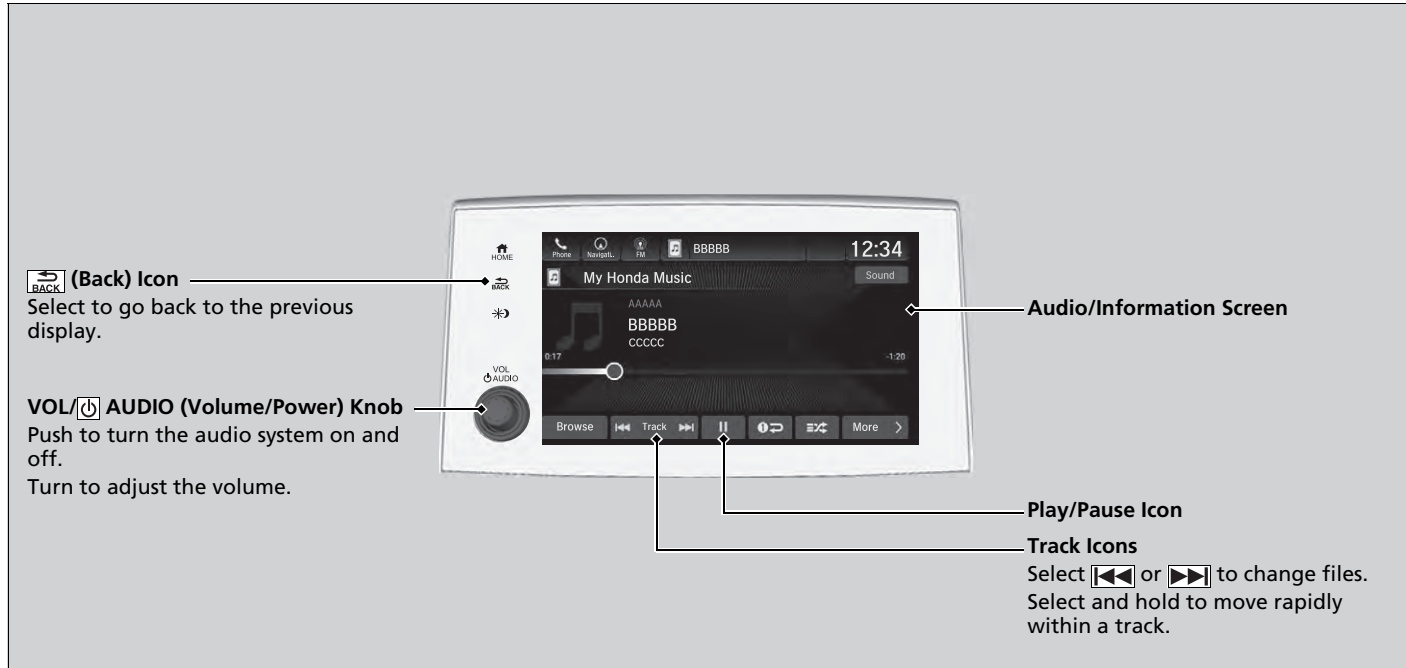

\*1: Only AAC format files recorded with iTunes are playable on this unit.

## ■ How to Transfer an Audio File

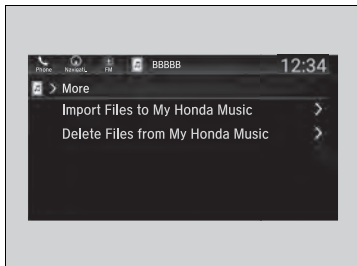

1. Connect a USB device into the USB port.  
    ▶ **USB Ports** P. 223
2. Select **More**.
3. Select **Import Files to My Honda Music**.  
    ▶ The **File Manager** screen is displayed.
4. Transfer an audio file to your audio system.  
    ▶ **How to Transfer a File** P. 248

## ■ How to delete an audio file

1. Select **More**.
2. Select **Delete Files from My Honda Music**.  
    ▶ The **File Manager** screen is displayed.
3. Delete an audio file.  
    ▶ **How to Delete a File** P. 251

## ▶▶ How to Transfer an Audio File

If there is no audio file in your audio system, the system will automatically proceed to step 3 after connecting a USB device.

Use the recommended USB flash drives.

- ▶ **General Information on the Audio System**  
P. 305

## How to Select a File from the Music Search List

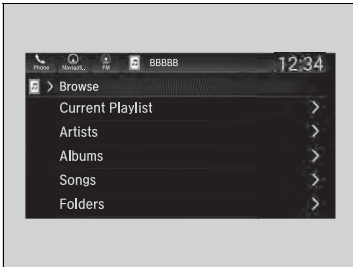

1. Select **Browse**.
2. Select the items on that menu.

### ▶▶ Playing My Honda Music

WMA files protected by digital rights management (DRM) cannot be played.  
The audio system displays **The selected file cannot be played on this system**, then skips to the next file.

## ■ How to Select a Play Mode

You can select repeat and random modes when playing a file.

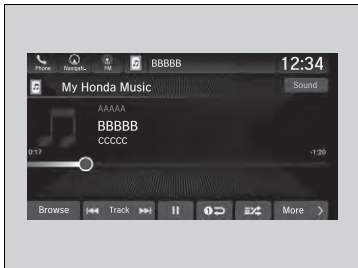

### ■ Random/Repeat

Select  or .

### ■ To turn off a play mode

Select the mode you want to turn off.

## ▶▶ How to Select a Play Mode

Play Mode Menu Items

### Random/Repeat

 **Random in Category:** Plays all files in the current category in random order.

**Random All Tracks:** Plays all files in random order.

 **Repeat Track:** Repeats the current file.

## Playing *Bluetooth*® Audio

Your audio system allows you to listen to music from your *Bluetooth*-compatible phone.

This function is available when the phone is paired and connected to the vehicle's *Bluetooth*® HandsFreeLink® (HFL) system.

📱 **Phone Setup** P. 348

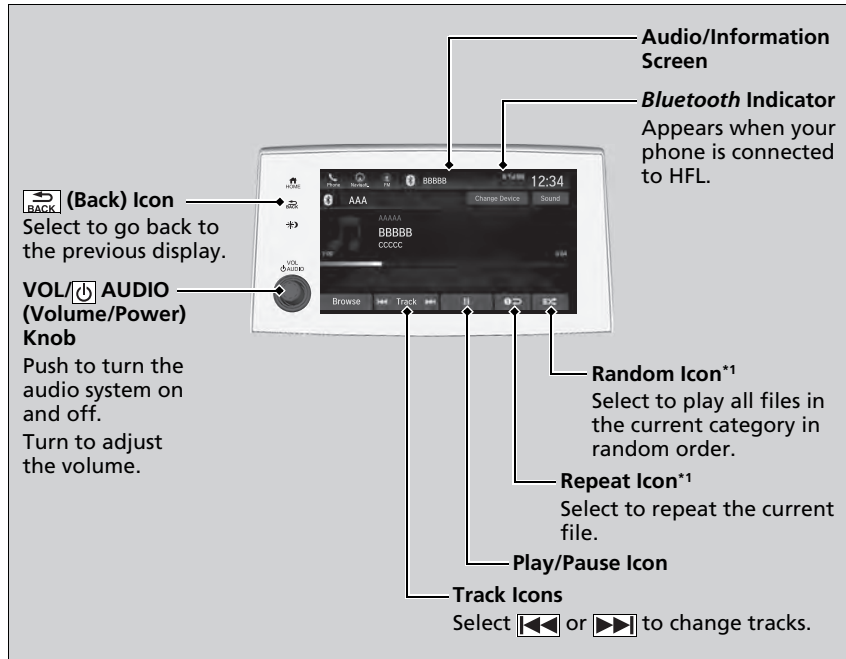

\*1: Depending on the *Bluetooth*® device you connect, this function may not be displayed.

### ▶▶ Playing *Bluetooth*® Audio

Not all *Bluetooth*-enabled phones with streaming audio capabilities are compatible with the system. For a list of compatible phones:

- U.S.: Visit <https://mygarage.honda.com/honda-handsfreelink-compatibility-check>, or call 1-888-528-7876.
- Canada: For more information on smartphone compatibility, call 1-855-490-7351.

It may be illegal to perform some data device functions while driving.

Only one phone can be used with HFL at a time. When there is more than one paired phone in the vehicle, the first paired phone the system finds is automatically connected.

If more than one phone is paired to the HFL system, there may be a delay before the system begins to play.

In some cases, the name of the artist, album, or track may not appear correctly.

Some functions may not be available on some devices.

If a phone is currently connected via Apple CarPlay or Android Auto, *Bluetooth*® Audio from that phone will be unavailable. However, you can have a second previously paired phone stream *Bluetooth*® Audio by selecting 🎵 from the *Bluetooth*® device list.

📱 **Phone Setup** P. 348



## ■ To Play *Bluetooth*® Audio Files

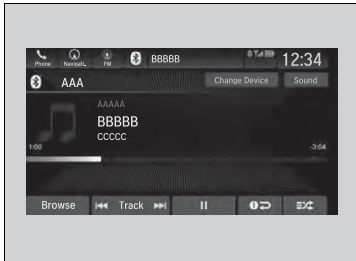

1. Make sure that your phone is paired and connected to the system.

▶ **Phone Setup** P. 348

2. Select the *Bluetooth*® Audio mode.

If the phone is not recognized, another HFL-compatible phone, which is not compatible for *Bluetooth*® Audio, may already be connected.

## ■ To pause or resume a file

Select the play/pause icon.

## ■ Searching for Music

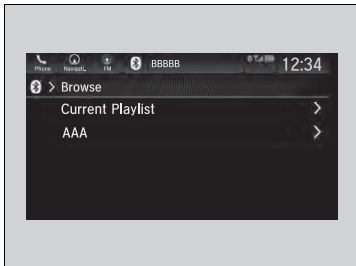

1. Select **Browse**.

2. Select a search category (e.g., Albums).

3. Select an item.

▶ The selection begins playing.

## ▶▶ To Play *Bluetooth*® Audio Files

To play the audio files, you may need to operate your phone. If so, follow the phone maker's operating instructions.

Switching to another mode pauses the music playing from your phone.

You can change the connected phone by selecting **Change Device**.

▶ **Phone Setup** P. 348

## ▶▶ Searching for Music

Depending on the *Bluetooth*® device you connect, some or all of the lists may not be displayed.

## Playing Social Playlist

The Honda CabinControl™ smartphone app allows users to share audio files from their devices to Social Playlist.

Unfortunately, the driver cannot select the audio files from the audio/information screen. The driver can play in order of their choice only if they individually select each song in the queue. The driver cannot rearrange the order of the playlist.

📶 **Wi-Fi Connection** P. 292

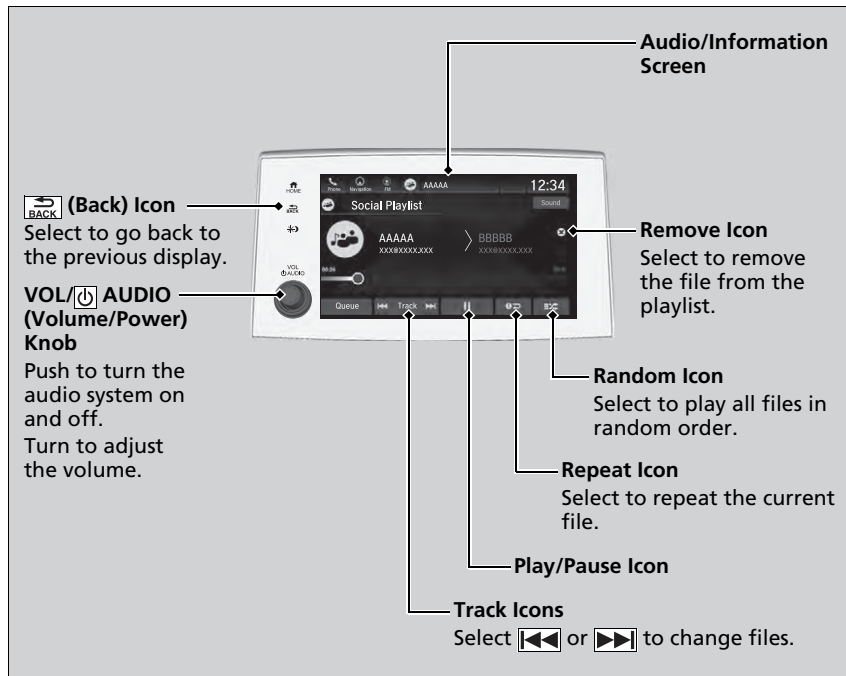

Continued

### ▶▶ Playing Social Playlist

For more information, check the Honda CabinControl smartphone app instruction manual.

## ■ How to Edit the Playlist

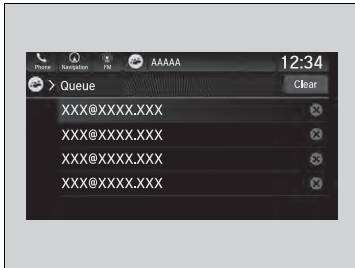

1. Select .

2. Select **Social Playlist**.

3. Select **Queue**.

To play a file on the playlist:

▶ Select the file.

To remove a file from the playlist:

▶ Select  on the file.

To clear the playlist:

▶ Select **Clear**, and then select **Request Songs** to reload a playlist.

To check the connected device:

▶ Select **Devices List**.

## HondaLink®

HondaLink® connects you to the latest information from Honda. You can connect your phone wirelessly through Wi-Fi or *Bluetooth®*.

➤ **Wi-Fi Connection** P. 292

➤ **Phone Setup** P. 348

### ■ To Connect to HondaLink® Service

Use the following procedure to connect to HondaLink® service.

#### ■ To enable the HondaLink® service

You must consent to location sharing to enable the HondaLink® service.

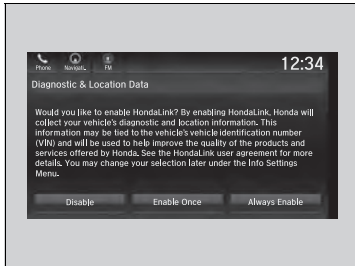

**Disable:** Does not allow this consent.

**Enable Once:** Allows only one time. (Shows again next time.)

**Always Enable:** Allows anytime. (Never show again.)

#### ▶▶ HondaLink®

The HondaLink® connect app is compatible with most iPhone and Android phones.

Some cell phone carriers charge for tethering and smartphone data use. Check your phone's data subscription package.

When Apple CarPlay or Android Auto is connected to the audio system, HondaLink® can be accessed even without a Wi-Fi connection.

### ■ To link with HondaLink®

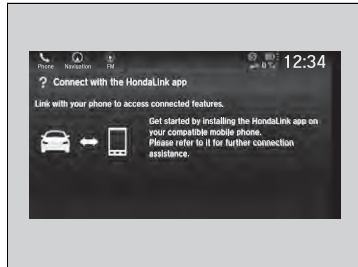

You may see the connection guide screen after launching HondaLink® when there is no connection available.

### ■ HondaLink® Menu

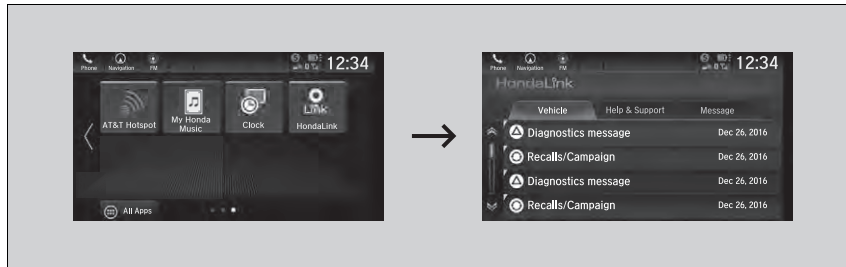

#### ■ Vehicle

Displays instruction messages when the vehicle needs service.

#### ■ Help & Support

Displays tips for vehicle usage, and get support via roadside or customer service center.

## ■ Messages from Honda

Displays helpful and important information from Honda.

### ■ Vehicle Information and Message from Honda Tips

You can check the messages that are received quickly in the shortcut operation.



1. A notification appears and notifies you of a new message in the header area.

2. A notification is continuously displayed in the header area until the new message is read.

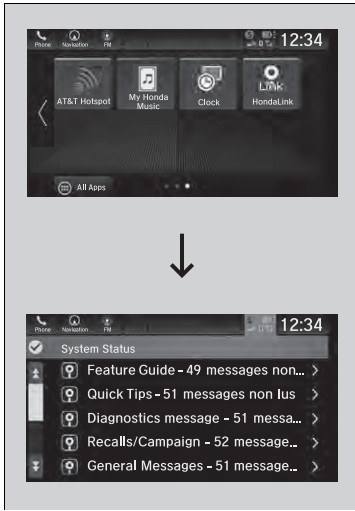



3. Select the system status icon to see the messages.

4. Select a new message to open.

## ■ Operator Assistance\*

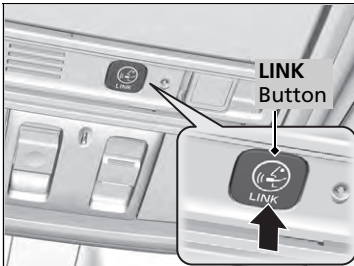
Connect to the HondaLink® operator when trying to find a destination or for roadside assistance.



1. Press the **LINK** button.
  - ▶ Connection to the operator begins.
2. Talk to the operator.
  - ▶ To disconnect, select **Hang Up** on the audio/information screen or press the  button on the steering wheel.

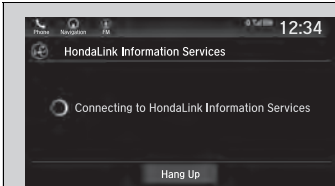

Audio/information screen when connected to the HondaLink® operator.

## ☒ Operator Assistance\*

Remain attentive to road conditions and driving during operator assistance.

If you want to add or renew a subscription, call the Operator Assistance.

1. Select .
2. Select **Settings**.
3. Select **System**.
4. Select **Subscription**.
5. Select **HondaLink Subscription Status**.

\* Not available on all models



## Wi-Fi Connection

This vehicle is equipped with Wi-Fi connectivity. You can connect to an external Wi-Fi hotspot or communication device.

### Wi-Fi Connection

Wi-Fi and Wi-Fi Direct a registered trademark of Wi-Fi Alliance®.



### Connect the vehicle to a Wi-Fi hotspot

You cannot go through the setting procedure while the vehicle is moving. Park in a safe place to setup the Wi-Fi connection.

Some cell phone carriers charge for tethering and smartphone data use. Check your phone's data subscription package.



Check your phone manual to find out if the phone has Wi-Fi connectivity.

You can confirm whether Wi-Fi connection is on or off with the  icon on the Wi-Fi network list. Transmission speed and others will not be displayed on this screen.

In case of Wi-Fi connection with your phone, make sure your phone's Wi-Fi setting is in access point (tethering) mode.

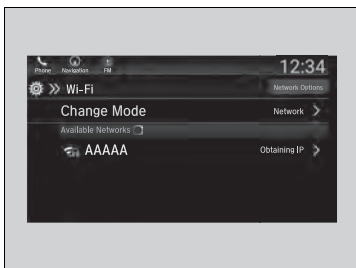
### Connect the vehicle to a Wi-Fi hotspot



1. Select .
2. Select **Settings**.
3. Select **Connections**.
4. Select **Wi-Fi**.
5. Select **Change Mode**.
6. Select **Network** or **HotSpot**, then **Save**.
  - ▶ To change the Wi-Fi settings, select **Network Options** or **HotSpot Options**.
  - ▶ Select the access point you want to connect to the system.
7. Select **Connect**.
  - ▶ Enter a password for the access point, and select **OK**.
  - ▶ When the connection is successful, the  icon is displayed on the list.
8. Select  to go back to the home screen.

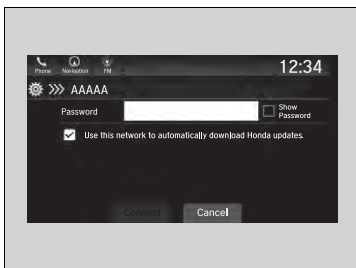

## AT&T Hotspot\*

If you have subscribed to AT&T hotspot services, your vehicle will provide data to connect your mobile devices to the Internet. You can use the AT&T Hotspot app to turn on/off vehicle data and monitor data usage left on your subscription.

### AT&T Hotspot Menu

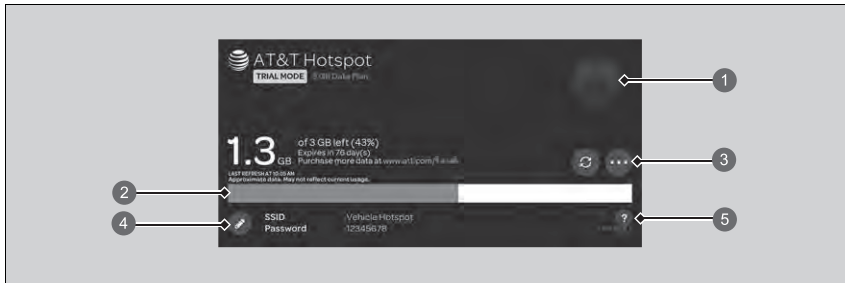

#### 1 Hotspot Enable

Turn on/off AT&T Hotspot.

#### 2 Data Usage Bar

Check the current status of your data plan. This Usage Bar will show your current plan and how much data remains on your plan. Subscription plans for AT&T Hotspot can be added/modified at [www.att.com/honda](http://www.att.com/honda).

#### 3 Refresh and Plan Info

Refreshes screen to show data remaining.

Shows your current AT&T subscription plan for the vehicle.

#### 4 Edit Hotspot Properties

Shows the current username and password for vehicle Hotspot. Hotspot settings can be changed while the vehicle is not in motion.

#### 5 Help

### AT&T Hotspot\*

To use AT&T Hotspot services, your vehicle must be subscribed to a data plan. If your vehicle is not subscribed to a data plan, you can visit [www.att.com/honda](http://www.att.com/honda) to add vehicle data services.

Hotspot username and password can be changed in the Edit Hotspot Properties of the AT&T Hotspot app. Settings cannot be accessed while driving. Park in a safe place to adjust Hotspot settings.

Alternatively, you can use your mobile hotspot to connect the vehicle and other mobile devices to the Internet.

▶ **Wi-Fi Connection** P. 292

\* Not available on all models

## Siri Eyes Free

You can talk to Siri using the  (Talk) button on the steering wheel when your iPhone is paired to the *Bluetooth*® HandsFreeLink® (HFL) system.

➔ **Phone Setup** P. 348

### ☒ Siri Eyes Free

Check Apple Inc. website for features available for Siri.

While driving we recommend only using Siri through the  button on the steering wheel (Siri Eyes Free).

### ☒ Using Siri Eyes Free

Some commands work only on specific phone features or apps.

## ■ Using Siri Eyes Free

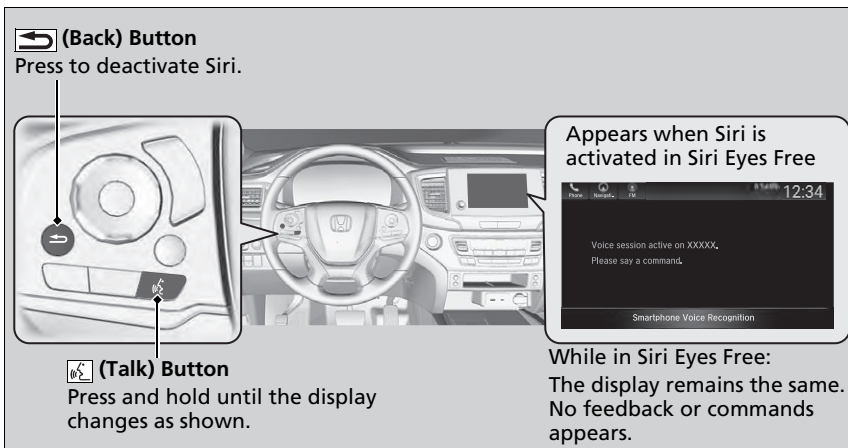

 **(Back) Button**  
Press to deactivate Siri.

 **(Talk) Button**  
Press and hold until the display changes as shown.

**Appears when Siri is activated in Siri Eyes Free**

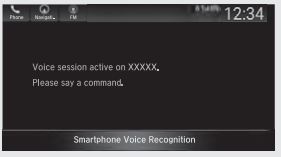

**While in Siri Eyes Free:**  
The display remains the same.  
No feedback or commands appears.

# Apple CarPlay

If you connect an Apple CarPlay-compatible iPhone to the system via the front USB port, you can use the audio/information screen, instead of the iPhone display, to make a phone call, listen to music, view maps (navigation), and access messages.

📄 **USB Ports** P. 223

## ■ Apple CarPlay Menu

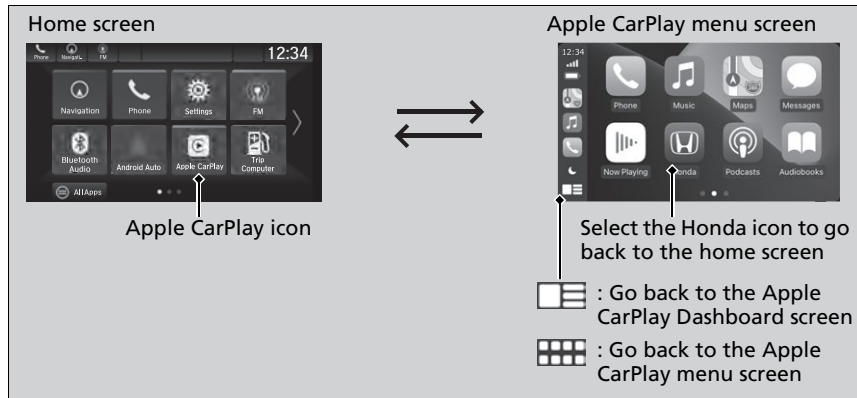

### ■ Phone

Access the contact list, make phone calls, or listen to voicemail.

### ■ Messages

Check and reply to text messages, or have messages read to you.

### ■ Music

Play music stored on your iPhone.

\* Not available on all models

### 📄 Apple CarPlay

Only iPhone 5 or newer versions with iOS 8.4 or later are compatible with Apple CarPlay.

Park in a safe place before connecting your iPhone to Apple CarPlay and when launching any compatible apps.

To use Apple CarPlay, connect the USB cable to the USB port located on the console panel. The USB ports located in the console compartment and on the back of the console compartment\* will not enable Apple CarPlay operation.

📄 **USB Ports** P. 223

While connected to Apple CarPlay, calls are only made through Apple CarPlay. If you want to make a call with HandsFreeLink, turn Apple CarPlay OFF or detach the USB cable from your iPhone.

📄 **Setting Up Apple CarPlay** P. 296

When your iPhone is connected to Apple CarPlay, it is not possible to use the *Bluetooth*® Audio or *Bluetooth*® HandsFreeLink®. However, other previously paired phones can stream audio via *Bluetooth*® while Apple CarPlay is connected.

📄 **Phone Setup** P. 348

For details on countries and regions where Apple CarPlay is available, as well as information pertaining to function, refer to the Apple homepage.

## ■ Maps

Display Apple Maps and use the navigation function just as you would on your iPhone.

### Models with navigation system

Only one navigation system (pre-installed navigation or Apple CarPlay) can give directions at a time. When you are using one system, directions to any prior destination set on the other system will be canceled, and the system you are currently using will direct you to your destination.

## ■ Setting Up Apple CarPlay

After you have connected your iPhone to the system via the front USB port, use the following procedure to set up Apple CarPlay. Use of Apple CarPlay will result in the transmission of certain user and vehicle information (such as vehicle location, speed, and status) to your iPhone to enhance the Apple CarPlay experience. You will need to consent to the sharing of this information on the audio/information screen.

## ■ Enabling Apple CarPlay

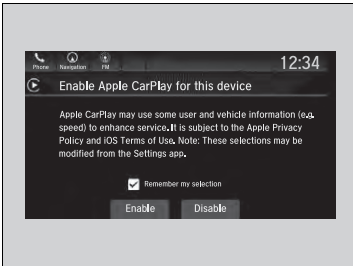

**Enable:** Allows this data sharing.

**Disable:** Does not allow this data sharing.

You may change the consent settings under the **Connections** settings menu.

## ▶▶ Apple CarPlay

### Apple CarPlay Operating Requirements & Limitations

Apple CarPlay requires a compatible iPhone with an active cellular connection and data plan. Your carrier's rate plans will apply.

Changes in operating systems, hardware, software, and other technology integral to providing Apple CarPlay functionality, as well as new or revised governmental regulations, may result in a decrease or cessation of Apple CarPlay functionality and services. Honda cannot and does not provide any warranty or guarantee of future Apple CarPlay performance or functionality.

It is possible to use 3rd party apps if they are compatible with Apple CarPlay. Refer to the Apple homepage for information on compatible apps.

### ▶▶ Setting Up Apple CarPlay

You can also use the method below to set up Apple CarPlay:  
Select HOME → Settings → Connections → Apple CarPlay

### Use of user and vehicle information

The use and handling of user and vehicle information transmitted to/from your iPhone by Apple CarPlay is governed by the Apple iOS terms and conditions and Apple's Privacy Policy.

## ■ Operating Apple CarPlay with Siri

Press and hold the  (Talk) button to activate Siri.

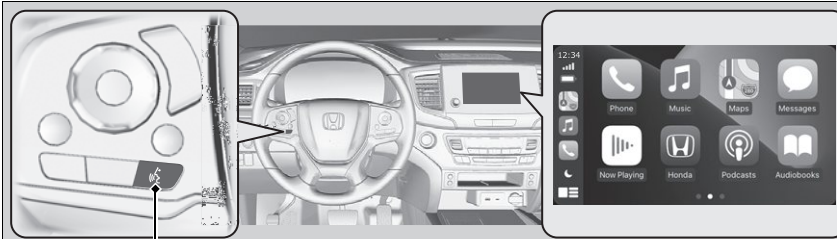

### (Talk) Button:

Press and hold to activate Siri.

Press again to deactivate Siri.

Press and release to activate standard voice recognition system.

## ☒ Operating Apple CarPlay with Siri

Below are examples of questions and commands for Siri:

- What movies are playing today?
- Call dad at work.
- What song is this?
- How's the weather tomorrow?
- Read my latest email.
- Find a table for four tonight in Chicago.

For more information, please visit [www.apple.com/ios/siri](http://www.apple.com/ios/siri).

## Android Auto™

When you connect an Android phone to the audio system via the front USB port, Android Auto is automatically initiated. When connected via Android Auto, you can use the audio/information screen to access the Phone, Google Maps (Navigation), Google Play Music, and Google Now functions. When you first use Android Auto, a tutorial will appear on the screen.

We recommend that you complete this tutorial while safely parked before using Android Auto.

➤ **USB Ports** P. 223

➤ **Auto Pairing Connection** P. 300

### Android Auto™

To use Android Auto, you need to download the Android Auto app from Google Play to your smartphone.

Only Android 5.0 (Lollipop) or later versions are compatible with Android Auto. Bluetooth A2DP cannot be used while your phone is connected to Android Auto.

Park in a safe place before connecting your Android phone to Android Auto and when launching any compatible apps.

To use Android Auto, connect the USB cable to the USB port located on the console panel. The USB ports located in the console compartment and on the back of the console compartment\* will not enable Android Auto operation.

➤ **USB Ports** P. 223

To directly access the Android Auto phone function, press **Phone** on the home screen.

➤ **Auto Pairing Connection** P. 300

When your Android phone is connected to Android Auto, it is not possible to use the *Bluetooth*® Audio. However, other previously paired phones can stream audio via *Bluetooth*® while Android Auto is connected.

➤ **Phone Setup** P. 348

Android Auto is a trademark of Google LLC.

## Android Auto Menu

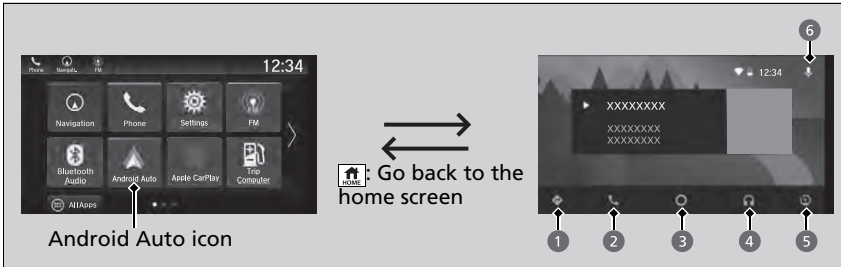

### 1 Maps (Navigation)

Display Google Maps and use the navigation function just as you would with your Android phone. When the vehicle is in motion, it is not possible to make keyboard entries. Stop the vehicle in a safe location to undertake a search or provide other inputs.

#### Models with navigation system

Only one navigation system (pre-installed navigation or Android Auto) can give directions at a time. When you are using one system, directions to any prior destination set on the other system will be canceled, and the system you are currently using will direct you to your destination.

The audio/information screen shows you turn-by-turn driving directions to your destination.

### 2 Phone (Communication)

Make and receive phone calls as well as listen to voicemail.

### 3 Google Now (Home screen)

Display useful information organized by Android Auto into simple cards that appear just when they're needed.

## Android Auto™

For details on countries and regions where Android Auto is available, as well as information pertaining to function, refer to the Android Auto homepage.

Screens may differ depending on the version of the Android Auto app you are using.

### Android Auto Operating Requirements & Limitations

Android Auto requires a compatible Android phone with an active cellular connection and data plan. Your carrier's rate plans will apply.

Changes in operating systems, hardware, software, and other technology integral to providing Android Auto functionality, as well as new or revised governmental regulations, may result in a decrease or cessation of Android Auto functionality and services. Honda cannot and does not provide any warranty or guarantee of future Android Auto performance or functionality.

It is possible to use 3rd party apps if they are compatible with Android Auto. Refer to the Android Auto homepage for information on compatible apps.



#### 4 Music and audio

Play Google Play Music and music apps that are compatible with Android Auto. To switch between music apps, press this icon.

#### 5 Go back to the Home Screen.

#### 6 Voice

Operate Android Auto with your voice.

### Auto Pairing Connection

When you connect an Android phone to the unit via the front USB port, Android Auto is automatically initiated.

#### Enabling Android Auto

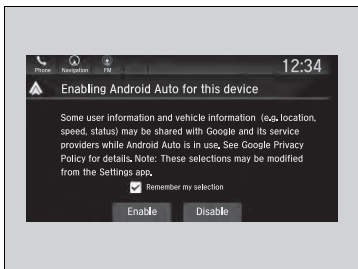

**Enable:** Allows this data sharing.

**Disable:** Does not allow this data sharing.

You may change the consent settings under the **Connections** settings menu.

#### Enabling Android Auto

Only initialize Android Auto when you are safely parked. When Android Auto first detects your phone, you will need to set up your phone so that auto pairing is possible. Refer to the instruction manual that came with your phone.

You can use the method below to change Android Auto settings after you have completed the initial setup:  
Select HOME → Settings → Connections → Android Auto

#### Use of user and vehicle information

The use and handling of user and vehicle information transmitted to/from your phone by Android Auto is governed by the Google's Privacy Policy.

## ■ Operating Android Auto with Voice Recognition

Press and hold the  (Talk) button to operate Android Auto with your voice.



## ☒ Operating Android Auto with Voice Recognition

Below are examples of commands you can give with voice recognition:

- Reply to text.
- Call my wife.
- Navigate to Honda.
- Play my music.
- Send a text message to my wife.
- Call flower shop.

For more information, please refer to the Android Auto homepage.

You can also activate the voice recognition function by pressing the  icon in the upper-right corner of the screen.

## iPod/USB Flash Drive

If an error occurs while playing an iPod or USB flash drive, you may see the following error messages. If you cannot clear the error message, contact a dealer.

Error Message	Solution
<b>Problem reading connected device. See Owner's Manual for a list of compatible devices. If device is compatible, try reconnecting device. If this error remains, contact Honda dealer.</b>	Appears when there is a problem with the audio system. Check if the device is compatible with the audio system.
<b>Problem reading connected device. See Owner's Manual for a list of compatible devices. If device is compatible, try reconnecting device. If this error remains, contact Honda dealer.</b>	Appears when an incompatible device is connected. Disconnect the device. Then, turn the audio system off and turn it on again. Do not reconnect the device that caused the error.
<b>Problem reading connected device. See Owner's Manual for a list of compatible devices. If device is compatible, try reconnecting device. If this error remains, contact Honda dealer.</b>	<ul style="list-style-type: none"><li>• Appears when an unsupported iPod is connected. If it appears when a supported iPod is connected, update the iPod software to the newer version.</li><li>• Appears when an unsupported device is connected. If it appears when a supported device is connected, reconnect the device.</li></ul>

Error Message	Solution
<p><b>Problem reading connected device. See Owner's Manual for a list of compatible devices. If device is compatible, try reconnecting device. If this error remains, contact Honda dealer.</b></p>	<p>Appears when the system does not acknowledge the iPod. Reconnect the iPod.</p>
<p><b>The selected file cannot be played on this system</b></p>	<p>Appears when the files in the USB flash drive are DRM or an unsupported format. This error message appears for about three seconds, then plays the next song.</p>
<p><b>The connected device does not contain any files that can be played on this system. See Owner's Manual for a list of compatible file types.</b></p>	<p><b>iPod</b> Appears when the iPod is empty.</p> <p><b>USB flash drive</b> Appears when the USB flash drive is empty or there are no MP3, WMA, or AAC files in the USB flash drive.</p> <p><b>iPod and USB flash drive</b> Check that compatible files are stored on the device.</p>

## Android/Apps

If an error occurs while using the audio system or apps, you may see the following error messages. If you cannot clear the error message, contact a dealer.

Error Message	Solution
Unfortunately, **** has stopped.* <sup>1</sup>	Error has occurred within app, select <b>OK</b> on the screen to close the app.
**** is not responding. Would you like to close it?*" <sup>1</sup>	App is not responding. Select <b>Wait</b> if you can wait for a response from app a little longer. If it does not respond even if you keep waiting, select <b>OK</b> to close the app and start it up. If the error message continues, perform <b>Factory Data Reset</b> .  <b>Defaulting All the Settings</b> P. 339

\*1:\*\*\*\*part is variable characters, and will change depending upon where an error occurs.

## SiriusXM® Radio Service \*

### ■ Subscribing to SiriusXM® Radio

1. You need your radio ID ready before registering for subscription. To see the ID in the screen, select **Channel** to 0.
2. Have your radio ID ready, and either call or visit the SiriusXM® website to subscribe.

### ■ Receiving SiriusXM® Radio

Switch to the SiriusXM® mode by using the audio remote controls on the steering wheel, or through the audio/information screen, and stay in this mode for about 30 minutes until the service is activated. Make sure your vehicle is in an open area with good reception.

### ■ SiriusXM® Radio Display Messages

#### **Channel not subscribed. Call SiriusXM to subscribe.:**

You are not subscribed to the channel selected.

#### **Subscription Update:**

SiriusXM® radio is receiving information update from the network.

#### **Channel Not Available:**

No such channel exists, or the artist or title information is unavailable.

#### **No Signal:**

The signal is too weak in the current location.

#### **Check Tuner:**

There is a problem with the SiriusXM® tuner. Contact a dealer.

#### **Check Antenna:**

There is a problem with the SiriusXM® antenna. Contact a dealer.

\* Not available on all models

### ☒ Subscribing to SiriusXM® Radio

Contact Information for SiriusXM® Radio:

- US: SiriusXM® Radio at [www.siriusxm.com/subscribeNOW](http://www.siriusxm.com/subscribeNOW), or 1-866-635-2349
- Canada: SiriusXM® Canada at [www.siriusxm.ca/subscribe-now](http://www.siriusxm.ca/subscribe-now), or 1-877-209-0079

### ☒ Receiving SiriusXM® Radio

The SiriusXM® satellites are in orbit over the equator; therefore, objects south of the vehicle may cause satellite reception interruptions. Satellite signals are more likely to be blocked by tall buildings and mountains the farther north you travel from the equator.

You may experience reception problems under the following circumstances:

- In a location with an obstruction to the south of your vehicle.
- In tunnels
- On the lower level of a multi-tiered road
- Large items carried on the roof rack

## Compatible iPod, iPad, iPhone, and USB Flash Drives

### ■ iPod, iPad, and iPhone Model Compatibility

Model
Made for iPod nano (7th generation) released 2012
Made for iPod touch (5th and 6th generation) released between 2012 and 2015
Made for iPhone 4S/iPhone 5/iPhone 5c/iPhone 5s/iPhone 6/iPhone 6 Plus/iPhone 6s/iPhone 6s Plus/iPhone SE/iPhone 7/iPhone 7 Plus
Made for iPad Pro 9.7 inch/iPad Pro 12.9 inch (1st generation)
Made for iPad 2/iPad (3rd generation)/iPad (4th generation)
Made for iPad Air/iPad Air 2
Made for iPad mini/iPad mini 2/iPad mini 3/iPad mini 4

### ⌘ iPod, iPad, and iPhone Model Compatibility

This system may not work with all software versions of these devices.

The Lightning connector works with iPhone 5, iPhone 5c, iPhone 5s, iPhone 6, iPhone 6 Plus, iPhone 6s, iPhone 6s Plus, iPhone SE, iPhone 7, iPhone 7 Plus, iPad Pro 9.7 inch, iPad Pro 12.9 inch (1st generation), iPad (4th generation), iPad Air, iPad Air 2, iPad mini, iPad mini 2, iPad mini 3, iPad mini 4, iPod nano (7th generation), iPod touch (5th and 6th generation).

The 30-pin connector works with iPhone 4S, iPad 2, iPad (3rd generation).

USB works with iPhone 4S, iPhone 5, iPhone 5c, iPhone 5s, iPhone 6, iPhone 6 Plus, iPhone 6s, iPhone 6s Plus, iPhone SE, iPhone 7, iPhone 7 Plus, iPad Pro 9.7 inch, iPad Pro 12.9 inch (1st generation), iPad 2, iPad (3rd generation), iPad (4th generation), iPad Air, iPad Air 2, iPad mini, iPad mini 2, iPad mini 3, iPad mini 4, iPod nano (7th generation), iPod touch (5th to 6th generation).

### ⌘ USB Flash Drives

Files on the USB flash drive are played in their stored order. This order may be different from the order displayed on your PC or device.

### ■ USB Flash Drives

- A USB flash drive of 256 MB or higher is recommended.
- Some digital audio players may not be compatible.
- Some USB flash drives (e.g., a device with security lockout) may not work.
- Some software files may not allow for audio play or text data display.
- Some versions of MP3, WMA, or AAC formats may be unsupported.

# Honda App License Agreement

## END USER LICENSE AGREEMENT

PLEASE CAREFULLY READ THIS END USER LICENSE AGREEMENT (THIS "AGREEMENT") WHICH GOVERNS YOUR USE OF THE SOFTWARE INSTALLED ON YOUR HONDA OR ACURA VEHICLE (YOUR "VEHICLE") AS WELL AS THE APPLICATIONS, SERVICES, FUNCTIONS, AND CONTENT PROVIDED THROUGH THE SOFTWARE (COLLECTIVELY, THE "SERVICES"). YOUR USE OF THE SOFTWARE OR SERVICES WILL SERVE AS YOUR CONSENT TO THE TERMS OF THIS AGREEMENT. THE SOFTWARE IS OWNED (OR LICENSED), PROVIDED, AND/OR OPERATED BY AMERICAN HONDA MOTOR CO. INC., ("HONDA," "US," "WE," OR "OUR"), WITH ITS BUSINESS ADDRESS AT 1919 TORRANCE BLVD., TORRANCE, CA 90501. REFERENCE TO "HONDA" IN THIS AGREEMENT INCLUDES HONDA'S PARENT COMPANY AND ITS AFFILIATES AND DESIGNATED AGENTS. THE SERVICES ARE OWNED (OR LICENSED), PROVIDED, AND/OR OPERATED BY HONDA OR A THIRD-PARTY SERVICE PROVIDER (A "PROVIDER"). REFERENCE TO A "PROVIDER" IN THIS AGREEMENT INCLUDES SUCH PROVIDER'S PARENT COMPANY, AFFILIATES, AND DESIGNATED AGENTS.

**A. Description of the Software.** The SOFTWARE includes the software, firmware and the like, installed and executing on your VEHICLE during manufacture, and thereafter updated from time to time by HONDA, you or an authorized HONDA dealer (a "DEALER"). The SOFTWARE allows you to access and use a variety of SERVICES, including but not limited to: (a) HONDA applications, services, and content provided through the SOFTWARE (together, "HONDA SERVICES"); and (b) PROVIDER applications, services, and content provided through the SOFTWARE (together, "PROVIDER SERVICES"), each of which may provide access to various information, media, content, and services.

### **B. SOFTWARE Licensing and Intellectual Property.**

**1. SOFTWARE.** This AGREEMENT grants you a non-exclusive, limited, and revocable license to use the SOFTWARE and SERVICES solely (a) as installed on your VEHICLE by HONDA, (b) as updated on your Vehicle by HONDA, you (but only as and when directed by HONDA), or a DEALER and (c) as permitted under the terms of this AGREEMENT.

**2. HONDA Services.** The SOFTWARE may provide you with access to various HONDA SERVICES. Installation, activation, or use of HONDA SERVICES may require your consent to additional terms, conditions, and privacy policies applicable to those HONDA SERVICES (the "HONDA TERMS"). You acknowledge and agree that any collection, use, sharing of data generated by your VEHICLE or your use of your VEHICLE, and your use of the HONDA SERVICES shall be subject to this AGREEMENT and any additional HONDA TERMS that may be specifically applicable to such HONDA SERVICES or data generation. The HONDA SERVICES may collect, use, and share such data while you are using the SOFTWARE.



**3. Open-Source Software.** The SOFTWARE and SERVICES may incorporate software licensed to HONDA under free or open-source licenses which govern HONDA's distribution and your use of such software. HONDA and the third-party authors, licensors, and distributors of such software disclaim all warranties and all liability arising from any and all use or distribution of the software. To the extent such software is provided under terms that differ from the applicable free or open-source licenses, those terms are offered by HONDA alone. Additional information regarding free and open-source software incorporated in the SOFTWARE and SERVICES is available in this manual or within the SOFTWARE.

**4. Provider Services.** The SOFTWARE may provide you with access to various PROVIDER SERVICES. Installation or use of such PROVIDER SERVICES may require your consent to additional terms, conditions, and privacy policies of the applicable PROVIDER (the "PROVIDER TERMS"). This AGREEMENT restricts the manner in which you can install and use PROVIDER SERVICES but does not grant you a license or permission to use such PROVIDER SERVICES. Your permission to use PROVIDER SERVICES is limited and subject to any license grants, conditions, and limitations included in the PROVIDER TERMS. You acknowledge that any collection, use, sharing of your information, targeted advertising practices by PROVIDERS, and your use of the PROVIDER SERVICES shall be subject to both this AGREEMENT and any applicable PROVIDER TERMS. The PROVIDER SERVICES may collect, use, and share such information while you are using the SOFTWARE.

### **5. License Limitations and Restrictions on Use.**

(a) Limited License. You understand and agree that the SOFTWARE and SERVICES are licensed, not sold, to you solely for use in accordance with this AGREEMENT and any applicable PROVIDER TERMS, and any documentation for the VEHICLE made available to you by HONDA (any "DOCUMENTATION"). HONDA and its licensors reserve all rights in the SOFTWARE and HONDA SERVICES not expressly granted to you under this AGREEMENT. PROVIDERS and their licensors reserve all rights in the PROVIDER SERVICES not expressly granted to you under the applicable PROVIDER TERMS.

(b) Restrictions on Use. The licenses granted under this AGREEMENT do not permit you to use the SOFTWARE or SERVICES on a device other than your VEHICLE. As a condition of using the SOFTWARE and SERVICES, you agree that you may not and will not:

- (1) copy, download, distribute, modify, publish, sell, rent, lease, lend, license, sublicense, reuse, or create derivative works of the SOFTWARE or SERVICES or any of the content or other material within the SOFTWARE or SERVICES, including without limitation, HONDA or PROVIDER names, logos, or any other trademarks of HONDA or PROVIDERS or used in association with the SOFTWARE or any SERVICES, except as required to use the SOFTWARE or SERVICES in accordance with this AGREEMENT, any applicable PROVIDER TERMS, and the DOCUMENTATION;
- (2) access or use the SOFTWARE or SERVICES in any manner intended to damage or impair the operation of the SOFTWARE or SERVICES or interfere with anyone else's use and enjoyment of the SOFTWARE or SERVICES;
- (3) access or attempt to access any system or server on which the SOFTWARE or SERVICES is hosted or modify or alter the SOFTWARE or SERVICES in any way;
- (4) use the SOFTWARE or SERVICES for any unlawful purpose, or in violation of any third party rights;
- (5) use the SOFTWARE or SERVICES in violation of any applicable traffic regulations, rules or laws, including but not limited to any driver distraction laws, rules or regulations;
- (6) violate the terms of this AGREEMENT, any HONDA TERMS, any PROVIDER TERMS or other applicable third-party terms, conditions, and privacy policies; or
- (7) reverse engineer, decompile, disassemble, attempt to derive the source code of, nor permit others to reverse engineer, decompile, or disassemble, or attempt to derive the source code of the SOFTWARE or SERVICES, except and only to the extent that such activity is expressly permitted (a) by applicable law notwithstanding this limitation or (b) the terms of applicable free or opensource software licenses.

**6. Intellectual Property Rights.** All title and intellectual property rights in and to the SOFTWARE and SERVICES, the accompanying DOCUMENTATION, and all copies of the SOFTWARE or SERVICES are owned by HONDA, PROVIDERS, or their suppliers or licensors. This AGREEMENT does not grant you any rights in connection with any trademarks or service marks of HONDA, PROVIDERS, or their licensors, affiliates, or suppliers.

**7. Export Restrictions:** You acknowledge that the SOFTWARE and SERVICES are subject to U.S., European Union, and other export jurisdictions. You agree to comply with all applicable international and national laws that apply to the SOFTWARE and SERVICES, including the U.S. Export Administration Regulations, as well as end-user, end-use, and destination restrictions issued by the U.S. and other governments.

### **C. SOFTWARE Operation**

**1.** HONDA reserves the right to suspend or terminate your access to and use of the SOFTWARE or SERVICES if you are found to be in violation of this AGREEMENT or as reasonably deemed necessary by HONDA.

**2. Eligibility/Registration/Activation.** The SOFTWARE is intended for and available to individuals who (a) are of legal age of majority in their jurisdiction of residence (and at least 18 years of age), or are younger than 18 years of age and possess a valid driver's license issued by their jurisdiction of residence, and (b) own or have permissive access to a compatible VEHICLE. We do not knowingly collect any information, including personal information, from children under 13. If we learn or are notified that we have collected personal information of a child under 13, we will immediately take steps to delete such information.

**3. Use of PROVIDER SERVICES through the SOFTWARE.** Certain PROVIDER SERVICES made available through the SOFTWARE may require that you register or otherwise have an account with the PROVIDER and agree to PROVIDER TERMS. Any use of any of such PROVIDER SERVICES within the SOFTWARE is subject to this AGREEMENT and the applicable PROVIDER TERMS. HONDA does not exercise control over such PROVIDER SERVICES and is not responsible or liable for the availability, security, or content of such PROVIDER SERVICES, and the inclusion of any PROVIDER SERVICES does not imply a referral from, the approval of, or the endorsement by HONDA of such PROVIDER SERVICES. HONDA is not responsible or liable, directly or indirectly, for any damage relating to or resulting from your use of the PROVIDER SERVICES.

**4. Links to Third Party Sites:** The SOFTWARE may provide you with the ability to access third-party sites and content through the use of the SOFTWARE or SERVICES. The third-party sites and content are not under the control of HONDA. HONDA is not responsible or liable, directly or indirectly, for such third-party websites and their content or for any damage relating to or resulting from your access or use of such websites and content.

**5. Unauthorized Use and Abuse.** You are responsible for ensuring your (and any authorized third parties') use of the SOFTWARE and SERVICES remains in compliance with this AGREEMENT and all other applicable HONDA TERMS and PROVIDER TERMS. You acknowledge and agree that any use of the SOFTWARE or SERVICES occurring through your VEHICLE will be deemed your actions and that HONDA and PROVIDERS may rely upon such actions. You agree to immediately notify us if you suspect fraudulent or abusive activity involving the SOFTWARE or SERVICES. If you so notify us or if we otherwise suspect fraudulent or abusive activity, you agree to cooperate with us in any fraud investigation and to use any fraud prevention measures we prescribe. Your failure to immediately notify us or cooperate to use such measures will result in your liability for all fraudulent usage or abusive activity associated with your VEHICLE.

**6. SOFTWARE Updates.** The SOFTWARE and SERVICES may be updated when your VEHICLE is serviced by a DEALER or remotely, over-the-air, by HONDA from time to time; such updates may occur with or without further notice or your future consent. The SOFTWARE may be updated at HONDA's discretion and for any purpose including, without limitation, to patch or otherwise improve the SOFTWARE or SERVICES functionality, security, or stability. All updates to the SOFTWARE and SERVICES are subject to this AGREEMENT and any other applicable HONDA TERMS and PROVIDER TERMS.

**7. Uninstalling, Removing, and Replacing the SOFTWARE.** Replacing SOFTWARE or HONDA SERVICES with software or firmware not provided and installed by HONDA or a DEALER will render all representations and warranties for the SOFTWARE, HONDA SERVICES, and VEHICLE functionality reliant upon the SOFTWARE or HONDA SERVICES null and void.

#### **D. SOFTWARE Operational Notices and Warnings**

**1. Vehicle Geolocation Information.** You acknowledge that your VEHICLE may be equipped with certain traffic and map features. The traffic feature will automatically collect and transmit, through GPS technology, your Vehicle's current location (longitude and latitude), travel direction and speed ("VEHICLE GEOLOCATION INFORMATION") to HONDA and PROVIDERS. The VEHICLE GEOLOCATION INFORMATION is used by HONDA and PROVIDERS to provide traffic and navigation-related information to you, but may also be used to provide other SERVICES or offers to you. HONDA will not use such VEHICLE GEOLOCATION INFORMATION for its own marketing efforts, or provide such information to unaffiliated third parties for their own purposes, without your express consent.

**2. Potential Map Inaccuracy and Route Safety.** Maps used by this system may be inaccurate because of changes in roads, traffic controls, routing, or driving conditions. Always use good judgment and common sense when following suggested routes. Do not follow the route suggestions if doing so would result in an unsafe or illegal driving maneuver, if you would be placed in an unsafe situation, or if you would be directed into an area that you consider unsafe. Do not rely on any navigation features included in the system to route you to emergency services. Not all emergency services such as police, fire stations, hospitals, or clinics are likely to be contained in the map database for such navigation features. Ask local authorities or an emergency services operator for such locations and routes. The driver is ultimately responsible for the safe operation of the vehicle and therefore, must evaluate whether it is safe to follow the suggested directions. Any navigation features are provided only as an aid. Make your driving decisions based on your observations of local conditions and existing traffic regulations. Navigation features are not a substitute for your personal judgment. Any route suggestions made by the SOFTWARE or SERVICES should never replace any local traffic regulations or your personal judgment or knowledge of safe driving practices.

**3. Speech Recognition:** You acknowledge and understand that HONDA and PROVIDERS may record, retain, and use voices commands when you use the speech recognition components of the SOFTWARE or SERVICES. You and all VEHICLE operators and passengers (a) consent to the recording and retention of voice commands in support of providing speech recognition components and (b) release HONDA and PROVIDERS from all claims, liabilities, and losses that may result from any use of such recorded voice commands. Recognition errors are inherent in speech recognition. It is your responsibility to monitor any speech recognition functions included in the system and address any errors. Neither HONDA nor PROVIDERS will be liable for any damages arising out of errors in the speech recognition process.

**4. Distraction Hazards.** Navigation features may require manual (non-verbal) input or setup. Attempting to perform such set-up or insert data while driving can seriously distract your attention and could cause a crash or other serious consequences; the ability to undertake such interactions may also be limited by state or local law, which laws you are responsible to know and follow. Even occasional short scans of the screen may be hazardous if your attention has been diverted away from your driving at a critical time. Pull over and stop the vehicle in a safe and legal manner before attempting to access a function of the system requiring prolonged attention. Do not raise the volume excessively. Keep the volume at a level where you can still hear outside traffic and emergency signals while driving. Driving while unable to hear these sounds could result in a crash.

## E. Information Collection and Storage

**1. Information Collection, Use, Transmission and Storage of Data. Consent to Use of Data:** You agree that HONDA and PROVIDERS may collect and use your information gathered in any manner as part of product support services related to the SOFTWARE or related services. HONDA may share such information with third parties, including, without limitation, PROVIDERS, third party software and services suppliers, their affiliates and/or their designated agents, solely to improve their products or to provide services or technologies to you. HONDA, third party software and systems suppliers, their affiliates and/or their designated agent may disclose this information to others, but not in a form that personally identifies you.

**2. Information Storage.** Depending on the type of multimedia system you have in your VEHICLE, certain information may be stored for ease of use of the SOFTWARE including, without limitation, search history, location history in certain applications, previous and saved destinations, map locations within certain applications, and device numbers and contact information.

(a) Vehicle Health Information. Your VEHICLE may remotely transmit information regarding the status and health of your VEHICLE (“VEHICLE INFORMATION”) to HONDA without notification to you. VEHICLE INFORMATION may contain VEHICLE maintenance and malfunction status that is derived from VEHICLE diagnostic data and includes, but is not limited to, status of powered doors and windows, battery life data, battery charging data, VEHICLE speed, coolant temperature, air compressor revolution, output power, warning codes, diagnostic trouble codes, fuel injection volume, and engine rotations per minute. VEHICLE HEALTH INFORMATION may be used by HONDA for research and development, to deliver HONDA SERVICES and information to you, and to contact you, and is retained only for a period of time necessary to fulfill these goals.

(b) VEHICLE Geolocation Data (non-navigation/map based). If you opt-in to geolocation-based SERVICES, your vehicle’s geolocation data (latitude and longitude) will be automatically sent from your VEHICLE to HONDA and PROVIDERS.

(c) You understand that the inputting or uploading of information to your VEHICLE’s multimedia system or the SOFTWARE or SERVICES is at your own risk and that HONDA is not responsible for unauthorized access to or use of any personal or other information. All information uploaded to the SOFTWARE and SERVICES may be stored on your VEHICLES’s multimedia system and you understand that the security and safety of your VEHICLE’s multimedia system is your sole responsibility.

**F. NO WARRANTY.** You understand and agree that your use of the SOFTWARE and SERVICES are solely at your own risk and that you will be solely responsible for any damage to your VEHICLE's multimedia system or any other equipment or any loss of data that may result from your use of the SOFTWARE or SERVICES. THE SOFTWARE AND SERVICES ARE PROVIDED ON AN "AS IS" AND "AS AVAILABLE" BASIS WITHOUT ANY WARRANTY OF ANY KIND, EXPRESSED, IMPLIED OR STATUTORY. WE SPECIFICALLY DISCLAIM ANY IMPLIED WARRANTIES OF MERCHANTABILITY, FITNESS FOR A PARTICULAR PURPOSE, AND NON-INFRINGEMENT. HONDA makes no warranties that the SOFTWARE or SERVICES will meet your requirements, or that the SOFTWARE or SERVICES will be uninterrupted, timely, secure, non-infringing or error free. You understand and agree that you are responsible for any and all charges, costs or expenses associated with your use of the SOFTWARE or SERVICES. Advice or information, whether oral or written, obtained by you from us or through the SOFTWARE or SERVICES are provided for informational purposes only and will not create any warranty not expressly made herein. You should not rely on any such information or advice. We assume no liability or responsibility for any errors or omissions in the SOFTWARE or SERVICES. We do not make any warranty or representation that your use of the material displayed on, or obtained through, the SOFTWARE or SERVICES is non-infringing of any rights of any third party. Any decision or action taken by you on the basis of information or content provided via the application is at your sole discretion and risk. HONDA and PROVIDERS are not responsible or liable for any such decision, or for the accuracy, completeness, usefulness, or availability of any content or information displayed, transmitted, or otherwise made available via the SOFTWARE or SERVICES. To the extent jurisdictions do not allow the exclusion of certain warranties, some of the above exclusions may not apply to you.

**G. LIMITATIONS ON LIABILITY.** You and HONDA are each waiving important rights.

**1. Limitations on YOUR liability.** HONDA cannot recover from you any consequential, indirect, incidental, or special damages, or attorney's fees in connection with your use of the SOFTWARE or HONDA SERVICES. HONDA WAIVES TO THE FULLEST EXTENT ALLOWED BY LAW ANY CLAIM FOR DAMAGES OTHER THAN DIRECT, COMPENSATORY DAMAGES AS LIMITED IN THIS AGREEMENT.

**2. Limitation on HONDA and PROVIDER liability.** Neither HONDA nor PROVIDERS will be liable to you or any other party for consequential, indirect, incidental, special, or punitive damages (including without limitation lost profits) in connection with your use of the SOFTWARE or SERVICES, even if HONDA or PROVIDERS are aware of the possibility of such damages. These limitations apply to all claims, including, without limitation, claims in contract and tort (such as negligence, product liability and strict liability). To the extent that a jurisdiction does not permit the exclusion or limitation of liability as set forth herein our liability is limited to the maximum extent permitted by law in such states. If HONDA or PROVIDERS are found liable to you for any reason, you agree that the aggregate liability of all these parties to you for any claim is limited to ten U.S. dollars (US \$10.00). Neither HONDA nor any PROVIDER would have agreed to provide the SOFTWARE or SERVICES to you if you did not agree to this limitation. This amount is the sole and exclusive liability of HONDA and PROVIDERS to you, and is payable as liquidated damages and not as a penalty. Except where prohibited by law, you may not bring any claim against HONDA or any third-party beneficiary more than two (2) years after the claim arises. We do not have any liability for SOFTWARE or SERVICES interruptions of any length.

(a) **Release of HONDA and PROVIDERS** For yourself and anyone else claiming under you, you agree to release and discharge HONDA, PROVIDERS, their respective officers, directors, and employees, and each third-party beneficiary from all claims, liabilities and losses in connection with the SOFTWARE or SERVICES, including, but not limited to claims for personal injury or property damage arising from the total or partial failure of performance of the SOFTWARE or SERVICES, even if caused by or based upon the negligence, gross negligence, strict products liability, Deceptive Trade Practices Act violations, bad faith, or breach of warranty of us or the malfunction of the SOFTWARE or SOFTWARE SERVICES. YOU AGREE TO WAIVE TO THE FULLEST EXTENT ALLOWED BY LAW, ANY CLAIM FOR DAMAGES OTHER THAN DIRECT, COMPENSATORY DAMAGES AS LIMITED IN THIS AGREEMENT. YOU HEREBY RELEASE AND DISCHARGE HONDA AND ITS LICENSORS AND CONTRACTORS (INCLUDING ANY THIRD PARTIES PROVIDING ALL OR PART OF THE SOFTWARE OR SERVICES) FROM AND AGAINST ANY CLAIMS, DAMAGES, EXPENSES AND LIABILITY ARISING FROM OR RELATED TO ANY INJURIES, DAMAGES, OR LOSSES TO ANY PERSON (INCLUDING DEATH) OR PROPERTY OF ANY KIND RESULTING IN WHOLE OR PART, DIRECTLY OR INDIRECTLY, FROM YOUR USE OF THE SOFTWARE OR SERVICES.

**H. Survival.** You agree that the limitations of liability and indemnities in this AGREEMENT will survive even after the AGREEMENT has ended. These limitations of liability apply not only to you, but to anyone using the SOFTWARE or SERVICES via your VEHICLE, to anyone making a claim on your behalf, and to any claims made by your family, employees, customers, or others arising out of or relating to your VEHICLE, the SOFTWARE, or SERVICES.



**I. Availability/Interruption.** The SOFTWARE and certain SERVICES are made available through your VEHICLE's compatible multimedia system when the VEHICLE is turned on. Certain SERVICES may be available only through your compatible mobile device when it is within the operating range of the VEHICLE and a wireless carrier. The availability of the SOFTWARE and SERVICES may be subject to transmission limitation or interruption, including but not limited to technical obsolescence or sunset of the hardware, software or firmware, inside of or external to the Vehicle, required for data transmission or receipt. HONDA does not guarantee that the SOFTWARE, SERVICES, or any portion thereof will be available at all times or in all areas. You acknowledge and agree that HONDA is not responsible for performance degradation, interruption or delays. You acknowledge that HONDA shall not be liable to you if the SOFTWARE or SERVICES in a given location are not available. If the SOFTWARE or SERVICES are not available within your intended location, you agree that your sole remedy shall be to cease using the SOFTWARE and SERVICES.

**J. PRODUCT SUPPORT:** Product support for the SOFTWARE is provided by HONDA. For product support, please refer to HONDA instructions provided in the DOCUMENTATION. Should you have any questions concerning this AGREEMENT, or if you desire to contact HONDA for any other reason, please refer to the HONDA contact information provided in the DOCUMENTATION.

#### **K. Termination and Transfer.**

**1. Termination.** This AGREEMENT is effective until terminated by you or US. WE may terminate this AGREEMENT for any or no reason, and with or without notice to you. Your rights under this AGREEMENT will terminate automatically without notice from US if you fail to comply with any term of this AGREEMENT. Upon termination of this AGREEMENT, you shall cease all use of the SOFTWARE and SERVICES.

**2. Transfer:** You may permanently transfer your rights under this AGREEMENT only as part of a sale or transfer of the VEHICLE, provided you retain no copies, you transfer all of the SOFTWARE and HONDA SERVICES (including all component parts, the media and printed materials, and any upgrades), and the recipient agrees to the terms of this AGREEMENT. You agree to notify HONDA upon the sale or transfer of the VEHICLE. To contact HONDA, please refer to the HONDA contact information provided in the DOCUMENTATION.

**L. Changes to the SOFTWARE or SERVICES.** WE may change, modify, or update the SOFTWARE or SERVICES from time to time. Unless explicitly stated otherwise, any new features or services that augment or enhance the SOFTWARE or SERVICES in the future shall respectively be considered part of the SOFTWARE or SERVICES and subject to this AGREEMENT. WE reserve the right at any time and from time to time to interrupt, restrict, modify, suspend, discontinue, temporarily or permanently, the SOFTWARE or SERVICES (or any portion thereof), with or without notice to you, and you agree that HONDA shall not be liable to you or to any third party for any modification, suspension or discontinuance of the SOFTWARE or SERVICES.

**M. ARBITRATION:**

PLEASE READ THIS ARBITRATION PROVISION CAREFULLY TO UNDERSTAND YOUR RIGHTS. YOU AGREE THAT ANY CLAIM THAT YOU MAY HAVE IN THE FUTURE MUST BE RESOLVED THROUGH BINDING ARBITRATION. YOU WAIVE THE RIGHT TO HAVE YOUR DISPUTE HEARD IN COURT AND WAIVE THE RIGHT TO BRING CLASS CLAIMS. YOU UNDERSTAND THAT DISCOVERY AND APPEAL RIGHTS ARE MORE LIMITED IN ARBITRATION.

Arbitration is a method of resolving a claim, dispute or controversy without filing a lawsuit. By agreeing to arbitrate, the right to go to court is waived and instead claims, disputes or controversies are submitted to binding arbitration. This provision sets forth the terms and conditions of our agreement. YOU and HONDA agree and acknowledge that this Agreement affects interstate commerce and the Federal Arbitration Act ("FAA") applies. By using the Software, Vehicle, or Services, YOU elect to have disputes resolved by arbitration. YOU, HONDA or any involved third party may pursue a Claim. "Claim" means any dispute between YOU, HONDA, or any involved third party relating to your use of the Software, the Vehicle, or the Services, this Agreement, or our relationship, including any representations, omissions or warranties. "Claim" does not include personal injury or wrongful death claims. YOU or HONDA may seek remedies in small claims court or provisional judicial remedies without arbitrating. In addition, notwithstanding anything herein to the contrary, YOU or HONDA may seek equitable relief in a court of competent jurisdiction.

YOU or HONDA may select arbitration with American Arbitration Association, JAMS or National Arbitration and Mediation. Contact these sponsors for their rules. The hearing will be in the federal district where YOU reside. If agreed, it may be by telephone or written submissions. Filing and arbitrator fees to be paid per the sponsor rules. You may contact the sponsor for a fee waiver. If no fee waivers, HONDA will pay filing and arbitrator fees up to \$5,000, unless law requires more. Each party is responsible for other fees. Arbitrator may award costs or fees to prevailing party, if permitted by law. HONDA will not seek fees, unless the claims are frivolous.

Arbitrator shall be an attorney or current or retired judge familiar with automotive or consumer software. The arbitrator shall follow substantive law, statute of limitations and decide all issues relating to the interpretation, construction, enforceability and applicability of this provision. The arbitrator may order relief permitted by law. This provision is governed and enforceable by the FAA. An award shall include a written opinion and be final, subject to appeal by the FAA.

This provision survives termination of this Agreement or relationship, bankruptcy, assignment or transfer. If part of this provision is unenforceable, the remainder remains in effect. If unenforceability allows arbitration as a class action, then this provision is entirely unenforceable. YOU may opt out within 30 days of your initial use of the Software by sending a signed, written notice to HONDA at Honda Financial Services, P.O. Box 165007, Irving, TX 75016. HONDA reserves the right to make changes to this provision after providing written notice and an opportunity to opt out.

**N. Miscellaneous:** You may not assign this AGREEMENT without HONDA's prior written consent. This AGREEMENT and any additional HONDA TERMS and PROVIDER TERMS represents the entire agreement between you and US. HONDA may amend the terms of this AGREEMENT by providing you with notices of such updated terms. If you do not consent to be bound by the updated terms, your sole remedy will be to cease using the SOFTWARE and SERVICES. If any part of this AGREEMENT is found invalid, void, or unenforceable, the balance of the AGREEMENT will remain valid and enforceable according to its terms. To the fullest extent permitted by law, and except as explicitly provided otherwise, this AGREEMENT and any disputes arising out of or relating to it will be governed by the laws of the State of California, except that California laws concerning choice of law or conflicts shall not apply if they would cause the substantive law of another jurisdiction to apply. Notwithstanding the foregoing, Section M shall be governed by the Federal Arbitration Act and the laws of the State of California, as applicable, as set forth therein. The failure to enforce any term of this AGREEMENT on one occasion shall not prevent enforcement on any other occasion or the enforcement of any other term. Headings and captions shall not be considered included for purposes of interpretation or application hereof, but are for convenience only.

## Legal Information on Apple CarPlay/Android Auto

### ■ OWNER'S MANUAL LICENSE/LIABILITY STATEMENTS

USE OF APPLE CARPLAY IS SUBJECT TO YOUR AGREEMENT TO THE CARPLAY TERMS OF USE, WHICH ARE INCLUDED AS PART OF THE APPLE iOS TERMS OF USE. IN SUMMARY, THE CARPLAY TERMS OF USE DISCLAIM APPLE AND ITS SERVICE PROVIDERS' LIABILITY IF THE SERVICES FAIL TO PERFORM CORRECTLY OR ARE DISCONTINUED, STRICTLY LIMIT APPLE AND ITS SERVICE PROVIDERS' OTHER LIABILITIES, DESCRIBE THE KINDS OF USER INFORMATION (INCLUDING, FOR EXAMPLE, VEHICLE LOCATION, VEHICLE SPEED, AND VEHICLE STATUS) BEING GATHERED AND STORED BY APPLE AND ITS SERVICE PROVIDERS, AND DISCLOSE CERTAIN POSSIBLE RISKS ASSOCIATED WITH THE USE OF CARPLAY, INCLUDING THE POTENTIAL FOR DRIVER DISTRACTION. SEE APPLE'S PRIVACY POLICY FOR DETAILS REGARDING APPLE'S USE AND HANDLING OF DATA UPLOADED BY CARPLAY.

USE OF ANDROID AUTO IS SUBJECT TO YOUR AGREEMENT TO THE ANDROID AUTO TERMS OF USE WHICH MUST BE AGREED TO WHEN THE ANDROID AUTO APPLICATION IS DOWNLOADED TO YOUR ANDROID PHONE. IN SUMMARY, THE ANDROID AUTO TERMS OF USE DISCLAIM GOOGLE AND ITS SERVICE PROVIDERS' LIABILITY IF THE SERVICES FAIL TO PERFORM CORRECTLY OR ARE DISCONTINUED, STRICTLY LIMIT GOOGLE AND ITS SERVICE PROVIDERS' OTHER LIABILITIES, DESCRIBE THE KINDS OF USER INFORMATION (INCLUDING, FOR EXAMPLE, VEHICLE LOCATION, VEHICLE SPEED, AND VEHICLE STATUS) BEING GATHERED AND STORED BY GOOGLE AND ITS SERVICE PROVIDERS, AND DISCLOSE CERTAIN POSSIBLE RISKS ASSOCIATED WITH THE USE OF ANDROID AUTO, INCLUDING THE POTENTIAL FOR DRIVER DISTRACTION. SEE GOOGLE'S PRIVACY POLICY FOR DETAILS REGARDING GOOGLE'S USE AND HANDLING OF DATA UPLOADED BY ANDROID AUTO.

## DISCLAIMER OF WARRANTIES; LIMITATION ON LIABILITY

YOU EXPRESSLY ACKNOWLEDGE AND AGREE THAT USE OF APPLE CARPLAY OR ANDROID AUTO (“THE APPLICATIONS”) IS AT YOUR SOLE RISK AND THAT THE ENTIRE RISK AS TO SATISFACTORY QUALITY, PERFORMANCE, ACCURACY AND EFFORT IS WITH YOU TO THE MAXIMUM EXTENT PERMITTED BY APPLICABLE LAW, AND THAT THE APPLICATIONS AND INFORMATION ON THE APPLICATIONS IS PROVIDED “AS IS” AND “AS AVAILABLE,” WITH ALL FAULTS AND WITHOUT WARRANTY OF ANY KIND, AND HONDA HEREBY DISCLAIMS ALL WARRANTIES AND CONDITIONS WITH RESPECT TO THE APPLICATIONS AND INFORMATION ON THE APPLICATIONS, EITHER EXPRESS, IMPLIED OR STATUTORY, INCLUDING, BUT NOT LIMITED TO, THE IMPLIED WARRANTIES AND/OR CONDITIONS OF MERCHANTABILITY, SATISFACTORY QUALITY, FITNESS FOR A PARTICULAR PURPOSE, ACCURACY, QUIET ENJOYMENT, AND NON-INFRINGEMENT OF THIRD PARTY RIGHTS. NO ORAL OR WRITTEN INFORMATION OR ADVICE GIVEN BY HONDA OR AN AUTHORIZED REPRESENTATIVE SHALL CREATE A WARRANTY. AS EXAMPLES, AND WITHOUT LIMITATION, HONDA DISCLAIMS ANY WARRANTY REGARDING THE ACCURACY OF DATA PROVIDED BY THE APPLICATIONS, SUCH AS THE ACCURACY OF DIRECTIONS, ESTIMATED TRAVEL TIME, SPEED LIMITS, ROAD CONDITIONS, NEWS, WEATHER, TRAFFIC, OR OTHER CONTENT PROVIDED BY APPLE, GOOGLE, THEIR AFFILIATES, OR THIRD PARTY PROVIDERS; HONDA DOES NOT GUARANTEE AGAINST LOSS OF APPLICATION DATA, WHICH MAY BE LOST AT ANY TIME; HONDA DOES NOT GUARANTEE THAT THE APPLICATIONS OR ANY SERVICES PROVIDED THROUGH THEM WILL BE PROVIDED AT ALL TIMES OR THAT ANY OR ALL SERVICES WILL BE AVAILABLE AT ANY PARTICULAR TIME OR LOCATION. FOR EXAMPLE, SERVICES MAY BE SUSPENDED OR INTERRUPTED WITHOUT NOTICE FOR REPAIR, MAINTENANCE, SECURITY FIXES, UPDATES, ETC., SERVICES MAY BE UNAVAILABLE IN YOUR AREA OR LOCATION, ETC. IN ADDITION, YOU UNDERSTAND THAT CHANGES IN THIRD PARTY TECHNOLOGY OR GOVERNMENT REGULATION MAY RENDER THE SERVICES AND/OR APPLICATIONS OBSOLETE AND/OR UNUSABLE.

TO THE EXTENT NOT PROHIBITED BY LAW, IN NO EVENT SHALL HONDA OR ITS AFFILIATES BE LIABLE FOR PERSONAL INJURY, OR ANY INCIDENTAL, SPECIAL, INDIRECT OR CONSEQUENTIAL DAMAGES WHATSOEVER, INCLUDING, WITHOUT LIMITATION, DAMAGES FOR LOSS OF PROFITS, CORRUPTION OR LOSS OF DATA, FAILURE TO TRANSMIT OR RECEIVE ANY DATA, BUSINESS INTERRUPTION OR ANY OTHER COMMERCIAL DAMAGES OR LOSSES, ARISING OUT OF OR RELATED TO THE APPLICATIONS OR YOUR USE OF OR INABILITY TO USE THE APPLICATIONS OR INFORMATION ON THE APPLICATIONS, HOWEVER CAUSED, REGARDLESS OF THE THEORY OF LIABILITY (CONTRACT, TORT OR OTHERWISE) AND EVEN IF HONDA WERE ADVISED OF THE POSSIBILITY OF SUCH DAMAGES. SOME STATES AND JURISDICTIONS DISALLOW THE EXCLUSION OR LIMITATION OF LIABILITY FOR DAMAGES, SO THESE LIMITATIONS AND EXCLUSIONS MAY NOT APPLY TO YOU. IN NO EVENT SHALL HONDA’S TOTAL LIABILITY TO YOU FOR ALL DAMAGES (OTHER THAN AS MAY BE REQUIRED BY APPLICABLE LAW IN CASES INVOLVING PERSONAL INJURY) EXCEED THE AMOUNT OF FIVE DOLLARS (\$5.00). THE FOREGOING LIMITATIONS WILL APPLY EVEN IF THE ABOVE STATED REMEDY FAILS OF ITS ESSENTIAL PURPOSE.

## About Open Source Licenses

---

To see the open source license information, follow these steps.

1. Select .
2. Select **Settings**.
3. Select **System**.
4. Select **About**.
5. Select **Legal Information**.

## License Information

---

### ■ DOLBY DIGITAL

Manufactured under license from Dolby Laboratories. Dolby, Dolby Audio, Pro Logic, and the double-D symbol are trademarks of Dolby Laboratories.



### ■ DTS

For DTS patents, see <http://patents.dts.com>. Manufactured under license from DTS Licensing Limited. DTS, DTS-HD, the Symbol, & DTS and the Symbol together are registered trademarks of DTS, Inc. ©DTS, Inc. All Rights Reserved.



## ■ Bluetooth

The *Bluetooth*® word mark and logos are registered trademarks owned by Bluetooth SIG, Inc. and any use of such marks by DENSO CORPORATION is under license. Other trademarks and trade names are those of their respective owners.



## ■ Windows Media

This product is protected by certain intellectual property rights of Microsoft. Use or distribution of such technology outside of this product is prohibited without a license from Microsoft.



## ■ Apple

“Made for iPod,” “Made for iPhone,” and “Made for iPad” mean that an electronic accessory has been designed to connect specifically to iPod, iPhone, or iPad, respectively, and has been certified by the developer to meet Apple performance standards. Apple is not responsible for the operation of this device or its compliance with safety and regulatory standards. Please note that the use of this accessory with iPod, iPhone, or iPad may affect wireless performance.

Apple, the Apple Logo, iPad, iPhone, iPod, iPod classic, iPod nano, and iPod touch are trademarks of Apple Inc., registered in the U.S. and other countries. iPad Air, iPad mini, iPad Pro, Apple CarPlay, iPod, iPhone, iTunes, Siri and Lightning are trademarks of Apple Inc. App Store is a service mark of Apple Inc.



## MPEG

### Mpeg4 Visual

THIS PRODUCT IS LICENSED UNDER THE MPEG-4 VISUAL PATENT PORTFOLIO LICENSE FOR THE PERSONAL AND NON-COMMERCIAL USE OF A CONSUMER FOR (i) ENCODING VIDEO IN COMPLIANCE WITH THE MPEG-4 VISUAL STANDARD (“MPEG-4 VIDEO”) AND/OR (ii) DECODING MPEG-4 VIDEO THAT WAS ENCODED BY A CONSUMER ENGAGED IN A PERSONAL AND NONCOMMERCIAL ACTIVITY AND/OR WAS OBTAINED FROM A VIDEO PROVIDER LICENSED BY MPEG LA TO PROVIDE MPEG-4 VIDEO. NO LICENSE IS GRANTED OR SHALL BE IMPLIED FOR ANY OTHER USE. ADDITIONAL INFORMATION INCLUDING THAT RELATING TO PROMOTIONAL, INTERNAL AND COMMERCIAL USES AND LICENSING MAY BE OBTAINED FROM MPEG LA, LLC.  
SEE [HTTP://WWW.MPEGLA.COM](http://www.mpegla.com).

### VC-1

This product is licensed under the AVC patent portfolio license and VC-1 patent portfolio license for the personal use of a consumer or other uses in which it does not receive remuneration to

- (i) encode video in compliance with the AVC Standard and VC-1 Standard (“AVC/VC-1 Video”) and/or
- (ii) decode AVC/VC-1 Video that was encoded by a consumer engaged in a personal activity and/or was obtained from a video provider licensed to provide AVC/VC-1 Video.

No license is granted or shall be implied for any other use.  
Additional information may be obtained from MPEG LA, L.L.C.  
See <http://www.mpegla.com>.

#### AVC/H.264

THIS PRODUCT IS LICENSED UNDER THE AVC PATENT PORTFOLIO LICENSE FOR THE PERSONAL AND NONCOMMERCIAL USE OF A CONSUMER TO (i) ENCODE VIDEO IN COMPLIANCE WITH THE AVC STANDARD (“AVC VIDEO”) AND/OR (ii) DECODE AVC VIDEO THAT WAS ENCODED BY A CONSUMER ENGAGED IN A PERSONAL AND NON-COMMERCIAL ACTIVITY AND/OR WAS OBTAINED FROM A VIDEO PROVIDER LICENSED TO PROVIDE AVC VIDEO. NO LICENSE IS GRANTED OR SHALL BE IMPLIED FOR ANY OTHER USE.

ADDITIONAL INFORMATION MAY BE OBTAINED FROM MPEG LA, L.L.C. SEE [HTTP://WWW.MPEGLA.COM](http://www.mpegla.com).

### ■ SDHC Memory Card

microSDHC Logo is a trademark of SD-3C, LLC.

# Customized Features

Use the audio/information screen to customize certain features.

## ■ How to customize

With the power mode in ON, select **Settings**, then select a setting item.

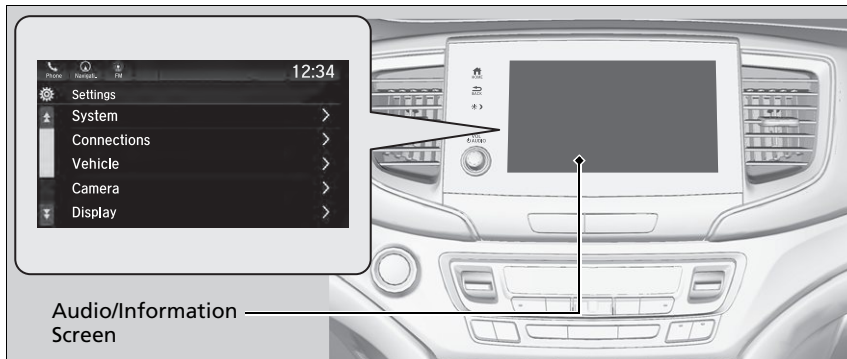

## ⌘ Customized Features

When you customize settings, make sure that the vehicle is at a complete stop and shift to **P**.

■ List of customizable options

Setup Group	Customizable Features	Description	Selectable Settings		
System	Date & Time	<b>Automatic Date &amp; Time</b>	Selects <b>ON</b> to have the GPS automatically adjust the clock. Select <b>OFF</b> to cancel this function.	<b>ON*<sup>1</sup>/OFF</b>	
		<b>Set Date &amp; Time</b>	<b>Set Date</b>	Adjusts date. <input checked="" type="checkbox"/> <b>Adjusting the Clock</b> P. 126	—
		<b>Set Time</b>	Adjusts clock. <input checked="" type="checkbox"/> <b>Adjusting the Clock</b> P. 126	—	
	Set Time Zone	<b>Automatic Time Zone*</b>	Sets the navigation system to automatically adjust the clock when driving through different time zones.	<b>ON*<sup>1</sup>/OFF</b>	
		<b>Select time zone</b>	Changes the time zone manually.	—	
		<b>Select Time Format</b>	Selects the digital clock display from 12H to 24H.	<b>12H*<sup>1</sup>/24H</b>	

\*1:Default Setting

Setup Group	Customizable Features	Description	Selectable Settings	
System	<b>System Volumes</b>	<b>System Sounds</b>	Changes the system sounds volume.	—
		<b>Navigation Guidance*</b>	Changes the navigation guidance volume.	—
	<b>Touch Sensitivity</b>	Sets the sensitivity of the touch panel screen.	<b>High/Low*</b> <sup>1</sup>	
	<b>Subscriptions</b>	<b>HondaLink Subscription Status</b>	Lists subscriptions and subscription status for HondaLink®.	—
	<b>Language</b>	Changes the display language.	<b>English</b> (United States)* <sup>1</sup> / <b>English</b> (United Kingdom)/ <b>Korean/French/Spanish/Arabic</b>	
	<b>Factory Data Reset</b>	Resets all the settings to their factory default.  <b>Defaulting All the Settings</b> P. 339	<b>Continue/Cancel</b>	
	<b>About</b>	Displays the Android setting items.	—	

\*1:Default Setting

\* Not available on all models

Setup Group	Customizable Features	Description	Selectable Settings	
System	Advanced Options	<b>App Manager</b>	Displays the Android system memory and apps information.	—
		<b>Recent Location Request from Apps</b>	Displays the recent location requests from apps.	—
		<b>Location Setting</b>	Selects <b>OFF</b> not to allow apps including the navigation system* to access the vehicle's location.	<b>ON*<sup>1</sup>/OFF</b>
	Inter-ruptions	<b>Inter-ruption Mode</b>	Sets the interruption mode for allowing to notify when calls and notifications arrive.	<b>Always interrupt*<sup>1</sup>/ Don't interrupt/ Allow only priority interruptions</b>
		<b>Events and reminders</b>	Sets priority interruptions of events and reminders.	<b>ON*<sup>1</sup>/OFF</b>
		<b>Calls</b>	Sets priority interruptions of calls.	<b>ON*<sup>1</sup>/OFF</b>
		<b>Messages</b>	Sets priority interruptions of messages.	<b>ON*<sup>1</sup>/OFF</b>
		<b>Calls/ messages from</b>	Sets priority interruptions of from who.	<b>Anyone*<sup>1</sup>/Contacts only/Starred contacts only</b>

\*1:Default Setting

Setup Group	Customizable Features	Description	Selectable Settings	
Connections	Bluetooth	<b>+ Connect New Device</b> Pairs a new phone to HFL. ☑ <b>Phone Setup</b> P. 348	—	
		<b>Saved Devices</b> Connects, disconnects, or deletes a paired phone. ☑ <b>Phone Setup</b> P. 348	—	
	Wi-Fi	<b>Change Mode</b> Changes the Wi-Fi mode.	<b>Network*<sup>1</sup>/HotSpot/ OFF</b>	
		<b>Available Networks/ Connected Devices</b> Displays the available network(s) or current connected device(s).	—	
	<b>Android Auto</b>	Sets up the Android Auto connection.	—	
	<b>Apple CarPlay</b>	Sets up the Apple CarPlay connection.	—	
	CabinControl	<b>Options</b>	<b>Cabin-Control</b> Turns the Honda CabinControl function on and off.	<b>ON*<sup>1</sup>/OFF</b>
			<b>Connection Information</b> Displays the Honda CabinControl connection information.	—
		(Device list)	Selects functions or deletes a device.	—

\*1:Default Setting



Setup Group	Customizable Features	Description	Selectable Settings	
Vehicle	<b>Driving Position Setup*</b>	<b>Seat Position Movement at Entry/Exit</b>	Moves the seat rearward when you get in/get out of the vehicle. Changes the setting for this feature.	<b>ON*<sup>1</sup>/OFF</b>
		<b>Memory Position Link</b>	Turns the driving position memory system on and off.	<b>ON*<sup>1</sup>/OFF</b>
	<b>Adjust Outside Temp Display</b>	Adjusts the temperature reading by a few degrees.	<b>-5°F ~ ±0°F*<sup>1</sup> ~ +5°F (U.S.) -3°C ~ ±0°C*<sup>1</sup> ~ +3°C (Canada)</b>	
	<b>Meter Setup</b>	<b>Trip A Reset Timing</b>	Changes the setting of how to reset trip meter A and average fuel economy A.	<b>With Refuel/IGN Off/Manually Reset*<sup>1</sup></b>
		<b>Trip B Reset Timing</b>	Changes the setting of how to reset trip meter B and average fuel economy B.	<b>With Refuel/IGN Off/Manually Reset*<sup>1</sup></b>
		<b>Reverse Shift Position Beep</b>	Turns the reverse alert tone on and off.	<b>ON/OFF*<sup>1</sup></b>
	<b>Adjust Alarm Volume</b>	Changes the alarm volume, such as the buzzers, warnings, turn signal sound, and so on.	<b>High/Mid*<sup>1</sup>/Low</b>	

\*1:Default Setting

Setup Group	Customizable Features	Description	Selectable Settings	
Vehicle	Meter Setup	<b>Turn by Turn Display</b>	Selects whether the turn-by-turn display comes on during the route guidance.	<b>ON*<sup>1</sup>/OFF</b>
		<b>Fuel Efficiency Backlight</b>	Turns the ambient meter feature on and off.	<b>ON*<sup>1</sup>/OFF</b>
		<b>Rear Seat Reminder</b>	Turns the Rear Seat Reminder feature on and off.	<b>ON*<sup>1</sup>/OFF</b>
	Power Tailgate Setup	<b>Power Tailgate Keyless Open Mode</b>	Changes the keyless setting for when the power tailgate opens.	<b>Anytime*<sup>1</sup>/When Unlocked</b>
		<b>Power Tailgate Open by Outer Handle</b>	Changes the setting to open power tailgate by tailgate outer handle.	<b>Off (Manual only)/ On (Power/ Manual)*<sup>1</sup></b>
		<b>Hands Free Access Power Tailgate*</b>	Changes the setting to open power tailgate by a swift forward in and out kicking motion under the rear bumper.	<b>ON*<sup>1</sup>/OFF</b>
	Keyless Access Setup	<b>Door Unlock Mode</b>	Changes which doors unlock when you grab the driver's door handle.	<b>Driver Door or Tailgate*<sup>1</sup>/All Doors</b>
		<b>Keyless Access Light Flash</b>	Causes some exterior lights to flash when you unlock/lock the doors.	<b>ON*<sup>1</sup>/OFF</b>
		<b>Keyless Access Beep</b>	Causes the beeper to sound when you unlock/lock the doors.	<b>ON*<sup>1</sup>/OFF</b>

\*1:Default Setting

\* Not available on all models

Setup Group	Customizable Features	Description	Selectable Settings	
Vehicle	Keyless Access Setup	<b>Remote Start System On/Off</b>	Turns the remote engine start feature on and off.	<b>ON*<sup>1</sup>/OFF</b>
		<b>Walk Away Auto Lock</b>	Changes the settings for the automatic locking the doors when you walk away from the vehicle while carrying the remote.	<b>Enable/Disable*<sup>1</sup></b>
	Driver Assist System Setup	<b>Forward Collision Warning Distance</b>	Changes the distance at which Collision Mitigation Braking System™ (CMBS™) alerts.	<b>Long/Normal*<sup>1</sup>/Short</b>
		<b>ACC Forward Vehicle Detect Beep</b>	Causes the system to beep when the system detects a vehicle, or when the vehicle goes out of the ACC range.	<b>ON/OFF*<sup>1</sup></b>
		<b>Road Departure Mitigation Setting</b>	Changes the setting for the road departure mitigation system.	<b>Normal*<sup>1</sup>/Wide/Warning Only</b>
		<b>Lane Keeping Assist Suspend Beep</b>	Switches the LKAS suspend alert beeps on and off.	<b>ON/OFF*<sup>1</sup></b>
		<b>Blind Spot Information</b>	Changes the setting for the blind spot information.	<b>Audible and Visual Alert*<sup>1</sup>/Visual Alert/OFF</b>

\*1:Default Setting

Setup Group	Customizable Features	Description	Selectable Settings	
<b>Vehicle</b>	<b>Door Setup</b>	<b>Auto Door Lock</b>	Changes the setting for the automatic locking feature.	<b>With Vehicle Speed<sup>*1</sup>/Shift from P/OFF</b>
		<b>Auto Door Unlock</b>	Changes the setting for when the doors unlock automatically.	<b>All Doors with Driver's Door Opens<sup>*1</sup>/All Doors with Shift to P/All Doors with IGN Off/OFF</b>
		<b>Key and Remote Unlock Mode</b>	Sets up either the driver's door or all doors to unlock on the first push of the remote or built-in key.	<b>Driver Door<sup>*1</sup>/All Doors</b>
		<b>Keyless Lock Answer Back</b>	LOCK/UNLOCK- The exterior lights flash. LOCK (2nd push)- The beeper sounds.	<b>ON<sup>*1</sup>/OFF</b>
		<b>Security Relock Timer</b>	Changes the time it takes for the doors to relock and the security system to set after you unlock the vehicle without opening any door.	<b>90 sec/60 sec/30 sec<sup>*1</sup></b>

\*1:Default Setting

Setup Group	Customizable Features	Description	Selectable Settings
Vehicle	<b>Interior Light Dimming Time</b>	Changes the length of time the interior lights stay on after you close the doors.	<b>60 sec/30 sec<sup>*1</sup>/15 sec</b>
	<b>Headlight Auto Off Timer</b>	Changes the length of time the exterior lights stay on after you close the driver's door.	<b>60 sec/30 sec/15 sec<sup>*1</sup>/0 sec</b>
	<b>Lighting Setup</b> <b>Auto Interior Illumination Sensitivity</b>	Changes the sensitivity of the brightness of the instrument panel when the headlight switch is in the <b>AUTO</b> position.	<b>Min/Low/Mid<sup>*1</sup>/High/Max</b>
	<b>Auto Headlight On with Wiper On</b>	Changes the settings for the wiper operation when the headlights automatically come on while the headlight switch is in the <b>AUTO</b> position.	<b>ON<sup>*1</sup>/OFF</b>
	<b>Auto Light Sensitivity<sup>*</sup></b>	Changes the timing for the headlights to come on.	<b>Max/High/Mid<sup>*1</sup>/Low/Min</b>
	<b>Wireless Charger</b>		Turns the wireless charger feature on and off.
<b>Maintenance Information</b>	<b>Oil Life</b>	Resets the engine oil life display when you have performed the maintenance service.	—

\*1:Default Setting

Setup Group	Customizable Features	Description	Selectable Settings
Camera	Rear Camera	<b>Default Camera View</b> Changes the camera view mode when the rear camera monitor is turned on. ➤ <b>Multi-View Rear Camera</b> P. 482	<b>Last Used/Normal View/Wide View</b> *1
		<b>Guidelines</b> Selects whether the guidelines come on the rear camera monitor. ➤ <b>Multi-View Rear Camera</b> P. 482	<b>Dynamic/Fixed/Both</b> *1/OFF
		<b>Cross Traffic Monitor</b> Turns the cross traffic monitor on and off.	<b>ON</b> *1/OFF
Display	<b>Brightness</b> <hr/> <b>Contrast</b> <hr/> <b>Black Level</b>	Adjusts the settings of the audio/information screen. ➤ <b>Display Setup</b> P. 255	

\*1:Default Setting

Setup Group	Customizable Features	Description	Selectable Settings
Sound	<b>Bass / Treble</b>	Adjusts the settings of the audio speakers' sound.  <b>Adjusting the Sound</b> P. 254	—
	<b>Center / Subwoofer Volume*</b>		
	<b>Subwoofer Volume*</b>		
	<b>Balance / Fader</b>		
	<b>Audio Zones*</b>		
	<b>Speed Volume Compensation</b>		
	<b>DTS Neural Surround*</b>		
<b>Notifications</b>	Changes the notification settings for apps.	—	

## Defaulting All the Settings

Reset all the menu and customized settings as the factory defaults.



1. Select .
2. Select **Settings**.
3. Select **System**.
4. Select **Factory Data Reset**.
  - ▶ A confirmation message appears on the screen.
5. Select **Continue** to reset the settings.
6. Select **Continue** again to reset the settings.
  - ▶ The system will reboot.

### Defaulting All the Settings

When you transfer the vehicle to a third party, reset all settings to default and delete all personal data.

If you perform **Factory Data Reset**, it will reset the preinstalled apps to their factory default.

If you perform **Factory Data Reset**, you cannot use the HondaLink® because it goes offline.

 **HondaLink®** P. 287



The HomeLink® Universal Transceiver can be programmed to operate up to three remote controlled devices around your home, such as garage doors, lighting, or home security systems.

## ■ Important Safety Precautions

Refer to the safety information that came with your garage door opener to test that the safety features are functioning properly. If you do not have the safety information, contact the manufacturer.

Before programming HomeLink, make sure that people and objects are out of the way of the garage or gate to prevent potential injury or damage.

When programming a garage door opener, park just outside the garage door's path.

## ⌘ HomeLink® Universal Transceiver\*

Before programming HomeLink to operate a garage door opener, confirm that the opener has an external entrapment protection system, such as an "electronic eye," or other safety and reverse stop features. If it does not, HomeLink may not be able to operate it.

### NOTE:

Some LED lightbulbs installed in the garage door opener can interfere with the training and consistent operation of your HomeLink device. Please consider use of Low RF interference bulbs in your garage door opener.

## Training HomeLink

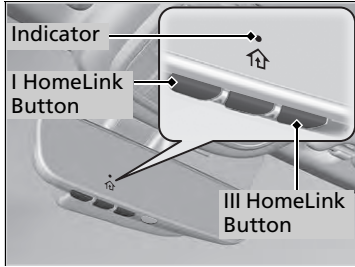

If it is necessary to erase a previously entered learned code:

- Press and hold the I and III HomeLink buttons for about 10 seconds, until the orange indicator blinks. Release the buttons, and proceed to step 1.
- If you are training the second or third button, go directly to step 1.

The instructions on the next page should work for most gate or garage openers, but may not work for all. For detailed instructions about your specific remote opener, visit <http://www.homelink.com> or call (800) 355-3515.

## ■ Programming a Button

**1.** Position the remote transmitter you wish to link 1 to 3 inches (3 - 8 cm) from the HomeLink® button you want to program.

**2.** Press and hold the desired HomeLink button. Is the HomeLink indicator (LED) *slowly flashing orange*?

**YES**

**3a.** Hold the button on the remote transmitter. Does HomeLink indicator (LED) change from *slowly flashing orange to rapidly flashing green or continuously on green*? The process should take less than 60 seconds.

**4.** Press and hold the programmed HomeLink button for about a second. Does the device (garage door opener) work?

**YES**

**Training Complete**

**NO**

**5.** Press and hold the HomeLink button again.

HomeLink LED is *continuously on green*.

**6.** Press and hold the HomeLink button again. The remote-controlled device should operate.

**Training Complete**

**NO**

**3b.** Canadian Garage Door Opener  
A. Press and release the HomeLink button. Press, hold and release the button on the remote every 2 secs. Does the HomeLink indicator (LED) change from *slowly flashing orange to rapidly flashing or continuously on green*? The process should take less than 60 seconds.

HomeLink indicator *rapidly flashes green*.

**5a.** The remote has a rolling code. Press the "learn" button on the remote-controlled device (e.g. garage door opener).

**5b.** Within 30 secs, press and hold the programmed HomeLink button for 2 secs.

## ▶▶ Training HomeLink

**Reprogramming a Button**  
If you want to retrain a programmed button for a new device, you do not have to erase all button memory. You can replace the existing memory code using this procedure:

- 1.** Press and hold the desired HomeLink button until the HomeLink indicator begins to *slowly flash orange*. This should take about 20 seconds.
- 2.** Release the HomeLink button and position the remote transmitter you wish to link 1 - 3 inches (3 - 8 cm) from the HomeLink button you want to program, then follow steps 3 - 6 under "programming a button."

**Erasing Button Memory**  
To erase programming from the buttons, press and hold the two outside HomeLink buttons until the HomeLink indicator changes from *orange to rapidly flashing green*. This should take about 10 seconds. You should erase all programming before selling the vehicle.

**Operating**  
To operate, simply press and release the programmed HomeLink button. Activation will now occur for the trained device.

**Questions**  
For questions or comments, visit [www.HomeLink.com](http://www.HomeLink.com), [www.youtube.com/HomeLinkGentex](http://www.youtube.com/HomeLinkGentex), or by calling the HomeLink Hotline (North America only) at (800) 355-3515.

HomeLink® is a registered trademark of Gentex Corporation.

Bluetooth® HandsFreeLink® (HFL) allows you to place and receive phone calls using your vehicle's audio system, without handling your cell phone.

## Using HFL

### HFL Buttons

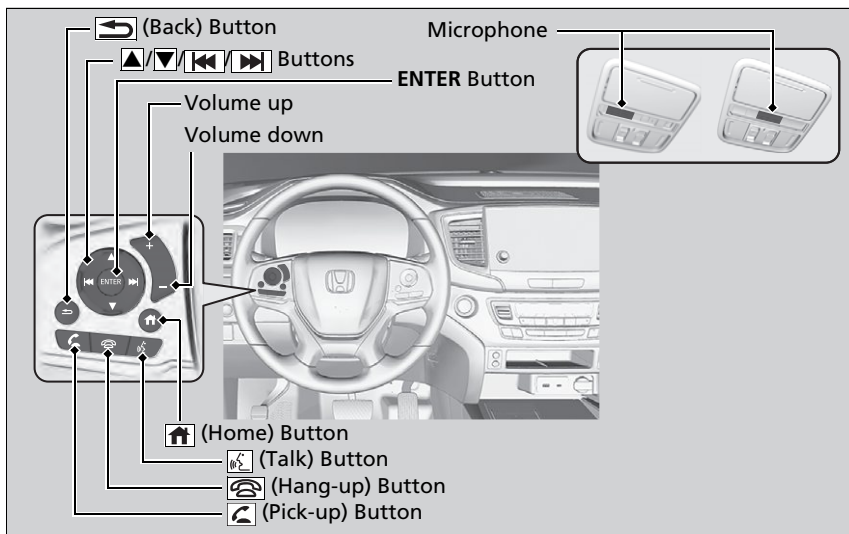

### Bluetooth® HandsFreeLink®

Place your phone where you can get good reception.

To use HFL, you need a *Bluetooth*-compatible cell phone. For a list of compatible phones, pairing procedures, and special feature capabilities,

- U.S.: Visit <https://mygarage.honda.com/s/honda-handsfreelink-compatibility-check>, or call 1-888-528-7876.
- Canada: For more information on smartphone compatibility, call 1-855-490-7351.

To use the system, the **Bluetooth** setting must be **ON**.

#### Phone Setup P. 348

Voice control tips

- Aim the vents away from the ceiling and close the windows, as noise coming from them may interfere with the microphones.
- Press the  button when you want to call a number using a phonebook name or a number. Speak clearly and naturally after a beep.
- If the microphones pick up voices other than yours, the command may be misinterpreted.
- To change the volume level, select the audio system's **VOL** (Volume) or use the remote audio controls on the steering wheel.

If there is no speed dial entry in the system, the pop-up notification appears on the screen.

#### Favorite Contacts P. 353

If there is no call history, the call history is disabled.

Continued

 **(Pick-up) button:** Press to go directly to the phone screen of the driver information interface, or to answer an incoming call.

 **(Hang-up) button:** Press to end a call.

 **(Back) button:** Press to go back to the previous screen, or cancel a command.

 **(Talk) button:** Press to access Voice Portal.

 **buttons:** Press to select an item displayed on the phone screen of the driver information interface.

**ENTER button:** Press to call a number listed in the selected item on the phone screen of the driver information interface.

 **(Home) button:** Press to go back to the home screen of the driver information interface.

To go to the phone screen of the driver information interface:

1. Press the  (home) button on the steering wheel.
2. Select **Phone**.
  - ▶ You can select **Favorite Contacts** or **Recent Calls**.

#### ▶▶ Bluetooth® HandsFreeLink®

##### *Bluetooth®* Wireless Technology

The *Bluetooth®* word mark and logos are registered trademarks owned by *Bluetooth* SIG, Inc., and any use of such marks by Honda Motor Co., Ltd., is under license. Other trademarks and trade names are those of their respective owners.

##### HFL Limitations

An incoming call on HFL will interrupt the audio system when it is playing. It will resume when the call is ended.

## ■ HFL Status Display

The audio/information screen notifies you when there is an incoming call.



## ■ Limitations for Manual Operation

Certain manual functions are disabled or inoperable while the vehicle is in motion. You cannot select a grayed-out option until the vehicle is stopped.

Only previously stored phonebook names or numbers can be called using voice commands while the vehicle is in motion.

➤ **Favorite Contacts** P. 353

## ▣ HFL Status Display

The information that appears on the audio/information screen varies between phone models.

## HFL Menu

The power mode must be in ACCESSORY or ON to use the system.

### ■ Phone settings screen

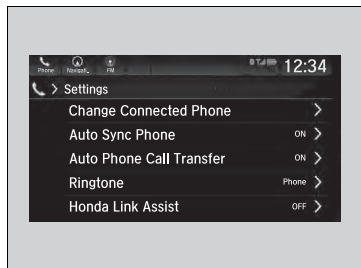

1. Select .
2. Select **Phone**.
3. Select **Settings**.

### ▶▶ HFL Menu

To use HFL, you must first pair your *Bluetooth*-compatible cell phone to the system while the vehicle is parked.

Some functions are limited while driving.

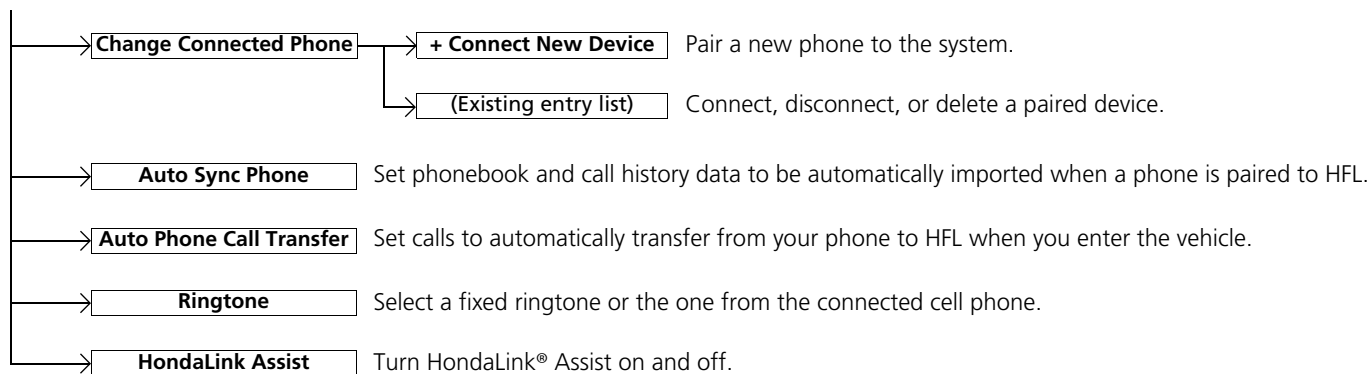

■ Phone menu screen

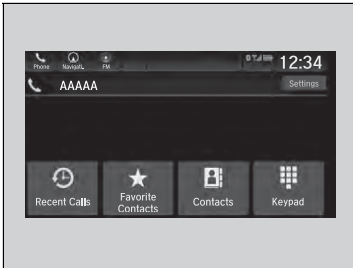

1. Select .
2. Select **Phone**.

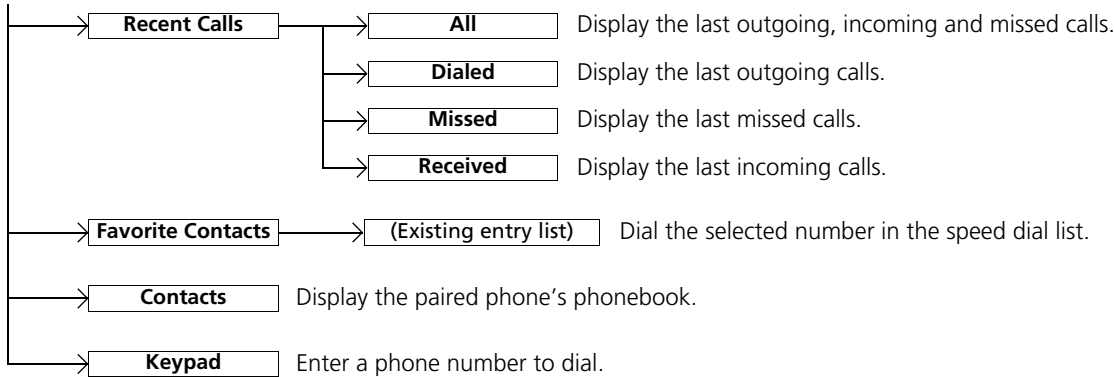



## Phone Setup

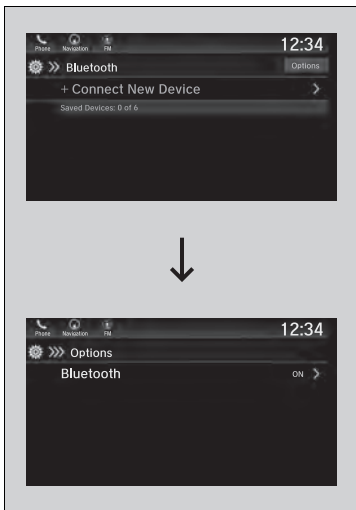

### ■ Bluetooth® setup

You can turn *Bluetooth*® function on and off.

1. Select .
2. Select **Settings**.
3. Select **Connections**.
4. Select **Bluetooth**.
5. Select **Options**.
6. Select **Bluetooth**, then **ON**.



■ **To pair a cell phone (when there is no phone paired to the system)**

1. Select .
2. Select **Phone**.
3. Select **Connect Phone**.
4. Make sure your phone is in search or discoverable mode, then select **+ Connect New Device**.
  - ▶ HFL automatically searches for a *Bluetooth*® device.
5. Select your phone when it appears on the list.
  - ▶ If your phone still does not appear, search for *Bluetooth*® devices using your phone.

From your phone, search for **HandsFree Link**.
6. The system gives you a pairing code on the audio/information screen.
  - ▶ Confirm if the pairing code on the screen and your phone match.

This may vary by phone.
7. Select desired functions and then select **Connect**.
  - ▶ A confirmation message appears on the screen. Select **Continue** or **Connect without Internet**.

☒ Phone Setup



Your *Bluetooth*-compatible phone must be paired to the system before you can make and receive hands-free calls.

Phone Pairing Tips:

- You cannot pair your phone while the vehicle is moving.
- Up to six phones can be paired.
- Your phone's battery may drain faster when it is paired to the system.
- If your phone is not ready to be paired or is not paired within three minutes, the system will time out and return to idle.

Once you have paired a phone, you can see it displayed on the screen with one or more icons on the right side.



These icons indicate the following:

- : The phone is compatible with *Bluetooth*® Audio.
- : The phone can be used with HFL.
- : The phone can be used with the internet tethering.

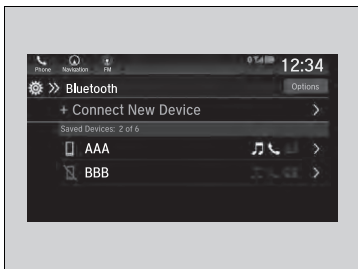
If there is an active connection to Apple CarPlay or Android Auto, pairing of additional *Bluetooth* compatible devices is unavailable and **+ Connect New Device** is grayed out from the **Bluetooth** screen.



■ **To change the currently paired phone**

1. Go to the phone settings screen.
  - ▶ **Phone settings screen** P. 346
2. Select **Change Connected Phone**.
3. Select a phone to connect.
  - ▶ HFL disconnects the connected phone and starts searching for another paired phone.
4. Select ,  or .
5. Select **Apply**.

■ **To delete a paired phone**

1. Go to the phone settings screen.
    - ▶ **Phone settings screen** P. 346
  2. Select **Change Connected Phone**.
  3. Select a phone you want to delete.
- 
4. Select **Delete Device**.
  5. A confirmation message appears on the screen. Select **Delete**.

▶▶ **To change the currently paired phone**

If no other phones are found or paired when trying to switch to another phone, HFL will inform you that the original phone is connected again.

To pair other phones, select + **Connect New Device** from the **Bluetooth** screen.

## Ringtone

You can change the ringtone setting.

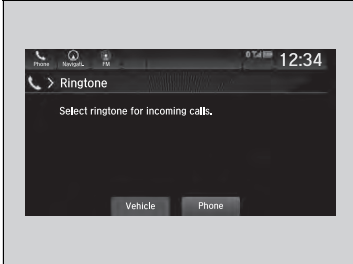

1. Go to the phone settings screen.  
➤ **Phone settings screen** P. 346
2. Select **Ringtone**.
3. Select **Vehicle** or **Phone**.

## Automatic Transferring

If you get into the vehicle while you are on the phone, the call can be automatically transferred to HFL.

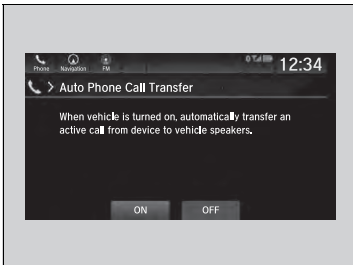

1. Go to the phone settings screen.  
➤ **Phone settings screen** P. 346
2. Select **Auto Phone Call Transfer**.
3. Select **ON** or **OFF**.

## Ringtone

**Vehicle:** The fixed ringtone sounds from the speakers.

**Phone:** Depending on the make and model of the cell phone, the ringtone stored in the phone will sound if the phone is connected.

## ■ Automatic Import of Cellular Phonebook and Call History

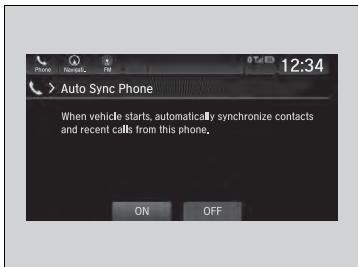
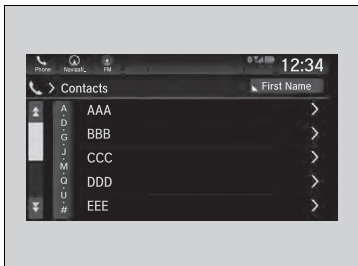

### ■ When Automatic Phone Sync is set to On:

When your phone is paired, the contents of its phonebook and call history are automatically imported to the system.

### ■ Changing the Automatic Phone Sync setting

1. Go to the phone settings screen.
  - ▶ **Phone settings screen** P. 346
2. Select **Auto Sync Phone**.
3. Select **ON** or **OFF**.

### ▶▶ Automatic Import of Cellular Phonebook and Call History

When you select a name from the list in the cellular phonebook, you can see a category icon. The icons indicate what types of numbers are stored for that name.

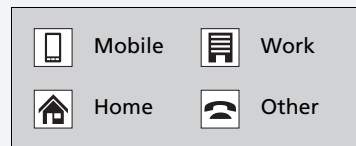

On some phones, it may not be possible to import the category icons to the system.

The phonebook is updated after every connection. Call history is updated after every connection or call.

## Favorite Contacts

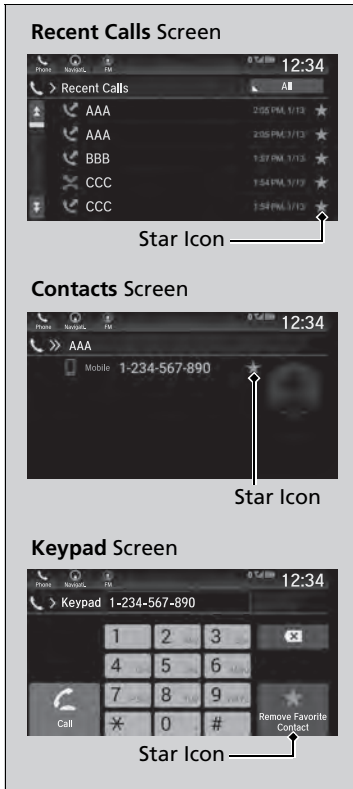

To store a speed dial number:

1. Go to the phone menu screen.
  - ▶ **Phone menu screen** P. 347
2. Select the **Recent Calls, Contacts,** or **Keypad** screen.
3. Select the star icon.
  - ▶ A notification appears on the screen if the speed dial is successfully stored.
  - ▶ To remove the speed dial, select the star icon again.

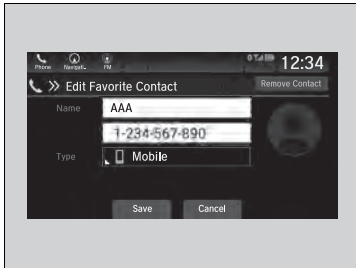

### ■ To edit a speed dial

1. Go to the phone menu screen.
  - ▶ **Phone menu screen** P. 347
2. Select **Favorite Contacts**.
3. Select **Edit** on the speed dial entry you want to edit.
4. Select a setting you want.

### ■ To delete a speed dial

1. Go to the phone menu screen.
  - ▶ **Phone menu screen** P. 347
2. Select **Favorite Contacts**.
3. Select **Edit** on the speed dial entry you want to delete.
4. Select **Remove Contact**.
5. A confirmation message appears on the screen. Select **Continue**.

## Making a Call

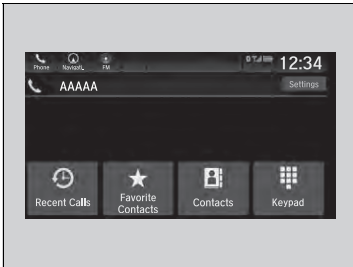

You can make calls by inputting any phone number, or by using the imported phonebook, call history, or speed dial entries.

## ▶▶ Making a Call

Once a call is connected, you can hear the voice of the person you are calling through the audio speakers.

While there is an active connection with Apple CarPlay, phone calls cannot be made with HandsFreeLink® and are only made from Apple CarPlay.



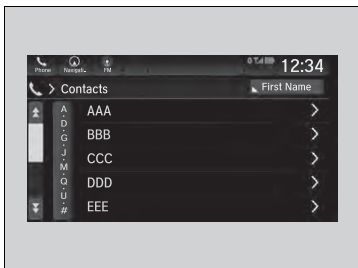

■ **To make a call using the imported phonebook**

1. Go to the phone menu screen.
  - ▶ **Phone menu screen** P. 347
2. Select **Contacts**.
3. Select a name.
  - ▶ You can sort by **First Name** or **Last Name**. Select the icon on the upper right of the screen.
4. Select a number.
  - ▶ Dialing starts automatically.

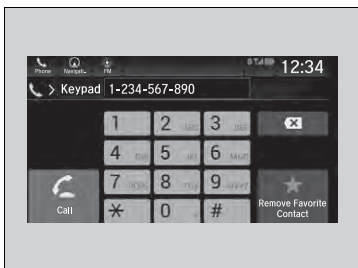

■ **To make a call using a phone number**

1. Go to the phone menu screen.
  - ▶ **Phone menu screen** P. 347
2. Select **Keypad**.
3. Select a number.
  - ▶ Use the keyboard on the touch screen for entering numbers.
4. Select **Call**.
  - ▶ Dialing starts automatically.

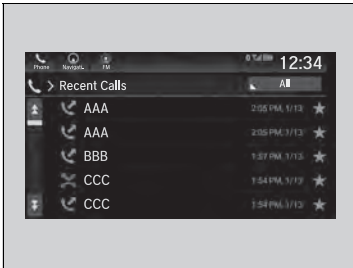

■ **To make a call using the call history**

Call history is stored by **All**, **Dialed**, **Missed**, and **Received**.

1. Go to the phone menu screen.
  - ▶ **Phone menu screen** P. 347
2. Select **Recent Calls**.
  - ▶ You can sort by **All**, **Dialed**, **Missed**, or **Received**. Select the icon on the upper right of the screen.
3. Select a number.
  - ▶ Dialing starts automatically.

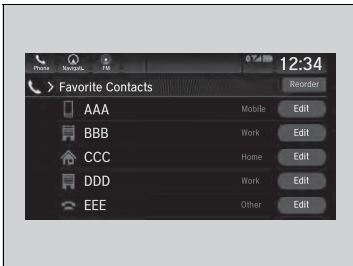

■ **To make a call using a speed dial entry**

1. Go to the phone menu screen.
  - ▶ **Phone menu screen** P. 347
2. Select **Favorite Contacts**.
  - ▶ You can change the order of speed dial entries by selecting **Reorder**.
3. Select a number.
  - ▶ Dialing starts automatically.



☒ **To make a call using the call history**

The call history appears only when a phone is connected to the system.

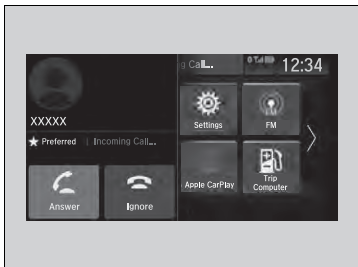
## ■ Receiving a Call



When there is an incoming call, an audible notification sounds (if activated) and the **Incoming Call...** screen appears.

Press the  button to answer the call.  
 Press the  button to decline or end the call.

## ■ Options During a Call

The following options are available during a call.

**Mute:** Mute your voice.

**Use Handheld:** Transfer a call from the system to your phone.

**Keypad:** Send numbers during a call. This is useful when you call a menu-driven phone system.

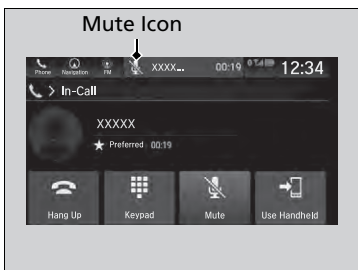

The available options are shown on the lower half of the screen.

Select the option.

- ▶ The mute icon appears when **Mute** is selected. Select **Mute** again to turn it off.

## ▣ Receiving a Call



### Call Waiting

Press the  button to put the current call on hold to answer the incoming call.

Press the  button again to return to the current call.

Select **Ignore** to ignore the incoming call if you do not want to answer it.

Press the  button if you want to hang up the current call.

You can select the icons on the audio/information screen instead of the  and  buttons.

## ▣ Options During a Call

**Keypad:** Available on some phones.

You can select the icons on the audio/information screen.

## ■ To Set Up Text Message Options

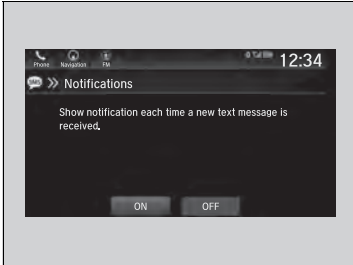

### ■ To turn on or off the text message notice

1. Select .
2. Select **Messages**.
3. Select **Settings**.
4. Select **Notifications**.
5. Select **ON** or **OFF**.

### ☒ To Set Up Text Message Options

To use the text message function, it may be necessary to set up on your phone.

### ☒ To turn on or off the text message notice

**ON:** A pop-up notification comes on every time you receive a new message.

**OFF:** The message you receive is stored in the system without notification.

## ■ Receiving a Text Message

HFL can display newly received text messages as well as the last 20 messages received on a linked cell phone. Each received message can be read aloud and replied to using a fixed common phrase.

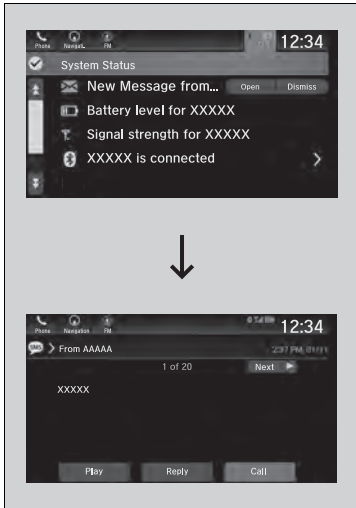

1. A pop-up appears and notifies you of a new text message.
2. Select **Open** to display the message.
  - ▶ The text message is displayed.
3. Select **Play** to listen to the message. To discontinue the message read-out, select **Stop**.

## ▣ Receiving a Text Message

The system does not display any received messages while you are driving. You can only hear them read aloud.

The system can only receive messages that are sent as text (SMS) messages. The message sent using the data services will not be displayed in the list.

With some phones, you may be able to display up to 20 of the last text messages received.

State or local laws may limit your use of the HFL text message feature. Only use the text message feature when conditions allow you to do so safely.

## Selecting a Phone

You can select one from the *Bluetooth*® device list to be active and receive notifications.

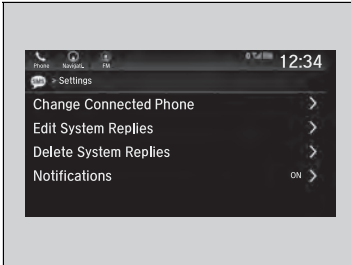

1. Select .
2. Select **Messages**.
3. Select **Settings**.
4. Select **Change Connected Phone**.
5. Change a desired phone.
  - ▣ **To change the currently paired phone**

P. 350

## Selecting a Phone

You can only receive notifications from one phone at a time.

## ■ Displaying Messages

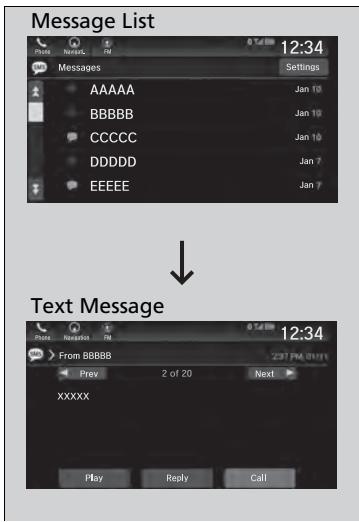



1. Select .
2. Select **Messages**.
  - ▶ Select a phone if necessary.
3. Select a message.
  - ▶ The text message is displayed.

## » Displaying Messages

The  (blue) icon appears next to an unread message.

If you delete a message on the phone, the message will also be deleted from the system. If you send a message from the system, the message goes to your phone's outbox.

To see the previous or next message, select  **Prev** or **Next** .

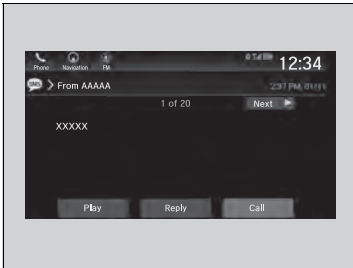

### ■ Read or Stop reading a message

1. Go to the text message screen.
2. Select **Play**.
  - ▶ The system starts reading the message aloud.
3. Select **Pause** to stop reading. Select **Play** again to start reading the message.



### ■ Reply to a message

1. Go to the text message screen.
2. Select **Reply**.
3. Select the reply message.
  - ▶ The pop-up menu appears on the screen.
4. Select **Send** to send the message.
  - ▶ **Message sent** appears on the screen when the reply message was successfully sent.

### ☒ Reply to a message

The available fixed reply messages are as follows:

- **Talk to you later, I'm driving.**
- **I'm on my way.**
- **I'm running late.**
- **OK**
- **Yes**
- **No**

You can add a reply message by selecting **+ Create New Message**.

☒ **To edit a reply message** P. 364

Only certain phones receive and send messages when paired and connected. For a list of compatible phones:

- U.S.: Visit <https://mygarage.honda.com/!honda-handsfreelink-compatibility-check>, or call 1-888-528-7876.
- Canada: For more information on smartphone compatibility, call 1-855-490-7351.



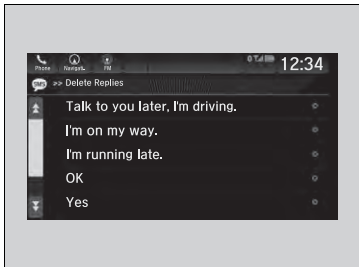
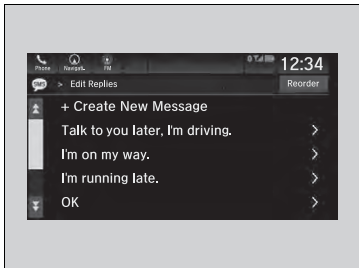



### ■ To edit a reply message

1. Select .
2. Select **Messages**.
3. Select **Settings**.
4. Select **Edit System Replies**.
5. Select the reply message you want to edit or + **Create New Message**.
  - ▶ The on-screen keyboard screen is displayed.
6. Enter a reply message, and then select **Save**.

### ■ To delete a reply message

1. Select .
2. Select **Messages**.
3. Select **Settings**.
4. Select **Delete System Replies**.
5. Select  on the reply message you want to delete.
  - ▶ The pop-up menu appears on the screen.
6. Select **Delete**.

### ▶▶ To edit a reply message

You can change the order of reply messages by selecting **Reorder**.

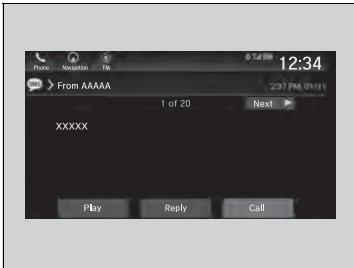

■ **Making a call to a sender**

1. Go to the text message screen.
2. Select **Call**.

## ■ In Case of Emergency

### ■ Automatic collision notification

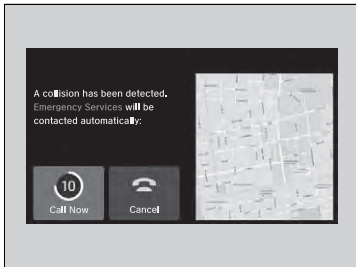

If your vehicle's airbags deploy or if the unit detects that the vehicle is severely impacted, your vehicle automatically will attempt to connect to the HondaLink® operator. If connected, information about your vehicle, its location, and its condition can be sent to the operator\*1; you also can speak to the operator when connected.

**IMPORTANT:** For vehicles equipped with HondaLink® Assist, owner activation constitutes authorization for Honda to collect information from your vehicle needed to provide the service, and agreement to the Terms of Use at <https://mygarage.honda.com/resource/AutoLinkLegalTerms/HondaLinkLegalTerms/HondaLinkTermsAndConditions.pdf>. In a crash, HondaLink® Assist will attempt to notify emergency services but NEITHER HONDA NOR ITS SERVICE PROVIDERS GUARANTEE THAT SUCH NOTIFICATION WILL OCCUR.

Honda reserves the right to terminate HondaLink® Assist services at any time or for any reason, and in the future may not be able to provide services due to changes in, or obsolescence of, technology integral to the service or changes in governmental regulation.

\*1: Depending on your phone and adequate cellular coverage, your vehicle's location may not be sent to the operator.

## ☒ In Case of Emergency

Your vehicle may not be able to connect to the operator if the battery level is low, the line is disconnected, or you do not have adequate cellular coverage.

You cannot use this emergency service when:

- You travel outside the HondaLink® service coverage areas.
- There is a problem with the connecting devices, such as the microphones, speakers, or the unit itself.

You cannot operate other phone-related functions using the screen while talking to the operator. Select **Hang Up** to terminate the connection to your vehicle.

## ☒ Automatic collision notification

If the unit fails to connect to the operator, it repeatedly tries until it succeeds.

## ■ To enable notification

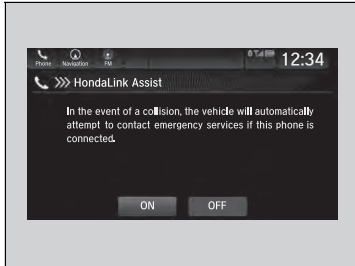

1. Go to the phone settings screen.  
▶ **Phone settings screen** P. 346
2. Select **HondaLink Assist**.
3. Select **ON** or **OFF**.

## ☒ To enable notification

Setting options:

- **ON**: Notification is available.
- **OFF**: Disable the feature.

Continued

### ■ Manual operator connection\*

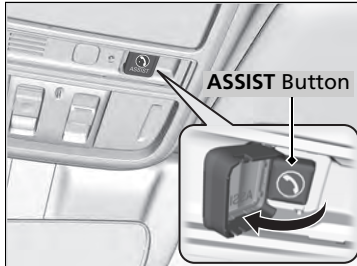

If you need to talk to the HondaLink® operator in a situation where no airbag has deployed, you can manually connect to them by pressing the **ASSIST** button with the power mode in ACCESSORY or ON.

1. Open the cover attached to the ceiling console.
2. Press the **ASSIST** button.
  - ▶ You are connected to the HondaLink® operator.

### ☒ Manual operator connection\*

Do not press the button while driving. When you need to contact the operator, park the vehicle in a safe place.

If the unit fails to connect to the operator, it automatically cancels the action after three minutes.

If necessary, the cover can be broken to access the **ASSIST** button.

# Driving

This chapter discusses driving and refueling.



<b>Before Driving</b> .....	370
<b>Towing a Trailer</b> .....	376
<b>Off-Highway Driving Guidelines</b> .....	386
<b>When Driving</b>	
Starting the Engine .....	388
Automatic Transmission .....	395
Shifting .....	396
Auto Idle Stop.....	404
ECON Mode .....	409
Intelligent Traction Management.....	410
Vehicle Stability Assist™ (VSA®), aka Electronic Stability Control (ESC), System.....	411
Agile Handling Assist .....	413
Blind spot information System.....	414

Intelligent Variable Torque Management (i- VTM4™) AWD System.....	417
Tire Pressure Monitoring System (TPMS) with Tire Fill Assist.....	418
Tire Pressure Monitoring System (TPMS) - Required Federal Explanation .....	420
<b>Honda Sensing®</b> .....	422
Collision Mitigation Braking System™ (CMBS™) .....	425
Road Departure Mitigation (RDM) System .....	437
Adaptive Cruise Control (ACC).....	442
Lane Keeping Assist System (LKAS) ..	455
Front Sensor Camera .....	464
Radar Sensor.....	466

<b>Braking</b>	
Brake System .....	467
Anti-lock Brake System (ABS).....	469
Brake Assist System .....	470
<b>Parking Your Vehicle</b>	
When Stopped .....	471
Parking Sensor System * .....	473
Cross Traffic Monitor .....	478
<b>Multi-View Rear Camera</b> .....	482
<b>Refueling</b>	
Fuel Information .....	484
How to Refuel .....	485
<b>Fuel Economy and CO<sub>2</sub> Emissions</b>	
Improving Fuel Economy and Reducing CO <sub>2</sub> Emissions.....	487

\* Not available on all models

## Driving Preparation

Check the following items before you start driving.

### Exterior Checks

- Make sure there are no obstructions on the windows, door mirrors, exterior lights, or other parts of the vehicle.
  - ▶ Remove any frost, snow, or ice.
  - ▶ Remove any snow on the roof, as this can slip down and obstruct your field of vision while driving. If frozen solid, remove ice once it has softened.
  - ▶ When removing ice from around the wheels, be sure not to damage the wheel or wheel components.
- Make sure the hood is securely closed.
  - ▶ If the hood opens while driving, your front view will be blocked.
- Make sure the tires are in good condition.
  - ▶ Check air pressures, and check for damage and excessive wear.
    - ✦ **Checking and Maintaining Tires** P. 522
- Make sure there are no people or objects behind or around the vehicle.
  - ▶ There are blind spots from the inside.

### Exterior Checks

#### NOTICE

When doors are frozen shut, use warm water around the door edges to melt any ice. Do not try to force them open, as this can damage the rubber trim around the doors. When done, wipe dry to avoid further freezing.

Do not pour warm water into the key cylinder. You will be unable to insert the key if the water freezes in the hole.

Heat from the engine and exhaust can ignite flammable materials left under the hood, causing a fire. If you've parked your vehicle for an extended period, inspect and remove any debris that may have collected, such as dried grass and leaves that have fallen or have been carried in for use as a nest by a small animal. Also, check under the hood for leftover flammable materials after you or someone else has performed maintenance on your vehicle.

## Interior Checks

- Store or secure all items on board properly.
  - ▶ Carrying too much cargo, or improperly storing it, can affect your vehicle's handling, stability, stopping distance, and tires, and make it unsafe.
    - ✦ **Maximum Load Limit** P. 373
- Do not pile items higher than the seat height.
  - ▶ They can block your view and may be thrown forward in the event of sudden braking.
- Do not place anything in the front seat footwells. Make sure to secure the floor mat.
  - ▶ An object or unsecured floor mat can interfere with your brake and accelerator pedal operation while driving.
- If you have any animals on board, do not let them move around in the vehicle.
  - ▶ They may interfere with driving and a crash could occur.
- Securely close and lock all doors and the tailgate.
  - ✦ **Locking/Unlocking the Doors from the Inside** P. 139
- Adjust your seating position properly.
  - ▶ Adjust the head restraint, too.
    - ✦ **Seats** P. 182
    - ✦ **Adjusting the Front and Rear Outer Seat Head Restraint Positions** P. 189
- Adjust the mirrors and steering wheel properly.
  - ▶ Adjust them while sitting in the proper driving position.
    - ✦ **Adjusting the Steering Wheel** P. 179
    - ✦ **Mirrors** P. 180

## Interior Checks

The headlight aim is set by the factory, and does not need to be adjusted. However, if you regularly carry heavy items in the cargo area or tow a trailer, have the aiming readjusted at a dealer or by a qualified technician.



- Be sure items placed on the floor behind the front seats cannot roll under the seats.
  - ▶ They can interfere with the driver's ability to operate the pedals, the operation of the seats, or the operation of the sensors under the seats.
- Everyone in the vehicle must fasten their seat belt.
  - 📄 **Fastening a Seat Belt** P. 44
- Make sure that the indicators in the instrument panel come on when you start the vehicle, and go off soon after.
  - ▶ Always have a dealer check the vehicle if a problem is indicated.
    - 📄 **Indicators** P. 82

## Maximum Load Limit

The maximum load for your vehicle is 948 lbs (430 kg).

See the Tire and Loading Information label attached to the driver's doorjamb.

Label Example

TIRE	SIZE	COLD TIRE PRESSURE	SEE OWNER'S MANUAL FOR ADDITIONAL INFORMATION
FRONT	XXXX/XXXX XXX	XXXKPA, XXPSI	
REAR	XXXX/XXXX XXX	XXXKPA, XXPSI	
SPARE	XXXX/XXXX XXX	XXXKPA, XXPSI	

This figure includes the total weight of all occupants, cargo, and accessories, and the tongue load if you are towing a trailer.

Steps for Determining Correct Load Limit -

- (1) Locate the statement "The combined weight of occupants and cargo should never exceed XXX kg or XXX lbs." on your vehicle's placard.
- (2) Determine the combined weight of the driver and passengers that will be riding in your vehicle.
- (3) Subtract the combined weight of the driver and passengers from XXX kg or XXX lbs.

### Maximum Load Limit

## ⚠ WARNING

Overloading or improper loading can affect handling and stability and cause a crash in which you can be hurt or killed.

Follow all load limits and other loading guidelines in this manual.

Gross Vehicle Weight Rating (GVWR):

The maximum allowable weight of the vehicle, all occupants, all accessories, all cargo, and the tongue load.

➤ Specifications P. 578

Gross Axle Weight Rating (GAWR):







The maximum allowable weight of the vehicle axle.

➤ Specifications P. 578

- (4)** The resulting figure equals the available amount of cargo and luggage load capacity. For example, if the “XXX” amount equals 1,400 lbs. and there will be five 150 lb. passengers in your vehicle, the amount of available cargo and luggage load capacity is 650 lbs.  $(1,400 - 750 (5 \times 150) = 650 \text{ lbs.})$
- (5)** Determine the combined weight of luggage and cargo being loaded on the vehicle. That weight may not safely exceed the available cargo and luggage load capacity calculated in step 4.
- (6)** If your vehicle will be towing a trailer, load from your trailer will be transferred to your vehicle. Consult this manual to determine how this reduces the available cargo and luggage load capacity of your vehicle.

In addition, the total weight of the vehicle, all occupants, accessories, cargo, and trailer tongue load must not exceed the Gross Vehicle Weight Rating (GVWR) or the Gross Axle Weight Rating (GAWR). Both are on a label on the driver's doorjamb.

**Load Limits Example**

<p>Example1</p>  <p>Max Load 948 lbs (430 kg)</p>	$\geq$	 <p>Passenger Weight 150 lbs x 2 = 300 lbs (68 kg x 2 = 136 kg)</p>	<p>+</p>	 <p>Cargo Weight 648 lbs (294 kg)</p>
<p>Example2</p>  <p>Max Load 948 lbs (430 kg)</p>	$\geq$	 <p>Passenger Weight 150 lbs x 5 = 750 lbs (68 kg x 5 = 340 kg)</p>	<p>+</p>	 <p>Cargo Weight 198 lbs (90 kg)</p>

▶▶ Maximum Load Limit

Towing a Trailer:

See Towing a Trailer to determine whether your vehicle is designed to tow a trailer.

▶ **Towing a Trailer** P. 376

## Towing Preparation

### Towing Load Limits

Your vehicle can tow a trailer if you carefully observe the load limits, use the proper equipment, and follow the towing guidelines. Check the load limits before driving.

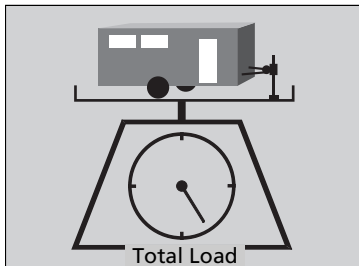

#### ■ Total trailer weight

Do not exceed the maximum allowable weight of the trailer, cargo, and everything in or on it shown in the table.

Towing loads in excess of this can seriously affect vehicle handling and performance and can damage the engine and drivetrain.

Number of occupants	Models with ATF cooler	Models without ATF cooler
2	5,000 lbs (2,268 kg)	3,500 lbs (1,588 kg)
3	4,750 lbs (2,155 kg)	3,250 lbs (1,474 kg)
4	4,500 lbs (2,041 kg)	3,000 lbs (1,361 kg)
5	4,250 lbs (1,928 kg)	2,750 lbs (1,247 kg)

Each weight limit is calculated based on the following conditions:

- Occupants fill seats from the front of the vehicle to the back.
- Each occupant weighs 150 lbs (68 kg).
- Each occupant has 17.6 lb (8 kg) cargo in the cargo area.

Any additional weight, cargo or accessories reduce the maximum trailer weight and maximum tongue load.

### » Towing Load Limits

## ⚠ WARNING

Exceeding any load limit or improperly loading your vehicle and trailer can cause a crash in which you can be seriously hurt or killed.

Check the loading of your vehicle and trailer carefully before starting to drive.

Check if all loads are within limits at a public scale. If a public scale is not available, add the estimated weight of your cargo load to the weight of your trailer (as quoted by the manufacturer), and then measure the tongue load with an appropriate scale or tongue gauge or estimate it based on cargo distribution.

Refer to the trailer owner's manual for additional information.

#### Break-in Period

Avoid towing a trailer during your vehicle's first 600 miles (1,000 km).

Never exceed the gross weight ratings.

Gross weight information

» **Vehicle Specifications** P. 578

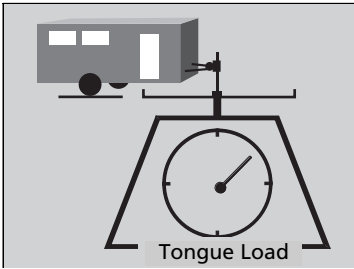

**■ Tongue load**

The weight of the tongue with a fully loaded trailer on the hitch should be approximately:

Boat trailers: 5 – 15% of the total trailer weight

Other trailers: 10 – 15% of total trailer weight

Number of occupants	Models with or without ATF cooler
2	500 lbs (227 kg)
3	475 lbs (215 kg)
4	405 lbs (183 kg)
5	234 lbs (106 kg)

### ■ How to weigh the trailer loads using the public scale

Check each weight in the order indicated as shown.

Refer to the table on the right for each weight's limit except for the tongue load.

➤ **Tongue load** P. 377

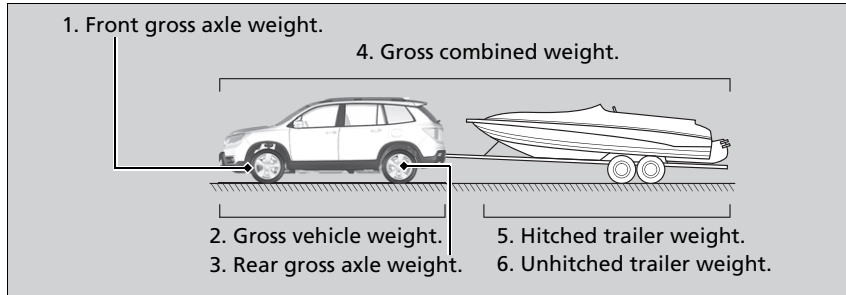

- If you cannot weigh the rear axle, subtract 1 from 2.
- The maximum gross combined weight (4) decreases by 2% for every 1,000 feet (305 meters) of elevation.
- To calculate the tongue load, subtract 5 from 6.
- Refer to the trailer owner's manual for additional information.

### ▶▶ How to weigh the trailer loads using the public scale

Fully load the vehicle and trailer. An attendant who watches the scale is needed as all occupants should stay in the vehicle.

Weight limit	
Front gross axle	2,855 lbs (1,295 kg)
Gross vehicle	5,401 lbs (2,450 kg)
Rear gross axle	3,141 lbs (1,425 kg)
Gross combined	9,755 lbs (4,425 kg)

If a public scale is not available, add the estimated weight of your cargo load to the weight of your trailer (as quoted by the manufacturer), and then measure the tongue load with an appropriate scale or tongue gauge or estimate it based on cargo distribution.

## ■ Towing Equipment and Accessories

Towing generally requires a variety of supplemental equipment. To ensure the best quality, we recommend that you purchase Honda equipment whenever possible.

### ■ Trailer brakes

Recommended for any trailer with a total weight of 1,000 lbs (450 kg) or more: There are two common types of trailer brakes: surge and electric. Surge brakes are common for boat trailers, since the brakes will get wet.

If you choose electric brakes, be sure they are electronically actuated. Do not attempt to attach trailer brakes to your vehicle's hydraulic system, as it will lower braking effectiveness and create a potential hazard.

The 4-pin gray connector installed in your vehicle has all of the circuits required to install most electric trailer brake controllers.

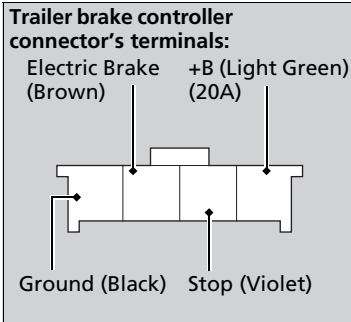

Have a qualified mechanic install your trailer brake controller following the trailer brake controller manufacturer's instructions. Failure to properly install the trailer brake controller may increase the distance it takes for you to stop your vehicle when towing a trailer.

## ▣ Towing Equipment and Accessories

Make sure that all equipment is properly installed and maintained, and that it meets federal, state, province/territory, and local regulations.

Consult your trailer maker for proper installation and setup of the equipment. Improper installation and setup can affect the handling, stability, and braking performance of your vehicle.

Consult your trailer sales or rental agency if any other items are recommended or required for your towing situation.

The lighting and wiring of trailers can vary by type and brand. If a connector is required, it should only be installed by a qualified technician.

Trailer packages and products available at a dealer:

- Ball mount, hitch plug, hitch pin, etc.
- Wiring harness kit
- Trailer hitch kit (jumper harness included)

### ▣ Trailer brakes P. 379

- Automatic transmission cooler

## ▣ Trailer brakes

The 4-pin gray connector is located under the instrument panel near the top of the parking brake pedal.



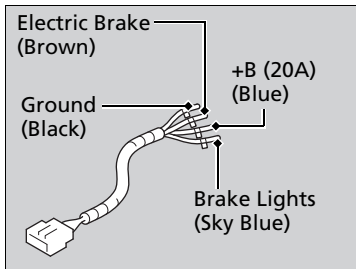

The trailer hitch harness is used to install the controller for the electric trailer brakes. Insert the trailer brake fuse into the engine compartment sub fuse box.

➤ **Engine Compartment Fuse Box Type B**

P. 568

## ■ Trailer light

Trailer lights and equipment must comply with federal, state, province/territory, and local regulations. Check with your local trailer sales or rental agency for the requirements in the area where you plan to tow.

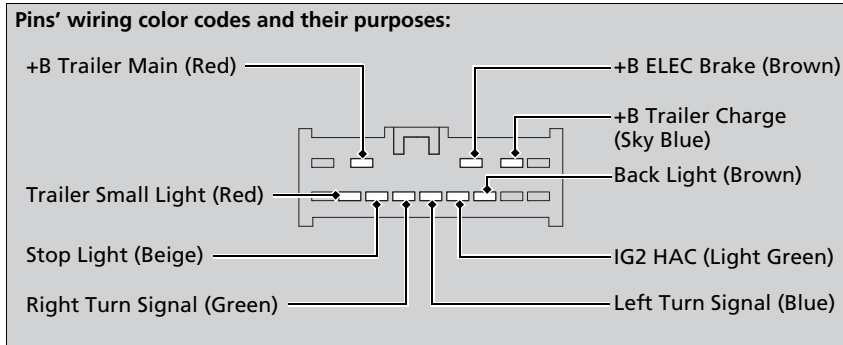

We recommend that you have a dealer install a Honda wiring harness and converter. They are designed for your vehicle.

## ■ Hitches

Read the trailer manufacturer's instructions, and select the appropriate draw bar for the height of the trailer you will be towing.

## ■ Weight distribution hitches

Your vehicle is designed to tow without the need for a load distributing hitch. If you wish to use one, please consult your trailer maker for proper installation and set-up. Improper set-up could degrade the handling, stability, and braking performance of your vehicle.

### ☒ Trailer light

The trailer lighting connector is located behind the left side panel in the cargo area. Even if you are planning to use the non-Honda trailer lighting harness and converter, ask a dealer for the correct connector and pins.

### ■ Safety chains

Always use safety chains when you tow a trailer. Leave enough slack to allow the trailer to turn corners easily, but do not allow the chains to drag on the ground.

### ■ Sway control

This device can be used if your trailer tends to sway. Your trailer maker can tell you what kind of sway control you need and how to install it. Improper installation could degrade the handling and stability of your vehicle.

### ■ Trailer mirrors

Many states, provinces and territories require special exterior mirrors when towing a trailer. Install special mirrors whenever you cannot clearly see behind you, or if the trailer creates a blind spot.

### ■ Automatic transmission cooler

An additional ATF (automatic transmission fluid) cooler is required to keep the transmission from overheating when towing more than 3,500 lbs (1,588 kg). You can get the additional ATF cooler at a dealer.

## Trailer Stability Assist

Helps to stabilize the vehicle and trailer when the trailer severely sways.

### ■ How trailer stability assist works

When the vehicle and trailer become unstable while driving, trailer stability assist determines the cause. If the trailer oscillation is detected as the cause, and the swaying increases, the system applies the brakes or controls engine output to reduce vehicle speed.

Both the vehicle and trailer brake lights come on automatically if you brake to reduce vehicle speed.

### ▣ Trailer Stability Assist

Trailer stability assist is not a function that prevents the vehicle and trailer from swaying. Avoid high speeds, abrupt steering, improper trailer load, and sudden braking to keep the trailer from swaying. When swayed too severely, the system becomes ineffective, and you may lose control of your vehicle, causing the trailer to roll over or get damaged.

➤ **Driving Safely with a Trailer** P. 384

Trailer towing sway is caused by:

- Crosswinds
- Improper towbar down load
- Excessive Speed

The VSA® system indicator blinks during the trailer stability assist operation.

➤ **VSA® Operation** P. 411

## Driving Safely with a Trailer

### ■ Things You Need To Know Before Towing a Trailer

- Have the trailer properly serviced and keep it in good condition.
- Make sure that all the weights and load in the vehicle and trailer are within limits.
  - ✦ **Towing Load Limits** P. 376
- When towing more than 3,500 lbs (1,588 kg), use of gasoline with a pump octane number of 87 or higher is recommended.
  - ▶ Towing performance can be affected by high altitude, high temperature, or steep uphill.
- Securely attach the hitch, safety chains, and other necessary parts to the trailer.
- Securely store all the items in and on the trailer so that they do not shift while driving.
- Check if the lights and brakes on the trailer are working properly.
- Check the pressures of the trailer tires.
- Turn off the Auto Idle Stop system using the Auto Idle Stop **OFF** button. The trailer weight can affect your vehicle's brake effectiveness if Auto Idle Stop is activated on a hill while towing a trailer.
- Turn off the rear parking sensor system.
  - ✦ **Turning off All Rear Sensors** P. 477

### ■ Towing Speeds and Gears

- Drive slower than normal.
- Obey posted speed limits for vehicles with trailers.
- Use the **D** position when towing a trailer on level roads.

### ■ Turning and Braking

- Turn more slowly and with a wider turning arc than normal.
- Allow more time and distance for braking.

#### ▶▶ Driving Safely with a Trailer

Operating speed when towing a trailer must not exceed 62 mph (100 km/h).

#### Parking

In addition to the normal precautions, place wheel chocks at each of the trailer's tires.

#### ▶▶ Towing Speeds and Gears

When towing a fixed-sided trailer (e.g., camper), do not exceed 55 mph (88 km/h).

At higher speeds, the trailer may sway or affect vehicle handling.

- Do not brake or turn suddenly.

### ■ Driving in Hilly Terrain

- Monitor your temperature gauge. If it nears the white (Hot) mark, turn off the climate control system and reduce speed. Pull to the side of the road safely to cool down the engine if necessary.
- Change the gear position to **[S]** position if the transmission shifts frequently.

### ■ Retrieving a Boat

When retrieving a boat from the water, we recommend using the sequential shift mode **[S]** to utilize the transmissions lower gears.

## Towing Your Vehicle

Your vehicle is not designed to be towed behind a motorhome. If your vehicle needs to be towed in an emergency, refer to the emergency towing information.

📖 **Emergency Towing** P. 572

### 📖 Driving in Hilly Terrain

If the automatic transmission fluid temperature exceeds the specified limit, the transmission will also automatically up shift, even in the sequential shift mode.

## General Information

Your vehicle has been designed primarily for use on pavement, however, its higher ground clearance allows you to occasionally travel on unpaved roads. It is not designed for trail-blazing, or other challenging off-highway activities.

If you decide to drive on unpaved roads, you will find that it requires somewhat different driving skills and that your vehicle will handle somewhat differently than it does on pavement. Pay attention to the precautions and tips in this section, and get acquainted with your vehicle before leaving the pavement.

## Important Safety Precautions

To avoid loss of control or rollover, be sure to follow all precautions and recommendations:

- Be sure to store cargo properly and do not exceed your cargo load limits.
  - ▣ **Maximum Load Limit** P. 373
- Whenever you drive, make sure you and your passengers always wear seat belts.
- Keep your speed low, and never go faster than the conditions allow.
- It's up to you to continually assess the situation and drive within the limits.

### Off-Highway Driving Guidelines

#### **WARNING**

Improperly operating this vehicle on or off pavement can cause a crash or rollover in which you and your passengers could be seriously injured or killed.

- Follow all instructions and guidelines in this owner's manual.
- Keep your speed low, and don't drive faster than conditions permit.

Failure to operate your vehicle correctly might result in a crash or a rollover.

- ▣ **Important Handling Information** P. 36
- ▣ **Precautions While Driving** P. 394

Spinning the tires excessively can also damage the Intelligent VT<sup>M</sup>4 (i-VT<sup>M</sup>4™) system.

## Avoiding Trouble

---

- **Check Out Your Vehicle** before you leave the pavement and make sure that all scheduled maintenance has been completed. Pay special attention to the condition of the tires, and check the tire pressures.
- **Remember** the route you choose presents limits (too steep or bumpy), you have limits (driving skill and comfort), and your vehicle has limits (traction, stability, and power). Failing to recognize these limits will likely put you and your passengers in a hazardous situation.
- **Accelerating and Braking** should be done slowly and gradually. Trying to start or stop too fast can cause a loss of traction and you could lose control.
- **Avoiding Obstacles and Debris** in the road reduces the likelihood of a rollover or damage to your suspension or other components.
- **Driving on Slopes** increases your risk of a rollover, particularly if you attempt to drive across a slope that is too steep. Going straight up or down a slope is usually the safest. If you can't clearly see all conditions or obstacles on a slope, walk it before you drive it. If there is any doubt whether you can safely pass, don't try it. Find another route. If you get stuck when climbing, do not try to turn around. Back down slowly following the same route you took up the hill.
- **Crossing a Stream** - Avoid driving through deep water. If you encounter water in your route (a small stream or large puddle, for example), evaluate it carefully before going ahead. Make sure it is shallow, flowing slowly, and has firm ground underneath. If you are not sure of the depth or the ground, turn around and find another route. Driving through deep water can also damage your vehicle. When driving in water that reaches around half of the wheel height, the water can get into the transmission and differential, diluting the lubricant and causing an eventual failure. It can also wash the grease out of the wheel bearings.
- **If You Get Stuck**, carefully go in the direction that you think will get you unstuck. Do not spin the tires as this will only make things worse and could damage the transmission. If you are unable to free yourself, your vehicle will need to be towed. Front tow hook is provided for this purpose.



## Starting the Engine

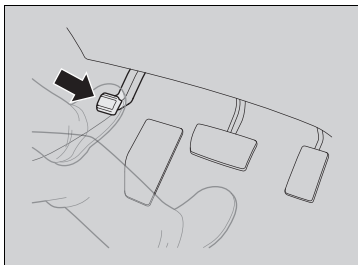

1. Make sure the parking brake is applied.

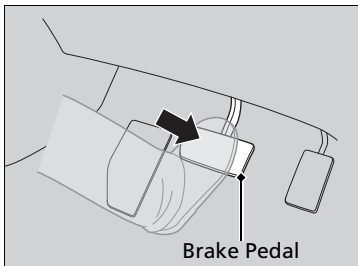

2. Depress the brake pedal.

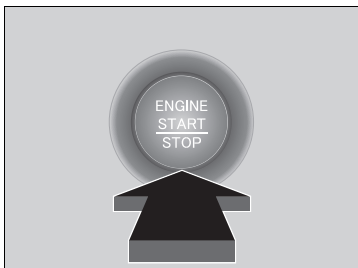

3. Press the **ENGINE START/STOP** button without depressing the accelerator pedal.

### Starting the Engine

Keep your foot firmly on the brake pedal when starting the engine.

The engine is harder to start in cold weather and in thinner air found at altitudes above 8,000 feet (2,400 meters).

When starting the engine in cold weather, turn off all electrical accessories such as the lights, climate control system and rear defogger in order to reduce battery drain.

If you live in a region where winter is extremely cold, an engine block heater will improve starting and warming of the engine. Consult a dealer for details.

If the exhaust system sounds abnormal or you can smell exhaust gas inside the vehicle, have your vehicle checked by a dealer. There may be a problem with the engine or exhaust system.

Bring the keyless remote close to the **ENGINE START/STOP** button if the battery in the keyless remote is weak.

**❏ If the Keyless Remote Battery is Weak**  
P. 555

The engine may not start if the keyless remote is subjected to strong radio waves.

## ■ Stopping the Engine

You can turn the engine off when the vehicle is completely stopped.

1. Depress the brake pedal and change the shift position to **P**.
  - ▶ Do not release the brake pedal until you have confirmed that **P** is shown on the gear position indicator.
2. Press the **ENGINE START/STOP** button.

## ▶▶ Starting the Engine

Do not hold the **ENGINE START/STOP** button to start the engine.

If the engine does not start, wait at least 30 seconds before starting the engine again.

The immobilizer system protects your vehicle from theft.

If an improperly coded device is used, the engine's fuel system is disabled.

▶ **Immobilizer System** P. 152



*Continued*

## ■ Remote Engine Start

You can remotely start the engine using the keyless remote.

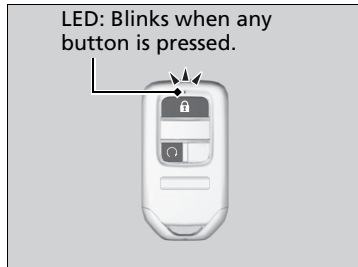
### ■ To start the engine



Press the  button, then press and hold the  button.

▶ Some exterior lights flash once.

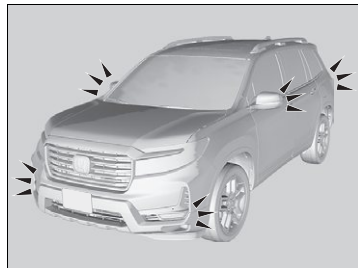

If the engine starts successfully, some exterior lights flash six times.

### ⓘ Remote Engine Start

## ⚠ WARNING

Carbon monoxide gas is toxic and can rapidly accumulate in closed or even partly enclosed areas.

Breathing it can cause unconsciousness and even kill you.

Never use the remote engine starter with the vehicle parked in a garage or other areas with limited ventilation.

The remote engine start may violate local laws. Before using the remote engine start, check your local laws.

If there are buildings and obstacles between your vehicle and the keyless remote, the range will be reduced.

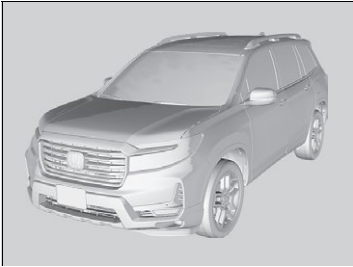

This distance may vary by external electrical interference.



If the engine does not start, exterior lights will not flash.

- ▶ Go within the range, and try again.

When started remotely, the engine automatically shuts off after 10 minutes of idling and/or the brake pedal and **ENGINE START/STOP** button have not been pressed simultaneously.

To extend the run time for another 10 minutes during the first run, press the  button, then press and hold the  button.

- ▶ Some exterior lights flash six times if a 10-minute extension request was transmitted successfully.

#### ▶▶ Remote Engine Start

The engine may not start by the remote engine start if:

- You have disabled a remote engine start setting.
  - ▶ **Customized Features** P. 327
- The power mode is not in VEHICLE OFF.
- The transmission is in a position other than **P**.
- The hood is open, or any door or the tailgate is unlocked.
- You have already used the keyless remote twice to start the engine.
- Another registered keyless remote is in the vehicle.
- There is any antenna failure.
- The door is unlocked with the built-in key.
- The engine oil pressure is low.
- The engine coolant temperature is extremely high.
- The telematics unit malfunctions.\*
- The security system alarm is not set.
- The 12-volt battery charge is too low.

\* Not available on all models

## ■ To stop the engine



Press and hold the  button for one second.

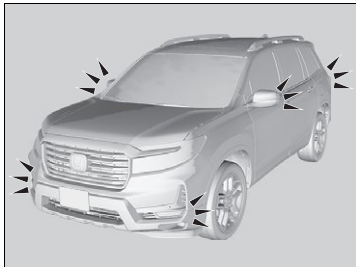

If the engine stops successfully, the exterior lights flash once.



When the keyless remote is out of the keyless access system range, the exterior lights will not flash.

The engine will not stop.

▶ Go within the range, and try again.

## ▣ To stop the engine

The engine may stop while it is running if:

- You do not start the vehicle within 10 minutes of starting the engine with the keyless remote.
- The engine is stopped by using the keyless remote.
- There is any antenna failure.
- The security system alarm is not set.
- The door is unlocked with the built-in key.
- The hood is open, or any door or the tailgate is unlocked.
- Any door is open.
- The telematics unit\* malfunction.
- The engine coolant temperature is extremely high.
- The battery is low.
- The engine oil pressure is low.
- The Malfunction Indicator Lamp comes on if there is a problem with the emissions control systems.
- The transmission is in a position other than **P**.

While the engine is running, the vehicle will automatically precondition inside the vehicle.

When it is warm outside:

- The climate control system is activated in recirculation mode.
  - The seat ventilator is activated\*.
- When it is cold outside:
- The defroster is activated at a moderately warm temperature.
  - The rear defogger and door mirror heaters are activated.
  - The seat heaters and heated steering wheel\* are activated.

▣ **Rear Defogger/Heated Door Mirror Button** P. 174

▣ **Heated Steering Wheel\*** P. 212

▣ **Front Seat Heaters/Ventilators\*** P. 210

## Starting to Drive

### When the engine was started using the keyless remote

1. Depress and hold the brake pedal and press the **ENGINE START/STOP** button.

### When the engine was started in any case

2. Keeping your right foot on the brake pedal, release the parking brake. Check that the parking brake and brake system indicator has gone off.

➤ **Parking Brake** P. 467

3. Put the transmission into **D**. Select **R** when reversing.

4. Gradually release the brake pedal and gently depress the accelerator pedal to pull away.

### ■ Hill start assist system

Hill start assist keeps the brake engaged briefly to help prevent the vehicle from rolling on inclines as you move your foot from the brake pedal to the accelerator.

Put the transmission into **D** or **S** when facing uphill, or **R** when facing downhill, then release the brake pedal.

### ▶▶ Starting to Drive

#### When the engine was started using the keyless remote

The engine stops when the transmission position is changed from **P** before the **ENGINE START/STOP** button is pressed. Follow step 1 when starting to drive.

### ▶▶ Hill start assist system

Hill start assist may not prevent the vehicle from rolling downhill on a very steep or slippery slope, and will not operate on small inclines.

Hill start assist is not a replacement for the parking brake.

Hill start assist will operate even when VSA® is switched off.

## Precautions While Driving

### ■ Driving Guidelines for Your Utility Vehicle

Utility vehicles have a significantly higher rollover rate than other types of vehicles. To prevent rollovers or loss of control:

- Take corners at slower speeds than you would with a passenger vehicle.
- Avoid sharp turns and abrupt maneuvers whenever possible.
- Do not modify your vehicle in any way that you would raise the center of gravity.
- Do not carry heavy cargo on the roof.

Never carry more than 165 lbs (75 kg) of cargo on the roof rack (Honda accessory).

### ■ In Rain

Avoid driving in deep water and on flooded roads. This can damage the engine, driveline, or cause electrical component failure.

### ■ Other Precautions

If there is a strong impact with something under the vehicle, stop in a safe location. Check the underside of the vehicle for damage or any fluid leaks.

### ▶▶ Precautions While Driving

#### NOTICE

Do not change the gear position while pressing the accelerator pedal. You could damage the transmission.

#### NOTICE

If you repeatedly turn the steering wheel at an extremely low speed, or hold the steering wheel in the full left or right position for a while, the electric power steering (EPS) system heats up. The system goes into a protective mode, and limits its performance. The steering wheel becomes harder and harder to operate. Once the system cools down, the EPS system is restored. Repeated operation under these conditions can eventually damage the system.

If the power mode is set to ACCESSORY while driving, the engine will shut down and all steering and brake power assist functions will stop, making it difficult to control the vehicle.

Do not select **N** while driving as you will lose engine braking (and acceleration) performance.

During the first 600 miles (1,000 km) of operation, avoid sudden acceleration or full throttle operation so as not to damage the engine or powertrain.

Avoid hard braking for the first 200 miles (300 km) after purchasing your new vehicle or replacing the brake pads or rotors, to allow for proper break-in.

## Automatic Transmission

### ■ Creeping

When the engine runs at higher idle speeds, the creeping force increases. Keep the brake pedal firmly depressed when stopped.

### ■ Kickdown

Quickly depressing the accelerator pedal while driving uphill may cause the transmission to drop to a lower gear, unexpectedly increasing vehicle speed. Depress the accelerator pedal carefully, especially on slippery roads and curves.

#### » Driving Guidelines for Your Utility Vehicle

Failure to operate your vehicle correctly might result in a crash or a rollover.

- **Important Handling Information** P. 36
- **Precautions While Driving** P. 394



## Shifting

Change the gear position in accordance with your driving needs.

### ■ Shift button positions



**P** **Park**  
Used when parking or starting the engine.

**R** **Reverse**  
Used when reversing.

**N** **Neutral**  
Transmission is not locked.

**D/S** **Drive/S Position**  
Each time you press the **D/S** button, the mode switches between Drive and S position mode.  
Used for:

**Drive**

- Normal driving (gears change between 1st and 9th automatically)
- Temporarily driving in the sequential mode

**S Position**

- Automatically changing gears between 1st and 8th (8th gear is used only at high speed)
- Driving in the sequential mode

### ▶▶ Shifting

## ⚠ WARNING

The vehicle can roll away if left unattended without confirming that Park is engaged.

A vehicle that rolls away could cause a crash resulting in serious injury or death.

Always keep your foot on the brake pedal until you have confirmed that **P** is shown on the gear position Indicator.

To prevent malfunction and unintended engagement:

- Do not spill any liquids on or around shift buttons.
- Do not place or drop any objects on or around shift buttons.
- Do not let passengers or children operate the shift buttons.

The beeper sounds and a message appears on the driver information panel when you depress the accelerator pedal with the gear position in **N**. Change the gear position to **D** or **R** with the brake pedal depressed.

▶▶ **Driver Information Interface Warning and Information Messages** P. 98

## ■ **P** (parking) button

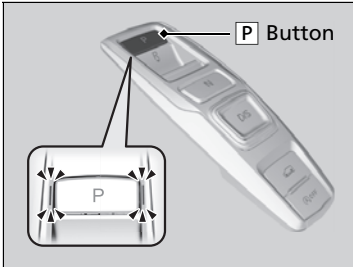

Park your vehicle in a safe place with the power mode in ON, then apply the brakes and press the **P** button to put the transmission in Park.

The indicators on the sides of the **P** button come on.

## ☞ Shifting

When shifting gears in extremely low temperatures ( $-22^{\circ}\text{F}/-30^{\circ}\text{C}$ ), there may be a short delay before the shift is indicated in the display. Always confirm you are in the correct gear before driving.

## ■ Shift Operation

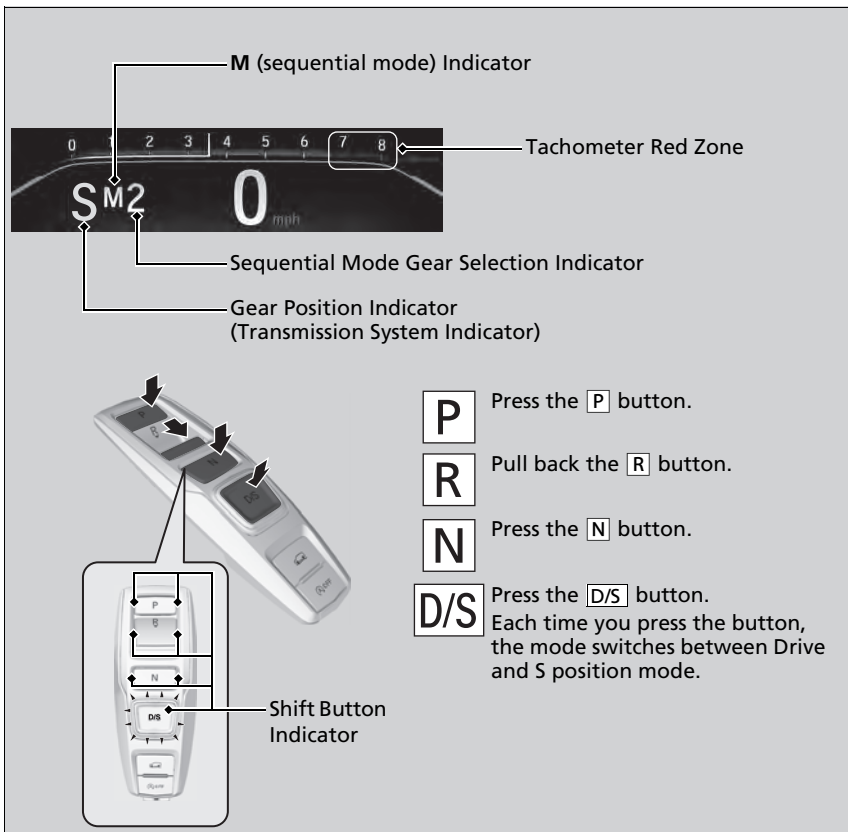

## ▶ Shift Operation

### NOTICE

When you change **D** to **R** and vice versa, depress the brake pedal to come to a complete stop, then select the intended gear position while maintaining brake pressure.

When changing the shift position to **P**, always keep your foot on the brake pedal until you have confirmed that **P** is shown on the gear position Indicator.

Use the gear position indicator and the shift button indicator to check the gear position before selecting a shift button.

If the indicator of the currently selected gear position, or all the gear position indicators are blinking simultaneously, there is a problem with the transmission.

Avoid sudden acceleration and have the transmission checked by a dealer as soon as possible.

The fuel supply may be cut off if you drive at engine speeds in or over the tachometer red zone (engine speed limit). If this happens, you may experience a slight jolt.

When the engine speed is increased while the transmission is in **N**, **P** or **R**, the fuel supply may be cut off even without the engine speed entering the tachometer red zone.

In freezing or sub-freezing conditions, the electronic gear selector response may be slow.

Always depress the brake pedal before changing the gear position to **P**, and confirm that **P** is shown on the gear position indicator before releasing the brake.

### ■ When opening the driver's door

If you open the driver's door under the following conditions, the gear position automatically changes to **P**.

- The vehicle is stationary with the engine running, or moving at 1 mph (2 km/h) or slower.
  - The transmission is in other than **P**.
  - You have unfastened the driver side seat belt.
- ▶ If you manually change the gear position from **P** with the brake pedal depressed, the gear position will automatically return to **P** once you release the brake pedal.

### ■ When turning off the power mode

If you turn the engine off while the vehicle is stationary, and the transmission is in other than **P**, the gear position automatically changes to **P**.

#### ☒ Shift Operation

From the audio/information screen, you can choose to have the system activate a beeper when you change to **R**.

☒ **Customized Features** P. 327

#### ☒ When opening the driver's door

You should always select **P** before opening the driver's door.

Make sure to park the vehicle in a safe place.

☒ **When Stopped** P. 471

If you want to drive the vehicle after the gear position has automatically changed to **P** under the described conditions, close the door, fasten the seat belt, depress the brake pedal, then change the gear position.

If you leave the vehicle, turn off the engine and lock the doors.

■ If you want to keep the transmission in **N** position [car wash mode]

With the engine running:

1. Press and hold the brake pedal.
2. Select **N**, then release the button to display (Neutral) **N** hold mode on the driver information interface.
3. Press and hold **N** again for two seconds.
  - ▶ This puts the vehicle in car wash mode which must be used when your vehicle is pulled through a conveyor type automatic car wash where you or an attendant do not remain in the vehicle.

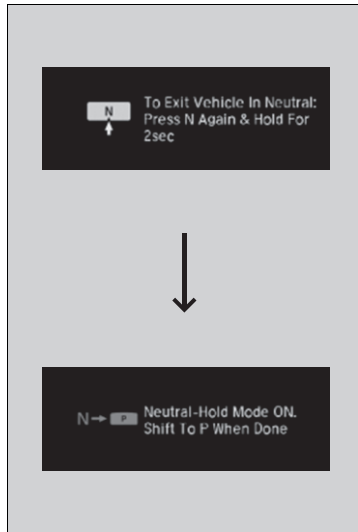

If the **ENGINE START/STOP** button is pressed after car wash mode has been activated, the power mode will change to ACCESSORY and a message will be displayed on the driver information interface.

- ▶ For 15 minutes the gear position remains in **N** with the power mode in ACCESSORY. After that, the position automatically changes to **P** and the power mode changes to OFF.
- ▶ Manually changing to **P** cancels ACCESSORY mode. The **P** indicator comes on and the power mode changes to OFF. You must always shift to **P** when car wash mode is no longer needed.

☒ If you want to keep the transmission in **N** position [car wash mode]

To keep the vehicle **N** position, you can also follow this procedure:

While the power mode is on, select **N**, and then within five seconds, press the **ENGINE START/STOP** button.

Note that the transmission may not stay in **N** position while any of the following indicators is on:

- Transmission system indicator.
- Malfunction indicator lamp.
- Charging system indicator.

**■ Restrictions on selecting a gear position**

You cannot select a gear position under certain circumstances that may lead to a crash.

When the transmission is in:	1. Under these circumstances:	2. If you try to change to the following:	3. The gear position remains in/changes to:	How to change the gear position
<b>P</b>	The brake pedal is not depressed. The accelerator pedal is depressed.	Other gear position	<b>P</b>	Release the accelerator pedal and depress the brake pedal.
<b>N</b>	The vehicle is moving at low speed without the brake pedal depressed. The vehicle is moving at low speed with the accelerator pedal depressed.		<b>N</b>	
<b>N, D or S</b>	The vehicle is moving forward.	<b>R</b>		Stop your vehicle in a safe place, keep the brake pedal pressed, and select the appropriate gear position.
<b>R or N</b>	The vehicle is moving backward.	<b>D, S</b>		
<b>R, N, D or S</b>	The vehicle is moving.	<b>P</b>		

## ■ Sequential Mode

Use the paddle shifters to change between 1st and 9th gears without removing your hands from the steering wheel. The transmission will switch to the sequential mode.

### ■ When the transmission is in **D**:

The vehicle will go into the sequential mode momentarily, and the sequential mode gear selection indicator will come on.

Once you start traveling at a constant speed, the sequential mode will automatically switch off, and the sequential mode gear selection indicator will go off.

Hold the **+** paddle shifter for two seconds or push **D/S** button to return to normal drive.

### ■ When the transmission is in **S**

The vehicle will go into the sequential mode, and the **M** (sequential mode) indicator and sequential mode gear selection indicator will come on.

If the vehicle speed increases and the engine speed reaches near the tachometer red zone, the transmission automatically shifts up to the next gear.

You can cancel this mode by holding the **+** paddle shifter for two seconds or push **D/S** button. When the sequential mode is canceled, the sequential mode indicator and sequential mode gear selection indicator go off.

## Sequential Mode Operation

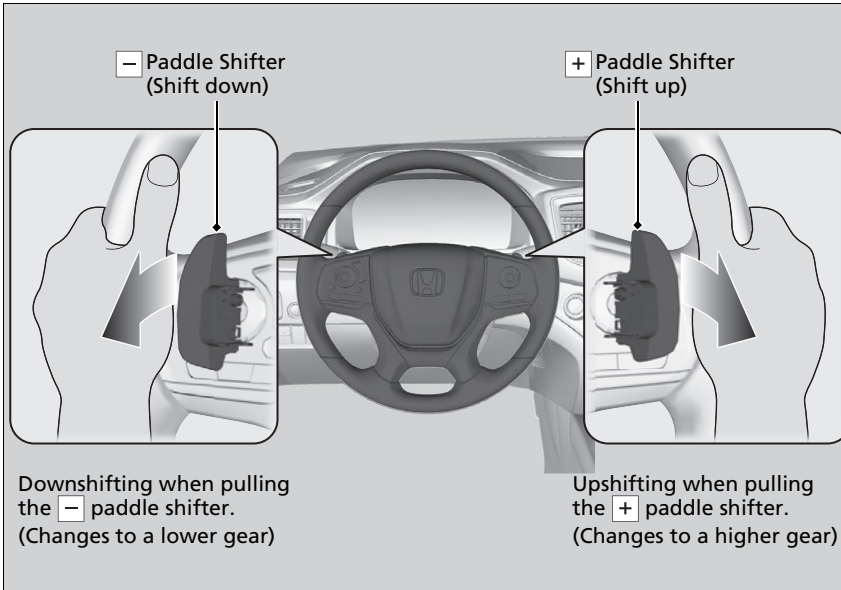

### Sequential Mode Operation

Each paddle shift operation makes a single gear change.

To change gears continuously, release the paddle shifter before pulling it again for the next gear.

If the sequential mode gear selection indicator blinks when you try to shift up or down, this means your vehicle speed is not in its allowable gear range or the protection of transmission system is necessary. Slightly accelerate to shift up and decelerate to shift down while the indicator is blinking.

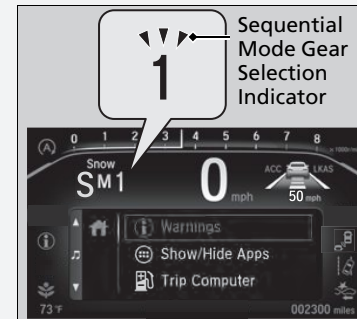



## Auto Idle Stop

To help maximize fuel economy, the engine automatically stops when the vehicle comes to a stop, depending on environmental and vehicle operating conditions. The indicator (green) comes on at this time.

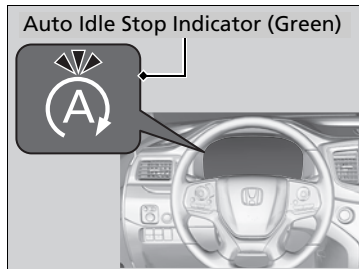

The environmental and vehicle conditions that impact Auto Idle Stop system operation are varied.

➤ **Auto Idle Stop Activates When:** P. 406, 407

The engine then restarts once the vehicle is about to move again, and the indicator (green) goes off.

➤ **The Engine Automatically Restarts When** P. 408

If the driver's door is opened while the indicator (green) comes on, a buzzer sounds to notify you that the Auto Idle Stop function is in operation.

A message associated with Auto Idle Stop appears on the driver information interface.

### Auto Idle Stop

The 12-volt battery installed in this vehicle is specifically designed for a model with Auto Idle Stop. Using a 12-volt battery other than this specified type may shorten the 12-volt battery life, and prevent Auto Idle Stop from activating. If you need to replace the 12-volt battery, make sure to select the specified type. Ask a dealer for more details.

The duration of the Auto Idle Stop operation:

- **Increases** in the ECON mode, compared to when the ECON mode is off, with climate control in use.
- **ECON Mode** P. 409



The Auto Idle Stop suspend indicator comes on and a message appears on the gauge when the Auto Idle Stop system cannot be activated.

- ▶ Indicators P. 82
- ▶ Auto Idle Stop System ON/OFF P. 405

## Auto Idle Stop System ON/OFF

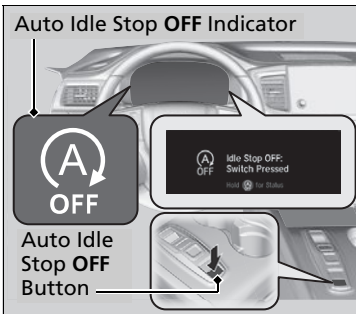

To turn the Auto Idle Stop system off, press this button. The Auto Idle Stop system stops. ▶ Auto Idle Stop system will stop, the indicator will come on and a message appears on the gauge.

The Auto Idle Stop system is turned on every time you start the engine, even if you turned it off the last time you drove the vehicle.

### Auto Idle Stop System ON/OFF

If you turn off the Auto Idle Stop system while it is activated, the engine will restart.

- ▶ Auto Idle Stop Activates When: P. 406

If you hold the Auto Idle Stop **OFF** button, you can disable idle stop messages.

- ▶ Indicators P. 82

## ■ Auto Idle Stop Activates When:

The vehicle stops with the gear position in **[D]** and the brake pedal depressed. When you put the transmission into **[P]**, the Auto Idle Stop continues to operate, even if the brake pedal is released.

▶ If you depress the brake pedal, the engine may automatically restart.

## ■ Auto Idle Stop does not activate when:

- The Auto Idle Stop **OFF** button is pressed.
- The driver's seat belt is not fastened.
- The engine is not adequately warmed up or coolant temperature is high.
- The transmission fluid temperature is low or high.
- The vehicle comes to a stop again before the vehicle speed reaches 3 mph (5 km/h) after the engine starts.
- The vehicle is stopped on a steep incline.
- A gear position other than **[D]**.
- The engine is started with the hood open.
  - ▶ Turn off the engine. Close the hood before you restart the engine to activate Auto Idle Stop.
- The battery charge is low.
- The internal temperature of the battery is 14°F (–10°C) or less.
- The climate control system is in use, and the outside temperature is below –4°F (–20°C) or over 104°F (40°C).
- The climate control system is in use, and the temperature is set to **Hi** or **Lo**.
-  is ON (indicator on).
- When the Intelligent Traction Management is set to **Snow**, **Mud**, or **Sand**.

## ⌘ Auto Idle Stop Activates When:

Do not open a hood, during idling stop. If the hood is opened, the engine will not restart automatically.

In this case, restart the engine with the **ENGINE START/STOP** button.

▶ **Starting the Engine** P. 388

Pressing the **ENGINE START/STOP** button causes the engine to no longer restart automatically. Follow the standard procedure to start the engine.

▶ **Starting the Engine** P. 388

**■ Auto Idle Stop may not activate when:**

- The vehicle is stopped by braking suddenly.
- The steering wheel is operated.
- The fan speed is high.
- The climate control system is in use, and there is a significant difference between the set temperature and the actual interior temperature.
- The climate control system is in use, and humidity in the interior is high.

## ■ The Engine Automatically Restarts When

The brake pedal is released.

### ■ The engine restarts even if the brake pedal is depressed when:

- The Auto Idle Stop **OFF** button is pressed.
- When a steering wheel is operated.
- The transmission is put into **R** or **S**, or when it is set from **N** to **D**.
  - ▶ If you put the transmission into **P** after the Auto Idle Stop activates, the Auto Idle Stop continues to operate. In this case, the engine restarts when you depress the brake pedal.
- The pressure on the brake pedal is reduced and the vehicle starts moving while stopped on an incline.
- The pressure on the brake pedal is repeatedly applied and released slightly during a stop.
- The battery charge becomes low.
- The accelerator pedal is depressed.
- The driver's seat belt is unlatched.
-  is ON (indicator on).
- The climate control system is in use, and the difference between the set temperature and actual interior temperature becomes significant.
- The climate control system is being used to dehumidify the interior.
- When the Intelligent Traction Management is set to **Snow**, **Mud**, or **Sand**.

## ■ Starting Assist Brake Function

Briefly keeps the brake applied after releasing the brake pedal to restart the engine. This can keep your vehicle from unexpectedly moving while on an incline.

## ▶▶ The Engine Automatically Restarts When

If you are using an electronic device during Auto Idle Stop, the device may temporarily be turned off when the engine restarts.

## ECON Mode

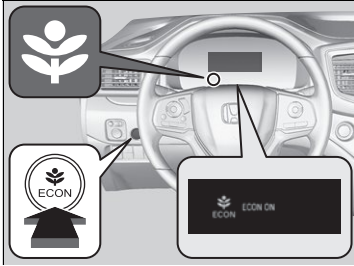

The **ECON** button turns the ECON mode on and off.

The ECON mode helps you improve your fuel economy by adjusting the performance of the engine, air conditioning system, and cruise control.

### ▶▶ ECON Mode

While in ECON mode, the climate control system has greater temperature fluctuations.

## Intelligent Traction Management

The Intelligent Traction Management optimizes vehicle performance to help you drive on various surfaces. The system has available modes to select from: **Normal**, **Snow**, **Mud**, and **Sand**.

Press the mode button to select the appropriate mode. The mode you select appears on the driver information interface. When the vehicle is turned off and restarted, Intelligent Traction Management mode will revert to **Normal**.

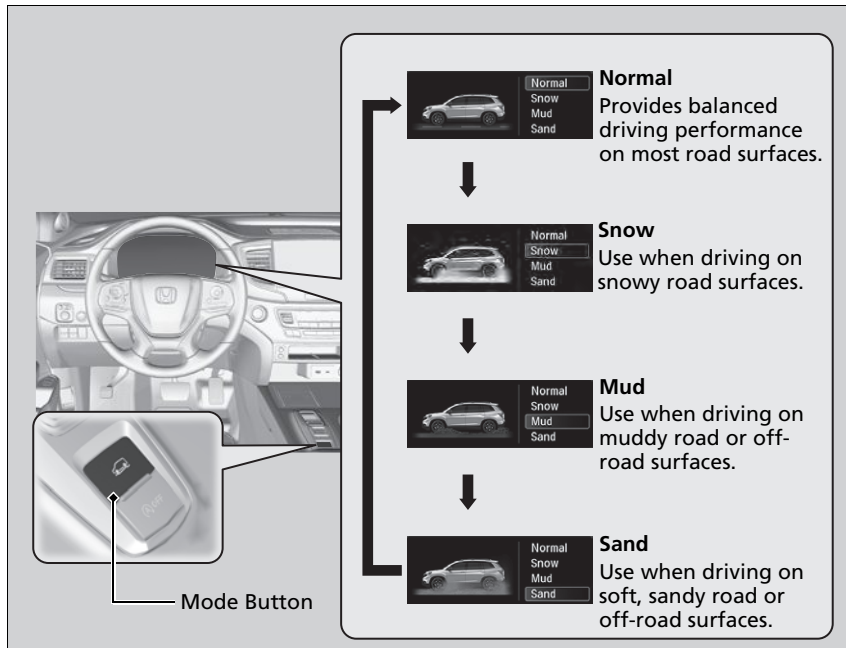

### ▶ Intelligent Traction Management

Refer to the Off-Highway Driving section for driving tips and safety precautions.

▶ **Off-Highway Driving Guidelines** P. 386

## Vehicle Stability Assist™ (VSA®), aka Electronic Stability Control (ESC), System

VSA® helps to stabilize the vehicle during cornering if the vehicle turns more or less than what was intended. It also assists in maintaining traction on slippery surfaces. It does so by regulating engine output and selectively applying the brakes.

### ■ VSA® Operation

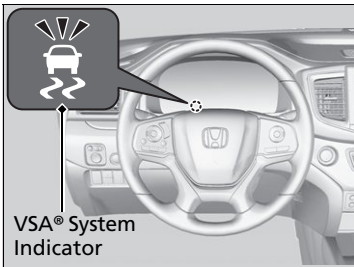

When VSA® activates, you may notice that the engine does not respond to the accelerator. You may also notice some noise from the hydraulic brake system. You will also see the indicator blink.

### ▣ Vehicle Stability Assist™ (VSA®), aka Electronic Stability Control (ESC), System

The VSA® may not function properly if tire type and size are mixed. Make sure to use the same size and type of tire, and the air pressures as specified.

When the VSA® system indicator comes on and stays on while driving, there may be a problem with the system. While this may not interfere with normal driving, have your vehicle checked by a dealer immediately.

VSA® cannot enhance stability in all driving situations and does not control the entire braking system. You still need to drive and corner at speeds appropriate for the conditions and always leave a sufficient margin of safety.

The main function of the VSA® system is generally known as Electronic Stability Control (ESC). The system also includes a traction control function.



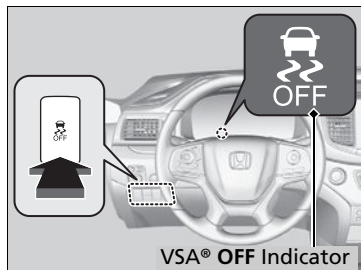

## ■ VSA® On and Off



This button is on the driver side control panel. To partially disable VSA® functionality/features, press and hold it until you hear a beep.

The traction control stops fully functioning, allowing the wheels to spin more freely at low speed. The VSA® **OFF** indicator will also come on and a message on the driver information interface informs you that the mode is changed.

Traction control mode cannot be changed during **Mud** or **Sand** modes. If you are driving on mud or sand, **Mud** or **Sand** Intelligent Traction Management modes can also be used to free a stuck vehicle. On other road surfaces, change to **Normal** or **Snow** mode, then press and hold the  (VSA® **OFF**) button.

To restore VSA® functionality/features, press the  (VSA® **OFF**) button until you hear a beep.

VSA® is turned on every time you start the engine, even if you turned it off the last time you drove the vehicle.

## ▣ Vehicle Stability Assist™ (VSA®), aka Electronic Stability Control (ESC), System

With the  (VSA® **OFF**) button pressed, your vehicle will have normal braking and cornering ability, but VSA® traction and stability enhancement becomes less effective.

In certain unusual conditions when your vehicle gets stuck in shallow mud or fresh snow, it may be easier to free it with the VSA® temporarily switched off.

When the  (VSA® **OFF**) button is pressed, the traction control function becomes less effective. This allows for the wheels to spin more freely at low speed. You should only attempt to free your vehicle with the VSA® off if you are not able to free it when the VSA® is on.

Immediately after freeing your vehicle, be sure to switch VSA® on again. We do not recommend driving your vehicle with the VSA® system switched off.

You may hear a motor sound coming from the engine compartment while system checks are being performed immediately after starting the engine or while driving. This is normal.

## Agile Handling Assist

---

Lightly brakes each of the front and rear wheels, as needed, when you turn the steering wheel, and helps support the vehicle's stability and performance during cornering.

### ⓘ Agile Handling Assist

The agile handling assist cannot enhance stability in all driving situations. You still need to drive and corner at speeds appropriate for the conditions and always leave a sufficient margin of safety.

When the VSA® system indicator comes on and stays on while driving, the agile handling assist does not activate.

You may hear a sound coming from the engine compartment while the agile handling assist is activated. This is normal.

## Blind spot information System

Is designed to detect vehicles in specified alert zones adjacent to your vehicle, particularly in harder to see areas commonly known as “blind spots”.

When the system detects vehicles approaching from behind in adjacent lanes, the appropriate indicator comes on for a few seconds, providing assistance when you change lanes.

### ■ How the system works

- The transmission is in **D**.
- Your vehicle speed is between 20 mph (32 km/h) and 100 mph (160 km/h)

#### Alert zone range

- A: Approx. 1.6 ft. (0.5 m)
- B: Approx. 10 ft. (3 m)
- C: Approx. 10 ft. (3 m)

Radar Sensors:  
underneath the  
rear bumper  
corners

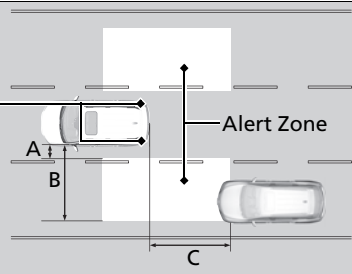

### Blind spot information System

## ⚠ WARNING

Failure to visually confirm that it is safe to change lanes before doing so may result in a crash and serious injury or death. Do not rely only on the blind spot information system when changing lanes.

Always look in your mirrors, to either side of your vehicle, and behind you for other vehicles before changing lanes.

#### Important Safety Reminder

Like all assistance systems, blind spot information system has limitations. Overreliance on blind spot information system may result in a collision.

The system is for your convenience only. Even if an object is within the alert zone, the following situations may occur.

- The blind spot information system alert indicator may not come on due to obstruction (splashes, etc.) even without the **Blind Spot Info Not Available** driver information interface appearing.
- The blind spot information system alert indicator may come on even with the message appearing.

## ■ When the system detects a vehicle

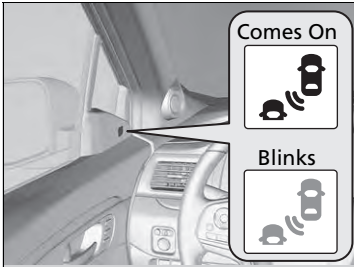

Blind spot information System Alert Indicator:  
Located near the pillar on both sides.

Comes on when:

- A vehicle enters the alert zone from behind to overtake you with a speed difference of no more than 31 mph (50 km/h) from your vehicle.
- You pass a vehicle with a speed difference of no more than 12 mph (20 km/h).

Blinks and a beeper sounds when:  
You move the turn signal lever in the direction of the detected vehicle. The beeper sounds three times.

## ▣ Blind spot information System

The blind spot information system alert indicator may not come on under the following conditions:

- A vehicle does not stay in the alert zone for more than two seconds.
- A vehicle is parked in a side lane.
- The speed difference between your vehicle and the vehicle you are passing is greater than 6 mph (10 km/h).
- An object not detected by the radar sensors approaches or passes your vehicle.
- A vehicle running in the adjacent lane is a motorcycle or other small vehicle.

The system does not operate when in **R**.

You can turn off the audible alert, or all the blind spot information system alert using the audio/information screen.

### ▣ Customized Features P. 327

Turn the system off when towing a trailer.

The system may not work properly for the following reasons:

- The added mass tilts the vehicle and changes the radar coverage.
- The trailer itself can be detected by the radar sensors, causing the blind spot information system alert indicators to come on.

#### ▶▶ Blind spot information System

Blind spot information system may be adversely affected when:

- Objects (guard rails, poles, trees, etc.) are detected.
- An object that does not reflect radio waves well, such as a motorcycle, is in the alert zone.
- Driving on a curved road.
- A vehicle is moving from a far lane to the adjacent lane.
- The system picks up external electrical interference.
- The rear bumper or the sensors have been improperly repaired or the rear bumper has been deformed.
- The orientation of the sensors has been changed.
- In bad weather (Heavy rain, snow, and fog).

For a proper blind spot information system operation:

- Always keep the rear bumper corner area clean.
- Do not cover the rear bumper corner area with labels or stickers of any kind.
- Take your vehicle to a dealer if you need the rear bumper corner area or the radar sensors to be repaired, or the rear bumper corner area is strongly impacted.

## Intelligent Variable Torque Management (i-VTM4™) AWD System

The intelligent variable torque management (i-VTM4™) AWD system is a full time all wheel drive system that automatically controls and transfers varying amount of engine torque to all wheels independently according to the driving conditions.

You still need to exercise the same care when accelerating, steering, and braking that you would in a two-wheel drive vehicle.

Avoid continuously driving on slippery surfaces where a wheel is likely to spin out, and do not drive if the **AWD** indicator starts blinking. Driving continuously under such conditions can damage the system's torque distribution unit.

If the **AWD** indicator blinks while driving, it indicates the differential temperature is too high. If this happens, pull to the side of the road when it is safe, shift to park, and idle the engine idle until the indicator goes off. If the indicator does not go off, take your vehicle to a dealer to have it checked.

### Intelligent Variable Torque Management (i-VTM4™) AWD System

#### NOTICE

Do not continuously spin the front tires of your vehicle. Continuously spinning the front tires can cause transmission or rear differential damage.

The intelligent variable torque management (i-VTM4™) AWD system may not function properly if tire type and size are mixed. Make sure to use the same size and type of tire, and the air pressures as specified.

➤ **Tire and Wheel Replacement** P. 528

## Tire Pressure Monitoring System (TPMS) with Tire Fill Assist

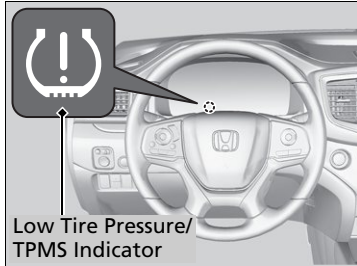

Monitors the tire pressure while you are driving. If your vehicle's tire pressure becomes significantly low, the Low Tire Pressure/TPMS indicator comes on and a message appears on the driver information interface.

### ▶ Tire Pressure Monitoring System (TPMS) with Tire Fill Assist

Conditions such as low ambient temperature and altitude change directly affect tire pressure and can trigger the Low Tire Pressure/TPMS indicator to come on.

#### ▶ If the Low Tire Pressure/Tire Pressure Monitoring System (TPMS) Indicator Comes On or Blinks P. 565

Tire pressure checked and inflated in:

- Warm weather can become under-inflated in colder weather.
- Cold weather can become overinflated in warmer weather.

The Low Tire Pressure/TPMS indicator will not come on as a result of overinflation.



The TPMS audibly and visually informs you of changes in tire pressure of the individual tire that you are adjusting using audible and visual indications.

If a change in tire pressure has been significant, the system beeps and the hazard lights flash continuously for five seconds when the specified tire pressure is reached. Stop filling the tire.

## ■ Tire Pressure Monitor



To select the tire pressure monitor, please follow the following steps using the buttons on the steering wheel.

1. Set the power mode to ON.
2. Press the  (home) button.
3. Press the  button repeatedly until **Maintenance** appears.
4. Press the **ENTER** button and select **Tire Pressure** by pressing the  button.
5. Press the **ENTER** button and the tire pressure appears on the driver information interface.

The pressure for each tire is displayed in psi.

**Tire Pressures Low** is displayed when a tire has significantly low pressure. The specific tire is displayed on the screen.



## ☒ Tire Pressure Monitor

The pressure displayed on the driver information interface can be slightly different from the actual pressure as measured by a gauge. If there is a significant difference between the two values, or if the Low Tire Pressure/TPMS indicator and the message on the driver information interface do not go off after you have inflated the tire to the specified pressure, have the system checked by a dealer.

**Tire Pressure Monitor Problem** may appear if you drive with the compact spare tire, or there is a problem with the TPMS.



## Tire Pressure Monitoring System (TPMS) - Required Federal Explanation

---

Each tire, including the spare (if provided), should be checked monthly when cold and inflated to the inflation pressure recommended by the vehicle manufacturer on the vehicle placard or tire inflation pressure label.

(If your vehicle has tires of a different size than the size indicated on the vehicle placard or tire inflation pressure label, you should determine the proper tire inflation pressure for those tires.)

As an added safety feature, your vehicle has been equipped with a tire pressure monitoring system (TPMS) that illuminates a low tire pressure telltale



when one or more of your tires is significantly under-inflated.

Accordingly, when the low tire pressure telltale illuminates, you should stop and check your tires as soon as possible, and inflate them to the proper pressure.

Driving on a significantly under-inflated tire causes the tire to overheat and can lead to tire failure. Under-inflation also reduces fuel efficiency and tire tread life, and may affect the vehicle's handling and stopping ability.

Please note that the TPMS is not a substitute for proper tire maintenance, and it is the driver's responsibility to maintain correct tire pressure, even if under-inflation has not reached the level to trigger illumination of the TPMS low tire pressure telltale.

Your vehicle has also been equipped with a TPMS malfunction indicator to indicate when the system is not operating properly. The TPMS malfunction indicator is combined with the low tire pressure telltale. When the system detects a malfunction, the telltale will flash for approximately one minute and then remain continuously illuminated. This sequence will continue upon subsequent vehicle start-ups as long as the malfunction exists.

When the malfunction indicator is illuminated, the system may not be able to detect or signal low tire pressure as intended.

TPMS malfunctions may occur for a variety of reasons, including the installation of replacement or alternate tires or wheels on the vehicle that prevent the TPMS from functioning properly.

Always check the TPMS malfunction telltale after replacing one or more tires or wheels on your vehicle to ensure that the replacement or alternate tires and wheels allow the TPMS to continue to function properly.

Assists with functions such as acceleration, braking, and steering in order to reduce the burden on the driver, as well as help avoid or reduce the severity of collisions.

Honda Sensing® has the following functions.

## ■ The functions which do not require switch operations to activate

- Collision Mitigation Braking System™ (CMBS™) 📄 P. 425
- Road Departure Mitigation (RDM) System 📄 P. 437
- Auto High-Beam 📄 P. 168
- Blind spot information System 📄 P. 414
- Cross Traffic Monitor 📄 P. 478
- Parking Sensor System\* 📄 P. 473

## ■ The functions which require switch operations to activate

- Adaptive Cruise Control (ACC) 📄 P. 442
- Lane Keeping Assist System (LKAS) 📄 P. 455

## ■ Operation Switches for the ACC/LKAS

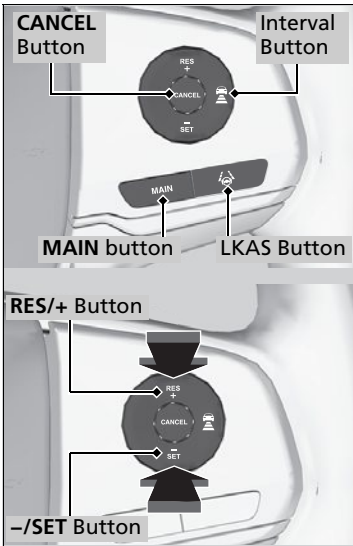

### ■ MAIN Button

Press to activate standby mode for ACC and LKAS. Or press to cancel these systems.

### ■ LKAS Button

Press to activate or cancel the LKAS.

### ■ RES/+/-/SET Button

Press **RES/+** to resume the ACC or increase the vehicle speed.

Press **-/SET** to set the ACC or decrease the vehicle speed.

### ■ Interval Button

Press the  (interval) button to change the ACC following-interval.

### ■ CANCEL Button

Press to cancel ACC.

## ■ Multi-Information Display Content

You can see the current state of ACC and LKAS.

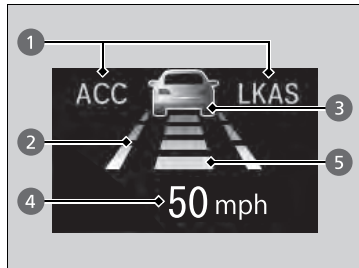

- ① Indicates that ACC and LKAS are ready to be activated.
- ② Indicates that LKAS is activated and whether or not traffic lane lines are detected.
- ③ Indicates whether or not a vehicle is detected ahead.
- ④ Shows the set vehicle speed.
- ⑤ Shows the set vehicle interval.

## Collision Mitigation Braking System™ (CMBS™)

The system can assist you when it determines there is a possibility of your vehicle colliding with a vehicle or a pedestrian detected in front of your vehicle. The CMBS™ is designed to alert you when the potential for a collision is determined, as well as to reduce your vehicle speed to help minimize collision severity when a collision is deemed unavoidable.

### ■ How the system works

**When to use**

The camera is located behind the rearview mirror.

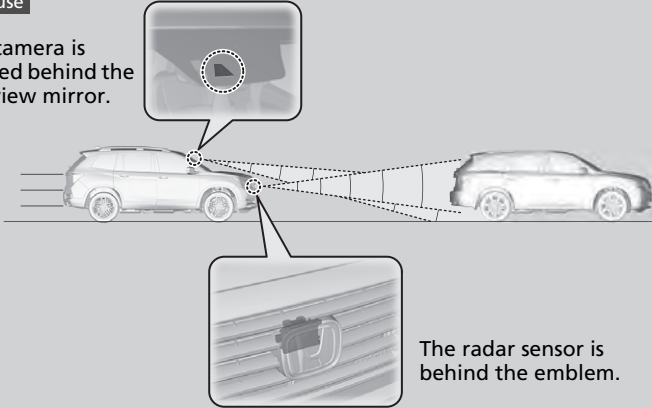

The radar sensor is behind the emblem.

The system starts monitoring the roadway ahead when your vehicle speed is about 3 mph (5 km/h) or above and will search for a vehicle in front of you.

The CMBS™ activates when:

- The speed difference between your vehicle and a vehicle or pedestrian detected in front of you becomes about 3 mph (5 km/h) and over with a chance of a collision.
- Your vehicle speed is about 62 mph (100 km/h) or less and there is a chance of a collision with an oncoming detected vehicle or a pedestrian in front of you.

### ⓘ Collision Mitigation Braking System™ (CMBS™)

#### Important Safety Reminder

The CMBS™ is designed to reduce the severity of an unavoidable collision. It does not prevent a collision nor stop the vehicle automatically. It is still your responsibility to operate the brake pedal and steering wheel appropriately according to the driving conditions.

The CMBS™ may not activate or may not detect a vehicle in front of your vehicle under certain conditions:

➤ **CMBS™ Conditions and Limitations** P. 429

For directions on the proper handling of the radar sensor, refer to the following page.

➤ **Radar Sensor** P. 466

You can read about handling information for the camera equipped with this system.

➤ **Front Sensor Camera** P. 464

### ⓘ How the system works

Rapid vibrations on the steering wheel alert you when your vehicle speed is between 19 and 62 mph (30 and 100 km/h) with an oncoming vehicle detected in front of you.

When the CMBS™ activates, it may automatically apply the brake. It will be canceled when your vehicle stops or a potential collision is not determined.

Continued

## ■ When the system activates

The system provides visual, audible and tactile alerts of a possible collision, and stops if the collision is avoided.

- ▶ Take appropriate action to prevent a collision (apply the brakes, change lanes, etc.)

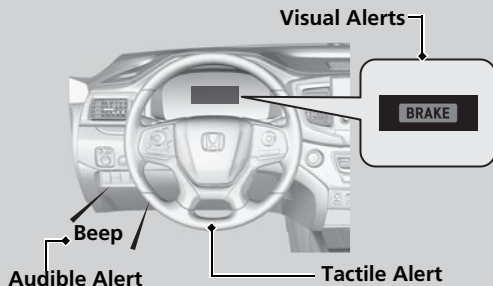

You can change the distance (**Long/Normal/Short**) between vehicles at which the system's earliest collision alert will come on.

- **Customized Features** P. 327

## ■ Vibration alert on the steering wheel

When a potential collision to an oncoming detected vehicle is determined, the system alerts you with rapid vibration on the steering wheel, in addition to visual and audible alerts.

- ▶ Take appropriate action to prevent a collision (apply the brakes, operate the steering wheel, etc.).

When in **Long**, visual and audible alerts come on at a longer distance from a vehicle ahead than in **Normal** setting, and in **Short**, at a shorter distance than in **Normal**.

## ⌘ When the system activates

The camera in the CMBS™ is also designed to detect pedestrians.

However, this pedestrian detection feature may not activate or may not detect a pedestrian in front of your vehicle under certain conditions.

Refer to the ones indicating the pedestrian detection limitations from the list.

- **CMBS™ Conditions and Limitations** P. 429

## ⌘ Vibration alert on the steering wheel

Vibration alert function is disabled when the electric power steering (EPS) system indicator comes on.

- **Driver Information Interface Warning and Information Messages** P. 98

## ■ Collision Alert Stages

The system has three alert stages for a possible collision. However, depending on circumstances, the CMBS™ may not go through all of the stages before initiating the last stage.

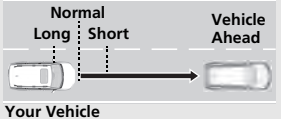
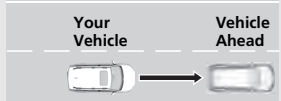
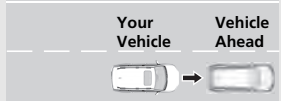
Distance between vehicles	CMBS™			
	The sensors detect a vehicle	Audible & Visual WARNINGS	Steering Wheel	Braking
<p>Stage one</p> 	<p>There is a risk of a collision with the vehicle ahead of you.</p>	<p>The visual alert flashes. If the distance between your vehicle and the vehicle in front of you continues to decrease, the audible alert sounds in addition to the visual alert flashing.</p> <ul style="list-style-type: none"> <li>▶ The collision warning distance can be changed.</li> <li>🔧 <b>Customized Features</b> P. 327</li> </ul>	<p>If an oncoming vehicle is detected, rapid vibration is provided.</p>	<p>—</p>
<p>Stage two</p> 	<p>The risk of a collision has increased, time to respond is reduced.</p>	<p>Visual and audible alerts.</p>	<p>—</p>	<p>Lightly applied</p>
<p>Stage three</p> 	<p>The CMBS™ determines that a collision is unavoidable.</p>		<p>—</p>	<p>Forcefully applied</p>



## ■ CMBS™ On and Off

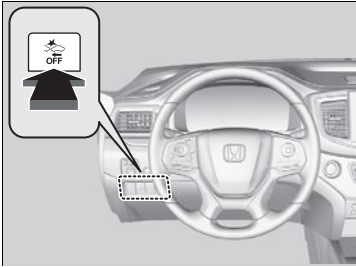

Press and hold the button until the beeper sounds to switch the system on or off.

When the CMBS™ is off:

- The CMBS™ indicator in the instrument panel comes on.
- A message on the driver information interface reminds you that the system is off.

The CMBS™ is turned on every time you start the engine, even if you turned it off the last time you drove the vehicle.

## ▶▶ Collision Mitigation Braking System™ (CMBS™)

The CMBS™ may automatically shut off, and the CMBS™ indicator will come and stay on under certain conditions:

▶ **CMBS™ Conditions and Limitations** P. 429

## ■ CMBS™ Conditions and Limitations

In the following situations, the radar sensor or camera may be unable to correctly detect vehicles, pedestrians, moving bicycles, or road conditions, potentially causing the CMBS™ to operate improperly.

📷 **Front Sensor Camera** P. 464

📷 **Radar Sensor** P. 466

### ■ Environmental conditions

- Driving in bad weather (rain, fog, snow, etc.).
- Sudden changes between light and dark, such as an entrance or exit of a tunnel.
- There is little contrast between objects and the background.
- Driving into low sunlight (e.g., at dawn or dusk).
- Strong light is reflected onto the roadway.
- Driving in the shadows of trees, buildings, etc.
- Roadway objects or structures are misinterpreted as vehicles and pedestrians.
- Reflections on the interior of the windshield.
- Driving at night or in a dark condition such as a tunnel.

### ■ Roadway conditions

- Driving on a snowy or wet roadway (obscured lane marking, vehicle tracks, reflected lights, road spray, high contrast).
- The road is hilly or the vehicle is approaching the crest of a hill.
- Driving on curvy, winding, or undulating roads.

■ **Vehicle conditions**

- Headlight lenses are dirty or the headlights are not properly adjusted.
- The outside of the windshield is blocked by dirt, mud, leaves, wet snow, etc.
- The inside of the windshield is fogged.
- An abnormal tire or wheel condition (incorrect sizes, varied sizes or construction, improperly inflated, compact spare tire, etc.).
- When tire chains are installed.
- The vehicle is tilted due to a heavy load or suspension modifications.
- The camera temperature gets too high.
- Driving with the parking brake applied.
- When the radar sensor in the front grille gets dirty.
- The vehicle is towing a trailer.

**■ Detection limitations**

- A vehicle or pedestrian suddenly crosses in front of you.
- The distance between your vehicle and the vehicle or pedestrian ahead of you is too short.
- A vehicle cuts in front of you at a slow speed, and it brakes suddenly.
- When you accelerate rapidly and approach the vehicle or pedestrian ahead of you at high speed.
- The vehicle ahead of you is a motorcycle, bicycle, mobility scooter or other small vehicle.
- When there are animals in front of your vehicle.
- When you drive on a curved, winding or undulating road that makes it difficult for the sensor to properly detect a vehicle in front of you.
- The speed difference between your vehicle and a vehicle or pedestrian in front of you is significantly large.
- An oncoming vehicle suddenly comes in front of you.
- Another vehicle suddenly comes in front of you at an intersection, etc.
- Your vehicle abruptly crosses over in front of an oncoming vehicle.
- When driving through a narrow iron bridge.
- When the lead vehicle suddenly slows down.

Limitations applicable to pedestrian detection only

- When there is a group of people in front of your vehicle walking together side by side.
- Surrounding conditions or belongings of the pedestrian alter the pedestrian's shape, preventing the system from recognizing that the person is a pedestrian.
- When the pedestrian is shorter than about 3.3 feet (1 meter) or taller than about 6.6 feet (2 meters) in height.
- When a pedestrian blends in with the background.
- When a pedestrian is bent over or squatting, or when their hands are raised or they are running.
- When several pedestrians are walking ahead in a group.
- When the camera cannot correctly identify that a pedestrian is present due to an unusual shape (holding luggage, body position, size).

**■ Automatic shutoff**

CMBS™ may automatically shut itself off and the CMBS™ indicator comes and stays on when:

- The temperature inside the system is high.
- You drive off-road or on a mountain road, or curved and winding road for an extended period.
- An abnormal tire condition is detected (wrong tire size, flat tire, etc.).
- The camera behind the rearview mirror, or the area around the camera, including the windshield, gets dirty.

Once the conditions that caused CMBS™ to shut off improve or are addressed (e.g., cleaning), the system comes back on.

### ■ With Little Chance of a Collision

The CMBS™ may activate even when you are aware of a vehicle ahead of you, or when there is no vehicle ahead. Some examples of this are:

#### ■ When Passing

Your vehicle approaches another vehicle ahead of you and you change lanes to pass.

#### ■ At an intersection

Your vehicle approaches or passes another vehicle that is making a left or right turn.

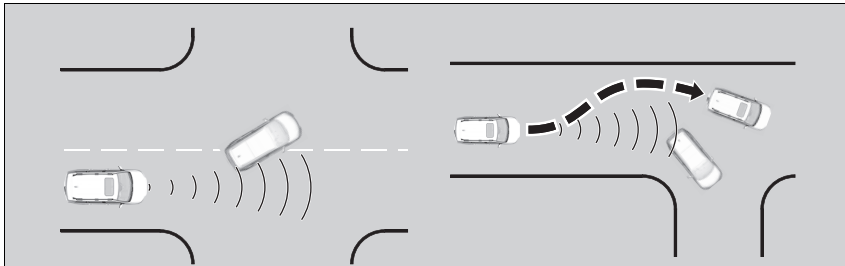

### ⓘ Collision Mitigation Braking System™ (CMBS™)

Have your vehicle checked by a dealer if you find any unusual behavior of the system (e.g., the warning message appears too frequently).

■ **On a curve**

When driving through curves, your vehicle comes to a point where an oncoming vehicle is right in front of you.

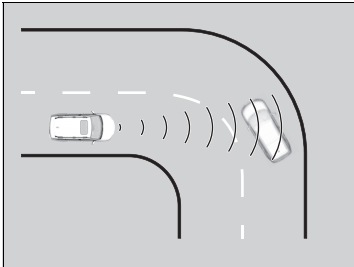

■ **Through a low bridge at high speed**

You drive under a low or narrow bridge at high speed.



■ **Speed bumps, road work sites, train tracks, roadside objects, etc.**

You drive over speed bumps, steel road plates, etc., or your vehicle approaches train tracks or roadside objects [such as a traffic sign and guard rail] on a curve or, when parking, stationary vehicles and walls.

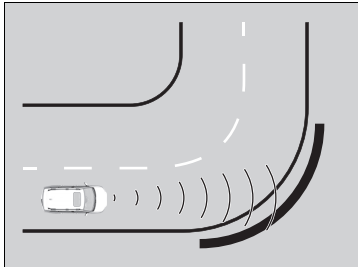

## Road Departure Mitigation (RDM) System

Alerts and helps to assist you when the system detects a possibility of your vehicle unintentionally crossing over detected lane markings and/or leaving the roadway altogether.

### How the System Works

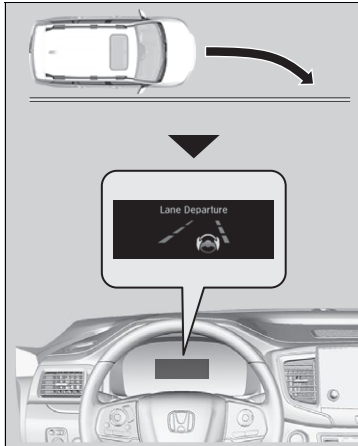

The front camera behind the rearview mirror monitors left and right lane markings (in white or yellow). If your vehicle is getting too close to detected lane markings without a turn signal activated, the system, in addition to a visual alert, applies steering torque and alerts you with rapid vibrations on the steering wheel, to help you remain within the detected lane.

▶ **Customized Features** P. 327

As a visual alert, the **Lane Departure** message appears on the driver information interface.

If the system determines that its steering input is insufficient to keep your vehicle on the roadway, it may apply braking.

▶ Braking is applied only when the lane markings are solid continuous lines.

The system cancels assisting operations when you turn the steering wheel to avoid crossing over detected lane markings.

If the system operates several times without detecting driver response, the system beeps to alert you.

### ⌘ Road Departure Mitigation (RDM) System

#### Important Safety Reminder

Like all assistance systems, the RDM system has limitations.

Overreliance on the RDM system may result in a collision. It is always your responsibility to keep the vehicle within your driving lane.

The RDM system only alerts you when lane drift is detected without a turn signal in use. The RDM system may not detect all lane markings or lane or roadway departures; accuracy will vary based on weather, speed and lane marker condition. It is always your responsibility to safely operate the vehicle and avoid collisions.

You can read about handling information for the camera equipped with this system.

▶ **Front Sensor Camera** P. 464

The RDM system may not work properly or may work improperly under the certain conditions:

▶ **RDM Conditions and Limitations** P. 440

There are times when you may not notice RDM functions due to your operation of the vehicle, or road surface conditions.

## ■ How the System Activates

The system activates when all the following conditions are met:

- The vehicle is traveling between about 45 and 90 mph (72 and 145 km/h).
- The vehicle is on a straight or slightly curved road.
- The turn signals are off.
- The brake pedal is not depressed.
- The wipers are not in continuous operation.
- The system makes a determination that the driver is not actively accelerating, braking, or steering.

## ▣ How the System Activates

The RDM system may automatically shut off and the  indicator comes and stays on.

▣ **Indicators** P. 82

RDM system function can be impacted when the vehicle is:

- Not driven within a traffic lane.
- Driven on the inside edge of a curve, or outside of a lane.
- Driven in a narrow lane.

## RDM On and Off

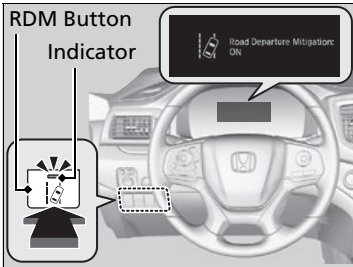

Press the RDM button to turn the system on and off.

- ▶ The indicator in the button comes on and the message appears on the driver information interface when the system is on.

## RDM On and Off

When you have selected **Warning Only** from the customized options using the audio/information screen, the system does not operate the steering wheel and braking.

➤ **Customized Features** P. 327

## ■ RDM Conditions and Limitations

The system may not properly detect lane markings and the position of your vehicle under certain conditions. Some examples of these conditions are listed below.

### ■ Environmental conditions

- Driving in bad weather (rain, fog, snow, etc.).
- Sudden changes between light and dark, such as an entrance or exit of a tunnel.
- There is little contrast between lane lines and the roadway surface.
- Driving into low sunlight (e.g., at dawn or dusk).
- Strong light is reflected onto the roadway.
- Driving in the shadows of trees, buildings, etc.
- Shadows of adjacent objects are parallel to lane markings.
- Roadway objects or structures are misinterpreted as lane markers.
- Reflections on the interior of the windshield.
- Driving at night or in a dark condition such as a tunnel.

**■ Roadway conditions**

- Driving on a snowy or wet roadway (obscured lane marking, vehicle tracks, reflected lights, road spray, high contrast).
- Driving on a road with temporary lane markings.
- Faint, multiple, or varied lane markings are visible on the roadway due to road repairs or old lane markings.
- The roadway has merging, split, or crossing lines (e.g., such as at an intersection or crosswalk).
- The lane markings are extremely narrow, wide, or changing.
- The vehicle in front of you is driving near the lane lines.
- The road is hilly or the vehicle is approaching the crest of a hill.
- Driving on rough or unpaved roads, or over bumpy surfaces.
- When objects on the road (curb, guard rail, pylons, etc.) are recognized as white lines (or yellow lines).
- Driving on roads with double lines.

**■ Vehicle conditions**

- Headlight lenses are dirty or the headlights are not properly adjusted.
- The outside of the windshield is streaked or blocked by dirt, mud, leaves, wet snow, etc.
- The inside of the windshield is fogged.
- The camera temperature gets too high.
- An abnormal tire or wheel condition (incorrect sizes, varied sizes or construction, improperly inflated, compact spare tire, etc.).
- The vehicle is tilted due to a heavy load or suspension modifications.
- When tire chains are installed.
- The vehicle is towing a trailer.

## Adaptive Cruise Control (ACC)

Helps maintain a constant vehicle speed and a set following-interval behind a vehicle detected ahead of yours, without you having to keep your foot on the brake or the accelerator.

**When to use**

The camera is located behind the rearview mirror.

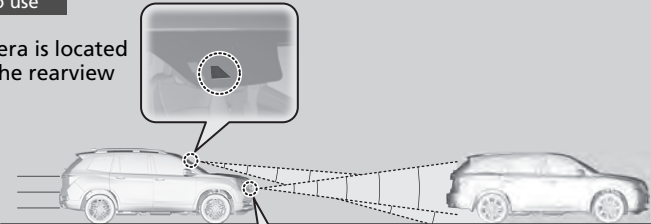

The radar sensor is behind the emblem.

- Vehicle speed for adaptive cruise control: Desired speed in a range above roughly 25 mph (40 km/h)
- Gear positions for adaptive cruise control: In **D** or **S**

### Adaptive Cruise Control (ACC)

#### **⚠ WARNING**

Improper use of ACC can lead to a crash. Use ACC only when driving on expressways or freeways and in good road and weather conditions.

#### **⚠ WARNING**

ACC has limited braking capability.

When your vehicle speed drops below 22 mph (35 km/h), ACC will automatically cancel and no longer will apply your vehicle's brakes.

Always be prepared to apply the brake pedal when conditions require.

ACC cannot be activated if Intelligent Traction Management setting is **Snow**, **Sand** or **Mud**.

## ■ How to activate the system

### How to use

**ACC is on in the driver information interface.**  
Adaptive cruise control is ready to use.

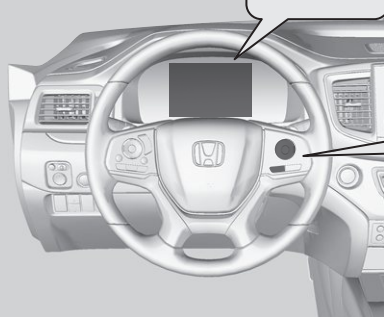
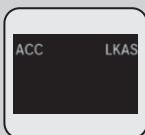

■ Press the **MAIN** button on the steering wheel.

### ⌘ Adaptive Cruise Control (ACC)

#### Important Reminder

As with any system, there are limits to ACC. Use the brake pedal whenever necessary, and always keep a safe interval between your vehicle and other vehicles.

You can read about handling information for the camera equipped with this system.

➤ **Front Sensor Camera** P. 464

The radar sensor for ACC is shared with the Collision Mitigation Braking System™ (CMBS™).

➤ **Collision Mitigation Braking System™ (CMBS™)** P. 425



## ■ To Set the Vehicle Speed

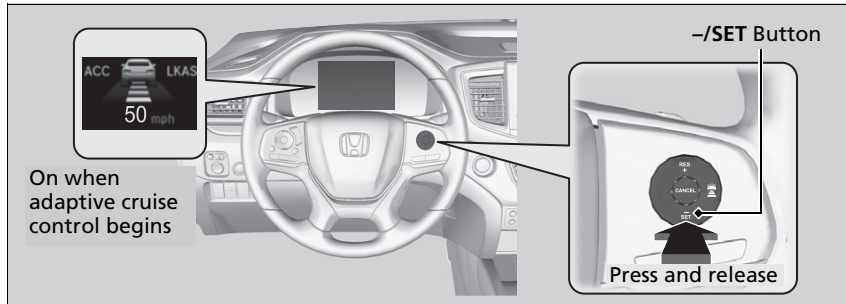

Take your foot off the pedal and press the **-/SET** button when you reach the desired speed. The moment you release the **-/SET** button, the set speed is fixed, and ACC begins.

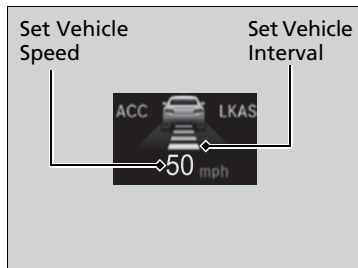

When ACC starts operating, the vehicle icon, distance bars and set speed appear on the driver information interface.

## ▶ Adaptive Cruise Control (ACC)

ACC may not work properly under certain conditions.

▶ **ACC Conditions and Limitations** P. 447

When not using ACC: Turn off adaptive cruise by pressing the **MAIN** button. This also will turn off the Lane Keeping Assist System (LKAS).

When the **MAIN** button is pressed, ACC and Lane Keeping Assist System (LKAS) are both turned on or off.

You can switch the displayed set speed measurements on the driver information interface between mph and km/h.

▶ **Units** P. 119

Do not use ACC under the following conditions:

- On roads with heavy traffic or while driving in continuous stop and go traffic.
- On roads with sharp turns.
- On roads with steep downhill sections, as the set vehicle speed can be exceeded by coasting. In such cases, ACC will not apply the brakes to maintain the set speed.
- On roads with toll collection facilities or other objects between lanes of traffic, or in parking areas, or facilities with drive through access.

## ■ When in Operation

### ■ There is a vehicle ahead

ACC monitors if a vehicle ahead of you enters the ACC range. If a vehicle is detected doing so, the ACC system maintains or decelerates your vehicle's set speed in order to keep the vehicle's set following-interval from the vehicle ahead.

📏 To Set or Change Following-interval P. 450

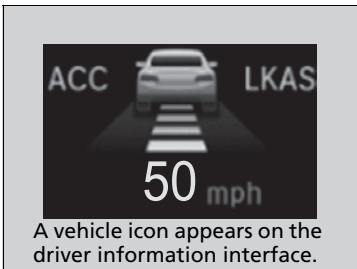
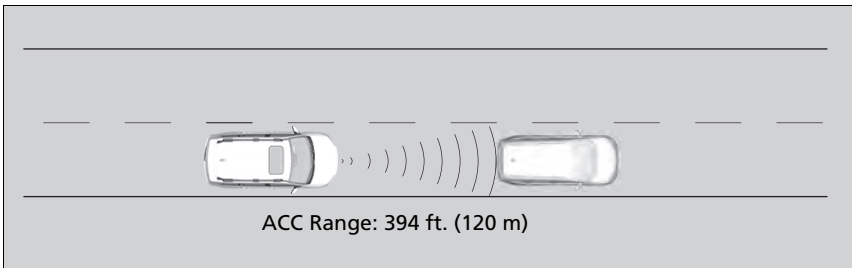

When a vehicle whose speed is slower than your set speed is detected in front of you, your vehicle starts to slow down.

## 📏 When in Operation

If the vehicle detected ahead of you slows down abruptly, or if another vehicle is detected cutting in front of you, the beeper sounds and a message appears on the driver information interface.

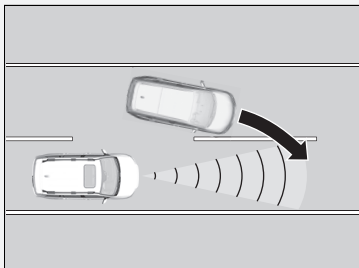

Depress the brake pedal, and keep an appropriate interval from the vehicle ahead.

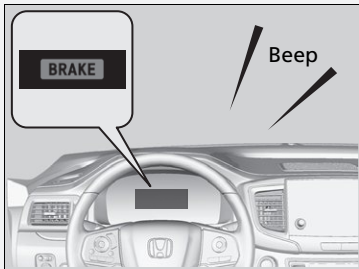

### ■ There is no vehicle ahead

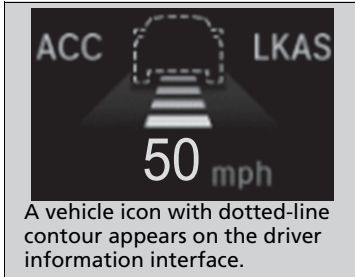

Your vehicle maintains the set speed without having to keep your foot on the brake or accelerator pedal.

If there previously was a vehicle detected ahead that kept your vehicle from traveling at the set speed, ACC accelerates your vehicle to the set speed, and then maintains it.

### ■ When you depress the accelerator pedal

You can temporarily increase the vehicle speed. In this case, there is no audible or visual alerts even if a vehicle is in ACC range.

ACC stays on unless you cancel it. Once you release the accelerator pedal, the system resumes the set speed.

### ⌘ When in Operation

Even if the interval between your vehicle and the vehicle detected ahead is short, ACC may start accelerating your vehicle under the following circumstances:

- The vehicle ahead of you is going at almost the same speed as, or faster than, your vehicle.
- A vehicle that cuts in front of you is going faster than your vehicle, gradually increasing the interval between the vehicles.

You can also set the system to beep when a vehicle in front of you comes in and goes out of the ACC detecting range. Change the **ACC Forward Vehicle Detect Beep** setting.

⌘ **Customized Features** P. 327

### Limitations

You may need to use the brake to maintain a safe interval when using ACC. Additionally, ACC may not work properly under certain conditions.

⌘ **ACC Conditions and Limitations** P. 447

## ■ ACC Conditions and Limitations

The system may automatically shut off and the **ACC** indicator will come on under certain conditions. Some examples of these conditions are listed below. Other conditions may reduce some of the ACC functions.

📷 **Front Sensor Camera** P. 464

📡 **Radar Sensor** P. 466

### ■ Environmental conditions

Driving in bad weather (rain, fog, snow, etc.).

### ■ Roadway conditions

Driving on a snowy or wet roadway (obscured lane marking, vehicle tracks, reflected lights, road spray, high contrast).

### ■ Vehicle conditions

- The outside of the windshield is blocked by dirt, mud, leaves, wet snow, etc.
- An abnormal tire or wheel condition (incorrect sizes, varied sizes or construction, improperly inflated, compact spare tire, etc.).
- The camera temperature gets too high.
- The parking brake is applied.
- When the front grille is dirty.
- The vehicle is tilted due to a heavy load or suspension modifications.
- When tire chains are installed.
- The vehicle is towing a trailer.

## 📷 ACC Conditions and Limitations

If you need the radar sensor to be repaired, or removed, or the radar sensor cover is strongly impacted, turn off the system by pressing the **MAIN** button and take your vehicle to a dealer.

Have your vehicle checked by a dealer if you find any unusual behavior of the system (e.g., the warning message appears too frequently).

If the front of the vehicle is impacted in any of the following situations, the radar sensor may not work properly. Have your vehicle checked by a dealer:

- The vehicle mounted onto a bump, curb, chock, embankment, etc.
- You drive the vehicle where water is deep.
- Your vehicle has a frontal collision.

### ■ Detection limitations

- A vehicle suddenly crosses in front of you.
- The interval between your vehicle and the vehicle ahead of you is too short.
- A vehicle cuts in front of you at a slow speed, and it brakes suddenly.
- You accelerate rapidly and approach the vehicle ahead of you at high speed.
- The vehicle ahead of you is a motorcycle, bicycle, mobility scooter, or other small vehicle.
- There are animals in front of your vehicle.
- You drive on a curved or winding or undulating road that makes it difficult for the sensor to properly detect a vehicle in front of you.

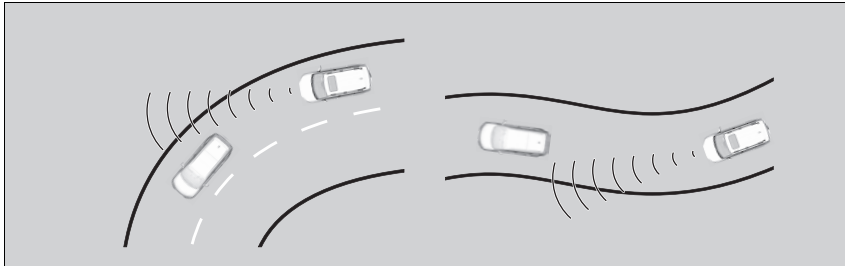

- A vehicle ahead of you stops and the speed difference between your vehicle and the vehicle ahead of you is significantly large.
- An oncoming vehicle suddenly comes in front of you.
- Your vehicle abruptly crosses over in front of an oncoming vehicle.

- Driving through a narrow metal bridge.

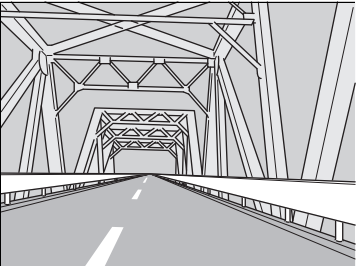

- The vehicle ahead of you brakes suddenly.
- The vehicle ahead of you has a unique shape.

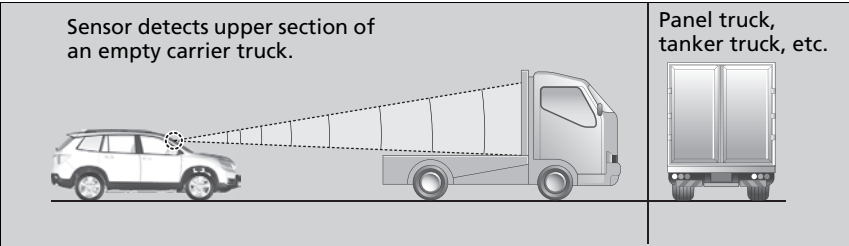

- Your vehicle or the vehicle ahead of you is driving on one edge of the lane.

## ■ To Adjust the Vehicle Speed

Increase or decrease the vehicle speed using the **RES/+** or **-/SET** buttons on the steering wheel.



- Each time you press the button, the vehicle speed is increased or decreased by about 1 mph or 1 km/h accordingly.
- If you keep the button pressed, the vehicle speed increases or decreases by about 5 mph or 5 km/h accordingly.

## ■ To Set or Change Following-interval

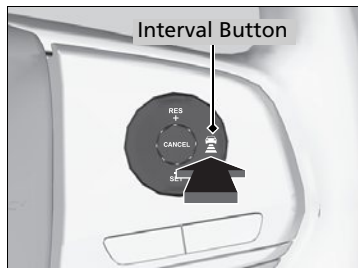

Press the  (Interval) button to change the ACC following-interval.

Each time you press the button, the following-interval (the interval behind a vehicle detected ahead of you) setting cycles through short, middle, long, and extra long following-interval.

## ▶▶ To Adjust the Vehicle Speed

If a vehicle detected ahead is going at a speed slower than your increased set speed, ACC may not accelerate your vehicle. This is to maintain the set interval between your vehicle and the vehicle ahead.





You can switch the displayed set speed measurements on the driver information interface between mph and km/h.

▶ **Units** P. 119

You can set the vehicle speed using the **-/SET** button on the steering wheel when adjusting the speed with the accelerator and brake pedals.

Determine the most appropriate following-interval setting based on your specific driving conditions. Be sure to adhere to any following-interval requirements set by local regulation.

The higher vehicle's following-speed is, the longer the short, middle, long or extra long following-interval becomes. See the following examples for your reference.

Following-interval		When the Set Speed is:	
		50 mph (80 km/h)	65 mph (104 km/h)
Short		83 feet 25 meters 1.1 sec	100 feet 31 meters 1.1 sec
Middle		110 feet 33 meters 1.5 sec	137 feet 42 meters 1.5 sec
Long		154 feet 47 meters 2.1 sec	200 feet 61 meters 2.1 sec
Extra Long		204 feet 62 meters 2.8 sec	265 feet 81 meters 2.8 sec



## ■ To Cancel

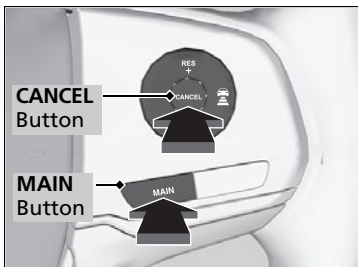

To cancel ACC, do any of the following:

- Press the **CANCEL** button.
- Press the **MAIN** button.
  - ▶ ACC indicator goes off.
- Depress the brake pedal while the vehicle is moving forward.

## ■ Automatic cancellation

The beeper sounds and a message appears on the driver information interface when ACC is automatically canceled. Any of these conditions may cause the ACC to automatically cancel:

- Bad weather (rain, fog, snow, etc.).
- When the radar sensor behind the emblem gets dirty.
- The vehicle ahead of you cannot be detected.
- An abnormal tire condition is detected, or the tires are skidding.
- Driving on a mountainous road for extended periods, or driving off road.
- Abrupt steering wheel movement.
- When the ABS, VSA®, or CMBS™ is activated.
- When the ABS or VSA® system indicator comes on.
- When you manually apply the parking brake.
- When the detected vehicle within the ACC range is too close to your vehicle.
- The camera behind the rearview mirror, or the area around the camera, including the windshield, gets dirty.

## ▶▶ To Cancel

Resuming the prior set speed: After you have canceled ACC, you can resume the prior set speed while it is still displayed. Press the **RES/+** button when driving at a speed of at least 25 mph (40 km/h) or more.

The set speed cannot be set or resumed when ACC has been turned off using the **MAIN** button. Press the **MAIN** button to activate the system, then set the desired speed.

## ▶▶ Automatic cancellation

Even though ACC has been automatically canceled, you can still resume the prior set speed. Wait until the condition that caused ACC to cancel improves, then press the **RES/+** button.

## ■ To Switch ACC to Cruise Control

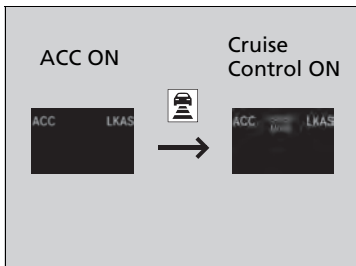

Press and hold the  (interval) button for one second. **Cruise Mode Selected** appears on the driver information interface for two seconds, and then the mode switches to Cruise.

To switch back to ACC, press and hold the  button again for one second.

## ■ When to use

Desired speed in a range above roughly 25 mph (40 km/h).

## ■ To Set the Vehicle Speed

Take your foot off the pedal and press the **-/SET** button when you reach the desired speed.

The moment you release the **-/SET** button, the set speed is fixed, and cruise control begins. The **CRUISE CONTROL** indicator comes on.

## ■ To Adjust the Vehicle Speed

Each time you press the **RES/+** or **-/SET** button, the vehicle speed is increased or decreased by about 1 mph (1.6 km/h).

If you keep the **RES/+** or **-/SET** button pressed, the vehicle speed increases or decreases until you release it. This speed is then set.

## ▶▶ To Switch ACC to Cruise Control

Always be aware which mode you are in. When you are driving in Cruise mode, the system will not assist you to maintain a following-interval from a vehicle ahead of you.

## ■ To Cancel

To cancel cruise control, do any of the following:

- Press the **CANCEL** button.
- Press the **MAIN** button.
- Depress the brake pedal.

The **CRUISE CONTROL** indicator goes off.

## ☞ To Cancel

Resuming the prior set speed:

After cruise control has been canceled, you can still resume the prior set speed by pressing the **RES/+** button while driving at a speed of at least 25 mph (40 km/h) or more.

You cannot set or resume in the following situations:

- When vehicle speed is less than 25 mph (40 km/h).
- When the **MAIN** button is turned off.

At vehicle speeds of 22 mph (35 km/h) or less, cruise control is canceled automatically.

## Lane Keeping Assist System (LKAS)

Provides steering input to help keep the vehicle in the middle of a detected lane and provides tactile and visual alerts if the vehicle is detected drifting out of its lane.

### ■ Steering input assist

The system applies torque to the steering to keep the vehicle between the left and right lane lines. The applied torque becomes stronger as the vehicle gets closer to either of the lane lines.

■ Front sensor camera  
Monitors the lane lines

### ■ Tactile and visual alerts

Rapid vibrations on the steering wheel and a warning display alert you that the vehicle is drifting out of a detected lane.

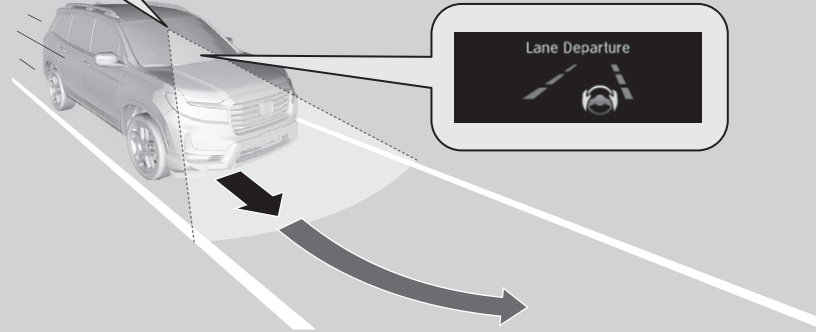

When you operate the turn signals to change lanes, the system is suspended, and resumes after the signals are off.

If you make a lane change without operating the turn signals, the LKAS alerts activate, and torque is applied to the steering.

### ▣ Lane Keeping Assist System (LKAS)

#### Important Safety Reminders

The LKAS is for your convenience only. It is not an autonomous driving system and always requires driver attention and control. The system does not work if you take your hands off the steering wheel or fail to steer the vehicle.

#### ▣ Driver Information Interface Warning and Information Messages P. 98

The LKAS is convenient when it is used on expressways or freeways.

Do not place objects on the instrument panel. Objects may reflect on the windshield and prevent correct detection of the traffic lanes.

The LKAS only alerts you when lane drift is detected without a turn signal in use. The LKAS may not detect all lane markings or lane departures; accuracy will vary based on weather, speed, and lane marker condition. It is always your responsibility to safely operate the vehicle and avoid collisions.

The LKAS may not work properly or may work improperly under the certain conditions:

#### ▣ LKAS Conditions and Limitations P. 461

The LKAS may not function as designed while driving in frequent stop and go traffic, or on roads with sharp curves.

### ■ Lane Keep Support Function

Provides assistance to keep the vehicle in the center of the lane. When the vehicle nears a white or yellow line, steering force of the electric power steering will become stronger.

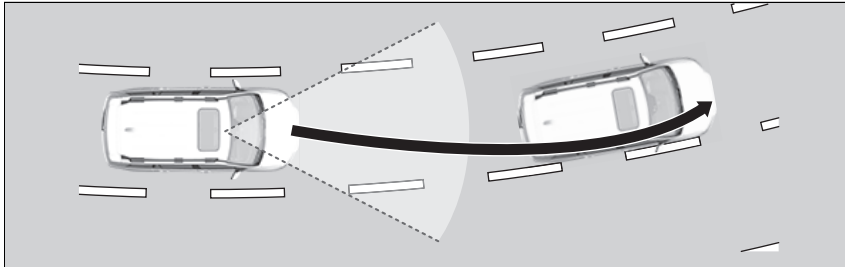

### ■ Lane Departure Warning Function

When the vehicle enters the warning area, the LKAS alerts you with slight steering wheel vibration as well as warning display.

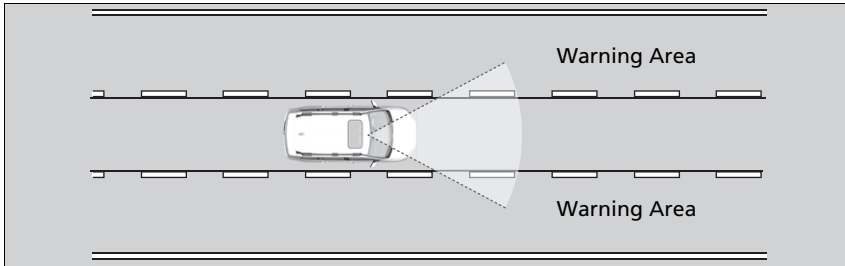

### ▶ Lane Keeping Assist System (LKAS)

You can read about handling information for the camera equipped with this system.

▶ **Front Sensor Camera** P. 464

When it fails to detect lanes, the system will temporarily be canceled. When a lane is detected, the system will recover automatically.

## ■ When the System can be Used

The system can be used when the following conditions are met.

- The lane in which you are driving has detectable lane markers on both sides, and your vehicle is in the center of the lane.
- The vehicle is traveling between about 45 and 90 mph (72 and 145 km/h).
- You are driving on a straight or slightly curved road.
- The turn signals are off.
- The brake pedal is not depressed.
- The wipers are not in high speed operation.

## ■ How to activate the system

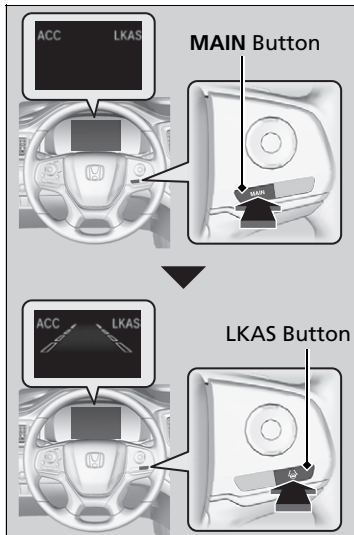

1. Press the **MAIN** button.
  - ▶ The LKAS is on in the driver information interface.  
The system is ready to use.
2. Press the LKAS button.
  - ▶ Lane outlines appear on the driver information interface.  
The system is activated.

## ⌘ Lane Keeping Assist System (LKAS)

If the vehicle drifts toward either left or right lane line due to the system applying torque, turn off the LKAS and have your vehicle checked by a dealer.



3. Keep your vehicle near the center of the lane while driving.
  - ▶ The lane outlines change to solid ones once the system starts operating after detecting the left and right lane markings.

## ■ To Cancel

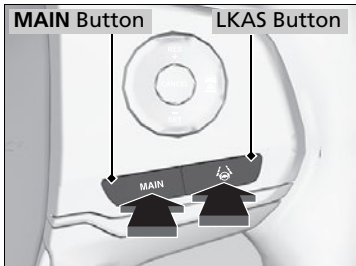

Press the **MAIN** or LKAS button.

The LKAS is turned off every time you stop the engine, even if you turned it on the last time you drove the vehicle.

## ▶▶ To Cancel

Pressing the **MAIN** button also turns ACC on and off.

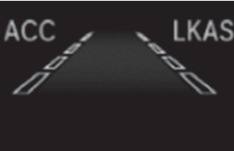

When the LKAS is suspended, the lane lines on the driver information interface change to lane outlines, and the beeper sounds (if activated).

■ **The system operation is suspended if you:**

- Set the wipers to HI.
  - ▶ Turning the wipers off resumes the LKAS.
- Decrease the vehicle speed to about 40 mph (64 km/h) or less.
  - ▶ Increasing the vehicle speed to about 45 mph (72 km/h) or more resumes the LKAS.
- Depress the brake pedal.
  - ▶ The LKAS resumes and starts detecting the lane lines again once you release the brake pedal.
- Your vehicle is driving to the right or the left of the lane.

**Models with automatic intermittent wipers**

- Set the wiper switch to **AUTO** and the wipers operate continuously.
  - ▶ The LKAS resumes when the wipers stop or operate intermittently.



■ **The LKAS may be automatically suspended when:**

- The system fails to detect lane lines.
- The steering wheel is quickly turned.
- You fail to steer the vehicle.
- Driving through a sharp curve.
- Driving at a speed in excess of approximately 90 mph (145 km/h).

Once these conditions no longer exist, the LKAS automatically resumes.

■ **The LKAS may be automatically canceled when:**

- The camera temperature gets extremely high or low.
- The camera behind the rearview mirror, or the area around the camera, including the windshield, gets dirty.
- The ABS or VSA® system engages.

The beeper sounds if the LKAS is automatically canceled.

## ■ LKAS Conditions and Limitations

The system may not detect lane markings and therefore may not keep the vehicle in the middle of a lane under certain conditions, including the following:

### ■ Environmental conditions

- Driving in bad weather (rain, fog, snow, etc.).
- Sudden changes between light and dark, such as an entrance or exit of a tunnel.
- There is little contrast between lane lines and the roadway surface.
- Driving into low sunlight (e.g., at dawn or dusk).
- Strong light is reflected onto the roadway.
- Driving in the shadows of trees, buildings, etc.
- Shadows of adjacent objects are parallel to lane markings.
- Roadway objects or structures are misinterpreted as lane markers.
- Reflections on the interior of the windshield.
- Driving at night or in a dark condition such as a tunnel.

### ■ Roadway conditions

- Driving on a snowy or wet roadway (obscured lane marking, vehicle tracks, reflected lights, road spray, high contrast).
- Driving on a road with temporary lane markings.
- Faint, multiple, or varied lane markings are visible on the roadway due to road repairs or old lane markings.

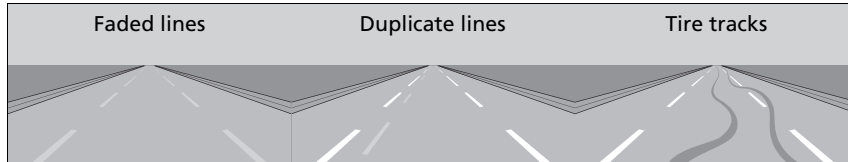

- The roadway has merging, split, or crossing lines (e.g., such as at an intersection or crosswalk).
- The lane markings are extremely narrow, wide, or changing.



- The vehicle in front of you is driving near the lane lines.
- The road is hilly or the vehicle is approaching the crest of a hill.
- Driving on rough or unpaved roads, or over bumpy surfaces.
- When objects on the road (curb, guard rail, pylons, etc.) are recognized as white lines (or yellow lines).

- Driving on roads with double lines.

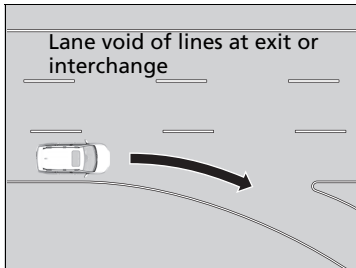

#### ■ Vehicle conditions

- Headlight lenses are dirty or the headlights are not properly adjusted.
- The outside of the windshield is streaked or blocked by dirt, mud, leaves, wet snow, etc.
- The inside of the windshield is fogged.
- The camera temperature gets too high.
- An abnormal tire or wheel condition (incorrect sizes, varied sizes or construction, improperly inflated, compact spare tire, etc.).
- The vehicle is tilted due to a heavy load or suspension modifications.
- The vehicle is towing a trailer.

## Front Sensor Camera

The camera, used in systems such as Auto High-Beam, CMBS™, RDM, ACC, and LKAS, is designed to detect an object that triggers any of the systems to operate its functions.

### ■ Camera Location and Handling Tips

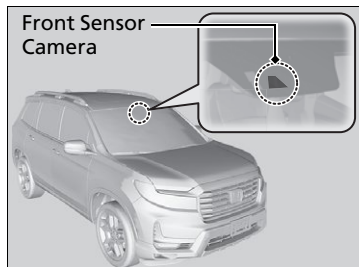

This camera is located behind the rearview mirror.

To help reduce the likelihood that high interior temperatures will cause the camera's sensing system to shut off, when parking, find a shady area or face the front of the vehicle away from the sun. If you use a reflective sun shade, do not allow it to cover the camera housing. Covering the camera can concentrate heat on it.

### ▣ Front Sensor Camera

Never apply a film or attach any objects to the windshield, the hood, or the front grille that could obstruct the camera's field of vision and cause the system to operate abnormally.

Scratches, nicks, and other damage to the windshield within the camera's field of vision can cause the system to operate abnormally. If this occurs, we recommend that you replace the windshield with a genuine Honda replacement windshield. Making even minor repairs within the camera's field of vision or installing an aftermarket replacement windshield may also cause the system to operate abnormally. After replacing the windshield, have a dealer recalibrate the camera. Proper calibration of the camera is necessary for the system to operate properly.

Do not place an object on the top of the instrument panel. It may reflect onto the windshield and prevent the system from detecting lane lines properly.

## ▶ Front Sensor Camera

If the **Some Driver Assist Systems Cannot**

**Operate: Camera Temperature Too High**  message appears:

- Use the climate control system to cool down the interior and, if necessary, also use defroster mode with the airflow directed toward the camera.
- Start driving the vehicle to lower the windshield temperature, which cools down the area around the camera.

If the **Some Driver Assist Systems Cannot**

**Operate: Clean Front Windshield**  message appears:

- Park your vehicle in a safe place, and clean the windshield. If the message does not disappear after you have cleaned the windshield and driven for a while, have your vehicle checked by a dealer.

## Radar Sensor

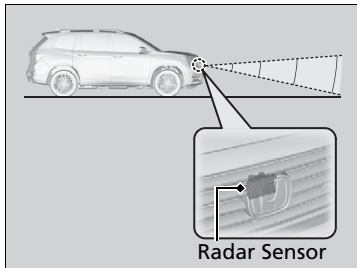

The radar sensor is located behind the emblem.

### ⌘ Radar Sensor

Avoid strong impacts to the radar sensor cover.

For the CMBS™ to work properly:

Always keep the radar sensor cover clean.

Never use chemical solvents or polishing powder for cleaning the sensor cover. Clean it with water or a mild detergent.

Do not put a sticker on the radar sensor cover or replace the radar sensor cover.

If you need the radar sensor to be repaired, or removed, or the radar sensor cover is strongly impacted, turn off the system by using the collision mitigation braking system™ (CMBS™) **OFF** button and take your vehicle to a dealer.

📄 **CMBS™ On and Off** P. 428

If the vehicle is involved in any of the following situations, the radar sensor may not work properly. Have your vehicle checked by a dealer:

- Your vehicle is involved in a frontal collision
- Your vehicle drives through deep water or is submerged in deep water
- Your vehicle strongly strikes a bump, curb, chock, slope, or embankment that could jar the radar sensor

## Brake System

### ■ Parking Brake

Use the parking brake to keep the vehicle stationary when parking.

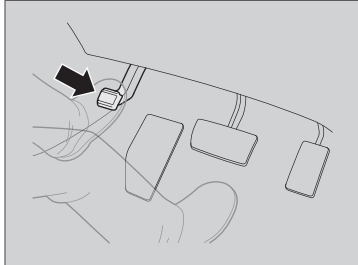

#### **To apply:**

Depress the parking brake pedal down with your foot.

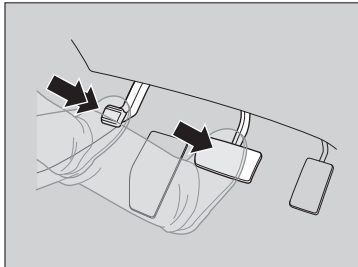

#### **To release:**

1. Depress the brake pedal.
2. Depress the parking brake.

### » Parking Brake

#### **NOTICE**

Release the parking brake fully before driving. The rear brakes and axle can be damaged if you drive with the parking brake applied.

If you start driving without fully releasing the parking brake, a buzzer sounds as a warning, and **Release Parking Brake** appears on the driver information interface.

Always apply the parking brake when parking.



## ■ Foot Brake

Your vehicle is equipped with disc brakes at all four wheels. A vacuum power assist helps reduce the effort needed on the brake pedal. The brake assist system increases the stopping force when you depress the brake pedal hard in an emergency situation. The anti-lock brake system (ABS) helps you retain steering control when braking very hard.

➤ **Brake Assist System** P. 470

➤ **Anti-lock Brake System (ABS)** P. 469

## ☒ Foot Brake

Check the brakes after driving through deep water, or if there is a buildup of road surface water. If necessary, dry the brakes by lightly depressing the pedal several times.

If you hear a continuous metallic friction sound when applying the brakes, this is caused by the brake wear indicator rubbing on the brake rotor and indicates that the brake pads need to be replaced. Have the vehicle checked by a dealer. If you hear only an occasional squeak or squeal when you initially apply the brake pedal, this may be normal and caused by high frequency vibration of the brake pads against the rotating brake disc.

Constantly using the brake pedal while going down a long hill builds up heat, which reduces the brake effectiveness. Apply engine braking by taking your foot off the accelerator pedal and downshifting to a lower gear.

Do not rest your foot on the brake pedal while driving, as it will lightly apply the brakes and cause them to lose effectiveness over time and reduce pad life. It will also confuse drivers behind you.

## Anti-lock Brake System (ABS)

### ■ ABS

Helps prevent the wheels from locking up, and helps you retain steering control by pumping the brakes rapidly, much faster than you can.

The electronic brake distribution (EBD) system, which is part of the ABS, also balances the front-to-rear braking distribution according to vehicle loading.

You should never pump the brake pedal. Let the ABS work for you by always keeping firm, steady pressure on the brake pedal. This is sometimes referred to as “stomp and steer.”

### ■ ABS operation

The brake pedal may pulsate slightly when the ABS is working. Depress the brake pedal and keep holding the pedal firmly down. On dry pavement, you will need to press on the brake pedal very hard before the ABS activates. However, you may feel the ABS activate immediately if you are trying to stop on snow or ice.

ABS may activate when you depress the brake pedal when driving on:

- Wet or snow covered roads.
- Roads paved with stone.
- Roads with uneven surfaces, such as potholes, cracks, manholes, etc.

When the vehicle speed goes under 6 mph (10 km/h), the ABS stops.

### ⓘ Anti-lock Brake System (ABS)

#### NOTICE

The ABS may not function correctly if you use a tire of the incorrect size or type.

If the ABS indicator comes on while driving, there may be a problem with the system. While normal braking will not be affected, there is a possibility that the ABS will not be operating. Have your vehicle checked by a dealer immediately.

The ABS is not designed for the purpose of reducing the time or distance it takes for a vehicle to stop: It is designed to limit brake lockup which can lead to skidding and loss of steering control.

In the following cases, your vehicle may need more distance to stop than a vehicle without the ABS:

- You are driving on rough or uneven road surfaces, such as gravel or snow.
- The tires are equipped with snow chains.

The following may be observed with the ABS system:

- Motor sounds coming from the engine compartment when the brakes are applied, or when system checks are being performed after the engine has been started and while the vehicle accelerates.
- Brake pedal and/or the vehicle body vibration when ABS activates.

These vibrations and sounds are normal to ABS systems and are no cause for concern.

## Brake Assist System

---

Designed to assist the driver by generating greater braking force when you depress the brake pedal hard during emergency braking.

### ■ Brake assist system operation

Press the brake pedal firmly for more powerful braking.

When brake assist operates, the pedal may wiggle slightly and an operating noise may be heard. This is normal. Keep holding the brake pedal firmly down.

## When Stopped

1. Depress the brake pedal firmly and come to a complete stop.
2. Apply the parking brake.
3. Change the gear position to **P**.
  - ▶ Do not release the brake pedal until you have confirmed that **P** is shown on the gear position indicator.
4. Turn off the engine.

Always set the parking brake firmly, in particular if you are parked on an incline.

### » Parking Your Vehicle

#### **⚠ WARNING**

The vehicle can roll away if left unattended without confirming that Park is engaged.

A vehicle that rolls away could cause a crash resulting in serious injury or death.

Always keep your foot on the brake pedal until you have confirmed that **P** is shown on the gear position Indicator.

Do not park your vehicle near flammable objects, such as dry grass, oil, or timber. Heat from the exhaust can cause a fire.

### » When Stopped

#### **NOTICE**

The following can damage the transmission:

- Depressing the accelerator and brake pedals simultaneously.
- Holding the vehicle in place when facing uphill by depressing the accelerator pedal.
- Changing into **P** before the vehicle stops completely.

☒ When Stopped

In extremely cold temperatures, the parking brake may freeze up if applied. If such temperatures are expected, do not apply the parking brake but, if parking on a slope, either turn the front wheels so they will contact the curb if the vehicle rolls down the slope or block the wheels to keep the vehicle from moving. If you do not take either precaution, the vehicle may roll unexpectedly, leading to a crash.

## Parking Sensor System\*

The corner and center sensors monitor obstacles near your vehicle, and the beeper and audio/information screen let you know the approximate distance between your vehicle and the obstacle.

### ■ The sensor location and range

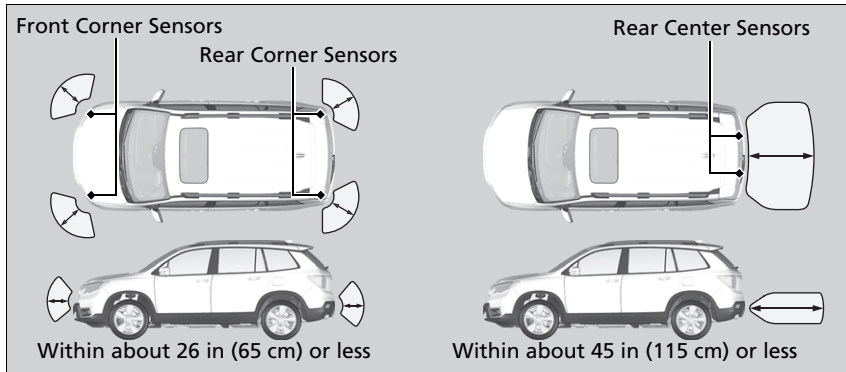

### ▣ Parking Sensor System\*

Even when the system is on, always confirm if there is no obstacle near your vehicle before parking.

The system may not work properly when:

- The sensors are covered with snow, ice, mud, or dirt.
- The vehicle has been out in hot or cold weather.
- There is something nearby that emits ultrasonic waves or high frequency sounds.
- Driving in bad weather (rain, fog, snow, etc.).

The system may not detect these obstacles:

- Thin or low objects.
- Sonic-absorptive materials, such as snow, cotton, or sponge.
- Objects directly under the bumper.

The system may falsely detect obstacles in the following situations:

- The vehicle is on uneven surface, such as grass, bumps, or a hill.
- When close to other vehicles with sonar sensors or other objects that emit ultrasonic waves.
- There is splashing water near the sensors due to heavy rains, etc.

Do not put any accessories on or around the sensors.

▶ If you put any accessories (such as a towing hitch or bicycle rack) on or around the rear sensors, the system may activate if it detects these accessories as an obstacle. In this case, turn off the rear sensor.

▣ **Turning off All Rear Sensors** P. 477

\* Not available on all models

### ■ Parking sensor system on and off

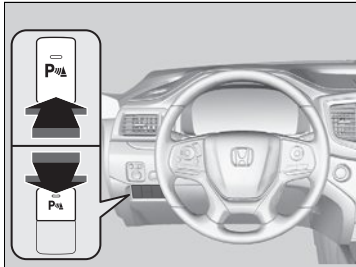

With the power mode in ON, press the parking sensor system button to turn on or off the system. The indicator in the button comes on when the system is on.

The front corner, rear center and rear corner sensors start to detect an obstacle when the transmission is in **R**, and the vehicle speed is less than 5 mph (8 km/h).

The front corner sensors start to detect an obstacle when the transmission is not in **P**, and the vehicle speed is less than 5 mph (8 km/h).

## ■ Screen Operation

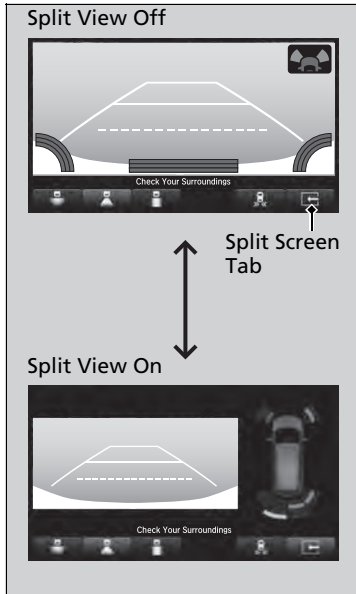

You can switch between split view off and split view on by touching the split screen tab.

### ☒ Screen Operation

The split screen tab disappears, and the split view returns to the last camera view mode under the following conditions:

- If the parking sensor system is turned off.
- If there is a malfunction in the system.

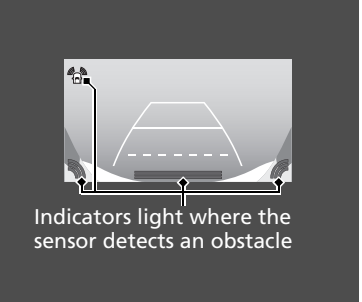

■ When the distance between your vehicle and obstacles becomes shorter

Length of the intermittent beep	Distance between the Bumper and Obstacle		Indicator	Audio/information screen
	Corner Sensors	Rear Center Sensors		
Moderate	—	About 45-30 in (115-75 cm)	Blinks in Yellow*1	
Short	—	About 30-26 in (75-65 cm)		
Very short	About 26-14 in (65-35 cm)	About 26-14 in (65-35 cm)	Blinks in Amber	
Continuous	About 14 in (35 cm) or less	About 14 in (35 cm) or less	Blinks in Red	

\*1: At this stage, only the center sensors detect obstacles.

## ■ Turning off All Rear Sensors

To deactivate the rear sensors, please take the following steps:

1. Make sure that the parking sensor system is not activated.
  - ▶ The indicator in the button turns off.
2. Set the power mode to VEHICLE OFF.
3. Press and hold the parking sensor system button, and set the power mode to ON.
4. Keep pressing the button for 10 seconds. Release the button when the indicator in the button flashes.
  - ▶ The beeper sounds once.
5. While the indicator is flashing, press the button again. The indicator in the button turns off.
  - ▶ The beeper sounds twice. The rear sensors are now turned off. They will remain turned off until manually turned back on again. To turn the rear sensors on again, follow the above procedure. The beeper sounds three times when the rear sensors come back on.

### ☒ Turning off All Rear Sensors

When you set the gear position to **[R]**, the indicator in the parking sensor system button blinks as a reminder that the rear sensors have been turned off.

## Cross Traffic Monitor

Monitors the rear corner areas using the radar sensors when reversing, and alerts you if a vehicle approaching from a rear corner is detected.

The system is convenient when you are backing out of a parking space.

### ⓘ Cross Traffic Monitor

#### CAUTION

Cross Traffic Monitor cannot detect all approaching vehicles and may not detect an approaching vehicle at all.

Failure to visually confirm that it is safe to back up the vehicle before doing so may result in a collision.

Do not solely rely on the system when reversing; always also use your mirrors, and look behind and to the sides of your vehicle before reversing.

## How the System Works

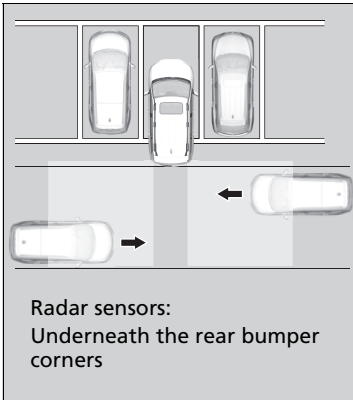

The system activates when:

- The power mode is in ON.
- The Cross Traffic Monitor is turned on.
  - ▶ **Cross Traffic Monitor On and Off** P. 481
- The transmission is in **R**.
- Your vehicle is moving at 3 mph (5 km/h) or lower.

When a vehicle is detected approaching from a rear corner, Cross Traffic Monitor alerts you with a buzzer and a displayed warning.

The system will not detect a vehicle that approaches from directly behind your vehicle, nor will it provide alerts about a detected vehicle when it moves directly behind your vehicle.

The system does not provide alerts for a vehicle that is moving away from your vehicle, and it may alert for pedestrians, bicycles, or stationary objects.

## ⊠ Cross Traffic Monitor

Cross Traffic Monitor may not detect or may delay alerting an approaching vehicle, or may alert without an approaching vehicle under the following conditions:

- An obstacle, such as another vehicle and a wall, near your vehicle's rear bumper, is blocking the radar sensor's scope.
- Your vehicle is moving at the speed of about 3 mph (5 km/h) or higher.
- A vehicle is approaching at the speed other than between about 6 and 16 mph (10 and 25 km/h).
- The system picks up external interference such as other radar sensors from another vehicle or strong radio wave transmitted from a facility nearby.
- Either corner of the rear bumper is covered with snow, ice, mud or dirt.
- When there is bad weather.
- Your vehicle is on an incline.
- Your vehicle is tilted due to a heavy load in the rear.
- Your vehicle is reversing toward a wall, a pole, a vehicle, and so on.

The rear bumper or the sensors have been improperly repaired or the rear bumper has been deformed. Have a vehicle checked by a dealer.



For proper operation, always keep the rear bumper corner area clean. Do not cover the rear bumper corner area with labels or stickers of any kind.

### ■ When the System Detects a Vehicle

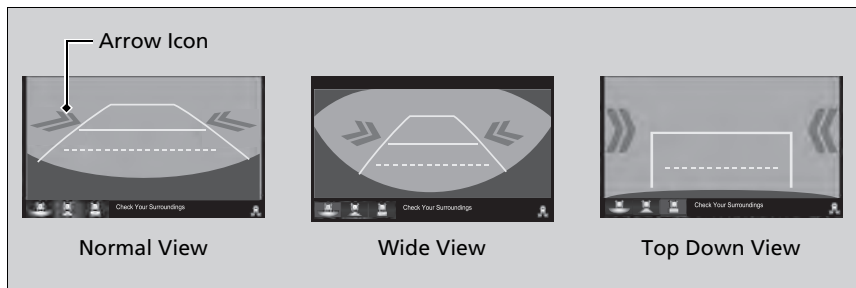
An arrow icon appears on the side a vehicle is approaching on the audio/information screen.



### ⚠ When the System Detects a Vehicle

If the  on the lower right changes to  in amber when the transmission is in **R**, mud, snow or ice, etc. may have accumulated in the vicinity of the sensor. The system is temporarily canceled. Check the bumper corners for any obstructions, and thoroughly clean the area if necessary.

If the  comes on when the transmission is in **R**, there may be a problem with the Cross Traffic Monitor system. Do not use the system and have your vehicle checked by a dealer.

If the display remains the same with the transmission in **R**, there may be a problem with the rear camera system and the Cross Traffic Monitor system. Do not use the system and have your vehicle checked by a dealer.

## ■ Cross Traffic Monitor On and Off

You can switch on and off the system using the audio/information screen.

1. Select .
2. Select **Settings**.
3. Select **Camera**.
4. Select **Rear Camera**.
5. Select **Cross Traffic Monitor**.
6. Select **ON** or **OFF**.

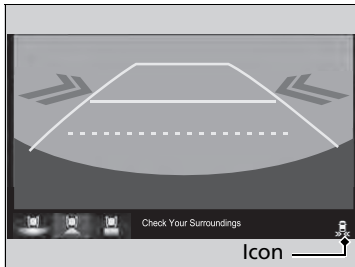

The system can also be turned on and off on the audio/information screen by pressing the CTM icon.

## About Your Multi-View Rear Camera

The audio/information screen can display your vehicle's rear view. The display automatically changes to a rear view when the gear position is changed to **R**.

### Multi-View Rear Camera Display Area

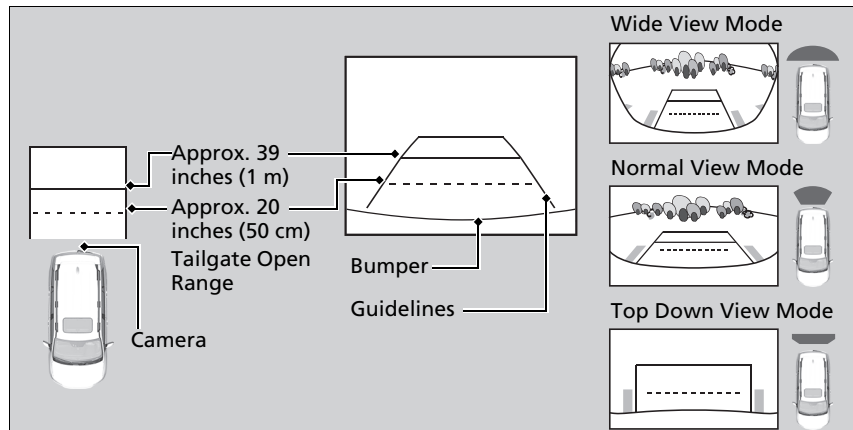

### About Your Multi-View Rear Camera

The rear camera view is restricted. You cannot see the corner ends of the bumper or what is underneath the bumper. Its unique lens also makes objects appear closer or farther than they actually are.

Visually confirm that it is safe to drive before backing up. Certain conditions (such as weather, lighting, and high temperatures) may also restrict the rear view. Do not rely on the rearview display which does not give you all information about conditions at the back of your vehicle.

If the camera lens is covered with dirt or moisture, use a soft, moist cloth to keep the lens clean and free of debris.

You can change the **Fixed**, **Dynamic**, **Both** and **OFF** settings.

**Customized Features** P. 327

**Fixed:** Guidelines appear when you put the transmission into **R**.

**Dynamic:** Guidelines move according to the steering wheel direction.

**Both:** Guidelines appear when you put the transmission into **R** and Guidelines move according to the steering wheel direction.

**OFF:** Guidelines do not appear.

You can view three different camera modes on the audio/information screen.

Select the appropriate icon to switch the angle.



: Wide view mode



: Normal view mode



: Top down view mode

- If you were last using Wide view mode or Normal view mode, the same view mode will be activated the next time you put the transmission into **R**.
- If you were using Top down view mode before you turned off the power system, Wide view mode will be activated the next time you set the power mode to ON and put the transmission into **R**.
- If you were using Top down view mode and 10 seconds elapsed after you took the transmission out of **R**, Wide view mode will be activated the next time you put the transmission into **R**.

#### ▶▶ About Your Multi-View Rear Camera

You can change the **Last Used, Normal View** and **Wide View** settings.

▶ **Customized Features** P. 327



## Fuel Information

### ■ Fuel recommendation

**Unleaded gasoline, pump octane number 87 or higher**

Use of a lower octane gasoline can cause a persistent, heavy metallic knocking noise that can lead to engine damage.

### ■ Top tier detergent gasoline

Because the level of detergency and additives in gasoline vary in the market, Honda endorses the use of "TOP TIER Detergent Gasoline" where available to help maintain the performance and reliability of your vehicle. TOP TIER Detergent Gasoline meets a new gasoline standard jointly established by leading automotive manufacturers to meet the needs of today's advanced engines.

Qualifying gasoline retailers will, in most cases, identify their gasoline as having met "TOP TIER Detergent Gasoline" standards at the retail location. This fuel is guaranteed to contain the proper level of detergent additives and be free of metallic additives. The proper level of detergent additives, and absence of harmful metallic additives in gasoline, help avoid buildup of deposits in your engine and emission control system.

For further important fuel-related information for your vehicle, or on information on gasoline that does not contain MMT, visit [www.hondacars.com](http://www.hondacars.com). In Canada, visit [www.honda.ca](http://www.honda.ca) for additional information on gasoline. For more information on top tier gasoline, visit [www.toptiergas.com](http://www.toptiergas.com).

■ **Fuel tank capacity: 19.5 US gal (73.8 L)**

### ⌘ Fuel Information

#### NOTICE

We recommend quality gasoline containing detergent additives that help prevent fuel system and engine deposits. In addition, in order to maintain good performance, fuel economy, and emissions control, we strongly recommend the use of gasoline that does NOT contain harmful manganese-based fuel additives such as MMT, if such gasoline is available.

Use of gasoline with these additives may adversely affect performance, and cause the malfunction indicator lamp on your instrument panel to come on. If this happens, contact a dealer for service. Some gasoline today is blended with oxygenates such as ethanol. Your vehicle is designed to operate on oxygenated gasoline containing up to 15% ethanol by volume. Do not use gasoline containing methanol. If you notice any undesirable operating symptoms, try another service station or switch to another brand of gasoline.

## How to Refuel

Your fuel tank is not equipped with a fuel filler cap. You can insert the filler nozzle directly into the filler neck. The tank seals itself again when you pull out the filler nozzle.

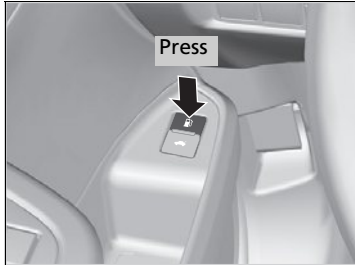

1. Stop your vehicle with the service station pump on the left side of the vehicle in the rear.
2. Turn off the engine.
3. Press the fuel fill door release button.
  - ▶ The fuel fill door opens.

### How to Refuel

## ⚠ WARNING

Gasoline is highly flammable and explosive. You can be burned or seriously injured when handling fuel.

- Stop the engine, and keep heat, sparks, and flames away.
- Handle fuel only outdoors.
- Wipe up spills immediately.

The fuel filler opening is designed to accept only service station filler nozzles for refueling. Use of smaller diameter tubes (e.g., those used to siphon fuel for other uses) or other non-service station devices can damage the area in and around the filler opening.

The filler nozzle automatically stops to leave space in the fuel tank so that fuel does not overflow as a result of changes in air temperature.

Do not continue to add fuel after the filler nozzle has automatically stopped. Additional fuel can exceed the full tank capacity.

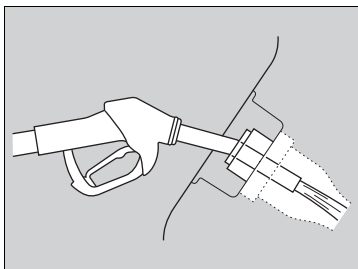

4. Place the end of the filler nozzle on the lower part of filler opening, then insert it slowly and fully.
  - ▶ Make sure that the end of the filler nozzle goes down along with the filler pipe.
  - ▶ Keep the filler nozzle level.
  - ▶ When the tank is full, the filler nozzle will click off automatically.
  - ▶ If you do not fill up the tank to full, always add a minimum of 3.5 US gal (13.3 L) of fuel.
  - ▶ After filling, wait about five seconds before removing the filler nozzle.
5. Shut the fuel fill door by hand.

#### How to Refuel

If the filler nozzle keeps turning off when the tank is not full, there may be a problem with the pump's fuel vapor recovery system. Try filling at another pump. If this does not fix the problem, consult a dealer.

If you repeatedly fill the tank with less than the specified minimum amount of fuel, the malfunction indicator lamp may come on. If this happens, have your vehicle checked by a dealer.

If you have to refuel your vehicle from a portable container, use the funnel provided with your vehicle.

#### Refueling From a Portable Fuel Container

P. 574

## Improving Fuel Economy and Reducing CO<sub>2</sub> Emissions

Achieving fuel economy and reducing CO<sub>2</sub> emissions is dependent on several factors, including driving conditions, load weight, idling time, driving habits, and vehicle condition. Depending on these and other factors, you may not achieve the rated fuel economy of this vehicle.

### Maintenance and Fuel Economy

You can optimize your fuel economy with proper maintenance of your vehicle. Always maintain your vehicle in accordance with the messages displayed on the driver information interface.

- Use engine oil with the viscosity recommended.
  - **Recommended Engine Oil** P. 503
- Maintain the specified tire pressure.
- Do not load the vehicle with excess cargo.
- Keep your vehicle clean. A buildup of snow or mud on your vehicle's underside adds weight and increases wind resistance.

### Improving Fuel Economy and Reducing CO<sub>2</sub> Emissions

Direct calculation is the recommended method to determine actual fuel consumed while driving.

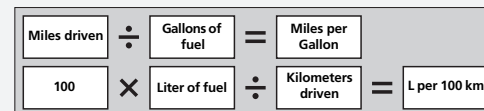

In Canada, posted fuel economy numbers are established following a simulated test. For more information on how this test is performed, please visit <https://www.nrcan.gc.ca> and search for “fuel consumption testing” in the search field at the top of the page.

This page intentionally left blank.

# Maintenance

This chapter discusses basic maintenance.



## Before Performing Maintenance

Inspection and Maintenance .....	490
Safety When Performing Maintenance.....	491
Parts and Fluids Used in Maintenance	
Service .....	493

<b>Maintenance Minder™</b> .....	494
----------------------------------	-----

## Maintenance Under the Hood

Maintenance Items Under the Hood.....	500
Opening the Hood .....	501
Engine Compartment Cover .....	502
Recommended Engine Oil .....	503
Oil Check .....	504
Adding Engine Oil .....	505

Changing the Engine Oil and Oil Filter .....	506
Engine Coolant .....	508
Transmission Fluid .....	510
Brake Fluid .....	511
Refilling Window Washer Fluid.....	511

<b>Replacing Light Bulbs</b> .....	512
------------------------------------	-----

<b>Checking and Maintaining Wiper Blades</b> .....	518
--	-----

## Checking and Maintaining Tires

Checking Tires .....	522
Tire and Loading Information Label ..	523
Tire Labeling .....	523
DOT Tire Quality Grading (U.S. Vehicles) ..	525

Wear Indicators .....	527
Tire Service Life .....	527
Tire and Wheel Replacement .....	528
Tire Rotation .....	529
Winter Tires .....	530

<b>Battery</b> .....	531
----------------------	-----

<b>Remote Transmitter Care</b> .....	533
--------------------------------------	-----

<b>Climate Control System Maintenance</b> .....	534
---	-----

## Cleaning

Interior Care .....	536
Exterior Care .....	538

<b>Accessories and Modifications</b> .....	541
--	-----

## Inspection and Maintenance

For your safety, perform all listed inspections and maintenance to keep your vehicle in good condition. If you become aware of any abnormality (noise, smell, insufficient brake fluid, oil residue on the ground, etc.), have your vehicle inspected by a dealer. (Note, however, that service at a dealer is not mandatory to keep your warranties in effect.)

### Types of Inspection and Maintenance

#### ■ Routine inspections

Perform inspections before long distance trips, when washing the vehicle, or when refueling.

➤ **Maintenance** P. 28

#### ■ Periodic inspections

- Check the brake fluid level monthly.
  - **Checking the Brake Fluid** P. 511
- Check the tire pressure monthly. Examine the tread for wear and foreign objects.
  - **Checking and Maintaining Tires** P. 522
- Check the operation of the exterior lights monthly.
  - **Replacing Light Bulbs** P. 512
- Check the condition of the wiper blades at least every six months.
  - **Checking and Maintaining Wiper Blades** P. 518

### Inspection and Maintenance

#### U.S. models

**Maintenance, replacement, or repair of emissions control devices and systems may be done by any automotive repair establishment or individuals using parts that are “certified” to EPA standards.**

According to state and federal regulations, failure to perform maintenance on the maintenance main items marked with # will not void your emissions warranties. However, all maintenance services should be performed in accordance with the intervals indicated by the driver information interface.

➤ **Maintenance Service Items** P. 497

If you want to perform complex maintenance tasks that require more skills and tools, you can purchase a subscription to the Service Express website at <https://techinfo.honda.com>.

➤ **Authorized Manuals** P. 588

If you want to perform maintenance yourself, make sure that you have the necessary tools and skills first. After performing maintenance, update the records in the separate maintenance booklet.

## Safety When Performing Maintenance

Some of the most important safety precautions are given here. However, we cannot warn you of every conceivable hazard that can arise in performing maintenance. Only you can decide whether you should perform a given task.

### Maintenance Safety

- To reduce the possibility of fire or explosion, keep cigarettes, sparks, and flames away from the battery and all fuel related parts.
- Never leave rags, towels, or other flammable objects under the hood.
  - ▶ Heat from the engine and exhaust can ignite them, causing a fire.
- To clean parts, use a commercially available degreaser or parts cleaner, not gasoline.
- Wear eye protection and protective clothing when working with the 12-volt battery or compressed air.
- Engine exhaust contains carbon monoxide, which is poisonous and can kill you.
  - ▶ Only operate the engine if there is sufficient ventilation.

### Vehicle Safety

- The vehicle must be in a stationary condition.
  - ▶ Make sure your vehicle is parked on level ground, the parking brake is set, and the engine is off.
- Make sure that the radiator fan is stopped before inspecting the engine compartment.
  - ▶ Depending on the vehicle condition, the radiator fan may operate even when the power mode is in VEHICLE OFF.
- Be aware that hot parts can burn you.
  - ▶ Make sure to let the engine and exhaust system cool thoroughly before touching vehicle parts.

#### ⚠ Safety When Performing Maintenance

### ⚠ WARNING

Improperly maintaining this vehicle or failing to correct a problem before driving can cause a crash in which you can be seriously hurt or killed.

Always follow the inspection and maintenance recommendations according to the schedules in this owner's manual.

### ⚠ WARNING

Failure to properly follow maintenance instructions and precautions can cause you to be seriously hurt or killed.

Always follow the procedures and precautions in this owner's manual.



- Be aware that moving parts can injure you.
  - ▶ Do not start the engine unless instructed, and keep your hands and limbs away from moving parts.
  - ▶ Do not open the hood while the Auto Idle Stop function is activated.

## Parts and Fluids Used in Maintenance Service

---

The use of Honda Genuine Parts and fluids is recommended when maintaining and servicing your vehicle. Honda Genuine Parts are manufactured according to the same high quality standards used in Honda vehicles.

### ▣ Parts and Fluids Used in Maintenance Service

#### NOTICE

Do not press the engine cover forcibly. This may damage the engine cover and component parts.

If the engine oil life is less than 15%, you will see the Maintenance Minder messages appear on the driver information interface every time you set the power mode to ON. The messages notify you when to change the engine oil, or when to bring your vehicle to a dealer for indicated maintenance services.

## To Use Maintenance Minder™

### ■ Displaying the Maintenance Minder Information

Maintenance items, which should be serviced at the same time that you replace the engine oil, appear on the driver information interface.

You can view them on the engine oil life screen at any time.

1. Set the power mode to ON.
2. Press the **ENTER** button repeatedly until home screen appears.
3. Select **Maintenance** by pressing the **▲/▼** button repeatedly and press **ENTER**.
4. Select **Oil Life** by pressing the **▲/▼** button and press **ENTER**.
5. The engine oil life appears on the screen.

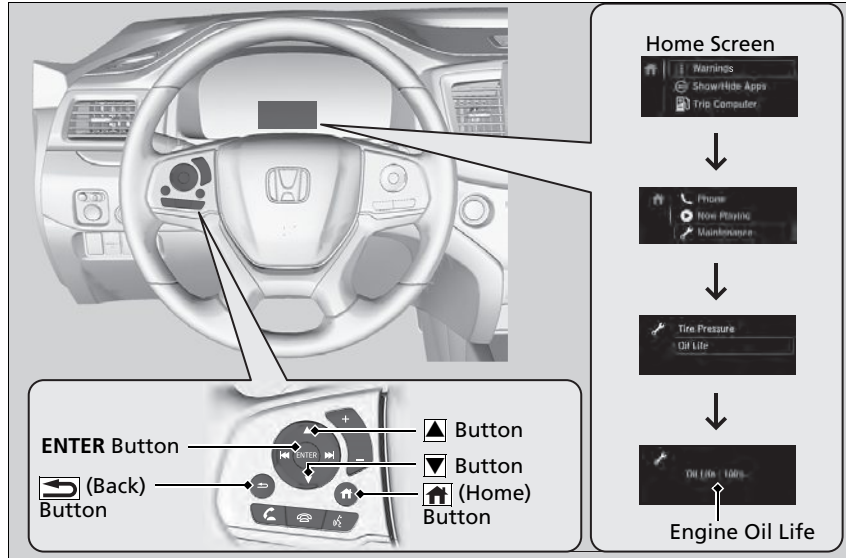

### ▣ Displaying the Maintenance Minder Information







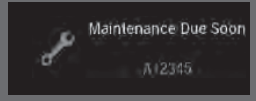
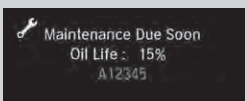

Based on the engine operating conditions, the remaining engine oil life is calculated and displayed as a percentage.

Displayed Engine Oil Life (%)	Calculated Engine Oil Life (%)
100	100 to 91
90	90 to 81
80	80 to 71
70	70 to 61
60	60 to 51
50	50 to 41
40	40 to 31
30	30 to 21
20	20 to 16
15	15 to 11
10	10 to 6
5	5 to 1
0	0

There is a list of maintenance main and sub items you can view on the driver information interface.

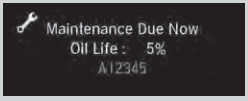
▣ **Maintenance Service Items** P. 497

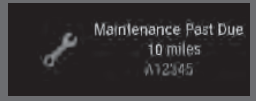
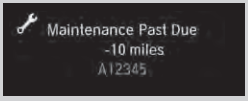
## ■ Maintenance Minder Messages on the Driver Information Interface

Maintenance Message	Oil Life Display	Explanation	Information
<b>Maintenance Due Soon</b> 	15% 	The remaining engine oil life is 15 to 6 percent. Once you switch the display by pressing the  , or  button, this message will go off.	The engine oil is approaching the end of its service life, and the maintenance items should be inspected and serviced soon.
<b>Maintenance Due Now</b> 	5% 	The remaining engine oil life is 5 to 1 percent. Press the  , or  button to switch to another display.	The engine oil has almost reached the end of its service life, and the maintenance items should be inspected and serviced as soon as possible.
<b>Maintenance Past Due</b> 	Negative Distance 	The remaining engine oil life has passed its service life, and a negative distance appears after driving over 10 miles (U.S. models) or 10 km (Canadian models). Press the  , or  button to switch to another display.	The engine oil life has passed. The maintenance items must be inspected and serviced immediately.

The system message indicator (i) comes on along with the Maintenance Minder message.

## Maintenance Service Items

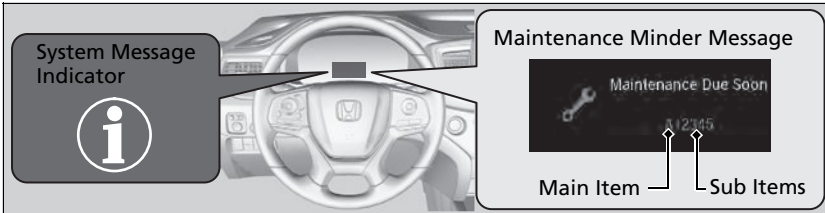

### U.S. models

CODE	Maintenance Main Items
A	<ul style="list-style-type: none"> <li>• Replace engine oil*<sup>1</sup></li> </ul>
B	<ul style="list-style-type: none"> <li>• Replace engine oil*<sup>1</sup> and oil filter</li> <li>• Inspect front and rear brakes</li> <li>• Check parking brake adjustment</li> <li>• Inspect tie rod ends, steering gearbox, and boots</li> <li>• Inspect suspension components</li> <li>• Inspect driveshaft boots</li> <li>• Inspect brake hoses and lines (Including ABS/VSA®)</li> <li>• Inspect all fluid levels and condition of fluids</li> <li>• Inspect exhaust system<sup>#</sup></li> <li>• Inspect fuel lines and connections<sup>#</sup></li> </ul>

CODE	Maintenance Sub Items
1	<ul style="list-style-type: none"> <li>• Rotate tires</li> </ul>
2	<ul style="list-style-type: none"> <li>• Replace air cleaner element*<sup>2</sup></li> <li>• Replace dust and pollen filter*<sup>3</sup></li> <li>• Inspect drive belt</li> </ul>
3	<ul style="list-style-type: none"> <li>• Replace transmission fluid and transfer fluid*</li> </ul>
4	<ul style="list-style-type: none"> <li>• Replace spark plugs</li> <li>• Replace timing belt and inspect water pump*<sup>4</sup></li> <li>• Inspect valve clearance</li> </ul>
5	<ul style="list-style-type: none"> <li>• Replace engine coolant</li> </ul>
6	<ul style="list-style-type: none"> <li>• Replace rear differential fluid*<sup>5</sup></li> </ul>
7	<ul style="list-style-type: none"> <li>• Replace brake fluid*<sup>6</sup></li> </ul>

Adjust the valves during services A, B, 1, 2, or 3 if they are noisy.

\*1: If the message **Maintenance Due Now** does not appear more than 12 months after the display is reset, change the engine oil every year.

#: See information on maintenance and emissions warranty in the first column on page 585.

\*2: If you drive in dusty conditions, replace every 15,000 miles (24,000 km).

\*3: If you drive primarily in urban areas that have high concentrations of soot in the air from industry and from diesel-powered vehicles, replace every 15,000 miles (24,000 km).

\*4: If you drive regularly in very high temperatures (over 110°F, 43°C), in very low temperatures (under -20°F, -29°C), replace every 60,000 miles (U.S.) /100,000 km (Canada).

\*5: Driving in mountainous areas at very low vehicle speeds or trailer towing results in higher level of mechanical (Shear) stress to fluid. This requires differential fluid changes more frequently than recommended by the Maintenance Minder. If you regularly drive your vehicle under these conditions, have the differential fluid changed at 7,500 miles (12,000 km), then every 15,000 miles (24,000 km).

\*6: If a Maintenance Minder message does not appear more than 36 months after the display for item 7 is reset, change the brake fluid every 3 years.

\* Not available on all models

Continued

Canadian models

CODE	Maintenance Main Items
A	• Replace engine oil*1
0	• Replace engine oil*1 and oil filter

Adjust the valves during services A, 0, 9, 1, 2, or 3 if they are noisy.

\*1: If the message **Maintenance Due Now** does not appear more than 12 months after the display is reset, change the engine oil every year.

\*2: If you drive in dusty conditions, replace every 24,000 km (15,000 miles).

\*3: If you drive primarily in urban areas that have high concentrations of soot in the air from industry and from diesel-powered vehicles, replace every 24,000 km (15,000 miles).

\*4: If you drive regularly in very high temperatures (over 43°C, 110°F), in very low temperatures (under -29°C, -20°F), replace every 100,000 km (60,000 miles).

\*5: Driving in mountainous areas at very low vehicle speeds or trailer towing results in higher level of mechanical (Shear) stress to fluid. This requires differential fluid changes more frequently than recommended by the Maintenance Minder. If you regularly drive your vehicle under these conditions, have the differential fluid changed at 12,000km (7,500 miles), then every 24,000 km (15,000 miles).

\*6: If a Maintenance Minder message does not appear more than 36 months after the display for item 7 is reset, change the brake fluid every 3 years.

#: See information on maintenance and emissions warranty in the first column on page 585.

CODE	Maintenance Sub Items
1	• Rotate tires
2	• Replace air cleaner element*2 • Replace dust and pollen filter*3 • Inspect drive belt
3	• Replace transmission fluid and transfer fluid
4	• Replace spark plugs • Replace timing belt and inspect water pump*4 • Inspect valve clearance
5	• Replace engine coolant
6	• Replace rear differential fluid*5
7	• Replace brake fluid*6
9	• Service front and rear brakes • Check parking brake adjustment • Inspect tie rod ends, steering gearbox, and boots • Inspect suspension components • Inspect driveshaft boots • Inspect brake hoses and lines (including ABS/VSA®) • Inspect all fluid levels and condition of fluids • Inspect exhaust system# • Inspect fuel lines and connections#

## ■ Resetting the Display

Reset the maintenance minder information display if you have performed the maintenance service.

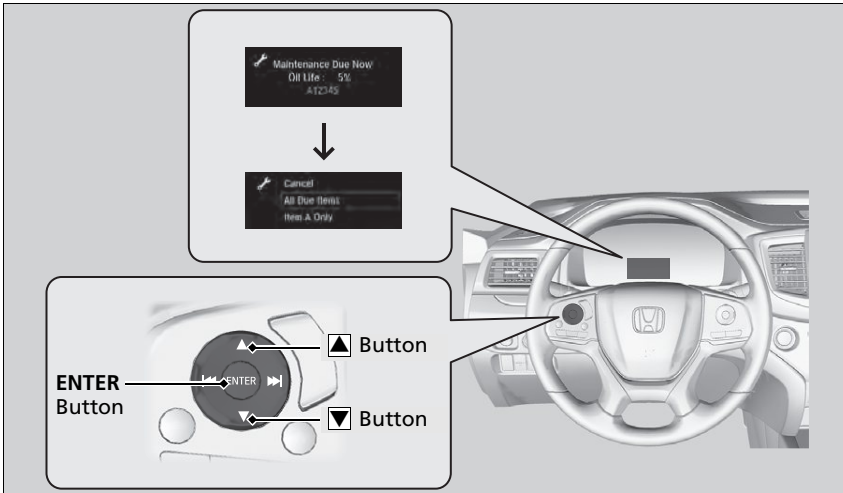

1. Set the power mode to ON.
2. Display the engine oil life.
  - ▶ **Displaying the Maintenance Minder Information** P. 495
3. Press and hold the **ENTER** button for about 10 seconds to enter the reset mode.
4. Press the ▲/▼ button to select a maintenance item to reset, or to select **All Due Items** (You can also select **Cancel** to end the process).
5. Press the **ENTER** button to reset the selected item.
6. Repeat from step 5 for other items you wish to reset.

## ▶▶ Resetting the Display

### NOTICE

Failure to reset the Maintenance Minder™ display after a maintenance service results in the system showing incorrect maintenance intervals, which can lead to serious mechanical problems.

The dealer will reset the Maintenance Minder™ display after completing the required maintenance service. If someone other than a dealer performs maintenance service, reset the Maintenance Minder™ display yourself.

You can also reset the Maintenance Minder™ display using the audio/information screen.

▶ **Customized Features** P. 327



## Maintenance Items Under the Hood

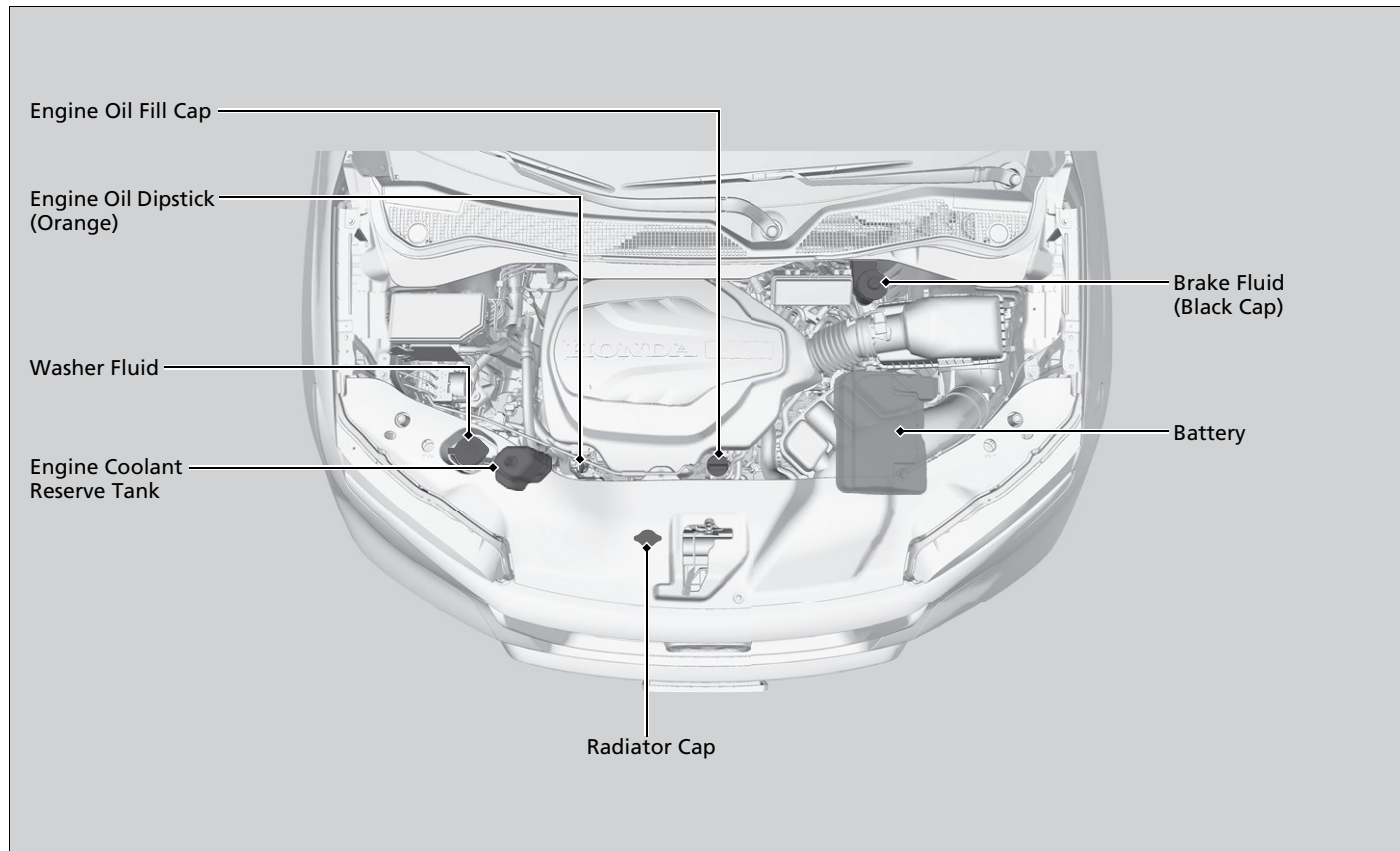

## Opening the Hood

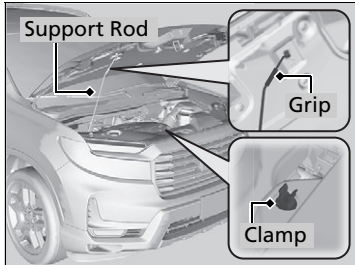
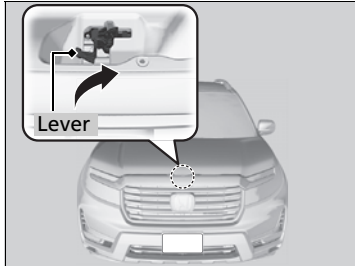
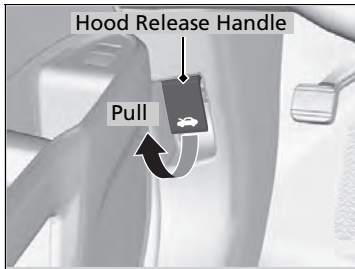

1. Park the vehicle on a level surface, and set the parking brake.
2. Pull the hood release handle under the driver's side lower corner of the dashboard.
  - The hood will pop up slightly.
3. Pull up the hood latch lever (located under the front edge of the hood to the center) and raise the hood. Once you have raised the hood slightly, you can release the lever.
4. Remove the support rod from the clamp using the grip. Mount the support rod in the hood.

When closing, remove the support rod and stow it in the clamp, then gently lower the hood. Remove your hand at a height of approximately 12 inches (30 cm) and let the hood close.

### Opening the Hood

#### NOTICE

Do not open the hood when the wiper arms are raised. The hood will strike the wipers, resulting in possible damage to the hood and/or the wipers.

#### NOTICE

Do not press the engine cover forcibly. This may damage the engine cover and component parts.

When closing the hood, check that the hood is securely latched.

If the hood latch lever moves stiffly, or if you can open the hood without lifting the lever, the latch mechanism should be cleaned and lubricated.

Do not open the hood while the Auto Idle Stop function is activated.

## Engine Compartment Cover

The component parts in the engine compartment are protected by a cover. You may need to remove the cover when you perform certain maintenance work. Pull up on the engine compartment cover, remove it from the pin holders.

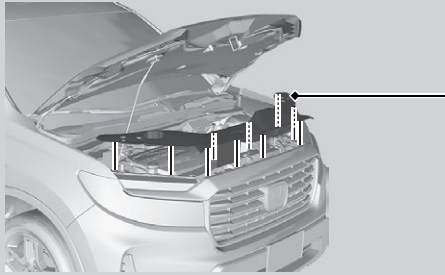

Engine Compartment Cover

## Recommended Engine Oil

Use a genuine engine oil or another commercial engine oil of suitable type and viscosity (for the ambient temperature) as shown in the image that follows.

Oil is a major contributor to your engine’s performance and longevity. If you drive the vehicle with insufficient or deteriorated oil, the engine may fail or be damaged.

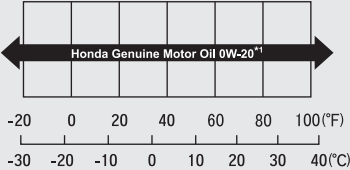
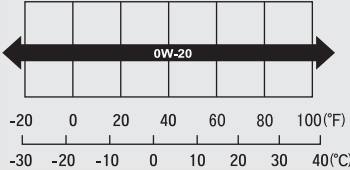
Genuine Engine Oil	Commercial Engine Oil
<ul style="list-style-type: none"> <li>• Honda Genuine Motor Oil</li> </ul>	<ul style="list-style-type: none"> <li>• API service SN or higher grade</li> <li>• API Certification Mark “Starburst”</li> </ul>
 <p style="text-align: center;">Ambient Temperature</p>	 <p style="text-align: center;">Ambient Temperature</p>

\*1: Formulated to improve fuel economy.

### ■ Synthetic oil

You may also use synthetic motor oil if it is labeled with the API Certification Seal and is the specified viscosity grade.

### Recommended Engine Oil

#### Engine Oil Additives

Your vehicle does not require oil additives. In fact, they may adversely affect the engine performance and durability.

The following seal indicates the oil is energy conserving and that it meets the American Petroleum Institute’s latest requirements.



## Oil Check

We recommend that you check the engine oil level every time you refuel.

Park the vehicle on level ground.

Wait approximately three minutes after turning the engine off before you check the oil.

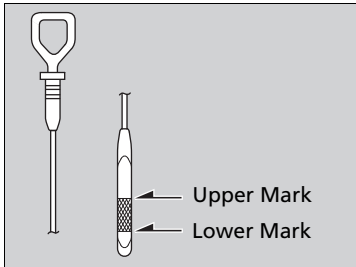
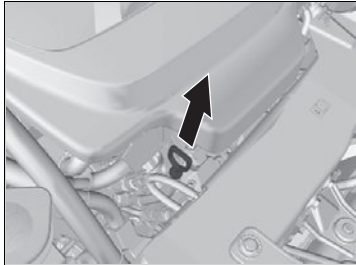

1. Remove the dipstick (orange).
2. Wipe the dipstick with a clean cloth or paper towel.
3. Insert the dipstick back all the way into its hole.
  
4. Remove the dipstick again, and check the level. It should be between the upper and lower marks. Add oil if necessary.

### Oil Check

If the oil level is near or below the lower mark, slowly add oil, being careful not to overfill.

## Adding Engine Oil

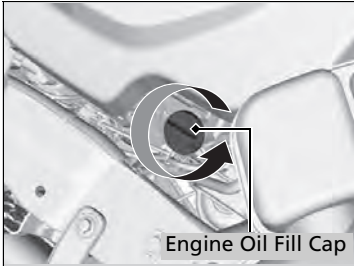

1. Unscrew and remove the engine oil fill cap.
2. Add oil slowly.
3. Reinstall the engine oil fill cap, and tighten it securely.
4. Wait for three minutes and recheck the engine oil dipstick.

### Adding Engine Oil

#### NOTICE

Do not fill the engine oil above the upper mark. Overfilling the engine oil may result in leaks and engine damage.

If any oil spills, wipe it away immediately. Spilled oil may damage the engine compartment components.

## Changing the Engine Oil and Oil Filter

You must change the engine oil and oil filter regularly in order to maintain the engine's lubrication. The engine may be damaged if they are not changed regularly.

Change the oil and filter in accordance with the maintenance message on the driver information interface.

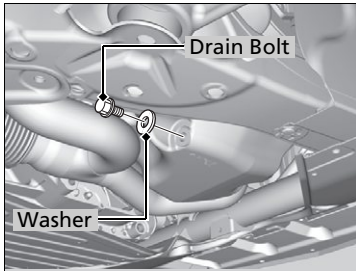

1. Run the engine until it reaches normal operating temperature, and then turn the engine off.
2. Open the hood and remove the engine oil fill cap.
3. Remove the drain bolt and washer from the bottom of the engine, and drain the oil into a suitable container.

### Changing the Engine Oil and Oil Filter

#### NOTICE

You may damage the environment if you do not dispose of the oil in a suitable way. If you are changing the oil by yourself, appropriately dispose of the used oil. Put the oil in a sealed container and take it to a recycling center. Do not throw the oil away into a garbage can or onto the ground.

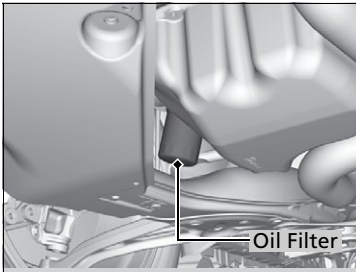

4. Remove the oil filter and dispose of the remaining oil.
5. Check that the filter gasket is not stuck to the engine contact surface.
  - If it is stuck, you must detach it.
6. Wipe away dirt and dust adhering to the contact surface of the oil filter base, and install a new oil filter.
  - Apply a light coat of new engine oil to the oil filter rubber seal.
7. Put a new washer on the drain bolt, then reinstall the drain bolt.
  - Tightening torque:  
29 lbf·ft (39 N·m, 4.0 kgf·m)
8. Pour the recommended engine oil into the engine.
  - Engine oil change capacity (including filter):  
5.7 US qt (5.4 L)
9. Reinstall the engine oil fill cap securely and start the engine.
10. Run the engine for a few minutes, and then check that there is no leak from the drain bolt or oil filter.
11. Stop the engine, wait for three minutes, and then check the oil level on the dipstick.
  - If necessary, add more engine oil.

#### ✕ Changing the Engine Oil and Oil Filter

You will need a special wrench to replace the oil filter. You can buy this wrench from a dealer.

When installing the new oil filter, follow the instructions supplied with the oil filter.

Reinstall the engine oil fill cap. Start the engine. The low oil pressure indicator should go off within five seconds. If it does not, turn off the engine, and check your work.



## Engine Coolant

**Specified coolant:** Honda Long Life Antifreeze/Coolant Type 2

This coolant is premixed with 50% antifreeze and 50% water. Do not add any straight antifreeze or water.

We recommend you check the engine coolant level every time you refuel. Check the reserve tank first. If it is completely empty, also check the coolant level in the radiator. Add the engine coolant accordingly.

### Reserve Tank

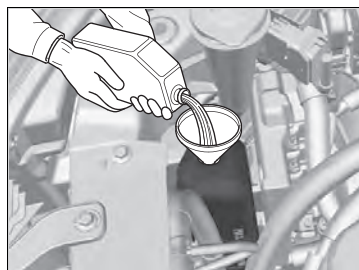
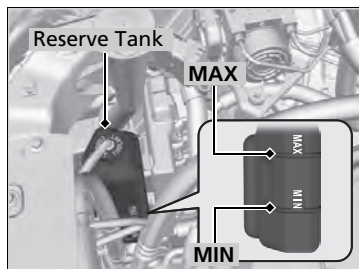

1. **Make sure the engine and radiator are cool.**
2. Remove the engine compartment cover.
  - **Engine Compartment Cover** P. 502
3. Check the amount of coolant in the reserve tank.
  - If the coolant level is below the **MIN** mark, add the specified coolant until it reaches the **MAX** mark.
4. Inspect the cooling system for leaks.

### Engine Coolant

## ⚠ WARNING

Removing the radiator cap while the engine is hot can cause the coolant to spray out, seriously scalding you.

Always let the engine and radiator cool down before removing the radiator cap.

### NOTICE

Genuine Honda engine coolant is a 50/50 mixture of antifreeze and water that can withstand freezing at temperatures as low as about -31°F (-35°C). If your vehicle is consistently subjected to temperatures below this, the concentration of antifreeze in the coolant should be increased. Consult a dealer for details.

If Honda antifreeze/coolant is not available, you may use another major brand of non-silicate coolant as a temporary replacement. Check that it is a high quality coolant recommended for aluminum engines. Continued use of any non-Honda coolant can result in corrosion, causing the cooling system to malfunction or fail. Have the cooling system flushed and refilled with Honda antifreeze/coolant as soon as possible.

Do not add rust inhibitors or other additives to your vehicle's cooling system. They may not be compatible with the coolant or with the engine components.

## Radiator

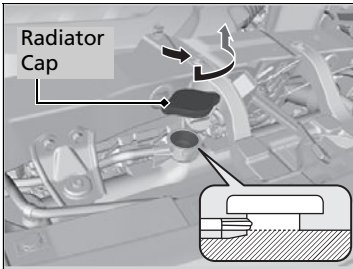

1. **Make sure the engine and radiator are cool.**
2. Remove the engine compartment cover.  
 **Engine Compartment Cover** P. 502
3. Turn the radiator cap 1/8th turn counter-clockwise and relieve any pressure in the cooling system. Do not push the cap down when turning.
4. Push down and turn the radiator cap counter-clockwise to remove it.
5. The coolant level should be up to the base of the filler neck. Add coolant if it is low.
6. Put the radiator cap back on, and tighten it fully.

### ⌘ Radiator

#### NOTICE

Pour the fluid slowly and carefully so you do not spill any. Clean up any spills immediately; they can damage components in the engine compartment.

## Transmission Fluid

### ■ Automatic Transmission Fluid

**Specified fluid: Honda ATF-TYPE 3.1 or higher**

Have a dealer check the fluid level and replace if necessary.

Do not attempt to check or change the automatic transmission fluid yourself.

### ⚠ Automatic Transmission Fluid

**Do not mix Honda ATF-TYPE 3.1 (or higher) with other transmission fluids.**

Using a transmission fluid other than Honda ATF-TYPE 3.1 (or higher) may adversely affect the operation and durability of your vehicle's transmission, and damage the transmission.

Any damage caused by using a transmission fluid that is not equivalent to Honda ATF-TYPE 3.1 (or higher) is not covered by Honda's new vehicle limited warranty.

## Brake Fluid

**Specified fluid:** Honda Heavy Duty Brake Fluid DOT 3

### ■ Checking the Brake Fluid

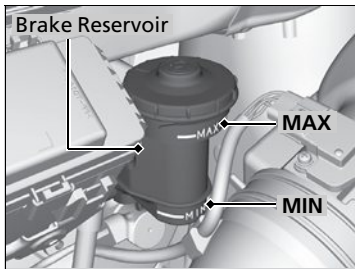

The fluid level should be between the **MIN** and **MAX** marks on the side of the reserve tank.

### Refilling Window Washer Fluid

If the washer fluid is low, a message appears on the driver information interface. Pour the washer fluid carefully. Do not overflow the reservoir.

#### ▣ Brake Fluid

##### NOTICE

Brake fluid marked DOT 5 is not compatible with your vehicle's braking system and can cause extensive damage.

If the specified brake fluid is not available, you should use only DOT 3 or DOT 4 fluid from a sealed container as a temporary replacement.

Using any non-Honda brake fluid can cause corrosion and decrease the longevity of the system. Have the brake system flushed and refilled with Honda Heavy Duty Brake Fluid DOT 3 as soon as possible.

If the brake fluid level is at or below the **MIN** mark, have a dealer inspect the vehicle for leaks or worn brake pads as soon as possible.

#### ▣ Refilling Window Washer Fluid

##### NOTICE

Do not use engine antifreeze or a vinegar/water solution in the windshield washer reservoir. Antifreeze can damage your vehicle's paint. A vinegar/water solution can damage the windshield washer pump.

Use only commercially available windshield washer fluid. Avoid prolonged use of hard water to prevent lime scale buildup.

## Headlight Bulbs

When replacing, use the following bulbs.

**High beam headlight: 60 W (HB3 for halogen bulb type)**

**Low beam headlight: LED type**

### High Beam Headlights

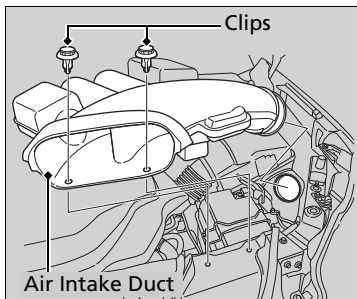

#### Driver side

1. Remove the engine compartment cover.  
🔧 **Engine Compartment Cover** P. 502
2. Remove the clips.
3. Remove the air intake duct.

#### Headlight Bulbs

##### NOTICE

Halogen bulbs get very hot when lit. Oil, perspiration, or a scratch on the glass can cause the bulb to overheat and shatter.

The headlight aim is set by the factory, and does not need to be adjusted. However, if you regularly carry heavy items in the cargo area or tow a trailer, have the aiming readjusted at a dealer or by a qualified technician.

Low beam headlights are LED type. Have an authorized Honda dealer inspect and replace the light assembly.

When replacing a halogen bulb, handle it by its base, and protect the glass from contact with your skin or hard objects. If you touch the glass, clean it with denatured alcohol and a clean cloth.

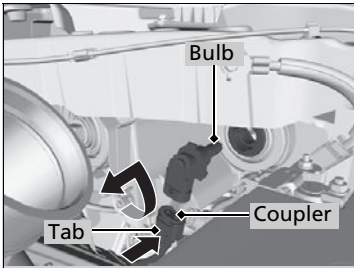

**Both sides**

4. Push the tab to remove the coupler.
5. Rotate the old bulb counter-clockwise to remove.
6. Insert a new bulb into the headlight assembly and turn it clockwise.
7. Insert the coupler into the connector of the bulb.

## Daytime Running Lights and Parking Lights

Daytime running lights and parking lights are LED type. Have an authorized Honda dealer inspect and replace the light assembly.

## Front Side Marker Lights

Front side marker lights are LED type. Have an authorized Honda dealer inspect and replace the light assembly.

⌘ Headlight Bulbs

Remove the clip using a Phillips-head screwdriver.

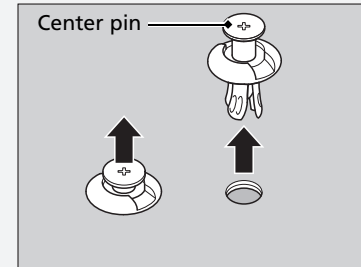

Insert the clip with the center pin raised, and push until it is flat.

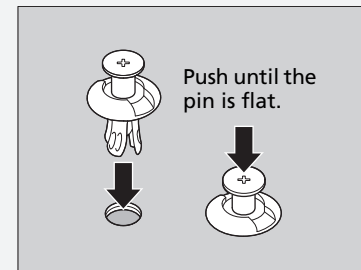

## Front Turn Signal Light Bulbs

When replacing, use the following bulbs.

**Front Turn Signal Light: 28/8W (Amber)**

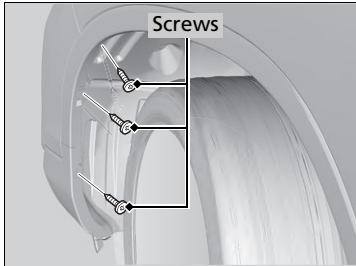

1. Remove the screws, pull the inner fender back.

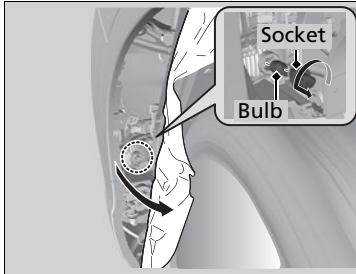

2. Turn the socket counter-clockwise and remove it.

3. Remove the old bulb and insert a new bulb.

## **Fog Lights\***

---

Fog lights are LED type. Have an authorized Honda dealer inspect and replace the light assembly.

## **Side Turn Signal/Emergency Indicator Lights**

---

Side turn lights are LED type. Have an authorized Honda dealer inspect and replace the light assembly.



## Brake/Taillights, Rear Side Marker Lights, and Rear Turn Signal Light Bulbs

When replacing, use the following bulbs.

<b>Brake/Taillight:</b>	<b>LED</b>
<b>Rear Side Marker Light:</b>	<b>LED</b>
<b>Rear Turn Signal Light:</b>	<b>21W (Amber)*1</b> <b>21W*2</b>

\*1: Models with AC power outlet

\*2: Models without AC power outlet

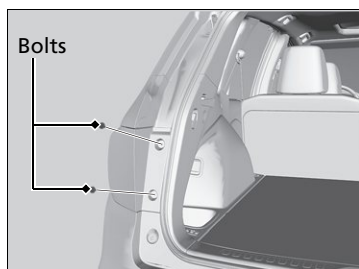

1. Use a Phillips-head screwdriver to remove the bolts.
2. Pull the light assembly out of the rear pillar.

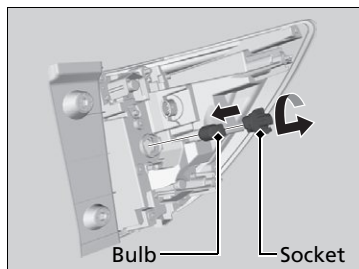

3. Turn the socket counter-clockwise and remove it. Remove the old bulb.
4. Insert a new bulb and turn clockwise.
5. Slide the light assembly onto the guide on the body.
6. Align the pins with the body grommets, then push in until they fully seat.

### ☒ Brake/Taillights, Rear Side Marker Lights, and Rear Turn Signal Light Bulbs

Brake/taillights and rear side marker lights are LED type. Have an authorized Honda dealer inspect and replace the light assembly.

## Back-Up Lights

---

When replacing, use the following bulbs.

**Back-Up Lights: 21 W**

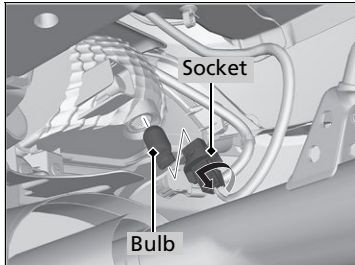

1. Turn the socket counter-clockwise and remove it. Remove the old bulb.
2. Insert a new bulb and turn clockwise.

## Rear License Plate Lights

---

Rear license plate lights are LED type. Have an authorized Honda dealer inspect and replace the light assembly.

## High-Mount Brake Light

---

High-mount brake light is LED type. Have an authorized Honda dealer inspect and replace the light assembly.

## Checking Wiper Blades

If the wiper blade rubber has deteriorated, it will leave streaks and become noisy, and the hard surfaces of the blade may scratch the window glass.

## Changing the Front Wiper Blade Rubber



1. Lift the driver side wiper arm first, then the passenger side.

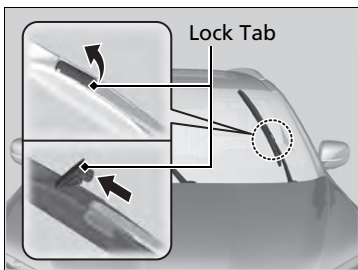

2. Place a cloth on the edge of the lock tab. Push the lock tab up with a flat-tip screw driver.
3. Slide the blade from the wiper arm.

### ☒ Changing the Front Wiper Blade Rubber

#### NOTICE

Avoid dropping the wiper arm onto the windshield, as it may damage the wiper arm and/or the windshield.

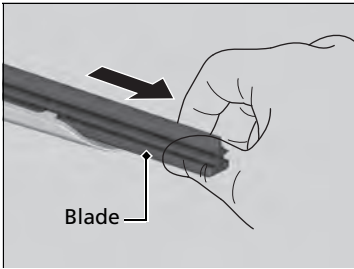

- 4.** Slide the wiper blade out of the holder by pulling the tabbed end out.

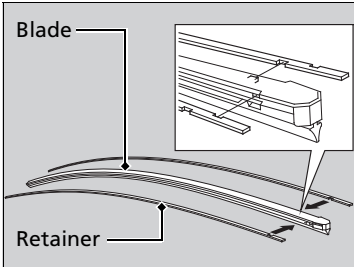

- 5.** Remove the retainers from the wiper blade that has been removed, and mount to a new wiper blade.  
 ▶ Correctly align the wiper blade protrusion and the retainer grooves.

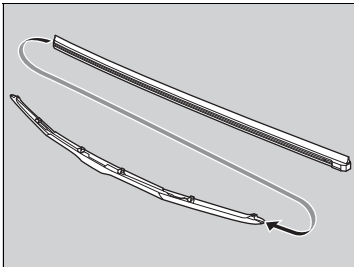

- 6.** Slide the new wiper blade onto the holder from the bottom end.  
 ▶ The tab on the holder should fit in the indent of the wiper blade.
- 7.** Slide the holder onto the wiper arm, then push down the lock tab.
- 8.** Lower the passenger side wiper arm first, then the driver side.

## Changing the Rear Wiper Blade Rubber

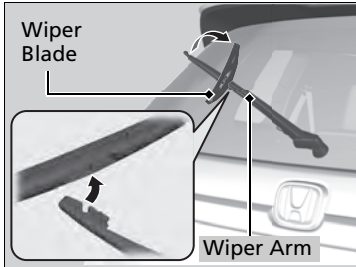

1. Raise the wiper arm off.
2. Pivot the bottom end of the wiper blade up until it comes off from the wiper arm.

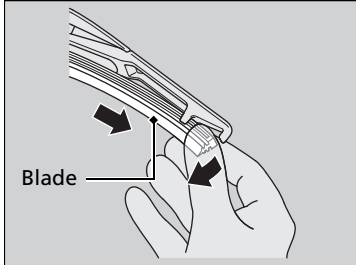

3. Slide the blade out of the holder.

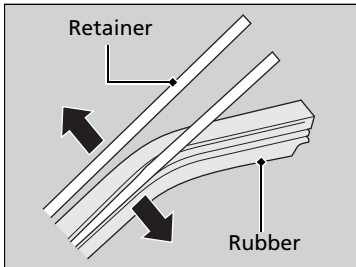

4. Remove the retainers from wiper blade and mount it to a new rubber blade.

### ▶▶ Changing the Rear Wiper Blade Rubber

#### NOTICE

Do not try to forcefully lift up the wiper arm. The wiper arm may be damaged if it is lifted too high.

#### NOTICE

Avoid dropping the wiper arm, as it may damage the rear window.

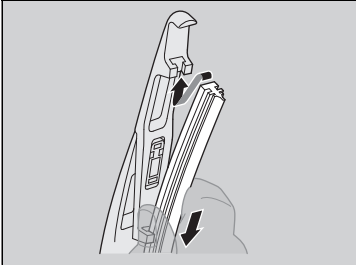

5. Slide the new wiper blade onto the holder.
  - ▶ Make sure it is engaged correctly, then install the wiper blade assembly onto the wiper arm.

## Checking Tires

To safely operate your vehicle, your tires must be of the proper type and size, in good condition with adequate tread, and properly inflated.

### ■ Inflation guidelines

Properly inflated tires provide the best combination of handling, tread life, and comfort. Refer to the driver's doorjamb label or specifications page for the specified pressure.

Underinflated tires wear unevenly, adversely affect handling and fuel economy, and are more likely to fail from overheating.

Overinflated tires make your vehicle ride harshly, are more prone to road hazards, and wear unevenly.

Every day before you drive, look at each of the tires. If one looks lower than the others, check the pressure with a tire gauge.

At least once a month or before long trips, use a gauge to measure the pressure in all tires, including the spare. Even tires in good condition can lose 1-2 psi (10-20 kPa, 0.1-0.2 kgf/cm<sup>2</sup>) per month.

### ■ Inspection guidelines

Every time you check inflation, also examine the tires and valve stems.

Look for:

- Bumps or bulges on the side or in the tread. Replace the tire if you find any cuts, splits, or cracks in the side of the tire. Replace it if you see fabric or cord.
- Remove any foreign objects and inspect for air leaks.
- Uneven tread wear. Have a dealer check the wheel alignment.
- Excessive tread wear.

📖 **Wear Indicators** P. 527

- Cracks or other damage around valve stem.

### 📖 Checking Tires

## ⚠️ WARNING

Using tires that are excessively worn or improperly inflated can cause a crash in which you can be seriously hurt or killed.

Follow all instructions in this owner's manual regarding tire inflation and maintenance.

Measure the air pressure when tires are cold. This means the vehicle has been parked for at least three hours, or driven less than 1 mile (1.6 km). If necessary, add or release air until the specified pressure is reached.

If checked when hot, tire pressure can be as much as 4-6 psi (30-40 kPa, 0.3-0.4 kgf/cm<sup>2</sup>) higher than if checked when cold.

Have a dealer check the tires if you feel a consistent vibration while driving. New tires and any that have been removed and reinstalled should be properly balanced.

## Tire and Loading Information Label

The label attached to the driver's doorjamb provides necessary tire and loading information.

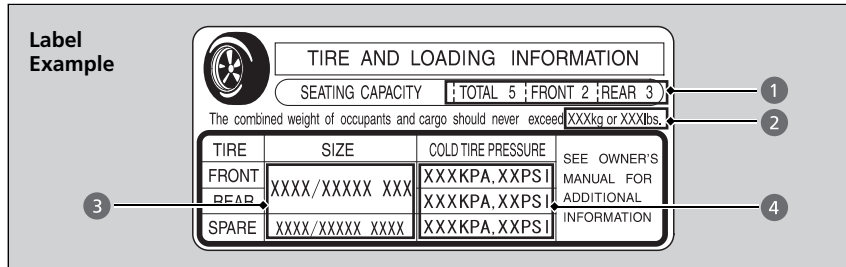

### Tire and Loading Information Label

The tire and loading information label attached to the driver's doorjamb contains:

- 1 The number of people your vehicle can carry.
- 2 The total weight your vehicle can carry. Do not exceed this weight.
- 3 The original tire sizes for front, rear, and spare.
- 4 The proper cold tire pressure for front, rear, and spare.

## Tire Labeling

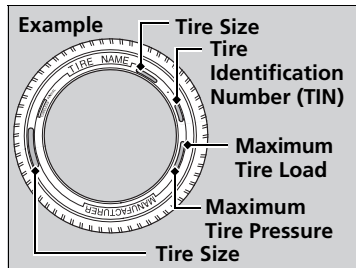

The tires that came on your vehicle have a number of markings. Those you should be aware of are described as shown.

### Tire Sizes

Following is an example of tire size with an explanation of what each component means.

#### **P235/60R18 102V**

P: Vehicle type (P indicates passenger vehicle).

235: Tire width in millimeters.

60: Aspect ratio (the tire's section height as a percentage of its width).

R: Tire construction code (R indicates radial).

18: Rim diameter in inches.

102: Load index (a numerical code associated with the maximum load the tire can carry).

V: Speed symbol (an alphabetical code indicating the maximum speed rating).

### Tire Sizes

Whenever tires are replaced, they should be replaced with tires of the same size.

Continued



## ■ Tire Identification Number (TIN)

The tire identification number (TIN) is a group of numbers and letters that look like the examples in the side column. TIN is located on the sidewall of the tire.

## ■ Glossary of Tire Terminology

**Cold Tire Pressure** – The tire air pressure when the vehicle has been parked for at least three hours or driven less than 1 mile (1.6 km).

**Load Rating** – Means the maximum load that a tire is rated to carry for a given inflation pressure.

**Maximum Inflation Pressure** – The maximum tire air pressure that the tire can hold.

**Maximum Load Rating** – Means the load rating for a tire at the maximum permissible inflation pressure for that tire.

**Recommended Inflation Pressure** – The cold tire inflation pressure recommended by the manufacturer.

**Treadwear Indicators (TWI)** – Means the projections within the principal grooves designed to give a visual indication of the degrees of wear of the tread.

## ►► Tire Identification Number (TIN)

There are two different formats that TIN may be listed in.

Format A

### **DOT B97R FW6X 2209**

DOT: This indicates that the tire meets all requirements of the U.S. Department of Transportation.

B97R: Manufacturer's identification mark.

FW6X: Tire type code.

22 09: Date of manufacture.

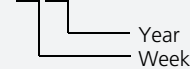

Format B

### **DOT 1A3 OFBEKP 1522**

DOT: This indicates that the tire meets all requirements of the U.S. Department of Transportation.

1A3: PLANT CODE

OFBEKP: MANUFACTURE CODE

15 22: DATE CODE

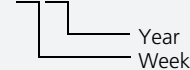

## DOT Tire Quality Grading (U.S. Vehicles)

The tires on your vehicle meet all U.S. Federal Safety Requirements. All tires are also graded for treadwear, traction, and temperature performance according to Department of Transportation (DOT) standards. The following explains these gradings.

### ■ Uniform Tire Quality Grading

Quality grades can be found where applicable on the tire sidewall between tread shoulder and maximum section width.

### ■ Treadwear

The treadwear grade is a comparative rating based on the wear rate of the tire when tested under controlled conditions on a specified government test course. For example, a tire graded 150 would wear one and one-half (1 1/2) times as well on the government course as a tire graded 100. The relative performance of tires depends upon the actual conditions of their use, however, and may depart significantly from the norm due to variations in driving habits, service practices and differences in road characteristics and climate.

### ▣ Uniform Tire Quality Grading

For example:  
**Treadwear 200**  
**Traction AA**  
**Temperature A**

All passenger car tires must conform to Federal Safety Requirements in addition to these grades.

## ■ Traction

The traction grades, from highest to lowest, are AA, A, B, and C. Those grades represent the tire's ability to stop on wet pavement as measured under controlled conditions on specified government test surfaces of asphalt and concrete. A tire marked C may have poor traction performance.

## ■ Temperature

The temperature grades are A (the highest), B, and C, representing the tire's resistance to the generation of heat and its ability to dissipate heat when tested under controlled conditions on a specified indoor laboratory test wheel. Sustained high temperature can cause the material of the tire to degenerate and reduce tire life, and excessive temperature can lead to sudden tire failure. The grade C corresponds to a level of performance which all passenger car tires must meet under the Federal Motor Vehicle Safety Standard No. 109. Grades B and A represent higher levels of performance on the laboratory test wheel than the minimum required by law.

### ⌘ Traction

Warning: The traction grade assigned to this tire is based on straight-ahead braking traction tests, and does not include acceleration, cornering, hydroplaning, or peak traction characteristics.

### ⌘ Temperature

Warning: The temperature grade for this tire is established for a tire that is properly inflated and not overloaded. Excessive speed, underinflation, or excessive loading, either separately or in combination, can cause heat buildup and possible tire failure.

## Wear Indicators

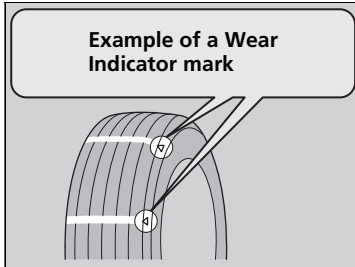

The groove where the wear indicator is located is about 1/16 inch (about 1.6 mm) shallower than elsewhere on the tire. If the tread has worn so that the indicator is exposed, replace the tire.

**Worn out tires have poor traction on wet roads.**

## Tire Service Life

The life of your tires is dependent on many factors, including driving habits, road conditions, vehicle loading, inflation pressure, maintenance history, speed, and environmental conditions (even when the tires are not in use).

In addition to regular inspections and inflation pressure maintenance, it is recommended that you have annual inspections performed once the tires reach five years old. All tires, including the spare, should be removed from service after 10 years from the date of manufacture, regardless of their condition or state of wear.

## Tire and Wheel Replacement

Replace your tires with radials of the same size, load range, speed rating, and maximum cold tire pressure rating (as shown on the tire's sidewall). Using tires of a different size or construction can cause certain vehicle systems such as the ABS and Vehicle Stability Assist™ (VSA®) system to work incorrectly.

It is best to replace all four tires at the same time. If that isn't possible, replace the front or rear tires in pairs.

Whenever you have a tire replaced or reset, make sure that the rubber valve stem is replaced and that the TPMS sensor is transferred from the old valve stem to the new one.

If you replace a wheel, make sure that the wheel's specifications match those of the original wheels.

### ▶▶ Tire and Wheel Replacement

#### **WARNING**

Installing improper tires on your vehicle can affect handling and stability. This can cause a crash in which you can be seriously hurt or killed.

Always use the size and type of tires recommended in this owner's manual.

## Tire Rotation

Rotating tires according to the maintenance messages on the driver information interface helps to distribute wear more evenly and increase tire life.

### ■ Tires without rotation marks

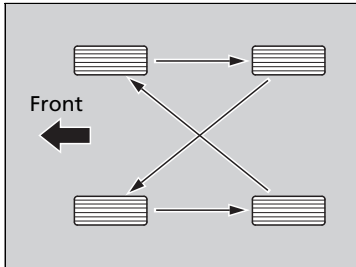

Rotate the tires as shown here.

### ■ Tires with rotation marks

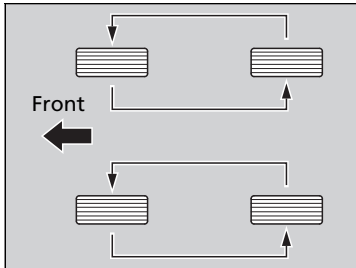

Rotate the tires as shown here.

### ☒ Tire Rotation

Tires with directional tread patterns should only be rotated front to back (not from one side to the other). Directional tires should be mounted with the rotation indication mark facing forward, as shown below.

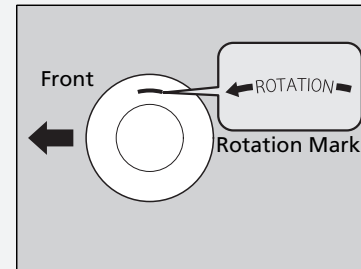

## Winter Tires

If driving on snowy or frozen roads, mount all season marked M+S tires, snow tires, or tire chains; reduce speed; and maintain sufficient distance between vehicles when driving.

Be particularly careful when operating the steering wheel or brakes to prevent skidding.

Use tire chains, snow tires, or all season tires when necessary or according to the law.

When mounting, refer to the following points.

For winter tires:

- Select the size and load ranges that are the same as the original tires.
- Mount the tires to all four wheels.

For tire chains:

- Install them on the front tires only.
- Because your vehicle has limited tire clearance, we strongly recommend using the chains listed below:

Models with 245/60R18 tires

**Cable-type: SCC Super Z LT ZT735**

Models with 265/45R20 tires

**Cable-type: SCC Super Z6 SZ435**

- Follow the chain manufacturer's instruction when installing. Mount them as tightly as you can.
- Check that the chains do not touch the brake lines or suspension.
- Drive slowly.

### Winter Tires

## WARNING

Using the wrong chains, or not properly installing chains, can damage the brake lines and cause a crash in which you can be seriously injured or killed.

Follow all instructions in this owner's manual regarding the selection and use of tire chains.

### NOTICE

Traction devices that are the wrong size or improperly installed can damage your vehicle's brake lines, suspension, body, and wheels. Stop driving if they are hitting any part of the vehicle.

When tire chains are mounted, follow the chain manufacturer's instructions regarding vehicle operational limits.

If your vehicle is equipped with summer tires, be aware that these tires are not designed for winter driving conditions. For more information, contact a dealer.

## Checking the Battery

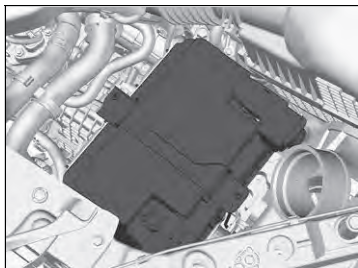

The condition of the battery is monitored by a sensor located on the negative terminal of the battery. If there is a problem with this sensor, the driver information interface will display a warning message. If this happens, have your vehicle inspected by a dealer.

Check the battery terminals for corrosion monthly.

To access the battery terminals:

1. Remove the engine compartment cover.  
➤ **Engine Compartment Cover** P. 502
2. Remove the clips using a Phillips-head screwdriver, then remove the air intake duct.  
➤ **High Beam Headlights** P. 512

If your vehicle's battery is disconnected or goes dead:

- The audio system is disabled.  
➤ **Audio System Theft Protection** P. 225
- The clock resets\*.  
➤ **Clock** P. 126

\* Not available on all models

### ⚠ Battery

## ⚠ WARNING

The battery gives off explosive hydrogen gas during normal operation.

A spark or flame can cause the battery to explode with enough force to kill or seriously hurt you.

When conducting any battery maintenance, wear protective clothing and a face shield, or have a skilled technician do it.

**WARNING:** Battery post, terminals, and related accessories contain lead and lead compounds.  
**Wash your hands after handling.**

When you find corrosion, clean the battery terminals by applying a baking powder and water solution. Clean the terminals with a damp towel. Cloth/towel dry the battery. Coat the terminals with grease to help prevent future corrosion.

When replacing the battery, the replacement must be of the same specifications.  
Consult a dealer for more information.



## Charging the AGM Battery

---

AGM labeled batteries like those installed in your vehicle require a compatible charger to be properly charged. Damage to the battery can result if the battery is charged improperly or with the wrong equipment. For more information on how to charge your vehicle's AGM battery, consult a dealer.

### ⌘ Battery

The battery installed in this vehicle is specifically designed for a model with Auto Idle Stop. Using a battery other than this specified type may shorten the battery life, and prevent Auto Idle Stop from activating. If you need to replace the battery, make sure to select the specified type and size. Ask a dealer for more details.

## Replacing the Remote Battery

If the indicator does not come on when the button is pressed, replace the battery.



**Battery type: CR2032**

1. Remove the built-in key.
2. With the buttons facing down, remove the upper half of the cover by carefully prying on the edge with a coin.
  - ▶ Wrap a coin with a cloth to prevent scratching the keyless remote.
3. Make sure to replace the battery with the correct polarity.

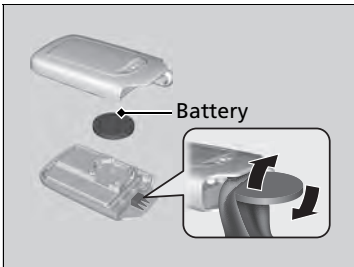

### Replacing the Remote Battery

## ⚠ WARNING

### CHEMICAL BURN HAZARD

The battery that powers the remote transmitter can cause severe internal burns and can even lead to death if swallowed. Keep new and used batteries away from children.

If you suspect that a child has swallowed the battery, seek medical attention immediately.

### NOTICE

An improperly disposed of battery can damage the environment. Always confirm local regulations for battery disposal.

Replacement batteries are commercially available or at a dealer.

## Air Conditioning

To ensure proper and safe operation, the Society of Automotive Engineers (SAE J2845) recommends that the refrigerant system only be serviced by trained and certified technicians.

Never repair or replace the air conditioning evaporator (cooling coil) with one removed from a used or salvaged vehicle.

New replacement mobile air conditioning evaporators must be certified (and labeled) as meeting SAE Standard J2842.

### Climate Control System Maintenance

#### NOTICE

Vented refrigerant is harmful to the environment. To avoid refrigerant from venting, never replace the evaporator with one removed from a used or salvaged vehicle.

Refrigerant in your vehicle's air conditioning system is flammable and can be ignited during servicing if proper procedures are not followed.

The air conditioner label is found under the hood:

➤ **Safety Labels** P. 80

➤ **Specifications** P. 578

#### Canadian models



 : Caution

 : Flammable Refrigerant

 : Requires Registered Technician to Service

 : Air Conditioning System

## Dust and Pollen Filter

---

The climate control system is equipped with a dust and pollen filter that collects pollen, dust, and other debris in the air. The Maintenance Minder™ messages will let you know when to replace the filter.

We recommend that you replace the dust and pollen filter sooner when using your vehicle in areas with high concentrations of dust.

### ▣ Dust and Pollen Filter

---

If the airflow from the climate control system deteriorates noticeably, and the windows fog up easily, the filter may need to be replaced. Please contact a dealer for replacement.

## Interior Care

Use a damp cloth with a mixture of mild detergent and warm water to remove dirt. Use a clean cloth to remove detergent residue.

### ■ Cleaning Seat Belts

Use a soft brush with a mixture of mild soap and warm water to clean the seat belts. Let the belts air dry. Wipe the loops of the seat belt anchors using a clean cloth.

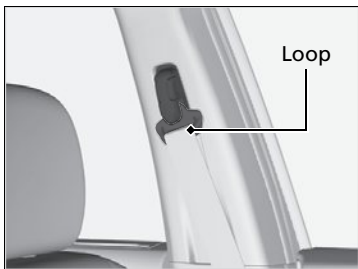

### ■ Cleaning the Window

Wipe using a glass cleaner.

#### ☒ Interior Care

Do not spill liquids inside the vehicle. Electrical devices and systems may malfunction if liquids are splashed on them.

Do not use silicone-based sprays on electrical devices such as audio devices and switches. Doing so may cause the items to malfunction or cause a fire inside the vehicle. If a silicone-based spray is inadvertently used on electrical devices, consult a dealer.

Depending on their composition, chemicals and liquid aromatics may cause discoloration, wrinkles, and cracking to resin-based parts and textiles. Do not use alkali solvents or organic solvents such as benzene or gasoline.

After using chemicals, make sure to gently wipe them away using a dry cloth. Do not place used cloths on top of resin-based parts or textiles for long periods of time without washing.

#### ☒ Cleaning the Window

Wires are mounted to the inside of the rear window. Wipe along the same direction as the wires with a soft cloth so as not to damage them.

Be careful not to spill fluids, such as water or glass cleaner, on or around the cover of the electrical components around the rearview mirror.

## Floor Mats

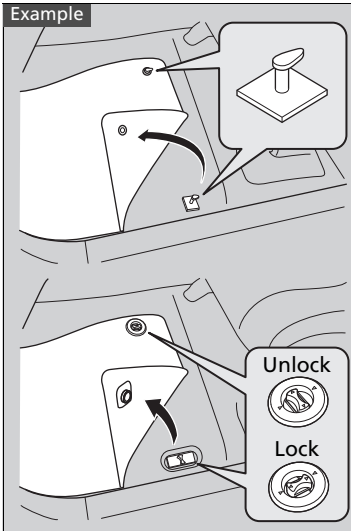

The driver's floor mat hooks over floor anchors, which keep the mat from sliding forward.

**Do not put any additional floor mats on top of the anchored mats.**

### ⌘ Floor Mats

If you use any floor mats that were not originally provided with your vehicle, make sure they are designed for your specific vehicle, fit correctly, and are securely anchored by the floor anchors. Position any rear seat floor mats properly. If not properly positioned, the floor mats can interfere with the front seat functions.

## Maintaining Genuine Leather

To properly clean leather:

1. Use a vacuum or soft dry cloth first to remove any dirt or dust.
2. Clean the leather with a soft cloth dampened with a solution comprised of 90% water and 10% neutral soap.
3. Wipe away any soap residue with a clean damp cloth.
4. Wipe away residual water and allow leather to air dry in the shade.

### ⌘ Maintaining Genuine Leather

It is important to clean or wipe away dirt or dust as soon as possible. Spills can soak into leather, resulting in stains. Dirt or dust can cause abrasions in the leather. In addition, please note that some dark colored clothing can rub onto the leather seats, resulting in discoloration or stains.

## Exterior Care

Dust off the vehicle body after you drive.

Regularly inspect your vehicle for scratches on painted surfaces. A scratch on a painted surface can result in body rust. If you find a scratch, promptly repair it.

### ■ Washing the Vehicle

Wash the vehicle regularly. Wash more frequently when driving in the following conditions:

- If driving on roads with road salt.
- If driving in coastal areas.
- If tar, soot, bird droppings, insects, or tree sap is stuck to painted surfaces.

### ■ Using an Automated Car Wash

- Fold in the door mirrors.
- For models equipped with automatic intermittent wipers, turn the wipers off.
- Make sure to follow the instructions indicated on the automated car wash.

### ■ Using High Pressure Cleaners

- Keep sufficient distance between the cleaning nozzle and the vehicle body.
- Take particular care around the windows. Standing too close may cause water to enter the vehicle interior.
- Do not spray high pressure water directly into the engine compartment. Instead, use low pressure water and a mild detergent.
- Do not spray water directly onto the camera or the area around it. Water may enter the lens and cause the camera to malfunction.

### ► Washing the Vehicle

Do not spray water into the air intake vents. It can cause a malfunction.

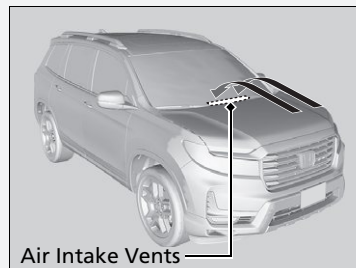

Air Intake Vents

Lock the doors when washing the vehicle. Do not spray water onto the capless unit when the fuel fill door is open. It can cause damage to the fuel system or engine.

When using an automated car wash that pulls the vehicle through with a conveyor, make sure the transmission is in **N** position.

► **If you want to keep the transmission in **N** position [car wash mode]** P. 400

## ■ Applying Wax

A good coat of automotive body wax helps protect your vehicle's paint from the elements. Wax will wear off over time and expose your vehicle's paint to the elements, so reapply as necessary.

## ■ Maintaining the Bumpers and Other Resin-Coated Parts

If you get gasoline, oil, engine coolant, or battery fluid on resin-coated parts, they may stain or the coating may peel. Promptly wipe it away using a soft cloth and clean water.

## ■ Cleaning the Window

Wipe using a glass cleaner.

## ■ Maintaining Aluminum Wheels

Aluminum is susceptible to deterioration caused by salt and other road contaminants. When necessary, as early as possible use a sponge and mild detergent to wipe away these contaminants. Do not use a stiff brush or harsh chemicals (including some commercial wheel cleaners). These can damage the protective finish on aluminum alloy wheels, resulting in corrosion. Depending on the type of finish, the wheels also may lose their luster or appear burnished. To avoid water stains, wipe the wheels dry with a cloth while they are still wet.

### ⌘ Applying Wax

#### NOTICE

Chemical solvents and strong cleaners can damage the paint, metal, and plastic on your vehicle. Wipe away spills immediately.

### ⌘ Maintaining the Bumpers and Other Resin-Coated Parts

Ask a dealer about the correct coating material when you want to repair the painted surface of the parts made of resin.



## ■ Fogged Exterior Light Lenses

The inside lenses of exterior lights (headlights, brake lights, etc.) may fog temporarily if you have driven in the rain, or after the vehicle has been run through a car wash. Dew condensation also may build up inside the lenses when there is a significant enough difference between the ambient and inside lens temperatures (similar to vehicle windows fogging up in rainy conditions). These conditions are natural processes, not structural design problems in the exterior lights.

Lens design characteristics may result in moisture developing on the light lens frame surfaces. This also is not a malfunction.

However, if you see large amounts of water accumulation, or large water drops building up inside the lenses, have your vehicle inspected by a dealer.

## Accessories

When installing accessories, check the following:

- Do not install accessories on the windshield. They can obstruct your view and delay your reaction to driving conditions.
- Do not install any items other than Honda Genuine Accessories designated for your vehicle over areas marked **SRS AIRBAG**, on the sides or backs of the front seats, on front or side pillars, or near the side windows.  
Items other than Honda Genuine Accessories designated for your vehicle installed in these areas may interfere with proper operation of the vehicle's airbags or may be propelled into you or another occupant if the airbags deploy.
- Be sure electronic accessories do not overload electrical circuits or interfere with proper operation of your vehicle.
  - **Fuses** P. 567
- Before installing any electronic accessory, have the installer contact a dealer for assistance. If possible, have a dealer inspect the final installation.

### Accessories and Modifications

## WARNING

**Improper accessories or modifications can affect your vehicle's handling, stability, and performance, and cause a crash in which you can be seriously hurt or killed.**

**Follow all instructions in this owner's manual regarding accessories and modifications.**

Honda Genuine Accessories are recommended to ensure proper operation on your vehicle.

Some Honda Genuine Accessories are supplied with an exclusive owner's manual for the operation and care detail of the product. If an accessory owner's manual is provided to you, please refer to it for full detail.

If any Honda Genuine Accessories become inoperable, refer to the separate accessory owner's manual (if applicable) or consult a dealer for assistance to troubleshoot the potential faulty condition.

## Modifications

---

Do not modify your vehicle in a manner that may affect its handling, stability, or reliability, or install non-genuine Honda parts or accessories that may have a similar effect.

Even minor modifications to vehicle systems can affect overall vehicle performance. Always make sure all equipment is properly installed and maintained, and do not make any modification to your vehicle or its systems that might cause your vehicle to no longer meet federal, state, province, territory, and local regulations.

The on-board diagnostic port (OBD-II/SAE J1962 connector) installed on this vehicle is intended to be used with automobile system diagnostic devices or with other devices that Honda has approved. Use of any other type of device may adversely affect the vehicle's electronic systems or allow them to be compromised, possibly resulting in a system malfunction, drained battery, or other unexpected problems.

Do not modify or attempt to repair any of the electrical components.

# Handling the Unexpected

This chapter explains how to handle unexpected troubles.



## **Tools**

Types of Tools..... 544

## **If a Tire Goes Flat**

Changing a Flat Tire..... 545

## **Engine Does Not Start**

Checking the Engine..... 553

If the Keyless Remote Battery is Weak .. 555

Emergency Engine Stop ..... 556

**If the Battery Is Dead** ..... 557

## **Overheating**

How to Handle Overheating..... 560

## **Indicator Coming On/Blinking**

If the Engine Oil Low Warning Appears..... 562

If the Charging System Indicator Comes On ..... 563

If the Malfunction Indicator Lamp Comes On or Blinks ..... 563

If the Brake System Indicator (Red) Comes On ..... 564

If the Electric Power Steering (EPS) System Indicator Comes On ..... 564

If the Low Tire Pressure/Tire Pressure Monitoring System (TPMS) Indicator Comes On or Blinks..... 565

If the Transmission Indicator Blinks along with the Warning Message ..... 566

## **Fuses**

Fuse Locations ..... 567

Inspecting and Changing Fuses..... 571

**Emergency Towing**..... 572

**If You Cannot Unlock the Fuel Fill Door**..573

## **Refueling**

Refueling From a Portable Fuel

Container ..... 574

**If You Cannot Open the Tailgate** .... 575

## Types of Tools

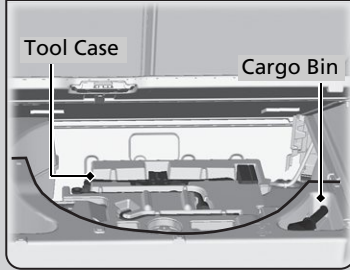
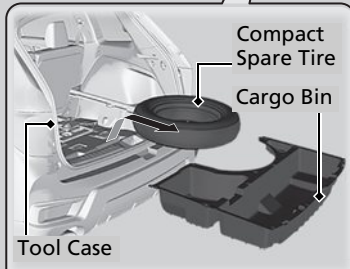

Wheel Nut Wrench/Jack Handle



Jack Handle Bar



Jack



Funnel



Storage Bag

### Types of Tools

The tools are stored in the cargo area.

## Changing a Flat Tire

If a tire goes flat while driving, grasp the steering wheel firmly, and brake gradually to reduce speed. Then, stop in a safe place. Replace the flat tire with a compact spare tire. Go to a dealer as soon as possible to have the regular tire repaired or replaced.

1. Park the vehicle on a firm, level, non-slippery surface and apply the parking brake.
2. Put the transmission into **P**.
3. Turn on the hazard warning lights and set the power mode to VEHICLE OFF.

### ✘ Changing a Flat Tire

Follow compact spare precautions:  
Periodically check the tire pressure of the compact spare. It should be set to the specified pressure.  
Specified Pressure: 60 psi (420 kPa, 4.2 kgf/cm<sup>2</sup>)

When driving with the compact spare tire, keep the vehicle speed under 50 mph (80 km/h). Replace with a regular tire as soon as possible.

The compact spare tire and wheel in your vehicle are specifically for this model. Do not use them with another vehicle. Do not use another type of compact spare tire or wheel with your vehicle.

Do not mount tire chains on a compact spare tire. If a chain-mounted front tire goes flat, remove one of the regular rear tires and replace it with the compact spare tire. Remove the flat front tire and replace it with the regular tire that was removed from the rear. Mount the tire chains on the front tire.

Do not use a puncture-repairing agent on a flat tire, as it can damage the tire pressure sensor.

## ■ Getting Ready to Replace the Flat Tire

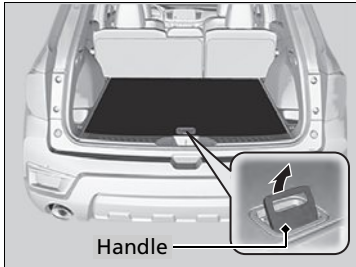

1. Push the rear edge of the handle on the cargo floor lid and open the lid.

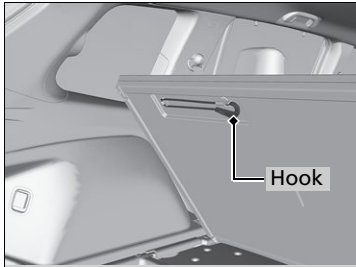

2. Lift the secondary lid, then remove the hook from the bottom of the lid.

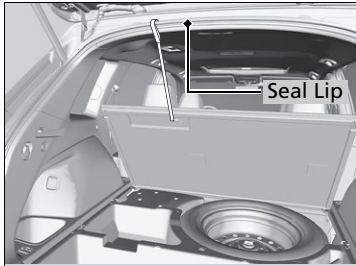

3. Attach the hook onto the weather seal lip.

## ✎ Changing a Flat Tire

### NOTICE

Do not use the jack if it doesn't work properly. Call your dealer or a professional towing service.

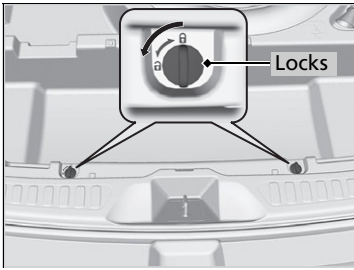

4. Unlock the cargo bin by turning the two locks. Remove the cargo bin from the vehicle.

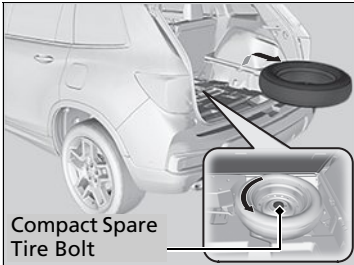

5. Unscrew the compact spare tire bolt and slide the tire to the rear of the vehicle. Remove the compact spare tire from vehicle.

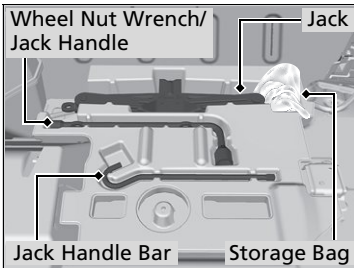

6. Pull out the wheel nut wrench, jack handle bar, storage bag, and jack from the tool case.



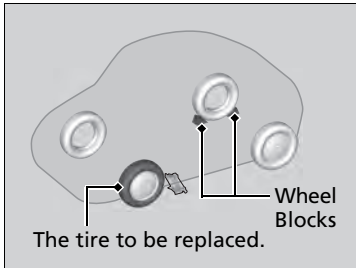

7. Place a wheel block or rock in front and rear of the wheel diagonal to the flat tire.

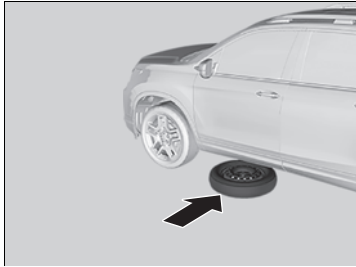

8. Place the compact spare tire (wheel side up) under the vehicle body, near the tire that needs to be replaced.



9. Loosen each wheel nut about one turn using the wheel nut wrench.

## How to Set Up the Jack

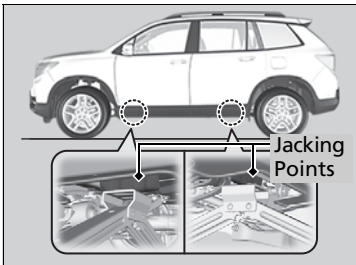

1. Place the jack under the jacking point closest to the tire to be changed.

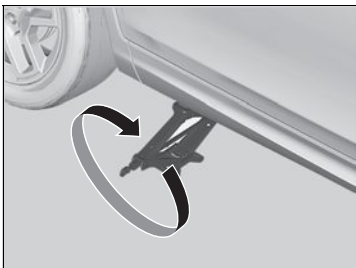

2. Turn the end bracket clockwise as shown in the image until the top of the jack contacts the jacking point.

▶ Make sure that the jacking point tab is resting in the jack notch.

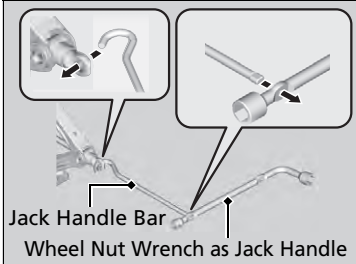

3. Raise the vehicle, using the jack handle bar and the jack handle, until the tire is off the ground.

### How to Set Up the Jack

## ⚠ WARNING

The vehicle can easily roll off the jack, seriously injuring anyone underneath.

Follow the directions for changing a tire exactly, and never get under the vehicle when it is supported only by the jack.

Do not use the jack with people or luggage in the vehicle.

Use the jack provided in your vehicle. Other jacks may not support the weight ("load") or may not fit the jacking point.

The following instructions must be followed to use the jack safely:

- Do not use while the engine is running.
- Use only where the ground is firm and level.
- Use only at the jacking points.
- Do not get in the vehicle while using the jack.
- Do not put anything on top of or underneath the jack.

## ■ Replacing the Flat Tire



1. Remove the wheel nuts and flat tire.

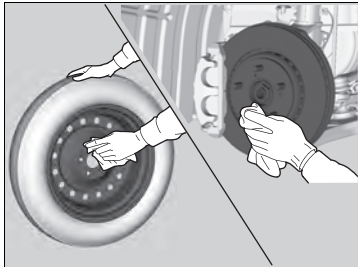

2. Wipe the mounting surfaces of the wheel with a clean cloth.

3. Mount the compact spare tire.

4. Screw the wheel nuts until they touch the lips around the mounting holes, then stop rotating.

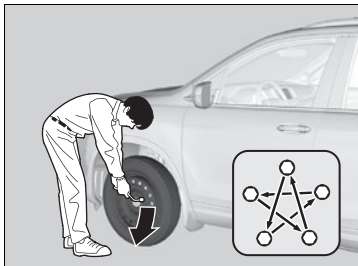

5. Lower the vehicle and remove the jack. Tighten the wheel nuts in the order indicated in the image. Go around, tightening the nuts, two to three times in this order.

### Wheel nut torque:

94 lbf-ft (127 N·m, 13 kgf·m)

## ▣ Replacing the Flat Tire

Do not over tighten the wheel nuts by applying extra torque using your foot or a pipe.

## Storing the Flat Tire

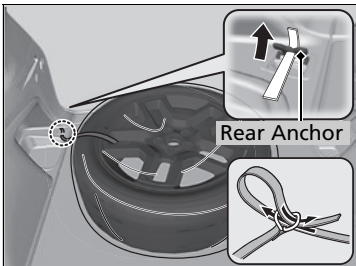
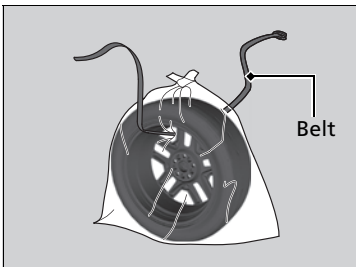
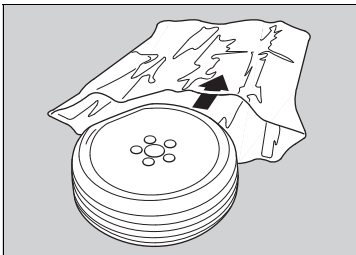

1. Put the flat tire in the storage bag provided with your vehicle.
  - ▶ The storage bag is in the tool case.
2. Knot the top of the storage bag.
3. Securely put the jack, jack handle bar and wheel nut wrench back in the tool case.
4. Bore through the bag, and pass the holding belt through the hole of the bag and the wheel of the flat tire as shown.
5. Place the flat tire in the cargo area, and thread the belt through the rear anchor as shown.
6. Pass the belt through the ring, and tighten the belt to secure the flat tire in place.

## Storing the Flat Tire

### **⚠ WARNING**

Loose items can fly around the interior in a crash and can seriously injure the occupants.  
Store the wheel, jack, and tools securely before driving.

### ■ TPMS with Tire Fill Assist and the Compact Spare Tire

If you replace a flat tire with the compact spare tire, the low tire pressure/TPMS indicator comes on while you are driving. After driving for a few miles (kilometers), the indicator will start blinking for a short time and then stay on. **Tire Pressure Monitor Problem** appears on the driver information interface, but this is normal.

If you replace the tire with a specified regular tire, the warning message on the driver information interface and the low tire pressure/TPMS indicator will go off after a few miles (kilometers).

### ▣ TPMS with Tire Fill Assist and the Compact Spare Tire

The system cannot monitor the pressure of the compact spare tire. Manually check the compact spare tire pressure to be sure that it is correct.

Use the TPMS specific wheels. Each is equipped with a tire pressure sensor mounted inside the tire behind the valve stem.

## Checking the Engine

If the engine does not start, check the starter.

Starter condition	Checklist
<b>Starter doesn't turn or turns over slowly.</b> The battery may be dead. Check each of the items on the right and respond accordingly.	<b>Check for a message on the driver information interface.</b> <ul style="list-style-type: none"><li>• If the <b>To Start, Hold Remote Near Start Button</b> message appears<ul style="list-style-type: none"><li>➤ <b>If the Keyless Remote Battery is Weak</b> P. 555</li></ul></li><li>▶ Make sure the keyless remote is in its operating range.<ul style="list-style-type: none"><li>➤ <b>ENGINE START/STOP Button Operating Range</b> P. 159</li></ul></li></ul>
<b>The starter turns over normally but the engine doesn't start.</b> There may be a problem with a fuse. Check each of the items on the right and respond accordingly.	<b>Check the fuses.</b> Check all fuses, or have your vehicle checked by a dealer. <ul style="list-style-type: none"><li>➤ <b>Inspecting and Changing Fuses</b> P. 571</li></ul> <b>Review the engine start procedure.</b> Follow its instructions, and try to start the engine again. <ul style="list-style-type: none"><li>➤ <b>Starting the Engine</b> P. 388</li></ul> <b>Check the immobilizer system indicator.</b> When the immobilizer system indicator is blinking, the engine cannot be started. <ul style="list-style-type: none"><li>➤ <b>Immobilizer System</b> P. 152</li><li>➤ <b>Immobilizer System Indicator</b> P. 89</li></ul>
	<b>Check the fuel level.</b> There should be enough fuel in the tank. <ul style="list-style-type: none"><li>➤ <b>Fuel Gauge</b> P. 109</li></ul>
	<b>Check the fuses.</b> Check all fuses, or have the vehicle checked by a dealer. <ul style="list-style-type: none"><li>➤ <b>Inspecting and Changing Fuses</b> P. 571</li></ul>
	<b>If the problem continues:</b> <ul style="list-style-type: none"><li>➤ <b>Emergency Towing</b> P. 572</li></ul>

If you cannot start the engine after checking all the items in the list above, have your vehicle checked by a dealer.

If you must start the vehicle immediately, use an assisting vehicle or booster battery to jump start it.

📖 **If the Battery Is Dead** P. 557

## If the Keyless Remote Battery is Weak

If the beeper sounds, the **To Start, Hold Remote Near Start Button** message appears on the driver information interface, the **ENGINE START/STOP** button flashes, and the engine won't start, start the engine as follows:

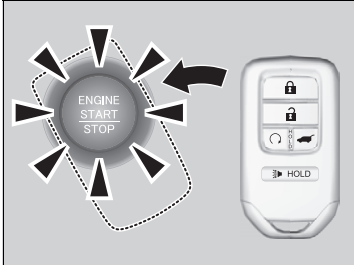

1. Press the **ENGINE START/STOP** button.
  - ▶ The beeper sounds and the **ENGINE START/STOP** button flashes for about 30 seconds.
2. Touch the centre of the **ENGINE START/STOP** button with the **H** logo on the keyless remote while the **ENGINE START/STOP** button is flashing. The buttons on the keyless remote should be facing you.
  - ▶ The beeper sounds, and the **ENGINE START/STOP** button stays on for about 10 seconds.
3. Depress the brake pedal and press the **ENGINE START/STOP** button while the **ENGINE START/STOP** button is on.
  - ▶ The engine starts.
  - ▶ If you don't depress the pedal, the mode will change to ACCESSORY.

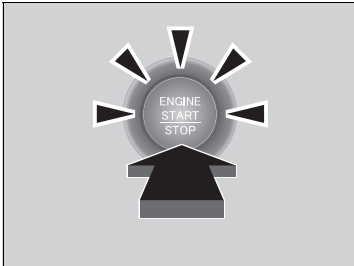



## Emergency Engine Stop

The **ENGINE START/STOP** button may be used to stop the engine due to an emergency situation even while driving. If you must stop the engine, do either of the following operations:

- Press and hold the **ENGINE START/STOP** button for about two seconds.
- Firmly press the **ENGINE START/STOP** button three times.

The steering wheel will not lock. However, because turning off the engine disables the power assist the engine provides to the steering and braking systems, it will require significantly more physical effort and time to steer and slow the vehicle. Use both feet on the brake pedal to slow down the vehicle and stop immediately in a safe place.

### U.S. models

The gear position automatically changes to **P** after the vehicle comes to a complete stop. Then, the power mode changes to VEHICLE OFF.

### Canadian models

The gear position automatically changes to **P** after the vehicle comes to a complete stop. Then, press the **ENGINE START/STOP** button twice without depressing the brake pedal to change the mode VEHICLE OFF.

### Emergency Engine Stop

#### NOTICE

Do not press the **ENGINE START/STOP** button while driving unless it is absolutely necessary for the engine to be turned off.

If you press the **ENGINE START/STOP** button while driving, the beeper sounds.

## Jump Starting Procedure

Turn off the power to electric devices, such as audio and lights. Turn off the engine, then open the hood.

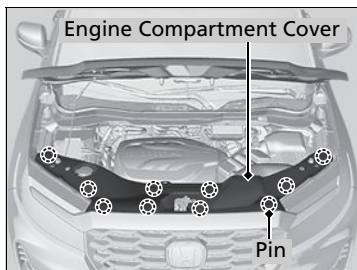

1. Pull up on the engine compartment cover, remove it from the pin holders.

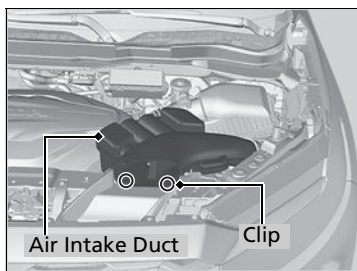

2. Remove the holding clips and the air intake duct.

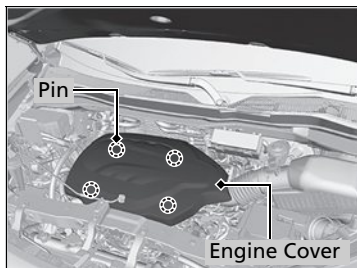

3. Pull up on the engine cover, remove it from the pins.
  - ▶ Start on the passenger side and lift the outermost edge of the cover.
  - ▶ Move towards the driver side while applying uniform upward pressure.
4. Connect the first jumper cable to your vehicle's battery ⊕ terminal.

ⓘ If the Battery Is Dead

### ⚠ WARNING

A battery can explode if you do not follow the correct procedure, seriously injuring anyone nearby.

Keep all sparks, open flames, and smoking materials away from the battery.

Securely attach the jumper cables clips so that they do not come off when the engine vibrates. Be careful not to tangle the jumper cables or allow the cable ends to touch each other while attaching or detaching the jumper cables.

Battery performance degrades in cold conditions and may prevent the engine from starting.

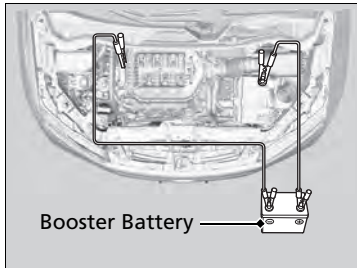

5. Connect the other end of the first jumper cable to the booster battery  $\oplus$  terminal.
  - ▶ Use a 12-volt booster battery only.
  - ▶ When using an automotive battery charger to boost your 12-volt battery, select a lower charging voltage than 15-volts. Check the charger manual for the proper setting.

6. Connect the second jumper cable to the booster battery  $\ominus$  terminal.

7. Connect the other end of the second jumper cable to the engine hanger as shown. Do not connect this jumper cable to any other part.

8. If your vehicle is connected to another vehicle, start the assisting vehicle's engine and increase its RPM slightly.

9. Attempt to start your vehicle's engine. If it turns over slowly, check that the jumper cables have good metal-to-metal contact.

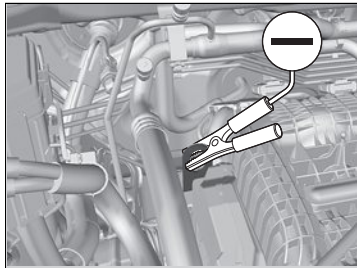

## ■ What to Do After the Engine Starts

Once your vehicle's engine has started, remove the jumper cables in the following order:

1. Disconnect the jumper cable from your vehicle's ground.
2. Disconnect the other end of the jumper cable from the booster battery  $\ominus$  terminal.
3. Disconnect the jumper cable from your vehicle's battery  $\oplus$  terminal.
4. Disconnect the other end of the jumper cable from the booster battery  $\oplus$  terminal.

Have your vehicle inspected by a nearby service station or a dealer.

## How to Handle Overheating

Overheating symptoms are as follows:

- The temperature gauge is at the **H** mark or the engine suddenly loses power.
- **Stop Driving When Safe. Engine Temperature Too Hot** message appears on the driver information interface.
- Steam or spray comes out of the engine compartment.

### ■ First thing to do

1. Immediately park the vehicle in a safe place.
2. Turn off all accessories and turn on the hazard warning lights.
  - ▶ **No steam or spray present:** Keep the engine running and open the hood.
  - ▶ **Steam or spray is present:** Turn off the engine and wait until it subsides. Then, open the hood.

### 🔗 How to Handle Overheating

## **WARNING**

Steam and spray from an overheated engine can seriously scald you.

Do not open the hood if steam is coming out.

### NOTICE

Continuing to drive with the temperature gauge at the **H** mark may damage the engine.

### NOTICE

Continuing to drive with the **Stop Driving When Safe. Engine Temperature Too Hot** message on the driver information interface may damage the engine.

### ■ Next thing to do

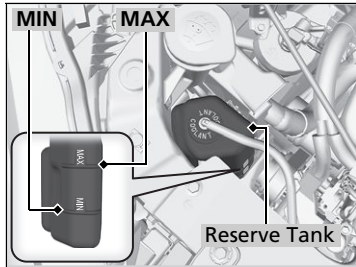

1. Check that the cooling fan is operating and stop the engine once the temperature gauge goes down.
  - ▶ If the cooling fan is not operating, immediately stop the engine.
2. Once the engine has cooled down, inspect the coolant level and check the cooling system components for leaks.
  - ▶ If the coolant level in the reserve tank is low, remove the engine compartment cover then add coolant until it reaches the **MAX** mark.
    - **Engine Compartment Cover** P. 502
  - ▶ If there is no coolant in the reserve tank, check that the radiator is cool. Cover the radiator cap with a heavy cloth and open the cap. If necessary, add coolant up to the base of the filler neck, and put the cap back on.

### ■ Last thing to do

Once the engine has cooled sufficiently, restart it and check the temperature gauge. If the temperature gauge has gone down, resume driving. If it has not gone down, contact a dealer for repairs.

#### ⚠ How to Handle Overheating

### ⚠ WARNING

Removing the radiator cap while the engine is hot can cause the coolant to spray out, seriously scalding you.

Always let the engine and radiator cool down before removing the radiator cap.

If the coolant is leaking, contact a dealer for repairs.

Use water as an emergency/temporary measure only. Have a dealer flush the system with proper antifreeze as soon as possible.

## If the Engine Oil Low Warning Appears



### ■ Reasons for the warning to appear

Appears when the engine oil pressure is low.

### ■ What to do as soon as the warning appears

1. Immediately park the vehicle on level ground in a safe place.
2. If necessary, turn the hazard warning lights on.

### ■ What to do after parking the vehicle

1. Stop the engine and let it sit for approximately three minutes.
2. Open the hood and check the oil level.
  - ▶ Add oil as necessary.
  - ▶ **Oil Check** P. 504
3. Start the engine and check the **Engine Oil Low** warning.
  - ▶ The warning disappears: Start driving again.
  - ▶ The warning does not disappear within 10 seconds: Immediately stop the engine and contact a dealer for repairs.

### ⓘ If the Engine Oil Low Warning Appears

#### NOTICE

Running the engine with low oil pressure can cause serious mechanical damage almost immediately.

## If the Charging System Indicator Comes On



### ■ Reasons for the indicator to come on

Comes on when there is a problem with the charging system.

### ■ What to do when the indicator comes on

Turn off the climate control system, rear defogger, and other electrical systems, and immediately contact a dealer for repairs.

## If the Malfunction Indicator Lamp Comes On or Blinks



### ■ Reasons for the indicator lamp to come on or blink

- Comes on when there is a problem with the engine emissions control system.
- Blinks when engine misfiring is detected.

### ■ What to do when the indicator lamp comes on

Avoid high speeds and immediately get your vehicle inspected at a dealer.

### ■ What to do when the indicator lamp blinks

Park the vehicle in a safe place with no flammable items and wait at least 10 minutes or more with the engine stopped until it cools.

### ⚠ If the Charging System Indicator Comes On

If you need to stop temporarily, do not turn off the engine. Restarting the engine may rapidly discharge the battery.

### ⚠ If the Malfunction Indicator Lamp Comes On or Blinks

#### NOTICE

If you drive with the malfunction indicator lamp on, the emissions control system and the engine could be damaged.

If the malfunction indicator lamp blinks again when restarting the engine, drive to the nearest dealer at 31 mph (50 km/h) or less. Have your vehicle inspected.



## If the Brake System Indicator (Red) Comes On

U.S.



Canada



### ■ Reasons for the indicator to come on

- The brake fluid is low.
- There is a malfunction in the brake system.

### ■ What to do when the indicator comes on while driving

Depress the brake pedal lightly to check pedal pressure.

- If normal, check the brake fluid level the next time you stop.
- If abnormal, take immediate action. If necessary, downshift the transmission to slow the vehicle using engine braking.

## If the Electric Power Steering (EPS) System Indicator Comes On



### ■ Reasons for the indicator to come on

- Comes on when there is a problem with the EPS system.

### ■ What to do when the indicator comes on

Stop the vehicle in a safe place and restart the engine.

If the indicator comes on and stays on, immediately have your vehicle inspected by a dealer.

### ▶▶ If the Brake System Indicator (Red) Comes On

Have your vehicle repaired immediately.

It is dangerous to drive with low brake fluid. If there is no resistance from the brake pedal, stop immediately in a safe place. If necessary downshift the gears.

If the brake system indicator and **ABS** indicator come on simultaneously, the electronic brake distribution system is not working. This can result in vehicle instability under sudden braking.

Have your vehicle inspected by a dealer immediately.

## If the Low Tire Pressure/Tire Pressure Monitoring System (TPMS) Indicator Comes On or Blinks



### ■ Reasons for the indicator to come on or blink

A tire pressure is significantly low. If there is a problem with the TPMS with Tire Fill Assist or the compact spare tire is installed, the indicator blinks for about one minute, and then stays on.

### ■ What to do when the indicator comes on

Stop your vehicle in a safe place. Check the tire pressure and adjust the pressure to the specified level. The specified tire pressure is on a label on the driver side doorjamb.

### ■ What to do when the indicator blinks, then remains on

Have the tire inspected by a dealer as soon as possible. If the compact spare tire causes the indicator to blink, change the tire to a regular tire. The indicator goes off after driving for a few miles (kilometers).

▶▶ If the Low Tire Pressure/Tire Pressure Monitoring System (TPMS) Indicator Comes On or Blinks

#### NOTICE

Driving on an extremely underinflated tire can cause it to overheat. An overheated tire can fail. Always inflate your tires to the prescribed level.

#### NOTICE

TPMS with Tire Fill Assist provides visual and audible assistance during tire pressure adjustment. With the power mode in ON and the transmission in [P], while you adjust tire pressure up or down, the system alerts you as follows:

**Below recommended pressure:** The beeper sounds and exterior lights flash once every five seconds.

**At recommended pressure:** The beeper sounds and exterior lights flash rapidly for ~ five seconds.

**Above recommended pressure:** The beeper sounds and lights flash twice every two seconds.

When a certain amount of time has passed since activation, Tire Fill Assist will be canceled until you set the power mode to OFF.

You cannot use Tire Fill Assist if the engine was started by the remote engine start, or if there is a malfunction in the system. If Tire Fill Assist does not work, use a tire pressure gauge.

## If the Transmission Indicator Blinks along with the Warning Message



### ■ Reasons for the indicator to blink

The transmission is malfunctioning.

### ■ What to do when the indicator blinks

- Immediately have your vehicle inspected by a dealer.
- Change the gear position to **[N]** after starting the engine.
  - ▶ Check if the **[N]** position in the instrument panel and the indicator on the **[N]** button light/blink.
  - ▶ The engine cannot be turned on unless the parking brake is set.
    - ▶ **Starting the Engine** P. 388

### ⚠ If the Transmission Indicator Blinks along with the Warning Message

You may not be able to start the engine.

Make sure to set the parking brake when parking your vehicle.

Call a professional towing service if you need to tow your vehicle.

▶ **Emergency Towing** P. 572

## Fuse Locations

If any electrical devices are not working, set the power mode to VEHICLE OFF and check to see if any applicable fuse is blown.

### ■ Engine Compartment Fuse Box Type A

Fuse locations are shown on the fuse box cover. Locate the fuse in question by the fuse number and box cover number. Located near the passenger's side damper house. Push the tabs to open the box.

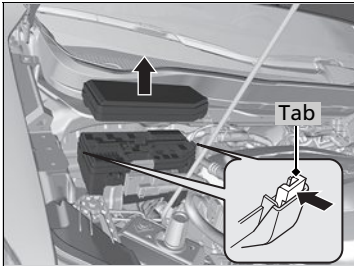

### ■ Circuit protected and fuse rating

	Circuit Protected	Amps
1	—	(70 A)
	REAR BLOWER	30 A
	ABS/VSA MTR	40 A
	ABS/VSA FSR	20 A
	MAIN FAN	30 A
	MAIN FUSE	150 A
	SUB FAN	30 A
	WIP MTR	30 A
	WASHER	20 A
	PREMIUM AMP*	(20 A)
	ENGINE MOUNT	30 A
2	FRONT BLOWER	40 A
	A/C INVERTER*	(30 A)
	STANDARD AMP*	(30 A)
	REAR DEF	40 A
	—	(30 A)
	PREMIUM AMP*	(20 A)
3	—	—
	—	—
	—	—
	—	—
4	PARKING LIGHT	10 A
5	CRUISE CANCEL SW	7.5 A
6	STOP LIGHT	10 A
7	FI SUB VSS	10 A

	Circuit Protected	Amps
8	L H/L LO	10 A
9	—	—
10	R H/L LO	10 A
11	IGPS	7.5 A
12	INJECTOR	20 A
13	H/L LO MAIN	20 A
14	VBUM	10 A
15	FRONT FOG*	(10 A)
16	HAZARD	15 A
17	PASSENGER P/ SEAT(RECLINE)*	(20 A)
18	PASSENGER P/SEAT(SLIDE)*	(20 A)
19	—	—
20	MG CLUTCH	7.5 A
21	MAIN RLY	15 A
22	FI SUB	15 A
23	IG COIL	15 A
24	DBW	15 A
25	SMALL/STOP MAIN	20 A
26	BACK UP	10 A
27	HTD STRG WHEEL*	(15 A)
28	HORN	10 A
29	RADIO/USB	15 A

\* Not available on all models

### ■ Engine Compartment Fuse Box Type B

Fuse locations are shown on the fuse box cover. Locate the fuse in question by the fuse number and box cover number. Located near the brake fluid reservoir. Push the tabs to open the box.

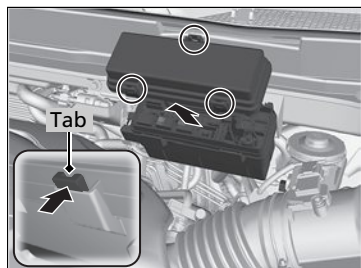

Handling the Unexpected

### ■ Circuit protected and fuse rating

	Circuit Protected	Amps
1	—	(40 A)
	4WD	(20 A)
	IG MAIN	30 A
	IG MAIN2	30 A
	P/TAILGATE MOTOR	(40 A)
	F/B MAIN2	60 A
	F/B MAIN	60 A
	EPS	60 A
2	TRAILER MAIN	(30 A)
3	TRAILER E-BRAKE	(20 A)
4	BATTERY SENSOR	7.5 A
5	H/L HI MAIN	20 A
6	P/TAILGATE CLOSER	(20 A)
7	—	—
8	REAR ACC SOCKET	(20 A)
9	FRONT WIPER DEICER*	(15 A)
10	ACC/IG2_MAIN	10 A
11	TRAILER CHARGE	(20 A)
12	IDLE STOP ST CUT	(30 A)
13	IDLE STOP	(30 A)
14	IDLE STOP	(30 A)
15	ELECTRONIC GEAR SELECTOR	(15 A)
16	REAR HEATED SEAT*	(20 A)
17	ST CUT FEED BACK	7.5 A

\* Not available on all models

### ■ Interior Fuse Box Type A

Located under the dashboard.

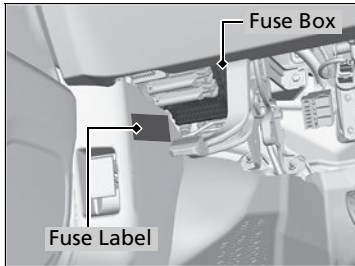

Fuse locations are shown on the label on the outer side of the side panel cover. Locate the fuse in question by the fuse number and label number.

### ■ Circuit protected and fuse rating

	Circuit Protected	Amps
1	DRIVER P/WINDOW	20 A
2	DOOR LOCK	20 A
3	SMART	7.5 A
4	PASSENGER P/WINDOW	20 A
5	FRONT ACC SOCKET	20 A
6	FUEL PUMP	20 A
7	ACG	15 A
8	FRONT WIPER	7.5 A
9	IG1 SMART	7.5 A
10	SRS	10 A
11	DRIVER REAR P/WINDOW	20 A
12	—	—
13	PASSENGER REAR P/WINDOW	20 A
14	FUEL LID	20 A
15	DRIVER P/SEAT(RECLINE)	(20 A)
16	—	(7.5 A)
17	FRONT SEAT HEATER	(20 A)
18	INTR LT	7.5 A
19	DRIVER REAR DOOR UNLOCK	10 A
20	PASSENGER SIDE DOOR UNLOCK	10 A
21	DRL	7.5 A
22	KEY LOCK	7.5 A
23	A/C	7.5 A

	Circuit Protected	Amps
24	IG1a FEED BACK	7.5 A
25	INST PANEL LIGHTS	7.5 A
26	LUMBAR SUPPORT	(10 A)
27	PARKING LIGHTS	7.5 A
28	OPTION	10 A
29	BACK LT	7.5 A
30	REAR WIPER	10 A
31	ST MOTOR	7.5 A
32	SRS	7.5 A
33	PASSENGER SIDE DOOR LOCK	10 A
34	DRIVER DOOR LOCK	10 A
35	DRIVER DOOR UNLOCK	10 A
36	DRIVER P/SEAT(SLIDE)	(20 A)
37	PASSENGER H/L HI	10 A
38	DRIVER H/L HI	10 A
39	IG1b FEED BACK	7.5 A
40	ACC	7.5 A
41	DRIVER REAR DOOR LOCK	10 A
42	—	—

### ■ Interior Fuse Box Type B

Located under the dashboard.

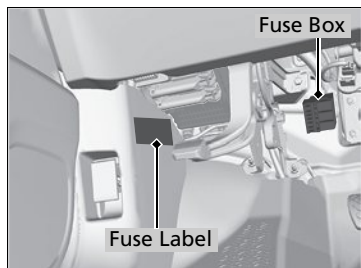

Fuse locations are shown on the image. Locate the fuse in question by the fuse number and label number.

### ■ Circuit protected and fuse rating

	Circuit Protected	Amps
A	METER	10 A
B	ABS/VSA	7.5 A
C	ACG	7.5 A
D	MICU	7.5 A
E	AUDIO	15 A
F	BACK UP	10 A
G	ACC	7.5 A

## Inspecting and Changing Fuses

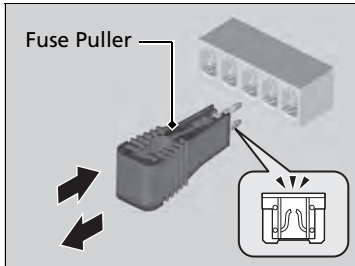
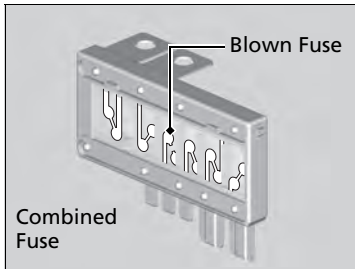

1. Set the power mode to VEHICLE OFF.  
Turn the headlights and all accessories off.
2. Remove the fuse box cover.
3. Check the large fuse in the engine compartment.
  - If the fuse is blown, use a Phillips-head screwdriver to remove the screw and replace it with a new one.
4. Inspect the small fuses in the engine compartment and the vehicle interior.
  - If there is a blown fuse, remove it with the fuse puller and replace it with a new one.

### ► Inspecting and Changing Fuses

#### NOTICE

Replacing a fuse with one that has a higher rating greatly increases the chances of damaging the electrical system.

Use the charts to locate the fuse in question and confirm the specified amperage on the fuse label.

► **Fuse Locations** P. 567

Replace with a fuse of the same specified amperage.

There is a fuse puller in the engine compartment fuse box.



Call a professional towing service if you need to tow your vehicle.

## ■ Flatbed equipment

The operator loads your vehicle on the back of a truck.

**This is the best way to transport your vehicle.**

## » Emergency Towing

### NOTICE

Trying to lift or tow your vehicle by the bumpers will cause serious damage. The bumpers are not designed to support the vehicle's weight.

### NOTICE

Improper towing such as towing behind a motorhome or other motor vehicle can damage the transmission.

Never tow your vehicle with just a rope or chain. It is very dangerous since ropes or chains may shift from side to side or break.

# If You Cannot Unlock the Fuel Fill Door

## ■ What to Do If Unable to Unlock the Fuel Fill Door

If you cannot unlock the fuel fill door, use the following procedure:

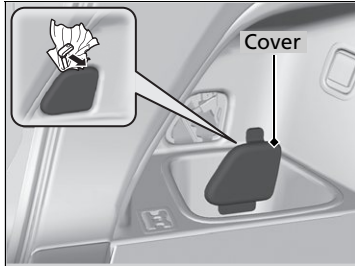

1. Open the tailgate.
2. Wrap a cloth around the built-in key. Put it into the cover slot as shown in the image, and remove the cover.



3. Pull the release lever toward you.  
▶ The release lever unlocks the fuel fill door when it is pulled.

## ▣ What to Do If Unable to Unlock the Fuel Fill Door

After taking these steps, contact a dealer to have the vehicle checked.

## Refueling From a Portable Fuel Container

If you have run out of fuel and need to refuel your vehicle from a portable fuel container, use the funnel provided with your vehicle.

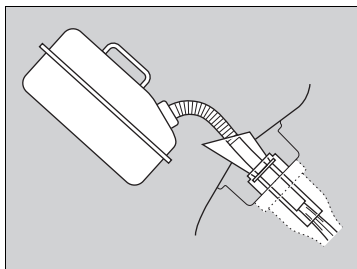
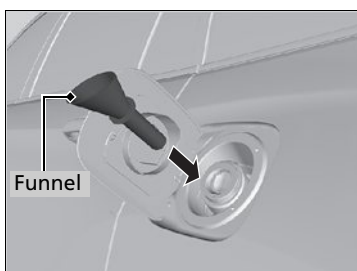
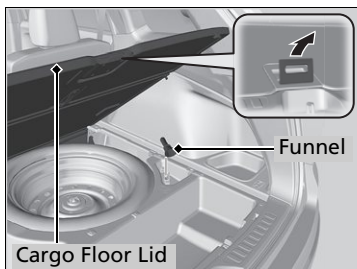

1. Turn off the engine.
2. Open the fuel fill door.
  - ▶ **How to Refuel** P. 485
3. Take the funnel out of the cargo bin in the cargo area.
  - ▶ **Types of Tools** P. 544
4. Place the end of the funnel on the lower part of filler opening, then insert it slowly and fully.
  - ▶ Make sure that the end of the funnel goes down along with the filler pipe.
5. Fill the tank with fuel from the portable fuel container.
  - ▶ Pour fuel carefully so you do not spill any.
6. Remove the funnel from the filler neck.
  - ▶ Wipe up any fuel from the funnel before storing it.
7. Shut the fuel fill door by hand.

### ▶▶ Refueling From a Portable Fuel Container

#### **⚠ WARNING**

Gasoline is highly flammable and explosive. You can be burned or seriously injured when handling fuel.

- Stop the engine, and keep heat, sparks, and flames away.
- Handle fuel only outdoors.
- Wipe up spills immediately.

#### **NOTICE**

Do not insert the nozzle of a portable fuel container or any funnel other than the one provided with your vehicle. Doing so can damage the fuel system. Do not try to pry open or push open the sealed fuel tank with foreign objects. This can damage the fuel system and its seal.

Make sure the fuel in the portable fuel container is gasoline before you refuel.

# If You Cannot Open the Tailgate

## What to Do If Unable to Open the Tailgate

If you cannot open the tailgate, use the following procedure:

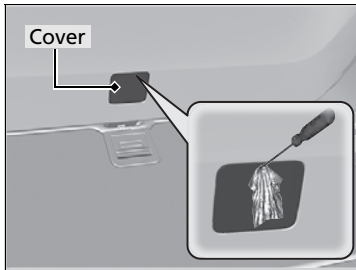

1. Use a flat-tip screwdriver and remove the cover on the inside of the tailgate.
  - ▶ Wrap the flat-tip screwdriver with a cloth to prevent scratches.

### Models with power tailgate

#### Screwdriver

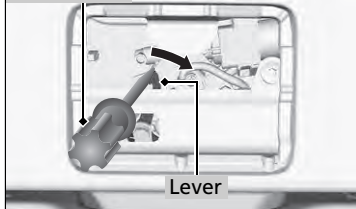

2. To open the tailgate, push the tailgate while pushing the lever to the right using a flat-tip screwdriver.

### Models without power tailgate

#### Screwdriver

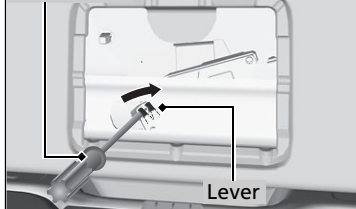

## What to Do If Unable to Open the Tailgate

Following up:

After taking these steps, contact a dealer to have the vehicle checked.

When you open the tailgate from inside, make sure there is enough space around the tailgate, and it does not hit anyone or any object.

This page intentionally left blank.

# Information

This chapter includes your vehicle's specifications, locations of identification numbers, and other information required by regulation.

<b>Specifications</b> .....	578
<b>Identification Numbers</b>	
Vehicle Identification Number (VIN), Engine Number, and Transmission Number .....	580
<b>Devices that Emit Radio Waves</b> .....	581
<b>Reporting Safety Defects</b> .....	582
<b>Emissions Testing</b>	
Testing of Readiness Codes .....	583
<b>Warranty Coverages</b> .....	585
<b>Authorized Manuals</b> .....	588
<b>Customer Service Information</b> .....	589

## ■ Vehicle Specifications

Model	Passport
No. of Passengers:	
Front	2
Rear	3
Total	5
<b>Weights:</b>	
Gross Vehicle Weight Rating	See the certification label on the driver's doorjamb
Gross Axle Weight Rating (Front)	See the certification label on the driver's doorjamb
Gross Axle Weight Rating (Rear)	See the certification label on the driver's doorjamb
Gross Combined Weight Rating	U.S.: 9,755 lbs (4,425 kg)
	Canada: 4,425 kg

## ■ Air Conditioning

Refrigerant Type	HFO-1234yf (R-1234yf)
Charge Quantity	21.3 – 23.1 oz (605 – 655 g)
Lubricant Type	RB100EV-01 (POE)
Quantity	7.75 – 9.33 cu-in (127 – 153 cm <sup>3</sup> )

## ■ Engine Specifications

Displacement	211.8 cu-in (3,471 cm <sup>3</sup> )
Spark Plugs	NGK DILZKR7B11G

## ■ Fuel

Type	Unleaded gasoline, pump octane number 87 or higher
Fuel Tank Capacity	19.5 US gal (73.8 L)

## ■ Washer Fluid

Tank Capacity	U.S.: 4 US qt (3.8 L)
	Canada: 5.6 US qt (5.3 L)

## ■ Light Bulbs

Headlights (Low Beam)	LED
Headlights (High Beam)	60 W (HB3)
Fog Lights*	LED
Front Turn Signal Lights	28/8 W (Amber)
Front Side Marker Lights	LED
Parking/Daytime Running Lights	LED
Side Turn Signal Lights (on Door Mirrors)	LED
Brake/Taillights	LED
Rear Side Marker Lights	LED
Back-Up Lights	21 W
Rear Turn Signal Lights	21 W (Amber) <sup>*1</sup>
	21 W <sup>*2</sup>
High-Mount Brake Light	LED
Rear License Plate Lights	LED
<b>Interior Lights</b>	
Front Map Lights	5 W
Rear Map Lights	5 W
Ambient Lights	LED
Vanity Mirror Lights	1.4 W
Door Courtesy Lights*	3.8 W
Door Inner Handle Lights*	LED
Door Pocket Lights*	LED
Beverage Holder Light*	LED
Foot Lights*	LED
Glove Box Light	1.4 W
Cargo Area Lights	8 W

\*1: Models with AC power outlet

\*2: Models without AC power outlet

### ■ Brake Fluid

Specified	Honda Heavy Duty Brake Fluid DOT 3
-----------	------------------------------------

### ■ Automatic Transmission Fluid

Specified	Honda ATF Type-3.1 or higher	
Capacity	Change	3.5 US qt (3.3 L)

### ■ Rear Differential Fluid

Specified	Honda DPSF-II	
Capacity	Change	1.92 US qt (1.82 L)

### ■ Transfer Assembly Fluid

Specified	Honda HGO-1	
Capacity	Change	0.45 US qt (0.43 L)

### ■ Engine Oil

Recommended	-Honda Genuine Motor Oil 0W-20	
	-API service SN or higher grade 0W-20	
Capacity	Change	5.4 US qt (5.1 L)
	Change including filter	5.7 US qt (5.4 L)

### ■ Engine Coolant

Specified	Honda Long Life Antifreeze/Coolant Type 2	
Ratio	50/50 with distilled water	
Capacity	1.96 US gal (7.40 L)	
	(change including the remaining 0.22 US gal (0.82 L) in the reserve tank)	

### ■ Tire

Regular	Size <sup>*1</sup>	245/60R18 105H 245/60R18 105T 265/45R20 104H
	Pressure psi (kPa [kgf/cm <sup>2</sup> ])	35 (240 [2.4]) <sup>*2</sup> 37 (255 [2.6]) <sup>*3</sup>
	Size	T165/80D17 104M
Compact Spare	Pressure psi (kPa [kgf/cm <sup>2</sup> ])	60 (420 [4.2])
	Wheel Size	Regular 18 x 8J <sup>*2</sup> Compact Spare 20 x 8 1/2J <sup>*3</sup> 17 x 4T

\*1: Original tire size is mentioned on the tire information label on the driver's doorjamb.

\*2: Models with 245/60R18

\*3: Models with 265/45R20



## Vehicle Identification Number (VIN), Engine Number, and Transmission Number

Your vehicle has a 17-digit vehicle identification number (VIN) used to register your vehicle for warranty purposes, and for licensing and insuring your vehicle.

The locations of your vehicle's VIN, engine number, and transmission number are shown as follows.

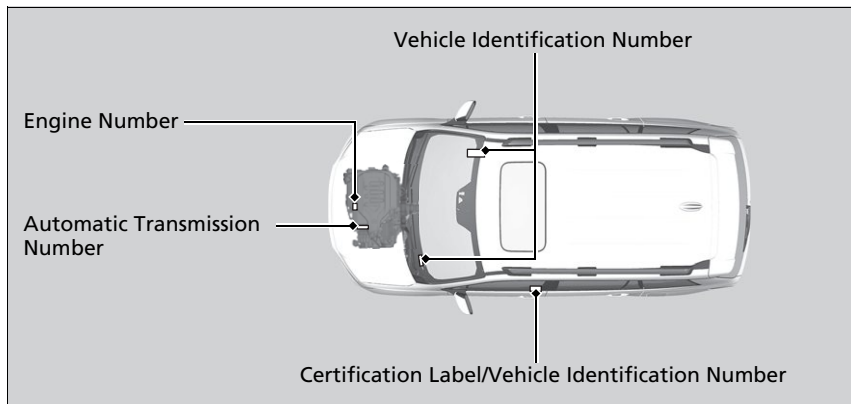

### Vehicle Identification Number (VIN), Engine Number, and Transmission Number

The interior vehicle identification number (VIN) is located under the cover.



Each radio frequency device installed in the vehicle conforms to the requirements and standards of the regulation listed below:

As required by the FCC:

This device complies with Part 15 of the FCC rules. Operation is subject to the following two conditions: (1) This device may not cause harmful interference, and (2) this device must accept any interference received, including interference that may cause undesired operation.

Changes or modifications not expressly approved by the party responsible for compliance could void the user's authority to operate the equipment.

This device complies with Industry Canada licence-exempt RSS standard(s).

Operation is subject to the following two conditions: (1) this device may not cause interference, and (2) this device must accept any interference, including interference that may cause undesired operation of the device.

In the U.S.

If you believe that your vehicle has a defect which could cause a crash or could cause injury or death, you should immediately inform the National Highway Traffic Safety Administration (NHTSA) in addition to notifying American Honda Motor Co., Inc.

If NHTSA receives similar complaints, it may open an investigation, and if it finds that a safety defect exists in a group of vehicles, it may order a recall and remedy campaign. However, NHTSA cannot become involved in individual problems between you, your dealer, or American Honda Motor Co., Inc.

To contact NHTSA, you may call the Vehicle Safety Hotline toll-free at 1-888-327-4236 (TTY: 1-800-424-9153); go to <http://www.safercar.gov>; or write to: Administrator, NHTSA, 1200 New Jersey Avenue, SE., Washington, DC 20590. You can also obtain other information about motor vehicle safety from <http://www.safercar.gov>.

In Canada

If you believe that your vehicle has a defect which could cause a crash or could cause injury or death, you should immediately inform Honda Canada Inc. and you may also inform Transport Canada.

If Transport Canada receives similar complaints, it may open an investigation, and if it finds that a safety defect exists in a group of vehicles, it may lead to a recall and remedy campaign. However, Transport Canada cannot become involved in individual problems between you, your dealer, or Honda Canada Inc.

To contact Transport Canada's Defect Investigations and Recalls Division, you may call 1-800-333-0510. For more information on reporting safety defects or about motor vehicle safety, go to <http://www.tc.gc.ca/roadsafety>.

## Testing of Readiness Codes

Your vehicle has readiness code as part of the onboard self diagnostic system. Some states use these codes for testing to verify whether your vehicle's emissions components are working properly. The codes may not be read properly if testing is performed just after the battery has gone dead or been disconnected.

To check if they are set, set the power mode to ON, without starting the engine. The malfunction indicator lamp will come on for several seconds. If it then goes off, the readiness codes are set. If it blinks five times, the readiness codes are not set.

If you are required to have your vehicle tested before the readiness codes are ready, prepare the vehicle for retesting by doing the following:

1. Fill the gas tank to approximately 3/4 full.
2. Park the vehicle and leave the engine off for 6 hours or more.
3. Make sure the ambient temperature is between 40°F and 95°F (4°C and 35°C).
4. Start the engine without touching the accelerator pedal, and let it idle for 20 seconds.
5. Keep the vehicle in **P**. Increase the engine speed to 2,000 rpm, and hold it there for about 3 minutes.
6. Let the engine idle with your foot off the accelerator for 20 seconds.

### Testing of Readiness Codes

The readiness codes are erased when the battery is disconnected, and set again only after several days of driving under a variety of conditions.

If a testing facility determines that the readiness codes are not set, you may be requested to return at a later date to complete the test.

If the testing facility determines the readiness codes are still not set, see a dealer.

7. Select a nearby, lightly traveled major highway where you can maintain a speed of 50 to 60 mph (80 to 97 km/h) for at least 20 minutes. Do not use cruise control and perform the following when traffic allows. When stopped before entering the highway, use paddle shifters. During acceleration up to speed, target 5,500 to 6,500 engine rpm continuously for at least 10 seconds. Then shift to **[D]** range and drive for 90 seconds without moving the accelerator pedal. (Vehicle speed may vary slightly; this is okay.) If you cannot do this for a continuous 90 seconds because of traffic conditions, drive for at least 30 seconds, then repeat it two more times (for a total of 90 seconds).
8. Drive in city or suburban traffic for at least 10 minutes. When traffic conditions allow, let the vehicle coast for several seconds without using the accelerator pedal or the brake pedal.
9. Park the vehicle and leave the engine off for 30 minutes.

## ■ U.S. Owners

Your new vehicle is covered by these warranties:

***New Vehicle Limited Warranty*** – covers your new vehicle, except for the emissions control systems and accessories, against defects in materials and workmanship.

***Emissions Control Systems Defects Warranty and Emissions Performance Warranty*** – these two warranties cover your vehicle's emissions control systems. Time, mileage, and coverage are conditional. Please read your warranty booklet for exact information.

***Seat Belt Limited Warranty*** – a seat belt that fails to function properly is covered by a limited warranty. Please read your warranty booklet for details.

***Rust Perforation Limited Warranty*** – all exterior body panels are covered against rusting from the inside out for the specified time period, regardless of mileage.

***Accessory Limited Warranty*** – Honda accessories are covered under this warranty. Time and mileage limits depend on the type of accessory and other factors. Please read your warranty booklet for details.

***Replacement Parts Limited Warranty*** – covers all Honda replacement parts against defects in materials and workmanship.

**Replacement Battery Limited Warranty** – provides prorated coverage for a replacement battery purchased from your dealer.

**Replacement Muffler Lifetime Limited Warranty** – provides coverage for as long as the purchaser of the muffler owns the vehicle.

Restrictions and exclusions apply to all these warranties. Please read the Honda warranty information booklet that came with your vehicle for precise information on warranty coverages. Your vehicle's original tires are covered by their manufacturer. Tire warranty information is in a separate booklet.

■ **Statement on Warranty Coverage for Aftermarket and Recycled Parts**

The Magnuson-Moss Warranty Act, 15 U.S.C. s.2301 et seq., makes it illegal for motor vehicle manufacturers to void a motor vehicle warranty or deny warranty coverage solely because an aftermarket or recycled part has been used to repair the vehicle or someone other than the authorized service provider performed service on the vehicle. This provision does not apply to a new motor vehicle purchased solely for commercial or industrial use.

Under federal law, a manufacturer may deny warranty coverage and charge for repairs to a vehicle if it is discovered that an aftermarket or recycled part installed on the vehicle is defective or was installed incorrectly and caused damage to another part of the vehicle otherwise covered under warranty. The Federal Trade Commission requires that a manufacturer demonstrate that an aftermarket or recycled part or service performed by a person other than an authorized service provider caused damage to another part of the vehicle otherwise covered under warranty before denying warranty coverage. Additionally, federal law allows a manufacturer to void a motor vehicle warranty or deny warranty coverage if the manufacturer provides the article or service to consumers free of charge under the warranty or the manufacturer has secured a waiver from the Federal Trade Commission.

#### ■ Canadian Owners

Please refer to the warranty manual that came with your vehicle.

#### ■ EPA Contact Information

An owner may obtain further information concerning emission warranties or report violations of the terms of the emission warranties by contacting:

Director,  
Light-Duty Vehicle Center,  
U.S. Environmental Protection Agency,  
Attention: Warranty Claim  
2000 Traverwood Drive,  
Ann Arbor, MI 48105;  
[complianceinfo@epa.gov](mailto:complianceinfo@epa.gov)



## ■ Service Express

For electronic copies of service publications, you can purchase a subscription to Service Express. Visit <https://techinfo.honda.com/> for pricing and options.

## ■ For U.S. Owners

Manuals can be purchased from Helm Incorporated. You can order a manual by phone at 1 (800) 782-4356 (credit card orders only), or online at [www.helminc.com](http://www.helminc.com).

## ■ For Canadian Owners

Please contact a dealer to order any manuals that you may require.

Honda dealership personnel are trained professionals able to deal with any problems you may encounter with your vehicle. If, however, you are faced with a problem that they cannot resolve to your satisfaction, contact Honda Customer Services.

## U.S. Owners

American Honda Motor Co., Inc.  
Honda Automobile Customer Service  
Mail Stop CHI-5  
1919 Torrance Blvd.  
Torrance, CA 90501-2746  
Tel: 1 (800) 999-1009

## In Puerto Rico and the U.S. Virgin Islands

Bella International  
P.O. Box 190816  
San Juan, PR 00919-0816  
Tel: 1 (787) 620-7546

## Canadian Owners

Honda Canada Inc.  
Customer Relations  
180 Honda Boulevard  
Markham, ON  
L6C 0H9  
Tel: 1-888-9-HONDA-9  
Fax: 1-877-939-0909  
E-mail: Honda\_cr@ch.honda.com

## In Guam

Triple J Autogroup  
157 S. Marine Corps Drive  
Tamuning, GU 96913  
Tel: (671) 648-2277

## In Saipan, Commonwealth of the Northern Mariana Islands

Joeten Motor Company, Inc.  
P.O. Box 500680  
Saipan, MP 96950  
Tel: (670) 234-5562

## Customer Service Information

When you call or write, please give us the following information:

- Vehicle Identification Number
  - **Vehicle Identification Number (VIN), Engine Number, and Transmission Number** P. 580
- Date of purchase
- Odometer reading of your vehicle
- Your name, address, and telephone number
- A detailed description of the problem
- Name of the dealer who sold the vehicle to you

This page intentionally left blank.

## A

- AAC..... 276, 279
- ABS (Anti-lock Brake System)..... 469
- AC Power Outlet..... 202
- Accessories and Modifications..... 541
- Accessory Power Sockets..... 201
- Adaptive Cruise Control (ACC)..... 442
- Adaptive Cruise Control (ACC) Indicator (Amber)..... 95
- Adaptive Cruise Control (ACC) Indicator (Green)..... 95
- Additives
  - Coolant..... 508
  - Engine Oil..... 503
  - Washer..... 511
- Additives, Engine Oil..... 503
- Adjusting
  - Armrest..... 192
  - Front Seats..... 182
  - Head Restraints..... 189, 190
  - Mirrors..... 180
  - Rear Seats..... 186
  - Steering Wheel..... 179
- Agile Handling Assist..... 413
- Air Conditioning System (Climate Control System)..... 213
  - Changing the Mode..... 213
  - Defrosting the Windshield and Windows..... 214
  - Dust and Pollen Filter..... 535
  - Recirculation/Fresh Air Mode..... 214
  - Sensor..... 219
  - Synchronization Mode..... 216
  - Using Automatic Climate Control..... 213
- Air Pressure..... 523, 579
- Airbags..... 49
  - Advanced Airbags..... 55
  - After a Collision..... 53
  - Airbag Care..... 63
  - Event Data Recorder..... 0
  - Front Airbags (SRS)..... 52
  - Indicator..... 60, 86
  - Passenger Airbag Off Indicator..... 61
  - Sensors..... 49
  - Side Airbags..... 57
  - Side Curtain Airbags..... 59
- All-wheel drive (AWD) Indicator..... 93
- AM/FM Radio..... 260
- Android Auto..... 298
- Anti-lock Brake System (ABS)..... 469
  - Indicator..... 85
- Apple CarPlay..... 295
- Armrest..... 192
- AT&T Hotspot..... 293
- Audio Remote Controls..... 226
- Audio System..... 222, 228
  - Adjusting the Sound..... 254
  - AM/FM Radio..... 260
  - Android Auto..... 298
  - Apple CarPlay..... 295
  - AT&T Hotspot..... 293
  - Audio/Information Screen..... 229
- Changing the Screen Brightness..... 255
- Display Setup..... 255
- Error Messages..... 302
- File Manager..... 248
- General Information..... 305
- HD Subchannel..... 262
- Home Screen..... 234
- HondaLink®..... 287
- How to Delete a File..... 251
- How to Transfer a File..... 248
- How to Update Wirelessly..... 242
- How to Update with a USB Device..... 246
- iPod..... 273
- Limitations for Manual Operation..... 256
- MP3/WMA/AAC..... 276, 279
- My Honda Music..... 279
- Playing AM/FM Radio..... 260
- Playing Bluetooth® Audio..... 283
- Playing SiriusXM® Radio..... 263
- Playing Social Playlist..... 285
- Reactivating..... 225
- Remote Controls..... 226
- Security Code..... 225
- Selecting an Audio Source..... 256
- Siri Eyes Free..... 294
- Status Area..... 239
- System Updates..... 242
- Theft Protection..... 225
- Updating Apps..... 240
- USB Flash Drives..... 276, 306
- USB Port..... 223

- Wallpaper Setup ..... 232
  - Wi-Fi Connection ..... 292
  - Audio/Information Screen** ..... 229
  - Authorized Manuals** ..... 588
  - Auto Door Locking/Unlocking** ..... 142
    - Customize ..... 335
  - Auto High-Beam** ..... 168
    - Indicator ..... 89
  - Auto Idle Stop** ..... 404
    - OFF Button ..... 405
  - Auto Idle Stop Indicator (Green)** ..... 91
  - Auto Idle Stop OFF Indicator** ..... 91
  - Auto Idle Stop Suspend Indicator** ..... 91
  - Auto Idle Stop System Indicator (Amber)** ..... 91
  - Automatic Intermittent Wipers** ..... 172
  - Automatic Lighting** ..... 164
  - Automatic Transmission** ..... 395
    - Creeping ..... 395
    - Fluid ..... 510
    - Kickdown ..... 395
    - Operating the Shift Button ..... 398
    - Shifting ..... 396
  - Average Fuel Economy** ..... 115
- B**
- Back-Up Light** ..... 517
  - Battery** ..... 531
    - Charging System Indicator ..... 83, 563
    - If the Battery Is Dead ..... 557
    - Maintenance (Checking the Battery) ..... 531
  - Belts (Seat)** ..... 39
  - Beverage Holders** ..... 197
  - Blind Spot Information System** ..... 414
  - Bluetooth® Audio** ..... 283
  - Bluetooth® HandsFreeLink®** ..... 343
  - Booster Seats (For Children)** ..... 78
  - Brake System** ..... 467
    - Anti-lock Brake System (ABS) ..... 469
    - Brake Assist System ..... 470
    - Fluid ..... 511
    - Foot Brake ..... 468
    - Indicator ..... 82, 564
    - Parking Brake ..... 467
  - Brightness Control (Instrument Panel)** ..... 176
  - Bulb Replacement** ..... 512
    - Back-Up Lights ..... 517
    - Brake lights ..... 516
    - Daytime Running Lights ..... 513
    - Fog Lights ..... 515
    - Front Side Marker Lights ..... 513
    - Front Turn Signal Lights ..... 514
    - Headlights ..... 512
    - High-Mount Brake Light ..... 517
    - Parking Lights ..... 513
    - Rear License Plate Lights ..... 517
    - Rear Side Marker Lights ..... 516
    - Rear Turn Signal Lights ..... 516
    - Side Turn Signal/Emergency Indicator Lights ..... 515
    - Taillights ..... 516
  - Bulb Specifications** ..... 578
- C**
- Car Wash Mode** ..... 400
  - Carbon Monoxide Gas** ..... 79
  - Carrying Cargo** ..... 371, 373
  - Certification Label** ..... 580
  - Changing Bulbs** ..... 512
  - Charging System Indicator** ..... 83, 563
  - Child Safety** ..... 64
    - Childproof Door Locks ..... 141
  - Child Seat** ..... 64
    - Booster Seats ..... 78
    - Child Seat for Infants ..... 66
    - Child Seat for Small Children ..... 67
    - Installing a Child Seat with a Lap/Shoulder Seat Belt ..... 72
    - Larger Children ..... 77
    - Rear-facing Child Seat ..... 66
    - Selecting a Child Seat ..... 68
  - Childproof Door Locks** ..... 141
  - Cleaning the Exterior** ..... 538
  - Cleaning the Interior** ..... 536
  - Climate Control System** ..... 213
    - Changing the Mode ..... 213
    - Defrosting the Windshield and Windows ..... 214
    - Dust and Pollen Filter ..... 535
    - Recirculation and Fresh Air Mode ..... 214
    - Sensors ..... 219

Synchronization Mode .....	216
Using Automatic Climate Control.....	213
<b>Clock</b> .....	126
<b>Coat Hook</b> .....	198
<b>Collision Mitigation Braking System™</b> (CMBS™) .....	425
<b>Collision Mitigation Braking System™</b> (CMBS™) Indicator .....	95, 96
<b>Compact Spare Tire</b> .....	545, 579
<b>Console Compartment</b> .....	196
<b>Controls</b> .....	125
<b>Coolant (Engine)</b> .....	508
Adding to the Radiator .....	509
Adding to the Reserve Tank .....	508
Overheating .....	560
Temperature Gauge.....	109
<b>Creeping (Automatic Transmission)</b> .....	395
<b>Cross Traffic Monitor</b> .....	478
<b>Cup Holders</b> .....	197
<b>Customer Service Information</b> .....	589
<b>Customized Features</b> .....	327
 <b>D</b>	
<b>Daytime Running Lights</b> .....	167
<b>Dead Battery</b> .....	557
<b>Defaulting All the Settings</b> .....	339
<b>Defrosting the Windshield and</b> <b>Windows</b> .....	214
<b>Detachable Anchor</b> .....	46
<b>Devices that Emit Radio Waves</b> .....	581

<b>Dimming</b>	
Headlights .....	163
Rearview Mirror .....	180
<b>Dipstick (Engine Oil)</b> .....	504
<b>Directional Signals (Turn Signal)</b> .....	162
<b>Door Mirrors</b> .....	181
<b>Doors</b> .....	128
Auto Door Locking .....	142
Auto Door Unlocking.....	142
Door Open Message .....	38
Keys .....	128
Locking/Unlocking the Doors from the Inside.....	139
Locking/Unlocking the Doors from the Outside.....	131
Lockout Prevention System .....	138
<b>DOT Tire Quality Grading</b> .....	525
<b>Driver Information Interface</b> .....	110
Accessing Content.....	112
Audio Source.....	120
AWD Torque .....	118
Maintenance .....	117
Navigation .....	116
Now Playing .....	119
Odometer.....	111
Outside Temperature .....	111
Phone.....	118
Seat Belts .....	120
Settings .....	122
Show/Hide Apps.....	121
Speedometer.....	110

Tachometer.....	110
Trip Computer.....	114
Units .....	119
Warnings .....	116
<b>Driver Information Interface Warning</b> <b>and Information Messages</b> .....	98
<b>Driving</b> .....	369
Adaptive Cruise Control (ACC).....	442
Automatic Transmission .....	395
Braking .....	467
Off-Highway Driving Guidelines.....	386
Shifting Gear.....	396
Starting the Engine.....	388
<b>Driving Position Memory System</b> .....	177
<b>Dust and Pollen Filter</b> .....	535

## E

<b>Eco Assist® System</b> .....	14
<b>ECON Button</b> .....	409
<b>Econ Mode</b> Indicator.....	90
<b>Electric Power Steering (EPS) System</b> Indicator.....	87, 564
<b>Electronic Stability Control (ESC)</b> .....	411
<b>Emergency</b> .....	572
<b>Emissions Testing (Readiness Codes)</b> .....	583
<b>Engine</b>	
Coolant.....	508
If the Battery Is Dead.....	557
Number.....	580

Oil .....	503
Remote Engine Start .....	390
Starting .....	388
<b>Engine Compartment Cover</b> .....	502
<b>Engine Coolant</b> .....	508
Adding to the Radiator .....	509
Adding to the Reserve Tank .....	508
Overheating.....	560
Temperature Gauge.....	109
<b>Engine Oil</b> .....	503
Adding .....	505
Checking.....	504
Displaying Maintenance Minder Information.....	495
Engine Oil Low Warning .....	562
Recommended Engine Oil.....	503
Engine Oil Low Warning.....	562
<b>ENGINE START/STOP Button</b> .....	159
<b>EPS (Electric Power Steering) System</b> .....	564
<b>Exhaust Gas Hazard (Carbon Monoxide)</b> ..	79
<b>Exterior Care (Cleaning)</b> .....	538
<b>Exterior Mirrors</b> .....	181
 <b>F</b>	
<b>Features</b> .....	221
<b>File Manager</b> .....	248
<b>Filters</b>	
Dust and Pollen .....	535
Oil .....	506
<b>Flat Tire</b> .....	545

<b>Floor Mats</b> .....	537
<b>Fluids</b>	
Automatic Transmission .....	510
Brake .....	511
Engine Coolant .....	508
Windshield Washer .....	511
<b>FM/AM Radio</b> .....	260
<b>Fog Light Indicator</b> .....	89
<b>Fog Lights</b> .....	166
<b>Folding Down the Rear Seat</b> .....	187
<b>Foot Brake</b> .....	468
<b>Front Airbags (SRS)</b> .....	52
<b>Front Seats</b> .....	182
Adjusting .....	182
<b>Front Sensor Camera</b> .....	464
<b>Fuel</b> .....	26, 484
Economy .....	487
Gauge .....	109
Instant Fuel Economy .....	115
Low Fuel Indicator .....	85
Range .....	115
Recommendation .....	484
Refueling.....	484
<b>Fuel Economy</b> .....	487
<b>Fuel Fill Cap</b> .....	486
<b>Fuel Fill Door</b> .....	26, 485
Unable to Unlock .....	573
<b>Fuses</b> .....	567
Inspecting and Changing.....	571
Locations.....	567, 568, 569, 570

## G

### Gasoline (Fuel)

Economy.....	487
Gauge .....	109
Information.....	484
Instant Fuel Economy .....	115
Low Fuel Indicator.....	85
Refueling .....	484

### Gauges .....

### Gear Position Indicator..... 83, 398

### Gear Shift Positions

Automatic Transmission .....	396
------------------------------	-----

### Glass (care) .....

### Glove Box .....

## H

### Handling the Unexpected .....

### HandsFreeLink® (HFL) .....

Automatic Import of Cellular Phonebook and Call History.....	352
Automatic Transferring .....	351
Displaying Messages .....	362
Favorite Contacts .....	353
HFL Buttons .....	343
HFL Menus.....	346
HFL Status Display .....	345
In Case of Emergency .....	366
Limitations for Manual Operation.....	345
Making a Call .....	355
Options During a Call.....	358

Phone Setup .....	348	<b>If the Transmission Indicator Blinks</b>		Lane Keeping Assist System (LKAS)	
Receiving a Call.....	358	<b>along with the Warning Message</b> .....	566	(Amber).....	93
Receiving a Text Message.....	360	<b>Illumination Control</b> .....	176	Lane Keeping Assist System (LKAS)	
Ringtone.....	351	Button.....	176	(Green).....	93, 457
Selecting a Phone .....	361	<b>Immobilizer System</b> .....	152	Lights On .....	88
To Set Up a Text Message Options.....	359	Indicator.....	89	Low Fuel .....	85
<b>Hazard Warning Button</b> .....	8	<b>Indicators</b> .....	82	Low Tire Pressure/TPMS.....	88, 565
<b>HD Radio™</b> .....	262	Adaptive Cruise Control (ACC) (Amber).....	95	M (sequential mode) .....	83
<b>Head Restraints</b> .....	189, 190	Adaptive Cruise Control (ACC) (Green).....	95	Malfunction Indicator Lamp.....	83, 563
<b>Headlights</b> .....	163	All-wheel drive (AWD) .....	93	Parking Brake and Brake System (Amber) ..	82
Auto High-Beam .....	168	Anti-lock Brake System (ABS).....	85	Parking Brake and Brake System	
Automatic Operation .....	164	Auto High-Beam.....	89	(Red) .....	82, 564
Dimming.....	163, 167	Auto Idle Stop (Green).....	91	Road Departure Mitigation (RDM) .....	94
Operating .....	163	Auto Idle Stop OFF Indicator .....	91	Seat Belt Reminder .....	41, 85
<b>Heated Steering Wheel</b> .....	212	Auto Idle Stop Suspend .....	91, 92	Security System Alarm .....	89
<b>Heated Windshield Button</b> .....	175	Auto Idle Stop System (Amber) .....	91	Sequential Mode Gear Selection .....	83
<b>Heater (Steering Wheel)</b> .....	212	Blind spot information .....	97, 415	Supplemental Restraint System.....	60, 86
<b>Heaters (Seat)</b> .....	209, 210, 211	Brake System (Amber) .....	82	System Message.....	90
<b>HFL (HandsFreeLink®)</b> .....	343	Brake System (Red) .....	82, 564	Transmission System.....	84
<b>High Beam Indicator</b> .....	88	Charging System .....	83, 563	Turn Signal.....	88
<b>Hill Start Assist System</b> .....	393	Collision Mitigation Braking System™		Vehicle Stability Assist™ (VSA®) OFF ..	87, 412
<b>HomeLink® Universal Transceiver</b> .....	340	(CMBS™).....	95, 96	Vehicle Stability Assist™ (VSA®)	
<b>Honda App License Agreement</b> .....	307	Econ Mode.....	90	System .....	86, 411
<b>Honda Sensing®</b> .....	27	Electric Power Steering (EPS) System ..	87, 564	<b>Information</b> .....	577
<b>HondaLink®</b> .....	287	Engine Oil Low Warning .....	562	<b>Instant Fuel Economy</b> .....	115
		Fog Light .....	89	<b>Instrument Panel</b> .....	81
		Gear Position .....	83	Brightness Control.....	176
		Hazard Warning .....	88	<b>Integrated Sunshades</b> .....	208
		High Beam .....	88	<b>Intelligent Traction Management</b>	
		Immobilizer System.....	89	<b>System</b> .....	410
		Intelligent Traction Management .....	90	<b>Intelligent VTM4 (i-VTM4™)</b> .....	417
<b>I</b>					
<b>Identification Numbers</b> .....	580				
Engine and Transmission.....	580				
Vehicle Identification.....	580				



Interior Convenience Items .....	193
Interior Lights .....	193
Interior Rearview Mirror .....	180
iPad .....	306
iPhone .....	306
iPod .....	273, 306

## J

Jack (Wheel Nut Wrench) .....	549
Jump Starting .....	557

## K

Key Number Tag .....	129
Keyless Lockout Prevention .....	138
Keys .....	128
Lockout Prevention .....	138
Number Tag .....	129
Rear Door Won't Open .....	141
Remote Transmitter .....	136
Types and Functions .....	128
Kickdown (Automatic Transmission) .....	395

## L

Lane Keeping Assist System (LKAS) .....	455
Lane Keeping Assist System (LKAS) Indicator (Amber) .....	93
Lane Keeping Assist System (LKAS) Indicator (Green) .....	93
LATCH (Child Seats) .....	69, 75

Legal Information on Apple CarPlay/ Android Auto .....	319
License Information .....	322
Lights .....	163, 512
Auto High-Beam .....	168
Automatic .....	164
Bulb Replacement .....	512
Daytime Running Lights .....	167
High Beam Indicator .....	88
Interior .....	193
Light Switches .....	163
Lights On Indicator .....	88
Turn Signals .....	162
Load Limits .....	373
Locking/Unlocking .....	128
Auto Door Locking/Unlocking .....	142
Childproof Door Locks .....	141
From Inside .....	139
From Outside .....	131
Keys .....	128
Using a Key .....	137
Lockout Prevention System .....	138
Low Battery Charge .....	563
Low Fuel Indicator .....	85
Lower Anchors .....	69, 75
Lubricant Specifications Chart .....	579
Luggage (Maximum Load Limit) .....	373
Lumbar Support .....	183
Lumbar Support Adjustment Switch .....	183

## M

Maintenance .....	117, 489
Battery .....	531
Brake Fluid .....	511
Cleaning .....	536
Coolant .....	508
Maintenance Minder™ .....	494
Oil .....	504
Precautions .....	490
Radiator .....	509
Remote Transmitter .....	533
Replacing Light Bulbs .....	512
Safety .....	491
Service Items .....	497
Tires .....	522
Transmission Fluid .....	510
Under the Hood .....	500
Malfunction Indicator Lamp .....	83, 563
Map Lights .....	194
Maximum Load Limit .....	373
Meters, Gauges .....	109
Mirrors .....	180
Adjusting .....	180
Door .....	181
Exterior .....	181
Interior Rearview .....	180
Modifications (and Accessories) .....	541
Moonroof .....	158
MP3 .....	276, 279
MP3/WMA/AAC .....	276, 279
Multi-View Rear Camera .....	482

My Honda Music ..... 279

## N

Navigation ..... 116

Now Playing ..... 119

Numbers (Identification) ..... 580

## O

Odometer ..... 111

Off-Highway Driving Guidelines ..... 386

Oil (Engine) ..... 503

    Adding ..... 505

    Checking ..... 504

    Displaying Maintenance Minder

        Information ..... 495

    Engine Oil Low Warning ..... 562

    Oil Life ..... 117

    Recommended Engine Oil ..... 503

    Viscosity ..... 503

Open Source Licenses ..... 321

Opening/Closing

    Hood ..... 501

    Moonroof ..... 158

    Power Windows ..... 155

    Tailgate ..... 143

Operating the Switches Around the

    Steering Wheel ..... 159

Other Interior Convenience Items ..... 201

Outside Temperature ..... 111

Overheating ..... 560

## P

Paddle Shifters (Sequential Mode) .... 25, 403

Panic Mode ..... 154

Parking ..... 471

Parking Brake ..... 467

Parking Brake and Brake System

    Indicator ..... 564

Parking Brake and Brake System

    Indicator (Amber) ..... 82

Parking Brake and Brake System

    Indicator (Red) ..... 82

Parking Sensor System ..... 473

Passenger Airbag Off Indicator ..... 61

Passing Indicators ..... 163

Phone ..... 118

Playing *Bluetooth*® Audio ..... 283

Power Tailgate ..... 145

Power Windows ..... 155

Precautions While Driving ..... 394

    Driving Guidelines for Your Utility Vehicle 394

    Rain ..... 394

Pregnant Women ..... 47

Puncture (Tire) ..... 545

## R

Radiator ..... 509

Radio (AM/FM) ..... 260

Radio (SiriusXM®) ..... 263

Radio Data System (RDS) ..... 262

Range ..... 115

RDS (Radio Data System) ..... 262

Readiness Codes (Emissions Testing) ..... 583

Rear Climate Control System

    From the Rear Panel ..... 218

Rear Defogger/Heated Door Mirror

    Button ..... 174

Rear Outer Seats Heaters ..... 211

Rear Seat (Folding Down) ..... 187, 188

Rear Seats ..... 186

Rearview Mirror ..... 180

Refueling ..... 484

    Fuel Gauge ..... 109

    Gasoline ..... 484, 578

    Low Fuel Indicator ..... 85

Regulations ..... 420, 525, 581

Remote Engine Start ..... 390

Remote Transmitter ..... 136

Replacement

    Battery ..... 533

    Bulbs ..... 512

    Front Wiper Blade Rubber ..... 518

    Fuses ..... 567, 568, 569, 570

    Rear Wiper Blade Rubber ..... 520

    Tires ..... 528

Reporting Safety Defects ..... 582

Reverse Tilt Door Mirror ..... 181

Road Departure Mitigation (RDM) ..... 437

    On and Off ..... 439

Road Departure Mitigation (RDM)	
Indicator .....	94

## S

Safe Driving.....	33
Safety Check.....	38
Safety Labels .....	80
Safety Message .....	4
Seat Belts.....	39, 120
Adjusting the Shoulder Anchor .....	45
Automatic Seat Belt Tensioners.....	43
Checking .....	48
Detachable Anchor.....	46
Fastening.....	44
Installing a Child Seat with a Lap/ Shoulder Seat Belt.....	72
Pregnant Women .....	47
Reminder.....	41
Warning Indicator.....	41, 85
Seat Heaters.....	209, 210, 211
Seat Ventilation .....	210
Seats .....	182
Adjusting.....	182
Driver's Seat Lumbar Support.....	183
Folding Down the Rear Seat.....	187, 188
Front Seats .....	182
Rear Seats.....	186
Seat Heaters .....	209, 210, 211
Seat Ventilation .....	210

Security System.....	152
Immobilizer System Indicator .....	89
Security System Alarm Indicator.....	89
Select Button .....	24, 396
Operation.....	24, 398
Selecting a Child Seat.....	68
Sequential Mode .....	402
Sequential Mode Operation.....	403
Setting the Clock .....	126
Settings	
Arrange Apps.....	122
Show Tachometer .....	123
Shift Button .....	24, 396
Shifting (Transmission).....	24, 396
Shoulder Anchor .....	45
Show Tachometer .....	123
Show/Hide Apps .....	121
Side Airbags.....	57
Side Curtain Airbags .....	59
Siri Eyes Free .....	294
SiriusXM® Radio.....	263
Snow Tires.....	530
Social Playlist .....	285
Spare Tire.....	545, 579
Spark Plugs .....	578
Specifications.....	578
Specified Fuel .....	484, 578
Speedometer .....	110
SRS Airbags (Airbags).....	52
Starting Assist Brake Function.....	408

Starting the Engine.....	388
Does Not Start .....	553
If the Battery Is Dead.....	557
Remote Engine Start .....	390
Steering Wheel .....	179
Adjusting .....	179
Heater .....	212
Stopping .....	471
Storage Items .....	196
Summer Tires.....	530
Sunglasses Holder .....	207
Sunshades.....	208
Supplemental Restraint System (SRS) .....	52
Switches	
(Around the Steering Wheel).....	8, 9, 159
SYNC Mode .....	216
System Message Indicator .....	90
System Updates.....	242

## T

Tachometer .....	110
Tailgate.....	143
Unable to Open .....	575
Temperature	
Gauge .....	109
Outside Temperature Display .....	111
Temperature Gauge .....	109
Temperature Sensor .....	111, 219
Tie-down Anchors.....	199
Time (Setting).....	126

Tire Fill Assist .....	565
Tire Pressure .....	117
<b>Tire Pressure Monitoring System (TPMS)</b>	
Indicator .....	88
<b>Tires</b> .....	522
Air Pressure.....	523, 579
Checking and Maintaining .....	522
Inspection .....	522
Labeling.....	523
Puncture (Flat Tire).....	545
Regulations.....	525
Rotation.....	529
Spare Tire .....	545, 579
Summer .....	530
Tire Chains.....	530
Wear Indicators.....	527
Winter .....	530
<b>Tools</b> .....	544
<b>Towing a Trailer</b> .....	376
Equipment and Accessories.....	379
Load Limits .....	376
<b>Towing Your Vehicle</b> .....	385
Emergency.....	572
<b>TPMS (Tire Pressure Monitoring System)</b>	
Indicator .....	88
<b>TPMS with Tire Fill Assist</b> .....	418
Indicator .....	565
Tire Fill Assist .....	565
<b>Trailer Stability Assist</b> .....	383
<b>Transmission</b> .....	24, 396
Automatic.....	24, 396

Fluid .....	510
Gear Position Indicator .....	83, 398
Number .....	580
Sequential Mode .....	402
<b>Trip Computer</b> .....	114
<b>Troubleshooting</b> .....	543
Blown Fuse.....	567, 568, 569, 570
Brake Pedal Vibrates .....	30
Buzzer Sounds When Opening Door.....	31
Emergency Towing .....	572
Engine Won't Start .....	553
Noise When Braking .....	31
Overheating .....	560
Puncture/Flat Tire.....	545
Rear Door Won't Open .....	30, 141
Warning Indicators .....	82
<b>Turn Signals</b> .....	162
Indicators (Instrument Panel).....	88

## U

<b>Under-floor Storage Area</b> .....	200
<b>Units</b> .....	119
<b>Unlocking the Doors</b> .....	131
<b>Unlocking the Front Doors from the</b>	
Inside .....	139
<b>USB Flash Drives</b> .....	276, 306
<b>USB Port</b> .....	223

## V

<b>Vanity Mirrors</b> .....	11
<b>Vehicle Identification Number</b> .....	580
<b>Vehicle Stability Assist™ (VSA®)</b> .....	411
Off Button.....	412
<b>Vehicle Stability Assist™ (VSA®)</b>	
OFF Indicator.....	87
<b>Vehicle Stability Assist™ (VSA®)</b>	
System Indicator.....	86, 411
Ventilation .....	214
<b>Viscosity (Oil)</b> .....	503, 579
<b>Voice Control Operation</b> .....	257
Audio Commands .....	259
Phone Commands.....	259
Voice Portal Screen.....	258
Voice Recognition .....	257

## W

<b>Wallpaper</b> .....	232
<b>Warning and Information Messages</b> .....	98
<b>Warning Indicator On/Blinking</b> .....	562
<b>Warning Labels</b> .....	80
<b>Warnings</b> .....	116
<b>Warranties (Warranty Manual provided</b>	
separately) .....	585
<b>Watts</b> .....	578
<b>Wear Indicators (Tire)</b> .....	527
<b>Wheel Nut Wrench (Jack Handle)</b> .....	549
<b>Wi-Fi Connection</b> .....	292

<b>Window Washers</b> .....	171
Adding/Refilling Fluid.....	511
Switch .....	171
<b>Windows (Opening and Closing)</b> .....	155
<b>Windshield</b> .....	171
Cleaning.....	536, 539
Defrosting/Defogging .....	214
Washer Fluid.....	511
Wiper Blades .....	518
Wipers and Washers .....	171
<b>Winter Tires</b> .....	530
Snow Tires.....	530
Tire Chains .....	530
<b>Wipers and Washers</b> .....	171
Automatic Intermittent Wipers.....	172
Checking and Replacing Wiper Blades .....	518
Front .....	171
Rear.....	173
<b>Wireless Charger</b> .....	203
<b>WMA</b> .....	276, 279
<b>Worn Tires</b> .....	522



**[mygarage.honda.com](https://mygarage.honda.com) (U.S.A.)**  
**[honda.ca](https://honda.ca) (Canada)**

31TGS650  
OM-21444  
00X31-TGS-6500

2024 Honda Passport Owner's Manual  
© 2023 Honda Motor Co., Ltd. — All Rights Reserved

Printed in the U.S.A.