

Pictorial index

Search by illustration

For safety and security

Make sure to read through them
(Main topics: Child seat, theft deterrent system)

1

Vehicle status information and indicators

Reading driving-related information
(Main topics: Meters, multi-information display)

2

Before driving

Opening and closing the doors and windows, adjustment before driving
(Main topics: Keys, doors, seats)

3

Driving

Operations and advice which are necessary for driving
(Main topics: Starting engine, refueling)

4

Interior features

Usage of the interior features
(Main topics: Air conditioner, storage features)

5

Maintenance and care

Caring for your vehicle and maintenance procedures
(Main topics: Interior and exterior, light bulbs)

6

When trouble arises

What to do in case of malfunction and emergency
(Main topics: Battery discharge, flat tire)

7

Vehicle specifications

Vehicle specifications, customizable features
(Main topics: Fuel, oil, tire inflation pressure)

8

For owners

Reporting safety defects for U.S. owners, and seat belt and SRS airbag instructions for Canadian owners

9

Index

Search by symptom

Search alphabetically

For your information	5
Reading this manual	12
How to search	13
Pictorial index	14

1 For safety and security

1-1. For safe use	
Before driving	24
For safe driving	25
Seat belts	27
SRS airbags	31
Front passenger occupant clas- sification system	40
Exhaust gas precautions	45
1-2. Child safety	
Riding with children	46
Child restraint systems	47
1-3. Emergency assistance	
Safety Connect	60
1-4. Theft deterrent system	
Engine immobilizer system ...	64
Alarm	65
Theft prevention labels (U.S.A.)	66

2 Vehicle status information and indicators

2-1. Instrument cluster	
Warning lights and indicators	68
Gauges and meters (4.2-inch display)	72
Gauges and meters (7-inch dis- play)	75
Multi-information display (4.2-inch display)	77
Multi-information display (7-inch display)	83
Fuel consumption information	88

3 Before driving

3-1. Key information	
Keys	92
3-2. Opening, closing and locking the doors	
Side doors	95
Back door	99
Smart key system	102
3-3. Adjusting the seats	
Front seats	107
Rear seats	108
Head restraints	110
3-4. Adjusting the steering wheel and mirrors	
Steering wheel	113
Inside rear view mirror	114
Outside rear view mirrors ...	115
3-5. Opening and closing the win- dows	
Power windows	117
3-6. Favorite settings	
My Settings	120

4 Driving

4-1. Before driving	
Driving the vehicle	122
Cargo and luggage	128
Vehicle load limits	131
Trailer towing	131
Dinghy towing	132
4-2. Driving procedures	
Engine (ignition) switch	133
Continuously variable transmis- sion	137
Turn signal lever	142
Parking brake	143
Brake Hold	146

4-3. Operating the lights and wipers
 Headlight switch 148
 AHB (Automatic High Beam) 150
 Fog light switch 153
 Windshield wipers and washer 154
 Rear window wiper and washer 155

4-4. Refueling
 Opening the fuel tank cap .. 157

4-5. Using the driving support systems
 Toyota Safety Sense 3.0 software update 159
 Toyota Safety Sense 3.0 161
 PCS (Pre-Collision System) 167
 LTA (Lane Tracing Assist)... 177
 LDA (Lane Departure Alert) 182
 PDA (Proactive driving assist) 189
 Dynamic radar cruise control 195
 Cruise control..... 206
 Emergency Driving Stop System 210
 RSA (Road Sign Assist) 212
 BSM (Blind Spot Monitor)... 215
 RCTA (Rear Cross Traffic Alert) function 220
 Safe Exit Assist 225
 Driving mode select switch 229
 Driving assist systems..... 230

4-6. Driving tips
 Winter driving tips..... 235

5 Interior features

5-1. Using the air conditioning system and defogger
 Automatic air conditioning system 240
 Heated steering wheel/seat heaters 247

5-2. Using the interior lights
 Interior lights list 249

5-3. Using the storage features
 List of storage features 251
 Luggage compartment features 254

5-4. Other interior features
 Other interior features 256

6 Maintenance and care

6-1. Maintenance and care
 Cleaning and protecting the vehicle exterior..... 266
 Cleaning and protecting the vehicle interior..... 268

6-2. Maintenance
 Maintenance requirements 271
 General maintenance..... 273
 Emission inspection and maintenance (I/M) programs 275

6-3. Do-it-yourself maintenance
 Do-it-yourself service precautions 277
 Hood 279
 Positioning a floor jack 280
 Engine compartment..... 281
 Tires 289
 Tire inflation pressure..... 306
 Wheels 308
 Air conditioning filter..... 309



Electronic key battery.....	311
Checking and replacing fuses	313
Light bulbs.....	315

7 When trouble arises

7-1. Essential information

Emergency flashers	320
If your vehicle has to be stopped in an emergency	320
If the vehicle is submerged or water on the road is rising	321

7-2. Steps to take in an emergency

If your vehicle needs to be towed	323
If you think something is wrong	326
Fuel pump shut off system	327
If a warning light turns on or a warning buzzer sounds ...	328
If a warning message is dis- played	338
If you have a flat tire (vehicles without spare tire)	343
If you have a flat tire (vehicles with a spare tire)	354
If the engine will not start ...	362
If you lose your keys	364
If the electronic key does not operate properly.....	364
If the vehicle battery is dis- charged.....	366
If your vehicle overheats	370
If the vehicle becomes stuck	372

8 Vehicle specifications

8-1. Specifications

Maintenance data (fuel, oil level, etc.).....	376
Fuel information	383
Tire information	385

8-2. Customization

Customizable features	396
-----------------------------	-----

8-3. Initialization

Items to initialize	406
---------------------------	-----

9 For owners

9-1. For owners

Reporting safety defects for U.S. owners	408
Reporting safety defects for Canadian owners.....	408
Seat belt instructions for Cana- dian owners (in French) ...	409
SRS airbag instructions for Canadian owners (in French)	410

Index

What to do if... (Troubleshooting)	418
Alphabetical Index.....	421

For your information

Main Owner's Manual

Please note that this manual applies to all models and explains all equipment, including options. Therefore, you may find explanations for equipment not installed on your vehicle and the illustrations used may differ from your vehicle.

All specifications provided in this manual are current at the time of printing. Over time, your vehicle may receive updates that modify the vehicle and make material in this manual incomplete and/or inaccurate. Because of Toyota's interest in continual product improvement, Toyota reserves the right to make changes to this manual at any time without notice.

If Toyota chooses to update the manual, updated versions can be viewed by selecting your vehicle by model and year at the following URL or on your mobile device if you have access to the Toyota app.

www.toyota.com/owners

Noise from under vehicle after turning off the engine

Approximately five hours after the engine is turned off, you may hear sound coming from

under the vehicle for several minutes. This is the sound of a fuel evaporation leakage check and, it does not indicate a malfunction.

Accessories, spare parts and modification of your Toyota

A wide variety of non-genuine spare parts and accessories for Toyota vehicles are currently available in the market. You should know that Toyota does not warrant these products and is not responsible for their performance, repair, or replacement, or for any damage they may cause to, or adverse effect they may have on, your Toyota vehicle.

This vehicle should not be modified with non-genuine Toyota products. Modification with non-genuine Toyota products could affect its performance, safety or durability, and may even violate governmental regulations. In addition, damage or performance problems resulting from the modification may not be covered under warranty.

Also, remodeling like this will have an effect on advanced safety equipment such as Toyota Safety Sense 3.0 and there is a danger that it will not work properly or the danger that it

may work in situations where it should not be working.

Cyber Attack Risk

Installing electronic devices and radios increases the risk of cyber attacks through the installed parts, which may lead to unexpected accidents and leakage of personal information. Toyota does not make any guarantees for problems caused by installing non-genuine Toyota products.

Installation of a mobile two-way radio system

The installation of a mobile two-way radio system in your vehicle could affect electronic systems such as:

- Multiport fuel injection system/sequential multiport fuel injection system
- Toyota Safety Sense 3.0
- Anti-lock brake system
- SRS airbag system
- Seat belt pretensioner system

Be sure to check with your Toyota dealer for precautionary measures or special instructions regarding installation of a mobile two-way radio system.

Vehicle data recording

This vehicle is equipped with sophisticated computers that record certain data regarding vehicle controls and operations.

- Data recorded by the computers^{*1}

Certain data, such as the following, is recorded depending on the operation timing and status of each function.

- Basic vehicle behavior related data (engine speed, accelerator/brake pedal operation, vehicle speed, etc.)
- Operating state of the driving support systems (recorded during system operation, includes basic vehicle behavior related data)
- Driving support system sensor data
- Image data (images from the front, rear and side cameras)^{*2}
- Location information

These computers do not record conversations, sounds, or images of the inside of the vehicle.

Also, personal information which may be used to identify the owner of the vehicle (name, gender, age, etc.) is not recorded.

^{*1}: The recorded data varies according to the vehicle grade level and options with which it is equipped.

^{*2}: The vehicle has multiple cameras. For details on from which

cameras images are recorded, contact your Toyota dealer.

- Usage of recorded data and personal information by the Toyota Safety Sense 3.0

The operating state of each system, data from each sensor, image data (images from the front/rear cameras), and position information is recorded by the Toyota Safety Sense 3.0 in the following situations. Toyota obtains this information when the vehicle is brought to the dealership or when sent to the Toyota servers.

- In certain collisions or collision-like situations
- When driving on roads with certain traffic situations, such as congestion, poor road surfaces, poor weather, etc.
- When driving on certain roads, such as roads which were recently opened or extended
- After the engine is started, for a certain amount of time

To learn more about the vehicle data collected, used and shared by Toyota, please visit www.toyota.com/privacyvts/.

- Data provision and use purpose by third parties

Data recorded by the computers may be used for collision analysis, malfunction diagnosis, automated driving, advanced safety and map related technologies (technology, product development, product improvement, etc.) and products and services which use data (maps used for automated driving and

advanced safety technologies, driving condition analysis, analysis of the driving environment, such as road infrastructure, traffic condition communication, etc. Herein referred to as “individual services”).) Also, this data may be used for customer support related to a collision, collision analysis or resolution.

In situations such as the following, Toyota may disclose the recorded data to a third party:

- When the consent of the vehicle owner (or the lessee if the vehicle is leased) has been given
- When officially requested by the police, a court of law or a government agency
- When it is to be used by Toyota in a lawsuit
- When data is to be used research purposes after processing so that the data is not tied to a specific vehicle or vehicle owner

In addition to the above, Toyota may disclose the data recorded by the Toyota Safety Sense 3.0 to a third party in the following situations:

- When separate consent of the vehicle owner (or the lessee if the vehicle is leased) has been given. This includes situations when the user subscribes to an individual service which is provided by a second party and uses vehicle recorded data, where the provider has obtained the user’s consent for providing data to a third-party
- When providing data to a company involved in autonomous

driving software, etc. for the purpose of research and development (technology, product development, product improvement, etc.) of automated driving, advanced safety and map related technologies

- When providing image data and position information to a company involved in map creation, etc. for the purpose of research and development map related technologies
- When providing image data and position information to a local government for the purpose of road maintenance, etc.
- When providing processed image data and position information to traffic condition communication individual services
- When providing image data from near a fire, or other area that emergency services are dispatched, to the fire department of a local government which has entered a separate contract with Toyota

Image information recorded by the vehicle can be erased by your Toyota dealer.

The image recording function can be disabled. However, if the function is disabled, data from when systems operate will not be available.

If you wish to stop the collection of Toyota Safety Sense 3.0 data by the Toyota servers for the purpose of research and development and provision to individual services, contact your Toyota dealer.

Usage of data collected through Safety Connect (U.S. mainland only)

If your Toyota has Safety Connect and if you have subscribed to those services, please refer to the Safety Connect Telematics Subscription Service Agreement for information on data collected and its usage.

To learn more about the vehicle data collected, used and shared by Toyota, please visit www.toyota.com/privacyvts/.

Statement on Warranty Coverage for Aftermarket and Recycled Parts (For U.S. Owners)

The Magnuson-Moss Warranty Act, 15 U.S.C. s.2301 et seq., makes it illegal for motor vehicle manufacturers to void a motor vehicle warranty or deny warranty coverage solely because an aftermarket or recycled part has been used to repair the vehicle or someone other than the authorized service provider performed service on the vehicle. This provision does not apply to a new motor vehicle purchased solely for commercial or industrial use.

Under federal law, a manufacturer may deny warranty coverage and charge for repairs to a

vehicle if it is discovered that an aftermarket or recycled part installed on the vehicle is defective or was installed incorrectly and caused damage to another part of the vehicle otherwise covered under warranty. The Federal Trade Commission requires that a manufacturer demonstrate that an aftermarket or recycled part or service performed by a person other than an authorized service provider caused damage to another part of the vehicle otherwise covered under warranty before denying warranty coverage. Additionally, federal law allows a manufacturer to void a motor vehicle warranty or deny warranty coverage if the manufacturer provides the article or service to consumers free of charge under the warranty or the manufacturer has secured a waiver from the Federal Trade Commission.

Event data recorder

This vehicle is equipped with an event data recorder (EDR). The main purpose of an EDR is to record, in certain crash or near crash-like situations, such as an air bag deployment or hitting a road obstacle, data that will assist in understanding how a vehicle's systems performed. The EDR is designed to record

data related to vehicle dynamics and safety systems for a short period of time, typically 30 seconds or less.

The EDR in this vehicle is designed to record such data as:

- How various systems in your vehicle were operating;
- Whether or not the driver and passenger safety belts were buckled/fastened;
- How far (if at all) the driver was depressing the accelerator and/or brake pedal; and,
- How fast the vehicle was traveling.

These data can help provide a better understanding of the circumstances in which crashes and injuries occur.

NOTE: EDR data are recorded by your vehicle only if a non-trivial crash situation occurs; no data are recorded by the EDR under normal driving conditions and no personal data (e.g., name, gender, age, and crash location) are recorded. However, other parties, such as law enforcement, could combine the EDR data with the type of personally identifying data routinely acquired during a crash investigation.

To read data recorded by an EDR, special equipment is required, and access to the vehicle or the EDR is needed. In

addition to the vehicle manufacturer, other parties, such as law enforcement, that have the special equipment, can read the information if they have access to the vehicle or the EDR.

- **Disclosure of the EDR data**

Toyota will not disclose the data recorded in an EDR to a third party except when:

- An agreement from the vehicle's owner (or the lessee for a leased vehicle) is obtained
- In response to an official request by the police, a court of law or a government agency

- For use by Toyota in a lawsuit

However, if necessary, Toyota may:

- Use the data for research on vehicle safety performance
- Disclose the data to a third party for research purposes without disclosing information about the specific vehicle or vehicle owner

Scrapping of your Toyota

The SRS airbag and seat belt pretensioner devices in your Toyota contain explosive chemicals. If the vehicle is scrapped with the airbags and seat belt pretensioners left as they are, this may cause an accident such as fire. Be sure to have the systems of the SRS airbag and seat belt pretensioner removed and disposed of by a qualified service shop or by your Toyota dealer before you scrap your

vehicle.

Perchlorate Material

Special handling may apply, See www.dtsc.ca.gov/hazardouswaste/perchlorate.

Your vehicle has components that may contain perchlorate. These components may include the airbags, seat belt pretensioners, wireless remote control batteries, and the batteries in the tire pressure warning valve and transmitters.

“QR Code”

The word “QR Code” is registered trademark of DENSO WAVE INCORPORATED in Japan and other countries.

**WARNING****■ General precautions while driving**

Driving under the influence: Never drive your vehicle when under the influence of alcohol or drugs that have impaired your ability to operate your vehicle. Alcohol and certain drugs delay reaction time, impair judgment and reduce coordination, which could lead to an accident that could result in death or serious injury.

Defensive driving: Always drive defensively. Anticipate mistakes that other drivers or pedestrians might make and be ready to avoid accidents.

Driver distraction: Always give your full attention to driving. Anything that distracts the driver, such as adjusting controls, talking on a cellular phone or reading can result in a collision with resulting death or serious injury to you, your occupants or others.

■ General precaution regarding children's safety



Never leave children unattended in the vehicle, and never allow children to have or use the key.



Children may be able to start the vehicle or shift the vehicle into neutral. There is also a danger that children may injure themselves by playing with the windows, or other features of the vehicle. In addition, heat build-up or extremely cold temperatures inside the vehicle can be fatal to children.

Reading this manual



Explains symbols used in this manual.

Symbols in this manual

Symbols	Meanings
	WARNING: Explains something that, if not obeyed, could cause death or serious injury to people.
	NOTICE: Explains something that, if not obeyed, could cause damage to or a malfunction in the vehicle or its equipment.
1 2 3...	Indicates operating or working procedures. Follow the steps in numerical order.

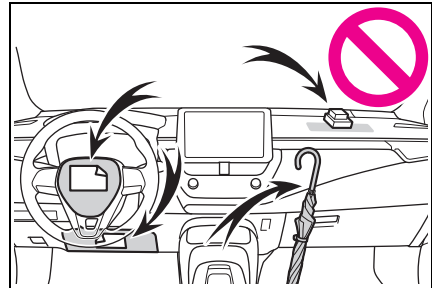
Symbols	Meanings
	Indicates the action (pushing, turning, etc.) used to operate switches and other devices.
	Indicates the outcome of an operation (e.g. a lid opens).



Symbols	Meanings
	Indicates the component or position being explained.
	Means Do not, Do not do this, or Do not let this happen.

Symbols in illustrations

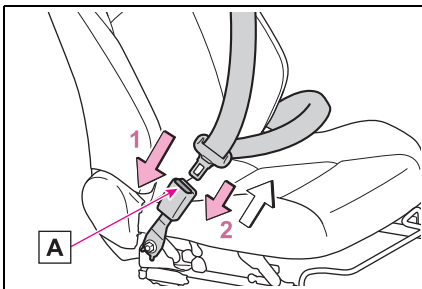

How to search

■ Searching by name

- Alphabetical index: →P.421

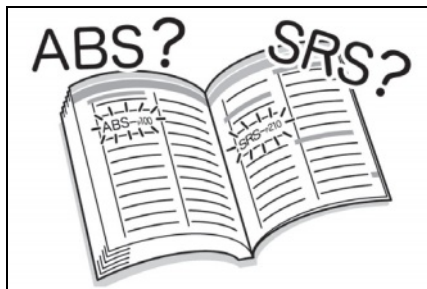

■ Searching by installation position

- Pictorial index: →P.14

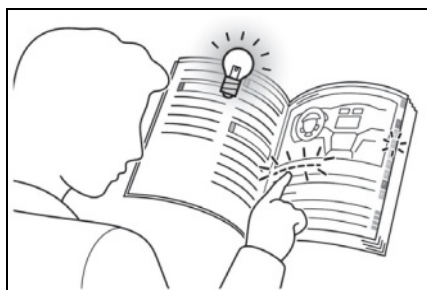

■ Searching by symptom or sound

- What to do if... (Troubleshooting): →P.418



■ Searching by title

- Table of contents: →P.2

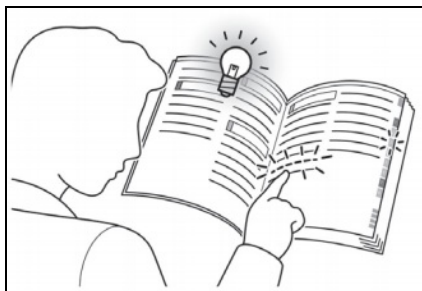

Pictorial index

■ Exterior

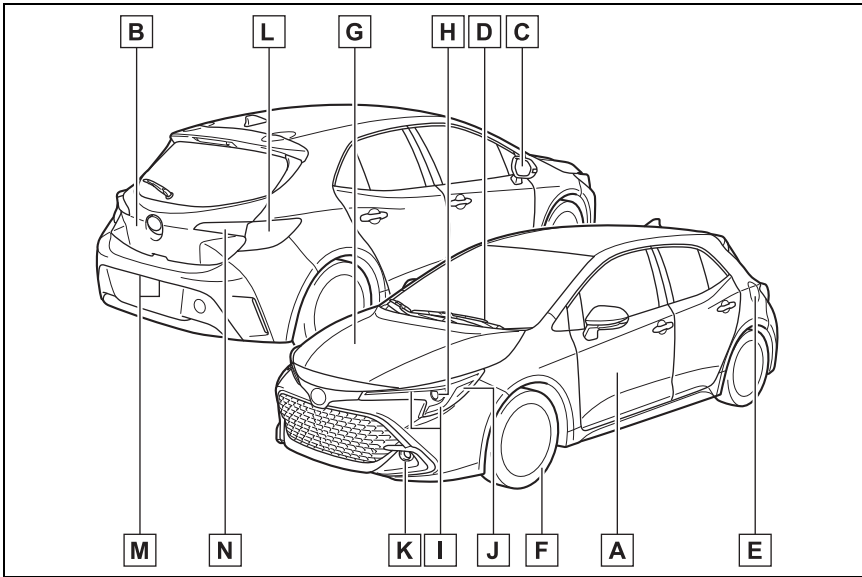

A	Side doors	P.95
	Locking/unlocking	P.95
	Opening/closing the side windows	P.117
	Locking/unlocking by using the mechanical key	P.364
	Warning messages	P.98
B	Back door	P.99
	Locking/unlocking	P.101
	Warning messages	P.101
C	Outside rear view mirrors	P.115
	Adjusting the mirror angle	P.115
	Folding the mirrors	P.116
	Defogging the mirrors	P.243
D	Windshield wipers.....	P.154
	Precautions for winter season.....	P.235
	To prevent freezing (windshield wiper de-icer)*	P.245
E	Fuel filler door	P.157

	Refueling method	P.158
	Fuel type/fuel tank capacity	P.377
F	Tires	P.289
	Tire size/inflation pressure	P.381
	Winter tires/tire chains	P.235
	Checking/rotation/tire pressure warning system	P.289
	Coping with flat tires.....	P.343, 354
G	Hood	P.279
	Opening	P.279
	Engine oil	P.378
	Coping with overheating	P.370

Light bulbs of the exterior lights for driving

(Replacing method: P.315, Watts: P.382)

H	Headlights/daytime running lights	P.148
I	Turn signal lights/parking lights	P.148
J	Front side marker lights	P.148
K	Fog lights *	P.153
L	Stop lights/tail lights/rear side marker lights/ turn signal lights	P.148
M	License plate lights	P.148
N	Tail lights	P.148
	Back-up lights	
	Shifting the shift position to R	P.137

*: If equipped

■ Instrument panel

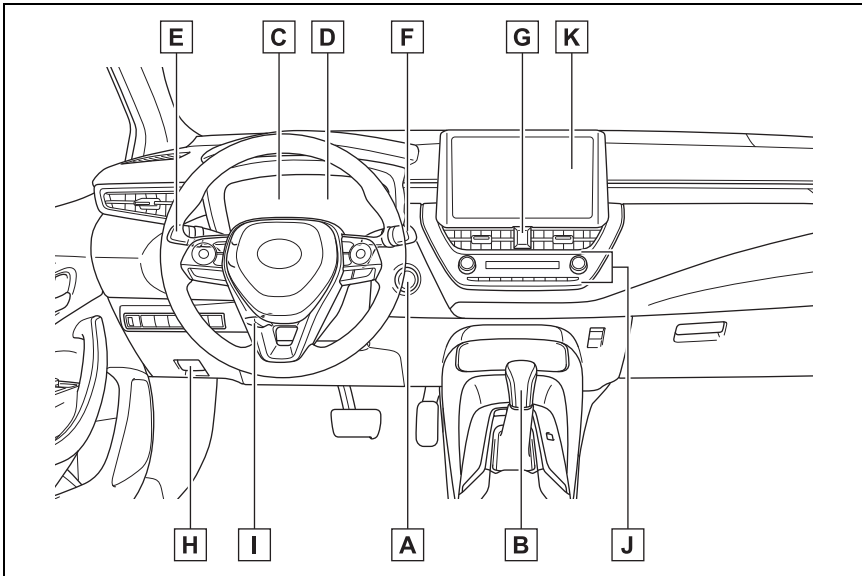

- A Engine switch** **P.133**
 Starting the engine/changing the modes P.133
 Emergency stop of the engine P.320
 When the engine will not start P.362
 Warning messages P.338
- B Shift lever** **P.137**
 Changing the shift position P.137
 Precautions for towing P.323
 When the shift lever does not move P.139
- C Meters** **P.72, 75**
 Reading the meters/adjusting the instrument panel light . P.72, 75
 Warning lights/indicator lights P.68
 When a warning light turns on P.328
- D Multi-information display** **P.77, 83**
 Display P.77, 83
 When a warning message is displayed P.338

E	Turn signal lever	P.142
	Headlight switch	P.148
	Headlights/parking lights/tail lights/side marker lights/ daytime running lights	P.148
	Fog lights *1	P.153
F	Windshield wiper and washer switch	P.154
	Rear window wiper and washer switch	P.155
	Usage.....	P.154, 155
	Adding washer fluid.....	P.287
G	Emergency flasher switch	P.320
H	Hood lock release lever	P.279
I	Tilt and telescopic steering lock release lever	P.113
J	Air conditioning system	P.240
	Usage.....	P.240
	Rear window defogger	P.243
K	Audio system *2	

*1: If equipped

*2: Refer to "MULTIMEDIA OWNER'S MANUAL".

■ Switches

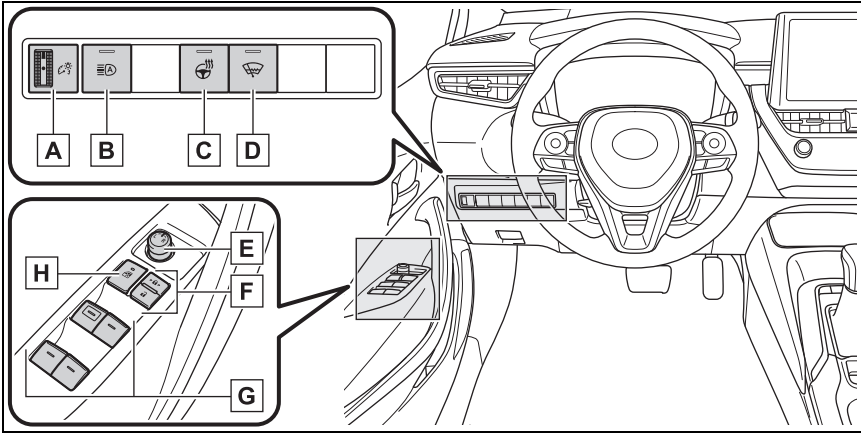

- A** Instrument panel light control dial P.74, 77
- B** Automatic High Beam switch P.150
- C** Heated steering wheel switch * P.248
- D** Windshield wiper de-icer switch * P.245
- E** Outside rear view mirror switch P.115
- F** Door lock switches P.98
- G** Power window switches P.117
- H** Window lock switch P.119

*: If equipped

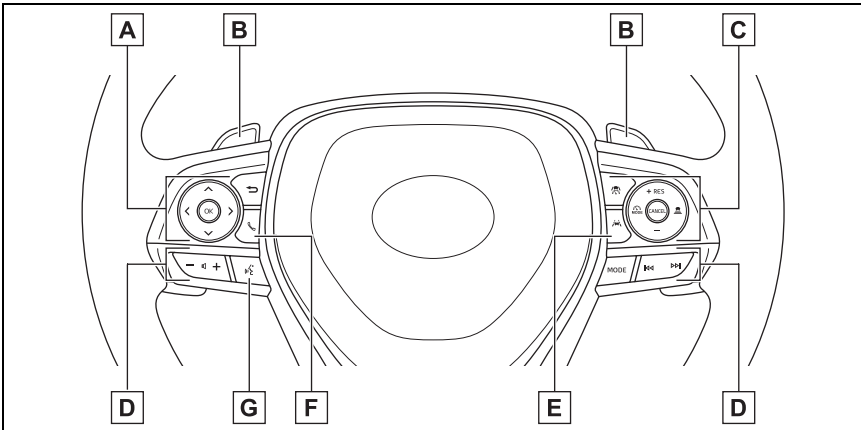

- A Meter control switches P.78, 83**
- B Paddle shift switches ^{*1} P.139**
- C Cruise control switches**
 - Dynamic radar cruise control P.195
 - Cruise control P.206
- D Audio remote control switches ^{*2}**
- E LTA (Lane Tracing Assist) switch P.177**
- F Phone switch ^{*2}**
- G Talk switch ^{*2}**

^{*1}: If equipped

^{*2}: Refer to “MULTIMEDIA OWNER’S MANUAL”.

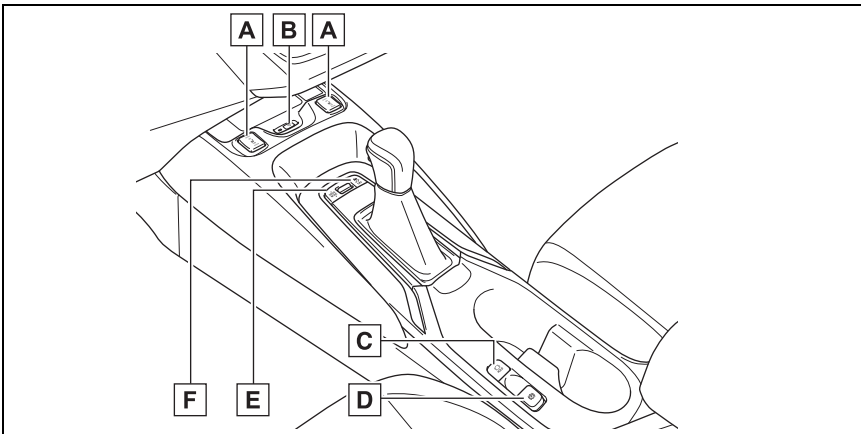

- A Seat heater switches ^{*} P.248**
- B Wireless charger switch ^{*} P.257**
- C Brake hold switch P.146**
- D Parking brake switch P.143**
 - Applying/releasing P.143
 - Precautions against winter season P.236
 - Warning buzzer/message P.328, 338
- E Drive mode select switch P.229**

F VSC OFF switch **P.231**

*: If equipped

■ Interior

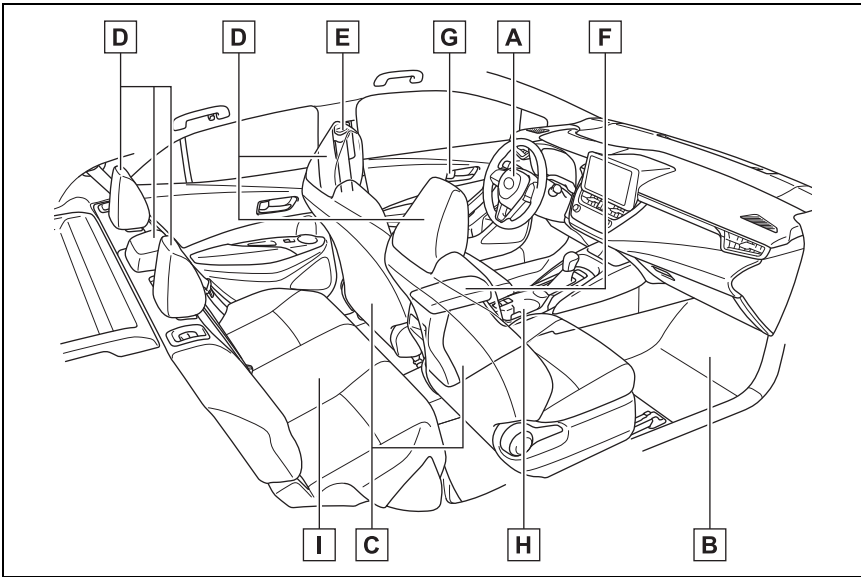

A	SRS airbags	P.31
B	Floor mats	P.24
C	Front seats	P.107
D	Head restraints	P.110
E	Seat belts	P.27
F	Console box	P.253
G	Inside lock buttons	P.98
H	Cup holders	P.252
I	Rear seats	P.108

■ Ceiling

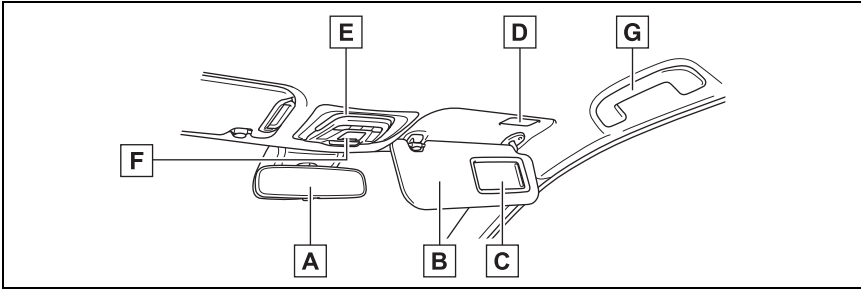

- | | | |
|----------|--|--------------|
| A | Inside rear view mirror | P.114 |
| B | Sun visors..... | P.263 |
| C | Vanity mirrors..... | P.263 |
| D | Vanity lights..... | P.263 |
| E | Interior lights/personal lights | P.249 |
| F | “SOS” button..... | P.60 |
| G | Assist grips | P.264 |

For safety and security

1

1-1. For safe use

Before driving	24
For safe driving	25
Seat belts	27
SRS airbags	31
Front passenger occupant classification system	40
Exhaust gas precautions	45

1-2. Child safety

Riding with children	46
Child restraint systems...	47

1-3. Emergency assistance

Safety Connect	60
----------------------	----

1-4. Theft deterrent system

Engine immobilizer system	64
Alarm.....	65
Theft prevention labels (U.S.A.)	66

Before driving

Observe the following before starting off in the vehicle to ensure safety of driving.

Floor mat

Use only floor mats designed specifically for vehicles of the same model and model year as your vehicle. Fix them securely in place onto the carpet.

- 1 Insert the retaining hooks (clips) into the floor mat eyelets.

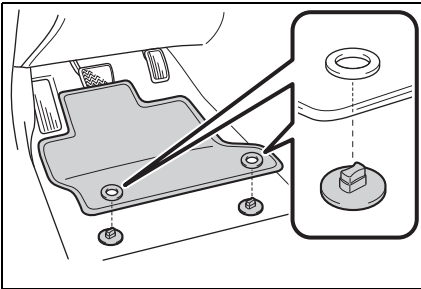

- 2 Turn the upper knob of each retaining hook (clip) to secure the floor mats in place.

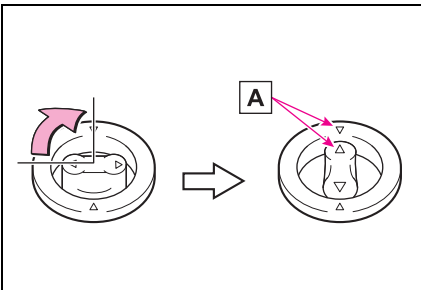

Always align the \triangle marks **A**.

The shape of the retaining hooks (clips) may differ from that shown in the illustration.

WARNING

Observe the following precautions. Failure to do so may cause the driver's floor mat to slip, possibly interfering with the pedals while driving. An unexpectedly high speed may result or it may become difficult to stop the vehicle. This could lead to an accident, resulting in death or serious injury.

■ When installing the driver's floor mat

- Do not use floor mats designed for other models or different model year vehicles, even if they are Toyota Genuine floor mats.
- Only use floor mats designed for the driver's seat.
- Always install the floor mat securely using the retaining hooks (clips) provided.
- Do not use two or more floor mats on top of each other.
- Do not place the floor mat bottom-side up or upside-down.

WARNING

■ Before driving

- Check that the floor mat is securely fixed in the correct place with all the provided retaining hooks (clips). Be especially careful to perform this check after cleaning the floor.

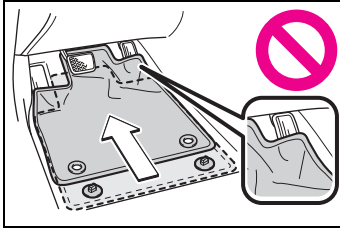

- With the engine stopped and the shift lever in P, fully depress each pedal to the floor to make sure it does not interfere with the floor mat.

For safe driving

For safe driving, adjust the seat and mirror to an appropriate position before driving.

Correct driving posture

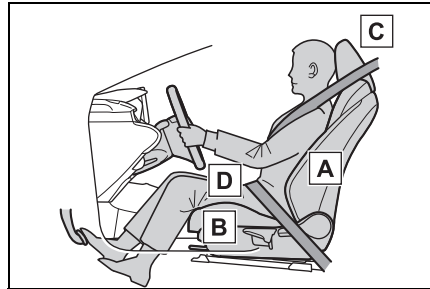

- A** Adjust the angle of the seat-back so that you are sitting straight up and so that you do not have to lean forward to steer. (→P.107)
- B** Adjust the seat so that you can depress the pedals fully and so that your arms bend slightly at the elbow when gripping the steering wheel. (→P.107)
- C** Lock the head restraint in place with the center of the head restraint closest to the top of your ears. (→P.107)
- D** Wear the seat belt correctly. (→P.27)

**WARNING****■ For safe driving**

Observe the following precautions.

Failure to do so may result in death or serious injury.

- Do not adjust the position of the driver's seat while driving. Doing so could cause the driver to lose control of the vehicle.
- Do not place a cushion between the driver or passenger and the seatback. A cushion may prevent correct posture from being achieved, and reduce the effectiveness of the seat belt and head restraint.
- Do not place anything under the front seats. Objects placed under the front seats may become jammed in the seat tracks and stop the seat from locking in place. This may lead to an accident and the adjustment mechanism may also be damaged.
- Always observe the legal speed limit when driving on public roads.
- When driving over long distances, take regular breaks before you start to feel tired. Also, if you feel tired or sleepy while driving, do not force yourself to continue driving and take a break immediately.

child becomes large enough to properly wear the vehicle's seat belt. (→P.47)

Adjusting the mirrors

Make sure that you can see backward clearly by adjusting the inside and outside rear view mirrors properly. (→P.114, 115)

Correct use of the seat belts

Make sure that all occupants are wearing their seat belts before driving the vehicle. (→P.27)

Use a child restraint system appropriate for the child until the

Seat belts

Make sure that all occupants are wearing their seat belts before driving the vehicle.

WARNING

Observe the following precautions to reduce the risk of injury in the event of sudden braking, sudden swerving or an accident. Failure to do so may cause death or serious injury.

■ Wearing a seat belt

- Ensure that all passengers wear a seat belt.
- Always wear a seat belt properly.
- Each seat belt should be used by one person only. Do not use a seat belt for more than one person at once, including children.
- Toyota recommends that children be seated in the rear seat and always use a seat belt and/or an appropriate child restraint system.
- To achieve a proper seating position, do not recline the seat more than necessary. The seat belt is most effective when the occupants are sitting up straight and well back in the seats.
- Do not wear the shoulder belt under your arm.
- Always wear your seat belt low and snug across your hips.

■ Pregnant women

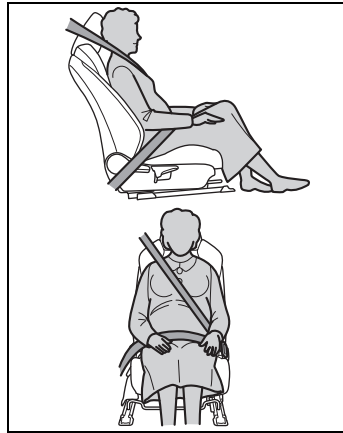

Obtain medical advice and wear the seat belt in the proper way. (→P.28)

Women who are pregnant should position the lap belt as low as possible over the hips in the same manner as other occupants, extending the shoulder belt completely over the shoulder and avoiding belt contact with the rounding of the abdominal area.

If the seat belt is not worn properly, not only the pregnant woman, but also the fetus could suffer death or serious injury as a result of sudden braking or a collision.

■ People suffering illness

Obtain medical advice and wear the seat belt in the proper way. (→P.28)

■ When children are in the vehicle

→P.55

■ Seat belt damage and wear

- Do not damage the seat belts by allowing the belt, plate, or buckle to be jammed in the door.

WARNING

- Inspect the seat belt system periodically. Check for cuts, fraying, and loose parts. Do not use a damaged seat belt until it is replaced. Damaged seat belts cannot protect an occupant from death or serious injury.
- Ensure that the belt and plate are locked and the belt is not twisted.
If the seat belt does not function correctly, immediately contact your Toyota dealer.
- Replace the seat assembly, including the belts, if your vehicle has been involved in a serious accident, even if there is no obvious damage.
- Do not attempt to install, remove, modify, disassemble or dispose of the seat belts. Have any necessary repairs carried out by your Toyota dealer. Inappropriate handling may lead to incorrect operation.

Correct use of the seat belts

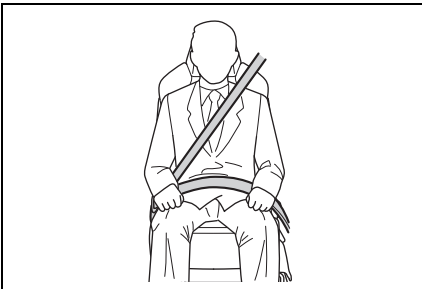

- Extend the shoulder belt so that it comes fully over the shoulder, but does not come into contact with the neck or slide off the shoulder.

- Position the lap belt as low as possible over the hips.
- Adjust the position of the seatback. Sit up straight and well back in the seat.
- Do not twist the seat belt.

■ Child seat belt usage

The seat belts of your vehicle were principally designed for persons of adult size.

- Use a child restraint system appropriate for the child, until the child becomes large enough to properly wear the vehicle's seat belt. (→P.47)
- When the child becomes large enough to properly wear the vehicle's seat belt, follow the instructions regarding seat belt usage. (→P.27)

■ Seat belt extender

If your seat belts cannot be fastened securely because they are not long enough, a personalized seat belt extender is available from your Toyota dealer free of charge.

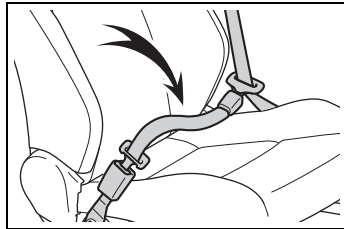

WARNING

■ Using a seat belt extender

- Do not wear the seat belt extender if you can fasten the seat belt without the extender.

WARNING

- Do not use the seat belt extender when installing a child restraint system because the belt will not securely hold the child restraint system, increasing the risk of death or serious injury in the event of an accident.
- The personalized extender may not be safe on another vehicle, when used by another person, or at a different seating position other than the one originally intended.

NOTICE

■ When using a seat belt extender

When releasing the seat belt, press on the buckle release button on the extender, not on the seat belt.

This helps prevent damage to the vehicle interior and the extender itself.

Fastening and releasing the seat belt

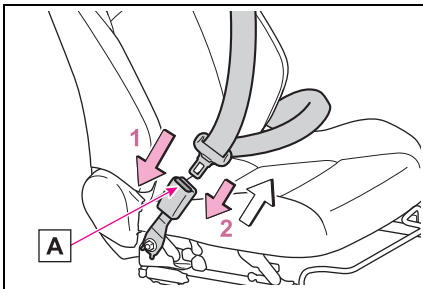

- 1 To fasten the seat belt, push the plate into the buckle until a click sound is heard.
- 2 To release the seat belt, press the release button **A**.

■ Emergency locking retractor (ELR)

The retractor will lock the belt during a sudden stop or on impact. It may also lock if you lean forward too quickly. A slow, easy motion will allow the belt to extend so that you can move around fully.

■ Automatic locking retractor (ALR)

When a passenger's shoulder belt is completely extended and then retracted even slightly, the belt is locked in that position and cannot be extended. This feature is used to hold the child restraint system (CRS) firmly. To free the belt again, fully retract the belt and then pull the belt out once more. (→P.47)

Adjusting the seat belt shoulder anchor height (front seats)

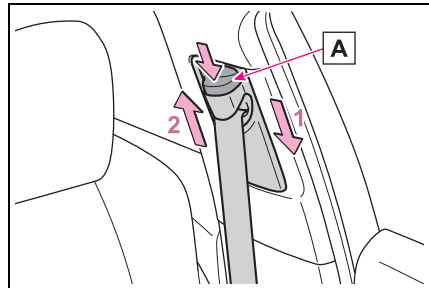

- 1 Push the seat belt shoulder anchor down while pressing the release button **A**.
- 2 Push the seat belt shoulder anchor up while pressing the release button **A**.

Move the height adjuster up and down as needed until you hear a click.

**WARNING**

■ **Adjustable shoulder anchor**

Always make sure the shoulder belt is positioned across the center of your shoulder. The belt should be kept away from your neck, but not falling off your shoulder. Failure to do so could reduce the amount of protection in an accident and cause death or serious injuries in the event of a sudden stop, sudden swerve or accident.

**Seat belt pretensioners
(front and outboard rear seats)**

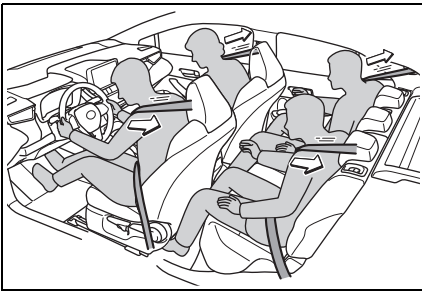

The pretensioners help the seat belts to quickly restrain the occupants by retracting the seat belts when the vehicle is subjected to certain types of severe frontal or side collision or a vehicle rollover.

The pretensioners do not activate in the event of a minor frontal impact, a minor side impact or a rear impact.

■ **Replacing the belt after the pretensioner has been activated**

If the vehicle is involved in multiple collisions, the pretensioner will acti-

vate for the first collision, but will not activate for the second or subsequent collisions.

■ **PCS-linked seat belt pretensioner control**

If the PCS (Pre-Collision System) determines that the possibility of a collision with a vehicle is high, the seat belt pretensioners will be prepared to operate.

**WARNING**

■ **Seat belt pretensioners**

Observe the following precautions to reduce the risk of injury in the event of sudden braking sudden swerving or an accident.

. Failure to do so may result in death or serious injury.

- Do not place anything, such as a cushion, on the front passenger's seat. Doing so will disperse the passenger's weight, which prevents the sensor from detecting the passenger's weight properly. As a result, the seat belt pretensioner for the front passenger's seat may not activate in the event of a collision.
- If a pretensioner has operated, the SRS warning light will illuminate. In this situation, the seat belt cannot be used and must be replaced by your Toyota dealer.

SRS airbags

The SRS airbags inflate when the vehicle is subjected to certain types of severe impacts that may cause significant injury to the occupants. They work together with the seat belts to help reduce the risk of death or serious injury.

SRS airbag system

■ Location of the SRS airbags

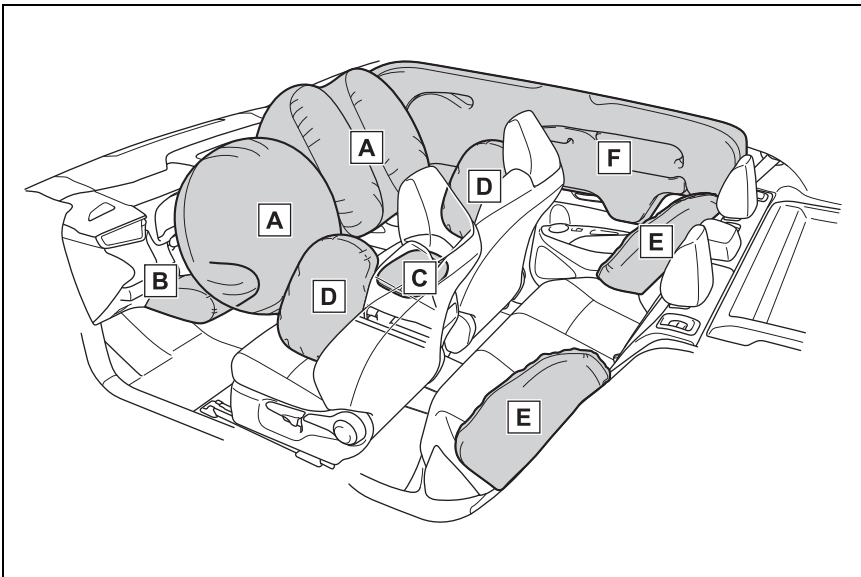

► SRS front airbags

A SRS driver airbag/front passenger airbag

Can help protect the head and chest of the driver and front passenger from impact with interior components

B SRS knee airbag

Can help provide driver protection

C SRS seat cushion airbag

Can help restrain the front passenger

► SRS side and curtain shield airbags

D SRS front side airbags

Can help protect the torso of the front seat occupants

E SRS rear side airbags

Can help protect the torso of occupants in the rear outer seats

F SRS curtain shield airbags

- Can help protect primarily the head of occupants in the outer seats
- Can help prevent the occupants from being thrown from the vehicle in the event of vehicle rollover

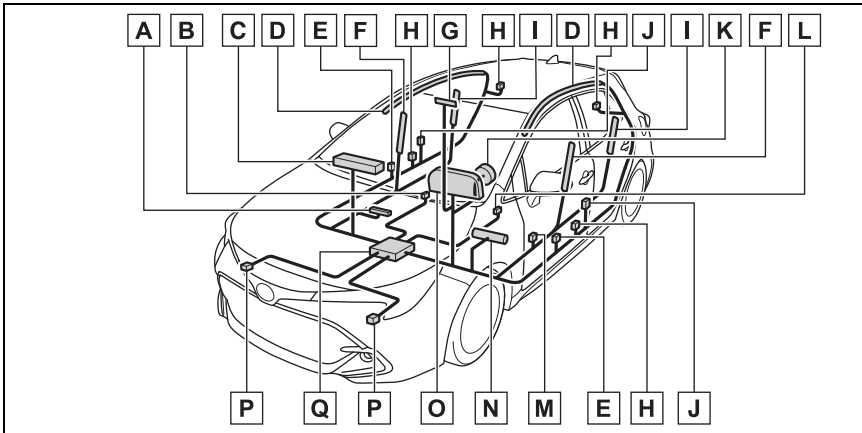
■ SRS airbag system components**A** Seat cushion airbag**B** Front passenger's seat belt buckle switch**C** Front passenger airbag**D** Curtain shield airbags**E** Side impact sensors (front doors)**F** Front side airbags**G** "AIR BAG ON" and "AIR BAG OFF" indicator lights**H** Seat belt pretensioners and force limiters**I** Rear side airbags**J** Side impact sensors (front)**K** Driver airbag**L** Driver's seat belt buckle switch**M** Driver's seat position sensor**N** Driver's knee airbag**O** SRS warning light

P Front impact sensors**Q** Airbag sensor assembly

Your vehicle is equipped with ADVANCED AIRBAGS designed based on the US motor vehicle safety standards (FMVSS208). The airbag sensor assembly (ECU) controls airbag deployment based on information obtained from the sensors etc. shown in the system components diagram above. This information includes crash severity and occupant information. As the airbags deploy, a chemical reaction in the inflators quickly fills the airbags with non-toxic gas to help restrain the motion of the occupants.

■ If the SRS airbags deploy (inflate)

- Slight abrasions, burns, bruising etc., may be sustained from SRS airbags, due to the extremely high speed deployment (inflation) by hot gases.
- A loud noise and white powder will be emitted.
- Parts of the airbag module (steering wheel hub, airbag cover and inflator) as well as the front seats, parts of the front and rear pillars, and roof side rails, may be hot for several minutes. The airbag itself may also be hot.
- The windshield may crack.
- The brakes and stop lights will be controlled automatically. (→P.231)
- The interior lights will turn on automatically. (→P.249)
- The emergency flashers will turn on automatically. (→P.320)
- Fuel supply to the engine will be stopped. (→P.327)
- For Safety Connect subscribers, if any of the following situations occur, the system is designed to send an emergency call to the response center, notifying them of the vehicle's location (without needing to push the "SOS" button) and an agent will attempt to speak with the occupants to ascertain

the level of emergency and assistance required. If the occupants are unable to communicate, the agent automatically treats the call as an emergency and helps to dispatch the necessary emergency services. (→P.60)

- An SRS airbag is deployed.
- A seat belt pretensioner is activated.
- The vehicle is involved in a severe rear-end collision.

■ SRS airbag deployment conditions (SRS front airbags)

- The SRS front airbags will deploy in the event of an impact that exceeds the set threshold level (the level of force corresponding to an approximately 12 - 18 mph [20 - 30 km/h] frontal collision with a fixed wall that does not move or deform).

However, this threshold velocity will be considerably higher in the following situations:

- If the vehicle strikes an object, such as a parked vehicle or sign pole, which can move or deform on impact
- If the vehicle is involved in an underride collision, such as a collision in which the front of the vehicle "underrides", or goes under, the bed of a truck
- Depending on the type of collision, it is possible that only the seat belt pretensioners will activate.

- The SRS front airbags for the front passenger will not activate if there is no passenger sitting in the front passenger seat. However, the SRS front airbags for the front passenger may deploy if luggage is put in the seat, even if the seat is unoccupied.

- The SRS seat cushion airbag on the front passenger seat will not operate if the occupant is not wearing a seat belt.

■ **SRS airbag deployment conditions (SRS side and curtain shield airbags)**

- The SRS side and curtain shield airbags will deploy in the event of an impact that exceeds the set threshold level (the level of force corresponding to the impact force produced by an approximately 3300 lb. [1500 kg] vehicle colliding with the vehicle cabin from a direction perpendicular to the vehicle orientation at an approximate speed of 12 - 18 mph [20 - 30 km/h]).

- Both SRS curtain shield airbags will deploy in the event of a side collision on either side.

- Both SRS curtain shield airbags will deploy in the event of vehicle rollover.

- Both SRS curtain shield airbags will deploy in the event of a severe frontal collision.

■ **Conditions under which the SRS airbags may deploy (inflate), other than a collision**

The SRS front airbags and SRS side and curtain shield airbags may also deploy if a serious impact occurs to the underside of your vehicle. Some examples are shown in the illustration.

- Hitting a curb, edge of pavement or hard surface
- Falling into or jumping over a deep hole

● Landing hard or falling

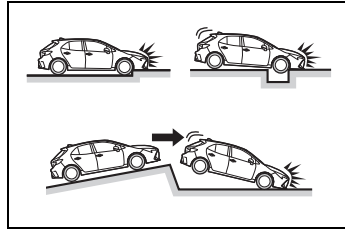

The SRS curtain shield airbags may also deploy under the situations shown in the illustration.

- The angle of vehicle tip-up is marginal.

- The vehicle skids and hits a curb stone.

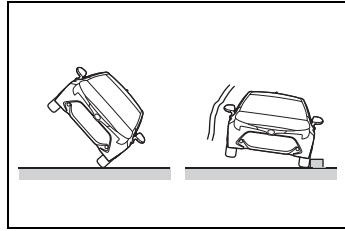

■ **Types of collisions that may not deploy the SRS airbags (SRS front airbags)**

The SRS front airbags do not generally inflate if the vehicle is involved in a side or rear collision, if it rolls over, or if it is involved in a low-speed frontal collision. But, whenever a collision of any type causes sufficient forward deceleration of the vehicle, deployment of the SRS front airbags may occur.

- Collision from the side
- Collision from the rear
- Vehicle rollover

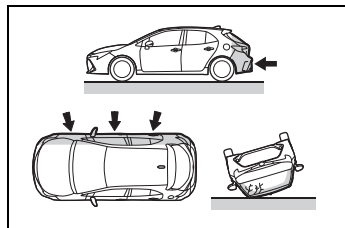

■ Types of collisions that may not deploy the SRS airbags (SRS side and curtain shield airbags)

The SRS side and curtain shield airbags may not activate if the vehicle is subjected to a collision from the side at certain angles, or a collision to the side of the vehicle body other than the passenger compartment.

- Collision from the side to the vehicle body other than the passenger compartment
- Collision from the side at an angle

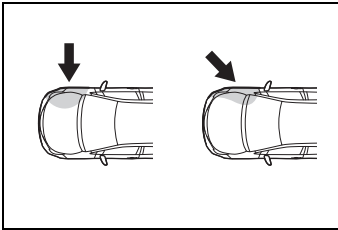

The SRS curtain shield airbags do not generally inflate if the vehicle is involved in a rear collision, if it pitches end over end, or if it is involved in a low-speed side or low-speed frontal collision.

- Collision from the rear
- Pitching end over end

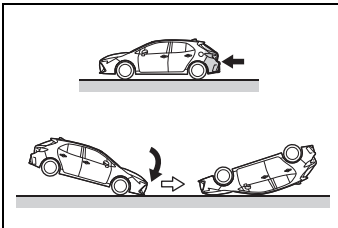

■ When to contact your Toyota dealer

In the following cases, the vehicle will require inspection and/or repair. Contact your Toyota dealer as soon as possible.

- Any of the SRS airbags have been inflated.
- The front of the vehicle is damaged or deformed, or was involved in an accident that was

not severe enough to cause the SRS front airbags to inflate.

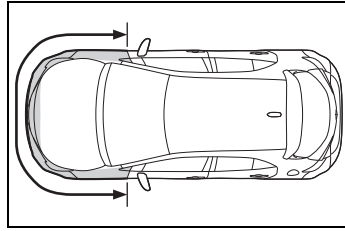

- A portion of a door or its surrounding area is damaged, deformed or has had a hole made in it, or the vehicle was involved in an accident that was not severe enough to cause the SRS side and curtain shield airbags to inflate.

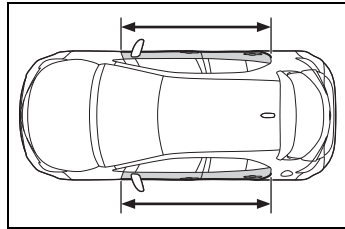

- The pad section of the steering wheel, dashboard near the front passenger airbag or lower portion of the instrument panel is scratched, cracked, or otherwise damaged.

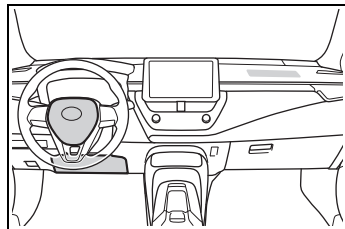

- The seat cushion surface is scratched, cracked, or otherwise damaged.

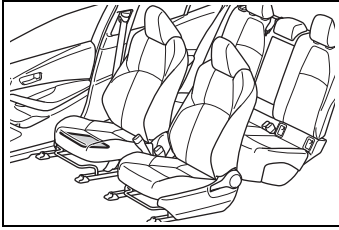

- The surface of the seats with the SRS side airbag is scratched, cracked, or otherwise damaged.

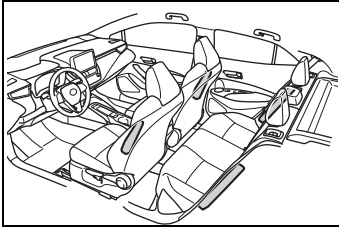

- The portion of the front pillars, rear pillars or roof side rail garnishes (padding) containing the SRS curtain shield airbags inside is scratched, cracked, or otherwise damaged.

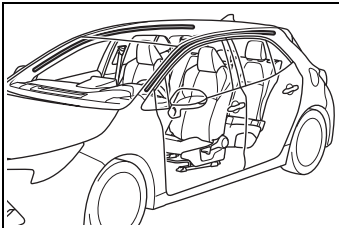

WARNING

■ SRS airbag precautions

Observe the following precautions regarding the SRS airbags. Failure to do so may cause death or serious injury.

- The driver and all passengers in the vehicle must wear their seat belts properly. The SRS airbags are supplemental devices to be used with the seat belts.

- The SRS driver airbag deploys with considerable force, and can cause death or serious injury especially if the driver is very close to the airbag. The National Highway Traffic Safety Administration (NHTSA) advises:

Since the risk zone for the driver's airbag is the first 2 - 3 in. (50 - 75 mm) of inflation, placing yourself 10 in. (250 mm) from your driver airbag provides you with a clear margin of safety. This distance is measured from the center of the steering wheel to your breastbone. If you sit less than 10 in. (250 mm) away now, you can change your driving position in several ways:

- Move your seat to the rear as far as you can while still reaching the pedals comfortably.

- Slightly recline the back of the seat.

Although vehicle designs vary, many drivers can achieve the 10 in. (250 mm) distance, even with the driver seat all the way forward, simply by reclining the back of the seat somewhat. If reclining the back of your seat makes it hard to see the road, raise yourself by using a firm, non-slippery cushion, or raise the seat if your vehicle has that feature.

- If your steering wheel is adjustable, tilt it downward. This points the airbag toward your chest instead of your head and neck.

The seat should be adjusted as recommended by NHTSA above, while still maintaining control of the foot pedals, steering wheel, and your view of the instrument panel controls.

WARNING

- If the seat belt extender has been connected to the front seat belt buckles but the seat belt extender has not also been fastened to the latch plate of the seat belt, the SRS front airbags will judge that the driver and front passenger are wearing the seat belt even though the seat belt has not been connected. In this case, the SRS front airbags may not activate correctly in a collision, resulting in death or serious injury in the event of a collision. Be sure to wear the seat belt with the seat belt extender.

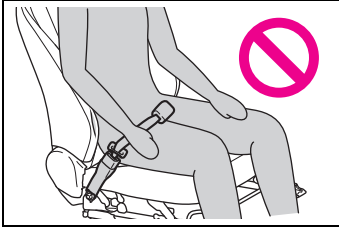

- The SRS front passenger airbag also deploys with considerable force, and can cause death or serious injury especially if the front passenger is very close to the airbag. The front passenger seat should be as far from the airbag as possible with the seat-back adjusted, so the front passenger sits upright.

- Improperly seated and/or restrained infants and children can be killed or seriously injured by a deploying airbag. An infant or child who is too small to use a seat belt should be properly secured using a child restraint system. Toyota strongly recommends that all infants and children be placed in the rear seats of the vehicle and properly restrained. The rear seats are safer for infants and children than the front passenger seat. (→P.47)

- Do not sit on the edge of the seat or lean against the dashboard.

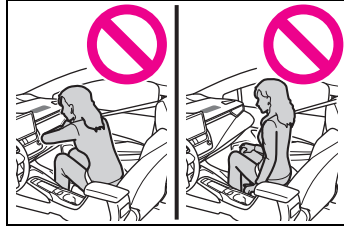

- Do not allow a child to stand in front of the SRS front passenger airbag unit or sit on the knees of a front passenger.

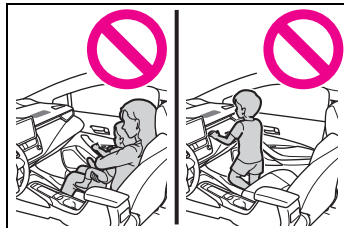

- Do not allow the front seat occupants to hold items on their knees.

WARNING

- Do not lean against the door, the roof side rail or the front, side and rear pillars.



- Do not allow anyone to kneel on the passenger seats toward the door or put their head or hands outside the vehicle.

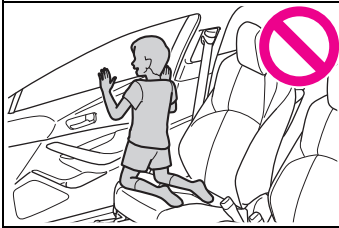

- Do not attach anything to or lean anything against areas such as the dashboard, steering wheel pad and lower portion of the instrument panel. These items can become projectiles when the SRS driver, front passenger and knee airbags deploy.

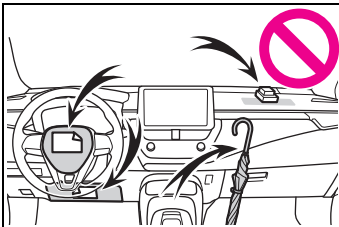

- Do not attach anything to areas such as a door, windshield, side windows, front or rear pillar, roof side rail and assist grip. (Except for the speed limit label →P.346)

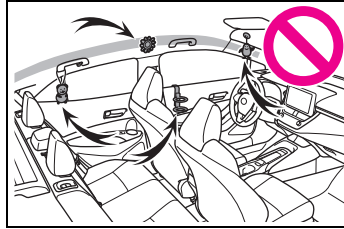

- Do not hang coat hangers or other hard objects on the coat hooks. All of these items could become projectiles and may cause death or serious injury, should the SRS curtain shield airbags deploy.
- If a vinyl cover is put on the area where the SRS driver's knee airbag will deploy, be sure to remove it.
- Do not use seat accessories which cover the parts where the SRS side airbags and SRS seat cushion airbag inflate as they may interfere with inflation of the SRS airbags. Such accessories may prevent the side airbags and seat cushion airbag from activating correctly, disable the system or cause the side airbags and seat cushion airbag to inflate accidentally, resulting in death or serious injury.
- Do not strike or apply significant levels of force to the area of the SRS airbag components or the front doors. Doing so can cause the SRS airbags to malfunction.
- Do not touch any of the component parts immediately after the SRS airbags have deployed (inflated) as they may be hot.

**WARNING**

- If breathing becomes difficult after the SRS airbags have deployed, open a door or window to allow fresh air in, or leave the vehicle if it is safe to do so. Wash off any residue as soon as possible to prevent skin irritation.
- If the areas where the SRS airbags are stored, such as the steering wheel pad and front and rear pillar garnishes, are damaged or cracked, have them replaced by your Toyota dealer.
- Do not place anything, such as a cushion, on the front passenger's seat. Doing so will disperse the passenger's weight, which prevents the sensor from detecting the passenger's weight properly. As a result, the SRS front airbags for the front passenger may not deploy in the event of a collision.

■ **Modification and disposal of SRS airbag system components**

Do not dispose of your vehicle or perform any of the following modifications without consulting your Toyota dealer. The SRS airbags may malfunction or deploy (inflate) accidentally, causing death or serious injury.

- Installation, removal, disassembly and repair of the SRS airbags
- Repairs, modifications, removal or replacement of the steering wheel, instrument panel, dashboard, seats or seat upholstery, front, side and rear pillars, roof side rails, front door panels, front door trims or front door speakers

- Modifications to the front door panel (such as making a hole in it)
- Repairs or modifications of the front fender, front bumper, or side of the occupant compartment
- Installation of a grille guard (bull bars, kangaroo bar, etc.), snow plows, winches or roof luggage carrier
- Modifications to the vehicle's suspension system
- Installation of electronic devices such as mobile two-way radios and CD players
- Modifications to your vehicle for a person with a physical disability

Front passenger occupant classification system

Your vehicle is equipped with a front passenger occupant classification system. This system detects the conditions of the front passenger seat and activates or deactivates the front passenger airbag and seat cushion airbag in the front passenger side.

System components

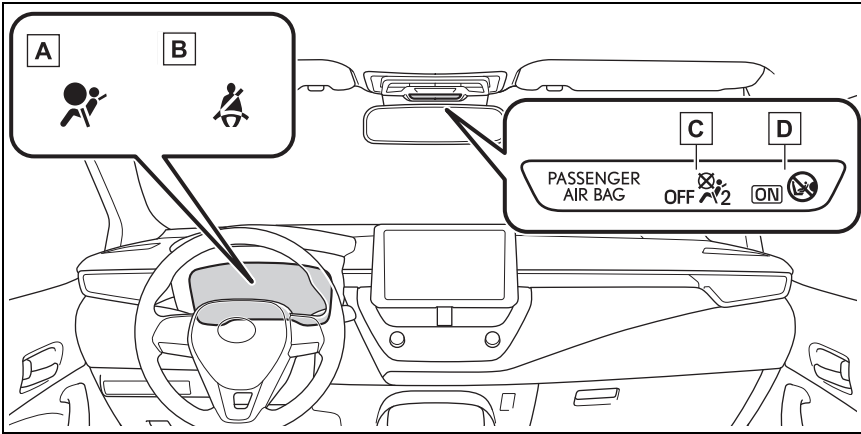

- A** SRS warning light
- B** Front passenger's seat belt reminder light
- C** "AIR BAG OFF" indicator light
- D** "AIR BAG ON" indicator light

⚠ WARNING

■ Front passenger occupant classification system precautions

Observe the following precautions regarding the front passenger occupant classification system. Failure to do so may cause death or serious injury.

- Wear the seat belt properly.

- Make sure the front passenger's seat belt plate has not been left inserted into the buckle before someone sits in the front passenger seat.

**WARNING**

- Make sure the “AIR BAG OFF” indicator light is not illuminated when using the seat belt extender for the front passenger seat. If the “AIR BAG OFF” indicator light is illuminated, disconnect the extender tongue from the seat belt buckle, and reconnect the seat belt. Reconnect the seat belt extender after making sure the “AIR BAG ON” indicator light is illuminated. If you use the seat belt extender while the “AIR BAG OFF” indicator light is illuminated, the SRS airbags for the front passenger may not activate, which could cause death or serious injury in the event of a collision.
- Do not apply a heavy load to the front passenger seat or equipment.
- Do not put weight on the front passenger seat by putting your hands or feet on the front passenger seat seatback from the rear passenger seat.
- Do not let a rear passenger lift the front passenger seat with their feet or press on the seatback with their legs.
- Do not put objects under the front passenger seat.

- Do not recline the front passenger seatback so far that it touches a rear seat. This may cause the “AIR BAG OFF” indicator light to be illuminated, which indicates that the SRS airbags for the front passenger will not activate in the event of a severe accident. If the seatback touches the rear seat, return the seatback to a position where it does not touch the rear seat. Keep the front passenger seatback as upright as possible when the vehicle is moving. Reclining the seatback excessively may lessen the effectiveness of the seat belt system.
- If an adult sits in the front passenger seat, the “AIR BAG ON” indicator light is illuminated. If the “AIR BAG OFF” indicator is illuminated, ask the passenger to sit up straight, well back in the seat, feet on the floor, and with the seat belt worn correctly. If the “AIR BAG OFF” indicator still remains illuminated, either ask the passenger to move to the rear seat, or if that is not possible, move the front passenger seat fully rearward.
- When it is unavoidable to install a forward-facing child restraint system on the front passenger seat, install the child restraint system on the front passenger seat in the proper order. (→P.47)
- Do not modify or remove the front seats.
- Do not kick the front passenger seat or subject it to severe impact. Otherwise, the SRS warning light may come on to indicate a malfunction of the front passenger occupant classification system. In this case, contact your Toyota dealer immediately.



WARNING

- Child restraint systems installed on the rear seat should not contact the front seatbacks.
- Do not use a seat accessory, such as a cushion and seat cover, that covers the seat cushion surface.
- Do not modify or replace the upholstery of the front seat.

Front passenger occupant classification system conditions and operation

■ **Adult*1**

Indicator/warning light	“AIR BAG ON” and “AIR BAG OFF” indicator lights	“AIR BAG ON”
	SRS warning light	Off
	Front passenger’s seat belt reminder light	Off*2 or flashing*3
Devices	Front passenger airbag	Activated
	Seat cushion airbag in the front passenger side	Activated*2 or deactivated*3

■ **Child*4**

Indicator/warning light	“AIR BAG ON” and “AIR BAG OFF” indicator lights	“AIR BAG OFF” or “AIR BAG ON”*4
	SRS warning light	Off
	Front passenger’s seat belt reminder light	Off*2 or flashing*3
Devices	Front passenger airbag	Deactivated or activated*4
	Seat cushion airbag in the front passenger side	Deactivated or activated*4, 2

■ Child restraint system with infant*5

Indicator/warning light	"AIR BAG ON" and "AIR BAG OFF" indicator lights	"AIR BAG OFF"*6
	SRS warning light	Off
	Front passenger's seat belt reminder light	Off*2 or flashing*3
Devices	Front passenger airbag	Deactivated
	Seat cushion airbag in the front passenger side	

■ Unoccupied

Indicator/warning light	"AIR BAG ON" and "AIR BAG OFF" indicator lights	"AIR BAG OFF"
	SRS warning light	Off
	Front passenger's seat belt reminder light	
Devices	Front passenger airbag	Deactivated
	Seat cushion airbag in the front passenger side	

■ There is a malfunction in the system

Indicator/warning light	"AIR BAG ON" and "AIR BAG OFF" indicator lights	"AIR BAG OFF"
	SRS warning light	On
	Front passenger's seat belt reminder light	
Devices	Front passenger airbag	Deactivated
	Seat cushion airbag in the front passenger side	

*1: The system judges a person of adult size as an adult. When a smaller adult sits in the front passenger seat, the system may not recognize him/her as an adult depending on his/her physique and posture.

*2: In the event the front passenger is wearing a seat belt.

*3: In the event the front passenger does not wear a seat belt.

*4: For some children, child in seat, child in booster seat or child in convert-

ible seat, the system may not recognize him/her as a child. Factors which may affect this can be the physique or posture.

- *5: Never install a rear-facing child restraint system on the front passenger seat. A forward-facing child restraint system should only be installed on the front passenger seat when it is unavoidable. (→P.47)
- *6: In case the indicator light is not illuminated, consult this manual on how to install the child restraint system properly. (→P.47)

Exhaust gas precautions

Harmful substance to the human body is included in exhaust gases if inhaled.

WARNING

Exhaust gases include harmful carbon monoxide (CO), which is colorless and odorless. Observe the following precautions. Failure to do so may cause exhaust gases enter the vehicle and may lead to an accident caused by light-headedness, or may lead to death or a serious health hazard.

■ **Important points while driving**

- Keep the back door closed.
- If you smell exhaust gases in the vehicle even when the back door is closed, open the windows and have the vehicle inspected at your Toyota dealer as soon as possible.

■ **When parking**

- If the vehicle is in a poorly ventilated area or a closed area, such as a garage, stop the engine.
- Do not leave the vehicle with the engine on for a long time. If such a situation cannot be avoided, park the vehicle in an open space and ensure that exhaust fumes do not enter the vehicle interior.
- Do not leave the engine running in an area with snow build-up, or where it is snowing. If snowbanks build up around the vehicle while the engine is running, exhaust gases may collect and enter the vehicle.

■ **Exhaust pipe**

The exhaust system needs to be checked periodically. If there is a hole or crack caused by corrosion, damage to a joint or abnormal exhaust noise, be sure to have the vehicle inspected and repaired by your Toyota dealer.

Riding with children

Observe the following precautions when children are in the vehicle.

Use a child restraint system appropriate for the child, until the child becomes large enough to properly wear the vehicle's seat belt.

- It is recommended that children sit in the rear seats to avoid accidental contact with the shift lever, wiper switch, etc.
- Use the rear door child-protector lock or the window lock switch to avoid children opening the door while driving or operating the power window accidentally.
(→P.98, 119)
- Do not let small children operate equipment which may catch or pinch body parts, such as the power window, hood, back door, seats, etc.



WARNING

■ **When children are in the vehicle**

Never leave children unattended in the vehicle, and never allow children to have or use the key.

Children may be able to start the vehicle or shift the vehicle into neutral. There is also a danger that children may injure themselves by playing with the windows or other features of the vehicle. In addition, heat build-up or extremely cold temperatures inside the vehicle can be fatal to children.

Child restraint systems

Before installing a child restraint system in the vehicle, there are precautions that need to be observed, different types of child restraint systems, as well as installation methods, etc., written in this manual.

Use a child restraint system when riding with a small child that cannot properly use a seat belt. For the child's safety, install the child restraint system to a rear seat. Be sure to follow the installation method that is in the operation manual enclosed with the restraint system.

Table of contents

- Points to remember: P.47
- Child restraint system: P.49
- When using a child restraint system: P.49
- Child restraint system installation method
- Fixed with a seat belt: P.51
 - Fixed with a child restraint LATCH anchor: P.56
 - Using an anchor bracket (for top tether strap): P.57

Points to remember

The laws of all 50 states of the U.S.A. as well as Canada now require the use of child restraint systems.

- Prioritize and observe the warnings, as well as the laws and regulations for child restraint systems.
- Use a child restraint system until the child becomes large enough to properly wear the vehicle's seat belt.
- Choose a child restraint system that suits your vehicle and is appropriate to the age and size of the child.



WARNING

■ When a child is riding

Observe the following precautions.

Failure to do so may result in death or serious injury.

- For effective protection in automobile accidents and sudden stops, a child must be properly restrained, using a seat belt or child restraint system which is correctly installed. For installation details, refer to the operation manual enclosed with the child restraint system. General installation instruction is provided in this manual.

**WARNING**

- Toyota strongly urges the use of a proper child restraint system that conforms to the weight and size of the child, installed on the rear seat. According to accident statistics, the child is safer when properly restrained in the rear seat than in the front seat.
- Holding a child in your or someone else's arms is not a substitute for a child restraint system. In an accident, the child can be crushed against the windshield or between the holder and the interior of the vehicle.

■ Handling the child restraint system

If the child restraint system is not properly fixed in place, the child or other passengers may be seriously injured or even killed in the event of sudden braking, sudden swerving, or an accident.

- If the vehicle were to receive a strong impact from an accident, etc., it is possible that the child restraint system has damage that is not readily visible. In such cases, do not reuse the restraint system.
- Make sure you have complied with all installation instructions provided with the child restraint system manufacturer and that the system is properly secured.
- Keep the child restraint system properly secured on the seat even if it is not in use. Do not store the child restraint system unsecured in the passenger compartment.
- If it is necessary to detach the child restraint system, remove it from the vehicle or store it securely in the luggage compartment.

Child restraint system

■ Types of child restraint system installation methods

Confirm with the operation manual enclosed with the child restraint system about the installation of the child restraint system.

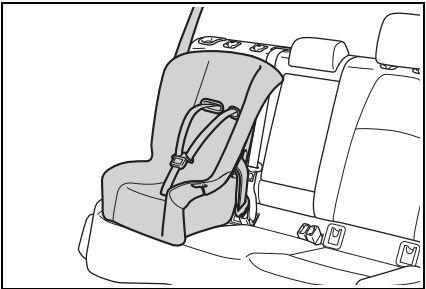
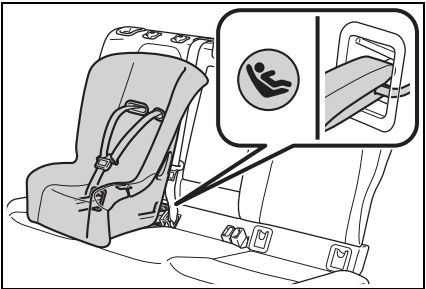
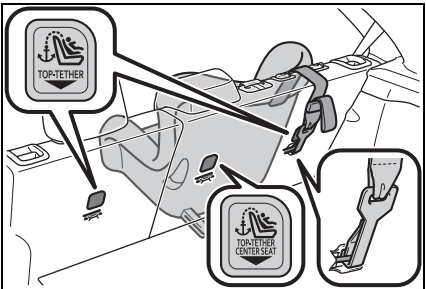
Installation method	Page
<p>Seat belt attachment</p>	 <p>P.51</p>
<p>Child restraint LATCH anchors attachment</p>	 <p>P.56</p>
<p>Anchor brackets (for top tether strap) attachment</p>	 <p>P.57</p>

When using a child restraint system

- When installing a child restraint system to a front passenger seat

For the safety of a child, install child restraint systems to a rear seats. When installing child restraint system to a front passenger seat is unavoidable, adjust the seat as follows and

install the child restraint system:

- Move the front seat fully rearward.
- Adjust the seat height to the upper most position.
- Adjust the seatback angle to the most upright position.
- If the head restraint interferes with the child restraint system installation and the head restraint can be removed, remove the head restraint.

Otherwise, put the head restraint in the upper most position.

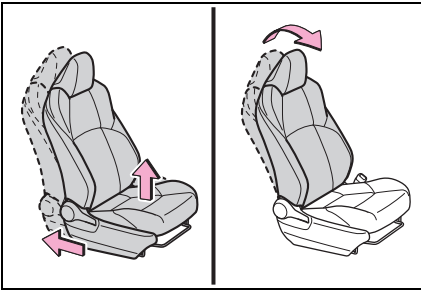

WARNING

■ When using a child restraint system

Observe the following precautions.

Failure to do so may result in death or serious injury.

- Never install a rear-facing child restraint system on the front passenger seat even if the “AIR BAG OFF” indicator light is illuminated. In the event of an accident, the force of the rapid inflation of the front passenger airbag can cause death or serious injury to the child if the rear-facing child restraint system is installed on the front passenger seat.

- A forward-facing child restraint system may be installed on the front passenger seat only when it is unavoidable. A child restraint system that requires a top tether strap should not be used in the front passenger seat since there is no top tether strap anchor for the front passenger seat.

- A forward-facing child restraint system may be installed on the front passenger seat only when it is unavoidable. When installing a forward-facing child restraint system on the front passenger seat, adjust the seatback angle to the most upright position, move the seat to the rearmost position, and raise the seat to the upper most position, even if the “AIR BAG OFF” indicator light is illuminated.

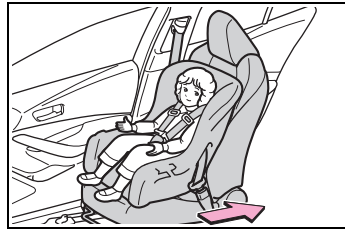

WARNING

- Do not allow the child to lean his/her head or any part of his/her body against the door or the area of the seat, front or rear pillars, or roof side rails from which the SRS side airbags or SRS curtain shield airbags deploy even if the child is seated in the child restraint system. It is dangerous if the SRS side and curtain shield airbags inflate, and the impact could cause death or serious injury to the child.

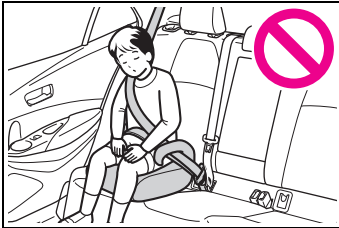

- When a booster seat is installed, always ensure that the shoulder belt is positioned across the center of the child's shoulder. The belt should be kept away from the child's neck, but not so that it could fall off the child's shoulder.
- Use child restraint system suitable to the age and size of the child and install it to the rear seat.

- If the driver's seat interferes with the child restraint system and prevents it from being attached correctly, attach the child restraint system to the right-hand rear seat.

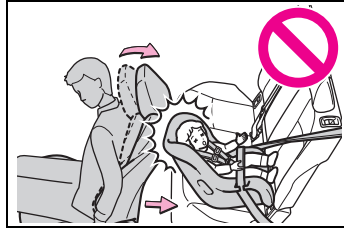

- Adjust the front passenger seat so that it does not interfere with the child restraint system.

Child restraint system fixed with a seat belt

A child restraint system for a small child or baby must itself be properly restrained on the seat with the lap portion of the lap/shoulder belt.

■ Installing child restraint system using a seat belt (child restraint lock function belt)

Install the child restraint system in accordance to the operation manual enclosed with the child restraint system.

■ Rear-facing — Infant seat/convertible seat

- 1 Place the child restraint system on the rear seat facing the rear of the vehicle.

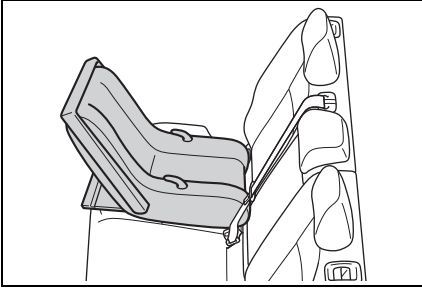

- 2 Run the seat belt through the child restraint system and insert the plate into the buckle. Make sure that the belt is not twisted.

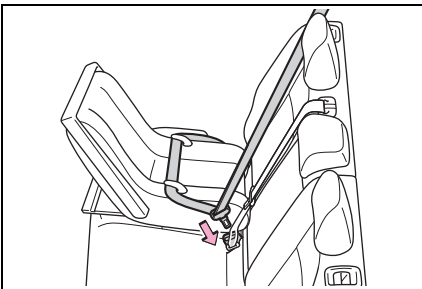

- 3 Fully extend the shoulder belt and allow it to retract to put it in lock mode. In lock mode, the belt cannot be extended.

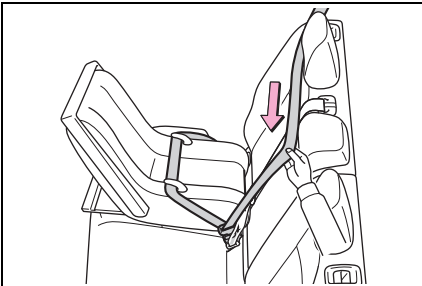

- 4 While pushing the child restraint system down into the rear seat, allow the shoulder belt to retract until the child restraint system is securely in place.

After the shoulder belt has retracted to a point where there is no slack in the belt, pull the belt to check that it cannot be extended.

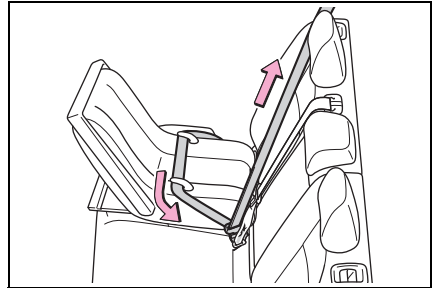

- 5 After installing the child restraint system, rock it back and forth to ensure that it is installed securely. (→P.55)

■ Forward-facing — Convertible seat

- 1 If installing the child restraint system to the front passenger seat is unavoidable, refer to P.49 for front passenger seat adjustment.
- 2 If the head restraint interferes with your child restraint system, and the head restraint

can be removed, remove the head restraint. (→P.110)

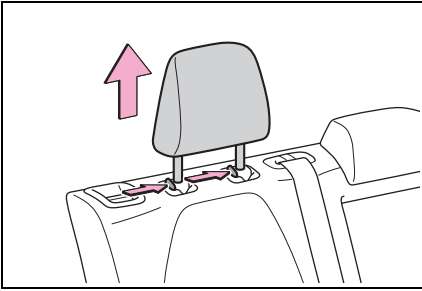

- 3 Place the child restraint system on the seat facing the front of the vehicle.

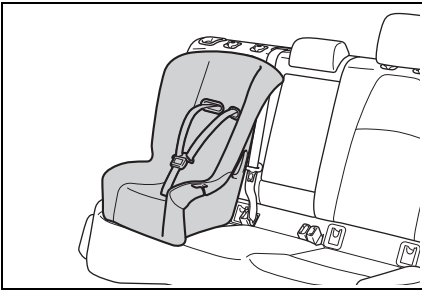

- 4 Run the seat belt through the child restraint system and insert the plate into the buckle. Make sure that the belt is not twisted.

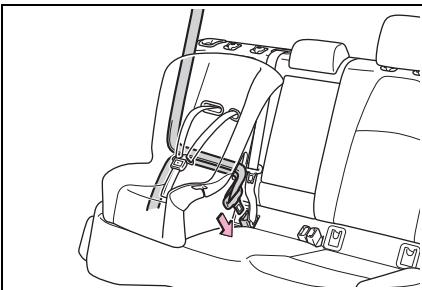

- 5 Fully extend the shoulder belt and allow it to retract to put it

in lock mode. In lock mode, the belt cannot be extended.

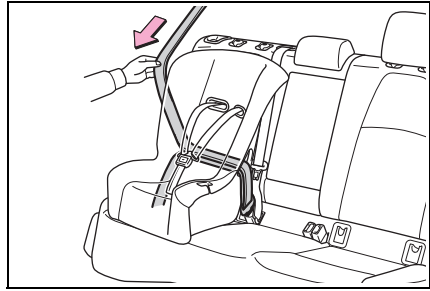

- 6 While pushing the child restraint system into the rear seat, allow the shoulder belt to retract until the child restraint system is securely in place.

After the shoulder belt has retracted to a point where there is no slack in the belt, pull the belt to check that it cannot be extended.

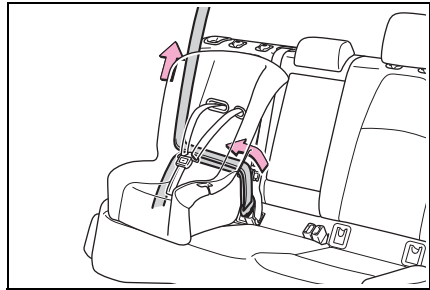

- 7 If the child restraint has a top tether strap, follow the child restraint manufacturer's operation manual regarding the installation, using the top tether strap to latch onto the top tether strap anchor. (→P.57)

- 8 After installing the child restraint system, rock it back

and forth to ensure that it is installed securely. (→P.55)

■ Booster seat

- 1 If installing the child restraint system to the front passenger seat is unavoidable, refer to P.49 for front passenger seat adjustment.
- 2 High back type: If the head restraint interferes with your child restraint system, and the head restraint can be removed, remove the head restraint. (→P.110)
- 3 Place the child restraint system on the seat facing the front of the vehicle.

▶ Booster type

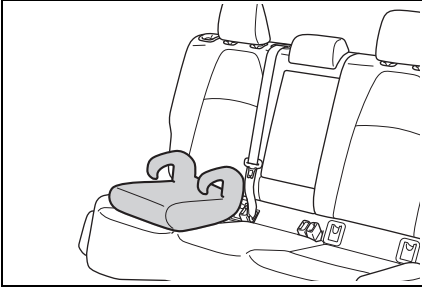

▶ High back type

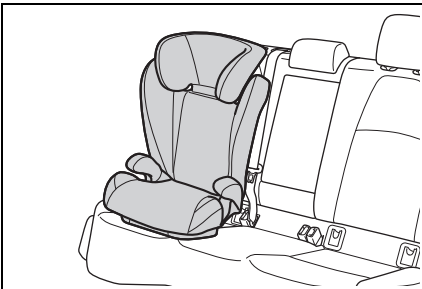

- 4 Sit the child in the child restraint system. Fit the seat

belt to the child restraint system according to the manufacturer's instructions and insert the plate into the buckle. Make sure that the belt is not twisted.

Check that the shoulder belt is correctly positioned over the child's shoulder and that the lap belt is as low as possible. (→P.27)

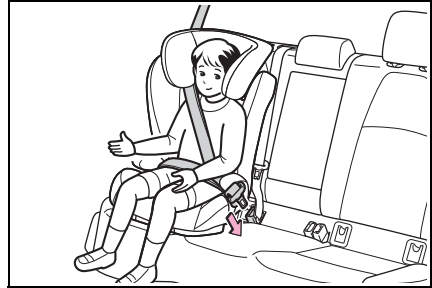

■ Removing a child restraint system installed with a seat belt

Press the buckle release button and fully retract the seat belt.

When releasing the buckle, the child restraint system may spring up due to the rebound of the seat cushion. Release the buckle while holding down the child restraint system.

Since the seat belt automatically reels itself, slowly return it to the stowing position.

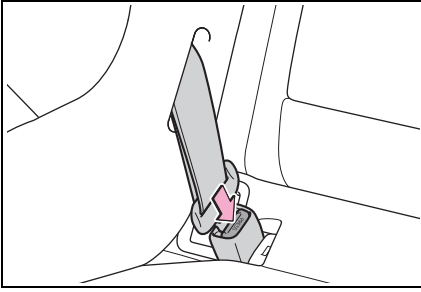

⚠ WARNING

■ **When installing a child restraint system**

Observe the following precautions.

Failure to do so may result in death or serious injury.

- Do not allow children to play with the seat belt. If the seat belt becomes twisted around a child's neck, it may lead to choking or other serious injuries that could result in death. If this occurs and the buckle cannot be unfastened, scissors should be used to cut the belt.
- Ensure that the belt and plate are securely locked and the seat belt is not twisted.
- Shake the child restraint system left and right, and forward and backward to ensure that it has been securely installed.
- After securing a child restraint system, never adjust the seat.
- When a booster seat is installed, always ensure that the shoulder belt is positioned across the center of the child's shoulder. The belt should be kept away from the child's neck, but not so that it could fall off the child's shoulder.
- Follow all installation instructions provided by the child restraint system manufacturer.

- When securing some types of child restraint systems in rear seats, it may not be possible to properly use the seat belts in positions next to the child restraint without interfering with it or affecting seat belt effectiveness. Be sure your seat belt fits snugly across your shoulder and low on your hips. If it does not, or if it interferes with the child restraint, move to a different position. Failure to do so may result in death or serious injury.

- When installing a child restraint system in the rear center seat, adjust both seat cushions to the same position and align both seatbacks at the same angle. Otherwise, the child restraint system cannot be securely restrained and this may cause death or serious injuries in the event of sudden braking, sudden swerving or an accident.

■ **When installing a booster seat**

To prevent the belt from going into ALR lock mode, do not fully extend the shoulder belt. ALR mode causes the belt to tighten only. This could cause injury or discomfort to the child. (→P.29)

■ **Do not use a seat belt extender**

If a seat belt extender is used when installing a child restraint system, the seat belt will not securely hold the child restraint system, which could cause death or serious injury to the child or other passengers in the event of sudden braking, sudden swerving or an accident.

Child restraint system fixed with a child restraint LATCH anchor

Child restraint LATCH anchors

LATCH anchors are provided for the outboard rear seat. (Marks displaying the location of the anchors are attached to the seats.)

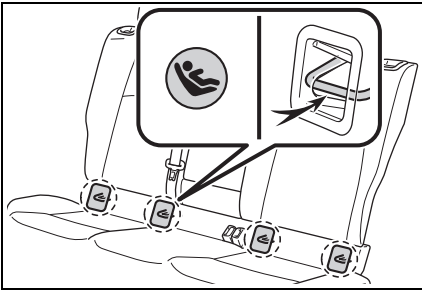

When installing in the rear outboard seats

Install the child restraint system in accordance to the operation manual enclosed with the child restraint system.

- 1 If the head restraint interferes with your child restraint system, and the head restraint can be removed, remove the head restraint. (→P.110)
 - ▶ With flexible lower attachments
- 2 Remove the anchor covers, and install the child restraint system to the seat.

The bars are installed behind the anchor covers.

For owners in Canada:

The symbol on a child restraint system indicates **A** the presence of a lower connector system.

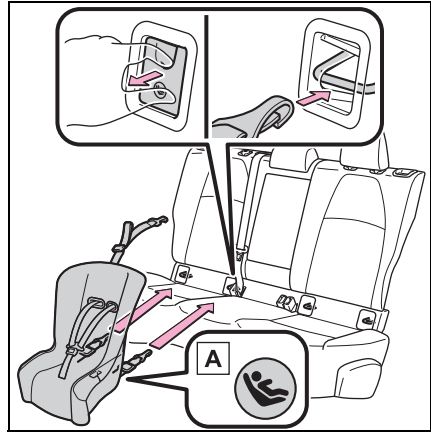

A Canada only

- ▶ With rigid lower attachments
- 2 Remove the anchor covers, and install the child restraint system to the seat.

The bars are installed behind the anchor covers.

For owners in Canada:

The symbol on a child restraint system indicates **A** the presence of a lower connector system.

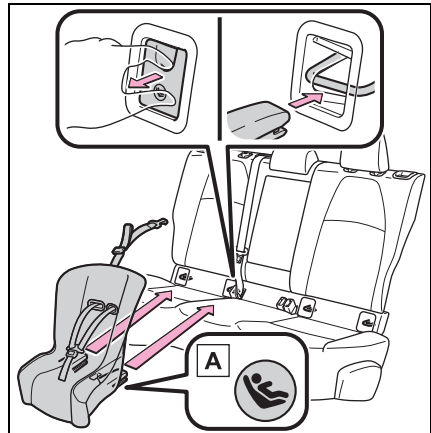

A Canada only

3 If the child restraint has a top tether strap, follow the child restraint manufacturer's operation manual regarding the installation, using the top tether strap to latch onto the top tether strap anchor. (→P.57)

4 After installing the child restraint system, rock it back and forth to ensure that it is installed securely. (→P.55)

■ When installing in the rear center seat

There are no LATCH anchors behind the rear center seat. However, the inboard LATCH anchors of the outboard seats, which are 15.6 in. (396 mm) apart, can be used if the child restraint system manufacturer's instructions permit use of those anchors with the anchor spacing stated.

Child restraint systems with rigid lower attachments cannot be installed in the center seat. This type of child restraint system can only be installed in the outboard seat.

■ Laws and regulations pertaining to anchors

The LATCH system conforms to FMVSS225 or CMVSS210.2. Child restraint systems conforming to FMVSS213 or CMVSS213 specifications can be used. This vehicle is designed to conform to SAE J1819.



WARNING

■ When installing a child restraint system

Observe the following precautions.

Failure to do so may result in death or serious injury.

- When using the LATCH anchors, be sure that there are no foreign objects around the anchors and that the seat belt is not caught behind the child restraint system.
- Follow all installation instructions provided by the child restraint system manufacturer.
- When securing some types of child restraint systems in rear seats, it may not be possible to properly use the seat belts in positions next to the child restraint without interfering with it or affecting seat belt effectiveness. Be sure your seat belt fits snugly across your shoulder and low on your hips. If it does not, or if it interferes with the child restraint, move to a different position. Failure to do so may result in death or serious injury.
- If the seat is adjusted, reconfirm the security of the child restraint system.

Using an anchor bracket (for top tether strap)

■ Anchor brackets (for top tether strap)

Anchor brackets are provided for each rear seat.

Use anchor brackets when fixing the top tether strap.

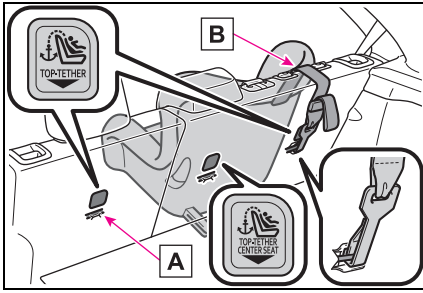

A Anchor brackets

B Top tether strap

■ Fixing the top tether strap to the anchor bracket

Install the child restraint system in accordance to the operation manual enclosed with the child restraint system.

▶ Rear outboard seats

- 1 Remove the head restraint. (→P.110)
- 2 Latch the hook onto the anchor bracket and tighten the top tether strap.

Make sure the top tether strap is securely latched. (→P.55)
If the head restraint does not interfere with the child restraint system installation, install the head restraint.

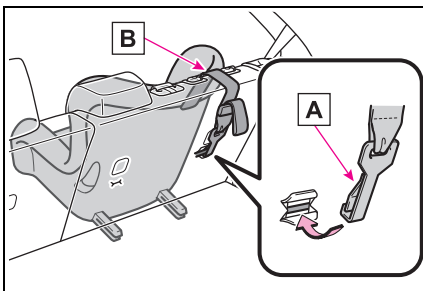

A Hook

B Top tether strap

▶ Rear center seat

- 1 Adjust the head restraint to the upmost position.

If the head restraint interferes with the child restraint system or top tether strap installation and the head restraint can be removed, remove the head restraint. (→P.110)

- 2 Latch the hook onto the anchor bracket and tighten the top tether strap.

Make sure the top tether strap is securely latched. (→P.55)
When installing the child restraint system with the head restraint being raised, be sure to have the top tether strap pass underneath the head restraint.

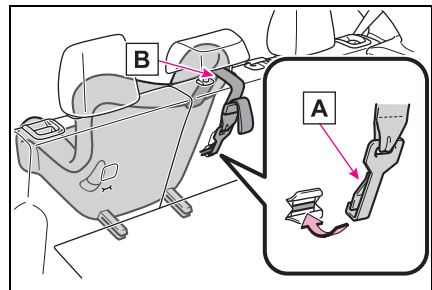

A Hook

B Top tether strap

■ Laws and regulations pertaining to anchors

The LATCH system conforms to FMVSS225 or CMVSS210.2.
Child restraint systems conforming to FMVSS213 or CMVSS213 specifications can be used.
This vehicle is designed to conform to SAE J1819.

**WARNING****■ When installing a child restraint system**

Observe the following precautions.

Failure to do so may result in death or serious injury.

- Firmly attach the top tether strap and make sure that the belt is not twisted.
- Do not attach the top tether strap to anything other than the anchor bracket.
- After securing a child restraint system, never adjust the seat.
- Follow all installation instructions provided by the child restraint system manufacturer.
- When installing the child restraint system with the head restraint being raised, after the head restraint has been raised and then the anchor bracket has been fixed, do not lower the head restraint.

Safety Connect

Safety Connect is a subscription-based telematics service that uses Global Positioning System (GPS) data and embedded cellular technology to provide safety and security features to subscribers. Safety Connect is supported by Toyota's designated response center, which operates 24 hours per day, 7 days per week.

Safety Connect service is available by subscription on select, telematics hardware-equipped vehicles.

By using the Safety Connect service, you are agreeing to be bound by the Telematics Subscription Service Agreement and its Terms and Conditions, as in effect and amended from time to time, a current copy of which is available at Toyota.com in the United States, Toyotapr.com in Puerto Rico and Toyota.ca in Canada. All use of the Safety Connect service is subject to such then-applicable Terms and Conditions.

System components

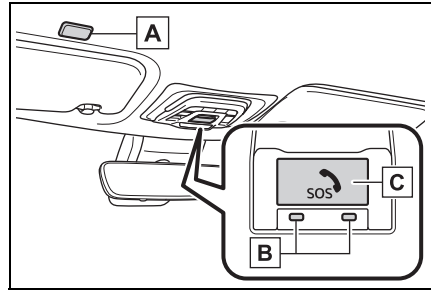

- A** Microphone (driver's side)
- B** LED light indicators
- C** "SOS" button

Services

Subscribers have the following Safety Connect services available:

- Automatic Collision Notification*

Helps drivers receive necessary response from emergency service providers. (→P.62)

*: U.S. Patent No. 7,508,298 B2

- Stolen Vehicle Location

Helps drivers in the event of vehicle theft. (→P.62)

- Emergency Assistance Button ("SOS")

Connects drivers to response-center support. (→P.62)

- Enhanced Roadside Assistance

Provides drivers various on-road assistance. (→P.63)

Subscription

After you have signed the Telematics Subscription Service Agreement and are enrolled, you can begin receiving services.

A variety of subscription terms are available for purchase. Contact your Toyota dealer, call the following appropriate Customer Experience Center or push the “SOS” button in your vehicle for further subscription details.

- The United States

1-800-331-4331

- Canada

1-888-869-6828

- Puerto Rico

1-877-855-8377

■ Safety Connect Services Information

- Phone calls using the vehicle's Bluetooth[®] technology will not be possible when Safety Connect is active and in use.
- Safety Connect is available beginning Fall 2009 on select Toyota models (in the contiguous United States only). Contact with the Safety Connect response center is dependent upon the telematics device being in operative condition, cellular connection availability, and GPS satellite signal reception, which can limit the ability to reach the response center or receive emergency service support. Enrollment and Telematics Subscription Service Agreement are required. A variety of subscription terms are available; charges vary by subscription term selected and location.

- Automatic Collision Notification, Emergency Assistance and Stolen Vehicle Location are available in the United States, including Hawaii and Alaska, Puerto Rico and Canada, and Enhanced Roadside Assistance are available in the United States, Puerto Rico and Canada.
- Automatic Collision Notification, Emergency Assistance, Stolen Vehicle and Enhanced Road Assistance are not available in the U.S. Virgin Islands. For vehicles first sold in the U.S. Virgin Islands, no Safety Connect services will function in or outside the U.S. Virgin Islands.
- Safety Connect services are not subject to section 255 of the Telecommunications Act and the device is not TTY compatible.

■ Languages

The Safety Connect response center will offer support in multiple languages.

The Safety Connect system will offer voice prompts in English, Spanish, and French. Please indicate your language of choice when enrolling.

■ When contacting the response center

You may be unable to contact the response center if the network is busy.

Safety Connect LED light Indicators

When the engine switch is turned to ON, the red indicator light comes on for 2 seconds then turns off. Afterward, the green indicator light comes on, indicating that the service is active.

The following indicator light patterns indicate specific system usage conditions:

- Green indicator light on = Active service
- Green indicator light flashing = Safety Connect call in process
- Red indicator light (except at vehicle start-up) = System malfunction (contact your Toyota dealer)
- No indicator light (off) = Safety Connect service not active

Safety Connect services

■ Automatic Collision Notification

In case of either airbag deployment or severe rear-end collision, the system is designed to automatically call the response center. The responding agent receives the vehicle's location and attempts to speak with the vehicle occupants to assess the level of emergency. If the occupants are unable to communicate, the agent automatically treats the call as an emergency, contacts the nearest emergency services provider to describe the situation, and requests that assistance be sent to the location.

■ Stolen Vehicle Location

If your vehicle is stolen, Safety Connect can work with local authorities to assist them in locating and recovering the vehicle. After filing a police report, call the Customer Experience Center at 1-800-331-4331 in the United States, 1-877-855-8377 in Puerto Rico or 1-888-869-6828 in Canada, and follow the prompts for Safety Connect to initiate this service.

In addition to assisting law enforcement with recovery of a stolen vehicle, Safety-Connect-equipped vehicle location data may, under certain circumstances, be shared with third parties to locate your vehicle. Further information is available at Toyota.com in the United States, Toyotapr.com in Puerto Rico and Toyota.ca in Canada.

■ Emergency Assistance Button ("SOS")

In the event of an emergency on the road, push the "SOS" button to reach the Safety Connect response center. The answering agent will determine your vehicle's location, assess the emergency, and dispatch the necessary assistance required.

If you accidentally press the "SOS" button, tell the response-center agent that you are not experiencing an emergency.

■ Enhanced Roadside Assistance

Enhanced Roadside Assistance adds GPS data to the already included warranty-based Toyota roadside service.

Subscribers can press the “SOS” button to reach a Safety Connect response-center agent, who can help with a wide range of needs, such as: towing, flat tire, fuel delivery, etc. For a description of the Enhanced Roadside Assistance services and their limitations, please see the Safety Connect Terms and Conditions, which are available at Toyota.com in the United States, Toyotapr.com in Puerto Rico and Toyota.ca in Canada.

Safety information for Safety Connect

Important! Read this information before using Safety Connect.

■ Exposure to radio frequency signals

The Safety Connect system installed in your vehicle is a low-power radio transmitter and receiver. It receives and also sends out radio frequency (RF) signals.

In August 1996, the Federal Communications Commission (FCC) adopted RF exposure guidelines with safety levels for

mobile wireless phones. Those guidelines are consistent with the safety standards previously set by the following U.S. and international standards bodies.

- ANSI (American National Standards Institute) C95.1 [1992]
- NCRP (National Council on Radiation Protection and Measurement) Report 86 [1986]
- ICNIRP (International Commission on Non-Ionizing Radiation Protection) [1996]

Those standards were based on comprehensive and periodic evaluations of the relevant scientific literature. Over 120 scientists, engineers, and physicians from universities, and government health agencies and industries reviewed the available body of research to develop the ANSI Standard (C95.1).

The design of Safety Connect complies with the FCC guidelines in addition to those standards.

■ Free/Open Source Software Information

This product contains Free/Open Source Software (FOSS).

The license information and/or the source code of such FOSS can be found at the following URL.

<https://opensource.lge.com/osSch/list?types=ALL&search=TL21BNU>

Engine immobilizer system

The vehicle's keys have built-in transponder chips that prevent the engine from starting if a key has not been previously registered in the vehicle's on-board computer.

Never leave the keys inside the vehicle when you leave the vehicle.

This system is designed to help prevent vehicle theft but does not guarantee absolute security against all vehicle thefts.

Operating the system

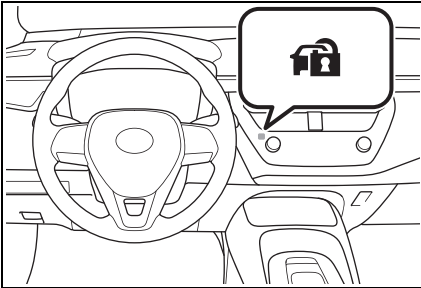

The indicator light flashes after the engine switch has been turned off to indicate that the system is operating.

The indicator light stops flashing after the engine switch has been turned to ACC or ON to indicate that the system has been canceled.

System maintenance

The vehicle has a maintenance-free type engine immobilizer system.

Conditions that may cause the system to malfunction

- If the grip portion of the key is in contact with a metallic object
- If the key is in close proximity to or touching a key to the security system (key with a built-in transponder chip) of another vehicle



NOTICE

To ensure the system operates correctly

Do not modify or remove the system. If modified or removed, the proper operation of the system cannot be guaranteed.

Alarm*

*: If equipped

The alarm uses light and sound to give an alert when an intrusion is detected. The alarm is triggered in the following situations when the alarm is set:

- A locked door or back door is unlocked or opened in any way other than using the entry function, wireless remote control or mechanical key. (The doors will lock again automatically.)
- The hood is opened.

Setting/deactivating/stopping the alarm system

■ Items to check before locking the vehicle

To prevent unexpected triggering of the alarm and vehicle theft, make sure of the following:

- Nobody is in the vehicle.
- The windows are closed before the alarm is set.
- No valuables or other personal items are left in the vehicle.

■ Setting

Close the doors, back door and hood, and lock all the doors. The system will set automatically after 30 seconds.

The indicator light changes from being on to flashing when the system is set.

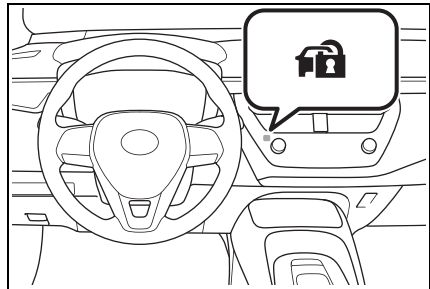

■ Deactivating or stopping

Do one of the following to deactivate or stop the alarms:

- Unlock the doors.
- Turn the engine switch to ACC or ON, or start the engine. (The alarm will be deactivated or stopped after a few seconds.)

■ System maintenance

The vehicle has a maintenance-free type alarm system.

■ Triggering of the alarm

The alarm may be triggered in the following situations: (Stopping the alarm deactivates the alarm system.)

- A person inside the vehicle opens a door, back door or hood, or unlocks the vehicle.



- A person inside the vehicle

unlocks the door using the inside lock buttons.

- The battery is recharged or replaced when the vehicle is locked. (→P.368)

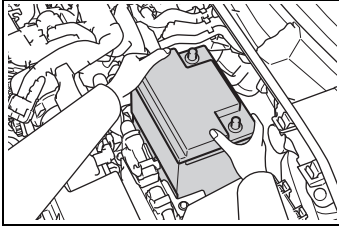

■ Alarm-operated door lock

In the following cases, depending on the situation, the door may automatically lock to prevent improper entry into the vehicle:

- When a person remaining in the vehicle unlocks the door and the alarm is activated.
- While the alarm is activated, a person remaining in the vehicle unlocks the door.
- When recharging or replacing the battery



NOTICE

■ To ensure the system operates correctly

Do not modify or remove the system. If modified or removed, the proper operation of the system cannot be guaranteed.

Theft prevention labels (U.S.A.)

These labels are attached to the vehicle to reduce vehicle theft by facilitating the tracing and recovery of parts from stolen vehicles. Do not remove under the penalty of law.

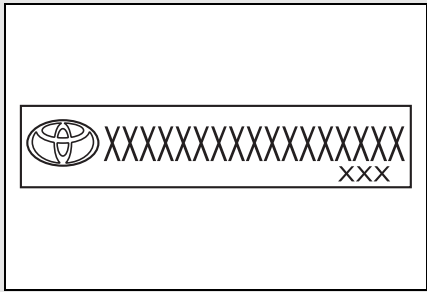

Vehicle status information and indicators

2

2-1. Instrument cluster

Warning lights and indicators	68
Gauges and meters (4.2-inch display)	72
Gauges and meters (7-inch display)	75
Multi-information display (4.2-inch display)	77
Multi-information display (7-inch display)	83
Fuel consumption information	88

Warning lights and indicators

The warning lights and indicators on the instrument cluster, center panel and outside rear view mirrors inform the driver of the status of the vehicle's various systems.

Warning lights and indicators displayed on the instrument cluster

For the purpose of explanation, the following illustrations display all warning lights and indicators illuminated.

▶ 4.2-inch display

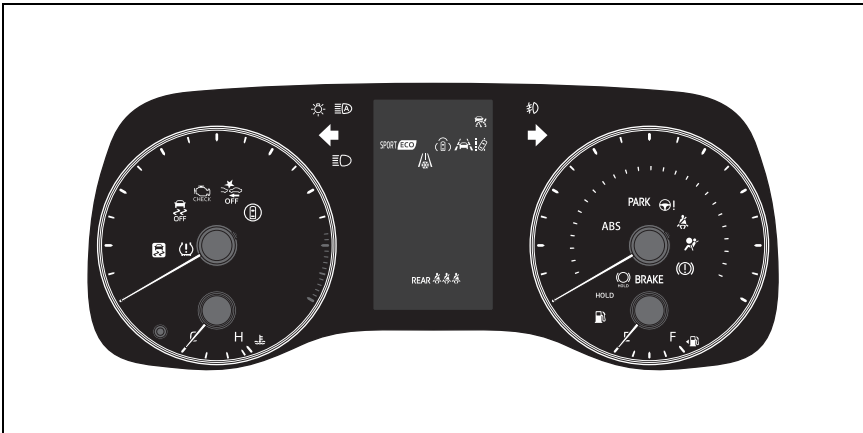



























▶ 7-inch display



Warning lights

Warning lights inform the driver of malfunctions in the indicated vehicle's systems.

-  Brake system warning light*¹ (→P.328)
(U.S.A.)
-  Brake system warning light*¹ (→P.328)
(Canada)
-  Brake system warning light*¹ (→P.328)
(Yellow)
-  High coolant temperature warning light*² (→P.328)
-  Charging system warning light*² (→P.329)
-  Low engine oil pressure warning light*² (→P.329)
-  Malfunction indicator lamp*¹ (→P.329)
(U.S.A.)
-  Malfunction indicator lamp*¹ (→P.329)
(Canada)
-  SRS warning light*¹ (→P.329)
-  ABS warning light*¹ (→P.330)
(U.S.A.)
-  ABS warning light*¹ (→P.330)
(Canada)
-  Inappropriate pedal operation warning light*² (→P.330)
-  Electric power steering system warning light*¹ (Red) (→P.330)

-  Electric power steering system warning light*¹ (Yellow) (→P.330)
-  Low fuel level warning light (→P.331)
-  Driver's and front passenger's seat belt reminder light (→P.331)
-  ^{*3} Rear passengers' seat belt reminder lights (→P.331)
-  ^{*4}
-  Tire pressure warning light*¹ (→P.332)
-  PCS warning light*¹ (Flashes or illuminates) (→P.332)
-  LTA indicator (→P.332)
(Yellow)
-  LDA indicator (→P.333)
(Yellow)
-  PDA indicator (→P.333)
(Yellow)
-  Dynamic radar cruise control indicator (→P.333)
(Yellow)
-  Cruise control indicator (→P.333)
(Yellow)
-  Driving assist information indicator*¹ (→P.334)
-  Slip indicator*¹ (→P.334)

PARK Parking brake indicator
(Flashes) (→P.334)
(U.S.A.)

(P) Parking brake indicator
(Flashes) (→P.334)
(Canada)

HOLD Brake hold operated indicator*1 (→P.335)
(Flashes)

*1: These lights come on when the engine switch is turned to ON to indicate that a system check is being performed. They will turn off after the engine is started, or after a few seconds. There may be a malfunction in a system if the lights do not come on, or turn off. Have the vehicle inspected by your Toyota dealer.

*2: This light illuminates on the multi-information display.

*3: 4.2-inch display.

*4: 7-inch display.

⚠ WARNING

■ If a safety system warning light does not come on

Should a safety system light such as the ABS and SRS warning light not come on when you start the engine, this could mean that these systems are not available to help protect you in an accident, which could result in death or serious injury. Have the vehicle inspected by your Toyota dealer immediately if this occurs.

Indicators

The indicators inform the driver of the operating state of the

vehicle's various systems.

 Turn signal indicator
(→P.142)

 Headlight indicator
(→P.148)
(U.S.A.)

 Tail light indicator
(→P.148)
(Canada)

 Headlight high beam indicator (→P.149)

 Automatic High Beam indicator (→P.150)

 Front fog light indicator (if equipped) (→P.153)

 PCS warning light*1, 2
(→P.168)

 LTA indicator (→P.181)
(Green/W hite/Yel- low
[Flashes])

 LDA indicator (→P.186)
(Green/W hite/Yel- low
[Flashes])

 LDA OFF indicator*2, 8
(→P.186)
(Yellow)

 PDA indicator (→P.193)
(Green/W hite)

 Cruise control indicator
(Green/W hite) (→P.198)

 Dynamic radar cruise control indicator (→P.198)
(Green/W hite)



Driving assist information indicator^{*1, 2} (→P.215, 220)



Outside rear view mirror indicators^{*3} (if equipped) (→P.215, 220, 225)



(Flashes)

Slip indicator^{*1} (→P.231)



VSC OFF indicator^{*1, 2} (→P.232)



Smart key system indicator^{*4} (→P.133)



(U.S.A.)

Parking brake indicator (→P.143)



(Canada)

Parking brake indicator (→P.143)



Brake hold standby indicator^{*1} (→P.146)



Brake hold operated indicator^{*1} (→P.146)



Eco Driving Indicator Light^{*1} (→P.79, 84)



Low outside temperature indicator^{*5} (→P.72, 75)



Security indicator^{*6} (→P.64, 65)



“AIR BAG ON/OFF” indicator^{*1, 7} (→P.40)



Eco drive mode indicator (→P.229)



Sport mode indicator (if equipped) (→P.229)

^{*1}: These lights come on when the engine switch is turned to ON to indicate that a system check is being performed. They will turn off after the engine is started, or

after a few seconds. There may be a malfunction in a system if the lights do not come on, or turn off. Have the vehicle inspected by your Toyota dealer.

^{*2}: This light comes on when the system is turned off.

^{*3}: This light illuminates on the outside rear view mirrors.

^{*4}: This light illuminates on the multi-information display.

^{*5}: When the outside temperature is approximately 37°F (3°C) or lower, this indicator will flash for approximately 10 seconds, then stay on.

^{*6}: This light illuminates on the center panel.

^{*7}: This light illuminates on the overhead console.

^{*8}: For Puerto Rico

Gauges and meters (4.2-inch display)

Meter display

■ Locations of gauges and meters

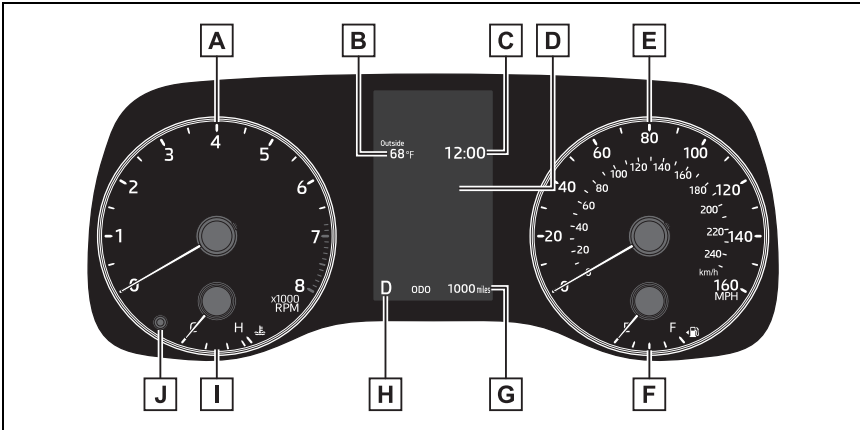

The units of measure may differ depending on the intended destination of the vehicle.

A Tachometer

Displays the engine speed in revolutions per minute

B Outside temperature

Displays the outside temperature within the range of -40°F (-40°C) to 140°F (60°C)

C Clock (→P.74)**D** Multi-information display

Presents the driver with a variety of vehicle data (→P.77)

Displays warning messages if a malfunction occurs (→P.338)

E Speedometer**F** Fuel gauge

Displays the quantity of fuel remaining in the tank

G Odometer and trip meter display (→P.73)**H** Shift position indicator (→P.137)**I** Engine coolant temperature gauge

Displays the engine coolant temperature

J Display change button (→P.73)

■ Outside temperature display

- In the following situations, the correct outside temperature may not be displayed, or the display may take longer than normal to change:
 - When stopped, or driving at low speeds (less than 12 mph [20 km/h])
 - When the outside temperature has changed suddenly (at the entrance/exit of a garage, tunnel, etc.)
- When "--" or "E" is displayed, the system may be malfunctioning. Take your vehicle to your Toyota dealer.

■ Liquid crystal display

→P.78

⚠ WARNING

■ The information display at low temperatures

Allow the interior of the vehicle to warm up before using the liquid crystal information display. At extremely low temperatures, the information display monitor may respond slowly, and display changes may be delayed.

For example, there is a lag between the driver's shifting and the new gear number appearing on the display. This lag could cause the driver to downshift again, causing rapid and excessive engine braking and possibly an accident resulting in death or injury.

⚠ NOTICE

■ To prevent damage to the engine and its components

- Do not let the indicator needle of the tachometer enter the red zone, which indicates the maximum engine speed.
- The engine may be overheating if the engine coolant temperature gauge is in the red zone (H). In this case, immediately stop the vehicle in a safe place, and check the engine after it has cooled completely. (→P.370)

■ Odometer and trip meter display

■ Changing the display

Press the display change button until the desired item is displayed.

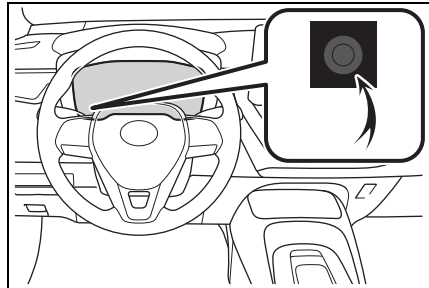

■ Display items

● Odometer

Displays the total distance the vehicle has been driven.

● Trip meter A/Trip meter B

Displays the distance the vehicle has been driven since the meter was last reset. Trip meters A and B can be used to record and display

different distances independently.

To reset, display the desired trip meter and press and hold the display change button.

Changing the instrument panel light brightness

The brightness of the instrument panel lights can be adjusted.

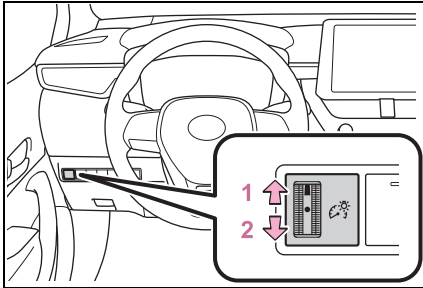

- 1 Brighter
- 2 Darker

■ Instrument panel light brightness adjustment

When the headlights or parking lights are turned on, the meter and instrument panel lights will be dimmed. However, if the instrument panel brightness dial is set to the highest position, the lights will not dim even if the headlights or parking lights are turned on.

Adjusting the clock

- The clocks can be adjusted on the audio system screen.

Refer to “MULTIMEDIA OWNER’S MANUAL”.

Gauges and meters (7-inch display)

Meter display

■ Locations of gauges and meters

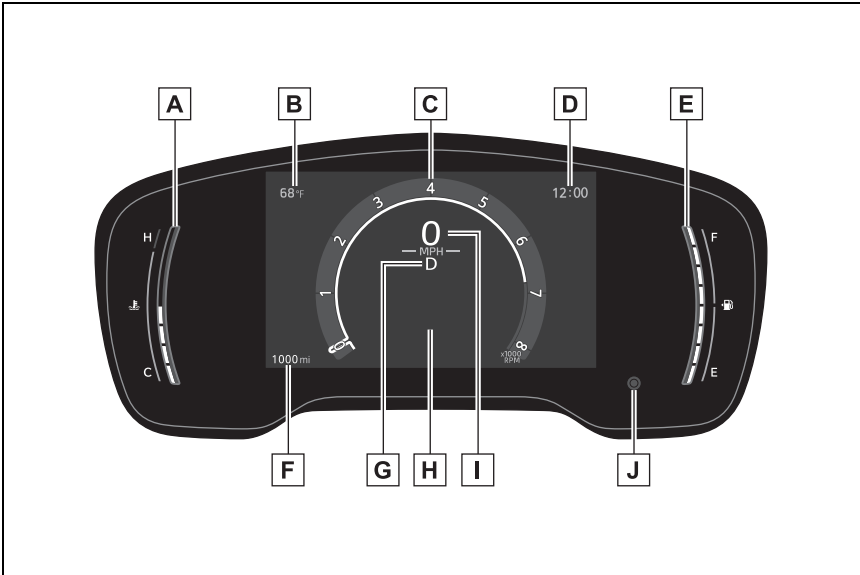
**A** Engine coolant temperature gauge

Displays the engine coolant temperature

B Outside temperature

Displays the outside temperature within the range of -40°F (-40°C) to 140°F (60°C)

C Speedometer/Tachometer

This setting can be changed on the setting screen. (→P.396)

D Clock (→P.77)**E** Fuel gauge

Displays the quantity of fuel remaining in the tank

F Odometer and trip meter display (→P.76)**G** Shift position indicator (→P.137)**H** Multi-information display

Presents the driver with a variety of vehicle data (→P.83)

Displays warning messages if a malfunction occurs (→P.338)

I Speedometer

J Display change button (→P.76)

■ Outside temperature display

- In the following situations, the correct outside temperature may not be displayed, or the display may take longer than normal to change:
 - When stopped, or driving at low speeds (less than 12 mph [20 km/h])
 - When the outside temperature has changed suddenly (at the entrance/exit of a garage, tunnel, etc.)
- When "--" or "E" is displayed, the system may be malfunctioning. Take your vehicle to your Toyota dealer.

■ Liquid crystal display

→P.83

■ Customization

The gauges and meters can be customized in  of the multi-information display. (→P.396)



WARNING

■ The information display at low temperatures

Allow the interior of the vehicle to warm up before using the liquid crystal information display. At extremely low temperatures, the information display monitor may respond slowly, and display changes may be delayed.

For example, there is a lag between the driver's shifting and the new gear number appearing on the display. This lag could cause the driver to downshift again, causing rapid and excessive engine braking and possibly an accident resulting in death or injury.



NOTICE

■ To prevent damage to the engine and its components

- Do not let the indicator needle of the tachometer enter the red zone, which indicates the maximum engine speed.
- The engine may be overheating if the engine coolant temperature gauge is in the red zone (H). In this case, immediately stop the vehicle in a safe place, and check the engine after it has cooled completely. (→P.370)

Odometer and trip meter display

■ Changing the display

Press the display change button until the desired item is displayed.

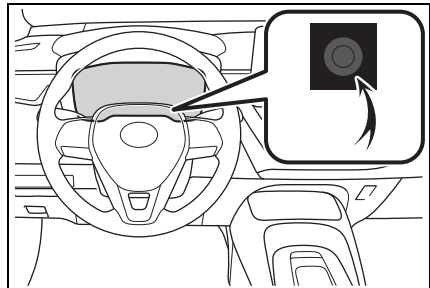

■ Display items

● Odometer

Displays the total distance the vehicle has been driven.

● Trip meter A/Trip meter B

Displays the distance the vehicle has been driven since the meter was last reset. Trip meters A and B

can be used to record and display different distances independently.

To reset, display the desired trip meter and press and hold the display change button.

Changing the instrument panel light brightness

The brightness of the instrument panel lights can be adjusted.

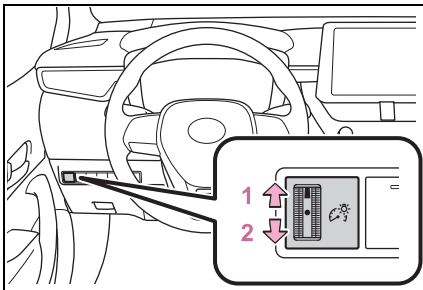

- 1 Brighter
- 2 Darker

Instrument panel light brightness adjustment

When the headlights or parking lights are turned on, the meter and instrument panel lights will be dimmed. However, if the instrument panel brightness dial is set to the highest position, the lights will not dim even if the headlights or parking lights are turned on.

Adjusting the clock

The clocks can be adjusted on the audio system screen.

Refer to “MULTIMEDIA OWNER’S MANUAL”.

Multi-information display (4.2-inch display)

Display and menu icons

Display

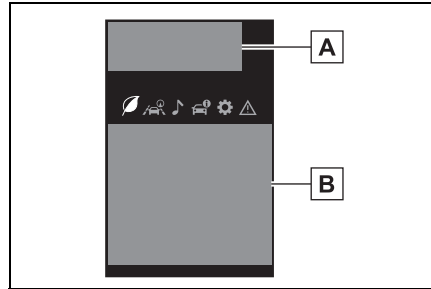

A Driving support system status display area

Displays an image when the following systems are operating and a menu icon other than  is selected:

- LTA (Lane Tracing Assist)
- LDA (Lane Departure Alert)
- RSA (Road Sign Assist) (if equipped)
- Dynamic radar cruise control
- Cruise control

B Content display area

By selecting menu icons on the multi-information display, a variety of driving-related information can be displayed. The multi-information display can also be used to change display settings and other vehicle settings.

Warning or advice pop-up displays are also displayed in certain situations.

Menu icons

The menu icons will be dis-

played by pressing the < or > meter control switch.



Driving information display
(→P.78)



Driving support system
information display
(→P.80)



Audio system-linked display
(→P.81)



Vehicle information display
(→P.81)



Settings display (→P.81)



Warning message display
(→P.338)

■ Liquid crystal display

Small spots or light spots may appear on the display. This phenomenon is characteristic of liquid crystal displays, and there is no problem continuing to use the display.



WARNING

■ Caution for use while driving

- When operating the multi-information display while driving, pay extra attention to the safety of the area around the vehicle.
- Do not look continuously at the multi-information display while driving as you may fail to see pedestrians, objects on the road, etc. ahead of the vehicle.

■ The information display at low temperatures

→P.73

Changing the meter display

The multi-information display is

operated using the meter control switches.

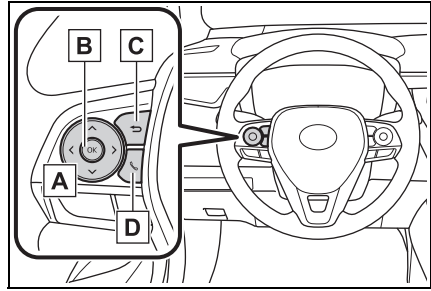

A < / > : Select menu icons
 ^ / v : Change displayed content, scroll up/down the screen and move the cursor up/down

B Press: Enter/Set
 Press and hold: Reset/Display customizable items

C Return to the previous screen

D Call sending/receiving and history display

Linked with the hands-free system, sending or receiving call is displayed. For details regarding the hands-free system, refer to the "Multimedia Owner's Manual".

Content of driving information

■ Display items

- Speedometer display/Driving range
- Fuel economy
- Eco Driving Indicator/Driving range

■ Speedometer display/Driving range

- Speedometer display
- Driving range

Displays driving range with remaining fuel. Use the displayed values as a reference only.

This distance is computed based on your average fuel consumption. As a result, the actual distance that can be driven may differ from that displayed.

When only a small amount of fuel is added to the tank, the display may not be updated.

When refueling, turn the engine switch off. If the vehicle is refueled without turning the engine switch off, the display may not be updated.

■ Fuel economy

Use the displayed values as a reference only.

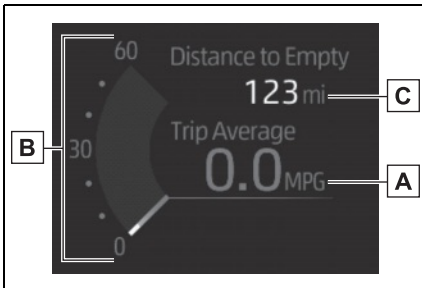

- A** Average fuel economy (after reset)

To reset the average fuel economy display, press and hold the OK meter control switch.

- B** Current fuel consumption

Displays instantaneous current fuel consumption.

- C** Driving range

Displays driving range with remaining fuel.

This distance is computed based on your average fuel consumption. As a result, the actual distance that can be driven may differ from that displayed.

When only a small amount of fuel is added to the tank, the display may not be updated.

When refueling, turn the engine switch off. If the vehicle is refueled without turning the engine switch off, the display may not be updated.

The average fuel economy display can be changed in . (→P.81)

- Average fuel economy (after start)

Displays the average fuel consumption since engine start.

- Average fuel economy (after refuel)

Displays the average fuel consumption since the vehicle was refueled.

■ Eco Driving Indicator/Driving range

- Eco Driving Indicator

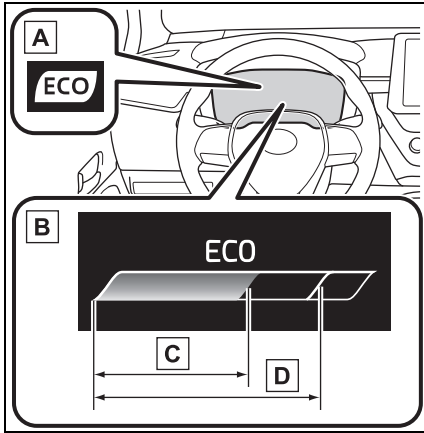

A Eco Driving Indicator Light
During Eco-friendly acceleration (Eco driving), the Eco Driving Indicator Light will turn on. When the acceleration exceeds the Zone of Eco driving, or when the vehicle is stopped, the light turns off.

B Eco Driving Indicator Zone Display

Suggests the Zone of Eco driving with current Eco driving ratio based on acceleration.

C Eco driving ratio based on acceleration

If the acceleration exceeds the Zone of Eco driving, the right side of the Eco Driving Indicator Zone Display will illuminate.

At this time, the Eco Driving Indicator Light will turn off.

D Zone of Eco driving

● Driving range

Displays driving range with remaining fuel. Use the displayed values as a reference only.

This distance is computed based on your average fuel consumption. As a result, the actual distance that can be driven may differ from that displayed.

When only a small amount of fuel is added to the tank, the display may not be updated.

When refueling, turn the engine switch off. If the vehicle is refueled without turning the engine switch off, the display may not be updated.

■ Eco Driving Indicator

Eco Driving Indicator will not operate under the following conditions:

- The shift lever is in any position other than D.
- A paddle shift switch is operated. (if equipped)
- The vehicle speed is approximately 130 km/h (80 mph) or higher.

Driving support system information display

■ Driving support system information

Select to display the operational status of the following systems:

- LTA (Lane Tracing Assist) (→P.177)
- LDA (Lane Departure Alert) (→P.182)
- Dynamic radar cruise control (→P.195)
- Cruise control (→P.206)

■ Navigation system-linked display (if equipped)

Select to display the following navigation system-linked information:

- Route guidance to destination
- Compass display (heading-up display)

Audio system-linked display

The operating conditions of the audio system can be displayed on the multi-information display.

This menu icon can be set to be displayed/not displayed in .

Vehicle information display

■ Drive information

Displays drive information such as the following:

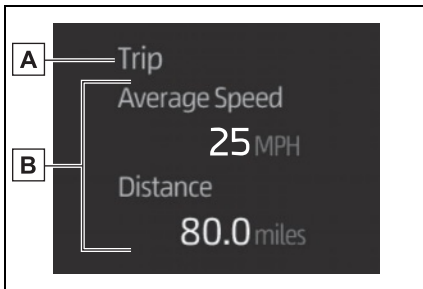

A Drive information type

B Drive information items

Displays the following depending on which drive information type and drive information items

were selected in . (→P.81)

- After start
 - Distance: Displays the distance driven since engine start
 - Elapsed time: Displays the elapsed time since engine start
 - Average vehicle speed: Displays the average vehicle speed since engine start
- After reset
 - Distance: Displays the distance driven since the display was reset*
 - Elapsed time: Displays the elapsed time since the display was reset*
 - Average vehicle speed: Displays the average vehicle speed since the display was reset*

*: To reset, display the desired item and press and hold the OK meter control switch.

Settings display

■ Meter display settings that can be changed

- Language

Select to change the language displayed.

- Units

Select to change the units of measure displayed.

- Eco Driving Indicator Light

Select to enable/disable the Eco Driving Indicator Light.



- Fuel economy display

Select to change the average fuel consumption display between after start/after reset. (→P.79)



Select to display/not display the audio system linked display.



Select to change the displayed content of the following:

- Drive information type

Select to change the drive information type display between after start/after reset.

- Drive information items

Select to set the first and second items of the drive information display to any of the following: average vehicle speed/distance/elapsed time.

- Pop-up display

Select to enable/disable pop-up displays for each relevant system.

- Multi-information display off

Select to turn the multi-information display off.

To turn the multi-information display on again, press any of the following meter control switches



- Default setting

Select to reset the meter display settings to the default setting.

■ Vehicle functions and settings that can be changed

→P.396

■ Suspension of the settings display

- Some settings cannot be changed while driving. When changing settings, park the vehicle in a safe place.
- If a warning message is displayed, operation of the settings display will be suspended.



WARNING

■ Cautions during setting up the display

If the engine is running when changing the display settings, ensure that the vehicle is parked in a place with adequate ventilation. In a closed area such as a garage, exhaust gases including harmful carbon monoxide (CO) may collect and enter the vehicle. This may lead to death or a serious health hazard.



NOTICE

■ During setting up the display

To prevent battery discharge, ensure that the engine is running while setting up the display features.

Multi-information display (7-inch display)

Display and menu icons

■ Display

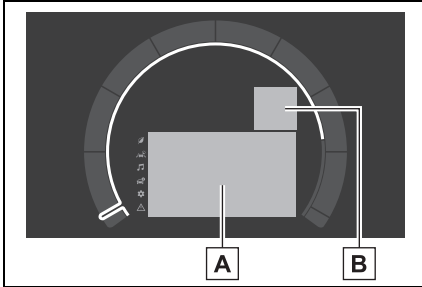

A Content display area

By selecting menu icons on the multi-information display, a variety of driving-related information can be displayed. The multi-information display can also be used to change display settings and other vehicle settings.



Warning or advice pop-up displays are also displayed in certain situations.







B Driving support system status display area

Displays an image when the following systems are operating and a menu icon other than  is selected:

- LTA (Lane Tracing Assist)
- LDA (Lane Departure Alert)
- Dynamic radar cruise control
- Cruise control

■ Menu icons

The menu icons will be displayed by pressing the  or  meter control switch.

-  Driving information display (→P.84)
-  Driving support system information display (→P.85)
-  Audio system-linked display (→P.86)
-  Vehicle information display (→P.86)
-  Settings display (→P.87)
-  Warning message display (→P.338)

■ Liquid crystal display

Small spots or light spots may appear on the display. This phenomenon is characteristic of liquid crystal displays, and there is no problem continuing to use the display.

WARNING

■ Caution for use while driving

- When operating the multi-information display while driving, pay extra attention to the safety of the area around the vehicle.
- Do not look continuously at the multi-information display while driving as you may fail to see pedestrians, objects on the road, etc. ahead of the vehicle.

■ The information display at low temperatures

→P.76

Changing the meter display

The multi-information display is operated using the meter control switches.

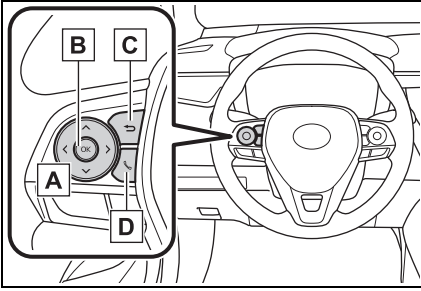

- A** \wedge/\vee : Select menu icons, scroll the screen and move the cursor
- \langle / \rangle : Change displayed content, scroll the screen and move the cursor
- B** Press: Enter/Set
Press and hold: Reset/Display customizable items
- C** Return to the previous screen
- D** Call sending/receiving and history display

Linked with the hands-free system, sending or receiving call is displayed. For details regarding the hands-free system, refer to the "Multimedia Owner's Manual".

Content of driving information

■ Display items

- Fuel economy
- Eco Driving Indicator/Driving range

■ Fuel economy

Use the displayed values as a reference only.

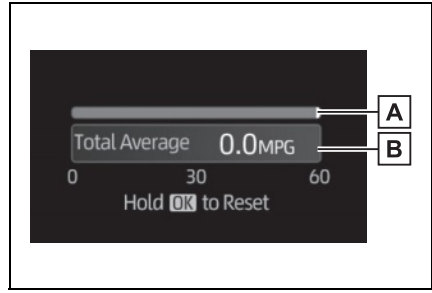

A Current fuel consumption
Displays instantaneous current fuel consumption.

B Average fuel economy (after reset)

To reset the average fuel economy display, press and hold the OK meter control switch.

The average fuel economy display can be changed in .
(→P.87)

- Average fuel economy (after start)
- Average fuel economy (after refuel)

Displays the average fuel consumption since the vehicle was refueled.

■ Eco Driving Indicator/Driving range

- Eco Driving Indicator

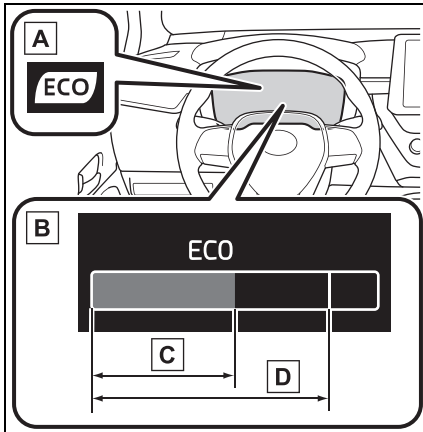

A Eco Driving Indicator Light
During Eco-friendly acceleration (Eco driving), the Eco Driving Indicator Light will turn on. When the acceleration exceeds the Zone of Eco driving, or when the vehicle is stopped, the light turns off.

B Eco Driving Indicator Zone Display

Suggests the Zone of Eco driving with current Eco driving ratio based on acceleration.

C Eco driving ratio based on acceleration

If the acceleration exceeds the Zone of Eco driving, the right side of the Eco Driving Indicator Zone Display will illuminate.

At this time, the Eco Driving Indicator Light will turn off.

D Zone of Eco driving

● Driving range

Displays driving range with remaining fuel. Use the displayed values as a reference only.

This distance is computed based on your average fuel consumption. As a result, the actual distance that can be driven may differ from that displayed.

When only a small amount of fuel is added to the tank, the display may not be updated.

When refueling, turn the engine switch off. If the vehicle is refueled without turning the engine switch off, the display may not be updated.

■ Eco Driving Indicator

Eco Driving Indicator will not operate under the following conditions:

- The shift lever is in any position other than D.
- The driving mode is set to sport mode.
- The vehicle speed is approximately 130 km/h (80 mph) or higher.

Driving support system information display

■ Driving support system information

Select to display the operational status of the following systems:

- LTA (Lane Tracing Assist) (→P.177)
- LDA (Lane Departure Alert) (→P.182)
- Dynamic radar cruise control (→P.195)
- Cruise control (→P.206)

■ Navigation system-linked display (if equipped)

Select to display the following navigation system-linked information:

- Route guidance to destination
- Compass display (head-up display)

Audio system-linked display

The operating conditions of the audio system can be displayed on the multi-information display.

This menu icon can be set to be displayed/not displayed in .

Vehicle information display

■ Display items

- Drive information
- Drive information of TRIP A/B

■ Drive information

Displays drive information such as the following:

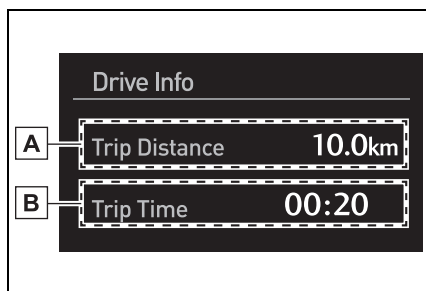

- A** Drive information 1
- B** Drive information 2

Displays the following depending on which drive information type and drive information items were selected in . (→P.87)

- Average speed: Displays the average vehicle speed since engine start
- Trip distance: Displays the distance driven since engine start
- Trip time: Displays the elapsed time since engine start

■ Drive information of TRIP A/B

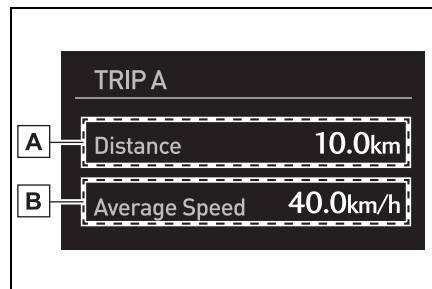

- A** Drive information of trip A/B 1
- B** Drive information of trip A/B 2

Displays the following depending on which drive information type and drive information items were selected in . (→P.87)

- Average speed: Displays the average vehicle speed of trip A/B
- Trip distance: Displays the distance driven of trip A/B
- Trip time: Displays the elapsed time of trip A/B

Settings display

■ Meter display settings that can be changed

● Language

Select to change the language displayed.

● Units

Select to change the units of measure displayed.

● Meter Type

Select to change the meter type.

● Dial Type

Select to change the display of the speedometer or tachometer.

● Eco Driving Indicator Light

Select to enable/disable the Eco Driving Indicator Light.



Fuel economy display

Select to change the average fuel consumption display to any of the following: trip average/total average/tank average. (→P.84)



Select to display/not display the audio system linked display.



Select to change the displayed content of the following:

• Drive information type

Select to change the drive information type display between trip information/total information.

• Drive information items

Select to set the first and second

items of the drive information display to any of the following: average vehicle speed/distance/elapsed time.

● Pop-up display

Select to enable/disable pop-up displays for each relevant system.

● Multi-information display off

Select to turn the multi-information display off.

To turn the multi-information display on again, press any of the following meter control switches

^ / v / < / > / OK / ↵.

● Default setting

Select to reset the meter display settings to the default setting.

■ Vehicle functions and settings that can be changed

→P.396

■ Suspension of the settings display

● Some settings cannot be changed while driving. When changing settings, park the vehicle in a safe place.

● If a warning message is displayed, operation of the settings display will be suspended.

⚠ WARNING

■ **Cautions during setting up the display**

If the engine is running when changing the display settings, ensure that the vehicle is parked in a place with adequate ventilation. In a closed area such as a garage, exhaust gases including harmful carbon monoxide (CO) may collect and enter the vehicle. This may lead to death or a serious health hazard.

⚠ NOTICE

■ **During setting up the display**

To prevent battery discharge, ensure that the engine is running while setting up the display features.

Fuel consumption information

Fuel consumption information can be displayed on the audio system screen.

System components

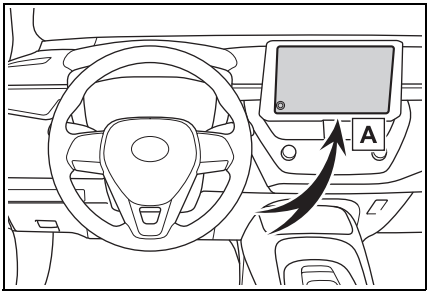

A Audio system screen

Consumption

■ **Trip information**

- 1 Select  on the main menu.
- 2 Select "Trip information".

If a screen other than "Current" is displayed, select "Current".

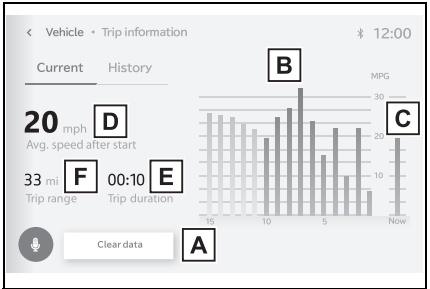

The image is an example only, and may vary slightly from actual conditions.

A Resetting the consumption

data

- B** Fuel consumption in the past 15 minutes
- C** Current fuel consumption
- D** Average vehicle speed since the engine was started.
- E** Elapsed time since the engine was started.
- F** Cruising range

Average fuel consumption for the past 15 minutes is divided by color into past averages and averages attained since the engine switch was last turned to ON. Use the displayed average fuel consumption as a reference.

■ History

- 1 Select  on the main menu.
- 2 Select “Trip information”.

If a screen other than “History” is displayed, select “History”.

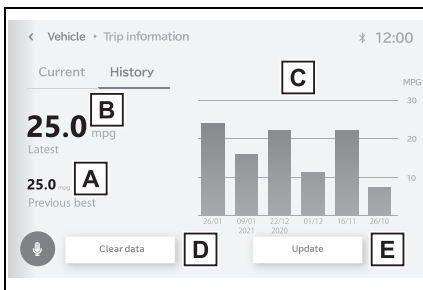

The image is an example only, and may vary slightly from actual conditions.

- A** Best recorded fuel consumption
- B** Latest fuel consumption

- C** Previous fuel consumption record
- D** Resetting the history data
- E** Updating the latest fuel consumption data

The average fuel consumption history is divided by color into past averages and the average fuel consumption since the last updated. Use the displayed average fuel consumption as a reference.

■ Updating the history data

Update the latest fuel consumption by selecting “Update” to measure the current fuel consumption again.

■ Resetting the data

The fuel consumption data can be deleted by selecting “Clear”.

■ Cruising range

Displays the estimated maximum distance that can be driven with the quantity of fuel remaining.

This distance is computed based on your average fuel consumption. As a result, the actual distance that can be driven may differ from that displayed.

3-1. Key information

Keys 92

3-2. Opening, closing and locking the doors

Side doors 95

Back door 99

Smart key system 102

3-3. Adjusting the seats

Front seats 107

Rear seats 108

Head restraints 110

3-4. Adjusting the steering wheel and mirrors

Steering wheel 113

Inside rear view mirror
..... 114Outside rear view mirrors
..... 115**3-5. Opening and closing the windows**

Power windows 117

3-6. Favorite settings

My Settings 120

Keys

The keys

The following keys are provided with the vehicle.

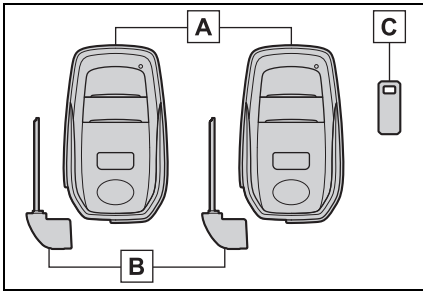

A Electronic keys

- Operating the smart key system (→P.102)
- Operating the wireless remote control function (→P.93)

B Mechanical keys

C Key number plate

■ When riding in an aircraft

When bringing an electronic key onto an aircraft, make sure you do not press any buttons on the electronic key while inside the aircraft cabin. If you are carrying an electronic key in your bag, etc., ensure that the buttons are not likely to be pressed accidentally. Pressing a button may cause the electronic key to emit radio waves that could interfere with the operation of the aircraft.

■ Electronic key battery depletion

- The standard battery life is 1 to 2 years.
- If the battery becomes low, an alarm will sound in the cabin and a message will be shown on the multi-information display when the engine is stopped.

- To reduce key battery depletion when the electronic key is to not be used for long periods of time, set the electronic key to the battery-saving mode. (→P.104)
- As the electronic key always receives radio waves, the battery will become depleted even if the electronic key is not used. The following symptoms indicate that the electronic key battery may be depleted. Replace the battery when necessary. (→P.311)
 - The smart key system or the wireless remote control does not operate.
 - The detection area becomes smaller.
 - The LED indicator on the key surface does not turn on.
- To avoid serious deterioration, do not leave the electronic key within 3 ft. (1 m) of the following electrical appliances that produce a magnetic field:
 - TVs
 - Personal computers
 - Cellular phones, cordless phones and battery chargers
 - Recharging cellular phones or cordless phones
 - Table lamps
 - Induction cookers
- If the electronic key is near the vehicle for longer than necessary, even if the smart key system is not operated, the key battery may become depleted faster than normal.

■ Replacing the battery

→P.311

■ The electronic key function is suspended when

The electronic key function may be suspended when the electronic key is kept unmoved in a same location for a certain period, such as it is left on a same place. This is to reduce battery consumption. The function will be restored automatically when the electronic key is moved, such as

it is picked up.

■ **If “A New Key has been Registered Contact Your Dealer for Details” is shown on the multi-information display**

This message will be displayed each time the driver's door is opened when the doors are unlocked from the outside for approximately 10 days after a new electronic key has been registered. If this message is displayed but you have not had a new electronic key registered, ask your Toyota dealer to check if an unknown electronic key (other than those in your possession) has been registered.



NOTICE

■ **To prevent key damage**

- Do not drop the keys, subject them to strong shocks or bend them.
- Do not expose the keys to high temperatures for long periods of time.
- Do not get the keys wet or wash them in an ultrasonic washer etc.
- Do not attach metallic or magnetic materials to the keys or place the keys close to such materials.
- Do not disassemble the keys.
- Do not attach a sticker or anything else to the surface of the key.
- Do not place the keys near objects that produce magnetic fields, such as TVs, audio systems and induction cookers, or medical electrical equipment, such as low-frequency therapy equipment.

■ **Carrying the electronic key on your person**

Carry the electronic key 3.9 in. (10 cm) or more away from electric appliances that are turned on. Radio waves emitted from electric appliances within 3.9 in. (10 cm) of the electronic key may interfere with the key, causing the key to not function properly.

■ **In case of a smart key system malfunction or other key-related problems**

→P.364

■ **When an electronic key is lost**

→P.364

Wireless remote control

The keys are equipped with the following wireless remote control:

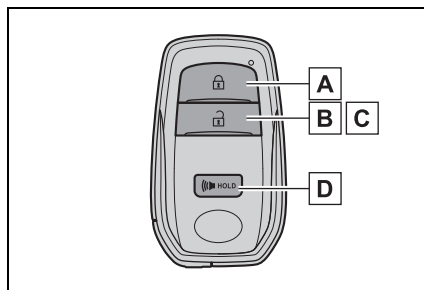

- A** Locks the doors (→P.95)
- B** Unlocks the doors (→P.95)
- C** Opens the windows* (→P.95)
- D** Sounds the alarm

*: This setting must be customized at your Toyota dealer.

■ **Panic mode**

When  is pressed for longer than about one second, an alarm

will sound intermittently and the vehicle lights will flash to deter any person from trying to break into or damage your vehicle.

To stop the alarm, press any button on the wireless remote control.



Using the mechanical key

To take out the mechanical key, push the release button and take the key out.

The mechanical key can only be inserted in one direction, as the key only has grooves on one side. If the key cannot be inserted in a lock cylinder, turn it over and re-attempt to insert it.

After using the mechanical key, store it in the electronic key.

Carry the mechanical key together with the electronic key.

If the electronic key battery is depleted or the entry function does not operate properly, you will need the mechanical key.

(→P.364)

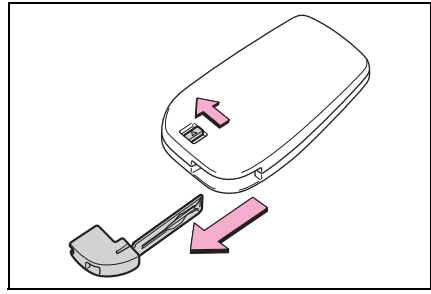

■ If you lose your mechanical keys

→P.364

■ If a wrong key is used

The key cylinder rotates freely, isolated from the internal mechanism.

Side doors

Unlocking and locking the doors from the outside

■ Smart key system

Carry the electronic key to enable this function.

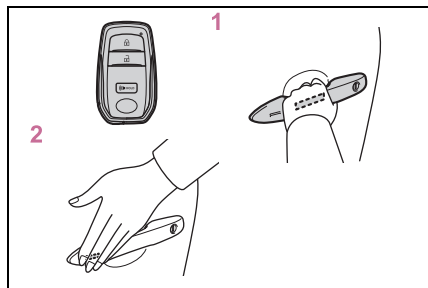

- 1 Grip the driver's door handle to unlock the door. Holding the driver's door handle for approximately 2 seconds unlocks all the doors. Grip the front passenger's door handle to unlock all the doors.*

Make sure to touch the sensor on the back of the handle.

The doors cannot be unlocked for 3 seconds after the doors are locked.

*: The door unlock settings can be changed. (→P.95, 396)

- 2 Touch the lock sensor (the indentation on the side of the front door handle) to lock all the doors.

Check that the door is securely locked.

■ Wireless remote control

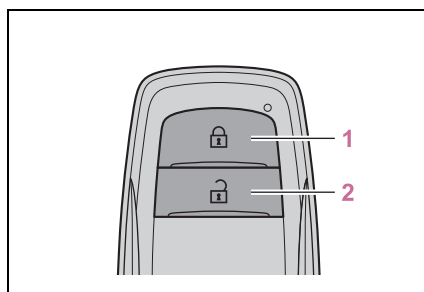

- 1 Locks all the doors

Check that the door is securely locked.

- 2 Unlocks all the doors



Pressing the button unlocks the driver's door. Pressing the button again within 5 seconds unlocks the other doors.

Press and hold to open the windows.*



*: This setting must be customized at your Toyota dealer.

■ Switching the door unlock function

It is possible to set which doors the entry function unlocks using the wireless remote control.

- 1 Turn the engine switch off.
- 2 When the indicator light on the key surface is not on, press and hold  or  for approximately 5 seconds while pressing and holding .

The setting changes each time an operation is performed, as shown below. (When changing the setting continuously, release the buttons, wait for at least 5 seconds, and repeat step 2.)

Multi-informa- tion display/Beep	Unlocking func- tion
 <p>Exterior: Beeps 3 times Interior: Pings once</p>	<p>Holding the driver's door handle unlocks only the driver's door.</p>
 <p>Exterior: Beeps twice Interior: Pings once</p>	<p>Holding either front door handle unlocks all the doors.</p>

For vehicles with an alarm: To prevent unintended triggering of the alarm, unlock the doors using the wireless remote control and open and close a door once after the settings have been changed. (If a door is not opened within 60 seconds after  is pressed, the doors will be locked again and the alarm will automatically be set.) In case that the alarm is triggered, immediately stop the alarm. (→P.65)

■ **Operation signals**

A buzzer sounds and the emergency flashers flash to indicate that the doors have been locked/unlocked using the entry function or wireless remote control. (Locked: Once; Unlocked: Twice)

A buzzer sounds to indicate that the windows are operating.

■ **Security feature**

If a door is not opened within approximately 60 seconds after the

vehicle is unlocked using the entry function or wireless remote control, the security feature automatically locks the vehicle again.

■ **When the door cannot be locked by the lock sensor on the surface of the front door handle**

If the doors cannot be locked by touching the lock sensor with a finger, touch the lock sensor with the palm of your hand.

If you are wearing gloves, remove them.

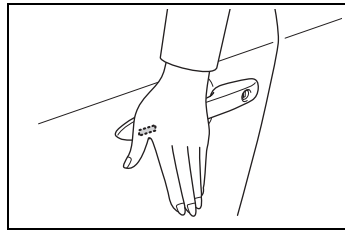

■ **Door lock buzzer**

If an attempt to lock the doors using the entry function or wireless remote control is made when a door is not fully closed, a buzzer will sound continuously for 5 seconds. Fully close the door to stop the buzzer, and lock the doors again.

■ **Alarm (if equipped)**

Locking the doors will set the alarm system. (→P.65)

■ **Conditions affecting the operation of the smart key system or wireless remote control**

→P.104

■ **If the smart key system or the wireless remote control does not operate properly**

Use the mechanical key to lock and unlock the doors. (→P.364)

Replace the key battery with a new one if it is depleted. (→P.311)

■ **If the battery is discharged**

The doors cannot be locked and unlocked using the smart key sys-

tem or wireless remote control. Lock or unlock the doors using the mechanical key. (→P.364)

■ Rear seat reminder function

In order to remind you not to forget luggage, etc. in the rear seat, when the engine switch is turned off after any of the following conditions are met, a buzzer will sound and a message will be displayed on the multi-information display for approximately 6 seconds.

Also, as the second reminder, when the doors are locked, a buzzer will sound and the emergency flashers will flash for a few seconds, and a message will be displayed on the multi-information display.

- The engine is started within approximately 10 minutes after opening and closing a rear door.
- A rear door has been opened and closed after the engine was started.

However, if a rear door is opened and then closed within approximately 2 seconds, the rear seat reminder function may not operate.

The rear seat reminder function determines that luggage, etc. has been placed in a rear seat based on opening and closing of a rear door. Therefore, depending on the situation, the rear seat reminder function may not operate and you may still forget luggage, etc. in the rear seat, or it may operate unnecessarily.

■ Customization

Some functions can be customized. (→P.396)



WARNING

■ To prevent an accident

Observe the following precautions while driving the vehicle. Failure to do so may result in a door opening and an occupant being thrown out of the vehicle, resulting in death or serious injury.

- Ensure that all doors are properly closed and locked.
- Do not pull the inside door handle while driving. Be especially careful of the front doors, as the doors may be opened even if the inside lock buttons are in the locked position.
- Set the rear door child-protector locks when children are seated in the rear seats.

■ When opening or closing a door

Check the surroundings of the vehicle such as whether the vehicle is on an incline, whether there is enough space for a door to open and whether a strong wind is blowing. When opening or closing the door, hold the door handle tightly to prepare for any unpredictable movement.

■ When using the wireless remote control and operating the power windows

Operate the power windows after checking to make sure that there is no possibility of any passenger having any of their body parts caught in the windows. Also, do not allow children to operate the wireless remote control. It is possible for children and other passengers to get caught in the power windows.

Unlocking and locking the doors from the inside

■ **Door lock switches (to lock/unlock)**

► For driver's side

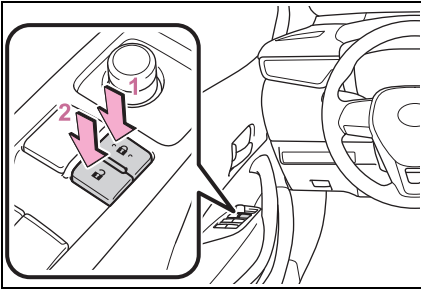

► For passenger's side

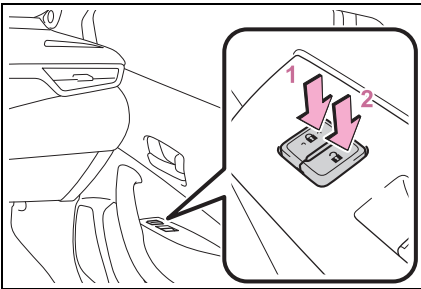

- 1 Locks all the doors
- 2 Unlocks all the doors

■ **Inside lock buttons**

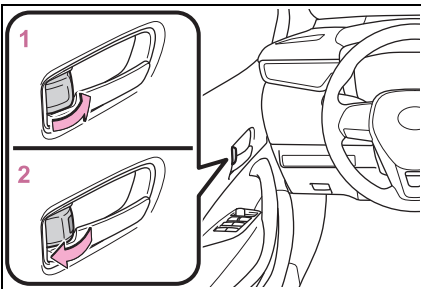

- 1 Locks the door
- 2 Unlocks the door

The front doors can be opened by

pulling the inside handle even if the lock buttons are in the lock position.

■ **Locking the front doors from the outside without a key**

- 1 Move the inside lock button to the lock position.
- 2 Close the door.

The door cannot be locked if the engine switch is in ACC or ON, or the electronic key is left inside the vehicle.

The key may not be detected correctly and the door may be locked.

■ **Open door warning buzzer**

If a door or the back door is not fully closed, a buzzer will sound when the vehicle speed reaches 3 mph (5 km/h).

The open door(s) or back door is indicated on the multi-information display.

Rear door child-protector lock

The door cannot be opened from inside the vehicle when lock is set.

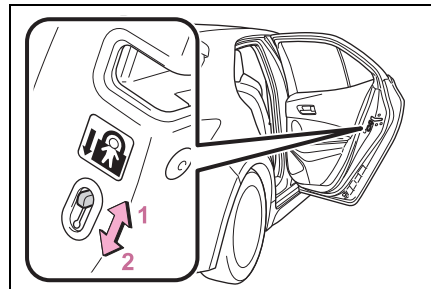

- 1 Unlock
- 2 Lock

These locks can be set to prevent children from opening the rear doors. Push down on each rear door switch to lock both rear doors.

Automatic door locking and unlocking systems

The following functions can be set or canceled:

For instructions on customizing, refer to P.396.

Function	Operation
Speed linked door locking function	All doors are automatically locked when vehicle speed is approximately 12 mph (20 km/h) or higher.
Shift position linked door locking function	All doors are automatically locked when shifting the shift lever out of P.
Shift position linked door unlocking function	All doors are automatically unlocked when shifting the shift lever to P.
Driver's door linked door unlocking function	All doors are automatically unlocked when driver's door is opened.

Back door

The back door can be locked/unlocked and opened by the following procedures.

WARNING

Observe the following precautions.

Failure to do so may result in death or serious injury.

■ Caution while driving

- Keep the back door closed while driving. If the back door is left open, it may hit near-by objects while driving or luggage may be unexpectedly thrown out, causing an accident. In addition, exhaust gases may enter the vehicle, causing death or a serious health hazard. Make sure to close the back door before driving.

- Before driving the vehicle, make sure that the back door is fully closed. If the back door is not fully closed, it may open unexpectedly while driving, causing an accident.

- Never let anyone sit in the luggage compartment. In the event of sudden braking or a collision, they are susceptible to death or serious injury.

■ When children are in the vehicle

- Do not allow children to play in the luggage compartment. If a child is accidentally locked in the luggage compartment, they could have heat exhaustion or other injuries.

WARNING

- Do not allow a child to open or close the back door. Doing so may cause the back door to move unexpectedly, or cause the child's hands, head, or neck to be caught by the closing back door.
- **Operating the back door**
- Remove any heavy loads, such as snow and ice, from the back door before opening it. Failure to do so may cause the back door to suddenly shut again after it is opened.
- When opening or closing the back door, thoroughly check to make sure the surrounding area is safe.
- If anyone is in the vicinity, make sure they are safe and let them know that the back door is about to open or close.
- Use caution when opening or closing the back door in windy weather as it may move abruptly in strong wind.
- The back door may suddenly shut if it is not opened fully. It is more difficult to open or close the back door on an incline than on a level surface, so beware of the back door unexpectedly opening or closing by itself. Make sure that the back door is fully open and secure before using the luggage compartment.

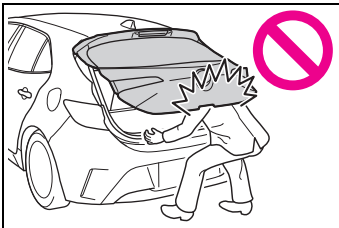

- When closing the back door, take extra care to prevent your fingers etc. from being caught.

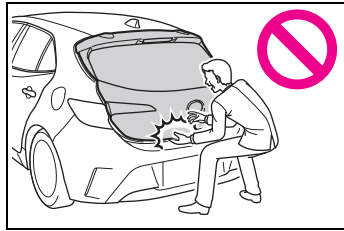

- When closing the back door, make sure to press it lightly on its outer surface. If the back door handle is used to fully close the back door, it may result in hands or arms being caught.
- Do not pull on the back door damper stay to close the back door, and do not hang on the back door damper stay. Doing so may cause hands to be caught or the back door damper stay to break, causing an accident.
- If a bicycle carrier or similar heavy object is attached to the back door, it may suddenly shut again after being opened, causing someone's hands, head or neck to be caught and injured. When installing an accessory part to the back door, using a genuine Toyota part is recommended.

Unlocking and locking the back door from the outside

■ Entry function

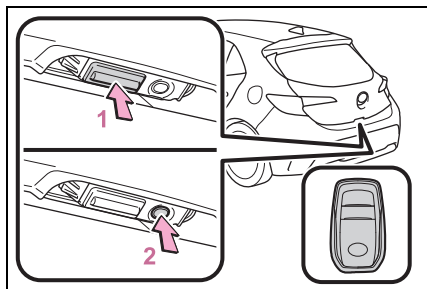

- 1 Press the button to unlock the back door.

The door cannot be unlocked for 3 seconds after the door is locked.

- 2 Press the button to lock the back door.

Check that the door is securely locked.

■ Wireless remote control

→P.95

■ Operation signals

→P.96

Unlocking and locking the back door from the inside

■ Door lock switches

→P.98

Opening/closing the back door

■ Open

Raise the back door while push-

ing up the back door opener switch.

The back door cannot be closed immediately after the back door opener switch is pushed.

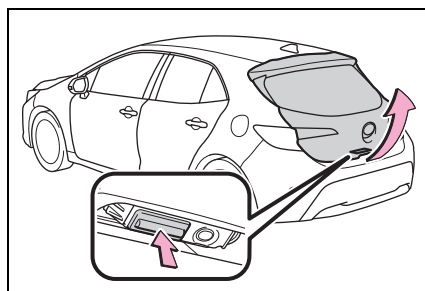

■ Close

Lower the back door using the back door handle, and make sure to push the back door down from the outside to close it.

Be careful not to pull the back door sideways when closing the back door with the handle.

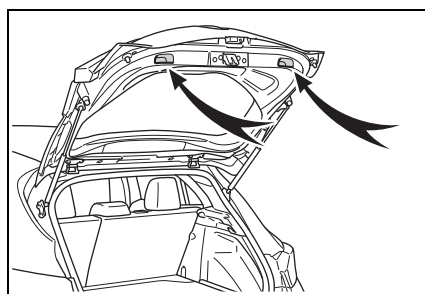

■ Open door warning buzzer

→P.98

■ Luggage compartment light

The luggage compartment light turns on when the back door is opened.

 NOTICE

■ **Back door damper stays**

The back door is equipped with damper stays that hold the back door in place.

Observe the following precautions.

Failure to do so may cause damage to the back door damper stay, resulting in malfunction.

- Do not attach any foreign objects, such as stickers, plastic sheets, or adhesives to the damper stay rod.

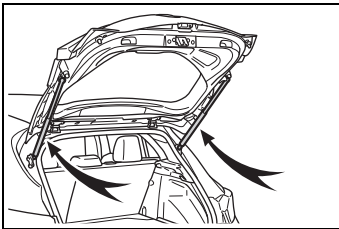

- Do not touch the damper stay rod with gloves or other fabric items.
- Do not attach any accessories other than genuine Toyota parts to the back door.
- Do not place your hand on the damper stay or apply lateral forces to it.

Smart key system

The following operations can be performed simply by carrying the electronic key on your person, for example in your pocket. The driver should always carry the electronic key.

- Locks and unlocks the doors (→P.95)
- Locks and unlocks the back door (→P.101)
- Starts the engine (→P.133)

■ **Antenna location**

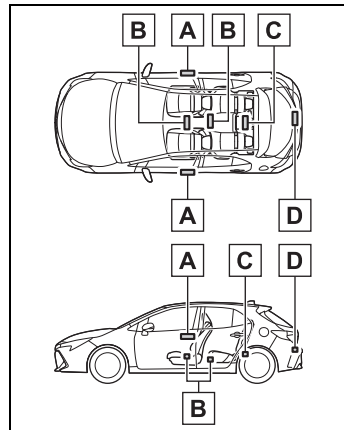

- A** Antennas outside the cabin
- B** Antennas inside the cabin
- C** Antenna inside the luggage compartment
- D** Antenna outside the luggage compartment

■ Effective range (areas within which the electronic key is detected)

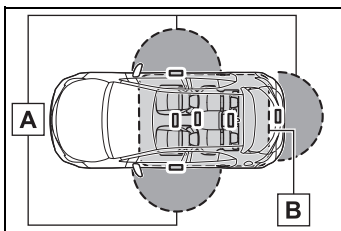

A When locking or unlocking the doors

The system can be operated when the electronic key is within about 2.3 ft. (0.7 m) of an outside front door handle and back door. (Only the doors detecting the key can be operated.)

B When starting the engine or changing engine switch modes

The system can be operated when the electronic key is inside the vehicle.

■ Alarms and warning messages

A combination of exterior and interior buzzers as well as warning messages shown on the multi-information display are used to prevent theft of the vehicle and accidents resulting from erroneous operation. Take appropriate measures based on the displayed message. (→P.338)

When only an alarm sounds, circumstances and correction procedures are as follows.

- Exterior buzzer sounds once for 5 seconds

Situation	Correction procedure
An attempt was made to lock the vehicle while a door was open.	Close all of the doors and lock the doors again.

- Interior buzzer sounds continuously

Situation	Correction procedure
The engine switch was turned to ACC while the driver's door was open (or the driver's door was opened while the engine switch was in ACC).	Turn the engine switch off and close the driver's door.
The engine switch was turned to off while the driver's door was open.	Close the driver's door

■ Battery-saving function



The battery-saving function will be activated in order to prevent the electronic key battery and the vehicle battery from being discharged while the vehicle is not operated for a long time.

- In the following situations, the smart key system may take some time to unlock the doors. Also the illuminated entry system may not operate properly.
 - The electronic key has been left within approximately 11 ft. (3.5 m) of the outside of the vehicle for 40 seconds or longer.
 - The smart key system has not been used for 5 days or longer.
 - If the smart key system has not been used for 14 days or longer, the doors cannot be unlocked from any door except the driver's

door. In this case, hold the driver's door handle, or use the wireless remote control or mechanical key to unlock the doors.

■ Electronic key battery-saving function

- When battery-saving mode is set, battery depletion is minimized by stopping the electronic key from receiving radio waves.

Press  twice while pressing and holding . Confirm that the electronic key indicator flashes 4 times.

While the battery-saving mode is set, the smart key system cannot be used. To cancel the function, press any of the electronic key buttons.

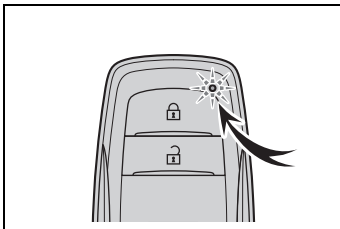

- Electronic keys that will not be used for long periods of time can be set to the battery-saving mode in advance.

■ Conditions affecting operation

The smart key system uses weak radio waves. In the following situations, the communication between the electronic key and the vehicle may be affected, preventing the smart key system, wireless remote control and engine immobilizer system from operating properly.

- When the electronic key battery is depleted
- Near a TV tower, electric power plant, gas station, radio station, large display, airport or other facility that generates strong radio waves or electrical noise
- When carrying a portable radio, cellular phone, cordless phone or other wireless communication

device

- When the electronic key is in contact with, or is covered by the following metallic objects
 - Cards to which aluminum foil is attached
 - Cigarette boxes that have aluminum foil inside
 - Metallic wallets or bags
 - Coins
 - Hand warmers made of metal
 - Media such as CDs and DVDs
- When other wireless keys (that emit radio waves) are being used nearby
- When carrying the electronic key together with the following devices that emit radio waves
 - Another vehicle's electronic key or a wireless key that emits radio waves
 - Personal computers or personal digital assistants (PDAs)
 - Digital audio players
 - Portable game systems
- If window tint with a metallic content or metallic objects are attached to the rear window
- When the electronic key is placed near a battery charger or electronic devices
- When the vehicle is parked in a pay parking spot where radio waves are emitted

If the doors cannot be locked/unlocked using the smart key system, lock/unlock the doors by performing any of the following:

- Bring the electronic key close to either front door handle and operate the entry function.
- Operate the wireless remote control.

If the doors cannot be locked/unlocked using the above methods, use the mechanical key. (→P.364)

If the engine cannot be started using the smart key system, refer to P.365.

■ Note for the entry function

- Even when the electronic key is within the effective range (detection areas), the system may not operate properly in the following cases:
 - The electronic key is too close to the window or outside door handle, near the ground, or in a high place when the doors are locked or unlocked.
 - The electronic key is on the instrument panel, luggage cover or floor, or in the door pockets or glove box when the engine is started or engine switch modes are changed.
- Do not leave the electronic key on top of the instrument panel or near the door pockets when exiting the vehicle. Depending on the radio wave reception conditions, it may be detected by the antenna outside the cabin and the door will become lockable from the outside, possibly trapping the electronic key inside the vehicle.
- As long as the electronic key is within the effective range, the doors may be locked or unlocked by anyone. However, only the doors detecting the electronic key can be used to unlock the vehicle.
- Even if the electronic key is not inside the vehicle, it may be possible to start the engine if the electronic key is near the window.
- The doors may unlock or lock if a large amount of water splashes on the door handle, such as in the rain or in a car wash when the electronic key is within the effective range. (The doors will automatically be locked after approximately 60 seconds if the doors are not opened and closed.)
- If the wireless remote control is used to lock the doors when the electronic key is near the vehicle, there is a possibility that the door may not be unlocked by the entry function. (Use the wireless remote control to unlock the doors.)
- Touching the door lock or unlock sensor while wearing gloves may prevent lock or unlock operation.
- When the lock operation is performed using the lock sensor, recognition signals will be shown up to two consecutive times. After this, no recognition signals will be given.
- If the door handle becomes wet while the electronic key is within the effective range, the door may lock and unlock repeatedly. In that case, follow the following correction procedures to wash the vehicle:
 - Place the electronic key in a location 6 ft. (2 m) or more away from the vehicle. (Take care to ensure that the key is not stolen.)
 - Set the electronic key to battery-saving mode to disable the smart key system. (→P.104)
- If the electronic key is inside the vehicle and a door handle becomes wet during a car wash, a message may be shown on the multi-information display and a buzzer will sound outside the vehicle. To turn off the alarm, lock all the doors.
- The lock sensor may not work properly if it comes into contact with ice, snow, mud, etc. Clean the lock sensor and attempt to operate it again.
- A sudden handle operation or a handle operation immediately after entering the effective range may prevent the doors from being unlocked. Touch the door unlock sensor and check that the doors are unlocked before pulling the door handle again.
- If there is another electronic key in the detection area, it may take slightly longer to unlock the doors after the door handle is gripped.

■ When the vehicle is not driven for extended periods

- To prevent theft of the vehicle, do not leave the electronic key within 6 ft. (2 m) of the vehicle.
- The smart key system can be deactivated in advance. (→P.396)
- Setting the electronic key to battery-saving mode helps to reduce key battery depletion. (→P.104)

■ To operate the system properly

Make sure to carry the electronic key when operating the system. Do not get the electronic key too close to the vehicle when operating the system from the outside of the vehicle.

Depending on the position and holding condition of the electronic key, the key may not be detected correctly and the system may not operate properly. (The alarm may go off accidentally, or the door lock prevention function may not operate.)

■ If the smart key system does not operate properly

- Locking and unlocking the doors: →P.364
- Starting the engine: →P.365

■ Customization

Some functions can be customized. (→P.396)

■ If the smart key system has been deactivated in a customized setting

- Locking and unlocking the doors: Use the wireless remote control or mechanical key. (→P.95, 364)
- Starting the engine and changing engine switch modes: →P.365
- Stopping the engine: →P.134



WARNING

■ Caution regarding interference with electronic devices

- People with implantable cardiac pacemakers, cardiac resynchronization therapy-pacemakers or implantable cardioverter defibrillators should keep away from the smart key system antennas. (→P.102)

The radio waves may affect the operation of such devices. If necessary, the entry function can be disabled. Ask your Toyota dealer for details, such as the frequency of radio waves and timing of the emitted radio waves. Then, consult your doctor to see if you should disable the entry function.

- Users of any electrical medical device other than implantable cardiac pacemakers, cardiac resynchronization therapy-pacemakers or implantable cardioverter defibrillators should consult the manufacturer of the device for information about its operation under the influence of radio waves.

Radio waves could have unexpected effects on the operation of such medical devices.

Ask your Toyota dealer for details on disabling the entry function.

Front seats

Adjustment procedure

▶ Manual seat

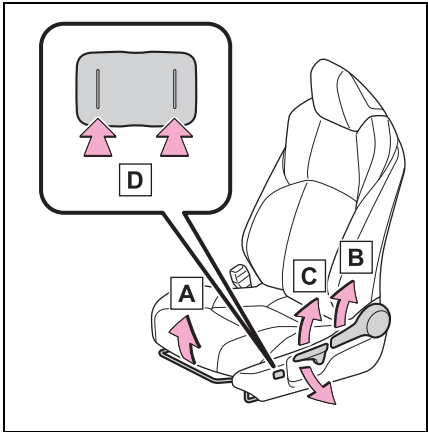

- A** Seat position adjustment lever
- B** Seatback angle adjustment lever
- C** Vertical height adjustment lever (driver's side only)
- D** Lumbar support adjustment switch* (driver's side only)

*: If equipped

▶ Power seat (driver's side only)

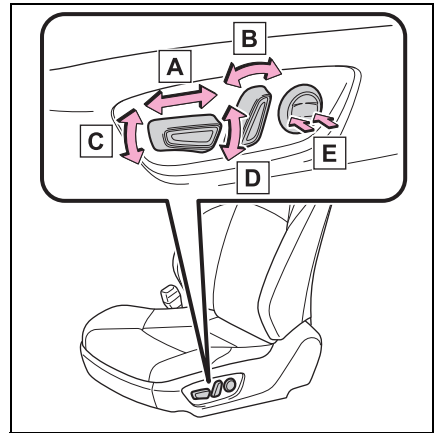

- A** Seat position adjustment switch
- B** Seatback angle adjustment switch
- C** Seat cushion (front) angle adjustment switch
- D** Vertical height adjustment switch
- E** Lumbar support adjustment switch

⚠ WARNING

- **When adjusting the seat position**
 - Take care when adjusting the seat position to ensure that other passengers are not injured by the moving seat.
 - Do not put your hands under the seat or near the moving parts to avoid injury. Fingers or hands may become jammed in the seat mechanism.
 - Make sure to leave enough space around the feet so they do not get stuck.

⚠ WARNING

■ **Seat adjustment**

- Be careful that the seat does not hit passengers or luggage.
- To reduce the risk of sliding under the lap belt during a collision, do not recline the seat more than necessary. If the seat is too reclined, the lap belt may slide past the hips and apply restraint forces directly to the abdomen, or your neck may contact the shoulder belt, increasing the risk of death or serious injury in the event of an accident. Adjustments should not be made while driving as the seat may unexpectedly move and cause the driver to lose control of the vehicle.
- Manual seat only: After adjusting the seat, make sure that the seat is locked in position.

⚠ NOTICE

■ **When adjusting a front seat**

When adjusting a front seat, make sure that the head restraint does not contact the headliner. Otherwise, the head restraint and headliner may be damaged.

Rear seats

The seatbacks of the rear seats can be folded down.

Folding down the rear seatbacks

- 1 Move the front seats forward. (→P.107)
- 2 Stow the rear armrest. (→P.263)
- 3 Lower the rear center seat head restraint to the lowest position. (→P.110)
- 4 Fold the rear outside seat head restraints. (→P.110)
- 5 Pull the seatback lock release lever and fold the seatback down.

Each seatback may be folded separately.

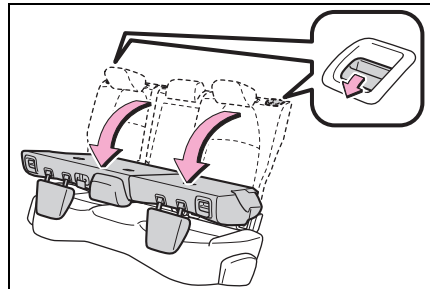

⚠ WARNING

Observe the following precautions. Failure to do so may result in death or serious injury.

⚠ WARNING**■ When folding the rear seatbacks down**

- Do not fold the seatbacks down while driving.
- Stop the vehicle on level ground, set the parking brake and shift the shift lever to P.
- Do not allow anyone to sit on a folded seatback or in the luggage compartment while driving.
- Do not allow children to enter the luggage compartment.
- Do not allow anyone to sit on the rear center seat if the rear right seat is folded down, as the seat belt buckle for the rear center seat belt is then concealed under the folded seat and cannot be used.
- Be careful not to get your hand caught when folding the rear seatbacks.
- Adjust the position of the front seats before folding down the rear seatbacks so that the front seats do not interfere with the rear seatbacks when folding down the rear seatbacks.

■ After returning the rear seatback to the upright position

- Make sure that the seatback is securely locked in position by lightly pushing it back and forth.

If the seatback is not securely locked, the red marking will be visible on the seatback lock release lever. Make sure that the red marking is not visible.

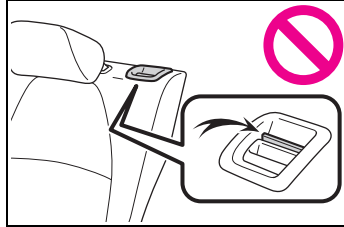

- Check that the seat belts are not twisted or caught in the seatback.

If the seat belt gets caught between the seatback's securing hook and latch, it may damage the seat belt.

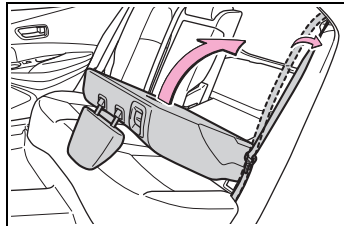

Head restraints

Head restraints are provided for all seats.

⚠ WARNING

■ Head restraint precautions

Observe the following precautions regarding the head restraints. Failure to do so may result in death or serious injury.

- Use the head restraints designed for each respective seat.
- Adjust the head restraints to the correct position at all times.
- After adjusting the head restraints, push down on them and make sure they are locked in position.
- Do not drive with the head restraints removed.

Adjusting a head restraint

■ Front seats

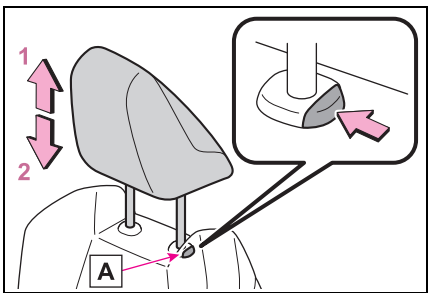

- 1 Up**
Pull the head restraints up.
- 2 Down**
Push the head restraint down while pressing the lock release button **A**.

■ Rear outside seats

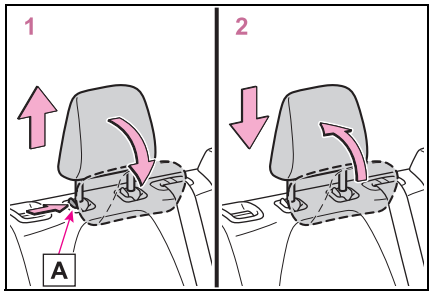

- 1 Folding the rear outside seat head restraints**
Pull the head restraint up while pressing only the right-side lock release button **A** and then fold it forward.
- 2 Setting up the rear outside seat head restraints**
Fold back the head restraint and then push it down to the lock position.

■ Rear center seat

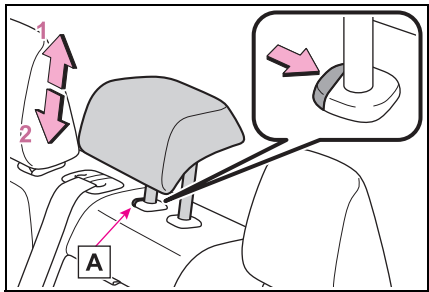

- 1 Up**
Pull the head restraint up.
- 2 Down**
Push the head restraint down while pressing the lock release button **A**.

■ Adjusting the height of the head restraints (front seats)

Make sure that the head restraints are adjusted so that the center of

the head restraint is closest to the top of your ears.

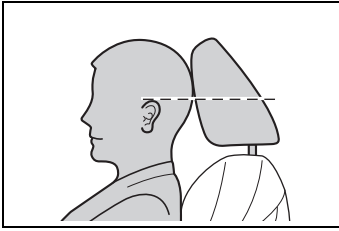

■ Adjusting the rear center seat head restraint

Always raise the head restraint one level from the stowed position when using.

Removing the head restraints

■ Front seats

Pull the head restraint up while pressing the lock release button

A.

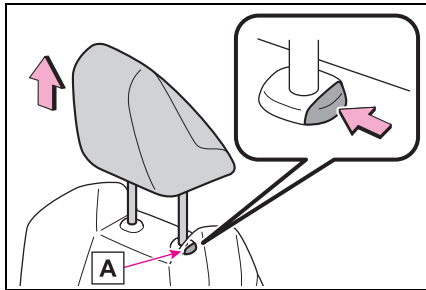

■ Rear outside seats

Pull the head restraint up while pressing the lock release buttons **A**.

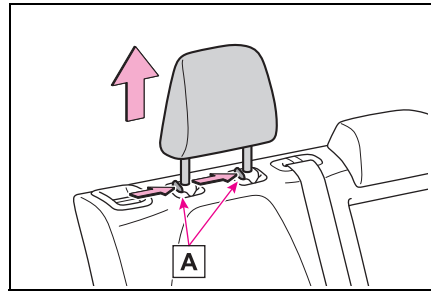

■ Rear center seat

Pull the head restraint up while pressing the lock release button

A.

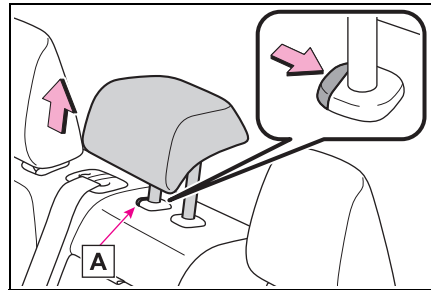

Installing the head restraints

■ Front seats

Align the head restraint with the installation holes and push it down to the lock position.

Press and hold the lock release button **A** when lowering the head restraint.

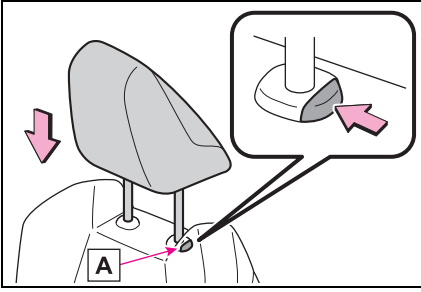

■ Rear outside seats

Align the head restraint with the installation holes and push it down to the lock position.

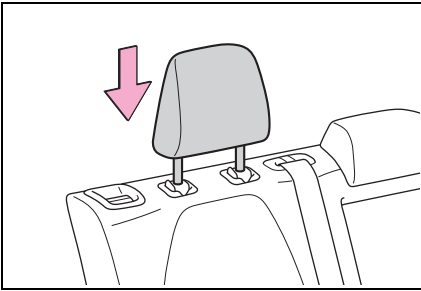

■ Rear center seat

Align the head restraint with the installation holes and push it down to the lock position.

Press and hold the lock release button **A** when lowering the head restraint.

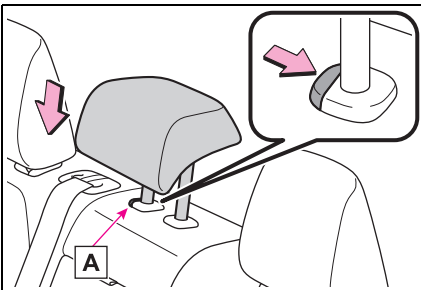

Steering wheel

Adjustment procedure

- 1 Hold the steering wheel and push the lever down.

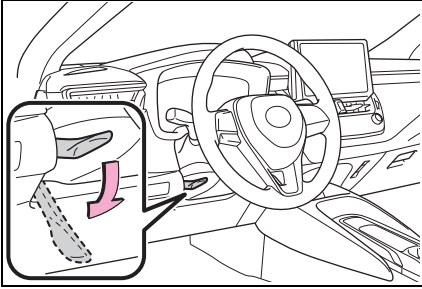

- 2 Adjust to the ideal position by moving the steering wheel horizontally and vertically.

After adjustment, pull the lever up to secure the steering wheel.

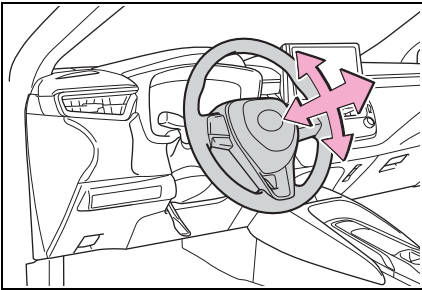

WARNING

■ Caution while driving

Do not adjust the steering wheel while driving. Doing so may cause the driver to mishandle the vehicle and cause an accident, resulting in death or serious injury.

■ After adjusting the steering wheel

Make sure that the steering wheel is securely locked.

Otherwise, the steering wheel may move suddenly, possibly causing an accident, and resulting in death or serious injury. Also, the horn may not sound if the steering wheel is not securely locked.

Horn

To sound the horn, press on or close to the  mark.

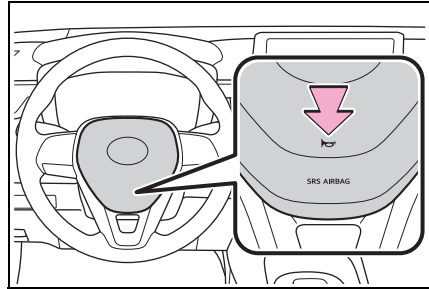

Inside rear view mirror

The rear view mirror's position can be adjusted to enable sufficient confirmation of the rear view.

Adjusting the height of rear view mirror

The height of the rear view mirror can be adjusted to suit your driving posture.

Adjust the height of the rear view mirror by moving it up and down.

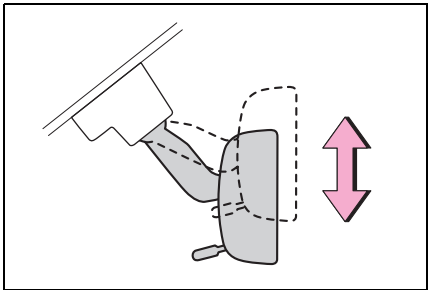

⚠ WARNING

■ **Caution while driving**

Do not adjust the position of the mirror while driving. Doing so may lead to mishandling of the vehicle and cause an accident, resulting in death or serious injury.

Anti-glare function

Reflected light from the headlights of vehicles behind can be reduced by operating the lever.

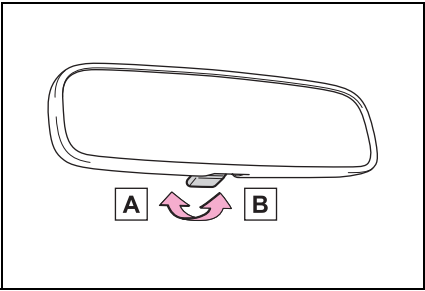

- A** Normal position
- B** Anti-glare position

Outside rear view mirrors

The rear view mirror's position can be adjusted to enable sufficient confirmation of the rear view.

■ When using the outside rear view mirrors in a cold weather

When it is cold and the outside rear view mirrors are frozen, it may not be possible to fold/extend them or adjust the mirror surface. Remove the ice, snow, etc. covering the outside rear view mirrors.

⚠ WARNING

■ Important points while driving

Observe the following precautions while driving. Failure to do so may result in loss of control of the vehicle and cause an accident, resulting in death or serious injury.

- Do not adjust the mirrors while driving.
- Do not drive with the mirrors folded.
- Both the driver and passenger side mirrors must be extended and properly adjusted before driving.

Adjustment procedure

- 1 To select a mirror to adjust, turn the switch.

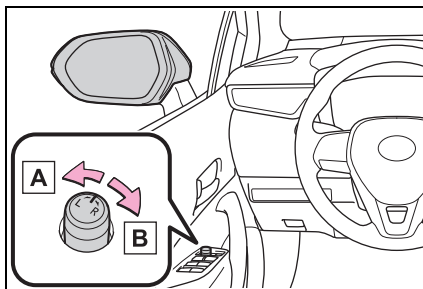

- A Left
- B Right

- 2 To adjust the mirror, operate the switch.

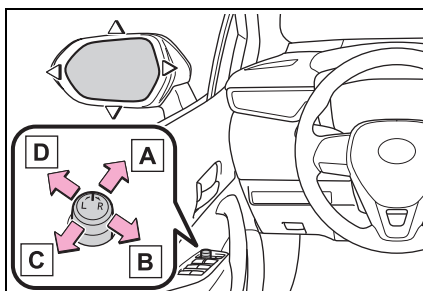

- A Up
- B Right
- C Down
- D Left

■ Mirror angle can be adjusted when

The engine switch is in ACC or ON.

■ When the mirrors are fogged up

The outside rear view mirrors can be cleared using the mirror defoggers. Turn on the rear window defogger to turn on the outside rear view mirror defoggers. (→P.243)

**WARNING****■ When the mirror defoggers are operating**

Do not touch the rear view mirror surfaces, as they can become very hot and burn you.

Folding and extending the mirrors

Push the mirror back in the direction of the vehicle's rear.

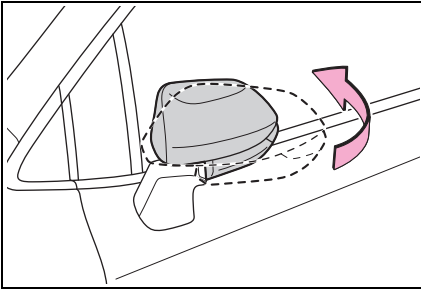

Power windows

Opening and closing the power windows

The power windows can be opened and closed using the switches.

Operating the switch moves the windows as follows:

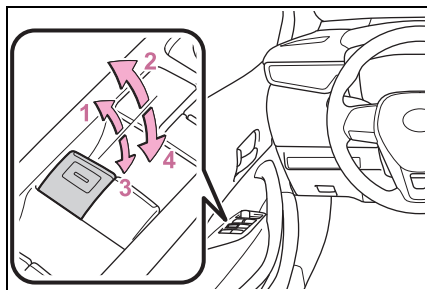

- 1 Closing
- 2 One-touch closing*
- 3 Opening
- 4 One-touch opening*

*: To stop the window partway, operate the switch in the opposite direction.

■ The power windows can be operated when

The engine switch is in ON.

■ Operating the power windows after turning the engine off

The power windows can be operated for approximately 45 seconds after the engine switch is turned to ACC or OFF. They cannot, however, be operated once either front door is opened.

■ Jam protection function

If an object becomes jammed between the window and the win-

ow frame while the window is closing, window movement is stopped and the window is opened slightly.

■ Catch protection function

If an object becomes caught between the door and window while the window is opening, window movement is stopped.

■ When the window cannot be opened or closed

When the jam protection function or catch protection function operates unusually and the door window cannot be opened or closed, perform the following operations with the power window switch of that door.

- Stop the vehicle. With the engine switch in ON, within 4 seconds of the jam protection function or catch protection function activating, continuously operate the power window switch in the one-touch closing direction or one-touch opening direction so that the door window can be opened and closed.
- If the door window cannot be opened and closed even when performing the above operations, perform the following procedure for function initialization.

- 1 Turn the engine switch to ON.
- 2 Pull and hold the power window switch in the one-touch closing direction and completely close the door window.
- 3 Release the power window switch for a moment, resume pulling the switch in the one-touch closing direction, and hold it there for approximately 6 seconds or more.
- 4 Press and hold the power window switch in the one-touch opening direction. After the door window is completely opened, continue holding the switch for an additional 1 second or more.
- 5 Release the power window switch for a moment, resume

pushing the switch in the one-touch opening direction, and hold it there for approximately 4 seconds or more.

- 6 Pull and hold the power window switch in the one-touch closing direction again. After the door window is completely closed, continue holding the switch for a further 1 second or more.

If you release the switch while the window is moving, start again from the beginning.

If the window reverses and cannot be fully closed or opened, have the vehicle inspected by your Toyota dealer.

■ Door lock linked window operation

- The power windows can be opened and closed using the mechanical key.* (→P.365)
- The power windows can be opened using the wireless remote control.* (→P.95)

*: These settings must be customized at your Toyota dealer.

■ Power windows open warning buzzer

A buzzer sounds and a message is shown on the multi-information display in the instrument cluster when the engine switch is turned off and the driver's door is opened with the power windows open.

■ Customization

Some functions can be customized. (→P.396)

⚠ WARNING
Observe the following precautions. Failure to do so may result in death or serious injury.

■ Closing the windows

- The driver is responsible for all the power window operations, including the operation for the passengers. In order to prevent accidental operation, especially by a child, do not let a child operate the power windows. It is possible for children and other passengers to have body parts caught in the power window. Also, when riding with a child, it is recommended to use the window lock switch. (→P.119)
- Check to make sure that all passengers do not have any part of their body in a position where it could be caught when a window is being operated.

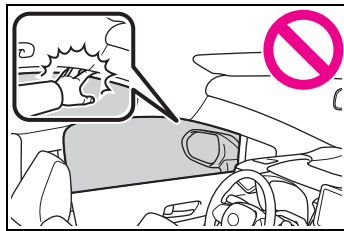

- When using the wireless remote control or mechanical key and operating the power windows, operate the power window after checking to make sure that there is no possibility of any passenger having any of their body parts caught in the window. Also do not let a child operate window by the wireless remote control or mechanical key. It is possible for children and other passengers to get caught in the power window.
- When exiting the vehicle, turn the engine switch off, carry the key and exit the vehicle along with the child. There may be accidental operation, due to mischief, etc., that may possibly lead to an accident.

WARNING

■ Jam protection function

- Never use any part of your body to intentionally activate the jam protection function.
- The jam protection function may not work if something gets jammed just before the window is fully closed. Be careful not to get any part of your body jammed in the window.

■ Catch protection function

- Never use any part of your body or clothing to intentionally activate the catch protection function.
- The catch protection function may not work if something gets caught just before the window is fully opened. Be careful not to get any part of your body or clothing caught in the window.

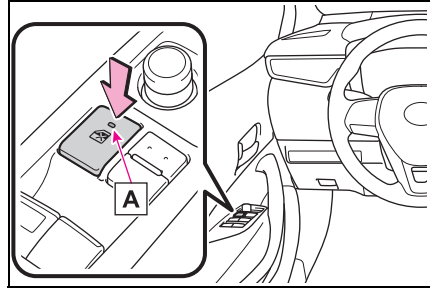

■ The power windows can be operated when

The engine switch is in ON.

■ When the battery is disconnected

The window lock switch is disabled. If necessary, press the window lock switch after reconnecting the battery.

Preventing accidental operation (window lock switch)

This function can be used to prevent children from accidentally opening or closing a passenger window.

Press the switch.

The indicator  will come on and the passenger windows will be locked.

The passenger windows can still be opened and closed using the driver's switch even if the lock switch is on.

My Settings

Drivers are identified using devices such as electronic keys to store the vehicle settings for each. Then the information can be recalled the next time the vehicle is driven.

Authentication devices can be assigned in advance to drivers so that they can drive using their preferred settings.

Settings for 3 drivers can be stored in My Settings.

For information on authentication devices registration/deletion, changing the driver's name, initializing driver registered settings, manually switching drivers and deleting drivers registration refer to the "MULTIMEDIA OWNER'S MANUAL".

Types of assigned authentication devices

An individual can be identified using the following authentication devices.

- **Electronic key**

An individual is identified when the smart entry & start system detects their electronic key. (→P.102)

- **Bluetooth® device**

An individual is identified when a Bluetooth® device is connected to the audio system. For information on how to connect Bluetooth® devices, refer to the "MULTIMEDIA OWNER'S MANUAL". When an individual is identified with an electronic key identifying using a Bluetooth® device is not performed.

Bluetooth is a registered trademark of Bluetooth SIG, Inc.

Recalled functions

When an individual is identified from an authentication device, settings for the following functions are recalled.

- **Meter displays and audio system information***

When an individual is identified, the display settings used when the engine switch was last turned off are recalled.

- **Vehicle settings that can be set using the audio system***

When an individual is identified, the vehicle settings used when the engine switch was last turned off are recalled.

*: Some settings are excluded

4-1. Before driving

Driving the vehicle.....	122
Cargo and luggage	128
Vehicle load limits	131
Trailer towing.....	131
Dinghy towing	132

4-2. Driving procedures

Engine (ignition) switch	133
Continuously variable trans- mission.....	137
Turn signal lever.....	142
Parking brake.....	143
Brake Hold	146

4-3. Operating the lights and wipers

Headlight switch.....	148
AHB (Automatic High Beam).....	150
Fog light switch	153
Windshield wipers and washer.....	154
Rear window wiper and washer.....	155

4-4. Refueling

Opening the fuel tank cap	157
------------------------------------	-----

4-5. Using the driving support systems

Toyota Safety Sense 3.0 software update.....	159
---	-----

Toyota Safety Sense 3.0	161
PCS (Pre-Collision System)	167
LTA (Lane Tracing Assist)	177
LDA (Lane Departure Alert)	182
PDA (Proactive driving assist).....	189
Dynamic radar cruise con- trol	195
Cruise control	206
Emergency Driving Stop System	210
RSA (Road Sign Assist)	212
BSM (Blind Spot Monitor)	215
RCTA (Rear Cross Traffic Alert) function	220
Safe Exit Assist	225
Driving mode select switch	229
Driving assist systems	230

4-6. Driving tips

Winter driving tips.....	235
--------------------------	-----

Driving the vehicle

The following procedures should be observed to ensure safe driving:

Driving procedure

■ Starting the engine

→P.133

■ Driving

- 1 With the brake pedal depressed, shift the shift lever to D. (→P.137)
- 2 Release the parking brake. (→P.143)

If the parking brake is in automatic mode, the parking brake will be released automatically. (→P.143)

- 3 Gradually release the brake pedal and gently depress the accelerator pedal to accelerate the vehicle.

■ Stopping

- 1 With the shift lever in D, depress the brake pedal.
- 2 If necessary, set the parking brake. (→P.143)

If the vehicle is to be stopped for an extended period of time, shift the shift lever to P. (→P.137)

■ Parking the vehicle

- 1 With the shift lever in D, depress the brake pedal to stop the vehicle completely.
- 2 Set the parking brake (→P.143), and shift the shift lever to P. (→P.137)

Make sure the parking brake indicator light is on.

Do not press the shift release button after shifting the shift position to P.

- 3 Press the engine switch to stop the engine.
- 4 Slowly release the brake pedal.
- 5 Lock the door, making sure that you have the key on your person.

If parking on a hill, block the wheels as needed.

■ Starting off on a steep uphill

- 1 Make sure that the parking brake is set and shift the shift lever to D.
- 2 Gently depress the accelerator pedal.
- 3 Release the parking brake.

■ Driving in the rain

- Drive carefully when it is raining, because visibility will be reduced, the windows may become fogged-up, and the road will be slippery.
- Drive carefully when it starts to rain, because the road surface will be especially slippery.
- Refrain from high speeds when driving on an expressway in the rain, because there may be a layer of water between the tires and the road surface, preventing the steering and brakes from operating properly.

■ Engine speed while driving

In the following conditions, the engine speed may become high while driving. This is due to auto-

matic up-shifting control or down-shifting implementation to meet driving conditions. It does not indicate sudden acceleration.

- The vehicle is judged to be driving uphill or downhill
- When the accelerator pedal is released
- When the brake pedal is depressed while sport mode is selected

■ Restraining the engine output (Brake Override System)

- When the accelerator and brake pedals are depressed at the same time, the engine output may be restrained.
- A warning message is displayed on the multi-information display while the system is operating.

■ Breaking in your new Toyota

To extend the life of the vehicle, observing the following precautions is recommended:

- For the first 186 miles (300 km):
Avoid sudden stops.
- For the first 621 miles (1000 km):
 - Do not drive at extremely high speeds.
 - Avoid sudden acceleration.
 - Do not drive continuously in low gears.
 - Do not drive at a constant speed for extended periods.

■ Operating your vehicle in a foreign country

Comply with the relevant vehicle registration laws and confirm the availability of the correct fuel. (→P.377)



WARNING

Observe the following precautions. Failure to do so may result in death or serious injury.

■ When starting the vehicle

Always keep your foot on the brake pedal while stopped with the engine running. This prevents the vehicle from creeping.

■ When driving the vehicle

- Do not drive if you are unfamiliar with the location of the brake and accelerator pedals to avoid depressing the wrong pedal.
- Accidentally depressing the accelerator pedal instead of the brake pedal will result in sudden acceleration that may lead to an accident.
- When backing up, you may twist your body around, leading to a difficulty in operating the pedals. Make sure to operate the pedals properly.
- Make sure to keep a correct driving posture even when moving the vehicle only slightly. This allows you to depress the brake and accelerator pedals properly.
- Depress the brake pedal using your right foot. Depressing the brake pedal using your left foot may delay response in an emergency, resulting in an accident.
- Do not drive the vehicle over or stop the vehicle near flammable materials. The exhaust system and exhaust gases can be extremely hot. These hot parts may cause a fire if there is any flammable material nearby.

**WARNING**

- During normal driving, do not turn off the engine. Turning the engine off while driving will not cause loss of steering or braking control, but the power assist to these systems will be lost. This will make it more difficult to steer and brake, so you should pull over and stop the vehicle as soon as it is safe to do so. However, in the event of an emergency, such as if it becomes impossible to stop the vehicle in the normal way:
→P.320
- Use engine braking (downshift) to maintain a safe speed when driving down a steep hill. Using the brakes continuously may cause the brakes to overheat and lose effectiveness. (→P.137)
- Do not adjust the positions of the steering wheel, the seat, or the inside or outside rear view mirrors while driving. Doing so may result in a loss of vehicle control.
- Always check that all passengers' arms, heads or other parts of their body are not outside the vehicle.
- Do not drive in excess of the speed limit. Even if the legal speed limit permits it, do not drive over 85 mph (140 km/h) unless your vehicle has high-speed capability tires. Driving over 85 mph (140 km/h) may result in tire failure, loss of control and possible injury. Be sure to consult a tire dealer to determine whether the tires on your vehicle are high-speed capability tires or not before driving at such speeds.

■ When driving on slippery road surfaces

- Sudden braking, acceleration and steering may cause tire slippage and reduce your ability to control the vehicle.
- Sudden acceleration, engine braking due to shifting, or changes in engine speed could cause the vehicle to skid.
- After driving through a puddle, lightly depress the brake pedal to make sure that the brakes are functioning properly. Wet brake pads may prevent the brakes from functioning properly. If the brakes on only one side are wet and not functioning properly, steering control may be affected.

■ When shifting the shift lever

- Do not let the vehicle roll backward while a forward driving position is selected, or roll forward while the shift lever is in R. Doing so may cause the engine to stall or lead to poor brake and steering performance, resulting in an accident or damage to the vehicle.
- Do not shift the shift lever to P while the vehicle is moving. Doing so can damage the transmission and may result in a loss of vehicle control.
- Do not shift the shift lever to R while the vehicle is moving forward. Doing so can damage the transmission and may result in a loss of vehicle control.
- Do not shift the shift lever to a driving position while the vehicle is moving backward. Doing so can damage the transmission and may result in a loss of vehicle control.

**WARNING**

- Moving the shift lever to N while the vehicle is moving will disengage the engine from the transmission. Engine braking is not available when N is selected.
- Be careful not to shift the shift lever with the accelerator pedal depressed. Shifting the shift lever to any positions other than P or N may lead to unexpected rapid acceleration of the vehicle that may cause an accident and result in death or serious injury.

■ **If you hear a squealing or scraping noise (brake pad wear indicators)**

Have the brake pads checked and replaced by your Toyota dealer as soon as possible.

Rotor damage may result if the pads are not replaced when needed.

It is dangerous to drive the vehicle when the wear limits of the brake pads and/or those of the brake discs are exceeded.

■ **When the vehicle is stopped**

- Do not race the engine. If the vehicle is in any gear other than P or N, the vehicle may accelerate suddenly and unexpectedly, causing an accident.
- In order to prevent accidents due to the vehicle rolling away, always keep depressing the brake pedal while the engine is running, and apply the parking brake as necessary.
- If the vehicle is stopped on an incline, in order to prevent accidents caused by the vehicle rolling forward or backward, always depress the brake pedal and securely apply the parking brake as needed.

- Avoid revving or racing the engine. Running the engine at high speed while the vehicle is stopped may cause the exhaust system to overheat, which could result in a fire if combustible material is nearby.

■ **When the vehicle is parked**

- Do not leave glasses, cigarette lighters, spray cans, or soft drink cans in the vehicle when it is in the sun. Doing so may result in the following:
 - Gas may leak from a cigarette lighter or spray can, and may lead to a fire.
 - The temperature inside the vehicle may cause the plastic lenses and plastic material of glasses to deform or crack.
 - Soft drink cans may fracture, causing the contents to spray over the interior of the vehicle, and may also cause a short circuit in the vehicle's electrical components.
- Do not leave cigarette lighters in the vehicle. If a cigarette lighter is in a place such as the glove box or on the floor, it may be lit accidentally when luggage is loaded or the seat is adjusted, causing a fire.
- Do not attach adhesive discs to the windshield or windows. Do not place containers such as air fresheners on the instrument panel or dashboard. Adhesive discs or containers may act as lenses, causing a fire in the vehicle.

**WARNING**

- Do not leave a door or window open if the curved glass is coated with a metallized film such as a silver-colored one. Reflected sunlight may cause the glass to act as a lens, causing a fire.
- Always apply the parking brake, shift the shift lever to P, stop the engine and lock the vehicle. Do not leave the vehicle unattended while the engine is running. If the vehicle is parked with the shift lever in P but the parking brake is not set, the vehicle may start to move, possibly leading to an accident.

- Do not touch the exhaust pipes while the engine is running or immediately after turning the engine off. Doing so may cause burns.

■ When taking a nap in the vehicle

Always turn the engine off. Otherwise, if you accidentally move the shift lever or depress the accelerator pedal, this could cause an accident or fire due to engine overheating. Additionally, if the vehicle is parked in a poorly ventilated area, exhaust gases may collect and enter the vehicle, leading to death or a serious health hazard.

■ When braking

- When the brakes are wet, drive more cautiously. Braking distance increases when the brakes are wet, and this may cause one side of the vehicle to brake differently than the other side. Also, the parking brake may not securely hold the vehicle.

- If the brake booster device does not operate, do not follow other vehicles closely and avoid hills or sharp turns that require braking.

In this case, braking is still possible, but the brake pedal should be depressed more firmly than usual. Also, the braking distance will increase. Have your brakes fixed immediately.

- Do not pump the brake pedal if the engine stalls. Each push on the brake pedal uses up the reserve for the power-assisted brakes.
- The brake system consists of 2 individual hydraulic systems; if one of the systems fails, the other will still operate. In this case, the brake pedal should be depressed more firmly than usual and the braking distance will increase. Have your brakes fixed immediately.

■ If the vehicle becomes stuck

Do not spin the wheels excessively when a driven wheel is up in the air, or the vehicle is stuck in sand, mud, etc. This may damage the driveline components or propel the vehicle forward or backward, causing an accident.

**NOTICE****■ When driving the vehicle**

- Do not depress the accelerator and brake pedals at the same time during driving, as this may restrain the engine output.
- Do not use the accelerator pedal or depress the accelerator and brake pedals at the same time to hold the vehicle on a hill.

**NOTICE****■ When parking the vehicle**

Always set the parking brake and shift the shift lever to P. Failure to do so may cause the vehicle to move or the vehicle may accelerate suddenly if the accelerator pedal is accidentally depressed.

■ Avoiding damage to vehicle parts

- Do not turn the steering wheel fully in either direction and hold it there for an extended period of time.
Doing so may damage the power steering motor.

- When driving over bumps in the road, drive as slowly as possible to avoid damaging the wheels, underside of the vehicle, etc.

■ If you get a flat tire while driving

A flat or damaged tire may cause the following situations. Hold the steering wheel firmly and gradually depress the brake pedal to slow down the vehicle.

- It may be difficult to control your vehicle.
- The vehicle will make abnormal sounds or vibrations.
- The vehicle will lean abnormally.

Information on what to do in case of a flat tire (→P.343,354)

■ When encountering flooded roads

Do not drive on a road that has flooded after heavy rain etc. Doing so may cause the following serious damage to the vehicle:

- Engine stalling
- Short in electrical components

- Engine damage caused by water immersion

In the event that you drive on a flooded road and the vehicle becomes flooded or stuck in mud or sand, be sure to have your Toyota dealer check the following:

- Brake function
- Changes in the quantity and quality of the engine oil, transaxle fluid, etc.
- Lubricant condition for the bearings and suspension joints (where possible), and the function of all joints, bearings, etc.

Sudden start restraint control (Drive-Start Control [DSC])

When the following unusual operation is performed with the accelerator pedal depressed, the engine output may be restrained.

- When the shift lever is shifted to R*.
- When the shift lever is shifted from P or R to forward drive shift position such as D*.

When the system operates, a message appears on the multi-information display. Read the message and follow the instruction.

*: Depending on the situation, the shift position may not be changed.

■ Drive-Start Control (DSC)

When the TRAC is turned off

(→P.232), sudden start restraint control also does not operate. If your vehicle have trouble escaping from the mud or fresh snow due to sudden start restraint control operation, deactivate TRAC (→P.232) so that the vehicle may become able to escape from the mud or fresh snow.

Cargo and luggage

Take notice of the following information about storage precautions, cargo capacity and load:

Capacity and distribution

Cargo capacity depends on the total weight of the occupants.

(Cargo capacity) = (Total load capacity) — (Total weight of occupants)

Steps for Determining Correct Load Limit —

- (1) Locate the statement “The combined weight of occupants and cargo should never exceed XXX kg or XXX lbs.” on your vehicle’s placard.
- (2) Determine the combined weight of the driver and passengers that will be riding in your vehicle.
- (3) Subtract the combined weight of the driver and passengers from XXX kg or XXX lbs.
- (4) The resulting figure equals the available amount of cargo and luggage load capacity.

For example, if the “XXX” amount equals 1400 lbs. and there will be five 150 lb passengers in your vehicle, the amount of available cargo and luggage load capacity is 650 lbs. (1400 –

750 (5 × 150) = 650 lbs.)

(5) Determine the combined weight of luggage and cargo being loaded on the vehicle. That weight may not safely exceed the available cargo and luggage load capacity calculated in Step 4.

(6) If your vehicle will be towing a trailer, load from your trailer will be transferred to your vehicle. Consult this manual to determine how this reduces the available cargo and luggage load capacity of your vehicle. (→P.376)

Toyota does not recommend towing a trailer with your vehicle. Your vehicle is not designed for trailer towing.

Calculation formula for your vehicle

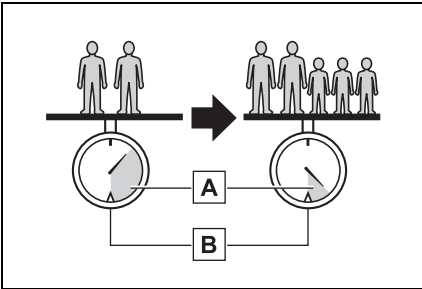

- A** Cargo capacity
- B** Total load capacity (vehicle capacity weight) (→P.376)

When 2 people with the combined weight of A lb. (kg) are riding in your vehicle, which has a

total load capacity (vehicle capacity weight) of B lb. (kg), the available amount of cargo and luggage load capacity will be C lb. (kg) as follows:

$$B^{*2} \text{ lb. (kg)} - A^{*1} \text{ lb. (kg)} = C^{*3} \text{ lb. (kg)}$$

*1: A =Weight of people

*2: B =Total load capacity

*3: C =Available cargo and luggage load

In this condition, if 3 more passengers with the combined weight of D lb. (kg) get on, the available cargo and luggage load will be reduced E lb. (kg) as follows:

$$C \text{ lb. (kg)} - D^{*4} \text{ lb. (kg)} = E^{*5} \text{ lb. (kg)}$$

*4: D =Additional weight of people

*5: E =Available cargo and luggage load

As shown in the example above, if the number of occupants increases, the cargo and luggage load will be reduced by an amount that equals the increased weight due to the additional occupants. In other words, if an increase in the number of occupants causes an excess of the total load capacity (combined weight of occupants plus cargo and luggage load), you must reduce the cargo and luggage on your vehicle.

**WARNING****■ Things that must not be carried in the luggage compartment**

The following things may cause a fire if loaded in the luggage compartment:

- Receptacles containing gasoline
- Aerosol cans

■ Storage precautions

Observe the following precautions.

Failure to do so may prevent the pedals from being depressed properly, may block the driver's vision, or may result in items hitting the driver or passengers, possibly causing an accident.

- Stow cargo and luggage in the luggage compartment whenever possible.
- Do not place cargo or luggage in or on the following locations.
 - At the feet of the driver
 - On the front passenger or rear seats (when stacking items)
 - On the luggage cover
 - On the instrument panel
 - On the dashboard
- Secure all items in the occupant compartment.

■ Capacity and distribution

- Do not exceed the maximum axle weight rating or the total vehicle weight rating.

- Even if the total load of occupant's weight and the cargo load is less than the total load capacity, do not apply the load unevenly. Improper loading may cause deterioration of steering or braking control which may cause death or serious injury.

Vehicle load limits

Vehicle load limits include total load capacity, seating capacity, towing capacity and cargo capacity.

- Total load capacity (vehicle capacity weight): →P.376

Total load capacity means the combined weight of occupants, cargo and luggage.

- Seating capacity: →P.376

Seating capacity means the maximum number of occupants whose estimated average weight is 150 lb. (68 kg) per person.

- Towing capacity

Toyota does not recommend towing a trailer with your vehicle.

- Cargo capacity

Cargo capacity may increase or decrease depending on the weight and the number of occupants.

■ **Total load capacity and seating capacity**

These details are also described on the tire and loading information label. (→P.306)

**WARNING**

■ **Overloading the vehicle**

Do not overload the vehicle. It may not only cause damage to the tires, but also degrade steering and braking ability, resulting in an accident.

Trailer towing

Toyota does not recommend towing a trailer with your vehicle. Toyota also does not recommend the installation of a tow hitch or the use of a tow hitch carrier for a wheelchair, scooter, bicycle, etc. Your vehicle is not designed for trailer towing or for the use of tow hitch mounted carriers.



Dinghy towing

Your vehicle is not designed to be dinghy towed (with 4 wheels on the ground) behind a motor home.

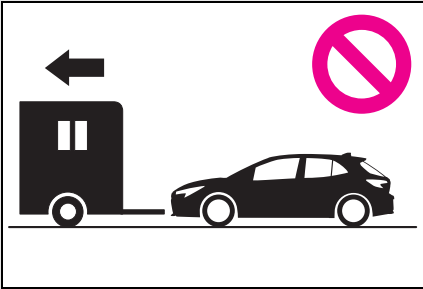

 NOTICE

■ **To avoid serious damage to your vehicle**

Do not tow your vehicle with the four wheels on the ground.

Engine (ignition) switch

Performing the following operations when carrying the electronic key on your person starts the engine or changes engine switch modes.

Starting the engine

- 1 Pull the parking brake switch to check that the parking brake is set. (→P.143)

The parking brake indicator will come on.

- 2 Check that the shift lever is set in P.
- 3 Firmly depress the brake pedal.

 and a message will be displayed on the multi-information display. If it is not displayed, the engine cannot be started.

- 4 Press the engine switch shortly and firmly.

When operating the engine switch, one short, firm press is enough. It is not necessary to press and hold the switch.

The engine will crank until it starts or for up to 30 seconds, whichever is less.

Continue depressing the brake pedal until the engine is completely started.

The engine can be started from any

engine switch mode.

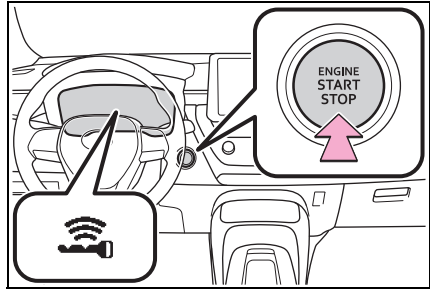

■ Engine switch illumination

According to the situation, the engine switch illumination operates as follows:

- When a door is opened, or the engine switch mode is changed from ACC or ON to off, the engine switch illumination comes on.
- When depressing the brake pedal with carrying the electronic key on your person, the engine switch illumination blinks.
- When the engine switch mode is in ACC or ON, the engine switch illumination is constantly illuminated.

■ If the engine does not start

- The engine immobilizer system may not have been deactivated. (→P.64)
Contact your Toyota dealer.
- If a message related to start-up is shown on the multi-information display, read the message and follow the instructions.

■ If the battery is discharged

The engine cannot be started using the smart key system. Refer to P.366 to restart the engine.

■ Electronic key battery depletion

→P.92

■ Conditions affecting operation

→P.104

■ **Notes for the entry function**

→P.105

■ **Electronic key battery**

→P.311

■ **Operation of the engine switch**

- If the switch is not pressed shortly and firmly, the engine switch mode may not change or the engine may not start.
- If attempting to restart the engine immediately after turning the engine switch off, the engine may not start in some cases. After turning the engine switch off, please wait a few seconds before restarting the engine.

■ **Customization**

If the smart key system has been deactivated in a customized setting, refer to P.364.



WARNING

■ **When starting the engine**

Always start the engine while sitting in the driver's seat. Do not depress the accelerator pedal while starting the engine under any circumstances. Doing so may cause an accident resulting in death or serious injury.



NOTICE

■ **When starting the engine**

- Do not race a cold engine.
- If the engine becomes difficult to start or stalls frequently, have your vehicle checked by your Toyota dealer immediately.

■ **Symptoms indicating a malfunction with the engine switch**

If the engine switch seems to be operating somewhat differently than usual, such as the switch sticking slightly, there may be a malfunction. Contact your Toyota dealer immediately.

Stopping the engine

- 1 Stop the vehicle completely.
- 2 Set the parking brake (→P.143), and shift the shift lever to P.

Check the parking brake indicator is illuminated.

Do not press the shift release button after shifting the shift position to P.

- 3 Press the engine switch shortly and firmly.

The engine will stop, and the meter display will be extinguished.

- 4 Release the brake pedal and check that "ACCESSORY", "IGNITION ON" or "POWER ON" is not shown on the multi-information display.

■ **Automatic engine shut off feature**

- The vehicle is equipped with a feature that automatically shuts off the engine when the shift lever is in P with the engine running for an extended period.
- The engine will automatically shut off after approximately 1 hour if it has been left running while the shift lever is in P.
- The timer for the automatic engine shut off feature will reset if the

brake pedal is depressed, or if the shift lever is in a position other than P.

- After the vehicle is parked, if the door is locked with the door lock switch (→P.98) from the inside or the mechanical key (→P.364) from the outside, the automatic engine shut off feature will be disabled. The timer for the automatic engine shut off feature will be re-enabled if the driver's door is opened.



WARNING

■ **Stopping the engine in an emergency**

- If you want to stop the engine in an emergency while driving the vehicle, press and hold the engine switch for more than 2 seconds, or press it briefly 3 times or more in succession. (→P.320)
However, do not touch the engine switch while driving except in an emergency. Turning the engine off while driving will not cause loss of steering or braking control, but the power assist to these systems will be lost. This will make it more difficult to steer and brake, so you should pull over and stop the vehicle as soon as it is safe to do so.
- If the engine switch is operated while the vehicle is running, a warning message will be shown on the multi-information display and a buzzer sounds.
- To restart the engine after performing an emergency shut-down, shift the shift lever to N and then press the engine switch.

■ **When parking**

Exhaust gases include harmful carbon monoxide (CO), which is colorless and odorless. Observe the following precautions.

Failure to do so may cause exhaust gases to enter the vehicle and may lead to an accident caused by light-headedness, or may lead to death or a serious health hazard.

- If the vehicle is in a poorly ventilated area or a closed area, such as a garage, stop the engine.
- Do not leave the vehicle with the engine running for a long time. If such a situation cannot be avoided, park the vehicle in an open space and ensure that exhaust fumes do not enter the vehicle interior.
- Do not leave the engine running in an area with snow build-up, or where it is snowing. If snowbanks build up around the vehicle while the engine is running, exhaust gases may collect and enter the vehicle.

Changing engine switch modes

Modes can be changed by pressing the engine switch with brake pedal released. (The mode changes each time the switch is pressed.)

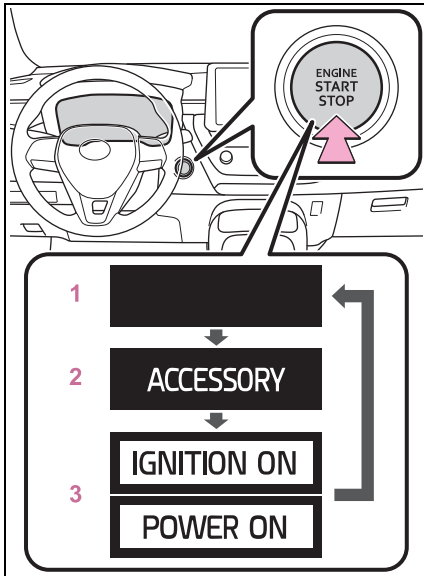

1 OFF^{*1}

The emergency flashers can be used.

2 ACC^{*2}

Some electrical components such as the audio system can be used. "ACCESSORY" will be displayed on the multi-information display.

3 ON

All electrical components can be used.

"IGNITION ON" or "POWER ON" will be displayed on the multi-information display.

^{*1}: If the shift lever is in a position other than P or the shift release button is pressed when turning off the engine, the engine switch will be remained to ON, not to off.

^{*2}: ACC mode can be enabled/disabled on the customize menu. (→P.396)

■ Auto power off function

If the vehicle is left in ACC or ON (the engine is not running) for more than 20 minutes with the shift lever is in P or the shift release button is not pressed, the engine switch will automatically turn to OFF.

However, this function cannot entirely prevent battery discharge. Do not leave the vehicle with the engine switch in ACC or ON for long periods of time when the engine is not running.

■ When ACC customization is in off

With the engine switch turned off, the multimedia system can still be used for a certain time until the battery saving function starts operating.

⚠ NOTICE

■ To prevent battery discharge

- Do not leave the engine switch in ACC or ON for long periods of time without the engine running.
- If "ACCESSORY", "IGNITION ON" or "POWER ON" is displayed on the multi-information display, the engine switch is not off. Exit the vehicle after turning the engine switch off.

When stopping the engine with the shift lever in a position other than P

If the engine is stopped when the shift lever is in a position other than P or the shift release button is pressed, the engine switch will not be turned off. Perform the following procedure to turn the switch off:

- 1 Check that the parking brake is set.
- 2 Shift the shift lever to P.

Do not press the shift release button after shifting the shift position to P.

- 3 Check that “IGNITION ON” or “POWER ON” is displayed on the multi-information display and press the engine switch shortly and firmly.
- 4 Check that “ACCESSORY” , “IGNITION ON” or “POWER ON” on the multi-information display are off.

 **NOTICE**

■ To prevent battery discharge
Do not stop the engine with the shift lever in a position other than P or the shift release button pressed. If the engine is stopped with the shift lever in a position other than P or the shift release button pressed, the engine switch will not be turned off and remained to ON. If the vehicle is left in ON, battery discharge may occur.

Continuously variable transmission

Select the shift position depending on your purpose and situation.

Shift position purpose and functions

Shift position	Objective or function
P	Parking the vehicle/starting the engine
R	Reversing
N	Neutral (Condition in which the power is not transmitted)
D	Normal driving*
M	10-speed sport sequential shiftmatic mode driving (→P.140)

*: To improve fuel efficiency and reduce noise, shift the shift lever to D for normal driving.

■ To protect the continuously variable transmission

If the continuously variable transmission fluid temperature is high, “Transmission Oil Temp. High Stop in a safe place and See owner’s manual” will be displayed on the multi-information display and the vehicle will go into transmission protection mode automatically. Have the vehicle inspected by your Toyota dealer.

■ **When driving with dynamic radar cruise control activated**

Even when switching the driving mode to sport mode with the intent of enabling engine braking, engine braking will not occur because dynamic radar cruise control range will not be canceled. (→P.229)

■ **Restraining sudden start (Drive-Start Control)**

→P.127

■ **G AI-SHIFT**

G AI-SHIFT automatically selects a suitable gear for sporty driving according to driver's input and driving conditions. G AI-SHIFT operates automatically when the shift lever is in D and sport mode is selected for the driving mode. (Selecting normal mode or shifting the shift lever to the M position cancels this function.)

■ **After recharging/reconnecting the battery**

→P.368

⚠ WARNING

■ **When driving on slippery road surfaces**

Do not accelerate or shift the shift gears suddenly. Sudden changes in engine braking may cause the vehicle to spin or skid, resulting in an accident.

Shifting the shift lever

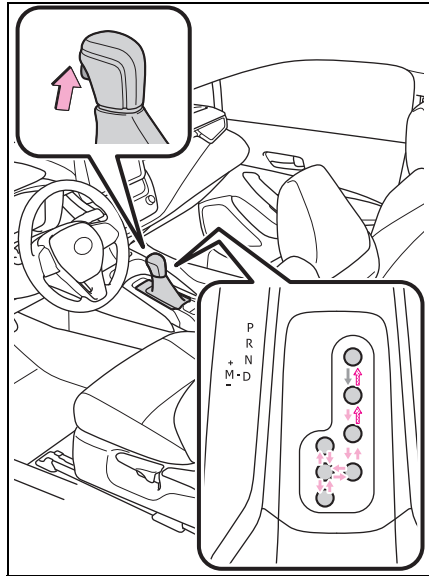

←:While the engine switch is in ON and the brake pedal depressed*, shift the shift lever while pushing the shift release button on the shift knob.

↔:Shift the shift lever while pushing the shift release button on the shift knob.

←:Shift the shift lever normally.

When shifting the shift lever between P and D, make sure that the vehicle is completely stopped and the brake pedal is depressed.

*: For the vehicle be able to be shifted from P, the brake pedal must be depressed before the shift release button is pushed. If the shift release button is pushed first, the shift lock will not be released.

■ **Shift lock system**

The shift lock system is a system to prevent accidental operation of the shift lever in starting.

The shift lever can be shifted from P only when the engine switch is in ON and the brake pedal is being depressed.

■ **If the shift lever cannot be shifted from P**

First, check whether the brake pedal is being depressed.

If the shift lever cannot be shifted with your foot on the brake pedal, there may be a problem with the shift lock system. Have the vehicle inspected by your Toyota dealer immediately.

The following steps may be used as an emergency measure to ensure that the shift lever can be shifted.

Releasing the shift lock:

- 1 Set the parking brake.
- 2 Turn the engine switch off.
- 3 Depress the brake pedal.
- 4 Ply the cover up with a flathead screwdriver or equivalent tool. To prevent damaging the cover, wrap the tip of the flathead screwdriver with a tape.

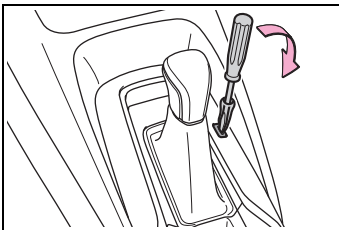

- 5 Press and hold the shift lock override button and then push the button on the shift knob.

The shift lever can be shifted while

the button is pressed.

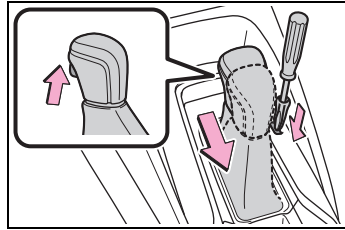

⚠ WARNING

■ **To prevent an accident when releasing the shift lock**

Before pressing the shift lock override button, make sure to set the parking brake and depress the brake pedal.

If the accelerator pedal is accidentally depressed instead of the brake pedal when the shift lock override button is pressed and the shift lever is shifted out of P, the vehicle may suddenly start, possibly leading to an accident resulting in death or serious injury.

Selecting the driving mode

→P.229

Selecting shift ranges in the D position (vehicles with paddle shift switches)

To drive using temporary shift range selection, operate the “-” or “+” paddle shift switch. When the “-” paddle shift switch is operated, the shift range switches to a range that enables engine braking force that is suitable to driving conditions. When the “+” paddle shift switch is

operated, the shift range switches to a range that is one range higher than the current range.

Changing the shift range allows restriction of the highest gear, preventing unnecessary upshifting and enabling the level of engine braking force to be selected.

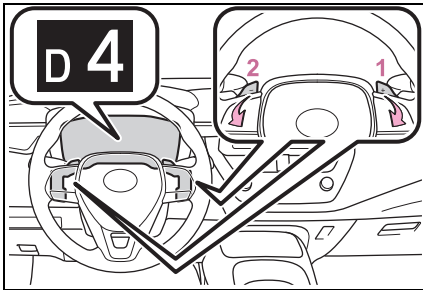

- 1 Upshifting
- 2 Downshifting

The selected shift range, from D1 to D10, will be displayed on the multi-information display.

■ Gear step functions

- You can choose from 10 levels of engine braking force.
- A lower gear step will provide greater engine braking force than a higher gear step, and the engine speed will also increase.

■ Deactivation of temporary 10-speed Sport Sequential Shiftmatic mode (vehicles with paddle shift switches)

In the following situations, temporary 10-speed Sport Sequential Shiftmatic mode will be deactivated:

- When the vehicle is stopped
- If the accelerator pedal is depressed continuously for more than a certain amount of time

while in one gear range

- If the accelerator pedal is depressed abruptly and heavily
- When the shift lever is shifted to a position other than D
- When the “+” paddle shift switch is operated for a certain amount of time continuously

Changing gears in the M position

To enter 10-speed sport sequential shiftmatic mode, shift the shift lever to M position. Gear steps can then be selected by operating the shift lever or paddle shift switches (if equipped), allowing you to drive in the gear step of your choosing.

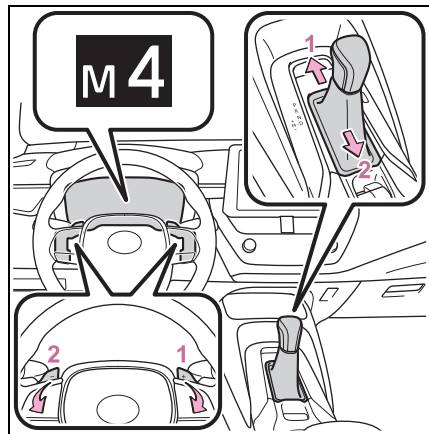

- 1 Upshifting
- 2 Downshifting

The gear changes once every time the shift lever or paddle shift switch is operated.

The selected gear step, from M1 to M10, will be displayed on the multi-information display.

However, even when in the M position, the gear steps will be automatically changed if the engine speed is too high, or too low.

■ Gear step functions

- You can choose from 10 levels of engine braking force.
- A lower gear step will provide greater engine braking force than a higher gear step, and the engine speed will also increase.

■ When the vehicle comes to a stop with the shift lever in the M position

- The transmission will automatically downshift to M1 once the vehicle is stopped.
- After a stop, the vehicle will start off in M1.
- When the vehicle is stopped, the transmission is set at M1.

■ Downshifting restriction warning buzzer

To help ensure safety and driving performance, downshifting operation may sometimes be restricted. In some circumstances, downshifting may not be possible even when the shift lever or paddle shift switch (if equipped) is operated. (A buzzer will sound twice.)

■ If the 10-speed sport sequential shiftmatic mode indicator does not come on even after shifting the shift lever to M

This may indicate a malfunction in the continuously variable transmission system. Have the vehicle inspected by your Toyota dealer immediately.

(In this situation, the transmission will operate in the same manner as when the shift lever is in D.)

■ Continuously variable transmission fail-safe control

The system detects malfunctioning parts targeted (all of the solenoids that perform the shifting function) by the On-Board Diagnostics, and performs fail-safe mechanisms, such as restricting the shifting function or transmission ratio control.

In this event, the malfunction indicator lamp turns on.

Turn signal lever

Operating instructions

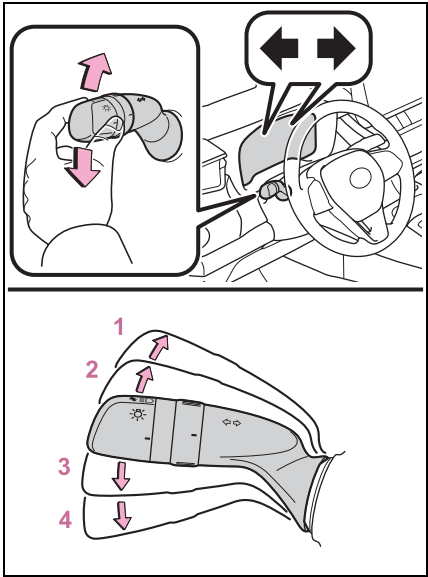

- 1 Right turn
- 2 Lane change to the right
(move the lever partway and release it)
- 3 Lane change to the left
(move the lever partway and release it)
- 4 Left turn

■ Turn signals can be operated when

The engine switch is in ON.

■ If the indicator flashes faster than usual

Check that all the turn signal lights are flashing.

When the indicators flash at an abnormally fast speed even though all the turn signal lights are flashing, have the vehicle inspected by your Toyota dealer.

■ Customization

Some functions can be customized. (→P.396)

Parking brake

The parking brake can be set or released automatically or manually.

In automatic mode, the parking brake can be set or released automatically according to shift lever operation.

Also, even in automatic mode, the parking brake can be set or released manually.

Operating instructions

■ Using the manual mode

The parking brake can be set and released manually.

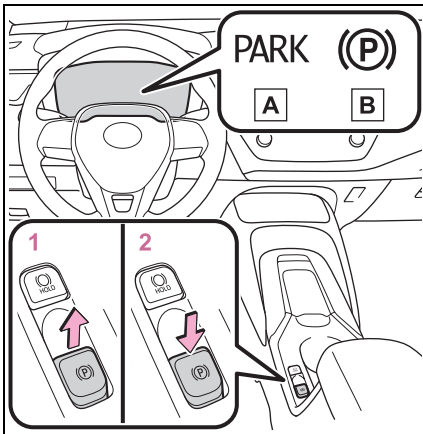

A U.S.A.

B Canada

1 Pull the switch to set the parking brake.

The parking brake indicator light will turn on.

Pull and hold the parking brake switch if an emergency occurs and it is necessary to operate the parking brake while driving.

2 Press the switch to release the parking brake.

- Operate the parking brake switch while depressing the brake pedal.
- Using the parking brake automatic release function, the parking brake can be released by depressing the accelerator pedal. When using this function, slowly depress the accelerator pedal. (→P.144)

Make sure that the parking brake indicator light turn off.

If the parking brake indicator light flash, operate the switch again. (→P.334)

■ Turning the automatic mode on

While the vehicle is stopped, pull and hold the parking brake switch until a buzzer sounds and a message is shown on the multi-information display.

When the automatic mode is turned on, the parking brake operates as follows.

- When the shift lever is shifted from P, the parking brake will be released, and the parking brake indicator light will turn off.
- When the shift lever is shifted to P, the parking brake will be set, and the parking brake indicator light will turn on.

Operate the shift lever with the vehicle stopped and the brake pedal depressed.

The auto function may not operate if the shift lever is moved extremely quickly. In this situation, apply the parking brake manually. (→P.143)

■ Turning the automatic mode off

While the vehicle is stopped and depressing the brake pedal, press and hold the parking brake switch until a buzzer sounds and a message is shown on the multi-information display.

■ Parking brake operation

- When the engine switch is not in ON, the parking brake cannot be released using the parking brake switch.
- When the engine switch is not in ON, automatic mode (automatic brake setting and releasing) is not available.

■ Parking brake automatic release function

When all of the following conditions are met, the parking brake can be released by depressing the accelerator pedal.

- The driver's door is closed
- The driver is wearing the seat belt
- The shift lever is in a forward driving position or reverse driving position
- The malfunction indicator lamp or brake system warning light is not illuminated.

When depressing the accelerator pedal, depress it slowly.

If the parking brake is not released

when the accelerator pedal is depressed, release the parking brake manually.

When the shift lever is shifted from P, the parking brake will be released automatically.

■ Parking brake automatic lock function

The parking brake will be set automatically under the following conditions:

- The brake pedal is not depressed
- The driver's door is open
- The driver's seat belt is not fastened
- The shift lever is in a position other than P or N
- The malfunction indicator lamp and brake system warning light are not illuminated

■ If "Parking Brake Temporarily Unavailable" is displayed on the multi-information display

If the parking brake is operated repeatedly over a short period of time, the system may restrict operation to prevent overheating. If this happens, refrain from operating the parking brake. Normal operation will return after about 1 minute.

■ If "Parking Brake Unavailable" is displayed on the multi-information display

Operate the parking brake switch. If the message does not disappear after operating the switch several times, the system may be malfunctioning. Have the vehicle inspected by your Toyota dealer.

■ Parking brake operation sound

When the parking brake operates, a motor sound (whirring sound) may be heard. This does not indicate a malfunction.

■ Parking brake indicator light

- Depending on the engine switch position/mode, the parking brake

indicator light will turn on and stay on as described below:

ON: Comes on until the parking brake is released.

Not in ON: Stays on for approximately 15 seconds.

- When the engine switch is turned off with the parking brake set, the parking brake indicator light will stay on for about 15 seconds. This does not indicate a malfunction.

■ **When the parking brake switch malfunctions**

Automatic mode (automatic brake setting and releasing) will be turned on automatically.

■ **Parking the vehicle**

→P.122

■ **Parking brake engaged warning buzzer**

A buzzer will sound if the vehicle is driven with the parking brake engaged. "Parking Brake ON" is displayed on the multi-information display (with the vehicle reaching a speed of 3 mph [5 km/h]).

■ **If the brake system warning light comes on**

→P.328

■ **Usage in winter time**

→P.235

 **WARNING**

■ **When parking the vehicle**
Do not leave a child in the vehicle alone. The parking brake may be released unintentionally by a child and there is the danger of the vehicle moving that may lead to an accident resulting in death or serious injury.

■ **Parking brake switch**
Do not set any objects near the parking brake switch. Objects may interfere with the switch and may lead the parking brake to unexpectedly operate.

■ **Parking brake automatic lock function**
Never use the automatic parking brake engagement function in place of normal parking brake operation. This function is designed to reduce the risk of a collision due to the driver forgetting to engage the parking brake. Over-reliance on this function to park the vehicle safely may lead to an accident resulting in death or serious injury.

 **NOTICE**

■ **When parking the vehicle**
Before you leave the vehicle, shift the shift lever to P, set the parking brake and make sure that the vehicle does not move.

■ **When the system malfunctions**
Stop the vehicle in a safe place and check the warning messages.

■ **When the vehicle battery is discharged**
The parking brake system cannot be activated. (→P.366)

■ **When the parking brake cannot be released due to a malfunction**
Driving the vehicle with the parking brake set will lead to brake components overheating, which may affect braking performance and increase brake wear.
Have the vehicle inspected by your Toyota dealer immediately if this occurs.

Brake Hold

The brake hold system keeps the brake applied when the shift lever is in D, M, N or P with the system on and the brake pedal has been depressed to stop the vehicle. The system releases the brake when the accelerator pedal is depressed with the shift lever in D or M to allow smooth start off.

Enabling the system

Turns the brake hold system on

The brake hold standby indicator (green) **A** comes on. While the system is holding the brake, the brake hold operated indicator (yellow) **B** comes on.

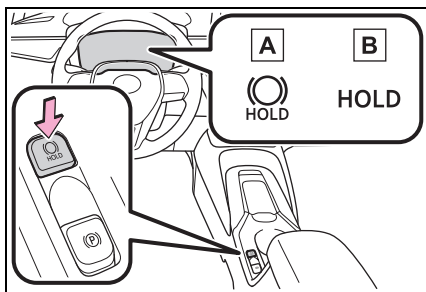

Brake hold system operating conditions

The brake hold system cannot be turned on in the following conditions:

- The driver's door is not closed.
- The driver is not wearing the seat belt.

If any of the conditions above are detected when the brake hold system is enabled, the system will turn off and the brake hold standby indicator light will go off. In addition, if any of the conditions are detected while the system is holding the brake, a warning buzzer will sound and a message will be shown on the multi-information display. The parking brake will then be set automatically.

Brake hold function

- If the brake pedal is left released for a period of about 3 minutes after the system has started holding the brake, the parking brake will be set automatically. In this case, a warning buzzer sounds and a message is shown on the multi-information display.
- To turn the system off while the system is holding the brake, firmly depress the brake pedal and press the button again.
- The brake hold function may not hold the vehicle when the vehicle is on a steep incline. In this situation, it may be necessary for the driver to apply the brakes. A warning buzzer will sound and the multi-information display will inform the driver of this situation. If a warning message is shown on the multi-information display, read the message and follow the instructions.
- When do not wish for the parking brake to operate automatically, press and hold the brake hold switch until the standby indicator (green) turns off, and then turn the engine switch off.

When the parking brake is set automatically while the system is holding the brakes

Perform any of the following operations to release the parking brake:

- Depress the accelerator pedal. (The parking brake will not be released automatically if the seat

belt is not fastened.)

- Operate the parking brake switch with the brake pedal depressed.

Make sure that the parking brake indicator light goes off. (→P.143)

■ When an inspection at your Toyota dealer is necessary

When the brake hold standby indicator (green) does not illuminate even when the brake hold switch is pressed with the brake hold system operating conditions met, the system may be malfunctioning. Have the vehicle inspected at your Toyota dealer.

■ If “Brake Hold Malfunction Press Brake to Deactivate Visit Your Dealer” or “Brake Hold Malfunction Visit Your Dealer” is displayed on the multi-information display

The system may be malfunctioning. Have the vehicle inspected by your Toyota dealer.

■ Warning messages and buzzers

Warning messages and buzzers are used to indicate a system malfunction or to inform the driver of the need for caution. If a warning message is shown on the multi-information display, read the message and follow the instructions.

■ If the brake hold operated indicator flashes

→P.335

WARNING

■ When the vehicle is on a steep incline

Take care when using the brake hold system on a steep incline, exercise caution. The brake hold function may not hold brakes in such situations.

Also, the system may not activate depending on the angle of the slope.

■ When stopped on a slippery road

The system cannot stop the vehicle when the gripping ability of the tires has been exceeded. Do not use the system when stopped on a slippery road.



NOTICE

■ When parking the vehicle

The brake hold system is not designed for use when parking the vehicle for a long period of time. Turning the engine switch off while the system is holding the brake may release the brake, which would cause the vehicle to move. When operating the engine switch, depress the brake pedal, shift the shift lever to P and set the parking brake.

Headlight switch

The headlights can be operated manually or automatically.

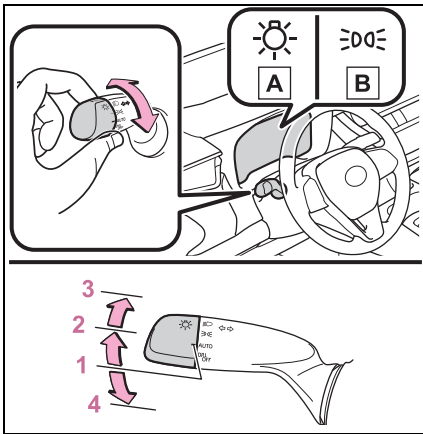

Operating instructions

Operating the  switch turns on the lights as follows:



A U.S.A.

B Canada

- 1  The headlights, daytime running lights (→P.148) and all the lights listed above turn on and off automatically.
- 2  The side marker, parking, tail, license plate, instrument panel lights, and daytime running lights (→P.148) turn on.
- 3  The headlights and all lights listed above (except daytime running lights) turn



on.

4  (U.S.A.) Off

■ **AUTO mode can be used when**

The engine switch is in ON.

■ **Daytime running light system**

- The daytime running lights illuminate using the same lights as the headlights and illuminate darker than the headlights.
- To make your vehicle more visible to other drivers during daytime driving, the daytime running lights turn on automatically when all of the following conditions are met. (The daytime running lights are not designed for use at night.)
 - The engine is running
 - The parking brake is released
 - The headlight switch is in the,  or  position

* : When the surroundings are bright

The daytime running lights remain on after they illuminate, even if the parking brake is set again.

- For the U.S.A.: Daytime running lights can be turned off by operating the switch.
- Compared to turning on the headlights, the daytime running light system offers greater durability and consumes less electricity, so it can help improve fuel economy.

■ **Headlight control sensor**

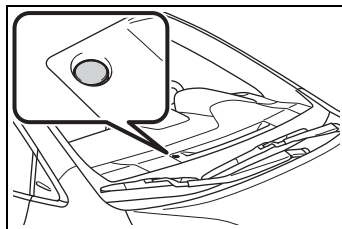

The sensor may not function properly if an object is placed on the sensor, or anything that blocks the

sensor is affixed to the windshield. Doing so interferes with the sensor detecting the level of ambient light and may cause the automatic headlight system to malfunction.

■ Automatic light off system

- When the headlights are on: The headlights and tail lights turn off 30 seconds after the driver's door is opened and closed if the engine switch is turned to ACC or OFF. (The lights turn off immediately if  on the key is pressed after all the doors are closed.)
- When only the tail lights are on: The tail lights turn off automatically if the engine switch is turned to ACC or OFF and the driver's door is opened.

To turn the lights on again, turn the engine switch to ON, or turn the light switch off once and then back to

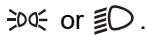
.

■ Light reminder buzzer

A buzzer sounds when the engine switch is turned to OFF or ACC and the driver's door is opened while the lights are turned on.

■ Automatic headlight leveling system (if equipped)

The level of the headlights is automatically adjusted according to the number of passengers and the loading condition of the vehicle to ensure that the headlights do not interfere with other road users.

■ Windshield wiper linked headlight illumination

When driving during daytime with the headlight switch turned to AUTO, if the windshield wipers are used, the headlights will turn on automatically after several seconds to help enhance the visibility of your vehicle.

■ Battery-saving function

In order to prevent the battery of the

vehicle from discharging, if the headlights and/or tail lights are on when the engine switch is turned off the battery saving function will operate and automatically turn off all the lights after approximately 20 minutes. When the engine switch is turned to ON, the battery-saving function will be disabled. When any of the following are performed, the battery-saving function is canceled once and then reactivated. All the lights will turn off automatically 20 minutes after the Battery-saving function has been reactivated:

- When the headlight switch is operated
- When a door is opened or closed

■ Customization

Some functions can be customized. (→P.396)

NOTICE

■ To prevent battery discharge

Do not leave the lights on longer than necessary when the engine is not running.

Turning on the high beam headlights

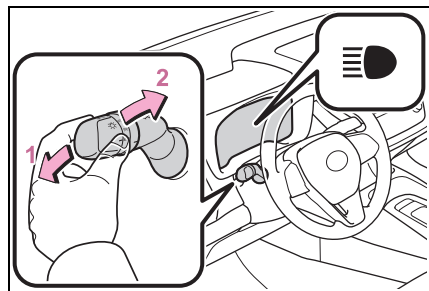

- 1 With the headlights on, push the lever away from you to turn on the high beams.

Pull the lever toward you to the

center position to turn the high beams off.

- 2 Pull the lever toward you and release it to flash the high beams once.

You can flash the high beams with the headlights on or off.

AHB (Automatic High Beam)

The Automatic High Beam uses a front camera located on the upper portion of the windshield to detect the brightness of the lights of vehicles ahead, street-lights, etc., and automatically changes the head lights between the high beams and low beams.

WARNING

■ For safe use

Do not overly rely on the Automatic High Beam. Always drive safely, taking care to observe your surroundings and turning the high beams on or off manually if necessary.

■ To prevent unintentional operation of the Automatic High Beam System

- When it is necessary to disable the system: →P.161

Using the Automatic High Beam system

- 1 Press the Automatic High Beam switch.

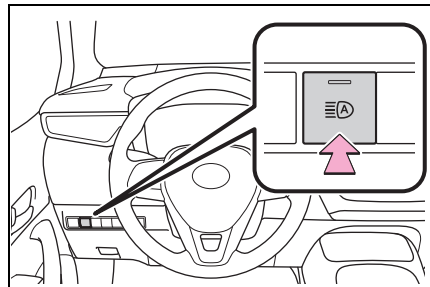

- 2 Turn the headlight switch to the **AUTO** or  position.

When the headlight switch lever is in the low beam position, the AHB system will be enabled and the AHB indicator will illuminate.

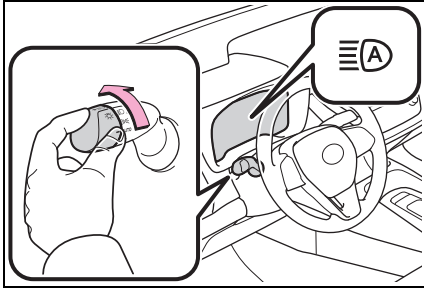

■ Automatic operating conditions of the high beams

- When all of the following conditions are met, the high beams will illuminate automatically:

- The vehicle speed is approximately 21 mph (34 km/h) or more.
- The area ahead of the vehicle is dark.
- There are no vehicles ahead with lights on.
- There are few streetlights or other lights on the road ahead.

- If any of the following conditions are met, the headlights will change to the low beams:

- Vehicle speed drops below approximately 17 mph (27 km/h).
- The area ahead of the vehicle is not dark.
- There is a vehicle ahead with lights on.
- There are many streetlights or other lights on the road ahead.

■ Front camera detection

- In the following situations, the high beams may not be automatically changed to the low beams:

- When a vehicle cuts in front of your vehicle
- When another vehicle crosses in front of the vehicle

- When vehicles ahead are repeatedly detected and then hidden due to repeated curves, road dividers or roadside trees
- When a vehicle ahead approaches from a far lane
- When a vehicle ahead is far away
- When a vehicle ahead has no lights
- When the lights of a vehicle ahead are dim
- When a vehicle ahead is reflecting strong light, such as own headlights
- Situations in which the sensors may not operate properly: →P.165

- The headlights may change to the low beams if a vehicle ahead that is using fog lights without its headlights turned on is detected.

- House lights, street lights, traffic signals, and illuminated billboards or signs may cause the high beams to change to the low beams, or the low beams to remain on.

- The following may change the timing at which the headlights change to the low beams:

- The brightness of lights of vehicles ahead
- The movement and direction of vehicles ahead
- The distance between the vehicle and a vehicle ahead
- When a vehicle ahead only has lights illuminated on one side
- When a vehicle ahead is a two-wheeled vehicle
- The condition of the road (gradient, curve, condition of the road surface, etc.)
- The number of passengers and amount of luggage

- The headlights may change between the high beams and low beams unexpectedly.

- Bicycles and other small vehicles may not be detected.

- In the following situations, the system may not be able to correctly detect the brightness of the sur-

roundings. This may cause the low beams to remain on or the high beams to flash or dazzle pedestrians or vehicles ahead. In such a case, it is necessary to manually change between the high beams and low beams.

- When there are lights similar to headlights or tail lights in the surrounding area
- When headlights or tail lights of vehicles ahead are turned off, dirty, changing color, or not aimed properly
- When the headlights are repeatedly changing between the high beams and low beams.
- When use of the high beams is inappropriate or when the high beams may be flashing or dazzling pedestrians or other drivers.
- When the vehicle is used in an area in which vehicles travel on the opposite side of the road of the country for which the vehicle was designed, for example using a vehicle designed for right-hand traffic in a left-hand traffic area, or vice versa
- When it is necessary to disable the system: →P.161
- Situations in which the sensors may not operate properly: →P.165

■ Temporarily reducing front camera sensitivity (for the U.S.A.)

The sensitivity of the front camera can be temporarily reduced.

- 1 Turn the engine switch off with the following conditions met.
 - The headlight switch is in the **AUTO** or  position.
 - The headlight switch lever is in the low beam position.
 - The automatic High Beam switch is on.
- 2 Press the engine switch to ON.
- 3 Within 60 seconds after performing step 2, push the headlight switch lever to the high beam position then pull it to the original

position quickly 10 times, then leave the lever in its original position.

- 4 If the sensitivity is changed, the Automatic High Beam indicator will blink 3 times.

Turning the high beams on/off manually

■ Changing to the high beams

Push the lever forward.

The AHB indicator will turn off and the high beam indicator will turn on.

Pull the lever to its original position to enable the Automatic High Beam system again.

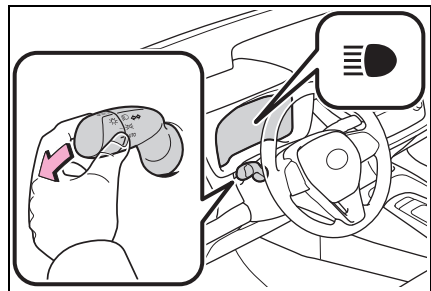

■ Changing to the low beams

Press the Automatic High Beam switch.

The AHB indicator will turn off.

Press the switch to enable the Automatic High Beam system again.

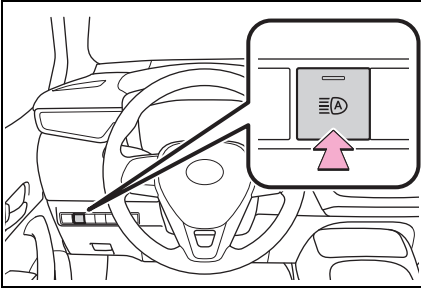

■ Temporarily changing to the low beams

It is recommended to switch to the low beams when use of the high beams is inappropriate or when the high beams may cause problems or distress to other drivers or pedestrians nearby.

Pull the lever rearward and then return it to its original position.

The high beams will illuminate while the lever is pulled, however, after the lever is returned to its original position, the low beams will remain on for a certain amount of time. After this, the Automatic High Beam system will operate.

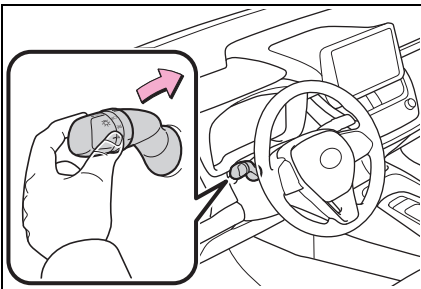

Fog light switch*

*: If equipped

The fog lights secure excellent visibility in difficult driving conditions, such as in rain and fog.

Operating instructions

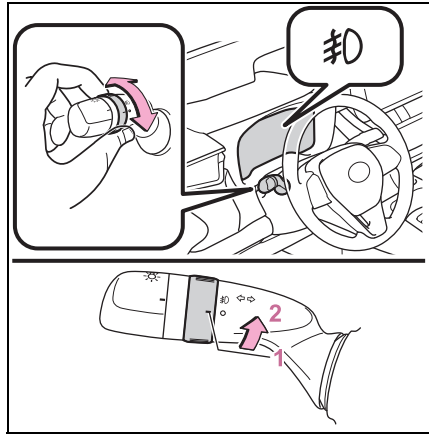

- 1 OFF (U.S.A) or \bullet (Canada)
Turns the front fog lights off
- 2 ⊘ Turns the front fog lights on

■ **Fog lights can be used when**
The headlights are on in low beam.

Windshield wipers and washer



Operating the lever can use the windshield wipers or the washer.

 **NOTICE**
■ When the windshield is dry
 Do not use the wipers, as they may damage the windshield.

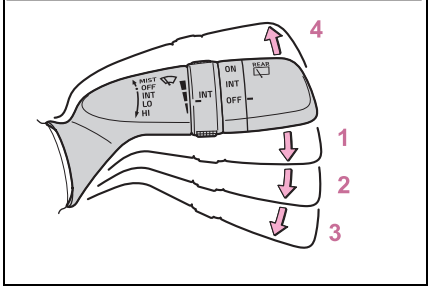
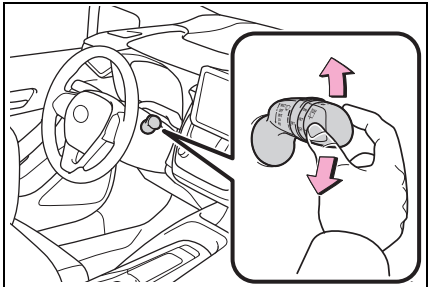

Operating the wiper lever

Operating the  lever operates the wipers or washer as follows.



- 1** INT (U.S.A.) or  (Canada)
Intermittent windshield wiper operation
- 2** LO (U.S.A.) or  (Canada)
Low speed windshield wiper

operation

- 3** HI (U.S.A.) or  (Canada)
High speed windshield wiper operation
- 4** MIST (U.S.A.) or  (Canada)
Temporary operation

Wiper intervals can be adjusted when intermittent operation is selected.

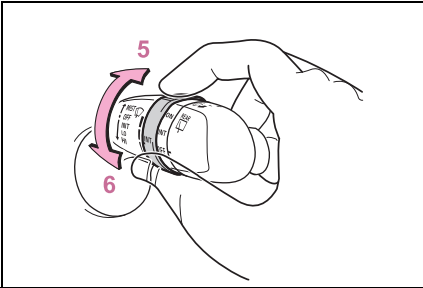

- 5** Increases the intermittent windshield wiper frequency
- 6** Decreases the intermittent windshield wiper frequency

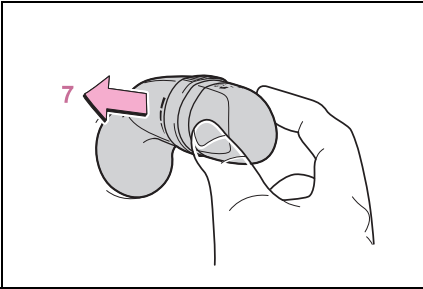

- 7**  **Washer/wiper dual operation**
 Pulling the lever operates the wipers and washer.
 Wipers will automatically operate a couple of times after the washer squirts.

■ The windshield wiper and washer can be operated when

The engine switch is in ON.

■ If no windshield washer fluid sprays

Check that the washer nozzles are not blocked if there is washer fluid in the windshield washer fluid reservoir.

■ When stopping the engine in an emergency while driving

If the windshield wipers are operating when the engine is stopped, the windshield wipers will operate in high speed operation. After the vehicle is stopped, operation will return to normal when the engine switch is turned to ON, or operation will stop when the driver's door is opened.

⚠ WARNING

■ Caution regarding the use of washer fluid

When it is cold, do not use the washer fluid until the windshield becomes warm. The fluid may freeze on the windshield and cause low visibility. This may lead to an accident, resulting in death or serious injury.

⚠ NOTICE

■ When the washer fluid tank is empty

Do not operate the switch continually as the washer fluid pump may overheat.

■ When a nozzle becomes blocked

In this case, contact your Toyota dealer. Do not try to clear it with a pin or other object. The nozzle will be damaged.

Rear window wiper and washer

Operating the lever can use the rear window wiper or the washer.

⚠ NOTICE

■ When the rear window is dry

Do not use the wiper, as it may damage the rear window.

Operating instructions

Operating the  switch operates the rear wiper as follows:

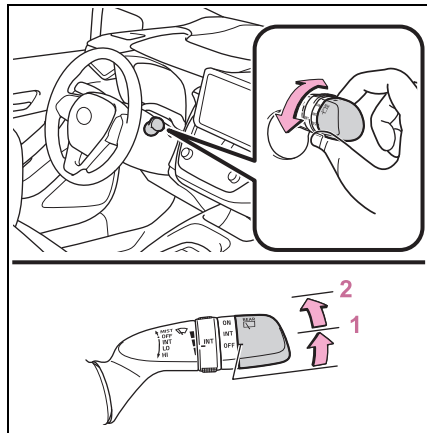

1 INT (U.S.A.) or ■■■ (Canada)
Intermittent window wiper operation

2 ON (U.S.A.) or — (Canada)
Normal window wiper operation

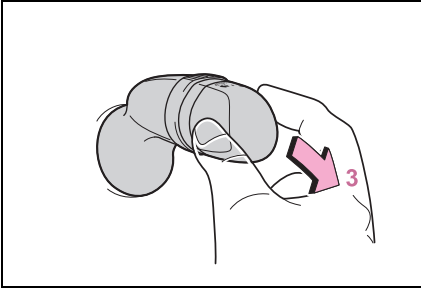

3 Washer/wiper dual operation

Pushing the lever operates the wiper and washer.

The wiper will automatically operate a couple of times after the washer squirts.

■ The rear window wiper and washer can be operated when

The engine switch is in ON.

■ If no windshield washer fluid sprays

Check that the washer nozzle is not blocked if there is washer fluid in the windshield washer fluid reservoir.

■ Back door opening linked rear window wiper stop function

When the rear window wiper are operating, if a back door is opened while the vehicle is stopped, operation of the rear window wiper will be stopped to prevent anyone near the vehicle from being sprayed by water from the wiper. When the back door is closed, wiper operation will resume.

■ When a nozzle becomes blocked

In this case, contact your Toyota dealer.

Do not try to clear it with a pin or other object. The nozzle will be damaged.



NOTICE

■ When the washer fluid tank is empty

Do not operate the switch continually as the washer fluid pump may overheat.

Opening the fuel tank cap

Perform the following steps to open the fuel tank cap:

Before refueling the vehicle

- Turn the engine switch off and ensure that all the doors and windows are closed.
- Confirm the type of fuel.

■ Fuel types

→P.383

■ Fuel tank opening for unleaded gasoline

To help prevent incorrect fueling, your vehicle has a fuel tank opening that only accommodates the special nozzle on unleaded fuel pumps.

■ If the malfunction indicator lamp illuminates

The malfunction indicator lamp may illuminate erroneously if refueling is performed repeatedly when the fuel tank is nearly full.



WARNING

■ When refueling the vehicle

Observe the following precautions while refueling the vehicle. Failure to do so may result in death or serious injury.

- After exiting the vehicle and before opening the fuel door, touch an unpainted metal surface to discharge any static electricity. It is important to discharge static electricity before refueling because sparks resulting from static electricity can cause fuel vapors to ignite while refueling.
 - Always hold the grips on the fuel tank cap and turn it slowly to remove it. A whooshing sound may be heard when the fuel tank cap is loosened. Wait until the sound cannot be heard before fully removing the cap. In hot weather, pressurized fuel may spray out the filler neck and cause injury.
 - Do not allow anyone that has not discharged static electricity from their body to come close to an open fuel tank.
 - Do not inhale vaporized fuel. Fuel contains substances that are harmful if inhaled.
 - Do not smoke while refueling the vehicle. Doing so may cause the fuel to ignite and cause a fire.
 - Do not return to the vehicle or touch any person or object that is statically charged. This may cause static electricity to build up, resulting in a possible ignition hazard.
- #### ■ When refueling
- Observe the following precautions to prevent fuel overflowing from the fuel tank:
- Securely insert the fuel nozzle into the fuel filler neck.
 - Stop filling the tank after the fuel nozzle automatically clicks off.

⚠ WARNING

- Do not top off the fuel tank.

⚠ NOTICE

■ **Refueling**

Do not spill fuel during refueling. Doing so may damage the vehicle, such as causing the emission control system to operate abnormally or damaging fuel system components or the vehicle's painted surface.

Opening the fuel tank cap

- 1 Pull up the opener to open the fuel filler door.

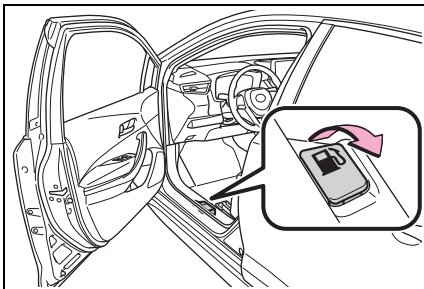

- 2 Turn the fuel tank cap slowly and remove it, then hang it on the back of the fuel filler door.

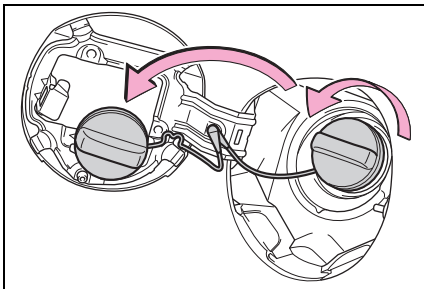

Closing the fuel tank cap

After refueling, turn the fuel tank cap until you hear a click. Once the cap is released, it will turn slightly in the opposite direction.

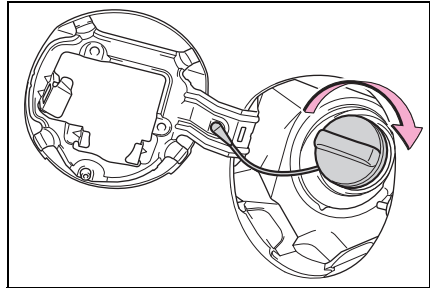

⚠ WARNING

■ **When replacing the fuel tank cap**

Do not use anything but a genuine Toyota fuel tank cap designed for your vehicle. Doing so may cause a fire or other incident which may result in death or serious injury.

Toyota Safety Sense 3.0 software update*

*: If equipped

It is necessary to enter a connected services contract, provided by Toyota, to use these functions. For details, contact your Toyota dealer.

WARNING

■ For safe use

When the Toyota Safety Sense 3.0 software is updated, the operating methods of functions may change. Using this system without knowing the correct operating methods may lead to an accident resulting in death or serious injury.

- Make sure to read the Digital Owner's Manual which corresponds to the software version of the system, available at the Owner's Manual website, before using this system.

Content of the Toyota Safety Sense Owner's Manual

This Owner's Manual contains information for Ver. 2. For the latest information about the controls, use, warnings/precautions, etc. of each function of Toyota Safety Sense, refer to the Digital Owner's Manual at the Owner's Manual website.

If the software of this system has been updated after initial

purchase of the vehicle, before using this system, be sure to read the Owner's Manual which corresponds to the software version of the system.

■ Precautions for use

- Be aware that some functions may temporarily be disabled if a legal or safety related issue occurs.
- If a connected services contract has not been entered or has expired, software updates will not be able to be performed wirelessly.

Checking your vehicle's Toyota Safety Sense version

If the software of this system has been updated after initial purchase of the vehicle, to access the appropriate Owner's Manual, it is necessary to check the software version of the system and then visit the Owner's Manual website.

Checking the version using Toyota app

The software version of the system can be checked using Toyota app.

Selecting your vehicle's Toyota Safety Sense version

- 1 Access the following URL using a computer or smart-phone:

- ▶ For the U.S.A. owners

<https://www.toyota.com/owners/resources/warranty-owners-manuals/manual?om=om12t33u.corollahatchback.2025.2404.cv.vh>



- ▶ For Canadian owners

<https://www.toyota.ca/toyota/owners/manual?om=om12t33u.corollahatchback.2025.2404.cv.vh>



- 2 Select the file which includes the previously checked system version.

Updating the software

If a software update is available, a notification will be displayed by Toyota app. Follow the instructions displayed on the screen.

■ Software update precautions

- After a software update has been performed, it will not be possible to revert to a previous version.
- Depending on the communication environment and the content of an update, a software update may take several hours. Although an update will be suspended when the engine switch is turned off, it will resume when the engine switch is changed back to ON.
- Toyota Safety Sense can still be used while a software update is being performed.

■ What can be checked using the Toyota app

The following items can be checked or performed.

- Software version, update details, precautions, use methods, etc.
- Software update

Toyota Safety Sense 3.0

The Toyota Safety Sense 3.0 consists of the driving assist systems and contributes to a safe and comfortable driving experience:

WARNING

■ Toyota Safety Sense 3.0

The Toyota Safety Sense 3.0 operates under the assumption that the driver will drive safely, and is designed to help reduce the impact to the occupants in a collision and assist the driver under normal driving conditions. As there is a limit to the degree of recognition accuracy and control performance that this system can provide, do not overly rely on this system. The driver is solely responsible for paying attention to the vehicle's surroundings and driving safely.

■ For safe use

- Do not overly rely on this system. The driver is solely responsible for paying attention to the vehicle's surroundings and driving safely. This system may not operate in all situations and provided assistance is limited. Over-reliance on this system to drive the vehicle safely may lead to an accident resulting in death or serious injury.
- Do not attempt to test the operation of the system, as it may not operate properly, possibly leading to an accident.

- If attention is necessary while performing driving operations or a system malfunction occurs, a warning message or warning buzzer will be operated. If a warning message is displayed on the display, follow the instructions displayed.

- Depending on external noise, the volume of the audio system, etc. it may be difficult to hear the warning buzzer. Also, depending on the road conditions, it may be difficult to recognize the operation of the system.

■ When it is necessary to disable the system

In the following situations, make sure to disable the system.

Failure to do so may lead to the system not operating properly, possibly leading to an accident resulting in death or serious injury.

- When the vehicle is tilted due to being overloaded or having a flat tire
- When driving at extremely high speeds
- When towing another vehicle
- When the vehicle is being transported by a truck, ship, train, etc.
- When the vehicle is raised on a lift and the tires are allowed to rotate freely
- When inspecting the vehicle using a drum tester such as a chassis dynamometer or speedometer tester, or when using an on vehicle wheel balancer
- When the vehicle is driven in a sporty manner or off-road
- When using an automatic car wash

⚠ WARNING

- When a sensor is misaligned or deformed due to a strong impact being applied to the sensor or the area around the sensor
- When accessories which obstruct a sensor or light are temporarily installed to the vehicle
- When a compact spare tire or tire chains are installed to the vehicle or an emergency tire puncture repair kit has been used
- When the tires are excessively worn or the inflation pressure of the tires is low
- When tires other than the manufacturer specified size are installed
- When the vehicle cannot be driven stably, due to a collision, malfunction, etc.

Driving assist system

- **AHB (Automatic High Beam)**
→P.150
- **PCS (Pre-Collision System)**
→P.167
- **LTA (Lane Tracing Assist)**
→P.177
- **LDA (Lane Departure Alert)**
→P.182
- **PDA (Proactive driving assist)**
→P.189

- **Emergency Driving Stop System**
→P.210
- **RSA (Road Sign Assist)**
→P.212
- **Dynamic radar cruise control**
→P.195
- **Cruise control**
→P.206

Sensors used by Toyota Safety Sense 3.0

Various sensors are used to obtain the necessary information for system operation.

■ **Sensors which detect the surrounding conditions**

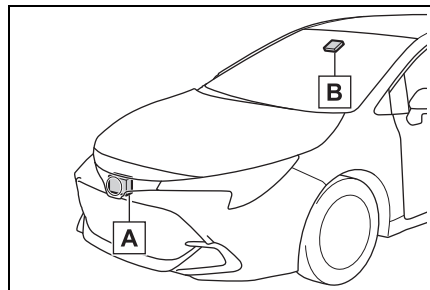

- A** Front radar sensor
- B** Front camera

WARNING

■ To prevent malfunction of the radar sensors

Observe the following precautions. Failure to do so may lead to a radar sensor not operating properly, possibly leading to an accident resulting in death or serious injury.

- Keep the radar sensors and radar sensor covers clean at all times.

Clean the front of a radar sensor or the front or back of a radar sensor cover if it is dirty or covered with water droplets, snow, etc.

When cleaning the radar sensor and radar sensor cover, use a soft cloth to remove dirt so as to not damage them.

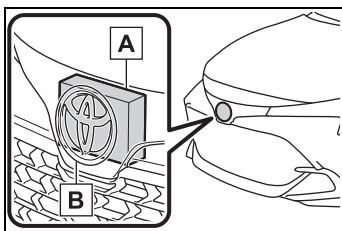

- A** Radar sensor
- B** Radar sensor cover

- Do not attach accessories, stickers (including transparent stickers), aluminum tape, etc. to a radar sensor or radar sensor cover and their surrounding area.
- Do not subject a radar sensor or its surrounding area to impact. If a radar sensor, the front grille, or front bumper has been subjected to a impact, have the vehicle inspected by your Toyota dealer.
- Do not disassemble the radar sensors.

- Do not modify or paint the radar sensors or radar sensor cover, or replace them with anything other than Toyota genuine parts.

- In the following situations, recalibration of the radar sensors will be necessary. For details, contact your Toyota dealer.

- When a radar sensor is removed and installed, or replaced
- When the front bumper or the front grille has been replaced

■ To prevent malfunction of the front camera

Observe the following precautions.

Failure to do so may lead to the front camera not operating properly, possibly leading to an accident resulting in death or serious injury.

- Always keep the windshield clean.
- If the windshield is dirty or covered with an oily film, water droplets, snow, etc., clean the windshield.
- Even if a glass coating agent is applied to the windshield, it will still be necessary to use the windshield wipers to remove water droplets, etc. from the area of the windshield in front of the front camera.
- If the inner side of the windshield where the front camera is installed is dirty, contact your Toyota dealer.

**WARNING**

- Do not attach stickers (including transparent stickers) or other items to the area of the windshield in front of the front camera (shaded area in the illustration).

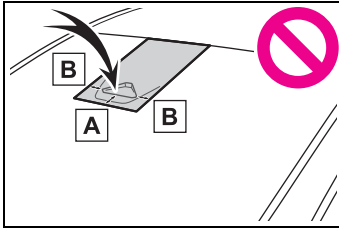

A Approximately 1.6 in. (4 cm)

B Approximately 1.6 in. (4 cm)

- If the part of the windshield in front of the front camera is fogged up or covered with condensation or ice, use the windshield defogger to remove the fog, condensation, or ice.
- If water droplets cannot be properly removed from the area of the windshield in front of the front camera by the windshield wipers, replace the wiper insert or wiper blade.
- Do not attach window tint to the windshield.
- Replace the windshield if it is damaged or cracked. If the windshield has been replaced, recalibration of the front camera will be necessary. For details, contact your Toyota dealer.
- Do not allow liquids to contact the front camera.
- Do not allow bright lights to shine into the front camera.

- Do not damage the lens of the front camera or allow it to become dirty. When cleaning the inside of the windshield, do not allow glass cleaner to contact the lens of the front camera. Do not touch the lens of the front camera. If the lens of the front camera is dirty or damaged, contact your Toyota dealer.

- Do not subject the front camera to a strong impact.

- Do not change the position or orientation of the front camera or remove it.

- Do not disassemble the front camera.

- Do not modify any parts around the front camera, such as the inside rear view mirror or ceiling.

- Do not attach accessories which may obstruct the front camera to the hood, front grille, or front bumper. For details, contact your Toyota dealer.

- If a surfboard or other long object is to be mounted on the roof, make sure that it will not obstruct the front camera.

- Do not modify or change the headlights and other lights.

■ Front camera installation area on the windshield

If the system determines that the windshield may be fogged up, it will automatically operate the heater to defog the part of the windshield around the front camera. When cleaning, etc., be careful not to touch the area around the front camera until the windshield has cooled sufficiently, as touching it may cause burns.

■ Situations in which the sensors may not operate properly

- When the height or inclination of the vehicle has been changed due to modifications
- When the windshield is dirty, fogged up, cracked or damaged
- When the ambient temperature is high or low
- When mud, water, snow, dead insects, foreign matter, etc., is attached to the front of the sensor
- When in inclement weather such as heavy rain, fog, snow, or a sandstorm
- When water, snow, dust, etc. is thrown up in front of the vehicle, or when driving through mist or smoke
- When the headlights are not illuminated while driving in the dark, such as at night or when in a tunnel
- When the lens of a headlight is dirty and illumination is weak
- When the headlights are misaligned
- When a headlight is malfunctioning
- When the headlights of another vehicle, sunlight, or reflected light shines directly into the front camera
- When the brightness of the surrounding area changes suddenly
- When driving near a TV tower, broadcasting station, electric power plant, radar equipped vehicles, etc., or other location where strong radio waves or electrical noise may be present
- When a wiper blade is blocking the front camera
- When in a location or near objects which strongly reflect radio waves, such as the following:
 - Tunnels

- Truss bridges
- Gravel roads
- Rutted, snow-covered roads
- Walls
- Large trucks
- Manhole covers
- Guardrail
- Metal plates
- When near a step or protrusion
- When a detectable vehicle is narrow, such as a small mobility vehicle
- When a detectable vehicle has a small front or rear end, such as an unloaded truck
- When a detectable vehicle has a low front or rear end, such as a low bed trailer

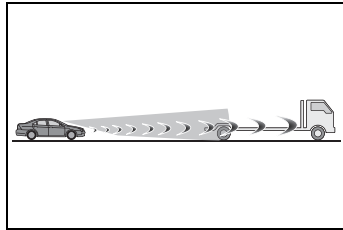

- When a detectable vehicle has extremely high ground clearance

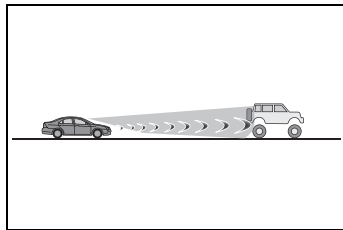

- When a detectable vehicle is carrying a load which protrudes from its cargo area
- When a detectable vehicle has little exposed metal, such as a vehicle which is partially covered with cloth, etc.
- When a detectable vehicle is irregularly shaped, such as a tractor, sidecar, etc.
- When the distance between the vehicle and a detectable vehicle

has become extremely short

- When a detectable vehicle is at an angle
 - When snow, mud, etc. is attached to a detectable vehicle
 - When driving on the following kinds of roads:
 - Roads with sharp curves or winding roads
 - Roads with changes in grade, such as sudden inclines or declines
 - Roads which is sloped to the left or right
 - Roads with deep ruts
 - Roads which are rough and unmaintained
 - Roads which frequently undulate or are bumpy
 - When the steering wheel is being operated frequently or suddenly
 - When the vehicle is not in a constant position within a lane
 - When parts related to this system, the brakes, etc. are cold or extremely hot, wet, etc.
 - When the wheels are misaligned
 - When driving on slick road surfaces, such as when it is covered with ice, snow, gravel, etc.
 - When the course of the vehicle differs from the shape of a curve
 - When the vehicle speed is excessively high when entering a curve
 - When entering/exiting a parking lot, garage, car elevator, etc.
 - When driving in a parking lot
 - When driving through an area where there are obstructions which may contact your vehicle, such as tall grass, tree branches, a curtain, etc.
 - When driving in strong wind
- **Situations in which the lane may not be detected**
- When the lane is extremely wide or narrow
 - Immediately after changing lanes or passing through an intersection
 - When driving in a temporary lane or lane regulated by construction
 - When there are structures, patterns, shadows which are similar to lane lines in the surrounding
 - When there are multiple white lines for a lane line
 - When the lane lines are not clear or driving on a wet road surface
 - When a lane line is on a curb
 - When driving on a bright, reflective road surface, such as concrete
- **Situations in which some or all of the functions of the system cannot operate**
- When a malfunction is detected in this system or a related system, such as the brakes, steering, etc.
 - When the VSC, TRAC, or other safety related system is operating
 - When the VSC, TRAC, or other safety related system is off
- **Changes in brake operation sound and pedal response**
- When the brakes have been operated, brake operation sounds may be heard and the brake pedal response may change, but this does not indicate a malfunction.
 - When the system is operating, the brake pedal may feel stiffer than expected or sink. In either situation the brake pedal can be depressed further. Further depress the brake pedal as necessary.

PCS (Pre-Collision System)

The pre-collision system uses sensors to detect objects (→P.167) in the path of the vehicle. When the system determines that the possibility of a frontal collision with a detectable object is high, a warning operates to urge the driver to take evasive action and the potential brake pressure is increased to help the driver avoid the collision. If the system determines that the possibility of a collision is extremely high, the brakes are automatically applied to help avoid the collision or help reduce the impact of the collision.

The pre-collision system can be disabled/enabled and the warning timing can be changed. (→P.176)



WARNING

■ For safe use

- Driving safely is solely the responsibility of the driver. Pay careful attention to the surrounding conditions in order to ensure safe driving. Never use the pre-collision system in place of normal braking operations. This system cannot help avoid or reduce the impact of a collision in every situation. Over-reliance on this system to drive the vehicle safely may lead to an accident resulting in death or serious injury.
- Although the pre-collision system is designed to help avoid or help reduce the impact of a collision, its effectiveness may change according to various conditions. Therefore, it may not always be able to achieve the same level of performance. Read the following items carefully. Do not overly rely on this system and always drive carefully.

- For safe use: →P.161

■ When to disable the pre-collision system

- When it is necessary to disable the system: →P.161

Detectable objects

The system can detect the following as detectable objects. (Detectable objects differ depending on the function.)

- Vehicles
- Bicycles*
- Pedestrians
- Motorcycles*

- Walls

*: Detected as a detectable object only when being ridden.

System functions

■ Pre-collision warning

When the system determines that the possibility of a collision is high, a buzzer will sound and an icon and warning message will be displayed on the multi-information display to urge the driver to take evasive action.

If the detectable object is a vehicle, moderate braking will be performed with the warning.

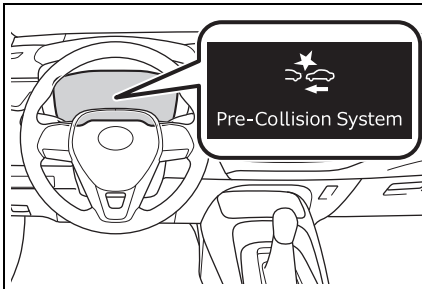

If the system determines that the accelerator pedal is strongly depressed, the following icon and message will be displayed on the multi-information display.

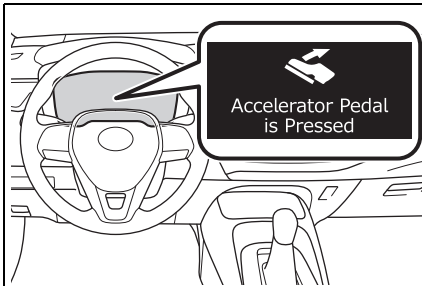

■ Pre-collision brake assist

If the system determines that the possibility of a collision is high and the brake operation by the driver is insufficient, the braking power will be increased.

■ Pre-collision brake control

If the system determines that the possibility of a collision is extremely high, the brakes are automatically applied to help avoid the collision or reduce the impact of the collision.

■ Emergency steering assist

If the system determines that the following conditions are met, assistance will be provided to help enhance vehicle stability and prevent lane departure. During assistance, in addition to the pre-collision warning, the following icon will be displayed on the multi-information display.

- The possibility of a collision is high
- There is sufficient space within the lane to perform evasive steering maneuvers
- The driver is operating the steering wheel

During assistance, the pre-collision warning will operate and a message will be displayed to warn the driver.

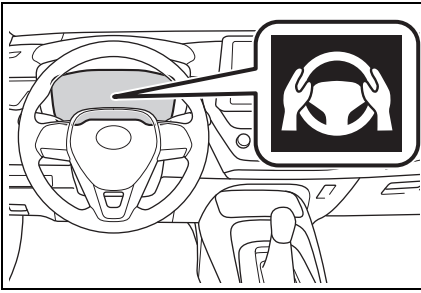

■ Intersection collision avoidance support (left/right turn)

In situations such as the following, if the system determines that the possibility of a collision is high, the pre-collision warning and pre-collision braking will operate.

Depending on the intersection, assistance may not operate correctly.

- When turning left/right at an intersection and crossing the path of an oncoming vehicle/oncoming motorcycle

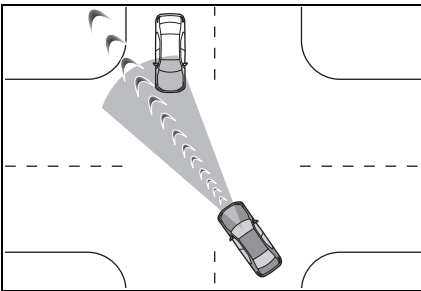

- When turning left/right and a pedestrian or bicycle is detected

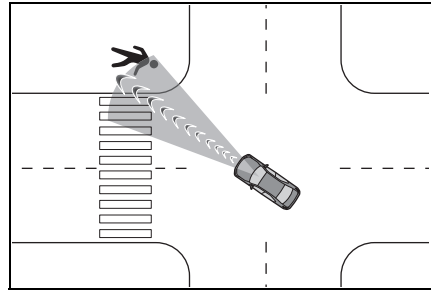

■ Intersection collision avoidance support (crossing vehicles)

At an intersection, etc., if the system determines that the possibility of a collision with an approaching vehicle or motorcycle is high, the pre-collision warning and pre-collision braking will operate.

Depending on the intersection, assistance may not operate correctly.

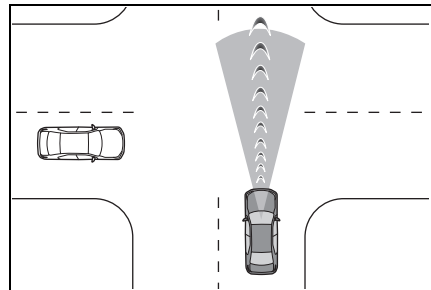

■ Acceleration Suppression at Low Speed

When driving at a low speed, if the accelerator pedal is strongly depressed and the system determines that there is a possibility of a collision, engine output will be restrained or the brakes will be applied weakly to restrict

acceleration. During operation, a buzzer will sound and a warning indicator and message will be displayed on the multi-information display.

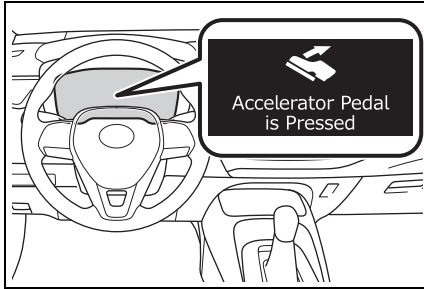

⚠ WARNING

■ **Pre-collision braking**

- When the pre-collision braking function is operating, a large amount of braking force will be applied.
- The pre-collision braking function is not designed to hold the vehicle stopped. If the vehicle is stopped by pre-collision brake control, the driver should operate the brakes immediately as necessary.
- The pre-collision braking function may not operate if certain operations are performed by the driver. If the accelerator pedal is being depressed strongly or the steering wheel is being turned, the system may determine that the driver is taking evasive action and possibly prevent the pre-collision braking function from operating.
- If the brake pedal is being depressed, the system may determine that the driver is taking evasive action and possibly delay the operation timing of the pre-collision brake control.

■ **Acceleration Suppression at Low Speed**

If the steering wheel is being turned, the system may determine that the driver is taking evasive action and possibly prevent the Acceleration Suppression at Low Speed function from operating or possibly causing its operation to be canceled.

■ **Emergency steering assist**

- The emergency steering assist will be canceled when the system determines that lane departure prevention control has completed.
- Depending on operations performed by the driver, emergency steering assist may not operate or operation may be canceled.
- If the accelerator pedal is depressed strongly, the steering wheel is turned heavily, the brake pedal is depressed, or the turn signal lever is operated, the system may determine that the driver is taking evasive action and the emergency steering assist may not operate.
- While the emergency steering assist is operating, if the accelerator pedal is depressed strongly, the steering wheel is turned heavily, or the brake pedal is depressed, the system may determine that the driver is taking evasive action and emergency steering assist operation may be canceled.
- While the emergency steering assist is operating, if the steering wheel is held or turned in the opposite direction of system operation, emergency steering assist operation will be canceled.

■ Operating conditions of each function of the pre-collision system

The pre-collision system is enabled and the system determines that the possibility of a frontal collision with a detected object is high.

However, the system will not operate in the following situations:

- When the vehicle has not been driven a certain amount after a terminal of the battery has been disconnected and reconnected
- When the shift lever is in R
- When the VSC OFF indicator is illuminated (only the pre-collision warning function will be operational)

The following are the operational speeds and cancelation conditions of each function:

- Pre-collision warning

Detectable objects	Vehicle speed	Relative speed between your vehicle and object
Preceding vehicles, stopped vehicles	Approximately 3 to 110 mph (5 to 180 km/h)	Approximately 3 to 110 mph (5 to 180 km/h)
Oncoming vehicles	Approximately 20 to 110 mph (30 to 180 km/h)	Approximately 50 to 130 mph (80 to 220 km/h)
Bicycles	Approximately 3 to 50 mph (5 to 80 km/h)	Approximately 3 to 50 mph (5 to 80 km/h)
Pedestrians	Approximately 3 to 50 mph (5 to 80 km/h)	Approximately 3 to 50 mph (5 to 80 km/h)
Preceding motorcycles, stopped motorcycles	Approximately 3 to 110 mph (5 to 180 km/h)	Approximately 3 to 50 mph (5 to 80 km/h)
Oncoming motorcycles	Approximately 20 to 110 mph (30 to 180 km/h)	Approximately 20 to 110 mph (30 to 180 km/h)

While the pre-collision warning is operating, if the steering wheel is operated heavily or suddenly, the pre-collision warning may be cancelled.

- Pre-collision brake assist

Detectable objects	Vehicle speed	Relative speed between your vehicle and object
Preceding vehicles, stopped vehicles	Approximately 20 to 110 mph (30 to 180 km/h)	Approximately 7 to 110 mph (10 to 180 km/h)
Bicycles	Approximately 20 to 50 mph (30 to 80 km/h)	Approximately 20 to 50 mph (30 to 80 km/h)

Detectable objects	Vehicle speed	Relative speed between your vehicle and object
Pedestrians	Approximately 20 to 50 mph (30 to 80 km/h)	Approximately 20 to 50 mph (30 to 80 km/h)
Preceding motorcycles, stopped motorcycles	Approximately 20 to 110 mph (30 to 180 km/h)	Approximately 7 to 50 mph (10 to 80 km/h)

● Pre-collision braking

Detectable objects	Vehicle speed	Relative speed between your vehicle and object
Preceding vehicles, stopped vehicles	Approximately 3 to 110 mph (5 to 180 km/h)	Approximately 3 to 110 mph (5 to 180 km/h)
Oncoming vehicles	Approximately 20 to 110 mph (30 to 180 km/h)	Approximately 50 to 130 mph (80 to 220 km/h)
Bicycles	Approximately 3 to 50 mph (5 to 80 km/h)	Approximately 3 to 50 mph (5 to 80 km/h)
Pedestrians	Approximately 3 to 50 mph (5 to 80 km/h)	Approximately 3 to 50 mph (5 to 80 km/h)
Preceding motorcycles, stopped motorcycles	Approximately 3 to 110 mph (5 to 180 km/h)	Approximately 3 to 50 mph (5 to 80 km/h)
Oncoming motorcycles	Approximately 20 to 110 mph (30 to 180 km/h)	Approximately 20 to 110 mph (30 to 180 km/h)

If either of the following occur while the pre-collision braking function is operating, it will be canceled:

- The accelerator pedal is strongly depressed
- The steering wheel is operated heavily or suddenly

● Emergency steering assist

The emergency steering assist will not operate when the turn signal lights are flashing.

Detectable objects	Vehicle speed	Relative speed between your vehicle and object
Preceding vehicles, stopped vehicles, bicycles, pedestrians, motorcycles	Approximately 25 to 50 mph (40 to 80 km/h)	Approximately 25 to 50 mph (40 to 80 km/h)

While the emergency steering assist is operating, if any of the following are performed, emergency steering assist operation may be cancelled:

- The accelerator pedal is strongly depressed

- The steering wheel is operated heavily or suddenly
- The brake pedal is depressed
- Intersection collision avoidance support (left/right turn)

The intersection collision avoidance support (for left/right turning vehicles) will not operate when the turn signal lights are not flashing.

Detectable objects	Vehicle speed	Oncoming vehicle speed	Relative speed between your vehicle and object
Oncoming vehicles	Approximately 3 to 25 mph (5 to 40 km/h)	Approximately 3 to 45 mph (5 to 75 km/h)	Approximately 7 to 70 mph (10 to 115 km/h)
Pedestrians	Approximately 3 to 20 mph (5 to 30 km/h)	—	Approximately 3 to 25 mph (5 to 40 km/h)
Bicycles	Approximately 3 to 20 mph (5 to 30 km/h)	—	Approximately 3 to 30 mph (5 to 50 km/h)
Oncoming motorcycles	Approximately 3 to 25 mph (5 to 40 km/h)	Approximately 3 to 45 mph (5 to 75 km/h)	Approximately 7 to 70 mph (10 to 115 km/h)

- Intersection collision avoidance support (crossing vehicles)

Detectable objects	Vehicle speed	Crossing vehicle speed	Relative speed between your vehicle and object
Vehicles, Motorcycles (side)	Approximately 3 to 38 mph (5 to 60 km/h)	<ul style="list-style-type: none"> • Your vehicle speed or less • Approximately 25 mph (40 km/h) or less 	Approximately 3 to 38 mph (5 to 60 km/h)

- Acceleration Suppression at Low Speed

The Acceleration Suppression at Low Speed function will not operate when the turn signal lights are flashing.

Detectable objects	Vehicle speed	Relative speed between your vehicle and object
Preceding vehicles, stopped vehicles, Pedestrians, Bicycles, Wall	Approximately 0 to 9 mph (0 to 15 km/h)	Approximately 0 to 9 mph (0 to 15 km/h)

While the Acceleration Suppression at Low Speed function is operating, if any of the following are performed, the low speed sudden acceleration suppression function operation will be cancelled:

- The accelerator pedal is released.
- The steering wheel is operated heavily or suddenly

■ Detection of detectable objects

Objects are detected based on their size, shape, and movement. Depending on the ambient brightness, movement, posture and direction of a detectable object, it may not be detected and the system may not operate properly. The system detects shapes, such as the following, as detectable objects.

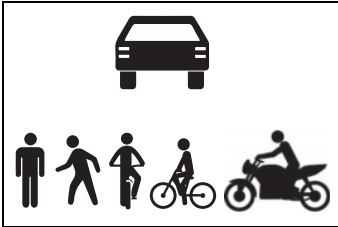

■ Situations in which the system may operate even though the possibility of a collision is not high

- In certain situations, such as the following, the system may determine that the possibility of a collision is high and operate:
 - When passing a detectable object
 - When changing lanes while overtaking a detectable object
 - When suddenly approaching a detectable object
 - When approaching a detectable object or other object on the roadside, such as guardrails, utility poles, trees, walls, etc.
 - When there is a detectable object or other object by the roadside at the entrance of a curve

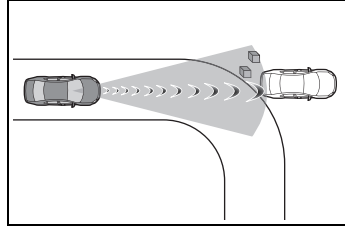

- When there are patterns or a painting ahead of the vehicle that may be mistaken for a detectable object
- When passing a detectable object that is changing lanes or turning left/right

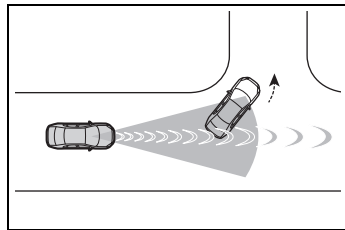

- When passing a detectable object which is stopped to make a left/right turn

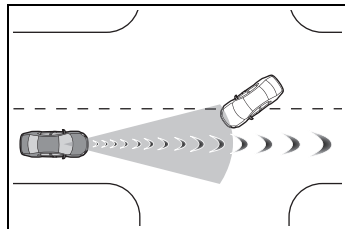

- When a detectable object stops immediately before entering the path of the vehicle
- When passing through a location with a structure above the road (traffic sign, billboard, etc.)

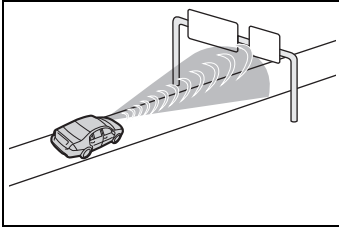

- When approaching an electric toll gate barrier, parking lot barrier, or other barrier that opens and closes
- When turning left/right and an oncoming vehicle, oncoming motorcycle, pedestrian or bicycle crosses in front of the vehicle
- When attempting to turn left/right in front of an oncoming vehicle, oncoming motorcycle, pedestrian or bicycle
- When turning left/right and an oncoming vehicle, oncoming motorcycle, pedestrian or bicycle stops or changes course immediately before entering the path of the vehicle
- When turning left/right and an oncoming vehicle/oncoming motorcycle turns left/right in front of the vehicle

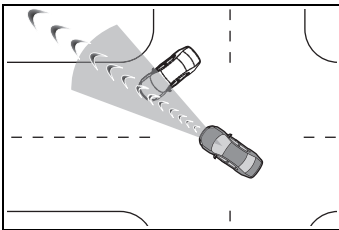

- When the steering wheel is operated toward the path of an oncoming vehicle
- When there is an object moving above or under the road

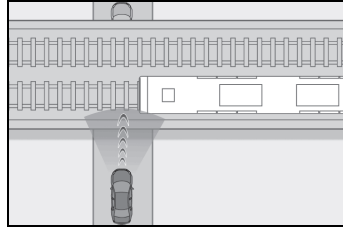

■ Situations in which the system may not operate properly

- In certain situations, such as the following, a detectable object may not be detected by the front sensors, and the system may not operate properly:
 - When a detectable object is approaching your vehicle
 - When your vehicle or a detectable object is wandering
 - When a detectable object makes an abrupt maneuver (such as sudden swerving, acceleration or deceleration)
 - When suddenly approaching a detectable object
 - When the detectable object is near a wall, fence, guardrail, manhole cover, steel plate on the road surface, or another vehicle
 - When there is a structure above a detectable object
 - When part of a detectable object is hidden by another object (large luggage, umbrella, guardrail, etc.)
 - When multiple detectable objects are overlapping
 - When a bright light, such as the sun, is reflecting off of a detectable object
 - When a detectable object is white and looks extremely bright
 - When the color or brightness of a detectable object causes it to blend in with its surroundings
 - When a detectable object cuts in front of or suddenly emerges in front of your vehicle
 - When approaching a vehicle which is diagonal
 - If a bicycle is a child sized bicycle, is carrying a large load, is carrying an extra passenger, is carrying a

forward leaning rider, or has an unusual shape (bicycles equipped with a child seat, tandem bicycles, etc.)

- If a pedestrian or bicycle is shorter than approximately 3.2 ft. (1 m) or taller than approximately 6.5 ft. (2 m).
- When the silhouette of a pedestrian or bicycle is unclear (such as when they are wearing a raincoat, long skirt, etc.)
- When a pedestrian is bending forward or squatting
- When a pedestrian or bicycle is moving at high speed
- When a pedestrian is pushing a stroller, wheelchair, bicycle or other vehicle
- When a detectable object blends in with the surrounding area, such as when it is dim (at dawn or dusk) or dark (at night or in a tunnel)
- When the vehicle has not been driven for a certain amount of time after the engine was started
- While turning left/right or a few seconds after turning left/right
- While driving around a curve and a few seconds after driving around a curve
- When turning left/right and an oncoming vehicle/oncoming motorcycle is driving in a lane 3 or more lanes from the vehicle
- When turning left/right and the direction of the vehicle differs greatly from the direction traffic flows in the oncoming lane

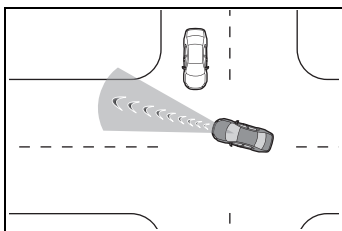

- When turning left/right, a pedestrian or bicycle behind the vehicle comes in front of it as if it overtakes the vehicle

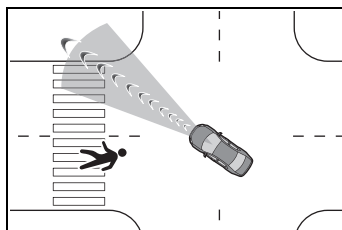

- When at an intersection, the approaching crossing vehicle is long in overall length, such as a large truck, towing trailer, etc.
- In addition to the preceding, in certain situations, such as the following, the emergency steering assist may not operate properly:
 - When a detectable object is too close to the vehicle
 - When there is insufficient space to perform evasive steering maneuvers or an obstruction exists in the evasion direction
 - When there is an oncoming vehicle
- In addition to the preceding, in certain situations, such as the following, walls may not be detected as a target object and the Acceleration Suppression at Low Speed function may not operate properly:
 - When scenery behind the wall is visible, such as a glass door, grid fence, etc.
 - When the wall is slanted or low
 - When the wall is narrow, such as a pole, etc.
 - When the wall is made of plants, such as a hedge, etc.
 - When the road, etc. is reflected on the wall
 - When the vehicle is approaching the wall at an angle

Changing the pre-collision setting

- The pre-collision system can be enabled/disabled through a customize setting. (→P.401)

The system is enabled each time the engine switch is turned to ON.

- When the system is disabled, the PCS warning light will illuminate and a message will be displayed on the multi-information display.
- The pre-collision setting can be changed on the customize settings. (→P.401)
- When the pre-collision warning timing is changed, the emergency steering assist timing will also be changed. When “Later” is selected, the emergency steering assist (excluding the active steering function) will not operate in most cases.
- When the dynamic radar cruise control is operating, the pre-collision warning will operate at the “Earlier” timing, regardless of the user setting.

LTA (Lane Tracing Assist)

LTA functions

- When driving on a road with clear lane lines with the dynamic radar cruise control operating, lane lines and preceding and surrounding vehicles are detected using the front camera and radar sensor, and the steering wheel is operated to maintain the vehicle's lane position.

Use this function only on highways and expressways.

If the dynamic radar cruise control is not operating, the function will not operate.

In situations where the lane lines are difficult to see or are not visible, such as when in a traffic jam, support will be provided using the path of preceding and surrounding vehicles.

If the system determines that the steering wheel has not been operated for a certain amount of time or the steering wheel is not being firmly gripped, the driver will be alerted and this function will be temporarily canceled.

If the steering wheel is firmly gripped, the function will begin operating again.

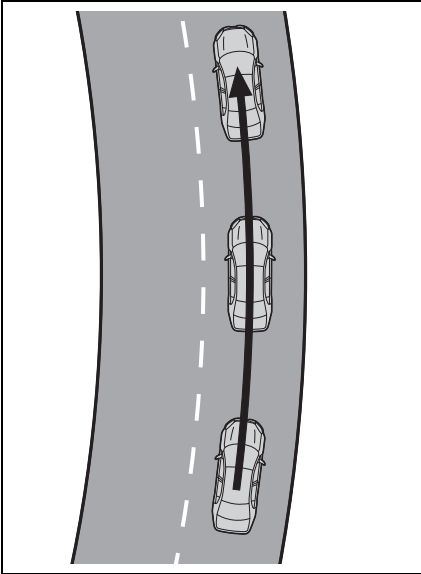

- When the function is operating, if the vehicle is likely to depart from its lane, the driver will be alerted via a display and buzzer.

When the buzzer sounds, check the area around the vehicle and carefully operate the steering wheel to move the vehicle back to the center of the lane.

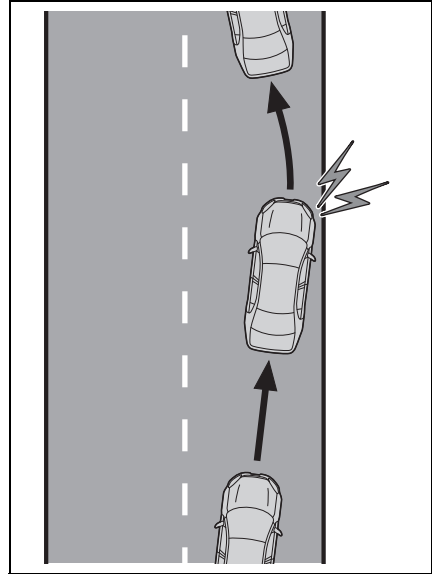

WARNING

Before using the LTA system

- Do not overly rely on the LTA system. The LTA system is not a system which provides automated assistance in driving and it is not a system which reduces the amount of attention necessary for safe driving. The driver is solely responsible for paying attention to their surroundings and operating the steering wheel as necessary to ensure safety. Also, the driver is responsible for taking adequate breaks when fatigued, such as when driving for a long time.
- Failure to perform appropriate driving operations and pay careful attention may lead to an accident.
- When not using the LTA system, turn it off using the LTA switch.

Operating conditions of function

This function is operable when all of

the following conditions are met:

- The LTA system detects lane lines or the path of preceding or surrounding vehicles.
- The dynamic radar cruise control is operating.
- The lane width is approximately 10 to 13 ft. (3 to 4 m).
- The turn signal lever is not being operated.
- The vehicle is not being driven around a sharp curve.
- The vehicle is not accelerating or decelerating more than a certain amount.
- The steering wheel is not being turned with a large force.
- The hands off steering wheel warning (→P.179) is not operating.
- The vehicle is being driven in the center of a lane.

■ Temporary cancelation of functions

- When the operating conditions are no longer met, a function may be temporarily canceled. However, when the operation conditions are met again, operation of the function will automatically be restored. (→P.178)
- If the operating conditions of a function are no longer met while the function is operating, a buzzer may sound to indicate that the function has been temporarily canceled.
- The steering assist operation of the function can be overridden by the steering wheel operation of the driver.

■ Lane departure warning function when the LTA is operating

- Even if the LDA warning method is changed to vibration of the steering wheel, if the vehicle deviates from the lane while the LTA is operating, the warning buzzer will

sound to alert the driver.

- If steering wheel operation equivalent to that necessary for a lane change is detected, the system will determine the vehicle is not deviating from the lane and the warning will not operate.
- #### ■ Hands off steering wheel warning operation
- When the system determines the driver is not holding the steering wheel, a message urging the driver to grip the steering wheel and the icon shown in the illustration will be displayed on the multi-information display to warn the driver. If the system detects that the steering wheel is held, the warning will be canceled. When using the system, make sure to grip the steering wheel firmly, regardless of whether the warning is operating or not.

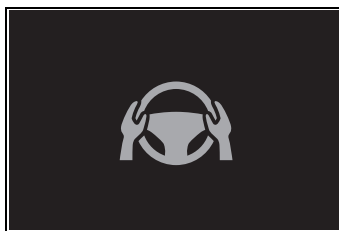

- If no operations are detected for a certain amount of time, the warning will operate and the function will be temporarily canceled. This warning may also operate if the driver only operates steering wheel a small amount continuously.
- #### ■ Situations in which the hands off steering wheel warning may not operate properly
- Depending on the condition of the vehicle, handle control condition and road surface, the warning function may not operate.

Enabling/disabling the system

The LTA will change between ON/OFF each time the LTA switch is pressed.

When the LTA is ON, the LTA indicator will illuminate.

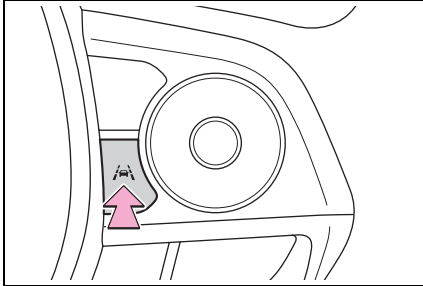

⚠ WARNING

■ Situations in which the functions may not operate properly

In the following situations, the functions may not operate properly and the vehicle may depart from its lane. Do not overly rely on these functions. The driver is solely responsible for paying attention to their surroundings and operating the steering wheel as necessary to ensure safety.



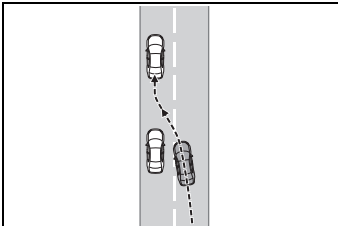





- When a preceding or surrounding vehicle changes lanes (Your vehicle may follow the preceding or surrounding vehicle and also change lanes)



- When a preceding or surrounding vehicle is swaying or surrounding vehicle is swaying (Your vehicle may sway accordingly and depart from the lane)
- When a preceding or surrounding vehicle departs from a lane (Your vehicle may follow the preceding or surrounding vehicle and also depart from the lane)
- When a preceding or surrounding vehicle is being driven extremely close to the left/right lane line (Your vehicle may follow the preceding or surrounding vehicle accordingly and depart from the lane)
- When there are moving objects or structures in the surrounding area (Depending on the position of the moving object or structure relative to your vehicle, your vehicle may sway)
- When the vehicle is struck by a crosswind or the turbulence of other nearby vehicles
- Situations in which the sensors may not operate properly: →P.165
- Situations in which the lane may not be detected: →P.166
- When it is necessary to disable the system: →P.161

Operation display of steering wheel operation support

The operating state of the LTA system is indicated.

Indicator	Lane display	Steering icon	Situation
 White	 Gray/White	 Gray	LTA is on standby
 Green	 Green	 Green	LTA is operating
 Yellow Flashing	 Yellow Flashing	 Green	The vehicle is departing the lane toward the side which the lane display is flashing

LDA (Lane Departure Alert)

Basic functions

The LDA system warns the driver if the vehicle may deviate from the current lane or course^{*}, and also can slightly operate the steering wheel to help avoid deviation from the lane or course^{*}.

The front camera is used to detect lane lines or a course^{*}.

^{*}: Boundary between the asphalt and grass, soil, etc., or structures, such as a curb, guardrail, etc.

■ Lane departure alert function

When the system determines that the vehicle might depart from its lane or course^{*}, a warning is displayed on a display, and either a warning buzzer will sound or the steering wheel will vibrate to alert the driver.

Check the area around your vehicle and carefully operate the steering wheel to move the vehicle back to the center of the lane or course^{*}.

Vehicles with BSM: If the system determines that the vehicle may collide with a vehicle in an adjacent lane, the lane departure alert will operate even if the turn signals are operating.

^{*}: Boundary between the asphalt and grass, soil, etc., or structures,

such as a curb, guardrail, etc.

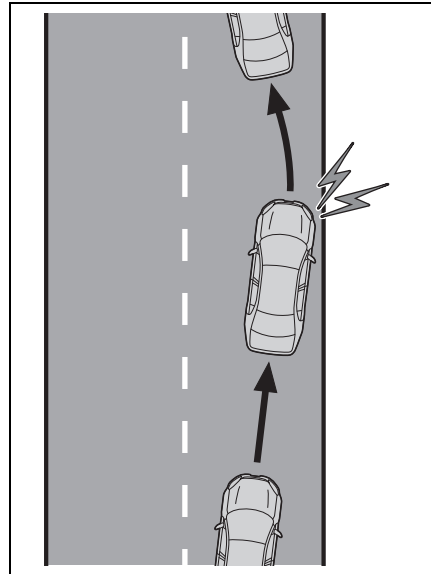

■ Lane departure prevention function

If the system determines that the vehicle is likely to depart from its lane or course^{*}, it provides assistance through steering wheel operations to help avoid deviation from the lane or course.

If the system determines that the steering wheel has not been operated for a certain amount of time or the steering wheel is not being firmly gripped, a warning message may be displayed and a warning buzzer may sound to alert the driver.

Vehicles with BSM: If the system determines that the vehicle may collide with a vehicle in an adjacent lane, the lane departure prevention function will operate even if the turn signals are operating.

* : Boundary between the asphalt and grass, soil, etc., or structures, such as a curb, guardrail, etc.

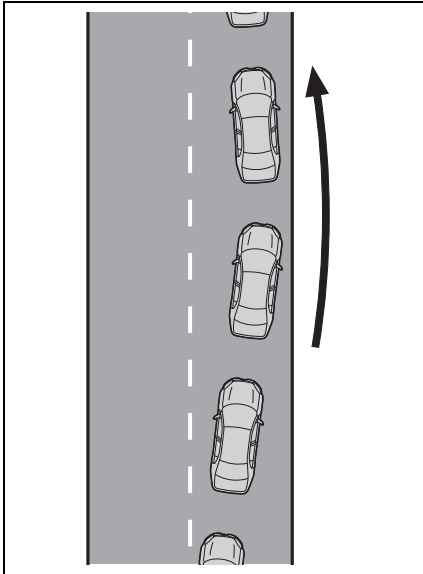

■ Break suggestion function

If the vehicle is swaying, a message will be displayed and a buzzer will sound to urge the driver to take a break.

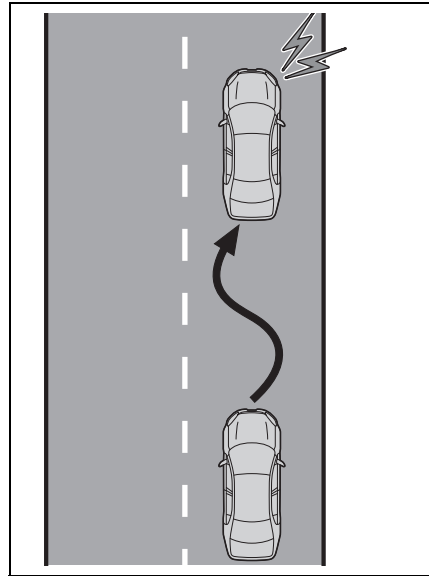

⚠ WARNING

■ Before using the LDA system

- Do not overly rely on the LDA system. The LDA system is not a system which provides automated assistance in driving. However, as it is not a system which reduces the amount of attention necessary for safe driving. The driver is solely responsible for paying attention to their surroundings and operating the steering wheel as necessary to ensure safety. Also, the driver is responsible for taking adequate breaks when fatigued, such as when driving for a long time.
- Failure to perform appropriate driving operations and pay careful attention may lead to an accident.

■ Operating conditions of each function

- Lane departure alert/prevention function

This function is operable when all of the following conditions are met:

- The vehicle speed is approximately 30 mph (50 km/h) or more.

Operation may be possible when the vehicle speed is approximately 25 mph (40 km/h) or more if vehicles, motorcycles, bicycles, or pedestrians are detected near the lane.

- The system recognizes a lane or course*. (When recognized on only one side, the system will operate only for the recognized side.)
- The lane width is approximately 9.8 ft. (3 m) or more.
- The turn signal lever is not being operated. (Vehicles with BSM: Except when a vehicle is detected in the direction that the turn signal lever is operated.)
- The vehicle is not being driven around a sharp curve.
- The vehicle is not accelerating or decelerating more than a certain amount.
- The steering wheel is not being turned sufficiently to perform a lane change.
- When the VSC or TRC system is not turned off

*: Boundary between the asphalt and grass, soil, etc., or structures, such as a curb, guardrail, etc.

■ Temporary cancellation of functions

When the operating conditions are no longer met, a function may be temporarily canceled. However, when the operation conditions are met again, operation of the function will automatically be restored. (→P.183)

■ Operation of the lane departure alert function/lane departure prevention function

- Depending on the vehicle speed, road conditions, lane departure

angle, etc., operation of the lane departure prevention function may not be felt or the function may not operate.

- Depending on the conditions, the warning buzzer may operate even if vibration is selected through a customize setting.
- If a course* is not clear or straight, the lane departure alert function or lane departure prevention function may not operate.
- The lane departure alert function or lane departure prevention function may not operate if the system judges that the vehicle is intentionally being steered to avoid a pedestrian or parked vehicle.
- Vehicles with BSM: It may not be possible for the system to judge if there is danger of a collision with a vehicle in an adjacent lane.
- The steering assist operation of the lane departure prevention function can be overridden by the steering wheel operation of the driver.

*: Boundary between the asphalt and grass, soil, etc., or structures, such as a curb, guardrail, etc.

■ Hands off steering wheel warning operation

In the following situations, a message urging the driver to operate the steering wheel and an icon will be displayed and a buzzer will sound to warn the driver. When using the system, make sure to grip the steering wheel firmly, regardless of whether the warning is operating or not.

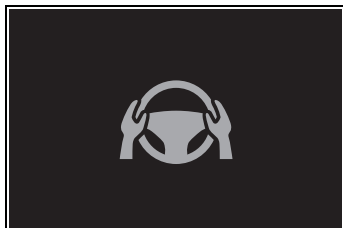

- When the system determines that the driver is not securely holding the steering wheel, or the steering wheel is not being operated when the steering assist operation of the lane departure prevention function is operating

The length of time that the warning buzzer operates will become longer as the frequency of the steering assist operating increases. Even if the system judges that the steering wheel has been operated, the warning buzzer will sound for a certain amount of time.

Except for Puerto Rico:

The length of time that the warning buzzer operates will become longer as the frequency of the steering assist operating increases. If the system judges that the steering wheel has been operated, the warning buzzer will stop.

For Puerto Rico:

The length of time that the warning buzzer operates will become longer as the frequency of the steering assist operating increases. Even if the system judges that the steering wheel has been operated, the warning buzzer will sound for a certain amount of time.

■ Break suggestion function

This function is operable when all of the following conditions are met:

- The vehicle speed is approximately 40 mph (65 km/h) or more.*1
- The vehicle speed is approximately 32 mph (50 km/h) or more.*2
- The lane width is approximately 9.8 ft. (3 m) or more.

Depending on the condition of the vehicle and road surface, the break

suggestion function may not operate.



Press the  meter control switch to turn off the message.*1

Unless  is pressed, the message of the break suggestion function will remain displayed.*1

*1: For Puerto Rico

*2: Except for Puerto Rico

Changing LDA settings

- The LDA system can be enabled/disabled through a customize setting. (→P.396)
- The settings of the LDA can be changed on the customize settings. (→P.396)

⚠ WARNING

■ Situations in which the system may not operate properly

In the following situations, the system may not operate properly and the vehicle may depart from its lane. Do not overly rely on these functions. The driver is solely responsible for paying attention to their surroundings and operating the steering wheel as necessary to ensure safety.

- When the boundary between the asphalt and grass, soil, etc., or structures, such as a curb, guardrail, etc. is not clear or straight



⚠ WARNING









- When the vehicle is struck by a crosswind or the turbulence of other nearby vehicles
- Situations in which the lane may not be detected: →P.166
- Situations in which the sensors may not operate properly: →P.165
- Situations in which some or all of the functions of the system cannot operate: →P.166
- When it is necessary to disable the system: →P.161

Displays and system operation





The operating state of the lane departure alert function and steering assist operation of the lane departure prevention function are indicated.









► For Puerto Rico

Indicator	Lane display	Steering icon	Situation
 Yellow illuminated	Not illuminated	Not illuminated	System disabled
Not illuminated	 Gray	Not illuminated	Lane lines are not detected by the system
Not illuminated	 White	Not illuminated	Lane lines are detected by the system

Indicator	Lane display	Steering icon	Situation
 Yellow Flashing	 Yellow Flashing	Not illuminated	Lane departure alert function is operating for the side which the lane display is flashing
 Green	 Green	 Green	Lane departure prevention function is operating for the side which the lane display is illuminated
 Yellow Flashing	 Yellow Flashing	 Green	Lane departure alert function/lane departure prevention function is operating for the side which the lane display is flashing

► Except for Puerto Rico

Indicator	Lane display	Steering icon	Situation
Not illuminated	Not illuminated	Not illuminated	System disabled
 White	 Gray	Not illuminated	Lane lines are not detected by the system
 White	 White	Not illuminated	Lane lines are detected by the system

Indicator	Lane display	Steering icon	Situation
 Yellow Flashing	 Yellow Flashing	Not illuminated	Lane departure alert function is operating for the side which the lane display is flashing
 Green	 Green	 Green	Lane departure prevention function is operating for the side which the lane display is illuminated
 Yellow Flashing	 Yellow Flashing	 Green	Lane departure alert function/lane departure prevention function is operating for the side which the lane display is flashing

PDA (Proactive driving assist)

When a detectable object (→P.190) is detected, the proactive driving assist operates the brakes and steering wheel to help prevent the vehicle from approaching too close to the object.

WARNING

■ For safe use

Driving safely is solely the responsibility of the driver.

- The proactive driving assist is designed to provide some assistance for regular braking and steering operations, as well as helping to prevent the vehicle from approaching too close to a detectable object. However, the scope of this assistance is limited.

The driver should perform brake and steering operations as necessary. Read the following items carefully. Do not overly rely on the proactive driving assist and always drive carefully.(→P.191)

- The proactive driving assist is not a system which reduces the amount of attention necessary for safe driving. Even if the system is operating correctly, the surrounding conditions as recognized by the driver and detected by the system may differ. It is necessary for the driver to pay attention, assess risks, and ensure safety. Over-reliance on this system to drive the vehicle safely may lead to an accident resulting in death or serious injury.

- Proactive driving assist is not a system which allows for inattentive driving and is not a system which assists in poor visibility conditions. The driver is solely responsible for paying attention to their surroundings and driving safely.

■ When turning proactive driving assist off

- Situations in which the sensors may not operate properly :→P.165
- When it is necessary to disable the system :→P.161

System operating conditions and detectable objects

According to the driving conditions, the operation and detectable objects of the proactive driving assist will change as follows.

Function	Conditions	Operation	Detectable objects
Obstacle Anticipation Assist (OAA)	A detectable object is detected crossing the road	Assistance with some brake operations is provided in order to reduce the possibility of a collision.	<ul style="list-style-type: none"> • Pedestrians • Bicyclists
	A detectable object is detected on the side of the road	Assistance with some brake and steering wheel operations are provided according to the surrounding conditions to help prevent the vehicle from approaching too close to a detected object.	<ul style="list-style-type: none"> • Pedestrians • Bicyclists • Parked vehicles
		Assistance with steering wheel operations is provided within a range that the vehicle will not deviate from its current lane.	
Deceleration Assist (DA)	A preceding vehicle or an adjacent vehicle cutting in front of the vehicle is detected	The vehicle is gently decelerated so that the vehicle-to-vehicle distance will not be excessively short.	<ul style="list-style-type: none"> • Preceding vehicles • Motorcycles
	A curve is detected ahead of the vehicle	The vehicle is gently decelerated if the vehicle speed is determined to be too high for the curve ahead.	None

■ Vehicle speeds at which the system can operate

- Detectable object crossing the road assistance

Approximately 20 to 35 mph (30 to 60 km/h)

- Detectable object on the side of the road assistance

Approximately 20 to 35 mph (30 to 60 km/h)

- Preceding vehicle deceleration assistance

Approximately 15 mph (20 km/h) or more

- Curve deceleration assistance

Approximately 15 mph (20 km/h) or more

■ System operation will be canceled when

- In the following situations, system operation will be canceled :

- When the dynamic radar cruise control or cruise control is operating
- When the PCS is off
- Situations in which some or all of the functions of the system cannot operate :→P.165
- When the P, R or N shift position is selected
- The driver's seat belt is unfastened

- In the following situations, the brake operation assist will be canceled:

- Approximately 9 mph (15 km/h) or less
- When a certain vehicle speed has been reached, as judged by the system, according to the surrounding conditions

- In the following situations, system operation may be canceled :

- When the brake control or output restriction control of a driving support system operates
(For example: PCS, drive-start

control)

- When the system determines that a detected object has moved away from the vehicle
- When lane lines can no longer be detected
- When the brake pedal has been depressed
- When the accelerator pedal has been depressed
- When the steering wheel has been operated with more than a certain amount of force
- When the turn signal lever is operated to the left/right turn position



WARNING

■ Situations in which the system may not operate properly

- Situations in which the lane may not be detected :→P.166

- When a detectable object stops immediately before entering the path of the vehicle

- When passing extremely close to a detectable object behind a guardrail, fence, etc.

- When changing lanes while overtaking a detectable object

- When passing a detectable object that is changing lanes or turning left/right

- When there are objects (guardrails, power poles, trees, walls, fences, poles, traffic cones, mailboxes, etc.) in the surrounding area

- When there are patterns or a painting ahead of the vehicle that may be mistaken for a detectable object

- When passing through a place with a low structure above the road (tunnel with a low ceiling, traffic sign, signboard, etc.)

**WARNING**

- When driving on snowy, icy, or rutted roads
- When a detectable object is approaching your vehicle
- When your vehicle or a detectable object is wandering
- When the movement of a detectable object changes (change in direction, sudden acceleration or deceleration, etc.)
- When suddenly approaching a detectable object
- When a preceding vehicle or motorcycle is not directly in front of your vehicle
- When there is a structure above a detectable object
- When part of a detectable object is hidden by another object (large luggage, umbrella, guardrail, etc.)
- When multiple detectable objects are overlapping
- When a bright light, such as the sun or headlights of another vehicle, is reflecting off of the detectable object
- When the detectable object is white and looks extremely bright
- When the color or brightness of the detectable object causes it to blend in with its surroundings
- When a detectable object cuts in front of or emerges from beside a vehicle
- When approaching a vehicle ahead which is perpendicular or at an angle to the vehicle, or is facing the vehicle
- If a parked vehicle is perpendicular or at an angle to the vehicle
- When a bicycle is a child sized bicycle, is carrying a large load, is carrying an extra passenger, or has an unusual shape (bicycles equipped with a child seat, tandem bicycles, etc.)
- When a pedestrian or bicyclist is shorter than approximately 3.2 ft. (1 m) or taller than approximately 6.5 ft. (2 m)
- When the silhouette of a pedestrian or bicyclist is unclear (such as when they are wearing a raincoat, long skirt, etc.)
- When a pedestrian or bicyclist is bending forward or squatting
- When a pedestrian or bicyclist is moving at high speed
- When a pedestrian is pushing a stroller, wheelchair, bicycle or other vehicle
- When a detectable object blends in with the surrounding area, such as when it is dim (at dawn or dusk) or dark (at night, in a tunnel, etc.)
- When the lane width is 13.1 ft. (4 m) or more
- When the lane width is 8.2 ft. (2.5 m) or less
- When the vehicle has not been driven for a certain amount of time after the engine was started
- While turning left or right or a few seconds after turning left or right
- While changing lanes or a few seconds after changing lanes

WARNING

- When entering a curve, driving around a curve and a few seconds after driving around a curve

can be enabled/disabled through a customize setting. (→P.396)

- The following settings of the proactive driving assist can be changed through customize settings.(→P.396)





Changing proactive driving assist settings

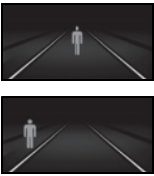

- The proactive driving assist

System operation display

Depending on the situation, the following indicators or icons will be displayed.

Some icons cannot be displayed unless the display is changed to the driving safety support function information screen.

Icon	Meaning
	<ul style="list-style-type: none"> White: Monitoring for detectable objects Green: Detectable object crossing the road or detectable object on the side of the road assistance operating
	A pedestrian has been detected as crossing the road or on the side of the road and brake or steering assistance is operating
	A vehicle has been detected on the side of the road and brake or steering operation assistance is being performed
	Steering operation assistance is being performed to prevent the vehicle from approaching too close to a detectable object on the side of the road
	Preceding vehicle deceleration assistance is being performed

Icon	Meaning
	Warning to maintain appropriate vehicle-to-vehicle distance
	Curve deceleration assistance is being performed

■ Hands off steering wheel warning operation

In the following situations, a message urging the driver to grip the steering wheel and the icon shown in the illustration will be displayed on the display to warn the driver. If the system detects that the steering wheel is held, the warning will be canceled. When using the system, make sure to grip the steering wheel firmly, regardless of whether the warning is operating or not.



- When assistance to a detectable object crossing the road or assistance to a detectable object on the side of the road is performed and the system determines the driver is not holding the steering wheel

If no operations are detected for a certain amount of time, a buzzer will sound, the warning will operate. This warning may also operate if the driver only operates steering wheel a small amount continuously.

■ Warning operation after preceding vehicle deceleration assistance has ended

After preceding vehicle deceleration assistance has ended, if the

driver does not operate the brake pedal or accelerator pedal and the vehicle approaches the preceding vehicle, the display will flash and a buzzer will sound to urge the driver to decelerate. If the system determines that the driver is operating the brake pedal or accelerator pedal, the warning will be canceled.



Dynamic radar cruise control

This dynamic radar cruise control detects the presence of vehicles ahead, determines the current vehicle-to-vehicle distance, and operates to maintain a suitable distance from the vehicle ahead. The desired vehicle-to-vehicle distance can be set by operating the vehicle-to-vehicle distance switch.

Use the dynamic radar cruise control only on highways and expressways.

WARNING

■ For safe use

- Driving safely is solely the responsibility of the driver. Do not overly rely on this system, and pay careful attention to the surrounding conditions in order to ensure safe driving.
- The dynamic radar cruise control provides driving assistance to reduce the driver's burden. However, there are limitations to the assistance provided.

Read the following items carefully. Do not overly rely on this system and always drive carefully.

Conditions under which the system may not operate correctly:
→P.201

- Set the speed appropriately according to the speed limit, traffic flow, road conditions, weather conditions, etc. The driver is responsible for confirming the set speed.
- Even if the system is operating correctly, the condition of a preceding vehicle as recognized by the driver and detected by the system may differ. Therefore, it is necessary for the driver to pay attention, assess risks, and ensure safety. Over-reliance on this system to drive the vehicle safely may lead to an accident resulting in death or serious injury.

■ Precautions for the driving assist systems

Observe the following precautions, as there are limitations to the assistance provided by the system. Over-reliance on this system may lead to an accident resulting in death or serious injury.

- Details of support provided for the driver's vision

The dynamic radar cruise control is only intended to help the driver in determining the distance between the driver's own vehicle and a designated preceding vehicle. It is not a system which allows for careless or inattentive driving, and is not a system which assists in poor visibility conditions.

The driver must pay attention to their surroundings, even when the vehicle stops.

- Details of support provided for the driver's judgement

**WARNING**

The dynamic radar cruise control determines whether the distance between the driver's own vehicle and a designated preceding vehicle is within a set range. It is not capable of making any other type of judgement. Therefore, it is absolutely necessary for the driver to remain vigilant and to determine whether or not there is a possibility of danger.

- Details of support provided for the driver's operation

The dynamic radar cruise control does not include functions which will prevent or avoid collisions with vehicles ahead of your vehicle. Therefore, if there is ever any possibility of danger, the driver must take immediate and direct control of the vehicle and act appropriately in order to ensure safety.

■ **Situations in which the dynamic radar cruise control should not be used**

Do not use the dynamic radar cruise control in the following situations. As the system will not be able to provide appropriate control, using it may lead to an accident resulting in death or serious injury.

- Roads where there are pedestrians, cyclists, etc.
- When driving on a highway or expressway entrance or exit
- When the approach warning sounds frequently
- Situations in which the sensors may not operate properly:
→P.165
- Situations in which the lane may not be detected: →P.166

Basic functions

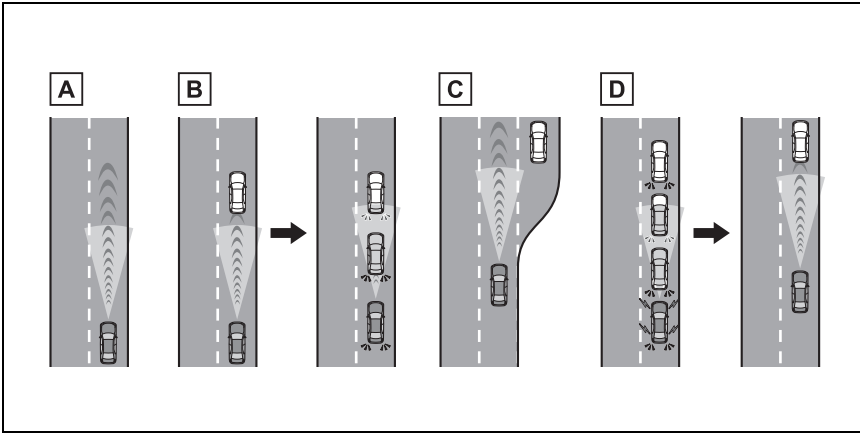

A Constant speed cruising:

When there are no vehicles ahead

The vehicle drives at the speed set by the driver.

If the set vehicle speed is exceeded while driving down a hill, the set vehicle speed display will blink and a buzzer will sound.

B Deceleration and follow-up cruising

When a preceding vehicle driving slower than the set vehicle speed is detected

When a vehicle is detected driving ahead of your vehicle, the vehicle automatically decelerates and if a greater reduction in vehicle speed is necessary, the brakes are applied (the stop lights will come on at this time). The vehicle is controlled to maintain the vehicle-to-vehicle distance set by the driver, in accordance with changes in the speed of the preceding vehicle. If vehicle deceleration is not sufficient and the vehicle approaches the vehicle ahead, the approach warning will sound.

C Acceleration

When there are no longer any preceding vehicles driving slower than the set vehicle speed

The vehicle accelerates until the set vehicle speed is reached and then resumes constant speed cruising.

D Starting off:

If a preceding vehicle stops, the vehicle will also stop (controlled stop). After the preceding vehicle starts off, pressing the "RES" switch or depressing the accelerator pedal will resume follow-up cruising (start off operation). If a start off operation is not per-

formed, the controlled stop will continue.

System Components

■ Meter display

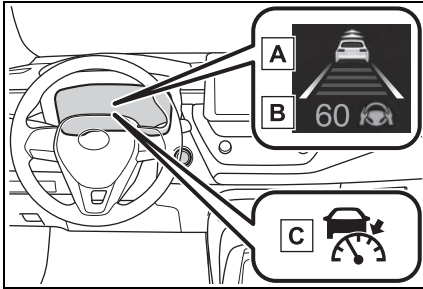

A Multi-information display

B Set vehicle speed

C Indicators

■ Switches

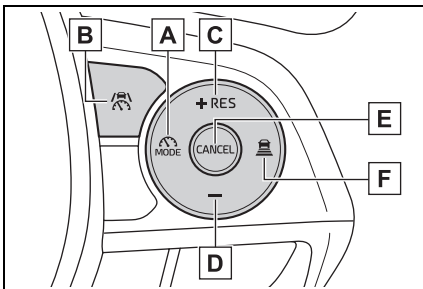

A Driving assist mode select switch

B Driving assist switch

C “+” switch / “RES” switch

D “-” switch

E Cancel switch

F Vehicle-to-vehicle distance switch

Using the dynamic radar cruise control

Setting the vehicle speed

- 1 Press the driving assist mode select switch to select dynamic radar cruise control.

The dynamic radar cruise control indicator will illuminate.

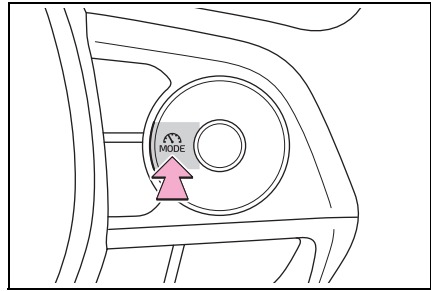

- 2 Using the accelerator pedal, accelerate or decelerate to the desired vehicle speed (approximately 20 mph [30 km/h] or more), and press the driving assist switch to set the set vehicle speed.

The set vehicle speed will be displayed on the multi-information display.

The vehicle speed at the moment the switch is released will be the set

vehicle speed.

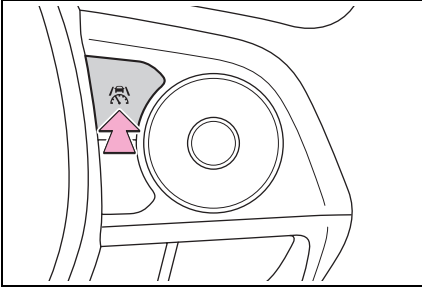

Adjusting the set vehicle speed

- Adjusting the set vehicle speed using the switches

To change the set vehicle speed, press the “+” switch or “-” switch until the desired speed is displayed.

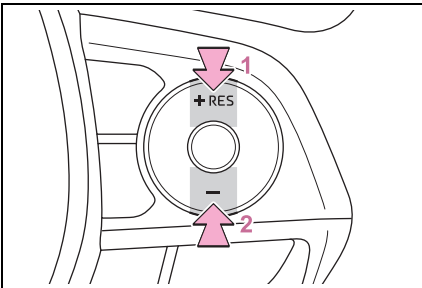

- 1 Increase set vehicle speed
- 2 Decrease set vehicle speed

Short press adjustment: Press the switch

Long press adjustment: Press and hold the switch until the desired set vehicle speed is reached.

The set vehicle speed will increase or decrease as follows:

- For the U.S.A.

Short press adjustment: Increases or decreases by 1 mph (1.6 km/h)

each time the switch is pressed

Long press adjustment: Increases or decreases in 1 mph (1.6 km/h) increments continuously while the switch is pressed and held

- For Canada

Short press adjustment: By 1 km/h (0.6 mph) or 1 mph (1.6 km/h) each time the switch is pressed

Long press adjustment: Increases or decreases in 5 km/h (3.1 mph) or 5 mph (8 km/h) increments continuously while the switch is pressed and held

- Increasing the set vehicle speed using the accelerator pedal

- 1 Depress the accelerator pedal to accelerate the vehicle to the desired vehicle speed.
- 2 Press the “+” switch.

Canceling/resuming control

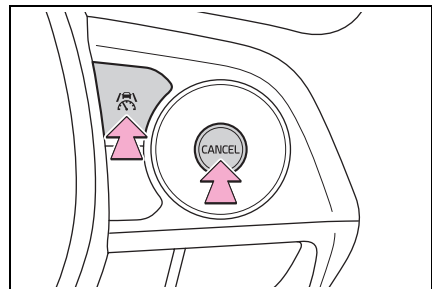

- 1 Press the cancel switch or driving assist switch to cancel control.

Control will also be canceled if the brake pedal is depressed.

(If the vehicle has been stopped by system control, depressing the brake pedal will not cancel control.)

- 2 Press the “RES” switch to resume control.

Changing the vehicle-to-vehicle distance

Each time the switch is pressed, the vehicle-to-vehicle distance setting will change as follows:

If a preceding vehicle is detected, the preceding vehicle mark will be displayed.

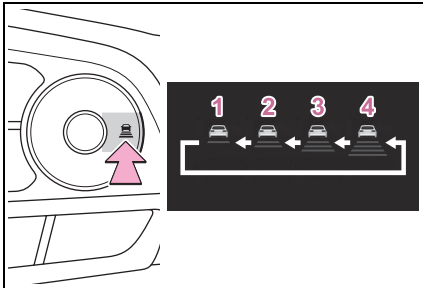

Illustration Number	Vehicle-to-vehicle distance	Approximate Distance (Vehicle Speed: 60 mph [100 km/h])
1	Short	Approximately 85 ft. (25 m)
2	Medium	Approximately 100 ft. (30 m)
3	Long	Approximately 145 ft. (45 m)
4	Extra long	Approximately 200 ft. (60 m)

The actual vehicle-to-vehicle distance varies in accordance with the vehicle speed. Also, when the vehicle is stopped by system control, it will be stopped at a certain distance from the preceding vehicle, depending on the situation, regardless of the setting.

Operating conditions

- The shift lever is in D.
- The desired set speed can be set when the vehicle speed is approximately 20 mph (30 km/h) or more.
- If the vehicle speed is set while driving at below approximately 20 mph (30 km/h), the set vehicle speed will be approximately 20 mph (30 km/h).
- If the vehicle speed is set while driving at a speed that exceeds

the system's upper limit, the set vehicle speed will be the system's upper limit.

Accelerating after setting the vehicle speed

As with normal driving, acceleration can be performed by depressing the accelerator pedal. After accelerating, the vehicle will return to the set vehicle speed. However, while in vehicle-to-vehicle distance control mode, the vehicle speed may

decrease to below the set vehicle speed in order to maintain the distance from the preceding vehicle.

■ **When the vehicle is stopped by system control during follow-up cruising**

- When the “+RES” switch is pressed while the vehicle is stopped by system control, if the preceding vehicle starts off within approximately 3 seconds, follow-up cruising will resume.
- If the preceding vehicle starts off within approximately 3 seconds of the vehicle being stopped by system control, follow-up cruising will resume.

■ **Automatic cancellation of vehicle-to-vehicle distance control mode**

In the following situations, vehicle-to-vehicle distance control mode will be canceled automatically:

- When the brake control or output restriction control of a driving support system operates (For example: Pre-Collision System, drive-start control)
- When the parking brake has been operated
- When the driver's seat belt is unfastened while driving
- When the Pre-Collision System is disabled
- When the vehicle is stopped by system control on a steep incline
- When any of the following are detected while the vehicle is stopped by system control:
 - The driver's seat belt is unfastened
 - The driver's door is opened
 - Approximately 3 minutes have elapsed since the vehicle was stopped

The parking brake may be activated automatically.

- Situations in which some or all of the functions of the system cannot

operate: →P.166

■ **Dynamic radar cruise control system warning messages and buzzers**

For safe use: →P.161

■ **Preceding vehicles that the sensor may not detect correctly**

In the following situations, depending on the conditions, if the system cannot provide sufficient deceleration or acceleration is necessary, operate the brake pedal or accelerator pedal.

As the sensor may not be able to correctly detect these types of vehicles, the approach warning (→P.201) may not operate.

- When a vehicle cuts in front of your vehicle or changes lanes away from your vehicle extremely slowly or quickly
- When changing lanes
- When a preceding vehicle is driving at a low speed
- When a vehicle is stopped in the same lane as the vehicle
- When a motorcycle is traveling in the same lane as the vehicle

■ **Conditions under which the system may not operate correctly**

In the following situations, operate the brake pedal (or accelerator pedal, depending on the situation) as necessary.

As the sensor may not be able to correctly detect a vehicle, the system may not operate properly.

- When a preceding vehicle brakes suddenly
- When changing lanes at low speeds, such as in a traffic jam

Approach warning

In situations where the vehicle

approaches a preceding vehicle and the system cannot provide sufficient deceleration, such as if a vehicle cuts in front of the vehicle, a warning display will flash and a buzzer will sound to alert the driver. Depress the brake pedal to ensure appropriate vehicle-to-vehicle distance.

■ Warnings may not occur when

In the following situations, the warning may not operate even though the vehicle-to-vehicle distance is short.

- When the preceding vehicle is traveling at the same speed or faster than your vehicle
- When the preceding vehicle is traveling at an extremely low speed
- Immediately after the vehicle speed has been set
- When the accelerator pedal is depressed

Curve speed reduction function

When a curve is detected, the vehicle speed will begin being reduced. When the curve ends, the vehicle speed reduction will end.

Depending on the situation, the vehicle speed will then return to the set vehicle speed.

In situations where vehicle-to-veh-

icle distance control needs to operate, such as when a preceding vehicle cuts in front of your vehicle, the curve speed reduction function will be canceled.



■ Situations in which the curve speed reduction function may not operate

In situations such as the following, the curve speed reduction function may not operate:

- When the vehicle is being driven around a gentle curve
- When the accelerator pedal is being depressed
- When the vehicle is being driven around an extremely short curve

Support for lane change

If your vehicle is being driven at approximately 50 mph (80 km/h) or more and a lane change to the passing lane is performed, when the turn signal lever is operated and the lane is changed, the vehicle will accelerate up to the set speed to assist in overtaking.

The system's recognition of which lane is the passing lane may be based solely on the location of the steering wheel in the vehicle

(left-hand drive/right-hand drive). If the vehicle is driven in a location where the passing lane is on the opposite side of that where the vehicle was originally sold, the vehicle may accelerate when the turn signal lever is operated away from the passing lane. (e.g. The vehicle was manufactured for a right-hand traffic location, but is being driven in a left-hand traffic location. The vehicle may accelerate when the turn signal lever is operated to the right.)

If your vehicle is being driven at approximately 50 mph (80 km/h) or





more and the lane is changed to that with a vehicle traveling slower than your vehicle, when the turn signal lever is operated the vehicle will gradually decelerate to assist in changing lanes.





Changing Dynamic radar cruise control settings



- The settings of Dynamic radar cruise control can be changed through customize settings. (→P.396)

Display and system operation state

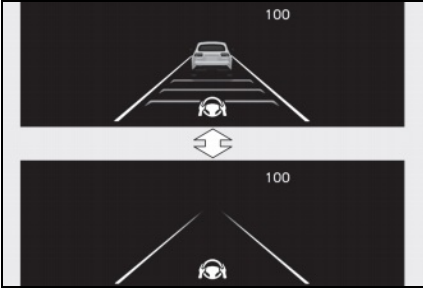
The operating state of Dynamic radar cruise control is indicated.

Indicator	Multi-information display	Situation
 White		Vehicle-to-vehicle distance setting: Gray Dynamic radar cruise control being OFF
 Green		Vehicle-to-vehicle distance setting: Blue Set vehicle speed: Green Constant speed cruising

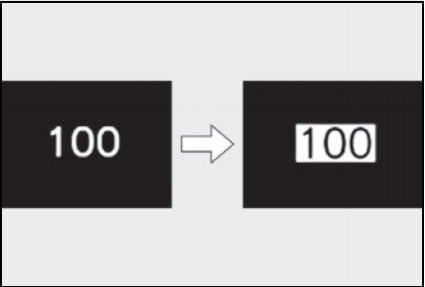
Indicator	Multi-information display		Situation
 <p>Green</p>		<p>Vehicle-to-vehicle distance setting: Blue</p> <p>Set vehicle speed: Green</p> <p>Preceding vehicle: White</p>	<p>Follow-up cruising</p>
 <p>Green</p>		<p>Vehicle-to-vehicle distance setting: Orange flashing</p> <p>Set vehicle speed: Green</p> <p>Preceding vehicle: Orange flashing</p>	<p>Approach warning</p>
 <p>Green</p>		<p>Vehicle-to-vehicle distance setting: Gray</p> <p>Set vehicle speed: White</p> <p>Preceding vehicle: Gray</p>	<p>Accelerating with the accelerator pedal</p>

Indicator	Multi-information display		Situation
 <p>Green</p>		<p>Set vehicle speed: Green in reverse display</p>	<p>Set vehicle speed being exceeded</p>
 <p>Green</p>		<p>Vehicle-to-vehicle distance setting: Gray Set vehicle speed: White Preceding vehicle: Gray</p>	<p>Vehicle in controlled stop</p>

Cruise control

The vehicle can be driven at a set speed even if the accelerator pedal is not depressed.

Use the cruise control only on highways and expressways.

⚠ WARNING

- **For safe use**
 - Driving safely is solely the responsibility of the driver. Therefore, do not overly rely on this system. The driver is solely responsible for paying attention to the vehicle's surroundings and driving safely.
 - Set the speed appropriately according to the speed limit, traffic flow, road conditions, weather conditions, etc. The driver is responsible for confirming the set speed.
- **Situations in which cruise control should not be used**

Do not use the cruise control in the following situations. As the system will not be able to provide appropriate control, using it may lead to an accident resulting in death or serious injury.

 - On roads with sharp bends
 - On winding roads
 - On slippery roads, such as those covered with rain, ice or snow
 - On steep downhills, or where there are sudden changes between sharp up and down gradients

Vehicle speed may exceed the set speed when driving down a steep hill.

- When it is necessary to disable the system: →P.161

System Components

■ Meter display

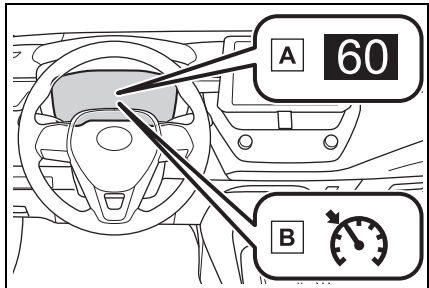

- A Set vehicle speed
- B Cruise control indicator

■ Switches

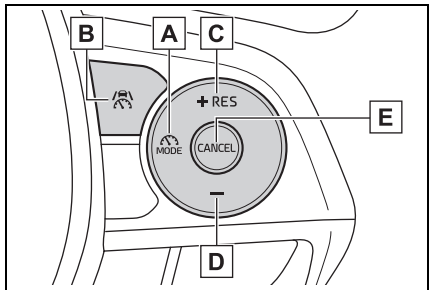

- A Driving assist mode select switch
- B Driving assist switch
- C "+" switch / "RES" switch
- D "-" switch
- E Cancel switch

Using the cruise control

Setting the vehicle speed

- 1 Press the driving assist mode select switch to select cruise control.

The cruise control indicator will illuminate.

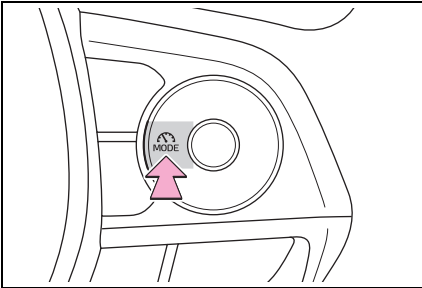

- 2 Using the accelerator pedal, accelerate to the desired vehicle speed (approximately 20 mph [30 km/h] or more), and press the driving assist switch to set the set vehicle speed.

The vehicle speed at the moment the switch is released will be the set vehicle speed.

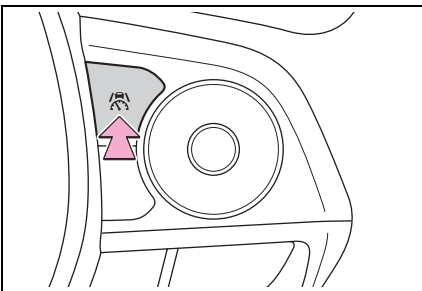

Adjusting the set vehicle speed

Adjusting the set vehicle speed using the switches

To change the set vehicle speed, press the “+” or “-” switch until the desired speed is displayed.

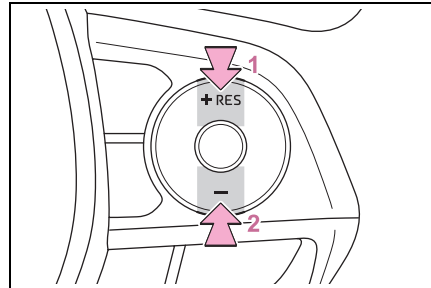

- 1 Increase set vehicle speed
- 2 Decrease set vehicle speed

The set vehicle speed will increase or decrease as follows:

Fine adjustment: By 1 mph (1.6 km/h) or 1 km/h (0.6 mph) each time the switch is pressed

Large adjustment: Increases continuously while the switch is pressed and held

Increasing the set vehicle speed using the accelerator pedal

- 1 Depress the accelerator pedal to accelerate the vehicle to the desired vehicle speed.
- 2 Press the “+” switch.

Canceling/resuming control

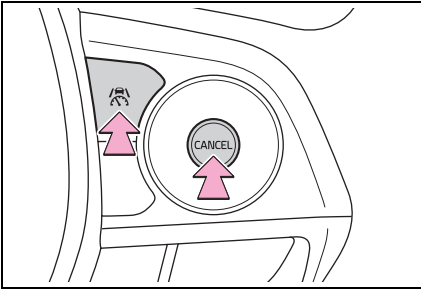

- 1 Press the cancel switch or driving assist switch to cancel control.

Control will also be canceled if the brake pedal is depressed.

- 2 Press the “RES” switch to resume control.





Automatic cancellation of the cruise control

In the following situations, the cruise control will be canceled automatically:

- When the vehicle speed drops approximately 10 mph (16 km/h) or more below the set vehicle speed
- When the vehicle speed drops below approximately 20 mph (30 km/h)
- When the brake control or output restriction control of a driving support system operates (For example: PCS, drive-start control)
- When the parking brake has been operated
- When the driver's seat belt is unfastened
- Situations in which some or all of the functions of the system cannot operate: →P.166

Display and system operation state

The operating state of cruise control is indicated.

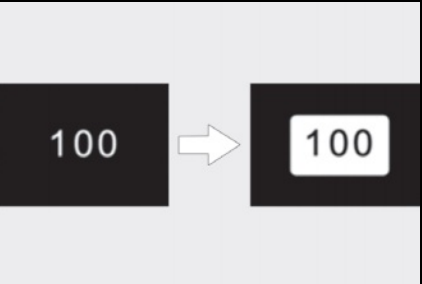
Indicator	Multi-information display		Situation
 White		Blank	Cruise control being OFF
 Green		Set vehicle speed: Green	Constant speed cruising
 Green		Set vehicle speed: Green in reverse display	Set vehicle speed being exceeded

Emergency Driving Stop System

The emergency driving stop system is a system which automatically decelerates and stops the vehicle within its lane if the driver becomes unable to continue driving the vehicle, such as if they have suffered a medical emergency, etc.

During LTA (Lane Tracing Assist) control, if the system does not detect driving operations, such as if the driver is not holding the steering wheel, and determines the driver is not responsive, the vehicle will be decelerated and stopped within its current lane to help avoid a collision or reduce the impact of a collision.



WARNING

■ For safe use

- Driving safely is solely the responsibility of the driver. Pay careful attention to the surrounding conditions in order to ensure safe driving. The emergency driving stop system is designed to provide support in an emergency where it is difficult for the driver to continue driving, such as if they have had a medical emergency. It is not designed to support driving while drowsy or in poor physical health, or inattentive driving.

- Although the emergency driving stop system is designed to decelerate the vehicle within its lane to help avoid or help reduce the impact of a collision if the system determines that it is difficult for the driver to continue driving, its effectiveness may change according to various conditions. Therefore, it may not always be able to achieve the same level of performance. Also, if the operating conditions are not met, this function will not operate.
- After the emergency driving stop system operates, if driving becomes possible again, immediately begin driving again or, if necessary, park the vehicle on the shoulder of the road and set a warning reflector and flare to warn other drivers of your stopped vehicle.
- After this system operates, passengers should attend to the driver as necessary and take appropriate hazard prevention measures, such as moving to a place where safety can be ensured, such as the shoulder of the road or behind a guard-rail.
- This system detects the condition of the driver through the operation of the steering wheel. This system may operate if the driver is aware but intentionally and continuously does not operate the vehicle. Also, the system may not operate if it cannot determine that the driver is not responsive, such as if they are leaning on the steering wheel.

Summary of the system

Operation of this system is separated into 4 control states.

Through control state “warning phase 1” and “warning phase 2”, the system determines if the driver is aware and responsive while outputting a warning and controlling the vehicle speed. If the system determines the driver is not responsive, it will operate in control state “deceleration stop phase” and “stop hold phase” and decelerate and stop the vehicle. It will then operate continuously in “stop hold phase”.

■ Operating conditions

This system operates when all of the following conditions are met:

- When the LTA is on
- When the vehicle speed is approximately 30 mph (50 km/h) or more

■ Operation cancelation conditions

In the following situations, system operation will be canceled:

- When LTA control has been canceled (the LTA switch has been pressed, etc.)
- When the dynamic radar cruise control has been canceled
- When driver operations are detected (the steering wheel is held, the brake pedal, accelerator pedal, parking brake, hazard light switch, or turn signal lever is operated)
- When the driving assist switch is pressed while in the stop and hold phase
- When the engine switch has been turned from ON to off
- Situations in which some or all of the functions of the system cannot

operate: →P.166

■ LTA control when operation is canceled

When emergency driving stop system operation is canceled, LTA control may also be canceled.

Warning phase 1

If driving operations are not detected after the hands off steering wheel warning operates, a buzzer will sound intermittently and a message will be displayed to warn the driver, and the system will judge if the driver is responsive or not. If driving operations, such as holding the steering wheel, are not performed within a certain amount of time, the system will enter warning phase 2.

Warning phase 2

After entering warning phase 2, a buzzer will sound in short intervals and a message will be displayed to warn the driver, and the vehicle will slowly decelerate. If driving operations, such as holding the steering wheel, are not performed within a certain amount of time, the system will determine that the driver is not responsive and enter the deceleration stop phase.

When the vehicle is decelerating, the brake lights may illuminate, depending on the road conditions, etc.

Deceleration stop phase

After entering the deceleration stop phase, a buzzer will sound continuously and a message will be displayed to warn the driver, and the vehicle will slowly decelerate and stop. After the vehicle stops, the system will enter the stop and hold phase.

Stop hold phase

After the vehicle is stopped, the parking brake will be applied automatically. After entering the stop and hold phase, the buzzer will continue sounding continuously and the emergency flashers (hazard lights) will flash to warn other drivers of the emergency.

Restricted functions after the operation is canceled

After shifting to the deceleration stop phase, the following functions will not be available until the engine is re-started even though the emergency driving stop system is canceled:

- LTA

RSA (Road Sign Assist)*

*: If equipped

The RSA system detects specific road signs using the front camera and/or navigation system (when speed limit information is available) and warns the driver via displays and buzzers.

! WARNING

- **For safe use**
 - Driving safely is solely the responsibility of the driver. Pay careful attention to the surrounding conditions in order to ensure safe driving.
 - Do not rely solely upon the RSA. The RSA assists the driver by providing road sign information, but it is not a replacement for the driver's own vision and awareness. Driving safely is solely the responsibility of the driver. Pay careful attention to the surrounding conditions in order to ensure safe driving.
- **Situations in which the RSA should not be used**
 - When it is necessary to disable the system: →P.161
- **Situations in which the system may not operate properly**
 - Situations in which the sensors may not operate properly: →P.165

Display Function

- When the front camera

detects a sign or information of a sign is available from the navigation system, the sign will be displayed on the display.

- Multiple signs can be displayed.

Depending on the specifications of the vehicle, the number of displayed signs may be limited.

■ Operating conditions of sign display

Signs will be displayed when the following conditions are met:

- The system has detected a sign

In the following situations, a displayed sign may stop being displayed:

- When a new sign has not been detected for a certain distance
- When the system determines that the road being driven on has changed, such as after a left or right turn

■ Situations in which the display function may not operate properly

In the following situations, the RSA system may not operate properly and may not detect signs or may display the incorrect sign. However, this does not indicate a malfunction.

- When a sign is dirty, faded, tilted or bent
- When the contrast of an electronic sign is low
- When all or part of a sign is hidden by a tree, utility pole, etc.
- When a sign is detected by the front camera for a short amount of time
- When the driving state (turning, changing lanes, etc.) is judged incorrectly

- When a sign is immediately after a freeway junction or in an adjacent lane just before merging
- When stickers are attached to the rear of a preceding vehicle
- When a sign similar to a system compatible sign is detected as a system compatible sign
- When a speed limit sign for a frontage road is within detection range of the front camera
- When driving around a roundabout
- When a sign intended for trucks, etc. is detected
- When a sign is with supplemental sign (End point, day of week, time etc.)
- When a sign is within road works area
- When the navigation system map data is out of date
- When the navigation system cannot be used

In this case, the speed limit signs displayed on the multi-information display and navigation system display may differ.

Notification function

In the following situations, the RSA system will output a warning to notify the driver.

- If the vehicle speed exceeds the speed warning threshold of the speed limit sign displayed on the display, the sign display will be emphasized and a buzzer will sound.
- When the RSA system detects a do not enter sign and determines that the vehicle has entered a no-entry

area, the do not enter sign displayed on the display will flash and a buzzer will sound.

■ Operating conditions of the notification functions

● Excess speed notification function

This function will operate when the following condition is met:

- A speed limit road sign is recognized by the system.

● No entry notification function



This function will operate when all of the following conditions are met:





- More than one no entry road signs are recognized by the system simultaneously.
- The vehicle is passing between no entry road signs recognized by the system.

Types of road signs supported

- The following types of road signs can be displayed.

However, non-standard or recently introduced traffic signs may not be displayed.

 (U.S.A.)  (Canada)	Speed limit
	Do Not Enter

	No U-turn
	No Turn On Red
	Stop
	Yield
	Warning

Changing RSA settings

The following settings of the RSA can be changed through customize settings. (→P.396)

BSM (Blind Spot Monitor)*

*: If equipped

The Blind Spot Monitor is a system that uses rear side radar sensors installed on the inner side of the rear bumper on the left and right side to assist the driver in confirming safety when changing lanes.

WARNING

■ Cautions regarding the use of the system

- The driver is solely responsible for safe driving. Always drive safely, taking care to observe your surroundings.
- The Blind Spot Monitor is a supplementary function which alerts the driver that a vehicle is in a blind spot of the outside rear view mirrors or is approaching rapidly from behind into a blind spot. Do not overly rely on the Blind Spot Monitor. As the function cannot judge if it is safe to change lanes, over reliance could lead to an accident resulting in death or serious injury. As the system may not function correctly under certain conditions, the driver's own visual confirmation of safety is necessary.

System components

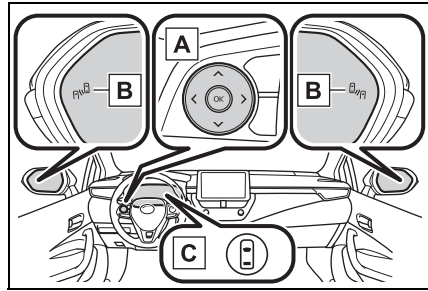

A Meter control switches

Turning the Blind Spot Monitor on/off.

B Outside rear view mirror indicators

When a vehicle is detected in a blind spot of the outside rear view mirrors or approaching rapidly from behind into a blind spot, the outside rear view mirror indicator (→P.70) on the detected side will illuminate. If the turn signal lever is operated toward the detected side, the outside rear view mirror indicator flashes.

C Driving assist information indicator

Illuminates when the Blind Spot Monitor is turned off. At this time, a message will be displayed on the multi-information display.

■ Outside rear view mirror indicator visibility

In strong sunlight, the outside rear view mirror indicator may be difficult to see.

■ Customization

Some functions can be customized. (→P.396)

**WARNING**

■ **To ensure the system can operate properly**

Blind Spot Monitor sensors are installed behind the left and right sides of the rear bumper respectively. Observe the following to ensure the Blind Spot Monitor can operate correctly.

- Keep the sensors and the surrounding areas on the rear bumper clean at all times.

If a sensor or its surrounding area on the rear bumper is dirty or covered with snow, the Blind Spot Monitor may not operate and a warning message will be displayed. In this situation, clear off the dirt or snow and drive the vehicle with the operation conditions of the BSM function (→P.218) satisfied for approximately 10 minutes. If the warning message does not disappear, have the vehicle inspected by your Toyota dealer.

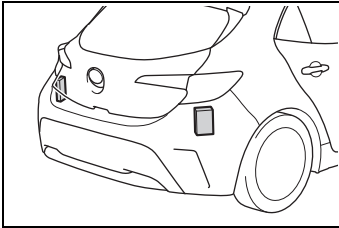

- Do not attach accessories, stickers (including transparent stickers), aluminum tape, etc. to a sensor or its surrounding area on the rear bumper.

- Do not subject a sensor or its surrounding area on the rear bumper to a strong impact. If a sensor is moved even slightly off position, the system may malfunction and vehicles may not be detected correctly. In the following situations, have your vehicle inspected by your Toyota dealer.

- A sensor or its surrounding area is subject to a strong impact.
- If the surrounding area of a sensor is scratched or dented, or part of them has become disconnected.

- Do not disassemble the sensor.

- Do not modify the sensor or surrounding area on the rear bumper.

- If a sensor or the rear bumper needs to be removed/installed or replaced, contact your Toyota dealer.

- Do not paint the rear bumper any color other than an official Toyota color.

Turning the Blind Spot Monitor on/off

The Blind Spot Monitor can be enabled/disabled through a customize setting. (→P.396)

When the Blind Spot Monitor is off, the driving assist information indicator (→P.70) will illuminate and a message will be displayed on the multi-information display.

Each time the engine switch is turned to ON, the Blind Spot Monitor is enabled.

Blind Spot Monitor operation

■ Objects that can be detected while driving

The Blind Spot Monitor uses rear side radar sensors to detect the following vehicles traveling in adjacent lanes and advises the driver of the presence of such vehicles via the indicators on the outside rear view mirrors.

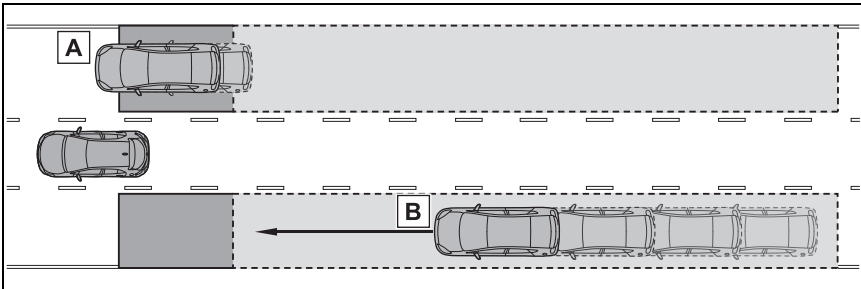

- A** Vehicles that are traveling in areas that are not visible using the outside rear view mirrors (the blind spots)
- B** Vehicles that are approaching rapidly from behind in areas that are not visible using the outside rear view mirrors (the blind spots)

■ Detection range while driving

The areas that vehicles can be detected in are outlined below.

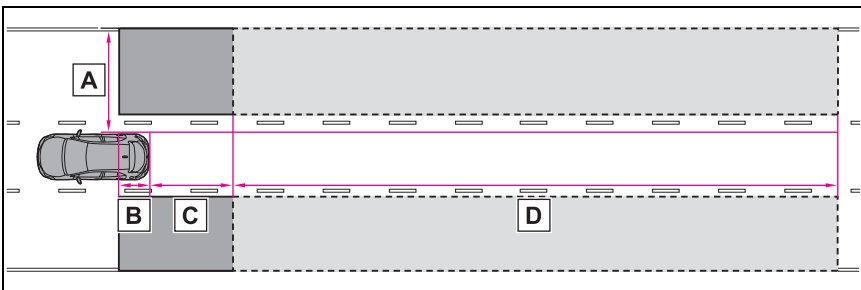

The range of each detection area is:

- A** Approximately 1.6 ft. (0.5 m) to 11.5 ft. (3.5 m) from either side of the vehicle^{*1}
- B** Approximately 3.3 ft. (1 m) forward of the rear bumper
- C** Approximately 9.8 ft. (3 m) from the rear bumper
- D** Approximately 9.8 ft. (3 m) to 197 ft. (60 m) from the rear bumper^{*2}

*1: The area between the side of the vehicle and 1.6 ft. (0.5 m) from the side of the vehicle cannot be detected.

*2: The greater the difference in speed between your vehicle and the detected vehicle is, the farther away the vehicle will be detected, causing the outside rear view mirror indicator to illuminate or flash.

■ **The Blind Spot Monitor linked function**

The LDA (Lane Departure Alert) has a function that uses information of detected vehicles driving in an adjacent lane. For details about the function and its operating conditions, →P.182.

■ **The Blind Spot Monitor is operational when**

The Blind Spot Monitor is operational when all of the following conditions are met:

- The engine switch is in ON.
- The Blind Spot Monitor is on.
- The shift lever is in a position other than R.
- The vehicle speed is approximately 7 mph (10 km/h) or more.

■ **The Blind Spot Monitor will detect a vehicle when**

The Blind Spot Monitor will detect a vehicle present in the detection area in the following situations:

- A vehicle in an adjacent lane overtakes your vehicle.
- You overtake a vehicle in an adjacent lane slowly.
- Another vehicle enters the detection area when it changes lanes.

■ **Situations in which the blind spot monitor cannot detect vehicles.**

The blind spot monitor cannot detect the following vehicles and other objects:

- Small motorcycles, bicycles, pedestrians, etc.*
- Vehicles traveling in the opposite direction
- Guardrails, walls, signs, parked vehicles and similar stationary

objects*

- Following vehicles that are in the same lane*
- Vehicles traveling 2 lanes away from your vehicle*
- Vehicles which are being overtaken rapidly by your vehicle*

*: Depending on the conditions, detection of a vehicle and/or object may occur.

■ **Conditions under which the System may not function correctly**

- The Blind Spot Monitor may not detect vehicles correctly in the following situations:
 - When the sensor is misaligned due to a strong impact to the sensor or its surrounding area
 - When mud, snow, ice, a sticker, etc. is covering the sensor or surrounding area on the rear bumper
 - When driving on a road surface that is wet with standing water during bad weather, such as heavy rain, snow, or fog
 - When multiple vehicles are approaching with only a small gap between each vehicle
 - When the distance between your vehicle and a following vehicle is short
 - When there is a significant difference in speed between your vehicle and the vehicle that enters the detection area
 - When the difference in speed

- between your vehicle and another vehicle is changing
- When a vehicle enters a detection area traveling at about the same speed as your vehicle
 - As your vehicle starts from a stop, a vehicle remains in the detection area
 - When driving up and down consecutive steep inclines, such as hills, dips in the road, etc.
 - When driving on roads with sharp bends, consecutive curves, or uneven surfaces
 - When vehicle lanes are wide, or when driving on the edge of a lane, and the vehicle in an adjacent lane is far away from your vehicle
 - When an accessory (such as a bicycle carrier) is installed to the rear of the vehicle
 - When there is a significant difference in height between your vehicle and the vehicle that enters the detection area
 - Immediately after the Blind Spot Monitor is turned on
 - When towing with the vehicle
 - Instances of the Blind Spot Monitor unnecessarily detecting a vehicle and/or object may increase in the following situations:
 - When the sensor is misaligned due to a strong impact to the sensor or its surrounding area
 - When the distance between your vehicle and a guardrail, wall, etc. that enters the detection area is short
 - When driving up and down consecutive steep inclines, such as hills, dips in the road, etc.
 - When vehicle lanes are narrow, or when driving on the edge of a lane, and a vehicle traveling in a lane other than the adjacent lanes enters the detection area
 - When driving on roads with sharp bends, consecutive curves, or uneven surfaces
 - When the tires are slipping or spinning
 - When the distance between your vehicle and a following vehicle is short
 - When an accessory (such as a bicycle carrier) is installed to the rear of the vehicle
 - When towing with the vehicle

RCTA (Rear Cross Traffic Alert) function *

*: If equipped

The RCTA function uses the BSM rear side radar sensors installed behind the rear bumper. This function is intended to assist the driver in checking areas that are not easily visible when backing up.

WARNING

Cautions regarding the use of the system

The driver is solely responsible for safe driving. Always drive safely, taking care to observe your surroundings. The RCTA function is only a supplementary function which alerts the driver that a vehicle is approaching from the right or left at the rear of the vehicle. As the RCTA function may not function correctly under certain conditions, the driver's own visual confirmation of safety is necessary. Over reliance on this function may lead to an accident resulting death or serious injury.

To ensure the system can operate properly

→P.216

System components

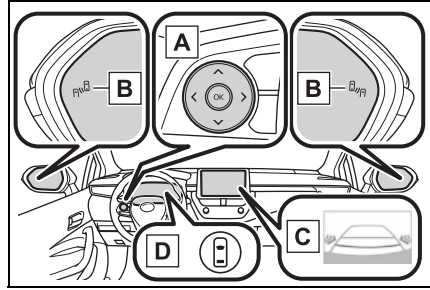

A Meter control switches

Operate the meter control switches to enable/disable the RCTA function on the multi-information display.

B Outside rear view mirror indicators

If a vehicle is detected as approaching from the left or right behind the vehicle, both outside rear view mirror indicators (→P.70) will blink and a buzzer will sound.

C Audio system screen

If a vehicle approaching from the right or left at the rear of the vehicle is detected, the RCTA icon (→P.221) for the detected side will be displayed on the audio system screen. This illustration shows an example of a vehicle approaching from both sides of the vehicle.

D Driving assist information indicator

Illuminates when the RCTA is turned off. At this time, a message will be displayed on the multi-information display.

Turning the RCTA function on/off

The RCTA can be enabled/disabled through a customize setting. (→P.396)

When the RCTA function is off, the driving assist information indicator (→P.70) will illuminate and a message will be displayed on the multi-information display.

Each time the engine switch is

turned to ON, the RCTA function is enabled.

■ Outside rear view mirror indicator visibility

In strong sunlight, the outside rear view mirror indicator may be difficult to see.

■ Hearing the RCTA buzzer

The RCTA buzzer may be difficult to hear over loud noises, such as if the audio system volume is high.

■ Rear side radar sensors

→P.216

RCTA function

■ Operation of the RCTA function

The RCTA function uses rear side radar sensors to detect vehicles approaching from the right or left at the rear of the vehicle and alerts the driver of the presence of such vehicles by flashing the outside rear view mirror indicators and sounding a buzzer.

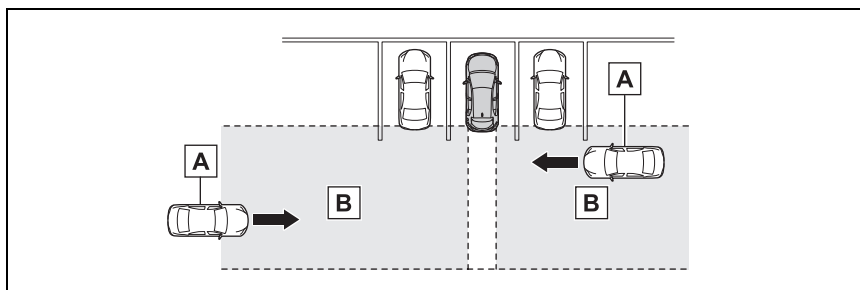

A Approaching vehicles

B Detection areas of approaching vehicles

■ RCTA icon display

When a vehicle approaching from the right or left at the rear of the vehicle is detected, the following will be displayed on the audio system screen.

Example: Vehicles are approaching from both sides of the vehicle

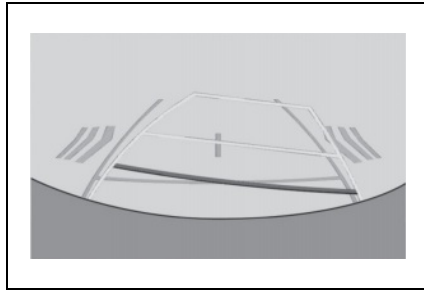

■ **RCTA function detection areas**

The areas that vehicles can be detected in are outlined below.

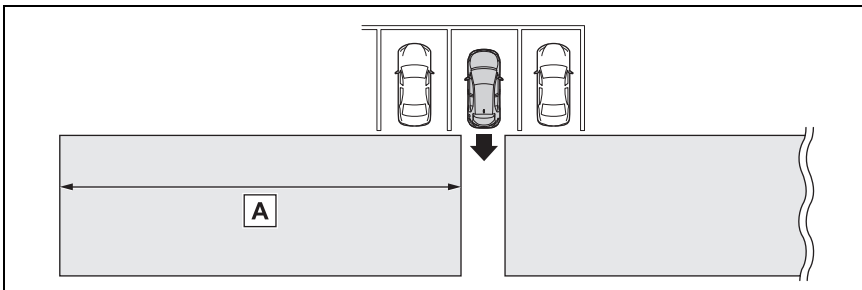

The buzzer can alert the driver of faster vehicles approaching from farther away.

Example:

Approaching vehicle speed	A Approximate alert distance
34 mph (56 km/h) (fast)	98 ft. (30 m)
5 mph (8 km/h) (slow)	13 ft. (4 m)

■ **The RCTA function is operational when**

The RCTA function operates when all of the following conditions are met:

- The engine switch is in ON.
- The RCTA function is on.
- The shift lever is in R.
- The vehicle speed is less than approximately 9 mph (15 km/h).
- The approaching vehicle speed is between approximately 5 mph (8 km/h) and 34 mph (56 km/h).

■ **Setting the buzzer volume**

The buzzer volume of the RCTA and Toyota parking assist-sensor can be adjusted all together through a customize setting. (→P.396)

■ **Conditions under which the system will not detect a vehicle**

The RCTA function is not designed to detect the following types of vehicles and/or objects:

- Vehicles approaching from directly behind
- Vehicles backing up in a parking space next to your vehicle

- Vehicles that the sensors cannot detect due to obstructions

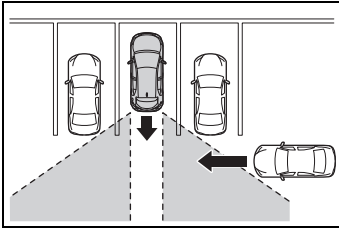

- Guardrails, walls, signs, parked vehicles and similar stationary objects*
- Small motorcycles, bicycles, pedestrians, etc.*
- Vehicles moving away from your vehicle
- Vehicles approaching from the parking spaces next to your vehicle*
- The distance between the sensor and approaching vehicle gets too close

*: Depending on the conditions, detection of a vehicle and/or object may occur.

Situations in which the system may not operate properly

The RCTA function may not detect vehicles correctly in the following situations:

- When the sensor is misaligned due to a strong impact to the sensor or its surrounding area
- When mud, snow, ice, a sticker, etc., is covering the sensor or surrounding area on the position above the rear bumper
- When driving on a road surface that is wet with standing water during bad weather, such as heavy rain, snow, or fog
- When multiple vehicles are approaching with only a small gap between each vehicle
- When a vehicle is approaching at

high speed

- When equipment that may obstruct a sensor is installed, such as a towing eyelet, bumper protector (an additional trim strip, etc.), bicycle carrier, or snow plow
- When backing up on a slope with a sharp change in grade

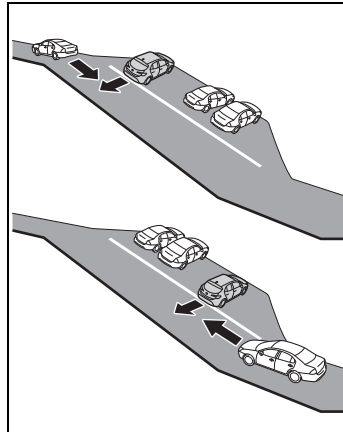

- When backing out of a sharp angle parking spot

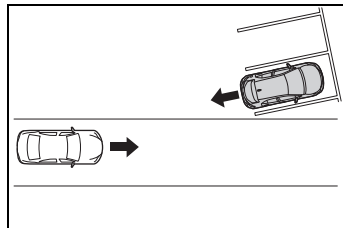

- Immediately after the RCTA function is turned on
- Immediately after the engine is started with the RCTA function on
- When the sensors cannot detect a vehicle due to obstructions
- When towing a trailer
- When there is a significant difference in height between your vehicle and the vehicle that enters the detection area
- When a sensor or the area around a sensor is extremely hot or cold
- If the suspension has been modified

fied or tires of a size other than specified are installed

- If the front of the vehicle is raised or lowered due to the carried load
- When turning while backing up

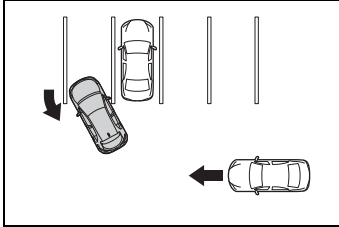

- When a vehicle turns into the detection area

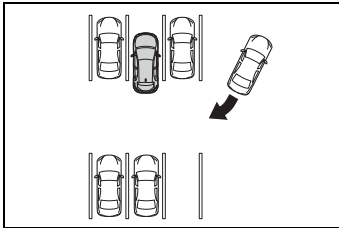

■ **Situations in which the system may operate even if there is no possibility of a collision**

Instances of the RCTA function unnecessarily detecting a vehicle and/or object may increase in the following situations:

- When the parking space faces a street and vehicles are being driven on the street

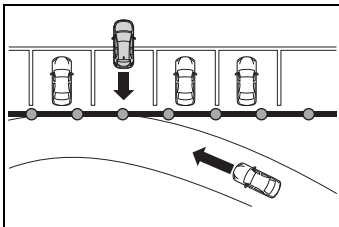

- When the distance between your vehicle and metal objects, such as a guardrail, wall, sign, or parked vehicle, which may reflect electrical waves toward the rear of the vehicle, is short

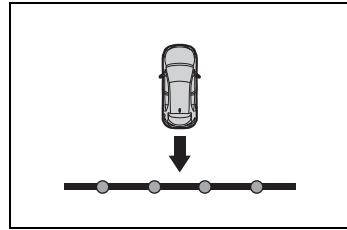

- When equipment that may obstruct a sensor is installed, such as a towing eyelet, bumper protector (an additional trim strip, etc.), bicycle carrier, or snow plow
- When a vehicle passes by the side of your vehicle

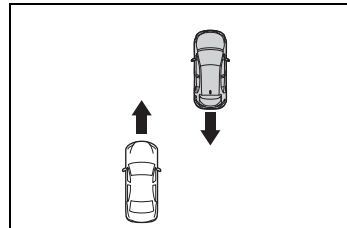

- When a detected vehicle turns while approaching the vehicle

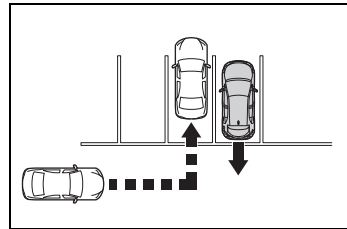

- When there are spinning objects near your vehicle such as the fan of an air conditioning unit
- When water is splashed or sprayed toward the rear bumper, such as from a sprinkler
- Moving objects (flags, exhaust fumes, large rain droplets or snowflakes, rain water on the road surface, etc.)
- When the distance between your vehicle and a guardrail, wall, etc., that enters the detection area is short
- Gratings and gutters

- When a sensor or the area around a sensor is extremely hot or cold
- If the suspension has been modified or tires of a size other than specified are installed
- If the front of the vehicle is raised or lowered due to the carried load
- When towing with the vehicle

Safe Exit Assist*

*: If equipped

The safe exit assist is a system that uses rear side radar sensors installed on the inner side of the rear bumper to help occupants judge if an approaching vehicle or bicycle may collide with a door when opening it or cancel opening of the door, to reduce the possibility of a collision.



WARNING

■ Cautions regarding the use of the system

- The driver is solely responsible for safe driving. Always drive safely, taking care to observe your surroundings.
- The safe exit assist is a supplementary system that, when the vehicle is stopped, informs occupants of the existence of approaching vehicles and bicycles. As this system alone cannot be used to judge safety, over-reliance on this system may lead to an accident resulting in death or serious injury.

In certain situations, this system may not function to its fullest extent. Therefore it is necessary for the occupants to visually check for safety directly and using the mirrors.

System components

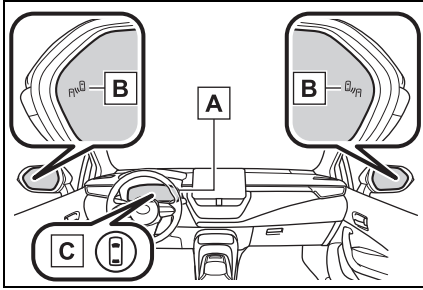

A Multi-information display

Turning the safe exit assist on/off. When the system determines that the possibility of a collision with a door is high, the target door is displayed on the multi-information display. Also, if the door is opened when the outside rear view mirror indicator is illuminated, a buzzer will sound as a warning.

B Outside rear view mirror indicators

When a vehicle or bicycle which may collide with a door (other than the back door) when opened is detected, the outside rear view mirror indicator (→P.70) on the detected side will illuminate. If the door on the detected side is opened, the outside rear view mirror indicator will blink.

C Driving assist information indicator

Illuminates when the safe exit assist is turned off. At this time, a message will be displayed on the multi-information display.

■ Outside rear view mirror indicator visibility

In strong sunlight, the outside rear

view mirror indicator may be difficult to see.

■ Buzzer

If the volume setting of the audio system is high or the surrounding area is loud, it may be difficult to hear the buzzer.

■ Customization

Some functions can be customized. (→P.396)

⚠ WARNING

■ To ensure the system can operate properly

→P.216

Turning the Safe exit assist system ON/OFF

The safe exit assist system can be enabled/disabled through a customize setting. (→P.396)

When the safe exit assist is off, the driving assist information indicator will illuminate and a message will be displayed on the multi-information display.

Each time the engine switch is turned to ON, the safe exit assist is enabled.*

*: When the engine switch is turned off and then to ON immediately after that, the safe exit assist may not be enabled.

Safe exit assist operation

■ Objects that can be detected by the Safe exit assist

When the safe exit assist detects the following vehicles or bicycles behind your vehicle using a rear side radar sensor, the occupants of the vehicle are informed through an outside rear view mirror indicator, buzzer, and the multi-information display.

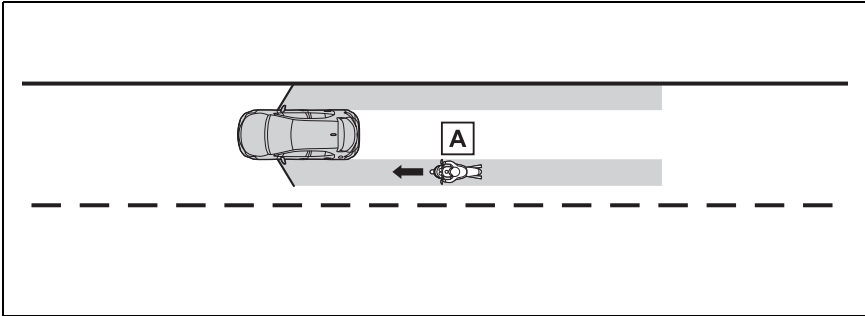

- A** Vehicle or bicycle which has a high possibility of colliding with a door (other than the back door) when opened

■ The Safe exit assist detection areas

The areas that vehicles can be detected in are outlined below.

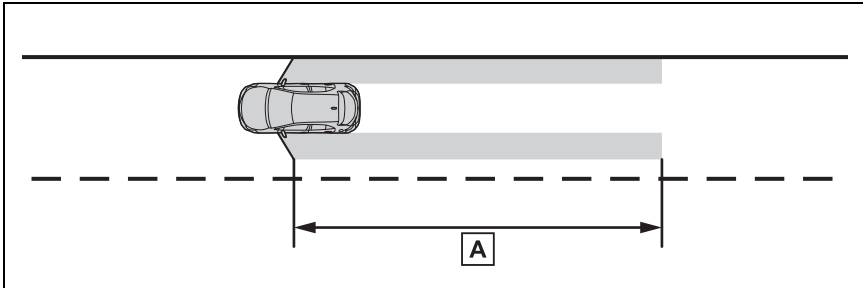

- A** Approximately 145 ft. (45 m) rearward from the front door*

*: The faster a vehicle or bicycle is approaching, the distance at which an outside rear view mirror indicator will illuminate or blink will become further.

■ The Safe exit assist is operational when

The Safe exit assist is operational when all of the following conditions are met:

- When the engine switch is ON, less than 3 minutes have elapsed since the engine was off, or less than 3 minutes have elapsed since a door was opened and someone has entered the vehicle (the time which operation is possi-

ble may be extended if a door is opened and closed)

- Safe exit assist is on
- The vehicle is stopped.
- The shift lever is in a position other than R.

■ The Safe exit assist will detect a vehicle when

The Safe exit assist will detect a vehicle present in the detection area in the following situations:

- When the vehicle is stopped and a vehicle or bicycle, which is traveling parallel to the vehicle, is approaching within the area that a door opens (other than the back door)

■ Conditions under which the system will not detect a vehicle

- Safe exit assist does not detect the following objects, vehicles, and bicycles:
 - Vehicles or bicycles which are approaching slowly*
 - Vehicles or bicycles which are determined to have a low possibility of colliding with a door (other than the back door) when opened*
 - Vehicles or bicycles which are approaching from directly behind*
 - Vehicles or bicycles which are approaching from the front*
 - Guardrails, walls, signs, parked vehicles, and other stationary objects*
 - Pedestrians, animals, etc.*

*: Depending on the conditions, detection of a vehicle and/or object may occur.

- In situations such as the following, safe exit assist will not operate:
 - When 3 minutes or more have elapsed since the engine off (the time which operation is possible may be extended if a door is opened and closed)
 - When your vehicle is not completely stopped

■ Conditions under which the system may not function correctly

- The Safe exit assist may not detect vehicles correctly in the following situations:
 - When the sensor is misaligned due to a strong impact to the sensor or its surrounding area
 - When mud, snow, ice, a sticker, etc. is covering the sensor or surrounding area on the rear bumper
 - When the vehicle is stopped on a wet road surface, such as in a puddle, while in inclement weather, such as heavy rain, snow, fog, etc.
 - When a vehicle or bicycle approaches from behind a nearby parked vehicle
 - When an approaching vehicle or bicycle suddenly changes direction
 - Immediately after a vehicle or bicycle starts moving
 - When the back door is open
 - When a bicycle carrier, ramp, or other accessory is installed to the back of the vehicle
 - When a parked vehicle, wall, sign, person or other stationary object is behind the vehicle
 - When the vehicle is stopped at an angle to the road
 - When a vehicle is traveling near an approaching vehicle or bicycle
 - When an approaching vehicle or bicycle is traveling along a stationary object, such a wall or sign
 - When a vehicle or bicycle is approaching at high speed
 - When towing with the vehicle
 - When stopped on a steep slope
 - When stopped on a curve or at the exit of a curve
- Instances of the Safe exit assist unnecessarily detecting a vehicle and/or object may increase in the following situations:
 - When the sensor is misaligned due to a strong impact to the sensor or its surrounding area
 - When a vehicle or bicycle

- approaches your vehicle from directly behind in an offset position
- When a vehicle or bicycle approaches from behind a parked vehicle at an angle
 - When a parked vehicle, wall, sign, person or other stationary object is behind the vehicle
 - When an approaching vehicle or bicycle suddenly changes direction
 - When an approaching vehicle or bicycle is traveling along a stationary object, such as a wall or sign
 - When the back door is open
 - When a bicycle carrier, ramp, or other accessory is installed to the back of the vehicle
 - When a vehicle or bicycle is approaching at high speed
 - When towing with the vehicle
 - When stopped on a steep slope
 - When stopped on a curve or at the exit of a curve
 - When a vehicle or bicycle approaches from behind a vehicle stopped in an adjacent lane

Driving mode select switch

The driving modes can be selected to suit driving condition.

Selecting a drive mode

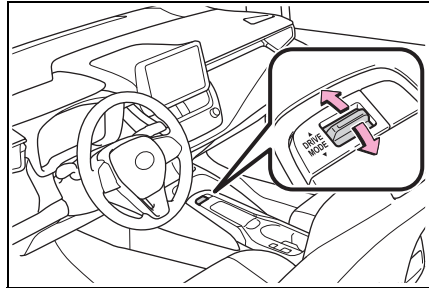

Operate the driving mode select switch forward or backward to select the desired driving mode on the multi-information display.

● Normal mode

Provides an optimal balance of fuel economy, quietness, and dynamic performance. Suitable for normal driving.

● Sport mode

Controls the transmission and engine to provide quick, powerful acceleration. This mode also changes the steering feel, making it suitable for when agile driving response is desired, such as when driving on roads with many curves.

When the sport mode is selected, sport mode indicator comes on.

● Eco drive mode

Helps the driver accelerate in an eco-friendly manner and improve

fuel economy through moderate throttle characteristics and by controlling the operation of the air conditioning system (heating/cooling).

When the eco mode is selected, eco drive mode indicator comes on.

Each time the switch is pressed, the system changes between power mode and normal mode.

■ Operation of the air conditioning system in Eco drive mode

Eco drive mode controls the heating/cooling operations and fan speed of the air conditioning system to enhance fuel efficiency. To improve air conditioning performance, perform the following operations:

- Turn off eco air conditioning mode (→P.243)
- Adjust the fan speed (→P.242)
- Turn off Eco drive mode

■ Automatic deactivation of sport mode

If the engine switch is turned off after driving in sport mode, the drive mode will be changed to normal mode.

Driving assist systems

To keep driving safety and performance, the following systems operate automatically in response to various driving situations. Be aware, however, that these systems are supplementary and should not be relied upon too heavily when operating the vehicle.

Summary of the driving assist systems

■ ABS (Anti-lock Brake System)

Helps to prevent wheel lock when the brakes are applied suddenly, or if the brakes are applied while driving on a slippery road surface

■ Brake assist

Generates an increased level of braking force after the brake pedal is depressed when the system detects a panic stop situation

■ VSC (Vehicle Stability Control)

Helps the driver to control skidding when swerving suddenly or turning on slippery road surfaces.

■ Enhanced VSC (Enhanced Vehicle Stability Control)

Provides cooperative control of the ABS, TRAC, VSC and EPS. Helps to maintain directional stability when swerving on slippery road surfaces by controlling steering performance.

■ The Secondary Collision Brake

When the SRS airbag sensor detects a collision and the system operates, the brakes and brake lights are automatically controlled to reduce the vehicle speed and help reduce the possibility of further damage due to a secondary collision.

■ TRAC (Traction Control)

Helps to maintain drive power and prevent the drive wheels from spinning when starting the vehicle or accelerating on slippery roads

■ Active Cornering Assist (ACA)

Helps to prevent the vehicle from drifting to the outer side by performing inner wheel brake control when attempting to accelerate while turning

■ Hill-start assist control

Helps to reduce the backward movement of the vehicle when starting on an uphill

■ EPS (Electric Power Steering)

Employs an electric motor to reduce the amount of effort needed to turn the steering wheel.

■ When the TRAC/VSC systems are operating

The slip indicator light will flash while the TRAC/VSC systems are operating.

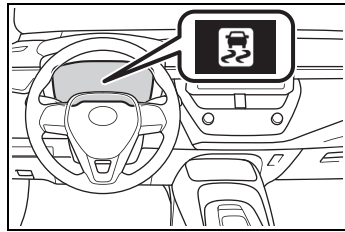

■ Disabling the TRAC system

If the vehicle gets stuck in mud, dirt or snow, the TRAC system may reduce power from the engine to the wheels. Pressing  to turn the system off may make it easier for you to rock the vehicle in order to free it.

To turn the TRAC system off, quickly press and release .

The “Traction Control Turned OFF” will be shown on the multi-information display.

Press  again to turn the system back on.

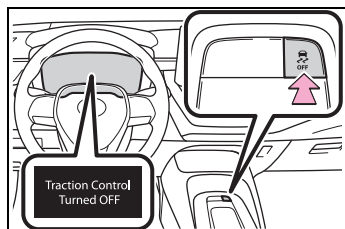

■ Turning off both TRAC and VSC systems

To turn the TRAC and VSC systems off, press and hold  for more than 3 seconds while the vehicle is stopped.

The VSC OFF indicator light will come on and the “Traction Control Turned OFF” will be shown on the multi-information display.*

Press  again to turn the system back on.

*: PCS will also be disabled (only Pre-Collision warning is available). The PCS warning light will come on and a message will be displayed on the multi-information display. (→P.176)

■ When the message is displayed on the multi-information display showing that TRAC has been disabled even if has not been pressed

TRAC is temporary deactivated. If the information continues to show, contact your Toyota dealer.

■ Operating conditions of hill-start assist control

When all of the following conditions are met, the hill-start assist control will operate:

- The shift lever is in a position other than P or N (when starting off forward/backward on an upward incline).
- The vehicle is stopped
- The accelerator pedal is not depressed
- The parking brake is not engaged
- The engine switch is turned to ON

■ Automatic system cancelation of hill-start assist control

The hill-start assist control will turn

off in any of the following situations:

- The shift lever is shifted to P or N.
- The accelerator pedal is depressed
- The parking brake is engaged
- 2 seconds at maximum elapsed after the brake pedal is released
- The engine switch is turned to OFF

■ Sounds and vibrations caused by the ABS, brake assist, VSC, TRAC and hill-start assist control systems

- A sound may be heard from the engine compartment when the brake pedal is depressed repeatedly, when the engine is started or just after the vehicle begins to move. This sound does not indicate that a malfunction has occurred in any of these systems.
- Any of the following conditions may occur when the above systems are operating. None of these indicates that a malfunction has occurred.
 - Vibrations may be felt through the vehicle body and steering.
 - A motor sound may be heard also after the vehicle comes to a stop.
 - The brake pedal may pulsate slightly after the ABS is activated.
 - The brake pedal may move down slightly after the ABS is activated.

■ Active Cornering Assist operation sounds and vibrations

When the Active Cornering Assist is operated, operation sounds and vibrations may be generated from the brake system, but this is not a malfunction.

■ EPS operation sound

When the steering wheel is operated, a motor sound (whirring sound) may be heard. This does not indicate a malfunction.

■ Automatic reactivation of TRAC and VSC systems

After turning the TRAC and VSC systems off, the systems will be automatically re-enabled in the following situations:

- When the engine switch is turned off
- If only the TRAC system is turned off, the TRAC will turn on when vehicle speed increases
- If both the TRAC and VSC systems are turned off, automatic re-enabling will not occur when vehicle speed increases.

■ Operating conditions of Active Cornering Assist

The system operates when the following occurs.

- TRAC/VSC can operate
- The driver is attempting to accelerate while turning
- The system detects that the vehicle is drifting to the outer side
- The brake pedal is released

■ Reduced effectiveness of the EPS system

The effectiveness of the EPS system is reduced to prevent the system from overheating when there is frequent steering input over an extended period of time. The steering wheel may feel heavy as a result. Should this occur, refrain from excessive steering input or stop the vehicle and turn the engine off. The EPS system should return to normal within 10 minutes.

■ Secondary Collision Brake operating conditions

The system operates when the SRS airbag sensor detects a collision while the vehicle is in motion.

However, the system does not operate when the components are damaged.

■ Secondary Collision Brake automatic cancellation

The system is automatically canceled in any of the following situations.

- The vehicle speed drops below approximately 0 mph (0 km/h)
- A certain amount of time elapses during operation
- The accelerator pedal is depressed a large amount



WARNING

■ The ABS does not operate effectively when

- The limits of tire gripping performance have been exceeded (such as excessively worn tires on a snow covered road).
- The vehicle hydroplanes while driving at high speed on wet or slick roads.

■ Stopping distance when the ABS is operating may exceed that of normal conditions

The ABS is not designed to shorten the vehicle's stopping distance. Always maintain a safe distance from the vehicle in front of you, especially in the following situations:

- When driving on dirt, gravel or snow-covered roads
- When driving with tire chains
- When driving over bumps in the road
- When driving over roads with potholes or uneven surfaces

**WARNING**

■ **TRAC/VSC may not operate effectively when**

Directional control and power may not be achievable while driving on slippery road surfaces, even if the TRAC/VSC system is operating. Drive the vehicle carefully in conditions where stability and power may be lost.

■ **Active Cornering Assist does not operate effectively when**

● Do not overly rely on Active Cornering Assist. Active Cornering Assist may not operate effectively when accelerating down slopes or driving on slippery road surfaces.

● When Active Cornering Assist frequently operates, Active Cornering Assist may temporarily stop operating to ensure proper operation of the brakes, TRAC and VSC.

■ **Hill-start assist control does not operate effectively when**

● Do not overly rely on hill-start assist control. Hill-start assist control may not operate effectively on steep inclines and roads covered with ice.

● Unlike the parking brake, hill-start assist control is not intended to hold the vehicle stationary for an extended period of time. Do not attempt to use hill-start assist control to hold the vehicle on an incline, as doing so may lead to an accident.

■ **When the TRAC/VSC is activated**

The slip indicator light flashes. Always drive carefully. Reckless driving may cause an accident. Exercise particular care when the indicator light flashes.

■ **When the TRAC/VSC systems are turned off**

Be especially careful and drive at a speed appropriate to the road conditions. As these are the systems to help ensure vehicle stability and driving force, do not turn the TRAC/VSC systems off unless necessary.

■ **Secondary Collision Brake**

Do not rely solely upon the Secondary Collision Brake. This system is designed to help reduce the possibility of further damage due to a secondary collision, however, that effect changes according to various conditions. Overly relying on the system may result in death or serious injury.

■ **Replacing tires**

Make sure that all tires are of the specified size, brand, tread pattern and total load capacity. In addition, make sure that the tires are inflated to the recommended tire inflation pressure level.

The ABS, TRAC and VSC systems will not function correctly if different tires are installed on the vehicle.

Contact your Toyota dealer for further information when replacing tires or wheels.

■ **Handling of tires and the suspension**

Using tires with any kind of problem or modifying the suspension will affect the driving assist systems, and may cause a system to malfunction.

Winter driving tips

Carry out the necessary preparations and inspections before driving the vehicle in winter. Always drive the vehicle in a manner appropriate to the prevailing weather conditions.

Pre-winter preparations

- Use fluids that are appropriate to the prevailing outside temperatures.
- Engine oil
- Engine coolant
- Washer fluid
- Have a service technician inspect the condition of the battery.
- Have the vehicle fitted with four snow tires or purchase a set of tire chains for the front tires.

Ensure that all tires are the same size and brand, and that chains match the size of the tires.

 WARNING**■ Driving with snow tires**

Observe the following precautions to reduce the risk of accidents. Failure to do so may result in a loss of vehicle control and cause death or serious injury.

- Use tires of the size specified.
- Maintain the recommended level of air pressure.

- Do not drive in excess of 75 mph (120 km/h), regardless of the type of snow tires being used.

- Use snow tires on all, not just some wheels.

■ Driving with tire chains

Observe the following precautions to reduce the risk of accidents. Failure to do so may result in the vehicle being unable to be driven safely, and may cause death or serious injury.

- Do not drive in excess of the speed limit specified for the tire chains being used, or 30 mph (50 km/h), whichever is lower.

- Avoid driving on bumpy road surfaces or over potholes.

- Avoid sudden acceleration, abrupt steering, sudden braking and shifting operations that cause sudden engine braking.

- Slow down sufficiently before entering a curve to ensure that vehicle control is maintained.

- Do not use LTA (Lane Tracing Assist) system.

- Do not use LDA (Lane Departure Alert) system.

**NOTICE****■ Repairing or replacing snow tires**

Request repairs or replacement of snow tires from Toyota dealers or legitimate tire retailers.

This is because the removal and attachment of snow tires affects the operation of the tire pressure warning valves and transmitters.

Before driving the vehicle

Perform the following according to the driving conditions:

- Do not try to forcibly open a window or move a wiper that is frozen. Pour warm water over the frozen area to melt the ice. Wipe away the water immediately to prevent it from freezing.
- To ensure proper operation of the climate control system fan, remove any snow that has accumulated on the air inlet vents in front of the windshield.
- Check for and remove any excess ice or snow that may have accumulated on the exterior lights, vehicle's roof, chassis, around the tires or on the brakes.
- Remove any snow or mud from the bottom of your shoes before getting in the vehicle.

When driving the vehicle

Accelerate the vehicle slowly, keep a safe distance between you and the vehicle ahead, and drive at a reduced speed suitable to road conditions.

When parking the vehicle

- Turn automatic mode of the parking brake off. Otherwise,

the parking brake may freeze and not be able to be released automatically.

Also, avoid using the following as the parking brake may operate automatically, even if automatic mode is off.

- Brake hold system
- Park the vehicle and shift the shift lever to P without setting the parking brake. The parking brake may freeze up, preventing it from being released. If the vehicle is parked without setting the parking brake, make sure to block the wheels.

Failure to do so may be dangerous because it may cause the vehicle to move unexpectedly, possibly leading to an accident.

- When the parking brake is in automatic mode, release the parking brake after shifting the shift lever to P. (→P.143)
- If the vehicle is parked without setting the parking brake, confirm that the shift lever cannot be moved out of P*.
- If the vehicle is left parked with the brakes damp in cold temperatures, there is a possibility of the brakes freezing.

*: The shift lever will be locked if it is attempted to be shifted from P to any other position without depressing the brake pedal. If the shift lever can be shifted from P,

there may be a problem with the shift lock system. Have the vehicle inspected by your Toyota dealer immediately.

Selecting tire chains

Use the correct tire chain size when mounting the tire chains. Chain size is regulated for each tire size.

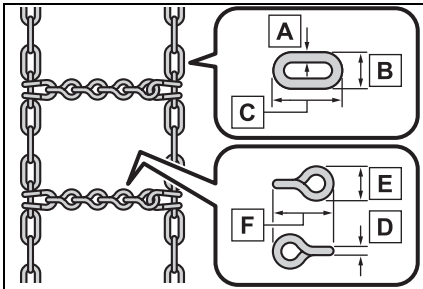

- A** Side chain (0.12 in. [3 mm] in diameter)
- B** Side chain (0.39 in. [10 mm] in width)
- C** Side chain (1.18 in. [30 mm] in length)
- D** Cross chain (0.16 in. [4 mm] in diameter)
- E** Cross chain (0.55 in. [14 mm] in width)
- F** Cross chain (0.98 in. [25 mm] in length)

Regulations on the use of tire chains

Regulations regarding the use of tire chains vary depending on location and type of road.

Always check local regulations before installing chains.

■ Tire chain installation

Observe the following precautions when installing and removing chains:

- Install and remove tire chains in a safe location.
- Install tire chains on the front tires only. Do not install tire chains on the rear tires.
- Install tire chains on the front tires as tightly as possible. Retighten chains after driving 1/4—1/2 mile (0.5—1.0 km).
- Install tire chains following the instructions provided with the tire chains.



NOTICE

■ Fitting tire chains

The tire pressure warning valves and transmitters may not function correctly when tire chains are fitted.

5-1. Using the air conditioning system and defogger

Automatic air conditioning system..... 240

Heated steering wheel/seat heaters 247

5-2. Using the interior lights

Interior lights list 249

5-3. Using the storage features

List of storage features 251

Luggage compartment features 254

5-4. Other interior features

Other interior features . 256

Automatic air conditioning system

Air outlets are automatically selected and fan speed is automatically adjusted according to the set temperature setting.

Air conditioning controls

- ▶ Vehicles without DUAL mode air conditioning system

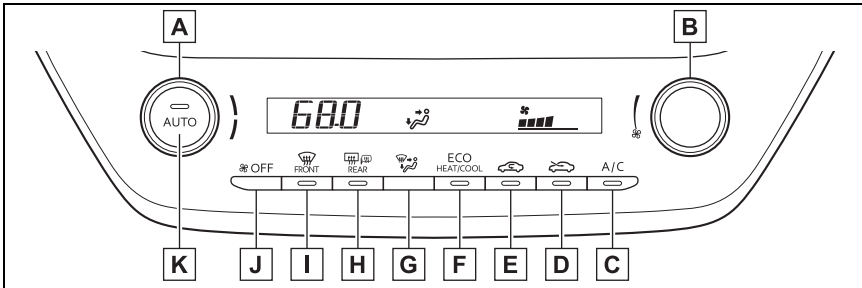

- A** Temperature control switch
- B** Fan speed control switch
- C** "A/C" switch
- D** Outside air mode switch
- E** Recirculated air mode switch
- F** Eco air conditioning mode switch
- G** Airflow mode control switch
- H** Rear window defogger and outside rear view mirror defoggers switch
- I** Windshield defogger switch
- J** Off switch
- K** Automatic mode switch

► Vehicles with DUAL mode air conditioning system

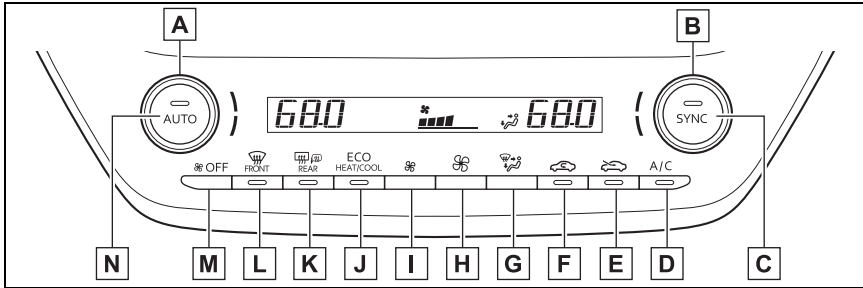

- A** Left-hand side temperature control switch
- B** Right-hand side temperature control switch
- C** “SYNC” switch
- D** “A/C” switch
- E** Outside air mode switch
- F** Recirculated air mode switch
- G** Airflow mode control switch
- H** Fan speed increases switch
- I** Fan speed decreases switch
- J** Eco air conditioning mode switch
- K** Rear window defogger and outside rear view mirror defoggers switch
- L** Windshield defogger switch
- M** Off switch
- N** Automatic mode switch

■ **Adjusting the temperature setting**

To adjust the temperature setting, turn the temperature control switch clockwise (warm) or counterclockwise (cool).

If “A/C” switch is not pressed, the system will blow ambient temperature air or heated air.

Vehicles with DUAL mode air conditioning system: The air condition-

ing system switches between individual and synchronized modes each time “SYNC” switch is pressed.

The air conditioning system switches between individual and synchronized modes each time “SYNC” switch is pressed.

Synchronized modes (indicator on):

The left-hand side temperature control switch can be used to adjust

the temperature for the driver's and front passenger's side. At this time, operate the right-hand side temperature control switch to enter individual mode.

Individual modes (indicator off):

The temperature for the driver's and front passenger's side can be adjusted separately.

■ Setting the fan speed

- ▶ Vehicles without DUAL mode air conditioning system

To adjust the fan speed, turn the fan speed control switch clockwise (increase) or counterclockwise (decrease).

Pressing the off switch to turns off the fan.

- ▶ Vehicles with DUAL mode air conditioning system

Operate the fan speed increases switch to increase the fan speed and the fan speed decrease switch to decrease the fan speed.

Pressing the off switch to turns off the fan.

■ Change the airflow mode

Press the airflow mode control switch.

The airflow mode changes as follows each time the switch is pressed.

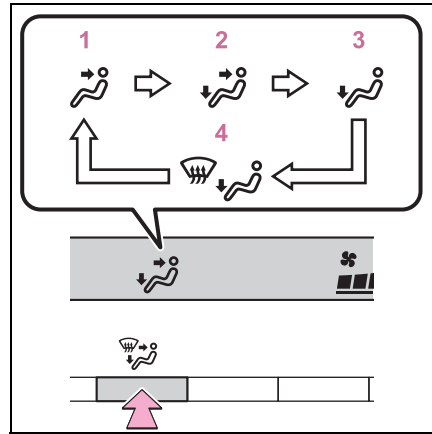

- 1 Upper body
- 2 Upper body and feet
- 3 Feet
- 4 Feet and the windshield defogger operates

■ Switching between outside air and recirculated air modes

- To change to recirculated air mode, press the recirculated air mode switch.

The indicator illuminates on the recirculated air mode switch.

- To change to outside air mode, press the outside air mode switch.

The indicator illuminates on the outside air mode switch.

■ Set cooling and dehumidification function

Press the "A/C" switch.

When the function is on, the indicator illuminates on the "A/C" switch.

■ Defogging the windshield

Defoggers are used to defog the

windshield and front side windows.

Press the windshield defogger switch.

Set the outside/recirculated air mode switch to outside air mode if the recirculated air mode is used. (It may switch automatically.)

To defog the windshield and the side windows quickly, turn the air flow and temperature up.

To return to the previous mode, press the windshield defogger switch again when the windshield is defogged.

When the windshield defogger switch is on, the indicator illuminates on the windshield defogger switch.

■ Defogging the rear window and outside rear view mirrors

Defoggers are used to defog the rear window, and to remove raindrops, dew and frost from the outside rear view mirrors.

Press the rear window and outside rear view mirror defoggers switch.

The defoggers will automatically turn off after a while.

When the rear window and outside rear view mirror defoggers switch is on, the indicator illuminates on the rear window and outside rear view mirror defoggers switch.

■ Eco air conditioning mode

The air conditioning is controlled with low fuel consumption priori-

tized such as reducing fan speed, etc.

Press the eco air conditioning mode switch.

When the eco air conditioning mode is on, the indicator illuminates on the eco air conditioning mode switch.

■ When the outside temperature exceeds 75°F (24°C) and the air conditioning system is on

- In order to reduce the air conditioning power consumption, the air conditioning system may switch to recirculated air mode automatically. This may also reduce fuel consumption.
- Recirculated air mode is selected as a default mode when the engine switch is turned to ON.
- It is possible to switch to outside air mode at any time by pressing the outside air mode switch.

■ Fogging up of the windows

- The windows will easily fog up when the humidity in the vehicle is high. Turning "A/C" on will dehumidify the air from the outlets and defog the windshield effectively.
- If you turn "A/C" off, the windows may fog up more easily.
- The windows may fog up if the recirculated air mode is used.

■ When driving on dusty roads

Close all windows. If dust thrown up by the vehicle is still drawn into the vehicle after closing the windows, it is recommended that the air intake mode be set to outside air mode and the fan speed to any setting except off.

■ Outside/recirculated air mode

- Setting to the recirculated air mode temporarily is recommended in preventing dirty air

from entering the vehicle interior and helping to cool the vehicle when the outside air temperature is high.

- Outside/recirculated air mode may automatically switch depending on the temperature setting or the inside temperature.

■ **Operation of the air conditioning system in Eco air conditioning mode**

- In Eco air conditioning mode, the air conditioning system is controlled as follows to prioritize fuel efficiency:
 - Heater and compressor operation controlled to restrict heating/cooling capacity
 - Fan speed restricted when automatic mode is selected
- To improve air conditioning performance, perform the following operations:
 - Turn off eco air conditioning mode (→P.243)
 - Adjust the fan speed

■ **When the outside temperature falls to nearly 32°F (0°C)**

The dehumidification function may not operate even when “A/C” switch is pressed.

■ **Ventilation and air conditioning odors**

- To let fresh air in, set the air conditioning system to the outside air mode.
- During use, various odors from inside and outside the vehicle may enter into and accumulate in the air conditioning system. This may then cause odor to be emitted from the vents.
- To reduce potential odors from occurring:
 - It is recommended that the air conditioning system be set to outside air mode prior to turning the vehicle off.
 - The start timing of the blower may be delayed for a short period of

time immediately after the air conditioning system is started in automatic mode.

- When parking, the system automatically switches to outside air mode to encourage better air circulation throughout the vehicle, helping to reduce odors that occur when starting the vehicle.

■ **Air conditioning filter**



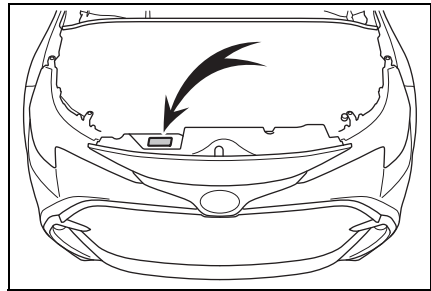

→P.309

■ **Air conditioning system refrigerant**

- A label regarding the refrigerant of the air conditioning system is attached to the engine compartment at the location shown in the following illustration.



- The meaning of each symbol on the label are as follows:

	Caution
	Air conditioning system
	Air conditioning system lubricant type
	Requires registered technician to service air conditioning system
	Flammable refrigerant

■ Using the voice command system

Air conditioning system can be operated using voice commands.

For details, refer to the “MULTIMEDIA OWNER’S MANUAL”.

■ Customization

Some functions can be customized. (→P.396)

▲ WARNING

■ To prevent the windshield from fogging up

Do not use the windshield defogger switch during cool air operation in extremely humid weather. The difference between the temperature of the outside air and that of the windshield can cause the outer surface of the windshield to fog up, blocking your vision.

■ When the outside rear view mirror defoggers are operating

Do not touch the outside rear view mirror surfaces, as they can become very hot and burn you.

▲ NOTICE

■ To prevent battery discharge

Do not leave the air conditioning system on longer than necessary when the engine is off.

■ When repairing/replacing parts of the air conditioning system

Have repair/replacement performed by your Toyota dealer. When a part of the air conditioning system, such as the evaporator, is to be replaced, it must be replaced with a new one.

Using automatic mode

- 1 Press the automatic mode switch.
- 2 Adjust the temperature setting.
- 3 To stop the operation, press the off switch.

If the fan speed setting or air flow modes are operated, the automatic mode indicator goes off. However, automatic mode for functions other than that operated is maintained.

■ Using automatic mode

Fan speed is adjusted automatically according to the temperature setting and the ambient conditions.

Therefore, the fan may stop for a while until warm or cool air is ready to flow immediately after the automatic mode switch pressed.

Windshield wiper de-icer (if equipped)

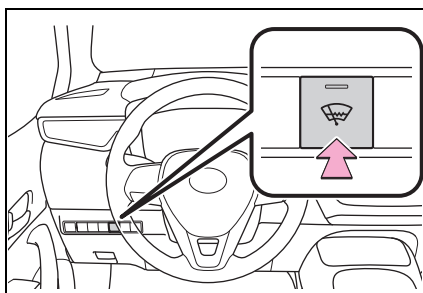

Prevent ice from building up on the windshield and wiper blades.

When the windshield wiper de-icer switch is on, the indicator illumi-

rates on the windshield wiper de-icer switch.

The windshield wiper de-icer will automatically turn off after a period of time.

⚠ WARNING

■ To prevent burns

Do not touch the glass at lower part of the windshield or to the side of the front pillars when the windshield wiper de-icer is on.

Air outlet layout and operations

■ Location of air outlets

The air outlets and air volume changes according to the selected air flow mode.

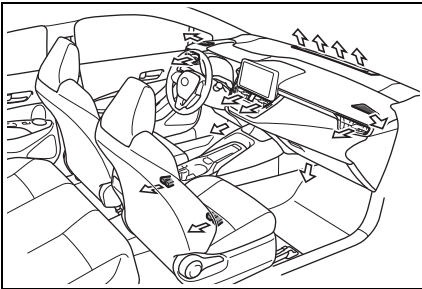

■ Adjusting the position of and opening and closing the air outlets

► Front center

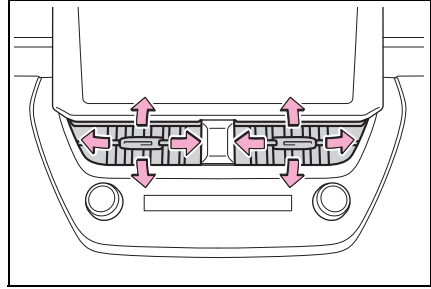

Direct air flow to the left or right, up or down

► Front right-hand side

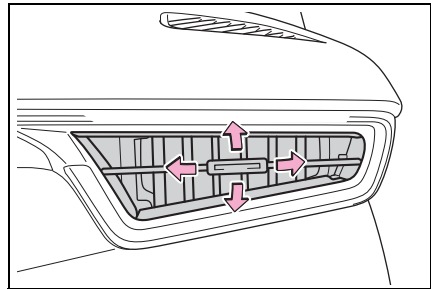

Direct air flow to the left or right, up or down

► Front left-hand side

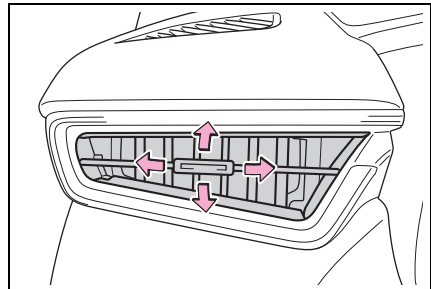

Direct air flow to the left or right, up or down

⚠ WARNING**■ To prevent the windshield defogger from operating improperly**

Do not place anything on the instrument panel which may cover the air outlets. Otherwise, air flow may be obstructed, preventing the windshield defoggers from defogging.

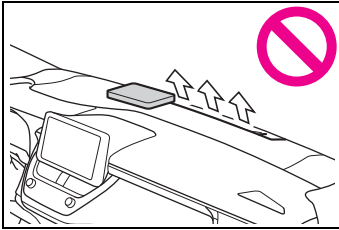
**Heated steering wheel^{*} / seat heaters^{*}**

^{*}: If equipped

● Heated steering wheel

Warms up the grip of the steering wheel

● Seat heaters

Warm up the seat upholstery

⚠ WARNING**■ To prevent minor burn injuries**

Care should be taken if anyone in the following categories comes in contact with the steering wheel or seats when the heater is on:

- Babies, small children, the elderly, the sick and the physically challenged
- Persons with sensitive skin
- Persons who are fatigued
- Persons who have taken alcohol or drugs that induce sleep (sleeping drugs, cold remedies, etc.)

⚠ NOTICE**■ To prevent damage to the seat heaters**

Do not put heavy objects that have an uneven surface on the seat and do not stick sharp objects (needles, nails, etc.) into the seat.

■ To prevent battery discharge

Do not use the functions when the engine is off.

Operation instructions

■ Heated steering wheel

Turns heated steering wheel on/off

When the heated steering wheel is on, the indicator illuminates on the heated steering wheel switch.

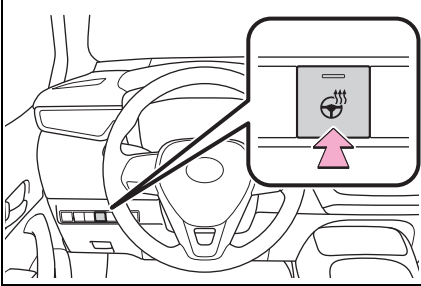

■ Seat heaters

Turns seat heaters on/off

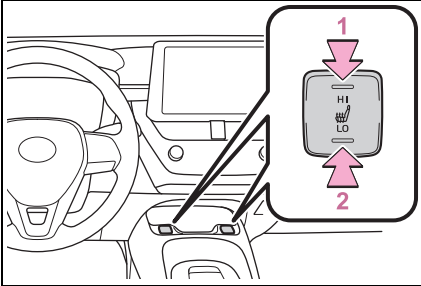

1 High temperature

2 Low temperature

When the seat heater is on, the indicator illuminates on the seat heater switch.

When not in use, put the switch in the neutral position. The indicator will turn off.

■ The heated steering wheel and seat heaters can be used when

The engine switch is in ON.



WARNING

■ To prevent overheating and minor burn injuries

Observe the following precautions when using the seat heaters.

- Do not cover the seat with a blanket or cushion when using the seat heater.
- Do not use seat heater more than necessary.

Interior lights list

Location of the interior lights

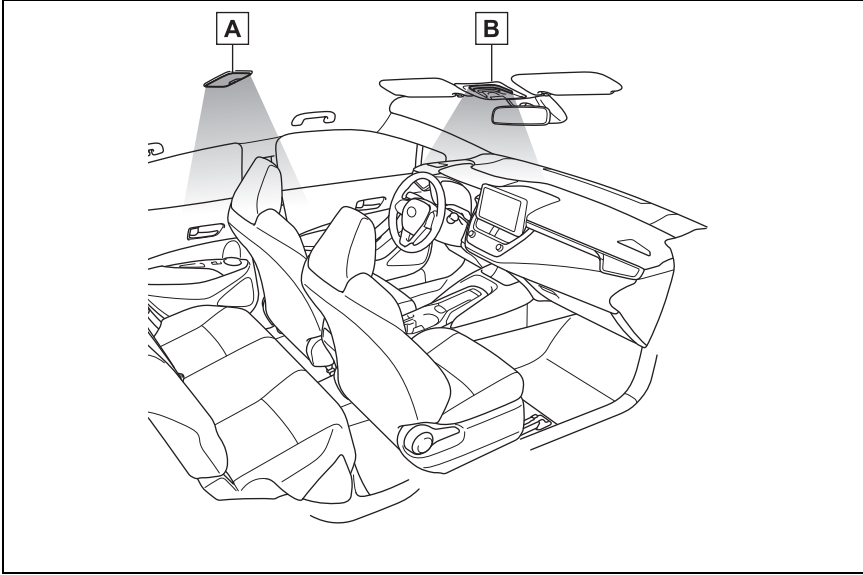

- A** Rear interior light (→P.249)
- B** Front interior/personal lights (→P.249)

Operating the interior lights

■ Front

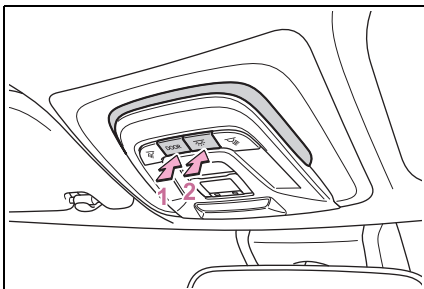

1 Turns the door position on/off
 When a door is opened while the door position is on, the lights turn

on.
2 Turns the lights on/off

■ Rear

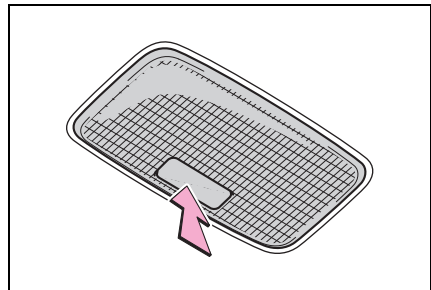

Turns the lights on/off
 When the door position is on for the front interior lights, the rear

interior light will turn on when a door is open and turn off when all of them are closed.

When the rear interior light is on linked to the door position for the front interior lights, it will not turn off even though the switch is pressed.

Operating the personal lights

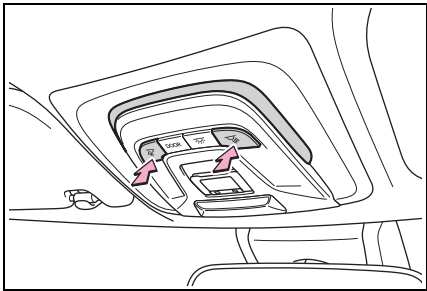

Turns the lights on/off

■ Illuminated entry system

The lights automatically turn on/off according to the engine switch mode, the presence of the electronic key, whether the doors are locked/unlocked, and whether the doors are opened/closed.

■ To prevent the battery from being discharged

If the interior lights remain on when the engine switch is turned off, the lights will go off automatically after 20 minutes.

■ The interior lights may turn on automatically when

If any of the SRS airbags deploy (inflate) or in the event of a strong rear impact, the interior lights will turn on automatically. The interior lights will turn off automatically after approximately 20

minutes. The interior lights can be turned off manually. However, in order to help prevent further collisions, it is recommended that they be left on until safety can be ensured. (The interior lights may not turn on automatically depending on the force of the impact and conditions of the collision.)

■ Customization

Some functions can be customized. (→P.396)

 NOTICE
■ To prevent battery discharge Do not leave the lights on longer than necessary when the engine is not running.

List of storage features

Location of the storage features

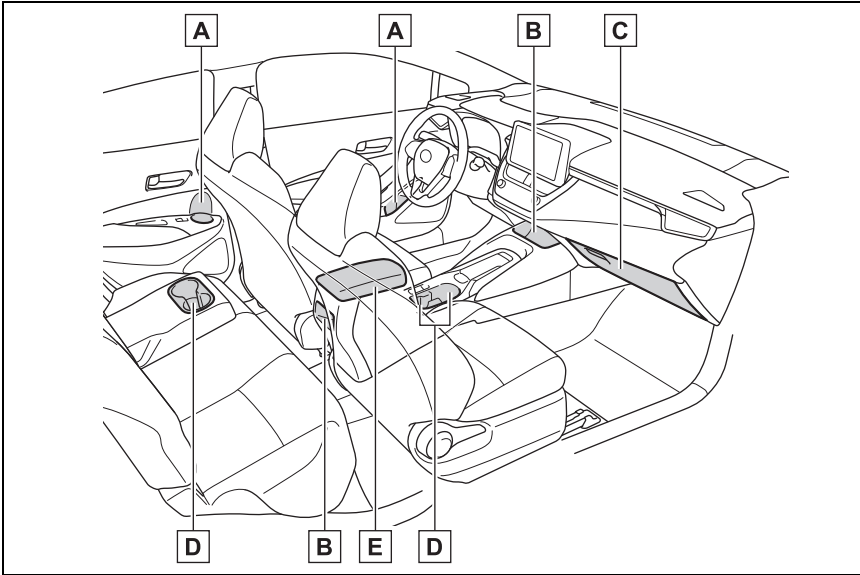

- A** Bottle holders (→P.252)
- B** Open trays (if equipped) (→P.253)
- C** Glove box (→P.252)
- D** Cup holders (→P.252)
- E** Console box (→P.253)



WARNING

■ Items that should not be left in the storage spaces

Do not leave glasses, lighters or spray cans in the storage spaces, as this may cause the following when cabin temperature becomes high:

- Glasses may be deformed by heat or cracked if they come into contact with other stored items.

- Lighters or spray cans may explode. If they come into contact with other stored items, the lighter may catch fire or the spray can may release gas, causing a fire hazard.

Glove box

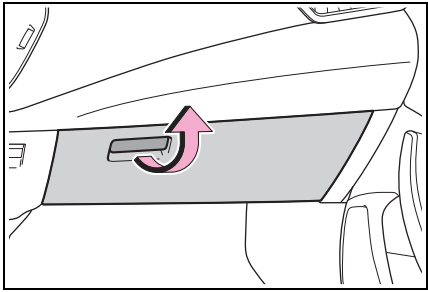

Pull up the lever to open the glove box.

■ Glove box light

The glove box light turns on when the tail lights are on.

⚠ WARNING

■ **Caution while driving**

Keep the glove box closed. In the event of sudden braking or sudden swerving, an accident may occur due to an occupant being struck by the open glove box or the items stored inside.

Cup holders

► Front

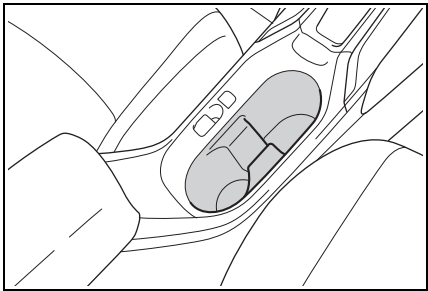

► Rear

Pull the armrest down.

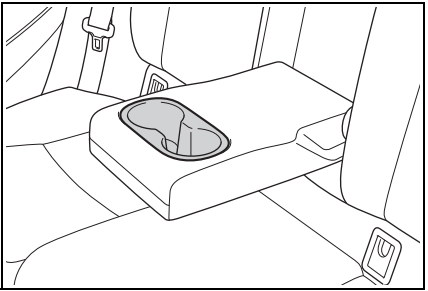

⚠ WARNING

■ **Items unsuitable for the cup holder**

Do not place anything other than cups or beverage cans in the cup holders. Inappropriate items must not be stored in the cup holders even if the lid is closed. Other items may be thrown out of the holders in the event of an accident or sudden braking and cause injury. If possible, cover hot drinks to prevent burns.

Bottle holders

► Front

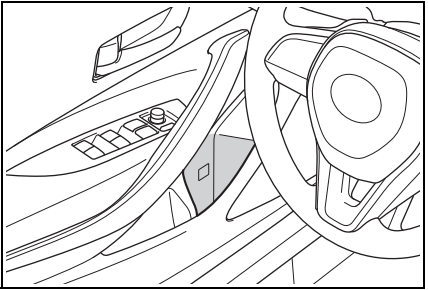

► Rear

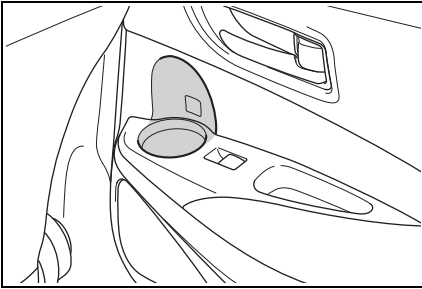

■ **Bottle holders**

- When storing a bottle, close the cap.
- The bottle may not be stored depending on its size or shape.

! WARNING

■ **Items unsuitable for the bottle holders**

Do not place anything other than a bottle in the bottle holders. Other items may be thrown out of the holders in the event of an accident or sudden braking and cause injury.

Console box

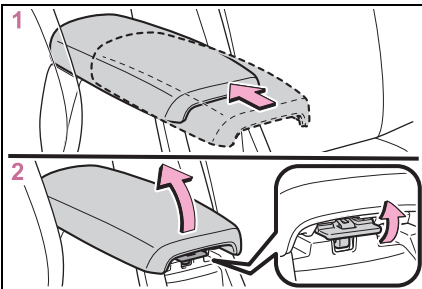

- 1** Slide the lid to the rear most position. (vehicles with a slide function)
- 2** Lift the lid while pulling up the knob.

■ **Slide function (if equipped)**

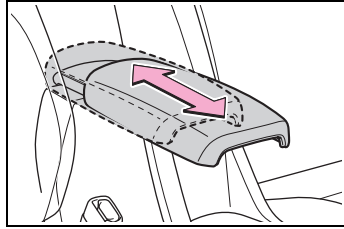

The console box lid can be slid forward or backward.

! WARNING

■ **Caution while driving**

Keep the console box closed. Injuries may result in the event of an accident or sudden braking.

Open trays (if equipped)

► Front

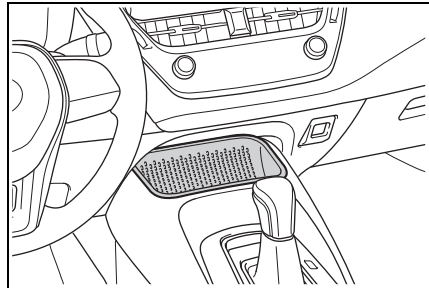

► Rear

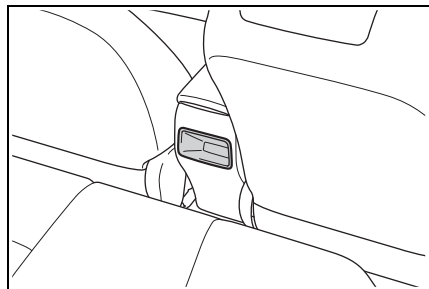

⚠ WARNING

■ Caution while driving

Observe the following precautions when putting items in the open tray. Failure to do so may cause items to be thrown out of the tray in the event of sudden braking or steering. In these cases, the items may interfere with pedal operation or cause driver distraction, resulting in an accident.

- Do not store items in the tray that can easily shift or roll out.
- Do not stack items in the tray higher than the tray's edge.
- Do not put items in the tray that may protrude over the tray's edge.

Luggage compartment features

Cargo hooks

The cargo hooks are provided for securing loose items.

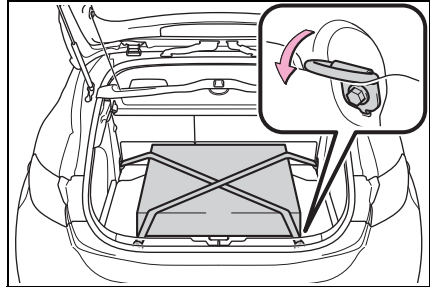

⚠ WARNING

■ When cargo hooks are not in use

To avoid injury, always return the hooks to their stowed positions when not in use.

Grocery bag hooks

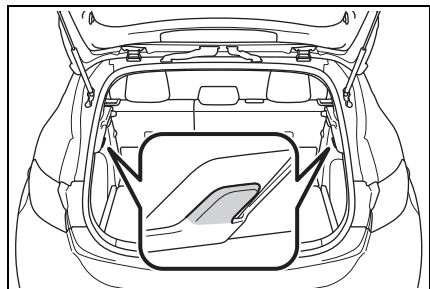

⚠ WARNING

■ To prevent damage to the grocery bag hooks

Do not hang any object heavier than 4.4 lb. (2 kg) on the grocery bag hooks.

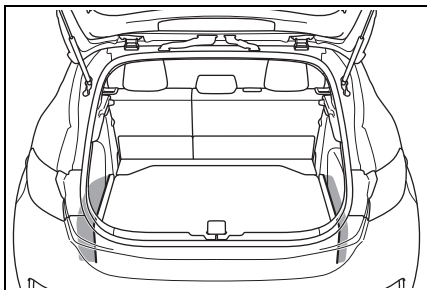
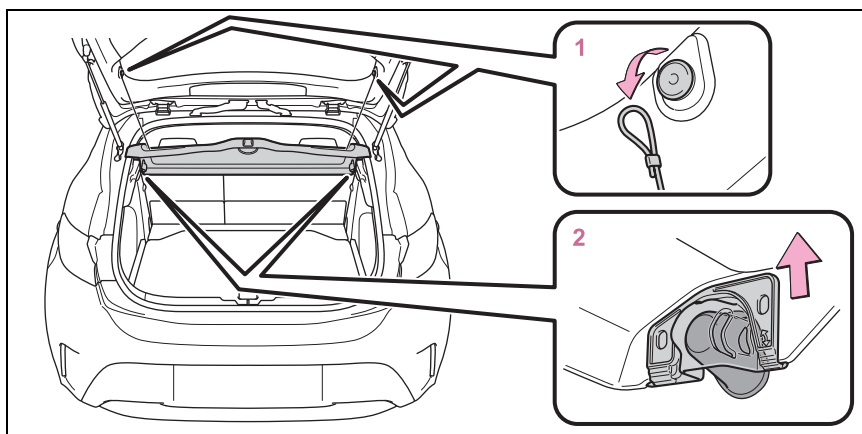
Side tray (if equipped)**Removing the luggage cover**

- 1 Unhook the cords.
- 2 Remove the cover from the anchors.

Other interior features

USB charging port

The USB charging port are used to supply 3.0 A of electricity at 5 V to external devices.

The USB charging port are for charging only. They are not designed for data transfer or other purposes.

Depending on the external device, it may not charge properly. Refer to the manual included with the device before using a USB charging port.

■ Using the USB charging port

► Front

Open the console box lid.

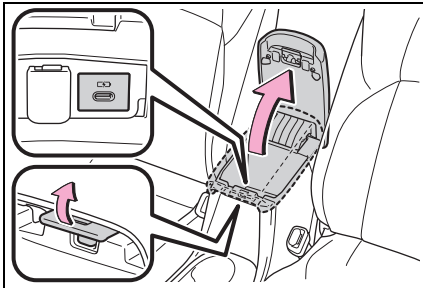

► Rear (if equipped)

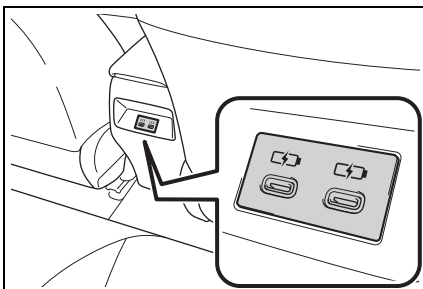

■ The USB charging port can be used when

The engine switch is in ACC or ON, or the multimedia system is on.

■ Situations in which the USB charging port may not operate correctly

- If a device which consumes more than 3.0 A at 5 V is connected
- If a device designed to communicate with a personal computer, such as a USB memory device, is connected
- If the connected external device is turned off (depending on device)
- If the temperature inside the vehicle is high, such as after the vehicle has been parked in the sun

■ About connected external device

Depending on the connected external device, charging may occasionally be suspended and then start again. This is not a malfunction.

⚠ NOTICE

■ To prevent damage to the USB charging port

- Do not insert foreign objects into the port.
- Do not spill water or other liquids into the port.
- Do not apply excessive force to or impact the USB charging port.
- Do not disassemble or modify the USB charging port.

■ To prevent damage to external devices

- Do not leave external devices in the vehicle. The temperature inside the vehicle may become high, resulting in damage to an external device.

! NOTICE

- Do not push down on or apply unnecessary force to an external device or the cable of an external device while it is connected.

- **To prevent battery discharge**

Do not use the USB charging port for a long period of time with the engine stopped.

Power outlets

The power outlet can be used for 12 V accessories that run on less than 10 A.

Open the console box lid and open the lid.

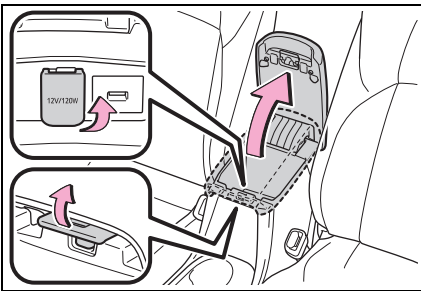

- **The power outlet can be used when**

The engine switch is in ACC or ON, or the multimedia system is on.

- **When turning the engine switch off**

Disconnect electrical devices with charging functions, such as mobile battery packs. If such devices are left connected, the engine switch may not be turned off normally.

! NOTICE

- **To prevent the fuse from being blown**

Do not use an accessory that uses more than 12 V 10 A.

- **To avoid damaging the power outlet**

Close the power outlet lid when the power outlet is not in use. Foreign objects or liquids that enter the power outlet may cause a short circuit.

- **To prevent the battery from being discharged**

Do not use the power outlet longer than necessary when the engine is not running.

Wireless charger (if equipped)

A portable device, such as a smartphone or mobile battery, can be charged by just placing it on the charging area, provided the device is compatible with the Qi wireless charging standard created by the Wireless Power Consortium.

The wireless charger cannot be used with a portable device that is larger than the charging area. Additionally, depending on the portable device, the wireless charger may not operate properly. Refer to the operation manual of the portable device.

- **The “Qi” symbol**

The “Qi” symbol is a trademark of the Wireless Power Consor-

tium.



■ Name for all parts

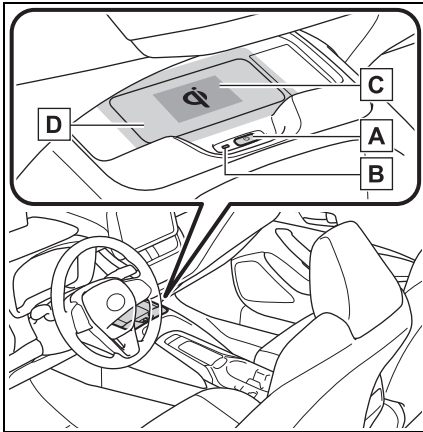

- A** Power supply switch
- B** Operation indicator light
- C** Charge area
- D** Charging tray

■ Using the wireless charger

- 1 Press the power supply switch of the wireless charger.

Pressing the switch again turns the wireless charger off. When turned on, the operation indicator light (green) comes on. When the engine switch is turned off, the on/off state of the wireless

charger will be memorized.

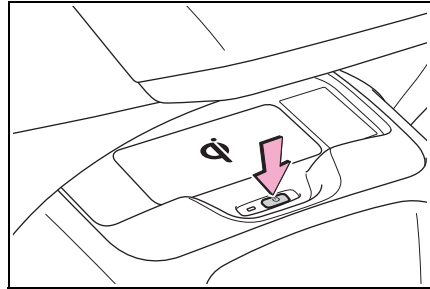

- 2 Place a portable device on the charging area with its charging surface facing down.

Depending on the portable device, its charging coil may not be in the center of the device. In this case, place the portable device so that its charging coil is centered in the charging area.

While charging, the operation indicator light (orange) will be illuminated.

If charging is not occurring, the operation indicator light slowly blink in green and orange alternately, and coil operating sound may be heard. Try placing the portable device as close to the center of the charging area as possible.

When charging is complete, the operation indicator light (green) will illuminate.

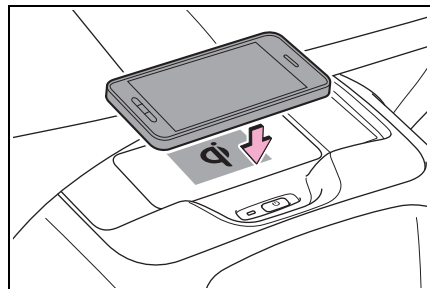

■ Recharging function

- If a certain amount of time has elapsed since charging com-

pleted and the portable device has not been moved, the wireless charger will restart charging.

- If a portable device is moved significantly within the charging area, the charging coil may disconnect and

charging may temporarily be stopped. However, if a charging coil is detected within the charging area, the charging coil inside the wireless charger will move near the other coil and charging will resume.

■ Operation indicator light status

Operation indicator light	State
Off	The Wireless charger is off
Green (illuminated)	Standby (charging is possible)
	Charging is complete *
Orange (illuminated)	A portable device has been placed on the charging area (identifying the portable device)
	Charging in progress

*: Depending on the portable device, the operation indicator light may stay illuminated (orange) after charging has completed.

- If the operation indicator light blinks

If an error is detected, the operation indicator light will blink (orange). Take the appropriate measures according to the table below.

Operation indicator light	Suspected cause	Measure
Blinks (orange) at a one second interval continuously	Vehicle to charger communication failure.	If the engine is running, stop and then restart the engine. If the engine switch is in ACC, start the engine.

Operation indicator light	Suspected cause	Measure
Blinks (orange) 3 times repeatedly	A foreign object exists between the portable device and charging area.	Remove the foreign object.
	Portable device is not positioned properly on the charging area.	If there is a case or cover attached to the portable device, remove it.
Blinks (orange) 4 times repeatedly	The temperature of the wireless charger is excessively high.	Stop charging, remove the portable device from the charging tray, wait for the temperature to drop, and then start charging again.

■ **The wireless charger can be operated when**

The engine switch is in ACC or ON, or the multimedia system is on.

■ **Portable devices that can be charged**

- Portable devices compatible with the Qi wireless charging standard can be charged by the wireless charger. However, compatibility with all devices which meet the Qi wireless charging standard is not guaranteed.
- The wireless charger is designed to supply low power electricity (5 W or less) to a cellular phone, smartphone, or other portable device.

■ **If a cover or accessory is attached to the portable device**

Do not charge a portable device if a cover or accessory which is not Qi compatible is attached. Depending on the type of cover (including for certain genuine manufacture parts) and/or accessory attached, it may not be possible to charge the portable device. If the portable device is placed on the charging area and

does not charge, remove the cover and/or accessories.

■ **If interference is heard in AM radio broadcasts while charging**

Turn off the wireless charger and check if the noise is reduced. If noise is reduced, press and hold the power supply switch of the wireless charger for 2 seconds. The frequency of the wireless charger is changed and noise may be reduced. When the frequency is changed, the operation indicator light will blink (orange) 2 times.

■ **Charging precautions**

- If the electronic key cannot be detected in the cabin, charging cannot be performed. When a door is opened and closed, charging may be temporarily suspended.
- While charging, the wireless charger and the portable device will become warm. This is not a malfunction. If a portable device becomes warm while charging and charging stops due to the protection function of the portable device, wait until the portable device cools down and

charge it again.

■ Sound generated during operation

When the power supply switch is turned on or while a portable device is being identified, operation sounds may be heard. This is not a malfunction.

■ Cleaning the wireless charger

→P.269

WARNING

■ Caution while driving

When charging a portable device, for safety reasons, the driver should not operate the main part of the portable device while driving.

■ Caution while in motion

Do not charge lightweight devices such as wireless headphones while in motion. These devices are very light and may be ejected from the charging tray, which may lead to unforeseen accidents.

■ Caution regarding interference with electronic devices

People with implantable cardiac pacemakers, cardiac resynchronization therapy-pacemakers or implantable cardioverters, as well as any other electrical medical device, should consult their physician about the usage of the wireless charger.

■ To prevent malfunctions or burns

Observe the following precautions. Failure to do so may result in a equipment failure and damage, catch fire, burns due to overheat or electric shock.

- Do not insert any metallic objects between the charge area and the portable device while charging
- Do not attach an aluminum sticker or other metallic object to the charge area
- Do not attach an aluminum sticker or other metallic object to the side of the portable device (or to its case or cover) that touches the charge area
- Do not use the charging tray as a small storage space
- Do not subject to a strong force or impact
- Do not disassemble, modify or remove
- Do not charge devices other than specified portable devices
- Keep away from magnetic items
- Do not charge devices if the charge area is covered in dust
- Do not cover with a cloth or similar material

NOTICE

■ Situations in which the function may not operate normally

Devices may not be charged normally in the following situations.

- The camera lens protrudes 0.12 in (3 mm) or more from the surface of the portable device
- The electronic key is not inside the vehicle
- The portable device is fully charged
- The portable device is being charged with a cable connected



NOTICE

- There is foreign matter between the charge area and portable device
- Charging has caused the portable device to heat up
- The temperature around the charging tray is 95°F (35°C) or higher, such as in extreme heat
- The portable device is placed with its charging side facing up
- The portable device is placed in an area misaligned from the charge area
- The portable device is larger than the charging tray
- A foldable and portable device is placed outside the charge area
- The vehicle is in an area where strong electrical waves or noise are emitted, such as near a television tower, power plant, gasoline station, broadcasting station, large display, airport, etc.
- Any of the following objects that is 0.08 in (2 mm) or thicker is between the charging side of the portable device and the charge area
 - Thick cases or covers
 - A case or cover attached with an uneven or tilted surface, so that the charging side is not flat
 - Thick decorations
 - Accessories, such as finger rings, straps, etc.

- When the portable device is in contact with, or is covered by any if the following metallic objects
 - A card that has metal on it, such as aluminum foil, etc.
 - A pack of cigarettes that includes aluminum foil
 - A wallet or bag that is made of metal
 - Coins
 - A heating pad
 - CDs, DVDs or other media
 - A metal accessory
 - A case or cover made of metal
 - A case which has magnet in it on the charging side of the portable device.
- Electric wave type wireless remote controls are being used nearby
- 2 or more portable devices are placed on the charging tray at the same time

If charging is abnormal or the operation indicator light continues to flash for any other reason, the wireless charger may be malfunctioning. Contact your Toyota dealer.

■ To prevent malfunctions and data corruptions

- When charging, bringing a credit, or other magnetic card, or magnetic storage media close to the charge area may clear any stored data due to magnetic influence. Also, do not bring a wristwatch or other precision instrument close to the charge area since doing so may cause it to malfunction.

⚠ NOTICE

- Do not charge with a non-contact IC card such as a transportation system IC card inserted between the charging side of a portable device and the charge area. The IC chip may become extremely hot and damage the portable device or IC card. Be especially careful not to charge a portable device inside a case or cover with a non-contact IC card attached.
- Do not leave portable devices inside the vehicle. The inside of the vehicle can become hot in extreme heat, which could cause a malfunction.
- **If the smartphone OS has been updated**

If the smartphone OS has been updated to a newer version, its charging specifications may have changed significantly. For details, check the information on the manufacturer's website.

- **To prevent battery discharge**

Do not use the wireless charger for a long period of time with the engine stopped.

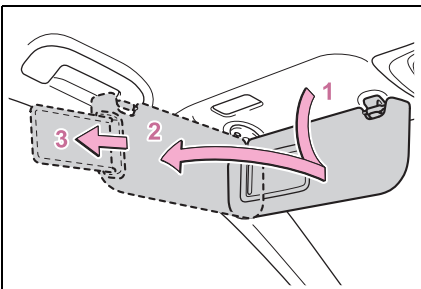
Sun visors

- 1** To set the visor in the forward position, flip it down.
- 2** To set the visor in the side

position, flip down, unhook, and swing it to the side.

- 3** To use the side extender, place the visor in the side position, then slide it backward.

Vanity mirrors

Slide the cover to open.

The vanity light turns on.

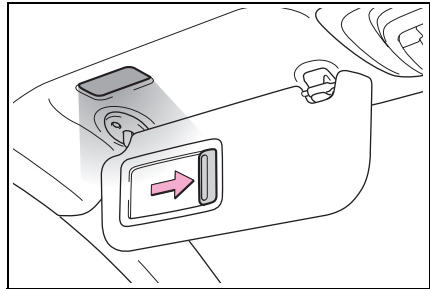

- **To prevent battery discharge**

If the vanity lights remain on when the engine switch is OFF, the lights will go off automatically after 20 minutes.

⚠ NOTICE

- **To prevent the battery from being discharged**

Do not leave the vanity lights on for extended periods while the engine is stopped.

Armrest

Fold down the armrest for use.

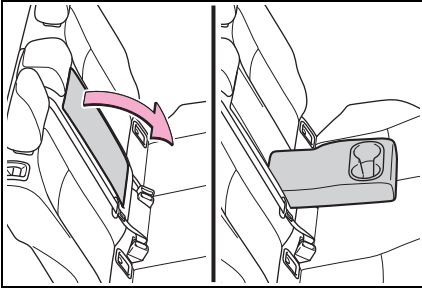
**NOTICE**

■ **To prevent damage to the armrest**

Do not apply too much load on the armrest.

Assist grips

An assist grip installed on the ceiling can be used to support your body while sitting on the seat.

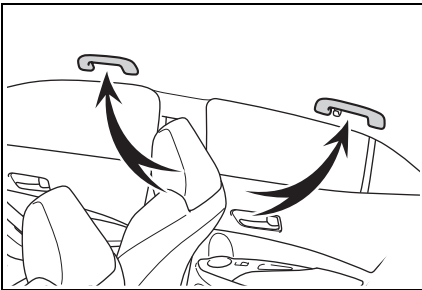
**WARNING**

■ **Assist grip**

Do not use the assist grip when getting in or out of the vehicle or rising from your seat.

**NOTICE**

■ **To prevent damage to the assist grip**

Do not hang any heavy object or put a heavy load on the assist grip.

Coat hooks

The coat hooks are provided with the rear assist grips.

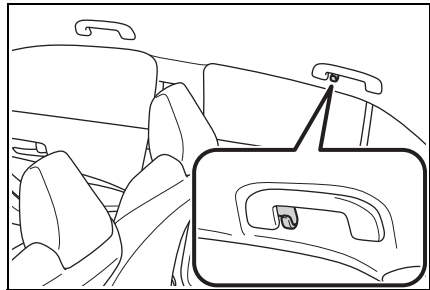
**WARNING**

■ **Items that cannot be hung on the coat hook**

Do not hang coat hangers or other hard or sharp objects on the hook. If the SRS curtain shield airbags deploy, these items may become projectiles, causing death or serious injury.

Maintenance and care

6

6-1. Maintenance and care

Cleaning and protecting the vehicle exterior 266

Cleaning and protecting the vehicle interior 268

6-2. Maintenance

Maintenance requirements 271

General maintenance.. 273

Emission inspection and maintenance (I/M) programs 275

6-3. Do-it-yourself maintenance

Do-it-yourself service precautions..... 277

Hood 279

Positioning a floor jack 280

Engine compartment... 281

Tires 289

Tire inflation pressure.. 306

Wheels 308

Air conditioning filter.... 309

Electronic key battery.. 311

Checking and replacing fuses..... 313

Light bulbs..... 315

Cleaning and protecting the vehicle exterior

Perform cleaning in a manner appropriate to each component and its material.

Cleaning instructions

- Working from top to bottom, liberally apply water to the vehicle body, wheel wells and underside of the vehicle to remove any dirt and dust.
- Wash the vehicle body using a sponge or soft cloth, such as a chamois.
- For hard-to-remove marks, use car wash soap and rinse thoroughly with water.
- Wipe away any water.
- Wax the vehicle when the waterproof coating deteriorates.

If water does not bead on a clean surface, apply wax when the vehicle body is cool.

■ Automatic car washes

- Fold the mirrors before washing the vehicle. Start washing from the front of the vehicle. Make sure to extend the mirrors before driving.
- Brushes used in automatic car washes may scratch the vehicle surface, parts (wheel, etc.) and harm your vehicle's paint.
- In certain automatic car washes, the rear spoiler may interfere with

machine operation. This may prevent the vehicle from being cleaned properly or result in damage to the rear spoiler.

■ High pressure car washes

As water may enter the cabin, do not bring the nozzle tip near the gaps around the doors or perimeter of the windows, or spray these areas continuously.

■ When using a car wash

If the door handle becomes wet while the electronic key is within the effective range, the door may lock and unlock repeatedly. In that case, follow the following correction procedures to wash the vehicle:

- Place the key in a position 6 ft. (2 m) or more separate from the vehicle while the vehicle is being washed. (Take care to ensure that the key is not stolen.)
- Set the electronic key to battery-saving mode to disable the smart key system. (→P.103)

■ Wheels and wheel ornaments

- Remove any dirt immediately by using a neutral detergent.
- Wash detergent off with water immediately after use.
- To protect the paint from damage, make sure to observe the following precautions.
 - Do not use acidic, alkaline or abrasive detergent
 - Do not use hard brushes
 - Do not use detergent on the wheels when they are hot, such as after driving or parking in hot weather

■ Brake pads and calipers

Rust may form if the vehicle is parked with wet brake pads or disc rotors, causing them to stick. Before parking the vehicle after it is washed, drive slowly and apply the brakes several times to dry the parts.

■ Bumpers

Do not scrub with abrasive cleaners.

■ Plated portions

If dirt cannot be removed, clean the parts as follows:

- Use a soft cloth dampened with an approximately 5% solution of neutral detergent and water to clean the dirt off.
- Wipe the surface with a dry, soft cloth to remove any remaining moisture.
- To remove oily deposits, use alcohol wet wipes or a similar product.

**WARNING****■ When washing the vehicle**

Do not apply water to the inside of the engine compartment. Doing so may cause the electrical components, etc. to catch fire.

■ Precautions regarding the exhaust pipe

Exhaust gasses cause the exhaust pipe to become quite hot. When washing the vehicle, be careful not to touch the pipe until it has cooled sufficiently, as touching a hot exhaust pipe can cause burns.

■ Precaution regarding the front bumper and rear bumper

If the paint of the front bumper and rear bumper is chipped or scratched, the following systems may not function correctly. If this occurs, consult your Toyota dealer.

- BSM (if equipped)
- RCTA (if equipped)
- SEA (if equipped)

**NOTICE****■ To prevent paint deterioration and corrosion on the body and components (aluminum wheels, etc.)**

- Wash the vehicle immediately in the following cases:
 - After driving near the sea coast
 - After driving on salted roads
 - If coal tar or tree sap is present on the paint surface
 - If dead insects, insect droppings or bird droppings are present on the paint surface
 - After driving in an area contaminated with soot, oily smoke, mine dust, iron powder or chemical substances
 - If the vehicle becomes heavily soiled with dust or mud
 - If liquids such as benzene and gasoline are spilled on the paint surface
- If the paint is chipped or scratched, have it repaired immediately.
- To prevent the wheels from corroding, remove any dirt and store in a place with low humidity when storing the wheels.
- Cleaning the exterior lights**
 - Wash carefully. Do not use organic substances or scrub with a hard brush. This may damage the surfaces of the lights.
 - Do not apply wax to the surfaces of the lights. Wax may cause damage to the lenses.



NOTICE

■ **When using a high pressure car wash**

- When washing the vehicle, do not spray the camera or its surrounding area directly with a high pressure washer. Shock applied from high pressure water may cause the device to not operate normally.
- Do not spray water directly on the radar which is equipped behind the emblem. Otherwise it may cause the device to be damaged.
- Do not bring the nozzle tip close to boots (rubber or resin manufactured cover), connectors or the following parts. The parts may be damaged if they come into contact with high-pressure water.
 - Traction related parts
 - Steering parts
 - Suspension parts
 - Brake parts
- Keep the cleaning nozzle at least 11.9 in. (30 cm) away from the vehicles body. Otherwise resin section, such as moldings and bumpers, may be deformed and damaged. Also, do not continuously hold the nozzle in the same place.
- Do not spray the lower part of the windshield continuously. If water enters the air conditioning system intake located near the lower part of the windshield, the air conditioning system may not operate correctly.
- Do not wash the underside of the vehicle using a high pressure car washer.

Cleaning and protecting the vehicle interior

Perform cleaning in a manner appropriate to each component and its material.

Protecting the vehicle interior

- Remove dirt and dust using a vacuum cleaner. Wipe dirty surfaces with a cloth dampened with lukewarm water.
- If dirt cannot be removed, wipe it off with a soft cloth dampened with neutral detergent diluted to approximately 1%.
Wring out any excess water from the cloth and thoroughly wipe off remaining traces of detergent and water.

■ Shampooing the carpets

There are several commercial foaming-type cleaners available. Use a sponge or brush to apply the foam. Rub in overlapping circles. Do not use water. Wipe dirty surfaces and let them dry. Excellent results are obtained by keeping the carpet as dry as possible.

■ Handling the seat belts

Clean with mild soap and lukewarm water using a cloth or sponge. Also check the belts periodically for excessive wear, fraying or cuts.

**WARNING****■ Water in the vehicle**

- Do not splash or spill liquid in the vehicle. Doing so may cause electrical components, etc. to malfunction or catch fire.
- Do not get any of the SRS components or wiring in the vehicle interior wet. (→P.32)
An electrical malfunction may cause the airbags to deploy or not function properly, resulting in death or serious injury.
- Vehicles with wireless charger: Do not let the wireless charger (→P.257) get wet. Failure to do so may cause the charger to become hot and cause burns or could cause electric shock resulting in death or serious injury.

■ Cleaning the interior (especially instrument panel)

Do not use polish wax or polish cleaner. The instrument panel may reflect off the windshield, obstructing the driver's view and leading to an accident, resulting in death or serious injury.

**NOTICE****■ Cleaning detergents**

- Do not use the following types of detergent, as they may discolor the vehicle interior or cause streaks or damage to painted surfaces:
 - Non-seat portions: Organic substances such as benzene or gasoline, alkaline or acidic solutions, dye, and bleach
 - Seats: Alkaline or acidic solutions, such as thinner, benzene, and alcohol

- Do not use polish wax or polish cleaner. The instrument panel's or other interior part's painted surface may be damaged.

■ Preventing damage to leather surfaces

Observe the following precautions to avoid damage to and deterioration of leather surfaces:

- Remove any dust or dirt from leather surfaces immediately.
- Do not expose the vehicle to direct sunlight for extended periods of time. Park the vehicle in the shade, especially during summer.
- Do not place items made of vinyl, plastic, or containing wax on the upholstery, as they may stick to the leather surface if the vehicle interior heats up significantly.

■ Water on the floor

Do not wash the vehicle floor with water.

Vehicle systems such as the audio system may be damaged if water comes into contact with electrical components such as the audio system above or under the floor of the vehicle. Water may also cause the body to rust.

■ When cleaning the inside of the windshield

Do not allow glass cleaner to contact the lens. Also, do not touch the lens. (→P.162)

**NOTICE**

■ **Cleaning the inside of the rear window**

- Do not use glass cleaner to clean the rear window, as this may cause damage to the rear window defogger heater wires or antenna. Use a cloth dampened with lukewarm water to gently wipe the window clean. Wipe the window in strokes running parallel to the heater wires or antenna.
- Be careful not to scratch or damage the heater wires or antenna.

Cleaning the areas with satin-finish metal accents

- Remove dirt using a water-dampened soft cloth or synthetic chamois.
- Wipe the surface with a dry, soft cloth to remove any remaining moisture.

■ **Cleaning the areas with satin-finish metal accents**

The metal areas use a layer of real metal for the surface. It is necessary to clean them regularly. If dirty areas are left uncleaned for long periods of time, they may be difficult to clean.

Cleaning the leather areas

- Remove dirt and dust using a vacuum cleaner.
- Wipe off any excess dirt and dust with a soft cloth dampened with diluted detergent.

Use a diluted water solution of approximately 5% neutral wool detergent.

- Wring out any excess water from the cloth and thoroughly wipe off all remaining traces of detergent.
- Wipe the surface with a dry, soft cloth to remove any remaining moisture. Allow the leather to dry in a shaded and ventilated area.

■ **Caring for leather areas**

Toyota recommends cleaning the interior of the vehicle at least twice a year to maintain the quality of the vehicle's interior.

Cleaning the synthetic leather areas

- Remove dirt and dust using a vacuum cleaner.
- Wipe it off with a soft cloth dampened with neutral detergent diluted to approximately 1%.
- Wring out any excess water from the cloth and thoroughly wipe off remaining traces of detergent and water.

Maintenance requirements

To ensure safe and economical driving, day-to-day care and regular maintenance are essential. It is the owner's responsibility to perform regular checks. Toyota recommends the maintenance below.

■ Repair and replacement

It is recommended that genuine Toyota parts be used for repairs to ensure performance of each system. If non-Toyota parts are used in replacement or if a repair shop other than a Toyota dealer performs repairs, confirm the warranty coverage.

■ Allow inspection and repairs to be performed by a Toyota dealer

- Toyota technicians are well-trained specialists and are kept up to date with the latest service information. They are well informed about the operation of all systems on your vehicle.
- Keep a copy of the repair order. It proves that the maintenance that has been performed is under warranty coverage. If any problem should arise while your vehicle is under warranty, your Toyota dealer will promptly take care of it.



WARNING

■ If your vehicle is not properly maintained

Improper maintenance could result in serious damage to the vehicle and possible death or serious injury.

■ Handling of the battery

- Engine exhaust, some of its constituents, and a wide variety of automobile components contain or emit chemicals known to the State of California to cause cancer and birth defects and other reproductive harm. Work in a well ventilated area.
- Oils, fuels and fluids contained in vehicles as well as waste produced by component wear contain or emit chemicals known to the State of California to cause cancer and birth defects or other reproductive harm. Avoid exposure and wash any affected area immediately.
- Battery posts, terminals and related accessories contain lead and lead compounds which are known to cause brain damage. Wash your hands after handling. (→P.286)

General maintenance

General maintenance should be performed on a daily basis. This can be done by yourself or by a Toyota dealer.

Scheduled maintenance

Scheduled maintenance should be performed at specified intervals according to the maintenance schedule.









For details about maintenance items and schedules, refer to the "Scheduled Maintenance Guide" or "Owner's Manual Supplement".

■ Resetting the message indicating maintenance is required

After the required maintenance is performed according to the maintenance schedule, please reset the message.









To reset the message, follow the procedure described below:

▶ 4.2-inch display

- 1 Press  or  of the meter control switch to select .
- 2 Press  or  to select "Vehicle Settings" and then press and hold OK .
- 3 Press  or  to select "Scheduled Maintenance" and then press OK .
- 4 Press  or  to select "Yes" and then press OK .

A message will be displayed on the multi-information display when the reset procedure has been completed.

▶ 7-inch display

- 1 Press  or  of the meter control switch to select .
- 2 Press  or  to select "Vehicle Settings" and then press and hold OK .
- 3 Press  or  to select "Scheduled Maintenance" and then press OK .
- 4 Press  or  to select "Yes" and then press OK .

A message will be displayed on the multi-information display when the reset procedure has been completed.

Do-it-yourself maintenance

You can perform some maintenance procedures by yourself. Please be aware that do-it-yourself maintenance may affect warranty coverage.

The use of Toyota repair manuals is recommended.

For details about warranty coverage, refer to the separate "Owner's Warranty Information Booklet" or "Owner's Manual Supplement".

General maintenance

Listed below are the general maintenance items that should be performed at the intervals specified in the “Owner’s Warranty Information Booklet” or “Owner’s Manual Supplement/Scheduled Maintenance Guide”. It is recommended that any problem you notice should be brought to the attention of your Toyota dealer or qualified service shop for advice.

WARNING

■ If the engine is running

Turn the engine off and ensure that there is adequate ventilation before performing maintenance checks.

Engine compartment

Items	Check points
Battery	Check the connections. (→P.286)
Brake fluid	Is the brake fluid at the correct level? (→P.285)
Engine coolant	Is the engine coolant at the correct level? (→P.284)
Engine oil	Is the engine oil at the correct level? (→P.281)

Items	Check points
Exhaust system	There should not be any fumes or strange sounds.
Radiator/condenser	The radiator and condenser should be free from foreign objects. (→P.284)
Washer fluid	Is there sufficient washer fluid? (→P.287)

Vehicle interior

Items	Check points
Accelerator pedal	<ul style="list-style-type: none"> The accelerator pedal should move smoothly (without uneven pedal effort or catching).
Continuously variable transmission “Park” mechanism	<ul style="list-style-type: none"> When parked on a slope and the shift lever is in P, is the vehicle securely stopped?

Items	Check points
Brake pedal	<ul style="list-style-type: none"> • Does the brake pedal move smoothly? • Does the brake pedal have appropriate clearance from the floor? (→P.380) • Does the brake pedal have the correct amount of free play? (→P.380)
Brakes	<ul style="list-style-type: none"> • The vehicle should not pull to one side when the brakes are applied. • The brakes should work effectively. • The brake pedal should not feel spongy. • The brake pedal should not get too close to the floor when the brakes are applied.
Head restraints	<ul style="list-style-type: none"> • Do the head restraints move smoothly and lock securely?
Indicators/buzzers	<ul style="list-style-type: none"> • Do the indicators and buzzers function properly?
Lights	<ul style="list-style-type: none"> • Do all the lights come on?

Items	Check points
Parking brake	<ul style="list-style-type: none"> • Does the parking brake operate normally? • When parked on a slope and the parking brake is on, is the vehicle securely stopped?
Seat belts	<ul style="list-style-type: none"> • Do the seat belts operate smoothly? • The seat belts should not be damaged.
Seats	<ul style="list-style-type: none"> • Do the seat controls operate properly?
Steering wheel	<ul style="list-style-type: none"> • Does the steering wheel rotate smoothly? • Does the steering wheel have the correct amount of free play? • There should not be any strange sounds coming from the steering wheel.

Vehicle exterior

Items	Check points
Doors	<ul style="list-style-type: none"> • Do the doors operate smoothly?
Engine hood	<ul style="list-style-type: none"> • Does the engine hood lock system work properly?
Fluid leaks	<ul style="list-style-type: none"> • There should not be any signs of fluid leakage after the vehicle has been parked.
Tires	<ul style="list-style-type: none"> • Is the tire inflation pressure correct? • The tires should not be damaged or excessively worn. • Have the tires been rotated according to the maintenance schedule? • The wheel nuts should not be loose.
Windshield wipers/rear window wiper	<ul style="list-style-type: none"> • The wiper blades should not show any signs of cracking, splitting, wear, contamination or deformation. • The wiper blades should clear the windshield/rear window without streaking or skipping.

Emission inspection and maintenance (I/M) programs

Some states have vehicle emission inspection programs which include OBD (On Board Diagnostics) checks. The OBD system monitors the operation of the emission control system.

If the malfunction indicator lamp comes on

The OBD system determines that a problem exists somewhere in the emission control system. Your vehicle may not pass the I/M test and may need to be repaired. Contact your Toyota dealer to service the vehicle.

Your vehicle may not pass the I/M test in the following situations:

- When the battery is disconnected or discharged
- Readiness codes that are set during ordinary driving are erased. Also, depending on your driving habits, the readiness codes may not be completely set.
- When the fuel tank cap is loose

The malfunction indicator lamp comes on indicating a temporary malfunction and your vehicle may not pass the I/M test.

When the malfunction indicator lamp still remains on after several driving trips

The error code in the OBD system will not be cleared unless the vehicle is driven 40 or more times.

If your vehicle does not pass the I/M test

Contact your Toyota dealer to prepare the vehicle for re-testing.

Do-it-yourself service precautions

If you perform maintenance by yourself, be sure to follow the correct procedure as given in these sections.

Maintenance

Items	Parts and tools
Battery condition (→P.286)	<ul style="list-style-type: none"> • Warm water • Baking soda • Grease • Conventional wrench (for terminal clamp bolts)
Brake fluid level (→P.285)	<ul style="list-style-type: none"> • FMVSS No.116 DOT 3 or SAE J1703 brake fluid • FMVSS No.116 DOT 4 or SAE J1704 brake fluid • Rag or paper towel • Funnel (used only for adding brake fluid)

Items	Parts and tools
Engine coolant level (→P.284)	<ul style="list-style-type: none"> • “Toyota Super Long Life Coolant” or a similar high quality ethylene glycol-based non-silicate, non-amine, non-nitrite and non-borate coolant with long-life hybrid organic acid technology For the U.S.A.: “Toyota Super Long Life Coolant” is pre-mixed with 50% coolant and 50% deionized water. For Canada: “Toyota Super Long Life Coolant” is pre-mixed with 55% coolant and 45% deionized water. • Funnel (used only for adding coolant)
Engine oil level (→P.281)	<ul style="list-style-type: none"> • “Toyota Genuine Motor Oil” or equivalent • Rag or paper towel • Funnel (used only for adding engine oil)
Fuses (→P.313)	<ul style="list-style-type: none"> • Fuse with same amperage rating as original
Light bulbs (→P.315)	<ul style="list-style-type: none"> • Bulb with same number and wattage rating as original • Flathead screwdriver • Wrench

Items	Parts and tools
Radiator and condenser (→P.284)	—
Tire inflation pressure (→P.306)	<ul style="list-style-type: none"> • Tire pressure gauge • Compressed air source
Washer fluid (→P.287)	<ul style="list-style-type: none"> • Water or washer fluid containing anti-freeze (for winter use) • Funnel (used only for adding water or washer fluid)

● Be extremely cautious when working on the battery. It contains poisonous and corrosive sulfuric acid.

■ **When working near the electric cooling fan or radiator grille**

Be sure the engine switch is off. With the engine switch in ON, the electric cooling fan may automatically start to run if the air conditioning is on and/or the coolant temperature is high. (→P.284)

■ **Safety glasses**

Wear safety glasses to prevent flying or falling material, fluid spray, etc. from getting in your eyes.



WARNING

The engine compartment contains many mechanisms and fluids that may move suddenly, become hot, or become electrically energized. To avoid death or serious injury, observe the following precautions.

■ **When working on the engine compartment**

- Keep hands, clothing and tools away from the moving fan and engine drive belt.
- Be careful not to touch the engine, radiator, exhaust manifold, etc. right after driving as they may be hot. Oil and other fluids may also be hot.
- Do not leave anything that may burn easily, such as paper and rags, in the engine compartment.
- Do not smoke, cause sparks or expose an open flame to fuel. Fuel fumes are flammable.



NOTICE

■ **If you remove the air cleaner filter**

Driving with the air cleaner filter removed may cause excessive engine wear due to dirt in the air.

Hood**Opening the hood**

- 1 Pull the hood lock release lever.

The hood will pop up slightly.

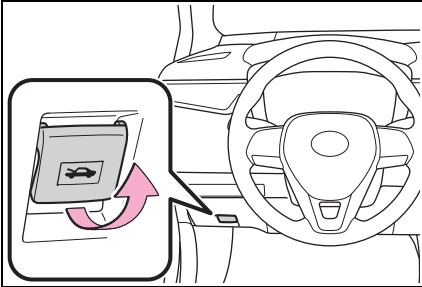

- 2 Pull the auxiliary catch lever to the left and lift the hood.

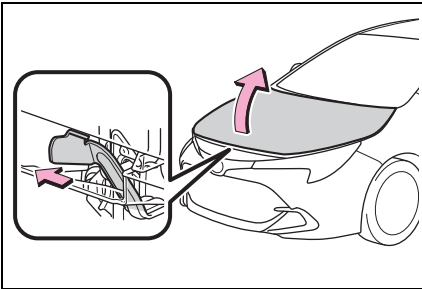

- 3 Hold the hood open by inserting the support rod into the slot.

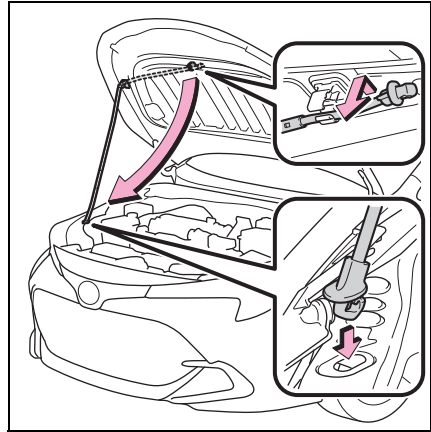
**⚠ WARNING****■ Pre-driving check**

Check that the hood is fully closed and locked.

If the hood is not locked properly, it may open while the vehicle is in motion and cause an accident, which may result in death or serious injury.

■ After installing the support rod into the slot

Make sure the rod supports the hood securely preventing it from falling down onto your head or body.

⚠ NOTICE**■ When closing the hood**

Be sure to return the support rod to its clip before closing the hood. Closing the hood with the support rod not clipped could cause the hood to bend.

Positioning a floor jack

When using a floor jack, follow the instructions in the manual provided with the jack and perform the operation safely.

When raising your vehicle with a floor jack, position the jack correctly. Improper placement may damage your vehicle or cause injury.

Location of the jack point

■ Front

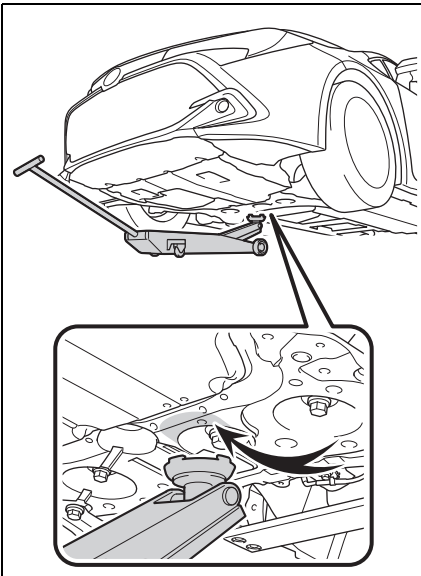

■ Rear

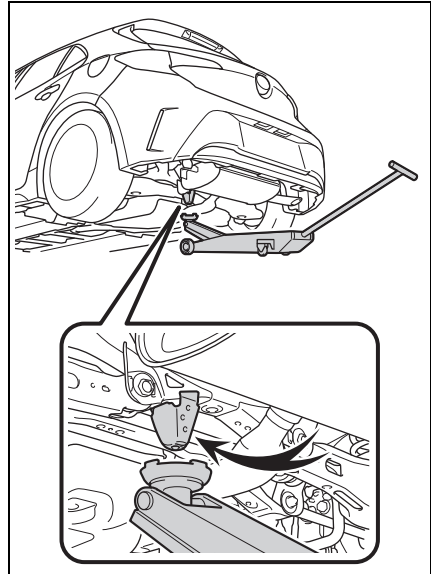

Engine compartment

Components

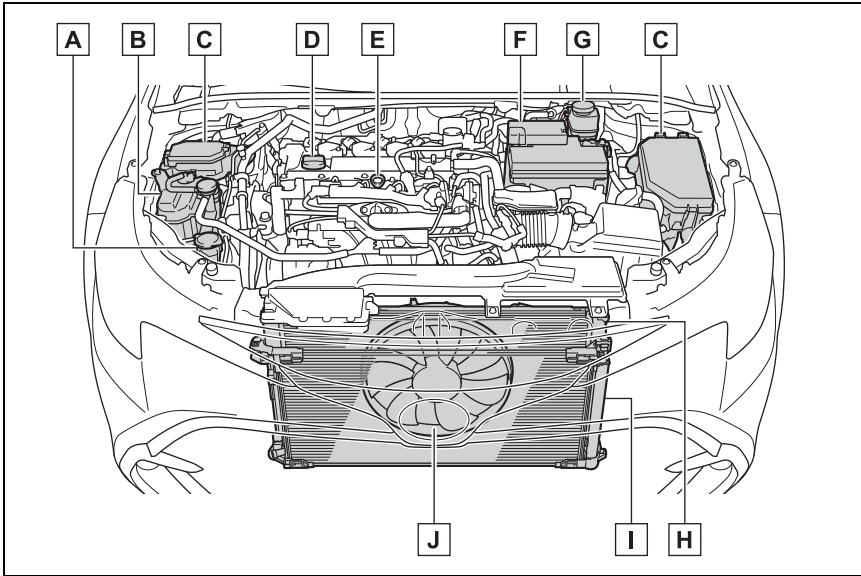

- A** Washer fluid tank (→P.287)
- B** Engine coolant reservoir (→P.281)
- C** Fuse boxes (→P.313)
- D** Engine oil filler cap (→P.283)
- E** Engine oil level dipstick (→P.281)
- F** Battery (→P.286)
- G** Brake fluid reservoir (→P.285)
- H** Radiator (→P.284)
- I** Condenser (→P.284)
- J** Electric cooling fan

Checking the engine oil

With the engine at operating temperature and turned off, check the oil level on the dipstick.

- 1 Park the vehicle on level ground. After warming up the engine and turning it off, wait about 5 minutes for the oil to drain back into the bottom of the engine.

- 2 Holding a rag under the end, pull the dipstick out.

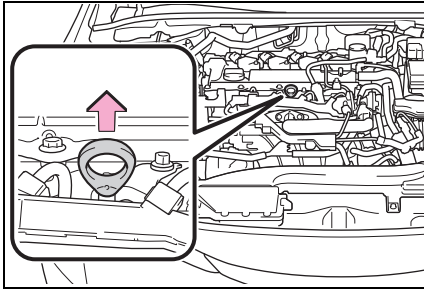

- 3 Wipe the dipstick clean.
- 4 Reinsert the dipstick fully.
- 5 Holding a rag under the end, pull the dipstick out and check whether the oil level is above low level mark.

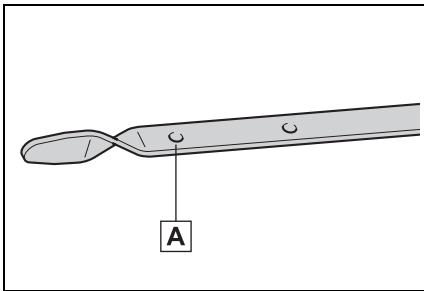

A Low level mark

The shape of the dipstick may differ depending on the type of vehicle or engine.

- 6 Wipe the dipstick and reinsert it fully.

 **NOTICE**

■ To prevent serious engine damage

Check the oil level on a regular basis.

■ Engine oil consumption

A certain amount of engine oil will be consumed while driving. In the following situations, oil consumption may increase, and engine oil may need to be refilled in between oil maintenance intervals.

- When the engine is new, for example directly after purchasing the vehicle or after replacing the engine
- If low quality oil or oil of an inappropriate viscosity is used
- When driving at high engine speeds or with a heavy load, or when driving while accelerating or decelerating frequently
- When leaving the engine idling for a long time, or when driving frequently through heavy traffic

■ Engine oil level rise

If the vehicle is repeatedly driven without the engine warmed up, moisture caused by dew condensation inside the engine or fuel which did not burn mixes into the engine oil, resulting in a rise in engine oil level. However, this is not a malfunction. For example, the engine become difficult to be warmed up in the following situations.

- When driving a short distance
- When driving at a low speed
- When the outside temperature is low

When checking the engine oil, make sure that the engine is warmed up. If the engine oil level exceeds the refill upper limit mark, contact your Toyota dealer.

Adding engine oil

■ Checking the oil type and preparing the item needed

Make sure to check the oil type

and prepare the items needed before adding oil.

- Engine oil selection
→P.378
- Oil quantity (Low level mark
→ Refill upper limit mark)
1.6 qt. (1.5 L, 1.3 Imp. qt.)
- Item
Clean funnel

■ Adding engine oil

If the oil level is below or near the low level mark, add engine oil of the same type as that already in the engine.

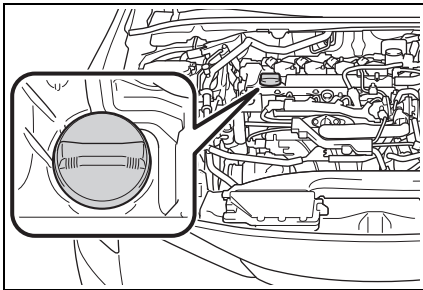

- 1 Remove the oil filler cap by turning it counterclockwise.
- 2 Add engine oil slowly, checking the dipstick.

Make sure that the oil level does not exceed the refill upper limit mark and is between the low level mark and refill upper limit mark.

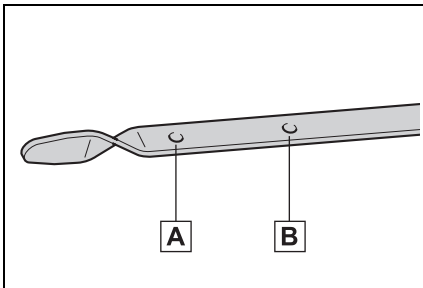

A Low level mark

B Refill upper limit mark

The shape of the dipstick may differ depending on the type of vehicle engine.

- 3 Install the oil filler cap by turning it clockwise.

⚠ WARNING

■ Used engine oil

- Used engine oil contains potentially harmful contaminants which may cause skin disorders such as inflammation and skin cancer, so care should be taken to avoid prolonged and repeated contact. To remove used engine oil from your skin, wash thoroughly with soap and water.
- Dispose of used oil and filters only in a safe and acceptable manner. Do not dispose of used oil and filters in household trash, in sewers or onto the ground. Call your Toyota dealer, service station or auto parts store for information concerning recycling or disposal.
- Do not leave used engine oil within the reach of children.

⚠ NOTICE

■ When replacing the engine oil

- Be careful not to spill engine oil on the vehicle components.
- Avoid overfilling, or the engine could be damaged.
- Check the oil level on the dipstick every time you refill the vehicle.
- Be sure the engine oil filler cap is properly tightened.

Checking the engine coolant

The coolant level is satisfactory if it is between the “MAX” and “MIN” lines on the reservoir when the engine is cold.

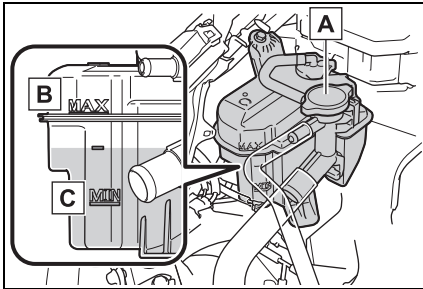

A Reservoir

B “MAX” line

C “MIN” line

If the level is on or below the “MIN” line, add coolant up to the “MAX” line. (→P.370)

■ Coolant selection

Only use “Toyota Super Long Life Coolant” or a similar high quality ethylene glycol based non-silicate, non-amine, non-nitrite, and non-borate coolant with long-life hybrid organic acid technology.

U.S.A.:

“Toyota Super Long Life Coolant” is a mixture of 50% coolant and 50% deionized water. (Minimum temperature: -31°F [-35°C])

Canada:

“Toyota Super Long Life Coolant” is a mixture of 55% coolant and 45% deionized water. (Minimum temperature: -44°F [-42°C])

For more details about coolant, contact your Toyota dealer.

■ If the coolant level drops within a short time of replenishing

Visually check the radiator, hoses, engine coolant reservoir caps, drain cock and water pump.

If you cannot find a leak, have your Toyota dealer test the cap and check for leaks in the cooling system.

⚠ WARNING

■ When the engine is hot

Do not remove the engine coolant reservoir cap. (→P.372)

The cooling system may be under pressure and may spray hot coolant if the cap is removed, causing serious injuries, such as burns.

⚠ NOTICE

■ When adding coolant

Coolant is neither plain water nor straight antifreeze. The correct mixture of water and antifreeze must be used to provide proper lubrication, corrosion protection and cooling. Be sure to read the antifreeze or coolant label.

■ If you spill coolant

Be sure to wash it off with water to prevent it from damaging parts or paint.

Checking the radiator and condenser

Check the radiator and condenser and clear away any foreign objects. If either of the above parts is extremely dirty or you are not sure of their condition, have your vehicle inspected by your Toyota dealer.

⚠ WARNING

■ **When the engine is hot**

Do not touch the radiator or condenser as they may be hot and cause serious injuries, such as burns.

Checking and adding the brake fluid

■ **Checking fluid level**

The brake fluid level should be between the “MAX” and “MIN” lines on the tank.

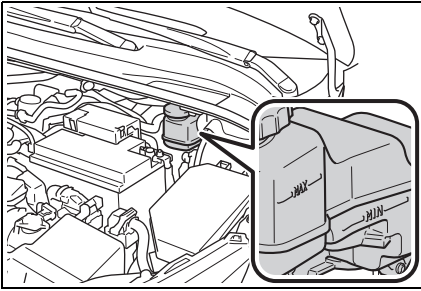

■ **Adding fluid**

- 1 Slide and lift up the rubber strip to partly remove it as shown.

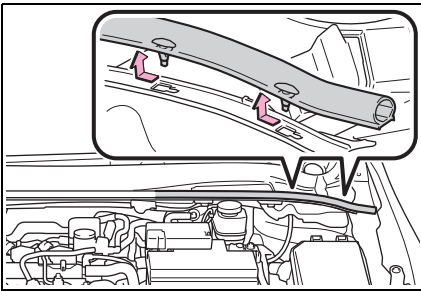

- 2 Disconnect the claws and remove the service cover.

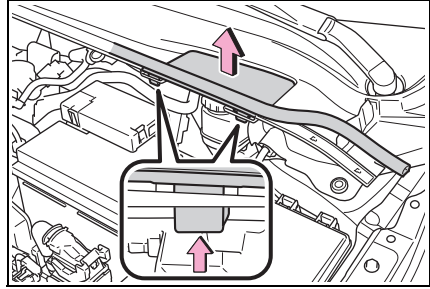

- 3 Remove the reservoir cap.

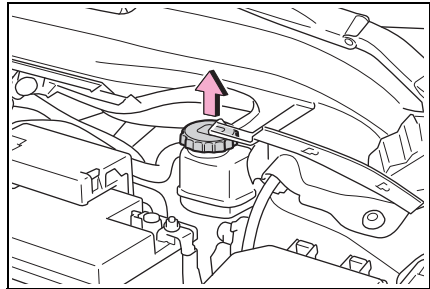

- 4 Add brake fluid slowly while checking the fluid level.

Make sure to check the fluid type and prepare the necessary item.

● **Fluid type**

FMVSS No.116 DOT 3 or SAE J1703 brake fluid

FMVSS No.116 DOT 4 or SAE J1704 brake fluid

● **Item**

Clean funnel

■ **Brake fluid can absorb moisture from the air**

Excess moisture in the brake fluid can cause a dangerous loss of braking efficiency. Use only newly opened brake fluid.

**WARNING****■ When filling the reservoir**

Take care as brake fluid can harm your hands and eyes and damage painted surfaces.

If fluid gets on your hands or in your eyes, flush the affected area with clean water immediately.

If you still experience discomfort, see a doctor.

**NOTICE****■ If the fluid level is low or high**

It is normal for the brake fluid level to go down slightly as the brake pads wear out or when the fluid level in the accumulator is high. If the reservoir needs frequent refilling, there may be a serious problem.

Battery

Check the battery as follows.

■ Battery exterior

Make sure that the battery terminals are not corroded and that there are no loose connections, cracks, or loose clamps.

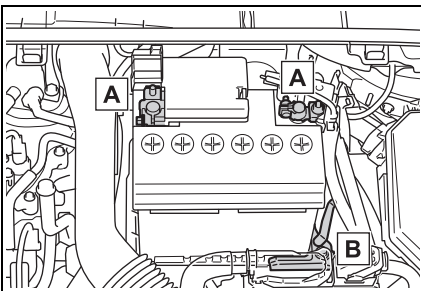

A Terminals

B Hold-down clamp

■ Before recharging

When recharging, the battery produces hydrogen gas which is flammable and explosive. Therefore, observe the following precautions before recharging:

- If recharging with the battery installed on the vehicle, be sure to disconnect the ground cable.
- Make sure the charger is off when connecting and disconnecting the charger cables to the battery.

■ After recharging/reconnecting the battery

- Unlocking the doors using the smart key system may not be possible immediately after reconnecting the battery. If this happens, use the wireless remote control or the mechanical key to lock/unlock the doors.
- Start the engine with the engine switch in ACC^{*}. The engine may not start with the engine switch turned off. However, the engine will operate normally from the second attempt.
- The engine switch mode is recorded by the vehicle. If the battery is reconnected, the vehicle will return the engine switch mode to the status it was in before the battery was disconnected. Make sure to turn off the engine before disconnecting the battery. Take extra care when connecting the battery if the engine switch mode prior to discharge is unknown.

If the system will not start even after multiple attempts, contact your Toyota dealer.

*: ACC mode can be enabled/disabled on the customize menu.
(→P.396)

**WARNING****■ Chemicals in the battery**

The battery contains poisonous and corrosive sulfuric acid and may produce hydrogen gas which is flammable and explosive. To reduce the risk of death or serious injury, take the following precautions while working on or near the battery:

- Do not cause sparks by touching the battery terminals with tools.
- Do not smoke or light a match near the battery.
- Avoid contact with eyes, skin and clothes.
- Never inhale or swallow electrolyte.
- Wear protective safety glasses when working near the battery.
- Keep children away from the battery.

■ Where to safely charge the battery

Always charge the battery in an open area. Do not charge the battery in a garage or closed room where there is insufficient ventilation.

■ Emergency measures regarding electrolyte

- If electrolyte gets in your eyes
Flush your eyes with clean water for at least 15 minutes and get immediate medical attention. If possible, continue to apply water with a sponge or cloth while traveling to the nearest medical facility.

- If electrolyte gets on your skin
Wash the affected area thoroughly. If you feel pain or burning, get medical attention immediately.

- If electrolyte gets on your clothes
It can soak through clothing on to your skin. Immediately take off the clothing and follow the procedure above if necessary.

- If you accidentally swallow electrolyte
Drink a large quantity of water or milk. Get emergency medical attention immediately.

■ When disconnecting the battery

Do not disconnect the negative (-) terminal on the body side. The disconnected negative (-) terminal may touch the positive (+) terminal, which may cause a short and result in death or serious injury.

**NOTICE****■ When recharging the battery**

Never recharge the battery while the engine is running. Also, be sure all accessories are turned off.

Adding the washer fluid

- ▶ Except for Canada

If the washer fluid level is at "LOW", add washer fluid.

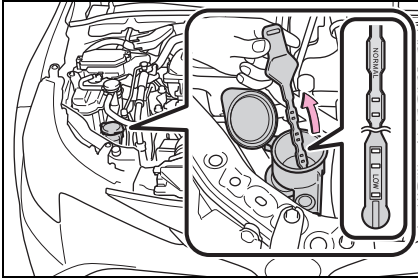

► For Canada

Add washer fluid in the following situations:

- A washer does not work.
- The warning message appears on the multi-information display.

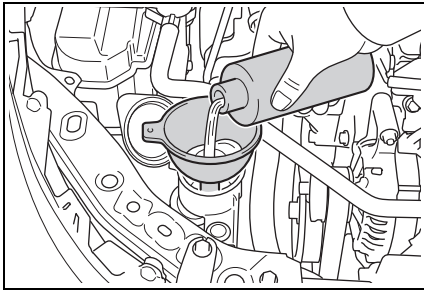

■ Using the gauge (Except for Canada)

The washer fluid level can be checked by observing the position of the level on the liquid-covered holes in the gauge.

If the level falls below the second hole from the bottom (the "LOW" position), refill the washer fluid.

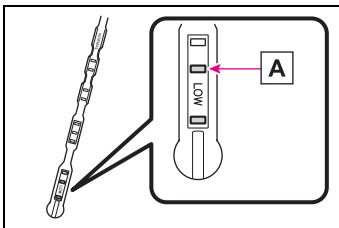

A Current fluid level

WARNING

■ When adding washer fluid

Do not add washer fluid when the engine is hot or running as washer fluid contains alcohol and may catch fire if spilled on the engine, etc.

NOTICE

■ Do not use any fluid other than washer fluid

Do not use soapy water or engine antifreeze instead of washer fluid. Doing so may cause streaking on the vehicle's painted surfaces, as well as damaging the pump leading to problems of the washer fluid not spraying.

■ Diluting washer fluid

Dilute washer fluid with water as necessary. Refer to the freezing temperatures listed on the label of the washer fluid bottle.

Tires

Replace or rotate tires in accordance with maintenance schedules and treadwear.

Checking tires

Check if the treadwear indicators are showing on the tires. Also check the tires for uneven wear, such as excessive wear on one side of the tread.

Check the spare tire condition and pressure if not rotated.

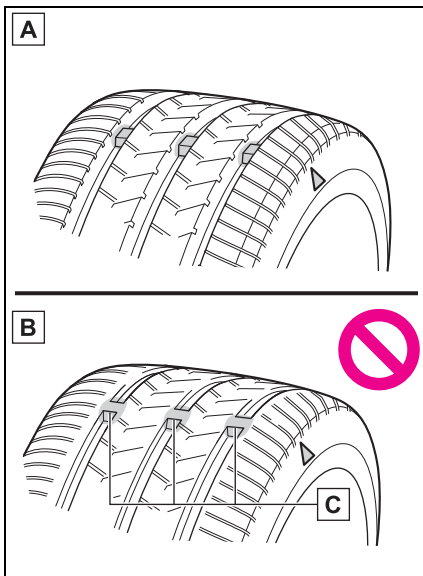

A New tread

B Worn tread

C Treadwear indicator

The location of treadwear indicators is shown by a “TWI” or “△” mark,

etc., molded into the sidewall of each tire.

Replace the tires if the treadwear indicators are showing on a tire.

■ When to replace your vehicle's tires

Tires should be replaced if:

- The treadwear indicators are showing on a tire.
- You have tire damage such as cuts, splits, cracks deep enough to expose the fabric, and bulges indicating internal damage
- A tire goes flat repeatedly or cannot be properly repaired due to the size or location of a cut or other damage

If you are not sure, consult with your Toyota dealer.

■ Tire life

Any tire over 6 years old must be checked by a qualified technician even if it has seldom or never been used or damage is not obvious.

■ Low profile tires (18-inch tires)

Generally, low profile tires will wear more rapidly and tire grip performance will be reduced on snowy and/or icy roads when compared to standard tires. Be sure to use snow tires or tire chains on snowy and/or icy roads and drive carefully at a speed appropriate for road and weather conditions.

■ Maximum load of tire

Check that the maximum load of the replacement tire is greater than 1/2 of the Gross Axle Weight Ratings (GAWR) of either the front axle or the rear axle, whichever is greater.

For the GAWR, see the Certification Label.

For the maximum load of the tire, see the load limit at maximum cold tire inflation pressure mentioned on the sidewall of the tire. (→P.385)

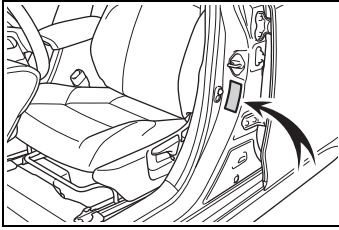

■ Tire types

● Summer tires

Summer tires are high-speed performance tires best suited to highway driving under dry conditions. Since summer tires do not have the same traction performance as snow tires, summer tires are inadequate for driving on snow-covered or icy roads. For driving on snow-covered roads or icy roads, the use of snow tires is recommended. When installing snow tires, be sure to replace all four tires.

● All season tires

All season tires are designed to provide better traction in snow and to be adequate for driving in most winter conditions as well as for use year-round. All season tires, however, do not have adequate traction performance compared with snow tires in heavy or loose snow. Also, all season tires fall short in acceleration and handling performance compared with summer tires in highway driving.

● Snow tires

For driving on snow-covered roads or icy roads, we recommend using snow tires. If you need snow tires, select tires of the same size, construction and load capacity as the originally installed tires. Since your vehicle has radial tires as original equipment, make sure your snow

tires also have radial construction. Do not install studded tires without first checking local regulations for possible restrictions. Snow tires should be installed on all wheels. (→P.235)

■ If the tread on snow tires wears down below 0.16 in. (4 mm)

The effectiveness of the tires as snow tires is lost.

■ Checking the tire valves

When replacing the tires, check the tire valves for deformation, cracks, and other damage.



WARNING

■ When inspecting or replacing tires

Observe the following precautions to prevent accidents.

Failure to do so may cause damage to parts of the drive train as well as dangerous handling characteristics, which may lead to an accident resulting in death or serious injury.

- Do not mix tires of different makes, models or tread patterns. Also, do not mix tires of remarkably different treadwear.
- Do not use tire sizes other than those recommended by Toyota.
- Do not mix differently constructed tires (radial, bias-belted or bias-ply tires).
- Do not mix summer, all season and snow tires.
- Do not use tires that have been used on another vehicle. Do not use tires if you do not know how they were used previously.

 NOTICE

■ **Low profile tires (18-inch tires)**

Low profile tires may cause greater damage than usual to the tire wheel when sustaining impact from the road surface. Therefore, pay attention to the following:

- Be sure to use proper tire inflation pressure. If tires are under-inflated, they may be damaged more severely.
- Avoid potholes, uneven pavement, curbs and other road hazards. Failure to do so may lead to severe tire and wheel damage.
- **If tire inflation pressure of each tire becomes low while driving**

Do not continue driving, or your tires and/or wheels may be ruined.

■ **Driving on rough roads**

Take particular care when driving on roads with loose surfaces or potholes.

These conditions may cause losses in tire inflation pressure, reducing the cushioning ability of the tires. In addition, driving on rough roads may cause damage to the tires themselves, as well as the vehicle's wheels and body.

Tire rotation

Rotate the tires in the order shown.

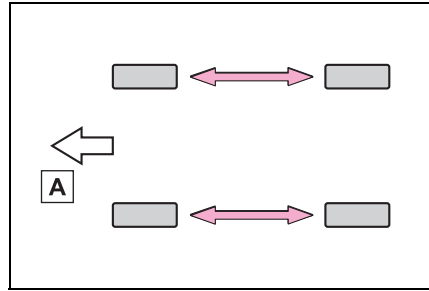

A Front

To equalize tire wear and extend tire life, Toyota recommends that tire rotation is carried out at the same interval as tire inspection.

Do not fail to initialize the tire pressure warning system after tire rotation.

Tire pressure warning system

Your vehicle is equipped with a tire pressure warning system that uses tire pressure warning valves and transmitters to detect low tire inflation pressure before serious problems arise.

The tire pressure warning system of this vehicle adopts a 2-type warning system.

- When “Adjust Pressure” is displayed (Normal Warning)

A warning with the tire pressure warning light and warning buzzer when there is an unknown level of low tire pressure with the appearance of the tire due to natural air leakage as well as the pressure lowering due to changes in the pressure according to the outside temperature. (Ways of coping:

→P.332, 381)

- When “Immediately Check Tire when Safe” is displayed (Emergency Warning)

A warning with the tire pressure warning light and warning buzzer when there is a known level of low tire pressure with the appearance of the tire due to pressure suddenly lowering. (Ways of coping: →P.332, 354)

However, the system may not be able to detect sudden tire ruptures (bursting, etc.).

The tire pressure detected by the tire pressure warning system can be displayed on the multi-information display.





■ How to change the unit



▶ 4.2-inch display



- 1 Park the vehicle in a safe place and turn the engine switch off.



Changing the unit cannot be performed while the vehicle is moving.

- 2 Turn the engine switch to ON.
- 3 Select  of the multi-information display and then press OK .

- 4 Press  or  to select “Vehicle Settings” and then press and hold OK .

- 5 Press  or  to select “TPWS setting” and then press OK .







- 6 Press  or  to select “Pressure unit setting”.

- 7 Press  or  to select the desired unit and then press OK .

▶ 7-inch display

- 1 Park the vehicle in a safe place and turn the engine switch off.

Changing the unit cannot be performed while the vehicle is moving.

- 2 Turn the engine switch to ON.
- 3 Select  of the multi-information display and then press OK .
- 4 Press  or  to select “Vehicle Settings” and then press and hold OK .
- 5 Press  or  to select “TPWS setting” and then press OK .
- 6 Press  or  to select “Pressure unit setting”.

- 7 Press < or > to select the desired unit and then press OK .

■ Routine tire inflation pressure checks

The tire pressure warning system does not replace routine tire inflation pressure checks. Make sure to check tire inflation pressure as part of your routine of daily vehicle checks.

■ Tire inflation pressure

- It may take a few minutes to display the tire inflation pressure after the engine switch is turned to ON. It may also take a few minutes to display the tire inflation pressure after inflation pressure has been adjusted.
- Tire inflation pressure changes with temperature. The displayed values may also be different from the values measured using a tire pressure gauge.

■ Situations in which the tire pressure warning system may not operate properly

- In the following cases, the tire pressure warning system may not operate properly.
 - If non-genuine Toyota wheels are used.
 - A tire has been replaced with a tire that is not an OE (Original Equipment) tire.
 - A tire has been replaced with a tire that is not of the specified size.
 - Tire chains, etc. are equipped.
 - An auxiliary-supported run-flat tire is equipped.
 - If a window tint that affects the radio wave signals is installed.
 - If there is a lot of snow or ice on the vehicle, particularly around the wheels or wheel housings.
 - If the tire inflation pressure is extremely higher than the specified level.

- If tires not equipped with tire pressure warning valves and transmitters are used.
- If the ID code on the tire pressure warning valves and transmitters is not registered in the tire pressure warning computer.
- Performance may be affected in the following situations.
 - Near a TV tower, electric power plant, gas station, radio station, large display, airport or other facility that generates strong radio waves or electrical noise.
 - When carrying a portable radio, cellular phone, cordless phone or other wireless communication device.
- When the vehicle is parked, the time taken for the warning to start or go off could be extended.
- When tire inflation pressure declines rapidly for example when a tire has burst, the warning may not function.

■ Warning performance of the tire pressure warning system

The warning of the tire pressure warning system will change in accordance with driving conditions. For this reason, the system may give a warning even if the tire pressure does not reach a low enough level, or if the pressure is higher than the pressure that was adjusted to when the system was initialized.

Installing tire pressure warning valves and transmitters

When replacing tires or wheels, tire pressure warning valves and transmitters must also be installed.

When new tire pressure warning valves and transmitters are

installed, new ID codes must be registered in the tire pressure warning computer and the tire pressure warning system must be initialized. Have tire pressure warning valves and transmitter ID codes registered by your Toyota dealer. (→P.300)

■ Replacing tires and wheels

If the ID code of the tire pressure warning valve and transmitter is not registered, the tire pressure warning system will not work properly. After driving for about 20 minutes, the tire pressure warning light blinks for 1 minute and stays on to indicate a system malfunction.



NOTICE

■ Repairing or replacing tires, wheels, tire pressure warning valves, transmitters and tire valve caps

- When removing or fitting the wheels, tires or the tire pressure warning valves and transmitters, contact your Toyota dealer as the tire pressure warning valves and transmitters may be damaged if not handled correctly.
- Make sure to install the tire valve caps. If the tire valve caps are not installed, water could enter the tire pressure warning valves and the tire pressure warning valves could be bound.
- When replacing tire valve caps, do not use tire valve caps other than those specified. The cap may become stuck.

■ To avoid damage to the tire pressure warning valves and transmitters

When a tire is repaired with liquid sealants, the tire pressure warning valve and transmitter may not operate properly. If a liquid sealant is used, contact your Toyota dealer or other qualified service shop as soon as possible. Make sure to replace the tire pressure warning valve and transmitter when replacing the tire. (→P.293)

Registration of the position of each wheel after performing a tire rotation







It is necessary to register the position of each wheel after performing a tire rotation.

Wheel position registration can be performed by oneself. Wheel position registration is performed by driving forward with moderate left and right turns. However, depending on the driving conditions and driving environment, registration may take some time to complete.

▶ 4.2-inch display

- 1 Park the vehicle in a safe place and turn the engine switch off, wait for approximately 20 minutes or more, and then start the engine.

The wheel position registration procedure cannot be performed while the vehicle is moving.

- 2 Select  of the multi-information display and then press OK .
- 3 Press  or  to select “Vehicle Settings” and then press and hold OK .
- 4 Press  or  to select “TPWS setting” and then press OK .
- 5 Press  or  to select “Tire Rotation” and then press OK .
- 6 Select “OK” and then press OK .

A message indicating that wheel position registration is being performed will be displayed on the multi-information display. “---” will be displayed for the tire inflation pressure of each tire and wheel position registration will begin.

- 7 Drive straight (with occasional left and right turns) at approximately 25 mph (40 km/h) or more for approximately 10 to 30 minutes.

When wheel position registration is complete, a message indicating that registration has been completed and the inflation pressure of each tire will be displayed on the multi-information display.







Even if it is not possible to drive continuously at approximately 25 mph (40 km/h) or more, registration can be completed by driving for a long time. However, if registration does not complete after driving for 1 hour or more, park the vehicle in

a safe place and leave it with the engine switch in ON for approximately 15 minutes or more, and then perform the driving procedure again.

▶ 7-inch display

- 1 Park the vehicle in a safe place and turn the engine switch off, wait for approximately 20 minutes or more, and then start the engine.

The wheel position registration procedure cannot be performed while the vehicle is moving.

- 2 Select  of the multi-information display and then press OK .
- 3 Press  or  to select “Vehicle Settings” and then press and hold OK .
- 4 Press  or  to select “TPWS setting” and then press OK .
- 5 Press  or  to select “Tire Rotation” and then press OK .
- 6 Select “OK” and then press OK .

A message indicating that wheel position registration is being performed will be displayed on the multi-information display. “---” will be displayed for the tire inflation pressure of each tire and wheel position registration will begin.

- 7 Drive straight (with occasional left and right turns) at

approximately 25 mph (40 km/h) or more for approximately 10 to 30 minutes.

When wheel position registration is complete, a message indicating that registration has been completed and the inflation pressure of each tire will be displayed on the multi-information display.

Even if it is not possible to drive continuously at approximately 25 mph (40 km/h) or more, registration can be completed by driving for a long time. However, if registration does not complete after driving for 1 hour or more, park the vehicle in a safe place and leave it with the engine switch in ON for approximately 15 minutes or more, and then perform the driving procedure again.

■ When performing wheel position registration

- Normally, wheel position registration can be completed within approximately 30 minutes.
- Wheel position registration is performed while driving at a vehicle speed of approximately 25 mph (40 km/h) or more.

■ Wheel position registration procedure

- If the engine switch is turned off while registering the wheel position, the next time the engine switch is turned to ON, the wheel position registration will resume and it will not be necessary to restart the procedure.
- While the position of each wheel is being determined and the inflation pressures are not being displayed, if the inflation pressure of a tire drops, the tire pressure warning light will come on.

■ If the wheel position cannot be registered easily

- In the following situations, wheel

position registration may take longer than usual to be completed or may not be possible.

- Vehicle is not driven at approximately 25 mph (40 km/h) or more
- Vehicle is driven on unpaved roads
- If wheel position registration does not complete after driving for 1 hour or more, park the vehicle in a safe place for approximately 15 minutes and then drive the vehicle again.
- If the vehicle is reversed during wheel position registration, all data collected until then will be cleared. Perform driving again.

Setting the tire pressure

In the following situations, it will be necessary to perform the tire inflation pressure setting procedure of the tire pressure warning system.

- When the specified tire inflation pressure has changed, such as due to carried load, etc.
- When the tire inflation pressure is changed such as when the tire size is changed.

If the tire inflation pressure has been adjusted to the specified level, perform the tire inflation setting procedure by selecting specified inflation pressure on the multi-information display.

When the tire inflation pressure is to be other than specified, such as when tires other than the specified size are used, etc., set the tire inflation pressure using the current pressure. Make sure to adjust the









tire inflation pressure of each tire to the appropriate level before performing tire pressure setting. The tire pressure warning system operates based on this tire inflation pressure.

■ Setting by selecting a specified tire inflation pressure

▶ 4.2-inch display

- 1 Park the vehicle in a safe place and then start the engine.

The tire inflation pressure cannot be set while the vehicle is moving.

- 2 Select  of the multi-information display and then press OK .
- 3 Press  or  to select “Vehicle Settings” and then press and hold OK .
- 4 Press  or  to select “TPWS setting” and then press OK .
- 5 Press  or  to select “Tire Pressure Setting” and then press OK .
- 6 Press  or  to select “Setting by Specified Pressure” and then press OK .
- 7 Select the desired tire pressures, then press OK .

The tire pressure warning light will slowly blink 3 times.

After setting the tire inflation pres-



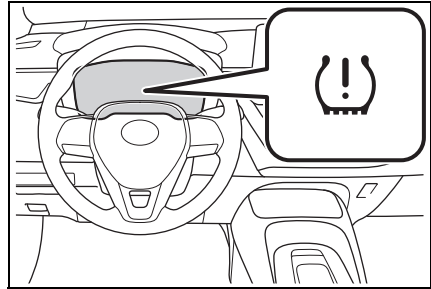





sure, a message indicating that setting has been completed will be displayed on the multi-information display.



▶ 7-inch display

- 1 Park the vehicle in a safe place and then start the engine.

The tire inflation pressure cannot be set while the vehicle is moving.

- 2 Select  of the multi-information display and then press OK .
- 3 Press  or  to select “Vehicle Settings” and then press and hold OK .
- 4 Press  or  to select “TPWS setting” and then press OK .
- 5 Press  or  to select “Tire Pressure Setting” and then press OK .
- 6 Press  or  to select “Setting by Specified Pressure” and then press OK .

- 7 Select the desired tire pressures, then press OK .

The tire pressure warning light will slowly blink 3 times.

After setting the tire inflation pressure, a message indicating that setting has been completed will be displayed on the multi-information display.

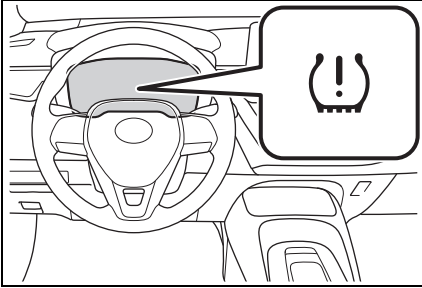

■ **If the tire inflation pressure cannot be set easily**

- If the tire pressure warning light does not blink 3 times when starting the tire inflation pressure setting procedure, the procedure may not have started. Perform the procedure again from the beginning.
- If tire inflation pressure setting procedure cannot be completed after performing the above procedure, contact your Toyota dealer.

■ **Setting using the current tire inflation pressure**

▲ **WARNING**









■ **Before performing tire pressure setting**

Make sure to adjust the tire inflation pressure of each tire to the appropriate level before performing tire pressure setting. Otherwise, the tire pressure warning light may not illuminate even if the tire inflation pressure drops or may illuminate even though the tire inflation pressure is normal.

▶ 4.2-inch display

- 1 Park the vehicle in a safe place and then start the engine.

The tire inflation pressure cannot be set while the vehicle is moving.

- 2 Select  of the multi-information display and then press OK .
- 3 Press  or  to select “Vehicle Settings” and then press and hold OK .
- 4 Press  or  to select “TPWS setting” and then press OK .
- 5 Press  or  to select “Tire Pressure Setting” and then press OK .
- 6 Press  or  to select “Setting by Current Pressure” and then press OK .

The tire pressure warning light will slowly blink 3 times and a message indicating that tire inflation pressure is being set will be displayed on the multi-information display.



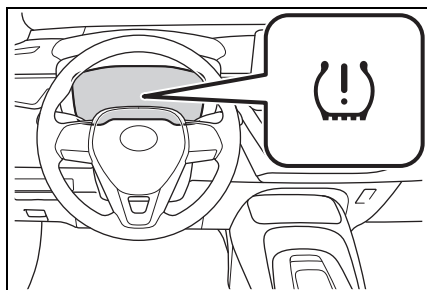



After setting the tire inflation pressure, a message indicating that setting has been completed will be displayed on the multi-information display.





► 7-inch display

- 1 Park the vehicle in a safe place and then start the engine.

The tire inflation pressure cannot be set while the vehicle is moving.

- 2 Select  of the multi-information display and then press OK .
- 3 Press  or  to select “Vehicle Settings” and then press and hold OK .
- 4 Press  or  to select “TPWS setting” and then press OK .
- 5 Press  or  to select “Tire Pressure Setting” and then press OK .

- 6 Press  or  to select “Setting by Current Pressure” and then press OK .

The tire pressure warning light will slowly blink 3 times and a message indicating that tire inflation pressure is being set will be displayed on the multi-information display.

After setting the tire inflation pressure, a message indicating that setting has been completed will be displayed on the multi-information display.

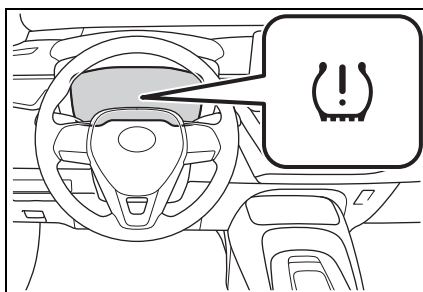

■ **Warning performance of the tire pressure warning system**

- When performing the tire pressure setting using the current tire inflation pressure, the warning timing of the tire pressure warning system will vary according to the conditions under which tire pressure setting was performed. Therefore, a warning may be output even if the tire inflation pressure drops slightly or if the tire inflation pressure increases above that when the tire inflation pressure was set.
- Make sure to perform the tire pressure setting procedure after adjusting the tire inflation pressure. Also, make sure the tires are cold before performing the tire pressure setting procedure or adjusting the tire inflation pressure.

■ Tire inflation pressure setting procedure

- If the engine switch is turned off while setting the tire inflation pressure, the next time the engine switch is turned to ON, the setting procedure will resume and it will not be necessary to restart the procedure.
- If the tire inflation pressure setting procedure is started unnecessarily, adjust the tire inflation pressure to the specified level with the tires cold and then perform setting by selecting a specified tire inflation pressure, or perform the tire inflation pressure setting procedure with the current tire inflation pressure.

■ If the tire inflation pressure cannot be set easily

- Normally, the tire inflation pressure setting procedure can be completed in 2 or 3 minutes.
- If the tire pressure warning light does not blink 3 times when starting the tire inflation pressure setting procedure, the procedure may not have started. Perform the procedure again from the beginning.
- If tire inflation pressure setting procedure cannot be completed after performing the above procedure, contact your Toyota dealer.

Registering ID codes

The tire pressure warning valve and transmitter is equipped with a unique ID code. When new tire pressure warning valves and transmitters are installed, new ID codes must be registered in the tire pressure warning computer.

- ID codes can be registered by

yourself, but depending on the driving conditions and driving environment, registration may take some time to complete.





- When using a wheel set which all of the ID codes have already been registered, the wheel set can be changed in a short amount of time.

Before performing ID code registration, make sure that no wheels with tire pressure warning valve and transmitters installed are near the vehicle.

▶ 4.2-inch display

- 1 Park the vehicle in a safe place and turn the engine switch off, wait for approximately 20 minutes or more, and then start the engine.

The ID code registration procedure cannot be performed while the vehicle is moving.

- 2 Select  of the multi-information display and then press OK .
- 3 Press  or  to select "Vehicle Settings" and then press and hold OK .
- 4 Press  or  to select "TPWS setting" and then press OK .

- 5 Press \wedge or \vee to select “Tire Set Switching” and then press OK .
- 6 Press \wedge or \vee to select “Register New Valve / ID” and then press OK ..
- 7 Press \wedge or \vee to select “Tire Set 1” or “Tire Set 2” .
Then press OK .

ID codes will be registered to the displayed wheel set.

If ID codes have already been registered for that wheel set, the tire pressure warning light will slowly blink 3 times, and a message indicating that change is occurring will be displayed on the multi-information display.

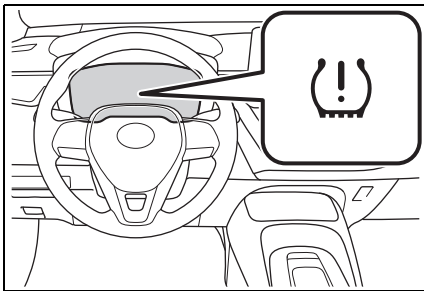

- 8 Select “OK” and then press OK .

The tire pressure warning light will slowly blink 3 times and a message indicating that ID code registration is being performed will be displayed on the multi-information display. Wheel set changing will be canceled and registration will begin.

When registration is being performed, the tire pressure warning light will blink for approximately 1 minute then illuminate and “---” will be displayed for the inflation pres-

sure of each tire on the multi-information display.

- 9 Drive straight (with occasional left and right turns) at approximately 25 mph (40 km/h) or more for approximately 10 to 30 minutes.

When registration is complete, the tire pressure warning light will turn off and a message indicating that registration has been completed will be displayed on the multi-information display.

Registration may take longer than normal to complete if the vehicle speed cannot be maintained at approximately 25 mph (40 km/h) or more. If registration cannot be completed after driving for 1 hour or more, perform the registration procedure again from the beginning.











- 10 If the tire inflation pressure of the wheel set installed differs from that of the previous set, it will be necessary to perform the tire inflation pressure setting procedure of the tire pressure warning system.

If the specified tire inflation pressure is the same, it will not be necessary to perform the tire inflation pressure setting procedure.

► 7-inch display

- 1 Park the vehicle in a safe place and turn the engine switch off, wait for approximately 20 minutes or more, and then start the engine.

The ID code registration procedure cannot be performed while the vehicle is moving.

- 2 Select  of the multi-information display and then press OK .
- 3 Press  or  to select “Vehicle Settings” and then press and hold OK .
- 4 Press  or  to select “TPWS setting” and then press OK .
- 5 Press  or  to select “Tire Set Switching” and then press OK .
- 6 Press  or  to select “Register New Valve / ID” and then press OK .
- 7 Press  or  to select “Tire Set 1” or “Tire Set 2” .
Then press OK .

ID codes will be registered to the displayed wheel set.

If ID codes have already been registered for that wheel set, the tire pressure warning light will slowly blink 3 times, and a message indicating that change is occurring will be displayed on the multi-information display.

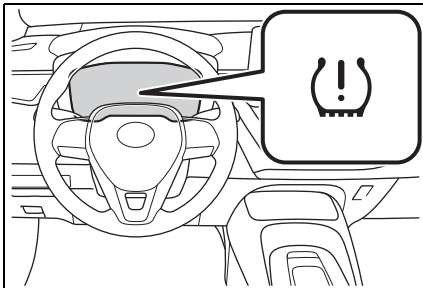

- 8 Select “OK” and then press OK .

The tire pressure warning light will slowly blink 3 times and a message indicating that ID code registration is being performed will be displayed on the multi-information display. Wheel set changing will be canceled and registration will begin.

When registration is being performed, the tire pressure warning light will blink for approximately 1 minute then illuminate and “---” will be displayed for the inflation pressure of each tire on the multi-information display.

- 9 Drive straight (with occasional left and right turns) at approximately 25 mph (40 km/h) or more for approximately 10 to 30 minutes.

When registration is complete, the tire pressure warning light will turn off and a message indicating that registration has been completed will be displayed on the multi-information display.

Registration may take longer than normal to complete if the vehicle speed cannot be maintained at approximately 25 mph (40 km/h) or more. If registration cannot be completed after driving for 1 hour or more, perform the registration procedure again from the beginning.

- 10 If the tire inflation pressure of the wheel set installed differs from that of the previous set, it will be necessary to perform the tire inflation pressure setting procedure of the tire pressure warning system.

If the specified tire inflation pressure is the same, it will not be necessary to perform the tire inflation pressure setting procedure.

■ When registering ID codes

- Normally, ID codes registration can be completed within approximately 30 minutes.
- ID code registration is performed while driving at a vehicle speed of approximately 25 mph (40 km/h) or more.

■ If ID codes are not registered easily

- In the following situations, ID code registration may take longer than usual to be completed or may not be possible.
 - When the vehicle has not been parked for approximately 20 minutes or more before being driven
 - Vehicle is not driven at approximately 25 mph (40 km/h) or more
 - Vehicle is driven on unpaved roads
 - Vehicle is driven near other vehicles and system cannot recognize tire pressure warning valve and transmitters of your vehicle over those of other vehicles
 - Wheel with tire pressure warning valve and transmitter installed is inside or near the vehicle
- If the vehicle is reversed during registration, all data collected until then will be cleared. Perform driving again.
- If the tire pressure warning light does not blink 3 times when starting ID code registration procedure to step 8, the procedure may not have started. Perform the procedure again from the beginning.
- If registration does not complete after driving for 1 hour or more, perform the ID code registration procedure again from the beginning.
- If the ID codes cannot be registered even when performing the above procedure, contact your Toyota dealer.

■ Canceling ID code registration

To cancel ID code registration after it has been started, select "Register Valve / ID" again on the multi-information display.

If ID code registration has been canceled, the tire pressure warning light will turn off.

If the warning light does not turn off, ID code registration may not have been cancelled correctly. To cancel registration, select "Register Valve / ID" on the multi-information display.











Selecting wheel set

Your vehicle is equipped with a tire pressure warning system with a function to register two sets of ID codes. This allows for registration of a second wheel set, for example a winter set.

The wheel set can be changed only if a second wheel set has been registered to the system. If a second wheel set has not been registered, it will not be possible to change to the selected wheel set.

ID codes can be registered by yourself.

- Only a change between both registered wheel set is possible, mixing between these wheel sets is not supported.
- While registering ID codes, it may not be possible to change between wheel sets normally. Cancel registration before changing between wheel sets.

- ▶ 4.2-inch display
- 1 Install the desired wheel set.
- 2 Select  of the multi-information display and then press OK .
- 3 Press  or  to select “Vehicle Settings” and then press OK .
- 4 Press  or  to select “TPWS setting” and then press OK .
- 5 Press  or  to select “Tire Set Switching” and then press OK .
- 6 Press  or  to select “Register Valve / ID” and then press OK .
- 7 Press  or  to select “Tire Set 1” or “Tire Set 2”. Then press OK .
- 8 Select “OK” and then press OK .

The tire pressure warning light will slowly blink 3 times, a message indicating that change is occurring will be displayed, and the wheel set change will begin.

Wheel set change will begin and the tire pressure warning light will blink for 1 minute and then illuminate.

Also, while the change is being performed, “---” will be displayed for the tire inflation pressure of each tire on the multi-information display.

After approximately 2 minutes, the wheel set change will complete, the tire pressure warning light will turn off, and a completion message will be displayed on the multi-information display.

If changing does not complete after approximately 4 minutes, a message indicating that the change could not be completed will be displayed.

Check which wheel set is installed and perform the change procedure again from the beginning.

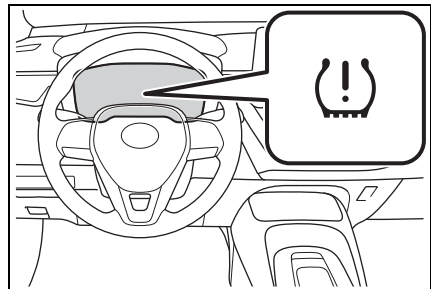

- 9 If the specified tire inflation pressure of the wheel set installed differs from that of the previous set, it will be necessary to perform the tire inflation pressure setting procedure of the tire pressure warning system. (→P.296)

If the specified tire inflation pressure is the same, it will not be necessary to perform the tire inflation pressure setting procedure.

- 10 Register the position of each wheel.

▶ 7-inch display

- 1 Install the desired wheel set.
- 2 Select  of the multi-information display and then press OK .

- 3 Press < or > to select “Vehicle Settings” and then press OK .
- 4 Press < or > to select “TPWS setting” and then press OK .
- 5 Press < or > to select “Tire Set Switching” and then press OK .
- 6 Press < or > to select “Register Valve / ID” and then press OK .
- 7 Press < or > to select “Tire Set 1” or “Tire Set 2”. Then press OK .
- 8 Select “OK” and then press OK .

The tire pressure warning light will slowly blink 3 times, a message indicating that change is occurring will be displayed, and the wheel set change will begin.

Wheel set change will begin and the tire pressure warning light will blink for 1 minute and then illuminate.

Also, while the change is being performed, “---” will be displayed for the tire inflation pressure of each tire on the multi-information display.

After approximately 2 minutes, the wheel set change will complete, the tire pressure warning light will turn off, and a completion message will be displayed on the multi-information display.

If changing does not complete after approximately 4 minutes, a mes-

sage indicating that the change could not be completed will be displayed.

Check which wheel set is installed and perform the change procedure again from the beginning.

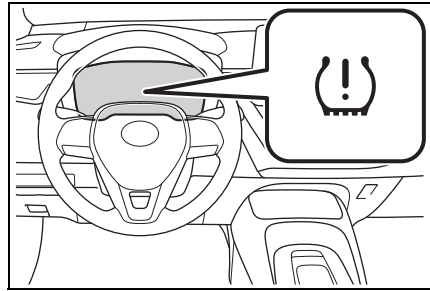

- 9 If the specified tire inflation pressure of the wheel set installed differs from that of the previous set, it will be necessary to perform the tire inflation pressure setting procedure of the tire pressure warning system. (→P.296)

If the specified tire inflation pressure is the same, it will not be necessary to perform the tire inflation pressure setting procedure.

- 10 Register the position of each wheel.

Tire inflation pressure

Checking the specified tire inflation pressure

The recommended cold tire inflation pressure and tire size are displayed on the tire and loading information label.

(→P.381)

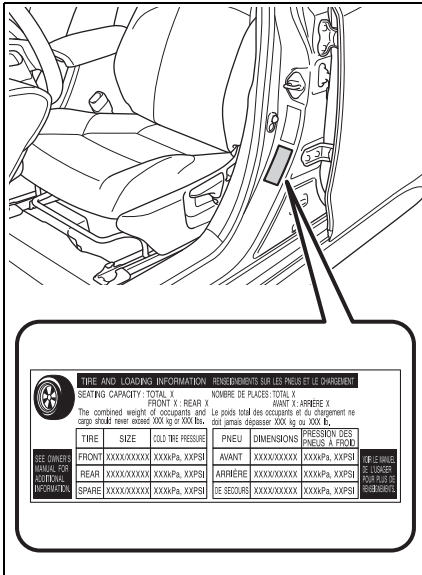

B Tire pressure gauge

- 1 Remove the tire valve cap.
- 2 Press the tip of the tire pressure gauge onto the tire valve.
- 3 Read the pressure using the gauge gradations.
- 4 If the tire inflation pressure is not at the recommended level, adjust the pressure. If you add too much air, press the center of the valve to deflate.
- 5 After completing the tire inflation pressure measurement and adjustment, apply soapy water to the valve and check for leakage.
- 6 Put the tire valve cap back on.

■ Tire inflation pressure check interval

You should check tire inflation pressure every two weeks, or at least once a month. Do not forget to check the spare.

■ Effects of incorrect tire inflation pressure

Driving with incorrect tire inflation pressure may result in the following:

- Reduced fuel economy
- Reduced driving comfort and poor handling
- Reduced tire life due to wear
- Reduced safety
- Damage to the drive train

If a tire needs frequent inflating, have it checked by your Toyota dealer.

Inspection and adjustment procedure

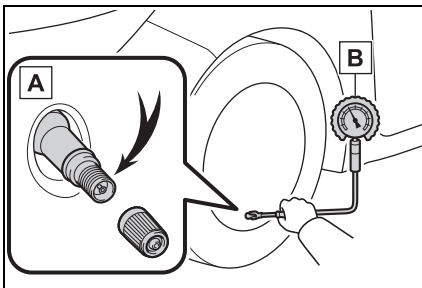

A Tire valve

■ Instructions for checking tire inflation pressure

When checking tire inflation pressure, observe the following:

- Check only when the tires are cold.
If your vehicle has been parked for at least 3 hours or has not been driven for more than 1 mile or 1.5 km, you will get an accurate cold tire inflation pressure reading.
- Always use a tire pressure gauge. It is difficult to judge if a tire is properly inflated based only on its appearance.
- It is normal for the tire inflation pressure to be higher after driving as heat is generated in the tire. Do not reduce tire inflation pressure after driving.
- Never exceed the vehicle capacity weight.
Passengers and luggage weight should be placed so that the vehicle is balanced.

- Greater possibility of tire damage while driving (due to road hazards, expansion joints, sharp edges on the road, etc.)

**NOTICE****■ When inspecting and adjusting tire inflation pressure**

Be sure to put the tire valve caps back on.

If a valve cap is not installed, dirt or moisture may get into the valve and cause an air leak, resulting in decreased tire inflation pressure.

**WARNING****■ Proper inflation is critical to save tire performance**

Keep your tires properly inflated. If the tires are not properly inflated, the following conditions may occur which could lead to an accident resulting in death or serious injury:

- Excessive wear
- Uneven wear
- Poor handling
- Possibility of blowouts resulting from overheated tires
- Air leaking from between tire and wheel
- Wheel deformation and/or tire damage

Wheels

If a wheel is bent, cracked or heavily corroded, it should be replaced. Otherwise, the tire may separate from the wheel or cause a loss of handling control.

Wheel selection

When replacing wheels, care should be taken to ensure that they are equivalent to those removed in load capacity, diameter, rim width and inset*.

Replacement wheels are available at your Toyota dealer.

*: Conventionally referred to as offset.

Toyota does not recommend using the following:

- Wheels of different sizes or types
- Used wheels
- Bent wheels that have been straightened

■ When replacing wheels

The wheels of your vehicle are equipped with tire pressure warning valves and transmitters that allow the tire pressure warning system to provide advance warning in the event of a loss in tire inflation pressure. Whenever wheels are replaced, the tire pressure warning valves and transmitters must be installed. (→P.293)



WARNING

■ When replacing wheels

- Do not use wheels that are a different size from those recommended in the Owner's Manual, as this may result in a loss of handling control.
- Never use an inner tube in a leaking wheel which is designed for a tubeless tire. Doing so may result in an accident, causing death or serious injury.

■ When installing the wheel nuts

- Be sure to install the wheel nuts with the tapered ends facing inward. (→P.359) Installing the nuts with the tapered ends facing outward can cause the wheel to break and eventually cause the wheel to come off while driving, which could lead to an accident resulting in death or serious injury.
- Never use oil or grease on the wheel bolts or wheel nuts. Oil and grease may cause the wheel nuts to be excessively tightened, leading to bolt or disc wheel damage. In addition, the oil or grease can cause the wheel nuts to loosen and the wheel may fall off, causing an accident and resulting in death or serious injury. Remove any oil or grease from the wheel bolts or wheel nuts.

■ Use of defective wheels prohibited

Do not use cracked or deformed wheels. Doing so could cause the tire to leak air during driving, possibly causing an accident.

**NOTICE**

- **Replacing tire pressure warning valves and transmitters**
- Because tire repair or replacement may affect the tire pressure warning valves and transmitters, make sure to have tires serviced by your Toyota dealer or other qualified service shop. In addition, make sure to purchase your tire pressure warning valves and transmitters at your Toyota dealer.
- Ensure that only genuine Toyota wheels are used on your vehicle. Tire pressure warning valves and transmitters may not work properly with non-genuine wheels.

Aluminum wheel precautions

- Use only Toyota wheel nuts and wheel nut wrenches designed for use with your aluminum wheels.
- When rotating, repairing or changing your tires, check that the wheel nuts are still tight after driving 1000 miles (1600 km).
- Be careful not to damage the aluminum wheels when using tire chains.
- Use only Toyota genuine balance weights or equivalent and a plastic or rubber hammer when balancing your wheels.

Air conditioning filter

The air conditioning filter must be changed regularly to maintain air conditioning efficiency.

Removing the air conditioning filter

- 1 Turn the engine switch off.
- 2 Open the glove box. Slide off the damper.

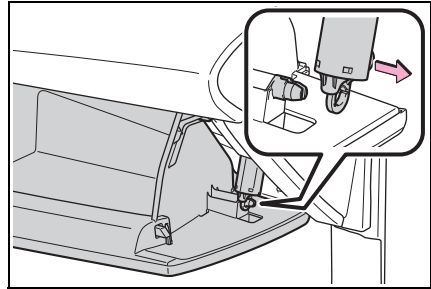

- 3 Push in the glove box on the vehicle's outer side to disconnect the claws. Then pull out the glove box and disconnect the lower claws.

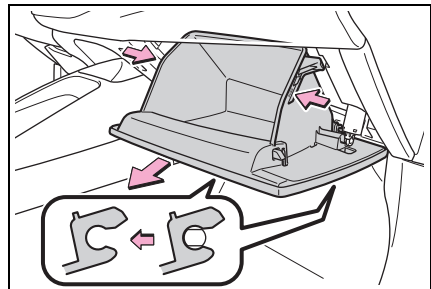

- 4 Unlock the filter cover (A), pull the filter cover out of the

claws (B), and remove the filter cover.

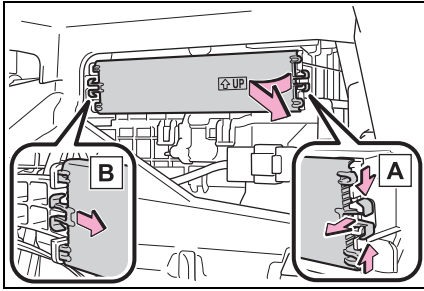

5 Remove the filter case.

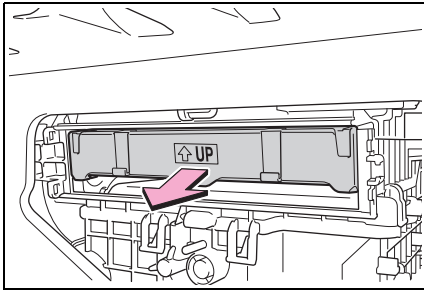

6 Remove the air conditioning filter from the filter case and replace it with a new one.

The “↑ UP” marks shown on the filter and the filter case should be pointing up.

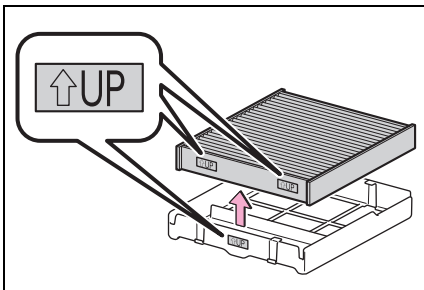

■ **Checking interval**

Inspect and replace the air conditioning filter according to the maintenance schedule. In dusty areas or areas with heavy traffic flow, more

frequent cleaning or early replacement may be required. (For scheduled maintenance information, please refer to the “Scheduled Maintenance Guide” or “Owner’s Manual Supplement”.)

■ **If air flow from the vents decreases dramatically**

The filter may be clogged. Check the filter and replace if necessary.

 **NOTICE**

■ **When using the air conditioning system**

Make sure that a filter is always installed. Using the air conditioning system without a filter may cause damage to the system.

■ **To prevent damage to the filter cover**

When moving the filter cover in the direction of arrow to release the fitting, pay attention not to apply excessive force to the claws. Otherwise, the claws may be damaged.

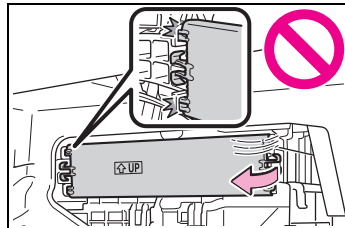

Electronic key battery

Replace the battery with a new one if it is depleted. As the key may be damaged if the following procedure is not performed properly, it is recommended that key battery replacement be performed by your Toyota dealer.

■ If the electronic key battery is depleted

The following symptoms may occur:

- The smart key system and wireless remote control will not function properly.
- The operational range will be reduced.

Items to prepare

- Flathead screwdriver
- Small flathead screwdriver
- Lithium battery CR2450

■ Use a CR2450 lithium battery

- Batteries can be purchased at your Toyota dealer, local electrical appliance shops or camera stores.
- Replace only with the same or equivalent type recommended by the manufacturer.
- Dispose of used batteries according to local laws.

Replacing the battery

- 1 Release the lock and remove the mechanical key.

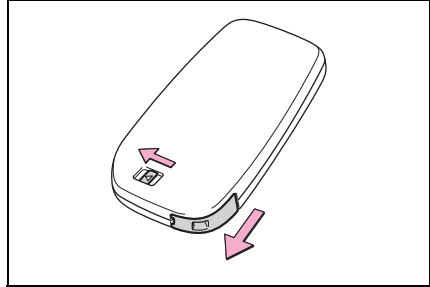

- 2 Remove the key cover.

To prevent damage to the key, cover the tip of the flathead screwdriver with a rag.

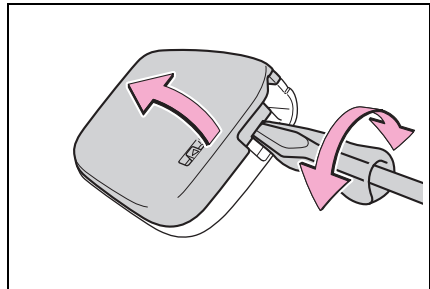



- 3 Remove the depleted battery using a small flathead screwdriver.

When removing the cover, the electronic key module may stick to the cover and the battery may not be visible. In this case, remove the electronic key module in order to remove the battery.

Insert a new battery with the “+” ter-

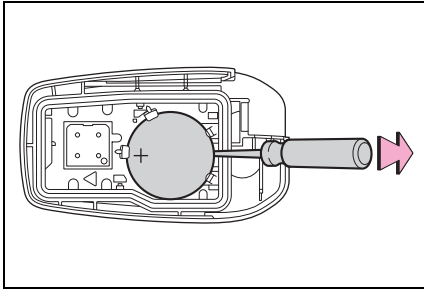
terminal facing up.



- 4 When installing the key cover and mechanical key, install by conducting step 2 and step 1 with the directions reversed.
- 5 Operate the  or  switch and check that the doors can be locked/unlocked.

 **WARNING**

■ **Battery precautions**

Observe the following precautions.

Failure to do so may result in death or serious injury.

- Do not swallow the battery. Doing so may cause chemical burns.
- A coin battery or button battery is used in the electronic key. If a battery is swallowed, it may cause severe chemical burns in as little as 2 hours and may result in death or serious injury.
- Keep away new and removed batteries from children.
- If the cover cannot be firmly closed, stop using the electronic key and stow the key in the place where children cannot reach, and then contact your Toyota dealer.

- If you accidentally swallow a battery or put a battery into a part of your body, get emergency medical attention immediately.

■ **To prevent battery explosion or leakage of flammable liquid or gas**

- Replace the battery with a new battery of the same type. If a wrong type of battery is used, it may explode.
- Do not expose batteries to extremely low pressure due to high altitude or extremely high temperatures.
- Do not burn, break or cut a battery.

 **NOTICE**

■ **When replacing the battery**

Use a flathead screwdriver of appropriate size. Applying excessive force may deform or damage the cover.

■ **For normal operation after replacing the battery**

Observe the following precautions to prevent accidents:

- Always work with dry hands. Moisture may cause the battery to rust.
- Do not touch or move any other component inside the remote control.
- Do not bend either of the battery terminals.

Checking and replacing fuses

If any of the electrical components do not operate, a fuse may have blown. If this happens, check and replace the fuses as necessary.

Checking and replacing fuses

- 1 Turn the engine switch off.
- 2 Open the fuse box cover.
 - ▶ Engine compartment: type A fuse box

Push the tabs in and lift the lid off.

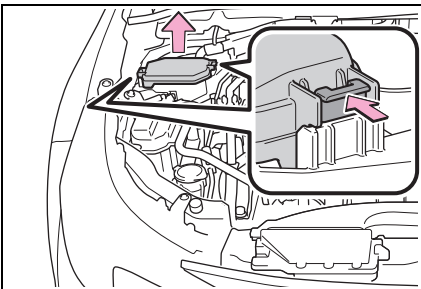

- ▶ Engine compartment: type B fuse box

Push the tabs in and lift the lid off.

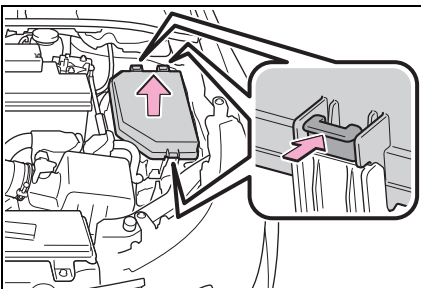

- ▶ Under the driver's side instrument panel

Remove the lid.

Make sure to push the claw when removing/installing the lid.

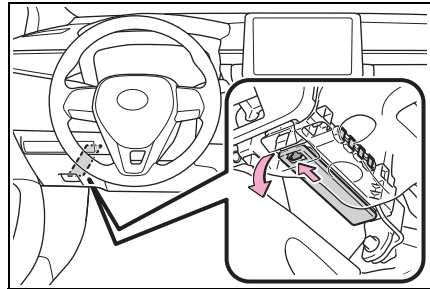

- 3 Remove the fuse with the pullout tool. Only type A fuse can be removed using the pullout tool.

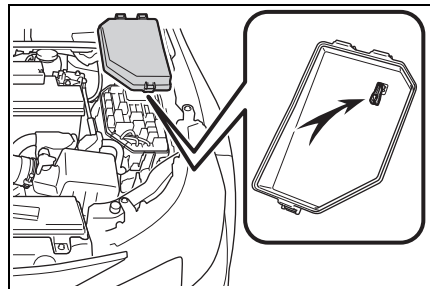

- 4 Check if the fuse is blown.

Replace the blown fuse with a new fuse of an appropriate amperage rating. The amperage rating can be found on the fuse box lid.

► Type A

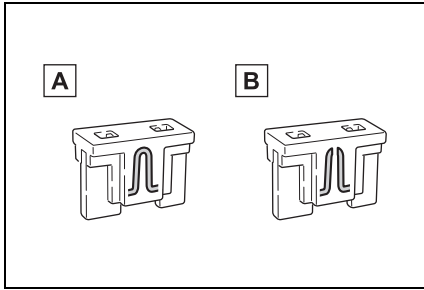

- A** Normal fuse
- B** Blown fuse

► Type B

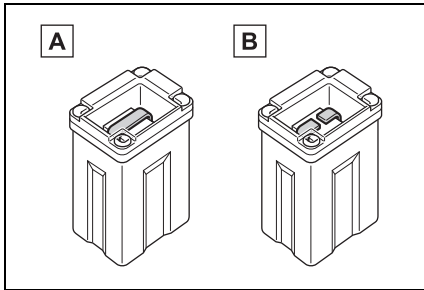

- A** Normal fuse
- B** Blown fuse

► Type C

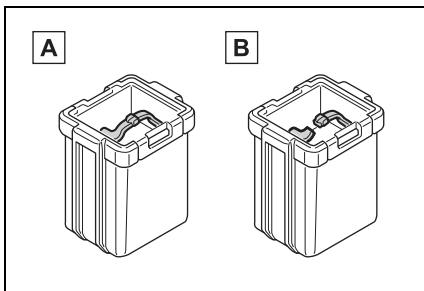

- A** Normal fuse
- B** Blown fuse

► Type D

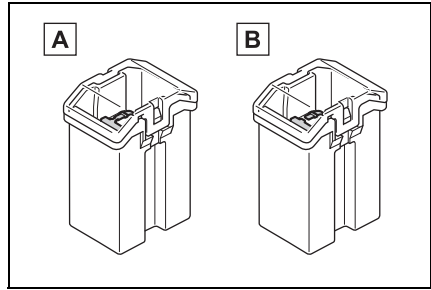

- A** Normal fuse
- B** Blown fuse

► Type E

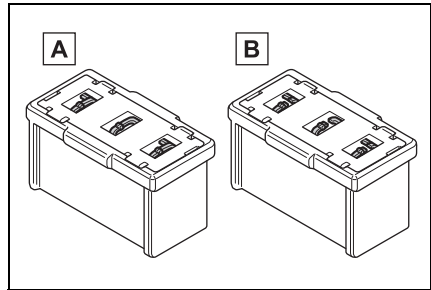

- A** Normal fuse
- B** Blown fuse

■ **After a fuse is replaced**

- When installing the lid, make sure that the tab is installed securely.
- If the lights do not turn on even after the fuse has been replaced, a bulb may need replacement.
- If the replaced fuse blows again, have the vehicle inspected by your Toyota dealer.

■ **If there is an overload in a circuit**

The fuses are designed to blow, protecting the wiring harness from damage.

■ **When replacing light bulbs**

Toyota recommends that you use

genuine Toyota products designed for this vehicle.
Because certain bulbs are connected to circuits designed to prevent overload, non-genuine parts or parts not designed for this vehicle may be unusable.

WARNING

■ To prevent system breakdowns and vehicle fire

Observe the following precautions.

Failure to do so may cause damage to the vehicle, and possibly a fire or injury.

- Never use a fuse of a higher amperage rating than that indicated, or use any other object in place of a fuse.
- Always use a genuine Toyota fuse or equivalent. Never replace a fuse with a wire, even as a temporary fix.
- Do not modify the fuses or fuse boxes.

NOTICE

■ Before replacing fuses

Have the cause of electrical overload determined and repaired by your Toyota dealer as soon as possible.

Light bulbs

You may replace the following bulbs yourself. The difficulty level of replacement varies depending on the bulb. If necessary bulb replacement seems difficult to perform, contact your Toyota dealer.

For more information about replacing other light bulbs, contact your Toyota dealer.

Preparing for light bulb replacement

Check the wattage of the light bulb to be replaced. (→P.382)

Bulb locations

■ Rear

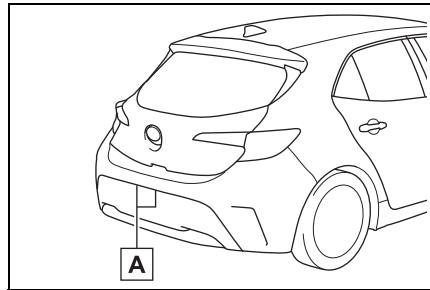

A License plate lights

■ Bulbs that need to be replaced by your Toyota dealer

- Headlights
- Parking lights

- Front side marker lights
- Daytime running lights
- Turn signal lights
- Front fog lights (if equipped)
- Tail lights
- Stop lights
- Back-up light
- High mounted stoplight

■ **LED light bulbs**

The lights other than the license plate lights consist of a number of LEDs. If any of the LEDs burn out, take your vehicle to your Toyota dealer to have the light replaced.

■ **Condensation build-up on the inside of the lens**

Temporary condensation build-up on the inside of the headlight lens does not indicate a malfunction. Contact your Toyota dealer for more information in the following situations:

- Large drops of water have built up on the inside of the lens.
- Water has built up inside the headlight.

■ **When replacing light bulbs**

→P.314

Replacing light bulbs

■ **License plate lights**

1 Remove the light unit.

Insert a flathead screwdriver or similar into the hole next to the light and remove it as shown in the illustration.

To prevent damaging the vehicle, wrap the flathead screwdriver with

a tape.

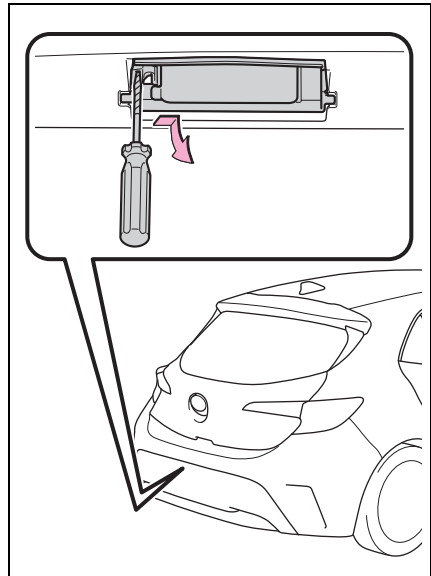

2 Turn the bulb base counter-clockwise and remove it.

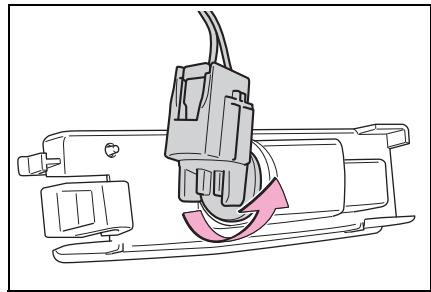

3 Remove the light bulb.

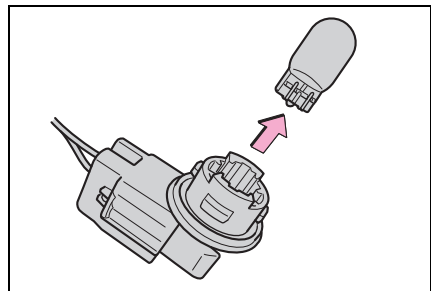

4 When installing, reverse the steps listed.

**WARNING****■ Replacing light bulbs**

- Turn off the lights. Do not attempt to replace the bulb immediately after turning off the lights. The bulbs become very hot and may cause burns.
- Do not touch the glass portion of the light bulb with bare hands. When it is unavoidable to hold the glass portion, use and hold with a clean dry cloth to avoid getting moisture and oils on the bulb. Also, if the bulb is scratched or dropped, it may blow out or crack.
- Fully install light bulbs and any parts used to secure them. Failure to do so may result in heat damage, fire, or water entering the light unit. This may damage the lights or cause condensation to build up on the lens.

■ To prevent damage or fire

Make sure bulbs are fully seated and locked.

When trouble arises

7

7-1. Essential information

Emergency flashers 320

If your vehicle has to be stopped in an emergency 320

If the vehicle is submerged or water on the road is rising 321

7-2. Steps to take in an emergency

If your vehicle needs to be towed..... 323

If you think something is wrong 326

Fuel pump shut off system 327

If a warning light turns on or a warning buzzer sounds 328

If a warning message is displayed..... 338

If you have a flat tire (vehicles without spare tire) 343

If you have a flat tire (vehicles with a spare tire) 354

If the engine will not start 362

If you lose your keys ... 364

If the electronic key does not operate properly.. 364

If the vehicle battery is discharged 366

If your vehicle overheats 370

If the vehicle becomes stuck 372

Emergency flashers

The emergency flashers are used to warn other drivers when the vehicle has to be stopped on the road due to a breakdown, etc.

Operating instructions

Press the switch.

All the turn signal lights will flash.

To turn them off, press the switch once again.

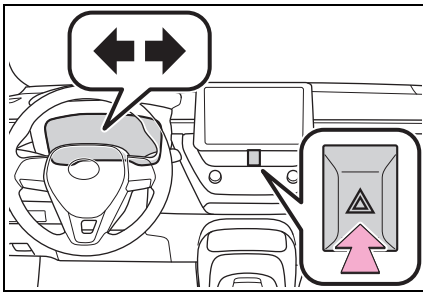

Emergency flashers

- If the emergency flashers are used for a long time while the engine is not operating, the battery may discharge.
- If any of the SRS airbags deploy (inflate) or in the event of a strong rear impact, the emergency flashers will turn on automatically. The emergency flashers will turn off automatically after operating for approximately 20 minutes. To manually turn the emergency flashers off, press the switch twice.
(The emergency flashers may not turn on automatically depending on the force of the impact and conditions of the collision.)

If your vehicle has to be stopped in an emergency

Only in an emergency, such as if it becomes impossible to stop the vehicle in the normal way, stop the vehicle using the following procedure:

Stopping the vehicle

- 1 Steadily step on the brake pedal with both feet and firmly depress it.
- 2 Shift the shift lever to N.
- ▶ If the shift lever is shifted to N
- 3 After slowing down, stop the vehicle in a safe place by the road.
- 4 Stop the engine.
- ▶ If the shift lever cannot be shifted to N

Do not pump the brake pedal repeatedly as this will increase the effort required to slow the vehicle.

- 3 Keep depressing the brake pedal with both feet to reduce vehicle speed as much as possible.
- 4 To stop the engine, press and hold the engine switch for 2 consecutive seconds or

more, or press it briefly 3 times or more in succession.

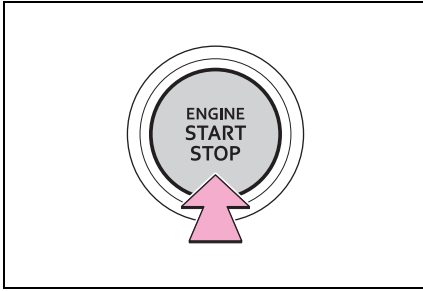

- 5** Stop the vehicle in a safe place by the road.

⚠ WARNING

■ If the engine has to be turned off while driving

Power assist for the brakes and steering wheel will be lost, making the brake pedal harder to depress and the steering wheel heavier to turn. Decelerate as much as possible before turning off the engine.

If the vehicle is submerged or water on the road is rising

This vehicle is not designed to be able to drive on roads that are deeply flooded with water. Do not drive on roads where the roads may be submerged or the water may be rising. It is dangerous to remain in the vehicle, if it is anticipated that the vehicle will be flooded or set adrift. Remain calm and follow the following.

- If the door can be opened, open the door and exit the vehicle.
- If the door cannot be opened, open the window using the power window switch and ensure an escape route.
- If the window can be opened, exit the vehicle through the window.
- If the door and window cannot be opened due to the rising water, remain calm, wait until the water level inside the vehicle rises to the point that the water pressure inside of the vehicle equals the water pressure outside of the vehicle and then open the door after waiting for the rising water to enter the vehicle, and exit the vehicle.

When the outside water level exceeds half the height of the door, the door cannot be opened from the inside due to water pressure.

■ Water level exceeds the floor

When the water level exceeds the floor and time has passed, the electrical equipment will get damaged, the power windows will not operate, the engine stop, and the vehicle may not be able to get moving.

■ Using an emergency escape hammer*

Laminated glass is used in the windshield on this vehicle.
Laminated glass cannot be shattered with an emergency hammer*.
Tempered glass is used in the windows on this vehicle.

*: Contact your Toyota dealer or aftermarket accessory manufacturer for further information about an emergency hammer.



WARNING

■ Caution while driving

Do not drive on roads where the roads may be submerged or the water may be rising. Otherwise the vehicle may be damaged and cannot move, as well as become flooded and set adrift, which may lead to death.

If your vehicle needs to be towed

If towing is necessary, we recommend having your vehicle towed by your Toyota dealer or commercial towing service, using a wheel-lift type truck or flat-bed truck.

Use a safety chain system for all towing, and abide by all state/provincial and local laws.

WARNING

Observe the following precautions.

Failure to do so may result in death or serious injury.

■ When towing the vehicle

Be sure to transport the vehicle with the front wheels raised or with all four wheels raised off the ground. If the vehicle is towed with the front wheels contacting the ground, the drivetrain and related parts may be damaged.

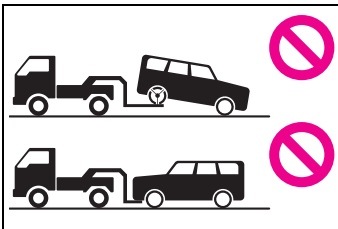

■ While towing

- When towing using cables or chains, avoid sudden starts, etc. which place excessive stress on the towing eyelets, cables or chains. The towing eyelets, cables or chains may become damaged, broken debris may hit people, and cause serious damage.

- Do not turn the engine switch off. There is a possibility that the steering wheel is locked and cannot be operated.

■ Installing towing eyelets to the vehicle

Make sure that towing eyelets are installed securely.

If not securely installed, towing eyelets may come loose during towing.

NOTICE

■ To prevent damage to the vehicle when towing using a wheel-lift type truck

- Do not tow the vehicle from the rear when the engine switch is off.

- When raising the vehicle, ensure adequate ground clearance for towing at the opposite end of the raised vehicle. Without adequate clearance, the vehicle could be damaged while being towed.

■ To prevent damage to the vehicle when towing with a sling-type truck

Do not tow with a sling-type truck, either from the front or rear.



NOTICE

■ To prevent damage to the vehicle during emergency towing

Do not secure cables or chains to the suspension components.

Situations when it is necessary to contact dealers before towing

The following may indicate a problem with your transmission. Contact your Toyota dealer or commercial towing service before towing.

- The engine is running but the vehicle does not move.
- The vehicle makes an abnormal sound.

Towing with a wheel-lift type truck

► From the front

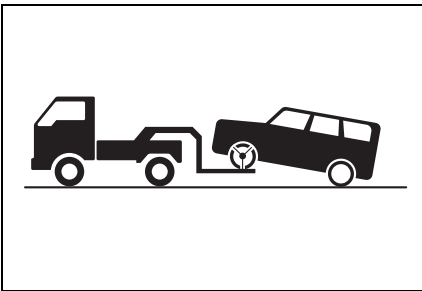

Release the parking brake.
Turn automatic mode off.
(→P.144)

► From the rear

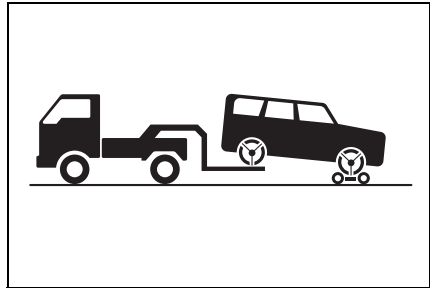

Use a towing dolly under the front wheels.



NOTICE

■ Towing with a sling-type truck

Do not tow with a sling-type truck to prevent body damage.

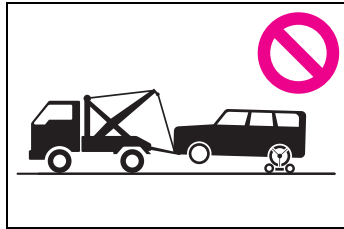

Using a flatbed truck

When using a flat-bed truck to transport the vehicle, use tire strapping belts. Refer to the owner's manual of the flat-bed truck for the tire strapping method.

In order to suppress vehicle movement during transportation, set the parking brake and turn the engine switch off.

Emergency towing

If a tow truck is not available in

an emergency, your vehicle may be temporarily towed using cables or chains secured to the emergency towing eyelets. This should only be attempted on hard surfaced roads for at most 50 miles (80 km) at under 18 mph (30 km/h).

A driver must be in the vehicle to steer and operate the brakes. The vehicle's wheels, drive train, axles, steering and brakes must be in good condition.

Only the front towing eyelets may be used.

Emergency towing procedure

To have your vehicle towed by another vehicle, the towing eyelet must be installed to your vehicle. Install the towing eyelet using the following procedure.

- 1 Take out the wheel nut wrench, flathead screwdriver and towing eyelet. (→P.344, 355)
- 2 Remove the eyelet cover using a flathead screwdriver.

To protect the bodywork, place a rag between the screwdriver and the vehicle body as shown in the

illustration.

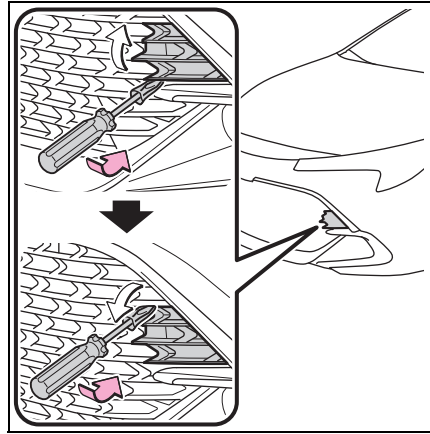

- 3 Insert the towing eyelet into the hole and tighten partially by hand.

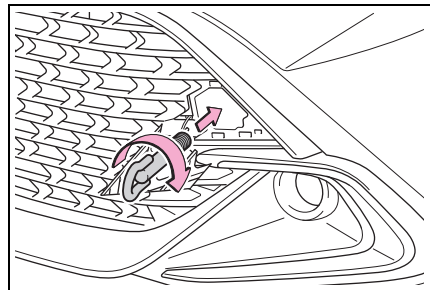

- 4 Tighten down the towing eyelet securely using a wheel nut wrench or hard metal bar.

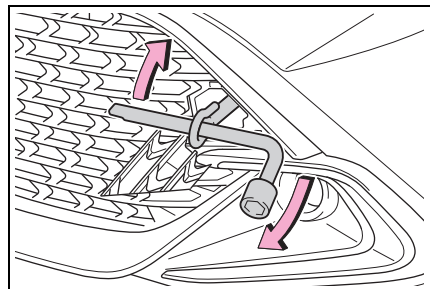

- 5 Securely attach cables or chains to the towing eyelet.

Take care not to damage the vehi-

cle body.

- 6 Enter the vehicle being towed and start the engine.

If the engine does not start, turn the engine switch to ON.

- 7 Shift the shift lever to N and release the parking brake. Turn automatic mode off. (→P.144)
When the shift lever cannot be shifted: →P.139

■ While towing

If the engine is not running, the power assist for the brakes and steering will not function, making steering and braking more difficult.

■ Wheel nut wrench

Wheel nut wrench is installed in luggage compartment. (→P.344, 355)

If you think something is wrong

If you notice any of the following symptoms, your vehicle probably needs adjustment or repair. Contact your Toyota dealer as soon as possible.

Visible symptoms

- Fluid leaks under the vehicle. (Water dripping from the air conditioning after use is normal.)
- Flat-looking tires or uneven tire wear
- Engine coolant temperature gauge needle continually points higher than normal.

Audible symptoms

- Changes in exhaust sound
- Excessive tire squeal when cornering
- Strange noises related to the suspension system
- Pinging or other noises related to the engine

Operational symptoms

- Engine missing, stumbling or running roughly
- Appreciable loss of power
- Vehicle pulls heavily to one

side when braking

- Vehicle pulls heavily to one side when driving on a level road
- Loss of brake effectiveness, spongy feeling, pedal almost touches the floor

Fuel pump shut off system

To minimize the risk of fuel leakage when the engine stalls or when an airbag inflates upon collision, the fuel pump shut off system stops the supply of fuel to the engine.

Restarting the engine

Follow the procedure below to restart the engine after the system is activated.

- 1 Turn the engine switch to ACC or OFF.
- 2 Restart the engine.



NOTICE

■ Before starting the engine

Inspect the ground under the vehicle.

If you find that fuel has leaked onto the ground, the fuel system has been damaged and is in need of repair. Do not restart the engine.

If a warning light turns on or a warning buzzer sounds

Calmly perform the following actions if any of the warning lights comes on or flashes. If a light comes on or flashes, but then goes off, this does not necessarily indicate a malfunction in the system. However, if this continues to occur, have the vehicle inspected by your Toyota dealer.

Actions to the warning lights or warning buzzers

■ Brake system warning light (warning buzzer)

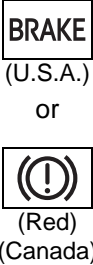
Warning light	Details/Actions
 <p>BRAKE (U.S.A.) or (Red) (Canada)</p>	<p>Indicates that:</p> <ul style="list-style-type: none"> ● The brake fluid level is low; or ● The brake system is malfunctioning <p>→ Immediately stop the vehicle in a safe place and contact your Toyota dealer. Continuing to drive the vehicle may be dangerous.</p>

■ Brake system warning light (warning buzzer)

Warning light	Details/Actions
 <p>(Red)</p>	<p>Indicates a malfunction in the parking brake system</p> <p>→ Have the vehicle inspected by your Toyota dealer immediately.</p>

■ High coolant temperature warning light* (warning buzzer)

Warning light	Details/Actions
	<p>Indicates that the engine coolant temperature is excessively high</p> <p>→ Immediately stop the vehicle in a safe place. Handling method (→P.370)</p>

*: This light illuminates on the multi-information display.

■ Charging system warning light*

Warning light	Details/Actions
	Indicates a malfunction in the vehicle's charging system → Immediately stop the vehicle in a safe place and contact your Toyota dealer.



*: This light illuminates on the multi-information display.

■ Low engine oil pressure warning light* (warning buzzer)

Warning light	Details/Actions
	Indicates that the engine oil pressure is excessively low → Immediately stop the vehicle in a safe place and contact your Toyota dealer.

*: This light illuminates on the multi-information display.



■ Malfunction indicator lamp (warning buzzer)

Warning light	Details/Actions
 (U.S.A.) or  (Canada)	Indicates a malfunction in: <ul style="list-style-type: none"> ● The electronic engine control system; ● The electronic throttle control system; or ● The electronic continuously variable transmission (if equipped) control system → Immediately stop the vehicle in a safe place and contact your Toyota dealer.

■ SRS warning light (warning buzzer)

Warning light	Details/Actions
	Indicates a malfunction in: <ul style="list-style-type: none"> ● The SRS airbag system; ● The front passenger occupant classification system; or ● The seat belt pretensioner system → Have the vehicle inspected by your Toyota dealer immediately.

■ **ABS warning light**



Warning light	Details/Actions
 <p>(U.S.A.) or</p>  <p>(Canada)</p>	<p>Indicates a malfunction in:</p> <ul style="list-style-type: none"> ● The ABS; or ● The brake assist system <p>→ Have the vehicle inspected by your Toyota dealer immediately.</p>

■ **Inappropriate pedal operation warning light* (warning buzzer)**

Warning light	Details/Actions
	<p>When a buzzer sounds:</p> <ul style="list-style-type: none"> ● Brake Override System is malfunctioning ● Drive-Start Control is malfunctioning ● Drive-Start Control is operating <p>→ Follow the instructions displayed on the multi-information display. (→P.338)</p> <p>When a buzzer does not sound: Brake Override System is operating.</p> <p>→ Release the accelerator pedal and depress the brake pedal.</p>

*: This light illuminates on the multi-information display.

■ **Electric power steering system warning light (warning buzzer)**

Warning light	Details/Actions
 <p>(Red) or</p>  <p>(Yellow)</p>	<p>Indicates a malfunction in the EPS (Electric Power Steering) system</p> <p>→ Have the vehicle inspected by your Toyota dealer immediately.</p>

■ Low fuel level warning light

Warning light	Details/Actions
	Indicates that remaining fuel is approximately 2 gal. (7.5 L, 1.6 Imp. gal.) or less → Refuel the vehicle.

■ Driver's and front passenger's seat belt reminder light (warning buzzer)*

Warning light	Details/Actions
	Warns the driver and/or front passenger to fasten their seat belts → Fasten the seat belt. If the front passenger's seat is occupied, the front passenger's seat belt also needs to be fastened to make the warning light (warning buzzer) turn off.



*: Driver's seat belt warning buzzer:

The driver's seat belt warning buzzer sounds to alert the driver that his or her seat belt is not fastened. Once the engine switch is turned to ON, the buzzer sounds. If the seat belt is still unfastened, the buzzer sounds intermittently for a certain period of time after the vehicle reaches a certain speed.

Front passenger's seat belt warning buzzer:

The front passenger's seat belt warning buzzer sounds to alert the front passenger that his or her seat belt is not fastened. If the seat belt is unfastened, the buzzer sounds intermittently for a certain period of time after the vehicle reaches a certain speed.

■ Rear passengers' seat belt reminder lights (warning buzzer)*

Warning light	Details/Actions
 (4.2-inch display)	Warns the rear passengers to fasten their seat belts → Fasten the seat belt.
 (7-inch display)	

*: Rear passengers' seat belt warning buzzer:

The rear passengers' seat belt warning buzzer sounds to alert the rear pas-

senger that his or her seat belt is not fastened. If the seat belt is unfastened, the buzzer sounds intermittently for a certain period of time, after the seat belt is fastened and unfastened and the vehicle reaches a certain speed.

■ **Tire pressure warning light**

Warning light	Details/Actions
	<p>When the light comes on after blinking for approximately 1 minute (a buzzer does not sound): Malfunction in the tire pressure warning system → Have the system checked by your Toyota dealer.</p> <p>When the light comes on (a buzzer sounds): Low tire inflation pressure from natural causes → After the temperature of the tires has lowered sufficiently, check the inflation pressure of each tire and adjust them to the specified level. (→P.306)</p> <p>Low tire inflation pressure from flat tire → Immediately stop the vehicle in a safe place and perform the necessary actions. (→P.335)</p>

■ **PCS warning light (warning buzzer)**

Warning light	Details/Actions
 <p>(Flashes or illuminates)</p>	<p>Indicates a malfunction in the PCS (Pre-Collision System). → Follow the instructions displayed on the multi-information display. (→P.338)</p> <p>If the PCS (Pre-Collision System) or VSC (Vehicle Stability Control) system is disabled, the PCS warning light will illuminate. → P.167</p>

■ **LTA indicator (warning buzzer)**

Warning light	Details/Actions
 <p>(yellow)</p>	<p>Indicates a malfunction in the LTA (Lane Tracing Assist). → Follow the instructions displayed on the multi-information display. (→P.338)</p>

■ LDA indicator (warning buzzer)

Warning light	Details/Actions
 (yellow)	Indicates a malfunction in the LDA (Lane Departure Alert). → Follow the instructions displayed on the multi-information display. (→P.338)

■ PDA indicator (warning buzzer)

Warning light	Details/Actions
 (yellow)	Indicates a malfunction in the PDA (Proactive Driving Assist). → Follow the instructions displayed on the multi-information display. (→P.338)

■ Dynamic radar cruise control indicator (warning buzzer)

Warning light	Details/Actions
 (yellow)	Indicates a malfunction in the dynamic radar cruise control. → Follow the instructions displayed on the multi-information display. (→P.338)

■ Cruise control indicator (warning buzzer)

Warning light	Details/Actions
 (yellow)	Indicates a malfunction in the cruise control. → Follow the instructions displayed on the multi-information display. (→P.338)

■ Driving assist information indicator



Warning light	Details/Actions
	<p>Indicates either of the following systems may be malfunctioning.</p> <ul style="list-style-type: none"> ● PCS (Pre-Collision System) ● LDA (Lane Departure Alert) ● Automatic Rear Flashing Hazard Lights <p>→ Follow the instructions displayed on the multi-information display. (→P.338)</p> <p>Indicates one of the following systems is malfunctioning or disabled.</p> <ul style="list-style-type: none"> ● BSM (Blind Spot Monitor)* ● RCTA(Rear cross traffic alert)* ● Safe Exit Assist (with door opening control)* <p>→ Follow the instructions displayed on the multi-information display. (→P.338)</p>

* : If equipped

■ Slip indicator

Warning light	Details/Actions
	<p>Indicates a malfunction in:</p> <ul style="list-style-type: none"> ● The VSC system; ● The TRAC system; or ● The hill-start assist control system <p>→ Have the vehicle inspected by your Toyota dealer immediately.</p>

■ Parking brake indicator

Warning light	Details/Actions
<p> (Flashes) (U.S.A.)</p> <p>or</p> <p> (Flashes) (Canada)</p>	<p>It is possible that the parking brake is not fully engaged or released</p> <p>→ Operate the parking brake switch once again.</p> <p>This light comes on when the parking brake is not released. If the light turns off after the parking brake is fully released, the system is operating normally.</p>

■ Brake hold operated indicator

Warning light	Details/Actions
<div style="border: 1px solid black; padding: 5px; display: inline-block;"> HOLD (Flashes) </div>	Indicates a malfunction in the brake hold system → Have the vehicle inspected by your Toyota dealer immediately.

■ Warning buzzer

In some cases, the buzzer may not be heard due to being in a noisy location or audio sound.

■ Front passenger detection sensor, seat belt reminder and warning buzzer

- If luggage is placed on the front passenger seat, the front passenger detection sensor may cause the warning light to flash and the warning buzzer to sound even if a passenger is not sitting in the seat.
- If a cushion is placed on the seat, the sensor may not detect a passenger, and the warning light may not operate properly.

■ SRS warning light

This warning light system monitors the airbag sensor assembly, front impact sensors, side impact sensors (front door), side impact sensors (front), driver's seat position sensor, driver's seat belt buckle switch, front passenger seat belt buckle switch, "AIR BAG ON" indicator light, "AIR BAG OFF" indicator light, seat belt pretensioners, airbags, interconnecting wiring and power sources. (→P.31)

■ If the malfunction indicator lamp comes on while driving

First check the following:

- Is the fuel tank empty?
If it is, fill the fuel tank immediately.
- Is the fuel tank cap loose?
If it is, tighten it securely.

The light will go off after several driving trips.

If the light does not go off even after several trips, contact your Toyota dealer as soon as possible.

■ Electric power steering system warning light (warning buzzer)

When the battery charge becomes insufficient or the voltage temporarily drops, the electric power steering system warning light may come on and the warning buzzer may sound.

■ When the tire pressure warning light comes on

Inspect the tires to check if a tire is punctured.

If a tire is punctured: →P.343, 354

If none of the tires are punctured: Turn the engine switch off then turn it to ON. Check if the tire pressure warning light comes on or blinks.

- ▶ If the tire pressure warning light blinks for approximately 1 minute then stays on

There may be a malfunction in the tire pressure warning system. Have the vehicle inspected by your Toyota dealer immediately.

- ▶ If the tire pressure warning light comes on

- 1 After the temperature of the tires has lowered sufficiently, check the inflation pressure of each tire and adjust them to the specified level.
- 2 If the warning light does not turn off even after several minutes have elapsed, check that the inflation pressure of each tire is at the specified level and perform initialization. (→P.294)

■ **The tire pressure warning light may come on due to natural causes**

The tire pressure warning light may come on due to natural causes such as natural air leaks and tire inflation pressure changes caused by temperature. In this case, adjusting the tire inflation pressure will turn off the warning light (after a few minutes).

■ **When a tire is replaced with a spare tire (vehicles with a compact spare tire)**

The compact spare tire is not equipped with a tire pressure warning valve and transmitter. If a tire goes flat, the tire pressure warning light will not turn off even though the flat tire has been replaced with the spare tire. Replace the spare tire with the repaired tire and adjust the tire inflation pressure. The tire pressure warning light will go off after a few minutes.

■ **Conditions that the tire pressure warning system may not function properly**

→P.293



WARNING

■ **If both the ABS and the brake system warning lights remain on**

Stop your vehicle in a safe place immediately and contact your Toyota dealer.

The vehicle will become extremely unstable during braking, and the ABS system may fail, which could cause an accident resulting in death or serious injury.

■ **When the electric power steering system warning light comes on**

When the light comes on yellow, the assist to the power steering is restricted. When the light comes on red, the assist to the power steering is lost and handling operations of the steering wheel become extremely heavy.

When steering wheel operations are heavier than usual, grip the steering wheel firmly and operate it using more force than usual.

■ **If the tire pressure warning light comes on**

Be sure to observe the following precautions.

Failure to do so could cause a loss of vehicle control and result in death or serious injury.

- Stop your vehicle in a safe place as soon as possible. Adjust the tire inflation pressure immediately.
- Vehicles with a compact spare tire: If the tire pressure warning light comes on even after tire inflation pressure adjustment, it is probable that you have a flat tire. Check the tires. If a tire is flat, change it with the spare tire and have the flat tire repaired by the nearest Toyota dealer.
- Vehicles with emergency tire puncture repair kit: If the tire pressure warning light comes on even after tire inflation pressure adjustment, it is probable that you have a flat tire. Check the tires. If a tire is flat, repair the flat tire by using emergency tire puncture repair kit.
- Avoid abrupt maneuvering and braking. If the vehicle tires deteriorate, you could lose control of the steering wheel or the brakes.

⚠ WARNING**■ If a blowout or sudden air leakage should occur**

The tire pressure warning system may not activate immediately.

■ Maintenance of the tires

Each tire, including the spare (if provided), should be checked monthly when cold and inflated to the inflation pressure recommended by the vehicle manufacturer on the vehicle placard or tire inflation pressure label (tire and load information label). (If your vehicle has tires of a different size than the size indicated on the vehicle placard or tire inflation pressure label [tire and load information label], you should determine the proper tire inflation pressure for those tires.)

As an added safety feature, your vehicle has been equipped with a tire pressure monitoring system (TPMS-tire pressure warning system) that illuminates a low tire pressure telltale (tire pressure warning light) when one or more of your tires is significantly under-inflated. Accordingly, when the low tire pressure telltale (tire pressure warning light) illuminates, you should stop and check your tires as soon as possible, and inflate them to the proper pressure. Driving on a significantly under-inflated tire causes the tire to overheat and can lead to tire failure. Under-inflation also reduces fuel efficiency and tire tread life, and may affect the vehicle's handling and stopping ability.

Please note that the TPMS (tire pressure warning system) is not a substitute for proper tire maintenance, and it is the driver's responsibility to maintain correct tire pressure, even if under-inflation has not reached the level to trigger illumination of the TPMS low tire pressure telltale (tire pressure warning light).

Your vehicle has also been equipped with a TPMS (tire pressure warning system) malfunction indicator to indicate when the system is not operating properly. The TPMS (tire pressure warning system) malfunction indicator is combined with the low tire pressure telltale (tire pressure warning light). When the system detects a malfunction, the telltale will flash for approximately one minute and then remain continuously illuminated. This sequence will continue upon subsequent vehicle start-ups as long as the malfunction exists. When the malfunction indicator is illuminated, the system may not be able to detect or signal low tire pressure as intended.

TPMS (tire pressure warning system) malfunctions may occur for a variety of reasons, including the installation of replacement or alternate tires or wheels on the vehicle that prevent the TPMS (tire pressure warning system) from functioning properly. Always check the TPMS (tire pressure warning system) malfunction telltale after replacing one or more tires or wheels on your vehicle to ensure that the replacement or alternate tires and wheels allow the TPMS (tire pressure warning system) to continue to function properly.



NOTICE

■ **To ensure the tire pressure warning system operates properly**

Do not install tires with different specifications or makers, as the tire pressure warning system may not operate properly.

If a warning message is displayed

The multi-information display shows warnings for system malfunctions and incorrectly performed operations, and messages that indicate a need for maintenance. When a message is displayed, perform the appropriate corrective action for the message. If a warning message is displayed again after the appropriate actions have been performed, contact your Toyota dealer. Additionally, if a warning light comes on or flashes at the same time that a warning message is displayed, take the appropriate corrective action for the warning light. (→P.328)

■ Warning messages

The warning messages explained below may differ from the actual messages according to operation conditions and vehicle specifications.

■ Warning buzzer

A buzzer may sound when a message is displayed.

The buzzer may not be audible if the vehicle is in a noisy location or if the audio system volume is high.

■ If “Engine Oil Level Low Add or Replace” is displayed

The engine oil level is low. Check the level of the engine oil, and add if

necessary. (→P.282)

■ If “**Engine Stopped Steering Power Low**” is displayed

This message is displayed if the engine is stopped while driving.

When steering wheel operations are heavier than usual, grip the steering wheel firmly and operate it using more force than usual.

■ If “**Auto Power OFF to Conserve Battery**” is displayed

Power was cut off due to the automatic power off function. Next time when starting the engine, increase the engine speed slightly and maintain that level for approximately 5 minutes to recharge the battery.

■ If “**Headlight System Malfunction Visit Your Dealer**” is displayed

The following systems may be malfunctioning. Have the vehicle inspected by your Toyota dealer immediately.

- The LED headlight system
- The automatic headlight leveling system (if equipped)
- AHB (Automatic High Beam)

■ If “**Parking Assist Unavailable Sensor Blocked**” is displayed on the multi-information display

A sensor may be covered with water drops, ice, snow, dirt, etc. Remove the water drops, ice, snow, dirt, etc., from the sensor to return the system to normal.

Also, due to ice forming on a sensor at low temperatures, a warning message may be displayed or the sensor may not be able to detect an object. Once the ice melts, the system will return to normal.





If a sensor is dirty, the position of the dirty sensor will be shown on the display.

If an abnormality is displayed even though there are no water drops, ice, snow or dirt, the sensor may be

operating abnormally. Have the vehicle inspected by your Toyota dealer.

■ If “**System Malfunction Visit Your Dealer**” is displayed





Indicates one of the following systems is disabled.

- PCS (Pre-Collision system)
- LDA (Lane Departure Alert)
- LTA (Lane Tracing Assist)
- AHB (Automatic High Beam)
- Dynamic radar cruise control
-  RSA (Road Sign Assist) (if equipped)
-  PDA (Proactive Driving Assist)
-  BSM (Blind Spot Monitor) (if equipped)
-  RCTA (Rear Cross Traffic Alert) (if equipped)
-  SEA (Safe Exit Assist) (if equipped)

Have the vehicle inspected by your Toyota dealer immediately.

■ If “**System Stopped See Owner’s Manual**” is displayed

Indicates one of the following systems is disabled.

- PCS (Pre-Collision system)
- LDA (Lane Departure Alert)
- LTA (Lane Tracing Assist)
- AHB (Automatic High Beam)
- Dynamic radar cruise control
-  RSA (Road Sign Assist) (if equipped)
-  PDA (Proactive Driving Assist)
-  BSM (Blind Spot Monitor) (if equipped)
-  RCTA (Rear Cross Traffic Alert) (if equipped)

-  SEA (Safe Exit Assist) (if equipped)

Follow the following correction methods.

- Check the voltage of the battery
- Check the sensors that the Toyota Safety Sense 3.0 uses for foreign matter covering them. Remove them if any. (→P.162)
- Check the sensors that the BSM (Blind Spot Monitor), RCTA (Rear Cross Traffic Alert) and SEA (Safe Exit Assist) uses for foreign matter covering them. Remove them if any. (→P.216, 226)



Indicates the sensors may not be operating properly.

- Toyota Safety Sense (→P.165)
- BSM (Blind Spot Monitor) (if equipped) (→P.218)
- RCTA (Rear Cross Traffic Alert) (if equipped) (→P.223)
- Safe Exit Assist (if equipped) (→P.228)

When problems are solved and the sensors are operational, this indication may disappear by itself.

■ If “System Stopped Front Camera Low Visibility See Owner’s Manual” is displayed

Indicates one of the following systems is disabled.



- PCS (Pre-Collision system)
- LDA (Lane Departure Alert)
- LTA (Lane Tracing Assist)
- AHB (Automatic High Beam)
- Dynamic radar cruise control
-  RSA (Road Sign Assist) (if equipped)
-  PDA (Proactive Driving Assist)

Follow the following correction methods.

- Using the windshield wipers, remove the dirt or foreign matter from the windshield.
- Using the air conditioning system, defog the windshield.
- Close the hood, remove any stickers, etc. to clear the obstruction in front of the front camera.

■ If “System Stopped Front Camera Out of Temperature Range Wait until Normal Temperature” is displayed

Indicates one of the following systems is disabled.

- PCS (Pre-Collision system)
- LDA (Lane Departure Alert)
- LTA (Lane Tracing Assist)
- AHB (Automatic High Beam)
- Dynamic radar cruise control
-  RSA (Road Sign Assist) (if equipped)
-  PDA (Proactive Driving Assist)

Follow the following correction methods.

- If the front camera is hot, such as after the vehicle is parked in the sun, use the air conditioning system to decrease the temperature around the front camera
- If a sunshade was used when the vehicle was parked, depending on its type, the sunlight reflected from the surface of the sunshade may cause the temperature of the front camera to become excessively high
- If the front camera is cold, such as after the vehicle is parked in an extremely cold environment, use the air conditioning system to increase the temperature around the front camera

■ If “**System Stopped Front Radar Sensor Blocked Clean Radar Sensor**” is displayed

Indicates one of the following systems is disabled.

- PCS (Pre-Collision system)
- LDA (Lane Departure Alert)
- LTA (Lane Tracing Assist)
- AHB (Automatic High Beam)
- Dynamic radar cruise control
-  PDA (Proactive Driving Assist)

Follow the following correction methods.

- Check if there is any foreign matter attached to the radar sensor or radar sensor cover and clean them if necessary (→P.163)
- This message may be displayed when driving in an open area with few nearby vehicles or structures, such as a desert, grasslands, suburbs, etc.

The message may be cleared by driving the vehicle in an area with structures, vehicles, etc., nearby.

■ If “**System Stopped Front Radar Sensor Out of Temperature Range Wait until Normal Temperature**” is displayed

Indicates one of the following systems is disabled.

- PCS (Pre-Collision system)
- LDA (Lane Departure Alert)
- LTA (Lane Tracing Assist)
- AHB (Automatic High Beam)
- Dynamic radar cruise control
-  PDA (Proactive Driving Assist)

Follow the following correction methods.

The temperature of the radar sensor is outside of the operating range. Wait for the temperature to become appropriate.

■ If “**System Stopped Front Radar In Self Calibration See Owner’s Manual**” is displayed

Indicates one of the following systems is disabled.

- PCS (Pre-Collision system)
- LDA (Lane Departure Alert)
- LTA (Lane Tracing Assist)
- AHB (Automatic High Beam)
- Dynamic radar cruise control
-  PDA (Proactive Driving Assist)

Follow the following correction methods.

- Check if there is any foreign matter attached to the radar sensor or radar sensor cover and clean them if necessary (→P.163)
- The radar sensor may be misaligned and will be adjusted automatically while driving. Continue driving for a while.

■ If “**Cruise Control Unavailable See Owner’s Manual**” is displayed

Indicates one of the following systems is disabled.

- Dynamic radar cruise control
- Cruise control

A message is displayed when the driving assist switch is pushed repeatedly.

Press the driving assist switch quickly and firmly.

■ If “**Maintenance Required Soon**” is displayed

Indicates that all maintenance according to the driven distance on the maintenance schedule* should be performed soon.

Comes on approximately 4500 miles (7200 km) after the message has been reset. If necessary, perform maintenance. Please reset the message after the maintenance is performed. (→P.272)

*: Refer to the separate “Scheduled Maintenance” or “Owner’s Manual Supplement” for the maintenance interval applicable to your vehicle.

■ If “Maintenance Required Visit Your Dealer” is displayed

Indicates that all maintenance is required to correspond to the driven distance on the maintenance schedule*.

Comes on approximately 5000 miles (8000 km) after the message has been reset. (The indicator will not work properly unless the message has been reset.) Perform the necessary maintenance. Please reset the message after the maintenance is performed. (→P.272)

*: Refer to the separate “Scheduled Maintenance” or “Owner’s Manual Supplement” for the maintenance interval applicable to your vehicle.

■ If “Engine Maintenance Required Visit Your Dealer” is shown

The engine or an engine component is malfunctioning. Have the vehicle inspected by your Toyota dealer immediately.

■ If a message that indicates the need for visiting your Toyota dealer is displayed

The system or part shown on the multi-information display is malfunctioning. Have the vehicle inspected by your Toyota dealer immediately.

■ If a message that indicates the need for referring to Owner’s Manual is displayed

- If “Engine Coolant Temp High” is displayed, follow the instructions accordingly. (→P.370)
- If any of the following messages are displayed on the multi-information display, it may indicate a

malfunction. Have the vehicle inspected by your Toyota dealer immediately.

- “Smart Key System Malfunction”
- If any of the following messages are displayed on the multi-information display, it may indicate a malfunction. Immediately stop the vehicle and contact your Toyota dealer.
 - “Braking Power Low”
 - “Charging System Malfunction”
 - “Oil Pressure Low”

 NOTICE

■ If “High Power Consumption Partial Limit on AC/Heater Operation” is displayed frequently

There is a possible malfunction relating to the charging system or the battery may be deteriorating. Have the vehicle inspected by your Toyota dealer.

If you have a flat tire (vehicles without spare tire)

Your vehicle is not equipped with a spare tire, but instead is equipped with an emergency tire puncture repair kit.

A puncture caused by a nail or screw passing through the tire tread can be repaired temporarily using the emergency tire puncture repair kit. (The kit contains a bottle of sealant. The sealant can be used only once to temporarily repair one tire without removing the nail or screw from the tire.) After temporarily repairing the tire with the kit, have the tire repaired or replaced by your Toyota dealer.

WARNING

■ If you have a flat tire

Do not continue driving with a flat tire.

Driving even a short distance with a flat tire can damage the tire and the wheel beyond repair, which could result in an accident.

Before repairing the tire

- Stop the vehicle in a safe place on a hard, flat surface.
- Set the parking brake.
- Shift the shift lever to P.

- Stop the engine.
- Turn on the emergency flashers.
- Check the degree of the tire damage.

A tire should only be repaired with the emergency tire puncture repair kit if the damage is caused by a nail or screw passing through the tire tread.

- Do not remove the nail or screw from the tire. Removing the object may widen the opening and make emergency repair with the repair kit impossible.
- To avoid sealant leakage, move the vehicle until the area of the puncture, if known, is positioned at the top of the tire.

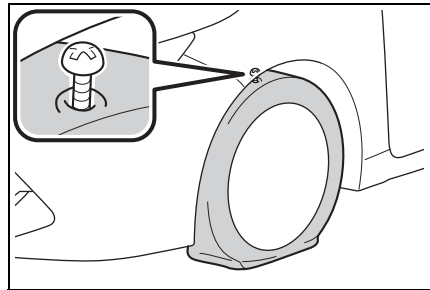

■ A flat tire that cannot be repaired with the emergency tire puncture repair kit

In the following cases, the tire cannot be repaired with the emergency tire puncture repair kit. Contact your Toyota dealer.

- When the tire is damaged due to driving without sufficient air pressure

- When there are any cracks or damage at any location on the tire, such as on the side wall, except the tread
- When the tire is visibly separated from the wheel
- When the cut or damage to the tread is 0.16 in. (4 mm) long or more
- When the wheel is damaged
- When two or more tires have been punctured
- When more than 2 sharp objects such as nails or screws have passed through the tread on a single tire
- When the sealant has expired

Location of the emergency tire puncture repair kit and tools

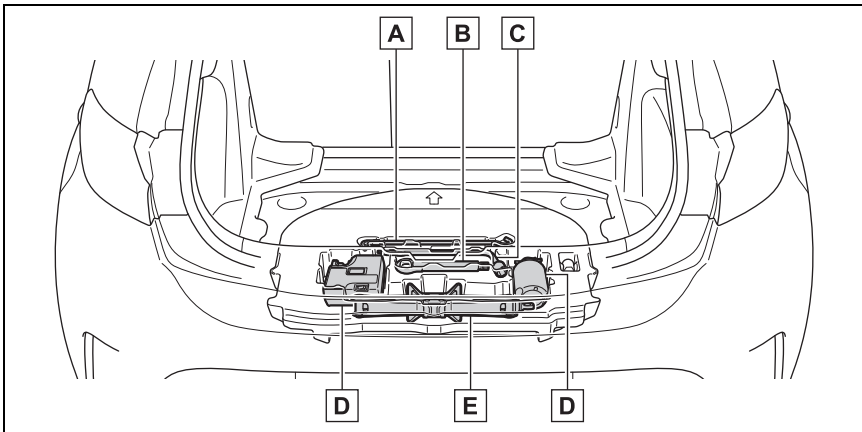

- A** Jack handle*
- B** Towing eyelet
- C** Wheel nut wrench*
- D** Emergency tire puncture repair kit
- E** Jack*
(Use of the jack: →P.357)

*: If equipped

Emergency tire puncture repair kit components

- ▶ Bottle

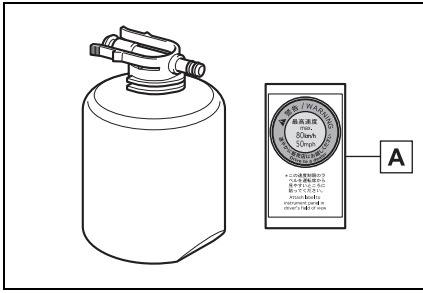

A Sticker

► Compressor

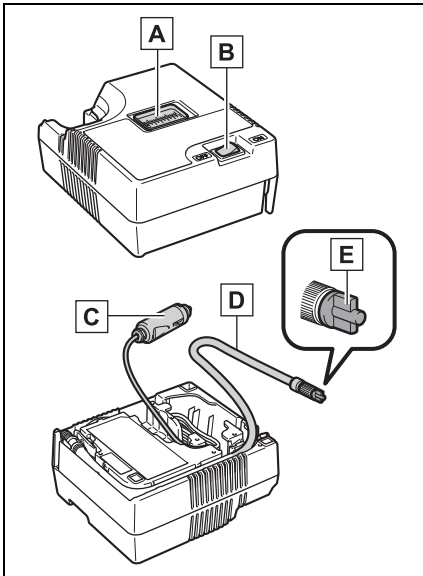

A Air pressure gauge

B Compressor switch

C Power plug

D Hose

E Air release cap

■ **Note for checking the emergency tire puncture repair kit**

Check the sealant expiry date occasionally. The expiry date is shown on the bottle. Do not use sealant whose expiry

date has already passed. Otherwise, repairs conducted using the emergency tire puncture repair kit may not be performed properly.

■ **Emergency tire puncture repair kit**

- The emergency tire puncture repair kit is for filling the car tire with air.
- The sealant has a limited life span. The expiry date is marked on the bottle. The sealant should be replaced with a new bottle before the expiry date. Contact your Toyota dealer for replacement.
- The sealant stored in the emergency tire puncture repair kit can be used only once to temporarily repair a single tire. If the sealant in the bottle and other parts of the kit have been used and need to be replaced, contact your Toyota dealer.
- The compressor can be used repeatedly.
- The sealant can be used when the outside temperature is from -40°F (-40°C) to 140°F (60°C).
- The kit is exclusively designed for size and type of tires originally installed on your vehicle. Do not use it for tires that a different size than the original ones, or for any other purposes.
- If the sealant gets on your clothes, it may stain.
- If the sealant adheres to a wheel or the surface of the vehicle body, the stain may not be removable if it is not cleaned at once. Immediately wipe away the sealant with a wet cloth.
- During operation of the repair kit, a loud operation noise is produced. This does not indicate a malfunction.
- Do not use to check or to adjust the tire pressure.

⚠ WARNING

■ **Caution while driving**

- Store the repair kit in the luggage compartment. Injuries may result in the event of an accident or sudden braking.
- The repair kit is exclusively only for your vehicle. Do not use repair kit on other vehicles, which could lead to an accident causing death or serious injury.
- Do not use repair kit for tires that are different size than the original ones, or for any other purpose. If the tires have not been completely repaired, it could lead to an accident causing death or serious injury.

■ **Precautions for use of the sealant**

- Ingesting the sealant is hazardous to your health. If you ingest sealant, consume as much water as possible, and then immediately consult a doctor.
- If sealant gets in eyes or adheres to skin, immediately wash it off with water. If discomfort persists, consult a doctor.

Taking out the jack

- 1 Lift the deck mat.

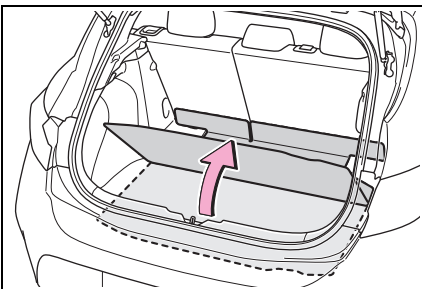

- 2 Take out the jack.

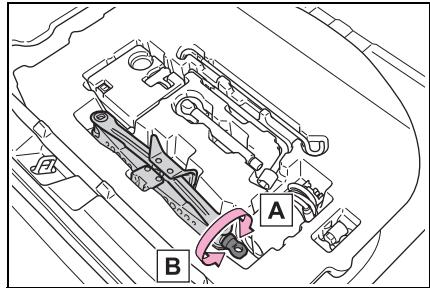

- A For tightening
- B For loosening

Taking out the emergency tire puncture repair kit

- 1 Lift the deck mat. (→P.346)
- 2 Take out the emergency tire puncture repair kit. (→P.344)

Emergency repair method

- 1 Take out the repair kit from the plastic bag.

Attach the sticker enclosed with the bottle on the specified locations. (See step10.)

- 2 Pull out the hose and power plug from the bottom side of the compressor.

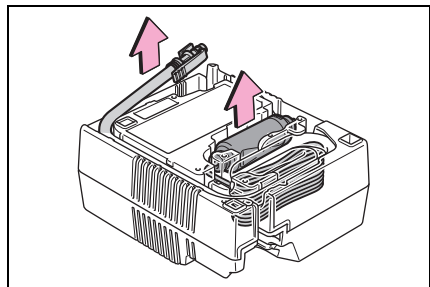

- 3 Connect the bottle to the compressor.

Make sure to press the bottle until its claws are securely engaged to the compressor and no longer visible.

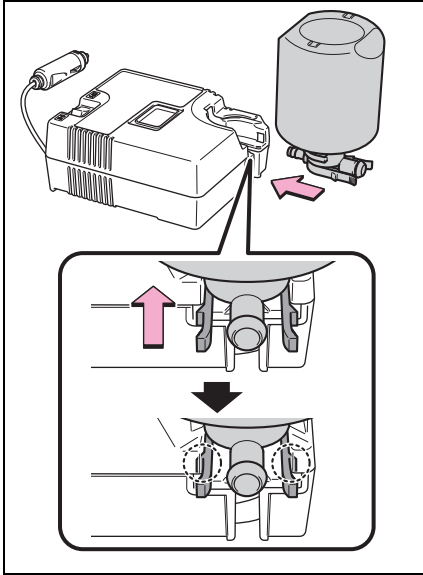

- 4 Connect the hose to the bottle.

Make sure to insert the hose until its claw is securely engaged to the

bottle.

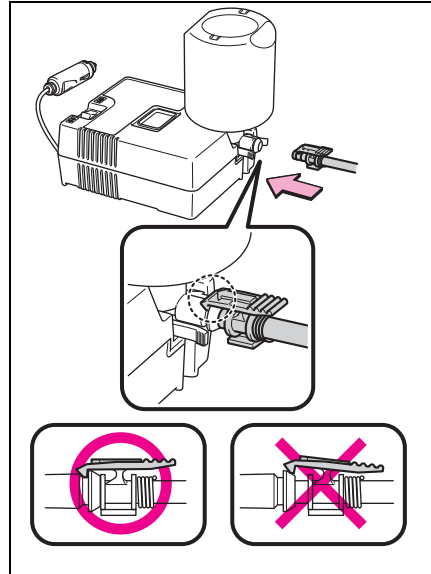

- 5 Remove the valve cap from the valve of the punctured tire.

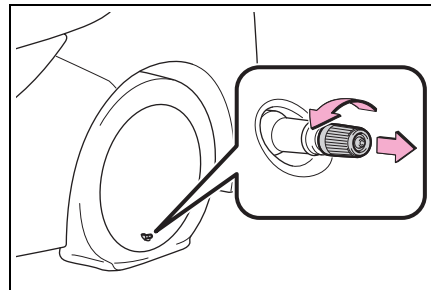

- 6 Extend the hose. Remove the air release cap from the hose.

You will use the air release cap again. Therefore keep it in a safe

place.

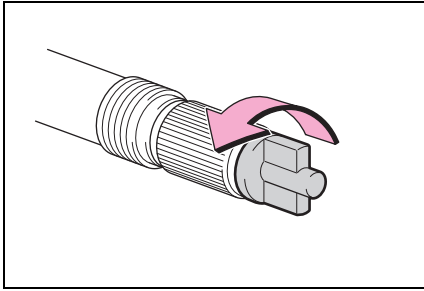

7 Connect the hose to the valve.

Screw the end of the hose clockwise as far as possible.

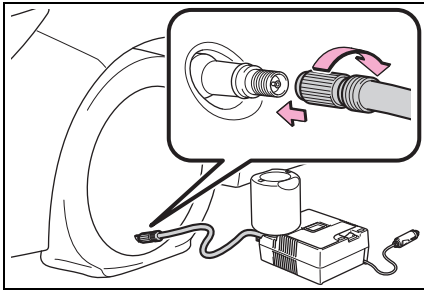

8 Remove the power plug from the compressor.

Make sure that the compressor-switch is off.

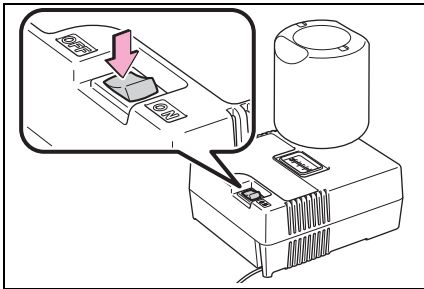

9 Connect the power plug to the power outlet socket. (→P.257)

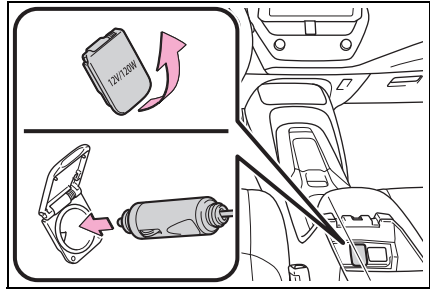

10 Attach the sticker provided with the tire puncture repair kit to a position easily seen from the driver's seat.

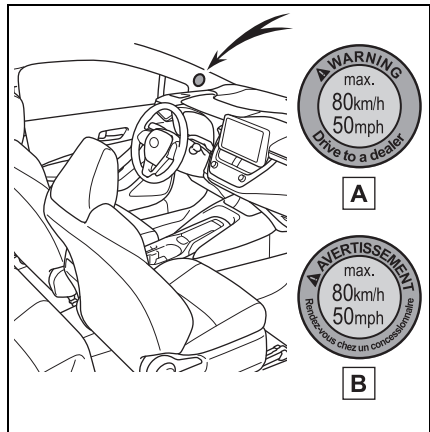

A U.S.A.

B Canada

11 Check the specified tire inflation pressure.

Tire inflation pressure is specified on the label on the driver's side pil-

lar as shown. (→P.381)

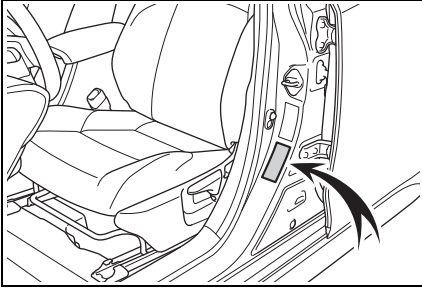

12 Start the engine. (→P.133)

13 To inject the sealant and inflate the tire, turn the compressor switch on.

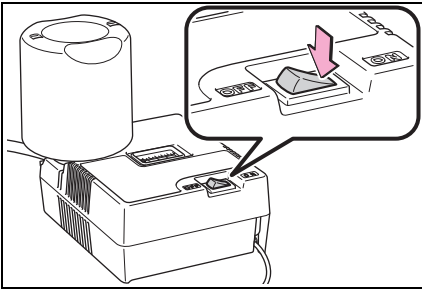

14 Inflate the tire until the specified air pressure is reached.

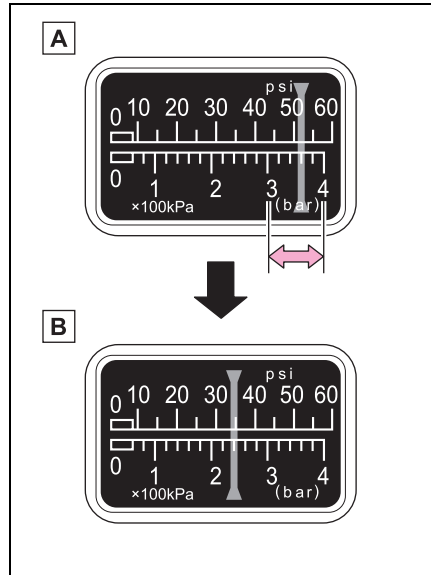

A The sealant will be injected and the pressure will spike to between 44 psi (300 kPa, 3.0 kgf/cm² or bar) and 58 psi (400 kPa, 4.0 kgf/cm² or bar), then gradually decrease.

B The air pressure gauge will display the actual tire inflation pressure about 1 to 5 minutes after the switch is turned on.

Turn the compressor switch off and then check the tire inflation pressure. Being careful not to over inflate, check and repeat the inflation procedure until the specified tire inflation pressure is reached.

The tire can be inflated for about 5 to 20 minutes (depending on the outside temperature). If the tire inflation pressure is still lower than the specified point after inflation for

25 minutes, the tire is too damaged to be repaired. Turn the compressor switch off and contact your Toyota dealer.

If the tire inflation pressure exceeds the specified air pressure, let out some air to adjust the tire inflation pressure. (→P.351, 381)

15 With the compressor switch off, disconnect the hose from the valve on the tire and then pull out the power plug from the power outlet socket.

Some sealant may leak when the hose is removed.

16 Install the valve cap onto the valve of the emergency repaired tire.

17 Attach the air release cap to the end of the hose.

If the air release cap is not attached, the sealant may leak and the vehicle may get dirty.

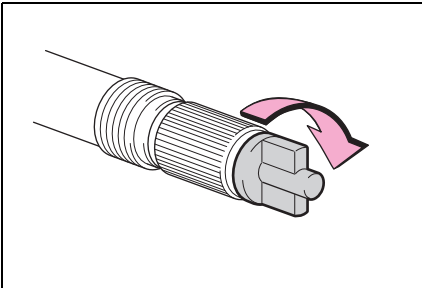

18 Temporarily store the bottle in the luggage compartment while it is connected to the compressor.

19 To spread the liquid sealant evenly within the tire, immediately drive safely for about 3 miles (5 km) below 50 mph (80 km/h).

20 After driving, stop your vehicle in a safe place on a hard, flat surface and reconnect the repair kit.

Remove the air release cap from the hose before reconnecting the hose.

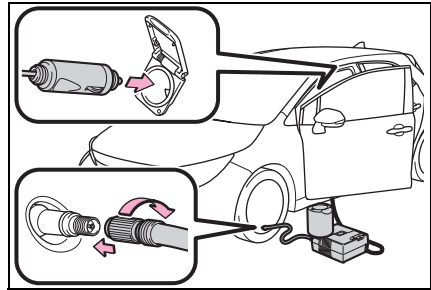

21 Turn the compressor switch on and wait for several seconds, then turn it off. Check the tire inflation pressure.

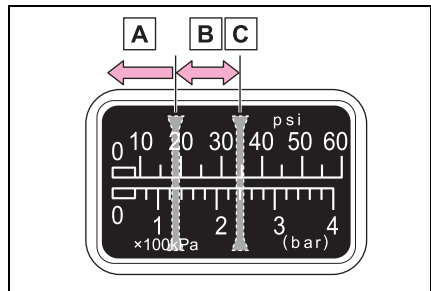

A If the tire inflation pressure is under 19 psi (130 kPa, 1.3 kgf/cm² or bar): The puncture cannot be repaired. Contact your Toyota dealer.

B If the tire inflation pressure is 130 kPa (1.3 kgf/cm² or bar, 19 psi) or higher, but less than the specified air pressure: Proceed to step 22.

C If the tire inflation pressure is

the specified air pressure (→P.381): Proceed to step **23**.

22 Turn the compressor switch on to inflate the tire until the specified air pressure is reached. Drive for about 3 miles (5 km) and then perform step **20**.

23 Attach the air release cap to the end of the hose.

If the air release cap is not attached, the sealant may leak and the vehicle may get dirty.

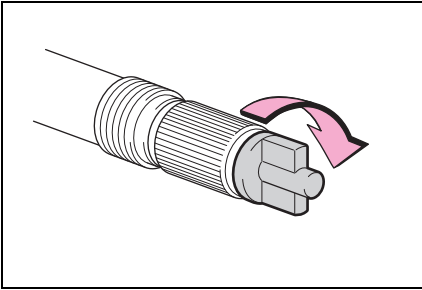

24 Store the bottle in the luggage compartment while it is connected to the compressor.

25 Taking precautions to avoid sudden braking, sudden acceleration and sharp turns, drive carefully at under 50 mph (80 km/h) to the nearest Toyota dealer that is less than 62 miles (100 km) away for tire repair or replacement.

When having the tire repaired or replaced, make sure to tell the Toyota dealer that the sealant is injected.

■ **If the tire is inflated to more than the specified air pressure**

- 1** Disconnect the hose from the valve.
- 2** Install the air release cap to the end of the hose and push the protrusion on the air release cap into the tire valve to let some air out.

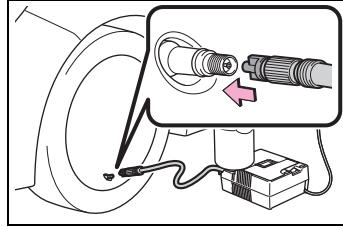

- 3** Disconnect the hose from the valve, remove the air release cap from the hose and then reconnect the hose.
- 4** Turn the compressor switch on and wait for several seconds, and then turn it off. Check that the air pressure indicator shows the specified air pressure. (→P.381)

If the air pressure is under the designated pressure, turn the compressor switch on again and repeat the inflation procedure until the specified air pressure is reached.



WARNING

■ **Do not drive the vehicle with a flat tire**

Do not continue driving with a flat tire.

Driving even a short distance with a flat tire can damage the tire and the wheel beyond repair.

Driving with a flat tire may cause a circumferential groove on the side wall. In such a case, the tire may explode when using a repair kit.

**WARNING**

■ **When fixing the flat tire**

- Stop your vehicle in a safe and flat area.
- Do not touch the wheels or the area around the brakes immediately after the vehicle has been driven.
After the vehicle has been driven, the wheels and the area around the brakes may be extremely hot. Touching these areas with hands, feet or other body parts may result in burns.
- Connect the valve and hose securely with the tire installed on the vehicle. If the hose is not properly connected to the valve, air leakage may occur as sealant may be sprayed out.
- If the hose comes off the valve while inflating the tire, there is a risk that the hose will move abruptly due to air pressure.
- After inflation of the tire has completed, the sealant may splatter when the hose is disconnected or some air is let out of the tire.
- Follow the operation procedure to repair the tire. If the procedures not followed, the sealant may spray out.
- Keep back from the tire while it is being repaired, as there is a chance of it bursting while the repair operation is being performed. If you notice any cracks or deformation of the tire, turn off the compressor switch and stop the repair operation immediately.

- The repair kit may overheat if operated for a long period of time. Do not operate the repair kit continuously for more than 40 minutes.
- Parts of the repair kit become hot during operation. Be careful when handling the repair kit during and after operation. Do not touch the metal part around the connecting area between the bottle and compressor. It will be extremely hot.
- Do not attach the vehicle speed warning sticker to an area other than the one indicated. If the sticker is attached to an area where an SRS airbag is located, such as the pad of the steering wheel, it may prevent the SRS airbag from operating properly.

■ **Driving to spread the liquid sealant evenly**

Observe the following precautions to reduce the risk of accidents. Failing to do so may result in a loss of vehicle control and cause death or serious injury.

- Drive the vehicle carefully at a low speed. Be especially careful when turning and cornering.
- If the vehicle does not drive straight or you feel a pull through the steering wheel, stop the vehicle and check the following.
 - Tire condition. The tire may have separated from the wheel.
 - Tire inflation pressure. If the tire inflation pressure is 19 psi (130 kPa, 1.3 kgf/cm² or bar) or less, the tire may be severely damaged.



NOTICE

■ When performing an emergency repair

- A tire should only be repaired with the emergency tire puncture repair kit if the damage is caused by a sharp object such as nail or screw passing through the tire tread.
Do not remove the sharp object from the tire. Removing the object may widen the opening and disenable emergency repair with the repair kit.
 - The repair kit is not waterproof. Make sure that the repair kit is not exposed to water, such as when it is being used in the rain.
 - Do not put the repair kit directly onto dusty ground such as sand at the side of the road. If the repair kit vacuums up dust etc., a malfunction may occur.
 - Make sure to stand the kit with the bottle vertical. The kit cannot work properly if it is laid on its side.
- Precautions for the emergency tire puncture repair kit**
- The repair kit power source should be 12 V DC suitable for vehicle use. Do not connect the repair kit to any other source.
 - If fuel splatters on the repair kit, the repair kit may deteriorate. Take care not to allow fuel to contact it.
 - Place the repair kit in a storage to prevent it from being exposed to dirt or water.
 - Store the repair kit in the tool tray under the deck mat out of reach of children.

- Do not disassemble or modify the repair kit. Do not subject parts such as the air pressure indicator to impacts. This may cause a malfunction.

**If you have a flat tire
(vehicles with a spare
tire)**

Your vehicle is equipped with a spare tire. The flat tire can be replaced with the spare tire.

**For details about tires:
→P.289**



WARNING

■ If you have a flat tire

Do not continue driving with a flat tire. Driving even a short distance with a flat tire can damage the tire and the wheel beyond repair, which could result in an accident.

**Before jacking up the
vehicle**

- Stop the vehicle in a safe place on a hard, flat surface.
- Set the parking brake.
- Shift the shift lever to P.
- Stop the engine.
- Turn on the emergency flashers.

Location of the spare tire, jack and tools

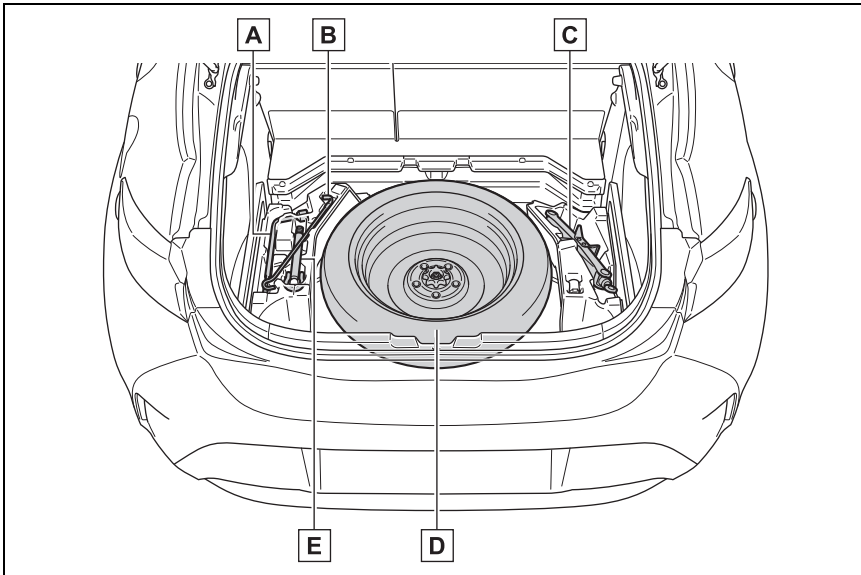

- A** Wheel nut wrench
- B** Jack handle
- C** Jack
- D** Spare tire
- E** Towing eyelet

WARNING

■ Using the tire jack

Observe the following precautions. Improper use of the tire jack may cause the vehicle to suddenly fall off the jack, leading to death or serious injury.

- Do not use the tire jack for any purpose other than replacing tires or installing and removing tire chains.

- Only use the tire jack that comes with this vehicle for replacing a flat tire. Do not use it on other vehicles, and do not use other tire jacks for replacing tires on this vehicle.
- Put the jack properly in its jack point.

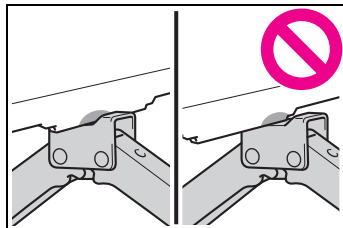

⚠ WARNING

- Do not put any part of your body under the vehicle while it is supported by the jack.
- Do not start the engine or drive the vehicle while the vehicle is supported by the jack.
- Do not raise the vehicle while someone is inside.
- When raising the vehicle, do not put an object on or under the jack.
- Do not raise the vehicle to a height greater than that required to replace the tire.
- Use a jack stand if it is necessary to get under the vehicle.
- When lowering the vehicle, make sure that there is no-one near the vehicle. If there are people nearby, warn them vocally before lowering.

Taking out the jack

- 1 Press the button to raise the deck board handle and then lift the deck board.

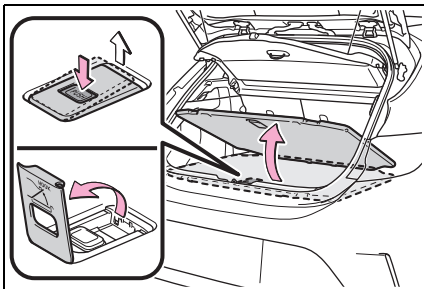

- 2 Secure the deck board.

- ▶ When the luggage cover is installed

Hook the deck board handle onto the underside of the luggage cover as shown in the illustration, to secure the deck board.

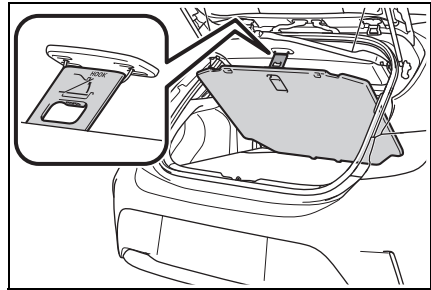

- ▶ When the luggage cover is not installed

Hook the deck board handle onto the upper edge of the back door opening as shown in the illustration.

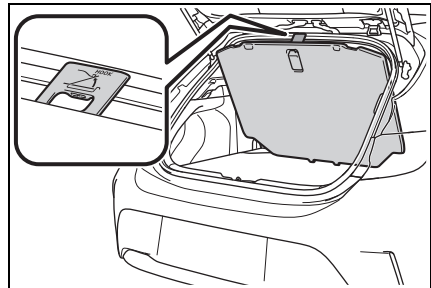

- 3 Take out the jack.

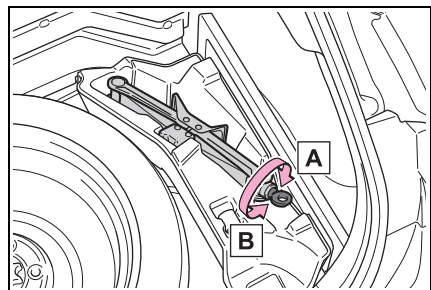

A For tightening

B For loosening

 NOTICE

■ **When the deck board is secured**

Make sure not to close the back door when the deck board is hooked onto the luggage cover or the back door opening. Doing so may lead to damage to interior parts.

Taking out the spare tire

- 1 Secure the deck board.
(→P.356)
- 2 Loosen the center fastener that secures the spare tire.

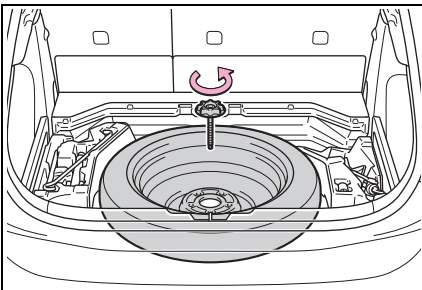

 WARNING

■ **When storing the spare tire**

Be careful not to catch fingers or other body parts between the spare tire and the body of the vehicle.

Replacing a flat tire

- 1 Chock the tires.

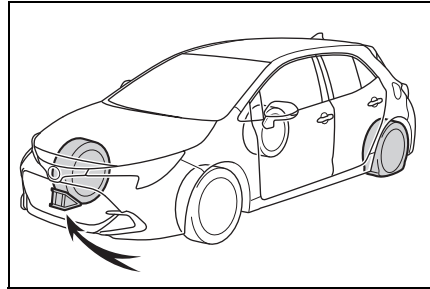

Flat tire	Wheel chock positions
Front left-hand side	Behind the rear right-hand side tire
Front right-hand side	Behind the rear left-hand side tire
Rear left-hand side	In front of the front right-hand side tire
Rear right-hand side	In front of the front left-hand side tire

- 2 Vehicles with a steel wheel:
Remove the wheel ornament using the wrench.

Insert the wrench into the notch **A** on the wheel cap.
To protect the wheel ornament, place a rag between the wrench

and the wheel ornament.

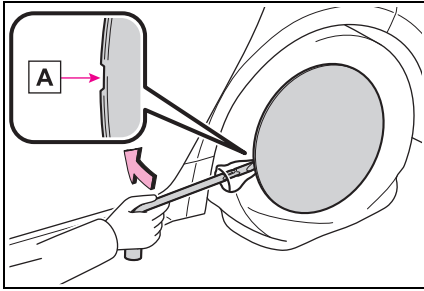

3 Slightly loosen the wheel nuts (one turn).

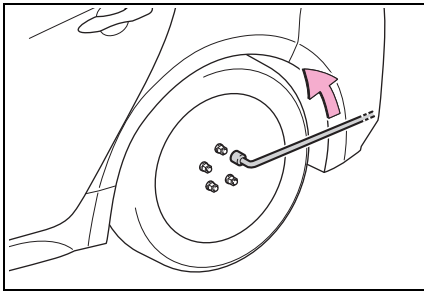

4 Turn the tire jack portion **A** by hand until the center of the recessed portion of the jack is in contact with the center of the jack point.

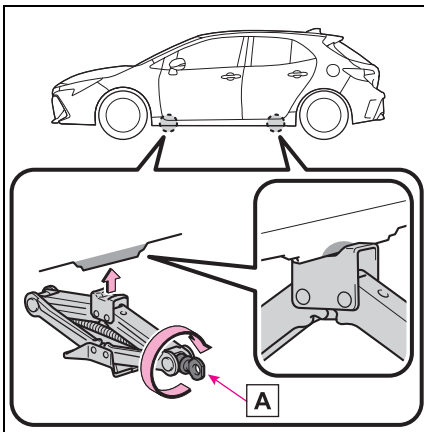

5 Assemble the jack handle extension.

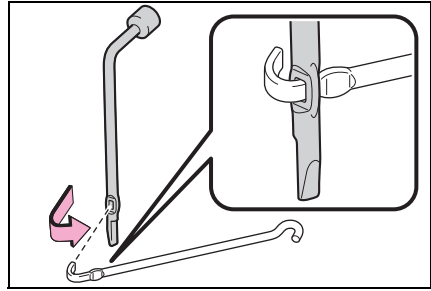

6 Raise the vehicle until the tire is slightly raised off the ground.

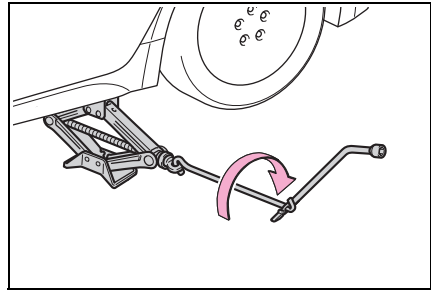

7 Remove all the wheel nuts and the tire.

When resting the tire on the ground, place the tire so that the wheel design faces up to avoid scratching the wheel surface.

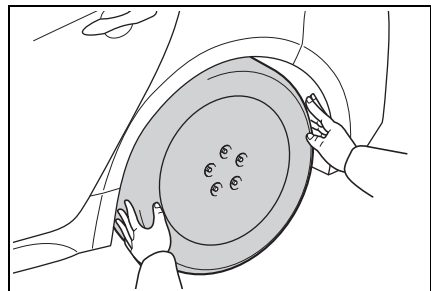

WARNING

■ Replacing a flat tire

- Do not touch the disc wheels or the area around the brakes immediately after the vehicle has been driven. After the vehicle has been driven the disc wheels and the area around the brakes will be extremely hot. Touching these areas with hands, feet or other body parts while changing a tire, etc. may result in burns.
- Failure to follow these precautions could cause the wheel nuts to loosen and the tire to fall off, resulting in death or serious injury.
- Never use oil or grease on the wheel bolts or wheel nuts. Oil and grease may cause the wheel nuts to be excessively tightened, leading to bolt or disc wheel damage. Remove any oil or grease that has adhered when installing the wheel nuts.
- After replacing a tire, check the tightening torque as soon as possible.
Wheel nuts torque: 76 ft•lb (103 N•m, 10.5 kgf•m)
- Do not attach a heavily damaged wheel ornament, as it may fly off the wheel while the vehicle is moving.
- When installing a tire, only use wheel nuts that have been specifically designed for that wheel.
- If there are any cracks or deformations in the bolt screws, nut threads or bolt holes of the wheel, have the vehicle inspected by your Toyota dealer.
- When installing the wheel nuts, be sure to install them with the tapered ends facing inward.

Installing the spare tire

- 1 Remove any dirt or foreign matter from the wheel contact surface.

If foreign matter is on the wheel contact surface, the wheel nuts may loosen while the vehicle is in motion, causing the tire to come off.

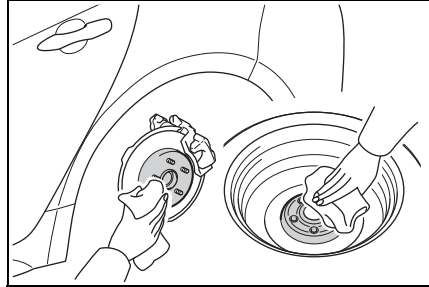

- 2 Install the tire and loosely tighten each wheel nut by hand by approximately the same amount.

When replacing a steel wheel with a steel wheel, tighten the wheel nuts until the tapered portion **A** comes into loose contact with the disc wheel seat **B**.

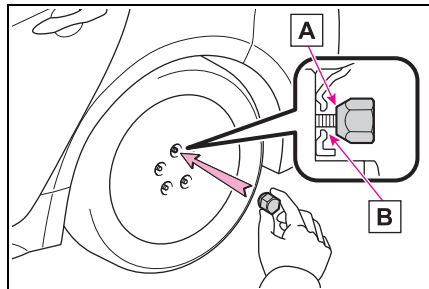

When replacing an aluminum wheel with a steel wheel, tighten the wheel nuts until the tapered portion **A** comes into loose contact with

the disc wheel seat **B**.

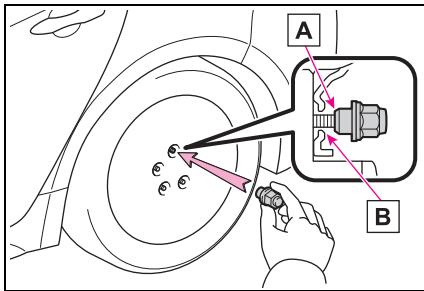

3 Lower the vehicle.

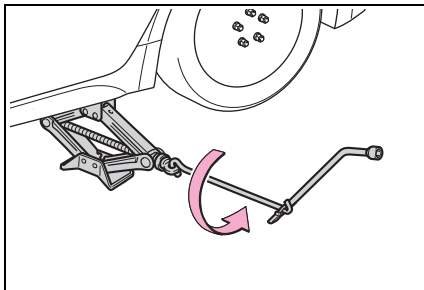

4 Securely tighten the wheel nuts two or three times in the order shown in the illustration using a wheel nut wrench.

Tightening torque:
76 ft•lb (103 N•m, 10.5 kg•m)

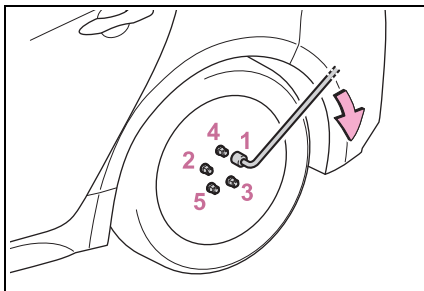

5 Stow the flat tire, tire jack and all tools.

■ The compact spare tire

- The compact spare tire is identified by the label “TEMPORARY

USE ONLY” on the tire sidewall. Use the compact spare tire temporarily, and only in an emergency.

- Make sure to check the tire inflation pressure of the compact spare tire. (→P.381)

■ When the compact spare tire is equipped

The vehicle becomes lower when driving with the compact spare tire compared to when driving with standard tires.

■ After completing the tire change

The tire pressure warning system must be reset. (→P.294)

■ When using the compact spare tire

As the compact spare tire is not equipped with a tire pressure warning valve and transmitter, low inflation pressure of the spare tire will not be indicated by the tire pressure warning system. Also, if you replace the compact spare tire after the tire pressure warning light comes on, the light remains on.

■ If you have a flat front tire on a road covered with snow or ice (vehicles with a compact spare tire)

Install the compact spare tire on one of the rear wheels of the vehicle. Perform the following steps and fit tire chains to the front tires:

- 1 Replace a rear tire with the compact spare tire.
- 2 Replace the flat front tire with the tire removed from the rear of the vehicle.
- 3 Fit tire chains to the front tires.

■ When reinstalling the wheel ornament (steel wheels except compact spare tire)

Align the cutout of the wheel ornament with the valve stem as shown in the illustration.

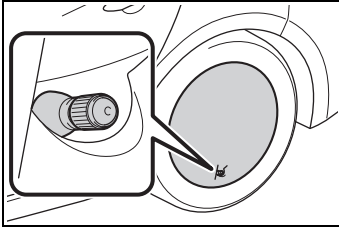

⚠ WARNING

■ When using the compact spare tire

- Remember that the compact spare tire provided is specifically designed for use with your vehicle. Do not use your compact spare tire on another vehicle.
- Do not use more than one compact spare tires simultaneously.
- Replace the compact spare tire with a standard tire as soon as possible.
- Avoid sudden acceleration, abrupt steering, sudden braking and shifting operations that cause sudden engine braking.

■ When the compact spare tire is attached

The vehicle speed may not be correctly detected, and the following systems may not operate correctly:

- ABS & Brake assist
- VSC
- TRAC
- Automatic High Beam
- Dynamic radar cruise control
- EPS
- PCS (Pre-Collision System)
- LDA (Lane Departure Alert)

- LTA (Lane Tracing Assist)
- BSM (if equipped)
- RCTA (if equipped)
- SEA (if equipped)
- Tire pressure warning system
- Navigation system (if equipped)

■ Speed limit when using the compact spare tire

Do not drive at speeds in excess of 50 mph (80 km/h) when a compact spare tire is installed on the vehicle.

The compact spare tire is not designed for driving at high speeds. Failure to observe this precaution may lead to an accident causing death or serious injury.

■ After using the tools and jack

Before driving, make sure all the tools and jack are securely in place in their storage location to reduce the possibility of personal injury during a collision or sudden braking.

⚠ NOTICE

■ Be careful when driving over bumps with the compact spare tire installed on the vehicle

The vehicle becomes lower when driving with the compact spare tire compared to when driving with standard tires. Be careful when driving over uneven road surfaces.



NOTICE

■ Driving with tire chains and the compact spare tire

Do not fit tire chains to the compact spare tire. Tire chains may damage the vehicle body and adversely affect driving performance.

■ When replacing the tires

When removing or fitting the wheels, tires or the tire pressure warning valve and transmitter, contact your Toyota dealer as the tire pressure warning valve and transmitter may be damaged if not handled correctly.

If the engine will not start

If the engine will not start even though correct starting procedures are being followed (→P.133), consider each of the following points:

The engine will not start even though the starter motor operates normally.

One of the following may be the cause of the problem:

- There may not be sufficient fuel in the vehicle's tank. Refuel the vehicle.
- The engine may be flooded. Try to restart the engine again following correct starting procedures. (→P.133)
- There may be a malfunction in the engine immobilizer system. (→P.64)

The starter motor turns over slowly, the interior lights and headlights are dim, or the horn does not sound or sounds at a low volume.

One of the following may be the cause of the problem:

- The battery may be discharged. (→P.366)

- The battery terminal connections may be loose or corroded. (→P.286)

The starter motor does not turn over

The engine starting system may be malfunctioning due to an electrical problem such as electronic key battery depletion or a blown fuse. However, an interim measure is available to start the engine. (→P.363)

The starter motor does not turn over, the interior lights and headlights do not turn on, or the horn does not sound.

One of the following may be the cause of the problem:

- The battery may be discharged. (→P.366)
- One or both of the battery terminals may be disconnected. (→P.286)

Contact your Toyota dealer if the problem cannot be repaired, or if repair procedures are unknown.

Emergency start function

When the engine does not start, the following steps can be used as an interim measure to start the engine if the engine switch is functioning normally.

Do not use this starting procedure except in case of emergency.

- 1 Pull the parking brake switch to check that the parking brake is set. (→P.143)

Parking brake indicator will come on.

- 2 Check that the shift lever is set in P.
- 3 Turn the engine switch to ACC^{*1, 2}.
- 4 Press and hold the engine switch for about 15 seconds while depressing the brake pedal.

Even if the engine can be started using the above steps, the system may be malfunctioning. Have the vehicle inspected by your Toyota dealer.

*1: ACC mode can be enabled/disabled on the customize menu. (→P.396)

*2: When ACC is disabled, turn the engine switch to ON then OFF, and perform the following step within 5 seconds.

If you lose your keys

New genuine mechanical keys can be made by your Toyota dealer using another mechanical key and the key number stamped on your key number plate.
Keep the plate in a safe place such as your wallet, not in the vehicle.

 NOTICE
■ **When an electronic key is lost**
If the electronic key remains lost, the risk of vehicle theft increases significantly. Visit your Toyota dealer immediately with all remaining electronic keys that were provided with your vehicle.

If the electronic key does not operate properly

If communication between the electronic key and vehicle is interrupted (→P.104) or the electronic key cannot be used because the battery is depleted, the smart key system and wireless remote control cannot be used. In such cases, the doors can be opened and the engine can be started by following the procedure below.

- **When the electronic key does not work properly**
- Make sure that the smart key system has not been deactivated in the customization setting. If it is off, turn the function on. (Customizable features →P.396)
- Check if battery-saving mode is set. If it is set, cancel the function. (→P.104)
- The electronic key function may be suspended. (→P.92)

 NOTICE
■ **In case of a smart key system malfunction or other key-related problems**
Take your vehicle with all the electronic keys provided with your vehicle to your Toyota dealer.

Locking and unlocking the doors

Use the mechanical key

(→P.94) in order to perform the following operations:

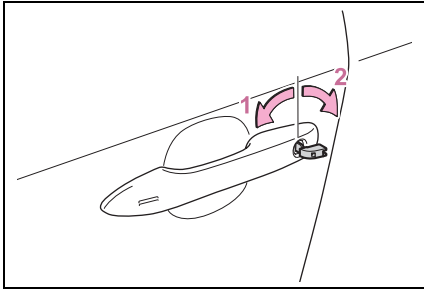

- 1** Locks all the doors
- 2** Unlocks all the doors

Turning the key unlocks the driver's door. Turning the key again unlocks the other doors.

■ Key linked functions

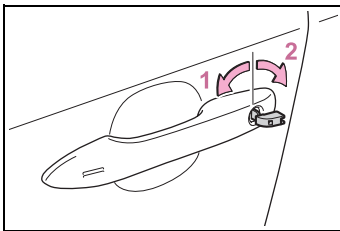

- 1** Closes the windows (turn and hold)*
- 2** Opens the windows (turn and hold)*

*: This setting must be customized at your Toyota dealer.

⚠ WARNING

■ When using the mechanical key and operating the power windows

Operate the power window after checking to make sure that there is no possibility of any passenger having any of their body parts caught in the window. Also, do not allow children to operate the mechanical key. It is possible for children and other passengers to get caught in the power window.

Starting the engine

- 1** Ensure that the shift lever is in P and depress the brake pedal.
- 2** Touch the electronic key to the engine switch.

When the electronic key is detected, a buzzer sounds and the engine switch will turn to ON.

When the smart key system is deactivated in customization setting and ACC customization is in on, the engine switch will turn to ACC.

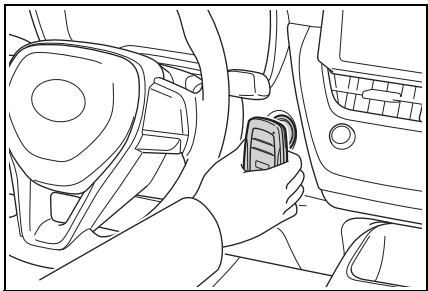

- 3** Firmly depress the brake pedal and check that  is shown on the multi-information display.

- 4 Press the engine switch shortly and firmly.

In the event that the engine still cannot be started, contact your Toyota dealer.

■ **Stopping the engine**

Shift the shift lever to P and press the engine switch as you normally do when stopping the engine.

■ **Electronic key battery**

As the above procedure is a temporary measure, it is recommended that the electronic key battery be replaced immediately when the battery is depleted. (→P.311)

■ **Changing engine switch modes**

Release the brake pedal and press the engine switch in step 3 above. The engine does not start and modes will be changed each time the switch is pressed. (→P.135)

If the vehicle battery is discharged

The following procedures may be used to start the engine if the vehicle's battery is discharged.

You can also call your Toyota dealer or a qualified repair shop.

Restarting the engine

If you have a set of jumper (or booster) cables and a second vehicle with a 12-volt battery, you can jump start your vehicle by following the steps below.

- 1 Vehicles with an alarm (→P.65): Confirm that the electronic key is being carried.

booster) cables, depending on the situation, the alarm may activate and doors locked. (→P.66)

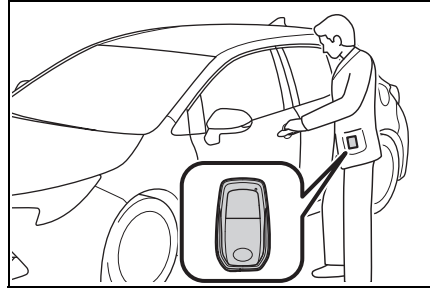

When connecting the jumper (or

- 2 Open the hood. (→P.279)

- 3 Connect a positive jumper cable clamp to **A** on your vehicle and connect the clamp on the other end of the positive cable to **B** on the second vehicle. Then, connect a negative cable clamp to **C** on the second vehicle and connect the clamp at the other end of the negative cable to **D**.

Use jumper cables that can reach the specified terminals and connecting point.

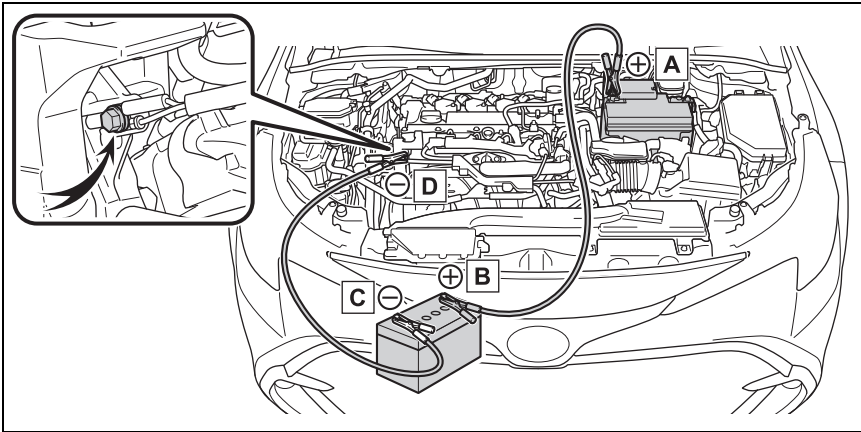

- A** Positive (+) battery terminal (your vehicle)
- B** Positive (+) battery terminal (second vehicle)
- C** Negative (-) battery terminal (second vehicle)
- D** Metallic point shown in the illustration

- 4 Start the engine of the second vehicle. Increase the engine speed slightly and maintain at that level for

approximately 5 minutes to recharge the battery of your vehicle.

- 5 Open and close any of the doors of your vehicle with the engine switch OFF.
- 6 Maintain the engine speed of the second vehicle and start the engine of your vehicle by turning the engine switch to ON.
- 7 Once the vehicle's engine has started, remove the jumper cables in the exact reverse order from which they were connected.

Once the engine starts, have the vehicle inspected at your Toyota dealer as soon as possible.

■ Starting the engine when the battery is discharged

The engine cannot be started by push-starting.

■ To prevent battery discharge

- Turn off the headlights and the audio system while the engine is off.
- Turn off any unnecessary electrical components when the vehicle is running at a low speed for an extended period, such as in heavy traffic.
- When ACC customization is in off, power is still provided to the multimedia system even though the engine switch is off.
To turn off the multimedia system, use the multimedia system engine switch.
For details, refer to the Multimedia Owner's Manual.

■ When the battery is removed or discharged

- Information stored in the ECU is cleared. When the battery is depleted, have the vehicle inspected at your Toyota dealer.
- Some systems may require initialization. (→P.406)

■ When removing the battery terminals

When the battery terminals are removed, the information stored in the ECU is cleared. Before removing the battery terminals, contact your Toyota dealer.

■ Charging the battery

The electricity stored in the battery will discharge gradually even when the vehicle is not in use, due to natural discharge and the draining effects of certain electrical appliances. If the vehicle is left for a long time, the battery may discharge, and the engine may be unable to start. (The battery recharges automatically during driving.)

■ When recharging or replacing the battery

- In some cases, it may not be possible to unlock the doors using the smart key system when the battery is discharged. Use the wireless remote control or the mechanical key to lock or unlock the doors.
- The engine may not start on the first attempt after the battery has recharged but will start normally after the second attempt. This is not a malfunction.
- The engine switch mode is memorized by the vehicle. When the battery is reconnected, the system will return to the mode it was in before the battery was discharged. Before disconnecting the battery, turn the engine switch off. If you are unsure what mode the engine switch was in before the battery discharged, be especially

careful when reconnecting the battery.

■ When replacing the battery

- Use a battery that conforms to European regulations.
- Use a battery that the case size is same as the previous one (LN1), 20 hour rate capacity (20HR) is equivalent (45Ah) or greater, and performance rating (CCA) is equivalent (307A) or greater.
- If the sizes differ, the battery cannot be properly secured.
- If the 20 hour rate capacity is low, even if the time period where the vehicle is not used is a short time, the battery may discharge and the engine may not be able to start.
- For details, consult your Toyota dealer.



WARNING

■ When removing the battery terminals

Always remove the negative (-) terminal first. If the positive (+) terminal contacts any metal in the surrounding area when the positive (+) terminal is removed, a spark may occur, leading to a fire in addition to electrical shocks and death or serious injury.

■ Avoiding battery fires or explosions

Observe the following precautions to prevent accidentally igniting the flammable gas that may be emitted from the battery:

- Make sure each jumper cable is connected to the correct terminal and that it is not unintentionally in contact with any other than the intended terminal.

- Do not allow the other end of the jumper cable connected to the "+" terminal to come into contact with any other parts or metal surfaces in the area, such as brackets or unpainted metal.

- Do not allow the + and - clamps of the jumper cables to come into contact with each other.

- Do not smoke, use matches, cigarette lighters or allow open flame near the battery.

■ Battery precautions

The battery contains poisonous and corrosive acidic electrolyte, while related parts contain lead and lead compounds. Observe the following precautions when handling the battery:

- When working with the battery, always wear safety glasses and take care not to allow any battery fluids (acid) to come into contact with skin, clothing or the vehicle body.

- Do not lean over the battery.

- In the event that battery fluid comes into contact with the skin or eyes, immediately wash the affected area with water and seek medical attention. Place a wet sponge or cloth over the affected area until medical attention can be received.

- Always wash your hands after handling the battery support, terminals, and other battery-related parts.

- Do not allow children near the battery.



NOTICE

■ **When handling jumper cables**

When connecting the jumper cables, ensure that they do not become entangled in the cooling fan or engine drive belt.

■ **When connecting jumper cables**

Make sure to connect jumper cables to the specified terminals and connecting point. Failure to do so may adversely affect the electronic devices or damage to them.

If your vehicle overheats

The following may indicate that your vehicle is overheating.

- The engine coolant temperature gauge (→P.72, 75) is in the red zone or a loss of engine power is experienced. (For example, the vehicle speed does not increase.)
- “Engine Coolant Temp High Stop in a Safe Place See Owner’s Manual” is shown on the multi-information display.
- Steam comes out from under the hood.

Correction procedures

- 1** Stop the vehicle in a safe place and turn off the air conditioning system, and then stop the engine.
- 2** If you see steam:
Carefully lift the hood after the steam subsides.
If you do not see steam:
Carefully lift the hood.
- 3** After the engine has cooled down sufficiently, inspect the

hoses and radiator core (radiator) for any leaks.

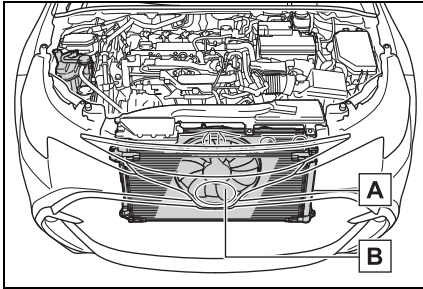

- A** Radiator
- B** Cooling fan

If a large amount of coolant leaks, immediately contact your Toyota dealer.

- 4** The coolant level is satisfactory if it is between the “MAX” and “MIN” lines on the reservoir.

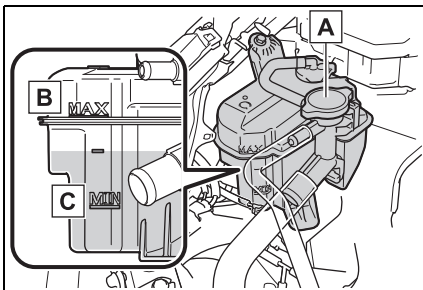

- A** Reservoir
- B** “MAX” line
- C** “MIN” line

- 5** Add engine coolant if necessary.

Water can be used in an emergency if engine coolant is unavailable.

able.

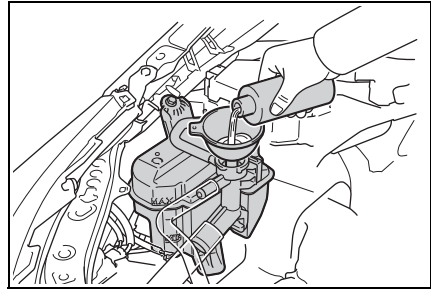

- 6** Start the engine and turn the air conditioning system on to check that the radiator cooling fan operates and to check for coolant leaks from the radiator or hoses.

The fan operates when the air conditioning system is turned on immediately after a cold start. Confirm that the fan is operating by checking the fan sound and air flow. If it is difficult to check these, turn the air conditioning system on and off repeatedly. (The fan may not operate in freezing temperatures.)

- 7** If the fan is not operating:
Stop the engine immediately and contact your Toyota dealer.
If the fan is operating:
Have the vehicle inspected at the nearest Toyota dealer.

⚠ WARNING

■ When inspecting under the hood of your vehicle

Observe the following precautions. Failure to do so may result in serious injury such as burns.



WARNING

- If steam is seen coming from under the hood, do not open the hood until the steam has subsided. The engine compartment may be very hot.
- Keep hands and clothing (especially a tie, a scarf or a muffler) away from the fan and belts. Failure to do so may cause the hands or clothing to be caught, resulting in serious injury.
- Do not loosen the coolant reservoir caps while the engine and radiator are hot. High temperature steam or coolant could spray out.



NOTICE

■ **When adding engine coolant**

Add coolant slowly after the engine has cooled down sufficiently. Adding cool coolant to a hot engine too quickly can cause damage to the engine.

■ **To prevent damage to the cooling system**

Observe the following precautions:

- Avoid contaminating the coolant with foreign matter (such as sand or dust etc.).
- Do not use any coolant additive.

If the vehicle becomes stuck

Carry out the following procedures if the tires spin or the vehicle becomes stuck in mud, dirt or snow:

Recovering procedure

- 1 Stop the engine. Set the parking brake and shift the shift lever to P.

Do not press the shift release button after shifting the shift position to P.

- 2 Remove the mud, snow or sand from around the front wheels.
- 3 Place wood, stones or some other material under the front wheels to help provide traction.
- 4 Restart the engine.
- 5 Shift the shift lever to D or R and release the parking brake. Then, while exercising caution, depress the accelerator pedal.

■ **When it is difficult to free the vehicle**

Press the  switch to turn off TRAC.

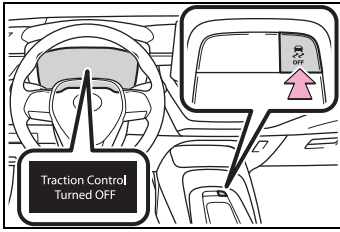

WARNING

■ When attempting to free a stuck vehicle

If you choose to push the vehicle back and forth to free it, make sure the surrounding area is clear to avoid striking other vehicles, objects or people. The vehicle may also lunge forward or lunge back suddenly as it becomes free. Use extreme caution.

■ When shifting the shift lever

Be careful not to shift the shift lever with the accelerator pedal depressed. This may lead to unexpected rapid acceleration of the vehicle that may cause an accident resulting in death or serious injury.

NOTICE

■ To avoid damaging the transmission and other components

- Avoid spinning the front wheels and depressing the accelerator pedal more than necessary.
- If the vehicle remains stuck even after these procedures are performed, the vehicle may require towing to be freed.

Vehicle specifications

8

8-1. Specifications

Maintenance data (fuel, oil level, etc.)..... 376

Fuel information 383

Tire information 385

8-2. Customization

Customizable features 396

8-3. Initialization

Items to initialize 406

Maintenance data (fuel, oil level, etc.)

Dimensions and weight

Overall length	172.0 in. (4370 mm)	
Overall width	70.5 in. (1790 mm)	
Overall height*	56.5 in. (1435 mm)	
Wheelbase	103.9 in. (2640 mm)	
Tread	Front	60.2 in. (1530 mm)
	Rear	60.2 in. (1530 mm)
Vehicle capacity weight (Occupants + luggage)	860 lb. (390 kg)	

*: Unladen vehicles

Seating capacity

Seating capacity	5 (Front 2, Rear 3)
------------------	---------------------

Vehicle identification

■ Vehicle identification number

The vehicle identification number (VIN) is the legal identifier for your vehicle. This is the primary identification number for your Toyota. It is used in registering the ownership of your vehicle.

This number is stamped under the right-hand front seat.

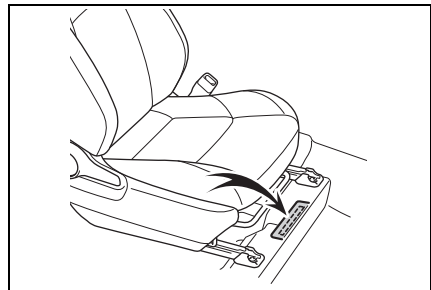

This number is also stamped on the top left of the instrument panel.

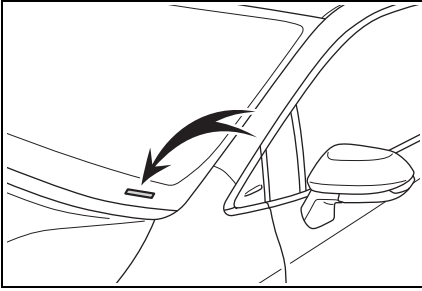

This number is also on the Certification Label.

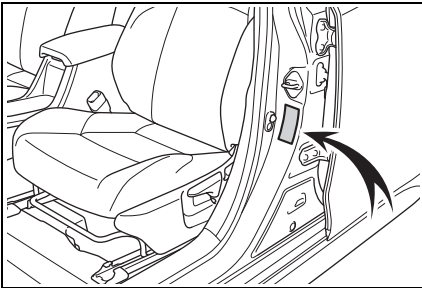

■ Engine number

The engine number is stamped on the engine block as shown.

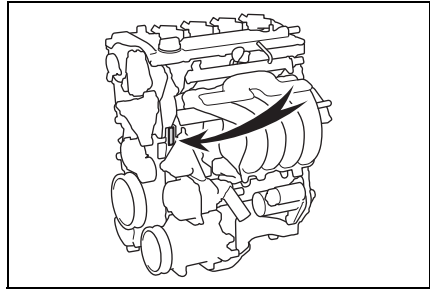

Engine

Model	2.0 L 4-cylinder (M20A-FKS)
Type	4-cylinder in line, 4-cycle, gasoline
Bore and stroke	3.17 × 3.84 in. (80.5 × 97.6 mm)
Displacement	121.3 cu. in. (1987 cm ³)
Valve clearance	Automatic adjustment
Drive belt tension	Automatic adjustment

Fuel

Fuel type	Unleaded gasoline only
Octane Rating	87 (Research Octane Number 91) or higher
Fuel tank capacity (Reference)	13.2 gal. (50.0 L, 11.0 Imp. gal.)

Lubrication system

Oil capacity (Drain and refill [Reference*])

With filter	4.4 qt. (4.2 L, 3.7 Imp. qt.)
Without filter	4.1 qt. (3.9 L, 3.4 Imp. qt.)

*: The engine oil capacity is a reference quantity to be used when changing the engine oil. When actually adding the engine oil, make sure that the oil level is between the low level mark and refill upper limit mark (→P.282). Warm up and turn off the engine, wait about 5 minutes, and check the oil level on the dipstick.

Engine oil selection

“Toyota Genuine Motor Oil” is used in your Toyota vehicle. Use Toyota approved “Toyota Genuine Motor Oil” or equivalent to satisfy the following grade and viscosity.

Oil grade: JASO GLV-1

Recommended viscosity: SAE 0W-8

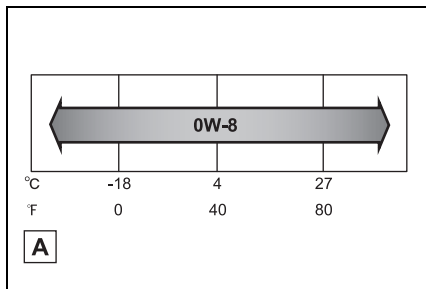

A Outside temperature

SAE 0W-8 is the best choice for good fuel economy and good starting in cold weather.

If SAE 0W-8 is not available, SAE 0W-16 oil may be used. However, it must be replaced with SAE 0W-8 at the next oil change.

Oil viscosity (0W-8 is explained here as an example):

- The 0W in 0W-8 indicates the characteristic of the oil which allows cold startability. Oils with a lower value before the W allow for easier starting of the engine in cold weather.
- The 8 in 0W-8 indicates the viscosity characteristic of the oil when the oil is at high temperature. An oil with a higher viscosity (one with a higher value) may be better suited if the vehicle is operated at high speeds, or under extreme load conditions.

How to read oil container label:

The Japanese Automotive Standards Organization (JASO) GLV-1 mark is added to some oil containers to help you select the oil you should use.





Cooling system

Capacity (Reference)	6.8 qt. (6.4 L, 5.6 Imp. qt.)
Coolant type	<p>Use either of the following:</p> <ul style="list-style-type: none"> • “Toyota Super Long Life Coolant” • Similar high-quality ethylene glycol-based non-silicate, non-amine, non-nitrite, and non-borate coolant with long-life hybrid organic acid technology <p>Do not use plain water alone.</p>

Ignition system (spark plug)

Make	DENSO FC20HR-Q8
Gap	0.032 in. (0.8 mm)

 **NOTICE**

 **Iridium-tipped spark plugs**
 Use only iridium-tipped spark plugs. Do not adjust the spark plug gap.

Electrical system (battery)

Open voltage at 68°F (20°C):	12.3 V or higher (Turn the engine switch off and turn on the high beam headlights for 30 seconds.)
Charging rates	5 A max.

Continuously variable transmission

Fluid capacity*	9.0 qt. (8.5 L, 7.5 Imp. qt.)
Fluid type	Toyota Genuine CVT Fluid FE

*: The fluid capacity is a reference quantity.
If replacement is necessary, contact your Toyota dealer.



NOTICE

Continuously variable transmission fluid type

Using continuously variable transmission fluid other than the above type may cause abnormal noise or vibration, or damage the continuously variable transmission of your vehicle.

Brakes

Pedal clearance* ¹	4.1 in. (105 mm) Min.
Pedal free play	0.04 — 0.24 in. (1 — 6 mm)
Brake pad wear limit	0.04 in. (1 mm)
Parking brake indicator* ²	When pulling the parking brake switch for 1 to 2 seconds: comes on When pushing the parking brake switch for 1 to 2 seconds: turns off
Fluid type	FMVSS No.116 DOT 3 or SAE J1703 FMVSS No.116 DOT 4 or SAE J1704

*¹: Minimum pedal clearance when depressed with a force of 67.4 lbf (300 N, 30.6 kgf) while the engine is running.

When performing the brake pedal inspection, also be sure to check that the brake system warning light is not illuminated when the engine is running. (If the brake system warning light is illuminated, refer to P.328.)

*²: Make sure to confirm that the brake warning light (yellow) does not illuminate. (If the brake warning light illuminates, refer to P.328.)

Steering

Free play	Less than 1.2 in. (30 mm)
-----------	---------------------------

Tires and wheels

► 15-inch tires

Tire size	195/65R15 91S
Tire inflation pressure (Recommended cold tire inflation pressure)	► Front tire 38 psi (260 kPa, 2.6 kgf/cm ² or bar) ► Rear tire 36 psi (250 kPa, 2.5 kgf/cm ² or bar)
Wheel size	15 × 6 1/2J
Wheel nut torque	76 ft•lbf (103 N•m, 10.5 kgf•m)

► 16-inch tires

Tire size	205/55R16 91H
Tire inflation pressure (Recommended cold tire inflation pressure)	► Front tire 35 psi (240 kPa, 2.4 kgf/cm ² or bar) ► Rear tire 33 psi (230 kPa, 2.3 kgf/cm ² or bar)
Wheel size	16 × 7J
Wheel nut torque	76 ft•lbf (103 N•m, 10.5 kgf•m)

► 18-inch tires

Tire size	225/40R18 88V
Tire inflation pressure (Recommended cold tire inflation pressure)	Driving under normal conditions ► Front tire 33 psi (230 kPa, 2.3 kgf/cm ² or bar) ► Rear tire 30 psi (210 kPa, 2.1 kgf/cm ² or bar) Driving at high speeds (above 100 mph [160 km/h]) (in countries where such speeds are per- mitted by law) Add 5 psi (30 kPa, 0.3 kgf/cm ² or bar) to the front tires and rear tires. Never exceed the maximum cold tire inflation pressure indicated on the tire sidewall.

Wheel size	18 × 8J
Wheel nut torque	76 ft•lbf (103 N•m, 10.5 kgf•m)

▶ Compact spare tire (if equipped)

Tire size	T125/70D17 98M
Tire inflation pressure (Recommended cold tire inflation pressure)	60 psi (420 kPa, 4.2 kgf/cm ² or bar)
Wheel size	17 × 4T
Wheel nut torque	76 ft•lbf (103 N•m, 10.5 kgf•m)

Light bulbs

	Light bulbs	Bulb No.	W	Type
Exterior	License plate lights	—	5	A
Interior	Luggage compartment light	—	5	A

A: Wedge base bulbs (clear)

Fuel information

You must only use unleaded gasoline.

Select octane rating of 87 (Research Octane Number 91) or higher. Use of unleaded gasoline with an octane rating lower than 87 may result in engine knocking. Persistent knocking can lead to engine damage.

At minimum, the gasoline you use should meet the specifications of ASTM D4814 in the U.S.A.

Gasoline quality

In very few cases, driveability problems may be caused by the brand of gasoline you are using. If driveability problems persist, try changing the brand of gasoline. If this does not correct the problem, consult your Toyota dealer.

Recommendation of the use of gasoline containing detergent additives

- Toyota recommends the use of gasoline that contains detergent additives to avoid the build-up of engine deposits.
- All gasoline sold in the U.S.A. contains minimum detergent additives to clean and/or keep clean intake systems, per EPA's lowest additives concentration program.
- Toyota strongly recommends the use of Top Tier Detergent Gasoline. For more information on Top Tier Detergent Gasoline and a list of marketers, please go to the official website www.toptiergas.com.

Recommendation of the use of low emissions gasoline

Gasolines containing oxygenates such as ethers and ethanol, as well as reformulated gasolines, are available in some cities. These fuels are typically acceptable for use, providing they meet other fuel requirements.

Toyota recommends these fuels, since the formulations allow for reduced vehicle emissions.

Non-recommendation of the use of blended gasoline

- Use only gasoline containing up to 15% ethanol. DO NOT use any flex-fuel or gasoline that could contain more than 15% ethanol, including from any pump labeled E30 (30% ethanol [A]), E50 (50% ethanol [B]), E85 (85% ethanol [C]) (which are only some examples of fuel containing more than 15% ethanol).

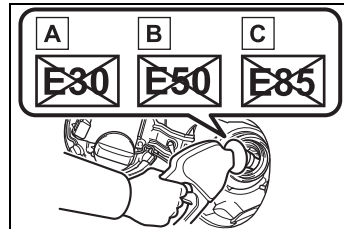

- If you use gasohol in your vehicle, be sure that it has an octane rating no lower than 87.
- Toyota does not recommend the use of gasoline containing methanol.

Non-recommendation of the use of gasoline containing MMT

Some gasoline contains an octane enhancing additive called MMT (Methylcyclopentadienyl Manganese Tricarbonyl).

Toyota does not recommend the use of gasoline that contains MMT. If fuel containing MMT is used, your emission control system may be

adversely affected.

The malfunction indicator lamp on the instrument cluster may come on. If this happens, contact your Toyota dealer for service.

■ **If your engine knocks**

- Consult your Toyota dealer.
- You may occasionally notice light knocking for a short time while accelerating or driving uphill. This is normal and there is no need for concern.

■ **When refueling with gasohol**

Take care not to spill gasohol. It can damage your vehicle's paint.



NOTICE

■ **Notice on fuel quality**

- Do not use improper fuels. If improper fuels are used, the engine will be damaged.
- Do not use leaded gasoline. Leaded gasoline can cause damage to your vehicle's three-way catalytic converters causing the emission control system to malfunction.
- Do not use gasohol other than the type previously stated. Other gasohol may cause fuel system damage or vehicle performance problems.
- Using unleaded gasoline with an octane number or rating lower than the level previously stated will cause persistent heavy knocking. At worst, this will lead to engine damage.

■ **Fuel-related poor driveability**

If poor driveability (poor hot starting, vaporization, engine knocking, etc.) is encountered after using a different type of fuel, discontinue the use of that type of fuel.

Tire information

Typical tire symbols

► Full-size tire

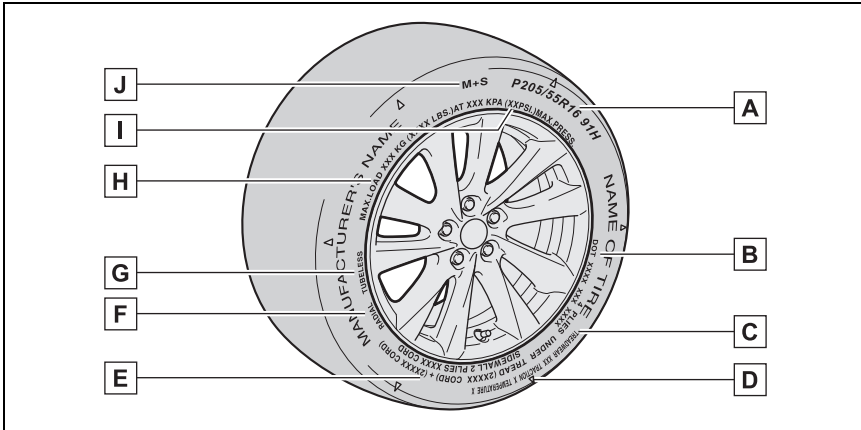

A Tire size (→P.387)

B DOT and Tire Identification Number (TIN) (→P.387)

C Uniform tire quality grading

For details, see “Uniform Tire Quality Grading” that follows.

D Location of treadwear indicators (→P.289)

E Tire ply composition and materials

Plies are layers of rubber-coated parallel cords. Cords are the strands which form the plies in a tire.

F Radial tires or bias-ply tires

A radial tire has “RADIAL” on the sidewall. A tire not marked “RADIAL” is a bias-ply tire.

G TUBELESS or TUBE TYPE

A tubeless tire does not have a tube and air is directly put into the tire. A tube type tire has a tube inside the tire and the tube maintains the air pressure.

H Load limit at maximum cold tire inflation pressure (→P.289)

I Maximum cold tire inflation pressure (→P.381)

This means the pressure to which a tire may be inflated.

J Summer tires or all season tires (→P.290)

An all season tire has “M+S” on the sidewall. A tire not marked “M+S” is a summer tire.

► Compact spare tire

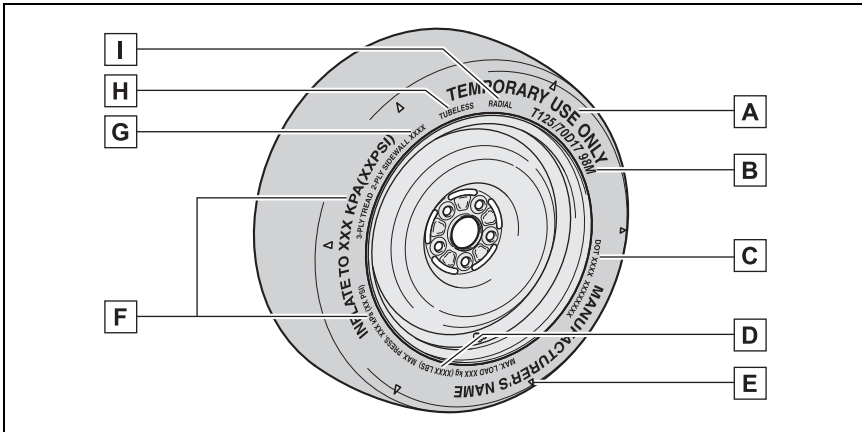

A “TEMPORARY USE ONLY”

A compact spare tire is identified by the phrase “TEMPORARY USE ONLY” molded on its sidewall. This tire is designed for temporary emergency use only.

B Tire size (→P.387)

C DOT and Tire Identification Number (TIN) (→P.387)

D Load limit at maximum cold tire inflation pressure (→P.289)

E Location of treadwear indicators (→P.289)

F Maximum cold tire inflation pressure (→P.381)

This means the pressure to which a tire may be inflated.

G Tire ply composition and materials

Plies are layers of rubber-coated parallel cords. Cords are the strands which form the plies in a tire.

H TUBELESS or TUBE TYPE

A tubeless tire does not have a tube and air is directly put into the tire. A tube type tire has a tube inside the tire and the tube maintains the air pressure.

I Radial tires or bias-ply tires

A radial tire has “RADIAL” on the sidewall. A tire not marked “RADIAL” is a bias-ply tire.

Typical DOT and Tire Identification Number (TIN)

► Type A

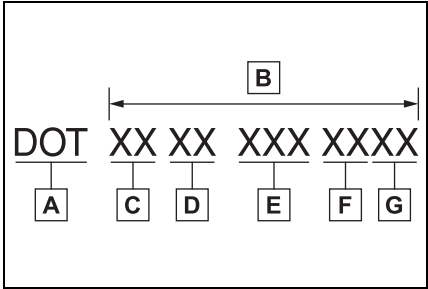

- A** DOT symbol*
- B** Tire Identification Number (TIN)
- C** Tire manufacturer's identification mark
- D** Tire size code
- E** Manufacturer's optional tire type code (3 or 4 letters)
- F** Manufacturing week
- G** Manufacturing year

*: The DOT symbol certifies that the tire conforms to applicable Federal Motor Vehicle Safety Standards.

► Type B

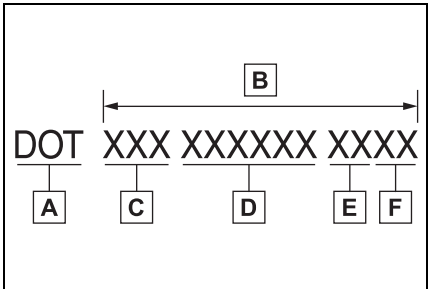

- A** DOT symbol*
- B** Tire Identification Number (TIN)
- C** Tire manufacturer's identification mark
- D** Manufacturer's code
- E** Manufacturing week
- F** Manufacturing year

*: The DOT symbol certifies that the tire conforms to applicable Federal Motor Vehicle Safety Standards.

Tire size

■ Typical tire size information

The illustration indicates typical tire size.

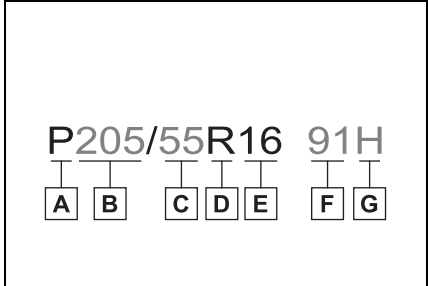

- A** Tire use (P = Passenger car, T = Temporary use)
- B** Section width (millimeters)
- C** Aspect ratio (tire height to section width)
- D** Tire construction code (R = Radial, D = Diagonal)
- E** Wheel diameter (inches)
- F** Load index (2 digits or 3 digits)

G Speed symbol (alphabet with one letter)

■ **Tire dimensions**

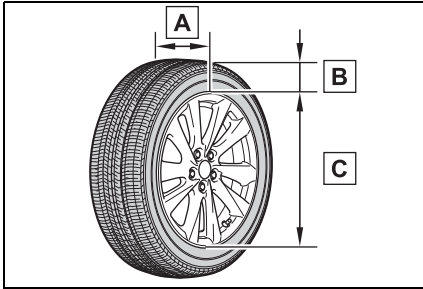

- A** Section width
- B** Tire height
- C** Wheel diameter

Tire section names

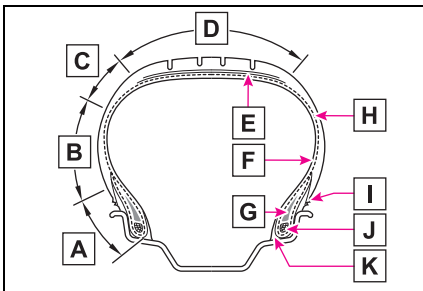

- A** Bead
- B** Sidewall
- C** Shoulder
- D** Tread
- E** Belt
- F** Inner liner
- G** Reinforcing rubber
- H** Carcass
- I** Rim lines
- J** Bead wires

K Chafer

Uniform Tire Quality Grading

This information has been prepared in accordance with regulations issued by the National Highway Traffic Safety Administration of the U.S. Department of Transportation.

It provides the purchasers and/or prospective purchasers of Toyota vehicles with information on uniform tire quality grading.

Your Toyota dealer will help answer any questions you may have as you read this information.

■ **DOT quality grades**

All passenger vehicle tires must conform to Federal Safety Requirements in addition to these grades. Quality grades can be found where applicable on the tire sidewall between tread shoulder and maximum section width.

For example: Treadwear 200 Traction AA Temperature A

■ **Treadwear**

The treadwear grade is a comparative rating based on the wear rate of the tire when tested under controlled conditions on a specified government test course.

For example, a tire graded 150

would wear one and a half (1 - 1/2) times as well on the government course as a tire graded 100. The relative performance of tires depends upon the actual conditions of their use. Performance may differ significantly from the norm due to variations in driving habits, service practices and differences in road characteristics and climate.

■ **Traction AA, A, B, C**

The traction grades, from highest to lowest, are AA, A, B and C, and they represent the tire's ability to stop on wet pavement as measured under controlled conditions on specified government test surfaces of asphalt and concrete.

A tire marked C may have poor traction performance.

Warning: The traction grade assigned to this tire is based on braking (straight ahead) traction tests and does not include cornering (turning) traction.

■ **Temperature A, B, C**

The temperature grades are A

(the highest), B, and C, representing the tire's resistance to the generation of heat and its ability to dissipate heat when tested under controlled conditions on a specified indoor laboratory test wheel.

Sustained high temperature can cause the material of the tire to degenerate and reduce tire life, and excessive temperature can lead to sudden tire failure.

Grade C corresponds to a level of performance which all passenger car tires must meet under the Federal Motor Vehicle Safety Standard No. 109.

Grades B and A represent higher levels of performance on the laboratory test wheel than the minimum required by law.

Warning: The temperature grades of a tire assume that it is properly inflated and not overloaded.

Excessive speed, underinflation, or excessive loading, either separately or in combination, can cause heat buildup and possible tire failure.

Glossary of tire terminology

Tire related term	Meaning
Cold tire inflation pressure	Tire pressure when the vehicle has been parked for three hours or more, or has not been driven more than 1 mile or 1.5 km under that condition
Maximum inflation pressure	The maximum cold inflated pressure to which a tire may be inflated, shown on the sidewall of the tire

Tire related term	Meaning
Recommended inflation pressure	Cold tire inflation pressure recommended by a manufacturer
Accessory weight	The combined weight (in excess of those standard items which may be replaced) of automatic transmission, power steering, power brakes, power windows, power seats, radio and heater, to the extent that these items are available as factory-installed equipment (whether installed or not)
Curb weight	The weight of a motor vehicle with standard equipment, including the maximum capacity of fuel, oil and coolant, and if so equipped, air conditioning and additional weight optional engine
Maximum loaded vehicle weight	The sum of: (a) Curb weight (b) Accessory weight (c) Vehicle capacity weight (d) Production options weight
Normal occupant weight	150 lb. (68 kg) times the number of occupants specified in the second column of Table 1* that follows
Occupant distribution	Distribution of occupants in a vehicle as specified in the third column of Table 1* below
Production options weight	The combined weight of installed regular production options weighing over 5 lb. (2.3 kg) in excess of the standard items which they replace, not previously considered in curb weight or accessory weight, including heavy duty brakes, ride levelers, roof rack, heavy duty battery, and special trim
Rim	A metal support for a tire or a tire and tube assembly upon which the tire beads are seated

Tire related term	Meaning
Rim diameter (Wheel diameter)	Nominal diameter of the bead seat
Rim size designation	Rim diameter and width
Rim type designation	The industry manufacturer's designation for a rim by style or code
Rim width	Nominal distance between rim flanges
Vehicle capacity weight (Total load capacity)	The rated cargo and luggage load plus 150 lb. (68 kg) times the vehicle's designated seating capacity
Vehicle maximum load on the tire	The load on an individual tire that is determined by distributing to each axle its share of the maximum loaded vehicle weight, and dividing by two
Vehicle normal load on the tire	The load on an individual tire that is determined by distributing to each axle its share of curb weight, accessory weight, and normal occupant weight (distributed in accordance with Table 1* below), and dividing by two
Weather side	The surface area of the rim not covered by the inflated tire
Bead	The part of the tire that is made of steel wires, wrapped or reinforced by ply cords and that is shaped to fit the rim
Bead separation	A breakdown of the bond between components in the bead
Bias ply tire	A pneumatic tire in which the ply cords that extend to the beads are laid at alternate angles substantially less than 90 degrees to the centerline of the tread
Carcass	The tire structure, except tread and sidewall rubber which, when inflated, bears the load
Chunking	The breaking away of pieces of the tread or sidewall
Cord	The strands forming the plies in the tire

Tire related term	Meaning
Cord separation	The parting of cords from adjacent rubber compounds
Cracking	Any parting within the tread, sidewall, or innerliner of the tire extending to cord material
CT	A pneumatic tire with an inverted flange tire and rim system in which the rim is designed with rim flanges pointed radially inward and the tire is designed to fit on the underside of the rim in a manner that encloses the rim flanges inside the air cavity of the tire
Extra load tire	A tire designed to operate at higher loads and at higher inflation pressures than the corresponding standard tire
Groove	The space between two adjacent tread ribs
Innerliner	The layer(s) forming the inside surface of a tubeless tire that contains the inflating medium within the tire
Innerliner separation	The parting of the innerliner from cord material in the carcass
Intended outboard sidewall	(a) The sidewall that contains a whitewall, bears white lettering, or bears manufacturer, brand, and/or model name molding that is higher or deeper than the same molding on the other sidewall of the tire, or (b) The outward facing sidewall of an asymmetrical tire that has a particular side that must always face outward when mounted on a vehicle
Light truck (LT) tire	A tire designated by its manufacturer as primarily intended for use on lightweight trucks or multipurpose passenger vehicles
Load rating	The maximum load that a tire is rated to carry for a given inflation pressure
Maximum load rating	The load rating for a tire at the maximum permissible inflation pressure for that tire

Tire related term	Meaning
Maximum permissible inflation pressure	The maximum cold inflation pressure to which a tire may be inflated
Measuring rim	The rim on which a tire is fitted for physical dimension requirements
Open splice	Any parting at any junction of tread, sidewall, or innerliner that extends to cord material
Outer diameter	The overall diameter of an inflated new tire
Overall width	The linear distance between the exteriors of the sidewalls of an inflated tire, including elevations due to labeling, decorations, or protective bands or ribs
Passenger car tire	A tire intended for use on passenger cars, multipurpose passenger vehicles, and trucks, that have a gross vehicle weight rating (GVWR) of 10,000 lb. or less.
Ply	A layer of rubber-coated parallel cords
Ply separation	A parting of rubber compound between adjacent plies
Pneumatic tire	A mechanical device made of rubber, chemicals, fabric and steel or other materials, that, when mounted on an automotive wheel, provides the traction and contains the gas or fluid that sustains the load
Radial ply tire	A pneumatic tire in which the ply cords that extend to the beads are laid at substantially 90 degrees to the centerline of the tread
Reinforced tire	A tire designed to operate at higher loads and at higher inflation pressures than the corresponding standard tire
Section width	The linear distance between the exteriors of the sidewalls of an inflated tire, excluding elevations due to labeling, decoration, or protective bands
Sidewall	That portion of a tire between the tread and bead

Tire related term	Meaning
Sidewall separation	The parting of the rubber compound from the cord material in the sidewall
Snow tire	A tire that attains a traction index equal to or greater than 110, compared to the ASTM E-1136 Standard Reference Test Tire, when using the snow traction test as described in ASTM F-1805-00, Standard Test Method for Single Wheel Driving Traction in a Straight Line on Snow-and Ice-Covered Surfaces, and which is marked with an Alpine Symbol () on at least one sidewall
Test rim	The rim on which a tire is fitted for testing, and may be any rim listed as appropriate for use with that tire
Tread	That portion of a tire that comes into contact with the road
Tread rib	A tread section running circumferentially around a tire
Tread separation	Pulling away of the tread from the tire carcass
Treadwear indicators (TWI)	The projections within the principal grooves designed to give a visual indication of the degrees of wear of the tread
Wheel-holding fixture	The fixture used to hold the wheel and tire assembly securely during testing

* : Table 1 -Occupant loading and distribution for vehicle normal load for various designated seating capacities

Designated seating capacity, Number of occupants	Vehicle normal load, Number of occupants	Occupant distribution in a normally loaded vehicle
2 through 4	2	2 in front
5 through 10	3	2 in front, 1 in second seat

Designated seating capacity, Number of occupants	Vehicle normal load, Number of occupants	Occupant distribution in a normally loaded vehicle
11 through 15	5	2 in front, 1 in second seat, 1 in third seat, 1 in fourth seat
16 through 20	7	2 in front, 2 in second seat, 2 in third seat, 1 in fourth seat

Customizable features



Your vehicle includes a variety of electronic features that can be personalized to suit your preferences. The settings of these features can be changed using the multi-information display, on the audio system screen, or at your Toyota dealer.

Some of the customizable features are changed in conjunction with the settings of My Settings. (→P.120)





Customizing vehicle features

■ Changing by using the audio system screen



- 1 Select  on the main menu.
- 2 Select "Vehicle customise".
- 3 Select the item to change the settings of from the list.

For functions that can be turned on/off, select  (ON)/  (OFF).

■ Changing by using the meter control switches

- 1 Select  (4.2-inch display) or  (7-inch display) of the multi-information display.
- 2 4.2-inch display meter: Press  or  to select the

desired item to be customized.

7-inch display meter: Press  or  to select the desired item to be customized.

- 3 Press or press and hold OK .

The available settings will differ depending on if OK is pressed or pressed and held. Follow the instructions on the display.



WARNING

■ During customization

As the engine needs to be running during customization, ensure that the vehicle is parked in a place with adequate ventilation. In a closed area such as a garage, exhaust gases including harmful carbon monoxide (CO) may collect and enter the vehicle. This may lead to death or a serious health hazard.



NOTICE

■ During customization

To prevent battery discharge, ensure that the engine is running while customizing features.

Customizable features

Some function settings are changed simultaneously with other functions being customized. Contact your Toyota dealer for further details.

- A** Settings that can be changed using the audio system screen
- B** Settings that can be changed using the meter control switches
- C** Settings that can be changed by your Toyota dealer

Definition of symbols: O = Available, — = Not available

■ Gauges, meters and multi-information display (→P.68, 72, 75, 77, 83)

Function ^{*1}	Default setting	Customized setting	A	B	C
Language ^{*4}	English	French	O	O	—
		Spanish			
Units ^{*2}	miles (MPG)	km (km/L)			
		km (L/100 km)	—	O	—
		miles (MPG Imperial)			
Meter Style ^{*3, 4}	Smart	Casual	—	O	—
		Sporty			
Dial Type ^{*3, 4}	Tachometer	Speedometer	—	O	—
		Simple (non-dial)			
Eco Driving Indicator Light ^{*4}	On	Off	—	O	—
Fuel economy display	Total average (Average fuel consumption [after reset])	Trip average (Average fuel consumption [after start])			
		Tank average (Average fuel consumption [after refuel])	—	O	—
Audio system linked display ^{*4}	On	Off	—	O	—

Function ^{*1}	Default setting	Customized setting	A	B	C
Drive information items (First item) ^{*4}	Distance	Average vehicle speed	—	O	—
		Elapsed time			
Drive information items (Second item) ^{*4}	Elapsed time	Average vehicle speed	—	O	—
		Distance			
Pop-up display ^{*4}	On	Off	—	O	—

^{*1}: For details about each function: →P.77, 83

^{*2}: The default setting varies according to country.

^{*3}: 7-inch display

^{*4}: This setting changes in accordance with My Settings.

■ **Door lock (→P.95, 99, 364)**

Function	Default setting	Customized setting	A	B	C
Unlocking using a mechanical key	Driver's door unlocked in one step, all doors unlocked in two step	All doors unlocked in one step	—	—	O
Automatic door locking function [*]	Shift position linked door locking operation	Off			
		Speed linked door locking operation	O	—	O
Automatic door unlocking function [*]	Shift position linked door unlocking operation	Off			
		Driver's door linked door unlocking operation	O	—	O

^{*}: This setting changes in accordance with My Settings.

■ **Rear seat reminder function (→P.97)**

Function	Default setting	Customized setting	A	B	C
Rear seat reminder function [*]	On	Off	—	O	—

* : This setting changes in accordance with My Settings.

■ **Smart key system and wireless remote control (→P.95, 102)**

Function	Default setting	Customized setting	A	B	C
Operating signal (Buzzers)*	5	Off	O	—	O
		1 to 7			
Operation signal (Emergency flashers)*	On	Off	O	—	O
Time elapsed before automatic door lock function is activated if door is not opened after being unlocked*	60 seconds	Off	O	—	O
		30 seconds			
		120 seconds			
Open door warning buzzer	On	Off	—	—	O

* : This setting changes in accordance with My Settings.

■ **Smart key system (→P.95, 102)**

Function	Default setting	Customized setting	A	B	C
Smart key system	On	Off	—	—	O
Smart door unlocking*	Driver's door	All the doors	O	—	O
Time elapsed before unlocking all the door when gripping and holding the driver's door handle	2.0 seconds	Off	—	—	O
		1.5 seconds			
		2.5 seconds			
Number of consecutive door lock operations	2 times	As many as desired	—	—	O
Engine switch illumination	On	Off	—	—	O

* : This setting changes in accordance with My Settings.

■ **Wireless remote control (→P.93, 95, 99)**

Function	Default setting	Customized setting	A	B	C
Wireless remote control	On	Off	—	—	○
Unlocking operation *	Driver's door unlocked in one step, all doors unlocked in two step	All doors unlocked in one step	○	—	○
Theft deterrent panic mode	On	Off	—	—	○
Locking operation when door opened	On	Off	○	—	○

*: This setting changes in accordance with My Settings.

■ **My Settings (→P.120)**

Function	Default setting	Customized setting	A	B	C
My Settings function	On	Off	—	○	—
Switching drivers	Guest	Driver1	○	○	—
		Driver2			
		Driver3			

■ **Engine switch (→P.133)**

Function	Customized setting	A	B	C
ACC customization Enabling/Disabling ACC mode	On, Off	○	—	○

■ **Power windows (→P.117)**

Function	Default setting	Customized setting	A	B	C
Mechanical key linked operation	Off	On	—	—	○

Function	Default setting	Customized setting	A	B	C
Wireless remote control linked operation	Off	On (open only)	—	—	O
Wireless remote control linked operation signal (buzzer)	On	Off	—	—	O

■ Automatic light control system (→P.148)

Function	Default setting	Customized setting	A	B	C
Light sensor sensitivity*	Standard	-2 to 2	O	—	O
Time elapsed before headlights automatically turn off after doors are closed*	30 seconds	Off	O	—	O
		60 seconds			
		90 seconds			
Windshield wiper linked headlight illumination	On	Off	—	—	O

*: This setting changes in accordance with My Settings.

■ Lights (→P.148)

Function	Default setting	Customized setting	A	B	C
Daytime running light system	On	Off	O	—	O

■ PCS (Pre-Collision System) (→P.167)

Function	Customized setting	A	B	C
PCS (Pre-Collision System)* ¹	On, Off	—	O	—
Warning timing* ²	Later, Default, Earlier	—	O	—

*¹: The system is automatically enabled each time the engine switch is turned to ON.

*²: This setting changes in accordance with My Settings.

■ **LDA (Lane Departure Alert) (→P.182)**

Function	Customized setting	A	B	C
LDA (Lane Departure Alert) system*	On, Off	—	O	—
Alert timing*	Default, Earlier	—	O	—
Alert options*	Vibration, Audible	—	O	—

*: This setting changes in accordance with My Settings.

■ **Dynamic radar cruise control (→P.195)**

Function	Customized setting	A	B	C
Acceleration setting*	High, Mid, Low	—	O	—
Guide message*	On, Off	—	O	—
Curve speed reduction*	High, Mid, Low, Off	—	O	—

*: This setting changes in accordance with My Settings.

■ **PDA (Proactive Driving Assist) (→P.189)**

Function	Customized setting	A	B	C
Proactive Driving Assist (PDA)	On, Off	—	O	—
Support sensitivity	Low, Mid, High	—	O	—
Obstacle Anticipation Assist (OAA)	On, Off	—	O	—
Deceleration Assist (DA)	On, Off	—	O	—

■ **RSA (Road Sign Assist)*¹ (→P.212)**

Function	Customized setting	A	B	C
RSA (Road Sign Assist)* ²	On, Off	—	O	—
Excess speed notification method* ²	None, Visual, Visual and Audible	—	O	—

Function	Customized setting	A	B	C
Other notifications method*2	None, Visual, Visual and Audible	—	O	—
Excess speed notification level*2	5 mph (10 km/h), 3 mph (5 km/h), 1 mph (2 km/h)	—	O	—

*1: If equipped

*2: This setting changes in accordance with My Settings

■ **Driver break suggestion (→P.185)**

Function	Customized setting	A	B	C
Driver break suggestion	On, Off	—	O	—

■ **BSM (Blind Spot Monitor)*1 (→P.215)**

Function	Customized setting	A	B	C
BSM (Blind Spot Monitor)	On/Off	—	O	—
Outside rear view mirror indicator brightness*2	Dim/Bright	—	O	—
Alert timing for presence of approaching vehicle (sensitivity)*2	Later/Default/Earlier	—	O	—

*1: If equipped

*2: This setting changes in accordance with My Settings

■ **RCTA (Rear Cross Traffic Alert) function*1 (→P.220)**

Function	Customized setting	A	B	C
RCTA (Rear Cross Traffic Alert)	On/Off	—	O	—
Buzzer volume of RCTA when operating*2,3	Level 1/Level 2/Level 3	—	O	—

*1: If equipped

*2: The sound volume is linked among the Toyota parking assist-sensor and RCTA.

*3: This setting changes in accordance with My Settings

■ **Safe Exit Assist*¹** (→P.225)

Function	Customized setting	A	B	C
Safe Exit Assist	On/Off	—	○	—
Outside rear view mirrors display* ²	On/Off	—	○	—
Detection sensitivity* ²	Low/Mid/High	—	○	—

*¹: If equipped

*²: This setting changes in accordance with My Settings

■ **Automatic air conditioning system** (→P.240)

Function	Default setting	Customized setting	A	B	C
Switching between outside air and recirculated air mode linked to automatic mode switch operation*	On	Off	○	—	○
A/C auto switch operation*	On	Off	○	—	○

*: This setting changes in accordance with My Settings

■ **Illumination** (→P.249)

Function	Default setting	Customized setting	A	B	C
Time elapsed before the interior lights turn off*	15 seconds	Off	○	—	○
		7.5 seconds			
		30 seconds			
Operation after the engine switch is turned off	On	Off	—	—	○
Operation when the doors are unlocked	On	Off	—	—	○
Operation when you approach the vehicle with the electronic key on your person	On	Off	—	—	○

* : This setting changes in accordance with My Settings

■ Vehicle customization

- When the smart key system is off, Smart door unlocking cannot be customized.
 - When the doors remain closed after unlocking the doors and the automatic door lock function is activated, the signals will be generated in accordance with the operation signal (buzzer) and the operation signal (emergency flashers) settings.
- **In the following situations, customize mode in which the settings can be changed through the multi-information display will automatically be turned off**
- A warning message appears after the customize mode screen is displayed
 - The engine switch is turned off.
 - The vehicle begins to move while the customize mode screen is displayed.

Items to initialize

The following items must be initialized for normal system operation after such cases as the battery being reconnected, or maintenance being performed on the vehicle:

List of items to initialize

Item	When to initialize	Reference
Message indicating maintenance is required	<ul style="list-style-type: none"> • After maintenance is performed 	P.272
Tire pressure warning system	<ul style="list-style-type: none"> • When rotating the tires. • When the tire inflation pressure is changed, such as when the tire size is changed. • When the tire inflation pressure is changed, such as when changing traveling speed. • When changing between two registered wheel sets 	P.294

9-1. For owners

- Reporting safety defects for
U.S. owners..... 408
- Reporting safety defects for
Canadian owners 408
- Seat belt instructions for
Canadian owners (in
French)..... 409
- SRS airbag instructions for
Canadian owners (in
French)..... 410

Reporting safety defects for U.S. owners

If you believe that your vehicle has a defect which could cause a crash or could cause injury or death, you should immediately inform the National Highway Traffic Safety Administration (NHTSA) in addition to notifying Toyota Motor Sales, U.S.A., Inc. (Toll-free: 1-800-331-4331).

If NHTSA receives similar complaints, it may open an investigation, and if it finds that a safety defect exists in a group of vehicles, it may order a recall and remedy campaign. However, NHTSA cannot become involved in individual problems between you, your dealer, or Toyota Motor Sales, U.S.A., Inc.

To contact NHTSA, you may call the Vehicle Safety Hotline toll-free at 1-888-327-4236 (TTY: 1-800-424-9153); go to <http://www.safercar.gov>; or write to: Administrator, NHTSA, 1200 New Jersey Ave. SE., Washington, DC 20590. You can also obtain other information about motor vehicle safety from <http://www.safercar.gov>.

Reporting safety defects for Canadian owners

Canadian customers who wish to report a safety-related defect to Transport Canada, Defects Investigations and Recalls, may telephone the toll-free hotline 1-800-333-0510, mail Transport Canada - ASFAD, 330 Sparks Street, Ottawa, ON, K1A 0N5, or complete the online form at <https://www.tc.gc.ca/recalls>.

Seat belt instructions for Canadian owners (in French)

The following is a French explanation of seat belt instructions extracted from the seat belt section in this manual.

See the seat belt section for more detailed seat belt instructions in English.

Utilisation correcte des ceintures de sécurité

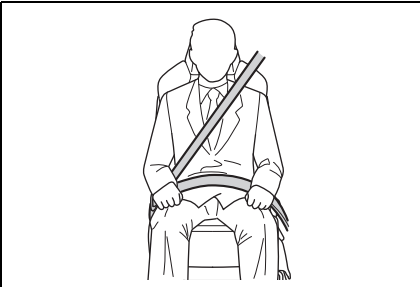

- Déroulez la sangle diagonale de telle sorte qu'elle passe bien sur l'épaule, sans pour autant être en contact avec le cou ou glisser de l'épaule.
- Placez la sangle abdominale le plus bas possible sur les hanches.
- Réglez la position du dossier de siège. Asseyez-vous le dos droit et caliez-vous bien dans le siège.
- Ne vrillez pas la ceinture de

sécurité.

Entretien et soin

■ Traitement des ceintures de sécurité

Nettoyez avec un chiffon ou une éponge humidifiés avec de l'eau savonneuse tiède. Vérifiez régulièrement que les ceintures ne sont pas usées, effilochées ou entaillées excessivement.



WARNING

■ Détérioration et usure des ceintures de sécurité

Inspectez le système de ceintures de sécurité régulièrement. Contrôlez l'absence de coupures, d'effilochages et de pièces desserrées. N'utilisez pas une ceinture de sécurité endommagée avant qu'elle ne soit remplacée. Une ceinture de sécurité endommagée ne permet pas de protéger un occupant de blessures graves ou mortelles.

SRS airbag instructions for Canadian owners (in French)

The following is a French explanation of SRS airbag instructions extracted from the SRS airbag section in this manual.

See the SRS airbag section for more detailed SRS airbag instructions in English.

Système de coussins gonflables SRS

■ Emplacement des coussins gonflables SRS

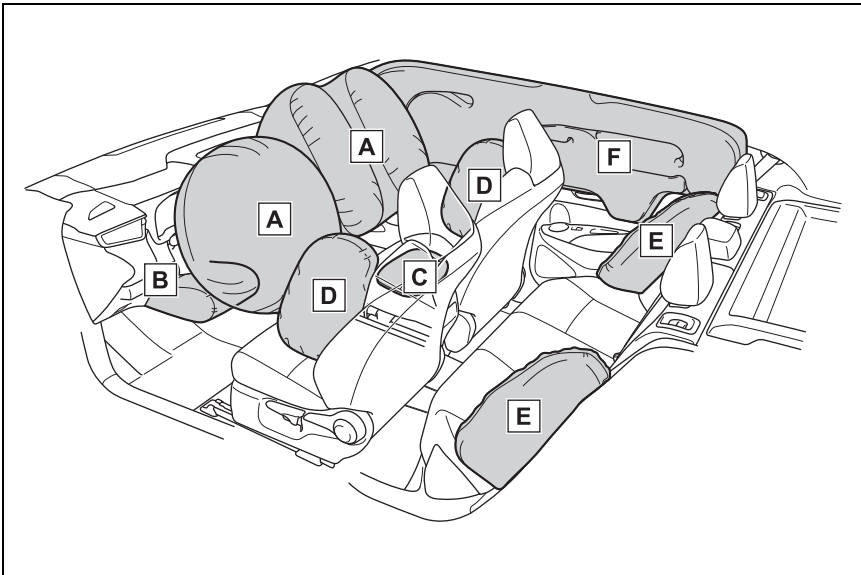

► Coussins gonflables frontaux SRS

A Coussin gonflable conducteur/coussin gonflable du passager avant SRS

Participe à la protection de la tête et du thorax du conducteur et du passager avant contre les chocs contre les éléments de l'habitacle

B Coussin gonflable de genoux SRS

Participe à la protection du conducteur

C Coussin gonflable de coussin de siège SRS

Contribue à retenir le passager avant

► Coussins gonflables latéraux et rideaux SRS

D Coussins gonflables latéraux avant SRS

Participent à la protection du torse des occupants de siège avant

E Coussins gonflables latéraux arrière SRS

Participent à la protection du torse des occupants des sièges latéraux arrière

F Coussins gonflables rideaux SRS

- Participent principalement à la protection de la tête des occupants des sièges latéraux
- Peut contribuer à empêcher les occupants d'être éjectés du véhicule en cas de tonneau

■ Composants du système de coussins gonflables SRS

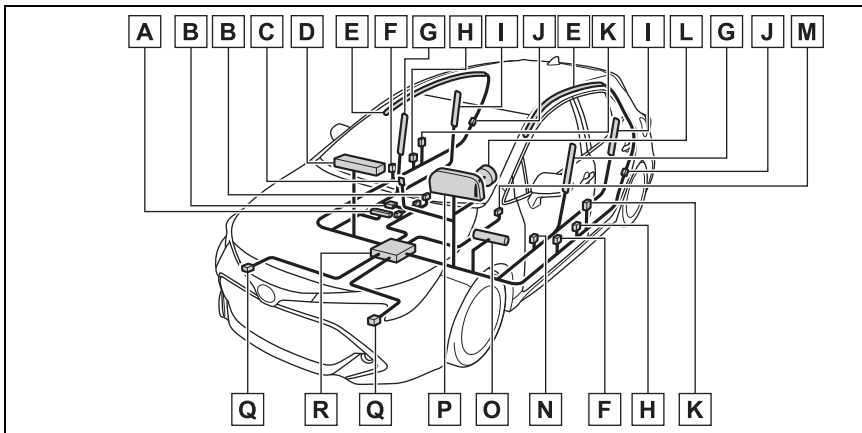

A Coussin gonflable de coussin de siège

B Système de classification de l'occupant du siège passager avant (ECU et capteurs)

C Témoins indicateurs "AIR BAG ON" et "AIR BAG OFF"

D Coussin gonflable passager avant

E Coussins gonflables rideaux

F Capteurs d'impact latéral (portes avant)

G Coussins gonflables latéraux avant

H Prétensionneurs de ceintures de sécurité et limiteurs de force

I Coussins gonflables latéraux arrière

J Capteurs d'impact latéral (arrière)

- K** Capteurs d'impact latéral (avant)
- L** Coussin gonflable conducteur
- M** Contact de boucle de ceinture de sécurité conducteur
- N** Capteur de position du siège conducteur
- O** Coussin gonflable de genoux du conducteur
- P** Témoin d'avertissement SRS
- Q** Capteurs d'impact avant
- R** Ensemble de capteurs de coussins gonflables

Votre véhicule est équipé de COUSSINS GONFLABLES INTELLIGENTS conçus selon les normes de sécurité américaines applicables aux véhicules à moteur (FMVSS208). L'ensemble de capteurs de coussins gonflables (ECU) régule le déploiement des coussins gonflables sur la base des informations qu'il reçoit des capteurs, etc., indiqués ci-dessus dans le schéma illustrant les composants du système. Parmi ces informations figurent la gravité du choc et l'occupation du véhicule par les passagers. Le déploiement rapide des coussins gonflables est obtenu au moyen d'une réaction chimique dans les dispositifs pyrotechniques, qui produit un gaz inoffensif permettant d'amortir le mouvement des occupants.

**WARNING****■ Précautions relatives aux coussins gonflables SRS**

Respectez les précautions suivantes concernant les coussins gonflables SRS.

Le non-respect de ces précautions peut occasionner des blessures graves, voire mortelles.

- Le conducteur et tous les passagers du véhicule doivent porter correctement leur ceinture de sécurité.
Les coussins gonflables SRS sont des dispositifs supplémentaires à utiliser avec les ceintures de sécurité.

WARNING

- Le coussin gonflable conducteur SRS se déploie avec une force considérable, pouvant occasionner des blessures graves, voire mortelles, si le conducteur se trouve très près du coussin gonflable. L'autorité fédérale chargée de la sécurité routière aux États-Unis (NHTSA) conseille:

La zone à risque du coussin gonflable conducteur se situant dans les premiers 2 à 3 in. (50 à 75 mm) de déploiement, vous placer à 10 in. (250 mm) de votre coussin gonflable conducteur vous garantit une marge de sécurité suffisante. Cette distance est à mesurer entre le centre du volant et le sternum. Si vous êtes assis à moins de 10 in. (250 mm), vous pouvez changer votre position de conduite de plusieurs façons:

- Reculez votre siège le plus possible, de manière à pouvoir encore atteindre confortablement les pédales.
- Inclinez légèrement le dossier du siège.

Bien que les véhicules aient une conception différente, un grand nombre de conducteurs peuvent s'asseoir à une distance de 10 in. (250 mm), même avec le siège conducteur complètement avancé, simplement en inclinant un peu le dossier de siège. Si vous avez des difficultés à voir la route après avoir incliné le dossier de votre siège, utilisez un coussin ferme et antidérapant pour vous rehausser ou remontez le siège si votre véhicule est équipé de cette fonction.

- Si votre volant est réglable, inclinez-le vers le bas. Cela a pour effet d'orienter le coussin gonflable en direction de votre poitrine plutôt que de votre tête et de votre cou.

Réglez votre siège selon les recommandations de la NHTSA ci-dessus, tout en conservant le contrôle des pédales, du volant et la vue des commandes du tableau de bord.

- Si vous attachez une rallonge de ceinture de sécurité aux boucles de ceinture de sécurité avant, sans l'attacher au pêne de la ceinture de sécurité, les coussins gonflables frontaux SRS déterminent que le conducteur et le passager avant ont attaché leur ceinture de sécurité, bien que la ceinture de sécurité ne soit pas attachée. Dans ce cas, les coussins gonflables frontaux SRS peuvent ne pas se déployer correctement en cas de collision, pouvant occasionner des blessures graves, voire mortelles. Veillez à porter la rallonge de ceinture de sécurité.

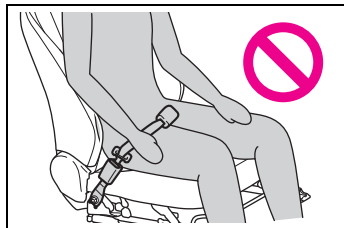

⚠ WARNING

- Le coussin gonflable passager avant SRS se déploie également avec une force considérable, pouvant occasionner des blessures graves, voire mortelles, si le passager avant se trouve très près du coussin gonflable. Le siège du passager avant doit être éloigné le plus possible du coussin gonflable en réglant le dossier de siège de façon à ce que le passager avant soit assis bien droit dans le siège.
- Les nourrissons et les enfants qui ne sont pas correctement assis et/ou attachés peuvent être grièvement blessés ou tués par le déploiement d'un coussin gonflable. Un nourrisson ou un enfant trop petit pour utiliser une ceinture de sécurité doit être correctement attaché au moyen d'un siège de sécurité enfant. Toyota recommande vivement d'installer tous les nourrissons et enfants sur les sièges arrière du véhicule et de prévoir pour eux des systèmes de retenue adaptés. Les sièges arrière sont plus sûrs pour les nourrissons et les enfants que le siège du passager avant.
- Ne vous asseyez pas sur le bord du siège et ne vous appuyez pas contre la planche de bord.

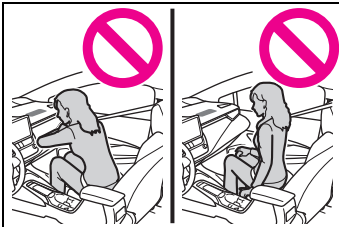

- Ne laissez pas un enfant rester debout devant le coussin gonflable passager avant SRS ou s'asseoir sur les genoux du passager avant.

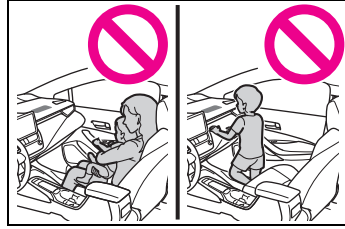

- Ne laissez pas les occupants des sièges avant voyager avec un objet sur les genoux.
- Ne vous appuyez pas contre la porte, le rail latéral de toit ou les montants avant, latéraux et arrière.

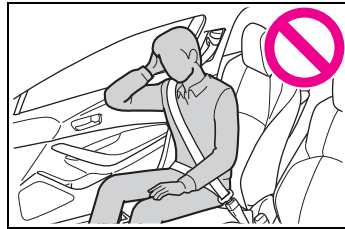

- Ne laissez personne s'agenouiller sur les sièges passagers en appui contre la porte ou sortir la tête ou les mains à l'extérieur du véhicule.

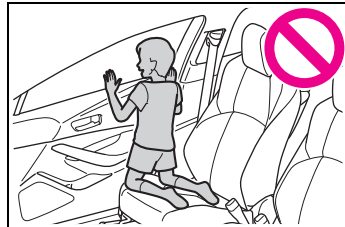

WARNING

- Ne fixez rien et ne posez rien sur des emplacements tels que la planche de bord, la garniture du volant et la partie inférieure du tableau de bord. Ces éléments peuvent se transformer en projectiles lorsque les coussins gonflables conducteur, passager avant et genoux SRS se déploient.

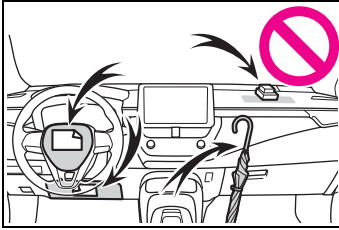

- Ne fixez rien aux portes, à la vitre du pare-brise, aux vitres latérales, aux montants avant et arrière, au rail latéral de toit et à la poignée de maintien.

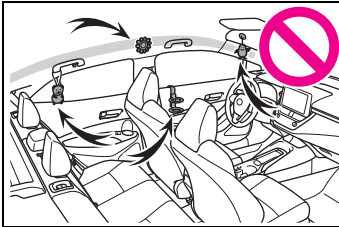

- Ne suspendez aucun cintre ou objet dur aux crochets à vêtements. Tous ces objets pourraient se transformer en projectiles et causer des blessures graves, voire mortelles en cas de déploiement des coussins gonflables rideaux SRS.
- Si un cache en vinyle est placé sur la zone où le coussin gonflable de genoux du conducteur SRS se déploie, assurez-vous de le retirer.

- N'utilisez aucun accessoire de siège recouvrant les zones de déploiement des coussins gonflables latéraux SRS et du coussin gonflable de coussin de siège SRS, car il risque de gêner le déploiement des coussins gonflables SRS. De tels accessoires peuvent empêcher les coussins gonflables latéraux et le coussin gonflable de coussin de siège de s'activer correctement, désactiver le système ou entraîner le déploiement accidentel des coussins gonflables latéraux et du coussin gonflable de coussin de siège, occasionnant des blessures graves, voire mortelles.
- Évitez de faire subir des chocs ou des pressions excessives aux parties renfermant les composants de coussins gonflables SRS ou aux portes avant. En effet, cela pourrait entraîner un dysfonctionnement des coussins gonflables SRS.
- Ne touchez aucun composant immédiatement après le déploiement (gonflage) des coussins gonflables SRS, car ils peuvent être chauds.
- Si vous avez des difficultés à respirer après le déploiement des coussins gonflables SRS, ouvrez une porte ou une vitre pour faire entrer de l'air frais, ou bien descendez du véhicule si cela ne présente pas de danger. Essayez tout résidu dès que possible afin d'éviter d'éventuelles irritations de la peau.
- Si les parties renfermant les coussins gonflables SRS, comme les garnitures du volant et des montants avant et arrière, sont endommagées ou craquelées, faites-les remplacer par votre concessionnaire Toyota.

**WARNING**

- Ne placez rien sur le siège du passager avant, comme un coussin par exemple. Cela a pour conséquence de répartir le poids du passager sur toute la surface du siège, ce qui empêche le capteur de détecter correctement le poids du passager. En conséquence, les coussins gonflables frontaux SRS du passager avant risquent de ne pas se déployer en cas de collision.

■ **Modification et mise au rebut des composants du système de coussins gonflables SRS**

Ne mettez pas votre véhicule au rebut et ne procédez à aucune des modifications suivantes sans consulter votre concessionnaire Toyota. Les coussins gonflables SRS peuvent ne pas fonctionner correctement ou se déployer (se gonfler) accidentellement, provoquant la mort ou de graves blessures.

- Installation, dépose, démontage et réparation des coussins gonflables SRS
- Réparations, modifications, démontage ou remplacement du volant, du tableau de bord, de la planche de bord, des sièges ou de leur garnissage, des montants avant, latéraux et arrière, des rails latéraux de toit, des panneaux de porte avant, des garnitures de porte avant ou des haut-parleurs de porte avant
- Modifications du panneau de porte avant (par exemple, perçage d'un trou dans le panneau)

- Réparations ou modifications des ailes avant, du pare-chocs avant ou des flancs de l'habitacle
- Installation d'un protège-calandre (pare-buffle, pare-kangourou, etc.), de chasse-neige, de treuils ou d'un porte-bagages de toit
- Modifications du système de suspension du véhicule
- Installation d'appareils électroniques tels que les émetteurs/récepteurs radios mobiles et les lecteurs CD
- Modifications de votre véhicule pour une personne atteinte d'un handicap physique

Index

What to do if... (Troubleshooting)	418
Alphabetical Index.....	421

What to do if... (Troubleshooting)

If you have a problem, check the following before contacting your Toyota dealer.

The doors cannot be locked, unlocked, opened or closed



You lose your keys

- If you lose your mechanical keys, new genuine mechanical keys can be made by your Toyota dealer. (→P.364)
- If you lose your electronic keys, the risk of vehicle theft increases significantly. Contact your Toyota dealer immediately. (→P.364)



The doors cannot be locked or unlocked

- Is the electronic key battery weak or depleted? (→P.311)
- Is the engine switch in ON?

When locking the doors, turn the engine switch off. (→P.134)

- Is the electronic key left inside the vehicle?

When locking the doors, make sure that you have the electronic key on your person.

- The function may not operate

properly due to the condition of the radio wave. (→P.104)



The rear door cannot be opened

- Is the child-protector lock set?

The rear door cannot be opened from inside the vehicle when the lock is set. Open the rear door from outside and then unlock the child-protector lock. (→P.98)

If you think something is wrong



The engine does not start

- Did you press the engine switch while firmly depressing the brake pedal? (→P.133)
- Is the shift lever in P? (→P.133)
- Is the electronic key anywhere detectable inside the vehicle? (→P.103)
- Is the electronic key battery weak or depleted?

In this case, the engine can be started in a temporary way. (→P.365)

- Is the battery discharged? (→P.366)



The shift lever cannot be shifted from P even if you depress the brake pedal

- Is the engine switch in ON?

If you cannot release the shift lever by depressing the brake pedal with the engine switch in ON. (→P.139)



The windows do not open or close by operating the power window switches

- Is the window lock switch pressed?

The power window except for the one at the driver's seat cannot be operated if the window lock switch is pressed. (→P.119)



The engine switch is turned off automatically

- The auto power off function will be operated if the vehicle is left in ACC or ON mode (the engine is not running) for a period of time. (→P.136)



A warning buzzer sounds during driving

- The seat belt reminder light is flashing

Are the driver and the front passenger wearing the seat belts? (→P.331)

- The parking brake indicator is on

Is the parking brake released? (→P.143)

Depending on the situation, other types of warning buzzer may also sound. (→P.328, 338)



An alarm is activated and the horn sounds (vehicles with an alarm)

- Did anyone inside the vehicle open a door during setting the alarm?

The sensor detects it and the alarm sounds. (→P.65)

Do one of the following to deactivate or stop the alarms:

- Unlock the doors.
- Turn the engine switch to ACC or ON, or start the engine. (The alarm will be deactivated or stopped after a few seconds.)



A warning buzzer sounds when leaving the vehicle

- Is the electronic key left inside the vehicle?

Check the message on the multi-information display. (→P.338)



A warning light turns on or a warning message is displayed

- When a warning light turns on or a warning message is displayed, refer to P.328, 338.

When a problem has occurred



If you have a flat tire

- Vehicles with an emergency tire puncture repair kit: Stop the vehicle in a safe place and repair the flat tire temporarily with the emergency tire puncture repair kit. (→P.343)
- Vehicles with spare tire: Stop the vehicle in a safe place and replace the flat tire with the spare tire. (→P.354)



The vehicle becomes stuck

- Try the procedure for when the vehicle becomes stuck in mud, dirt, or snow. (→P.372)

Alphabetical Index

A

A/C

- Air conditioning filter309
- Automatic air conditioning system240

ABS (Anti-lock Brake System)

-230
- Warning light330

ACA (Active Cornering Assist)

-231

Active Cornering Assist (ACA)

-231

AHB (Automatic High Beam).150

Air conditioning filter309

Air conditioning system

- Air conditioning filter309
- Automatic air conditioning system240

Airbags

- Airbag operating conditions....33
- Airbag precautions for your child36
- Correct driving posture25
- Curtain shield airbag operating conditions34
- Curtain shield airbag precautions36
- Front passenger occupant classification system40
- General airbag precautions36
- Locations of airbags31
- Modification and disposal of airbags39
- Side airbag operating conditions34
- Side airbag precautions36
- Side and curtain shield airbags operating conditions34
- Side and curtain shield airbags precautions.....36
- SRS airbags31

- SRS warning light329

Alarm

- Alarm65
- Warning buzzer328

Anchor brackets49, 57

Antennas (smart key system)102

Anti-lock Brake System (ABS)

-230
- Warning light.....330

Approach warning201

Armrest.....263

Assist grips264

Audio system-linked display .81, 86

Automatic air conditioning system240

Automatic headlight leveling system149

Automatic High Beam150

Automatic light control system148

Average fuel economy79, 84

Average vehicle speed81, 86

B

Back door99

Back-up light

- Replacing light bulbs316

Battery

- Battery checking286
- If the battery is discharged ...366
- Preparing and checking before winter235
- Replacing369
- Warning light.....329

Blind Spot Monitor (BSM)215

Bottle holders252

Brake

- Brake hold146
- Fluid.....285, 380
- Parking brake143
- Warning light.....328

Brake assist230
Break-in tips 123
Brightness control
 Instrument panel light control74,
 77
 Meter light control..... 76
BSM (Blind Spot Monitor)..... 215

C

Care
 Exterior.....266
 Interior268
 Seat belts268
 Wheels and wheel ornaments
266
Cargo capacity 131
Cargo hooks254
Chains237
Child restraint system
 Fixed with a LATCH system ...56
 Fixed with a seat belt51
 Front passenger occupant clas-
 sification system.....40
 Points to remember47
 Riding with children46
 Types of child restraint system
 installation method 49
 Using an anchor bracket 57
Child safety
 Airbag precautions 36
 Battery precautions287, 369
 Child restraint system..... 49
 Heated steering wheel and seat
 heater precautions247
 How your child should wear the
 seat belt.....28
 Power window lock switch... 119
 Power window precautions .. 118
 Rear door child-protectors..... 98
 Seat belt extender precautions
28
 Seat belt precautions46

Child-protectors.....98
Cleaning
 Exterior266
 Interior268
 Seat belts268
 Wheels and wheel ornaments
266
Clock.....72, 74, 75, 77
Coat hooks264
Condenser284
Console box253
Consumption screen.....88
**Continuously variable transmis-
 sion**137
 If the shift lever cannot be shifted
 from P139
 M mode140
 Paddle shift switches ... 139, 140
Cooling system.....284
 Engine overheating370
Cruise control206
Cup holders.....252
Current fuel consumption..79, 84
Curtain shield airbags.....31
Customizable features396

D

Daytime running light system148
Defogger
 Outside rear view mirrors243
 Rear window.....243
 Windshield.....242
Dimensions376
Dinghy towing.....132
Display
 Cruise control206
 Dynamic radar cruise control198
 Multi-information display...77, 83
 RCTA220
 Warning message.....338
Display change button73, 76
Do-it-yourself maintenance ...272

- Door lock**
 - Back door 99
 - Side doors 95
 - Smart key system..... 102
 - Wireless remote control 93

- Doors**
 - Automatic door locking and unlocking system..... 99
 - Back door 99
 - Door glasses 117
 - Door lock 95, 99
 - Open door warning buzzer 96, 98
 - Outside rear view mirrors 115
 - Rear door child-protectors..... 98
 - Side doors 95

- Drive distance..... 81, 86**
- Drive information 81, 86**
- Drive-Start Control (DSC) 127**

- Driving**
 - Break-in tips 123
 - Correct driving posture 25
 - Driving mode select switch... 229
 - Procedures..... 122
 - Winter drive tips 235

- Driving information display 78, 84**
- Driving range 79, 84**
- Driving support system information display 80, 85**
- DSC (Drive-Start Control) 127**
- Dynamic radar cruise control 195**

E

- Eco Driving Indicator 79, 84**
- Eco Driving Indicator Light 79, 84**
- EDR (Event data recorder)..... 9**
- Elapsed time 81, 86**
- Electric Power Steering (EPS) 231**
 - Warning light 330
- Electronic key 92**
 - Battery-saving function..... 103

- If the electronic key does not operate properly 364
- Replacing the battery 311

- Emergency Driving Stop System 210**

- Emergency flashers 320**

- Emergency tire puncture repair kit 343**

- Emergency, in case of**

- If a warning buzzer sounds .. 328
- If a warning light turns on 328
- If a warning message is displayed..... 338
- If the battery is discharged ... 366
- If the electronic key does not operate properly 364
- If the engine will not start..... 362
- If the vehicle is submerged or water on the road is rising .. 321
- If you have a flat tire 343
- If you lose your keys..... 364
- If you think something is wrong 326
- If your vehicle becomes stuck 372
- If your vehicle has to be stopped in an emergency..... 320
- If your vehicle needs to be towed 323
- If your vehicle overheats 370

- Engine**

- ACCESSORY mode 135
- Compartment..... 281
- Engine switch 133
- Fuel pump shut off system ... 327
- Hood 279
- How to start the engine 133
- Identification number 377
- If the engine will not start..... 362
- If your vehicle has to be stopped in an emergency..... 320

Ignition switch (engine switch)
..... 133

Overheating 370

Tachometer 72

Engine coolant

Capacity 379

Checking 284

Preparing and checking before
winter..... 235

**Engine coolant temperature
gauge..... 72, 75**

Engine immobilizer system 64

Engine oil

Adding 282

Capacity 378

Checking 281

Preparing and checking before
winter..... 235

Warning light 329

Engine switch 133

Auto power off function 136

Changing the engine switch
modes 135

If your vehicle has to be stopped
in an emergency..... 320

Enhanced VSC..... 231

**EPS (Electric Power Steering)
..... 231**

Warning light 330

Event data recorder (EDR)..... 9

F

Flat tire

Tire pressure warning system
..... 291

Vehicles without a spare tire 343

Floor mats 24

Fluid

Brake 380

Continuously variable transmis-
sion..... 380

Washer 287

Fog lights 153

Replacing light bulbs 316

Switch 153

Front fog lights

Replacing light bulbs 316

Switch 153

**Front passenger occupant clas-
sification system 40**

Front seats

Adjustment 107

Cleaning 268

Correct driving posture 25

Head restraints 110

Seat heaters 247

Front side marker lights

Light switch..... 148

Front turn signal lights

Replacing light bulbs 316

Turn signal lever 142

Fuel

Capacity 377

Fuel gauge 72, 75

Fuel pump shut off system ... 327

Information 383

Refueling 157

Type..... 377

Warning light..... 331

Fuel consumption

Average fuel economy 79, 84

Current fuel consumption . 79, 84

Fuel economy 79, 84

Fuel filler door

Refueling 157

Fuel gauge..... 72, 75

Fuel pump shut off system.... 327

Fuses 313

G

Gauges 72, 75

Glove box 252

Glove box light..... 252

Grocery bag hooks..... 254

H

Head restraints 110

Headlights
 AHB (Automatic High Beam) 150
 Light switch 148
 Replacing light bulbs 316

Heated steering wheel 247

Heaters
 Automatic air conditioning system 240
 Heated steering wheel 247
 Outside rear view mirrors 243
 Seat heaters 247

High mounted stoplight
 Replacing light bulbs 316

Hill-start assist control 231

Hood
 Open 279

Hooks
 Cargo hooks 254
 Coat hooks 264
 Grocery bag hooks 254
 Retaining hooks (floor mat) 24

Horn 113

I

I/M test 275

Identification
 Engine 377
 Vehicle 376

Ignition switch (engine switch)
 133
 Auto power off function 136
 Changing the engine switch modes 135
 If your vehicle has to be stopped in an emergency 320

Illuminated entry system 250

Indicators 70

Initialization
 Items to initialize 406

Maintenance 272
 Power windows 117

Inside rear view mirror 114

Instrument panel light control 74, 77

Intercooler coolant
 Capacity 379

Interior lights 249
 Front interior light 249
 Rear interior light 249

J

Jack
 Positioning a floor jack 280
 Vehicle-equipped jack .. 344, 355

Jack handle 344, 355

Jam protection function
 Power windows 117

K

Keyless entry
 Smart key system 102
 Wireless remote control 93

Keys
 Battery-saving function 103
 Electronic key 92
 Engine switch 133
 If the electronic key does not operate properly 364
 If you lose your keys 364
 Key number plate 92
 Keyless entry 95, 101, 102
 Mechanical key 92
 Replacing the battery 311
 Warning buzzer 103
 Wireless remote control 93

Knee airbags 31

L

Lane Departure Alert (LDA) ... 182

Lane Tracing Assist (LTA)..... 177
 Operation 177

Language (multi-information display)..... 81, 87

LATCH anchors56

LDA (Lane Departure Alert) ... 182
 Operation 182

Lever
 Auxiliary catch lever279
 Hood lock release lever.....279
 Shift lever 137
 Turn signal lever..... 142
 Wiper lever 154

License plate lights
 Light switch 148
 Replacing light bulbs 316
 Wattage382

Light
 Wattage382

Light bulbs
 Replacing 315

Lights
 AHB (Automatic High Beam) 150
 Front interior lights 249
 Headlight switch 148
 Interior lights.....249
 Interior lights list249
 Luggage compartment light.. 101
 Personal lights.....250
 Rear interior lights 249
 Replacing light bulbs 316
 Turn signal lever..... 142
 Vanity lights 263
 Wattage382

LTA (Lane Tracing Assist)..... 177
 Operation 177

**LTA (Lane Tracing Assist) switch
 180**

**Luggage compartment features
 254**

Luggage compartment light
 Wattage382

Luggage cover255

M

Maintenance
 Do-it-yourself maintenance ..277
 General maintenance273
 Maintenance data.....376
 Maintenance requirements...271

Malfunction indicator lamp....329

Menu icons.....77, 83

Meter
 Clock72, 75
 Indicators.....70
 Instrument panel light control74,
 77
 Meter control switches.....78, 83
 Meter light control.....76
 Meters 72, 75
 Multi-information display...77, 83
 Settings81, 87
 Warning lights.....328
 Warning message.....338

Mirrors
 Inside rear view mirror 114
 Outside rear view mirror defog-
 gers243
 Outside rear view mirrors 115
 Vanity mirrors.....263

Multi-information display
 Audio system-linked display .81,
 86
 Clock74, 77
 Cruise control206
 Driving information display78, 84
 Driving support system informa-
 tion display80, 85
 Dynamic radar cruise control 198
 Eco Driving Indicator79, 84
 Fuel economy79, 84
 Menu icons77, 83
 Meter control switches.....78, 83

- Navigation system-linked display 80, 85
- Settings 81, 87
- Tire pressure 291
- Vehicle information display 81, 86
- Warning message 338

N

- Navigation system-linked display** 80, 85
- Noise from under vehicle** 5

O

- Odometer** 73, 76
- Odometer and trip meter display**
 - Display change button 73, 76
 - Display items 73, 76
- Oil**
 - Engine oil 378
- Open tray** 253
- Opener**
 - Back door 101
 - Fuel filler door 157
 - Hood 279
- Outside rear view mirrors**
 - Adjustment 115
 - BSM (Blind Spot Monitor) 215
 - Folding 116
 - Outside rear view mirror defoggers 243
 - RCTA function 220
 - Safe Exit Assist 225
- Outside temperature** 72, 75
- Overheating** 370

P

- Paddle shift switches** 139, 140
- Panic mode** 93
- Parking brake**
 - Operation 143

- Parking brake engaged warning
 - buzzer 145
 - Warning light 334
 - Warning message 145

Parking lights

- Light switch 148
- Replacing light bulbs 316

PCS (Pre-Collision System) ... 167

- Function 168
- Warning light 332

PDA (Proactive driving assist) [PDA (Proactive driving assist)] 189

Personal lights 249

- Wattage 382

Power outlets 257

Power steering (Electric power steering system) 231

- Warning light 330

Power windows

- Door lock linked window operation 118
- Jam protection function 117
- Operation 117
- Window lock switch 119

Pre-Collision System (PCS) ... 167

- Function 168
- Warning light 332

R

Radiator 284

RCTA

- Function 220

RCTA function 221

Rear Cross Traffic Alert (RCTA) 220

Rear seats 108

- Head restraints 110

Rear side marker lights

- Light switch 148

Rear turn signal lights

- Replacing light bulbs 316

Turn signal lever	142
Rear view mirror	
Inside rear view mirror	114
Outside rear view mirrors	115
Rear window defogger	243
Rear window wiper	155
Refueling	
Capacity	377
Fuel types	377
Opening the fuel tank cap	157
Replacing	
Electronic key battery	311
Fuses	313
Light bulbs	315
Reporting safety defects for	
Canadian owners	408
Reporting safety defects for U.S.	
owners	408
Resetting the message indicat-	
ing maintenance is required	272
Road Sign Assist (RSA)	212
RSA (Road Sign Assist)	212

S

Safe Exit Assist	225
Safety Connect	60
Seat belt reminder light	331
Seat belts	27
Automatic Locking Retractor ..	29
Child restraint system installation	
.....	49
Cleaning and maintaining the	
seat belt	268
Emergency Locking Retractor	29
How to wear your seat belt	28
How your child should wear the	
seat belt	28
Pregnant women, proper seat	
belt use	27
Reminder light and buzzer ...	331
Seat belt extender	28
Seat belt pretensioners	30
SRS warning light	329
Seat heaters	247
Seating capacity	131, 376
Seats	
Adjustment	107
Adjustment precautions	107
Child seats/child restraint system	
installation	47
Cleaning	268
Head restraints	110
Properly sitting in the seat	25
Seat heaters	247
Secondary Collision Brake	231
Sensor	
AHB (Automatic High Beam)	150
Automatic headlight system	148
BSM (Blind Spot Monitor)	215
Radar sensor	216, 226
RCTA	221
Service reminder message	272
Shift lever	
Continuously variable transmis-	
sion	137
Side airbags	31
Side marker lights	
Light switch	148
Wattage	382
Side mirrors	
Adjustment	115
BSM (Blind Spot Monitor)	215
Folding	116
RCTA function	220
Side turn signal lights	
Replacing light bulbs	316
Turn signal lever	142
Side windows	117
Smart key system	
Antenna location	102
Entry functions	95, 101
Starting the engine	133
Snow tires	235

Spare tire
 Inflation pressure..... 381
 Storage location 355

Spark plug..... 379

Specifications 376

Speedometer 72, 75

Steering wheel
 Adjustment 113
 Heated steering wheel 247
 Meter control switches 78, 83

Stop lights
 Replacing light bulbs 316

Storage features 251

Stuck
 If the vehicle becomes stuck 372

Sun visors 263

Switches
 AHB (Automatic High Beam) 150
 Brake Hold switch 146
 Display change button..... 73, 76
 Door lock switches 98
 Driving mode select switch... 229
 Dynamic radar cruise control
 switch 198
 Emergency flashers switch .. 320
 Engine switch 133
 Heated steering wheel switch
 247
 Ignition switch..... 133
 Instrument panel light control
 switches 74, 77
 Light switches..... 148
 LTA (Lane Tracing Assist) switch
 180
 Meter control switches 78, 83
 Outside rear view mirror
 switches 115
 Paddle shift switches.... 139, 140
 Parking brake switch 143
 Power door lock switch 98
 Power window switches 117
 RCTA switch 221

Rear window and outside rear
 view mirror defoggers switch
 240

Seat heater switches 247

“SOS” button 60

Vehicle-to-vehicle distance
 switch 200

VSC OFF switch 231

Window lock switch 119

Windshield wiper and washer
 switch 154

T

Tachometer 72

Tail lights
 Light switch..... 148
 Replacing light bulbs 316

Theft deterrent system
 Alarm 65
 Engine immobilizer system.... 64

Tire inflation pressure 306
 Maintenance data 381
 Warning light..... 332

Tire information 385
 Glossary 389
 Size 387
 Tire identification number 387
 Uniform Tire Quality Grading 388

Tire pressure warning system
 Function..... 291
 Installing tire pressure warning
 valves and transmitters 293
 Registering ID codes 300
 Registration of the position of
 each wheel 294
 Setting the tire pressure 296
 Warning light..... 332

Tires
 Chains 237
 Checking 289
 Emergency tire puncture repair
 kit..... 343

If you have a flat tire 343
 Inflation pressure..... 306
 Information 385
 Rotating tires 291
 Size 381
 Snow tires 235
 Tire pressure warning system
 291
 Warning light 332
Tools 344, 355
Top tether strap 57
Total load capacity 376
Towing
 Dinghy towing..... 132
 Emergency towing..... 323
 Towing eyelet 325
 Trailer towing..... 131
Toyota Safety Sense
 AHB (Automatic High Beam) 150
 Cruise control 206
 Dynamic radar cruise control 195
 Emergency Driving Stop System
 210
 LDA (Lane Departure Alert) .. 182
 LTA (Lane Tracing Assist) 177
 PCS (Pre-Collision System) . 167
 RSA (Road Sign Assist) 212
Toyota Safety Sense 3.0 161
**Toyota Safety Sense 3.0[Toyota
 Safety Sense 3.0]**
 PDA(Proactive driving
 assist)[PDA(Proactive driving
 assist)]..... 189
TRAC (Traction Control) 231
Traction Control (TRAC) 231
Trailer towing 131
Transmission
 Continuously variable transmis-
 sion..... 137
 Driving mode select switch... 229
 M mode 140
 Paddle shift switches.... 139, 140

Trip meters 73, 76
Turn signal lights
 Replacing light bulbs 316
 Turn signal lever 142

U

USB charging port..... 256

V

Vanity lights 263
 Wattage 382
Vanity mirrors 263
Vehicle data recording 6
Vehicle identification number 376
Vehicle information display 81, 86
**Vehicle Stability Control (VSC)
 230**
**VSC (Vehicle Stability Control)
 230**

W

Warning buzzers
 ABS 330
 Airbags 329
 Approach warning 201
 Brake hold 335
 Brake Override System 330
 Brake system..... 328
 Charging system 329
 Downshifting 141
 Drive-Start Control..... 330
 Electric power steering 330
 Engine 329
 High coolant temperature 328
 LDA (Lane Departure Alert) 182,
 333
 Low engine oil pressure 329
 LTA (Lane Tracing Assist) .. 177,
 332
 Open door 96, 98

Open window 118
 PDA (Proactive Driving Assist)
 333
 Seat belt 331
Warning lights 328
 ABS 330
 Brake hold operated indicator
 335
 Brake Override System 330
 Brake system 328
 Charging system 329
 Cruise control indicator 333
 Drive-Start Control 330
 Driving assist information indica-
 tor 334
 Dynamic radar cruise control
 indicator..... 333
 Electric power steering 330
 High coolant temperature 328
 LDA indicator 333
 Low engine oil pressure 329
 Low fuel level 331
 LTA indicator 332
 Malfunction indicator lamp ... 329
 Parking brake indicator 334
 PDA indicator 333
 Pre-collision system 332
 Seat belt reminder light 331
 Slip indicator..... 334
 SRS 329
 Tire pressure 332
Warning messages..... 338
Washer
 Checking 287
 Preparing and checking before
 winter..... 235
 Switch..... 154
Washing and waxing 266
Weight
 Cargo capacity 131
 Load limits 131
 Weight 376

Wheels 308
 Replacing 308
 Size 381
Window lock switch 119
Windows
 Power windows 117
 Rear window defogger 243
 Washer 154
Windshield wipers 154
Winter driving tips 235
Wireless charger..... 257
Wireless remote control
 Battery-Saving Function 103
 Locking/Unlocking 93
 Replacing the battery 311

Refer to “MULTIMEDIA
 OWNER’S MANUAL” for
 information regarding the
 equipment listed below.

- Navigation system
- Audio/visual system
- Rear view monitor system

Certifications

► Safety connect

FCC ID : BEJTL21BNN

This device complies with part 15 of the FCC Rules and RSS-Gen of IC Rules.

Operation is subject to the following two conditions:

- (1) This device may not cause harmful interference, and
- (2) this device must accept any interference received, including interference that may cause undesired operation.

Changes or modifications not expressly approved by the manufacturer (or party responsible) for compliance could void the user's authority to operate the equipment.

This equipment complies with FCC RF Radiation exposure limits set forth for an uncontrolled environment. This device and its antenna must not be co-located or operating in conjunction with any other antenna or transmitter. This equipment should be installed and operated with a minimum distance of 20 cm between the radiator and your body.

IC : 2703H-TL21BNN

IC Radiation Exposure Statement:

This equipment complies with IC radiation exposure limits set forth for an uncontrolled environment.

This equipment should be installed and operated with minimum distance 20 cm between the radiator & your body.

Operation is subject to the following two conditions:

- (1) This device may not cause interference.
- (2) This device must accept any interference, including interference that may cause undesired operation of the device.

NOTE: THE MANUFACTURER IS NOT RESPONSIBLE FOR ANY RADIO OR TV INTERFERENCE CAUSED BY UNAUTHORIZED MODIFICATIONS TO THIS EQUIPMENT. SUCH MODIFICATIONS COULD VOID THE USER'S AUTHORITY TO OPERATE THE EQUIPMENT.

IC : 2703H-TL21BNN

Avis d'Industrie Canada sur l'exposition aux rayonnements

Cet appareil est conforme aux limites d'exposition aux rayonnements d'Industrie Canada pour un environnement non contrôlé.

Il doit être installé de façon à garder une distance minimale de 20 centimètres entre la source de rayonnements et votre corps.

L'exploitation est autorisée aux deux conditions suivantes :

1. L'appareil ne doit pas produire de brouillage;
2. L'appareil doit accepter tout brouillage radioélectrique subi, même si le brouillage est susceptible d'en compromettre le fonctionnement.

REMARQUE: LE FABRICANT N'EST PAS RESPONSABLE DES INTERFÉRENCES RADIOÉLECTRIQUES CAUSÉES PAR DES MODIFICATIONS NON AUTORISÉES APPORTÉES À CET APPAREIL. DE TELLES MODIFICATIONS POURRAIT ANNULER L'AUTORISATION ACCORDÉE À L'UTILISATEUR DE FAIRE FONCTIONNER L'APPAREIL.

► Engine immobilizer system

FCC ID: NI4TMLF19T-2

This device complies with part 15 of the FCC Rules. Operation is subject to the following two conditions: (1) This device may not cause harmful interference, and (2) this device must accept any interference received, including interference that may cause undesired operation.

Changes or modifications not expressly approved by the party responsible for compliance could void the user's authority to operate the equipment.

This device complies with Industry Canada's licence-exempt RSSs. Operation is subject to the following two conditions: (1) This device may not cause interference; and (2) This device must accept any interference, including interference that may cause undesired operation of the device.

Le présent appareil est conforme aux CNR d'Industrie Canada applicables aux appareils radio exempts de licence. L'exploitation est autorisée aux deux conditions suivantes : 1) l'appareil ne doit pas produire de brouillage; 2) l'utilisateur de l'appareil doit accepter tout brouillage radioélectrique subi, même si le brouillage est susceptible d'en compromettre le fonctionnement.

► Smart key system

FCC ID:NI4TMLF19T-2

This device complies with part 15 of the FCC Rules. Operation is subject to the following two conditions: (1) This device may not cause harmful interference, and (2) this device must accept any interference received, including interference that may cause undesired operation.

Changes or modifications not expressly approved by the party responsible for compliance could void the user's authority to operate the equipment.

This device complies with Industry Canada's licence-exempt RSSs. Operation is subject to the following two conditions: (1) This device may not cause interference; and (2) This device must accept any interference, including interference that may cause undesired operation of the device.

Le présent appareil est conforme aux CNR d'Industrie Canada applicables aux appareils radio exempts de licence. L'exploitation est autorisée aux deux conditions suivantes : 1) l'appareil ne doit pas produire de brouillage; 2) l'utilisateur de l'appareil doit accepter tout brouillage radioélectrique subi, même si le brouillage est susceptible d'en compromettre le fonctionnement.

US

FCC ID:HYQ23ABN

FCC ID:HYQ14FBW

NOTE:

This device complies with part 15 of the FCC Rules. Operation is subject to the following two conditions: (1) This device may not cause harmful interference, and (2) this device must accept any interference received, including interference that may cause undesired operation.

FCC WARNING:

Changes or modifications not expressly approved by the party responsible for compliance could void the user's authority to operate the equipment.

<For 14FBW>

The FCC ID is affixed inside the equipment. You can find the ID when replacing the battery.

00

CA

NOTE:

This device contains licence-exempt transmitter(s)/receiver(s) that comply with Innovation, Science and Economic Development Canada's licence-exempt RSS(s).

Operation is subject to the following two conditions:

- (1) This device may not cause interference.
- (2) This device must accept any interference, including interference that may cause undesired operation of the device.

<For 14FBW>

The IC Certification number is affixed inside the equipment. You can find the number when replacing the battery.

02

NOTE:

L'émetteur/récepteur exempt de licence contenu dans le présent appareil est conforme aux CNR d'Innovation, Sciences et Développement économique Canada applicables aux appareils radio exempts de licence.

L'exploitation est autorisée aux deux conditions suivantes :

- (1) L'appareil ne doit pas produire de brouillage;
- (2) L'appareil doit accepter tout brouillage radioélectrique subi, même si le brouillage est susceptible d'en compromettre le fonctionnement.

<Pour 14FBW>

Le numéro d'accréditation IC est apposé à l'intérieur de l'appareil. Ce numéro est visible au remplacement de la pile.

► Millimeter wave radar sensor

FCC ID: HYQDNMWR011

D11 US 01

NOTE:

This device complies with part 15 of the FCC Rules. Operation is subject to the following two conditions: (1) This device may not cause harmful interference, and (2) this device must accept any interference received, including interference that may cause undesired operation.

FCC WARNING:

Changes or modifications not expressly approved by the party responsible for compliance could void the user's authority to operate the equipment.

US 01

Radiofrequency radiation exposure Information:

This equipment complies with FCC radiation exposure limits set forth for an uncontrolled environment. This equipment should be installed and operated with minimum distance of 20 cm between the radiator (antenna) and your body. This transmitter must not be co-located or operating in conjunction with any other antenna or transmitter.

US 02

NOTE:

This device contains licence-exempt transmitter(s)/receiver(s) that comply with Innovation, Science and Economic Development Canada's licence-exempt RSS(s). Operation is subject to the following two conditions:

- (1) This device may not cause interference.
- (2) This device must accept any interference, including interference that may cause undesired operation of the device.

This equipment complies with ISED radiation exposure limits set forth for an uncontrolled environment and meets RSS-102 of the ISED radio frequency (RF) Exposure rules. This equipment should be installed and operated keeping the radiator at least 20 cm or more away from person's body.

CA 01

NOTE:

L'émetteur/récepteur exempt de licence contenu dans le présent appareil est conforme aux CNR d'Innovation, Sciences et Développement économique Canada applicables aux appareils radio exempts de licence. L'exploitation est autorisée aux deux conditions suivantes :

- (1) L'appareil ne doit pas produire de brouillage;
- (2) L'appareil doit accepter tout brouillage radioélectrique subi, même si le brouillage est susceptible d'en compromettre le fonctionnement.

Cet équipement est conforme aux limites d'exposition aux rayonnements énoncées pour un environnement non contrôlé et respecte les règles d'exposition aux fréquences radioélectriques (RF) CNR-102 de l'ISDE. Cet équipement doit être installé et utilisé en gardant une distance de 20 cm ou plus entre le dispositif rayonnant et le corps.

CA 02

► **Tire pressure warning system**

FCC ID: PAXPMVG001

NOTE

This device complies with part 15 of the FCC Rules.

Operation is subject to the following two conditions:

- (1) This device may not cause harmful interference, and
- (2) this device must accept any interference received, including interference that may cause undesired operation.

FCC WARNING

Changes or modifications not expressly approved by the party responsible for compliance could void the user's authority to operate the equipment.

FCC ID: PAXPMVG101

NOTE

This device complies with part 15 of the FCC Rules.

Operation is subject to the following two conditions:

- (1) This device may not cause harmful interference, and
- (2) this device must accept any interference received, including interference that may cause undesired operation.

FCC WARNING

Changes or modifications not expressly approved by the party responsible for compliance could void the user's authority to operate the equipment.

NOTE

This device contains licence-exempt transmitter(s)/ receiver(s) that comply with Innovation, Science and Economic Development Canada's licence-exempt RSS(s).

Operation is subject to the following two conditions:

- (1) This device may not cause interference.
- (2) This device must accept any interference, including interference that may cause undesired operation of the device.

NOTE

L'émetteur/récepteur exempt de licence contenu dans le présent appareil est conforme aux CNR d'Innovation, Sciences et Développement économique Canada applicables aux appareils radio exempts de licence.

L'exploitation est autorisée aux deux conditions suivantes :

- (1) L'appareil ne doit pas produire de brouillage;
- (2) L'appareil doit accepter tout brouillage radioélectrique subi, même si le brouillage est susceptible d'en compromettre le fonctionnement.

“Perchlorate Material – special handling may apply, See www.dtsc.ca.gov/hazardouswaste/perchlorate.”

► BSM (Blind Spot Monitor)

FCC ID : OAYSRR3A

This device complies with part 15 of the FCC Rules. Operation is subject to the following two conditions:

- (1) This device may not cause harmful interference, and
- (2) this device must accept any interference received, including interference that may cause undesired operation.

FCC Warning

Changes or modifications not expressly approved by the party responsible for compliance could void the user's authority to operate the equipment.

C3-002

This device contains licence-exempt transmitter(s)/receiver(s) that comply with Innovation, Science and Economic Development Canada's licence-exempt RSS(s). Operation is subject to the following two conditions:

1. This device may not cause interference.
2. This device must accept any interference, including interference that may cause undesired operation of the device.

Radiofrequency radiation exposure information:

This equipment complies with radiation exposure limits set forth for an uncontrolled environment. This equipment should be installed and operated with minimum distance of 20 cm between the radiator and your body.

C3-005

L'émetteur/récepteur exempt de licence contenu dans le présent appareil est conforme aux CNR d'Innovation, Sciences et Développement économique Canada applicables aux appareils radio exempts de licence. L'exploitation est autorisée aux deux conditions suivantes:

1. L'appareil ne doit pas produire de brouillage;
2. L'appareil doit accepter tout brouillage radioélectrique subi, même si le brouillage est susceptible d'en compromettre le fonctionnement.

Informations sur l'exposition aux rayonnements radiofréquences:
Cet équipement est conforme aux limites d'exposition aux rayonnements définies pour un environnement non contrôlé. Cet équipement doit être installé et utilisé avec un minimum de 20 cm de distance entre la source de rayonnement et votre corps.

C3-006

► Wireless charger

FCC Provided Information:

This equipment has been tested and found to comply with Part 18 of the FCC Rules. These limits are designed to provide reasonable protection against harmful interference in a residential installation. Any changes or modifications not expressly approved by the party responsible for compliance could void the user's authority to operate this equipment. This device complies with Part 18 of the FCC Rules. Operation is subject to the following two conditions:

- (1) This device may not cause harmful interference, and (2) this device must accept any interference received, including interference that may cause undesired operation.

Declaration of Conformity

Trade Name: Panasonic
Model Numbers: AT1701
Responsible Party: Panasonic Corporation of North America
Two Riverfront Plaza, Newark, NJ 07102-5490
Support Contact: <http://shop.panasonic.com/support>

Panasonic

PRODUCT SAFETY AND COMPLIANCE DEPARTMENT . PANASONIC CORPORATION OF NORTH AMERICA . TWO RIVERFRONT PLAZA, 9TH FLOOR, NEWARK, NJ 07102-5490

FCC Declaration of Conformity

Summary

Product Name	In-Vehicle Wireless Charger	
Model Number	AT1701	
Brand Name	Panasonic	
Size and Mass	<ul style="list-style-type: none"> 245mm (w), 136mm (l) and 48mm (h) and mass is 515grams 	
Purpose Updated DoC	Added similarity variant model / AT1701 contains CA-QS03J1AJ	
Compliance Information	<ul style="list-style-type: none"> 47 CFR, FCC Part 18, Subpart C for ISM Equipment FCC's KDB 680106 D01 RF Exposure Wireless Charging Apps v02 Industry Canada RSS-216, Issue 1, dated August 2014 For Wireless Power Transfer Devices (Wireless Chargers) 	
Responsible Applicant	Panasonic Corporation Automotive & Industrial Systems Company Automotive Infotainment Systems Business Division 4261, Ikonobe-cho, Tsuzuki-ku, Yokohama-shi, 224-8520, Japan	
Responsible Factories	<ul style="list-style-type: none"> Panasonic Corporation, Automotive & Industrial Systems Company Automotive Infotainment / Systems Business Division Global Manufacturing Innovation Center, Matsumoto Factory 5652 Sasaga, Matsumoto city, Nagano 399-8730, Japan Panasonic Automotive Systems Czech, s.r.o. U Panasonicu 266, 530 06 Pardubice-Stare Cvice, Czech Republic Panasonic Automotive Systems Asia Pacific (Thailand) Co.,Ltd. 101 Moo 2 Teparak Road, T.Bangsaothong Ging A.Bangsaothong Samutprakarn 10540 Thailand Panasonic Automotive Systems Dalian Co., Ltd. No.300, HongGang Road, GanJingZi District, Dalian, Liaoning Province, 116033 China 	
Responsible Sales Company	Panasonic Consumer Electronics Company Division of Panasonic Corporation of North America Two Riverfront Plaza, Newark, NJ 07102-5490 General Contact: http://shop.panasonic.com/support	
Special Conditions For Compliance	In-Vehicle Wireless Charger will be installed and used exclusively within transportation vehicle and as such, it is exempt from the following requirements: (1) Part 15 digital device technical rules in accordance with §15.103(a); and (2) §15.105(b) full text information to user to appear in User Manual in accordance with §18.213.	
EMI Test Report	TCB	UL Japan
	Test Report	10120384-R2
	Model Tested	AT1701 contains CA-QS03J1AJ
	Date Issued	12/14/2015
	Methodology	FCC-OET MP-4

PRODUCT SAFETY AND COMPLIANCE DEPARTMENT . PANASONIC CORPORATION OF NORTH AMERICA . TWO RIVERFRONT PLAZA, 9TH FLOOR, NEWARK, NJ 07102-5490

Panasonic

PRODUCT SAFETY AND COMPLIANCE DEPARTMENT . PANASONIC CORPORATION OF NORTH AMERICA . TWO RIVERFRONT PLAZA, 9TH FLOOR, NEWARK, NJ 07102-5490

FCC Declaration of Conformity Summary

RF Exposure Evaluation	TCB	UL Japan
	MPE	10197157S-E-R1
	Test Report	
	Model Tested	AT1701 contains CA-QS03J1AJ
	Date Issued	12/14/2015
	Methodology	KDB 680106 D01 RF Exposure Wireless Charging Apps v02
Importation	The subject In-Vehicle Wireless Charger can be imported on behalf of Panasonic affiliated sales companies by PNA's Logistics Import Customs, or their authored brokers, by electrically filing FCC Form 740 while declaring Box 2 with no reference to any FCC ID.	

This DoC is granted for the subject In-Vehicle Wireless Charger on the basis of the manufacturer's attested compliance with the above described conditions and in accordance with FCC Part 18 and FCC's KDB 0680106 D01 RF Exposure Wireless Charging Apps v02.

Certificate Number: DoC 2014-008C
Applicant Ref No.: PAS-16-F001

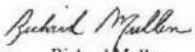
Issued by: Richard Mullen
Issue Date: January 14, 2016

PRODUCT SAFETY AND COMPLIANCE DEPARTMENT . PANASONIC CORPORATION OF NORTH AMERICA . TWO RIVERFRONT PLAZA, 9TH FLOOR, NEWARK, NJ 07102-5490

GAS STATION INFORMATION

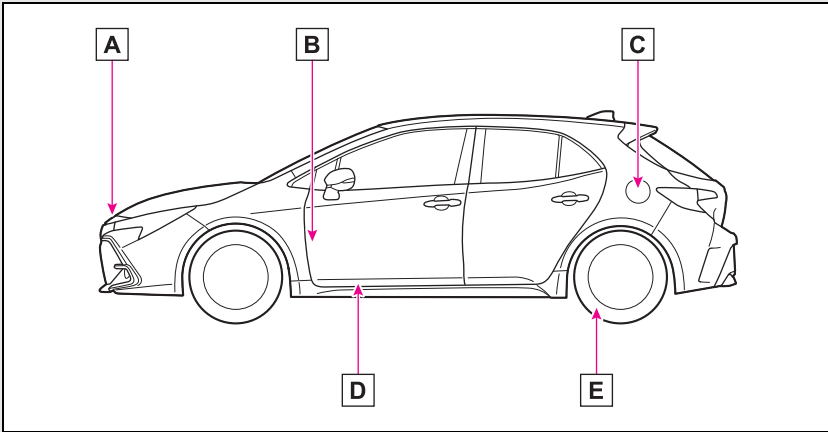

- A** Auxiliary catch lever (→P.279)
- B** Hood lock release lever (→P.279)
- C** Fuel filler door (→P.158)
- D** Fuel filler door opener (→P.158)
- E** Tire inflation pressure (→P.381)

Fuel tank capacity (Reference)	13.2 gal. (50.0 L, 11.0 Imp. gal.)	
Fuel type	Unleaded gasoline only	P.377 P.383
Cold tire inflation pressure		P.381
Engine oil capacity (Drain and refill — reference)		P.378
Engine oil type	“Toyota Genuine Motor Oil” or equivalent	P.378