

[Content](#)

[A-Z](#)



OWNER'S MANUAL.

BMW X2.





WELCOME TO BMW.

Owner's Manual.

Thank you for choosing a BMW.

The more familiar you are with your vehicle, the better control you will have on the road. We therefore strongly suggest:

Read this Owner's Manual before starting off in your new BMW. Also use the Integrated Owner's Manual in your vehicle. It contains important notes on vehicle operation that will help you make full use of the technical features available in your BMW. The manual also contains information designed to enhance operating reliability and traffic safety, and to contribute to maintaining the value of your BMW.

Any updates made after the editorial deadline can be found in the appendix of the printed Owner's Manual for the vehicle.

You can find supplementary information in the additional brochures in the onboard literature.

We wish you a safe and enjoyable ride.

TABLE OF CONTENTS

Navigation, Entertainment and Communication can be called up via the Integrated Owner's Manual in the vehicle.

! NOTES

Information	6
-------------------	---

🔗 QUICK REFERENCE

Getting in	14
Set-up and use	18
On the road	22

🗄️ AT A GLANCE

Dashboard	30
iDrive	34
Voice activation system	42
General settings	45
Owner's Manual media	56

👉 CONTROLS

Opening and closing	58
Seats, mirrors and steering wheel	80
Transporting children safely	91
Driving	97
Displays	120
Lights	136
Safety	141
Driving stability control systems	163
Driving comfort	170
Climate control	190
Interior equipment	198
Storage compartments	211

DRIVING TIPS

Things to remember when driving	216
Loading	221
Reducing fuel consumption	224

MOBILITY

Refueling	232
Fuel	234
Wheels and tires	236
Engine compartment	256
Engine oil	259
Coolant	263
Maintenance	265
Replacing components	267
Breakdown Assistance	274
Vehicle Care	281

REFERENCE

Technical data	286
Appendix	288
Everything from A to Z	290

© 2022 Bayerische Motoren Werke

Aktiengesellschaft

Munich, Germany

Reprinting, including excerpts, only with the written consent of BMW AG, Munich.

US English ID5 II/22, -

Printed on environmentally friendly paper, bleached without chlorine, suitable for recycling.

Information

Using this Owner's Manual

Orientation

The fastest way to find information on a particular topic is by using the index.

An initial overview of the vehicle is provided in the first chapter.

Updates made after the editorial deadline

Due to updates after the editorial deadline, differences may exist between the printed Owner's Manual and the Integrated Owner's Manual in the vehicle.

Notes on updates can be found in the appendix of the printed Owner's Manual for the vehicle.

Owner's Manual for Navigation, Entertainment, Communication

The Owner's Manual for Navigation, Entertainment, and Communication can be obtained as a printed book from the service center.

The topics are also discussed in the Integrated Owner's Manual in the vehicle.

Additional sources of information

Service center

A service center will be glad to answer questions at any time.

Internet

Vehicle information and general information on BMW, for instance, on technology, are available on the Internet: www.bmwusa.com.

Integrated Owner's Manual in the vehicle

The Integrated Owner's Manual specifically describes features and functions found in the vehicle. The Integrated Owner's Manual can be displayed on the Control Display. Additional information, refer to page 56.

BMW Driver's Guide app



Driver's Guide App shows the most suitable information for the selected vehicle. If possible, only equipment and functions that are actually installed in the vehicle will be explained.

BMW Driver's Guide Web

The BMW Driver's Guide Web shows the most suitable information for the selected vehicle. If possible, only equipment and functions that are actually installed in the vehicle will be explained. The BMW Driver's Guide Web can be displayed in any current browser.

Symbols and displays

Symbols in the Owner's Manual

Icon	Meaning
	Precautions that must be followed in order to avoid the possibility of injury to yourself and to others as well as serious damage to the vehicle.
	Measures that can be taken to help protect the environment.
"..."	Texts in vehicle used to select individual functions.

Icon Meaning

>...< Verbal instructions to use with the voice activation system.

»...« Responses generated by the voice activation system.

Action steps

Action steps to be carried out are presented as a numbered list. The steps must be carried out in the defined order.

1. First action step.
2. Second action step.

Enumerations

Enumerations without mandatory order or alternative possibilities are presented as a list with bullet points.

- ▷ First possibility.
- ▷ Second possibility.

Icons on vehicle components

 This symbol on a vehicle component indicates that further information on the component is available in the Owner's Manual.

Vehicle equipment and options

This Owner's Manual describes all models and all standard, country-specific and optional equipment that is offered in the model series. Therefore, this Owner's Manual also describes and illustrates features and functions that are not available in a vehicle, for example because of the selected optional equipment or the country-specific version.

This also applies to safety-related functions and systems.

When using these functions and systems, the applicable laws and regulations must be observed.

For any options and equipment not described in this Owner's Manual, refer to the Supplementary Owner's Manuals.

Your dealer's service center is happy to answer any questions that you may have about the features and options applicable to your vehicle.

Status of the Owner's Manual

Basic information

The manufacturer of your vehicle pursues a policy of constant development that is conceived to ensure that our vehicles continue to embody the highest quality and safety standards. In rare cases, therefore, the features described in this Owner's Manual may deviate from those in your vehicle.

Updates made after the editorial deadline

Due to updates after the editorial deadline, differences may exist between the printed Owner's Manual and the Integrated Owner's Manual in the vehicle.

Notes on updates can be found in the appendix of the printed Owner's Manual for the vehicle.

For Your Own Safety

Intended use

Heed the following when using the vehicle:

- ▷ Owner's Manual.
- ▷ Information on the vehicle. Do not remove stickers.
- ▷ Technical vehicle data.

- ▶ The traffic, speed, and safety laws where the vehicle is driven.
- ▶ Vehicle documents and statutory documents.

Warranty

Your vehicle is technically configured for the operating conditions and registration requirements applying in the country of first delivery, also known as homologation. If your vehicle is to be operated in a different country it might be necessary to adapt your vehicle to potentially differing operating conditions and registration requirements. Noncompliance with homologation requirements in a certain country may affect warranty coverage. Please consult the New Vehicle Limited Warranty Booklet for further information on warranty matters.

Maintenance and repairs

Advanced technology, for instance the use of modern materials and high-performance electronics, requires suitable maintenance and repair work.

The manufacturer of the vehicle recommends that you entrust corresponding procedures to a BMW center. If you choose to use another service facility, BMW recommends use of a facility that performs work, e.g., maintenance and repair, according to BMW specifications with properly trained personnel, referred to in the Owner's Manual as "another qualified service center or repair shop".

If work is performed improperly, for instance maintenance and repair, there is a risk of subsequent damage and related safety risks.

Improperly performed work on the vehicle paintwork can lead to a failure or fault of components, e.g., the radar sensors, and thereby result in a safety hazard.

Parts and accessories

BMW recommends the use of parts and accessory products approved by BMW.

Approved parts and accessories, and advice on their use and installation are available from a BMW center.

BMW parts and accessories have been tested by BMW for their safety and suitability in BMW vehicles.

BMW warrants genuine BMW parts and accessories.

BMW does not evaluate whether each individual product from another manufacturer can be used with BMW vehicles without presenting a safety hazard, even if a country-specific official approval was issued. BMW does not evaluate whether these products are suitable for BMW vehicles under all usage conditions.

California Proposition 65 Warning

For vehicles sold in California, the law requires vehicle manufacturers to provide the following warning:

Warning

Engine exhaust and a wide variety of Automobile components and parts, including components found in the interior furnishings in a vehicle, contain or emit chemicals known to the State of California to cause cancer and birth defects and reproductive harm. In addition, certain fluids contained in vehicles and certain products of component wear contain or emit chemicals known to the State of California to cause cancer and birth defects or other reproductive harm. Battery posts, terminals and related accessories contain lead and lead compounds. Batteries also contain other chemicals known to the State of California to cause cancer. Wash your hands after handling. Used engine oil contains chemicals that have caused cancer in laboratory animals. Always protect your skin by washing thoroughly with soap and water. For more information go to www.P65Warnings.ca.gov/passenger-vehicle.

⚠ Warning

Operating, servicing and maintaining a passenger vehicle or off-highway motor vehicle can expose you to chemicals including engine exhaust, carbon monoxide, phthalates, and lead, which are known to the State of California to cause cancer and birth defects or other reproductive harm. To minimize exposure, avoid breathing exhaust, do not idle the engine except as necessary, service your vehicle in a well-ventilated area and wear gloves or wash your hands frequently when servicing your vehicle. For more information go to www.P65Warnings.ca.gov/passenger-vehicle.

Service and warranty

We recommend that you read this publication thoroughly. Your vehicle is covered by the following warranties:

- ▷ New Vehicle Limited Warranty.
- ▷ Rust Perforation Limited Warranty.
- ▷ Federal Emissions System Defect Warranty.
- ▷ Federal Emissions Performance Warranty.
- ▷ California Emission Control System Limited Warranty.

Detailed information about these warranties is listed in the New Vehicle Limited Warranty Booklet.

Your vehicle has been specifically adapted and designed to meet the particular operating conditions and homologation requirements in your country and continental region in order to deliver the full driving pleasure while the vehicle is operated under those conditions. If you wish to operate your vehicle in another country or region, you may be required to adapt your vehicle to meet different prevailing operating conditions and homologation requirements. You should also be aware of any applicable warranty limitations or exclusions for such country

or region. In such case, please contact Customer Relations for further information.

Maintenance

Maintain the vehicle regularly to sustain the road safety, operational reliability and the New Vehicle Limited Warranty.

Specifications for maintenance measures:

- ▷ BMW maintenance system.
Maintenance, refer to page 265.
- ▷ Maintenance Booklet, available online and accessible via a QR code in the New Vehicle Limited Warranty Booklet.
- ▷ Warranty and Service Guide Booklet for Canadian models.

If the vehicle is not maintained or is improperly maintained, this could result in serious damage to the vehicle.

A failure to maintain your vehicle or improper maintenance may affect your warranty coverage. Please consult the New Vehicle Limited Warranty Booklet for further information on warranty matters.

Refer to section on engine oil change regarding recommended service intervals for oil changes.

Data memory

General information

Electronic control devices are installed in the vehicle. Electronic control units process data they receive from vehicle sensors, self-generate or exchange with each other. Some control units are necessary for the vehicle to function safely or provide assistance during driving, for instance driver assistance systems. Furthermore, control units facilitate comfort or infotainment functions.

Information about stored or exchanged data can be requested from the manufacturer of the vehicle, in a separate booklet, for example.

Personal reference

Each vehicle is marked with a unique vehicle identification number. Depending on the country, the vehicle owner can be identified with the vehicle identification number, license plate and corresponding authorities. In addition, there are other options to track data collected in the vehicle to the driver or vehicle owner, for instance, via the ConnectedDrive account that is used.

Operating data in the vehicle

Control units process data to operate the vehicle.

For example, this includes:

- ▶ Status messages for the vehicle and its individual components, e.g., wheel RPM, wheel speed, deceleration, lateral acceleration, engaged seat belt indicator.
- ▶ Ambient conditions, e.g., temperature, rain sensor signals.

The processed data is only processed in the vehicle itself and generally volatile. The data is not stored beyond the operating period.

Electronic components, e.g. control units and vehicle keys, contain components for storing technical information. Information about the vehicle condition, component usage, maintenance recommendations, events or faults can be stored temporarily or permanently.

This information generally documents the state of a component, a module, a system, or the surrounding area, for instance:

- ▶ Operating states of system components, for instance, fill levels, tire pressure, battery status.
- ▶ Malfunctions and faults in important system components, for instance lights and brakes.
- ▶ Responses by the vehicle to special driving situations such as airbag deployment or

engagement of the driving stability control systems.

- ▶ Information on vehicle-damaging events.

The data is required to perform the control unit functions. Furthermore, it also serves to detect and correct malfunctions, and helps the vehicle manufacturer to optimize vehicle functions.

The majority of this data is stored temporarily and is only processed within the vehicle itself. In some circumstances the vehicle may store some data for an additional but limited period of time.

When servicing, for instance during repairs, service processes, warranty cases, and quality assurance measures, this technical information can be read out from the vehicle together with the vehicle identification number.

A dealer's service center or another qualified service center or repair shop can read out the information. The diagnostic socket required by law in the vehicle is used to read out data.

The data is collected, processed, and used by the relevant organizations in the service network. The data documents technical conditions of the vehicle, which can be used to determine vehicle maintenance status, and facilitate quality improvement.

Fault and event memories in the vehicle can be reset when a dealer's service center or another qualified service center or repair shop performs repair or servicing work.

Data entry and data transfer into the vehicle

General information

Depending on the vehicle equipment, comfort and individual settings can be stored in the vehicle and modified or reset at any time.

For example, this includes:

- ▶ Settings for the seat and steering wheel positions.
- ▶ Chassis and climate control settings.

If necessary, data can be transferred to the entertainment and communication system of the vehicle, for instance via smartphone.

This includes the following depending on the respective equipment:

- ▶ Multimedia data such as music, films or photos for playback in an integrated multimedia system.
- ▶ Address book data for use in conjunction with an integrated hands-free system or an integrated navigation system.
- ▶ Entered navigation destinations.
- ▶ Data on the use of Internet services.

This data can be stored locally in the vehicle or is found on a device that has been connected to the vehicle, e.g., a smartphone, USB stick or MP3 player. If this data is stored in the vehicle, it can be deleted at any time.

This data is only transmitted to third parties upon personal request as part of the use of online services. The transmission depends on the selected settings for the use of the services.

Incorporation of mobile devices

Depending on the vehicle equipment, mobile devices connected to the vehicle, for instance smartphones, can be controlled via the vehicle control elements.

The sound and picture from the mobile devices can be played back and displayed through the multimedia system. Certain information is transferred to the mobile devices at the same time. Depending on the type of incorporation, this includes, for instance position data and other general vehicle information. This optimizes the way in which selected apps, for instance navigation or music playback, work.

There is no further interaction between the mobile device and the vehicle, such as active access to vehicle data.

How the data will be processed further is determined by the provider of the particular app being used. The extent of the possible settings

depends on the respective app and the operating system of the mobile device.

Services

General information

If the vehicle has a wireless network connection, it will enable data to be exchanged between the vehicle and other systems. The wireless network connection is realized via an in-vehicle transmitter and receiver unit or via personal mobile devices brought into the vehicle, for instance smartphones. This wireless network connection enables 'online functions' to be used. These include online services and apps supplied by the vehicle manufacturer or by other providers.

Services from the vehicle manufacturer

Where online services from the vehicle manufacturer are concerned, the corresponding functions are described in the appropriate place, for instance the Owner's Manual or manufacturer's web page. The relevant legal information pertaining to data protection may also be found on the manufacturer's website. Personal data may be used to perform online services. Data is exchanged over a secure connection, for instance with the IT systems of the vehicle manufacturer intended for this purpose.

Any collection, processing, and use of personal data above and beyond that needed to provide the services must always be based on a legal permission, contractual arrangement or consent. It is also possible to activate or deactivate the data connection as a whole. That is, with the exception of functions and services required by law such as Assist systems.

Services from other providers

When using online services from other providers, these services are the responsibility of the relevant provider and subject to their data privacy conditions and terms of use. The vehicle manufacturer has no influence on the content

exchanged during this process. Information on the way in which personal data is collected and used in relation to services from third parties, the scope of such data, and its purpose, can be obtained from the relevant service provider.

Event Data Recorder EDR

This vehicle is equipped with an event data recorder EDR. The main purpose of an EDR is to record, in certain crash or near crash-like situations, such as an air bag deployment or hitting a road obstacle, data that will assist in understanding how a vehicle's systems performed. The EDR is designed to record data related to vehicle dynamics and safety systems for a short period of time, typically 30 seconds or less.

The EDR in this vehicle is designed to record such data as:

- ▶ How various systems in your vehicle were operating.
- ▶ Whether or not the driver and passenger seat belts were fastened.
- ▶ How far, if at all, the driver was depressing the accelerator and/or brake pedal.
- ▶ How fast the vehicle was traveling.

This data can help provide a better understanding of the circumstances in which crashes and injuries occur.

EDR data is recorded by your vehicle only if a nontrivial crash situation occurs; no data is recorded by the EDR under normal driving conditions and no personal data, for instance name, gender, age, and crash location, are recorded.

However, other parties, such as law enforcement, could combine the EDR data with the type of personally identifying data routinely acquired during a crash investigation.

To read data recorded by an EDR, special equipment is required, and access to the vehicle or the EDR is needed. In addition to the vehicle manufacturer, other parties, such as law

enforcement, that have the special equipment, can read the information if they have access to the vehicle or the EDR.

Vehicle identification number

General information

Depending on the national-market equipment, the vehicle identification number is located in different positions in the vehicle. This chapter describes all possible positions for the series.

Engine compartment

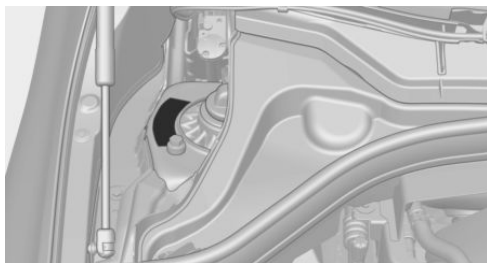

The engraved vehicle identification number can be found in the engine compartment, on the right-hand side of the vehicle.

Right nameplate

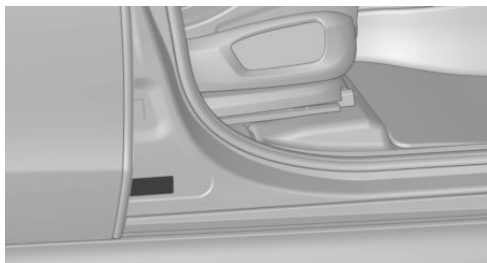

The vehicle identification number can be found on the nameplate, on the right-hand side of the vehicle.

Left nameplate

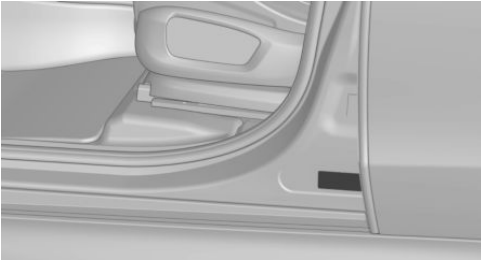

The vehicle identification number can be found on the nameplate, on the left-hand side of the vehicle.

Windshield



The vehicle identification number can also be found behind the windshield.

iDrive

It is also possible to display the vehicle identification number via iDrive, refer to page 50.

Reporting safety defects

For US customers

The following only applies to vehicles owned and operated in the US.

If you believe that your vehicle has a defect which could cause a crash or could cause injury or death, you should immediately inform the National Highway Traffic Safety Administration NHTSA, in addition to notifying BMW of

North America, LLC, P.O. Box 1227, Westwood, New Jersey 07675-1227, Telephone 1-800-831-1117.

If NHTSA receives similar complaints, it may open an investigation, and if it finds that a safety defect exists in a group of vehicles, it may order a recall and remedy campaign.

However, NHTSA cannot become involved in individual problems between you, your dealer, or BMW of North America, LLC.

To contact NHTSA, you may call the Vehicle Safety Hotline toll-free at 1-888-327-4236 (TTY: 1-800-424-9153); go to <http://www.safercar.gov>; or write to: Administrator, NHTSA, 1200 New Jersey Avenue, SE., Washington, DC 20590. You can also obtain other information about motor vehicle safety from <http://www.safercar.gov>.

For Canadian customers

Canadian customers who wish to report a safety-related defect to Transport Canada, Defect Investigations and Recalls, may call the toll-free hotline 1-800-333-0510. You can also obtain other information about motor vehicle safety from <http://www.tc.gc.ca/roadsafety>.

Getting in

Opening and closing

Buttons on the vehicle key

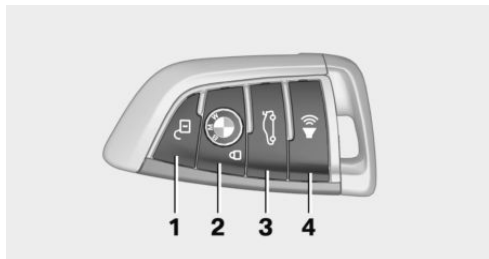

- 1 Unlocking
- 2 Locking
- 3 Unlocking the tailgate
With automatic trunk lid actuation: open the tailgate
- 4 Panic mode

Unlocking the vehicle

 Press the button on the vehicle key.

Depending on the settings, either only the driver's door or all vehicle access points are unlocked.

If only the driver's door is unlocked, press the button on the vehicle key again to unlock the other vehicle access points.

 Press and hold the button on the vehicle key after unlocking.

The windows and the glass sunroof are opened, as long as the button on the vehicle key is pressed.

Locking the vehicle

 Press the button on the vehicle key.

All vehicle access points are locked.

Buttons for the central locking system

Overview



Buttons for the central locking system.

Locking

 Press the button with the front doors closed.

The fuel filler flap remains unlocked.

Unlocking

 Press the button.

Panic mode

You can trigger the alarm system if you find yourself in a dangerous situation.

 Press the button on the vehicle key for at least 3 seconds.

To switch off the alarm: press any button.

Comfort Access

Principle

The vehicle can be accessed without operating the vehicle key.

Carrying the vehicle key with you, e.g., in your pants pocket, is sufficient.

The vehicle automatically detects the vehicle key when it is in close proximity or in the interior.

Unlocking the vehicle

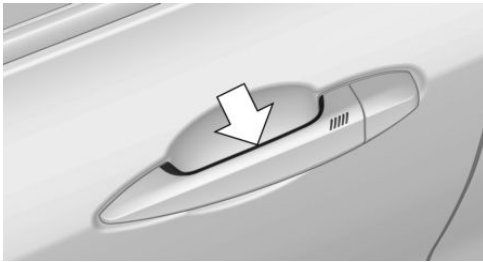

Grasp the door handle on the driver's or front passenger door completely.

Locking the vehicle



Touch the surface on the door handle of the driver's or front passenger door with your finger for approx. 1 second without grasping the door handle.

With automatic trunk lid actuation: contactless trunk opening and closing

Principle

The trunk can be opened and closed contactless using the vehicle key you are carrying.

Performing the foot movement

1. Stand in the middle behind the vehicle at approx. one arm's length away from the rear of the vehicle.
2. Wave a foot under the vehicle in the driving direction and immediately pull it back. With this movement, the leg must pass through the ranges of both sensors.

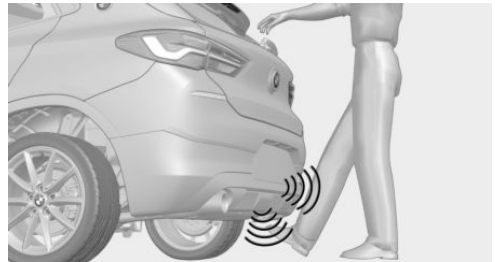

Tailgate

Opening



- ▶ Unlock the vehicle and press the top half of the BMW plaque.
- ▶ If carrying the vehicle key, press the top half of the BMW plaque.
- ▶  Press the button on the vehicle key for approx. 1 second.

Depending on the setting, the doors may also be unlocked.

Closing



▶ Press button on the inside of the tailgate, arrow 1.

▶ Press button, arrow 2.

The vehicle will be locked after closing the tailgate. The driver's door must be closed for this purpose and the vehicle key must be outside of the vehicle in the area of the tailgate.

Displays and control elements

In the vicinity of the steering wheel

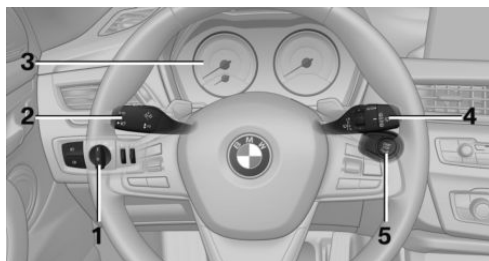

- 1 Light switch element
- 2 High beams, headlight flasher, turn sig.
- 3 Instrument cluster
- 4 Window wiper system
- 5 Start/Stop button

Indicator/warning lights

The indicator/warning lights can light up in a variety of combinations and colors.

Several of the lights are checked for proper functioning and light up temporarily when the engine is started or the ignition is switched on.

Driver's door

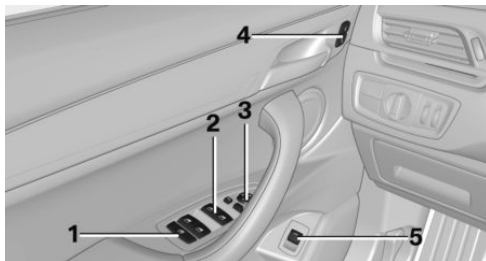

- 1 Safety switch
- 2 Power windows
- 3 Exterior mirrors
- 4 Central locking system
- 5 With automatic trunk lid actuation: opening/closing the tailgate

Switch console

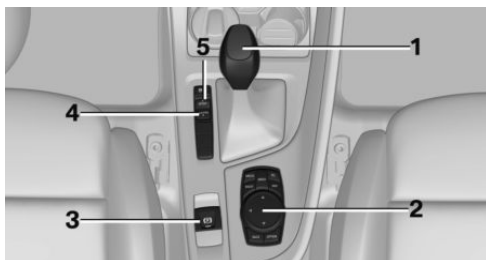

- 1 Selector lever
- 2 Controller
- 3 Parking brake
- 4 Driver assistance systems
- 5 Driving Dynamics Control

iDrive

Principle

The iDrive combines the functions of many switches. These functions can be operated via the Controller.







If no other commands are possible, operate the function via iDrive.

Ending the voice control system



Press the button on the steering wheel or >Cancel.

Buttons on the Controller

Button	Function
	Press once: calls up the main menu. Press twice: displays all menu items of the main menu.
	Call up the Communication menu.
	Call up the Media/Radio menu.
	Call up the destination input menu for navigation.
	Call up the navigation map.
	Press once: opens the previous display. Press and hold: open the menus used last.
	Call up the Options menu.

Voice control

Activating the voice control system

-  Press the button on the steering wheel.
- Wait for the signal tone.
- Say the command.



This icon indicates that the voice activation system is active.

Set-up and use

Seats, mirrors and steering wheel

Electrically adjustable seats

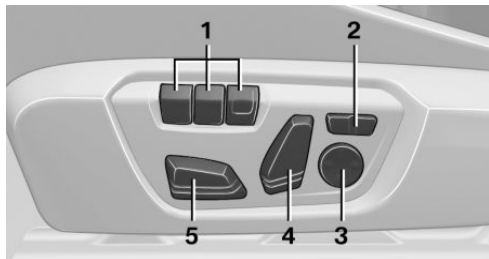

- 1 Memory function
- 2 Backrest width
- 3 Lumbar support
- 4 Backrest tilt
- 5 Longitudinal direction, height, inclination

Adjusting the head restraint

Height

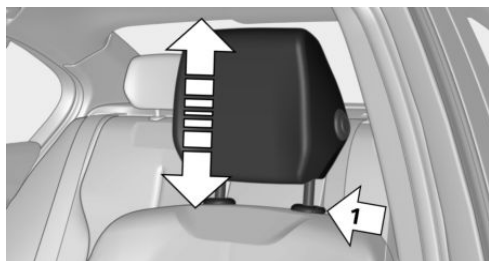

- ▶ To raise: push the head restraint up.
- ▶ To lower: press button, arrow 1, and push head restraint down.

For equipment specification with M sport seat:
The height of the head restraints cannot be set.

Adjusting the exterior mirrors



- 1 Adjusting
- 2 Selecting a mirror, Automatic Curb Monitor
- 3 Folding in and out

Adjusting the steering wheel

Manual steering wheel adjustment

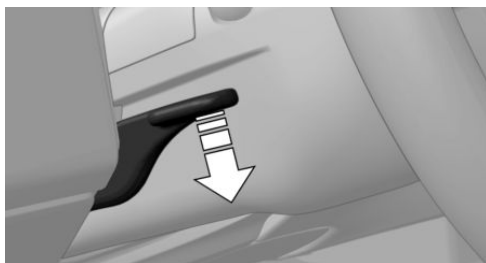

- 1. Fold the lever down.
- 2. Move the steering wheel to the preferred height and angle to suit your seat position.
- 3. Fold the lever back up.

Memory function

Principle

The following settings can be stored and, if necessary, retrieved using the memory function:

- ▷ Seat position.
- ▷ Exterior mirror position.
- ▷ Height of the Head-up Display.

Storing

1. Turn on the ignition.
2. Set the desired position.
3.  Press the button. The LED in the button lights up.
4. Press the desired button 1 or 2 while the LED is lit. The LED goes out.

Calling up settings

Press the desired button 1 or 2.

The stored position is called up automatically.



The procedure stops when a seat setting switch or one of the memory buttons is pressed.







The adjustment of the seat position on the driver's side is interrupted after a short time while driving.

Infotainment

Radio

Buttons and functions

Button	Function
	Press: turns sound output on/off. Turn: adjusts the volume.
	Change the entertainment source.

Button	Function
	Press once: changes the station/track. Press and hold: fast forward/fast rewind the track.
	Programmable memory buttons.
	
	ConnectedDrive. Depending on the vehicle equipment, programmable memory button 8 is replaced with this button.
	Changeover of wave range/satellite radio.
	
	Eject CD/DVD.

Navigation destination input

Entering a destination via address

Via iDrive:

State/province

1. "Navigation"
2.  "Enter address"
3. "State/Province?"
4. Select the country from the list.

Entering the address

The address can be entered in any order.

Example: entering the address via the town/city

1. "City/Postal code?"
2. Enter the town/city.

The list is narrowed down further with each entry.

3. **OK** Select the icon.
4. Select a town/city from the list.
5. If necessary, enter the street.
6. Select the street as you would the town/city.
7. If necessary, enter a house number.
8. **OK** Select the icon.
9. Select a house number or range of house numbers from the list.

Starting destination guidance

"Start guidance"

Destination guidance is started to the town/city center if no street is entered.

Connecting a mobile phone

After the mobile phone is connected once to the vehicle, the mobile phone can be operated using iDrive, the steering wheel buttons and spoken instructions.

1. "My Vehicle"
2. "iDrive settings"
3. "Mobile devices"
4. "Connect new device"
5. Select the functions for which the mobile phone is to be used.

The vehicle's Bluetooth name is displayed on the Control Display.

6. To perform additional steps on the mobile phone, refer to the mobile phone operating instructions: e.g., search for or connect the Bluetooth device or a new device.

The Bluetooth name of the vehicle appears on the mobile phone display. Select the Bluetooth name of the vehicle.

7. Depending on the mobile device, a control number is displayed or the control number must be entered.

- ▶ Compare the control number displayed on the Control Display with the control number on the display of the device.

Confirm the control number on the device and on the Control Display.

- ▶ Enter and confirm the same control number on the device and via iDrive.

The device is connected and displayed in the device list.

Using the telephone

Accepting a call

Incoming calls can be accepted via iDrive or the button on the steering wheel.

Via iDrive

 "Accept"

Via the button on the steering wheel



Press the button.

Dialing a number

1. "Communication"
2. "Dial number"
3. Enter the numbers.
4.  Select the icon. The connection is established via the mobile phone to which this function has been assigned.

Establish the connection via the additional telephone:

1.  Press the button.
2. "Call via"

Apple CarPlay preparation

Principle

CarPlay allows select functions of a compatible Apple iPhone to be used via Siri voice control and iDrive.

Functional requirements

- ▷ Compatible iPhone: iPhone 5 or later with iOS 7.1 or later.
- ▷ Corresponding mobile contract.
- ▷ Bluetooth, Wi-Fi, and Siri voice control are activated on the iPhone.
- ▷ Wi-Fi and Bluetooth are enabled in the vehicle.
- ▷ If necessary, the setting for mobile data must be activated on the iPhone.

Turning on Bluetooth and CarPlay

Via iDrive:

1. "My Vehicle"
2. "iDrive settings"
3. "Mobile devices"
4. "Settings"
5. Select the following settings:
 - ▷ "Bluetooth®"
 - ▷ "Apple CarPlay"

Pairing the iPhone with CarPlay

Pair iPhone via Bluetooth with the vehicle.

Select CarPlay as the function:

- ▶ "Apple CarPlay"

The iPhone is connected to the vehicle and displayed in the device list.

On the road

Driving

Starting and stopping the engine

Ignition on/off



▶ On: press the Start/Stop button.

Most of the indicator/warning lights light up for a varied length of time.

▶ Off: press the Start/Stop button again.

All indicator lights turn off.

▶ Radio-ready state: when the ignition is switched off, press the ON/OFF button on the radio or when the engine is running, press the Start/Stop button.

Some electrical components remain ready for operation.

Start/stop engine

Steptronic transmission: starting

1. Depress the brake pedal.
2. Press the Start/Stop button.

Steptronic transmission: switching off

1. When the vehicle is stationary, apply the parking brake.
2. Engage selector lever position P.
3. Press the Start/Stop button.

Auto Start/Stop function

Steptronic transmission: switches the engine off automatically to save fuel. The engine starts automatically when the brake pedal is released.

Parking brake

Setting



Pull the switch.

The LED on the switch and the indicator light in the instrument cluster are illuminated.

Releasing



With the ignition switched on:

Steptronic transmission: press the switch while the brake is pressed or selector lever position P is set.

The LED and indicator light turn off.

The parking brake is released.

Steptronic transmission

Selector lever positions

Parking position P.

R is reverse.

Neutral N.

Gear position D.

Engage selector lever position P or R only when the vehicle is stationary.

To prevent the vehicle from creeping after you select a gear position or reverse, maintain pressure on the brake pedal until you are ready to drive off.

Selector lever lock

A lock prevents an inadvertent change from selector lever position P to another selector lever position and, depending on the transmission version, inadvertent switching to selector lever position P or R.

To release the lock: with the brake pedal depressed, press the button on the front or side of the selector lever.

Steptronic transmission, Sport program and manual mode

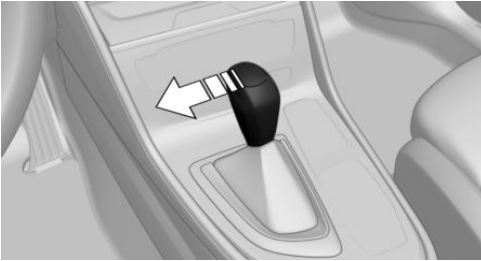

Sport program:

Press the selector lever to the left from selector lever position D.

Manual mode:

- ▶ Downshifting: press the selector lever forward.
- ▶ Upshifting: pull the selector lever rearwards.

High beams, headlight flasher, turn signal, roadside parking light

High beams, headlight flasher

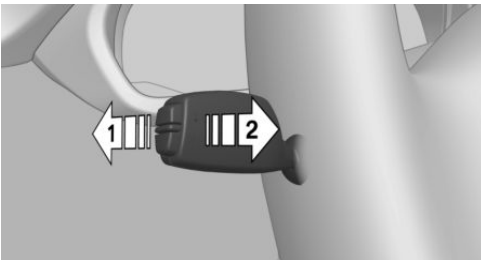

Press the lever forward or pull it backward.

- ▶ High beams on, arrow 1.
The high beams light up when the low beams are switched on.
- ▶ High beams off/headlight flasher, arrow 2.

Turn signal

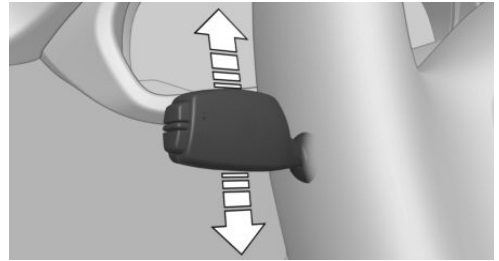

- ▶ Blinking: press the lever past the resistance point.
- ▶ Triple turn signal activation: lightly tap the lever up or down.
- ▶ Brief blinking: press the lever to the resistance point and hold it there for as long as you want the turn signal to blink.

Canada: roadside parking light

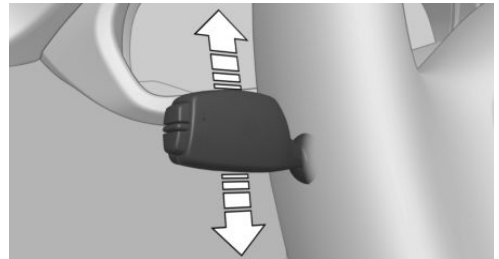







To illuminate the vehicle on one side.

- ▶ On: with the ignition switched off, press the lever either up or down past the resistance point for approx. 2 seconds.
- ▶ Off: briefly press the lever to the resistance point in the opposite direction.

Lights and lighting

Lighting functions

Icon	Function
	Bad weather light.
	Automatic headlight control. Cornering light and variable light distribution. Cornering light.
	Lights off. Daytime driving lights.
	Parking lights.
	Low beams.
	Instrument lighting.

Window wiper system

Turning the wipers on/off and flick wipe

Turning on

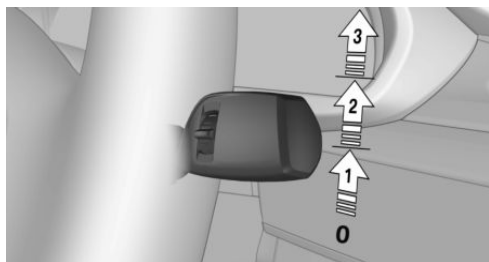

Press the lever up until the desired position is reached.

- ▶ Resting position of the wipers: position 0.
- ▶ Rain sensor: position 1.
- ▶ Normal wiper speed: position 2.
- ▶ Fast wiper speed: position 3.

Turning off and flick wipe

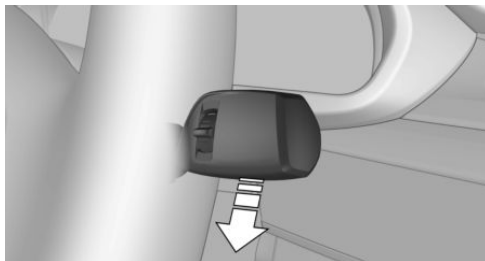

Press the lever down.

- ▶ Switching off: press the lever down until it reaches its basic setting.
- ▶ Flick wipe: press the lever down from the basic setting.

Rain sensor

Activate/deactivate

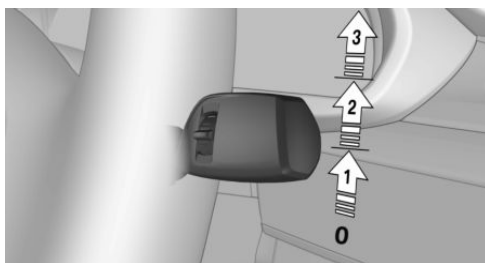

To activate: press the lever up once from its basic setting, arrow 1.

To deactivate: press the lever back into the basic setting.

Set interval period or sensitivity of the rain sensor

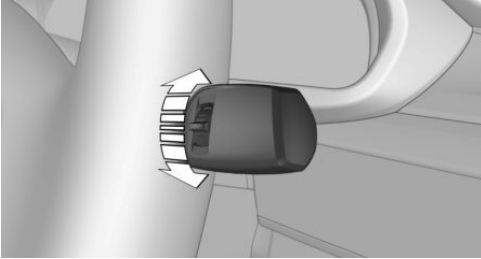

Turn the thumbwheel on the wiper lever.

Cleaning the windshield and headlights

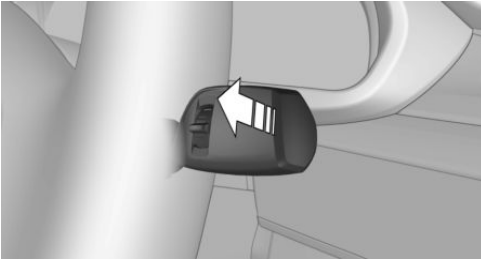

Pull the lever.

Rear wiper

Turning on

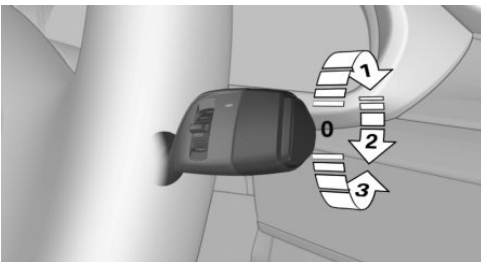

Turn the outer switch upward.

- ▷ Resting position of the wiper, position 0.
- ▷ Intermittent operation, arrow 1. When reverse gear is engaged, the system switches to continuous operation.

Clean the rear window

Turn the outer switch in the desired direction.

- ▷ In resting position: turn the switch downward, arrow 3. The switch automatically returns to its idle position when released.
- ▷ In intermittent operation: turn the switch further, arrow 2. The switch automatically returns to its interval position when released.

Canada: window wiper system Window wiper system

Turning the wipers on/off and flick wipe

Turning on

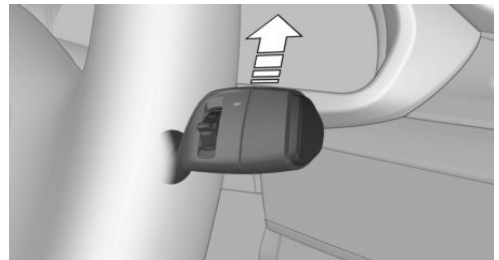

- ▷ Normal wiper speed: tap up once.
- ▷ Fast wiper speed: tap up twice or tap once beyond the resistance point.

Turning off and flick wipe

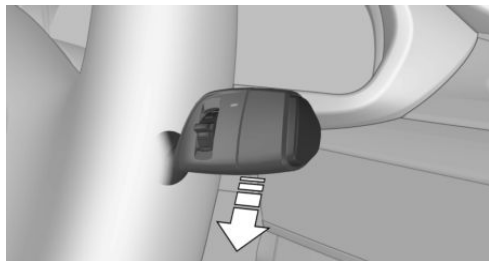

Push wiper lever down.

- ▶ Flick wipe: press down once.
- ▶ To turn off normal wipe: press down once.
- ▶ To turn off fast wipe: press down twice.

Rain sensor

Activate/deactivate

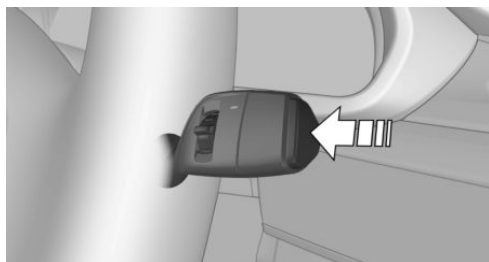

Press the button on the wiper lever.

Adjusting the sensitivity

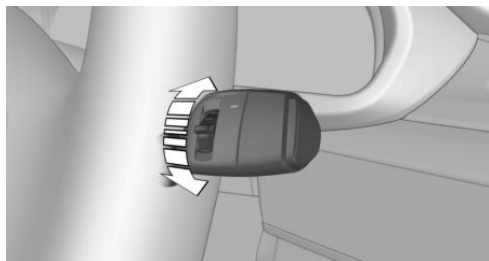

Turn the thumbwheel on the wiper lever.

Cleaning the windshield and headlights

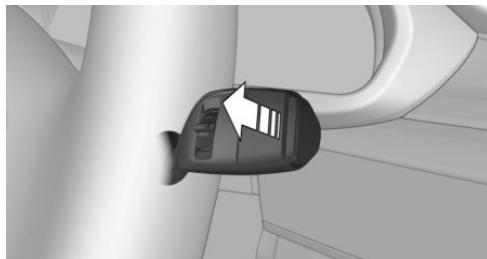

Pull the wiper lever towards you.

Rear wiper

Turning on

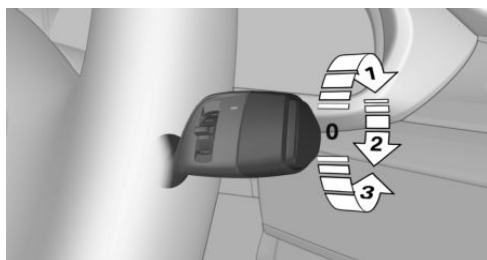

Turn the outer switch upward.

- ▶ Resting position of the wiper, position 0.
- ▶ Intermittent operation, arrow 1. When reverse gear is engaged, the system switches to continuous operation.







Clean the rear window

Turn the outer switch in the desired direction.





- ▶ In resting position: turn the switch downward, arrow 3. The switch automatically returns to its idle position when released.
- ▶ In intermittent operation: turn the switch further, arrow 2. The switch automatically returns to its interval position when released.





Climate control

Air conditioning system

Button	Function
	Temperature.
	Air conditioning.
	Air recirculation mode.
	Air flow, manual.
	Air distribution, manual.
	Rear window defroster.
	Seat heating.

Automatic climate control

Button	Function
	Temperature.
	Air conditioning.
	Maximum cooling.
	AUTO program.

Button	Function
	Recirculated-air mode/AUC.
	Air flow, manual.
	Air distribution, manual.
	SYNC program.
	Defrost and defog window.
	Rear window defroster.
	Seat heating.
	Turns off the system.

Refueling stop

Refueling

Fuel cap

1. To open the fuel filler flap, press on the rear edge, arrow. The fuel filler flap opens.



2. Turn the fuel cap counterclockwise.
3. Place the fuel cap in the bracket attached to the fuel filler flap.

Gasoline

For the best fuel efficiency, the gasoline should be sulfur-free or very low in sulfur content.

Refuel only with unleaded gasoline without metallic additives.

Information on the recommended gasoline quality can be found in the Owner's Manual.

Wheels and tires

Tire pressure specifications

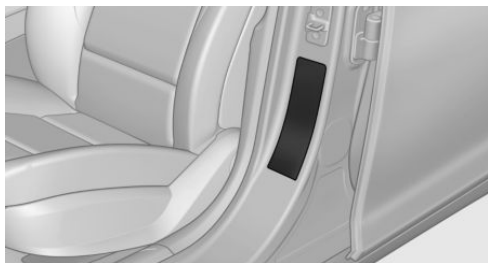

The tire inflation pressure values can be found on the sign on the door pillar.

After correcting the tire pressure

For flat tire monitor: reinitialize flat tire monitor.

For Tire Pressure Monitor: reset the Tire Pressure Monitor.

Checking the tire pressure

Regularly check the tire inflation pressure and correct it as needed:

- ▷ At least twice a month.
- ▷ Before embarking on an extended trip.

Electronic oil measurement

Prerequisites

A current measured value is available after approx. 30 minutes of driving. During a shorter trip, the status of the last, sufficiently long trip is displayed.

Displaying the engine oil level

1. "My Vehicle"
2. "Vehicle status"
3.  "Engine oil level"

Adding engine oil

General information

Turn off the ignition and safely park the vehicle before engine oil is added.

Adding engine oil

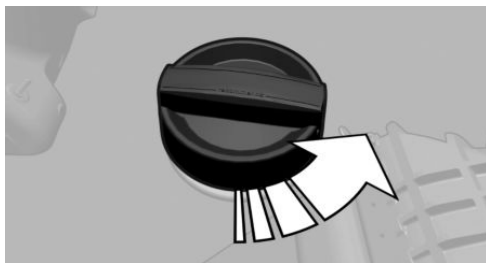

Only add engine oil when the message is displayed in the instrument cluster.

Observe the top-up quantity in the message.

Take care not to add too much engine oil.

Observe recommended engine oil types.

Providing assistance

Hazard warning flashers

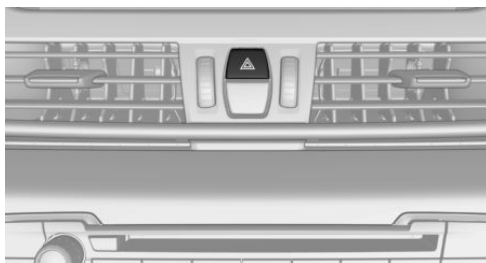

The button is located in the center console.

Breakdown Assistance

BMW Roadside Assistance

Via iDrive:

1. "ConnectedDrive"
2. "BMW Assist"
3. "BMW Roadside Assistance"

A voice connection is established to BMW Roadside Assistance.

ConnectedDrive

Concierge service

The BMW Assist Concierge service offers information on events, filling stations or hotels, and provides phone numbers and addresses. Many hotels can be booked directly by the BMW Concierge service. The Concierge service is part of the optional BMW Assist Response Center.

1. "ConnectedDrive"
2. "Concierge"

Teleservices

Teleservices are services that help to maintain vehicle mobility.

Depending on the equipment version, Teleservices comprise the following services:

- ▶ Roadside Assistance.
- ▶ Teleservice Call.
- ▶ Automatic Teleservice Call.
- ▶ Your dealer's service center.

Dashboard

Vehicle features and options

This chapter describes all standard, country-specific and optional features offered with the series. It also describes features and functions that are not necessarily available in your vehi-

cle, e.g., due to the selected options or country versions. This also applies to safety-related functions and systems. When using these functions and systems, the applicable laws and regulations must be observed.

In the vicinity of the steering wheel

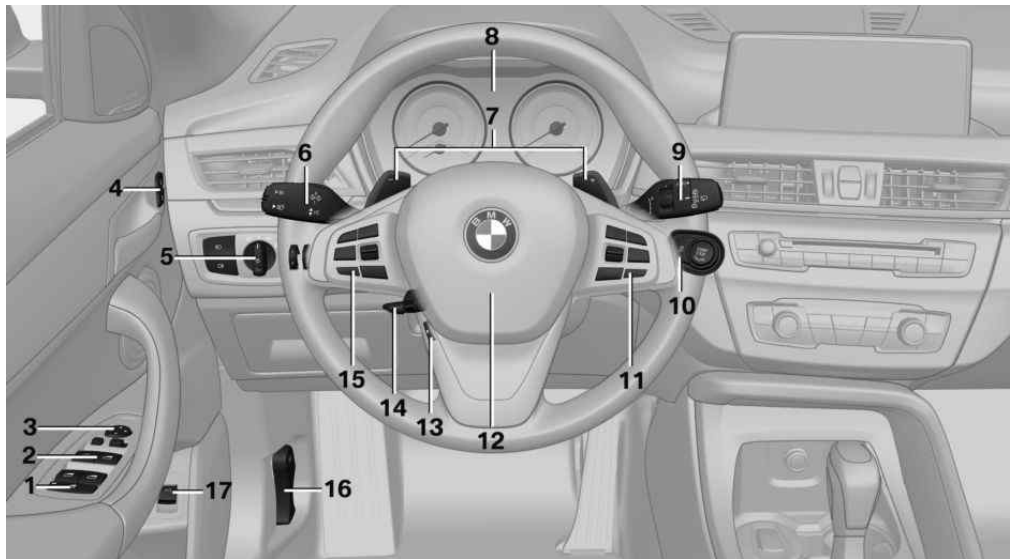

- 1 Rear window safety switch [77](#)
- 2 Power windows [76](#)
- 3 Exterior mirror adjustment button [88](#)
- 4 Central locking system



Unlocking [63](#)



Locking [63](#)

- 5 Lights



Bad weather light [139](#)



























Light switch [136](#)



Lights off
Daytime driving lights [138](#)



Parking lights [136](#)

-  Low beams [136](#)
-  Automatic headlight control [137](#)
Cornering light [138](#)
Automatic High Beam Assistant [138](#)
-  Instrument lighting [139](#)
- 6** Pitman arm, left
-  Turn signal [103](#)
-  High beams, headlight flasher [103](#)
-  Automatic High Beam Assistant [138](#)
-  Roadside parking lights [137](#)
-  Trip computer [129](#)
- 7** Shift paddles [112](#)
- 8** Instrument cluster [120](#)
- 9** Pitman arm, right
-  Wipers [104](#)
Wiper on Canadian models [108](#)
-  Rain sensor [105](#)
Rain sensor on Canadian models [109](#)
-  Cleaning the windshield [106](#)
-  Rear wiper in Canadian models [110](#)
-  Rear wiper [106](#)
-  Clean the rear window [106](#)
- 10**  Start/stop the engine and switch the ignition on/off [98](#)
-  Auto Start/Stop function [99](#)
- 11** Steering wheel buttons, right
-  Entertainment source
-  Volume
-  Voice control [42](#)
-  Telephone, see Owner's Manual for Navigation, Entertainment and Communication [6](#)
- Thumbwheel for selection lists [129](#)
- 12**  Horn, entire surface
- 13**  Steering wheel heating [90](#)
- 14** Adjusting the steering wheel [90](#)
- 15** Steering wheel buttons, left
-  Cruise control on/off [176](#)
-  Active Cruise Control on/off [170](#)
-  Cruise control: to store the speed
-  Interrupting, continuing cruise control



Camera-based cruise control: reduce distance



Camera-based cruise control: increase distance

Cruise control rocker switch

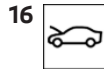

Unlocking the hood [257](#)

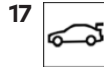

With automatic trunk lid actuation: open/close the tailgate [67](#)

In the vicinity of the center console

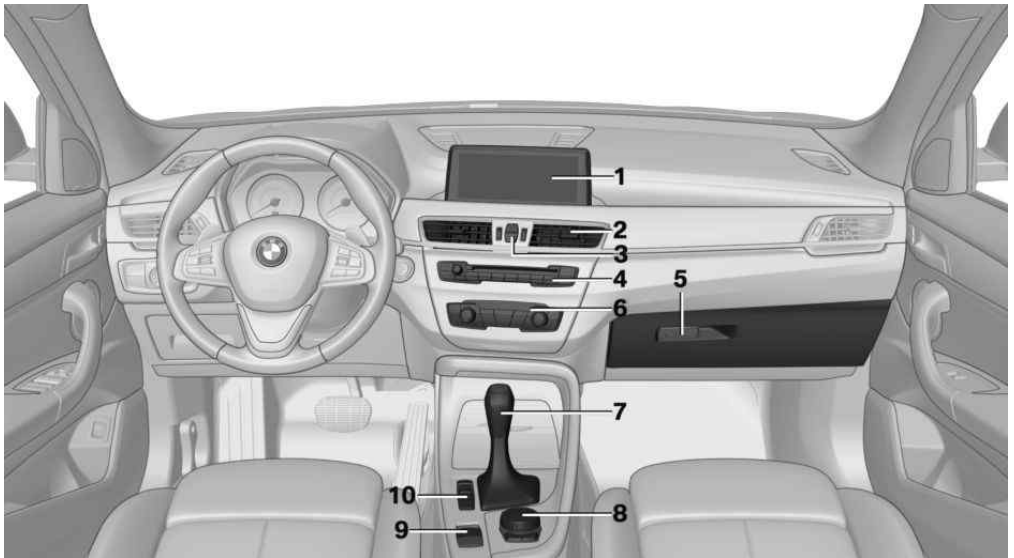

1 Control Display [34](#)

2 Ventilation [196](#)

3  Hazard warning system [274](#)

 Intelligent Safety [152](#)

4 Radio/Multimedia

5 Glove compartment [212](#)

6 Climate control [190](#)

7 Steptronic transmission selector lever [112](#)

8 Controller with buttons [36](#)





Controller with buttons [37](#)

9 Parking brake [102](#)

- 10**  DSC Dynamic Stability Control [163](#)
-  Driving Dynamics Control [167](#)
-  PDC Park Distance Control [179](#)
- Rearview camera [182](#)
- Automatic Parking Assistant [185](#)
-  HDC Hill Descent Control [165](#)

In the vicinity of the headliner



- 1**  Emergency Call, SOS [276](#)
- 2**  Glass sunroof [77](#)
- 3**  Indicator light, front passenger airbag [144](#)
- 4**  Reading lights [140](#)
- 5**  Interior lights [140](#)

iDrive

Vehicle features and options

This chapter describes all standard, country-specific and optional features offered with the series. It also describes features and functions that are not necessarily available in your vehicle, e.g., due to the selected options or country versions. This also applies to safety-related functions and systems. When using these functions and systems, the applicable laws and regulations must be observed.

Principle

The iDrive combines the functions of many switches. These functions can be operated via the Controller and, depending on the equipment version, the touchscreen.

Safety information



Warning

Operating the integrated information systems and communication devices while driving can distract from surrounding traffic. It is possible to lose control of the vehicle. There is a risk of accident. Only use the systems or devices when the traffic situation allows. As warranted, stop and use the systems and devices while the vehicle is stationary.

Input and display

Letters and numbers

Depending on the menu, you can switch between entering upper and lower case letters, numbers and characters.

Icon	Function
abc ABC	Change between capital and lower-case letters.
	Insert blank space.
	Use voice control.
OK	Confirm entry.

Entry comparison

When entering names and addresses, the choice is narrowed down with every letter entered and letters may be added automatically. Entries are continuously compared with data stored in the vehicle.

- ▶ Only those letters are offered during entry for which data is available.
- ▶ Destination search: place names can be entered in all languages that are available in iDrive.

Activating/deactivating the functions

Several menu items are preceded by a checkbox. The checkbox indicates whether the function is activated or deactivated. Selecting the menu item activates or deactivates the function.



- Function is activated.
- Function is deactivated.

Status information













General information

The status field can be found in the upper area of the Control Display. Status information is displayed in the form of symbols.



Radio symbols



Icon	Meaning
	HD Radio station is being received.
	Satellite radio is switched on.

Telephone symbols





Icon	Meaning
	Incoming or outgoing call.
	Missed call.
	Signal strength of mobile phone network.
	Network search.
	Mobile phone network is not available.
	The critical charge state of the mobile phone has been reached.
	Roaming is active.
	SMS text message received.
	Message received.
	Reminder.
	Sending not possible.
	Contacts are being loaded.

Entertainment symbols

Icon	Meaning
	CD/DVD drive.
	Bluetooth audio.

Icon	Meaning
	USB device.
	Online Entertainment.
	Apple CarPlay.

Other symbols

Icon	Meaning
	Check Control message.
	The sound output has been switched off.
	Encrypted connection not active.
	Request for the current vehicle position.
	Checking the current vehicle position.

Split screen, split screen display

General information

Additional information, for instance information from the trip computer can be displayed in several menus on the right side of the screen display, referred to as the split screen.

The additional information remains visible even when switching to another menu on the split screen.

Turning on/off

-  Press the button.
- "Split screen"

Selecting the display

The display can be selected in menus which support the split screen function.

- Tilt the Controller to the right until the split screen is selected.
- Press the Controller.
- Select the desired setting.

Specifying the number of displays

It is possible to specify the number of displays.

1. Tilt the Controller to the right until the split screen is selected.
2. Press the Controller.
3. "Personalize menu"
4. Select the desired setting.
5. Tilt the Controller to the left.

Control elements

Overview



- 1 Control Display
- 2 Controller

Control Display

General information

To clean the Control Display, follow the vehicle care instructions, refer to page 285.

In the case of very high temperatures on the Control Display, for instance due to intense solar radiation, the brightness may be reduced down to complete deactivation. Once the temperature is reduced, for instance through shade or air conditioning system, the normal functions are restored.

Safety information

NOTICE

Objects in the area in the front of the Control Display can slip and damage the Control Display. There is a risk of damage to property, among other potential damage. Do not place objects in the area in front of the Control Display.

Switching on/off automatically

The Control Display is switched on automatically when the vehicle is unlocked or as soon as the Control Display is needed for operation.

In certain situations, the Control Display is switched off automatically, for instance if no operation is performed on the vehicle for several minutes.

Switching on/off manually

The Control Display can also be switched off manually.

1.  Press the button.
2. "Turn off control display"

Press the Controller or any button on the Controller to switch it back on again.

Controller with navigation system

General information

The buttons can be used to open the menus directly. The Controller can be used to select menu items and enter the settings.

Operation

- ▶ Turn to switch between menu items, for example.

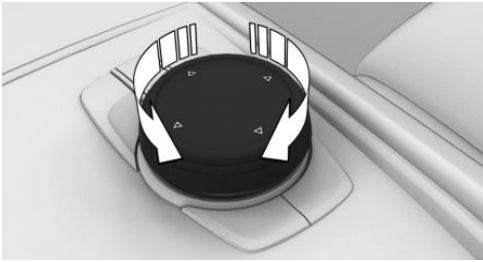

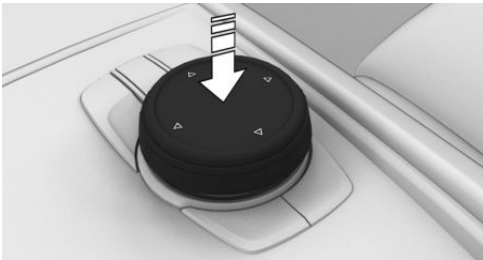

- ▶ Press to select a menu item, for example.



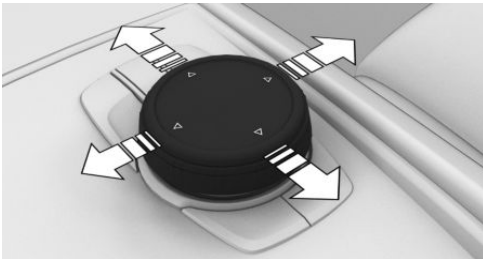



- ▶ Tilt in four directions to switch between displays, for example.



Buttons on the Controller

Button	Function
	Press once: calls up the main menu. Press twice: displays all menu items of the main menu.
	Call up the Communication menu.
	Call up the Media/Radio menu.

Button	Function
	Call up the destination input menu for navigation.
	Call up the navigation map.
	Press once: opens the previous display. Press and hold: open the menus used last.
	Call up the Options menu.

Controller without navigation system

General information

The buttons can be used to open the menus directly. The Controller can be used to select menu items and enter the settings.

Operation

- ▶ Turn to switch between menu items, for example.

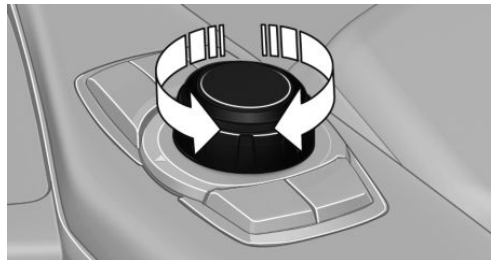



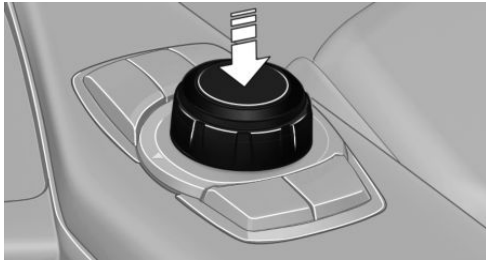

- ▶ Press to select a menu item, for example.

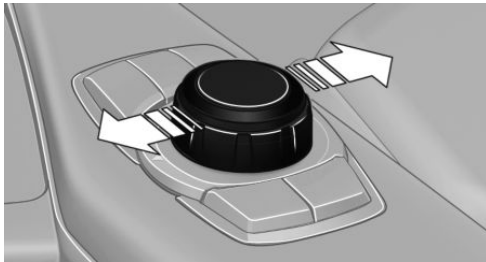

▷ Tilt in two directions to switch between displays, for example.



Buttons on the Controller

Button	Function
	Press once: calls up the main menu. Press twice: displays all menu items of the main menu.
	Call up the Communication menu.
	Call up the Media/Radio menu.
	Press once: opens the previous display. Press and hold: open the menus used last.
	Call up the Options menu.

Operating via the Controller

Opening the main menu

 Press the button.

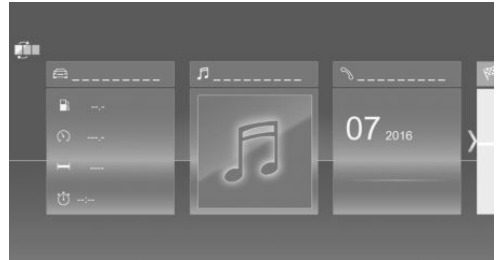

The main menu is displayed.

All iDrive functions can be called up via the main menu.

Adjusting the main menu

-  Press the button twice.
All menu items of the main menu are displayed.
- Select a menu item.
- To move the menu item to the desired position, tilt the Controller to the right or left.

Selecting menu items

Highlighted menu items can be selected.

- Turn the Controller until the desired menu item is highlighted.

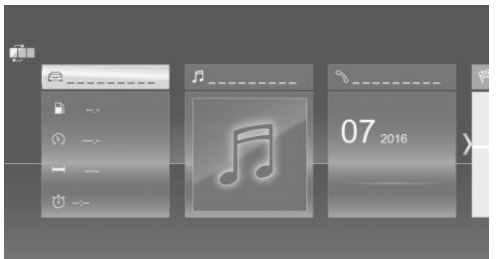

- Press the Controller.

Dynamic contents

You can display dynamic contents within the menu items. The contents of the menu items update automatically, e.g., the active destination guidance in the navigation.

Via iDrive:

1. "My Vehicle"
2. "Contents of main menu"

Changing between displays

After a menu item is selected, for instance "iDrive settings", a new display appears.

- ▷ Tilt the Controller to the left.

The current display closes and the previous display is shown.

- ▷  Press the button.

The previous display re-opens.

- ▷ Tilt the Controller to the right.

The new display opens.

An arrow indicates that additional displays can be opened.

Opening recently used menus

- ▷  Press and hold this button.

The recently used menus are displayed.

Going to the Options menu

- ▷  Press the button.

The "Options" menu is displayed.

The menu consists of various areas, for instance:

- ▷ "Split screen": screen settings.
- ▷ "Media/Radio": control options for the selected main menu.
- ▷ "Save station": if applicable, further control options for the selected menu.

Entering letters and numbers

Input

1. Turn the Controller: select letter or number.
2. **OK** : confirm entry.

Deleting

Icon Function

 Press the Controller: delete letter or number.

 Hold the Controller down: delete all letters or numbers.

Using alphabetical lists

For alphabetical lists with more than 30 entries, the letters for which there is an entry are displayed at the left edge.

1. Turn the Controller to the left or right quickly.
All letters for which there are entries are displayed on the left edge.
2. Select the first letter of the desired entry.
The first entry of the selected letter is displayed.

Operation via touchscreen

General information

Depending on the equipment version, the Control Display is equipped with a touchscreen.

Touch the touchscreen with your fingers. Do not use any objects.

Opening the main menu

 Tap on the icon.

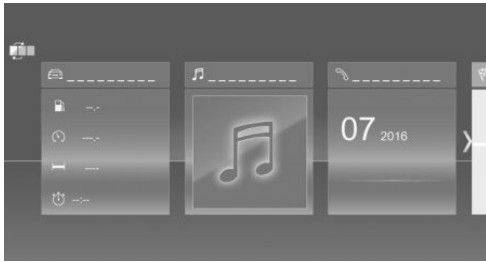

The main menu is displayed.
All iDrive functions can be called up via the main menu.

Adjusting the main menu

1. Tap on the icon.
All menu items of the main menu are displayed.
2. Drag the menu item to the desired position on the right or left.

Selecting menu items

Tap the desired menu item.

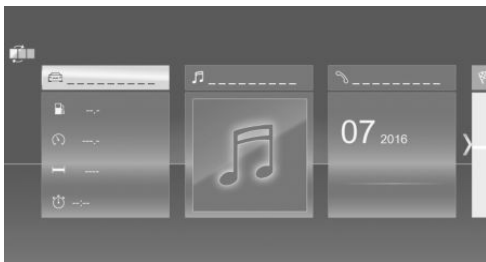

Dynamic contents

You can display dynamic contents within the menu items. The contents of the menu items update automatically, e.g., the active destination guidance in the navigation.

Via iDrive:

1. "My Vehicle"
2. "Contents of main menu"

Changing between displays

After a menu item is selected, a new display opens.
An arrow indicates that additional displays can be opened.

- ▶ Swipe to the left.
- ▶ Tap arrow.

 The new display opens.

Entering letters and numbers

Input

1. Tap the icon on the touchscreen.
A keyboard is displayed on the Control Display.
2. Enter desired letters and numbers.

Deleting

Icon	Function
←	Tapping the icon: deletes the letter or number.
←	Tapping and holding the icon all letters: deletes all letters or numbers.

Operating navigation map

The navigation map can be moved using the touchscreen.

Function	Operation
Enlarge/shrink map.	Drag in or out with the fingers.

Programmable memory buttons



General information

The iDrive functions can be stored on the programmable memory buttons and called up di-

rectly, for instance radio stations, navigation destinations, phone numbers and menu entries.

Settings are stored for the driver profile currently used.

Storing a function

1. Select function via iDrive.
2. ... Press and hold the desired button until a signal sounds.

Executing a function

- ... Press the button.

The function will work immediately. This means, for instance that the connection is established when a phone number is selected.

Displaying the key assignment

Touch buttons with finger. Do not wear gloves or use objects.

The assignment of the buttons is displayed in the upper area of the Control Display.

Deleting the button assignments

1. Press buttons 1 and 8 simultaneously for approx. 5 seconds.
2. "OK"

Voice activation system

Vehicle features and options

This chapter describes all standard, country-specific and optional features offered with the series. It also describes features and functions that are not necessarily available in your vehicle, e.g., due to the selected options or country versions. This also applies to safety-related functions and systems. When using these functions and systems, the applicable laws and regulations must be observed.

Principle

Most functions displayed on the Control Display can be operated by voice commands via the voice activation system. The system supports you with announcements during input.

General information

- ▶ Functions that can only be used when the vehicle is stationary can only be operated via the voice activation system to a limited extent.
- ▶ The system uses a special microphone on the driver's side.
- ▶ >...< in the Owner's Manual denotes verbal instructions to use with the voice activation system.

Functional requirements

- ▶ A language must be set via iDrive that is supported by the voice activation system. To set the language, refer to page 45.
- ▶ Always say commands in the language of the voice activation system.

Using the voice activation system

Activating the voice control system

1.  Press the button on the steering wheel.
2. Wait for the signal tone.
3. Say the command.



This icon indicates that the voice activation system is active.

No other commands may be available. In this case, operate the function via iDrive.

Ending the voice control system



Press the button on the steering wheel or >Cancel<.

Possible commands

General information

Most menu items on the Control Display can be spoken as commands.

Commands from other menus can also be spoken.

You can also select list entries such as phone list entries via the voice activation system. Read these list entries out loud exactly as they are shown in the respective list.

Displaying possible commands

The following is displayed in the top area of the Control Display:

- ▷ Some possible commands for the current menu.
- ▷ Some possible commands from other menus.
- ▷ Status of the speech recognition.
- ▷  Encrypted connection is not available.

Example: going to the sound settings

The commands of the menu items are spoken just as they are selected via the Controller.

1. Switch on the Entertainment sound output, if needed.
2.  Press the button on the steering wheel.
3. ›Media and radio‹
4. ›Tone‹

Help on the voice activation system

- ▷ ›General information on voice control: have information on the operating principle of the voice activation system read out loud.
- ▷ ›Help‹: have help for the current menu read out loud.

Information for Emergency Requests

Do not use the voice activation system to initiate an Emergency Request. In stressful situations, the voice and vocal pitch can change. This can unnecessarily delay the establishment of a telephone connection.

Instead, use the SOS button, refer to page 276, close to the interior mirror.

Settings

Setting the voice control

You can set the system to use standard dialog or a short version.

The short version of the voice control plays back short messages in abbreviated form.

Via iDrive:

1. "My Vehicle"
2. "iDrive settings"
3. "Language"
4. "Speech mode:"
5. Select the desired setting.

Speaking during voice output

It is possible to answer during inquiries of the voice activation system. The function can be deactivated if inquiries are often undesirably canceled, for instance due to background noise or conversations in the vehicle.

Via iDrive:

1. "My Vehicle"
2. "iDrive settings"
3. "Language"
4. "Speaking during voice output"

Online speech processing

Online speech processing provides a dictation function, a natural method of destinations input and improves the quality of speech recognition. To use the functions, data is transmitted to a service provider via an encrypted connection and stored locally there.

Via iDrive:

1. "My Vehicle"
2. "iDrive settings"
3. "Language"
4. "Server speech recognition"

Adjusting the volume

Turn the volume button during the voice guidance until the desired volume is set.

- ▷ The volume remains constant even if the volume of other audio sources is changed.
- ▷ The volume is stored for the driver profile currently used.

System limits

- ▷ Certain noises can be detected and may lead to problems. Keep the doors, windows, and glass sunroof closed.
- ▷ Noises from the front passenger or the rear seat bench can impair the system. Avoid making other noise in the vehicle while speaking.
- ▷ Major language dialects can cause problems with the speech recognition feature. Speak loud and clear.

Using the voice activation system of the smartphone

A smartphone connected to the vehicle can be used via voice control.

Activate voice command response on the smartphone for this purpose.

1.  Press and hold the button on the steering wheel for approx. 3 seconds. Voice command response is activated on the smartphone.

2.  Release the button.

If activation is successful, a confirmation appears on the Control Display.

If it was not possible to activate voice command response, the list of Bluetooth devices appears on the Control Display.

General settings

Vehicle features and options

This chapter describes all standard, country-specific and optional features offered with the series. It also describes features and functions that are not necessarily available in your vehicle, e.g., due to the selected options or country versions. This also applies to safety-related functions and systems. When using these functions and systems, the applicable laws and regulations must be observed.

Language

Adjusting the language

Via iDrive:

1. "My Vehicle"
2. "iDrive settings"
3. If necessary, "Language"
4. "Language:"
5. Select the desired setting.

The setting is stored for the driver profile currently used.

Time

Setting the time zone

Via iDrive:

1. "My Vehicle"
2. "iDrive settings"
3. "Date and time"
4. "Time zone:"
5. Select the desired setting.

The setting is stored for the driver profile currently used.

Setting the time

Via iDrive:

1. "My Vehicle"
2. "iDrive settings"
3. "Date and time"
4. "Time:"
5. Turn the Controller until the desired hours are displayed.
6. Press the Controller.
7. Turn the Controller until the desired minutes are displayed.
8. Press the Controller.

Setting the time format

Via iDrive:

1. "My Vehicle"
2. "iDrive settings"
3. "Date and time"
4. "Time format:"
5. Select the desired setting.

The setting is stored for the driver profile currently used.

Automatic time setting

Depending on your vehicle's optional features, the time, date and, if needed, the time zone are updated automatically.

Via iDrive:

1. "My Vehicle"
2. "iDrive settings"
3. "Date and time"
4. "Automatic time setting"

The setting is stored for the driver profile currently used.

Date

Setting the date

Via iDrive:

1. "My Vehicle"
2. "iDrive settings"
3. "Date and time"
4. "Date:"
5. Turn the Controller until the desired day is displayed.
6. Press the Controller.
7. Make the settings for the month and year.

Setting the date format

Via iDrive:

1. "My Vehicle"
2. "iDrive settings"
3. "Date and time"
4. "Date format:"
5. Select the desired setting.

The setting is stored for the driver profile currently used.

Setting the units of measurement

You can set the units of measurement for some values, for example, consumption, distances and temperature.

Via iDrive:

1. "My Vehicle"
2. "iDrive settings"
3. "Units"
4. Select the desired menu item.
5. Select the desired setting.

The setting is stored for the driver profile currently used.

Activating/deactivating the display of the current vehicle position

Principle

If vehicle tracking has been activated, the current vehicle position can be displayed in the BMW Connected App or in the ConnectedDrive customer portal.

Activating/deactivating

Via iDrive:

1. "My Vehicle"
2. "Vehicle settings"
3. "Data privacy"
4. "Vehicle tracking"
5. Select the desired setting.

Activating/deactivating pop-ups

For some functions, pop-ups are displayed automatically on the Control Display. Some of these pop-ups can be activated or deactivated.

Via iDrive:

1. "My Vehicle"
2. "iDrive settings"
3. "Pop-ups"
4. Select the desired setting.

The setting is stored for the driver profile currently used.

Control Display

Brightness

Via iDrive:

1. "My Vehicle"
2. "iDrive settings"
3. "Displays"
4. "Control display"
5. "Brightness at night"
6. Turn the Controller until the desired brightness is set.
7. Press the Controller.

The setting is stored for the driver profile currently used.

Depending on the light conditions, the brightness control may not be clearly visible.

Screensaver

If no settings are made via iDrive, a screensaver will be displayed after an adjustable time.

Via iDrive:

1. "My Vehicle"
2. "iDrive settings"
3. "Displays"
4. "Control display"
5. "Screensaver"
6. Select the desired setting.

The setting is stored for the driver profile currently used.

Selecting the contents of the main menu

You can select the displayed contents for some menu items in the main menu.

1.  Press the button.
2. "Contents of main menu"
3. Select the desired menu and the desired content.

The setting is stored for the driver profile currently used.

Notifications

Principle

The menu centrally displays all messages arriving in the vehicle in list form.

General information

The following messages can be displayed:

- ▶ Traffic messages.
- ▶ Communication messages, for example e-mails, SMS text messages or reminders.
- ▶ Messages from, e.g., the Concierge service or the BMW Connected app.
- ▶ Check Control messages.
- ▶ Messages on service notifications.
- ▶ Messages from the vehicle manufacturer.

Notifications are additionally displayed in the status field.

Retrieving notifications

Via iDrive:

1. "Notifications"
2. Select the desired notification.

The menu in which the notification is displayed will open.

Deleting notifications

Notifications can be deleted from the list.

Sustained Check Control messages or messages from the vehicle manufacturer with important customer information are displayed as long as they are relevant.

Via iDrive:

1. "Notifications"
2. Select the desired notification.
3.  Press the button.
4. "Delete this notification" or "Delete all notifications"

Settings

The following settings can be adjusted:

- ▶ Select the applications, from which notifications will be permitted.
- ▶ Sort the notifications according to date or priority.

Via iDrive:

1. "My Vehicle"
2. "iDrive settings"
3. "Notifications"
4. Select the desired setting.

Data protection

Data transfer

Principle

The vehicle offers different functions, whose use requires a data transfer to BMW or a service provider. The data transfer can be deactivated for some functions.

General information

With data transfer deactivated, the respective function cannot be used.

Only make these settings while stationary.

Activate/deactivate

Follow the instructions on the Control Display. Via iDrive:

1. "My Vehicle"
2. "iDrive settings"
3. "Data privacy"
4. Select the desired setting.

Deleting personal data in the vehicle

Principle

Depending on the usage, the vehicle stores personal data, such as stored radio stations. This personal data can be permanently deleted using iDrive.

General information

Depending on the equipment package, the following data can be deleted:

- ▶ Driver profile settings.
- ▶ Stored radio stations.
- ▶ Stored programmable memory buttons.
- ▶ Travel and trip computer information.
- ▶ Music collection.
- ▶ Navigation, for instance stored destinations.
- ▶ Phone book.
- ▶ Online data, for instance Favorites, cookies.
- ▶ Office data, for instance voice memos.
- ▶ Login accounts.

Altogether, the deletion of the data can take up to 15 minutes.

Functional requirement

Data can only be deleted while stationary.

Deleting data

Note and follow the instructions on the Control Display.

Via iDrive:

1. "My Vehicle"
2. "iDrive settings"
3. "Data privacy"
4. "Delete personal data"
5. "Delete personal data"
6. "OK"
7. Exit and lock the vehicle.

The deletion process takes 15 minutes to complete.

If not all data was deleted, repeat the deletion.

Canceling deletion

Start the engine to cancel deletion of the data.

Connections

Principle

Various connection types are available for using mobile devices in the vehicle. The connection type to select depends on the mobile device and the desired function.

General information

The following overview shows possible functions and the suitable connection types for them. The range of functions depends on the mobile device.

Function	Connection type
Making calls via the hands-free system.	Bluetooth.
Using phone functions via iDrive.	
Using the smartphone Office functions.	
Playing music from the smartphone or the audio player.	Bluetooth or USB.
Using compatible apps via iDrive.	Bluetooth or USB.
USB storage device:	USB.
Exporting and importing driver profiles.	
Performing software updates.	
Exporting and importing stored trips.	
Playing music.	
Playing videos from the smartphone or the USB device.	USB.
Using Apple CarPlay apps via iDrive and voice operation.	Bluetooth and Wi-Fi.

The following connection types require one-time pairing with the vehicle:

- ▶ Bluetooth.
- ▶ Apple CarPlay.

Paired devices are automatically recognized later on and connected to the vehicle.

Safety information

Warning

Operating the integrated information systems and communication devices while driving can distract from surrounding traffic. It is possible to lose control of the vehicle. There is a risk of accident. Only use the systems or devices

when the traffic situation allows. As warranted, stop and use the systems and devices while the vehicle is stationary.

Compatible devices

General information

Information on compatible mobile devices is available as follows:

- ▶ On the BMW homepage.
- ▶ Via Hotline/Customer Support
- ▶ At a dealer's service center or another qualified service center or repair shop.

Displaying the vehicle identification number and software part number

With a search for compatible devices, you may have to state the vehicle identification number and the software part number. These numbers can be displayed in the vehicle.

Via iDrive:

1. "My Vehicle"
2. "iDrive settings"
3. "Mobile devices"
4. "Settings"
5. "Bluetooth® info"
6. "System information"

A software update, refer to page 55, can be performed, if needed.

Bluetooth connection

Functional requirements

- ▶ Compatible device, refer to page 50, with Bluetooth interface.
- ▶ The vehicle key is in the vehicle.
- ▶ The device is ready for operation.

- ▶ Bluetooth is activated on the device and in the vehicle, refer to page 50.
- ▶ Bluetooth presets, such as visibility, may be required on the device; refer to the operating instructions of the device.

Switching on Bluetooth

Via iDrive:

1. "My Vehicle"
2. "iDrive settings"
3. "Mobile devices"
4. "Settings"
5. "Bluetooth®"

Activating/deactivating telephone functions

To use all supported functions of a mobile phone, the following functions must be activated prior to pairing.

Via iDrive:

1. "My Vehicle"
2. "iDrive settings"
3. "Mobile devices"
4. "Settings"
5. Select the desired setting, e.g.:
 - ▶ "Office"

Activate function to transmit short messages, e-mails, calendars, tasks, memos, and reminders to the vehicle. Costs can be incurred by transmitting all data to the vehicle.
 - ▶ "Contact images"





Activate function to show the contact pictures.
 - ▶ "Apple CarPlay"

Activate the function to use Apple CarPlay.

Pairing the mobile device with the vehicle

Via iDrive:

1. "My Vehicle"
2. "iDrive settings"
3. "Mobile devices"
4. "Connect new device"
5. Select the functions for which the device will be used:

- ▷  "Telephone"
- ▷  "Bluetooth® audio"
- ▷  "Apps"
- ▷  "Apple CarPlay"

The vehicle's Bluetooth name is displayed on the Control Display.

6. On the mobile device, search for Bluetooth® devices in the surrounding area.
The Bluetooth name of the vehicle appears on the mobile device display.
Select the Bluetooth name of the vehicle.
7. Depending on the mobile device, a control number is displayed or the control number must be entered.

- ▷ Compare the control number displayed on the Control Display with the control number on the display of the device.

Confirm the control number on the device and on the Control Display.

- ▷ Enter and confirm the same control number on the device and via iDrive.

The device is connected and displayed in the device list, refer to page 54.

If connection was not successful: Frequently Asked Questions, refer to page 51.

Frequently Asked Questions

All prerequisites are met and all required steps were completed in the specified order. Despite that, the mobile device does not function as expected.

In this case, the following explanations can help:

Why could the mobile phone not be paired or connected?

- ▷ There are too many Bluetooth devices connected to the mobile phone or vehicle.

In the vehicle, delete Bluetooth connections with other devices.

Delete all known Bluetooth connections from the device list on the mobile phone and start a new device search.

- ▷ The mobile phone is in power-save mode or has only a limited remaining battery life.
Charge the mobile phone.

Why does the mobile phone no longer react?

- ▷ The applications on the mobile phone do not function anymore.

Switch the mobile phone off and on again.

- ▷ Too high or too low ambient temperatures for mobile phone operation.

Do not subject the mobile phone to extreme ambient temperatures.

Why can telephone functions not be used via iDrive?

- ▷ The mobile phone may not be properly configured, for instance as Bluetooth audio device.

Connect the mobile phone with the telephone or additional telephone function.

Why are no or not all telephone book entries displayed or why are they incomplete?

- ▷ Transmission of the telephone book entries is not yet complete.

- ▷ It is possible that only the telephone book entries of the mobile phone or the SIM card are transmitted.

- ▷ It may not be possible to display telephone book entries with special characters.

- ▷ It may not be possible to transmit contacts from social networks.

- ▶ The number of telephone book entries to be stored is too high.
- ▶ Data volume of the contact too large, for instance due to stored information such as memos.
Reduce the data volume of the contact.
- ▶ A mobile phone can only be connected as audio source or as telephone.
Configure the mobile phone and connect it with the telephone or additional telephone function.

How can the telephone connection quality be improved?

- ▶ The strength of the Bluetooth signal on the mobile phone can be adjusted, depending on the mobile phone.
- ▶ Insert the mobile phone into the snap-in adapter or place it in the area of the center console.
- ▶ Insert the mobile phone into the wireless charging tray.
- ▶ Adjust the volume of the microphone and loudspeakers separately.

If all points in this list have been checked and the required function is still not available, contact Customer Relations, a dealer's service center or another qualified service center or repair shop.

USB connection

General information

The following mobile devices can be connected to the USB port:

- ▶ Mobile phones.
The snap-in adapter features a separate USB port that is automatically connected when a compatible mobile phone is inserted.
- ▶ Audio devices with USB port, for instance MP3 players.
- ▶ USB storage devices.

Common file systems are supported. FAT32 and exFAT are the recommended formats.

A connected USB device will be supplied with charge current via the USB port if the device supports this. Follow the maximum charge current of the USB port.

The following uses are possible on USB ports with data transfer:

- ▶ Exporting and importing driver profiles, refer to page 70.
- ▶ Playing music files via USB audio.
- ▶ Playing videos via USB video.
- ▶ Loading of software updates, refer to page 55.

Follow the following when connecting:

- ▶ Do not use force when plugging the connector into the USB port.
- ▶ Use a flexible adapter cable.
- ▶ Protect the USB device against mechanical damage.
- ▶ Due to the large number of USB devices available on the market, it cannot be guaranteed that every device is operable on the vehicle.
- ▶ Do not expose USB devices to extreme environmental conditions, such as very high temperatures; refer to the operating instructions of the device.
- ▶ Due to the many different compression techniques, proper playback of the media stored on the USB device cannot be guaranteed in all cases.
- ▶ To ensure proper transmission of the stored data, do not charge a USB device via the onboard socket, when it is connected to the USB port.
- ▶ Depending on how the USB device is being used, settings may be required on the USB storage device, refer to the operating instructions of the device.

Not compatible USB devices:

- ▷ USB hard drives.
- ▷ USB hubs.
- ▷ USB memory card readers with multiple slots.
- ▷ HFS-formatted USB devices.
- ▷ Devices such as fans or bulbs.

Functional requirement

Compatible device, refer to page 50, with USB port.

Connecting the device

Connect the USB device using a suitable adapter cable to a USB port, refer to page 202.

The USB device is displayed in the device list, refer to page 54.

Apple CarPlay preparation

Principle

CarPlay allows select functions of a compatible Apple iPhone to be used via Siri voice control and iDrive.

Functional requirements

- ▷ Compatible iPhone, refer to page 50. iPhone 5 or later with iOS 7.1 or later.
- ▷ Corresponding mobile contract.
- ▷ Bluetooth, Wi-Fi, and Siri voice control are activated on the iPhone.
- ▷ Wi-Fi and Bluetooth are enabled in the vehicle.
- ▷ If necessary, the setting for mobile data must be activated on the iPhone.

Turning on Bluetooth and CarPlay

Via iDrive:

1. "My Vehicle"
2. "iDrive settings"
3. "Mobile devices"

4. "Settings"
5. Select the following settings:
 - ▷ "Bluetooth®"
 - ▷ "Apple CarPlay"

Pairing the iPhone with CarPlay

Pair the iPhone with the vehicle via Bluetooth, refer to page 51.

Select CarPlay as the function:

 "Apple CarPlay"

The iPhone is connected to the vehicle and displayed in the device list, refer to page 54.

Operation

For more information, refer to the Integrated Owner's Manual or the Owner's Manual for Navigation, Entertainment, Communication.

Frequently Asked Questions

All prerequisites are met and all required steps were completed in the specified order. Despite that, the mobile device does not function as expected.

In this case, the following explanations can help:

The iPhone has already been paired with Apple CarPlay. When a new connection is set up, CarPlay can no longer be selected.

- ▷ Delete the iPhone concerned from the device list.
- ▷ On the iPhone, delete the vehicle concerned from the list of stored vehicles under Bluetooth and under Wi-Fi.
- ▷ Pair the iPhone as a new device.

If the steps listed have been carried out and the required function is still not available: contact Customer Relations, a dealer's service center or another qualified service center or repair shop.

Managing mobile devices

General information

- ▶ After one-time pairing, the devices are automatically recognized and reconnected when the ignition is switched on.
- ▶ The data stored on the SIM card or in the mobile phone are transferred to the vehicle after recognition.
- ▶ For some devices, certain settings may be necessary, for instance authorization, see operating instructions of the device.





Displaying the device list

All devices paired or connected with the vehicle are displayed in the device list.

Via iDrive:

1. "My Vehicle"
2. "iDrive settings"
3. "Mobile devices"

An icon indicates, for which function a device is used.

Icon	Function
	"Telephone"
	"Additional telephone"
	"Bluetooth® audio"
	"Apps"
	"Apple CarPlay"

Configuring the device

Functions can be activated or deactivated for paired and connected devices.

Via iDrive:

1. "My Vehicle"
2. "iDrive settings"
3. "Mobile devices"

4. Select the desired device.
5. Select the desired setting.

If a function is assigned to a device, the function will be deactivated where appropriate for a device that is already connected and the device will be disconnected.

Disconnecting the device

The device's connection to the vehicle is disconnected.

The device remains paired and can be connected again, refer to page 54.

Via iDrive:

1. "My Vehicle"
2. "iDrive settings"
3. "Mobile devices"
4. Select device.
5. "Disconnect device"

Connecting the device

A disconnected device can be reconnected.

Via iDrive:

1. "My Vehicle"
2. "iDrive settings"
3. "Mobile devices"
4. Select device.
5. "Connect device"

The functions that were assigned to the device before disconnecting are assigned to the device when it is reconnected. The functions may be deactivated on a device already connected.

Deleting the device

Via iDrive:

1. "My Vehicle"
2. "iDrive settings"
3. "Mobile devices"
4. Select device.
5. "Delete device"

The device is disconnected and removed from the device list.

Swapping the telephone and additional telephone

If two mobile phones are connected to the vehicle, the functions of the telephone and additional telephone can be switched.

Via iDrive:

1. "My Vehicle"
2. "iDrive settings"
3. "Mobile devices"
4. "Settings"
5. "Swap telephone/additional tel."

Software update

General information

The vehicle supports a large number of mobile devices, for instance mobile phones and MP3 players. Software updates are available for many of the supported devices. The vehicle is kept up-to-date via regular vehicle software updates.

Updates and related current notes are available on the www.bmw.com/update website.

Displaying the version of the installed software

The software version installed in the vehicle is displayed.

Via iDrive:

1. "My Vehicle"
2. "iDrive settings"
3. "Software update"
4. "Show current version"

If an update has been carried out before, select the desired version to display additional information.

Updating software via USB

The software may only be updated when the vehicle is stationary.

Via iDrive:

1. Store the file for the software update in the main folder of a USB device.
2. Connect the USB stick at a USB port, refer to page 202.
3. "My Vehicle"
4. "iDrive settings"
5. "Software update"
6. "Update software"
7. "USB"
8. "Install software"
9. "OK"
10. Wait for the update to complete.
11. Confirm system restart.

Restoring the software version

You can restore the software to the version prior to the last update or to its factory settings.

The software may only be restored when the vehicle is stationary.

Via iDrive:

1. "My Vehicle"
2. "iDrive settings"
3. "Software update"
4. "Restore software"
5. ▷ "Previous version"
 - The previous software version is restored.
 - ▷ "Default software settings"
 - The first software version is restored.
6. "Remove software"
7. "OK"
8. Wait for software restore.
9. Confirm system restart.

Owner's Manual media

Vehicle features and options

This chapter describes all standard, country-specific and optional features offered with the series. It also describes features and functions that are not necessarily available in your vehicle, e.g., due to the selected options or country versions. This also applies to safety-related functions and systems. When using these functions and systems, the applicable laws and regulations must be observed.

General information

You can use the following media formats to call up the content in the Owner's Manual:

- ▶ Printed Owner's Manual, refer to page 56.
- ▶ Integrated Owner's Manual in the vehicle, refer to page 56.

Printed Owner's Manual

Principle

The printed Owner's Manual describes all standard, country-specific, and optional equipment offered with the series.

General information

The Owner's Manual for Navigation, Entertainment, and Communication can be obtained as a printed book from the service center.

Supplementary Owner's Manuals

Also follow the Supplementary Owner's Manuals, which are included in addition to the on-board literature.

Integrated Owner's Manual in the vehicle

Principle

The Integrated Owner's Manual specifically describes features and functions found in the vehicle. The Integrated Owner's Manual can be displayed on the Control Display.

Selecting the Owner's Manual

1.  Press the button.
2. "My Vehicle"
3. "Owner's Manual"
4. Select the desired method of accessing the contents.

Scrolling through the Owner's Manual

Turn the Controller, until the next or previous contents are displayed.

Context help

General information

The section of the Owner's Manual relating to the function that is currently selected can be displayed directly.

Opening via iDrive

Change directly to the Options menu from the function on the Control Display:

1.  Press the button.
2. "Owner's Manual"



Opening when a Check Control message is displayed

Directly from the Check Control message on the Control Display:

 "Owner's Manual"

Changing between a function and the Owner's Manual

To switch from a function, for instance radio, to the Owner's Manual on the Control Display and to alternate between the two displays:

1.  Press the button.
2. "Owner's Manual"
3. Select the desired page in the Owner's Manual.
4.  Press the button again to return to the last displayed function.
5.  Press the button to return to the page of the Owner's Manual displayed last.

To alternate continuously between the last displayed function and the last displayed page of the Owner's Manual, repeat steps 4 & 5.

Opens a new display every time.

Opening and closing

Vehicle features and options

This chapter describes all standard, country-specific and optional features offered with the series. It also describes features and functions that are not necessarily available in your vehicle, e.g., due to the selected options or country versions. This also applies to safety-related functions and systems. When using these functions and systems, the applicable laws and regulations must be observed.

Vehicle key

General information

Two vehicle keys are included in the scope of delivery, each containing an integrated key.

Each vehicle key contains a replaceable battery, refer to page 61.

Depending on the equipment and country version, various settings, refer to page 73, can be configured for the button functions.

A personal driver profile, refer to page 70, for each vehicle key is stored in the vehicle.

To provide information on maintenance recommendations, the service data is stored in the vehicle key, refer to page 265.

To prevent possible locking in of the vehicle key, take the vehicle key with you when exiting the vehicle.

Safety information

Warning

The vehicle key has a button cell battery. Batteries or button cell batteries can be swallowed and lead to serious or fatal injuries within two hours, for example, due to internal

burns or chemical burns. There is a risk of injury or danger to life. Keep the vehicle key and batteries out of reach of children. Immediately seek medical help if there is any suspicion that a battery or button cell battery has been swallowed or is located in any part of the body.

Warning

People or animals in the vehicle can lock the doors from the inside and lock themselves in. In this case, the vehicle cannot be opened from the outside. There is a risk of injury. Take the vehicle key with you so that the vehicle can be opened from the outside.

Warning

Unattended children or animals in the vehicle can cause the vehicle to move and endanger themselves and traffic, for instance due to the following actions:

- ▷ Pressing the Start/Stop button.
- ▷ Releasing the parking brake.
- ▷ Opening and closing the doors or windows.
- ▷ Engaging selector lever position N.
- ▷ Using vehicle equipment.

There is a risk of accidents or injuries. Do not leave children or animals unattended in the vehicle. Take the vehicle key with you when exiting and lock the vehicle.

Overview



- 1 Unlocking
- 2 Locking
- 3 Unlocking the tailgate

With automatic trunk lid actuation: open the tailgate

- 4 Panic mode

Unlocking



Press the button on the vehicle key.

Depending on the settings, refer to page 73, the following access points are unlocked:

- ▷ Driver's door and fuel filler flap.
Press the button on the vehicle key again to unlock the other vehicle access points.
- ▷ All doors, tailgate, and fuel filler flap.

In addition, the following functions are executed:

- ▷ Unlocking is confirmed by the turn signals and the horn. This function must be activated in the settings, refer to page 73.
- ▷ The settings stored in the driver profile, refer to page 70, are applied.
- ▷ The driver's seat is set to the last seat position saved in the driver profile. This function must be activated in the settings, refer to page 73.
- ▷ The interior lights, refer to page 140, are switched on, unless they were manually switched off.

- ▷ Depending on the settings, the welcome light and pathway lighting, refer to page 137, are switched on.
- ▷ Exterior mirrors folded through convenient closing are folded open.
- ▷ The alarm system, refer to page 74, is switched off.

The lighting functions may depend on the ambient brightness.

Convenient opening



Press and hold the button on the vehicle key after unlocking.

The windows and the glass sunroof are opened, as long as the button on the vehicle key is pressed.

Locking

1. Close the driver's door.
2.  Press the button on the vehicle key.

The following functions are executed:

- ▷ All doors, the tailgate, and the fuel filler flap are locked.
- ▷ Locking is confirmed by the turn signals and the horn. This function must be activated in the settings, refer to page 73.
- ▷ The alarm system, refer to page 74, is switched on.

If the engine or ignition is still switched on when you lock the vehicle, the vehicle horn honks twice. In this case, the engine or ignition must be switched off by means of the Start/Stop button.

With Comfort Access: convenient closing

Safety information

Warning

With convenient closing, body parts can be jammed. There is a risk of injury. Make sure that the area of movement of the doors is clear during convenient closing.

Closing

 Press and hold the button on the vehicle key in close range to the vehicle.

The windows and the glass sunroof are closed, as long as the button on the vehicle key is pressed.

The exterior mirrors are folded in.

The exterior mirrors are not folded in when the hazard warning flashers are switched on.

Switching on interior lights and courtesy lights

 Press the button on the vehicle key with the vehicle locked.

This function is not available, if the interior lights were switched off manually.

The lighting functions may depend on the ambient brightness.

After locking, wait 10 seconds before pressing the button again.

Panic mode

You can trigger the alarm system if you find yourself in a dangerous situation.

 ▶ Press the button on the vehicle key and hold for at least 3 seconds.

▶ Briefly press the button on the vehicle key three times in succession.

To switch off the alarm: press any button.

Tailgate

General information

To avoid locking the vehicle key in the vehicle, do not place the vehicle key in the cargo area.

Depending on the vehicle equipment and country version, it is possible to specify whether the tailgate can be unlocked with the vehicle key and how the vehicle doors will respond to this. To perform settings, refer to page 73.

Safety information

Warning

Body parts can be jammed when operating the tailgate. There is a risk of injury. Make sure that the travel path of the tailgate is clear during opening and closing.

Warning

The tailgate swings back and up when it opens. There is a risk of injury or risk of damage to property. Make sure that the travel path of the tailgate is clear during opening and closing.

NOTICE

Sharp-edged or pointed objects can hit the windows and heating elements while driving. There is a risk of damage to property, among other potential damage. Cover the edges and ensure that pointed objects do not hit the windows.

Opening



Press the button on the vehicle key for approx. 1 second.

Without automatic trunk lid actuation:

The tailgate is unlocked and can be swung upward.

With automatic trunk lid actuation:

The tailgate opens automatically.

Replacing the battery

NOTICE

Improper batteries in a battery-operated device can damage the device. There is a risk of damage to property. Always replace the discharged battery with a battery with the same voltage, the same size and the same specification.

1. Remove the integrated key from the vehicle key, refer to page 63.
2. Place the integrated key underneath the battery compartment cover, arrow 1, and lift the lid with a lever movement of the integrated key, arrow 2.

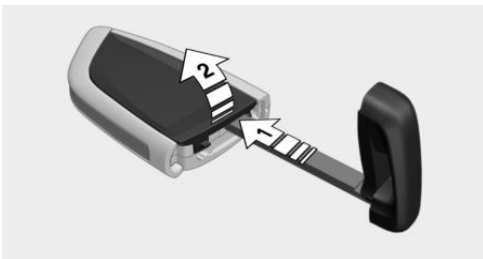

3. Push battery in arrow direction using a pointed object and lift it out.

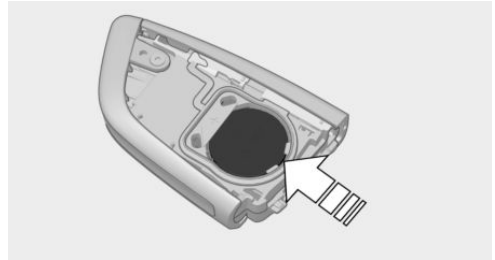

4. Insert a type CR 2032 3V battery with the positive side facing up.
5. Press the lid closed.
6. Push the integrated key into the vehicle key until it engages.



Have old batteries disposed of by a dealer's service center or another qualified service center or repair shop or take them to a collection point.

Additional vehicle keys

Additional vehicle keys are available from a service center or another qualified service center or repair shop.

Loss of vehicle keys

A lost vehicle key can be disabled and replaced by a dealer's service center or another qualified service center or repair shop.

Malfunction

General information

A Check Control message is displayed.

Vehicle key detection by the vehicle may malfunction under the following circumstances:

- ▶ The battery of the vehicle key is discharged. For replacing the battery, refer to page 61.
- ▶ Fault of the radio link from transmission towers or other equipment with high transmitting power.
- ▶ Shielding of the vehicle key due to metal objects.
Do not transport the vehicle key together with metal objects.
- ▶ Fault of the radio link from mobile phones or other electronic devices in direct proximity to the vehicle key.
Do not carry the vehicle key in close proximity to other electronic devices.
- ▶ Fault of radio transmission by a charging process of mobile devices, for instance charging of a mobile phone.
- ▶ The vehicle key is in direct proximity of the wireless charging tray.
Place the vehicle key in a different location.

In the case of interference, the vehicle can be unlocked and locked from the outside with the integrated key, refer to page 62.

Starting the engine via emergency detection of the Vehicle key

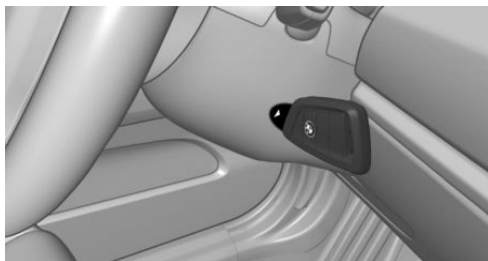

It is not possible to start the engine if the vehicle key has not been detected.
Proceed as follows in this case:

1. Hold the vehicle key with its tip against the mark on the steering column. Pay attention to the display in the instrument cluster.
2. If the vehicle key is detected:

Start the engine within 10 seconds.
If the vehicle key is not recognized, slightly change the position of the vehicle key and repeat the procedure.

Frequently Asked Questions

What precautions can be taken to be able to open a vehicle with an accidentally locked in vehicle key?

- ▶ The options provided by the Remote Services of the BMW app include the ability to lock and unlock a vehicle.
This requires an active BMW ConnectedDrive contract and the BMW app must be installed on a smartphone.
- ▶ Unlocking the vehicle can be requested via the BMW ConnectedDrive Call Center.
An active BMW ConnectedDrive contract is required.

Integrated key

General information

The driver's door can be locked and unlocked without the vehicle key using the integrated key.

Safety information

NOTICE

The door lock is permanently joined with the door. The door handle can be moved. When pulling the door handle with the integrated key inserted, paint or the integrated key can be damaged. There is a risk of damage to property, among other potential damage. Remove the integrated key before pulling the external door handle.

Removing

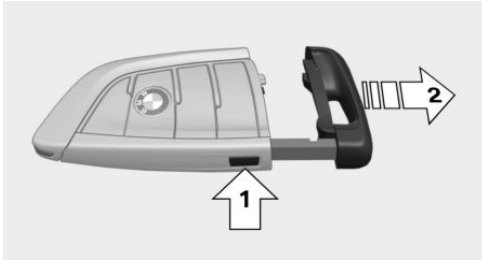

Press the button, arrow 1, and pull out the integrated key, arrow 2.

Locking/unlocking via the door lock

1. Remove cover cap on the door lock.

To do this, slide the integrated key into the opening to the stop from below and remove the cover cap.

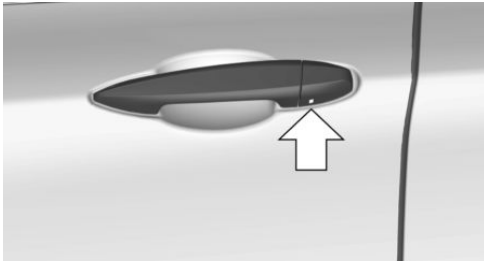

2. Unlock or lock the door lock using the integrated key.

The other doors must be unlocked or locked from the inside.

Alarm system

The alarm system is not switched on if the vehicle is locked with the integrated key.

The alarm system is triggered when the door is opened, if the vehicle has been unlocked via the door lock.

Buttons for the central locking system

General information

In the event of a severe accident, the vehicle is automatically unlocked. The hazard warning system and interior lights come on.

Overview



Buttons for the central locking system.

Locking

 Press the button with the front doors closed.

The fuel filler flap remains unlocked.

The vehicle is not secured against theft when locking.

Unlocking

 Press the button.

Opening

- ▶  Press button to unlock the doors together, and then pull the door handle above the armrest.
- ▶ Front doors: pull the door handle on the door to open the door. The other doors remain locked.
- ▶ Back doors: pull twice on the door handle on the door to be opened; the first time unlocks the door, the second time opens it. The other doors remain locked.

Comfort Access

Principle

The vehicle can be accessed without operating the vehicle key.

Carrying the vehicle key with you, e.g., in your pants pocket, is sufficient.

The vehicle automatically detects the vehicle key when it is in close proximity or in the interior.

General information

Comfort Access supports the following functions:

- ▶ Unlocking and locking the vehicle.
- ▶ Convenient closing.
- ▶ Open the tailgate.
- ▶ Opening/closing the tailgate with no-touch activation.

Functional requirements

- ▶ To lock the vehicle, the vehicle key must be outside of the vehicle near the doors.
- ▶ The next unlocking and locking cycle is not possible until after approx. 2 seconds.

Unlocking

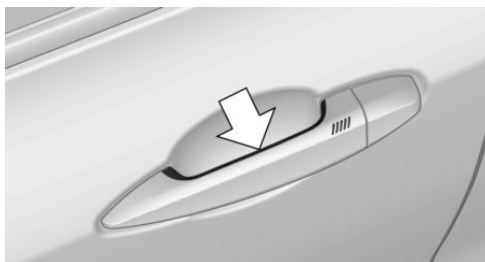

Grasp the door handle on the driver's or front passenger door completely.

This corresponds to pressing the button  on the vehicle key.

Locking

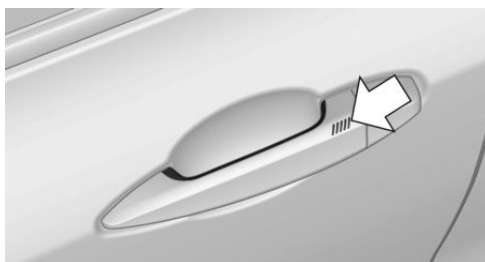

Touch the surface on the door handle of the driver's or front passenger door with your finger for approx. 1 second without grasping the door handle.

This corresponds to pressing the button  on the vehicle key.

Convenient closing

Safety information

Warning

With convenient closing, body parts can be jammed. There is a risk of injury. Make sure that the area of movement of the doors is clear during convenient closing.

Closing



Touch the surface on the door handle of the driver's or front passenger door, arrow, with your finger and hold it there without grasping the door handle.

This corresponds with pressing and holding the button  on the vehicle key.

In addition to locking, the windows and the glass sunroof close. The exterior mirrors fold in, depending on the model.

Opening the tailgate

General information

To avoid locking the vehicle key in the vehicle, do not place the vehicle key in the cargo area.

If the tailgate is opened via Comfort Access, locked doors are not unlocked.

Safety information

Warning

Body parts can be jammed when operating the tailgate. There is a risk of injury. Make sure that the travel path of the tailgate is clear during opening and closing.

Warning

The tailgate swings back and up when it opens. There is a risk of injury or risk of damage to property. Make sure that the travel path of the tailgate is clear during opening and closing.

NOTICE

Sharp-edged or pointed objects can hit the windows and heating elements while driving. There is a risk of damage to property, among other potential damage. Cover the edges and ensure that pointed objects do not hit the windows.

Opening



Press button next on tailgate.

This corresponds to pressing the button  on the vehicle key.

Without automatic trunk lid actuation:

The tailgate is unlocked and can be swung upward.

With automatic trunk lid actuation:

The tailgate opens automatically.



With automatic trunk lid actuation: contactless trunk opening and closing

Principle

The trunk can be opened and closed contactless using the vehicle key you are carrying. Two sensors detect a forward-directed foot movement in the central rear area and the tailgate is opened or closed.

General information

To avoid locking the vehicle key in the vehicle, do not place the vehicle key in the cargo area. If the vehicle key is in the sensor area, the tailgate may open or close inadvertently if you unintentionally move your foot or if a foot movement is detected.

The sensor has an approximate range of 5 ft/1.50 m extending from the rear area.

If the trunk is opened contactless, locked doors are not unlocked.

Contactless trunk opening and closing must be activated in the settings.

Safety information

Warning

During no-touch activation, vehicle parts may be touched, such as the hot exhaust system. There is a risk of injury. When moving your foot, make sure you have a firm stance and do not touch the vehicle.

Warning

Body parts can be jammed when operating the tailgate. There is a risk of injury. Make sure that the travel path of the tailgate is clear during opening and closing.

Warning

The tailgate swings back and up when it opens. There is a risk of injury or risk of damage to property. Make sure that the travel path of the tailgate is clear during opening and closing.

Settings

1. "My Vehicle"
2. "Vehicle settings"
3. "Doors/Key"
4. "Tailgate"
5. Select the desired setting:
 - ▶ "Open by foot movement"
Contactless trunk opening is switched on or off.
 - ▶ "Close by foot movement"
Contactless trunk closing is switched on or off.

Performing the foot movement

1. Stand in the middle behind the vehicle at approx. one arm's length away from the rear of the vehicle.
2. Wave a foot under the vehicle in the driving direction and immediately pull it back. With this movement, the leg must pass through the ranges of both sensors.

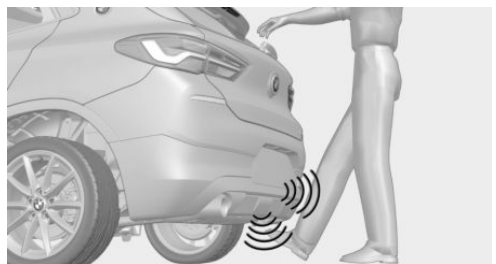

Opening

Perform the foot movement described earlier.

Before the opening, the hazard warning system flashes.

If contactless closing is switched on:

Moving a foot again will stop the opening procedure.

The subsequent foot movement will close the tailgate again.

Closing

Perform the foot movement described earlier.

Before closing, the hazard warning system flashes and an acoustic signal sounds.

Moving a foot again will stop the closing process.

The subsequent foot movement will open the tailgate again.

System limits

The detection of the foot movement may be limited due to the following external conditions:

- ▷ Ice, snow or slush on the rear of the vehicle.
- ▷ Dirt or road salt on the rear of the vehicle.

Movement in the range of the sensors may cause unintended opening or closing of the cargo area, for instance due to water running down when cleaning the vehicle or with heavy rainfall. To prevent such unintended opening or closing of the cargo area in such cases, keep the vehicle key at a sufficient distance from the rear of the vehicle.

Malfunction

Vehicle key detection by the vehicle may malfunction under the following circumstances:

- ▷ The battery of the vehicle key is discharged. Replace the battery, refer to page 61.
- ▷ Fault of the radio link from transmission towers or other equipment with high transmitting power.
- ▷ Shielding of the vehicle key due to metal objects.

Do not transport the vehicle key together with metal objects.

- ▷ Fault of the radio link from mobile phones or other electronic devices in direct proximity to the vehicle key.

Do not carry the vehicle key in close proximity to other electronic devices.

Wet or snowy conditions may disrupt the locking request detection on the door handles.

In the case of a malfunction, unlock and lock the vehicle using the buttons of the vehicle key or using the integrated key, refer to page 62.

Tailgate

General information

To avoid locking the vehicle key in the vehicle, do not place the vehicle key in the cargo area.

Depending on the vehicle equipment and country version, it is possible to specify whether the tailgate can be unlocked with the vehicle key and how the vehicle doors will respond to this. To perform settings, refer to page 73.

Safety information

Warning

Body parts can be jammed when operating the tailgate. There is a risk of injury. Make sure that the travel path of the tailgate is clear during opening and closing.

Warning

The tailgate swings back and up when it opens. There is a risk of injury or risk of damage to property. Make sure that the travel path of the tailgate is clear during opening and closing.

**NOTICE**

Sharp-edged or pointed objects can hit the windows and heating elements while driving. There is a risk of damage to property, among other potential damage. Cover the edges and ensure that pointed objects do not hit the windows.

Without automatic trunk lid actuation**Opening from the outside**

- ▶ Without Comfort Access: unlock vehicle.
With Comfort Access: unlock the vehicle or have the vehicle key with you.
Press on the top half of the BMW plaque.
- ▶  Press the button on the vehicle key for approx. 1 second.
Depending on the setting, the doors may also be unlocked. Unlocking using the vehicle key, refer to page 60.

The tailgate is opened slightly and can be swung upward at the folded up BMW plaque.

Opening from the inside

With Steptronic transmission:

With the vehicle stationary, pull the button in the storage compartment of the driver's door upwards.

If the vehicle is locked, selector lever position P must be engaged first.



With manual transmission:

With the vehicle stationary, pull the button in the storage compartment of the driver's door upwards twice in quick succession.

The tailgate is opened slightly and can be swung upward.

Closing

Grasp the recessed grip and pull tailgate down.

With automatic trunk lid actuation**Opening****Adjusting the opening height**

You can set how far the tailgate should open. When adjusting the opening height, ensure that there is a clearance of at least 4 in/10 cm above the tailgate.

1. "My Vehicle"
2. "Vehicle settings"
3. "Doors/Key"
4. "Tailgate"
5. Monitor the tailgate and set the desired opening height.

From the outside



- ▷ Without Comfort Access: unlock vehicle.
With Comfort Access: unlock the vehicle or have the vehicle key with you.
Press on the top half of the BMW plaque.

- ▷  Press the button on the vehicle key for approx. 1 second.
Depending on the setting, the doors may also be unlocked. Opening with the vehicle key, refer to page 60.

If the vehicle is stationary, the tailgate opens automatically to the adjusted opening height.

From the inside

-  With Steptronic transmission:
Pull button in the storage compartment of the driver's door upward.

If the vehicle is locked, selector lever position P must be engaged first.

-  With manual transmission:
With the vehicle stationary, pull the button in the storage compartment of the driver's door upwards twice in quick succession.

If the vehicle is stationary, the tailgate opens automatically to the adjusted opening height.

Interruption of the opening procedure

The opening procedure is interrupted in the following situations:

- ▷ When the vehicle starts moving.
- ▷ By pressing the button on the outer side of the tailgate. Pressing again closes the tailgate.
- ▷ By pressing the button on the inside of the tailgate. Pressing again closes the tailgate.
- ▷ By pressing the button on the vehicle key. Pressing again continues the opening procedure.
- ▷ By pressing or pulling the button in the storage compartment. Pulling again continues the opening procedure.

Closing

From the outside

Press the button on the outer side of the tailgate.

From the inside

-  Press button in the storage compartment of the driver's door and keep it pressed.

The vehicle key must be located in the interior for this function.

An acoustic signal sounds before the tailgate is closed.

From inside the tailgate

Without Comfort Access:

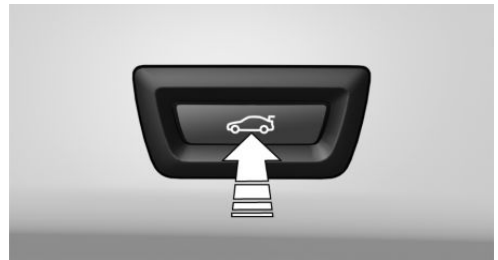

Press the button on the inside of the tailgate.

With Comfort Access:

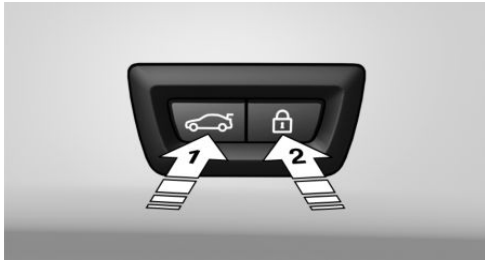

- ▶ Press button on the inside of the tailgate, arrow 1.
- ▶ Press button, arrow 2.

The vehicle will be locked after closing the tailgate. The driver's door must be closed for this purpose and the vehicle key must be outside of the vehicle in the area of the tailgate.

Interruption of the closing procedure

The closing procedure is interrupted in the following situations:

- ▶ If the vehicle drives off with a jerky movement.
- ▶ By pressing the button on the outer side of the tailgate. Pressing again re-opens the tailgate.
- ▶ By pressing the button on the inside of the tailgate. Pressing again re-opens the tailgate.
- ▶ By releasing the button in the storage compartment of the driver's door. Pulling again and holding continues the closing motion.

Malfunction

Safety information

Warning

With manual operation of a blocked tailgate, it can release itself unexpectedly from the blocking. There is a risk of injury or risk of damage to property. Do not operate the tailgate manually if it is blocked. Have it checked

by a dealer's service center or another qualified service center or repair shop.

Manual operation

Operate the unlocked tailgate manually with a slow and smooth motion.

To close the tailgate fully, press down lightly only. Closing occurs automatically.

Driver profiles

Principle

In the driver profiles, individual settings for several drivers can be stored and called up again when required.

General information

There are three driver profiles with which personal vehicle settings can be stored. Every vehicle key has been assigned one of these driver profiles.

If the vehicle is unlocked using a vehicle key, the assigned personal driver profile will be activated. All settings stored in the driver profile are automatically applied.

If several drivers use their own vehicle keys, the vehicle will apply the personal settings as it is being unlocked. These settings are also restored, if the vehicle has been used in the meantime by a person with a different vehicle key.

Changes to the settings are automatically stored in the driver profile currently activated.

If another driver profile is selected via iDrive, the settings stored in it will be applied automatically. The new driver profile is assigned to the vehicle key that is currently in use.

There is an additional guest profile available that is not assigned to any vehicle key. It can be used to apply settings in the vehicle without changing the personal driver profiles.

Functional requirements

For the system to be able to identify the driver profile associated to a particular driver, the detected vehicle key must be clearly allocated to the driver.

This is the case when:

- ▶ The driver is only carrying his or her own vehicle key.
- ▶ The driver unlocks the vehicle.
- ▶ The driver gets into the vehicle through the driver's door.

Settings

The settings, for instance for the following systems and functions, are stored in the active profile. The scope of storable settings depends on country and equipment.

- ▶ Unlocking and locking.
- ▶ Lights.
- ▶ Climate control.
- ▶ Radio.
- ▶ Instrument cluster.
- ▶ Programmable memory buttons.
- ▶ Volumes, sound.
- ▶ Control Display.
- ▶ Navigation.
- ▶ PDC Park Distance Control.
- ▶ Rearview camera.
- ▶ Head-up Display.
- ▶ Driving Dynamics Control.
- ▶ Seat position, exterior mirror position, steering wheel position where applicable.
Both the positions saved via the seat memory and the last position set are saved.
- ▶ Intelligent Safety.

Profile management

Selecting a driver profile

Regardless of the vehicle key in use, a different driver profile may be activated. This allows you to call up personal vehicle settings, even if you did not unlock the vehicle with your own vehicle key.

Via iDrive:

1. "My Vehicle"
2. "Driver profiles"
3. Select driver profile.
4. "OK"
 - ▶ All settings stored in the selected driver profile are automatically applied.
 - ▶ The called-up driver profile is assigned to the vehicle key being used at the time.
 - ▶ If the driver profile is already assigned to a different vehicle key, this driver profile will be valid for both vehicle keys.

Using a guest profile

The guest profile is for individual settings that are stored in none of the three personal driver profiles.

Via iDrive:

1. "My Vehicle"
2. "Driver profiles"
3. "Drive off (guest)"
4. "OK"

The guest profile cannot be renamed. It is not assigned to the vehicle key currently in use.

Renaming a driver profile

A personal name can be assigned to the active driver profile to avoid confusion between the driver profiles.

Via iDrive:

1. "My Vehicle"
2. "Driver profiles"
3. Select driver profile.
 -  The driver profile marked with this icon can be renamed.
4. "Change driver profile name"
5. Enter profile name.
6. **OK** Select the icon.

Resetting a driver profile

The settings of the driver profile currently in use are reset to their factory settings.

Via iDrive:

1. "My Vehicle"
2. "Driver profiles"
3. Select driver profile.
 -  The driver profile marked with this icon can be reset.
4. "Reset driver profile"
5. "OK"

Exporting driver profiles

Most settings of the active driver profile can be exported.

Exporting is helpful when storing and retrieving personal settings, for instance prior to a workshop visit. The stored driver profiles can be taken into another vehicle.

Via iDrive:

1. "My Vehicle"
2. "Driver profiles"
3. Select driver profile.
 -  The driver profile marked with this icon can be exported.
4. "Export driver profile (USB)"
 - Select the USB storage device, as needed, refer to page [52](#).

Importing driver profiles

The existing settings of the active driver profile are overwritten with the settings of the imported driver profile.

Via iDrive:

1. "My Vehicle"
2. "Driver profiles"
3. Select the driver profile to be overwritten.
 -  The driver profile marked with this icon can be overwritten.
4. "Import driver profile (USB)"
 - Select USB storage device as needed.
5. Select the driver profile to be imported.

Displaying driver profiles during start

The driver profiles can be displayed at each startup to select the desired profile.

Via iDrive:

1. "My Vehicle"
2. "Driver profiles"
3. "Show driver profiles at startup"

System limits

A clear assignment between the vehicle key and driver may not be possible in the following cases, for example.

- ▶ The front passenger unlocks the vehicle with his or her own vehicle key, but another person is driving.
- ▶ The driver unlocks the vehicle via Comfort Access and has multiple vehicle keys with him or her.
- ▶ The driver changes, but the vehicle is not locked and unlocked.
- ▶ Multiple vehicle keys are located in the outer area of the vehicle.

Settings

General information



Depending on the package and country version, various settings are available for the vehicle key functions.

These settings are stored for the driver profile, refer to page 70, currently used.

Unlocking

Doors

Via iDrive:

1. "My Vehicle"
2. "Vehicle settings"
3. "Doors/Key"
4.  "Driver's door" or  "All doors"
5. Select the desired setting:
 - ▷ "Driver's door only"

Only the driver's door and the fuel filler flap are unlocked. Pressing again unlocks the entire vehicle.
 - ▷ "All doors"

The entire vehicle is unlocked.

Tailgate

Depending on the vehicle equipment and country version, this setting may not be offered.

Via iDrive:

1. "My Vehicle"
2. "Vehicle settings"
3. "Doors/Key"
4. 

The text next to the icon indicates the current setting.
5. Select the desired setting:
 - ▷ "Tailgate"

Depending on your vehicle's optional features, the tailgate is either unlocked or opened.

- ▷ "Tailgate and door(s)"

Depending on your vehicle's optional features, the tailgate is either unlocked or opened and the doors unlocked.
- ▷ "Tailgate opens after unlocking"

The vehicle must be unlocked before the tailgate can be used with the vehicle key.
- ▷ "Button lock"

The operation of the tailgate via the vehicle key is disabled.

Adjusting the last seat and mirror position

Via iDrive:

1. "My Vehicle"
2. "Driver profiles"
3. Select driver profile.
 -  The setting can be made for the driver profile marked with this icon.
4. "Last seat position automatic"

When the vehicle is unlocked, the driver's seat and exterior mirrors resume their last set positions.

The most recent position is independent of the positions saved via the seat memory.

Confirmation signals from the vehicle

Via iDrive:

1. "My Vehicle"
2. "Vehicle settings"
3. "Doors/Key"
4. Deactivate or activate the desired confirmation signals.
 - ▷ "Flash for lock/unlock"



Unlocking is signaled by blinking twice, locking by blinking once.

- ▷ With alarm system:

"Acoustic signal for lock/unlock"

Unlocking is signaled by one honk of the horn.

Automatic locking

Via iDrive:

1. "My Vehicle"
2. "Vehicle settings"
3. "Doors/Key"
4. Select the desired setting:
 - ▷ "Lock automatically"

The vehicle locks automatically after a while if no door is opened after unlocking.
 - ▷ "Lock after starting to drive"

The vehicle locks automatically after you drive off.

Automatic unlocking

Via iDrive:

1. "My Vehicle"
2. "Vehicle settings"
3. "Doors/Key"
4. "Unlock at end of trip"

After the engine is switched off by pressing the Start/Stop button, the locked vehicle is automatically unlocked.

Alarm system

General information

When the vehicle is locked, the vehicle alarm system reacts to the following changes:

- ▷ Unauthorized opening of a door, the hood or the tailgate.
- ▷ Movements in the vehicle interior.
- ▷ Changes in the vehicle inclination, for instance, during attempts at stealing a wheel or when towing the vehicle.
- ▷ Disconnected battery voltage.
- ▷ Improper use of the socket for OBD on-board diagnostics.
- ▷ Locking the vehicle while a device is connected to the socket for the diagnostic socket. For socket for the OBD on-board diagnostics, refer to page 266.

The alarm system signals these changes visually and acoustically:

- ▷ Acoustic alarm:

Depending on local regulations, the acoustic alarm may be suppressed.
- ▷ Optical alarm:

By blinking of the hazard warning system and headlights, where required.

Do not modify the system to ensure function of the alarm system.

Turning on/off

The alarm system is switched off or on as soon as the vehicle is unlocked or locked with the vehicle key or via Comfort Access.

Opening the doors with the alarm system switched on

The alarm system is triggered when a door is opened if the door was unlocked using the integrated key in the door lock.

End alarm, refer to page 76.

Opening the tailgate with the alarm system switched on

The tailgate can be opened even when the alarm system is switched on.

After the tailgate is closed, it is locked and monitored again provided the doors are locked. The hazard warning system flashes once.

Panic mode

You can trigger the alarm system if you find yourself in a dangerous situation.



▶ Press the button on the vehicle key and hold for at least 3 seconds.

- ▶ Briefly press the button on the vehicle key three times in succession.

To switch off the alarm: press any button.

Indicator light on the interior mirror

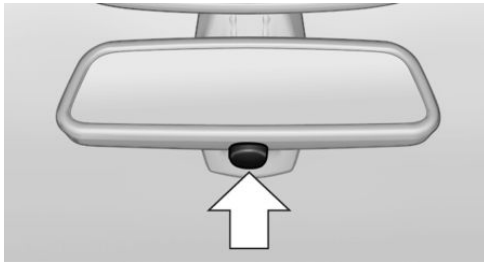

- ▶ The indicator light flashes briefly every 2 seconds:

The alarm system is switched on.

- ▶ Indicator light flashes for approx. 10 seconds, then it flashes briefly every 2 seconds:

Interior motion sensor and tilt alarm sensor are not active, as doors, hood, or tailgate are not correctly closed. Correctly closed access points are secured.

When the still open access points are closed, the interior motion sensor and tilt alarm sensor will be switched on.

- ▶ The indicator light goes out after unlocking:

The vehicle has not been tampered with.

- ▶ The indicator light flashes after unlocking until the engine ignition is switched on, but no longer than approx. 5 minutes:

An alarm has been triggered.

Tilt alarm sensor

The inclination of the vehicle is monitored.

The alarm system responds in situations such as attempts to steal a wheel or when the vehicle is towed.

Interior motion sensor

The windows and the glass sunroof must be closed for the system to function properly.

Avoiding unintentional alarms

General information

The tilt alarm sensor and interior motion sensor can trigger an alarm, although no unauthorized action occurred.

Possible situations for an unwanted alarm:

- ▶ In car washes.
- ▶ In duplex garages.
- ▶ During transport on trains carrying vehicles, at sea or on a trailer.
- ▶ With animals in the vehicle.
- ▶ When the vehicle is locked after start of refueling.

The tilt alarm sensor and the interior motion sensor can be switched off in such situations.

Switching off the tilt alarm sensor and interior motion sensor



Press the button on the vehicle key within 10 seconds as soon as the vehicle is locked.

The indicator light lights up for approx. 2 seconds and then continues to flash.

The tilt alarm sensor and interior motion sensor are switched off until the vehicle is locked again.

Ending the alarm

- ▷ Unlock the vehicle with the vehicle key.
- ▷ Unlock the vehicle with the integrated key and switch on the ignition using the emergency detection of the vehicle key, refer to page 61.
- ▷ With Comfort Access:
When carrying the vehicle key, grasp the driver's door or front passenger door handle completely.

Power windows

General information

If an accident of a certain severity occurs, the windows are automatically closed except a gap.

In the radio-ready state, the windows can continue to be operated for an extended period of time. After switching off the radio-ready state, the windows can be operated for approx. one minute longer.

Safety information

Warning

When operating the windows, body parts and objects can be jammed. There is a risk of injury or risk of damage to property. Make sure that the travel path of the windows is clear during opening and closing.



Overview



 Power windows



 Safety switch

Opening

- ▷  Press the switch to the resistance point.
The window opens while the switch is being held.
- ▷  Press the switch beyond the resistance point.
The window opens automatically. Pressing the switch again stops the motion.

Convenient opening with the vehicle key, refer to page 59.

Closing

- ▷  Pull the switch to the resistance point.
The window closes while the switch is being held.
- ▷  Pull the switch beyond the resistance point.
The window closes automatically if the door is closed. Pulling again stops the motion.

Closing via Comfort Access, refer to page 64.

Jam protection system

Principle

The jam protection prevents objects or body parts becoming jammed between the door frame and window while a window is being closed.

General information

If resistance or a blockage is detected while a window is being closed, the closing action is interrupted.



Safety information

Warning

Accessories on the windows such as antennas can impact jam protection. There is a risk of injury. Do not install accessories in the area of movement of the windows.

Closing without the jam protection system

In case of danger from the outside or if icing might prevent normal closing, proceed as follows:

-  Pull the switch past the resistance point and hold it there.
The window closes with limited jam protection. If the closing force exceeds a specific threshold, closing is interrupted.
-  Pull the switch past the resistance point again within approx. 4 seconds and hold it there.
The window closes without jam protection.

Safety switch

General information

The safety switch can be used to prevent children, for instance from opening and closing the rear windows using the switches in the rear. If an accident of a certain severity occurs, the safety function is switched off automatically.

Turning on/off



Press the button.

The LED lights up if the safety function is switched on.

Panoramic glass sunroof

General information

The glass sunroof is ready for operation when the ignition is switched on.

In the event of a severe accident, the glass sunroof is automatically closed.

Safety information

Warning

Body parts can be jammed when operating the glass sunroof. There is a risk of injury. Make sure that the area of movement of the glass sunroof is clear during opening and closing.

Overview



Tilting up and closing the tilted glass sunroof



Push switch briefly upward.

- ▶ The closed glass sunroof tilts and the sun protection opens slightly.
- ▶ The opened glass sunroof closes until it is in the tilted position. The sun protection does not move.

- ▶ The tilted glass sunroof closes.

Opening/closing the glass sunroof and sun protection separately

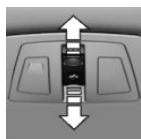

▶ Slide switch back to the resistance point and hold.

Holding down the switch opens the sun protection. If the sun protection is already fully open, the glass sunroof opens.

- ▶ Slide switch forward to the resistance point and hold.

The glass sunroof closes while the switch is being held. If the glass sunroof is already closed or in the tilted position, the sun protection closes.

- ▶ Slide the switch back past the resistance point.

The sun protection opens automatically. If the sun protection is already fully open, the glass sunroof opens automatically.

Pressing the switch again stops the motion.

- ▶ Push the switch forward past the resistance point.

The glass sunroof closes automatically. If the glass sunroof is already closed or in the tilted position, the sun protection closes automatically.

Pressing the switch again stops the motion.

Opening/closing the glass sunroof and sun protection together

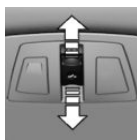

- ▶ Briefly press out the switch twice in succession toward the rear past the resistance point.

The glass sunroof and sun protection are opening together.

Pressing the switch again stops the motion.

- ▶ Briefly press out the switch twice in succession toward the front past the resistance point.

The glass sunroof and sun protection are closing together.

Pressing the switch again stops the motion.

Convenient opening with the vehicle key, refer to page [59](#).

Closing via Comfort Access, refer to page [64](#).

Comfort position

In some models, the wind noises in the car's interior are lowest when the glass sunroof is not fully open. In these models, the automatic function initially only opens the glass sunroof up to this comfort position.

Pressing the switch again opens the glass sunroof fully.

Jam protection system

General information

If a resistance or blockage is detected while the glass sunroof is closing, the closing operation is interrupted once the roof reaches the half-open position, or it is stopped when closing from the tilted position.

The glass sunroof opens slightly.

Closing from the open position without jam protection

If there is an external danger, proceed as follows:

1. Push the switch forward past the resistance point and hold.

The glass sunroof closes with limited jam protection. If the closing force exceeds a specific threshold, closing is interrupted.

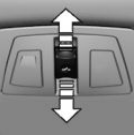

2. Push the switch forward again past the resistance point and hold until the glass sunroof closes without jam protection. Make sure that the closing path is clear.

Closing from the raised position without jam protection

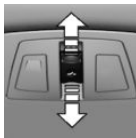

If there is an external danger, push the switch forward past the resistance point and hold it.

The glass sunroof closes without jam protection.

Initializing after a power interruption

General information

After a power interruption during the opening or closing process, the glass sunroof can only be operated to a limited extent.

The system can be initialized under the following conditions:

- ▶ The vehicle is parked in a horizontal position.
- ▶ The vehicle will not be moved until the initialization is completed.
- ▶ The engine is running.
- ▶ The outside temperature is above 41 °F/5 °C.

During initialization, the glass sunroof closes without jam protection.

Make sure that the closing path is clear.

Initializing the system

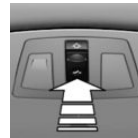

Press the switch up and hold it until initialization is complete.

Initialization begins within 15 seconds.

- ▶ If the glass sunroof is closed, it opens then closes again.
- ▶ If the glass sunroof is open, it first closes, then opens and closes again.

Initialization is complete once the glass sunroof and sun protection have opened then closed again.

Seats, mirrors and steering wheel

Vehicle features and options

This chapter describes all standard, country-specific and optional features offered with the series. It also describes features and functions that are not necessarily available in your vehicle, e.g., due to the selected options or country versions. This also applies to safety-related functions and systems. When using these functions and systems, the applicable laws and regulations must be observed.

Sitting safely

An ideal seat position that meets the needs of the occupants can make a vital contribution to relaxed, fatigue-free driving.

In the event of an accident, the correct seat position plays an important role. Additionally, follow the following chapters for safe driving:

- ▶ Seats, refer to page 80.
- ▶ Seat belts, refer to page 83.
- ▶ Head restraints, refer to page 85.
- ▶ Airbags, refer to page 141.

Front seats

Safety information

 **Warning**

Seat setting while driving can lead to unexpected movements of the seat. Vehicle control could be lost. There is a risk of accident. Only adjust the seat on the driver's side when the vehicle is stationary.

 **Warning**

With a backrest inclined too far to the rear, the protective effect of the seat belt can no longer be ensured. There is a risk of sliding under the seat belt in an accident. There is a risk of injury or danger to life. Adjust the seat prior to starting the trip. Adjust the backrest so that it is in the most upright position as possible and do not adjust again while driving.

 **Warning**

There is a risk of jamming when moving the seats. There is a risk of injury or risk of damage to property. Make sure that the travel path of the seat is clear prior to any adjustment.

Electrically adjustable seats

General information

The seat setting for the driver's seat is stored for the profile currently used. When the vehicle is unlocked via the vehicle key, the position is automatically retrieved if the function, refer to page 73, is activated for this purpose.

The current seat position can be stored using the memory function, refer to page 87.

Overview

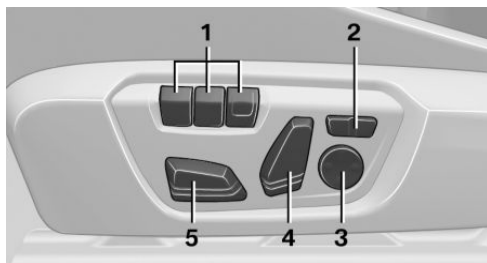

- 1 Memory function
- 2 Backrest width
- 3 Lumbar support
- 4 Backrest tilt
- 5 Forward/backward, height, seat tilt

Longitudinal direction

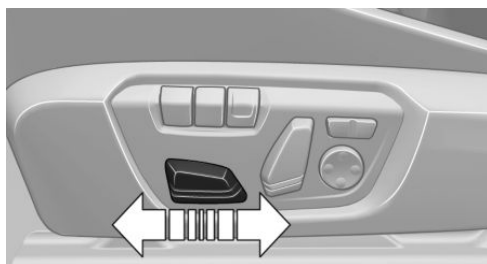

Press switch forward or backward.

Height

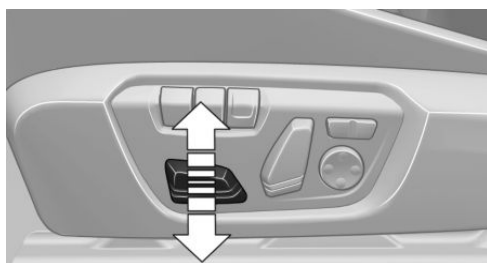

Press switch up or down.

Seat tilt

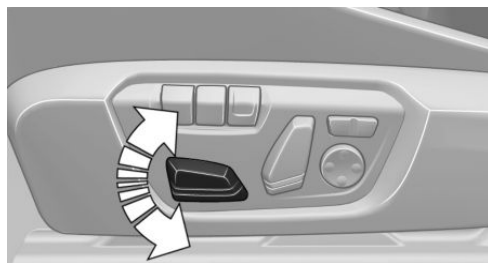

Tilt switch up or down.

Backrest tilt

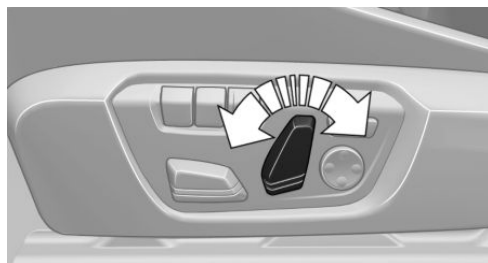

Tilt switch forward or backward.

Thigh support

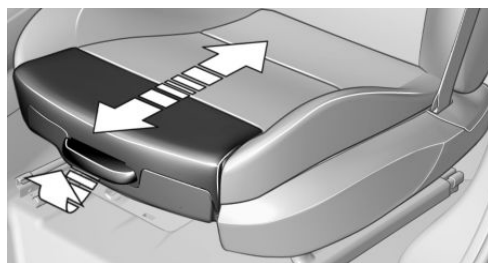

Pull the lever at the front of the seat and adjust the thigh support.

Lumbar support

The curvature of the seat backrest can be adjusted in a way that it supports the lumbar region of the spine. The lower back and the spine are supported for upright sitting position.



- ▶ Press the front/rear section of the button:
The curvature is increased/decreased.
- ▶ Press the upper/lower section of the button:
The curvature is shifted up/down.

Backrest width

Principle

Adjusting the backrest width may improve side support when cornering.

General information

You can change the backrest width by adjusting the side wings of the backrest.

Adjusting



- ▶ Press the button forward: backrest width is reduced.
- ▶ Press the button back: backrest width is increased.

Front seat heating

Overview



Seat heating

Turning on



Press the button once for each temperature level.

The maximum temperature is reached when three LEDs are lit.

If the trip is continued within approx. 15 minutes after a stop, seat heating is activated automatically with the temperature selected last.

When ECO PRO is activated, refer to page 225, the heater output is reduced.

Turning off



Press and hold the button until the LEDs turn off.

Rear seats

Second row of seats

Safety information

Warning

There is a danger of jamming when folding down the center armrest in the rear. There is a risk of injury. Make sure that the area of movement of the center armrest is clear during folding down.

Warning

Unexpected movements of the rear seat backrest while driving may occur due to unintentional unlocking of the rear seat backrests by the loops. There is a risk of injury. Only use loops for releasing the rear seat backrests. Do not attach objects on the loops.

Backrest tilt

1. Pull loop to unlock the backrest.

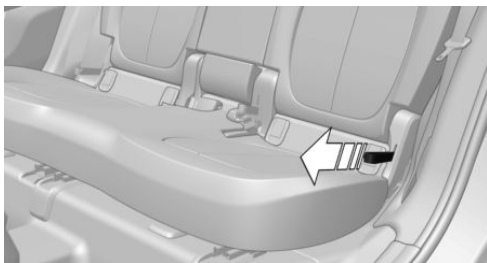

2. Apply or lift weight on the backrest as needed.

After the adjustment, move the backrest slightly forward or back to engage it correctly.

Seat belts

General information

The vehicle is fitted with five seat belts to ensure occupant safety. However, the seat belts can only offer protection when adjusted correctly.

Always make sure that seat belts are being worn by all occupants before driving off. Although airbags enhance safety by providing added protection, they do not replace seat belts.

All belt fastening points are designed to achieve the best possible protective effect of the seat belts with proper use of the seat belts and correct seat setting. Follow notes on sitting safely, refer to page 80.

The two outer seat belt buckles of the rear seat are intended for the persons sitting on the left and right.

The center seat belt buckles of the rear seat are intended for the persons sitting in the middle.

Safety information

Warning

Use of a seat belt to buckle more than one person will potentially defeat the ability of the seat belt to serve its protective function. There is a risk of injury or danger to life. Do not allow more than one person to fasten a single seat belt. Infants and children are not allowed on an occupant's lap, but must be transported and secured in designated child restraint systems.

Warning

The protective effect of safety gear, including seat belts, can be limited or lost when seat belts are fastened incorrectly. An incorrectly fastened seat belt can cause additional injuries, for instance in the event of an accident, braking or evasive maneuvers. There is a risk of injury or danger to life. Make sure that all occupants are wearing seat belts correctly.

Warning

With a rear seat backrest that is not locked, the protective effect of the middle seat belt is not guaranteed. There is a risk of injury or danger to life. If you are using the middle seat belt, lock the wider rear seat backrest.

Warning

The protective effect of safety gear, including seat belts, may not be fully functional or fail in the following situations:

- ▷ The seat belts or seat belt buckles are damaged, soiled, or changed in any other way.
- ▷ Seat belt tensioners or roll-up mechanism were modified.

Seat belts can be imperceptibly damaged in the event of an accident. There is a risk of injury or danger to life. Do not modify seat belts, seat belt buckles, seat belt tensioners, roll-up mechanisms, or belt anchors and keep them clean. Have the seat belts checked after an accident at the dealer's service center or another qualified service center or repair shop.

Correct use of seat belts

- ▶ Wear the seat belt twist-free and tight to your body over your lap and shoulders.
- ▶ Wear the seat belt deep on your hips over your lap. The seat belt may not press on your stomach.
- ▶ Do not rub the seat belt against sharp edges, or guide it or jam it in across hard or fragile objects.
- ▶ Avoid thick clothing.
- ▶ Re-tighten the seat belt frequently upward around your upper body area.

Buckling the seat belt

1. Guide the seat belt slowly over shoulder and hip to put it on.
2. Insert the buckle tongue into the seat belt buckle. The seat belt buckle must engage audibly.

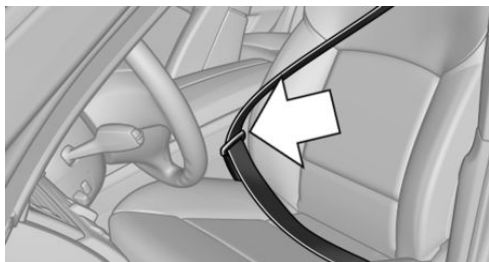

Unbuckling the seat belt

1. Hold down the seat belt firmly.
2. Press the red button in the belt buckle.
3. Guide the seat belt back into its roll-up mechanism.

Middle seat belt in the rear

Buckling the seat belt

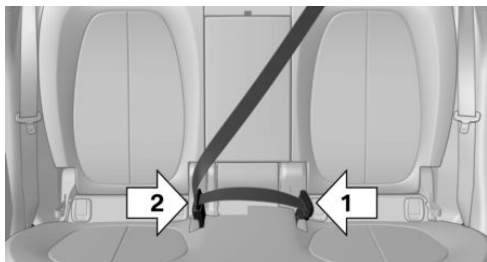

1. Pull the buckle tongues out of the mounts in the roof.
2. Insert the lower buckle tongue in the belt buckle, arrow 1.
3. Insert the upper buckle tongue in the belt buckle, arrow 2.

Seat belt buckles must audibly click into place.

Unbuckling the seat belt

1. Hold down the seat belt firmly.
2. Press the red button in the belt buckle.

- Use the buckle tongue, arrow 1, to open the second seat belt buckle, arrow 2.

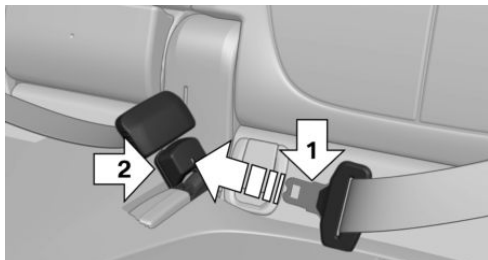

- Guide the seat belt to the mount in the headliner.

Seat belt reminder for driver's and front passenger's seat

General information

The seat belt reminder is issued when the driver's side seat belt is not buckled.

The seat belt reminder is also active when the front passenger seat belt is not buckled or objects are on the front passenger seat.

The seat belt reminder is also activated when a passenger unbuckles a seat belt during the trip.

Display in the instrument cluster



The indicator light lights up and a signal sounds. Make sure that the seat belts are positioned correctly. The seat belt reminder can also be activated if objects are placed on the front passenger seat.

Front head restraints

Safety information

Warning

Removal or incorrect adjustment of head restraints can cause injuries in the head and neck area. There is a risk of injury.

- ▷ Before driving, install the removed head restraints on the occupied seats.
- ▷ Adjust the head restraint so its center supports the back of the head at as close to eye level as possible.
- ▷ Adjust the distance so that the head restraint is as close as possible to the back of the head. Adjust the distance via the backrest tilt as needed.

Warning

Body parts can be jammed when moving the head restraint. There is a risk of injury. Make sure that the area of movement is clear when moving the head restraint.

Warning

Objects on the head restraint reduce the protective effect in the head and neck area. There is a risk of injury.

- ▷ Do not use seat or head restraint covers.
- ▷ Do not hang objects, for instance clothes hangers, directly on the head restraint.
- ▷ Only use accessories that have been determined to be safe for attachment to a head restraint.
- ▷ Do not use any accessories, for instance pillows, while driving.

Adjusting the height

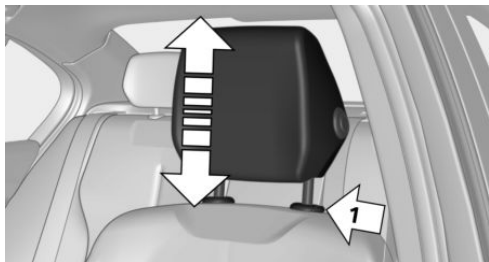

- ▷ To raise: push the head restraint up.
- ▷ To lower: press button, arrow 1, and push head restraint down.

After setting the height, make sure that the head restraint engages correctly.

Adjusting the height: M sport seat

The height of the head restraints cannot be set.

Removing: basic seat

Only remove the head restraint if no one will be sitting in the seat in question.

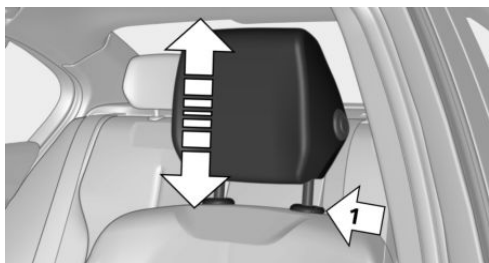

1. Raise the head restraint up against the resistance.
2. Press the button, arrow 1, and pull the head restraint out completely.

Remove: M sport seat

The head restraints cannot be removed.

Installing

Proceed in the reverse order to install the head restraint.

Rear head restraints

Safety information

Warning

Removal or incorrect adjustment of head restraints can cause injuries in the head and neck area. There is a risk of injury.

- ▷ Before driving, install the removed head restraints on the occupied seats.
- ▷ Adjust the head restraint so its center supports the back of the head at as close to eye level as possible.
- ▷ Adjust the distance so that the head restraint is as close as possible to the back of the head. Adjust the distance via the backrest tilt as needed.

Warning

Body parts can be jammed when moving the head restraint. There is a risk of injury. Make sure that the area of movement is clear when moving the head restraint.

Warning

Objects on the head restraint reduce the protective effect in the head and neck area. There is a risk of injury.

- ▷ Do not use seat or head restraint covers.
- ▷ Do not hang objects, for instance clothes hangers, directly on the head restraint.

- ▷ Only use accessories that have been determined to be safe for attachment to a head restraint.
- ▷ Do not use any accessories, for instance pillows, while driving.

Height

Adjusting

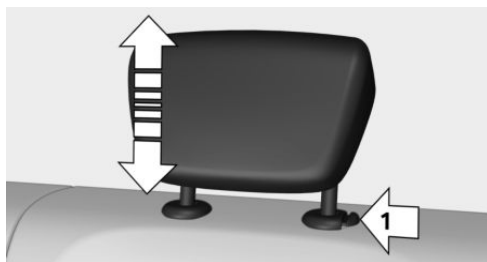

- ▷ To lower: press the button, arrow 1, and push the head restraint down.
- ▷ To raise: push the head restraint up.

After setting the height, make sure that the head restraint engages correctly.

Folding down the head restraint

Only fold the head restraint back if no one will be sitting in the seat in question.

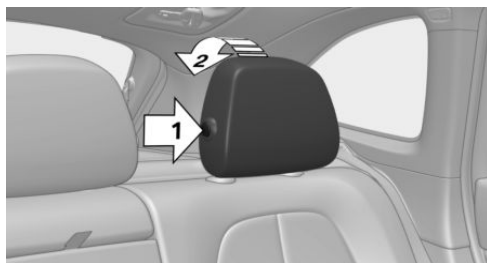

- ▷ To the back: press the button, arrow 1, and fold the head restraint back, arrow 2.
- ▷ Forward: fold the head restraint toward the front as far as it will go. Make sure that the head restraint engages correctly.

Removing

The head restraints cannot be removed.

Memory function

Principle

The following settings can be stored and, if necessary, retrieved using the memory function:

- ▷ Seat position.
- ▷ Exterior mirror position.
- ▷ Height of the Head-up Display.

General information

Different settings can be assigned to two memory locations.

Depending on the vehicle equipment, the following settings are not stored:

- ▷ Backrest width.
- ▷ Lumbar support.

Safety information

Warning

Using the memory function while driving can lead to unexpected movements of the seat. Vehicle control could be lost. There is a risk of accident. Only retrieve the memory function when the vehicle is stationary.

Warning

There is a risk of jamming when moving the seats. There is a risk of injury or risk of damage to property. Make sure that the travel path of the seat is clear prior to any adjustment.

Overview



Storing

1. Turn on the ignition.
2. Set the desired position.
3.  Press the button. The LED in the button lights up.
4. Press the desired button 1 or 2 while the LED is lit. The LED goes out.

 Button was pressed inadvertently:
Press the button again.

The LED goes out.

Calling up settings

The stored position is called up automatically.

Press the desired button 1 or 2.

The procedure stops when a seat setting switch or one of the memory buttons is pressed.

Once underway, adjustment of the seat position on the driver's side is disabled after a short while.

Call up deactivated

After a brief period, calling up stored seat positions is deactivated to save battery power.

To reactivate calling up of a seat position:

- ▶ Open or close the door or tailgate.
- ▶ Press a button on the vehicle key.
- ▶ Press the Start/Stop button.

Mirrors

Exterior mirrors

General information

The front passenger's side exterior mirror is more curved than the driver's side mirror.

The mirror setting is stored for the driver profile currently in use. When the vehicle is unlocked via the vehicle key, the position is automatically retrieved if the function, refer to page 73, is activated for this purpose.

The current exterior mirror position can be stored using the memory function, refer to page 87.

Safety information

Warning

Objects reflected in the mirror are closer than they appear. The distance to the road users behind could be incorrectly estimated, for instance while changing lanes. There is a risk of accident. Estimate the distance to the traffic behind by looking over your shoulder.

Overview



- 1 Adjusting
- 2 Selecting a mirror, Automatic Curb Monitor
- 3 Folding in and out

Selecting a mirror



To change over to the other mirror:
Slide the switch.

Adjusting electrically



Press the button.
The mirror movement follows the button movement.

Malfunction

In case of an electrical malfunction, adjust the mirror by pressing the edges of the mirror glass.

Folding in and out

NOTICE

Depending on the vehicle width, the vehicle can be damaged in car washes. There is a risk of damage to property, among other potential damage. Before washing, fold in the mirrors by hand or with the button.



Press the button.

Folding is only possible up to a speed of approx. 15 mph/20 km/h.

Folding the mirrors in and out is helpful in the following situations:

- ▶ In car washes.
- ▶ On narrow roads.

Mirrors that were folded in are folded out automatically at a speed of approx. 25 mph/40 km/h.

Automatic heating

Both exterior mirrors are automatically heated as needed and when the ignition is switched on.

Automatic dimming feature

The exterior mirror on the driver's side is automatically dimmed. Photocells in the interior mirror are used to control this.

Automatic Curb Monitor

Principle

If reverse gear is engaged, the mirror glass on the passenger's side is tilted downward. This improves your view of the curb and other low-lying obstacles when parking, for instance.

Activating

1.  slide the switch to the driver's side mirror position.
2. Engage selector lever position R.

Deactivating

Slide the switch to the front passenger's side exterior mirror position.

Interior mirror, manually dimmable

Turn button

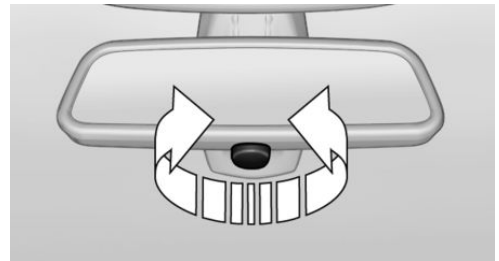

Turn the button to reduce the blinding glare by the interior mirror.

Interior mirror, automatic dimming feature

Overview

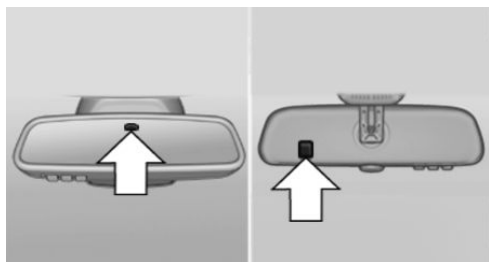

Photocells are used for control:

- ▷ In the mirror glass.
- ▷ On the rear of the mirror.

Functional requirements

- ▷ Keep the photocells clean.
- ▷ Do not cover the area between the interior mirror and the windshield.

Steering wheel

Safety information

Warning

Steering wheel adjustments while driving can lead to unexpected steering wheel movements. Vehicle control could be lost. There is a risk of accident. Adjust the steering wheel while the vehicle is stationary only.

Adjusting

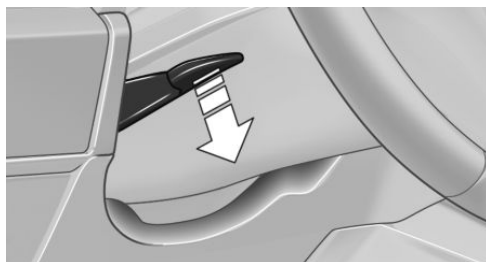

1. Fold the lever down.
2. Move the steering wheel to the preferred height and angle to suit your seat position.
3. Fold the lever back up.

Steering wheel heating

Overview



 Steering wheel heating

Turning on/off

-  Press the button.
- ▷ On: the LED lights up.
 - ▷ Off: the LED goes out.

Transporting children safely

Vehicle features and options

This chapter describes all standard, country-specific and optional features offered with the series. It also describes features and functions that are not necessarily available in your vehicle, e.g., due to the selected options or country versions. This also applies to safety-related functions and systems. When using these functions and systems, the applicable laws and regulations must be observed.

The right place for children

Safety information

Warning

Unattended children or animals in the vehicle can cause the vehicle to move and endanger themselves and traffic, for instance due to the following actions:

- ▷ Pressing the Start/Stop button.
- ▷ Releasing the parking brake.
- ▷ Opening and closing the doors or windows.
- ▷ Engaging selector lever position N.
- ▷ Using vehicle equipment.

There is a risk of accidents or injuries. Do not leave children or animals unattended in the vehicle. Take the vehicle key with you when exiting and lock the vehicle.

Warning

A heated vehicle may result in death to persons, especially children, or animals. There is a risk of injury or danger to life. Do not leave persons, especially children, or animals unattended in the vehicle.

Warning

Exposure to intense sunlight can cause child restraint systems and their components to become very hot. Persons may sustain burn injuries when touching the hot components. There is a risk of injury. Do not expose the child restraint system to direct sunlight or cover where necessary. If necessary, let the child restraint system cool down before transporting a child. Do not leave children unattended in the vehicle.

Transport children in the rear seat

General information

Accident research shows that the safest place for children is in the rear seat.

Children younger than 13 years of age or shorter than 5 ft/150 cm should be transported in the rear seat in suitable child restraint systems designed for the age, weight and size of the child. Children 13 years of age or older must wear a seat belt as soon as a suitable child restraint system can no longer be used due to their age, weight, or size.



Safety information

Warning

The seat belt cannot be fastened correctly on children shorter than 5 ft/150 cm without suitable additional child restraint systems. The protective effect of safety gear, including seat belts, can be limited or lost when seat belts are fastened incorrectly. An incorrectly fastened seat belt can cause additional injuries, for instance in the event of an accident, braking or evasive maneuvers. There is a risk of injury or danger to life. Secure children shorter than 5 ft/150 cm using suitable child restraint systems.

Children on the front passenger seat

General information

Before using a child restraint system on the front passenger seat, ensure that the front, knee, and side airbags on the passenger's side are deactivated. For automatic deactivation of front passenger airbags, refer to page 143.

Safety information

Warning

Active front passenger airbags can injure a child in a child restraint system when the airbags are deployed. There is a risk of injury. Make sure that the front passenger airbags are deactivated and that the PASSENGER AIRBAG OFF indicator light lights up.

Installing child restraint systems

General information

Pay attention to the specifications of the child restraint system manufacturer when selecting, installing, and using child restraint systems.

Safety information

Warning

The stability of the child restraint system is limited or compromised with incorrect seat setting or improper installation of the child seat. There is a risk of injury or danger to life. Make sure that the child restraint system fits securely against the backrest. If possible, adjust the backrest tilt for all affected backrests and correctly adjust the seats. Make sure that seats and backrests are securely engaged or locked. If necessary, adjust the height of the head restraints or remove them.

Warning

The protective effect of child restraint systems and their fastening systems which have been damaged or exposed to an accident can be limited or lost. A child cannot be properly restrained in the event of an accident, braking or evasive maneuvers. There is a risk of injury or danger to life.

Do not use child restraint systems which have been damaged or exposed to an accident.

If a child restraint system and its fastening system has been damaged or exposed to an accident, have these systems checked and replaced by a dealer's service center or another qualified service center or repair shop.

On the front passenger seat

Deactivating airbags

Warning

Active front passenger airbags can injure a child in a child restraint system when the airbags are deployed. There is a risk of injury. Make sure that the front passenger airbags are deactivated and that the PASSENGER AIRBAG OFF indicator light lights up.

Before installing a child restraint system in the front passenger seat, make sure that the front, knee and side airbags on the passenger's side are deactivated.

Deactivate the front passenger airbags automatically, refer to page 143.

Seat position and height

After installing a child restraint system, move the front passenger seat as far back as possible and bring it as far up as possible to obtain the best possible position for the belt and to offer optimal protection in the event of an accident.

If the upper attachment point of the seat belt is located in front of the belt guide of the child restraint seat, move the front passenger seat carefully forward until the best possible belt guide position is reached.

Backrest width

Adjustable backrest width: before installing a child restraint system in the front passenger seat, open the backrest width completely. Do not change the backrest width again and do not call up a memory position.

Child seat security



The rear seat belts and the front passenger seat belt can be permanently locked to fasten child restraint systems.

Locking the seat belt

1. Pull out the belt strap completely.
2. Secure the child restraint system with the seat belt.
3. Allow the belt strap to be pulled in and pull it tight against the child restraint system. The seat belt is disabled.

Unlocking the seat belt

1. Unbuckle the seat belt buckle.
2. Remove the child restraint system.
3. Allow the belt strap to be pulled in completely.

In some cases it may be necessary to separate the lower belt attachment. Seat belts, refer to page 84.

LATCH child seat mountings

General information

LATCH: Lower Anchors and Tether for Children.

Pay attention to the operating and safety information from the child restraint system manu-

facturer when installing and using LATCH child restraint fixing systems.

Mounts for the lower LATCH anchors

General information

The lower anchors may be used to attach the CRS to the vehicle seat up to a combined child and CRS weight of 65 lbs/30 kg when the child is restrained by the internal harnesses.

Safety information



Warning

If the lower mountings of the child restraint system are not correctly engaged, the protective effect of the child restraint system is limited. There is a risk of injury or danger to life. Make sure that the lower mountings are correctly engaged and that the child restraint system fits securely against the backrest.

Warning

The mounts for the lower mountings and attachment points of the child restraint system are intended for attaching child restraint systems only. If other objects are attached, the mounts or attachment points can be damaged. There is a risk of injury or risk of damage to property. Attach child restraint systems only at the corresponding mounts for the lower mountings or attachment points.

Position

Icon	Meaning
	The corresponding icon shows the mounts for the lower LATCH anchors.
	Seats equipped with lower mountings are marked with a pair, (2), of LATCH symbols. For vehicles equipped with a middle seat: It is not recommended to use the inner lower mountings of standard outer LATCH positions to fasten a child restraint system on the middle seat. Use the vehicle seat belt instead for the middle seat.

Before installing LATCH child restraint systems

Pull the seat belt away from the area of the child seat mountings.

Installation of LATCH child restraint fixing systems

1. Mount child restraint system, see manufacturer's information.
2. Ensure that both LATCH anchors are properly engaged.

Child restraint systems with tether strap

Safety information

Warning

If the upper retaining strap is incorrectly used for the child restraint system, the protective effect is reduced. There is a risk of injury. Make sure that the upper retaining strap does not run over sharp edges and is not twisted as it passes the upper anchor.

Warning

If the rear seat backrest is not locked, the protective effect of the child restraint system is limited or there is none. In certain situations, for instance braking maneuvers or in case of an accident, the rear seat backrest can fold forward. There is a risk of injury or danger to life. Make sure that the rear seat backrests are locked.

Warning

The mounts for the lower mountings and attachment points of the child restraint system are intended for attaching child restraint systems only. If other objects are attached, the mounts or attachment points can be damaged. There is a risk of injury or risk of damage to property. Attach child restraint systems only at the corresponding mounts for the lower mountings or attachment points.

Attachment points



The respective icon shows the attachment point for the upper retaining strap. Seats with an upper top tether

are marked with this icon. It can be found on the rear seat backrest or the rear shelf.

Routing the retaining strap

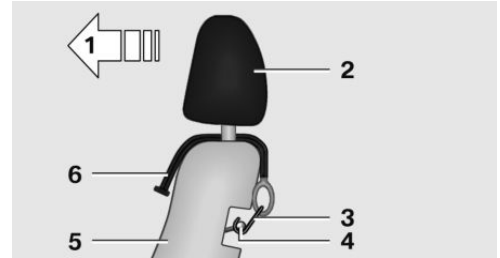

- 1 Driving direction
- 2 Head restraint
- 3 Hook for upper retaining strap
- 4 Attachment point
- 5 Seat backrest
- 6 Upper retaining strap

Attaching the upper retaining strap to the attachment point

1. Raise the head restraint, if needed.
2. Guide the upper retaining strap between or along both sides of the supports of the head restraint to the attachment point.
3. If there is a retaining strap, run it between the backrest and the cargo cover.
4. Attach the hook of the retaining strap to the attachment point.
5. Tighten the retaining strap by pulling it down.
6. Lower and engage head restraint as needed.

Locking the doors and windows in the rear

Rear doors

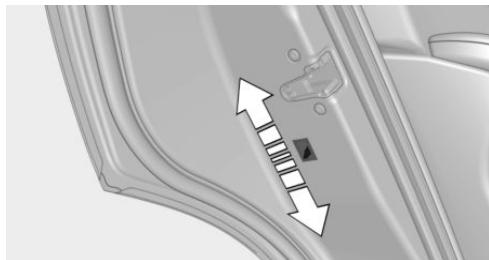

Push the locking lever on the rear doors up.

The door can now be opened from the outside only.

Safety switch for the rear



Press the button on the driver's door.

The LED lights up if the safety function is switched on.

This disables various functions so that they cannot be operated from the rear.

Driving

Vehicle features and options

This chapter describes all standard, country-specific and optional features offered with the series. It also describes features and functions that are not necessarily available in your vehicle, e.g., due to the selected options or country versions. This also applies to safety-related functions and systems. When using these functions and systems, the applicable laws and regulations must be observed.

Start/Stop button

Principle



Pressing the Start/Stop button switches the ignition on or off and starts the engine.

Steptronic transmission: the engine starts with the brake pedal pressed when you press the Start/Stop button.

Ignition on

Steptronic transmission: press the Start/Stop button, but do not press on the brake pedal at the same time.

All vehicle systems are ready for operation.

Most of the indicator/warning lights in the instrument cluster light up for a varied length of time.

To save battery power when the engine is off, switch off the ignition and any unnecessary electrical components.

Ignition off

Steptronic transmission: shift to selector lever position P, press the Start/Stop button again without stepping on the brake.

All indicator lights in the instrument cluster turn off.

To save battery power when the engine is off, switch off the ignition and any unnecessary electrical components.

Safety precautions

The ignition is switched off automatically in the following situations while the vehicle is stationary and the engine is off:

- ▶ When locking the vehicle, even if the low beams are switched on.
- ▶ Shortly before the battery is discharged completely, so that the engine can still be started.
- ▶ When opening or closing the driver's door, if the driver's seat belt is unbuckled and the low beams are switched off.
- ▶ While the driver's seat belt is unbuckled with driver's door open and low beams off.
- ▶ When the front doors are opened if there is no other person sitting in the front seats.

The low beams switch to parking lights after some minutes of no use.

Steptronic transmission with a tap-operated selector lever, refer to page 112: when switching off the ignition, the selector lever position P is engaged automatically if the selector lever position R, D or M/S is engaged.

Radio-ready state

General information

In the radio-ready state, certain electrical components remain ready for operation.

Activating

With the engine running, press the Start/Stop button.



If the engine is not running and the ignition is switched on: the system automatically activates radio-ready state when the door is opened if the lights are switched off or the daytime driving lights are switched on.

Radio-ready state remains active if, for instance the ignition is automatically switched off for the following reasons:

- ▷ Opening or closing the driver's door.
- ▷ Unfastening of the driver's seat belt.
- ▷ When automatically changing over from low beams to parking lights.

Switching off automatically

The radio-ready state is switched off automatically in the following situations:

- ▷ If the driver's or front passenger door is opened when exiting the vehicle, with the engine switched off manually.
- ▷ If the ignition is switched off manually with the Start/Stop button.
- ▷ After approx. 8 minutes.
- ▷ When the vehicle is locked using the central locking system.
- ▷ Shortly before the battery is discharged completely, so that the engine can still be started.

Starting the engine

Safety information

DANGER

If the exhaust pipe is blocked or ventilation is insufficient, harmful exhaust gases can penetrate the vehicle. The exhaust gases contain pollutants which are colorless and odorless. In enclosed areas, exhaust gases can also accumulate outside of the vehicle. There is a

danger to life. Keep the exhaust pipe free and ensure sufficient ventilation.

Warning

An unsecured vehicle can begin to move and possibly roll away. There is a risk of accident. Before leaving the vehicle, secure the vehicle against rolling away.

In order to ensure that the vehicle is secured against rolling away, follow the following:

- ▷ Set the parking brake.
- ▷ On uphill grades or on a downhill slope, turn the front wheels in the direction of the curb.
- ▷ On uphill grades or on a downhill slope, also secure the vehicle, for instance with a wheel chock.

NOTICE

Repeated attempts to start the vehicle or repeated starting of the vehicle in rapid succession can cause the starter to overheat. This also results in unburned or inadequately burned fuel, and can cause the catalytic converter to overheat. There is a risk of damage to property, among other potential damage. Avoid repeated starting of the vehicle, particularly repeated starting in rapid succession.

Gasoline engine

Depending on the motorization, the full drive power may not be available for approximately 30 seconds after starting the engine. In this case, the vehicle will not accelerate as usual.

Steptronic transmission

Starting the engine

1. Depress the brake pedal.
2. Press the Start/Stop button.

The ignition is activated automatically for a brief time and is stopped as soon as the engine starts.

Engine stop

Safety information

Warning

Unattended children or animals in the vehicle can cause the vehicle to move and endanger themselves and traffic, for instance due to the following actions:

- ▷ Pressing the Start/Stop button.
- ▷ Releasing the parking brake.
- ▷ Opening and closing the doors or windows.
- ▷ Engaging selector lever position N.
- ▷ Using vehicle equipment.

There is a risk of accidents or injuries. Do not leave children or animals unattended in the vehicle. Take the vehicle key with you when exiting and lock the vehicle.

Warning

An unsecured vehicle can begin to move and possibly roll away. There is a risk of accident. Before leaving the vehicle, secure the vehicle against rolling away.

In order to ensure that the vehicle is secured against rolling away, follow the following:

- ▷ Set the parking brake.
- ▷ On uphill grades or on a downhill slope, turn the front wheels in the direction of the curb.
- ▷ On uphill grades or on a downhill slope, also secure the vehicle, for instance with a wheel chock.

Steptronic transmission

Switching off the engine

1. When the vehicle is stationary, apply the parking brake.
2. Engage selector lever position P.
3. Press the Start/Stop button.
The engine is switched off.
The radio-ready state is switched on.

Auto Start/Stop function

Principle

The Auto Start/Stop function helps save fuel. The system switches off the engine during a stop, for instance in traffic jam or at traffic lights. The ignition remains switched on. The engine starts automatically for driving off.

General information

After each engine start using the Start/Stop button, the Auto Start/Stop function is ready.

The function is activated from speeds of approx. 3 mph/5 km/h.

Depending on the selected driving mode, the system is automatically activated or deactivated.

Engine stop

Functional requirements

The engine is switched off automatically during a stop under the following conditions:

Steptronic transmission:

- ▷ The selector lever is in selector lever position D.
- ▷ The brake pedal remains depressed while the vehicle is at a standstill.
- ▷ The driver's seat belt is buckled or the driver's door is closed.

In order to be able to release the brake pedal at a vehicle standstill, engage the selector lever in position P. The engine remains off.

To continue driving depress the brake pedal. When a gear is engaged, the engine starts automatically.

The air flow from the air conditioning system is reduced when the engine is switched off.

Steptronic transmission: manual engine stop

Depending on the vehicle equipment and country version, the engine can be switched off manually, if the engine was not switched off automatically when the vehicle stopped:

- ▷ Depress the brake pedal forcefully again from the current pedal position.
- ▷ Engage selector lever position P.

If all functional preconditions are fulfilled, the engine switches off.

Displays in the instrument cluster

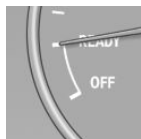

The READY display in the tachometer signals that the Auto Start/Stop function is ready to start the engine automatically.



The display indicates that the conditions for an automatic engine stop have not been met.

Functional limitations

The engine is not switched off automatically in situations such as the following:

- ▷ In case of a steep downhill grade.
- ▷ Outside temperature too low.
- ▷ The outside temperature is high and automatic climate control is running.
- ▷ The car's interior has not yet been heated or cooled to the required level.

- ▷ The engine is not yet at operating temperature.
- ▷ The wheels are at a sharp angle or the steering wheel is being turned.
- ▷ After driving in reverse.
- ▷ Where there is a risk of window condensation when the automatic climate control is switched on.
- ▷ Vehicle battery is heavily discharged.
- ▷ At higher elevations.
- ▷ The hood is unlocked.
- ▷ HDC Hill Descent Control is activated.
- ▷ The Automatic Parking Assistant is activated.
- ▷ Stop-and-go traffic.
- ▷ Selector lever in selector lever position N, M/S or R.
- ▷ Use of fuel with high ethanol content.

Starting the engine

The engine starts automatically to drive off under the following conditions:

- ▷ Steptronic transmission: by releasing the brake pedal.

After the engine starts, accelerate as usual.

Safety mode

After the engine switches off automatically, it will not start again automatically if any one of the following conditions are met:

- ▷ The driver's seat belt is unbuckled and the driver's door is open.
- ▷ The hood was unlocked.

Some indicator lights light up for a varied length of time.

The engine can only be started via the Start/Stop button.

Functional limitations

Even if driving off was not intended, the deactivated engine starts up automatically in the following situations:

- ▶ Excessive heating up of the car's interior when air conditioning is switched on.
- ▶ With steering operation.
- ▶ Steptronic transmission: change from selector lever position D to R, N or M/S.
- ▶ Steptronic transmission: change from selector lever position P to N, D, R or M/S.
- ▶ Where there is a risk of window condensation when the automatic climate control is switched on.
- ▶ Vehicle battery is heavily discharged.
- ▶ Excessive cooling of the car's interior when the heating is switched on.

Additional Auto Start/Stop function

Depending on the vehicle equipment and country-specific version, the vehicle features a variety of sensors for assessing the traffic situation. The Auto Start/Stop function uses this information to adapt to various traffic situations in a proactive manner.

For instance, this applies to the following situations:

- ▶ If a situation is detected in which the stopping time is expected to be very short, the engine is not switched off automatically. A message appears on the Control Display, depending on the situation.
- ▶ If a situation is detected in which the vehicle needs to drive off immediately, the engine is started automatically.

The function may be restricted if the navigation data is invalid, outdated or not available, for example.

Activating/deactivating the system manually

Using the button



Press the button.

- ▶ LED comes on: Auto Start/Stop function is deactivated.
The engine is started during an automatic engine stop.
The engine can only be stopped or started via the Start/Stop button.
- ▶ LED goes out: Auto Start/Stop function is activated.

Switching off the vehicle during an automatic engine stop

During an automatic engine stop, the vehicle can be switched off permanently, for instance when leaving it.

Steptronic transmission:

1. Engage selector lever position P.
2. Press the Start/Stop button. The ignition is switched off. The Auto Start/Stop function is deactivated.
3. Set the parking brake.

Engine start as usual via Start/Stop button.

Automatic deactivation

In certain situations, the Auto Start/Stop function is deactivated automatically for safety reasons, for instance if no driver is detected.



Malfunction

The Auto Start/Stop function no longer switches off the engine automatically. A Check Control message is displayed. It is possible to continue driving. Have the system checked by a dealer's service center or another qualified service center or repair shop.

Parking brake

Principle

The parking brake is used to prevent the vehicle from rolling when it is parked.

Safety information

Warning

An unsecured vehicle can begin to move and possibly roll away. There is a risk of accident. Before leaving the vehicle, secure the vehicle against rolling away.

In order to ensure that the vehicle is secured against rolling away, follow the following:

- ▷ Set the parking brake.
- ▷ On uphill grades or on a downhill slope, turn the front wheels in the direction of the curb.
- ▷ On uphill grades or on a downhill slope, also secure the vehicle, for instance with a wheel chock.

Warning

Unattended children or animals in the vehicle can cause the vehicle to move and endanger themselves and traffic, for instance due to the following actions:

- ▷ Pressing the Start/Stop button.
- ▷ Releasing the parking brake.
- ▷ Opening and closing the doors or windows.

- ▷ Engaging selector lever position N.
- ▷ Using vehicle equipment.

There is a risk of accidents or injuries. Do not leave children or animals unattended in the vehicle. Take the vehicle key with you when exiting and lock the vehicle.

Overview



 Parking brake

Setting the parking brake

With a stationary vehicle

 Pull the switch.
The LED lights up.

 The indicator light lights up red. The parking brake is set.

Depending on the stopping situation, the parking brake is engaged automatically.

Steptronic transmission: in some parking situations, the parking brake is automatically engaged, when selector lever position P is engaged. In these cases, the parking brake is released automatically when you leave the selector lever position P.

While driving

To use as emergency brake while driving:

Pull the switch and hold it. The vehicle brakes hard while the switch is being pulled.



The indicator lights light up red, a signal sounds, and the brake lights illuminate.

A Check Control message is displayed.

If the vehicle is decelerated to a complete stop, the parking brake is engaged.

Releasing the parking brake

Releasing the parking brake manually

1. Turn on the ignition.
2.  Steptronic transmission: press the switch while the brake is pressed or selector lever position P is set.

The LED and the indicator light go out.

The parking brake is released.

Automatic release in cars with Steptronic transmission

For automatic release, step on the accelerator pedal.

The LED and indicator light turn off.

The parking brake is automatically released when you step on the accelerator when the following prerequisites are met:

- ▷ Engine on.
- ▷ Gear position engaged.
- ▷ Driver buckled in and doors closed.

Malfunction

If the parking brake fails or in case of a fault, secure the vehicle against rolling away before exiting.

A Check Control message is displayed.

Secure the vehicle against rolling away, for instance with a wheel chock, after getting out of the vehicle.

After a power interruption

Commissioning

1. Turn on the ignition.
2.  Press the switch while stepping on the brake pedal or selector lever position P is set.

Commissioning may take a few seconds. Some mechanical sounds associated with this process are normal.



The indicator light in the instrument cluster turns off as soon as the parking brake is ready for operation again.

Turn signal, high beams, headlight flasher

Turn signal

Turn signal in exterior mirror

When driving and during operation of the turn signals or hazard warning system, do not fold in the exterior mirrors, so that the turn signal lamps on the exterior mirror are easy to see.

Blinking

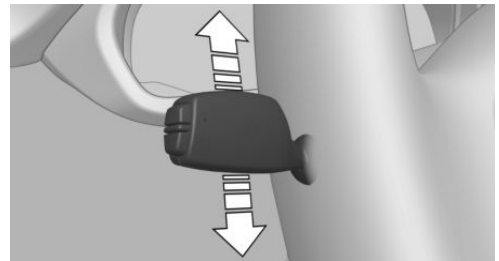

Press the lever past the resistance point.

Canada: the lever returns into its initial position after actuation. To switch off manually, slightly tap the lever to the resistance point.



Triple turn signal activation

Lightly tap the lever up or down.

The turn signal flashes three times.

The function can be activated or deactivated.

Via iDrive:

1. "My Vehicle"
2. "Vehicle settings"
3. "Lighting"
4. "Exterior lighting"
5. "One-touch turn signal"
6. Select the desired setting.

Settings are stored for the profile currently used.

Brief blinking

Press the lever to the resistance point and hold it there for as long as you want the turn signal to flash.

Malfunction

Unusually rapid blinking of the indicator light indicates that a turn signal bulb has failed.

High beams, headlight flasher

Press the lever forward or pull it backward.

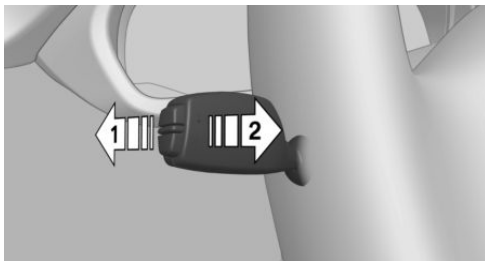

- ▷ High beams on, arrow 1.
The high beams light up when the low beams are switched on.
- ▷ High beams off/headlight flasher, arrow 2.

Window wiper system

Safety information

Warning

If the wipers start moving in the folded away state, body parts can be jammed or damage may occur to parts of the vehicle. There is a risk of injury or risk of damage to property. Make sure that the vehicle is switched off when the wipers are in the folded away state and the wipers are folded in when switching on.

NOTICE

The wiper blades can wear out or become damaged prematurely when wiping on a dry window for a longer period of time. The wiper motor can overheat. There is a risk of damage to property, among other potential damage. Do not use the wipers when the window is dry.

NOTICE

If the wipers are frozen to the windshield, the wiper blades can be torn off and the wiper motor can overheat when switching on. There is a risk of damage to property, among other potential damage. Defrost the windshield prior to switching the wipers on.

Turning on

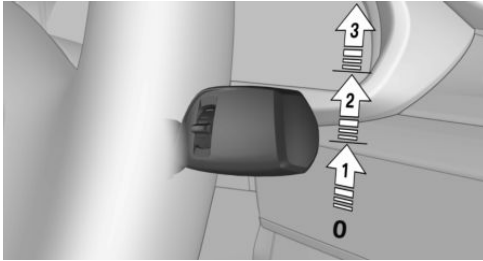

Press the lever up until the desired position is reached.

- ▷ Resting position of the wipers, position 0.
- ▷ Intermittent operation or rain sensor, position 1.
- ▷ Normal wiper speed, position 2.
- ▷ Fast wiper speed, position 3.

When the journey is interrupted with the window wiper system switched on: when travel continues, the wipers resume at their previous level.

Turning off and flick wipe

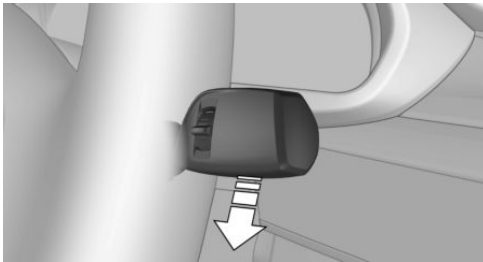

Press the lever down.

- ▷ Switching off: press the lever down until it reaches its basic setting.
- ▷ Flick wipe: press the lever down from the basic setting.
The lever automatically returns to its basic setting when released.

Intermittent operation or rain sensor

Principle

The rain sensor automatically controls the wiper operation depending on the intensity of the rainfall.

General information

The sensor is located on the windshield, directly in front of the interior mirror. Without the rain sensor, the interval of the wiper operation is predefined.

Safety information

NOTICE

If the rain sensor is activated, the wipers can accidentally start moving in car washes. There is a risk of damage to property, among other potential damage. Deactivate the rain sensor in car washes.

Activating

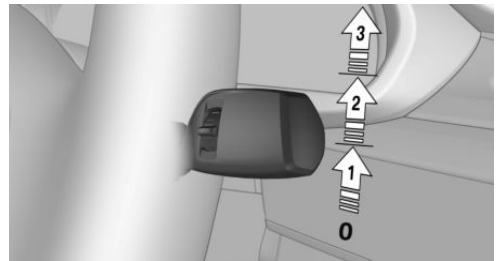

Press the lever up once from its basic setting, arrow 1.

Wiping operation is started.

The LED in the wiper lever is illuminated.

In frosty conditions, wiping operation may not start.

Deactivating

Press the lever back into the basic setting.

Setting the interval period or sensitivity of the rain sensor

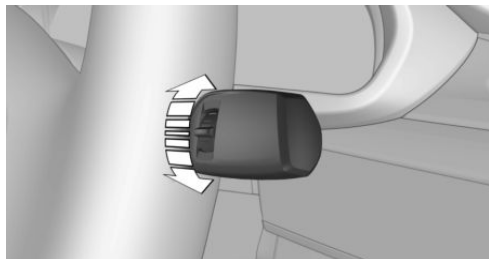

Turn the thumbwheel to adjust the interval period or sensitivity of the rain sensor.

Up: short interval or high sensitivity of the rain sensor.

Down: long interval or low sensitivity of the rain sensor.

Windshield and headlight washer system

Safety information

Warning

The washer fluid can freeze onto the window at low temperatures and obstruct the view. There is a risk of accident. Only use the washer systems, if the washer fluid cannot freeze. Use washer fluid with antifreeze, if needed.

NOTICE

When the washer fluid reservoir is empty, the washer pump cannot work as intended. There is a risk of damage to property, among other potential damage. Do not use the washer system when the washer fluid reservoir is empty.

Cleaning the windshield

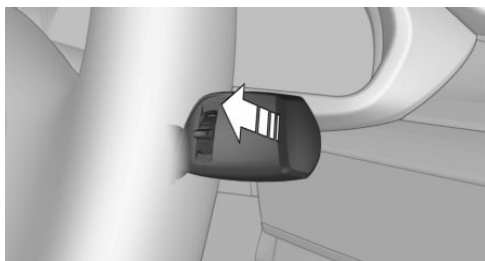

Pull the lever.

The washer fluid is sprayed on the windshield, and the wipers are turned on briefly.

In addition, the headlights are cleaned at regular intervals when the vehicle lighting is switched on.

Windshield washer nozzles

The washer jets are automatically heated whenever the ignition is switched on.

Rear wiper

Switching on the rear wiper

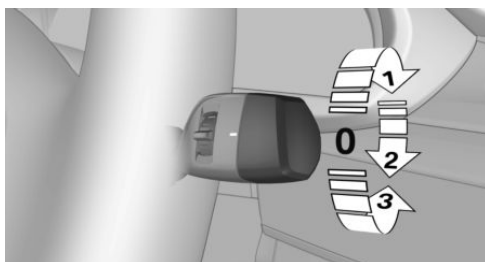

Turn the outer switch upward.

- ▷ Resting position of the wiper, position 0.
- ▷ Intermittent operation, arrow 1. When reverse gear is engaged, the system switches to continuous operation.

Clean the rear window

Turn the outer switch in the desired direction.

- ▷ In resting position: turn the switch downward, arrow 3. The switch automatically returns to its idle position when released.
- ▷ In intermittent operation: turn the switch further, arrow 2. The switch automatically returns to its interval position when released.

The function is deactivated if the washer fluid reservoir fill level is low.

Fold-out position of the wipers

Principle

The fold-out position enables the wipers to be folded out from the windshield.

General information

Important, for instance when changing the wiper blades or for folding out under frosty conditions.

Safety information

Warning

If the wipers start moving in the folded away state, body parts can be jammed or damage may occur to parts of the vehicle. There is a risk of injury or risk of damage to property. Make sure that the vehicle is switched off when the wipers are in the folded away state and the wipers are folded in when switching on.

NOTICE

If the wipers are frozen to the windshield, the wiper blades can be torn off and the wiper motor can overheat when switching on. There is a risk of damage to property, among other potential damage. Defrost the windshield prior to switching the wipers on.

Folding out the wipers

1. Switch the ignition on and off again.
2. Press and hold the wiper lever down, until the wipers stop in a close to vertical position.

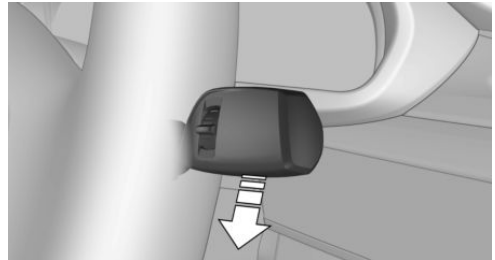

3. Fold the wipers all the way out from the windshield.

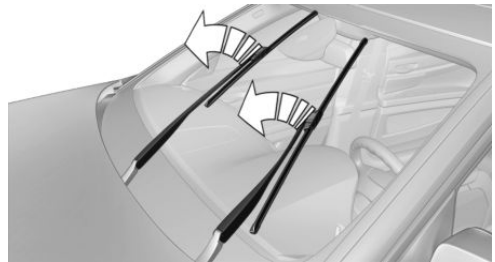

Folding in the wipers

After the wipers are folded back down, the window wiper system must be reactivated.

1. Fold the wipers back in onto the windshield.
2. Turn on the ignition.
3. Push wiper lever down. Wipers return to their resting position and are ready again for operation.

Canada: window wiper system

Safety information

Warning

If the wipers start moving in the folded away state, body parts can be jammed or damage may occur to parts of the vehicle. There is a risk of injury or risk of damage to property. Make sure that the vehicle is switched off when the wipers are in the folded away state and the wipers are folded in when switching on.

NOTICE

The wiper blades can wear out or become damaged prematurely when wiping on a dry window for a longer period of time. The wiper motor can overheat. There is a risk of damage to property, among other potential damage. Do not use the wipers when the window is dry.

NOTICE

If the wipers are frozen to the windshield, the wiper blades can be torn off and the wiper motor can overheat when switching on. There is a risk of damage to property, among other potential damage. Defrost the windshield prior to switching the wipers on.

Turning on

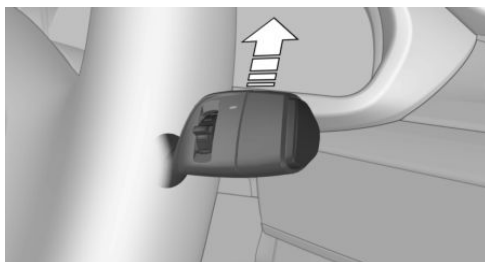

Tap up the lever or press it past the resistance point.

- ▶ Normal wiper speed: tap up once.
- ▶ Fast wiper speed: tap up twice or tap once beyond the resistance point.

The lever automatically returns to its basic setting when released.

Turning off and flick wipe

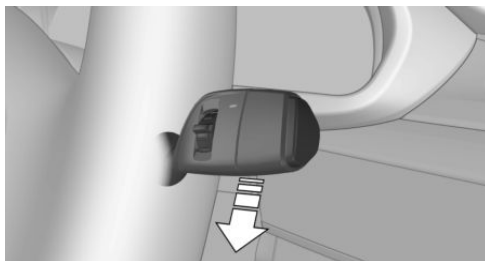

Press the lever down.

- ▶ To switch off from fast wiper speed: press down twice.
- ▶ To switch off from normal wiper speed: press down once.
- ▶ Flick wipe: press down once.

The lever automatically returns to its basic setting when released.

Intermittent operation or rain sensor

Principle

The rain sensor automatically controls the wiper operation depending on the intensity of the rainfall.

General information

The sensor is located on the windshield, directly in front of the interior mirror. Without the rain sensor, the interval of the wiper operation is predefined.

Safety information

NOTICE

If the rain sensor is activated, the wipers can accidentally start moving in car washes. There is a risk of damage to property, among other potential damage. Deactivate the rain sensor in car washes.

Activating/deactivating

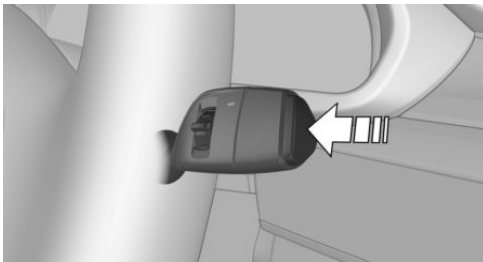

Press the button on the wiper lever.

Wiping operation is started.

If the vehicle is equipped with a rain sensor: the LED in the wiper lever is illuminated.

In frosty conditions, wiping operation may not start.

If a journey is interrupted with the rain sensor switched on: if the trip is resumed within ap-

prox. 15 minutes, the rain sensor is automatically activated again.

Setting the interval period or sensitivity of the rain sensor

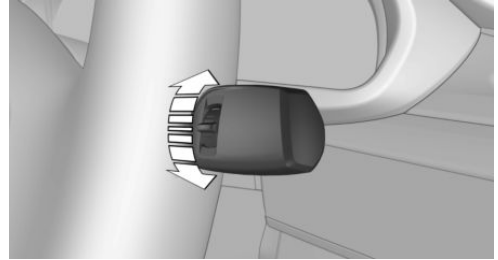

Turn the thumbwheel to adjust the interval period or sensitivity of the rain sensor.

Up: short interval or high sensitivity of the rain sensor.

Down: long interval or low sensitivity of the rain sensor.

Windshield and headlight washer system

Safety information

Warning

The washer fluid can freeze onto the window at low temperatures and obstruct the view. There is a risk of accident. Only use the washer systems, if the washer fluid cannot freeze. Use washer fluid with antifreeze, if needed.

NOTICE

When the washer fluid reservoir is empty, the washer pump cannot work as intended. There is a risk of damage to property, among other potential damage. Do not use the



washer system when the washer fluid reservoir is empty.

Cleaning the windshield

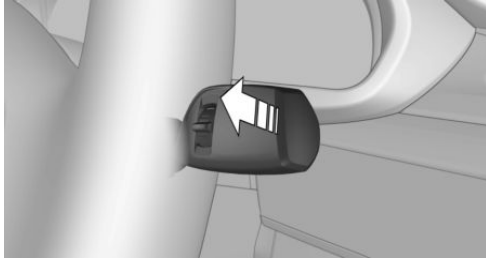

Pull the lever.

The washer fluid is sprayed on the windshield, and the wipers are turned on briefly.

In addition, the headlights are cleaned at regular intervals when the vehicle lighting is switched on.

Windshield washer nozzles

The washer jets are automatically heated whenever the ignition is switched on.

Rear wiper

Switching on the rear wiper

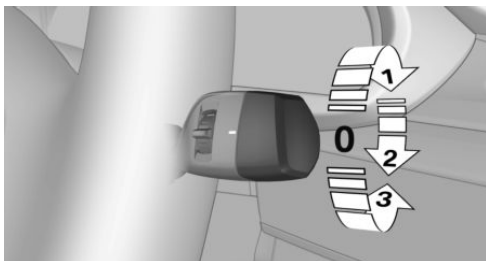

Turn the outer switch upward.

- ▷ Resting position of the wiper, position 0.
- ▷ Intermittent operation, arrow 1. When reverse gear is engaged, the system switches to continuous operation.

Clean the rear window

Turn the outer switch in the desired direction.

- ▷ In resting position: turn the switch downward, arrow 3. The switch automatically returns to its idle position when released.
- ▷ In intermittent operation: turn the switch further, arrow 2. The switch automatically returns to its interval position when released.

The function is deactivated if the washer fluid reservoir fill level is low.

Fold-out position of the wipers

Principle

The fold-out position enables the wipers to be folded out from the windshield.

General information

Important, for instance when changing the wiper blades or for folding out under frosty conditions.

Safety information

Warning

If the wipers start moving in the folded away state, body parts can be jammed or damage may occur to parts of the vehicle. There is a risk of injury or risk of damage to property. Make sure that the vehicle is switched off when the wipers are in the folded away state and the wipers are folded in when switching on.

NOTICE

If the wipers are frozen to the windshield, the wiper blades can be torn off and the wiper motor can overheat when switching on. There is a risk of damage to property, among

other potential damage. Defrost the windshield prior to switching the wipers on.

Folding out the wipers

1. Switch the ignition on and off again.
2. In case of risk of frost, make sure that the blades are not frozen to the windshield.
3. Press the wiper lever up past the point of resistance and hold it for approx. 3 seconds, until the wipers remain in a nearly vertical position.
4. Fold the wipers all the way out from the windshield.

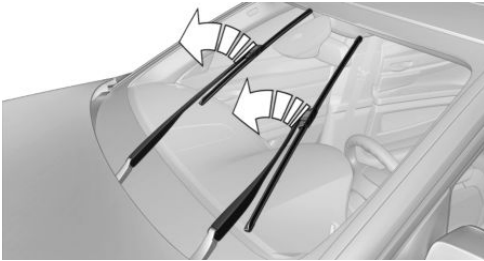

Folding in the wipers

After the wipers are folded back down, the window wiper system must be reactivated.

1. Fold the wipers back in onto the windshield.
2. Turn on the ignition.
3. Push wiper lever down. Wipers return to their resting position and are ready again for operation.

Washer fluid

General information

All windshield washer jets are supplied from one tank.

Use a mixture of tap water and windshield washer concentrate. If desired, a windshield

washer concentrate containing antifreeze can be used.

Recommended minimum fill quantity:
0.2 US gal/1 liter.

Safety information

Warning

Some types of antifreeze can contain harmful substances and are flammable. There is a risk of fire and an injury hazard. Follow the instructions on the containers. Keep antifreeze away from ignition sources. Do not refill operating materials into different bottles. Store operating materials out of reach of children.

United States: the washer fluid mixture ratio is regulated by the U.S. EPA and many individual states; do not exceed the allowable washer fluid dilution ratio limits that apply. Follow the usage instructions on the washer fluid container.

Use of BMW's Windshield Washer Concentrate or the equivalent is recommended.

Warning

Washer fluid can ignite and catch fire on contact with hot engine parts. There is a risk of injury or risk of damage to property. Only add washer fluid when the engine is cooled down. Next, fully close the lid of the washer fluid reservoir.

NOTICE

Silicon-containing additives in the washer fluid for the water-repelling effect on the windows can lead to damage to the washing system. There is a risk of damage to property, among other potential damage. Do not add silicon-containing additives to the washer fluid.



NOTICE

Mixing different windshield washer fluid concentrates or antifreeze can damage the car wash. There is a risk of damage to property, among other potential damage. Do not mix different windshield washer fluid concentrates or antifreeze. Follow the information and mixture ratios provided on the containers.

Overview



The washer fluid reservoir is located in the engine compartment.

Malfunction

The use of undiluted windshield washer fluid concentrate or alcohol-based antifreeze can lead to incorrect readings at temperatures below +5 °F/-15 °C.

Steptronic transmission

Principle

The Steptronic transmission combines the functions of an automatic transmission with the possibility of manual shifting, if needed.

Safety information

Warning

An unsecured vehicle can begin to move and possibly roll away. There is a risk of accident. Before leaving the vehicle, secure the vehicle against rolling away.

In order to ensure that the vehicle is secured against rolling away, follow the following:

- ▷ Set the parking brake.
- ▷ On uphill grades or on a downhill slope, turn the front wheels in the direction of the curb.
- ▷ On uphill grades or on a downhill slope, also secure the vehicle, for instance with a wheel chock.

Selector lever version

General information

Depending on the vehicle equipment, a transmission with either a latching selector lever or a tap-operated selector lever is installed.

Transmission with a latching selector lever

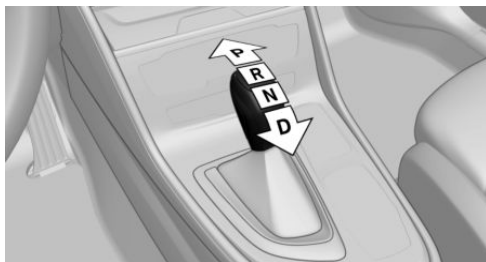

The selector lever positions P, R, N, and D are selected by moving the selector lever into the respective selector lever position. The selector lever engages in the selector lever positions.

Transmission with a tap-operated selector lever



The selector lever positions R, N, and D are selected by tapping the selector lever forward or back. The selector lever automatically returns to the center position when released.

The selector lever position P is engaged by pressing the P button on the selector lever or, in certain situations, automatically, refer to page 113.

Selector lever positions

Gear position D

Selector lever position for normal driving. All gears for forward travel are activated automatically.

R is reverse

Engage selector lever position R only when the vehicle is stationary.

Neutral N

The vehicle may be pushed or roll without drivetrain, for instance in car washes, refer to page 115, in selector lever position N.

Parking position P

General information

Selector lever position, for instance for parking the vehicle.

The transmission blocks the drive wheels in selector lever position P.

Engage selector lever position P only when the vehicle is stationary.

Before exiting the vehicle, make sure that selector lever position P is set. Otherwise, the vehicle may begin to move. Also set parking brake.

Automatic parking position for a transmission with a tap-operated selector lever

Selector lever position P is engaged automatically in situations such as the following:

- ▶ After the engine is switched off when the vehicle is in the radio-ready state, refer to page 97, or when the ignition is switched off, refer to page 97, while selector lever position R, D or M/S is engaged.
- ▶ If the driver's seat belt is unbuckled, the driver's door is opened, and the brake pedal is not pressed while the vehicle is stationary and selector lever position D, M/S or R is engaged.
- ▶ After the ignition has been switched off while selector lever position N is engaged.

Engaging selector lever positions: with a latching selector lever

General information

To prevent the vehicle from creeping after you select a gear position, maintain pressure on the brake pedal until you are ready to drive off.

Functional requirements

The selector lever can only be taken out of selector lever position P if the ignition is on or the engine is running.

Engaging selector lever position D, N, R, or P

With the vehicle stationary, depress the brake pedal before shifting out of selector lever position P or N; otherwise, the gearshift block will



not be deactivated and the gearshift request will not be executed.

A selector lever lock prevents the following incorrect operation:

- ▷ Unintentional shifting into selector lever position P or R.
 - ▷ Unintentional shifting from selector lever position P into another selector lever position.
1. To release the selector lever lock: with the brake pedal depressed, press the button on the front of the selector lever.



2. Move the selector lever into the desired position.



Engaging selector lever positions: with a tap-operated selector lever

General information

To prevent the vehicle from creeping after you select a gear position, maintain pressure on the brake pedal until you are ready to drive off.

Functional requirements

Only when the brake pedal is depressed is it possible to change from selector lever position P to another selector lever position.

Depending on the transmission version, the engine may have to be running too.

The selection lever position P cannot be changed until all technical prerequisites are met.

Engaging selector lever position D, N, R

A selector lever lock prevents the following incorrect operation:

- ▷ Unintentional shifting into selector lever position R.
- ▷ Unintentional shifting from selector lever position P into another selector lever position.

1. Fasten driver's seat belt.
2. Press and hold the button to release the selector lever lock.



3. Push the selector lever in the desired direction, past a resistance point, if needed. The

selector lever automatically returns to the center position when released.

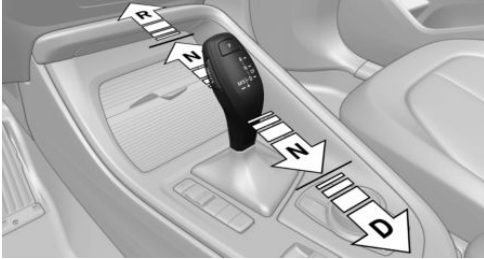

Manually unlock the transmission lock, if needed, refer to page 117.

Engaging selector lever position N: with a tap-operated selector lever

NOTICE

Selector lever position P is automatically engaged when the ignition is switched off. There is a risk of damage to property, among other potential damage. Do not switch ignition off in car washes.

Engaging selector lever position P

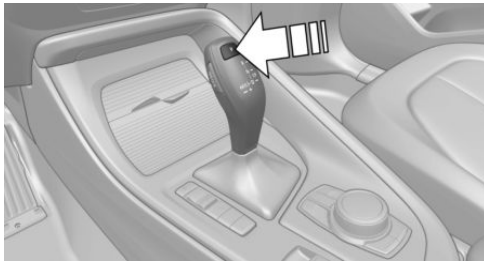

Press button P.

1. Start the engine while pressing on the brake pedal.
2. If necessary, release the parking brake.
3. Depress the brake pedal.
4. Touch the selector lever lock and engage selector lever position N.
5. Switch the engine off.

In this way, the ignition remains switched on, and a Check Control message is displayed.

The vehicle can roll.

Rolling or pushing the vehicle

General information

In some situations, the vehicle is to roll without its own power for a short distance, for instance in a car wash, or be pushed.

Irrespective of the ignition, the selector lever position P is automatically engaged after approx. 15 minutes.

If there is a malfunction, you may not be able to change the selector lever position.

Electronically unlock the transmission lock, if needed, refer to page 118.

Engaging selector lever position N: with a latching selector lever

1. Turn on the ignition.
2. If necessary, release the parking brake.
3. Depress the brake pedal.
4. Touch the selector lever lock and engage selector lever position N.

5. Release brake.

The vehicle can roll.

If there is a malfunction, you may not be able to change the selector lever position.

Kickdown

Kickdown is used to achieve maximum driving performance.

Step on the accelerator pedal beyond the resistance point at the full throttle position.

Sport program M/S

Principle

The shifting points and shifting times in the Sport program are designed for sportier handling. The transmission, for instance shifts up later and the shifting times are shorter.

Activating the Sport program



Press the selector lever to the left from selector lever position D.

The engaged gear is displayed in the instrument cluster, for instance S1.

The sport program of the transmission is activated.

Ending the Sport program

Press the selector lever to the right.

D is displayed in the instrument cluster.

Manual mode M/S

Principle

Manual gear-shifting is possible in manual mode.

Activating manual mode

1. Press the selector lever to the left from selector lever position D, arrow 1.

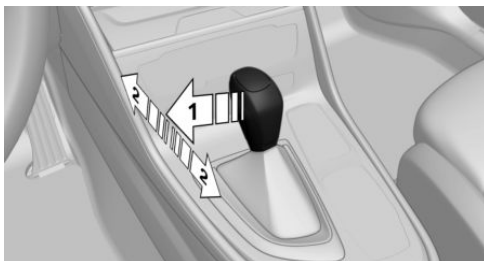

2. Press the selector lever forward or pull it backward, arrows 2.

Manual mode becomes active and the gear is changed.

The engaged gear is displayed in the instrument cluster, for instance M1.

Shifting

- ▶ To downshift: press the selector lever forward.
- ▶ Upshifting: pull the selector lever rearwards.

The transmission continues shifting automatically in certain situations, for instance when RPM limits are reached.

With a tap-operated selector lever: when M2 is set manually while the vehicle is stationary, the transmission will no longer shift back to M1.

This shift characteristic is retained until you engage M1 manually or exit M.

Steptronic Sport transmission: prevent automatic upshifting in M/S manual mode

Once a particular engine speed is attained, M/S manual mode is automatically upshifted as needed.

The Steptronic Sport transmission does not automatically upshift in M/S manual mode once certain RPM limits are reached, if one of the following conditions is met:

- ▷ Dynamic Stability Control deactivated.
- ▷ Dynamic Traction Control activated.

In addition, there is no downshifting for kick-down.

M35i: once a particular engine speed is attained, M/S manual mode does not upshift automatically.

With the appropriate transmission version, the lowest possible gear can be selected by simultaneously activating kickdown and operating the left shift paddles. This is not possible by switching briefly via the shift paddles from selector lever position D to manual mode M/S.

Ending the manual mode

Press the selector lever to the right.

D is displayed in the instrument cluster.

Shift paddles

Principle

The shift paddles on the steering wheel allow you to change gears quickly while keeping both hands on the steering wheel.

General information

Shifting

The gear is only changed at suitable RPM and road speeds.

Short-term manual mode

In selector lever position D, actuating a shift paddle switches into manual mode temporarily.

After conservative driving in manual mode without acceleration or shifting via the shift paddles for a certain amount of time, the transmission switches back to automatic mode.

It is possible to switch into automatic mode as follows:

- ▷ Pull and hold right shift paddle.
- ▷ In addition to the briefly pulled right shift paddle, briefly pull the left shift paddle.

Continuous manual mode

In selector lever position S, actuating a shift paddle switches into manual mode permanently.

Shifting

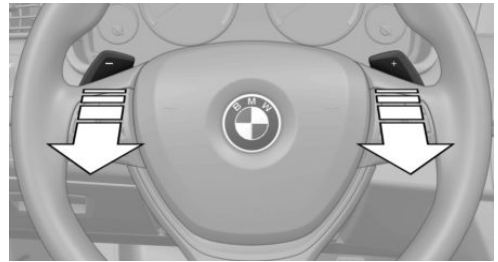

- ▷ Upshifting: briefly pull right shift paddle.
- ▷ To downshift: briefly pull left shift paddle.
- ▷ The lowest possible gear can be selected by pulling and holding the left shift paddle.

The selected gear is briefly displayed in the instrument cluster, followed by the current gear.

Displays in the instrument cluster

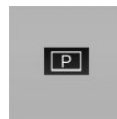

The selector lever position is displayed, for example P.

Releasing the transmission lock manually: with a latching selector lever

If the selector lever is locked in selector lever position P despite the ignition being switched on, the brake pedal being depressed and the button on the selector lever being pressed, the transmission lock can be unlocked manually:



Before unlocking the transmission lock manually, set the parking brake to prevent the vehicle from rolling away.

1. Loosen the selector lever sleeve at the bottom from the center console.



2. Lift the sleeve. Detach the cable connector, if needed.
3. Using the screwdriver from the onboard vehicle tool kit, refer to page 267, press the yellow release lever downward, arrow.



4. Press the button on the front of the selector lever and move the selector lever back slightly.
Release the release lever.
5. Bring the selector lever into the desired position.

For additional information, see the chapter on tow-starting and towing.

Releasing the transmission lock electronically: with a tap-operated selector lever

General information

Electronically unlock the transmission lock to maneuver vehicle from a hazardous area.

Before unlocking the transmission lock, set the parking brake to prevent the vehicle from rolling away.

Engaging selector lever position N

Unlocking is possible, if the starter can crank the engine.

1. Press and hold down brake pedal.
2. Press the Start/Stop button. The starter must audibly start.
3. Press the button on the selector lever, arrow 1, and press and hold the selector lever into selector lever position N, arrow N, until selector lever position N is displayed in the instrument cluster.

A Check Control message is displayed.

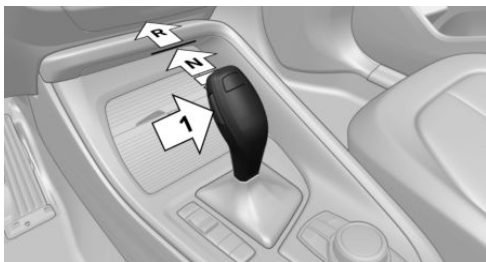

4. Release the selector lever.
5. Release brake, as soon as the starter stops.
6. Maneuver the vehicle from the hazardous area and secure it against rolling away.

With some transmission versions, the procedure for unlocking is as follows:

1. Press the Start/Stop button three times in a row.
2. Press and hold down brake pedal.
3. Press the button on the selector lever, arrow 1, and press and hold the selector lever into selector lever position N, arrow N, until selector lever position N is displayed in the instrument cluster.
A Check Control message is displayed.
4. Release the selector lever.
5. Release the brake.
6. Maneuver the vehicle from the hazardous area and secure it against rolling away.

For additional information, see the chapter on tow-starting and towing.

Steptronic Sport transmission: Launch Control

Principle

Launch Control enables optimum acceleration on roads with good traction under dry surrounding conditions.

General information

The use of Launch Control causes premature component wear since this function represents a very heavy load for the vehicle.

Do not use Launch Control during the break-in, refer to page 216.

To drive off with Launch Control, point the front wheels straight forwards.

Functional requirements

Launch Control is available as soon as the engine and transmission are at operating temperature.

Depending on the outside temperature and driving style, the engine and transmission require an interrupted trip of up to

30 miles/50 km in order to reach the operating temperature needed for Launch Control.

Start with launch control

While the engine is running:

1.  Press the button and select SPORT with the Driving Dynamics Control. TRACTION is displayed in the instrument cluster in combination with SPORT and the DSC OFF indicator light lights up.
2. Engage selector lever position S.
3. With the left foot, forcefully press down on the brake.
4. Press and hold down the accelerator pedal beyond the resistance point at the full throttle position, kickdown.
A destination flag is displayed in the instrument cluster.
5. The starting engine speed adjusts. Wait briefly until the engine speed is constant. Keep accelerator pedal in this position.
6. Release the brake within 3 seconds after the destination flag illuminates.

The vehicle accelerates.

Upshifting occurs automatically as long as the destination flag is displayed and the accelerator pedal is not released.

Repeated use during a trip

After Launch Control has been used, the transmission must cool down for approx. 5 minutes before Launch Control can be used again.

After using Launch Control

To support driving stability, reactivate Dynamic Stability Control.

System limits

An experienced driver may be able to achieve better acceleration values in DSC OFF mode.

Displays

Vehicle features and options

This chapter describes all standard, country-specific and optional features offered with the series. It also describes features and functions that are not necessarily available in your vehi-

cle, e.g., due to the selected options or country versions. This also applies to safety-related functions and systems. When using these functions and systems, the applicable laws and regulations must be observed.

Overview, instrument cluster

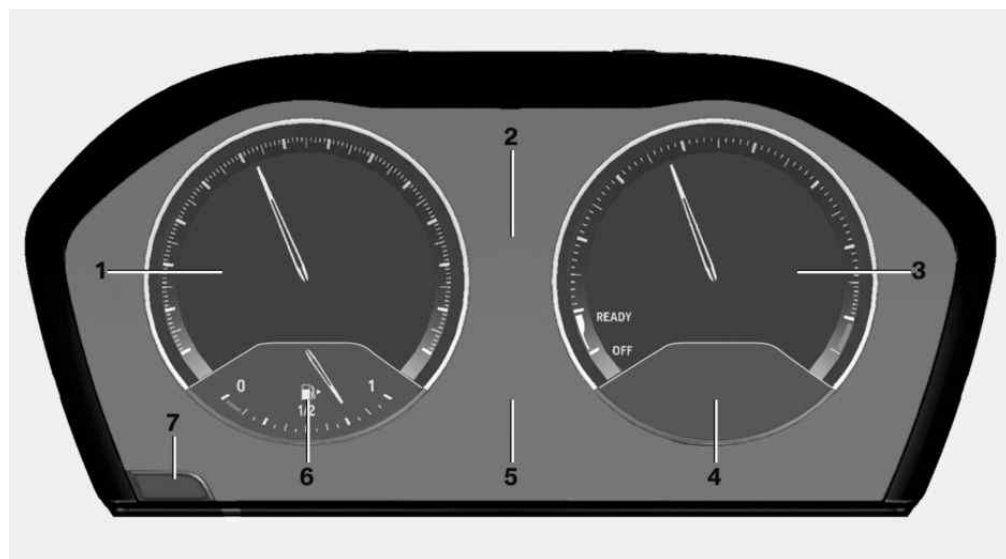

- | | |
|--|--|
| 1 Speedometer | 5 Electronic displays |
| 2 Messages, for instance Check Control | 6 Fuel gauge 124 |
| 3 Tachometer 124 | 7 Reset kilometers 124 |
| 4 Current consumption | |



Check Control

Principle

The Check Control system monitors functions in the vehicle and notifies you of faults in the monitored systems.

General information

A Check Control message is displayed as a combination of indicator or warning lights and text messages in the instrument cluster and in the Head-up Display.

In addition, an acoustic signal may sound and a text message may appear on the Control Display.

Indicator/warning lights

General information

The indicator/warning lights in the instrument cluster can light up in a variety of combinations and colors.

Several of the lights are checked for proper functioning and light up temporarily when the engine is started or the ignition is switched on.

Red lights

Seat belt reminder



Seat belt on the driver's side is not buckled. For some country versions: front passenger belt is not worn or objects are detected on the front passenger seat.

Indicator light flashes or is illuminated: seat belt on the driver or passenger's side is not buckled. The seat belt reminder can also be activated if objects are placed on the front passenger seat.

Make sure that the seat belts are positioned correctly.

Airbag system



Airbag system and seat belt tensioner may not be working.

Have the vehicle checked immediately by a dealer's service center or another qualified service center or repair shop.

Parking brake



The parking brake is set.

For releasing the parking brake, refer to page 103.

Brake system



Brake system fault. Continue to drive moderately.



Have the vehicle checked immediately by a dealer's service center or another qualified service center or repair shop.

Forward Collision Warning



Indicator light illuminates: prewarning is issued, for example when there is the impending risk of a collision or the distance to the vehicle ahead is too small.

Increase the distance.

Indicator light flashes: acute warning of the imminent risk of a collision when the vehicle approaches another vehicle at a relatively high differential speed.

Intervene by braking or make an evasive maneuver.

Pedestrian Warning



Symbol in the instrument cluster.

If a collision with a detected person is imminent, the icon lights up and a signal sounds.



Orange lights

Active Cruise Control



The number bars shows the selected distance from the vehicle driving ahead.

Camera-based cruise control with Stop&Go function, refer to page [170](#).

Vehicle detection, Active Cruise Control



Indicator light illuminates: a vehicle has been detected ahead of you.

Indicator light flashes: the conditions are not adequate for the system to work.

The system was deactivated but applies the brakes until the driver actively resumes control of the vehicle by pressing on the brake pedal or accelerator pedal.

Yellow lights

Anti-lock Braking System



The Brake Assistant function may not activate. Avoid abrupt braking. Take the longer braking distance into account.



Have the system immediately checked by a dealer's service center or another qualified service center or repair shop.

Dynamic Stability Control



Indicator light blinks: Dynamic Stability Control controls the drive and brake forces. The vehicle is stabilized. Reduce speed and modify your driving style to the driving circumstances.

Indicator light illuminates: the Dynamic Stability Control has malfunctioned.

Have the system checked by a dealer's service center or another qualified service center or repair shop.

Dynamic Stability Control, refer to page [163](#).

The Dynamic Stability Control deactivated or the Dynamic Traction Control activated



The Dynamic Stability Control is deactivated or the Dynamic Traction Control is activated.

Dynamic Stability Control, refer to page [163](#), and Dynamic Traction Control, refer to page [165](#).

Flat Tire Monitor



The flat tire monitor reports a tire pressure loss in a tire.

Reduce your speed and stop cautiously. Avoid sudden braking and steering maneuvers.

Flat tire monitor, refer to page [149](#).

Tire pressure monitor



The indicator light illuminates: the Tire Pressure Monitor reports a low tire pressure or a flat tire. Follow the information in the Check Control message.

The indicator light flashes and is then illuminated continuously: flat tires or tire pressure losses cannot be detected.

- ▶ Fault caused by systems or devices with the same radio frequency: after leaving the area of the interference, the system automatically becomes active again.
- ▶ The Tire Pressure Monitor could not complete the reset: reset the system again.
- ▶ A wheel without wheel electronics is mounted: have it checked by a dealer's service center or another qualified service center or repair shop as needed.
- ▶ Malfunction: have the system checked by a dealer's service center or another qualified service center or repair shop.

Tire pressure monitor, refer to page [145](#).



Steering system



Steering system may be faulty.

Have the system checked by a dealer's service center or another qualified service center or repair shop.

Emissions



▶ The warning light lights up:

Emissions are deteriorating. Have the vehicle checked as soon as possible.

▶ The warning light flashes under certain circumstances:

This indicates that there is excessive misfiring in the engine.

Reduce the vehicle speed and have the system checked immediately; otherwise, serious engine misfiring within a brief period can seriously damage emission control components, in particular the catalytic converter.

Socket for OBD on-board diagnostics, refer to page [266](#).

Lane departure warning



System is switched on and, when certain prerequisites are met, warns if a detected lane is left without blinking beforehand.

Lane departure warning, refer to page [159](#).

Green lights

Turn signal



Turn signal switched on.

Unusually rapid blinking of the indicator light indicates that a turn signal bulb has failed.

Turn signal, refer to page [103](#).

Parking lights, headlights



Parking lights or headlights are switched on.

Parking lights/low beams, headlight control, refer to page [136](#).

Automatic High Beam Assistant



Automatic High Beam Assistant is switched on.

High beams are switched on and off automatically depending on the traffic situation.

Automatic High Beam Assistant, refer to page [138](#).

Cruise control



The system is switched on. It maintains the speed that was predefined using the control elements on the steering wheel.

Blue lights

High beams



High beams are switched on.

High beams, refer to page [104](#).

Hiding Check Control messages

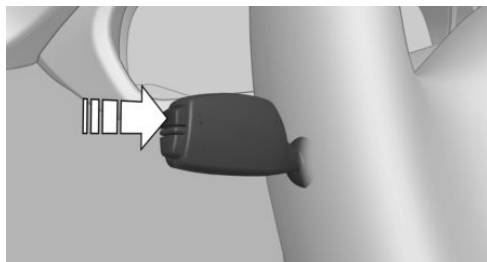

Press the button on the turn signal lever.

Continuous display

Some Check Control messages are displayed continuously and are not cleared until the fault is eliminated. If several faults occur at once, the messages are displayed consecutively.

The messages can be hidden for approx. 8 seconds. After this time, they are displayed again automatically.

Temporary display

Some Check Control messages are hidden automatically after approx. 20 seconds. The Check Control messages are stored and can be displayed again later.

Displaying stored Check Control messages

Via iDrive:

1. "My Vehicle"
2. "Vehicle status"
3.  "Check Control"
4. Select the text message.

Display

Check Control



At least one Check Control message is displayed or stored.

Text messages

Text messages in combination with an icon in the instrument cluster explain a Check Control message and the meaning of the indicator/warning lights.

Supplementary text messages

Additional information, such as on the cause of an error or the required action, can be called up via Check Control.

With urgent messages the added text will be automatically displayed on the Control Display.

Messages after trip completion

Certain messages displayed while driving are displayed again after the ignition is switched off.

Fuel gauge



An arrow beside the fuel pump icon shows which side of the vehicle the fuel filler flap is on.

Vehicle inclination may cause the display to vary.

Follow the information on refueling.



The yellow indicator light illuminates, once the fuel reserve is reached.

Tachometer

Always avoid RPM in the red warning field. In this range, the fuel supply is reduced to protect the engine.

Odometer and trip odometer

Display



- ▶ Odometer, arrow 1.
- ▶ Trip odometer, arrow 2.

Showing/resetting kilometers



Press the button.

- ▶ When the ignition is switched off, the time, the outside

temperature and the odometer are displayed.

- ▶ When the ignition is switched on, the trip odometer is reset.

Outside temperature

General information

If the indicator drops to +37 °F/+3 °C or lower, a signal sounds.

A Check Control message is displayed.

There is an increased risk of ice on roads.

Safety information

Warning

Even at temperatures above +37 °F/+3 °C there can be a risk of icy roads, for instance on bridges or shady sections of the road. There is a risk of accident. Modify your driving style to the weather conditions at low temperatures.

Display



+74.0 °F

The outside temperature is displayed in the instrument cluster.

Time



11:35

The time is displayed in the instrument cluster.

The time can be set on the Control Display.

Date



13/12/23

The date is displayed in the instrument cluster.

The date can be set on the Control Display.

Range

General information

When the remaining range is low:

- ▶ A Check Control message is displayed briefly.
- ▶ The remaining range is shown on the trip computer.
- ▶ With a sporty driving style, for instance fast cornering, the engine function is not always ensured.

The Check Control message appears continuously below a range of approx. 30 miles/50 km.

Safety information

NOTICE

With a range below 30 miles/50 km, the engine may no longer have sufficient fuel. Engine functions are not ensured anymore. There is a risk of damage to property, among other potential damage. Refuel promptly.

Display



→ 79 mi

The current range is displayed in the instrument cluster.



Current consumption

Instrument cluster



Displays the current fuel consumption. Check whether you are currently driving in an efficient and environmentally-friendly manner.

Instrument cluster with enhanced features



Displays the current fuel consumption. Check whether you are currently driving in an efficient and environmentally-friendly manner.

Displaying the current consumption

Depending on your vehicle's optional features, the current consumption can also be a bar display in the instrument cluster.

Via iDrive:

1. "My Vehicle"
2. "iDrive settings"
3. "Displays"
4. "Instrument panel"
5. "Additional indicators"

Energy recovery

Display



In coasting/overrun mode the kinetic energy of the vehicle is converted to electrical energy. The vehicle battery is partially charged and fuel consumption can be reduced.

Service notifications

Principle

The function displays the service notifications and the corresponding maintenance scopes.

General information

After the ignition is switched on the instrument cluster briefly displays available distance travelled or time to the next scheduled maintenance.

A service advisor can read out the current service notifications from your vehicle key.

Display

Detailed information on service notifications



More information on the type of service required may be displayed on the Control Display.

Via iDrive:

1. "My Vehicle"
2. "Vehicle status"
3. Tilt the Controller to the left.
4.  "Service required"
Maintenance work and legally mandated inspections are displayed.
5. Select an entry to call up detailed information.



Icons

Icons	Description
	No service is currently required.
	The time for recommended maintenance or a legally mandated inspection is approaching.
	Service interval is exceeded.

Entering appointment dates

Enter the dates for the mandatory vehicle inspections.

Make sure that the vehicle's date and time are set correctly.

Via iDrive:

1. "My Vehicle"
2. "Vehicle status"
3. Tilt the Controller to the left.
4.  "Service required"
5. "Vehicle inspection"
6. "Date:"
7. Select the desired setting.

Automatic Service Request

Data regarding the service status or legally mandated vehicle inspections is automatically transmitted to your dealer's service center before your vehicle is due for service.

You can check when your dealer's service center was notified.

Via iDrive:

1. "My Vehicle"
2. "Vehicle status"
3. Tilt the Controller to the left.
4.  "Teleservice Call"

Gear shift indicator

Principle



The system recommends the most efficient gear for the current driving situation.

General information

Depending on the vehicle equipment and country version, the gear shift indicator is active in the manual mode of the Steptronic transmission and with manual transmission. Suggestions to upshift or downshift are displayed in the instrument cluster.

On vehicles without a gear shift indicator, the engaged gear is displayed.

Steptronic transmission: displaying

Example	Description
	Efficient gear is set.
	Shift into efficient gear.

Speed Limit Info

Speed Limit Info

Principle

Speed Limit Info shows the current maximum permitted speed in the instrument cluster.

General information

The camera in the area of the interior mirror detects traffic signs at the edge of the road as well as overhead sign posts. Traffic signs with extra symbols for wet road conditions, etc., are also detected and compared with the vehicle's onboard data, such as from the rain sensor,

and will be displayed depending on the situation.

With the navigation system, the system takes into account the information stored in the navigation data and also displays speed limits present on routes without signs.

Without a navigation system, the system is subject to limitations imposed by technology. Traffic signs with speed limitations are detected and displayed only. Speed limitations due to entering or exiting towns, highway signs, etc. are not displayed. Speed limits with extra traffic signs are always displayed.

Safety information

Warning

The system cannot serve as a substitute for the driver's personal judgment in assessing the traffic situation. Based on the limits of the system, it cannot independently react to all traffic situations. There is a risk of accident. Adjust driving style to traffic conditions. Watch the surrounding traffic situation closely, be ready to take over steering and braking at any time, and actively intervene where appropriate.

Overview

Camera

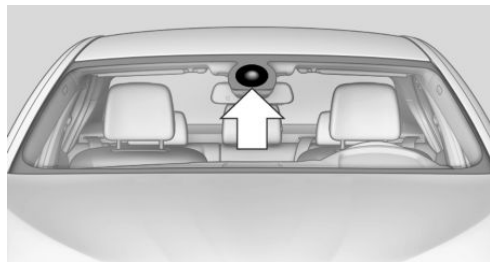

The camera is installed near the interior mirror.

Keep the windshield in front of the interior mirror clean and clear.

Display

General information

Speed Limit Info is permanently displayed in the instrument cluster.

Speed Limit Info



The last speed limit detected.

Without a navigation system the traffic signals are grayed out after curves or longer stretches of distance travelled.



With navigation system:

Speed Limit Info not available.

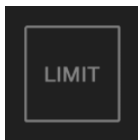

Without navigation system:

No speed limit or cancellation detected.

Speed Limit Info can also be displayed in the Head-up Display.

System limits

The system function may be limited and may provide incorrect information in the following situations:

- ▶ In heavy fog, rain or snowfall.
- ▶ When signs are fully or partially concealed by objects, stickers or paint.
- ▶ When driving very close to the vehicle in front of you.
- ▶ When driving toward bright lights or strong reflections.

- ▶ When the windshield in front of the interior mirror is fogged up, dirty or covered by a sticker, etc.
- ▶ In the event of incorrect detection by the camera.
- ▶ If the speed limits stored in the navigation system are incorrect.
- ▶ In areas not covered by the navigation system.
- ▶ When roads deviate from the navigation, such as due to changes in road layout.
- ▶ When passing buses or trucks with a speed sticker.
- ▶ If the traffic signs are non-conforming.
- ▶ During calibration of the camera immediately after vehicle delivery.
- ▶ When signs that are valid for a parallel road are detected.

Selection lists

General information

Depending on your vehicle's equipment, the following can be displayed or operated using the buttons and the thumbwheel on the steering wheel and via the displays in the instrument cluster and the Head-up Display:

- ▶ Current audio source.
- ▶ Phone redial.
- ▶ Turn on voice activation system.

Activating a list and adjusting the setting

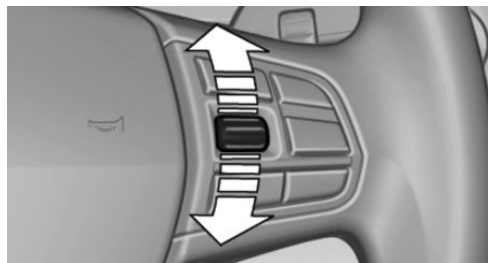

On the right side of the steering wheel, turn the thumbwheel to activate the corresponding list.

1. Turn the thumbwheel and select the desired setting.
2. Press the thumbwheel.

Display

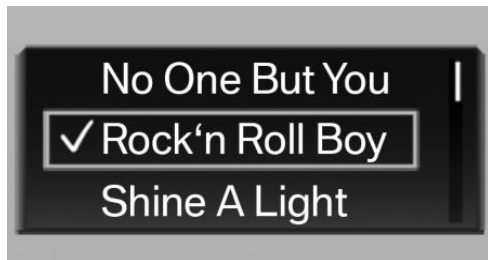

Depending on the equipment version, the list in the instrument cluster may differ from the illustration.

Trip computer

Principle

The trip computer displays different vehicle data in the instrument cluster, such as average values.

Calling up information on the Info Display

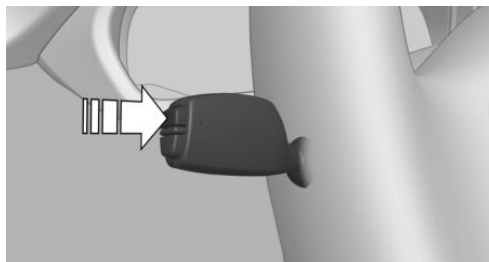

Press the button on the turn signal lever.

Information is displayed in the Info Display of the instrument cluster. Pressing the button repeatedly displays additional information.

Information at a glance

Repeatedly pressing the button on the turn signal lever calls up the following information in the Info Display:

- ▷ Range.
- ▷ Average consumption, fuel.
- ▷ Average consumption since delivery from the factory.
- ▷ Current consumption, fuel.
- ▷ Average speed.
- ▷ Date.
- ▷ Engine temperature display.
- ▷ Vehicle speed.
- ▷ Depending on the equipment, the arrival time.
When destination guidance is activated in the navigation system.
- ▷ Depending on the equipment, the distance to destination.
When destination guidance is activated in the navigation system.
- ▷ ECO PRO bonus range.

Selecting information

You can select what information from the trip computer is to be displayed on the Info Display of the instrument cluster.

Via iDrive:

1. "My Vehicle"
2. "iDrive settings"
3. "Displays"
4. "Instrument panel"
5. Select the desired setting.

Indication in the Info Display

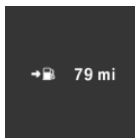

The information from the On-board Computer is shown in the Info Display in the instrument cluster.

Information in detail

Range

Displays the estimated cruising range available with the remaining fuel.

The range is calculated based on your driving style over the last 20 miles/30 km.

Average fuel consumption

The average consumption is calculated for the period while the engine is running.

The average consumption is calculated for the distance traveled since the last reset by the trip computer.

Average speed

Periods in which the vehicle is parked with the engine manually stopped are not included in the calculation of the average speed.

Resetting average values

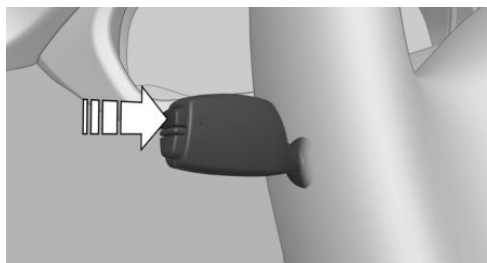

Press and hold the button on the turn signal lever.

The average consumption since delivery from the factory cannot be reset.

Engine temperature display

Principle

Depending on the vehicle equipment, the current engine temperature is displayed, based on a combination of the coolant temperature and engine oil temperature. As soon as the optimum operating temperature has been attained, the indicator is in the center position.

General information

If the engine oil or coolant, and thus the engine, become too hot, a Check Control message is displayed too.

To check the coolant level, refer to page 263.

Display



Distance to destination

Depending on the vehicle equipment, the distance remaining to the destination is displayed if a destination is entered in the navigation system before the trip is started.

The distance to the destination is adopted automatically.

Arrival time

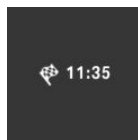

Depending on the vehicle equipment, the estimated arrival time is displayed if a destination is entered in the navigation system before the trip is started.

The prerequisite is that the time must be correctly set.

Trip computer on the Control Display

Principle

The trip computer displays different vehicle data on the Control Display, such as average values.

General information

Two types of trip computers are available on the Control Display:

- ▶ "Onboard info": average values, such as the consumption, are displayed. The values can be reset individually.
- ▶ "Trip computer": the values deliver an overview of a specific distance covered and can be reset as often as necessary.

Calling up the trip computer or travel computer

Via iDrive:

1. "My Vehicle"
2. "Driving information"
3. "Onboard info" or "Trip computer"



Resetting the on-board computer

Via iDrive:

1. "My Vehicle"
2. "Driving information"
3. "Onboard info"
4. "Consumption" or "Speed"
5. "OK"

Resetting the trip computer

Via iDrive:

1. "My Vehicle"
2. "Driving information"
3. "Trip computer"
4. Tilt the Controller to the left, if needed.
 - ▷  "Reset": all values are reset.
 - ▷  "Automatic reset": all values are re-set approx. 4 hours after the vehicle has come to a standstill.
5. If necessary, "OK"

Sport displays

Principle

On the Control Display, sport instruments can be displayed, and the vehicle condition can be checked before the use of the SPORT program.

Sport instruments

General information

On the Control Display, values for power and torque are displayed.

Displaying sport instruments

Via iDrive:

1. "My Vehicle"
2. "Technology in action"
3.  "Sports instruments"

Via the Driving Dynamics Control

1. Activate SPORT.
2. "Sport displays"

Vehicle condition

General information

The following vehicle and environment data is evaluated:

- ▷ Engine temperature.
- ▷ Outside temperature.
- ▷ Tire temperature and tire inflation pressure.

Tire temperature and tire filling pressure are determined while driving.

Checking vehicle condition

Via iDrive:

1. "My Vehicle"
2. "Technology in action"
3.  "Vehicle and surroundings"

Via the Driving Dynamics Control

1. Activate SPORT.
2. "Sport displays"

Speed warning

Principle

The system can be used to set a speed limit. A warning will be issued when this speed limit is exceeded.

General information

The warning is repeated if the vehicle speed exceeds the set speed limit again, after it has dropped below it by 3 mph/5 km/h.

Adjusting

Via iDrive:

1. "My Vehicle"
2. "Vehicle settings"
3. "Speed warning"
4. "Warning at:"
5. Turn the Controller until the desired speed is displayed.
6. Press the Controller.

Activate/deactivate

Via iDrive:

1. "My Vehicle"
2. "Vehicle settings"
3. "Speed warning"
4. "Speed warning"

Accept current speed as the speed warning

Via iDrive:

1. "My Vehicle"
2. "Vehicle settings"
3. "Speed warning"
4. "Select current speed"

Head-up Display

Principle

This system projects important information into the driver's field of view, for instance the speed.

The driver can quickly absorb information and concentrate on the surrounding traffic situation.

Overview

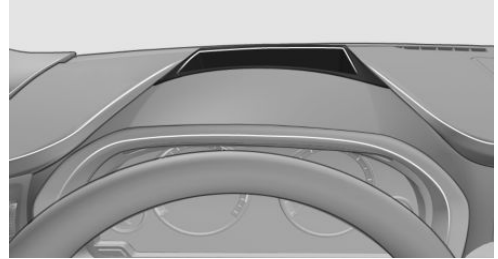

The protective glass of the Head-up display is located in the position marked.

Turning on/off

Via iDrive:

1. "My Vehicle"
2. "iDrive settings"
3. "Displays"
4. "Head-Up Display"
5. "Head-Up Display"

Display

For an overview,

The following information is displayed on the Head-up Display:

- ▷ Vehicle speed.
- ▷ Navigation instructions.
- ▷ Check Control messages.
- ▷ Selection list from the instrument cluster.
- ▷ Driver assistance systems.

Some of this information is only displayed briefly as needed.



Selecting displays in the Head-up Display

Via iDrive:

1. "My Vehicle"
2. "iDrive settings"
3. "Displays"
4. "Head-Up Display"
5. "Displayed information"
6. Select the desired setting.

Settings are stored for the profile currently used.

Setting the brightness

The brightness is automatically adjusted to the ambient brightness.

The base setting can be adjusted manually.

Via iDrive:

1. "My Vehicle"
2. "iDrive settings"
3. "Displays"
4. "Head-Up Display"
5. "Brightness"
6. Turn the Controller until the desired brightness is set.
7. Press the Controller.

When the low beams are switched on, the brightness of the Head-up Display can be adjusted using the instrument lighting.

Settings are stored for the profile currently used.

Adjusting the height

Via iDrive:

1. "My Vehicle"
2. "iDrive settings"
3. "Displays"
4. "Head-Up Display"
5. "Height"

6. Turn the Controller until the desired height is reached.
7. Press the Controller.

Settings are stored for the profile currently used.

The height of the Head-up Display can also be stored using the memory function, refer to page 87.

Setting the rotation

The screen of the Head-up Display can be rotated around its own axis.

Via iDrive:

1. "My Vehicle"
2. "iDrive settings"
3. "Displays"
4. "Head-Up Display"
5. "Rotation"
6. Turn the Controller until the desired setting is selected.
7. Press the Controller.

Settings are stored for the profile currently used.

Display visibility

The visibility of the displays in the Head-up Display is influenced by the following factors:

- ▶ Seat position.
- ▶ Objects on the protective glass of the Head-up display.
- ▶ Dust or dirt on the protective glass of the Head-up display.
- ▶ Windshield dirty on inside or outside.
- ▶ Sunglasses with certain polarization filters.
- ▶ Wet road.
- ▶ Unfavorable light conditions.

If the image is distorted, have the base settings checked by a dealer's service center or another qualified service center or repair shop.



Follow the instructions for cleaning the Head-up Display, refer to page [285](#).

Special windshield

The windshield is part of the system.

The shape of the windshield makes it possible to display a precise illustration.

A film in the windshield prevents double images from being displayed.

For this reason, it is strongly recommended to have the special windshield replaced by a dealer's service center or another qualified service center or repair shop, if necessary.

Vehicle status

General information





The status can be displayed and actions performed for several systems.



Going to the vehicle status

Via iDrive:

1. "My Vehicle"
2. "Vehicle status"

Information at a glance

Icons	Description
	"Flat Tire Monitor": status of the flat tire monitor, refer to page 149 .
	"Tire Pressure Monitor": status of the Tire Pressure Monitor status, refer to page 145 .
	"Engine oil level": electronic oil-level check, refer to page 259 .
	"Check Control": displaying stored Check Control messages, refer to page 124 .

Icons	Description
	"Service required": displaying service notifications, refer to page 126 .
	"Teleservice Call": Teleservice Call.

Lights

Vehicle features and options

This chapter describes all standard, country-specific and optional features offered with the series. It also describes features and functions that are not necessarily available in your vehicle, e.g., due to the selected options or country versions. This also applies to safety-related functions and systems. When using these functions and systems, the applicable laws and regulations must be observed.

Overview

Switches in the vehicle



The light switch element is located next to the steering wheel.

Icon	Function
	Bad weather light.
	Automatic headlight control. Cornering light and variable light distribution. Cornering light.
	Lights off. Daytime driving lights.

Icon	Function
	Parking lights.
	Low beams.
	Instrument lighting.

Parking lights, low beams and roadside parking lights

General information

Switch position: 0, , 

If the driver's door is opened when the ignition is switched off, the exterior lighting is automatically switched off.

Parking lights

Switch position: 

The vehicle is illuminated on all sides.

Do not use the parking lights for extended periods; otherwise, they might drain the vehicle battery and it would then be impossible to start the engine.

When parking, switch on the one-sided roadside parking light, refer to page 137.

Low beams

Switch position: 

The low beams light up when the ignition is switched on.

Canada: roadside parking light

Principle

The vehicle can be illuminated on one side.

Turning on

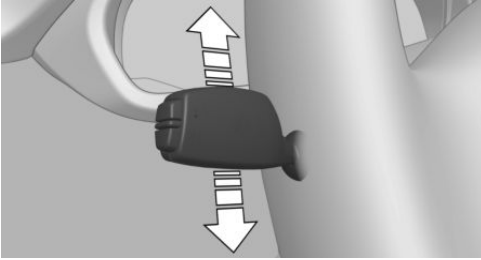

With radio-ready state switched off, press the lever either up or down past the resistance point for approx. 2 seconds.

Turning off

Briefly press the lever to the resistance point in the opposite direction.

Welcome lights and pathway lighting

Welcome lights

General information

Depending on the vehicle equipment and the ambient brightness, individual lighting functions may be switched on briefly when the vehicle is unlocked.

Activate/deactivate

Switch position:  , 

Via iDrive:

1. "My Vehicle"
2. "Vehicle settings"
3. "Lighting"

4. "Exterior lighting"

5. "Welcome lights"

The setting is stored for the driver profile currently used.

Pathway lighting

General information

The low beams stay lit for a short while if the headlight flasher is switched on after the radio-ready state is switched off.

Setting the duration

Via iDrive:

1. "My Vehicle"
2. "Vehicle settings"
3. "Lighting"
4. "Exterior lighting"
5. "Pathway lighting"
6. Set length of time.

The setting is stored for the driver profile currently used.

Automatic headlight control

Principle

The low beams are switched on and off automatically depending on the ambient brightness, for example in tunnels, in twilight or if there is precipitation.

General information

A blue sky with the sun low on the horizon can cause the lights to be turned on.

The low beams always stay on when the fog light is switched on.

Activating

Switch position: 

The indicator light in the instrument cluster is illuminated when the low beams are switched on.



System limits

The automatic headlight control cannot replace your personal judgment of lighting conditions.

For example, the sensors are unable to detect fog or hazy weather. In these situations, turn the lights on manually.

Daytime driving lights

General information

Switch position:  ,  , 

The daytime driving lights light up when the ignition is switched on. After the ignition is switched off, the parking lights light up in position  .

Activate/deactivate

In some countries, daytime driving lights are mandatory, so it may not be possible to deactivate the daytime running lights.

Via iDrive:

1. "My Vehicle"
2. "Vehicle settings"
3. "Lighting"
4. "Exterior lighting"
5. Select the desired setting.

Settings are stored for the profile currently used.

Cornering light

General information

Switch position: 

In tight curves, for instance on mountainous roads or when turning, an additional, cornering light is switched on that lights up the inside of the curve when the vehicle is moving below a certain speed.

The cornering light is automatically switched on depending on the steering-wheel angle or, where applicable, the use of turn signals.

When driving in reverse, the cornering lights may be automatically switched on regardless of the steering-wheel angle.

Adaptive headlight range control

The adaptive headlight range control feature balances out acceleration and braking processes as well as the vehicle load conditions in order to avoid blinding oncoming traffic. Illumination of the road is optimized.

Automatic High Beam Assistant

Principle

The Automatic High Beam Assistant detects other road users early on and automatically switches the high beams on or off depending on the traffic situation.

General information

The Automatic High Beam Assistant ensures that the high beams are switched on, whenever the traffic situation allows. In the low speed range, the high beams are not switched on by the system.

The system responds to light from oncoming traffic and traffic driving ahead of you, and to ambient lighting, for instance in towns and cities.

The high beams can be switched on and off manually at any time.

Activate/deactivate

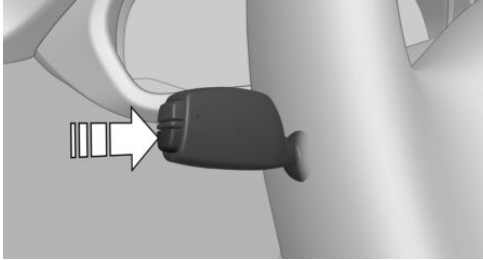

Switch position, depending on the vehicle equipment:  , 

Press the button on the turn signal lever.



The indicator light in the instrument cluster is illuminated when the low beams are switched on.

The headlights are automatically changed between low beams and high beams.



The blue indicator light in the instrument cluster lights up when the system switches on the high beams.

The Automatic High Beam Assistant is deactivated when manually switching the high beams on and off, refer to page 104.

To reactivate the Automatic High Beam Assistant, press the button on the turn signal lever.

System limits

The Automatic High Beam Assistant cannot replace the driver's personal judgment of when to use the high beams. In situation that require this, therefore dimming manually.

The system is not fully functional in the following situations, and driver intervention may be necessary:

- ▷ In very unfavorable weather conditions, such as fog or heavy precipitation.
- ▷ When detecting poorly-lit road users such as pedestrians, cyclists, horseback riders and wagons; when driving close to train or ship traffic; and at animal crossings.
- ▷ In tight curves, on hilltops or in depressions, in crossing traffic or half-observed oncoming traffic on highways.
- ▷ In poorly-lit towns and cities and in the presence of highly reflective signs.
- ▷ When the windshield in front of the interior mirror is fogged up, dirty or covered with stickers, etc.

Fog lights

Bad weather light

Principle

The bad weather light ensures optimized illumination of the roadway in poor visibility, such as fog or rain. The light distribution of the low beams is adapted to the visibility.

Functional requirement

The automatic headlight control must be activated before switching on the bad weather light.

Turning on/off



Press the button.

Instrument lighting

Functional requirement

The parking lights or low beams must be switched on to set the brightness.

Adjusting



Adjust the brightness with the thumbwheel.

Interior lights

General information

Depending on the equipment, the interior lights, footwell lights, entry lights, and courtesy lights are controlled automatically.

The thumbwheel for the instrument lighting controls brightness of some of these features.

Overview



- 1 Interior lights
- 2 Reading lights

Switching the interior lights on/off



Press the button.

To switch off permanently: press the button and hold for approx. 3 seconds.

Switching the reading lights on/off



Press the button.

Depending on the vehicle equipment, the reading lights are located next to the interior lights in the front and rear.

Ambient light

General information

Depending on the equipment version, lighting can be adjusted for some lights in the car's interior.

Selecting the color scheme

Via iDrive:

1. "My Vehicle"
2. "Vehicle settings"
3. "Lighting"
4. "Interior lighting"
5. "Lighting design"
6. Select the desired setting.

To deactivate the ambient light: "Off".

Setting the brightness

Via iDrive:

1. "My Vehicle"
2. "Vehicle settings"
3. "Lighting"
4. "Interior lighting"
5. "Brightness"
6. Adjust the brightness.

Safety

Vehicle features and options

This chapter describes all standard, country-specific and optional features offered with the series. It also describes features and functions that are not necessarily available in your vehi-

cle, e.g., due to the selected options or country versions. This also applies to safety-related functions and systems. When using these functions and systems, the applicable laws and regulations must be observed.

Airbags

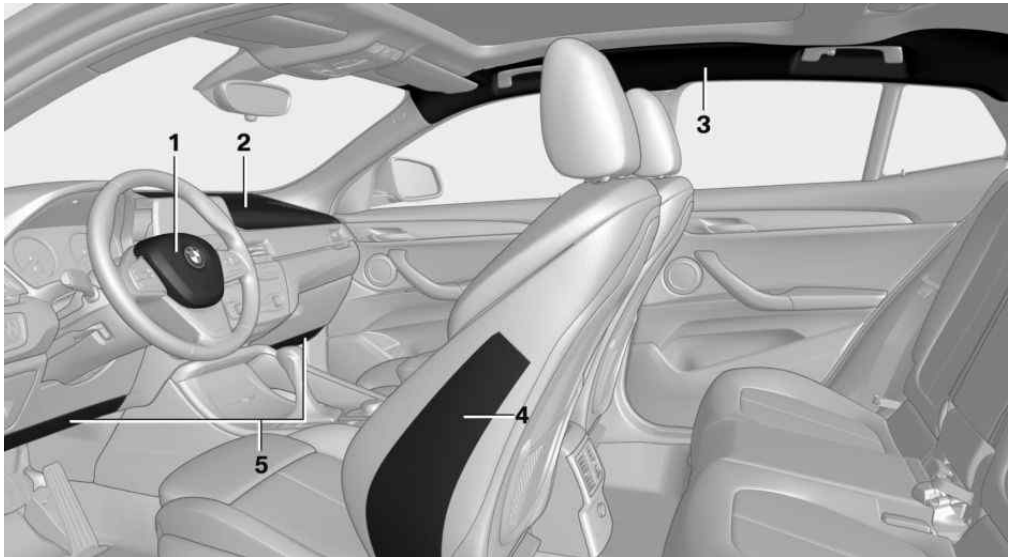

- 1 Front airbag, driver
- 2 Front airbag, front passenger
- 3 Head airbag
- 4 Side airbag
- 5 Knee airbag

Front airbags

Front airbags help protect the driver and the front passenger by responding to frontal impacts in which seat belts alone would not provide adequate protection.

Side airbag

In the event of a side collision, the side airbag protects the side of the body in the chest and lap area.



Head airbag

In the event of a side collision, the head airbag protects the head.

Ejection Mitigation

The head airbag system is designed as an ejection mitigation countermeasure to reduce the likelihood of ejections of vehicle occupants through side windows during rollovers or side collision events.

Knee airbag

The knee airbag protects the legs in the event of a frontal impact.

Protective effect

Airbags are not deployed in every impact situation, for instance in less severe accidents or rear-end collisions.

Information on optimum protective effect of the airbags

Warning

If the seat position is incorrect or the deployment area of the airbags is impaired, the airbag system cannot provide protection as intended and may cause additional injuries due to deployment. There is a risk of injury or danger to life. Follow the information on achieving the optimum protective effect of the airbag system.

- ▷ Keep a distance from the airbags.
- ▷ Always grasp the steering wheel on the steering wheel rim. Hold your hands at the 3 o'clock and 9 o'clock positions, to keep the risk of injury to your hands or arms as low as possible when the airbag is deployed.
- ▷ Adjust seat and steering wheel so that hands can be crossed over the steering wheel. Select the settings so that the

shoulder rests against the backrest when crossing the hands and the upper body is as far back as possible while still maintaining a comfortable grip on the steering wheel.

- ▷ Make sure that occupants keep their heads away from the side airbag.
- ▷ Make sure that the front passenger is sitting correctly, i.e., keeps his or her feet and legs in the footwell and does not support them on the dashboard.
- ▷ There should be no additional persons, animals or objects between an airbag and a person.
- ▷ Dashboard and windshield on the passenger's side must stay clear - do not attach adhesive film or coverings and do not attach brackets or cables, for instance for navigation devices or mobile phones.
- ▷ Do not bond the airbag cover panels with adhesive, do not cover them or modify them in any way.
- ▷ Do not use the cover of the front airbag on the passenger's side as a storage area.
- ▷ Do not attach slip covers, seat cushions or other objects to the front seats that are not specifically suited for seats with integrated side airbags.
- ▷ Do not hang pieces of clothing, such as jackets, over the backrests.
- ▷ Never modify either the individual components or the wiring in the airbag system. This also applies to steering wheel covers, the dashboard, and the seats.
- ▷ Do not disassemble the airbag system.

Even when you follow all instructions very closely, injury from contact with the airbags cannot be fully ruled out in certain situations.

The ignition and inflation noise may lead to short-term and, in most cases, temporary hearing impairment in sensitive occupants.

Vehicle modifications for a person with disabilities may affect the air bag system; contact

BMW Customer Relations for further information.

Warnings and information on the airbags are also found on the sun visors.

Operational readiness of the airbag system

Safety information

Warning

Individual components can be hot after deployment of the airbag system. There is a risk of injury. Do not touch individual components.

Warning

Improperly executed work can lead to failure, malfunction or unintentional deployment of the airbag system. In the case of a malfunction, the airbag system might not deploy as intended despite the accident severity. There is a risk of injury or danger to life. Have the airbag system checked, repaired, disassembled and scrapped by a dealer's service center or another qualified service center or repair shop.

Correct function



When the ignition is switched on, the warning light in the instrument cluster lights up briefly, thereby indicating the operational readiness of the entire airbag system and the seat belt tensioners.

Airbag system fault

- ▷ Warning light does not come on when the ignition is switched on.
- ▷ The warning light lights up continuously.

Automatic deactivation of the front passenger airbags

Principle

The system reads if the front passenger seat is occupied by measuring the human body's resistance.

Front, knee, and side airbag on the front passenger's side are activated or deactivated.

General information

Before transporting a child on the front passenger seat, refer to the safety information and instructions for children on the front passenger seat, see Children.

Safety information

Warning

To ensure the front passenger airbag function, the system must be able to detect whether a person is sitting in the front passenger seat. The entire seat surface must be used for this purpose. There is a risk of injury or danger to life. Make sure that the front passenger keeps his or her feet in the footwell.

Fault of the automatic deactivation system

When transporting older children and adults, the front passenger airbags may be deactivated in certain seat positions. In this case, the indicator light for the front passenger airbags lights up.

In this case, change the seat position so that the front passenger airbags are activated and the indicator light goes out.

If it is not possible to activate the airbags, have the person sit in the rear seat.

To enable accurate recognition of the occupied seat surface

- ▶ Do not attach covers, cushions, ball mats or other items to the front passenger seat unless they are specifically determined to be safe for use on the front passenger seat.
- ▶ Do not place any electronic devices on the front passenger seat if a child restraint system is to be installed on it.
- ▶ Do not place objects under the seat that could press against the seat from below.
- ▶ No moisture in or on the seat.

Indicator light for the front passenger airbags



The indicator light for the front passenger airbags indicates the operating state of the front passenger airbags.

The light indicates whether the airbags are either activated or deactivated.



- ▶ The indicator light lights up when a child is properly seated in a child restraint system or when the seat is empty. The airbags on the passenger's side are not activated.
- ▶ The indicator light does not light up when, for instance a correctly seated person of sufficient size is detected on the seat. The airbags on the passenger's side are activated.

Detected child restraint systems

The system generally detects children seated in a child restraint system, particularly in child

restraint systems required by NHTSA at the point in time when the vehicle was manufactured. After installing a child restraint system, make sure that the indicator light for the front passenger airbags lights up. This indicates that the child restraint system has been detected and the front passenger airbags are not activated.

Strength of the driver's and front passenger airbag

The power that deploys the driver's/front passenger airbags depends on the position of the driver's/front passenger seat.

To maintain the accuracy of this function over the long term, calibrate the front seats as soon as a respective message appears on the Control Display.

Calibrating the front seats

Warning

There is a risk of jamming when moving the seats. There is a risk of injury or risk of damage to property. Make sure that the travel path of the seat is clear prior to any adjustment.

A corresponding message appears on the Control Display.

1. Press the switch and move the respective seat all the way forward, until it stops.
2. Press the switch forward again. The seat still moves forward slightly.
3. Readjust the seat to the desired seat position.

The calibration procedure is completed when the message on the Control Display disappears.

If the message continues to be displayed, repeat the calibration.

If the message does not disappear after a repeat calibration, have the system checked as soon as possible.

Tire pressure monitor

Principle

The system monitors tire pressure in the four mounted tires. The system warns you if there is a significant loss of pressure in one or more tires.

General information

Sensors in the tire valves measure the tire inflation pressure and, depending on the model, the tire temperature.

Further information and instructions on using the system can also be found under Tire inflation pressure, refer to page [236](#).

Functional requirements

The following prerequisites must be met for the system; otherwise, reliable message of a tire pressure loss is not assured:

- ▶ After a tire or wheel change, a reset was performed with the correct tire inflation pressure.
- ▶ After the tire inflation pressure was adjusted to a new value, a reset was performed.
- ▶ Wheels with wheel electronics.

Status display

Current status

The system status can be displayed on the Control Display, e.g., whether or not the system is active.

Via iDrive:

1. "My Vehicle"
2. "Vehicle status"
3.  "Tire Pressure Monitor"

The current status is displayed.

Tire conditions

General information

Tire and system status are indicated by the color of the wheels and a text message on the Control Display.

All wheels green

System is active and will issue a warning related to the tire inflation pressures stored during the last reset.

One to four yellow wheels

A flat tire or major tire pressure loss has occurred in the indicated tires.

Gray wheels

It may not be possible to identify tire pressure losses.

Possible causes:

- ▶ Malfunction.
- ▶ The system is being reset.

Additional information

The status control display additionally shows the current tire inflation pressures and, depending on the model, the tire temperatures. The values shown are instantaneous measurements and may vary depending on driving or weather conditions.

Resetting the system

Via iDrive:

1. "My Vehicle"
2. "Vehicle status"



3. (1) ^{RESET} "Tire Pressure Monitor"
4. Start the engine but do not drive off.
5. Reset tire pressure: "Perform reset".
6. Drive away.

The wheels are displayed in gray and the following is displayed "Resetting Tire Pressure Monitor...".

After a travel time of several minutes, the set tire inflation pressures are accepted as reference values. The reset is completed automatically while driving.

After a successfully completed reset, the wheels on the Control Display are shown in green and "Tire Pressure Monitor active. See label for recommended pressures." is displayed.

You may interrupt this trip at any time. When you continue driving the reset resumes automatically.

Messages

General information

When a flat tire is indicated, the Dynamic Stability Control may be turned on.

Safety information

Warning

A damaged regular tire with low or missing tire inflation pressure impacts handling, such as steering and braking response. Runflat tires can maintain limited stability. There is a risk of accident. Do not continue driving if the vehicle is equipped with normal tires. Follow the information on runflat tires and continued driving with these tires.

If a tire inflation pressure check is required

Message

An icon with a Check Control message appears on the Control Display.

Icon	Possible cause
	The system has detected a wheel change, but no reset was done. No reset was performed for the system. The system issues a warning based on the tire inflation pressures stored during the last reset. Inflation was not carried out according to specifications.
	The tire inflation pressure has fallen below the level of the last reset.



Measure

1. Check the tire pressure and correct as needed.
2. Reset the system.

If the tire inflation pressure is too low

Message



A yellow warning light is illuminated in the instrument cluster.

In addition, an icon with a Check Control message appears on the Control Display.

Icon	Possible cause
	There is a tire pressure loss. No reset was performed for the system. The system issues a warning based on the tire inflation pressures stored during the last reset.



Measure

1. Reduce your speed and drive moderately. Do not exceed a speed of 80 mph/130 km/h.
2. At the next opportunity, for instance filling station, check and correct the tire inflation pressure in all four tires, if necessary.
3. Reset the system.

If there is a significant tire pressure loss

Message



A yellow warning light is illuminated in the instrument cluster.

In addition, an icon with the affected tire appears in a Check Control message on the Control Display.

Icon	Possible cause
------	----------------



There is a flat tire or a major tire pressure loss.

No reset was performed for the system. The system issues a warning based on the tire inflation pressures stored during the last reset.

Measure

1. Reduce your speed and stop cautiously. Avoid sudden braking and steering maneuvers.
2. Check whether the vehicle is fitted with standard tires or runflat tires.
Runflat tires, refer to page 244, are labeled with a circular icon containing the letters RSC marked on the tire sidewall.

Actions in the event of a flat tire

Standard tires

1. Identify the damaged tire.

To do this, check the air pressure in all four tires, for instance using the tire pressure display of a flat tire kit.

If the tire pressure in all four tires is correct, the Tire Pressure Monitor may not have been reset. In this case, perform the reset.

If identification of flat tire damage is not possible, please contact a dealer's service center or another qualified service center or repair shop.

2. Repair the flat tire, e.g., with a flat tire kit or by changing the wheel.

Use of sealing compound, for instance from the flat tire kit, may damage the wheel electronics. In this case, have the electronics checked and replaced at the next opportunity.

Runflat tires

Safety information

Warning

The vehicle handles differently when a runflat tire has insufficient or no tire pressure; for instance, reduced directional stability when braking, braking distances are longer and the self-steering properties will change. There is a risk of accident. Drive moderately and do not exceed a speed of 50 mph/80 km/h.

Maximum speed

You may continue driving with a damaged tire at speeds up to 50 mph/80 km/h.

Continued driving with a flat tire

If continuing to drive with a damaged tire:

1. Avoid sudden braking and steering maneuvers.
2. Do not exceed a speed of 50 mph/80 km/h.
3. Check the air pressure in all four tires at the next opportunity.



If the tire pressure in all four tires is correct, the Tire Pressure Monitor may not have been reset. In this case, perform the reset.

Possible distance travelled with a depressurized tire

The distance travelled for which it may be possible to drive safely varies depending on how the vehicle is loaded and used, e.g., speed, road conditions, outside temperature. The distance travelled may be less but may also be more if an economical driving style is used.

If the vehicle is loaded with an average weight and used under favorable conditions, the distance travelled for which it may be safe to drive may be up to 50 miles/80 km.

Vehicle handling with damaged tires

Vehicles driven with a damaged tire will handle differently, potentially leading to conditions such as the following:

- ▶ Greater likelihood of skidding of the vehicle.
- ▶ Longer braking distances.
- ▶ Changed self-steering properties.

Modify your driving style. Avoid abrupt steering maneuvers or driving over obstacles, for instance curbs or potholes.

Final tire failure

Vibrations or loud noises while driving can indicate the final failure of a tire.

Reduce speed and stop; otherwise, pieces of the tire could come loose and cause an accident.

Do not continue driving. Contact a dealer's service center or another qualified service center or repair shop.

System limits

Temperature

The tire inflation pressure depends on the tire's temperature.

Driving or exposure to the sun will increase the tire temperature, thus increasing the tire inflation pressure.

The tire inflation pressure is reduced when the tire temperature falls again.

These circumstances may cause a warning when temperatures fall very sharply.

Sudden tire pressure loss

The system cannot indicate sudden serious tire damage caused by external circumstances.

Failure performing a reset

The system does not function properly if a reset has not been carried out, for instance a flat tire is reported though tire inflation pressures are correct.

Malfunction



The yellow warning light flashes and is then illuminated continuously. A Check Control message is displayed. It may not be possible to identify tire pressure losses.

Examples and recommendations in the following situations:

- ▶ A wheel without wheel electronics is mounted: have it checked by a dealer's service center or another qualified service center or repair shop as needed.
- ▶ A wheel without wheel electronics, for instance an emergency wheel, is mounted: have it checked by a dealer's service center or another qualified service center or repair shop as needed.
- ▶ Malfunction: have system checked by a dealer's service center or another qualified service center or repair shop.
- ▶ The system was unable to complete the reset. Perform a system reset again.
- ▶ Fault caused by systems or devices with the same radio frequency: after leaving the

area of the interference, the system automatically becomes active again.

Declaration according to NHTSA/ FMVSS 138 Tire Pressure Monitoring System

Each tire, including the spare (if provided) should be checked monthly when cold and inflated to the inflation pressure recommended by the vehicle manufacturer on the vehicle placard or tire inflation pressure label. (If your vehicle has tires of a different size than the size indicated on the vehicle placard or tire inflation pressure label, you should determine the proper tire inflation pressure for those tires.) As an added safety feature, your vehicle has been equipped with a tire pressure monitoring system (TPMS) that illuminates a low tire pressure telltale when one or more of your tires is significantly under-inflated. Accordingly, when the low tire pressure telltale illuminates, you should stop and check your tires as soon as possible, and inflate them to the proper pressure. Driving on a significantly under-inflated tire causes the tire to overheat and can lead to tire failure. Under-inflation also reduces fuel efficiency and tire tread life, and may affect the vehicle's handling and stopping ability. Please note that the TPMS is not a substitute for proper tire maintenance, and it is the driver's responsibility to maintain correct tire pressure, even if under-inflation has not reached the level to trigger illumination of the TPMS low tire pressure telltale. Your vehicle has also been equipped with a TPMS malfunction indicator to indicate when the system is not operating properly. The TPMS malfunction indicator is combined with the low tire pressure telltale. When the system detects a malfunction, the telltale will flash for approximately one minute and then remain continuously illuminated. This sequence will continue upon subsequent vehicle start-ups as long as the malfunction exists. When the malfunction indicator is illuminated, the system may not be able to detect or signal low tire pressure as intended.

TPMS malfunctions may occur for a variety of reasons, including the installation of replacement or alternate tires or wheels on the vehicle that prevent the TPMS from functioning properly. Always check the TPMS malfunction telltale after replacing one or more tires or wheels on your vehicle to ensure that the replacement or alternate tires and wheels allow the TPMS to continue to function properly.

Flat Tire Monitor

Principle

The system detects tire pressure loss on the basis of rotation speed differences between the individual wheels while driving.

In the event of a tire pressure loss, the diameter and therefore the rotational speed of the corresponding wheel changes. The difference will be detected and reported as a flat tire.

The system does not measure the actual inflation pressure in the tires.

Functional requirements

The following prerequisites must be met for the system; otherwise, reliable message of a tire pressure loss is not assured:

- ▶ After a tire or wheel change, an initialization was performed with the correct tire inflation pressure.
- ▶ After the tire pressure was adjusted to a new value, an initialization was performed.

Status display

The current status of the flat tire monitor can be displayed, e.g., whether the flat tire monitor is active.

Via iDrive:

1. "My Vehicle"
2. "Vehicle status"
3.  "Flat Tire Monitor"



The status is displayed.

Initialization required

An initialization must be performed in the following situations:

- ▷ After the tire inflation pressure has been adjusted.
- ▷ After a tire or wheel change.

Performing initialization

When initializing, the set tire inflation pressures serve as reference values in order to detect a flat tire. Initialization is started by confirming the tire inflation pressures.

Do not initialize the system when driving with tire chains.

Via iDrive:

1. "My Vehicle"
2. "Vehicle status"
3.  "Flat Tire Monitor"
4. Start the engine but do not drive off.
5. Start the initialization with: "Perform reset"
6. Drive away.

The initialization is completed while driving, which can be interrupted at any time.

The initialization automatically continues when driving continues.

Messages

General information

When a flat tire is indicated, the DSC Dynamic Stability Control is turned on, if needed.

Safety information

Warning

A damaged regular tire with low or missing tire inflation pressure impacts handling, such as steering and braking response. Runflat tires can maintain limited stability. There is a risk of accident. Do not continue driving if the vehicle is equipped with normal tires. Follow the information on runflat tires and continued driving with these tires.

Indication of a flat tire



A yellow warning light is illuminated in the instrument cluster.

In addition, an icon with a Check Control message appears on the Control Display.

Icon	Possible cause
	There is a flat tire or a major tire pressure loss.



Measure

1. Reduce your speed and stop cautiously. Avoid sudden braking and steering maneuvers.
2. Check whether the vehicle is fitted with standard tires or runflat tires. Runflat tires, refer to page 244, are labeled with a circular icon containing the letters RSC marked on the tire sidewall.

Actions in the event of a flat tire

Standard tires

1. Identify the damaged tire. To do this, check the air pressure in all four tires, for instance using the tire pressure display of a flat tire kit.

If the tire inflation pressure in all four tires is correct, the Flat Tire Monitor may not have been initialized. In this case, initialize the system.

If identification of flat tire damage is not possible, please contact a dealer's service center or another qualified service center or repair shop.

2. Repair the flat tire, e.g., with a flat tire kit or by changing the wheel.

Runflat tires

Safety information

Warning

The vehicle handles differently when a runflat tire has insufficient or no tire pressure; for instance, reduced directional stability when braking, braking distances are longer and the self-steering properties will change. There is a risk of accident. Drive moderately and do not exceed a speed of 50 mph/80 km/h.

Maximum speed

You may continue driving with a damaged tire at speeds up to 50 mph/80 km/h.

Continued driving with a flat tire

If continuing to drive with a damaged tire:

1. Avoid sudden braking and steering maneuvers.
2. Do not exceed a speed of 50 mph/80 km/h.
3. Check the air pressure in all four tires at the next opportunity.

If the tire inflation pressure in all four tires is correct, the Flat Tire Monitor may not have been initialized. In this case, initialize the system.

Possible distance travelled with a depressurized tire

The distance travelled for which it may be possible to drive safely varies depending on how the vehicle is loaded and used, e.g., speed, road conditions, outside temperature. The distance travelled may be less but may also be more if an economical driving style is used.

If the vehicle is loaded with an average weight and used under favorable conditions, the distance travelled for which it may be safe to drive may be up to 50 miles/80 km.

Vehicle handling with damaged tires

Vehicles driven with a damaged tire will handle differently, potentially leading to conditions such as the following:

- ▶ Greater likelihood of skidding of the vehicle.
- ▶ Longer braking distances.
- ▶ Changed self-steering properties.

Modify your driving style. Avoid abrupt steering maneuvers or driving over obstacles, for instance curbs or potholes.

Final tire failure

Vibrations or loud noises while driving can indicate the final failure of a tire.

Reduce speed and stop; otherwise, pieces of the tire could come loose and cause an accident.

Do not continue driving. Contact a dealer's service center or another qualified service center or repair shop.

System limits

The system could be delayed or malfunction in the following situations:



- ▶ A natural, even tire pressure loss in all four tires will not be recognized. Therefore, check the tire inflation pressure regularly.
- ▶ Sudden serious tire damage caused by external circumstances cannot be recognized in advance.
- ▶ When the system has not been initialized.
- ▶ When driving on a snowy or slippery road.
- ▶ Sporty driving style: slip on traction wheels, high lateral acceleration (drifting).
- ▶ When driving with tire chains.

Intelligent Safety

Principle

Intelligent Safety enables central operation of the driver assistance systems. Depending on how the vehicle is equipped, Intelligent Safety consists of one or more systems that can help prevent an imminent collision.

- ▶ Forward Collision Warning with city collision mitigation, refer to page 153.
- ▶ Pedestrian Warning, refer to page 156.
- ▶ Lane departure warning, refer to page 159.

Safety information

Warning

The system cannot serve as a substitute for the driver's personal judgment in assessing the traffic situation. Based on the limits of the system, it cannot independently react to all traffic situations. There is a risk of accident. Adjust driving style to traffic conditions. Watch the surrounding traffic situation closely, be ready to take over steering and braking at any time, and actively intervene where appropriate.

Warning

Indicators and warnings cannot serve as a substitute for the driver's personal judgment. Due to its limits, the system may not issue warnings or reactions, or these may be issued late or in a manner that is not consistent with their normal use. There is a risk of accident. Adjust driving style to traffic conditions. Watch surrounding traffic closely and actively intervene where appropriate.

Warning

Due to system limits, individual functions can malfunction during tow-starting/towing with the Intelligent Safety systems activated. There is a risk of accident. Switch all Intelligent Safety systems off prior to tow-starting/towing.

Overview

Button in the vehicle



 Intelligent Safety button

Turning on/off

Some Intelligent Safety systems are automatically active after every departure. Some Intelligent Safety systems activate according to the last setting.



Press button briefly:

- ▶ The menu for the Intelligent Safety system is displayed. The systems are individually switched off according to their respective settings.
- ▶ LED lights up orange or goes out respective to their individual settings.

Adjust the settings as needed. Individual settings are stored for the profile currently used.



Press button again:

- ▶ All Intelligent Safety systems are switched on.
- ▶ The LED lights up green.



Hold down button:

- ▶ All Intelligent Safety systems are switched off.
- ▶ The LED goes out.

Forward Collision Warning with city collision mitigation

Principle

The system may prevent some accidents. In the event of an accident, the system may reduce impact speed.

The system sounds a warning for a possible risk of collision and activates brakes independently, if needed.

The automatic brake intervention occurs with limited force and duration.

A camera in the area of the interior mirror controls the system.

The Forward Collision Warning is available even if cruise control has been deactivated.

The driver's own driving behavior is taken into account in the reactions of the system, e.g., if you deliberately approach a vehicle, the Forward Collision Warning and the brake intervention will take place later.

General information

The system issues a two-phase warning of an imminent risk of collision at speeds from approx. 3 mph/5 km/h. The timing of warnings may vary with the current driving situation.

If necessary, a brake intervention will occur. Depending on the equipment and national-market version, the brake intervention will occur up to approx. 35 mph/60 km/h or up to approx. 35 mph/60 km/h.

Safety information

Warning

The system cannot serve as a substitute for the driver's personal judgment in assessing the traffic situation. Based on the limits of the system, it cannot independently react to all traffic situations. There is a risk of accident. Adjust driving style to traffic conditions. Watch the surrounding traffic situation closely, be ready to take over steering and braking at any time, and actively intervene where appropriate.

Warning

Indicators and warnings cannot serve as a substitute for the driver's personal judgment. Due to its limits, the system may not issue warnings or reactions, or these may be issued late or in a manner that is not consistent with their normal use. There is a risk of accident. Adjust driving style to traffic conditions. Watch surrounding traffic closely and actively intervene where appropriate.

Warning

Due to system limits, individual functions can malfunction during tow-starting/towing with the Intelligent Safety systems activated. There is a risk of accident. Switch all Intelli-

gent Safety systems off prior to tow-starting/towing.

Overview

Button in the vehicle



 Intelligent Safety button

Camera

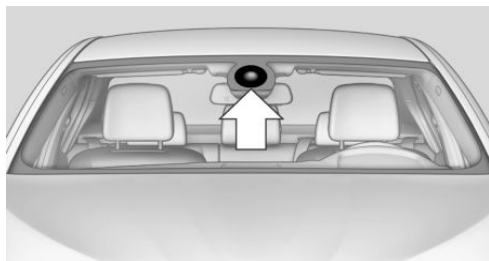

The camera is installed near the interior mirror. Keep the windshield in front of the interior mirror clean and clear.

Detection range

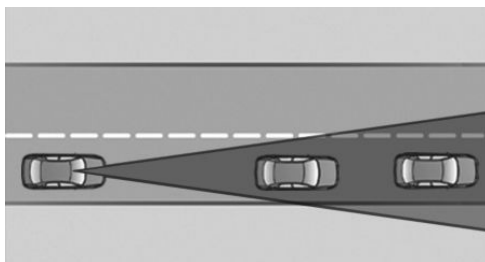

Objects that the system can detect are taken into account.

Turning on/off

Turning on automatically

The system is automatically active when the vehicle is turned on.

Switching on/off manually

-  Press button briefly:
 - ▶ The menu for the Intelligent Safety system is displayed. The systems are individually switched off according to their respective settings.

- ▶ LED lights up orange or goes out respective to their individual settings.

Adjust the settings as needed. The individual settings are stored for the driver profile currently in use.

-  Press button again:
 - ▶ All Intelligent Safety systems are switched on.

- ▶ The LED lights up green.

-  Hold down button:
 - ▶ All Intelligent Safety systems are switched off.

- ▶ The LED goes out.

Setting the warning time

The warning time can be set.

Via iDrive:



1. "My Vehicle"
2. "Vehicle settings"
3. "Intelligent Safety"
4. "Warning time"
5. Select the desired setting.

The selected time is stored for the profile currently used.

Warning with light braking function

Display

A warning symbol appears in the instrument cluster and in the Head-up Display if a collision with a detected vehicle is imminent.

Icon	Measure
	Icon lights up red: prewarning. Brake and increase distance.
	Symbol flashes red and an acoustic signal sounds: acute warning. Brake and make an evasive maneuver, if necessary.

Prewarning

This prewarning is provided, for instance when there is impending risk of a collision or the distance to the vehicle ahead is too small.

If a prewarning is provided, respond by braking as warranted.

Acute warning with light braking function

An acute warning is displayed when there is an imminent danger of collision due to the vehicle approaching another object at a high speed.

The driver must intervene actively when there is an acute warning. If necessary, the driver is

assisted by a minor automatic brake intervention in a possible risk of collision.

Acute warnings may be provided even when there has been no prior warning.

Brake intervention

The warning prompts the driver to intervene. When a warning occurs, the maximum braking force is used when the brake is applied. To activate the Brake Assistance function, the brake pedal must be applied sufficiently quickly and forcefully. If there is a risk of collision, the system may assist with a minor brake intervention. When the vehicle is traveling at a low speed, the vehicle may come to a complete stop.

The driver may interrupt the braking intervention function by stepping on the accelerator pedal or by actively moving the steering wheel.

The system's ability to detect objects may be limited in some circumstances. Refer to the information in this Owner's Manual regarding the limitations of the system and actively intervene as warranted.

System limits

Safety information

Warning

The system is designed to operate in certain conditions and circumstances. Due to conditions or other factors, the system may not respond. There may be a risk of accident or risk of damage to property. Actively intervene as warranted. Refer to the information in this Owner's Manual regarding the scope of the system's operation and limitations.

Detection range

The system's detection capability is limited. Thus, a system response might not come or might come late.



The following situations may not be detected, for example:

- ▶ Slow moving vehicles when you approach them at high speed.
- ▶ Vehicles that suddenly swerve in front of you, or strongly decelerating vehicles.
- ▶ Vehicles with an unusual rear view.
- ▶ Two-wheeled vehicles ahead of you.

Functional limitations

The system may be limited in the following situations:

- ▶ In heavy fog, wet conditions, or snowfall.
- ▶ In tight curves.
- ▶ If the driving stability control systems are deactivated, for instance DSC OFF.
- ▶ If the field of view of the camera in the mirror is dirty or obscured.
- ▶ Up to 10 seconds after the start of the engine via the Start/Stop button.
- ▶ During calibration of the camera immediately after vehicle delivery.
- ▶ If there are constant blinding glares because of oncoming light, for instance from the sun low in the sky.

Warning sensitivity

The more sensitive the warning settings are, for example the warning time, the more warnings are displayed. Therefore, there may also be an excess of unwarranted warnings and responses.

Pedestrian Warning with City light braking function

Principle

The system may prevent some accidents with pedestrians.

When driving in the city speed range, the system will issue a warning if there is imminent risk of a collision with pedestrians, and support this with a light braking function.

The camera in the area of the interior mirror controls the system.

General information

In sufficiently bright conditions, the system issues a warning of a possible risk of collision with pedestrians and assists with brake intervention just before a collision in the speed range from approx. 6 mph/10 km/h to approx. 35 mph/60 km/h.

The system reacts to people who are within the detection range of the system.

Safety information

Warning

The system cannot serve as a substitute for the driver's personal judgment in assessing the traffic situation. Based on the limits of the system, it cannot independently react to all traffic situations. There is a risk of accident. Adjust driving style to traffic conditions. Watch the surrounding traffic situation closely, be ready to take over steering and braking at any time, and actively intervene where appropriate.

Warning

Indicators and warnings cannot serve as a substitute for the driver's personal judgment. Due to its limits, the system may not issue warnings or reactions, or these may be issued late or in a manner that is not consistent with their normal use. There is a risk of accident. Adjust driving style to traffic conditions. Watch surrounding traffic closely and actively intervene where appropriate.

Warning

Due to system limits, individual functions can malfunction during tow-starting/towing with the Intelligent Safety systems activated. There is a risk of accident. Switch all Intelligent Safety systems off prior to tow-starting/towing.

Overview

Button in the vehicle



Intelligent Safety button

Camera

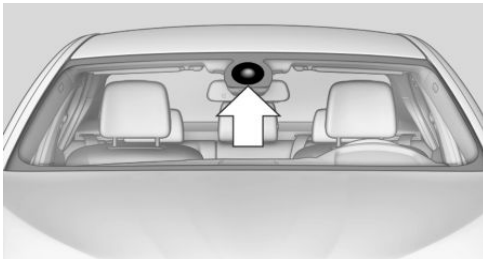

The camera is installed near the interior mirror. Keep the windshield in front of the interior mirror clean and clear.

Detection range

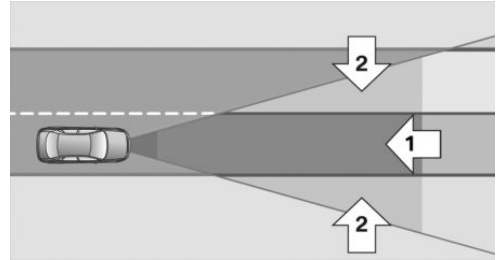

The detection range in front of the vehicle is divided into two areas:

- ▶ Central area, arrow 1, directly in front of the vehicle.
- ▶ Extended area, arrows 2, to the right and left of the central area.

A collision is imminent if pedestrians are located within the central area. A warning is issued about pedestrians who are located within the extended area only if they are moving in the direction of the central area.

Turning on/off

Turning on automatically

The system is automatically active when the vehicle is turned on.

Switching on/off manually



Press button briefly:

- ▶ The menu for the Intelligent Safety system is displayed. The systems are individually switched off according to their respective settings.
- ▶ LED lights up orange or goes out respective to their individual settings.

Adjust the settings as needed. The individual settings are stored for the driver profile currently in use.



Press button again:



- ▶ All Intelligent Safety systems are switched on.
- ▶ The LED lights up green.



Hold down button:

- ▶ All Intelligent Safety systems are switched off.
- ▶ The LED goes out.

Warning with light braking function

Display

If a collision with a detected person is imminent, a warning symbol appears on the instrument cluster and in the Head-up Display.



The red icon is displayed and a signal sounds.

Intervene immediately by braking or make an evasive maneuver.

Brake intervention

The warning prompts the driver to intervene. When a warning occurs, the maximum braking force is used when the brake is applied. To activate the Brake Assistance function, the brake pedal must be applied sufficiently quickly and forcefully. If there is a risk of collision, the system may assist with a minor brake intervention. When the vehicle is traveling at a low speed, the vehicle may come to a complete stop.

The driver may interrupt the braking intervention function by stepping on the accelerator pedal or by actively moving the steering wheel.

The system's ability to detect objects may be limited in some circumstances. Refer to the information in this Owner's Manual regarding the limitations of the system and actively intervene as warranted.

System limits

Safety information

Warning

The system is designed to operate in certain conditions and circumstances. Due to conditions or other factors, the system may not respond. There may be a risk of accident or risk of damage to property. Actively intervene as warranted. Refer to the information in this Owner's Manual regarding the scope of the system's operation and limitations.

Detection range

The detection capability of the camera is limited.

Thus, a warning might not be issued or be issued late.

The following situations may not be detected, for example:

- ▶ Partially covered pedestrians.
- ▶ Pedestrians that are not detected as such because of the viewing angle or contour.
- ▶ Pedestrians outside of the detection range.
- ▶ Pedestrians having a body size less than 32 in/80 cm.

Functional limitations

The system may be limited or may not be available in the following situations:

- ▶ In heavy fog, wet conditions, or snowfall.
- ▶ In tight curves.
- ▶ If the driving stability control systems are deactivated, for instance DSC OFF.
- ▶ If the camera field of view or the windshield is dirty or covered.
- ▶ Up to 10 seconds after the start of the engine via the Start/Stop button.

- ▷ During calibration of the camera immediately after vehicle delivery.
- ▷ If there are constant blinding glares because of oncoming light, for instance from the sun low in the sky.
- ▷ When it is dark outside.

Lane departure warning

Principle

The lane departure warning alerts when the vehicle on roads with lane markings is about to leave the lane.

General information

Depending on the country version, the system issues a warning at speeds between 35 mph/55 km/h and 45 mph/70 km/h.

Warnings are issued by means of a steering wheel vibration. The time of the warning may vary depending on the current driving situation.

The system does not provide a warning if the turn signal is set before exiting the lane.

Safety information

Warning

The system cannot serve as a substitute for the driver's personal judgment in assessing road and traffic situation. There is a risk of accident. Adjust driving style to traffic conditions. Watch surrounding traffic closely and actively intervene where appropriate. Do not jerk the steering wheel in response to a warning.

Warning

Indicators and warnings cannot serve as a substitute for the driver's personal judgment. Due to its limits, the system may not issue warnings or reactions, or these may be issued late or in a manner that is not consistent with their normal use. There is a risk of accident. Adjust driving style to traffic conditions. Watch surrounding traffic closely and actively intervene where appropriate.

Overview

Button in the vehicle



 Intelligent Safety button

Camera

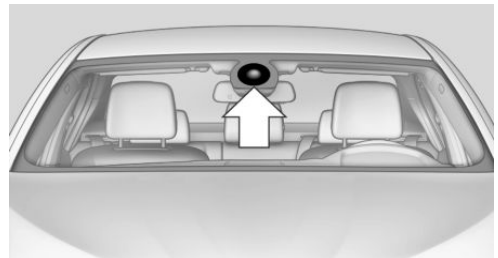

The camera is installed near the interior mirror. Keep the windshield in front of the interior mirror clean and clear.

Turning on/off

Turning on automatically

The lane departure warning is automatically activated after departure, if the function was switched on the last time the engine was stopped.

Switching on/off manually



Press button briefly:

- ▶ The menu for the Intelligent Safety system is displayed. The systems are individually switched off according to their respective settings.

- ▶ LED lights up orange or goes out respective to their individual settings.

Adjust the settings as needed. The individual settings are stored for the driver profile currently in use.



Press button again:

- ▶ All Intelligent Safety systems are switched on.

- ▶ The LED lights up green.



Hold down button:

- ▶ All Intelligent Safety systems are switched off.

- ▶ The LED goes out.

Display in the instrument cluster



- ▶ Yellow icon: system is activated.
- ▶ Green icon: at least one lane marking was detected and warnings can be issued.

Output of warning

If you leave the lane

If you leave the lane and if a lane marking has been detected, the steering wheel vibrates.

If the turn signal is switched on before changing the lane, a warning is not issued.

End of warning

The warning is canceled in the following situations:

- ▶ Automatically after approx. 3 seconds.
- ▶ When returning to your own lane.
- ▶ When braking hard.
- ▶ When blinking.

System limits

Safety information

Warning

The system is designed to operate in certain conditions and circumstances. Due to conditions or other factors, the system may not respond. There may be a risk of accident or risk of damage to property. Actively intervene as warranted. Refer to the information in this Owner's Manual regarding the scope of the system's operation and limitations.

Functional limitations

The system may be limited in the following situations:

- ▶ In heavy fog, wet conditions, or snowfall.
- ▶ In the event of missing, worn, poorly visible, merging, diverging, or multiple lane markings such as in construction areas.
- ▶ When lane markings are covered in snow, ice, dirt or water.
- ▶ In tight curves or on narrow roads.
- ▶ When lane markings are covered by objects.
- ▶ When driving very close to the vehicle in front of you.
- ▶ When driving toward bright lights.

- ▷ When the windshield in front of the interior mirror is fogged up, dirty or covered with stickers, etc.
- ▷ During calibration of the camera immediately after vehicle delivery.

Fatigue alert

Principle

The system can detect decreasing alertness or fatigue of the driver during long, monotonous trips, for instance on highways. In this situation, it is recommended that the driver takes a break.

Safety information

Warning

The system cannot serve as a substitute for the driver's personal judgment in assessing one's physical state. An increasing lack of alertness or fatigue may not be detected or not be detected in time. There is a risk of accident. Make sure that the driver is rested and alert. Adjust driving style to traffic conditions.

Function

The system is switched on each time the engine is started and cannot be switched off.

After start of the trip, the system monitors certain aspects of the driver's behavior, so that decreasing alertness or fatigue can be detected.

This procedure takes the following criteria into account:

- ▷ Personal driving style, for instance steering behavior.
- ▷ Driving conditions, for instance time, length of trip.

Starting at approximately 43 mph/70 km/h, the system is active and can display a break recommendation.

Break recommendation

If the driver becomes less alert or fatigued, a message is displayed in the Control Display with the recommendation to take a break.

A break recommendation is displayed only once during an uninterrupted trip.

After a break, another break recommendation cannot be displayed until after approximately 45 minutes.

System limits

The function may be limited in the following situations and may issue an incorrect warning or no warning at all:

- ▷ When the time is set incorrectly.
- ▷ When the vehicle speed is mainly below about 43 mph/70 km/h.
- ▷ With a sporty driving style, such as during rapid acceleration or when cornering fast.
- ▷ In active driving situations, such as when changing lanes frequently.
- ▷ When the road condition is poor.
- ▷ In the event of strong side winds.

The system is reset approx. 45 minutes after parking the vehicle, for instance in the case of a break during longer trips on highways.

PostCrash – iBrake

Principle

In the event of an accident, the system can bring the vehicle to a halt automatically without intervention by the driver in certain situations. This can reduce the risk of a further collision and the consequences thereof.



Harder vehicle deceleration

In certain situations, it can be necessary to bring the vehicle to a halt more quickly than the Brake Assistant allows.

To do this, quickly apply extra force to the brake. For a brief period, the brake pressure will be higher than the brake pressure that is achieved by the automatic braking function. This interrupts automatic brake actuation.

Canceling automatic braking

It can be necessary to interrupt automatic braking in certain situations, for example for an evasive maneuver.

Canceling automatic braking:

- ▶ By pressing the brake pedal.
- ▶ By pressing the accelerator pedal.

At standstill

After coming to a halt, the brake is released automatically.

Driving stability control systems

Vehicle features and options

This chapter describes all standard, country-specific and optional features offered with the series. It also describes features and functions that are not necessarily available in your vehicle, e.g., due to the selected options or country versions. This also applies to safety-related functions and systems. When using these functions and systems, the applicable laws and regulations must be observed.

Anti-lock Braking System

The Antilock Braking System prevents locking of the wheels during braking.

The vehicle maintains its steerability even during emergency braking, which increases the active driving safety.

The Antilock Braking System is ready after each engine start.

Brake assistant

When you apply the brakes rapidly, this system automatically boosts the vehicle braking capability to the furthest possible extent. It reduces the braking distance to a minimum during emergency braking. This system utilizes all of the capabilities provided by the Antilock Brake System.

Do not reduce the pressure on the brake pedal for the duration of emergency braking.

Automatic Differential Brake

The system controls the driving power by automatic brake intervention on individual

wheels. The function corresponds to a differential lock: the system detects if a wheel begins to spin, because of loose road surface, for instance and automatically brakes it.

The driving power is diverted to the wheel with better traction.

As a result, the engine force is transferred more efficiently to the wheels during accelerations.

Dynamic Stability Control

Principle

Within the physical limits, the system helps to keep the vehicle on a steady course by reducing engine power and by applying brake intervention to the individual wheels.

General information

Dynamic Stability Control will detect, e.g., the following unstable driving conditions:

- ▶ Skidding, which can lead to oversteering.
- ▶ Loss of adhesion of the front wheels, which can lead to understeering.

Dynamic Traction control, refer to page 165, is a version of the Dynamic Stability Control where drive power is optimized.

Safety information

Warning

The system cannot serve as a substitute for the driver's personal judgment in assessing the traffic situation. Based on the limits of the system, it cannot independently react to all traffic situations. There is a risk of accident. Adjust driving style to traffic conditions. Watch the surrounding traffic situation

closely, be ready to take over steering and braking at any time, and actively intervene where appropriate.

Warning

When driving with a roof load, for instance with roof-mounted luggage rack, the vehicle's center of gravity is higher, which increases the risk of the vehicle tipping in critical driving situations. There may be a risk of accident or risk of damage to property. Driving with roof load only with activated Dynamic Stability Control.

Overview

Button in the vehicle



 DSC OFF button

Indicator/warning lights

 Indicator light blinks: Dynamic Stability Control controls the drive and brake forces.

Indicator light illuminates: the Dynamic Stability Control has malfunctioned.

Deactivate Dynamic Stability Control: DSC OFF

General information

When the Dynamic Stability Control is deactivated, driving stability is limited when accelerating and cornering.

To support driving stability, reactivate Dynamic Stability Control as soon as possible.

Deactivating the system

 Press and hold this button but not longer than approx. 10 seconds, until the indicator light for DSC OFF lights up in the instrument cluster and displays DSC OFF. Dynamic Stability Control is switched off.

Activating the system

 Press the button. DSC OFF and the DSC OFF indicator light turn off.

Indicator/warning lights

If the Dynamic Stability Control is deactivated, DSC OFF is displayed in the instrument cluster.

 Indicator light illuminates: Dynamic Stability Control is deactivated.

Automatic activation

If Dynamic Stability Control is deactivated, it is automatically activated in the following situations:

- ▶ The vehicle has a flat tire.
- ▶ When activating cruise control in TRAC-TION or DSC OFF mode.

Dynamic Traction Control

Principle

The Dynamic Traction Control is a variant of the Driving Stability Control where the drive power is optimized.

The system ensures maximum drive power on unusual road conditions, for instance unpaved snow covered roads, or loose road surfaces, but with somewhat limited driving stability.

When the Dynamic Traction Control is activated, there is maximum traction. Driving stability is limited during acceleration and when cornering.

Drive carefully.

A brief activation of the Dynamic Traction Control may be useful in the following exceptional situations:

- ▶ When driving in slush or on uncleared, snow-covered roads.
- ▶ When driving off from deep snow or loose ground.
- ▶ When driving with tire chains.

Activating/deactivating the Dynamic Traction Control

Activating the system



Press the button.

TRACTION is displayed in the instrument cluster and the indicator light for DSC OFF lights up.

Deactivating the system



Press the button again.

TRACTION and the DSC OFF indicator light turn off.

Performance Control

Performance Control enhances the agility of the vehicle.

To increase maneuverability, wheels are braked individually when a sporty driving style is used.

xDrive

xDrive is the all-wheel-drive system of the vehicle. xDrive and Dynamic Stability Control work together to optimize the traction and driving dynamics. The xDrive all-wheel-drive system variably distributes the drive forces to the front and rear axles as demanded by the driving situation and road condition.

Hill Descent Control

Principle

Hill Descent Control is a downhill control feature that adjusts the vehicle speed on steep downhill gradients, e.g., when driving on unpaved roads.

When the system is active, the vehicle moves at the speed set by the driver, without the driver having to depress the brake pedal.

While Hill Descent Control is adjusting the speed, the system automatically distributes the brake force to the individual wheels. This improves driving stability and steerability. If necessary, the Antilock Braking System prevents the wheels from locking.

General information

The system can be activated below approx. 25 mph/40 km/h.

Speeds can be set between approx. 2 mph/3 km/h and approx. 20 mph/30 km/h. When the vehicle is driving downhill, the sys-

tem reduces the speed to the set value, within the physical limits.

Only use Hill Descent Control in low gears or in selector lever position D or R.

Overview

Button in the vehicle



 Hill Descent Control

Activate Hill Descent Control

 Press the button. The LED above the button lights up.

Speeds between approx. 2 mph/3 km/h and approx. 20 mph/30 km/h are adopted as the set speed.

Display in the instrument cluster



An icon and the selected desired speed are displayed.

- ▶ Indicator green: Hill Descent Control is active. The system is actively braking the vehicle.
- ▶ Indicator orange: Hill Descent Control is on standby.

Display in the Head-up Display

The status of the system can also be shown in the Head-up display.

Increasing or decreasing vehicle speed

Using the cruise control rocker switch

The set speed can be changed using the cruise control rocker switch on the steering wheel.

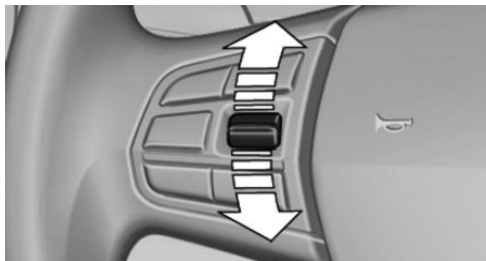

- ▶ Press the rocker switch up: the speed increases gradually.
- ▶ Press the rocker switch up and hold: the speed increases while the rocker switch is pressed.
- ▶ Press the rocker switch down: the speed decreases gradually.
- ▶ Press the rocker switch down and hold: the speed decreases while the rocker switch is pressed.

Using the brake pedal

While the system is adjusting the speed, the set speed can be reduced by depressing the brake pedal.

Deactivating Hill Descent Control

 Press the button again. The LED goes out.

The system is automatically deactivated above approx. 25 mph/40 km/h.

Malfunction

If a malfunction occurs, a message is displayed in the instrument cluster.

Servotronic

Principle

Servotronic is a speed-dependent power steering function.

The system provides the steering force with more support at low speeds than at higher ones. This makes it easier to park, for instance, and makes steering firmer when driving at faster speeds.

Furthermore, the steering force adapts according to the driving program, so that a firm, sporty feel or a comfortable steering response is conveyed.

M sports steering

The M sports steering creates direct handling by using smaller steering angles. M sports steering features variable steering support that takes the speed and lateral acceleration into account. The system enhances agility and improves handling while maintaining a sporty driving style; for example, in tight corners or during evasive maneuvers. At the same time, it ensures improved comfort during parking, turning, and maneuvering.

Driving Dynamics Control

Principle

The Driving Dynamics Control helps to fine-tune the vehicle's settings and features. Various programs can be selected for this purpose.

Overview

Button in the vehicle



Operating the programs

Button	Program
	SPORT
	COMFORT
	ECO PRO

SPORT

Principle

Consistently sporty setting of the steering and drivetrain for greater driving agility.

With the appropriate equipment, the setting of the chassis also changes and SPORT can be individually configured.

The configuration is stored for the profile currently used.

Activating SPORT



Press the button repeatedly until SPORT is displayed in the instrument cluster.

Configuring SPORT

Via iDrive:

1. "My Vehicle"
2. "Vehicle settings"
3. If necessary, "Driving mode"
4. "Configure SPORT"
5. Select the desired setting.

The setting is stored for the driver profile currently used.

This configuration is retrieved when the SPORT driving mode is activated.

COMFORT

Principle

For a balanced setting.

Activating COMFORT



Press the button repeatedly until COMFORT is displayed in the instrument cluster.

ECO PRO

Principle

ECO PRO, refer to page 225, provides consistent settings to maximize range.

Activating ECO PRO



Press the button repeatedly until ECO PRO is displayed in the instrument cluster.

Configuring ECO PRO

Via iDrive:

1. "My Vehicle"
2. "Vehicle settings"
3. If necessary, "Driving mode"

4. "Configure ECO PRO"

5. Select the desired setting.

The setting is stored for the driver profile currently used.

Displays

Program selection

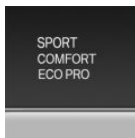

Pressing the button displays a list of the selectable programs. Depending on your vehicle's optional features, the list in the instrument cluster can differ from the illustration shown.

Selected program



The instrument cluster displays the selected program.

Adaptive suspension

Principle

The setting of the chassis can be changed with the system.

Programs

The system offers several different programs. Select the programs via the Driving Dynamics Control, refer to page 167.

SPORT

Consistently sporty setting of the shock absorbers for greater driving agility.

COMFORT/ECO PRO

Balanced setting of the shock absorbers for more comfort.

Drive-off assistant

Principle

This system supports driving off on uphill grades. The parking brake is not required.

Driving off with the drive-off assistant

1. Hold the vehicle in place with the foot brake.
2. Release the foot brake and drive off without delay.

After the foot brake is released, the vehicle is held in place for approx. 2 seconds.

Depending on the vehicle load or when a trailer is towed, the vehicle may roll back slightly.

Driving comfort

Vehicle features and options

This chapter describes all standard, country-specific and optional features offered with the series. It also describes features and functions that are not necessarily available in your vehicle, e.g., due to the selected options or country versions. This also applies to safety-related functions and systems. When using these functions and systems, the applicable laws and regulations must be observed.

Camera-based cruise control with Stop&Go function

Principle

Using this system, a set speed and a distance to a vehicle ahead can be adjusted using the buttons on the steering wheel.

The system maintains the set speed on clear roads. The vehicle accelerates or brakes automatically.

If a vehicle is driving ahead of you, the system adjusts the speed of your vehicle so that the set distance to the vehicle ahead is maintained. The speed is adjusted as far as the given situation allows.

The distance can be adjusted at several levels. For safety reasons, it depends on the respective speed.

If the vehicle ahead of you brakes to a halt, and then proceeds to drive again within a brief period, the system is able to detect this within the given system limits.

General information

A camera on the interior mirror is used to detect vehicles driving ahead.

Depending on the settings, the cruise control settings may change under certain conditions.

Safety information

Warning

The system cannot serve as a substitute for the driver's personal judgment in assessing the traffic situation. Based on the limits of the system, it cannot independently react to all traffic situations. There is a risk of accident. Adjust driving style to traffic conditions. Watch the surrounding traffic situation closely, be ready to take over steering and braking at any time, and actively intervene where appropriate.

Warning

An unsecured vehicle can begin to move and possibly roll away. There is a risk of accident. Before leaving the vehicle, secure the vehicle against rolling away.

In order to ensure that the vehicle is secured against rolling away, follow the following:

- ▷ Set the parking brake.
- ▷ On uphill grades or on a downhill slope, turn the front wheels in the direction of the curb.
- ▷ On uphill grades or on a downhill slope, also secure the vehicle, for instance with a wheel chock.

Warning

The set speed can be incorrectly adjusted or called up by mistake. There is a risk of accident. Adjust the set speed to the traffic conditions. Watch surrounding traffic closely and actively intervene where appropriate.

Warning

Risk of accident due to too high speed differences to other vehicles, for instance in the following situations:

- ▷ When fast approaching a slowly moving vehicle.
- ▷ Vehicle suddenly swerving into own lane.
- ▷ When fast approaching standing vehicles.

There is a risk of injury or danger to life. Watch surrounding traffic closely and actively intervene where appropriate.

Overview

Buttons on the steering wheel

Button Function

Cruise control on/off, refer to page 171.



Store/maintain speed, refer to page 172.



Interrupt cruise control, refer to page 171.

Continue cruise control with the last setting, refer to page 173.



Reduce distance, refer to page 173.

Button Function

Increase the distance, refer to page 173.



Rocker switch.

Set speed, refer to page 172.

Camera

A camera in the area of the interior mirror serves to detect vehicles.

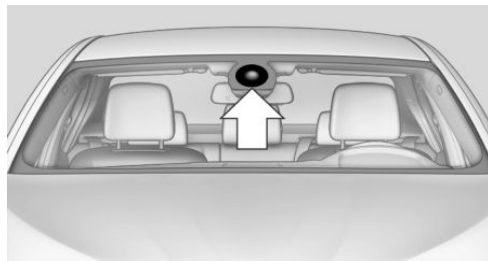

Keep the windshield in front of the interior mirror clean and clear.

Functional requirements

The system is best used on well-constructed roads.

The desired speed can be set between 20 mph/30 km/h and 85 mph/140 km/h.

If distance control is switched off, refer to page 173, higher desired speeds can be selected as well.

The system can also be activated when stationary.

Turning on/off and interrupting cruise control

Turning on



Press the button on the steering wheel.

The indicator lights in the instrument cluster light up and the mark in the speedometer is set to the current speed.

Cruise control is active and maintains the set speed.

If necessary, the Dynamic Stability Control will be turned on.

Turning off

To switch off the system while standing, step on brake pedal at the same time.

 Press the button on the steering wheel.

The displays turn off. The stored set speed is deleted.

Interrupting manually

 Press the button on the steering wheel.

If interrupting the system while stationary, press on the brake pedal at the same time.

Interrupting automatically

The system is automatically interrupted in the following situations:

- ▶ When the driver applies the brakes.
- ▶ When selector lever position D is disengaged.
- ▶ When Dynamic Traction Control is activated.
- ▶ When the Dynamic Stability Control is adjusting.
- ▶ If the seat belt and the driver's door are opened while the vehicle is standing still.
- ▶ If the detection range of the camera is impaired, for instance by contamination, heavy precipitation or blinding glare from the sun.
- ▶ After a stationary period of approx. 3 seconds when the vehicle has been braked to a stop by the system.

Adjusting the speed

Maintaining/storing the speed

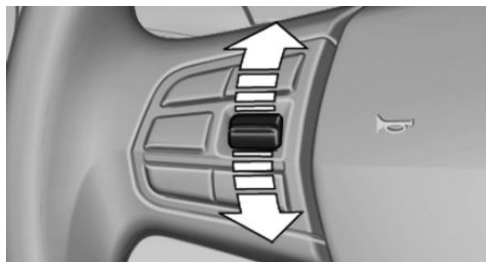

Press the rocker switch up or down once while the system is interrupted.

When the system is switched on, the current speed is maintained and stored as the set speed.

The stored speed is displayed in the speedometer and briefly in the instrument cluster, refer to page 174.

If necessary, the Dynamic Stability Control will be turned on.

 The speed can also be stored by pressing a button. Press the button.

Changing the speed

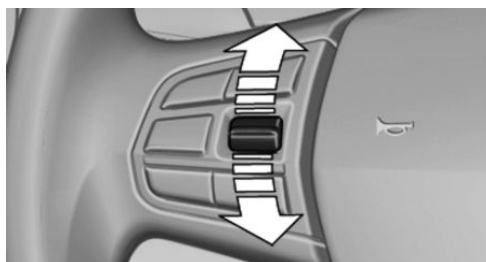

Press the rocker switch up or down repeatedly until the desired speed is set.

If active, the displayed speed is stored and the vehicle reaches the stored speed when the road is clear.



- ▷ Each time the rocker switch is tapped to the resistance point, the set speed increases or decreases by approx. 1 mph/1 km/h.
- ▷ Each time the rocker switch is pressed past the resistance point, the desired speed changes by a maximum of 5 mph/10 km/h.

Hold the rocker switch in position to repeat the action.

Adjusting the distance

Safety information

Warning

The system cannot serve as a substitute for the driver's personal judgment. Due to the system limits, deceleration can be late. There may be a risk of accident or risk of damage to property. Be aware to the surrounding traffic situation at all times. Adjust the distance to the traffic and weather conditions and maintain the prescribed safety distance, possibly by braking.

Reducing distance



Press the button repeatedly until the desired distance is set.



The instrument cluster displays the set distance.

Increasing distance



Press the button repeatedly until the desired distance is set.



The instrument cluster displays the set distance.

Continuing cruise control

General information

An interrupted cruise control can be continued by calling up the stored speed.

Make sure that the difference between current speed and stored speed is not too large before calling up the stored speed. Otherwise, unintentional deceleration or acceleration may occur.

In the following cases, the stored speed value is deleted and cannot be called up again:

- ▷ When the system is switched off.
- ▷ When the ignition is switched off.

Calling up the stored speed and distance



Press the button with the system interrupted. Cruise control is continued with the stored values. The selected speed is briefly displayed in the Info Display.

Switching distance control on/off

Safety information

Warning

The system does not react to traffic driving ahead of you, but instead maintains the stored speed. There may be a risk of accident or risk of damage to property. Adjust the set speed to the traffic conditions and brake as needed.

Switching distance control off

Distance control can be switched off and on when driving with cruise control activated.



Press and hold this button, or



Press and hold this button.



The indicator light in the instrument cluster lights up.

To switch distance control back on, press button again briefly.

After changing over distance control, a Check Control message is displayed.

Displays in the instrument cluster

Set speed and stored speed

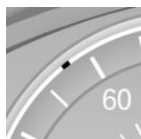

- ▶ Mark lights up green: system is active, the mark indicates the set speed.
- ▶ Mark lights up orange: system is interrupted, the mark indicates the stored speed.

- ▶ The mark does not light up: the system is switched off.

Brief status display



Selected set speed.

If no speed is indicated, it is possible that the conditions necessary for operation are not currently fulfilled.

Distance to vehicle ahead of you

Selected distance to the vehicle ahead of you is shown.

Distance display



Distance 1



Distance 2

Distance display



Distance 3



Distance 4

This value is set automatically after the system is switched on.

Detected vehicle



Icon lights up orange:

A vehicle has been detected ahead of you.



Rolling bars: the detected vehicle has driven away.

The system does not accelerate. To accelerate, activate the system by briefly stepping on the accelerator pedal or pressing the RES CNCL button or the rocker switch.

Indicator/warning lights



Icon flashes orange:

The conditions are not adequate for the system to work.

The system was deactivated but applies the brakes until you actively resume control by pressing on the brake pedal or accelerator pedal.



Icon flashes red and a signal sounds:

You are requested to intervene by braking or making an evasive maneuver.



The system has been interrupted or distance control is temporarily suppressed because the accelerator pedal is being pressed; a vehicle was not detected.



Distance control is temporarily suppressed because the accelerator pedal

is being pressed; a vehicle was detected.

Displays in the Head-up Display

Some system information can also be displayed in the Head-up Display.

System limits

Detection range

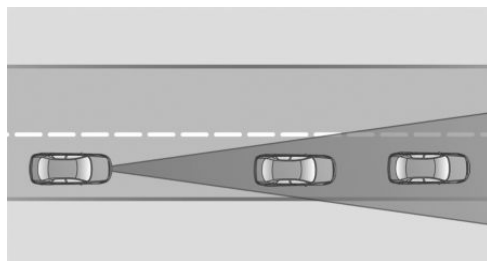

The detection capability of the system and the automatic braking performance are limited.

For instance, two-wheeled vehicles may not be detected.

Deceleration

The system does not decelerate in the following situations:

- ▶ For pedestrians, cyclists or similarly slow-moving road users.
- ▶ For red traffic lights.
- ▶ For cross traffic.
- ▶ For oncoming traffic.
- ▶ Unlit vehicles or vehicles with faulty lighting at night.

Merging vehicles

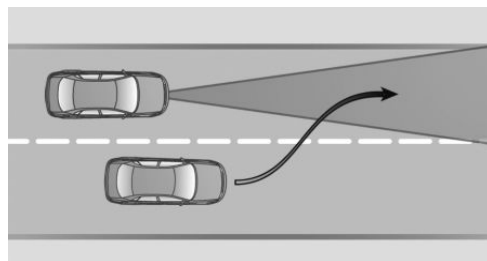

A vehicle driving in front of you is not detected until it is completely within the same lane as your vehicle.

If a vehicle driving ahead of you suddenly merges into your lane, the system may not be able to automatically restore the selected distance. It may not be possible to restore the selected distance in certain situations, including if you are driving significantly faster than vehicles driving ahead of you, for instance when rapidly approaching a truck. When a vehicle driving ahead of you is reliably detected, the system requests that the driver intervene by braking and carrying out evasive maneuvers, if needed.

Cornering

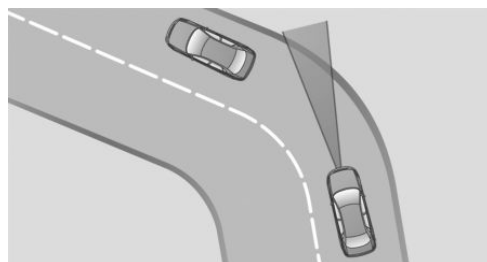

If the desired speed is too high for a curve, the speed is reduced slightly, although curves cannot be anticipated in advance. Therefore, drive into a curve at an appropriate speed.

The system has a limited detection range. Situations can arise in tight curves where a vehi-



cle driving ahead will not be detected or will be detected very late.

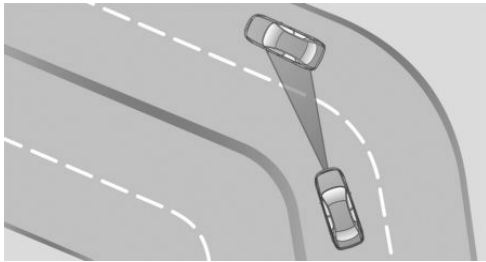

When you approach a curve the system may briefly report vehicles in the next lane due to the bend of the curve. If the system decelerates you may compensate it by briefly accelerating. After releasing the accelerator pedal the system is reactivated and controls speed independently.

Driving off

In some situations, the vehicle cannot drive off automatically; for example:

- ▶ On steep uphill grades.
- ▶ In front of bumps in the road.

In these cases, press on the accelerator pedal.

Weather

The following restrictions can occur under unfavorable weather or light conditions:

- ▶ Poorer vehicle detection.
- ▶ Short-term interruptions for vehicles that are already recognized.

Examples of unfavorable weather or light conditions:

- ▶ Wet conditions.
- ▶ Snowfall.
- ▶ Slush.
- ▶ Fog.
- ▶ Glare.

Drive attentively, and react to the current surrounding traffic situation. If necessary, inter-

vene actively, for instance by braking, steering or evading.

Engine power

The desired speed may not be maintained on uphill grades if engine power is insufficient.

Malfunction

A Check Control message is displayed if the system has malfunctioned or was automatically deactivated.

The system may be limited in the following situations:

- ▶ When an object was not correctly detected.
- ▶ In heavy fog, rain, sprayed water or snowfall.
- ▶ In tight curves.
- ▶ If the camera field of view or the windshield is dirty or covered.
- ▶ When driving toward bright lights.
- ▶ Up to 20 seconds after the start of the engine, via the Start/Stop button.
- ▶ During calibration of the camera immediately after vehicle delivery.

Cruise control

Principle

Using this system, a set speed can be adjusted using the buttons on the steering wheel. The system maintains the set speed. The system accelerates and brakes automatically as needed.

General information

Depending on the settings, the cruise control settings may change under certain conditions.

Safety information

Warning

The system cannot serve as a substitute for the driver's personal judgment in assessing the traffic situation. Based on the limits of the system, it cannot independently react to all traffic situations. There is a risk of accident. Adjust driving style to traffic conditions. Watch the surrounding traffic situation closely, be ready to take over steering and braking at any time, and actively intervene where appropriate.

Warning

The use of the system can lead to an increased risk of accidents in the following situations, for instance:

- ▷ On winding roads.
- ▷ With high traffic volume.
- ▷ On slippery roads, in fog, snow, or wet conditions, or on a loose road surface.

There may be a risk of accident or risk of damage to property. Only use the system if driving at constant speed is possible.

Warning

The set speed can be incorrectly adjusted or called up by mistake. There is a risk of accident. Adjust the set speed to the traffic conditions. Watch surrounding traffic closely and actively intervene where appropriate.

Overview

Buttons on the steering wheel

Button Function



Cruise control on/off, refer to page 177.



Store speed, refer to page 178.



Interrupt cruise control, refer to page 177.

Continue cruise control with the last setting, refer to page 178.



Rocker switch:

Set speed, refer to page 178.

Turning on/off and interrupting cruise control

Turning on



Press the button on the steering wheel.

The mark in the speedometer is set to the current speed.

Cruise control is active and maintains the set speed.

If necessary, the Dynamic Stability Control will be turned on.

Turning off



Press the button on the steering wheel.

The displays turn off. The stored set speed is deleted.

Interrupting manually



When active, press the button on the steering wheel.

Interrupting automatically

The system is automatically interrupted in the following situations:

- ▶ When the driver applies the brakes.
- ▶ If the clutch pedal is depressed for a few seconds or released while a gear is not engaged.
- ▶ If the gear engaged is too high for the current speed.
- ▶ If selector lever position N is set.
- ▶ When Dynamic Traction Control is activated or Dynamic Stability Control is deactivated.
- ▶ When the Dynamic Stability Control is adjusting.

Adjusting the speed

Maintaining/storing the speed

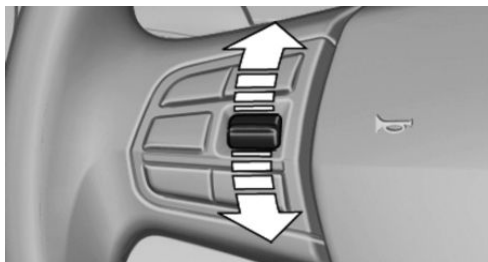

Press the rocker switch up or down once while the system is interrupted.

When the system is switched on, the current speed is maintained and stored as the set speed.

The stored speed is displayed in the speedometer and in the instrument cluster, refer to page 179.

If necessary, the Dynamic Stability Control will be turned on.

The speed can also be stored by pressing a button.

SET

Press the button.

Changing the speed

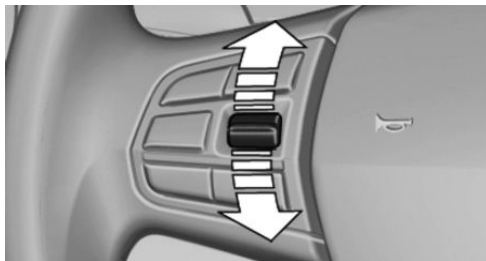

Press the rocker switch up or down repeatedly until the desired speed is set.

If active, the displayed speed is stored and the vehicle reaches the stored speed when the road is clear.

- ▶ Each time the rocker switch is tapped to the point of resistance, the desired speed increases or decreases by approx. 1 mph/1 km/h.
- ▶ Each time the rocker switch is pressed past the resistance point, the set speed increases or decreases by a maximum of 5 mph/10 km/h.
- ▶ Pressing the rocker switch to the resistance point and holding it: vehicle accelerates or decelerates without pressure on the accelerator pedal.

After the rocker switch is released, the vehicle maintains its final speed. Pressing the switch beyond the resistance point causes the vehicle to accelerate more rapidly.

Continuing cruise control

General information

An interrupted cruise control can be continued by calling up the stored speed.

Make sure that the difference between current speed and stored speed is not too large before calling up the stored speed. Otherwise, unintentional deceleration or acceleration may occur.

In the following cases, the stored speed value is deleted and cannot be called up again:

- ▷ When the system is switched off.
- ▷ When the ignition is switched off.

Calling up the stored speed

 Press the button on the steering wheel.

The stored speed is reached again and maintained.

Displays in the instrument cluster

Indicator light



Depending on how the vehicle is equipped, the indicator light in the instrument cluster indicates whether the system is switched on.

Set speed and stored speed



- ▷ Mark lights up green: system is active, the mark indicates the set speed.
- ▷ Mark lights up orange: system is interrupted, the mark indicates the stored speed.
- ▷ The mark does not light up: the system is switched off.

Status display



Selected set speed.

If no speed is indicated, it is possible that the conditions necessary for operation are not currently fulfilled.

Displays in the Head-up Display

Some system information can also be displayed in the Head-up Display.

System limits

Engine power

The set speed is also maintained downhill, but may not be maintained on uphill grades if engine power is insufficient.

Park Distance Control

Principle

Park Distance Control assists with parking. The system detects objects behind the vehicle. If equipped with Park Distance Control in the front, objects in front of the vehicle are also detected. Objects that you are approaching slowly are indicated by signal tones and a display on the Control Display.

General information

The ultrasound sensors for measuring the distances are located in the bumpers.

The range, depending on obstacles and environmental conditions, is approx. 6 ft/2 m.

An acoustic warning is first given in the following situations:

- ▷ By the front sensors and the two rear corner sensors at approx. 24 in/60 cm from the object.
- ▷ By the rear middle sensors at a distance to the object of approx. 5 ft/1.50 m.
- ▷ When a collision is imminent.

Safety information

Warning

The system cannot serve as a substitute for the driver's personal judgment in assessing the traffic situation. Based on the limits of the system, it cannot independently react to all traffic situations. There is a risk of accident. Adjust driving style to traffic conditions.

Check surrounding traffic and vehicle's surroundings closely and actively intervene where appropriate.

Warning

Due to high speeds when the Park Distance Control is activated, the warning can be delayed due to physical circumstances. There is a risk of injury or risk of damage to property. Avoid approaching an object too fast. Avoid driving off quickly while Park Distance Control is not yet active.

Overview

With front Park Distance Control: button in the vehicle



 Park assistance button

Ultrasound sensors



Ultrasonic sensors of the Park Distance Control, in the bumpers, for example.

Functional requirements

Ensure full operability:

- ▶ Do not cover sensors, for instance with stickers, bicycle racks.
- ▶ Keep the sensors clean and unobstructed.

Turning on/off

Turning on automatically

The system switches on automatically in the following situations:

- ▶ If selector lever position R is engaged when the engine is running.
The rearview camera also switches on.
- ▶ If equipped with front Park Distance Control: when obstacles are detected behind or in front of the vehicle by Park Distance Control and the speed is slower than approx. 2.5 mph/4 km/h.

You may switch automatic activation when obstacles are detected on and off. Via iDrive:

1. "My Vehicle"
2. "Vehicle settings"
3. "Parking"
4. "Automatic PDC Activation": depending on the vehicle equipment.
5. "Automatic PDC Activation"
The setting is stored for the driver profile currently used.

To prevent unwarranted warnings, e.g., in car washes, turn off the automatic activation of the Park Distance Control in the event of obstacle detection if necessary.

Automatic deactivation during forward travel

The system switches off when a certain distance travelled or speed is exceeded. Switch the system back on, if needed.

With front Park Distance Control: switch on/off manually

 Press the park assistance button.

- ▶ On: the LED lights up.
- ▶ Off: the LED goes out.

The rearview camera image is displayed if the reverse gear is engaged when pressing the park assistance button.

Depending on the equipment version, the system cannot be switched off manually if the reverse gear is engaged.

Warning

Signal tones

An intermittent tone indicates when the vehicle is approaching an object. E.g., when an object is detected at the rear left of the vehicle, a signal tone sounds from the rear left speaker.

The shorter the distance to the object, the shorter the intervals.

When the distance to a detected object is less than approx. 10 inches/25 cm, a continuous tone is sounded.

With front PDC: when objects are simultaneously located both in front of and behind the vehicle, an alternating continuous signal is sounded.

The signal tone is switched off, when selector lever position P is engaged on vehicles with Steptronic transmission.

Volume

The ratio of the volume of the Park Distance Control signal tone to the entertainment volume can be adjusted.

Via iDrive:

1. "My Vehicle"
2. "iDrive settings"
3. "Tone"
4. "Volume settings"
5. "PDC"
6. Set the desired value.

The setting is stored for the driver profile currently used.

Visual warning



The approach of the vehicle to an object is shown on the Control Display. Objects that are farther away are already displayed on the Control Display before a signal sounds.

The display appears as soon as Park Distance Control is activated.

The detection range of the sensors is represented in the colors green, yellow and red.

When the image of the rearview camera is displayed, it is possible to switch to Park Distance Control:

1. Tilt the Controller to the left, if needed.
2.  "Rear view camera"

System limits

Safety information

Warning

The system is designed to operate in certain conditions and circumstances. Due to conditions or other factors, the system may not respond. There may be a risk of accident or risk of damage to property. Actively intervene as warranted. Refer to the information in this Owner's Manual regarding the scope of the system's operation and limitations.



Limits of ultrasonic measurement

The detection of objects with ultrasonic measurements can run into physical limits, e.g., in the following situations:

- ▷ For small children and animals.
- ▷ For persons with certain clothing, for instance jacket.
- ▷ With external fault of the ultrasound, for instance from passing vehicles or loud machines.
- ▷ When sensors are dirty, iced over, damaged or out of position.
- ▷ Under certain weather conditions such as high moisture, wet conditions, snowfall, extreme heat, or strong wind.
- ▷ With tow bars and trailer couplings of other vehicles.
- ▷ With thin or wedge-shaped objects.
- ▷ With moving objects.
- ▷ With elevated, protruding objects such as ledges or cargo.
- ▷ With objects with corners and sharp edges.
- ▷ With objects with a fine surface structure such as fences.
- ▷ For objects with porous surfaces.
- ▷ If cargo protrudes.
- ▷ Low objects already displayed, for instance curbs, can move into the blind area of the sensors before or after a continuous tone sounds.

Unwarranted warnings

The system may issue a warning under the following conditions even though there is no obstacle within the detection range:

- ▷ In heavy rain.
- ▷ When sensors are very contaminated or covered with ice.
- ▷ When sensors are covered in snow.
- ▷ On rough road surfaces.

- ▷ On uneven surfaces, such as speed bumps.
- ▷ In large buildings with right angles and smooth walls, for instance in underground garages.
- ▷ In automatic car washes.
- ▷ Due to heavy exhaust.
- ▷ Due to other ultrasound sources, for instance sweeping machines, steam cleaners or neon lights.

The malfunction is signaled by a continuous tone alternating between the front and rear speakers.

As soon as the malfunction due to other ultrasound sources is no longer present, the system is again fully functional.

To prevent unwarranted warnings, for instance in car washes, turn off automatic Park Distance Control activation on obstacle detection.

Malfunction

A Check Control message is displayed.

The detection range of the sensors is shown as a shaded area on the Control Display.

Park Distance Control malfunction. Have the system checked by a dealer's service center or another qualified service center or repair shop.

Rearview camera

Principle

The rearview camera provides assistance in reverse parking and maneuvering. The area behind the vehicle is shown on the Control Display.

Safety information

Warning

The system cannot serve as a substitute for the driver's personal judgment in assessing the traffic situation. Based on the limits of the system, it cannot independently react to all traffic situations. There is a risk of accident. Adjust driving style to traffic conditions. Check surrounding traffic and vehicle's surroundings closely and actively intervene where appropriate.

Overview

Depending on the vehicle equipment: button in the vehicle



 Park assistance button

Camera



The camera lens is located between the license plate lights.

The image quality may be impaired by dirt. If necessary, clean the camera lens.

Turning on/off

Turning on automatically

The system is switched on automatically if selector lever position R is engaged when the engine is running.

Automatic deactivation during forward travel

The system switches off when a certain distance travelled or speed is exceeded.

Switch the system back on, if needed.

Depending on the vehicle equipment: switching on/off manually

 Press the park assistance button.

- ▷ On: the LED lights up.
- ▷ Off: the LED goes out.

The parking assistance functions are shown on the Control Display.

Switching the view via iDrive

If the rearview camera view is not displayed, change the view via iDrive:

1. Tilt the Controller to the left, if needed.
2.  "Rear view camera"

The rearview camera image is displayed.

Display on the Control Display

Functional requirements

- ▷ The rearview camera is switched on.
- ▷ The tailgate is fully closed.
- ▷ Keep the detection range of the camera open. Protruding cargo or rear-mounted luggage racks and trailers that are not con-



connected to a trailer power socket can lead to malfunctions.

Activating assistance functions

More than one assistance function can be active at the same time.

Tilt the Controller to the left, if needed.

▷ Parking aid lines

"Parking aid lines"

Lanes and turning circle lines are indicated.

▷ Obstacle marking

"Obstacle marking"

Obstacles are marked, depending on the vehicle equipment.

Pathway lines

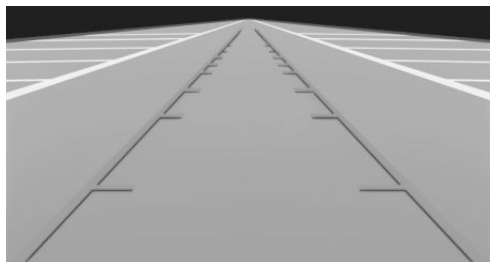

Pathway lines can be superimposed on the image of the rearview camera.

Pathway lines help you to estimate the space required when parking and maneuvering on level roads.

Pathway lines depend on the current steering-wheel angle and are continuously adjusted to the steering wheel movements.

Turning circle lines

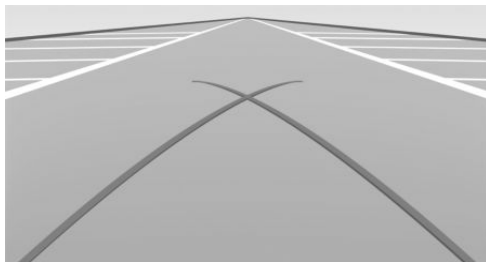

Turning circle lines can only be superimposed on the rearview camera image together with pathway lines.

Turning circle lines show the course of the smallest possible turning radius on a level road.

Only one turning circle line is displayed after the steering wheel is turned past a certain angle.

Obstacle marking

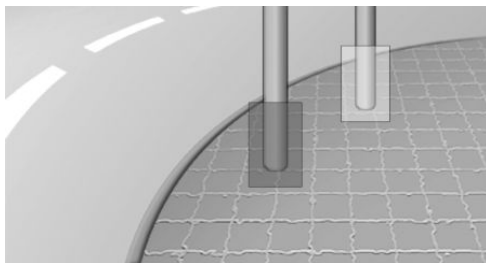

Depending on the vehicle equipment, obstacle markings can be faded into the image of the rearview camera.

The colored steps of the obstacle markings match the marks of the Park Distance Control.

Parking using lanes and turning circle lines

1. Position the vehicle so that the turning circle lines lead to within the limits of the parking space.

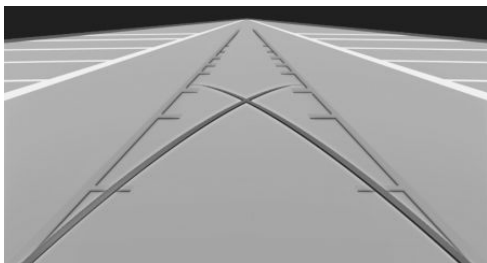

2. Turn the steering wheel to the point where the pathway line covers the corresponding turning circle line.

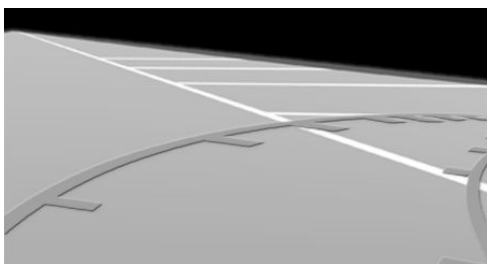

Display settings

Brightness

With the rearview camera switched on:

1. Tilt the Controller to the left, if needed.
2.  Select the icon.
3. Turn the Controller until the desired setting is reached, and press the Controller.

Contrast

With the rearview camera switched on:

1. Tilt the Controller to the left, if needed.
2.  Select the icon.
3. Turn the Controller until the desired setting is reached, and press the Controller.

System limits

Detection of objects

Very low obstacles as well as high, protruding objects such as ledges may not be detected by the system.

Depending on the equipment, some assistance functions also take into account data from the Park Distance Control.

Follow the notes in the Park Distance Control chapter.

The objects displayed on the Control Display may be closer than they appear. Do not estimate the distance from the objects on the display.

The bumper of the vehicle is not visible in the camera picture. Do not drive closer toward an obstacle than shown by the marks in the camera picture. This also applies, when the camera picture still shows a gap between the vehicle and the obstacle.

Automatic Parking Assistant

Principle

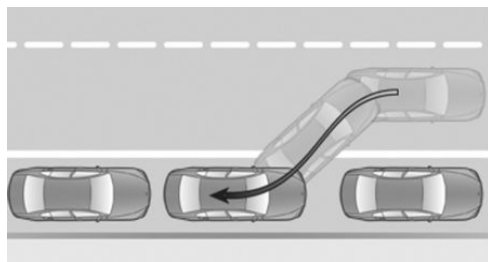



This system assists the driver in parking parallel to the road.

General information

Automatic Parking Assistant handling is divided into three steps:

- ▷ Switching on and activating.
- ▷ Parking space search.
- ▷ Parking.

System status and instructions on required actions are displayed on the Control Display.

Ultrasound sensors measure parking spaces on both sides of the vehicle.

The Automatic Parking Assistant calculates the best possible parking line and takes control of steering during the parking operation.

The Automatic Parking Assistant uses the sensors of Park Distance Control. Also follow the safety instructions for Park Distance Control.

Safety information

Warning

The system cannot serve as a substitute for the driver's personal judgment in assessing the traffic situation. Based on the limits of the system, it cannot independently react to all traffic situations. There is a risk of accident. Adjust driving style to traffic conditions. Check surrounding traffic and vehicle's surroundings closely and actively intervene where appropriate.

NOTICE

The system can steer the vehicle over or onto curbs. There is a risk of damage to property, among other potential damage. Watch surrounding traffic closely and actively intervene where appropriate.

Also follow the safety instructions for Park Distance Control.

Overview

Button in the vehicle



 Park assistance button

Ultrasound sensors

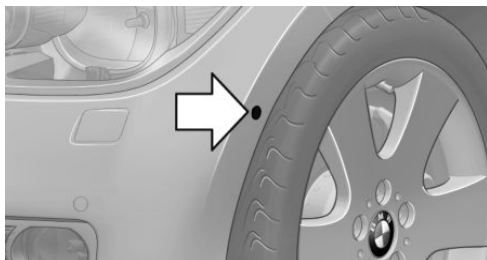

The ultrasound sensors for measuring parking spaces are located on the side of the vehicle.

Functional requirements

Ultrasound sensors

Ensure full operability:

- ▷ Do not cover sensors, for instance with stickers.
- ▷ Keep the sensors clean and unobstructed.

For the measurement of parking spaces

- ▶ Maximum speed while driving forward approx. 22 mph/35 km/h.
- ▶ Maximum distance to row of parked vehicles: 5 ft/1.5 m.

Suitable parking space

- ▶ Gaps behind an object that has a minimum length of 5 ft/1.5 m.
- ▶ Gap between two objects with a minimum length of approx. 5 ft/1.5 m.
- ▶ Minimum length of gap between two objects: own vehicle length plus approx. 3.3 ft/1.0 m.
- ▶ Minimum depth: approx. 5 ft/1.5 m.

For the parking operation

- ▶ Doors and tailgate closed.
- ▶ Parking brake released.
- ▶ When parking in parking spaces on the driver's side, the corresponding turn signal must be switched on.

Switching on and activating

Switching on with the button



Press the park assistance button.

The LED lights up.

The current status of the parking space search is indicated on the Control Display.

 Automatic Parking Assistant is activated automatically.

Switching on with reverse gear

Shift into reverse.

The current status of the parking space search is indicated on the Control Display.

To activate:  "Parking Assistant"

Display on the Control Display

System activated/deactivated

Icon Meaning

 Gray: the system is not available.
White: the system is available but not activated.

 The system is activated.

Parking space search and system status

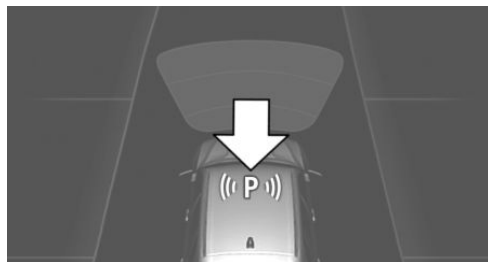

- ▶ Symbol P on the vehicle image: the Automatic Parking Assistant is activated and the parking space search is active.
- ▶ Control Display shows suitable parking spaces at the edge of the road next to the vehicle symbol. When the Automatic Parking Assistant is active, suitable parking spaces are highlighted.
- ▶  The parking operation is active. Steering control has been taken over by system.
- ▶ Parking space search is always active whenever the vehicle is moving forward slow and straight, even if the system is deactivated. When the system is deactivated, the displays on the Control Display are shown in gray.

Parking using the Automatic Parking Assistant

1.  Press the park assistance button or shift into reverse gear to switch on the Automatic Parking Assistant, refer to page 187. Activate the Automatic Parking Assistant, if needed.

 Automatic Parking Assistant is activated.
2. Pass the row of parked vehicles at a speed of up to approx. 22 mph/35 km/h and at a distance of maximum 5 ft/1.5 m.

The status of the parking space search and possible parking spaces are displayed, refer to page 187, on the Control Display.
3. Follow the instructions on the Control Display.



The Automatic Parking Assistant takes control of steering during the parking operation. The driver takes over braking and accelerating.

The best possible parking position will come after gear change on the stationary vehicle - wait for the automatic steering operation.

The end of the parking operation is indicated on the Control Display.
4. Adjust the parking position yourself, if needed.

Canceling manually

The Automatic Parking Assistant can be interrupted at any time:

- ▷  "Parking Assistant" Select the icon on the Control Display.
- ▷  Press the park assistance button.

Canceling automatically

The system is interrupted automatically in the following situations:

- ▷ If the driver grasps the steering wheel or takes over steering.
- ▷ If a gear is selected that does not match the instruction on the display.
- ▷ If the vehicle speed exceeds approx. 6 mph/10 km/h.
- ▷ Possibly on snow-covered or slippery road.
- ▷ If a maximum number of parking attempts or the time taken for parking is exceeded.
- ▷ If Park Distance Control displays clearances that are too small.
- ▷ When changing over to another function on the Control Display.

A Check Control message is displayed.

Resuming

An interrupted parking operation can be continued, if needed.

Reactivate the Automatic Parking Assistant, refer to page 187, and follow the instructions on the display.

Turning off

The system can be switched off as follows:

- ▷  Press the park assistance button.
- ▷ Switching off the ignition.

System limits

Safety information

Warning

The system is designed to operate in certain conditions and circumstances. Due to conditions or other factors, the system may not respond. There may be a risk of accident or risk of damage to property. Actively intervene as warranted. Refer to the information in this Owner's Manual regarding the scope of the system's operation and limitations.

No parking assistance

The Automatic Parking Assistant does not offer assistance in the following situations:

- ▷ In tight curves.

Functional limitations

The system may be limited in the following situations:

- ▷ On bumpy road surfaces such as gravel roads.
- ▷ On slippery ground.
- ▷ On steep uphill or downhill grades.
- ▷ With accumulations of leaves/snow in the parking space.
- ▷ With a mounted emergency wheel.
- ▷ With ditches or edges, for instance an edge of a port.

Limits of ultrasonic measurement

The detection of objects with ultrasonic measurements can run into physical limits, e.g., in the following situations:

- ▷ For small children and animals.
- ▷ For persons with certain clothing, for instance jacket.
- ▷ With external fault of the ultrasound, for instance from passing vehicles or loud machines.
- ▷ When sensors are dirty, iced over, damaged or out of position.
- ▷ Under certain weather conditions such as high moisture, wet conditions, snowfall, extreme heat, or strong wind.
- ▷ With tow bars and trailer couplings of other vehicles.
- ▷ With thin or wedge-shaped objects.
- ▷ With moving objects.
- ▷ With elevated, protruding objects such as ledges or cargo.
- ▷ With objects with corners and sharp edges.

- ▷ With objects with a fine surface structure such as fences.
- ▷ For objects with porous surfaces.
- ▷ If cargo protrudes.
- ▷ Low objects already displayed, for instance curbs, can move into the blind area of the sensors before or after a continuous tone sounds.
- ▷ Parking spaces that are not suitable may be detected or suitable parking spaces may not be detected at all.

Tire size

The parking position may vary depending on the tire size.

Malfunction

A Check Control message is displayed.

The Automatic Parking Assistant has malfunctioned. Have the system checked by a dealer's service center or another qualified service center or repair shop.

Climate control

Vehicle features and options

This chapter describes all standard, country-specific and optional features offered with the series. It also describes features and functions that are not necessarily available in your vehicle, e.g., due to the selected options or country versions. This also applies to safety-related functions and systems. When using these functions and systems, the applicable laws and regulations must be observed.

- ▷ Emission tested passenger compartment.
- ▷ Microfilter.
- ▷ Air conditioning system to control the temperature, air flow and recirculated-air mode.

Depending on the equipment specification:

- ▷ Microfilter/activated-charcoal filter.
- ▷ Automatic recirculated-air control AUC.
- ▷ Pre-ventilation.

Interior air quality

The air quality in the vehicle is improved by the following components:

Air conditioning system

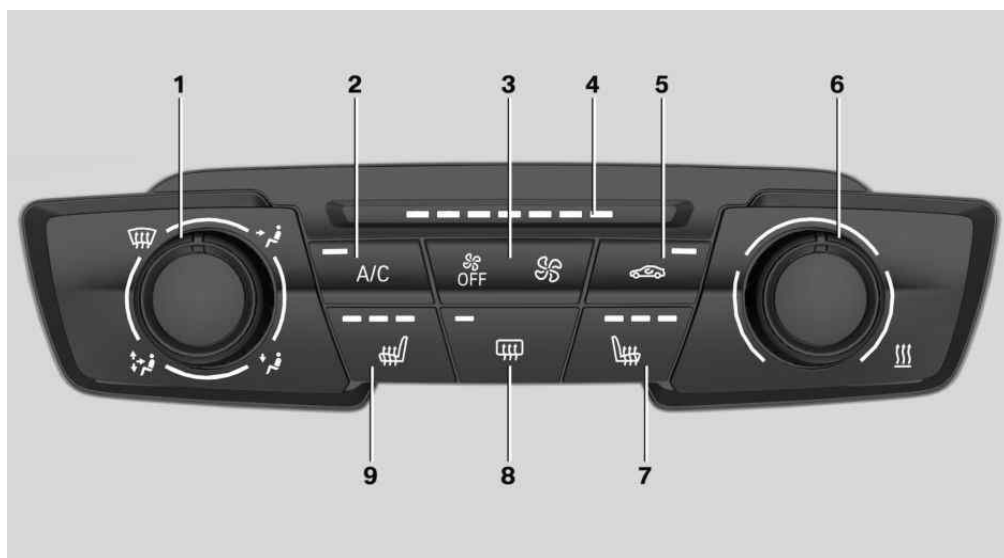

1 Air distribution settings

2 Air conditioning

- 3 Air flow
- 4 Air flow display
- 5 Air recirculation mode
- 6 Temperature

- 7 Seat heating, right [82](#)
- 8 Rear window defroster
- 9 Seat heating, left [82](#)

Climate control functions in detail

Switching the system on/off

Turning on

Press any button except for the following:

- ▶ Rear window defroster.
- ▶ Seat heating.

Turning off



Press and hold the left button until the control panel switches off.

Temperature

Principle

The system heats or cools, depending on the set temperature.

Adjusting



Turn the wheel to set the desired temperature.

Do not rapidly change between different temperature settings. Otherwise, the automatic climate control will not have sufficient time to adjust the set temperature.

Air conditioning

Principle

The air in the interior will be cooled and dehumidified and, depending on the temperature setting, warmed again.

The car's interior can only be cooled with the engine running.

Turning on/off



Press the button.

The LED is illuminated with air conditioning switched on.

Depending on the weather, the windshield and side windows may fog up briefly when the engine is started.

The cooling mode produces condensation, refer to page [219](#), that will exit from below the vehicle.

Air recirculation mode

Principle

You may react to unpleasant odors or pollutants in the immediate environment by temporarily suspending the supply of outside air. The system then recirculates the interior air.

Operation



Press button repeatedly to select an operating mode:

- ▶ LED off: outside air flows in continuously.
- ▶ LED on, recirculated-air mode: the supply of outside air into the vehicle is permanently disabled.

To prevent window condensation, recirculated-air mode switches off automatically after a certain amount of time, depending on the environmental conditions.

With constant air recirculation mode, the air quality in the interior deteriorates and window fogging increases.

In case of window condensation, switch off air recirculation mode and increase the air flow, if needed.

Air flow, manual

Principle

The air flow for climate control can be adjusted manually.

Adjusting



Press the left or right side of the button: to decrease or increase air flow.

The intensity is indicated by LEDs. The highest level is active when seven LEDs are lit.

The air conditioning system air flow may be reduced to preserve the vehicle battery.

Manual air distribution

Principle

The air distribution for climate control can be adjusted manually.

Adjusting



Turn the wheel to select the desired program or the desired intermediate setting.

- ▷ Windows.
- ▷ Upper body area.
- ▷ Footwell.
- ▷ Windows, upper body area and footwell.

To defrost windows and remove condensation

Make the following settings to defrost the windows and remove condensation:

- ▷ Direct the air distribution onto the windows.
- ▷ Increasing the air flow.
- ▷ Increase the temperature.
- ▷ Switch on air conditioning if needed.

Rear window defroster



Press the button. The LED lights up.

The rear window defroster switches off automatically after a certain period of time.

For permanent activation, press the button for longer than 3 seconds. To deactivate, press the button again.

The rear window defroster can only be activated continuously at an outside temperature below approx. 41 °F/5 °C.

Microfilter

In external and recirculated-air mode, the microfilter filters dust and pollen from the air.

Have this filter changed during vehicle maintenance, refer to page [265](#).

Automatic climate control

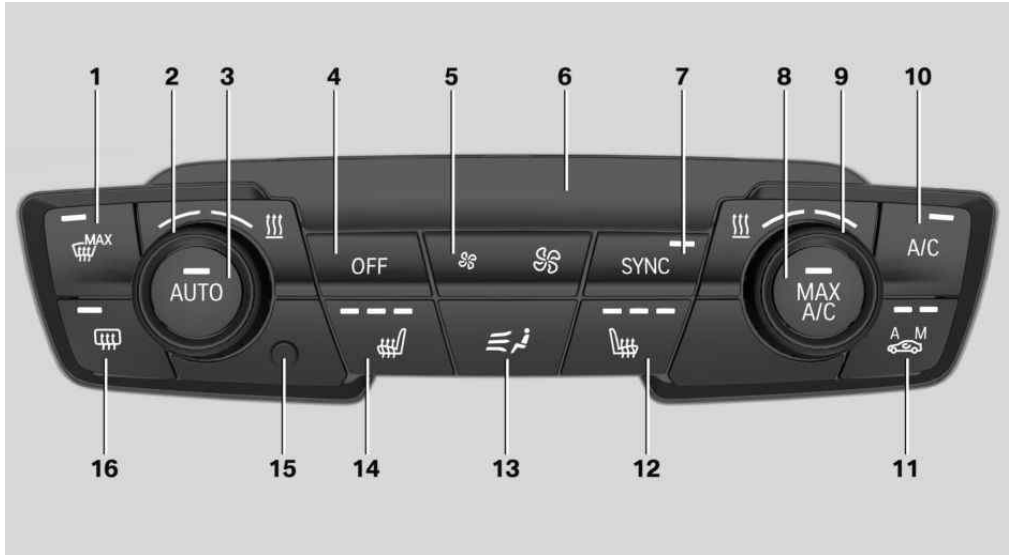

- | | |
|--|--|
| <p>1 To defrost windows and remove condensation</p> <p>2 Temperature, left</p> <p>3 AUTO program</p> <p>4 To turn off the system</p> <p>5 Air flow, AUTO intensity</p> <p>6 Display</p> <p>7 SYNC program</p> <p>8 Maximum cooling</p> | <p>9 Temperature, right</p> <p>10 Air conditioning</p> <p>11 Automatic recirculated-air control/recirculated-air mode</p> <p>12 Seat heating, right 82</p> <p>13 Air distribution settings</p> <p>14 Seat heating, left 82</p> <p>15 Interior temperature sensor</p> <p>16 Rear window defroster</p> |
|--|--|

Climate control functions in detail

Switching the system on/off

Turning on

Press any button except for the following:

- ▷ SYNC program.
- ▷ Rear window defroster.
- ▷ Seat heating.

Turning off

 Press the button.

Temperature

Principle

The automatic climate control achieves the set temperature as quickly as possible, if necessary by using the maximum cooling or heater output, and then keeps it constant.



Adjusting



Turn the wheel to set the desired temperature.

The selected temperature is shown on the display of the automatic climate control.

Do not rapidly change between different temperature settings. Otherwise, the automatic climate control will not have sufficient time to adjust the set temperature.

Air conditioning

Principle

The air in the interior will be cooled and dehumidified and, depending on the temperature setting, warmed again.

The car's interior can only be cooled with the engine running.

Turning on/off



Press the button.

The LED is illuminated with air conditioning switched on.

Depending on the weather, the windshield and side windows may fog up briefly when the engine is started.

Air conditioning is switched on automatically with the AUTO program.

When using the cooling mode, condensation that will exit below the vehicle.

Maximum cooling

Principle

The system is set to the lowest temperature, optimum air flow and air recirculation mode.

Functional requirement

The function is available above an outside temperature of approx. 32 °F/0 °C And with the engine running.

Turning on/off



Press the button.

The LED is illuminated with the system switched on.

Air flows out of the air vents to the upper body area. The air vents need to be open for this.

The air flow can be adjusted with the program active.

AUTO program

Principle

The AUTO program cools, ventilates or heats the car's interior automatically.

The air distribution and temperature are controlled automatically depending on the interior temperature and the desired temperature setting including the selected intensity of the air flow.

Turning on/off



Press the button.

The LED is illuminated with the AUTO program switched on.

Depending on the selected settings and outside influences, the air is directed to the windshield, side windows, upper body, and into the footwell.

Air conditioning, refer to page 194, is switched on automatically with the AUTO program.

Point the side air vents toward the side windows.

At the same time, a condensation sensor controls the program so as to prevent window condensation as much as possible.

Intensity

With the AUTO program switched on, the intensity can be adjusted. This changes the automatic control for the air mass.



Press the left or right side of the button: to decrease or increase intensity.

The selected intensity is shown on the display of the automatic climate control.

Automatic recirculated-air control/ recirculated-air mode

Principle

The automatic recirculated-air control recognizes pollutants in the outside air. The outside air supply is shut off and the interior air is recirculated.

General information

If the system is activated, a sensor detects pollutants in the outside air and controls the shut-off automatically.

If the system is deactivated, outside air continuously flows into the interior.

With constant air recirculation mode, the air quality in the interior deteriorates and window fogging increases.

Turning on/off



Press button repeatedly to select an operating mode:

- ▷ LEDs off: outside air flows in continuously.
- ▷ Left LED on, automatic recirculated-air control: a sensor detects pollutants in the outside air and shuts off automatically.
- ▷ Right LED on, recirculated-air mode: the supply of outside air into the vehicle is permanently disabled.

Recirculated-air mode switches off automatically at low outside temperatures after a certain amount of time in order to avoid window condensation.

In case of window condensation, switch off the recirculated-air mode and press the AUTO button to utilize the condensation sensor. Make sure that air can flow to the windshield.

Air flow, manual

Principle

The air flow for climate control can be adjusted manually.

General information

To adjust the air flow manually switch off AUTO program first.

Adjusting



Press the left or right side of the button: to decrease or increase air flow.

The selected air flow is shown on the display of the automatic climate control.

The air flow may be reduced to preserve the vehicle battery.

Manual air distribution

Principle

The air distribution for climate control can be adjusted manually.

Adjusting



Press the button repeatedly to select a program:

- ▷ Upper body area and footwell.
- ▷ Footwell.
- ▷ Windows and footwell.
- ▷ Windows.
- ▷ Windows and upper body area.
- ▷ Upper body area.
- ▷ Windows, upper body area, and footwell.



In case of window condensation, press the AUTO button to utilize the condensation sensor.

SYNC program

Principle

The system allows the transfer of the current setting of the temperature on the driver's side to the front passenger side.

Turning on/off



Press the button.

The current setting of the temperature on the driver's side is transferred to the passenger's side.

The program is switched off if the setting on the passenger's side is changed.

To defrost windows and remove condensation

Principle

Ice and condensation are quickly removed from the windshield and the front side windows.

Turning on/off



Press the button.

The LED is illuminated with the system switched on.

The air flow can be adjusted with the program active.

In case of window condensation, you can also switch on air conditioning or press the AUTO button to utilize the condensation sensor.

Rear window defroster



Press the button. The LED lights up.

The rear window defroster switches off automatically after a certain period of time.

For permanent activation, press the button for longer than 3 seconds. To deactivate, press the button again.

The rear window defroster can only be activated continuously at an outside temperature below approx. 41 °F/5 °C.

Microfilter/activated-charcoal filter

In external and recirculated-air mode, the microfilter/activated-charcoal filter filters dust, pollen, and gaseous pollutants out of the air.

Have this filter changed during vehicle maintenance, refer to page 265.

Ventilation

Front ventilation

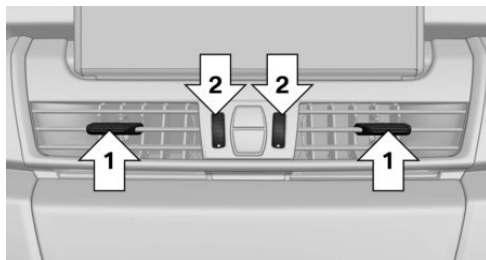

- ▷ Lever for changing the airflow direction, arrow 1.
- ▷ Thumbwheels for opening and closing the air vents continuously, arrows 2.

Adjusting

- ▷ Ventilation for cooling:
Adjust the air vent so that the air is directed towards you, for instance when the vehicle is too hot.
- ▷ Draft-free ventilation:
Adjust the air vent to let the air flow past you.

Ventilation in the rear

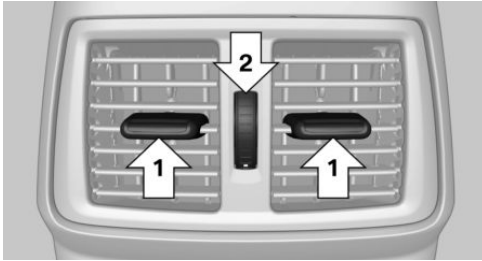

- ▶ Lever for changing the airflow direction, arrow 1.
- ▶ Thumbwheel for variable opening and closing of the air vents, arrow 2.

Pre-ventilation

Principle

The pre-ventilation ventilates the interior and lowers its temperature, if needed.

General information

The pre-ventilation can be switched on and off directly or by using two preset activation times. The system remains switched on for 30 minutes.

The pre-ventilation system is operated via iDrive.

Functional requirements

- ▶ Direct operation: vehicle is in radio-ready state.
- ▶ Direct operation or preset activation time: does not depend on outside temperature.
- ▶ The vehicle battery is sufficiently charged. If pre-ventilation is switched on, the vehicle battery will be discharged. Thus, limit the maximum activation time to save the vehicle battery. The system will be available again after the engine is started or after a short trip.

- ▶ Make sure that the vehicle's date and time are set correctly.
- ▶ Open the air vents of the ventilation to allow air to flow out.

Switching on/off directly

Via iDrive:

1. "My Vehicle"
 2. "Vehicle settings"
 3. If necessary, "Climate functions"
 4. "Activate comfort ventilation now"
-  The icon on the automatic climate control flashes if the system is switched on.



Preselecting the activation time

Via iDrive:

1. "My Vehicle"
2. "Vehicle settings"
3. If necessary, "Climate functions"
4. "Comfort ventilation"
5. Select the desired activation time.
6. Set the desired time.

Activating the activation time

Via iDrive:

1. "My Vehicle"
 2. "Vehicle settings"
 3. If necessary, "Climate functions"
 4. "For start time at:"
 - Activate the desired activation time.
 -  The icon on the automatic climate control lights up when the activation time is activated.
 -  The icon on the automatic climate control flashes when the system has been switched on.
- The system will only be switched on within the next 24 hours. After that, it needs to be reactivated.

Interior equipment

Vehicle features and options

This chapter describes all standard, country-specific and optional features offered with the series. It also describes features and functions that are not necessarily available in your vehicle, e.g., due to the selected options or country versions. This also applies to safety-related functions and systems. When using these functions and systems, the applicable laws and regulations must be observed.

Integrated Universal Remote Control

Principle

The integrated Universal Remote Control in the interior mirror can operate up to 3 functions of remote-controlled systems such as garage door drives, barriers, or lighting systems.

General information

The Integrated Universal Remote Control replaces up to 3 different hand-held transmitters. To operate the remote control, the buttons on the interior mirror must be programmed with the desired functions. The hand-held transmitter for the particular system is required in order to program the remote control.

Before selling the vehicle, delete the stored functions for the sake of security.

If possible, do not install the antenna of the remote-controlled system, e.g. the garage door drive, near metal objects to ensure the best possible operation.

Safety information

Warning

The operation of remote-controlled systems with the integrated universal remote control, such as the garage door, may result in injury, for example, body parts becoming jammed in a garage door. There is a risk of injury or risk of damage to property. Make sure that the travel path of the respective system is clear during programming and operation. Also follow the safety information for the hand-held transmitter.

Compatibility



If this symbol is printed on the packaging or in the operating instructions of the system to be controlled, the system is generally compatible with the integrated Universal Remote Control.

Additional questions are answered by:

- ▶ A dealer's service center or another qualified service center or repair shop.
- ▶ www.homelink.com on the Internet.

HomeLink is a registered trademark of Gentex Corporation.

Control elements on the interior mirror

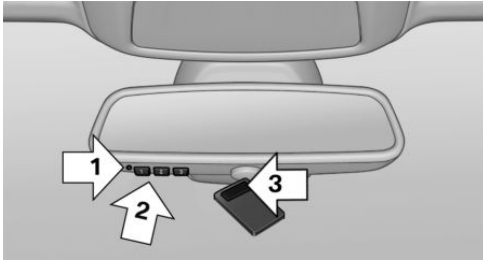

- ▶ LED, arrow 1.
- ▶ Buttons, arrow 2.
- ▶ The hand-held transmitter, arrow 3, is required for programming.

Programming

General information

The battery of the hand-held transmitter must be fully charged at the time of programming to ensure an optimal range of the integrated universal remote control.

1. Turn on the ignition.
2. Initial commissioning:

Press and hold the two outer buttons on the interior mirror simultaneously for approximately 10 seconds until the LED flashes green rapidly. This erases all programming of the buttons on the interior mirror.
3. Press the interior mirror button to be programmed. The LED on the interior mirror will slowly begin flashing orange.
4. Hold the hand-held transmitter for the system to be used approx. 1 to 12 in/2.5 to 30 cm away from the buttons on the interior mirror. The required distance depends on the hand-held transmitter.
5. Press and hold the button of the desired function on the hand-held transmitter.

Canada: if programming with the hand-held transmitter was interrupted, hold down the interior mirror button and repeatedly press and release the hand-held transmitter button for 2 seconds.

6. ▶ The LED lights up green: programming completed.

Release the button.

 - ▶ The LED flashes fast: programming is not complete.

Press the button on the interior mirror for 2 seconds and release. Perform this procedure three times to complete the programming procedure.

If the integrated universal remote control remains nonoperational, continue with the special features for change code wireless systems.

 - ▶ LED does not flash green after 60 seconds: programming not completed.

Repeat steps 3 to 6.

To program other functions on other buttons, repeat steps 3 to 5.

Special feature of the rolling code wireless system

If you are unable to operate the remote-controlled system after repeated programming, please check if the system to be controlled features a rolling code radio system.

Refer to the operating instructions for the system.

For systems with a rolling code radio system, the integrated Universal Remote Control and the system also have to be synchronized.

Please read the operating instructions to find out how to synchronize the system.

Synchronizing is easier with the aid of a second person.



Synchronizing the universal remote control with the system:

1. Park the vehicle within range of the remote-controlled system.
2. Program the desired button on the interior mirror as described.
3. Locate and press the synchronizing button on the system being programmed, e.g. at the garage gate. You have approx. 30 seconds for the next step.
4. Hold down the programmed button on the interior mirror for approximately 3 seconds and then release it. If necessary, repeat this step up to three times in order to end synchronization. Once synchronization is complete, the programmed function will be carried out.

Reprogramming individual buttons

1. Turn on the ignition.
2. Press and hold the interior mirror button to be programmed.
3. As soon as the LED on the interior mirror flashes orange after approx. 20 seconds, release the button.
4. Hold the hand-held transmitter for the system to be used approx. 1 to 12 in/2.5 to 30 cm away from the buttons on the interior mirror. The required distance depends on the hand-held transmitter.
5. Press and hold the button of the desired function on the hand-held transmitter.

Canada: if programming with the hand-held transmitter was interrupted, hold down the interior mirror button and repeatedly press and release the hand-held transmitter button for 2 seconds.

6. The LED can light up in different ways.
 - ▶ The LED lights up green: the programming procedure is completed.

Release the button.

- ▶ The LED flashes fast: the hand-held transmitter was detected but programming is not complete.

Press the button on the interior mirror for 2 seconds and release. Perform this procedure three times to complete the programming procedure.

If the integrated universal remote control remains nonoperational, continue with the special features for change code wireless systems.

- ▶ LED does not flash green after 60 seconds: programming not completed.

Repeat steps 3 to 6.

If the programming procedure is not completed, the previous programming will remain unchanged.

Operation

Warning

The operation of remote-controlled systems with the integrated universal remote control, such as the garage door, may result in injury, for example, body parts becoming jammed in a garage door. There is a risk of injury or risk of damage to property. Make sure that the travel path of the respective system is clear during programming and operation. Also follow the safety information for the hand-held transmitter.

The system, such as the garage door, can be operated using the button on the interior mirror while the engine is running or when the ignition is started. To do this, hold down the button within receiving range of the system until the function is activated. The interior mirror LED stays lit while the wireless signal is being transmitted.

Deleting stored functions

All stored functions will be deleted. The functions cannot be deleted individually.

Press and hold the two outer buttons on the interior mirror simultaneously for approximately 10 seconds until the LED on the interior mirror flashes green fast.

Sun visor

Glare shield

Fold the sun visor down or up.

Vanity mirror

A vanity mirror is located in the sun visor behind a cover. Depending on the equipment version, the mirror lighting may switch on when the cover is opened.

Ashtray/cigarette lighter

Ashtray

Opening

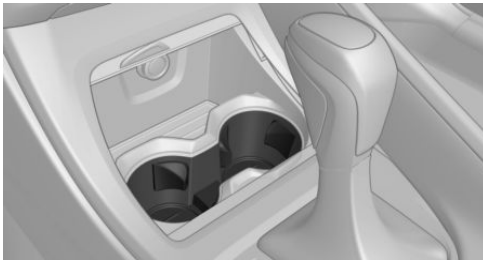

The ashtray can be inserted in the cup holder.

Emptying

Take out the insert.

Cigarette lighter

Warning

Contact with the hot heating element or the hot socket of the cigarette lighter can cause burns. Flammable materials can ignite if the cigarette lighter falls down or is held against the objects. There is a risk of fire and an injury hazard. There is a risk of damage to property, among other potential damage. Take hold of the cigarette lighter by its handle. Make sure that children do not use the cigarette lighter.

NOTICE

If metal objects fall into the socket, they can cause a short circuit. There is a risk of damage to property, among other potential damage. Insert the cigarette lighter or socket cover again after using the socket.

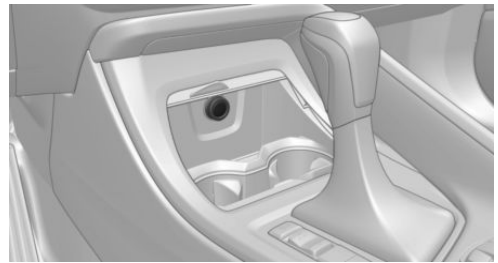

The cigarette lighter is located in the center console.



Push in the cigarette lighter.

The cigarette lighter can be removed as soon as it pops back out.

Sockets

General information

The socket can be used for electronic devices while the engine is running or when the ignition is switched on.

The total load of all sockets must not exceed 140 watts at 12 volts.

Do not damage the socket by using unsuitable connectors.

Safety information

Warning

Devices and cables in the unfolding area of the airbags, such as portable navigation devices, can hinder the unfolding of the airbag or be thrown around in the car's interior during unfolding. There is a risk of injury. Make sure that devices and cables are not in the airbag's area of unfolding.

NOTICE

If metal objects fall into the socket, they can cause a short circuit. There is a risk of damage to property, among other potential damage. Insert the cigarette lighter or socket cover again after using the socket.

Front center console



Remove the cover or cigarette lighter.

In the front passenger footwell



The socket is located below the glove compartment.

In the cargo area



The socket is located on the right side in the cargo area.

USB port

Principle

Mobile devices with a USB port can be connected to the USB port.

General information

Follow the information regarding the connection of mobile devices to the USB port in the section on USB connections, refer to page 52.

USB port in front

In the center console

- ▷ USB port Type A.
- ▷ For charging of mobile devices.
- ▷ Charge current: max. 1.5 A.

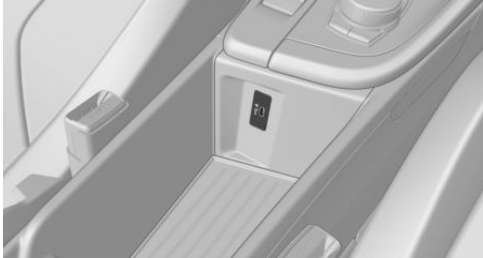

The USB port is located in the center console.

- ▷ USB port Type A.
- ▷ For charging of mobile devices.
- ▷ Charge current: max. 1.5 A.

Properties:

- ▷ USB port Type C.
- ▷ With Wireless Charging: for charging of mobile devices.
- ▷ Without Wireless Charging: for charging of mobile devices.
- ▷ Charge current: max. 3 A.

In the front center console



The USB port is located in the front center console.

- ▷ USB port Type A.
- ▷ For charging mobile devices and for data transfer.
- ▷ Charge current: max. 1.5 A.

In the rear center console



Two USB ports are located in the rear center console.

Properties:

- ▷ USB port Type C.
- ▷ For charging of mobile devices.
- ▷ Charge current: max. 3 A per connection.

Connecting an external device

Follow the following when connecting:

- ▷ Do not use force when plugging the connector into the USB port.
- ▷ Use a flexible adapter cable.
- ▷ Protect the USB device against mechanical damage.
- ▷ Due to the large number of USB devices available on the market, it cannot be guaranteed that every device is operable on the vehicle.
- ▷ Do not expose USB devices to extreme environmental conditions, such as very high temperatures; refer to the operating instructions of the device.
- ▷ Due to the many different compression techniques, proper playback of the media stored on the USB device cannot be guaranteed in all cases.



- ▶ A connected USB device will be supplied with charge current via the USB port if the device supports this. At higher temperatures, the charge current through the USB device may be reduced.
- ▶ To ensure proper transmission of the stored data, do not charge a USB device via the onboard socket, when it is connected to the USB port.
- ▶ Depending on how the USB device is being used, settings may be required on the USB storage device, refer to the operating instructions of the device.

Non-compatible USB devices:

- ▶ USB hard drives.
- ▶ USB hubs.
- ▶ USB memory card readers with multiple slots.
- ▶ HFS-formatted USB devices.
- ▶ Devices such as fans or bulbs.

Wireless charging tray

Principle

The wireless charging tray enables the following functions to be performed without cables:

- ▶ Charging the rechargeable battery of a mobile phone with Qi capability and of other mobile devices, which support the Qi standard.
- ▶ Connect the mobile phone to the external antenna.

Depending on the country, this provides for better network reception and a consistent reproduction quality.

General information

When inserting the mobile phone, make sure there are no objects between it and the wireless charging tray.

During charging, the surface of the tray and the mobile phone may heat up. Higher temperatures may lead to a reduction in the charge current through the mobile phone, and in isolated cases the charging process is paused temporarily. Follow the relevant instructions in the mobile phone owner's manual.

NOTE

This device has been tested for human exposure limits and found compliant at a minimum distance of 4 in/10 cm during operation.

Therefore, a distance of 4 in/10 cm must be maintained in every direction when operating the device.

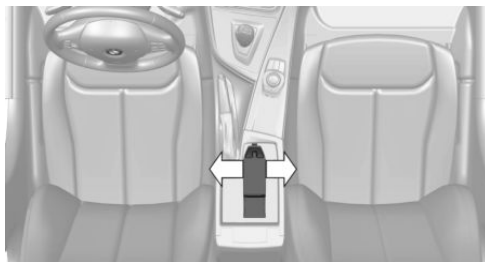

Mounting position of the product.

Safety information

Warning

When charging a device that meets the Qi standard in the wireless charging tray, any metal objects located between the device and the tray can become very hot. Placing storage devices or electronic cards, such as chip cards, cards with magnetic strips or cards for signal transmission, between the device and the tray may impair the card function. There is a risk of injury and risk of damage to property. When charging mobile devices, make sure there are no objects between the device and the tray.

⚠ NOTICE

The tray is intended for mobile phones up to a particular size. Forceful inserting of the mobile phone into the tray can damage the tray or the mobile phone. There is a risk of damage to property, among other potential damage. Observe the maximum dimensions for mobile phones. Do not force the mobile phone into the tray.

Overview

Tray in the center console:

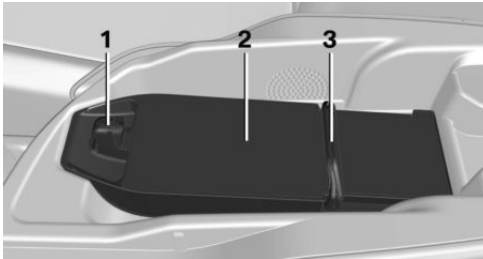

- 1** Front holder with LED
- 2** Storage area
- 3** Movable retaining clip

Functional requirements

- ▶ The mobile phone must compatibly support the required Qi standard.

If the mobile phone does not support the Qi standard, the mobile phone can be charged using a special Qi-compatible charging case.
- ▶ The ignition is switched on.
- ▶ Observe the maximum dimensions of the mobile phone.
- ▶ Use only protective sleeves and covers up to a maximum thickness of 0.07 in/2 mm.

Otherwise, the charging function may be impaired.

- ▶ The mobile phone to be charged is located in the center of the tray.

Operation

Inserting the mobile phone

The mobile phone must not exceed the maximum size of approximately 5.9 x 3.07 x 0.62 in/150 x 78 x 16 mm.

1. Open the center armrest.
2. Push back the retaining clip.
3. Insert the mobile phone with the display facing upward in the direction of the front holder, arrow 1.

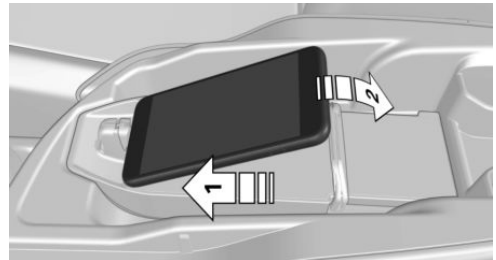

4. Place the mobile phone in the storage area, arrow 2.
5. Push the retaining clip forward and clip the mobile phone in the tray.
6. Close the center armrest.

Removing the mobile phone

1. Open the center armrest.
2. Push the retaining clip back and remove the mobile phone.



LED displays

Color	Meaning
Blue	The mobile phone is charging. Depending on the model and the vehicle, the blue LED is no longer illuminated once the inserted mobile phone with Qi capability is fully charged.
Orange	The mobile phone is not charging. Temperature on the mobile phone possibly too high or foreign object in the charging tray.
Red	The mobile phone is not charging. Contact a dealer's service center or another qualified service center or repair shop.

System limits

At high temperatures on the mobile phone or in the vehicle, the charging functions of the mobile phone may be limited and some functions may no longer work.

LTE-Compensator - Information and User Manual

Your car is equipped with a wireless charging tray (WCA) to charge your mobile phone and connect it to the mobile network. To ensure the best possible connection a signal booster (LTE-Compensator) is used in conjunction with the WCA. The following paragraphs refer to this booster:

This is a CONSUMER device.

BEFORE USE, you MUST REGISTER THIS DEVICE with your wireless provider and have your provider's consent. Most wireless providers consent to the use of Compensators. Some providers may not consent to the use of this device on their network. If you are unsure, contact your provider. You MUST operate this device with approved antennas and cables as

specified by the manufacturer. Antennas MUST be installed at least 20 cm (8 inches) from any person. You MUST cease operating this device immediately if requested by the FCC or a licensed wireless service provider. Warning E911 location information may not be provided or may be inaccurate for calls served by using this device.

Please observe additionally the following information

- ▶ Sprint Nextel will allow consumers to register their signal boosters by calling their toll-free number.
- ▶ T-Mobile online registration link: (www.T-Mobile.com/BoosterRegistration); (<https://saqat.t-mobile.com/sites/SignalBooster#>).
- ▶ Verizon's online registration link: (<http://www.verizonwireless.com/wcms/consumer/register-signal-booster.html>).
- ▶ AT&T online registration link (<https://securec45.securewebsession.com/attsignalbooster.com/>).
- ▶ U.S.Cellular online registration link (<http://www.uscellular.com/uscellular/support/fcc-booster-registration.jsp>).

Before use you must register your booster device with your wireless provider.

If you should be requested by the FCC to cease operating your booster you are not allowed to insert your mobile phone in the charging tray anymore unless the booster is permanently deactivated by your local BMW dealer.

You must not remove the booster from the car nor use it with any other than the preinstalled coupling device or antenna. Any modification of the existing antenna or coupling device as well as the use of other antennas or coupling devices will cause the cease of the booster's operating license.

The booster device fulfills the network protection standards as required by the FCC, such as intermodulation limits, oscillation detection and gain limits.

Booster Manufacturer: Kathrein Automotive
 Model Number: LTECOMPB0
 Part Number: 6803145-01
 FCC-ID: 2ACC7LTECOMPB0

Cargo area

Cargo cover

Safety information

Warning

Devices connected to the vehicle via a cable, such as mobile phones or loose objects, can be thrown through the vehicle interior while driving such as in the event of an accident, braking or evasive maneuver. There is a risk of injury. Secure loose objects or devices that are connected to the vehicle via a cable.

General information

The cargo cover can be removed in order to load bulky luggage.

Removing

1. Detach the retaining straps at the tailgate.
2. Pry cover up a bit, arrow 1, and pull out of the brackets toward the back, arrow 2.

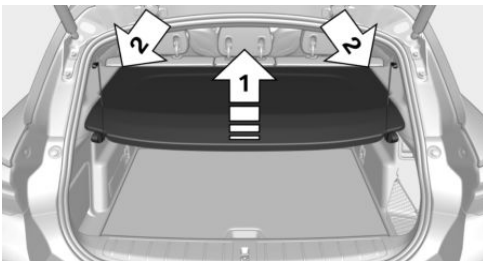

Installing

Proceed in the reverse order to reinstall. The cargo cover must engage audibly into place on its holders.

Variable cargo floor panel

Principle

With the variable cargo area floor, the cargo area can be configured corresponding to transport requirements.

General information

Follow the information on securing the cargo, refer to page [222](#).

Removing the cargo floor panel

1. Fold the rear part of the cargo floor panel forward.

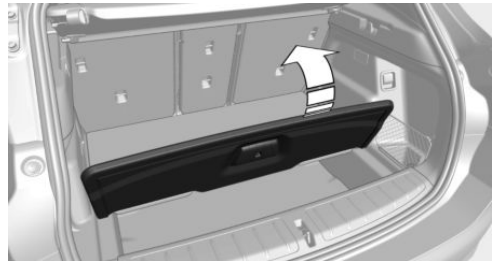

2. Grasp the cargo floor panel in the rear and fold up above the locking point of the upper position, refer to page [208](#).
3. Pull the cargo floor panel backward from the brackets.



Inserting the cargo floor panel

1. Push the cargo area floor into the supports at a shallow angle. The cargo area floor must engage noticeably.

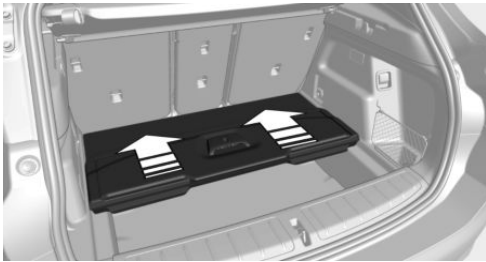

2. Fold the cargo area floor over downward.

Folded up position

Safety information

Warning

Improper use of the cargo area floor can lead to a risk of objects flying about during braking and evasive maneuvers, for example. There is a risk of injury and risk of damage to property.

- ▷ Do not use the cargo area floor to separate the cargo area and vehicle interior in the sense of a luggage net.
- ▷ Only use the cargo area floor in the folded-up position when the rear seat backrests are folded up and locked.
- ▷ Fold down the cargo area floor before driving off.
- ▷ Always secure cargo against slipping, using straps, belts and lashing eyes, for instance.

Fold up the cargo floor panel

Fold the rear part of the cargo floor panel upward.

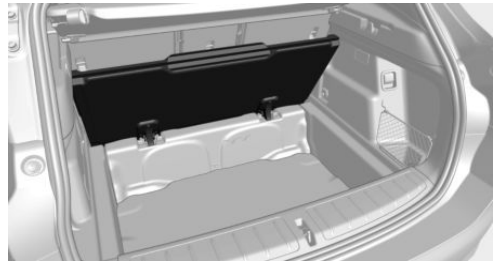

Fold up the cargo area floor. You've reached the maximum cargo height.

Enlarging the cargo area

Principle

The cargo area can be enlarged as follows:

- ▷ The rear seat backrests can be folded down.
- ▷ The rear seat backrests can be moved into an upright position, refer to page 82.

General information

The rear seat backrest is divided at a ratio of 40–20–40. The side rear seat backrests and the center section can be folded down separately.

The rear seat backrests can be folded down from the rear.

Safety information

Warning

There is a danger of jamming with folding down the rear seat backrests. There is a risk of injury or risk of damage to property. Make sure that the area of movement of the rear seat backrest and the of the head restraint is clear prior to folding down.

⚠ Warning

If a rear seat backrest is not locked, unsecured cargo can be thrown about the car's interior; for instance, in the event of an accident, braking or an evasive maneuver. There is a risk of injury. Make sure that the rear seat backrest is locked after folding it back.

⚠ Warning

Unexpected movements of the rear seat backrest while driving may occur due to unintentional unlocking of the rear seat backrests by the loops. There is a risk of injury. Only use loops for releasing the rear seat backrests. Do not attach objects on the loops.

⚠ Warning

With a rear seat backrest that is not locked, the protective effect of the middle seat belt is not guaranteed. There is a risk of injury or danger to life. If you are using the middle seat belt, lock the wider rear seat backrest.

⚠ Warning

The stability of the child restraint system is limited or compromised with incorrect seat setting or improper installation of the child seat. There is a risk of injury or danger to life. Make sure that the child restraint system fits securely against the backrest. If possible, adjust the backrest tilt for all affected backrests and correctly adjust the seats. Make sure that seats and backrests are securely engaged or locked. If necessary, adjust the height of the head restraints or remove them.

⚠ NOTICE

Vehicle parts can be damaged when folding down the rear seat backrest. There is a risk of damage to property, among other potential damage. Make sure that the area of movement of the rear seat backrest including head restraint is clear when folding down.

Folding down the rear seat backrest from the rear

1. Pull loop to unlock the rear seat backrest.

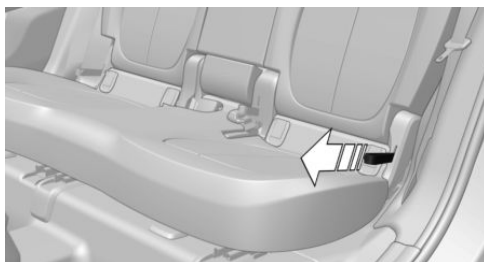

2. The rear seat backrest folds forward.

Folding back the backrest

1. Pull the loop.

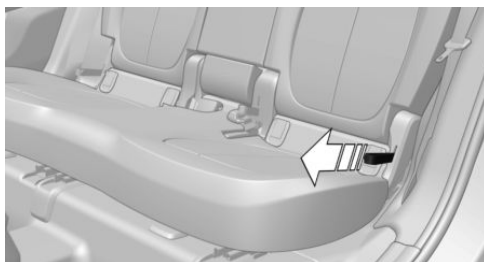

2. Fold the rear seat backrest rearward. The rear seat backrest first engages in an upright position.
3. Pull the loop again.
4. Return the rear seat backrest to the upright seat position and engage it.



Ski and snowboard bag

The ski and snowboard bag is contained in a protective sleeve in the cargo area.

Follow the installation and operating instructions included in the protective sleeve.

Storage compartments

Vehicle features and options

This chapter describes all standard, country-specific and optional features offered with the series. It also describes features and functions that are not necessarily available in your vehicle, e.g., due to the selected options or country versions. This also applies to safety-related functions and systems. When using these functions and systems, the applicable laws and regulations must be observed.

Safety information

Warning

Devices connected to the vehicle via a cable, such as mobile phones or loose objects, can be thrown through the vehicle interior while driving such as in the event of an accident, braking or evasive maneuver. There is a risk of injury. Secure loose objects or devices that are connected to the vehicle via a cable.

NOTICE

Anti-slip pads such as anti-slip mats can damage the dashboard. There is a risk of damage to property, among other potential damage. Do not use anti-slip pads.

Storage compartments in the car's interior

The following storage compartments are available in the interior:

- ▶ Storage compartment up front in the center console, refer to page 211.
- ▶ Glove compartment on the passenger's side, refer to page 212.
- ▶ Glove compartment on the driver's side, refer to page 212.
- ▶ Compartments in the doors, refer to page 212.
- ▶ Storage compartment in the center armrest, refer to page 213.
- ▶ Cup holder, refer to page 213.
- ▶ Storage compartment in the rear center console, refer to page 213.
- ▶ Coat hooks, refer to page 214.
- ▶ Storage compartments in the cargo area, refer to page 215.
- ▶ Additional storage compartments in the car's interior, refer to page 214.

Storage compartment up front in the center console

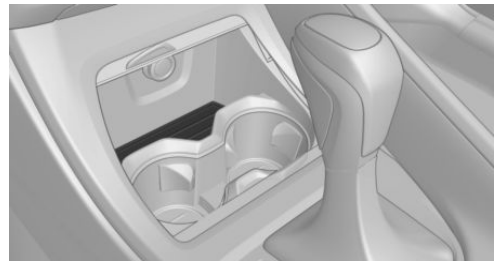

There is a storage compartment under the cover.

Glove compartment

Passenger's side

Safety information

 **Warning**

Folded open, the glove compartment protrudes in the car's interior. Objects in the glove compartment can be thrown into the car's interior while driving, for instance in the event of an accident, braking or evasive maneuvers. There is a risk of injury. Always close the glove compartment immediately after using it.

Opening



Pull the handle.

The light in the glove compartment switches on.

Closing

Fold lid closed.

Driver's side

Safety information

 **Warning**

Folded open, the glove compartment protrudes in the car's interior. Objects in the glove compartment can be thrown into the car's interior while driving, for instance in the event of an accident, braking or evasive maneuvers. There is a risk of injury. Always close the glove compartment immediately after using it.

Opening

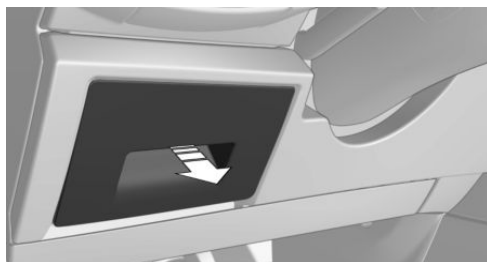

Pull the handle.

Closing

Fold lid closed.

Compartments in the doors

General information

There are storage compartments in the doors.

Safety information

Warning

Breakable objects, such as glass bottles or glasses, can break in the event of an accident or a braking or evasive maneuver. Broken glass can be scattered in the car's interior. There is a risk of injury or risk of damage to property. Do not use any breakable objects while driving. Only stow breakable objects in closed storage compartments.

Center armrest

Front

A storage compartment is located in the center armrest between the front seats.

Opening



Pull the lever, arrow 1, and fold the center armrest up, arrow 2.

Adjusting

The center armrest can be adjusted at several inclination levels.

Storage compartment in the rear center console

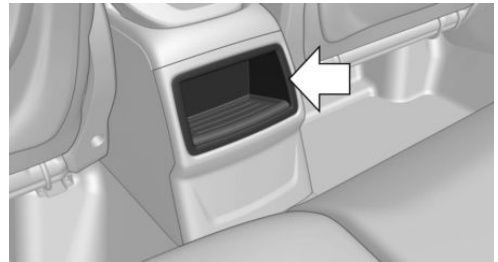

A storage compartment is located in the center console.

Cup holders

Safety information

Warning

Unsuitable containers in the cup holders may damage the cup holders or be thrown about the car's interior in the event of an accident, an evasive maneuver, or forceful braking. Spilled liquids can distract from the surrounding traffic conditions and lead to an accident. Hot drinks can damage the cup holder or lead to scalding. There is a risk of injury or risk of damage to property. Do not force objects into the cup holder. Use lightweight, shatterproof, and sealable containers. Do not transport hot beverages.



Front

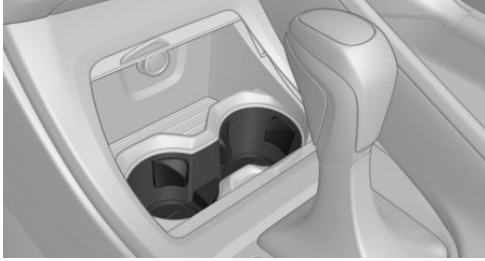

Two cup holders are located under the cover.

Back

NOTICE

With an open cup holder, the center armrest cannot be folded back up. There is a risk of damage to property, among other potential damage. Press back the covers before the center armrest is folded up.

In the center armrest.

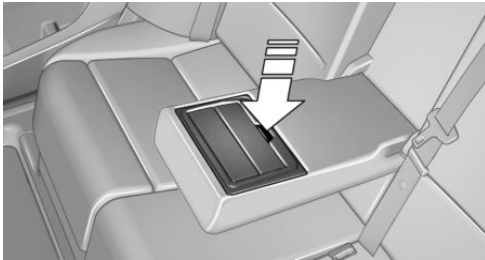

Pull the center armrest forward at the loop.

To open: press the button.

To close: push both covers back in, one after the other.

Additional storage compartments in the car's interior

Nets on the backrests of the front seats

The nets on the backrests of the front seats can also be used to store small parts.

Coat hooks

General information

The coat hooks are located in the grab handles in the rear.

Safety information

Warning

Clothing articles on the coat hooks can obstruct the view while driving. There is a risk of accident. When suspending clothing articles from the coat hooks, ensure that they will not obstruct the driver's view.

Warning

Improper use of the coat hooks can lead to a risk of objects flying about during braking and evasive maneuvers. There is a risk of injury and risk of damage to property. Only hang lightweight objects, for instance clothing articles, from the coat hooks.

Storage compartments in the cargo area

Side storage compartment, right

A storage compartment is located on the right-hand side.

Net for storage compartment

Smaller objects can be stored in the net of right storage compartment.

Multifunction hook

Warning

Improper use of the multifunction hooks can lead, e.g., to a risk of objects flying about during braking and evasive maneuvers. There is a risk of injury and risk of damage to property. Only hang lightweight objects from the multifunction hooks. Only transport heavy luggage in the cargo area if it has been appropriately secured.

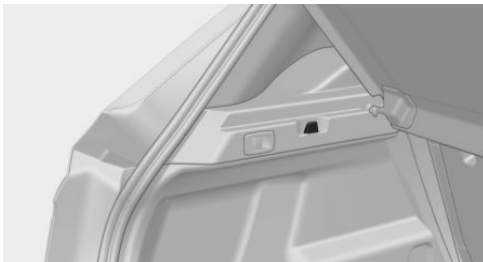

A multifunction hook is located on each side of the cargo area.

Retaining strap

A retaining strap is available on the left side trim panel for fastening small objects.

Lashing eyes in the cargo area

To secure the cargo, refer to page 222, there are lashing eyes in the cargo area.

Storage space under cargo area floor

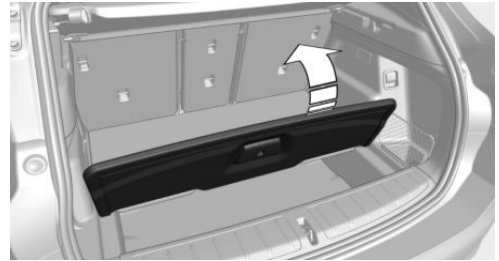

There is a storage space under the cargo floor panel:

1. Fold down the rear part of the cargo floor panel.
2. Grasp the cargo floor panel in the rear and fold up above the locking point of the upper position, refer to page 208.

Things to remember when driving

Vehicle features and options

This chapter describes all standard, country-specific and optional features offered with the series. It also describes features and functions that are not necessarily available in your vehicle, e.g., due to the selected options or country versions. This also applies to safety-related functions and systems. When using these functions and systems, the applicable laws and regulations must be observed.

Break-in

General information

Moving parts need to begin working together smoothly.

The following instructions will help you to achieve a long vehicle service life and good efficiency.

During break-in, do not use the Launch Control.

Safety information

Warning

Due to new parts and components, safety and driver assistance systems can react with a delay. There is a risk of accident. After installing new parts or with a new vehicle, drive conservatively and intervene early if necessary. Observe the break-in procedures of the respective parts and components.

Engine, transmission, and axle drive

Up to 1,200 miles/2,000 km

Do not exceed the maximum engine and road speed:

- ▶ For gasoline engine 4,500 rpm and 100 mph/160 km/h.

Avoid full throttle or kickdown under all circumstances.

From 1,200 miles/2,000 km

The engine and vehicle speed can gradually be increased.

Tires

Tire traction is not optimal due to manufacturing circumstances when tires are brand-new; they achieve their full traction potential after a break-in time.

Drive conservatively for the first 200 miles/300 km.

Brake system

Brake disks and brake pads only reach their full effectiveness after approx. 300 miles/500 km. Drive moderately during this break-in period.

Following part replacement

Observe the break-in procedures again, if components mentioned above are replaced.

Driving on poor roads

Principle

Because of its greater ground clearance, the vehicle can be driven on a variety of road types and qualities.

All-wheel drive can help improve drive power.

Safety information

NOTICE

Objects in unpaved areas, for instance stones or branches, can damage the vehicle. There is a risk of damage to property, among other potential damage. Do not drive on unpaved terrain.

When driving on poor roads

For your own safety, for the safety of passengers and of the vehicle, heed the following points:

- ▶ Familiarize yourself with the vehicle before driving.
- ▶ Do not take risks when driving.
- ▶ Adjust the speed to the road surface conditions. The steeper and more uneven the road, the slower the speed should be.
- ▶ When driving on steep uphill or downhill grades: add engine oil and coolant up to near the maximum mark.
- ▶ On steep downhill driving, use Hill Descent Control.
- ▶ Avoid body bottom coming in contact with the ground.
The ground clearance is no more than 7.8 inches/20 cm and can vary according to the vehicle's load status.
- ▶ When wheels continue to spin, depress the accelerator so that driving stability control systems can distribute the driving power to the wheels. If necessary, activate the Dynamic Traction Control.

After a trip on poor roads

After a trip on poor roads, check wheels and tires for damage to maintain driving safety. Clear heavy soiling from the body.

General driving notes

Closing the tailgate

Safety information

Warning

An open tailgate protrudes from the vehicle and can endanger occupants and other road users or damage the vehicle in the event of an accident, braking or evasive maneuvers. In addition, exhaust fumes may enter the vehicle interior. There is a risk of injury or risk of damage to property. Do not drive with the tailgate open.

Driving with the tailgate open

If the vehicle still needs to be driven with the trunk lid open:

- ▶ Close all windows and the glass sunroof.
- ▶ Greatly increase the blower output.
- ▶ Drive moderately.

Hot exhaust system

Warning

High temperatures can occur underneath the body, for instance caused by the exhaust system, while driving. Contact with the exhaust system can cause burns. There is a risk of injury. Do not touch the hot exhaust system, including the exhaust pipe.

Warning

If combustible materials, such as leaves or grass, come in contact with hot parts of the exhaust system, these materials can ignite. There is a risk of fire and an injury hazard. Do not remove the heat shields installed and never apply undercoating to them. Make sure

that no combustible materials can come in contact with hot vehicle parts while driving, in Neutral or during parking.

Mobile radio in the vehicle

Warning

Vehicle electronics and mobile communication devices can influence one another. There is radiation due to the transmission operations of mobile communication devices. There is a risk of injury or risk of damage to property. If possible, in the car's interior use only mobile communication devices, such as mobile phones with direct connections to an external antenna in order to exclude mutual interference and deflect the radiation from the vehicle interior.

Aquaplaning

On wet or slushy roads, a wedge of water can form between the tires and road surface.

This phenomenon is referred to as aquaplaning. It is characterized by a partial or complete loss of contact between the tires and the road surface, ultimately undermining your ability to steer and brake the vehicle.

Driving through water

General information

When driving through water, follow the following:

- ▶ Deactivate Auto Start/Stop function.
- ▶ Drive through calm water only.
- ▶ Drive through water only if it is not deeper than a maximum of 9.8 inches/25 cm.
- ▶ Drive through water at a maximum of walking speed, up to 3 mph/5 km/h.

Safety information

NOTICE

When driving too quickly through deep water, the water can penetrate the engine compartment, the electrical system, or the transmission. There is a risk of damage to property, among other potential damage. When driving through water, do not exceed the maximum indicated water level and the maximum speed for driving through water.

Braking safely

General information

The vehicle is equipped with an Antilock Braking System as a standard feature.

Perform emergency braking in situations that require such.

Steering is still responsive. You can still avoid any obstacles with a minimum of steering movement.

The pulsation of the brake pedal and sounds from the hydraulic circuits indicate that the Antilock Braking System is in its active mode.

Objects in the movement area around pedals and footwell

Warning

Objects in the driver's footwell can limit the pedal travel or block a depressed pedal. There is a risk of accident. Stow objects in the vehicle such that they are secured and cannot enter into the driver's footwell. Use floor mats that are suitable for the vehicle and can be safely attached to the floor. Do not use loose floor mats and do not layer several floor mats. Make sure that there is sufficient clearance for the pedals. Ensure that the floor

mats are securely fastened again after they were removed, for instance for cleaning.

accident. Do not attempt to drive in idle state or with the engine switched off.

Driving in wet conditions

In case of wet roads, exposure to road salt, in heavy rain, gently press the brake pedal every few kilometers.

Ensure that this action does not endanger other road users.

The heat generated during braking dries brake disks and brake pads and protects them against corrosion.

In this way the brake force will be available when you need it.

Hills

General information

Drive long or steep downhill gradients in the gear that requires least braking effort. Otherwise, the brake system may overheat and reduce braking effect.

You can increase the engine's braking effect by downshifting, going all the way to first gear, if needed.

Safety information

Warning

Light but consistent pressure on the brake pedal can lead to high temperatures, brake wear and possibly even brake system failure. There is a risk of accident. Avoid placing excessive stress on the brake system.

Warning

In idle state or with the engine switched off, safety functions, for instance engine braking effect, braking assistance and steering assistance, may not be available. There is a risk of

Brake disk corrosion

Corrosion on the brake disks and contamination on the brake pads are increased by the following circumstances:

- ▶ Low mileage.
- ▶ Extended stationary periods.
- ▶ Infrequent use of the brakes.
- ▶ Aggressive, acidic, or alkaline cleaning agents.

Corrosion buildup on the brake disks will cause a pulsating effect on the brakes when braking slowly - generally this cannot be corrected.

Condensation water under the parked vehicle

When using the automatic climate control, condensation water develops and collects underneath the vehicle.

Driving on racetracks

Warning

The vehicle is not designed for use in M Sport or motor sport type competition. There is a risk of accident. Do not use the vehicle for M Sport or motor sport type competitions.

Higher mechanical and thermal loads during racetrack operation lead to increased wear. Use of the vehicle in M Sport or motor sport type competition is an improper use of the vehicle and may affect your warranty coverage. Please consult the "New Vehicle Limited Warranty" Booklet for further information on warranty matters.

Have vehicle checked by a dealer's service center or another qualified service center or re-

pair shop before and after driving on a race-track.

Loading

Vehicle features and options

This chapter describes all standard, country-specific and optional features offered with the series. It also describes features and functions that are not necessarily available in your vehicle, e.g., due to the selected options or country versions. This also applies to safety-related functions and systems. When using these functions and systems, the applicable laws and regulations must be observed.

Safety information

Warning

High gross vehicle weight can overheat the tires, damage them internally and cause a sudden tire pressure loss. Driving characteristics may be negatively impacted, reducing directional stability, lengthening the braking distances and changing the steering response. There is a risk of accident. Pay attention to the permitted load-carrying capacity of the tires and never exceed the permitted gross vehicle weight.

Warning

Devices connected to the vehicle via a cable, such as mobile phones or loose objects, can be thrown through the vehicle interior while driving such as in the event of an accident, braking or evasive maneuver. There is a risk of injury. Secure loose objects or devices that are connected to the vehicle via a cable.

Warning

Unexpected movements of the rear seat backrest while driving may occur due to unintentional unlocking of the rear seat backrests by the loops. There is a risk of injury. Only use loops for releasing the rear seat backrests. Do not attach objects on the loops.

Warning

Improperly stowed objects can slip and be thrown into the car's interior, for instance in the event of an accident or during braking and evasive maneuver. Vehicle occupants can be hit and injured. There is a risk of injury. Stow and secure objects and cargo properly.

NOTICE

Fluids in the cargo area can cause damage. There is a risk of damage to property, among other potential damage. Make sure that no fluids leak in the cargo area.



Steps for Determining Correct Load Limit

1. Locate the statement "The combined weight of occupants and cargo should never exceed XXX kg or XXX lbs" on your vehicle's placard.
2. Determine the combined weight of the driver and passengers that will be riding in your vehicle.
3. Subtract the combined weight of the driver and passengers from XXX kg or XXX lbs

4. The resulting figure equals the available amount of cargo and luggage load capacity. For example, if the "XXX" amount equals 1,400 lbs and there will be five 150 lbs passengers in your vehicle, the amount of available cargo and luggage load capacity is 650 lbs (1,400 - 750 (5 x 150) = 650 lbs)
5. Determine the combined weight of luggage and cargo being loaded on the vehicle. That weight may not safely exceed the available cargo and luggage load capacity calculated in Step 4.
6. If your vehicle will be towing a trailer, load from your trailer will be transferred to your vehicle. Consult this manual to determine how this reduces the available cargo and luggage load capacity of your vehicle.

- ▶ Very heavy cargo: when the rear seat is not occupied, secure each of the outer seat belts in the opposite buckle.
- ▶ The cargo area, refer to page 207, can be extended to transport large or bulky cargo.
- ▶ Do not stack cargo above the upper edge of the backrests.
- ▶ Smaller and light cargo: secure with luggage straps or draw straps.
- ▶ Larger and heavy cargo: secure with cargo straps.

Payload

	\leq	Max. Load
	\leq	Max. Load
	\leq	Max. Load

The maximum payload is the sum of the weight of the occupants and the cargo.

The greater the weight of the occupants, the less cargo that can be transported.

Stowing and securing cargo

- ▶ Cover sharp edges and corners on the cargo.
- ▶ Heavy cargo: stow as far forward as possible, directly behind and at the bottom of the rear seat backrests.

Lashing eyes in the cargo area

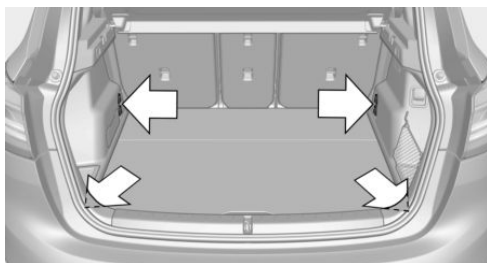

The number of lashing eyes in the cargo area may vary depending on the equipment

Attach auxiliary materials to secure the cargo, such as lashing straps, tensioning straps, draw straps or cargo nets, to the lashing eyes in the cargo area.

Roof-mounted luggage rack

General information

Installation only possible with roof rack.

Roof racks are available as optional accessories.

Safety information

Warning

When driving with a roof load, for instance with roof-mounted luggage rack, the vehicle's center of gravity is higher, which increases the risk of the vehicle tipping in critical driving situations. There may be a risk of accident or risk of damage to property. Driving with roof load only with activated Dynamic Stability Control.

Installation

Follow the assembly instructions of the roof rack.

Loading

Because roof-mounted luggage racks raise the vehicle's center of gravity when loaded, they have a major effect on vehicle handling and steering response.

Therefore, note the following when loading and driving:

- ▶ Do not exceed the approved roof/axle weights and the approved gross vehicle weight.
- ▶ Be sure that adequate clearance is maintained for tilting and opening the glass sunroof.
- ▶ Distribute the roof load uniformly.
- ▶ The roof load should not extend past the loading area.
- ▶ Always place the heaviest pieces on the bottom.
- ▶ Secure the roof luggage firmly, for instance using luggage straps.
- ▶ Do not let objects project into the swiveling range of the tailgate.
- ▶ Drive cautiously and avoid driving off and braking with jerky movements or fast cornering.

Reducing fuel consumption

Vehicle features and options

This chapter describes all standard, country-specific and optional features offered with the series. It also describes features and functions that are not necessarily available in your vehicle, e.g., due to the selected options or country versions. This also applies to safety-related functions and systems. When using these functions and systems, the applicable laws and regulations must be observed.

General information

The vehicle contains advanced technologies for the reduction of consumption and emission values.

Fuel consumption depends on a number of different factors.

Carrying out certain measures, such as a moderate driving style and regular maintenance, can influence fuel consumption and the environmental pollution.

Remove unnecessary cargo

Additional weight increases fuel consumption.

Remove attached parts following use

Remove roof-mounted luggage racks that are no longer required following use.

Attached parts on the vehicle impair the aerodynamics and increase the fuel consumption.

Close the windows and glass sunroof

Driving with the glass sunroof and windows open results in increased drag and thereby reduces the range.

Tires

General information

Tires can affect consumption in various ways, for instance tire size may influence consumption.

Check the tire pressure regularly

Check and, if needed, correct the tire inflation pressure at least twice a month and before starting on a long trip.

Low tire inflation pressure increases rolling resistance and thus raises fuel consumption and tire wear.

Drive away immediately

Do not wait for the engine to warm-up while the vehicle remains stationary. Start driving right away, but at moderate RPM.

This is the fastest way of warming the cold engine up to operating temperature.

Anticipating driving

A smooth and anticipating driving style reduces fuel consumption.

Avoid unnecessary acceleration and braking.

By maintaining a suitable distance to the vehicle driving ahead of you.

Avoid high RPM

Driving at low RPM lowers fuel consumption and reduces wear.

If necessary, observe the vehicle's gear shift indicator, refer to page [127](#).

Use coasting/overrun mode

When approaching a red traffic light, take your foot off the accelerator and let the vehicle coast to a halt.

For going downhill take your foot off the accelerator and let the vehicle roll.

The fuel supply is interrupted in coasting/overrun mode.

Switch off the engine during longer stops

Switching off the engine

Switch off the engine during longer stops, for instance at traffic lights, railroad crossings or in traffic jam.

Auto Start/Stop function

The Auto Start/Stop function of the vehicle automatically switches off the engine during a stop.

If the engine is switched off and then restarted rather than leaving the engine running constantly, fuel consumption and emissions are reduced. Savings can begin within a few seconds of an engine stop.

In addition, fuel consumption is also determined by other factors, such as driving style, road conditions, maintenance or environmental factors.

Switch off any functions that are not currently needed

Functions such as seat heating and the rear window defroster require a lot of energy and reduce the range, especially in city traffic and with stop-and-go driving.

Switch off these functions if they are not needed.

The ECO PRO driving mode supports the energy conserving use of comfort features. These functions are automatically deactivated partially or completely.

Have maintenance carried out

Have the vehicle maintained regularly to achieve optimal vehicle efficiency and service life. BMW recommends that maintenance work be performed by a dealer's service center.

Additional information:

BMW maintenance system, refer to page [265](#).

ECO PRO

Principle

ECO PRO supports a driving style that saves on consumption. For this purpose, the engine control and comfort features, for instance the climate control output, are adjusted.

In addition, context-sensitive instructions are displayed to assist with an efficient driving style.

The achieved extended range is displayed in the instrument cluster as bonus range.

General information

The system includes the following EfficientDynamics functions and EfficientDynamics displays:

- ▷ ECO PRO bonus range, refer to page 227.
- ▷ Activate/deactivate the display, refer to page 227.
- ▷ ECO PRO climate control, refer to page 226.
- ▷ Coasting mode, refer to page 228.
- ▷ Driving style analysis, refer to page 229.

Overview



Driving Dynamics Control

Activating ECO PRO



Press the button repeatedly until ECO PRO is displayed in the instrument cluster.

Configuring ECO PRO

Via the Driving Dynamics Control

1. Activate ECO PRO.
2. "Configure ECO PRO"
3. Select the desired setting.

Via iDrive

1. "My Vehicle"
2. "Vehicle settings"

3. If necessary, "Driving mode"
4. "Configure ECO PRO"
5. Select the desired setting.

Settings are stored for the profile currently used.

Activating/deactivating the functions

The following functions can be activated/deactivated:

- ▷ "ECO PRO speed warning"
- ▷ "ECO PRO climate control"
- ▷ "Coasting"

Settings are stored for the driver profile currently used.

ECO PRO speed

- ▷ "ECO PRO speed warning": activate ECO PRO speed.

An ECO PRO tip is displayed if the speed of the set ECO PRO speed is exceeded.

- ▷ "Tip at:"

Set the desired speed for the ECO PRO speed.

ECO PRO climate control

"ECO PRO climate control"

Climate control is set to be efficient.

This means, it is possible to deviate slightly from the set temperature or to heat or cool down the car's interior more slowly, to economize on consumption.

In addition, the power output of the seat and mirror heating is reduced.

Coasting

Efficiency can be optimized by disengaging the engine and coasting in Neutral.

Deactivate the function to use the braking effect of the engine when traveling downhill.

ECO PRO potential savings

Shows potential savings with the current configuration in percentages.

Display in the instrument cluster

ECO PRO bonus range

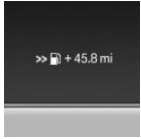

A modified driving style helps you extend your driving range.

The range extension can be displayed as the bonus range in the instrument cluster.

The bonus range is shown in the range display.

The bonus range is automatically reset every time the vehicle is refueled.

ECO PRO efficiency display

The color of the ECO PRO displays in the instrument cluster tell you how efficiently you are driving:

- ▶ Blue display: efficient driving style.
- ▶ Gray display: modify driving style, for example by backing off the accelerator pedal.

The display switches to blue as soon as all conditions for efficient driving are met.

Depending on your vehicle's equipment, the ECO PRO displays also inform you about your current driving style. This is indicated by a needle which moves along a scale. The needle tells you whether energy is being consumed to accelerate the vehicle or whether energy is being recovered through coasting or braking. If the needle remains in the blue range on the scale, you are driving efficiently.

ECO PRO tip, driving tip





The ECO PRO tip indicates that your driving style can be modified to be more efficient, for example by backing off the accelerator.

Activating/deactivating the display

1. "My Vehicle"
2. "iDrive settings"
3. "Displays"
4. "Instrument panel"
5. "ECO PRO info"

ECO PRO tip, symbols

An additional icon and text instructions are displayed.

Icon	Measure
	For efficient driving, accelerate more moderately or decelerate proactively to allow time to assess road conditions.
	Reduce speed to the selected ECO PRO speed.
	Steptronic transmission: Switch from M/S to D and avoid manual shift interventions.

Indications on the Control Display

Displaying EfficientDynamics information

The current operating principle of the ECO PRO functions can be displayed on the Control Display.

Via iDrive:

1. "My Vehicle"
2. "Technology in action"
3. "EfficientDynamics"
4.  Select the icon.

The following functions are displayed:

- ▶ Auto Start/Stop function.
- ▶ Energy recovery.
- ▶ Coasting.

Displaying consumption history



The average consumption can be displayed on the Control Display.

Via iDrive:



1. "My Vehicle"
2. "Technology in action"
3. "EfficientDynamics"
4.  Select the icon.

Vertical bars show consumption for the selected time span.

Adjusting the consumption history time span

1. "My Vehicle"
2. "Technology in action"
3. "EfficientDynamics"
4.  Select the icon.
5.  Press the button.
6. Adjust the time span.

Resetting consumption history

1. "My Vehicle"
2. "Technology in action"
3. "EfficientDynamics"
4.  Select the icon.
5.  Press the button.
6. "Reset consumption history"

Coasting

Principle

Under certain conditions the engine is automatically decoupled from the transmission in the D selector lever position. The vehicle continues traveling in Neutral to reduce consumption. Selector lever position D remains engaged.

This driving condition is referred to as coasting.

As soon as you step on the brake or accelerator pedal, the engine is automatically coupled again.

General information

Coasting is a component of the ECO PRO driving mode.

Coasting is automatically activated when ECO PRO driving mode is called via the Driving Dynamics Control.

A proactive driving style helps the driver to use the function as often as possible and supports the efficient effect of coasting.

Functional requirements

The function is available in the speed range from approx. 15 mph/25 km/h up to 100 mph/160 km/h.

The function is active if the following conditions are met:

- ▶ Accelerator pedal and brake pedal not depressed.
- ▶ The selector lever is in selector lever position D.
- ▶ Engine and transmission are at operating temperature.
- ▶ With a camera in the area of the interior mirror: the system does not detect any vehicles ahead of you.
- ▶ With the route-ahead assistant: the system does not detect any obstructive traffic situations or routes.

Operation via shift paddles

Principle

Depending on your vehicle's equipment, the Coasting mode can be influenced with the shift paddles.

Activating/deactivating coasting via shift paddles

1. Shift to the highest gear by pulling the right shift paddle.
2. To activate Coasting mode, actuate the right shift paddle again.

To deactivate, actuate the left shift paddle.

Display

Display in the instrument cluster

The tachometer shows the idle speed.

The mark in the efficiency display is backlit in blue and is located at the zero point. The coasting point indicator is illuminated at the zero point during coasting.

Indications on the Control Display

The Coasting mode is displayed in EfficientDynamics while driving.

The distance traveled in Coasting mode is shown in the consumption history. The meter reading is reset prior to every departure.

Displaying EfficientDynamics information

Via iDrive:

1. "My Vehicle"
2. "Technology in action"
3. "EfficientDynamics"
4.  Select the icon.

System limits

The function is not available if one of the following conditions applies:

- ▷ DSC OFF or TRACTION activated.
- ▷ If cruise control is activated.
- ▷ If driving in the dynamic limit range.
- ▷ If driving on steep uphill or downhill grades.

- ▷ If the battery charge state is temporarily too low.
- ▷ If the vehicle electrical system is drawing excessive current.

Driving style analysis

Principle

The function helps develop an especially efficient driving style and to conserve fuel.

For this purpose, the driving style is analyzed. The assessment is done in various categories and is displayed on the Control Display.

This display will help you adjust your driving style and save some fuel.

The last 15 minutes of a trip are evaluated.

The range of the vehicle can be extended by adopting an efficient driving style.

This gain in range is displayed as a bonus range in the instrument cluster and on the Control Display.

Functional requirement

This function is available in ECO PRO driving mode.

Calling up ECO PRO Driving style analysis

Via iDrive:

1. "My Vehicle"
2. "Technology in action"
3. "Driving style analysis"

Display on the Control Display

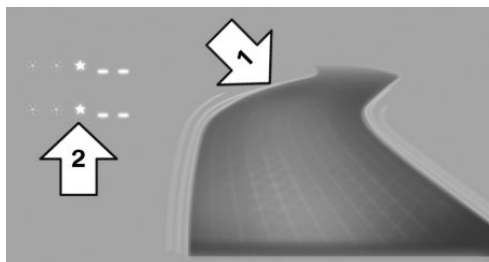

The display of the ECO PRO Driving style analysis consists of a symbolized route and a lookup table.

The road symbolizes the efficiency of the driving style. The more efficient your driving style, the smoother the depicted route becomes, arrow 1.

The table of values contains stars. The more efficient the driving style, the more stars are included in the table and the faster the bonus range increases, arrow 2.

If, on the other hand, the driving style is inefficient, a more wavy road and a reduced number of stars are displayed.

To support an efficient driving style, ECO PRO tips are displayed during driving.

Tips for an energy-saving driving style, Saving fuel, refer to page [224](#).

Refueling

Vehicle features and options

This chapter describes all standard, country-specific and optional features offered with the series. It also describes features and functions that are not necessarily available in your vehicle, e.g., due to the selected options or country versions. This also applies to safety-related functions and systems. When using these functions and systems, the applicable laws and regulations must be observed.

General information

Follow the fuel recommendation, refer to page 234, prior to refueling.

Safety information

NOTICE

With a range below 30 miles/50 km, the engine may no longer have sufficient fuel. Engine functions are not ensured anymore. There is a risk of damage to property, among other potential damage. Refuel promptly.

Fuel cap

Opening

1. To open the fuel filler flap, press on the rear edge, arrow. The fuel filler flap opens.



2. Turn the fuel cap counterclockwise.

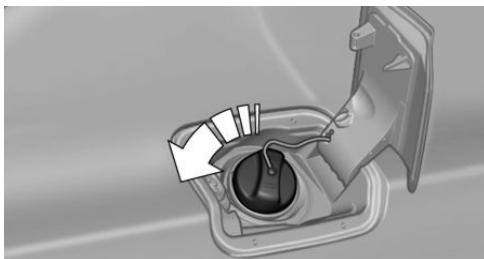

3. Place the fuel cap in the bracket attached to the fuel filler flap.

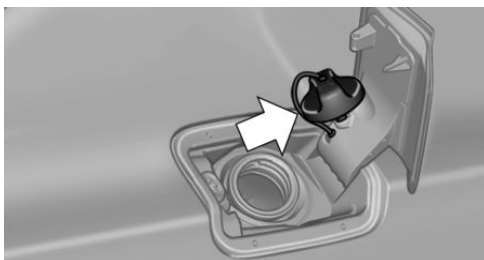

Closing

Warning

The retaining strap of the fuel cap can be jammed and crushed during closing. The cap cannot be correctly closed. Fuel or fuel vapors can escape. There is a risk of injury or risk of damage to property. Pay attention that the retaining strap is not jammed or crushed when closing the cap.

1. Fit the cap and turn it clockwise until you clearly hear a click.
2. Press on the fuel filler flap until it engages.

Emergency unlocking

It may be necessary in certain situations to unlock the fuel filler flap manually, for instance with an electrical malfunction.

Have fuel filler flap unlocked by a dealer's service center or another qualified service center or repair shop.

Follow the following when refueling

General information

When refueling, hook the filler nozzle completely into the filler pipe. Lifting up the filler nozzle during refueling causes:

- ▷ Premature switching off.
- ▷ Reduced return of the fuel vapors.

The fuel tank is full when the filler nozzle clicks off the first time.

Make sure that the fuel cap is closed properly after refueling, otherwise the emissions warning light may light up.

Follow safety regulations posted at the filling station.

Safety information

NOTICE

Fuels are toxic and aggressive. Overfilling of the fuel tank can damage the fuel system. Painted surfaces may be damaged by contact with fuel. Escaping fuel can harm the environment. There is a risk of damage to property, among other potential damage. Avoid overfilling.

Fuel

Vehicle features and options

This chapter describes all standard, country-specific and optional features offered with the series. It also describes features and functions that are not necessarily available in your vehicle, e.g., due to the selected options or country versions. This also applies to safety-related functions and systems. When using these functions and systems, the applicable laws and regulations must be observed.

Fuel recommendation

General information

Depending on the region, many filling stations sell fuel that has been customized to winter or summer conditions. Fuel that is available in winter, for instance helps make a cold start easier.

Gasoline

General information

For the best fuel efficiency, the gasoline should be sulfur-free or very low in sulfur content.

Fuels that are marked on the gas pump as containing metal must not be used.

Fuels with a maximum ethanol content of 25 %, i. e. E10 or E25, may be used for refueling.

To achieve nominal values for mileage and consumption, follow the specified fuel quality in the sales literature.



Ethanol should meet the following quality standards:

US: ASTM 4806–xx

CAN: CGSB-3.511–xx

xx: comply with the current valid standard in each case.

The use of fuels of minimum quality has no influence on the service life of the engine.

Safety information

NOTICE

Even small quantities of the wrong fuel or wrong fuel additives can damage the fuel system and engine. Furthermore, the catalytic converter is permanently damaged. There is a risk of damage to property, among other potential damage. Do not refuel or add the following in the case of gasoline engines:

- ▷ Leaded gasoline.
- ▷ Metallic additives, for instance manganese or iron.

Do not press the Start/Stop button after refueling with the wrong fuel. Contact a dealer's service center or another qualified service center or repair shop.

⚠ NOTICE

Incorrect fuels can damage the fuel system and the engine. There is a risk of damage to property, among other potential damage. Do not use fuels with a higher ethanol content than recommended. Do not refuel with fuels containing methanol, e.g. M5 to M100.

⚠ NOTICE

Fuel that does not comply with the minimum quality can compromise engine function or cause engine damage. There is a risk of damage to property, among other potential damage. Do not fill with fuel that does not comply with the minimum quality.

⚠ CAUTION

The use of poor-quality fuels may result in harmful engine deposits or damage. Additionally, problems relating to drivability, starting and stalling, especially under certain environmental conditions such as high ambient temperature and high altitude, may occur.

If drivability problems are encountered, we recommend switching to a high quality gasoline brand and a higher octane grade — AKI number — for a few tank fills. To avoid harmful engine deposits, it is highly recommended to purchase gasoline from Top Tier retailers.

Failure to comply with these recommendations may result in the need for additional maintenance.

Minimum fuel grade

BMW recommends AKI 87.

If you use gasoline with this minimum AKI Rating, the engine may produce knocking sounds when starting at high external temperatures. This has no effect on the engine life.

**BMW recommends
Shell Quality Fuels** **Recommended gas quality**

BMW recommends AKI 91.

M Performance model:

BMW recommends AKI 93.

Wheels and tires

Vehicle features and options

This chapter describes all standard, country-specific and optional features offered with the series. It also describes features and functions that are not necessarily available in your vehicle, e.g., due to the selected options or country versions. This also applies to safety-related functions and systems. When using these functions and systems, the applicable laws and regulations must be observed.

Tire pressure

General information

The tire inflation pressure and tire condition influence the following:

- ▶ The service life of the tires.
- ▶ Driving safety.
- ▶ Driving comfort.
- ▶ Driving dynamics.
- ▶ Fuel consumption.

Safety information

Warning

A tire with too little or no tire inflation pressure may heat up significantly and sustain damage. This will have a negative impact on aspects of handling, such as steering and braking response. There is a risk of accident. Regularly check the tire inflation pressure, and correct it as needed, for instance twice a month and before a long trip.

Tire pressure specifications

In the tire inflation pressure table

The tire inflation pressure table, refer to page 237, contains all tire inflation pressure specifications for the specified tire sizes at the ambient temperature. The tire inflation pressure values apply to tire sizes approved by the manufacturer of the vehicle for the vehicle type.

To identify the correct tire inflation pressure, please note the following:

- ▶ Tire sizes of your vehicle.
- ▶ Maximum speed for driving.

Checking the tire pressure

General information

Tires heat up while driving. The tire pressure increases with the tire temperature.

Tires have a natural, consistent tire pressure loss.

The displays of inflation devices may under-read by up to 0.1 bar/2 psi.

Checking using tire inflation pressure specifications in the tire inflation pressure table

The tire inflation pressure specifications in the tire inflation pressure table only relate to cold tires or tires at the same temperature as the ambient temperature.

Only check the tire inflation pressure levels when the tires are cold, i.e.:

- ▶ Distance travelled of max. 1.25 miles/2 km has not been exceeded.
- ▶ If the vehicle has not moved again for at least 2 hours after a trip.

Also check the tire inflation pressure of the emergency wheel in the cargo area regularly, and correct it as needed.

1. Determine the intended tire inflation pressure levels for the mounted tires.
2. Check the tire inflation pressure in all four tires, using a pressure gage, for example.
3. Correct the tire inflation pressure if the actual tire inflation pressure deviates from the intended tire inflation pressure.
4. Check whether all valve caps are screwed onto the tire valves.

After correcting the tire pressure

For flat tire monitor: reinitialize flat tire monitor.

For Tire Pressure Monitor: reset the Tire Pressure Monitor.

Tire inflation pressures up to 100 mph/160 km/h

For speeds of up to 100 mph/160 km/h and for optimum driving comfort, note the tire inflation pressure values in the tire inflation pressure table, refer to page 237, and adjust as necessary.





These tire inflation pressure values can also be found on the tire pressure label on the driver's door pillar.

Do not exceed a speed of 100 mph/160 km/h.

Tire pressure values up to 100 mph/160 km/h

X2 sDrive28i, X2 xDrive28i

Tire size	Pressure specifications in bar/PSI	
Specifications in bar/PSI with cold tires		
		
225/50 R 18 95 V A/S	2.2 / 32	2.2 / 32
225/50 R 18 95 H M+S		
225/45 R 19 96 Y XL	2.5 / 36	2.5 / 36
225/45 R 19 96 H XL A/S		
205/55 R 18 96 H XL M+S		
225/45 R 19 96 W XL		
225/45 R 19 96 V XL M+S		
225/40 R 20 94 Y XL	2.7 / 39	2.7 / 39
Emergency wheel:	Speed up to a max. of 50 mph / 80 km/h	
T 115/95 R 17 95 M	4.2 / 60	

X2 M35i

Tire size	Pressure specifications in bar/PSI	
-----------	------------------------------------	--

Specifications in bar/PSI with cold tires

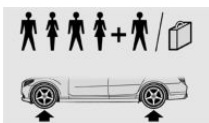

225/45 R 19 96 Y XL	2.5 / 36	2.5 / 36
---------------------	----------	----------

225/45 R 19 96 H XL A/S		
-------------------------	--	--

225/45 R 19 96 W XL		
---------------------	--	--

205/55 R 18 96 H XL M+S		
-------------------------	--	--

225/45 R 19 96 V XL M+S		
-------------------------	--	--

225/40 R 20 94 Y XL	2.7 / 39	2.7 / 39
---------------------	----------	----------

Tire inflation pressures at max. speeds above 100 mph/160 km/h

Warning

In order to drive at maximum speeds in excess of 100 mph/160 km/h, please observe, and, if necessary, adjust tire pressures for speeds exceeding 100 mph/160 km/h from the relevant table on the following pages. Otherwise, tire damage and accidents could occur.

For speeds over 100 mph/160 km/h and for optimum driving comfort, note the pressure values in the tire pressure table, refer to page 238, and adjust as necessary.

Tire pressure values over 100 mph/160 km/h

X2 sDrive28i, X2 xDrive28i

Without high-speed tuning feature

Tire size	Pressure specifications in bar/PSI	
-----------	------------------------------------	--

Specifications in bar/PSI with cold tires

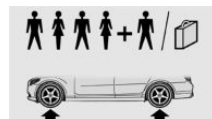

225/50 R 18 95 V A/S	2.5 / 36	2.5 / 36
----------------------	----------	----------

225/50 R 18 95 H M+S		
----------------------	--	--

225/45 R 19 96 Y XL		
---------------------	--	--

225/45 R 19 96 H XL A/S	2.8 / 41	2.8 / 41
-------------------------	----------	----------

205/55 R 18 96 H XL M+S		
-------------------------	--	--

225/45 R 19 96 V XL M+S		
-------------------------	--	--

225/40 R 20 94 Y XL		
---------------------	--	--

Emergency wheel:	Speed up to a max. of 50 mph / 80 km/h
------------------	--

T 115/95 R 17 95 M	4.2 / 60
--------------------	----------

With high-speed tuning feature

Tire size **Pressure specifications in bar/PSI**

Specifications in bar/PSI with cold tires

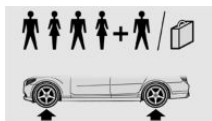
 225/50 R 18 95 2.8 / 41 2.8 / 41
 V A/S

 225/50 R 18 95
 H M+S

 225/45 R 19 96
 H XL A/S

 225/45 R 19 96
 Y XL

 205/55 R 18 96
 H XL M+S

 225/45 R 19 96 3.1 / 45 3.1 / 45
 W XL

 225/45 R 19 96
 V XL M+S

 225/40 R 20 94
 Y XL

 Emergency Speed up to a max. of
 wheel: 50 mph / 80 km/h

 T 115/95 R 17 95 4.2 / 60
 M

X2 M35i

Without high-speed tuning feature

Tire size **Pressure specifications in bar/PSI**

Specifications in bar/PSI with cold tires

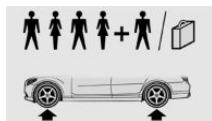
 225/45 R 19 96 2.5 / 36 2.5 / 36
 Y XL

 225/45 R 19 96 2.8 / 41 2.8 / 41
 H XL A/S

 205/55 R 18 96
 H XL M+S

 225/45 R 19 96
 V XL M+S

 225/40 R 20 94
 Y XL

With high-speed tuning feature

Tire size **Pressure specifications in bar/PSI**

Specifications in bar/PSI with cold tires

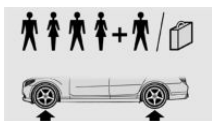
 225/45 R 19 96 2.8 / 41 2.8 / 41
 Y XL

 205/55 R 18 96
 H XL M+S

 225/45 R 19 96 3.1 / 45 3.1 / 45
 W XL

 225/45 R 19 96
 V XL M+S

 225/40 R 20 94
 Y XL

Tire marking

Tire size

245/45 R 18 96 Y

245: nominal width in mm

45: cross-sectional relationship in %

R: radial tire code

18: rim diameter in inches

96: load bearing capacity

Y: speed code letter

ZR tires: reinforced radial tire for speeds exceeding 150 mph/240 km/h

Maximum tire load

Maximum tire load is the maximum permissible weight for which the tire is approved.

Locate the maximum tire load on the tire sidewall and the Gross Axle Weight Rating – GAWR – on the certification label on the driver's door pillar.

Divide the tire load by 1.1. It must be greater than one-half of the vehicle's Gross Axle Weight Rating – GAWR. Note, front vs. rear GAWR and tire loads, respectively.

Speed letter

Designation	Maximum speed
Q	up to 100 mph/160 km/h
R	up to 106 mph/170 km/h
S	up to 112 mph/180 km/h
T	up to 118 mph/190 km/h
H	up to 131 mph/210 km/h
V	up to 150 mph/240 km/h
W	up to 167 mph/270 km/h
Y	up to 186 mph/300 km/h

Tire Identification Number

DOT code: DOT xxxx xxx 0122

xxxx: manufacturer code for the tire brand

xxx: tire size and tire design

0122: tire age

Tires with DOT codes meet the guidelines of the U.S. Department of Transportation.

Tire age

Recommendation

Regardless of the tire tread depth, replace tires at least every 6 years.

Manufacture date

You can find the manufacture date of the tire on the tire sidewall.

Designation	Manufacture date
DOT ... 0122	1st week 2022

Uniform Tire Quality Grading

Quality grades can be found where applicable on the tire sidewall between tread shoulder and maximum section width.

E.g.: Treadwear 200; Traction AA; Temperature A

DOT Quality Grades

Treadwear

Traction AA A B C

Temperature A B C

All passenger vehicle tires must conform to Federal Safety Requirements in addition to these grades.

Treadwear

The treadwear grade is a comparative rating based on the wear rate of the tire when tested under controlled conditions on a specified government test course. E.g., a tire graded 150

would wear one and one-half, 1 g, times as well on the government course as a tire graded 100. The relative performance of tires depends upon the actual conditions of their use, however, and may depart significantly from the norm due to variations in driving habits, service practices and differences in road characteristics and climate.

Traction

The traction grades, from highest to lowest, are AA, A, B, and C.

Those grades represent the tire's ability to stop on wet pavement as measured under controlled conditions on specified government test surfaces of asphalt and concrete. A tire marked C may have poor traction performance.

The traction grade assigned to this tire is based on straight-ahead braking traction tests, and does not include acceleration, cornering, hydroplaning, or peak traction characteristics.

Temperature

The temperature grades are A, the highest, B, and C, representing the tire's resistance to the generation of heat and its ability to dissipate heat when tested under controlled conditions on a specified indoor laboratory test wheel. Sustained high temperature can cause the material of the tire to degenerate and reduce tire life, and excessive temperature can lead to sudden tire failure. The grade C corresponds to a level of performance which all passenger car tires must meet under the Federal Motor Vehicle Safety Standard No. 109. Grades Band A represent higher levels of performance on the laboratory test wheel than the minimum required by law.

Warning

The temperature grade for this tire is established for a tire that is properly inflated and not overloaded. Excessive speed, underinflation, or excessive loading, either separately or in combination, can cause heat buildup and possible tire failure.

Runflat tires

Runflat tires, refer to page 244, are labeled with a circular icon containing the letters RSC marked on the tire sidewall.

M+S

Winter and all-season tires with better cold weather performance than summer tires.

Tire tread

Summer tires

Do not drive with a tire tread depth of less than 0.12 in/3 mm, otherwise there is an increased risk of aquaplaning.

Winter tires

Do not drive with a tire tread depth of less than 0.16 in/4 mm, as such tires are less suitable for winter driving conditions.

Minimum tread depth

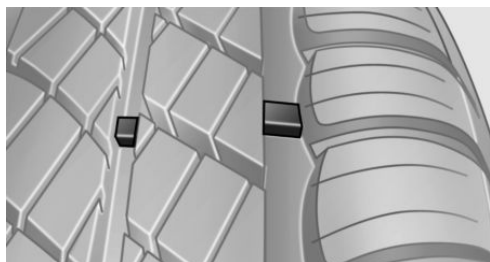

Distributed over the tire circumference are the tire manufacturer's wear indicators with a height of at least 0.06 in/1.6 mm, which serve as an indicator of tire tread wear.

The positions of the wear indicators are marked on the tire sidewall with TWI, Tread Wear Indicator.

Irrespective of the wear indicators, observe the statutory regulations on the minimum tread depth.

Tire damage

General information

Check your tires regularly for damage, foreign bodies lodged in the tread, and tread wear.

Driving over rough or damaged road surfaces, as well as debris, curbs and other obstacles can cause serious damage to wheels, tires and suspension parts. This is more likely to occur with low-profile tires, which provide less cushioning between the wheel and the road. Be careful to avoid road hazards and reduce your speed, especially if your vehicle is equipped with low-profile tires.

Indications of tire damage or other vehicle malfunctions:

- ▶ Unusual vibrations.
- ▶ Unusual tire or running noises.

- ▶ Unusual handling such as a strong tendency to pull to the left or right.
- ▶ Uneven wear pattern, e.g., increased wear in the area of the tire shoulder.

Damage can be caused by the following situations, for instance:

- ▶ Driving over curbs.
- ▶ Road damage.
- ▶ Tire pressure too low.
- ▶ Vehicle overloading.
- ▶ Incorrect tire storage.

Safety information

Warning

Damaged tires can lose tire inflation pressure, which can lead to loss of vehicle control. There is a risk of accident. If tire damage is suspected while driving, immediately reduce speed and stop. Have wheels and tires checked. For this purpose, drive carefully to the nearest dealer's service center or another qualified service center or repair shop. Have vehicle towed or transported as needed. Do not repair damaged tires, but have them replaced.

Warning

Tires can become damaged by driving over obstacles, e.g., curbs or road damage, at high speed. Larger wheels have a smaller tire cross-section. The smaller the tire cross-section, the higher the risk of tire damage. There may be a risk of accidents and risk of damage to property. If possible, avoid driving over objects or road conditions that may damage tires, or drive over them slowly and carefully.

Exchanging wheels and tires

Installation

Have mounting and wheel balancing carried out by a dealer's service center or another qualified service center or repair shop.

Approved wheels and tires

General information

The following properties are recommended and approved by the manufacturer of the vehicle for the approved wheels and tires per vehicle type and special equipment:

- ▷ Wheel and tire combinations.
- ▷ Rim designs.
- ▷ Tire sizes.
- ▷ Tire brands.

You can ask a dealer's service center or another qualified service center or repair shop about the approved wheels and tires for the vehicle and the special equipment.

Safety information

Warning

Wheels and tires which are not suitable for your vehicle can damage parts of the vehicle, for instance due to contact with the body due to tolerances despite the same official size rating. There is a risk of an accident. The manufacturer of your vehicle strongly suggests that you use wheels and tires that have been recommended by the vehicle manufacturer for your vehicle type.

Warning

Incorrect wheel/tire combinations will impair the vehicle's handling characteristics and a variety of system functions, such as the Anti-lock Braking System or Dynamic Stability Control. There is a risk of accident. To maintain good handling and vehicle response, use only tires with a single tread configuration from a single manufacturer. The manufacturer of the vehicle recommends that you use wheels and tires that have been recommended by the vehicle manufacturer for your vehicle type. Following tire damage, have the original wheel/tire combination remounted on the vehicle as soon as possible.

Recommended tire brands



For each tire size, the manufacturer of the vehicle recommends certain tire brands. The tire brands can be identified by a star on the tire sidewall.

New tires

Tire traction is not optimal due to manufacturing circumstances when tires are brand-new; they achieve their full traction potential after a break-in time.

Drive conservatively for the first 200 miles/300 km.

Retreaded tires

Warning

Retreaded tires can have different tire casing structures. With advanced age the service life can be limited. There is a risk of accident.

The manufacturer of the vehicle does not recommend the use of retreaded tires.

Winter tires



Winter tires are recommended for operating on winter roads.

Winter tires can be identified by the symbol with mountain and snowflake, as well as the M+S marking on the tire sidewall.

So-called all-season tires with M+S designation, but without symbol with mountain and snowflake, have better winter characteristics than summer tires but generally do not achieve the performance of winter tires.

Maximum speed of winter tires

If the maximum speed of the vehicle is higher than the permissible speed for the winter tires, then attach a sign showing the permissible maximum speed in the field of vision. The sign is available from a dealer's service center or another qualified service center or repair shop.

With winter tires mounted, observe and do not exceed the permissible maximum speed.

Changing runflat tires

When changing from runflat tires to standard tires, it must be ensured that the vehicle contains an emergency wheel or tire mobility kit. Further information is available from a dealer's service center or another qualified service center or repair shop.

Wheel change between axles

Different abrasion patterns can occur on the front and rear axles depending on individual driving conditions. The tires can be rotated in pairs between the axles to achieve even abrasion. Further information is available from a dealer's service center or another qualified service center or repair shop. After changing, check the tire pressure and correct, if needed.

Storing tires

Tire pressure

Do not exceed the maximum tire inflation pressure indicated on the tire sidewall.

Storage

- ▶ Store wheels and tires in a cool, dry and dark place.
- ▶ Always protect tires against all contact with oil, grease, and solvents.
- ▶ Do not leave tires in plastic bags.
- ▶ Remove dirt from wheels or tires.

Runflat tires

Principle

Runflat tires permit continued driving under limited conditions even in the event of a complete tire pressure loss.

General information

The wheels consist of tires that are self-supporting, to a limited degree, and possibly special rims.

The reinforcement of the sidewall allows the tire to remain drivable to a limited degree in the event of a tire pressure loss.

Follow the instructions for continued driving with a flat tire.

Safety information

Warning

The vehicle handles differently when a runflat tire has insufficient or no tire pressure; for instance, reduced directional stability when braking, braking distances are longer and the self-steering properties will change. There is a risk of accident. Drive moderately and do not exceed a speed of 50 mph/80 km/h.

Identification



Runflat tires are labeled with a circular icon containing the letters RSC marked on the tire sidewall.

Repairing a flat tire

Safety precautions

- ▶ Park the vehicle as far away as possible from passing traffic and on solid ground.
- ▶ Turn on the hazard warning system.
- ▶ Secure the vehicle against rolling away by setting the parking brake.
- ▶ Turn the steering wheel until the front wheels are in the straight-ahead position and engage the steering wheel lock.
- ▶ Have all vehicle occupants get out of the vehicle and ensure that they remain outside the hazardous area in a safe place, such as behind a guardrail.
- ▶ If necessary, set up a warning triangle at an appropriate distance.

Tire repair set

Principle

With the tire repair set, minor tire damage can be sealed temporarily to enable continued driving. To accomplish this, sealing compound is pumped into the tires, which hardens and seals the damage from the inside.

General information

- ▶ Follow the instructions on using the tire repair set found on the compressor and sealant bottle.
- ▶ Use of the tire repair set may be ineffective if the tire puncture measures approx. 4 mm or more.
- ▶ Contact a dealer's service center or another qualified service center or repair shop if the tire cannot be made drivable.
- ▶ Do not remove foreign objects that have penetrated the tire. Only remove foreign bodies if they are visibly protruding from the tire.

- ▶ Detach the speed limit sticker from the sealant bottle and apply it to the steering wheel.
- ▶ The use of a sealing compound can damage the wheel electronics. In this case, have the wheel electronics replaced at the next opportunity.
- ▶ The compressor can be used to check the tire inflation pressure.

Overview

Storage

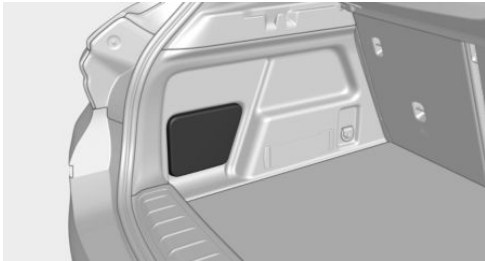

The tire repair set is located in the cargo area behind the left side trim panel.

Sealant bottle

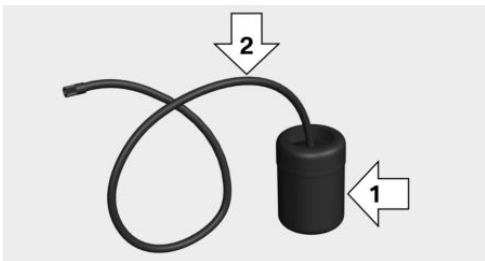

- ▶ Sealant bottle, arrow 1.
- ▶ Filler hose, arrow 2.

Observe expiration date on the sealant bottle.

Compressor

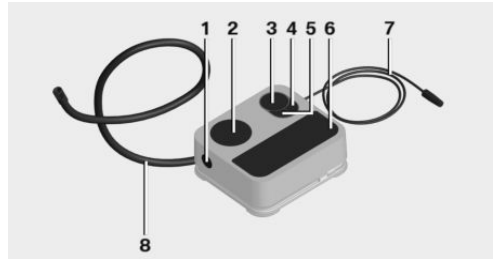

- 1 Sealant bottle unlocking
- 2 Sealant bottle mount
- 3 Tire pressure display
- 4 Reduce tire inflation pressure button
- 5 On/off switch
- 6 Compressor
- 7 Connector/cable for socket
- 8 Connection hose

Filling the tire with sealing compound

Safety information

DANGER

If the exhaust pipe is blocked or ventilation is insufficient, harmful exhaust gases can penetrate the vehicle. The exhaust gases contain pollutants which are colorless and odorless. In enclosed areas, exhaust gases can also accumulate outside of the vehicle. There is a danger to life. Keep the exhaust pipe free and ensure sufficient ventilation.

⚠ NOTICE

The compressor can overheat during extended operation. There is a risk of damage to property, among other potential damage. Do not run the compressor for more than 10 minutes.

Filling

1. Shake the sealant bottle.



2. Pull filler hose completely out of the cover of the sealant bottle. Do not kink the hose.

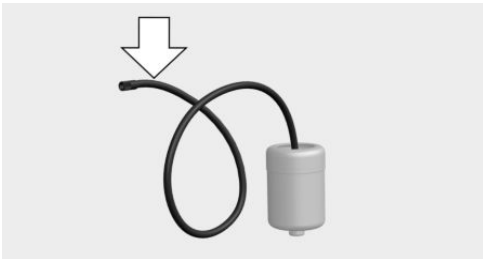

3. Slide the sealant bottle into the mount on the compressor housing, ensuring that it engages audibly.

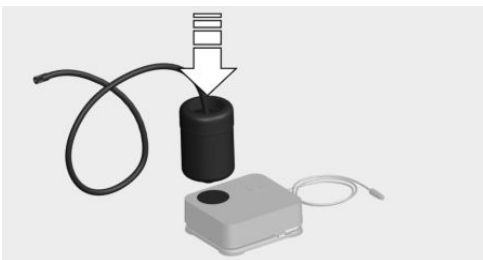

4. Screw the filler hose of the sealant bottle onto the tire valve of the faulty wheel.

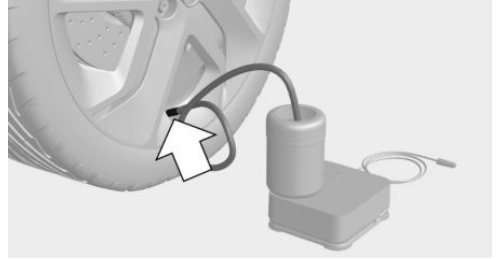

5. With the compressor switched off, insert the connector into the power socket in the vehicle interior.

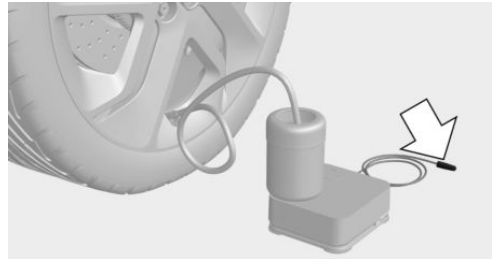

6. With the ignition switched on or the engine running, switch on the compressor.

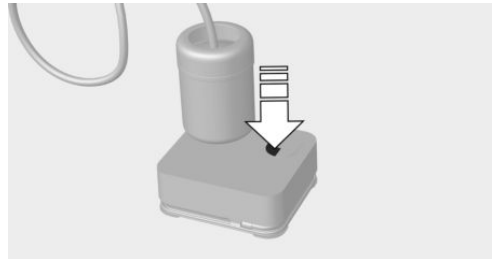

Let the compressor run for max. 10 minutes to fill the tire with sealing compound and achieve a tire inflation pressure of approx. 2.0 bar.

While the tire is being filled with sealing compound, the tire inflation pressure may sporadically reach approx. 5 bar. Do not switch off the compressor in this phase.

Checking and adjusting the tire inflation pressure

Checking

1. Switch off the compressor.
2. Read the tire pressure on the tire pressure display.

To continue the trip, a tire inflation pressure of at least 2 bar must be reached.

Removing and stowing the sealant bottle

1. Unscrew the filler hose of the sealant bottle from the tire valve.
2. Press the red unlocking device.
3. Remove the sealant bottle from the compressor.
4. Wrap and store the sealant bottle in suitable material to avoid contamination of the cargo area.

Minimum tire inflation pressure is not reached

1. Pull the connector out of the power socket in the vehicle interior.
2. Drive 33 ft/10 m forward and back to distribute the sealing compound in the tire.
3. Screw the connection hose of the compressor directly onto the tire valve stem.

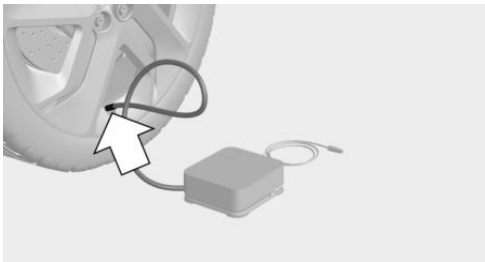

4. Insert the connector into the power socket in the vehicle interior.

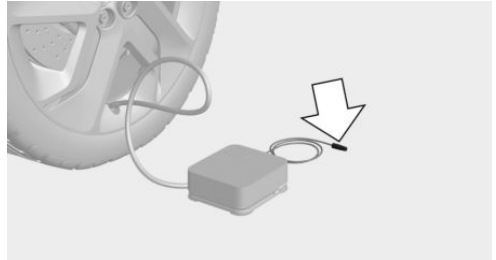

5. With the ignition turned on or the engine running, turn on the compressor and let it run for a maximum of 10 minutes.
If a tire inflation pressure of at least 2 bar cannot be reached, contact a dealer's service center or another qualified service center or repair shop.
If a tire inflation pressure of at least 2 bar is reached, see Minimum tire inflation pressure is reached.
6. Unscrew the connection hose of the compressor from the tire valve.
7. Pull the connector out of the power socket in the vehicle interior.
8. Stow the tire repair set in the vehicle.

Minimum tire inflation pressure is reached

1. Unscrew the connection hose of the compressor from the tire valve.
2. Pull the connector out of the power socket in the vehicle interior.
3. Stow the tire repair set in the vehicle.
4. Immediately drive approx. 5 miles/10 km to ensure that the sealing compound is evenly distributed in the tire.

Do not exceed a speed of 50 mph/80 km/h.

If possible, do not drive at speeds less than 12 mph/20 km/h.

Adjustment

1. Stop at a suitable location.
2. Screw the connection hose of the compressor directly onto the tire valve stem.

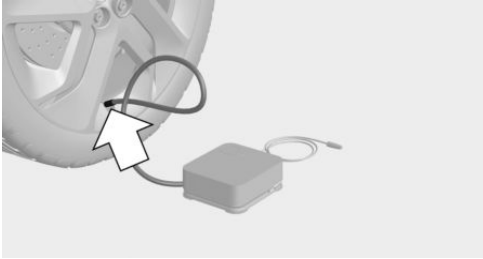

3. Insert the connector into the power socket in the vehicle interior.

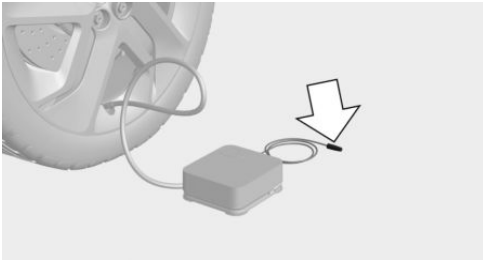

4. Correct the tire inflation pressure to at least 2.0 bar.
 - ▶ Increase tire pressure: with the ignition turned on or the engine running, turn on the compressor and let it run for a maximum of 10 minutes.
 - ▶ To reduce the pressure: press the button on the compressor.
5. Unscrew the connection hose of the compressor from the tire valve.
6. Pull the connector out of the power socket in the vehicle interior.
7. Stow the tire repair set in the vehicle.

Continuing the trip

Do not exceed the permissible maximum speed of 50 mph/80 km/h.

Reinitialize the Flat Tire Monitor.

Reset the Tire Pressure Monitor again.

Replace the faulty tire and the sealant bottle of the tire repair set as soon as possible.

Tire chains

Safety information

Warning

With the mounting of tire chains on unsuitable tires, the tire chains can come into contact with vehicle parts. There may be a risk of accident or risk of damage to property. Only mount tire chains on tires that are designated by their manufacturer as suitable for the use of tire chains.

Warning

Insufficiently tight tire chains may damage tires and vehicle components. There may be a risk of accident or risk of damage to property. Make sure that the tire chains are always sufficiently tight. Re-tighten as needed according to the tire chain manufacturer's instructions.

Fine-link tire chains

The manufacturer of the vehicle recommends the use of fine-link tire chains. Certain types of fine-link tire chains have been tested by the manufacturer of the vehicle and recommended as road-safe and suitable.

Information regarding suitable tire chains is available from a dealer's service center or another qualified service center or repair shop.

Use

Use only in pairs on the front wheels, equipped with the tires of the following size:

► 205/55 R 18.

Follow the tire chain manufacturer's instructions.

Do not initialize the flat tire monitor after mounting tire chains, as doing so may result in incorrect readings.

Do not reset the Tire Pressure Monitor after mounting tire chains, as doing so may result in incorrect readings.

When driving with tire chains, activate Dynamic Traction Control temporarily.

Maximum speed with tire chains

Do not exceed a speed of 30 mph/50 km/h when using tire chains.

Changing wheels/tires

General information

When using runflat tires or a flat tire kit, a wheel does not always need to be changed immediately in case of a breakdown when there is a tire pressure loss due to a flat tire.

If needed, the appropriate tool for a wheel change, e.g., a jack, is available as an accessory from a dealer's service center, another qualified service center or a repair shop.

Safety information

DANGER

The jack is only provided for short-term lifting of the vehicle for wheel changes. Even if all safety precautions are observed, there is a risk of the raised vehicle falling, if the jack tips over. There is a risk of injury or danger to life.

If the vehicle is raised with the jack, do not lie under the vehicle and do not start the engine.

Warning

Supports such as wooden blocks under the jack reduce the load-carrying capacity of the jack to bear weight. The load-carrying capacity of the wooden blocks may be exceeded and the vehicle may tip over. There is a risk of injury or danger to life. Do not place supports under the jack.

Warning

The jack, issued by the vehicle manufacturer, is provided in order to perform a wheel change in the event of a breakdown. The jack is not designed for frequent use; for example, changing from summer to winter tires. Using the jack frequently may cause it to become jammed or damaged. There is a risk of injury and risk of damage to property. Only use the jack to change an emergency or spare wheel in the event of a breakdown.

Warning

On soft, uneven or slippery ground, for example snow, ice, tiles, etc., the jack can slip away. There is a risk of injury. If possible, change the wheel on a flat, solid, and slip-resistant surface.

Warning

The jack is optimized for lifting the vehicle and for the jacking points on the vehicle only. There is a risk of injury. Do not lift any other vehicle or cargo using the jack.

⚠ Warning

When the jack is not inserted into the jacking point provided for this purpose, the vehicle may be damaged or the jack may slip when it is being cranked up. There is a risk of injury or risk of damage to property. When cranking up the jack, ensure that it is inserted in the jacking point next to the wheel well.

⚠ Warning

A vehicle that is raised on a jack may fall off of the jack if lateral forces are exerted on it. There is a risk of injury and risk of damage to property. While the vehicle is raised, do not exert lateral effort on the vehicle or pull abruptly on the vehicle. Have a stuck wheel removed by a dealer's service center or another qualified service center or repair shop.

Securing the vehicle against rolling away

General information

The vehicle manufacturer recommends to additionally secure the vehicle against rolling away when changing a wheel.

On a level surface

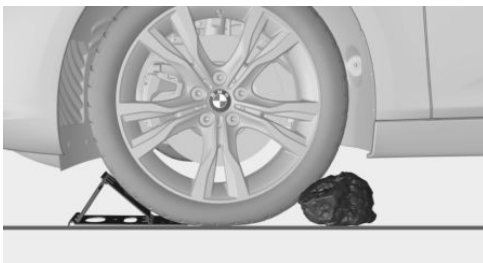

Place chocks or other suitable objects, for example rocks, in front of and behind the wheel

that is diagonally opposite to the wheel that you wish to change.

On a slight downhill gradient

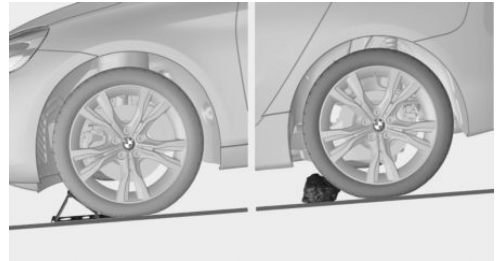

If you need to change a wheel on a slight downhill grade, place chocks and other suitable objects, for instance rocks, under the wheels of both the front and rear axles against the rolling direction.

Lug bolt lock

Principle

The wheel lug bolts have a special coding. The lug bolts can only be released with the adapter which matches the coding.

Overview

The adapter of the lug bolt lock is in the on-board vehicle tool kit or in a storage compartment close to the onboard vehicle tool kit.

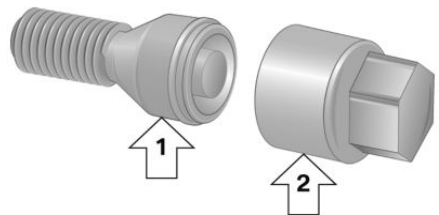

- ▷ Lug bolt, arrow 1.
- ▷ Adapter, arrow 2.

Unscrewing

1. Attach the adapter to the lug bolt.
2. Unscrew the lug bolt.
3. Remove the adapter after unscrewing the lug bolt.

Screwing on

1. Attach the adapter to the lug bolt. If necessary, turn the adapter until it fits on the lug bolt.
2. Screw on the lug bolt. The tightening torque is 101 lbs ft/140 Nm.
3. Remove the adapter and stow it after screwing on the lug bolt.

Preparing the vehicle

- ▷ Park the vehicle on solid and non-slip ground at a safe distance from road traffic.
- ▷ Turn on the hazard warning system.
- ▷ Set the parking brake.
- ▷ Engage a gear or move the selector lever to position P.
- ▷ As soon as permitted by the traffic flow, have all vehicle occupants get out of the vehicle and ensure that they remain outside the hazardous area in a safe place, such as behind a guardrail.
- ▷ Depending on the vehicle equipment, get wheel change tools and, if necessary, the emergency wheel from the vehicle.
- ▷ If necessary, set up a warning triangle or portable hazard warning light at an appropriate distance.
- ▷ Secure the vehicle additionally against rolling away.
- ▷ Loosen the lug bolts a half turn.

Jacking points

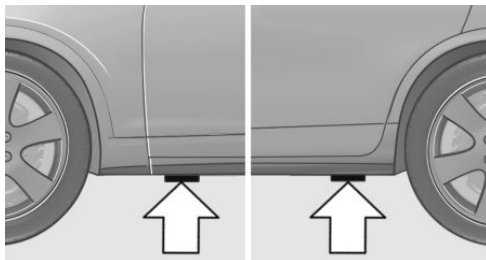

The jacking points are located at the indicated positions.

Jacking up the vehicle

Warning

Hands and fingers can be jammed when using the jack. There is a risk of injury. Comply with the described hand position and do not change this position while using the jack.

1. Hold the jack with one hand, arrow 1, and grasp the jack crank handle with your other hand, arrow 2.

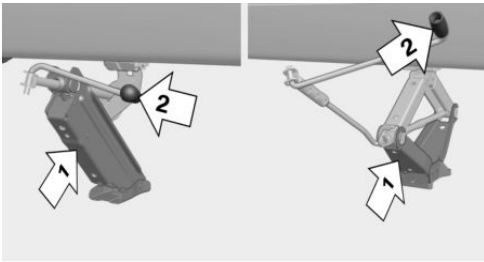

2. Insert the jack into the rectangular recess of the jacking point closest to the wheel to be changed.

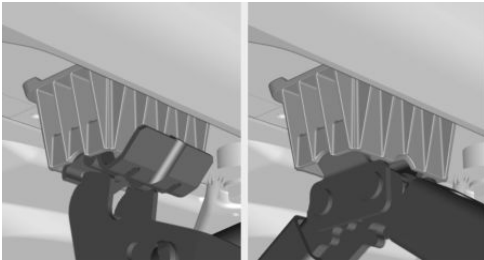

3. Extend the jack by turning the jack crank handle or lever clockwise.

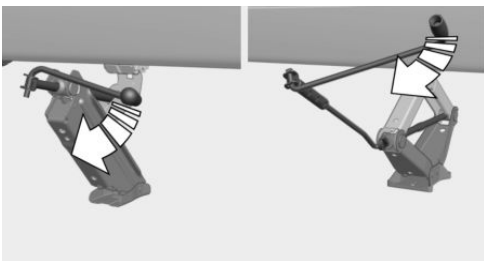

4. Take your hand away from the jack as soon as the jack is under load and continue turning the jack crank handle or lever with one hand.

5. Make sure that the car jack foot stands vertically and at a right angle beneath the jacking point.

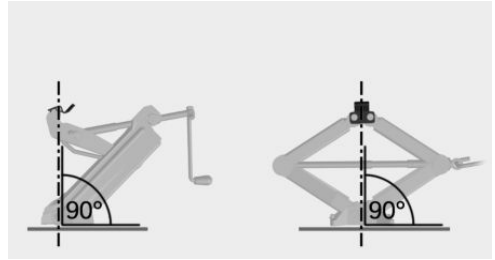

6. Make sure that the car jack foot stands vertically and perpendicularly beneath the jacking point after extending the vehicle jack.

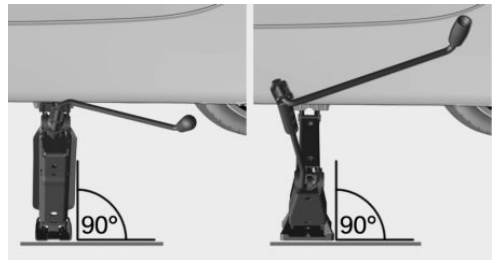

7. Crank the vehicle up, until the vehicle jack is with the entire surface on the ground and the relevant wheel is maximum 1.2 inches/3 cm above ground.

Mounting a wheel

Mount one emergency wheel only, as required.

1. Unscrew the lug bolts.
2. Remove the wheel.
3. Put the new wheel or emergency wheel on and screw in at least two lug bolts in a crosswise pattern until hand-tight.

If non-original light-alloy wheels of the vehicle manufacturer are mounted, the accompanying lug bolts may have to be used as well.

4. Hand-tighten the remaining lug bolts and tighten all lug bolts well in a crosswise pattern.
5. Turn the jack crank handle counterclockwise to retract the jack and lower the vehicle.
6. Remove the jack and stow it securely.

After the wheel change

1. Tighten the lug bolts crosswise. The tightening torque is 101 lbs ft/140 Nm.
2. Stow the faulty wheel in the cargo area, if necessary.
3. Check tire inflation pressure at the next opportunity and correct as needed.
4. Reinitialize the Flat Tire Monitor. Reset the Tire Pressure Monitor again.
5. Check to make sure the lug bolts are tight with a calibrated torque wrench.
6. Have the damaged tire renewed at the nearest dealer's service center or another qualified service center or repair shop.

Emergency wheel

Principle

In the event of a flat tire, the emergency wheel can be used in place of the wheel with the faulty tire. The emergency wheel is only intended for temporary use until the faulty tire/wheel has been replaced.

General information

Mount one emergency wheel only.

Also check the tire inflation pressure of the emergency wheel in the cargo area regularly, and correct it as needed.

Safety information

Warning

The emergency wheel has particular dimensions. When driving with an emergency wheel, changed driving properties may occur, for instance reduced directional stability when braking, longer braking distance, and changed self-steering properties in the limit range. There is a risk of accident. Drive moderately and do not exceed a speed of 50 mph/80 km/h.

Overview

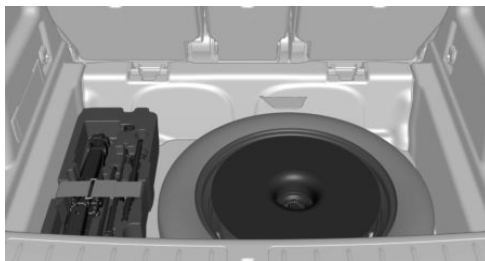

The emergency wheel and the wheel change tools are located in the cargo area under the cargo area floor.

Removing the emergency wheel

1. Pull up and remove the cargo area floor.
2. Unscrew the wing screw.
3. Remove the retaining plate or the cover.
4. Where applicable, remove the holder and the trailer hitch.
5. Remove the jacking point and the tool holder on the left next to the emergency wheel.
6. Slide the emergency wheel to the left and remove it.

Inserting the emergency wheel

1. Insert the emergency wheel on the left and slide it to the right.
2. Where applicable, mount the holder and the trailer hitch.
3. Attach the retaining plate or the cover.
4. Screw on and tighten the wing screw.
5. Insert and secure the jacking point and the tool holder on the left next to the emergency wheel.
6. Insert the cargo area floor.

Engine compartment

Vehicle features and options

This chapter describes all standard, country-specific and optional features offered with the series. It also describes features and functions that are not necessarily available in your vehi-

cle, e.g., due to the selected options or country versions. This also applies to safety-related functions and systems. When using these functions and systems, the applicable laws and regulations must be observed.

Overview

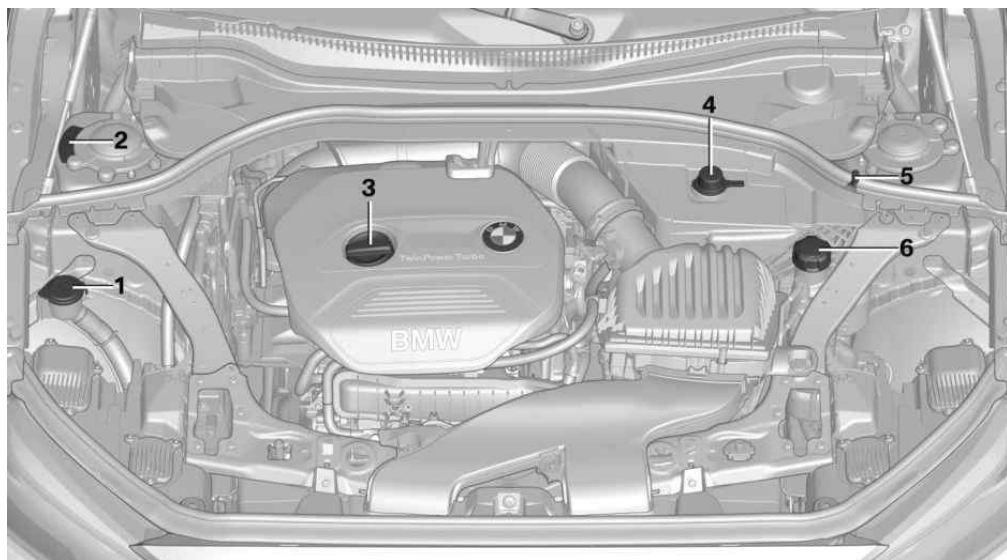

- 1 Filler neck for washer fluid
- 2 Vehicle identification number
- 3 Oil filler neck

- 4 Jump-starting, positive battery terminal
- 5 Jump-starting, negative battery terminal
- 6 Coolant reservoir

Hood

Safety information

Warning

Improperly executed work in the engine compartment can damage vehicle components and impair vehicle functions. There is a risk of an accident and damage to property. Have work in the engine compartment performed by a dealer's service center or another qualified service center or repair shop.

Warning

The engine compartment accommodates moving components. Certain components in the engine compartment can also move with the vehicle switched off, for instance the radiator fan. There is a risk of injury. Do not reach into the area of moving parts. Keep articles of clothing and hair away from moving parts.

Warning

There are protruding parts, for instance locking hooks, on the inside of the hood. There is a risk of injury. If the hood is open, pay attention to protruding parts and keep clear of these areas.

Warning

An incorrectly locked hood can open while driving and restrict the view. There is a risk of accident. Stop immediately and correctly close the hood.

Warning

Body parts can be jammed when opening and closing the hood. There is a risk of injury. Make sure that the travel path of the hood is clear during opening and closing.

NOTICE

Folded-away wipers can be jammed when the hood is opened. There is a risk of damage to property, among other potential damage. Make sure that the wipers with the wiper blades mounted are folded down onto the windshield before opening the hood.

NOTICE

When the hood is closed, it must engage on both sides. Pressing again can damage the hood. There is a risk of damage to property, among other potential damage. Open the hood again and then close it energetically. Avoid pressing again.

Opening the hood

1. Pull lever, arrow 1.
Hood is unlocked.



2. After the lever is released, pull the lever again, arrow 2.
Hood can be opened.

Indicator/warning lights

When the hood is unlocked, a Check Control message is displayed.

Closing the hood

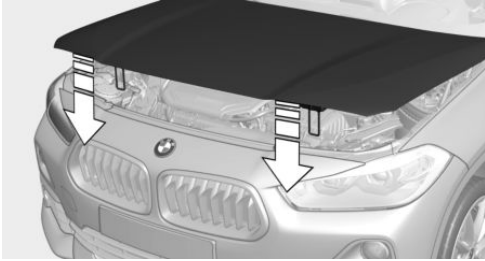

Energetically close the hood from approx. 20 in/50 cm.

The hood must engage on both sides.

Engine oil

Vehicle features and options

This chapter describes all standard, country-specific and optional features offered with the series. It also describes features and functions that are not necessarily available in your vehicle, e.g., due to the selected options or country versions. This also applies to safety-related functions and systems. When using these functions and systems, the applicable laws and regulations must be observed.

General information

The engine oil consumption is dependent on your driving style and driving conditions.

Therefore, regularly check the engine oil level after refueling by taking a detailed measurement.

The engine oil consumption can increase in the following situations, for instance:

- ▶ Sporty driving style.
- ▶ Break-in of the engine.
- ▶ Idle operation of the engine.
- ▶ With use of engine oil types that are classified as not suitable.

Different Check Control messages appear on the Control Display depending on the engine oil level.

The vehicle manufacturer recommends that you have a dealer's service center or another qualified service center or repair shop change the engine oil.

Safety information

NOTICE

An engine oil level that is too low causes engine damage. There is a risk of damage to property, among other potential damage. Immediately add engine oil.

NOTICE

Too much engine oil can damage the engine or the catalytic converter. There is a risk of damage to property, among other potential damage. Do not add too much engine oil. When too much engine oil is added, have the engine oil level corrected by a dealer's service center or another qualified service center or repair shop.

NOTICE

Engine oil that is not changed in timely fashion can cause increased engine wear and thus engine damage. There is a risk of damage to property. It is recommended that you do not exceed the service intervals indicated in the vehicle.

Electronic oil measurement

General information

The electronic oil measurement has two measuring principles:

- ▶ Monitoring.
- ▶ Detailed measurement.

When making frequent short-distance trips or using a dynamic driving style, for instance when cornering aggressively, regularly perform a detailed measurement.

Monitoring

Principle

The engine oil level is monitored electronically while driving and can be shown on the Control Display.

If the engine oil level is outside its permissible operating range, a Check Control message is displayed.

Functional requirements

A current measured value is available after approx. 30 minutes of normal driving.

Displaying the engine oil level

Via iDrive:

1. "My Vehicle"
2. "Vehicle status"
3.  "Engine oil level"

The engine oil level is displayed.

System limits

When making frequent short-distance trips or using a dynamic driving style, it may not be possible to calculate a measured value. In this case, the measured value for the last, sufficiently long trip is displayed.

Detailed measurement

Principle

The engine oil level is checked when the vehicle is stationary and displayed via a scale.

If the engine oil level is outside its permissible operating range, a Check Control message is displayed.

General information

During the measurement, the idle speed is increased somewhat.

Functional requirements

- ▷ Vehicle is parked in a horizontal position.
- ▷ Steptronic transmission: selector lever in selector lever position N or P and accelerator pedal not depressed.
- ▷ Engine is running and is at operating temperature.

Performing a detailed measurement

Via iDrive:

1. "My Vehicle"
2. "Vehicle status"
3.  "Engine oil level"
4. "Measure engine oil level"
5. "Start measurement"

The engine oil level is checked and displayed via a scale.

Adding engine oil

General information

Only add engine oil when the message is displayed in the instrument cluster. The top-up quantity is indicated in the message displayed in the instrument cluster.

Only add suitable types of engine oil.

Safely park the vehicle and switch off the ignition before adding engine oil.

Take care not to add too much engine oil.

Safety information

Warning

Operating materials, for instance oils, greases, coolants, fuels, can contain harmful ingredients. There is a risk of injury or danger to life. Follow the instructions on the containers. Avoid the contact of articles of clothing, skin or eyes with operating materials. Do not refill operating materials into different bottles. Store operating materials out of reach of children.

NOTICE

An engine oil level that is too low causes engine damage. There is a risk of damage to property, among other potential damage. Immediately add engine oil.

NOTICE

Too much engine oil can damage the engine or the catalytic converter. There is a risk of damage to property, among other potential damage. Do not add too much engine oil. When too much engine oil is added, have the engine oil level corrected by a dealer's service center or another qualified service center or repair shop.

Overview

The oil filler neck is located in the engine compartment, refer to page 256.

Adding engine oil

1. Open the hood, refer to page 257.
2. Open the lid counterclockwise.

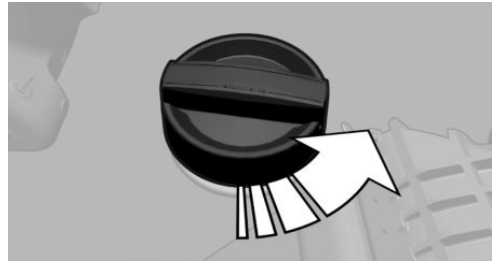

3. Add engine oil.
4. Close the lid.

Engine oil types to add

General information

The engine oil grade is critical for the service life of the engine.

Only add with the types of engine oil which are listed.

Safety information

NOTICE

Oil additives can damage the engine. There is a risk of damage to property, among other potential damage. Do not use oil additives.

NOTICE

Incorrect engine oil can cause malfunctions in the engine or damage it. There is a risk of damage to property, among other potential damage. When selecting an engine oil, make sure that the engine oil has the correct oil specification.

Suitable engine oil types

Up to 1 US quart/liter of an engine oil with the following oil specification can be topped up:

Gasoline engine

BMW Longlife-17 FE+.

Alternative engine oil types

If an engine oil suitable for continuous use is not available, up to 1 US quart/liter of an engine oil with the following oil rating can be added:

Oil specification

API SL.

API SM.

API SN.

Viscosity grades

When selecting an engine oil, make sure that the engine oil has a suitable viscosity grade. The suitable viscosity grade is indicated on a sign in the engine compartment.

Viscosity grades

SAE 0W-20.

More information about suitable oil specifications and viscosity grades of engine oils can be requested from a dealer's service center or another qualified service center or repair shop.

**BMW recommends
Original BMW Engine Oil.**

Coolant

Vehicle features and options

This chapter describes all standard, country-specific and optional features offered with the series. It also describes features and functions that are not necessarily available in your vehicle, e.g., due to the selected options or country versions. This also applies to safety-related functions and systems. When using these functions and systems, the applicable laws and regulations must be observed.

General information

Coolant consists of water and coolant additive. Not all commercially available additives are suitable for the vehicle. The vehicle manufacturer recommends using coolant with the BMW LC-18 specification. Do not mix additives of different colors. Observe the water - additive mixture ratio of 50:50. Information about suitable additives is available from a dealer's service center or another qualified service center or repair shop.

Safety information

Warning

With the engine hot and the cooling system open, coolant can escape and lead to scalding. There is a risk of injury. Only open the cooling system with the engine cooled down.

Warning

Additives are harmful and incorrect additives can damage the engine. There is a risk of injury and risk of damage to property. Do not allow additives to come into contact with skin, eyes or articles of clothing. Use suitable additives only.

Coolant level

Checking

There are yellow minimum and maximum marks in the coolant reservoir.

1. Let the engine cool down.
2. Open the hood.
3. Turn the lid of the coolant reservoir slightly counterclockwise to allow any excess pressure to dissipate, then open it.

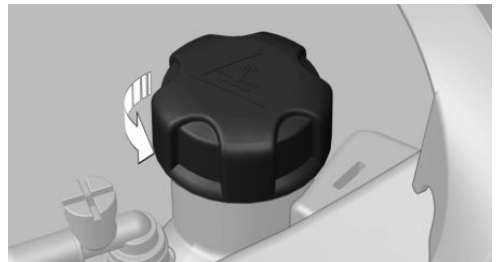

4. Open the coolant reservoir lid.
5. The coolant level is correct if it lies between the minimum and maximum marks in the filler neck.
6. Close the lid.

Adding coolant

1. Let the engine cool down.
2. Open the hood.
3. Turn the lid of the coolant reservoir slightly counterclockwise to allow any excess pressure to dissipate, then open it.

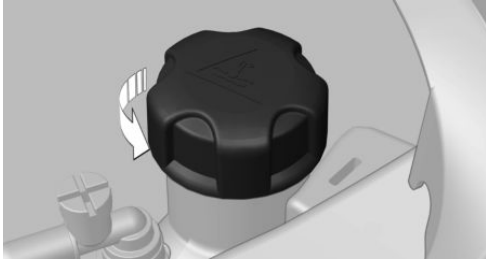

4. If the coolant is low, slowly add coolant up to the specified fill level; do not overfill.
5. Close the lid.
6. Have the cause of the coolant loss eliminated as soon as possible.

Disposal



Comply with the relevant environmental protection regulations when disposing of coolant and coolant additives.

Maintenance

Vehicle features and options

This chapter describes all standard, country-specific and optional features offered with the series. It also describes features and functions that are not necessarily available in your vehicle, e.g., due to the selected options or country versions. This also applies to safety-related functions and systems. When using these functions and systems, the applicable laws and regulations must be observed.

BMW maintenance system

The maintenance system provides service notifications and thereby provides support in maintaining road safety and the operational reliability of the vehicle.

In some cases, scopes and intervals of the maintenance system may vary according to the country version. Replacement work, spare parts, fuels and lubricants, and wear materials are calculated separately. Further information is available from a dealer's service center or another qualified service center or repair shop.

Condition Based Service

Principle

Condition Based Service determines the maintenance recommendation using sensors and special algorithms that take into account the operating conditions of the vehicle.

The system makes it possible to adapt the amount of maintenance corresponding to your user profile.

General information

Information on service notifications, refer to page 126, can be displayed on the Control Display.

Service data in the vehicle key

Information on the service notifications is continuously stored in the vehicle key. The service center can read this data out and suggest a maintenance scope for the vehicle.

Therefore, hand the service advisor the vehicle key with which the vehicle was driven most recently.

Stationary periods

Stationary periods during which the vehicle battery was disconnected are not taken into account.

If this occurs, have a dealer's service center or another qualified service center or repair shop update the time-dependent maintenance procedures, such as checking brake fluid and, if necessary, changing the engine oil and the microfilter/activated-charcoal filter.

Maintenance Booklet for US Models

Please consult your Maintenance Booklet for additional information on the performance of service and maintenance work.

The manufacturer of your vehicle recommends that maintenance and repair be performed by a service center or another qualified service center or repair shop. Records of regular maintenance and repair work should be retained.

Diagnostic socket

General information

Devices connected to the diagnostic socket will trigger the alarm system after locking the vehicle. Remove devices connected to the diagnostic socket before locking the vehicle.

Safety information

NOTICE

The socket for Onboard Diagnosis is an intricate component intended to be used in conjunction with specialized equipment to check the vehicle's primary emissions system. Improper use of the socket for Onboard Diagnosis, or contact with the socket for Onboard Diagnosis for other than its intended purpose, can cause vehicle malfunctions and creates risks of personal and property damage. Given the foregoing, the manufacture of your vehicle strongly recommends that access to the socket for Onboard Diagnosis be limited to a dealer's service center or another qualified service center or repair shop or other persons that have the specialized training and equipment for purposes of properly utilizing the socket for Onboard Diagnosis.

Position

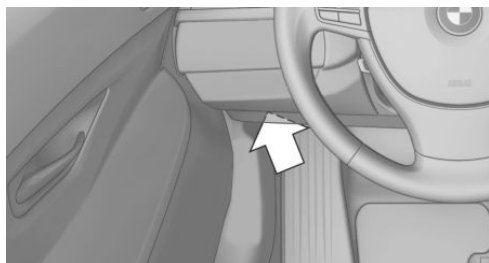

On the driver's side, there is a socket for onboard diagnosis to check components that are relevant for the vehicle's emission mix.

Emissions



- ▶ The warning light lights up: Emissions are deteriorating. Have the vehicle checked as soon as possible.
- ▶ The warning light flashes under certain circumstances: This indicates that there is excessive misfiring in the engine.

Reduce the vehicle speed and have the system checked immediately; otherwise, serious engine misfiring within a brief period can seriously damage emission control components, in particular the catalytic converter.

Replacing components

Vehicle features and options

This chapter describes all standard, country-specific and optional features offered with the series. It also describes features and functions that are not necessarily available in your vehicle, e.g., due to the selected options or country versions. This also applies to safety-related functions and systems. When using these functions and systems, the applicable laws and regulations must be observed.

Onboard vehicle tool kit

Depending on the vehicle equipment, the onboard vehicle tool kit is located:

- ▶ Without emergency wheel: behind the left cover in the cargo area.

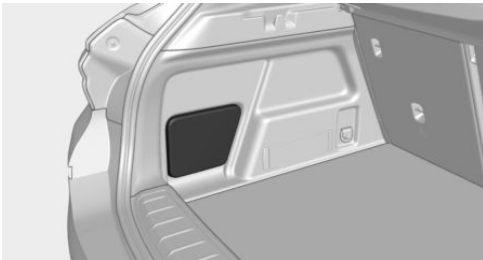

- ▶ With emergency wheel: in the box under the cargo floor panel.

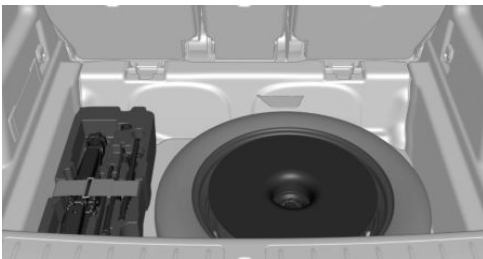

Wiper blades

Safety information

NOTICE

The window may sustain damage if the wiper falls onto it without the wiper blade installed. There is a risk of damage to property, among other potential damage. Hold the wiper firmly when changing the wiper blade. Do not fold in or switch on the wiper without a wiper blade installed.

NOTICE

Folded-away wipers can be jammed when the hood is opened. There is a risk of damage to property, among other potential damage. Make sure that the wipers with the wiper blades mounted are folded down onto the windshield before opening the hood.

Replacing the front wiper blades

1. To change the wiper blades, bring wipers into fold-out position, refer to page 107.
2. Fold up and hold the wiper arm firmly.
3. Press the button, arrow 1, and swing out the wiper blade, arrow 2.

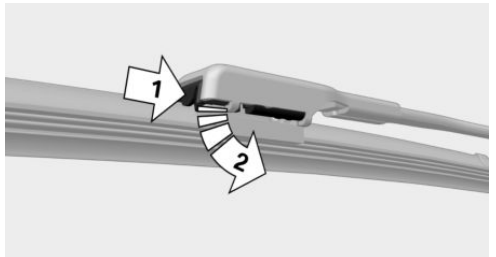

4. Attach a new wiper blade. The wiper blade must engage audibly.
5. Fold in the wiper arm.

Replacing the rear wiper blade

1. Lift the wiper up fully and detach the wiper blade, arrow.

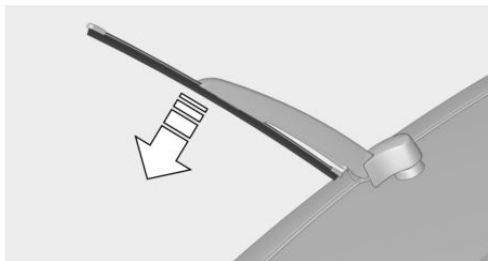

2. Position the new wiper blade and press it on until it you hear it snap into place.
3. Fold the wipers in.

Light and bulb replacement

General information

Lights and bulbs

Lights and bulbs make an essential contribution to driving safety.

The vehicle manufacturer recommends that you have the relevant work carried out at a dealer's service center or another qualified service center or repair shop.

A replacement bulb set is available from a dealer's service center or another qualified service center or repair shop.

Follow the safety information, refer to page 268.

Light-emitting diodes (LEDs)

Some items of equipment use light-emitting diodes installed behind a cover as a light source. These light-emitting diodes are related

to conventional lasers and are officially designated as Class 1 light-emitting diodes.

Follow the safety information, refer to page 268.

Safety information

Lights and bulbs

Warning

Bulbs can get hot during operation. Contact with the bulbs can cause burns. There is a risk of injury. Only change bulbs after they have cooled off.

Warning

Work on switched-on lighting systems can cause short circuits. There is a risk of injury or risk of damage to property. When working on the lighting system, switch off the lights in question. If necessary, heed the bulb manufacturer's instructions.

NOTICE

Dirty bulbs have a reduced service life. There is a risk of damage to property, among other potential damage. Do not hold new glass bulbs with your bare hands. Use a clean cloth or something similar, or hold the bulb by its base.

Light-emitting diodes (LEDs)

Warning

Intensive brightness can irritate or damage the retina of the eye. There is a risk of injury. Do not look directly into the headlights or other light sources. Do not remove the LED covers.

Headlight glass

The inside of the headlight glass can fog up in cool or humid weather. When driving with the lights switched on, the condensation evaporates after a short time. The headlight glass does not need to be changed.

If despite driving with the headlights switched on, increasing moisture forms, for instance water droplets in the light, have the headlights checked.

Headlight adjustment

The headlight settings can be affected by changing lights and bulbs. After the headlight adjustment was changed, have it checked and, if necessary, corrected by a dealer's service center or another qualified service center or repair shop.

Front lights, bulb exchange

LED headlights

Follow the safety information, refer to page 268.

All bulbs and lights are made using LED technology.

In the case of a malfunction, contact a dealer's service center or another qualified service center or repair shop.

Turn signal in exterior mirror

The turn signals in the exterior mirrors feature LED technology. In the case of a malfunction, contact a dealer's service center or another qualified service center or repair shop.

Tail lights, bulb exchange

Overview

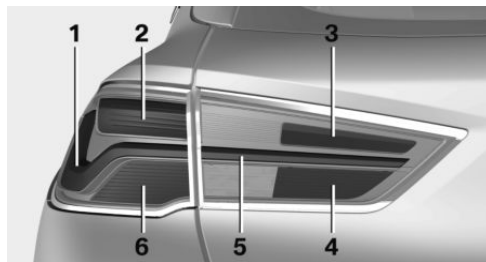

- 1 Tail light/side marker light
- 2 Turn signal
- 3 Reversing light
- 4 Inside brake light
- 5 Tail lights
- 6 Brake light

The tail light and brake lights feature LED technology. In the case of a malfunction, contact a dealer's service center or another qualified service center or repair shop.

Bulb exchange, exterior tail lights

General information

Follow the safety information, refer to page 268.

Turn signal: 21-watt bulb, P21WLL.

Removing the exterior tail light

1. Open the tailgate.
2. Remove the fastening using the screw driver from the onboard vehicle tool kit, arrow 1.

Remove cover, arrow 2.



- Loosen both nuts, arrow 1, of the outer tail light. Use the handle of the screwdriver from the onboard vehicle tool kit to loosen. Carefully pull out the tail light from the body toward the front, arrow 2. Ensure that the wiring is not damaged.

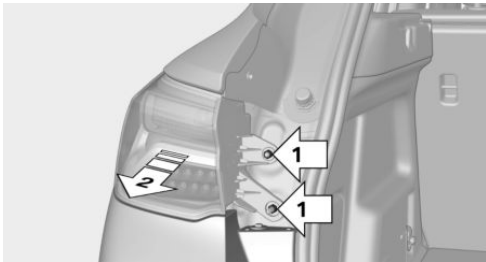

- Detach the connector from the light bracket and detach the tail light wiring.

Replacing the bulbs

- Turn the light bracket counterclockwise and remove.

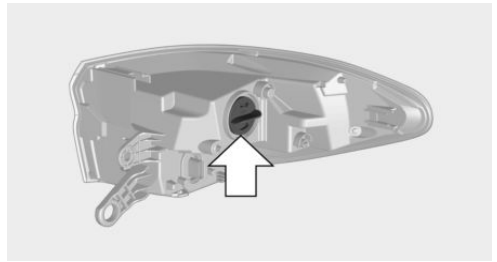

- Press the faulty bulb gently into the socket, turn counterclockwise and remove.
- Proceed in the reverse order to insert the new bulb and attach the light bracket.

Installing the tail light

- Connect the plug and hook the wiring on the tail light, arrow 1.
- Place the tail light with the lugs, arrows 2, on the attachment points of the body and push onto both of the threaded bolts.

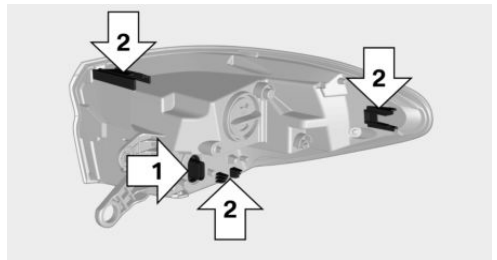

- Press on the tail lights until flush and tighten both of the nuts.
- Mount the cover. Make sure that the plastic tabs of the cover are correctly seated in the corresponding recesses of the body.

Lights in the tailgate

General

Follow the safety information, refer to page [268](#).

Reversing light: 21-watt bulb, P21WLL
 Inner brake light: 21-watt bulb, P21WLL

Accessing the lights

1. Open the tailgate.
2. Pull out the cover at the recessed grip.



3. Detach the connector from the light bracket.

Replacing reversing light and inner brake light

1. Loosen the fasteners, arrow 1, on the light bracket.

Remove the light bracket from the tail light, arrow 2.

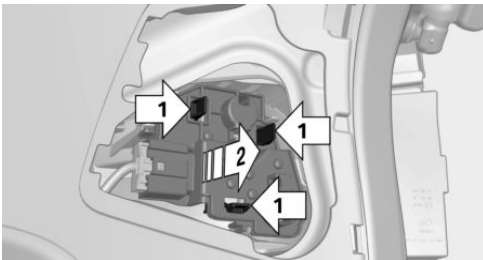

2. Press the faulty bulb gently into the socket, turn counterclockwise and remove.
 - ▶ Upper bulb: reversing light
 - ▶ Lower bulb: inner brake light

Installing the light bracket

1. Proceed in the reverse order to insert the new bulb and attach the light bracket.

- Connect the connector to the light bracket.
2. Make sure that the light bracket is correctly and firmly seated.

Central brake light and license plate lights

Follow the safety information, refer to page 268.

These lights are made using LED technology. In the case of a malfunction, contact a dealer's service center or another qualified service center or repair shop.

Vehicle battery

General information

The battery is maintenance-free.

More information about the battery can be requested from a dealer's service center or another qualified service center or repair shop.

Safety information

DANGER

Contact with live components can lead to an electric shock. There is a risk of injury or danger to life. Do not touch any components that are under voltage.

Warning

Vehicle batteries that are not compatible can damage vehicle systems and impair vehicle functions. There is a risk of an accident and damage to property. Only vehicle batteries that are compatible with your vehicle type should be installed in your vehicle. Information on compatible vehicle batteries is available at your dealer's service center.

Register the battery to the vehicle

The manufacturer of the vehicle recommends that you have a dealer's service center or another qualified service center or repair shop register the vehicle battery to the vehicle after the battery has been changed. Once the battery has been registered again, all comfort features will be available without limitation and any Check Control messages displayed which relate to comfort features will disappear.

Charging the battery

General information

Make sure that the battery is always sufficiently charged to guarantee that the battery remains usable for its full service life.



A discharged battery is indicated by a red indicator light.

Charge the battery when acceleration is insufficient.

The following circumstances can have a negative effect on the performance of the battery:

- ▶ Frequent short-distance drives.
- ▶ Stationary periods of more than one month.

Safety information

NOTICE

Battery chargers that charge the vehicle battery via sockets or cigarette lighters in the vehicle may overload or damage the 12 V electrical system. There is a risk of damage to property, among other potential damage. Only connect battery chargers for the vehicle battery to the jump-start terminals in the engine compartment.

Charging the battery

Charge the battery only when the engine is off and via the jump-start terminals, refer to page 277, in the engine compartment.

Power interruption

After a power interruption, some equipment needs to be newly initialized or individual settings updated, for example:

- ▶ Memory function: store the positions again.
- ▶ Time: update.
- ▶ Date: update.
- ▶ Glass sunroof: initialize the system.

Disposing of old batteries



Have old batteries disposed of by a dealer's service center or another qualified service center or repair shop or take them to a collection point.

Maintain the filled battery in an upright position for transport and storage. Secure the battery so that it does not tip over during transport.

Fuses

Safety information

Warning

Incorrect and repaired fuses can overload electrical lines and components. There is a risk of fire. Never attempt to repair a blown fuse. Do not replace a nonworking fuse with a substitute of another color or amperage rating.

Accessing the fuses

The fuses are located in the glove compartment.

1. Open the glove compartment.
2. Swing the cover down, arrow.

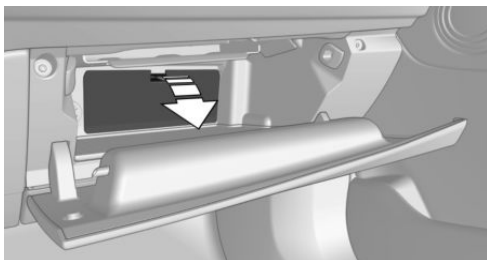

Information on the fuse layout, as well as the positions of any other fuse boxes, is available on the Internet: www.bmw.com/fusecard.

Where applicable, information on the fuse layout is also found on a separate sheet in the fuse box.

Replacing fuses

The vehicle manufacturer recommends that you have a dealer's service center or another qualified service center or repair shop replace the fuses.

Breakdown Assistance

Vehicle features and options

This chapter describes all standard, country-specific and optional features offered with the series. It also describes features and functions that are not necessarily available in your vehicle, e.g., due to the selected options or country versions. This also applies to safety-related functions and systems. When using these functions and systems, the applicable laws and regulations must be observed.

Hazard warning flashers

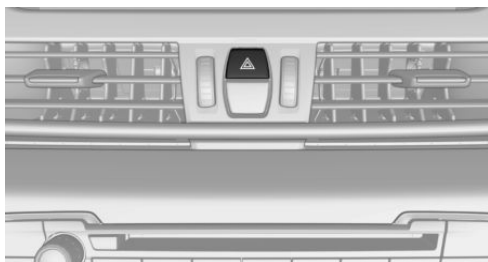

The button is located in the center console. The red light in the button flashes when the hazard warning flashers are activated.

Warning triangle



The warning triangle is located on the inside of the tailgate.

Move the warning triangle sideways and remove it.

First-aid kit

General information

Depending on the vehicle equipment and country-specific version, the vehicle is equipped with a first-aid kit.

Some of the articles have a limited service life.

Check the expiration dates of the contents regularly and replace any expired items promptly.

Storage

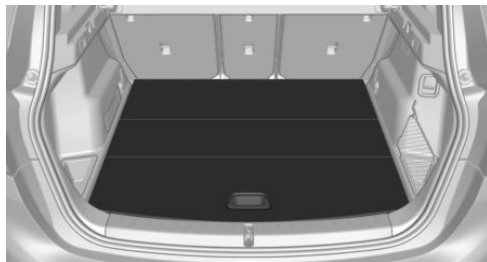

Storage for the first-aid kit is provided in the cargo area, if applicable under the cargo area floor.

BMW Roadside Assistance

Principle

Contact the BMW Group Roadside Assistance if assistance is needed in the event of a breakdown.

General information

In the event of a breakdown, data on the vehicle's condition is sent to the vehicle manufacturer.

There are various ways of making contact.

- ▶ Via a Check Control message, refer to page 124.
- ▶ Calling with a mobile phone.
- ▶ Via the BMW Connected App.

Prerequisites

- ▶ Active ConnectedDrive contract, equipment with intelligent emergency call or BMW ConnectedDrive services.
- ▶ Cellular network reception.
- ▶ The ignition is switched on.

Starting

If the vehicle is equipped with Teleservices, support is offered through Teleservice Diagnosis.

Via iDrive:

1. "ConnectedDrive"
2. "BMW Assist"
3. "BMW Roadside Assistance"

The contact to Roadside Assistance is established.

A telephone number is displayed, if needed. Select to dial the telephone number on a connected mobile phone.

Teleservice Diagnosis

Teleservice Diagnosis enables the wireless transmission of detailed vehicle data that is important for vehicle diagnosis. This data is transmitted automatically.

Teleservice Help

Depending on the country, the Teleservice Help enables a more in-depth diagnosis of the vehicle via wireless transmission.

You can launch Teleservice Help by requesting it through the Service Specialist.

1. Park the vehicle in a safe place.
2. Set the parking brake.
3. Control Display is switched on.
4. Confirm Teleservice Help.

The driving ability of the vehicle can be restored for specific functions.

If this is not possible, further measures will be initiated, for instance Mobile Assistance vehicle will be informed.

Emergency Call

Intelligent emergency call

Principle

In case of an emergency, an emergency call can be triggered automatically by the system or manually.

General information

Depending on vehicle equipment and national-market version, the vehicle is equipped with an Assist system.

Only press the SOS button in an emergency.

Intelligent emergency call establishes a connection with the BMW Response Center.

For technical reasons, the Emergency Call cannot be guaranteed under unfavorable conditions.

Overview



SOS button in the headliner.

Functional requirements

- ▶ The Assist system is functional.
- ▶ The ignition is switched on.
- ▶ If the vehicle is equipped with intelligent emergency call: the integrated SIM card in the vehicle has been activated.

Automatic triggering

Under certain conditions, for instance if the airbags deploy, an emergency call is automatically initiated immediately after an accident of corresponding severity. Automatic Collision Notification is not affected by pressing the SOS button.

Manual triggering

1. Tap the cover flap.
2. Press and hold the SOS button until the LED on the button illuminates green.

- ▶ The LED is illuminated green when an emergency call has been initiated.

If a cancel prompt appears on the Control Display, the emergency call can be aborted.

If the situation allows, wait in your vehicle until the voice connection has been established.

- ▶ The LED flashes green when a connection to the BMW Response Center has been established.

The BMW Response Center then makes contact with you and takes further steps to help you.

Even if you are unable to respond, the BMW Response Center can take further steps to help you under certain circumstances.

For this purpose, data that serves to determine the necessary rescue measures, for instance the current position of the vehicle when it can be determined, is transmitted to the BMW Response Center.

Even if you can no longer hear the BMW Response Center through the loudspeakers, the BMW Response Center may still be able to hear you.

The BMW Response Center ends the emergency call.

Jump-starting

General information

If the battery is discharged, the engine can be started using the battery of another vehicle and two jumper cables. Only use jumper cables with fully insulated clamp handles.

Safety information

DANGER

Contact with live components can lead to an electric shock. There is a risk of injury or danger to life. Do not touch any components that are under voltage.

Warning

If the jumper cables are connected in the incorrect order, spark formation may occur. There is a risk of injury. Pay attention to the correct order during connection.

NOTICE

In the case of body contact between the two vehicles, a short circuit can occur during jump-starting. There is a risk of damage to property, among other potential damage. Make sure that no body contact occurs.

Preparation

1. Check whether the battery of the other vehicle has a voltage of 12 volts. The voltage information can be found on the battery.
2. Switch off the engine of the assisting vehicle.
3. Switch off any electrical components in both vehicles.

Jump-start terminals

The jump-start terminal in the engine compartment, refer to page 256, acts as the positive battery terminal.

Open the lid of the jump-start terminal.

A special connection on the body in the engine compartment, refer to page 256, acts as the negative battery terminal.

Connecting the cables

To prevent personal injury or damage to both vehicles, adhere strictly to the following procedure.

1. Detach the cover cap of the BMW jump-start terminal.
2. Attach one terminal clamp of the positive jumper cable to the positive battery terminal, or to the corresponding jump-start terminal of the vehicle providing assistance.
3. Attach the terminal clamp on the other end of the cable to the positive battery terminal, or to the corresponding jump-start terminal of the vehicle to be started.
4. Attach one terminal clamp of the negative jumper cable to the negative battery terminal, or to the corresponding engine or body ground of assisting vehicle.
5. Attach the second terminal clamp to the negative battery terminal, or to the corresponding engine or body ground of the vehicle to be started.

Starting the engine

Never use spray fluids to start the engine.

1. Start the engine of the assisting vehicle and let it run for several minutes at an increased idle speed.
2. Start the engine of the vehicle that is to be started in the usual way.

If the first attempt to start the engine is not successful, wait a few minutes before mak-

ing another attempt in order to allow the discharged battery to recharge.

3. Let both engines run for several minutes.
4. Disconnect the jumper cables in the reverse order.

Check the battery and recharge, if needed.

Tow-starting and towing

Safety information

Warning

Due to system limits, individual functions can malfunction during tow-starting/towing with the Intelligent Safety systems activated. There is a risk of accident. Switch all Intelligent Safety systems off prior to tow-starting/towing.

Steptronic transmission without xDrive: transporting the vehicle

General information

The vehicle must not be towed if the front wheels are touching the ground.

Safety information

NOTICE

The vehicle can be damaged when towing the vehicle with a lifted rear axle. There is a risk of damage to property, among other potential damage. Have vehicle towed only with lifted front axle or on a loading platform.

Pushing the vehicle

To remove a broken-down vehicle from the hazardous area, it can be pushed for a short distance.

For rolling or pushing the vehicle, refer to page 115.

Tow truck

NOTICE

The vehicle can become damaged when lifting and securing it.

There is a risk of damage to property, among other potential damage.

- ▷ Lift the vehicle using suitable means.
- ▷ Do not lift or secure the vehicle by its tow fitting, body parts, or suspension parts.

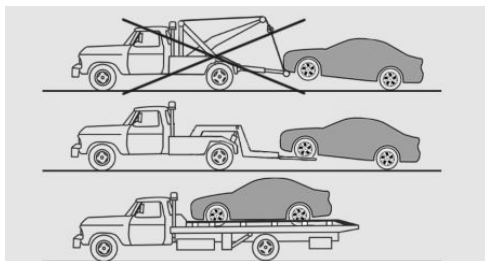

Your vehicle should be transported with a tow truck with a so-called spectacle lift or on a loading platform.

Steptronic transmission with xDrive: transporting the vehicle

General information

The vehicle is not permitted to be towed.

Pushing the vehicle

To remove a broken-down vehicle from the hazardous area, it can be pushed for a short distance.

For rolling or pushing the vehicle, refer to page 115.

Tow truck

NOTICE

The vehicle can become damaged when lifting and securing it.

There is a risk of damage to property, among other potential damage.

- ▷ Lift the vehicle using suitable means.
- ▷ Do not lift or secure the vehicle by its tow fitting, body parts, or suspension parts.

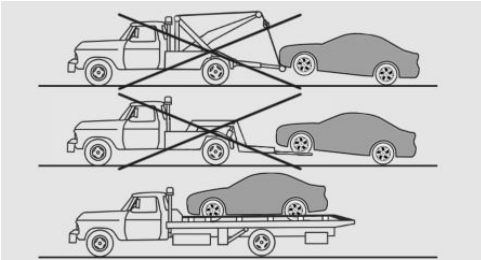

The vehicle should only be transported on a loading platform.

Towing other vehicles

General information

Switch on the hazard warning system, depending on local regulations.

If the electrical system has failed, clearly identify the vehicle being towed by placing a sign or a warning triangle in the rear window.

Safety information

Warning

If the approved gross vehicle weight of the towing vehicle is lighter than the vehicle to be towed, the tow fitting can tear off or it will not be possible to control handling. There is a risk of accident. Make sure that the gross ve-

hicle weight of the towing vehicle is heavier than the vehicle to be towed.

NOTICE

If the tow bar or tow rope is attached incorrectly, damage to other vehicle parts can occur. There is a risk of damage to property, among other potential damage. Correctly attach the tow bar or tow rope to the tow fitting.

Tow bar

The tow fittings used should be on the same side on both vehicles.

If it is impossible to avoid mounting the tow bar at an inclination, note the following:

- ▷ Free movement is limited when cornering.
- ▷ The tow bar will generate lateral forces if it is secured with an inclination.

Tow rope

Observe the following notes when using the tow rope:

- ▷ Use nylon ropes or straps, which will enable the vehicle to be towed without jerking.
- ▷ Make sure the tow rope is not twisted when fastening.
- ▷ Check the attachment of the tow fitting and tow rope in regular intervals.
- ▷ Do not exceed a towing speed of 30 mph/50 km/h.
- ▷ Do not exceed a towing distance of 3 miles/5 km.
- ▷ When driving off to tow the vehicle, make sure that the tow rope is taut.

Tow fitting

General information

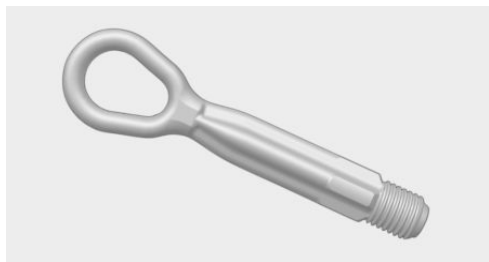

The screw-in tow fitting should always be carried in the vehicle.

The tow fitting can be screwed in at the front or rear of the vehicle.

The tow fitting and the onboard vehicle tool kit, refer to page 267, are together in the cargo area.

Use of the tow fitting:

- ▶ Use only the tow fitting provided with the vehicle.
- ▶ Turn the tow fitting at least 5 turns clockwise and screw it in as far as it will go. If necessary, tighten with a suitable object.
- ▶ After use, unscrew the tow fitting counter-clockwise.
- ▶ Use the tow fitting for towing on paved roads only.
- ▶ Avoid lateral loading of the tow fitting, for instance do not lift the vehicle by the tow fitting.
- ▶ Check the attachment of the tow fitting in regular intervals.

Safety information

NOTICE

If the tow fitting is not used as intended, there may be damage to the vehicle or to the tow fitting. There is a risk of damage to property, among other potential damage. Follow the notes on using the tow fitting.

Screw thread for tow fitting

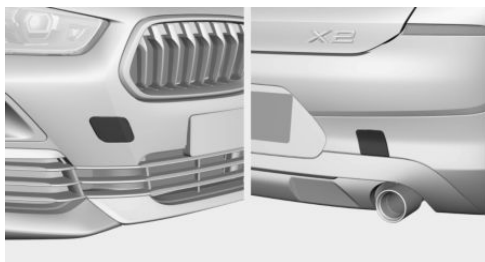

Press on the mark on the edge of the cover to push it out.

Tow-starting

Steptronic transmission

Do not tow-start the vehicle.

Tow-starting the engine is not possible due to the Steptronic transmission.

Have the cause of the starting difficulties corrected by a dealer's service center or another qualified service center or repair shop.

Vehicle Care

Vehicle features and options

This chapter describes all standard, country-specific and optional features offered with the series. It also describes features and functions that are not necessarily available in your vehicle, e.g., due to the selected options or country versions. This also applies to safety-related functions and systems. When using these functions and systems, the applicable laws and regulations must be observed.

Washing the vehicle

General information

Regularly remove foreign bodies such as leaves in the area below the windshield when the hood is raised.

Wash your vehicle frequently, particularly in winter. Intense contamination and road salt can damage the vehicle.

Safety information

NOTICE

When washing with an open fuel filler flap, damage may occur. There is a risk of damage to property, among other potential damage. Close the fuel filler flap before washing. Clean dirt behind the fuel filler flap with a cloth.

Steam cleaner and high pressure cleaner

Safety information

NOTICE

When cleaning with high pressure cleaners, components can be damaged due to the pressure or temperatures being too high. There is a risk of damage to property, among other potential damage. Maintain sufficient distance and do not spray too long continuously. Follow the operating instructions for the high pressure cleaners.

Distances and temperature

- ▶ Maximum temperature: 140 °F/60 °C.
- ▶ Minimum distance from sensors, cameras, seals and lights: 12 inches/30 cm.
- ▶ Minimum distance from glass sunroof: 31.5 in/80 cm.

Automatic car washes or car washes

Safety information

NOTICE

Improper use of automatic car washes can cause damage to the vehicle. There is a risk of damage to property, among other potential damage. Follow the following instructions:

- ▷ Give preference to cloth car washes or those that use soft brushes in order to avoid paint damage.
- ▷ Do not drive through a car wash with guide rails higher than 4 in/10 cm to avoid damage to the body.
- ▷ Observe the tire width of the guide rail to avoid damage to tires and rims.
- ▷ Fold in exterior mirrors to avoid damage to the exterior mirrors.
- ▷ Deactivate the wiper and, if necessary, rain sensor to avoid damage to the window wiper system.

Driving into a car wash with a Steptronic transmission

Safety information

NOTICE

Selector lever position P is automatically engaged when the ignition is switched off. There is a risk of damage to property, among other potential damage. Do not switch ignition off in car washes.

General information

In a car wash, the vehicle must be able to roll freely.

To roll or push the vehicle, refer to page 115.

Some car washes do not permit persons in the vehicle. The vehicle cannot be locked from the outside when in selector lever position N. A signal sounds when an attempt is made to lock the vehicle.

Driving out of a car wash

Ensure that the vehicle key is in the car.

Start the engine. Starting the engine, refer to page 98.

Lights

Do not rub wet lights dry and do not use abrasive or acidic cleaning agents or cleaning agents containing alcohol.

Soak areas that have been dirtied, for instance from insects, with auto shampoo and wash off with water.

Thaw ice with de-icing spray; do not use an ice scraper.

After washing the vehicle

After washing the vehicle, apply the brakes briefly to dry them; otherwise, braking effect can be reduced. The heat generated during braking dries brake disks and brake pads and protects them against corrosion.

Completely remove all residues on the windows, to minimize loss of visibility due to smearing and to reduce wiper noises and wiper blade wear.

Vehicle care

Vehicle care products

General information

BMW recommends using vehicle care and cleaning agents from BMW. Suitable vehicle care products are available from a dealer's service center or another qualified service center or repair shop.

Safety information

Warning

Cleaning agents can contain substances that are dangerous and harmful to your health. There is a risk of injury. When cleaning the interior, open the doors or windows. Only use products intended for cleaning vehicles. Follow the instructions on the packaging.

Vehicle paintwork

General information

Regular vehicle care contributes to driving safety and value retention. Environmental influences in areas with elevated air pollution or natural contaminants, such as tree resin or pollen can affect the vehicle paintwork. Tailor the frequency and extent of your vehicle care to these influences.

Corrosive substances such as spilled fuel, oil, grease or bird droppings, must be removed immediately to prevent the finish from being altered or discolored.

Matte paintwork

Only use cleaning and care products suitable for vehicles with matte paintwork.

Leather care

Remove dust from the leather regularly, using a cloth or vacuum cleaner.

Otherwise, particles of dust and road grime chafe in pores and folds, and lead to heavy abrasion and premature degradation of the leather surface.

To guard against discoloration, such as from clothing, clean leather and provide leather care roughly every two months.

Clean light-colored leather more frequently because contamination on such surfaces is substantially more visible.

Use leather care products; otherwise, dirt and grease will gradually break down the protective coating of the leather surface.

Synthetic leather care

Clean synthetic leather regularly with a damp microfiber cloth or vacuum cleaner.

Otherwise, dust and road grime particles will rub into pores and folds, causing significant abrasion and premature degradation of the surface.

In case of major soiling, use a moist soft sponge or microfiber cloth with suitable interior cleaners.

Immediately remove aggressive substances such as sunscreen to prevent the synthetic leather from being altered or discolored.

Upholstery material care

General information

Vacuum the cushions regularly with a vacuum cleaner.

If upholstery is very contaminated, for instance with beverage stains, use a soft sponge or microfiber cloth with a suitable interior cleaner.

Clean the cushions down to the seams using large sweeping motions. Avoid rubbing the material vigorously.

Safety information

NOTICE

Open hook and loop fasteners on articles of clothing can damage the seat covers and other cloth upholstery in the vehicle. There is a risk of damage to property, among other potential damage. Ensure that any Velcro® fasteners are closed.

Caring for special components

Light-alloy wheels

When cleaning the vehicle, use only neutral rim cleaners having a pH value from 5 to 9. Do not use abrasive cleaning agents or steam cleaners above 140 °F/60 °C. Follow the manufacturer's instructions.

Aggressive, acidic or alkaline cleaning agents can destroy the protective coating of adjacent components, such as the brake disk.

After cleaning, apply the brakes shortly to dry them. The heat generated during braking dries

brake disks and brake pads and protects them against corrosion.

Chrome surfaces

Carefully clean components such as the radiator grille or door handles with plenty of water, if necessary, with auto shampoo added, particularly when they have been exposed to road salt.

Rubber components

Environmental influences can cause surface contamination of rubber parts and a loss of gloss. Use only water and suitable cleaning agents for cleaning.

Treat especially worn rubber parts with rubber care products at regular intervals. When cleaning rubber seals, do not use any silicon-containing vehicle care products in order to avoid damage or noises.

Wiper blades

The wiper blades are cleaned by using the washer system.

Avoid cleaning the wiper blades manually, as this may reduce wiper performance.

Fine wood parts

Clean fine wood facing and fine wood components only with a moist rag. Then dry with a soft cloth.

Plastic components

NOTICE

Solvent cleaners that contain alcohol or solvents, such as lacquer thinners, cold cleaning agents, fuel and such, can damage plastic parts. There is a risk of damage to property, among other potential damage. Clean with a microfiber cloth. Dampen the cloth lightly with water, if needed.

Clean with a microfiber cloth.

Dampen the cloth lightly with water, if needed.

Do not soak the headliner.

Seat belts

Warning

Chemical solvent cleaners can destroy the seat belt fabric. Missing protective effect of the seat belts. There is a risk of injury or danger to life. Use only a mild soap solution for cleaning the seat belts.

Dirty belt straps impede the reeling action and thus have a negative impact on safety.

Use only a mild soap solution, with the seat belts clipped into their buckles.

Seat belts should only be allowed to retract if they are dry.

Carpets and floor mats

Warning

Objects in the driver's footwell can limit the pedal travel or block a depressed pedal. There is a risk of accident. Stow objects in the vehicle such that they are secured and cannot enter into the driver's footwell. Use floor mats that are suitable for the vehicle and can be safely attached to the floor. Do not use loose floor mats and do not layer several floor mats. Make sure that there is sufficient clearance for the pedals. Ensure that the floor mats are securely fastened again after they were removed, for instance for cleaning.

Floor mats can be removed from the car's interior for cleaning.

If the floor carpets are very contaminated, clean with a microfiber cloth and water or a textile cleaner. To prevent matting of the carpet, rub back and forth in the driving direction only.

Sensor/camera lenses

To clean sensors and camera lenses, use a cloth moistened with a small amount of glass detergent.

Displays/screens/protective glass of the Head-up Display

NOTICE

Chemical solvent cleaners, moisture or fluids of any kind can damage the surface of displays and screens. There is a risk of damage to property, among other potential damage. Clean with a clean, antistatic microfiber cloth.

NOTICE

The surface of displays can be damaged with improper cleaning. There is a risk of damage to property, among other potential damage. Avoid pressure that is too high and do not use any scratching materials.

Use a dry, clean antistatic microfiber cloth. Clean the protective glass of the Head-up Display using a microfiber cloth and commercially available household detergent.

Taking the vehicle out of service

When the vehicle is shut down for longer than three months, special measures must be taken. Further information is available from a dealer's service center or another qualified service center or repair shop.

Technical data

Vehicle features and options

This chapter describes all standard, country-specific and optional features offered with the series. It also describes features and functions that are not necessarily available in your vehi-

cle, e.g., due to the selected options or country versions. This also applies to safety-related functions and systems. When using these functions and systems, the applicable laws and regulations must be observed.

General information

The technical data and specifications in the Owner's Manual are used as guidance values. Vehicle-specific data may deviate from this, for instance due to the optional equipment chosen, national-market version, or country-

specific measuring process. Detailed values can be found in the approval documents, on signs on the vehicle or can be obtained from a dealer's service center or another qualified service center or repair shop.

Dimensions

The dimensions can vary depending on the model version, equipment version or country-specific measurement procedure.

The height of the vehicle can also differ, e.g., due to tires and vehicle load.

BMW X2

Width with mirrors	in/mm	82.6/2,098
Width without mirrors	in/mm	71.8/1,824
Height	in/mm	60.1/1,526
Length	in/mm	172.2/4,374
Wheelbase	in/mm	105.1/2,670
Smallest turning radius diam.	ft/m	37.1/11.3

Weights

X2 sDrive28i

Approved gross vehicle weight	lbs/kg	4,597/2,085
Payload	lbs/kg	970/440
Approved front axle weight	lbs/kg	2,425/1,100
Approved rear axle weight	lbs/kg	2,271/1,030

X2 xDrive28i

Approved gross vehicle weight	lbs/kg	4,729/2,145
Payload	lbs/kg	941/427
Approved front axle weight	lbs/kg	2,447/1,110
Approved rear axle weight	lbs/kg	2,381/1,080

X2 M35i powered by BMW M

Approved gross vehicle weight	lbs/kg	4,795/2,175
Payload	lbs/kg	999/453
Approved front axle weight	lbs/kg	2,469/1,120
Approved rear axle weight	lbs/kg	2,414/1,095

Filling capacities

BMW X2

Fuel tank, approx.	US gal/liters	16.1/61.0
--------------------	---------------	-----------

Observe further information on fuel quality, refer to page [234](#).

Appendix

Any updates to the Owner's Manual of the vehicle are listed here.

Updates made after the editorial deadline

The following chapters were updated in the printed version of the Owner's Manual after the editorial deadline for the Integrated Owner's Manual in the vehicle had closed:

- ▷ Overview: iDrive: operating elements: overview.
- ▷ Operation: driving: wiper system: safety instructions.
- ▷ Operation: displays: Speed Limit Info: safety instructions.
- ▷ Operation: safety: Intelligent Safety: safety instructions.
- ▷ Operation: safety: Forward Collision Warning with city collision mitigation.
- ▷ Operation: safety: Pedestrian Warning with city collision mitigation: safety instructions.
- ▷ Operation: driving stability control systems: Dynamic Stability Control: safety instructions.
- ▷ Operation: driving comfort: camera-based cruise control with Stop&Go function: safety instructions.
- ▷ Operation: driving comfort: cruise control: safety instructions.
- ▷ Operation: driving comfort: Park Distance Control: safety instructions.
- ▷ Operation: driving comfort: Automatic Parking Assistant: safety instructions.

License Texts and Certifications

USA/Canada

Telematics Communication Box

USA

Model: ATM-01 R2-US-4G, ATM-01 T2-US-4G

FCC ID: QWY-V1140-101-1

Model: ATM-01 R2-US-4GW

FCC ID: QWY-ATM-R-622

ATM-01 T2-US-4GW

FCC ID: QWY-ATM-T-622

Canada

Model: ATM-01 R2-US-4G, ATM-01 T2-US-4G

Contains IC: 6588A-V11401011

Model: ATM-01 R2-US-4GW

IC: 6588A-ATMR622

Model: ATM-01 T2-US-4GW

IC: 6588A-ATMT622

Everything from A to Z

Index

A

ABS, see Antilock Braking System [163](#)
 Acceleration Assistant, see Launch Control [119](#)
 Accessories and parts [8](#)
 ACC, see Cruise Control with Distance Control [170](#)
 Activated charcoal filter [196](#)
 Activation times, pre-ventilation [197](#)
 Active Cruise Control [170](#)
 Adaptive chassis [168](#)
 Adaptive suspension [168](#)
 Adding engine oil types [261](#)
 Additives, engine oil types [261](#)
 Adjustments, steering wheel [90](#)
 Airbags [141](#)
 Airbags, indicator and warning light [143](#)
 Air circulation, see Recirculated-air mode [191](#)
 air conditioning, climate [194](#)
 Air conditioning system [190](#)
 Air distribution, manual [192](#), [195](#)
 Air drying, see air conditioning [194](#)
 Air flow, air conditioning system [192](#)
 Air flow, automatic climate control [195](#)
 Air outlets, see Ventilation [196](#)
 Air pressure, tires [236](#)
 Air vent, see Ventilation [196](#)
 Alarm system [74](#)
 Alarm, unintentional [75](#)
 All-season tires, see Winter tires [244](#)
 All-wheel-drive, see xDrive [165](#)
 Ambient light [140](#)
 Antifreeze, see Washer fluid [111](#)
 Antilock Braking System [163](#)
 Anti-theft protection, lug bolt lock [251](#)
 Apps, see Owner's Manual for Navigation, Entertainment, Communication [6](#)
 Aquaplaning [218](#)
 Arrival time [131](#)
 Ashtray [201](#)

Assistance when driving off, see Drive-off assistant [169](#)
 Assistance with breakdown [274](#)
 Audio, see Owner's Manual for Navigation, Entertainment and Communication [6](#)
 Automatic climate control [193](#)
 Automatic control, headlight [137](#)
 Automatic Curb Monitor, exterior mirror [89](#)
 Automatic deactivation, front-seat passenger airbags [143](#)
 Automatic dimming, see Automatic High Beam Assistant [138](#)
 Automatic headlight control [137](#)
 Automatic High Beam Assistant [138](#)
 Automatic locking [74](#)
 Automatic Parking Assistant [185](#)
 Automatic program, automatic climate control [194](#)
 Automatic Recirculating Air Control [195](#)
 Automatic tailgate [68](#)
 Automatic transmission, see Steptronic transmission [112](#)
 Automatic unlocking [74](#)
 AUTO program, automatic climate control [194](#)
 AUTO program, intensity [195](#)
 Auto Start/Stop function [99](#)
 Average consumption [130](#)
 Average speed [130](#)
 Axle loads, approved [287](#)

B

Backrest curvature, see Lumbar support [81](#)
 Backrest, seats [80](#)
 Backrest width [82](#)
 Bad road trips [216](#)
 Bad weather light [139](#)
 Battery, disposing of [272](#)
 Battery, vehicle [271](#)

Being towed, see Tow-starting and towing [278](#)
Belts, see Seat belts [83](#)
Beverage holder, see Cup holders [213](#)
Blocking, power window, see Safety switch [77](#)
Blower [192, 195](#)
Bluetooth connection [50](#)
Blu-ray, see Owner's Manual for Navigation, Entertainment, Communication [6](#)
BMW Assist, see Owner's Manual for Navigation, Entertainment and Communication [6](#)
BMW Homepage, see Internet [6](#)
BMW Internet page [6](#)
BMW maintenance system [265](#)
BMW Roadside Assistance [275](#)
Bonus range, ECO PRO [227](#)
Bottle holder, see Cup holders [213](#)
Brake assistant [163](#)
Brake disks, breaking in [216](#)
Brake disks, see Brake system [216](#)
Brake pads, breaking in [216](#)
Brake pads, see Brake system [216](#)
Brake system [216](#)
Braking, information [218](#)
Breakdown assistance [274](#)
Breaking in [216](#)
Brightness, Control Display [47](#)
Bulb replacement [268](#)
Bulb replacement, front [269](#)
Bulb replacement, rear [269](#)
Bulbs and lights [268](#)
Button, central locking system [63](#)
Button, Hill Descent Control [165](#)
Buttons on the steering wheel [30](#)
Button, SOS, see Intelligent emergency call [276](#)
Button, Start/Stop [97](#)
Bypassing, see Jump-starting [277](#)

C

Calendar day, see Date [46](#)
California Proposition 65 Warning [8](#)
Calling up mirror adjustment [73](#)
Camera-based assistance systems, see Intelligent Safety [152](#)
Camera lenses, care [285](#)
Camera, rearview camera [182](#)
Can holder, see Cup holders [213](#)
Care [281](#)
Care, displays, screens [285](#)
Care, Head-up Display [285](#)
Care, light-alloy wheels [283](#)
Care, vehicle [282](#)
Cargo [221](#)
Cargo area [207](#)
Cargo area, enlarging [208](#)
Cargo area, storage compartments [215](#)
Cargo, stowing and securing [222](#)
Car key, see Vehicle key [58](#)
Carpet, care [284](#)
Car wash [281](#)
Car wash, automatic [281](#)
Catalytic converter, see Hot exhaust gas system [217](#)
CBS, see Condition Based Service [265](#)
Cell phone, see Owner's Manual for Navigation, Entertainment and Communication [6](#)
Center armrest [213](#)
Center console [32](#)
Central Information Display (CID), see Control Display [36](#)
Central locking switch, see Central locking system [63](#)
Central locking system [63](#)
Central screen, see Control Display [36](#)
Changes, technical, see For Your Own Safety [7](#)
Change, wheels and tires [243](#)
Changing parts [267](#)
Changing wheels [250](#)
Charging cradle [204](#)
Charging smartphone, see Wireless charging tray [204](#)
Charging tray for smartphones, see Wireless charging tray [204](#)
Chassis number, see Vehicle identification number [12](#)
Check Control [121](#)
Checking the engine oil level electronically [259](#)
Children, seating position [91](#)
Children, transporting safely [91](#)

Child restraint seats [91](#)
 Child restraint system [91](#)
 Child restraint systems, mounting [92](#)
 Child safety latch [96](#)
 Child safety locks [96](#)
 Child seat installation [92](#)
 Child seat, mounting [92](#)
 Child seat mountings LATCH [93](#)
 Child seats [91](#)
 Chrome parts, care [284](#)
 Cigarette lighter [201](#)
 City light braking function [156](#)
 Cleaning, displays, screens [285](#)
 Cleaning, Head-up Display [285](#)
 Clearance, water [218](#)
 Climate control [190, 193](#)
 Clothes hooks [214](#)
 Coasting [228](#)
 Coasting with idling engine [228](#)
 Coat hooks [214](#)
 Combination switch, see Turn signals [103](#)
 Combination switch, see Washer/wiper system [104, 108](#)
 Comfort Access [64](#)
 COMFORT program, driving dynamics [168](#)
 Communication, see Owner's Manual for Navigation, Entertainment and Communication [6](#)
 Compact wheel, see Emergency wheel [254](#)
 Compartments in the doors [212](#)
 Compatible devices, see Suitable devices [50](#)
 Compatible mobile phones [50](#)
 Computer, see Trip computer [129](#)
 Concierge Service, see Owner's Manual for Navigation, Entertainment, Communication [6](#)
 Condensation under the vehicle [219](#)
 Condensation, windows [192, 196](#)
 Condition Based Service [265](#)
 Confirmation signal from the vehicle [73](#)
 ConnectedDrive, see Owner's Manual for Navigation, Entertainment and Communication [6](#)
 Connection, electrical devices, see Sockets [202](#)
 Connections [49](#)
 Consumption display, average consumption [130](#)
 Consumption history [227](#)

Consumption, see Current consumption [126](#)
 Contactless trunk closing [66](#)
 Contactless trunk opening [66](#)
 Contacts, see Owner's Manual for Navigation, Entertainment, Communication [6](#)
 Continued driving with a flat tire, see Tire Pressure Monitor [145](#)
 Continued driving with flat tire, see Flat tire monitor [149](#)
 Control Display [36](#)
 Control Display, brightness [47](#)
 Controller [36, 37](#)
 Control systems, driving stability [163](#)
 Convenient closing, vehicle key [60](#)
 Convenient opening, vehicle key [59](#)
 Coolant [263](#)
 Cooling, maximum [194](#)
 Cooling system [263](#)
 Cornering light [138](#)
 Corrosion, brake disks [219](#)
 Cosmetic mirror [201](#)
 Courtesy lights during unlocking [59](#)
 Courtesy lights, locked vehicle [60](#)
 Cruise Control, see Cruise Control with Distance Control [170](#)
 Cruise Control with Distance Control [170](#)
 Cruise Control without Distance Control [176](#)
 Cruising range [125](#)
 Cup holder [213](#)
 Current consumption [126](#)
 Customer service, see Owner's Manual for Navigation, Entertainment, Communication [6](#)
 Customer Support [6](#)

D

Damage, tires [242](#)
 Dashboard [30](#)
 Dashboard, see Instrument cluster [120](#)
 Data protection, settings [48](#)
 Data, see Personal data, deleting [48](#)
 Data, technical [286](#)
 Date [46](#)
 Date, display [125](#)
 Daytime driving lights [138](#)
 Daytime running lights [138](#)

- DCC, see Cruise Control without Distance Control [176](#)
- Defrosting, see Windows, defrosting [192](#), [196](#)
- Defrosting, windows [192](#), [196](#)
- Deleting, personal data [48](#)
- Departure schedule, see Pre-ventilation [197](#)
- Destination distance [131](#)
- Destination input [6](#)
- Device, connecting [49](#)
- Device list [49](#)
- Device, pairing, see Pair device [49](#)
- Device, registering [49](#)
- Devices, suitable [50](#)
- Diagnostic connection [266](#)
- Diagnostic socket [266](#)
- Digital clock [125](#)
- Dimensions [286](#)
- Dimmable exterior mirrors [89](#)
- Dimmable interior mirror [90](#)
- Direct dial buttons, see Programmable memory buttons [40](#)
- Direction indicator, see Turn signals [103](#)
- Display, date [125](#)
- Display, engine temperature [131](#)
- Display, iDrive [34](#)
- Display in instrument cluster [131](#)
- Display in the windshield, see Head-up Display [133](#)
- Display lighting, see Instrument lighting [139](#)
- Display panel, see Instrument cluster [120](#)
- Display, speed limiting function, see Speed Limit Info [127](#)
- Disposal, coolant [264](#)
- Disposal, vehicle battery [272](#)
- Distance control, see Cruise Control [170](#)
- Distance to destination [131](#)
- Distance warning, see Park Distance Control [179](#)
- Divided screen view, split screen [35](#)
- Downhill control, see Hill Descent Control [165](#)
- Drive-off assistant [169](#)
- Drive-off assistant, see Dynamic Stability Control [163](#)
- Driver assistance, see Intelligent Safety [152](#)
- Driver profiles [70](#)
- Driver profiles, exporting profiles [72](#)
- Driver profiles, importing profiles [72](#)
- Driving Dynamics Control [167](#)
- Driving mode, ECO PRO [225](#)
- Driving mode, see Driving Dynamics Control [167](#)
- Driving note, ECO PRO [227](#)
- Driving notes, breaking in [216](#)
- Driving notes, general [217](#)
- Driving on bad roads [216](#)
- Driving on racetracks [219](#)
- Driving stability control systems [163](#)
- Driving, Start/Stop button [97](#)
- Driving style analysis, ECO PRO [229](#)
- Driving through water [218](#)
- Driving tips, see General driving notes [217](#)
- DSC, see Dynamic Stability Control [163](#)
- DTC, see Dynamic Traction Control [165](#)
- DVD, video, see Owner's Manual for Navigation, Entertainment, Communication [6](#)
- Dynamic damping, see Adaptive chassis [168](#)
- Dynamic Stability Control [163](#)
- Dynamic Traction Control [165](#)

E

- Easy Opener [66](#)
- ECO PRO [225](#)
- ECO PRO, bonus range [227](#)
- ECO PRO, driving style analysis [229](#)
- ECO PRO program, driving dynamics [168](#)
- ECO PRO, tip [227](#)
- Efficiency display, ECO PRO [227](#)
- EfficientDynamics, display [227](#)
- Electronic oil measurement [259](#)
- Electronic Stability Program ESP, see Dynamic Stability Control [163](#)
- E-mail, see Owner's Manual for Navigation, Entertainment, Communication [6](#)
- Emergency braking, see PostCrash – iBrake [161](#)
- Emergency call [276](#)
- Emergency service, see BMW Roadside Assistance [275](#)
- Emergency unlocking, fuel filler flap [233](#)
- Emergency unlocking, transmission lock [118](#)
- Emergency wheel [254](#)

Energy control [126](#)
 Energy recovery [126](#)
 Engine, automatic Start/Stop function [99](#)
 Engine compartment [256](#)
 Engine coolant [263](#)
 Engine idling when driving, see [Coasting 228](#)
 Engine oil [259](#)
 Engine oil filler neck [260](#)
 Engine oil, topping up [260](#)
 Engine oil types to add [261](#)
 Engine start, see [Jump-starting 277](#)
 Engine start, see [Starting the engine 98](#)
 Engine stop [99](#)
 Engine temperature, display [131](#)
 Entering a destination, see [Owner's Manual for Navigation, Entertainment, Communication 6](#)
 Entering an address, navigation, see [Owner's Manual for Navigation, Entertainment and Communication 6](#)
 Entertainment, see [Owner's Manual for Navigation, Entertainment and Communication 6](#)
 Equipment, interior [198](#)
 ESP Electronic Stability Program, see [Dynamic Stability Control 163](#)
 Exchange, wheels and tires [243](#)
 Exhaust gas system [217](#)
 Exhaust, see [Exhaust gas system 217](#)
 Exterior mirror [88](#)
 Exterior mirror, Automatic Curb Monitor [89](#)
 Exterior mirror, automatic dimming [89](#)
 Exterior mirrors, malfunction [89](#)
 External start, see [Jump-starting 277](#)
 External temperature display [125](#)
 External temperature warning [125](#)

F

Failure message, see [Check Control 121](#)
 Fan, see [Air flow 192, 195](#)
 Fastening seat belts, see [Seat belts 83](#)
 Fatigue Alert [161](#)
 Fatigue warner, see [Fatigue Alert 161](#)
 Fault indications, see [Check Control 121](#)
 Filler neck for engine oil [260](#)
 Filter, see [Microfilter 192](#)
 Fine wood, care [284](#)

Fine wood parts, care [284](#)
 First-aid kit [274](#)
 Flat tire, changing wheels [250](#)
 Flat tire, continued driving, see [Flat tire monitor 149](#)
 Flat tire, continued driving, see [Tire Pressure Monitor 145](#)
 Flat tire message, see [Flat tire monitor 150](#)
 Flat tire message, see [Tire Pressure Monitor 147](#)
 Flat tire monitor [149](#)
 Flat tire, repairing [245](#)
 Flat tire, see [Flat tire monitor 149](#)
 Flat tire, see [Tire Pressure Monitor 145](#)
 Flat tire warning light, see [Flat tire monitor 150](#)
 Flat tire warning light, see [Tire Pressure Monitor 147](#)
 Flooding, driving through [218](#)
 Floor carpet, care [284](#)
 Floor mats, care [284](#)
 Fold-away position, wiper [107, 110](#)
 Fold-out position [107, 110](#)
 Foot brake [218](#)
 Forward Collision Warning with city collision mitigation [153](#)
 Forward Collision Warning with City light braking function [153](#)
 Forward Collision Warning with collision mitigation [153](#)
 For Your Own Safety [7](#)
 Front airbags [141](#)
 Front lights [269](#)
 Front passenger's side exterior mirror, tilting down, see [Automatic Curb Monitor 89](#)
 Front passenger airbags, automatic deactivation [143](#)
 Front-seat passenger airbags, indicator light [144](#)
 Front seats [80](#)
 Fuel [234](#)
 Fuel cap [232](#)
 Fuel filler flap [232](#)
 Fuel filler flap, emergency unlocking [233](#)
 Fuel gauge [124](#)
 Fuel quality [234](#)
 Fuel recommendation [234](#)

Fuel, saving [224](#)
Fuel tank, see Filling capacity [287](#)
Fuses [272](#)

G

Garage door opener, see Integrated Universal Remote Control [198](#)
Gasoline [234](#)
Gasoline quality [235](#)
Gear change, Steptronic transmission [112](#)
Gear shift indicator [127](#)
General driving notes [217](#)
General settings [45](#)
Glare shield, see Sun visor [201](#)
Glass sunroof, initialize the system [79](#)
Glass sunroof, see Panoramic glass sunroof [77](#)
Global Positioning System geolocation [46](#)
Global Positioning System, navigation [6](#)
Glove compartment [212](#)
GPS geolocation, vehicle position [46](#)
GPS, navigation, see Owner's Manual for Navigation, Entertainment, Communication [6](#)
Gross vehicle weight, approved [287](#)

H

Handbrake, see Parking brake [102](#)
Hand-held transmitter, alternating code [199](#)
Hands-free device, see Owner's Manual for Navigation, Entertainment, Communication [6](#)
Hands-free system [6](#)
Hazard warning system [274](#)
HDC, see Hill Descent Control [165](#)
Head airbag [142](#)
Headlight cleaning system [104](#), [108](#)
Headlight control, automatic [137](#)
Headlight flasher [104](#)
Headlight glass [269](#)
Headlights [269](#)
Headlights, care [282](#)
Headlights, turning up, dimming, see Automatic High Beam Assistant [138](#)
Headliner [33](#)
Head restraints and seats [80](#)

Head restraints, front [85](#)
Head restraints, rear [86](#)
Head-up Display [133](#)
Head-up Display, care [285](#)
Head-up display, position, saving see Memory function [87](#)
Heated steering wheel [90](#)
Heavy cargo, stowing [222](#)
Height, vehicle [286](#)
High beams [104](#)
Hill Descent Control [165](#)
Hills [219](#)
Hill start assistant, see Drive-off assistant [169](#)
Holder for beverages, see Cup holders [213](#)
HomeLink, see Integrated Universal Remote Control [198](#)
Homepage, see Internet [6](#)
Hood [257](#)
Horn [30](#)
Hot exhaust gas system [217](#)
Hour, see Time [45](#)
Humidity in the headlight, see Headlight glass [269](#)

I

iBrake – PostCrash [161](#)
Ice warning, see External temperature warning [125](#)
Icy roads, see External temperature warning [125](#)
Identification marks, tires [240](#)
Identification number, see Vehicle identification number [12](#)
iDrive [34](#)
ID transmitter, see Vehicle key [58](#)
Ignition key, see Vehicle key [58](#)
Ignition off [97](#)
Ignition on [97](#)
Indicator and warning lights, see Check Control [121](#)
Indicator light, front-seat passenger airbags [144](#)
Indicator light, see Check Control [121](#)
Individual air distribution [192](#), [195](#)
Individual settings, see Driver profiles [70](#)

Inductive charging, smartphone, see Wireless charging tray [204](#)

Info Display [129](#)

Information [6](#)

Initialization, see flat tire monitor [150](#)

Input, iDrive [34](#)

Installation of child restraining systems [92](#)

Instrument cluster [120](#)

Instrument lighting [139](#)

Instrument panel, see Instrument cluster [120](#)

Integrated key [62](#)

Integrated Owner's Manual in the vehicle [56](#)

Integrated Universal Remote Control [198](#)

Intelligent emergency call [276](#)

Intelligent Safety [152](#)

Intended use [7](#)

Intensity, AUTO program [195](#)

Interior equipment [198](#)

Interior lights [140](#)

Interior lights during unlocking [59](#)

Interior lights, locked vehicle [60](#)

Interior mirror [88](#)

Interior mirror, automatic dimming feature [90](#)

Interior mirror, manually dimmable [89](#)

Interior motion sensor [75](#)

Intermittent operation [105](#), [109](#)

Internet page [6](#)

Interval display, service notifications [126](#)

Interval indicator, service notifications [126](#)

Interval mode [105](#), [109](#)

In the vicinity of the center console [32](#)

In the vicinity of the roofliner [33](#)

J

Jack [252](#)

Jacking points [252](#)

Jacking points for the vehicle jack [252](#)

Jam protection system, glass sunroof [79](#)

Jam protection system, windows [77](#)

Joystick, Steptronic transmission [112](#)

Jump-starting [277](#)

Jump-starting terminals [277](#)

Jump-start terminals [277](#)

K

Keyless Go, see Comfort Access [64](#)

Key, mechanical [62](#)

Key, see Vehicle key [58](#)

Kickdown, Steptronic transmission [115](#)

Knee airbag [142](#)

L

Labeling [240](#)

Label on recommended tires [243](#)

Lane boundary [159](#)

Lane departure warning [159](#)

Lane threshold, warning [159](#)

Language, setting [45](#)

LATCH child seat mountings [93](#)

Launch Control [119](#)

Leather care [283](#)

LED headlights [269](#)

LEDs, light-emitting diodes [268](#)

Length, vehicle [286](#)

Letters and numbers, entering [34](#)

Light-alloy wheels, care [283](#)

Light-emitting diodes, LEDs [268](#)

Lighter [201](#)

Lighting [136](#)

Light replacement [268](#)

Light replacement, front [269](#)

Light replacement, rear [269](#)

Lights [136](#)

Lights and bulbs [268](#)

Lights, care [282](#)

Light switch [136](#)

List, instrument cluster, see Selection lists [129](#)

List, notifications, see Notifications [47](#)

Load [222](#)

Loading [221](#)

Loading the cargo area, see Stowing cargo [222](#)

Local time, see Time [45](#)

Location, vehicle position [46](#)

Locking, automatic [74](#)

Locking, see Opening and Closing [58](#)

Locking, settings [73](#)

Lock, lug bolts [251](#)

Low beams, operation [136](#)
Lower back support, see Lumbar support [81](#)
Lug bolt lock [251](#)
Luggage rack, see Roof-mounted luggage rack [222](#)
Lumbar support [81](#)

M

Maintenance [265](#)
Maintenance requirement, see Condition Based Service [265](#)
Maintenance, service notifications [126](#)
Maintenance system, BMW [265](#)
Make-up mirror [201](#)
Malfunction displays, see Check Control [121](#)
Malfunction, vehicle key [61](#)
Manual air flow [192](#)
Manual brake, see Parking brake [102](#)
Manual control, air distribution [192](#), [195](#)
Manual control, air flow [195](#)
Manual operation, PDC Park Distance Control [180](#)
Manual operation, rearview camera [183](#)
Map update, see Owner's Manual for Navigation, Entertainment, Communication [6](#)
Matte paintwork [283](#)
Matt paint, care [283](#)
Maximum cooling [194](#)
Maximum speed, display, see Speed Limit Info [127](#)
Maximum speed, winter tires [244](#)
Media of the Owner's Manual [56](#)
Medical supplies, see First-aid kit [274](#)
Memory function [87](#)
Menus [38](#)
Menus, operating, iDrive [34](#)
Messages, see Check Control [121](#)
Meters, see Instrument cluster [120](#)
Microfilter [192](#), [196](#)
Minimum tread, tires [242](#)
Mirror position, saving, see Memory function [87](#)
Mirrors [88](#)
Mobile phone, connecting [49](#)

Mobile phone, see Owner's Manual for Navigation, Entertainment and Communication [6](#)
Mobile phones, suitable [50](#)
Mobile radio in the vehicle [218](#)
Mobile Service, see BMW Roadside Assistance [275](#)
Mobility System, see Tire repair set [245](#)
Mode, ECO PRO [225](#)
Modifications, technical, see For Your Own Safety [7](#)
Moisture [269](#)
Monitor, see Control Display [36](#)
Mounting of child restraint systems [92](#)
MP3 player, see Owner's Manual for Navigation, Entertainment, Communication [6](#)
M sports steering [167](#)
M Sport steering [167](#)
Multi-function steering wheel [30](#)
Multifunction steering wheel, buttons [30](#)
Multimedia, see Owner's Manual for Navigation, Entertainment and Communication [6](#)
Music collection, see Owner's Manual for Navigation, Entertainment, Communication [6](#)

N

Navigation, see Owner's Manual for Navigation, Entertainment and Communication [6](#)
Neck restraints, front, see Head restraints, front [85](#)
Neck restraints, rear, see Head restraints, rear [86](#)
Neutral cleaner, see Light-alloy wheels, care [283](#)
Notifications [47](#)
No-touch closing of the tailgate [66](#)
No-touch opening of the tailgate [66](#)

O

OBD, see On-board diagnosis [266](#)
Obstacle marking, rearview camera [184](#)
Octane number, see Gasoline quality [235](#)
Odometer [124](#)
Oil [259](#)
Oil filler neck [260](#)

Oil level, checking electronically [259](#)
 Oil service interval, service notifications [126](#)
 Oil, topping up [260](#)
 Oil types to add, engine [261](#)
 Old battery [272](#)
 On-board diagnosis [266](#)
 Onboard literature, printed [56](#)
 Onboard vehicle tool kit [267](#)
 On-call service, see BMW Roadside Assistance [275](#)
 Opening and closing [58](#)
 Operate tailgate with vehicle key [60](#)
 Operating concept, iDrive [34](#)
 Operating via iDrive [38](#)
 Operation via touchscreen [39](#)
 Operation via voice [42](#)
 Operation with the Controller [38](#)
 Optional equipment, see Vehicle equipment [7](#)
 Outside air, see Automatic Recirculating Air Control [195](#)
 Outside temperature display [125](#)
 Overwintering, see Long-term vehicle storage [285](#)
 Owner's Manual, printed [56](#)

P

Paint, vehicle care [283](#)
 Paintwork [283](#)
 Panic alarm, see Panic mode [75](#)
 Panic mode [75](#)
 Panoramic glass sunroof [77](#)
 Park Distance Control [179](#)
 Parked vehicle, condensation [219](#)
 Parking assistance, see Park Distance Control [179](#)
 Parking assistant [185](#)
 Parking brake [102](#)
 Parking lights [136](#)
 Parts and accessories [8](#)
 Pathway lighting [137](#)
 Pathway lines, rearview camera [184](#)
 Payload [222](#)
 Payload, technical data [287](#)
 PDC, see Park Distance Control [179](#)

Pedestrian Collision Warning with City Collision Mitigation [156](#)
 Pedestrian Warning with City Collision Mitigation [156](#)
 Performance Control [165](#)
 Performance display, see Sport displays [132](#)
 Personal data, deleting [48](#)
 Personal profile, see Driver profiles [70](#)
 Physical units, see Units of measurement, setting [46](#)
 Plastic, care [284](#)
 Plastic parts, care [284](#)
 PostCrash – iBrake [161](#)
 Power failure [272](#)
 Power interruption [272](#)
 Power windows [76](#)
 Pressure monitor, tire, see Tire Pressure Monitor [145](#)
 Pressure, tires [236](#)
 Pressure warning, see Flat tire monitor [149](#)
 Pressure warning, see Tire Pressure Monitor [145](#)
 Pre-ventilation [197](#)
 Printed onboard literature [56](#)
 Profiles, see Driver profiles [70](#)
 Programmable memory buttons, iDrive [40](#)
 Protective function, glass sunroof, see Jam protection system [79](#)
 Protective function, windows, see Jam protection system [77](#)
 Push-and-turn reel, see Controller [36, 37](#)

R

Racetrack operation [219](#)
 Radiator fluid [263](#)
 Radio-ready state [97](#)
 Radio, see Owner's Manual for Navigation, Entertainment and Communication [6](#)
 Rain sensor [105, 109](#)
 Rear lights [269](#)
 Rear seat backrests, folding down [208](#)
 Rear seats [82](#)
 Rearview camera [182](#)
 Rear-view mirror, exterior [88](#)
 Rear window defroster [192, 196](#)

- Rear window wiper, operation [106, 110](#)
Rear wiper [106, 110](#)
Recirculated-air filter, see Microfilter/activated-charcoal filter [196](#)
Recirculated-air mode [191](#)
Recommended tire brands [243](#)
Refueling [232](#)
Remote control for audio, see Owner's Manual for Navigation, Entertainment, Communication [6](#)
Remote control, see Vehicle key [58](#)
Remote control, universal [198](#)
Remote services, app, see Owner's Manual for Navigation, Entertainment, Communication [6](#)
Renewal, wheels and tires [243](#)
Replace battery, vehicle key [61](#)
Replacement, wheels and tires [243](#)
Replacing parts [267](#)
Reporting safety malfunctions [13](#)
RES CNCL button, camera-based cruise control [170](#)
RES CNCL button, cruise control [176](#)
Reserve warning, see Range [125](#)
Resetting, Tire Pressure Monitor [145](#)
Reset, Tire Pressure Monitor [145](#)
Retreaded tires [244](#)
Roadside parking lights [137](#)
Rolling code hand-held transmitter [199](#)
Rolling to a stop with engine decoupled, see Coasting [228](#)
RON, see gasoline quality [235](#)
Roofliner [33](#)
Roof-mounted luggage rack [222](#)
Route, navigation, see Owner's Manual for Navigation, Entertainment, Communication [6](#)
RTTI, see Owner's Manual for Navigation, Entertainment, Communication [6](#)
Rubber components, care [284](#)
Runflat tires [244](#)
- S**
- Safe braking [218](#)
Safety locks, doors, and windows [96](#)
Safety switch, windows [77](#)
Safety systems, see Airbags [141](#)
- Screen, see Control Display [36](#)
Screwdriver, see Onboard vehicle tool kit [267](#)
Sealing compound, see Tire repair set [245](#)
Seat belt reminder for driver and front passenger seat, see Seat belts [85](#)
Seat belts [83](#)
Seat belts, care [284](#)
Seat heating, front [82](#)
Seating position for children [91](#)
Seat position, saving, see Memory function [87](#)
Seats and head restraints [80](#)
Seat setting, calling up [73](#)
Seats, front [80](#)
Seats, rear [82](#)
Securing, cargo [222](#)
Selection list on the instrument cluster [129](#)
Selector lever, Steptronic transmission [112](#)
Sensors, care [285](#)
Service and warranty [9](#)
Service Center, see BMW Roadside Assistance [275](#)
Service notifications, display [126](#)
Service notifications, see Condition Based Service [265](#)
Services, ConnectedDrive, see Owner's Manual for Navigation, Entertainment and Communication [6](#)
Servotronic [167](#)
SET button, camera-based cruise control [170](#)
SET button, cruise control [176](#)
Set clock [45](#)
Set day, see Date [46](#)
Set time, see Time [45](#)
Setting, Control Display [47](#)
Settings, general [45](#)
Settings, locking/unlocking [73](#)
Settings, mirrors [88](#)
Settings, seats and head restraints [80](#)
Shift paddles on the steering wheel [117](#)
Side airbag [141](#)
Signaling, horn [30](#)
Signals when unlocking, see Confirmation signals from the vehicle [73](#)
Sitting safely [80](#)
Ski and snowboard bag [210](#)
Slide/tilt glass roof [77](#)

- Smallest turning circle, vehicle [286](#)
 - Smartphone, connecting [49](#)
 - Smartphone, see Owner's Manual for Navigation, Entertainment and Communication [6](#)
 - Smartphone, using via voice control [44](#)
 - SMS, see Short messages, see Owner's Manual for Navigation, Entertainment, Communication [6](#)
 - Sockets, electrical devices [202](#)
 - Software update [55](#)
 - Software, updating [55](#)
 - SOS button, see Intelligent emergency call [276](#)
 - Sound [6](#)
 - Sound output, see Owner's Manual for Navigation, Entertainment, Communication [6](#)
 - Spare tire, see Emergency wheel [254](#)
 - Speech recognition [42](#)
 - Speed limit, display, see Speed Limit Info [127](#)
 - Speed Limit Info [127](#)
 - Speed, see Average speed [130](#)
 - Speed warning [132](#)
 - Split screen [35](#)
 - Sport displays [132](#)
 - SPORT program, driving dynamics [167](#)
 - Sports steering [167](#)
 - Stability control systems [163](#)
 - Standard equipment, see Vehicle equipment [7](#)
 - Start/stop, automatic function [99](#)
 - Start/Stop button [97](#)
 - Starting aid terminals [277](#)
 - Starting the engine [98](#)
 - Stations, AM/FM, see Owner's Manual for Navigation, Entertainment, Communication [6](#)
 - Status control display, tires [145](#)
 - Status information, iDrive [35](#)
 - Status of Owner's Manual [7](#)
 - Status, vehicle [135](#)
 - Steering column adjustment [90](#)
 - Steering support, see Servotronic [167](#)
 - Steering wheel, adjusting [90](#)
 - Steering wheel, buttons [30](#)
 - Steering wheel heating [90](#)
 - Steptronic Sport transmission, see Steptronic transmission [112](#)
 - Steptronic transmission [112](#)
 - Stopping the engine [99](#)
 - Storage compartment, rear [213](#)
 - Storage compartments [211](#)
 - Storage compartments, locations [211](#)
 - Storage, tires [244](#)
 - Storing the vehicle [285](#)
 - Stowing, cargo [222](#)
 - Suitable devices [50](#)
 - Suitable mobile phones [50](#)
 - Summer tires, tread [241](#)
 - Sun visor [201](#)
 - Supplementary Owner's Handbooks [56](#)
 - Supplementary Owner's Manuals [56](#)
 - Switches, see Dashboard [30](#)
 - Switch for driving dynamics, see Driving Dynamics Control [167](#)
 - Symbols [6](#)
 - SYNC program, automatic climate control [196](#)
 - System language, setting, see Language, setting [45](#)
 - System settings, see General settings [45](#)
- ## T
- Tachometer [124](#)
 - Tailgate, automatic [68](#)
 - Tailgate, closing with no-touch activation [66](#)
 - Tailgate, opening [68](#)
 - Tailgate, opening with no-touch activation [66](#)
 - Tail lights [269](#)
 - Taking the vehicle out of service [285](#)
 - Tank capacity [287](#)
 - Technical changes, see For Your Own Safety [7](#)
 - Technical data [286](#)
 - Telephone, see Owner's Manual for Navigation, Entertainment and Communication [6](#)
 - Teleservices, see Owner's Manual for Navigation, Entertainment, Communication [6](#)
 - Temperature, air conditioning system [191](#)
 - Temperature, automatic climate control [193](#)
 - Temperature display for external temperature [125](#)
 - Temperature, engine [131](#)
 - Text message, Check Control [121](#)
 - Theft alarm system, see Alarm system [74](#)

- Thigh support [81](#)
 - Tilt alarm sensor [75](#)
 - Tilting down, front passenger's side exterior mirror, see Automatic Curb Monitor [89](#)
 - Time [45](#)
 - Time of day, see Time [45](#)
 - Tire brands, recommended [243](#)
 - Tire chains [249](#)
 - Tire change [243](#)
 - Tire damage [242](#)
 - Tire identification marks [240](#)
 - Tire inflation pressure [236](#)
 - Tire marking [240](#)
 - Tire pressure [236](#)
 - Tire Pressure Monitor [145](#)
 - Tire pressure monitoring, see Flat tire monitor [149](#)
 - Tire Pressure Monitor, reset [145](#)
 - Tire Pressure Monitor, resetting [145](#)
 - Tire pressure, tires [236](#)
 - Tire pressure warning, see Flat tire monitor [149](#)
 - Tire repair set [245](#)
 - Tires [236](#)
 - Tire sealant, see Tire repair set [245](#)
 - Tires, run-flat [244](#)
 - Tire tread [241](#)
 - Tone, see Owner's Manual for Navigation, Entertainment and Communication [6](#)
 - Tool [267](#)
 - Torque display, see Sport displays [132](#)
 - Touchscreen [39](#)
 - Towing [278](#)
 - Tow-starting [278](#)
 - Traction Control [165](#)
 - Traction control system, see Dynamic Stability Control [163](#)
 - TRACTION, driving dynamics [165](#)
 - Traffic bulletins, see Owner's Manual for Navigation, Entertainment, Communication [6](#)
 - Transmission lock, electronic unlocking [118](#)
 - Transmission lock, releasing manually [117](#)
 - Transmission, see Steptronic transmission [112](#)
 - Transporting children safely [91](#)
 - Tread, tires [241](#)
 - Trip computer [129](#), [131](#)
 - Triple turn signal activation [104](#)
 - Trip odometer [124](#)
 - Trip recorder, see Trip odometer [124](#)
 - Trunk, see Cargo area [207](#)
 - Turning circle lines, rearview camera [184](#)
 - Turning circle, vehicle [286](#)
 - Turn signal, indicator light [123](#)
 - Turn signals, operation [103](#)
 - Turn signals, rear, bulb replacement [269](#)
- ## U
- Unintentional alarm, avoiding [75](#)
 - Units of measurement, setting [46](#)
 - Units, see Units of measurement, setting [46](#)
 - Universal remote control [198](#)
 - Unlock button, Steptronic transmission [112](#)
 - Unlocking, automatic [74](#)
 - Unlocking, see Opening and Closing [58](#)
 - Unlocking, settings [73](#)
 - Unpaved roads, cross-country trips [216](#)
 - Updates made after the editorial deadline [7](#)
 - Updating, software [55](#)
 - Upholstery care [283](#)
 - Upper retaining strap, top tether [95](#)
 - USB connection [52](#)
 - USB interface [202](#)
 - USB port, general information [202](#)
 - USB port, see USB port [202](#)
 - Used battery, disposing of [272](#)
 - Use, intended [7](#)
- ## V
- Vanity mirror [201](#)
 - Vehicle battery [271](#)
 - Vehicle breakdown, see Breakdown assistance [274](#)
 - Vehicle, breaking in [216](#)
 - Vehicle care [282](#)
 - Vehicle care products [282](#)
 - Vehicle equipment [7](#)
 - Vehicle identification number [12](#)
 - Vehicle issues [274](#)
 - Vehicle jack [252](#)
 - Vehicle key [58](#)

Vehicle key, additional [61](#)
 Vehicle key, integrated key [62](#)
 Vehicle key, loss [61](#)
 Vehicle key, malfunction [61](#)
 Vehicle key, replace battery [61](#)
 Vehicle paint, care [283](#)
 Vehicle paintwork [283](#)
 Vehicle position, vehicle location [46](#)
 Vehicle status [135](#)
 Vehicle storage [285](#)
 Vehicle tracking [46](#)
 Ventilation [196](#)
 Ventilation, see Pre-ventilation [197](#)
 Venting, see Ventilation [196](#)
 Video, see Owner's Manual for Navigation, Entertainment and Communication [6](#)
 VIN, see Vehicle identification number [12](#)
 Voice activation system [42](#)
 Voice command response [42](#)
 Voice control [42](#)
 Voice control system [42](#)

W

Warning and indicator lights, see Check Control [121](#)
 Warning displays, see Check Control [121](#)
 Warning messages, see Check Control [121](#)
 Warning triangle [274](#)
 Warranty [8](#)
 Warranty Booklet, see Warranty [8](#)
 Washer fluid [111](#)
 Washer nozzles, windshield [106](#), [110](#)
 Washer system [104](#), [108](#)
 Washing the vehicle [281](#)
 Washing, vehicle [281](#)
 Water on roads [218](#)
 Website [6](#)
 Weights [287](#)
 Welcome lights [137](#)
 Welcome lights during unlocking [59](#)
 Wheelbase [286](#)
 Wheel base, vehicle [286](#)
 Wheel change [250](#)
 Wheels [236](#)
 Wheels and tires, exchange [243](#)

Width, vehicle [286](#)
 Windows, powered [76](#)
 Windshield washer fluid, see Washer fluid [111](#)
 Windshield washer nozzles [106](#), [110](#)
 Windshield washer system, see Washer/wiper system [104](#), [108](#)
 Windshield wiper, see Wiper system [104](#), [108](#)
 Winter storage, see Long-term vehicle storage [285](#)
 Winter tires, suitable tires [244](#)
 Winter tires, tread [241](#)
 Wiper blades, changing [267](#)
 Wiper fluid, see Washer fluid [111](#)
 Wiper, fold-away position [107](#), [110](#)
 Wiper, see Washer/wiper system [104](#), [108](#)
 Wiper system [104](#), [108](#)
 Wireless charging, smartphone, see Wireless charging tray [204](#)
 Wireless charging tray for smartphones [204](#)
 Wood, care [284](#)
 Wordmatch principle [34](#)
 Word match principle, navigation [34](#)
 Working in, engine compartment [257](#)
 Wrench, see Onboard vehicle tool kit [267](#)

X

xDrive [165](#)



01405A540A1 ue

California Proposition 65 Warning

For vehicles sold in California:

California Proposition 65 Warning



WARNING

Operating, servicing and maintaining a passenger vehicle or off-highway motor vehicle can expose you to chemicals including engine exhaust, carbon monoxide, phthalates, and lead, which are known to the State of California to cause cancer and birth defects or other reproductive harm. To minimize exposure, avoid breathing exhaust, do not idle the engine except as necessary, service your vehicle in a well-ventilated area and wear gloves or wash your hands frequently when servicing your vehicle. For more information go to www.P65Warnings.ca.gov/passenger-vehicle.

BMW DRIVER'S GUIDE APP.

YOUR DIGITAL VEHICLE INFORMATION.

The BMW Driver's Guide app explains the equipment of your vehicle and offers further scopes and functions:



All information surrounding navigation, entertainment and communication

Photorealistic animations for various vehicle functions

Keyword search

360° view: Explore your vehicle interactively inside and out

Smart Scan for Apple iPhone: Icon and optical character recognition on the buttons in the vehicle

Available in more than 30 languages

Can be used offline after download



01405A540A1 ue

