

# OWNER'S MANUAL

Operation  
Maintenance  
Specifications

All information in this Owner's Manual is current at the time of publication. However, HYUNDAI reserves the right to make changes at any time so that our policy of continual product improvement may be carried out.

This manual applies to all HYUNDAI models and includes descriptions and explanations of optional as well as standard equipment. As a result, you may find material in this manual that does not apply to your specific vehicle.

## CAUTION: MODIFICATIONS TO YOUR HYUNDAI

Your HYUNDAI should not be modified in any way. Such modifications may adversely affect the performance, safety or durability of your HYUNDAI and may, in addition, violate conditions of the limited warranties covering the vehicle. Certain modifications may also be in violation of regulations established by the U.S. Department of Transportation and other federal or state agencies.

## TWO-WAY RADIO OR CELLULAR TELEPHONE INSTALLATION

Your vehicle is equipped with electronic fuel injection and other electronic components. It is possible for an improperly installed/adjusted two-way radio or cellular telephone to adversely affect electronic systems. For this reason, we recommend that you carefully follow the radio manufacturer's instructions or consult your HYUNDAI dealer for precautionary measures or special instructions if you choose to install one of these devices.

## SAFETY AND VEHICLE DAMAGE WARNING

This manual includes information titled as DANGER, WARNING, CAUTION and NOTICE.

These titles indicate the following:



### DANGER

**DANGER** indicates a hazardous situation which, if not avoided, will result in death or serious injury.



### WARNING

**WARNING** indicates a hazardous situation which, if not avoided, could result in death or serious injury.



### CAUTION

**CAUTION** indicates a hazardous situation which, if not avoided, could result in minor or moderate injury.

### NOTICE

**NOTICE** indicates a situation which, if not avoided, could result in vehicle damage.

---

## HYUNDAI VEHICLE OWNER PRIVACY POLICY

Your Hyundai vehicle may be equipped with technologies and services that use information collected, generated, recorded or stored by the vehicle. Hyundai has created a Vehicle Owner Privacy Policy to explain how these technologies and services collect use and share this information.

You may read our Vehicle Owner Privacy Policy on the Hyundaiusa.com website at: <https://www.hyundaiusa.com/owner-privacy-policy.aspx>

If you would like to receive a hard copy of our Vehicle Owner Privacy Policy, please contact our Customer Connect Center at:

Hyundai Customer Care  
P.O. Box 20850  
Fountain Valley, CA 92728 800-633-5151  
[consumeraffairs@hmausa.com](mailto:consumeraffairs@hmausa.com)

Hyundai's Customer Connect Center representatives are available Monday through Friday, between the hours of 5:00 AM and 7:00 PM PST and Saturday and Sunday between 6:30 AM and 3:00 PM PST (English).

For Customer Connect Center assistance in Spanish or Korean, representatives are available Monday through Friday between 6:30 AM and 3:00 PM PST.



# Table of Contents

Foreword	1
Vehicle Information	2
Seats & Safety System	3
Instrument Cluster	4
Convenient Features	5
While Driving	6
Emergency Situations	7
Maintenance	8
Index	I

# 1. Foreword

Introduction.....	1-2
Hyundai Motor America .....	1-2
Guide to Hyundai Genuine Parts .....	1-3
How to Use This Manual.....	1-4
Safety Messages .....	1-4
Fuel Requirements.....	1-5
Vehicle Modifications .....	1-7
Vehicle Break-In Process.....	1-7
Vehicle Data Collection and Event Data Recorders .....	1-8

## INTRODUCTION

Congratulations, and thank you for choosing HYUNDAI. We are pleased to welcome you to the growing number of discerning people who drive HYUNDAs. We are very proud of the advanced engineering and high-quality construction of each HYUNDAI we build.

Your Owner's Manual will introduce you to the features and operation of your new HYUNDAI. To become familiar with your new HYUNDAI, so that you can fully enjoy it, read this Owner's Manual carefully before driving your new vehicle.

This manual contains important safety information and instructions intended to familiarize you with your vehicle's controls and safety features so you can safely operate your vehicle.

This manual also contains information on maintenance designed to enhance safe operation of the vehicle. It is recommended that all service and maintenance on your car be performed by an authorized HYUNDAI dealer. HYUNDAI dealers are prepared to provide high-quality service, maintenance and any other assistance that may be required.

This Owner's Manual should be considered a permanent part of your vehicle, and should be kept in the vehicle so you can refer to it at any time. The manual should stay with the vehicle if you sell it to provide the next owner with important operating, safety and maintenance information.

## HYUNDAI MOTOR AMERICA



### CAUTION

**Severe engine and transmission damage may result from the use of poor quality fuels and lubricants that do not meet HYUNDAI specifications. You must always use high quality fuels and lubricants that meet the specifications listed on Page 2-11 in the Vehicle Specifications section of the Owner's Manual.**

Copyright 2019 HYUNDAI Motor America. All rights reserved. No part of this publication may be reproduced, stored in any retrieval system or transmitted in any form or by any means without the prior written permission of HYUNDAI Motor America.

## GUIDE TO HYUNDAI GENUINE PARTS

### 1. What are HYUNDAI Genuine Parts?

HYUNDAI Genuine Parts are the same parts used by HYUNDAI Motor Company to manufacture vehicles. They are designed and tested for the optimum safety, performance, and reliability for our customers.



### 2. Why Hyundai Genuine Parts?

HYUNDAI Genuine Parts are engineered and built to meet rigid manufacturing requirements. Damage caused by using imitation, counterfeit or used salvage parts is not covered under the HYUNDAI New Vehicle Limited Warranty or any other HYUNDAI warranty.

In addition, any damage to or failure of HYUNDAI Genuine Parts caused by the installation or failure of an imitation, counterfeit or used salvage part is not covered by any HYUNDAI Warranty.



### 3. How can you tell if you are purchasing HYUNDAI Genuine Parts?

Look for the HYUNDAI Genuine Parts Logo on the package (see below).

HYUNDAI Genuine Parts exported to the U.S. are packaged with labels written only in English.

HYUNDAI Genuine Parts are only sold through authorized HYUNDAI Dealerships.

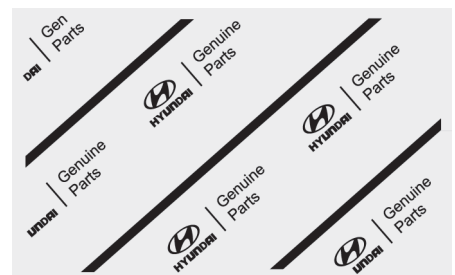



## HOW TO USE THIS MANUAL

We want to help you get the greatest possible driving pleasure from your vehicle. Your Owner's Manual can assist you in many ways. To gain an overview of the contents of your Owner's Manual, use the Table of Contents in the front of the manual. The first page of each Chapter includes a detailed Table of Contents of the topics in that Chapter.

To quickly locate information about your vehicle, use the Index in the back of the manual. It is an alphabetical list of what is in this manual and the page number where it can be found.

For your convenience, we have incorporated tabs on the right-hand page edges. These tabs are coded with the Chapter titles to assist you with navigating through the manual.

## SAFETY MESSAGES

Your safety, and the safety of others, is very important. This Owner's Manual provides you with many safety precautions and operating procedures. This information alerts you to potential hazards that may hurt you or others, as well as cause damage to your vehicle.

Safety messages found on vehicle labels and in this manual describe these hazards and what to do to avoid or reduce the risks.

Warnings and instructions contained in this manual are for your safety. Failure to follow safety warnings and instructions can lead to serious injury or death.

Throughout this manual DANGER, WARNING, CAUTION, NOTICE and the SAFETY ALERT SYMBOL will be used.



This is the safety alert symbol. It is used to alert you to potential physical injury hazards. Obey all safety messages that follow this symbol to avoid possible injury or death. The safety alert symbol precedes the signal words DANGER, WARNING and CAUTION.



## **DANGER**

**DANGER** indicates a hazardous situation which, if not avoided, will result in death or serious injury.



## **WARNING**

**WARNING** indicates a hazardous situation which, if not avoided, could result in death or serious injury.



## **CAUTION**

**CAUTION** indicates a hazardous situation which, if not avoided, could result in minor or moderate injury.

## **NOTICE**

**NOTICE** indicates a situation which, if not avoided, could result in vehicle damage.

## **FUEL REQUIREMENTS**

Your new vehicle is designed to obtain maximum performance with UNLEADED FUEL, as well as minimize exhaust emissions and spark plug fouling.

Your new vehicle is designed to use only unleaded fuel having an octane number ((R+M)/2) of 87 (Research Octane Number 91) or higher. (Do not use methanol blended fuels)

## **NOTICE**

To prevent damage to the engine and engine components, never add any fuel system cleaning agents to the fuel tank other than what has been specified.

Consult an authorized HYUNDAI dealer for additional information.



## **WARNING**

- Do not “top off” after the nozzle automatically shuts off when refueling.
- Always check that the fuel cap is installed securely to prevent fuel spillage in the event of an accident.

### **Gasoline containing alcohol or methanol**

Gasohol, a mixture of gasoline and ethanol (also known as grain alcohol) are being marketed along with or instead of leaded or unleaded gasoline. For example, “E15” is a gasohol comprised of 15% ethanol and 85% gasoline.

Do not use gasohol containing more than 15% ethanol, and do not use gasoline or gasohol containing any methanol. Either of these fuels may cause drivability problems and damage to the fuel system, engine control system and emission control system.

Discontinue using gasohol of any kind if drivability problems occur.

“E85” fuel is an alternative fuel comprised of 85 percent ethanol and 15 percent gasoline, and is manufactured exclusively for use in Flexible Fuel Vehicles. “E85” is not compatible with your vehicle. Use of “E85” may result in poor engine performance and damage to your vehicle’s engine and fuel system. HYUNDAI recommends that customers do not use fuel with an ethanol content exceeding 15 percent.

#### **NOTICE**

**To prevent damage to your vehicle’s engine and fuel system:**

- **Never use gasohol which contains methanol.**
- **Never use gasohol containing more than 15% ethanol.**
- **Never use leaded fuel or leaded gasohol.**
- **Never use “E85” fuel.**

**Your New Vehicle Limited Warranty does not cover damage to the fuel system or any performance problems caused by the use of “E85” fuel.**

### **Using Fuel Additives (except Detergent Fuel Additives)**

Using fuel additives such as:

- Silicone fuel additive
- Ferrocene (iron-based) fuel additive
- Other metallic-based fuel additives

may result in cylinder misfire, poor acceleration, engine stalling, damage to the catalyst, or abnormal corrosion, and may cause damage to the engine resulting in a reduction in the overall life of the powertrain.

- The Malfunction Indicator Lamp (MIL) may illuminate.

#### **NOTICE**

**Damage to the fuel system or performance problem caused by the use of these fuels or fuel additives may not be covered by your New Vehicle Limited Warranty.**

### **Gasoline containing MMT**

Some gasoline contains harmful manganese-based fuel additives such as MMT (Methylcyclopentadienyl Manganese Tricarbonyl).

HYUNDAI does not recommend the use of gasoline containing MMT.

This type of fuel can reduce vehicle performance and affect your emission control system.

The malfunction indicator lamp on the cluster may come on.

### **Detergent Fuel Additives**

HYUNDAI recommends that you use good quality gasolines treated with detergent additives such as TOP TIER Detergent Gasoline, which help prevent deposit formation in the engine. These gasolines will help the engine run cleaner and enhance performance of the Emission Control System. For more information on TOP TIER Detergent Gasoline, please go to the website ([www.toptiergas.com](http://www.toptiergas.com)).

For customers who do not use TOP Tier Detergent Gasoline regularly, and have problems starting or the engine does not run smoothly, detergent-based fuel additives that you can purchase separately may be added to the gasoline. If TOP TIER Detergent Gasoline is not available, one bottle of additive added to the fuel tank according to the maintenance schedule is recommended (refer to the Maintenance Schedule in chapter 8).

Additives are available from your authorized HYUNDAI dealer along with information on how to use them. Do not mix other additives.

### **Operation in foreign countries**

If you are going to drive your vehicle in another country, be sure to:

- Observe all regulations regarding registration and insurance.
- Determine that acceptable fuel is available.

## **VEHICLE MODIFICATIONS**

- This vehicle should not be modified. Modification of your vehicle could affect its performance, safety or durability and may even violate governmental safety and emissions regulations.  
In addition, damage or performance problems resulting from any modification may not be covered under warranty.
- If you use unauthorized electronic devices, it may cause the vehicle to operate abnormally, wire damage, battery discharge and fire. For your safety, do not use unauthorized electronic devices.

## **VEHICLE BREAK-IN PROCESS**

By following a few simple precautions for the first 600 miles (1,000 km) you may add to the performance, economy and life of your vehicle.

- Do not race the engine.
- While driving, keep your engine speed (rpm, or revolutions per minute) between 2,000 rpm and 4,000 rpm.
- Do not maintain a single speed for long periods of time, either fast or slow. Varying engine speed is needed to properly break-in the engine.
- Avoid hard stops, except in emergencies, to allow the brakes to seat properly.



## **WARNING**

### **CALIFORNIA PROPOSITION 65 WARNING**

Items contained in motor vehicles or emitted from them are known to the State of California to cause cancer and birth defects or reproductive harm.

These include:

- Gasoline and its vapors
- Engine exhaust
- Used engine oil
- Interior passenger compartment components and materials
- Component parts which are subject to heat and wear

In addition, battery posts, terminals and related accessories contain lead, lead compounds and other chemicals known to the State of California to cause cancer and reproductive harm.

For more information go to <https://www.p65warnings.ca.gov/passenger-vehicle>

## **VEHICLE DATA COLLECTION AND EVENT DATA RECORDERS**

This vehicle is equipped with an event data recorder (EDR). The main purpose of an EDR is to record, in certain crash or near crash-like situations, such as an air bag deployment or hitting a road obstacle, data that will assist in understanding how a vehicle's systems performed. The EDR is designed to record data related to vehicle dynamics and safety systems for a short period of time, typically 30 seconds or less. The EDR in this vehicle is designed to record such data as:

- How various systems in your vehicle were operating;
- Whether or not the driver and passenger safety belts were buckled/ fastened;
- How far (if at all) the driver was depressing the accelerator and/or brake pedal; and,
- How fast the vehicle was traveling.

This data can help provide a better understanding of the circumstances in which crashes and injuries occur. **NOTE:** EDR data is recorded by your vehicle only if a non-trivial crash situation occurs; no data is recorded by the EDR under normal driving conditions and no personal data (e.g., name, gender, age, and crash location) are recorded. However, other parties, such as law enforcement, could combine the EDR data with the type of personally identifying data routinely acquired during a crash investigation.

To read data recorded by an EDR, special equipment is required, and access to the vehicle or the EDR is needed. In addition to the vehicle manufacturer, other parties, such as law enforcement, that have the special equipment, can read the information if they have access to the vehicle or the EDR.

# 2. Vehicle Information

Exterior Overview .....	2-2
Interior Overview .....	2-4
Instrument Panel Overview.....	2-5
Engine Compartment.....	2-6
Dimensions.....	2-7
Engine Specification.....	2-7
Bulb Wattage.....	2-8
Tires and Wheels.....	2-9
Volume and Weight .....	2-10
Air Conditioning System.....	2-10
Recommended Lubricants and Capacities.....	2-11
Recommended SAE Viscosity Number .....	2-12
Vehicle Identification Number (VIN) .....	2-13
Vehicle Certification Label .....	2-13
Tire Specification and Pressure Label .....	2-14
Engine Number .....	2-14
Refrigerant Label .....	2-15

## EXTERIOR OVERVIEW

■ Front view



- |                           |      |  |      |
|---------------------------|------|--|------|
| 1. Hood .....             | 5-64 | 5. Panoramic sunroof .....             | 5-60 |
| 2. Headlamp.....          | 8-55 | 6. Front windshield wiper blades ..... | 8-29 |
| 3. Tires and wheels ..... | 8-34 | 7. Windows .....                       | 5-56 |
| 4. Side view mirror.....  | 5-53 |  |      |

■ Rear view

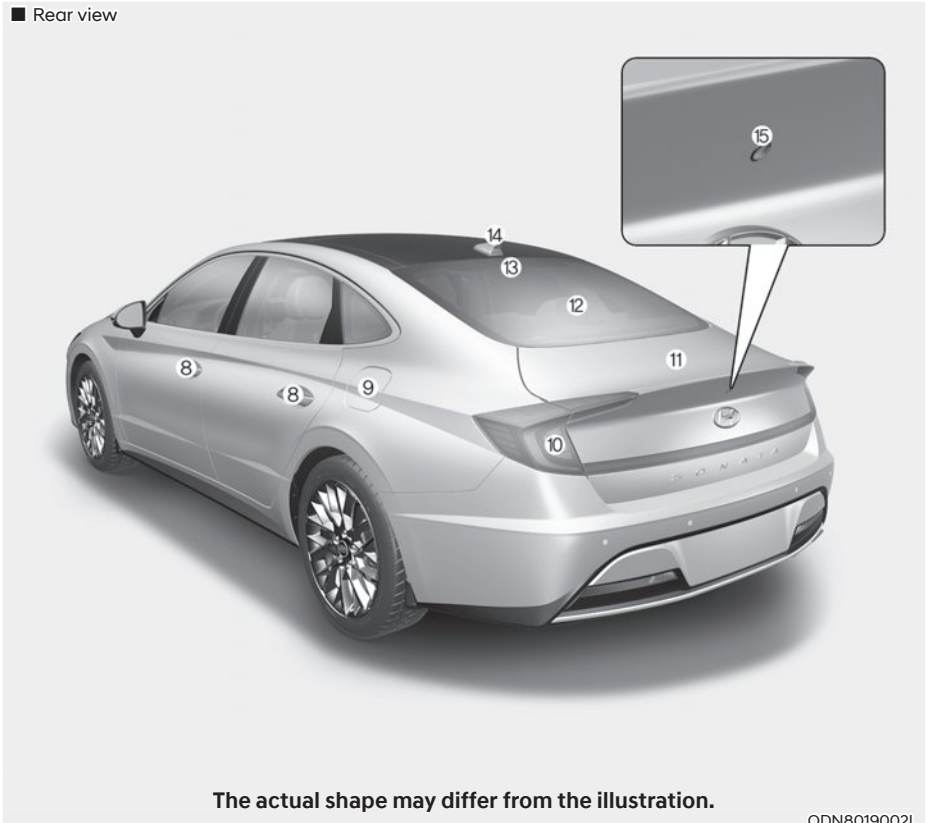

- |                          |      |                                 |       |
|--------------------------|------|---------------------------------|-------|
| 8. Door handle .....     | 5-31 | 12. Defroster .....             | 5-142 |
| 9. Fuel filler door..... | 5-70 | 13. High mounted stop lamp..... | 8-58  |
| 10. Rear tail lamp.....  | 8-56 | 14. Antenna.....                | 5-152 |
| 11. Trunk.....           | 5-65 | 15. Rear view camera.....       | 5-86  |



## INTERIOR OVERVIEW

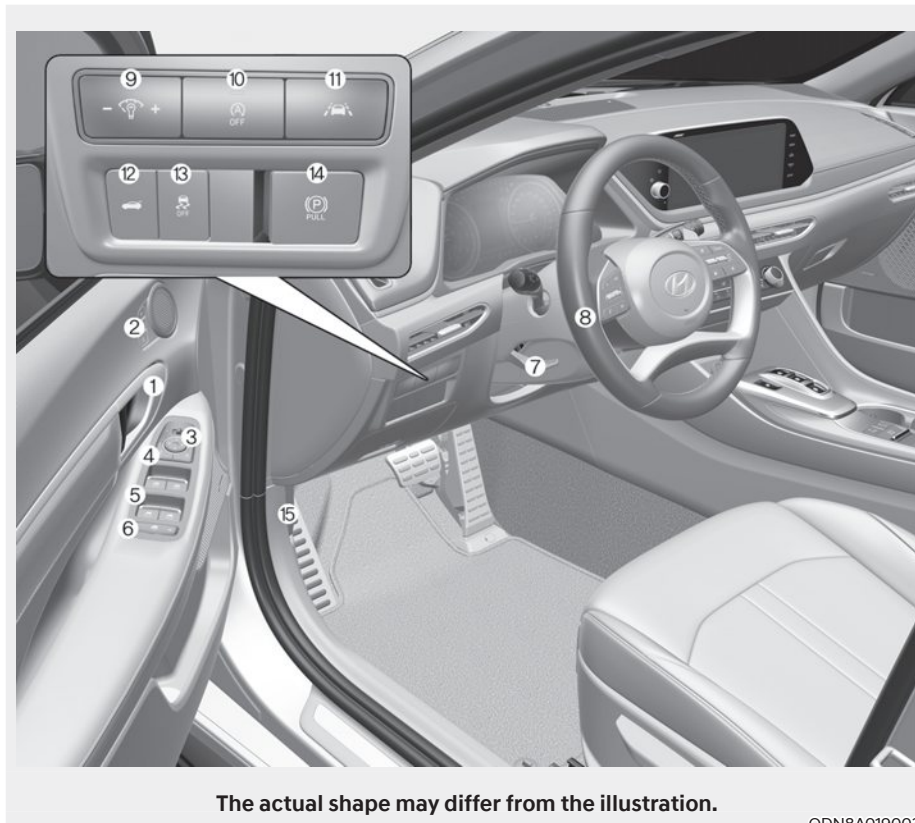

- |  |      |   |      |
|--|------|---|------|
| 1. Inside door handle.....                   | 5-32 | 9. Instrument panel illumination control switch ..... | 4-3  |
| 2. Seat position memory system .....         | 5-39 | 10. Idle Stop and Go (ISG) OFF button.....            | 6-33 |
| 3. Side view mirror control switch.....      | 5-54 | 11. Lane Keeping Assist system button ....            | 6-58 |
| 4. Central door lock switch .....            | 5-33 | 12. Trunk release button .....                        | 5-65 |
| 5. Power window switches .....               | 5-56 | 13. ESC OFF button .....                              | 6-29 |
| 6. Power window lock button .....            | 5-59 | 14. EPB (Electronic Parking Brake).....               | 6-21 |
| 7. Steering wheel tilt/telescopic lever .... | 5-43 | 15. Hood release lever .....                          | 5-64 |
| 8. Steering wheel.....                       | 5-42 |   |      |

## INSTRUMENT PANEL OVERVIEW

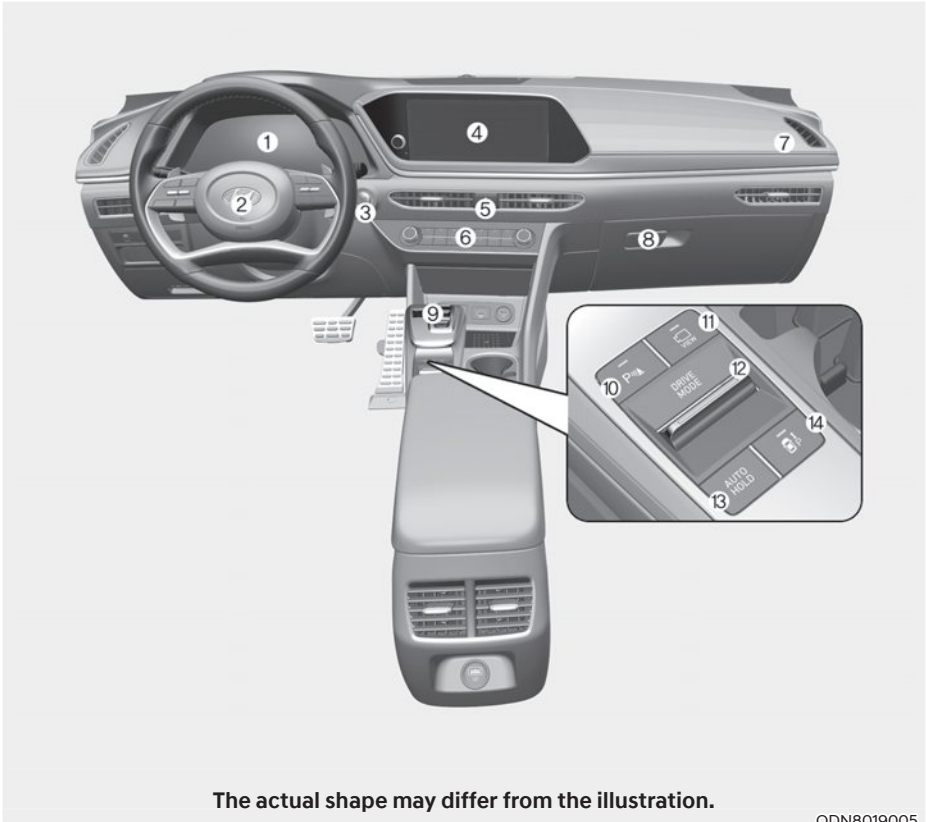

ODN8019005

- |   |       |  |       |
|---|-------|--|-------|
| 1. Instrument cluster .....               | 4-2   | 10. Reverse Parking Distance<br>Warning/ .....                 | 5-95  |
| 2. Driver's front air bag.....            | 3-39  | Forward/Reverse Parking Distance<br>Warning system button..... | 5-99  |
| 3. Key ignition switch/ .....             | 6-6   | 11. Surround View Monitor system button                        | 5-88  |
| Engine Start/Stop button.....             | 6-9   | 12. Drive mode integrated control system                       | 6-37  |
| 4. Audio / Video / Navigation system..... | 5-154 | 13. AUTO HOLD .....  | 6-24  |
| 5. Hazard warning flasher switch .....    | 7-2   | 14. Remote Smart Parking Assist (RSPA)<br>system button.....   | 5-104 |
| 6. Manual climate control system/.....    | 5-118 |  |       |
| Automatic climate control system .....    | 5-127 |  |       |
| 7. Passenger's front air bag .....        | 3-39  |  |       |
| 8. Glove box .....                        | 5-144 |  |       |
| 9. Transmission shift button .....        | 6-13  |  |       |

## ENGINE COMPARTMENT

■ Smartstream G1.6 T-GDi

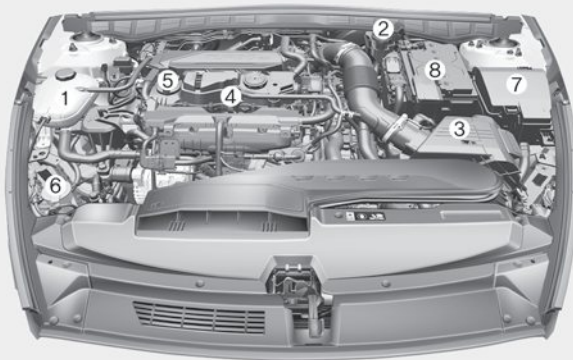

■ Smartstream G2.5 GDi

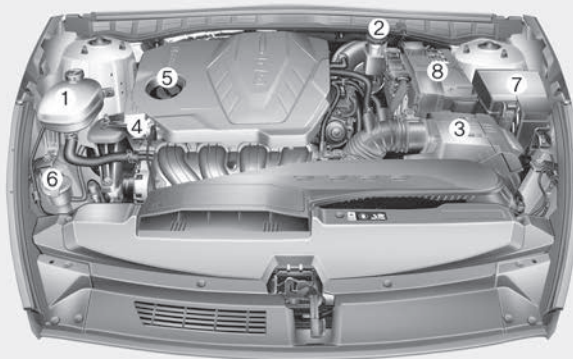

The actual engine room in the vehicle may differ from the illustration.

ODN8089103/ ODN8089048L

- |                                   |      |  |      |
|-----------------------------------|------|--|------|
| 1. Engine coolant reservoir ..... | 8-21 | 5. Engine oil filler cap .....             | 8-19 |
| 2. Brake fluid reservoir .....    | 8-24 | 6. Windshield washer fluid reservoir ..... | 8-25 |
| 3. Air cleaner .....              | 8-26 | 7. Fuse box .....                          | 8-46 |
| 4. Engine oil dipstick .....      | 8-19 | 8. Battery .....                           | 8-31 |

## DIMENSIONS

Items		in. (mm)
Overall length		192.9 (4,900)
Overall width		73.2 (1,860)
Overall height		56.9 (1,445)
Front tread	205/65 R16	64.3 (1,633)
	215/55 R17	63.9 (1,623)
	235/45 R18	63.7 (1,618)
Rear tread	205/65 R16	64.6 (1,640)
	215/55 R17	64.2 (1,630)
	235/45 R18	64.0 (1,625)
Wheelbase		111.8 (2,840)

## ENGINE SPECIFICATION

Item	Smartstream G1.6 T-GDi	Smartstream G2.5 GDi
Displacement cu. in. (cc)	97.08 (1,591)	152.37 (2,497)
Bore x Stroke in. (mm)	3.03 x 3.06 (77 x 85.44)	3.47 x 4.00 (88.5 x 101.5)
Firing order	1-3-4-2	1-3-4-2
No. of cylinders	4, in-line	4, in-line

## BULB WATTAGE

Light bulb		Bulb type	Wattage
Front	Headlamp (High/Low)		LED
	Daytime running lamp (DRL)/ Position lamp		LED
	Turn signal lamp		LED
	Side repeater lamp (Outside mirror)		LED
Rear	Stop lamp	Bulb type	PY21W
		LED type	LED
	Tail lamp		LED
	Turn signal lamp		LED
	Back up Lamp		W16W
	High mounted stop lamp		LED
	License plate lamp		W5W
	Interior	Map lamp	Type A
Type B			LED
Personal lamp (if equipped)		LED	
Room lamp (if equipped)		FESTOON	
Vanity mirror lamp		FESTOON	
Luggage compartment lamp		FESTOON	

## TIRES AND WHEELS

Item	Tire Size	Wheel Size	Inflation pressure kPa (psi)				Wheel lug nut torque kgf-m (lbf-ft, N-m)
			Normal load *1		Maximum load		
			Front	Rear	Front	Rear	
Full size tire	205/65 R16	6.5Jx16	240 (35)	240 (35)	240 (35)	240 (35)	11-13 (79-94, 107-127)
	215/55 R17	7.0Jx17	240 (35)	240 (35)	240 (35)	240 (35)	
	235/45 R18	7.5Jx18	240 (35)	240 (35)	240 (35)	240 (35)	
Compact spare tire (if equipped)	T125/80 D16	4Tx16	420 (60)	420 (60)	420 (60)	420 (60)	
	T135/80 D17	4Tx17	420 (60)	420 (60)	420 (60)	420 (60)	
	T135/80 D18	4Tx18	420 (60)	420 (60)	420 (60)	420 (60)	

\*1: Normal load: Up to 3 persons

### NOTICE

- It is permissible to add 3 psi to the standard tire pressure specification if colder temperatures are expected soon.  
Tires typically lose 1psi (7kPa) for every 12°F temperature drop. If extreme temperature variations are expected, recheck your tire pressure as necessary to keep them properly inflated.
- Tire inflation pressures will vary with changes in elevation. If driving in areas of higher or lower elevation, be sure to check and adjust for proper tire inflation.

### CAUTION

- When replacing tires, use the same size originally supplied with the vehicle.  
Using tires of a different size can damage the related parts or not work properly.
- When replacing tires, ALWAYS use the same size, type, construction and tread pattern supplied with the vehicle for all tires.

## VOLUME AND WEIGHT

Items		Smartstream G1.6 T-GDi	Smartstream G2.5 GDi
		A/T	A/T
Gross vehicle weight	lbs. (kg)	4354 (1975)	
Luggage volume (SAE)	cu ft (ℓ)	16 (453)	

A/T : Automatic Transmission

## AIR CONDITIONING SYSTEM

Item		Weight of Volume	Classification
Refrigerant oz. (g)	Smartstream G1.6 T-GDi	17.6±0.88 (500±25)	R-1234yf
	Smartstream G2.5 GDi	18.3±0.88 (520±25)	R-1234yf
Compressor lubricant	oz. (g)	32.8±0.35 (80±10)	PAG (FD46XG)

Contact an authorized HYUNDAI dealer for more details.

## RECOMMENDED LUBRICANTS AND CAPACITIES

To help achieve proper engine and powertrain performance and durability, use only lubricants of the proper quality. The correct lubricants also help promote engine efficiency that results in improved fuel economy.

These lubricants and fluids are recommended for use in your vehicle.

Lubricant		Volume	Classification
Engine oil *1 *2 (drain and refill) 	Smartstream G1.6 T-GDi	4.76 US qt. (4.5 ℓ)	API Lastest (SN PLUS) *3
	Smartstream G2.5 GDi	5.49 US qt. (5.2 ℓ)	API Lastest (SN PLUS) *3
Automatic transmission fluid		6.89 US qt. (6.5ℓ)	MICHANG ATF SP-IV, SK ATF SP IV, NOCA ATF SP-IV, S-oil ATF SP-IV HYUNDAI genuine ATF SP-IV or other brands meeting the above specification approved by HYUNDAI Motor Co.
Coolant	Smartstream G1.6 T-GDi	4.76 US qt. (4.5 ℓ)	Mixture of antifreeze and distilled water (Ethylene glycol base coolant for aluminum radiator)
	Smartstream G2.5 GDi	5.49 US qt. (5.2 ℓ)	
Brake fluid *4		0.74 ~ 0.85 US qt. (0.7 ~ 0.8 ℓ)	DOT-4
Fuel		15.85 US gal. (60 ℓ) 14.79 US gal. (56 ℓ) (for ECO package model)	Refer to "Fuel requirements" in chapter 1.

\*1: Refer to the recommended SAE viscosity numbers on page 12.

\*2: Engine oils labeled Energy Conserving Oil are now available. Along with other additional benefits, they contribute to fuel economy by reducing the amount of fuel necessary to overcome engine friction. Often, these improvements are difficult to measure in everyday driving, but in a year's time, they can offer significant cost and energy savings.

\*3: If the recommended engine oil is not available in your country, you are able to use API SL/ILSAC GF-3 or ACEA A3.

\*4: To maintain the best braking performance and ABS/ESC performance, we recommend that you use genuine brake fluid that conform to specifications. (Standard : SAE J1704 DOT-4 LV, ISO4925 CLASS-6 and FMVSS 116 DOT-4)



## Recommended SAE Viscosity Number

### CAUTION

Always be sure to clean the area around any filler plug, drain plug, or dipstick before checking or draining any lubricant. This is especially important in dusty or sandy areas and when the vehicle is used on unpaved roads. Cleaning the plug and dipstick areas will prevent dirt and grit from entering the engine and other mechanisms that could be damaged.

Engine oil viscosity (thickness) has an effect on fuel economy and cold weather operating (engine start and engine oil flowability). Lower viscosity engine oils can provide better fuel economy and cold weather performance, however, higher viscosity engine oils are required for satisfactory lubrication in hot weather.

Using oils of any viscosity other than those recommended could result in engine damage.

When choosing an oil, consider the range of temperature your vehicle will be operated in before the next oil change. Proceed to select the recommended oil viscosity from the chart.

Temperature Range for SAE Viscosity Numbers										
Temperature	°C	-30	-20	-10	0	10	20	30	40	50
	(°F)	-10	0	20	40	60	80	100	120	
Engine Oil	10W-30									
	0/5W-20, 0/5W-30									

\*1: For better fuel economy, it is recommended to use the engine oil of a viscosity grade 0W-20 (API Latest (SN PLUS)). However, if the engine oil is not available in your country, select the proper engine oil using the engine oil viscosity chart.



## VEHICLE IDENTIFICATION NUMBER (VIN)

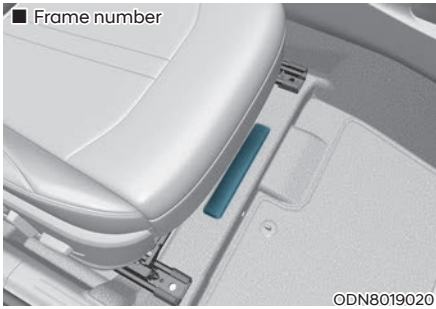

The vehicle identification number (VIN) is the number used in registering your car and in all legal matters pertaining to its ownership, etc.

The number is punched on the floor under the passenger seat.

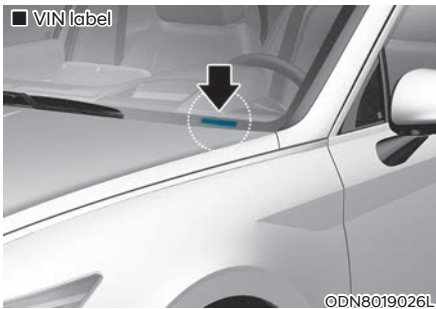

The VIN is also on a plate attached to the top of the dashboard. The number on the plate can easily be seen through the windshield from outside.

## VEHICLE CERTIFICATION LABEL

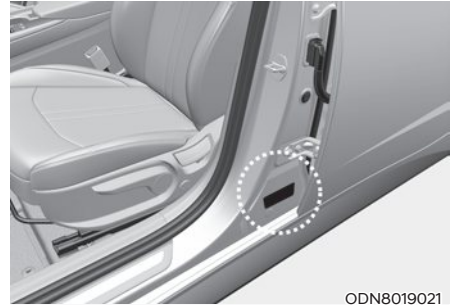

The vehicle certification label attached on the driver's side center pillar gives the Vehicle Identification Number (VIN).

## TIRE SPECIFICATION AND PRESSURE LABEL

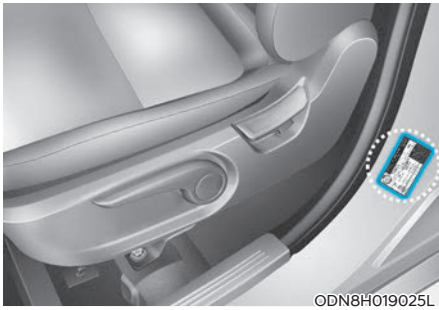

The tires supplied on your new vehicle are chosen to provide the best performance for normal driving.

The tire label located on the driver's side center pillar gives the tire pressures recommended for your car.

## ENGINE NUMBER

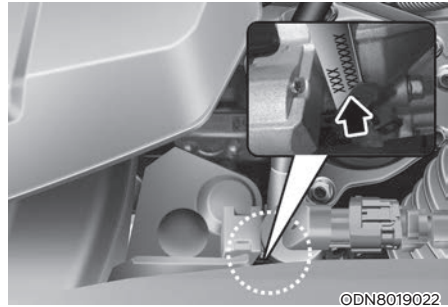

The engine number is stamped on the engine block as shown in the drawing.

## REFRIGERANT LABEL (IF EQUIPPED)

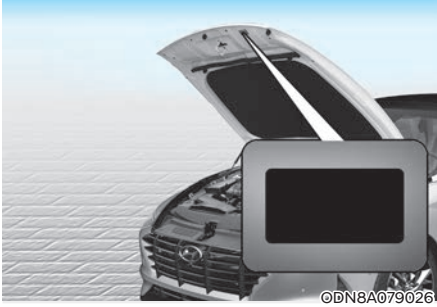

©DN8A079026

The refrigerant label provides information such as refrigerant type and amount. (R-1234yf)

# 3. Seats & Safety System

This chapter provides you with important information about how to protect yourself and your passengers. It explains how to properly use your seats and seat belts, and how your air bags work. Additionally, this chapter explains how to properly restrain infants and children in your vehicle.

- Important Safety Precautions ..... 3-2
  - Always Wear Your Seat Belt ..... 3-2
  - Restrain All Children..... 3-2
  - Air Bag Hazards ..... 3-2
  - Driver Distraction ..... 3-2
  - Control Your Speed ..... 3-2
  - Keep Your Vehicle in Safe Condition..... 3-2
- Seats ..... 3-3
  - Safety Precautions ..... 3-4
  - Front Seats..... 3-5
  - Rear Seats ..... 3-10
  - Head Restraints ..... 3-11
  - Seat Warmers and Air Ventilation Seats ..... 3-15
- Seat Belts..... 3-19
  - Seat Belt Safety Precautions ..... 3-19
  - Seat Belt Warning Light ..... 3-20
  - Seat Belt Restraint System ..... 3-21
  - Additional Seat Belt Safety Precautions ..... 3-26
  - Care of Seat Belts..... 3-28
- Child Restraint System (CRS)..... 3-29
  - Children Always in the Rear ..... 3-29
  - Selecting a Child Restraint System (CRS)..... 3-30
  - Installing a Child Restraint System (CRS) ..... 3-31
- Air Bag - Advanced Supplemental Restraint System ..... 3-37
  - Where Are the Air Bags? ..... 3-39
  - How Does the Air Bag System Operate?..... 3-42
  - What to Expect After an Air Bag Inflates ..... 3-46
  - Occupant Classification System (OCS)..... 3-47
  - Why Didn't My Air Bag Go Off in a Collision? ..... 3-52
  - SRS Care ..... 3-56
  - Additional Safety Precautions ..... 3-57
  - Air Bag Warning Labels..... 3-57

### IMPORTANT SAFETY PRECAUTIONS

You will find many safety precautions and recommendations throughout this section, and throughout this manual. The safety precautions in this section are among the most important.

#### Always Wear Your Seat Belt

A seat belt is your best protection in all types of accidents. Air bags are designed to supplement seat belts, not replace them. So even though your vehicle is equipped with air bags, ALWAYS make sure you and your passengers wear your seat belts, and wear them properly.

#### Restrain All Children

All children under age 13 should ride in your vehicle properly restrained in a rear seat, not the front seat. Infants and small children should be restrained in an appropriate child restraint. Larger children should use a booster seat with the lap/shoulder belt until they can use the seat belt properly without a booster seat.

#### Air Bag Hazards

While air bags can save lives, they can also cause serious or fatal injuries to occupants who sit too close to them, or who are not properly restrained. Infants, young children, and shorter adults are at the greatest risk of being injured by an inflating air bag. Follow all instructions and warnings in this manual.

#### Driver Distraction

Driver distraction presents a serious and potentially deadly danger, especially for inexperienced drivers. Safety should be the first concern when behind the wheel, and drivers need to be aware of the wide array of potential distractions, such as drowsiness, reaching for objects, eating, personal grooming, other passengers, and using cellular phones.

Drivers can become distracted when they take their eyes and attention off the road or their hands off the wheel to focus on activities other than driving. To reduce your risk of distraction or getting into an accident:

- ALWAYS set up your mobile devices (i.e., MP3 players, phones, navigation units, etc.) when your vehicle is parked or safely stopped.
- ONLY use your mobile device when allowed by laws and when conditions permit safe use. NEVER text or email while driving. Most states have laws prohibiting drivers from texting. Some states and cities also prohibit drivers from using handheld phones.
- NEVER let the use of a mobile device distract you from driving. You have a responsibility to your passengers and others on the road to always drive safely, with your hands on the wheel as well as your eyes and attention on the road.

#### Control Your Speed

Excessive speed is a major factor in crash injuries and deaths. Generally, the higher the speed, the greater the risk, but serious injuries can also occur at lower speeds. Never drive faster than is safe for current conditions, regardless of the maximum speed posted.

#### Keep Your Vehicle in Safe Condition

Having a tire blowout or a mechanical failure can be extremely hazardous. To reduce the possibility of such problems, check your tire pressures and condition frequently, and perform all regularly scheduled maintenance.

## SEATS

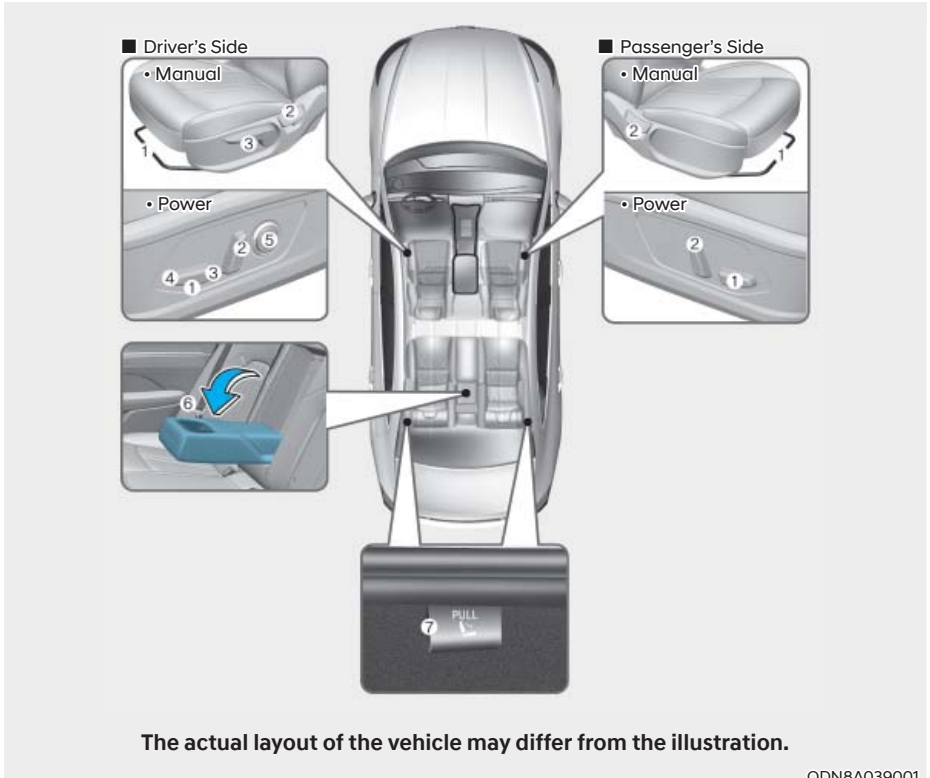
**Front seats**

- (1) Forward and rearward
- (2) Seatback angle
- (3) Seat cushion height
- (4) Seat cushion angle
- (5) Lumbar support

**Rear seats**

- (6) Armrest
- (7) Seatback folding

### Safety Precautions

Adjusting the seats so that you are sitting in a safe, comfortable position plays an important role in driver and passenger safety together with the seat belts and air bags in an accident.



#### WARNING

**Do not use a cushion that reduces friction between the seat and the passenger. The passenger's hips may slide under the lap portion of the seat belt during an accident or a sudden stop. Serious or fatal internal injuries could result because the seat belt cannot operate properly.**

#### Air bags

You can take steps to reduce the risk of being injured by an inflating air bag. Sitting too close to an air bag greatly increases the risk of injury in the event the air bag inflates.

The National Highway Traffic Safety Administration (NHTSA) recommends that drivers allow at least 10 inches (25 cm) between the center of the steering wheel and their chest.



#### WARNING

**To reduce the risk of serious injury or death from an inflating air bag, take the following precautions:**

- **Adjust the driver's seat as far to the rear as possible while maintaining the ability to maintain full control of the vehicle.**
- **Adjust the front passenger seat as far to the rear as possible.**
- **Hold the steering wheel by the rim with hands at the 9 o'clock and 3 o'clock positions to minimize the risk of injuries to your hands and arms.**

- **NEVER place anything or anyone between the steering wheel and the air bag.**
- **Do not allow the front passenger to place feet or legs on the dashboard to minimize the risk of leg injuries.**

#### Seat belts

Always fasten your seat belt before starting any trip.

At all times, passengers should sit upright and be properly restrained. Infants and small children must be restrained in appropriate child restraint systems. Adults and children who have outgrown a booster seat must be restrained using the seat belts.



#### WARNING

**Take the following precautions when adjusting your seat belt:**

- **NEVER use one seat belt for more than one occupant.**
- **Always position the seatback upright with the lap portion of the seat belt snug and low across the hips.**
- **NEVER allow children or small infants to ride on a passenger's lap.**
- **Do not route the seat belt across your neck, across sharp edges, or reroute the shoulder strap away from your body.**
- **Do not allow the seat belt to become caught or jammed.**



## Front Seats



### WARNING

Take the following precautions when adjusting your seat:

- **NEVER attempt to adjust the seat while the vehicle is moving.** The seat could respond with unexpected movement and may cause loss of vehicle control resulting in an accident.
- Do not place anything under the front seats. Loose objects in the driver's foot area could interfere with the operation of the foot pedals, causing an accident.
- Do not allow anything to interfere with the normal position and proper locking of the seatback.
- Do not place a cigarette lighter on the floor or seat. When you operate the seat, gas may exit out of the lighter causing a fire.
- Use extreme caution when picking up small objects trapped under the seats or between the seat and the center console. Your hands might be cut or injured by the sharp edges of the seat mechanism.
- If there are occupants in the rear seats, be careful while adjusting the front seat position.
- Make sure that the seat is locked in place after the adjustment. If not, the seat might move unexpectedly resulting in an accident.



### CAUTION

To prevent injury:

- Do not adjust your seat while wearing your seat belt. Moving the seat cushion forward may cause strong pressure on your abdomen.
- Do not allow your hands or fingers to get caught in the seat mechanisms while the seat is moving.

### Manual adjustment (if equipped)

The front seat can be adjusted by using the levers located on the outside of the seat cushion. Before driving, adjust the seat to the proper position so that you can easily control the steering wheel, foot pedals and controls on the instrument panel.

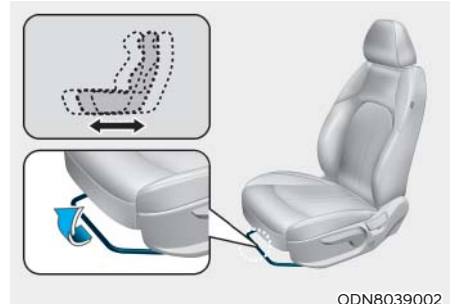

ODN8039002

### Forward and rearward adjustment

To move the seat forward or rearward:

1. Pull up the seat slide adjustment lever and hold it.
2. Slide the seat to the position you desire.
3. Release the lever and make sure the seat is locked in place. Move forward and rearward without using the lever. If the seat moves, it is not locked properly.

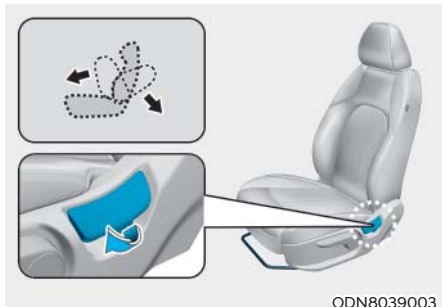

### Seatback angle

To recline the seatback:

1. Lean forward slightly and lift up the seatback lever.
2. Carefully lean back on the seat and adjust the seatback to the position you desire.
3. Release the lever and make sure the seatback is locked in place. (The lever **MUST** return to its original position for the seatback to lock.)

### Reclining seatback

Sitting in a reclined position when the vehicle is in motion can be dangerous. Even when buckled up, the protection of your restraint system (seat belts and air bags) is greatly reduced by reclining your seatback.

### **WARNING**

**NEVER** ride with a reclined seatback when the vehicle is moving.

**Riding with a reclined seatback increases your chance of serious or fatal injuries in the event of a collision or sudden stop.**

**Drivers and passengers should ALWAYS sit well back in their seats, properly belted, and with the seatbacks upright.**

Seat belts must be snug against your hips and chest to work properly. When the seatback is reclined, the shoulder belt cannot do its job because it will not be snug against your chest. Instead, it will be in front of you. During an accident, you could be thrown into the seat belt, causing neck or other injuries.

The more the seatback is reclined, the greater chance the passenger's hips will slide under the lap belt or the passenger's neck will strike the shoulder belt.

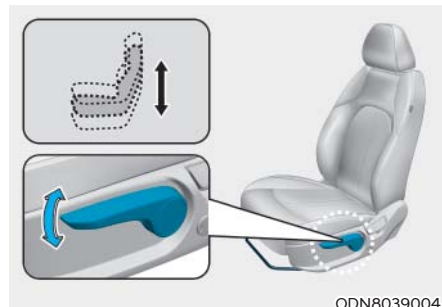

### Seat cushion height

To change the height of the seat cushion:

- Push down on the lever several times, to lower the seat cushion.
- Pull up on the lever several times, to raise the seat cushion.

### Power adjustment (if equipped)

The front seat can be adjusted by using the control switches located on the outside of the seat cushion. Before driving, adjust the seat to the proper position so that you can easily control the steering wheel, foot pedals and controls on the instrument panel.



### WARNING

**NEVER** allow children in the vehicle unattended. The power seats are operable when the vehicle is turned off.

### NOTICE

To prevent damage to the seats:

- Always stop adjusting the seats when the seat has moved as far forward or rearward as possible.
- Do not adjust the seats for longer than necessary when the vehicle is turned off. This may result in unnecessary battery drain.
- Do not operate two or more seats at the same time. This may result in an electrical malfunction.

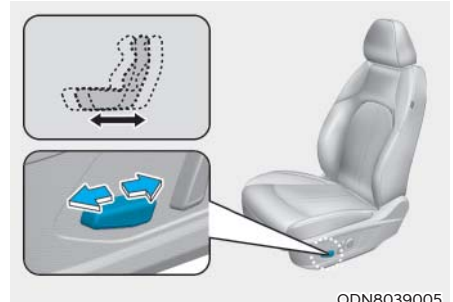

### Forward and rearward adjustment

To move the seat forward or rearward:

1. Push the control switch forward or rearward.
2. Release the switch once the seat reaches the desired position.

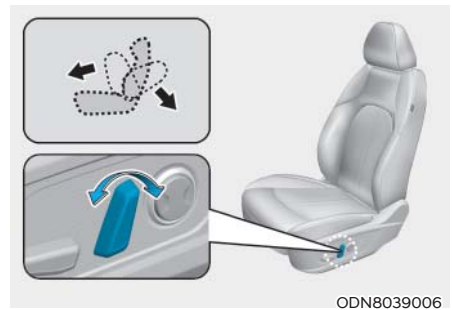

### Seatback angle

To adjust the seatback:

1. Rotate the top of control switch forward or rearward.
2. Release the switch once the seatback reaches the desired position.

### Reclining seatback

Sitting in a reclined position when the vehicle is in motion can be dangerous. Even when buckled up, the protection of your restraint system (seat belts and air bags) is greatly reduced by reclining your seatback.



### WARNING

**NEVER ride with a reclined seatback when the vehicle is moving. Riding with a reclined seatback increases your chance of serious or fatal injuries in the event of a collision or sudden stop. Driver and passengers should ALWAYS sit well back in their seats, properly belted, and with the seatbacks upright.**

Seat belts must be snug against your hips and chest to work properly. When the seatback is reclined, the shoulder belt cannot do its job because it will not be snug against your chest. Instead, it will be in front of you. During an accident, you could be thrown into the seat belt, causing neck or other injuries. The more the seatback is reclined, the greater chance the passenger's hips will slide under the lap belt or the passenger's neck will strike the shoulder belt.

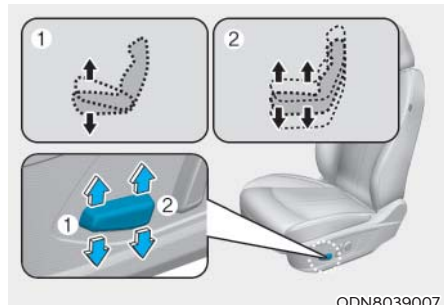

#### Seat cushion tilt (1)

To change the angle of the front part of the seat cushion: Push the front portion of the control switch up to raise or down to lower the front part of the seat cushion. Release the switch once the seat reaches the desired position.

#### Seat cushion height (2)

To change the height of the seat cushion: Push the rear portion of the control switch up to raise or down to lower the height of the seat cushion. Release the switch once the seat reaches the desired position.

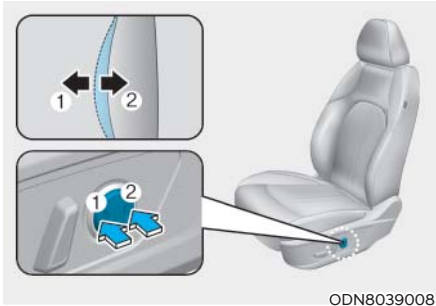

ODN8039008

### Lumbar support (for driver's seat, if equipped)

The lumbar support can be adjusted by pressing the lumbar support switch. Press the front portion of the switch (1) to increase support or the rear portion of the switch (2) to decrease support.

### Seatback pocket (if equipped)

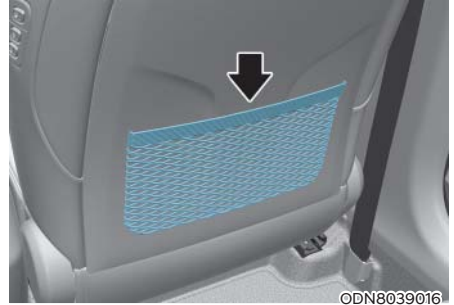

ODN8039016

The seatback pocket is provided on the back of the front seatbacks.



### WARNING

To prevent the Occupant Classification System from malfunctioning:

Do not hang onto the front passenger's seatback.



### CAUTION

Do not put heavy or sharp objects in the seatback pockets. In an accident they could come loose from the pocket and injure occupants.

## Rear Seats

### Folding the rear seat

The rear seatbacks can be folded down to facilitate carrying long items or to increase the luggage capacity of the vehicle.

#### WARNING

- **Never allow passengers to sit on top of the folded down seatback while the vehicle is moving. This is not a proper seating position and no seat belts are available for use. This could result in serious injury or death in case of an accident or sudden stop.**
- **Objects carried on the folded down seatback should not extend higher than the top of the front seatbacks. This could allow cargo to slide forward and cause injury or damage during sudden stops.**

To fold down the rear seatback:

1. Set the front seatback to the upright position and if necessary, slide the front seat forward.

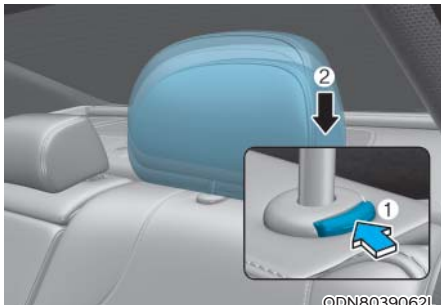

2. Lower the rear head restraints to the lowest position by pushing and holding the release button and pushing down on the head restraint.



3. Pull on the seatback folding lever located in the trunk.



4. Fold the seatback toward the front of the vehicle.
5. To use the rear seat, lift and pull the seatback rearward. Pull the seatback firmly until it clicks into place. Make sure the seatback is locked in place.

### **WARNING**

When returning the rear seatback from a folded to an upright position, hold the seatback and return it slowly. Ensure that the seatback is completely locked into its upright position by pushing on the top of the seatback. In an accident or sudden stop, an unlocked seatback could allow cargo to move forward with great force and enter the passenger compartment, which could result in serious injury or death.

### **WARNING**

Do not place objects in the rear seats, since they cannot be properly secured and may hit vehicle occupants in a collision causing serious injury or death.

### **WARNING**

Make sure the vehicle is off, the shift button is in P (Park), and the parking brake is securely applied whenever loading or unloading cargo. Failure to take these steps may allow the vehicle to move if the shift button is inadvertently moved to another position.

### Armrest



The armrest is located in the center of the rear seat. Pull the armrest down from the seatback to use it.

### Head Restraints

The vehicle's front and rear seats have adjustable head restraints. The head restraints provide comfort for passengers, but more importantly they are designed to help protect passengers from whiplash and other neck and spinal injuries during an accident, especially in a rear impact collision.

### **WARNING**

To reduce the risk of serious injury or death in an accident, take the following precautions when adjusting your head restraints:

- Always properly adjust the head restraints for all passengers **BEFORE** starting the vehicle.
- **NEVER** let anyone ride in a seat with the head restraints removed or reversed.

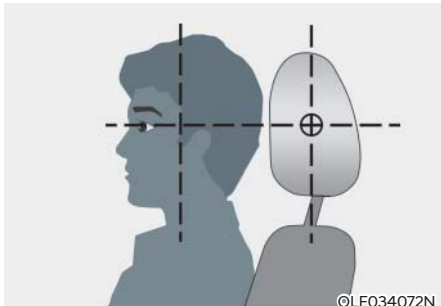

- Adjust the head restraints so the middle of the head restraint is at the same height as the height of the top of the eyes.
- NEVER adjust the head restraint position of the driver's seat when the vehicle is in motion.
- Adjust the head restraint as close to the passenger's head as possible. Do not use a seat cushion that holds the body away from the seatback.
- Make sure the head restraint locks into position after adjusting it.

**NOTICE**

To prevent damage, NEVER hit or pull on the head restraints.

**CAUTION**

When there are no occupants in the rear seats, adjust the height of the head restraint to the lowest position. The rear seat head restraint can reduce the visibility of the rear area.

**Front seat head restraints**

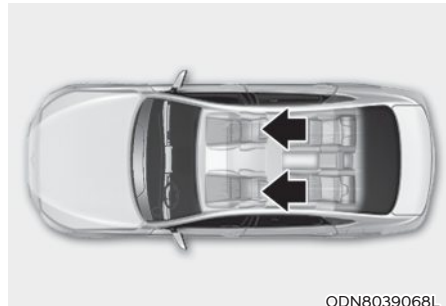

Both the driver's and passenger's front seat are equipped with adjustable head restraints for the safety and comfort.

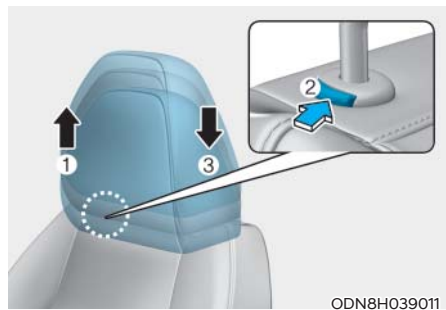

**Adjusting the height up and down**

To raise the head restraint:

1. Pull it up to the desired position (1).

To lower the head restraint:

1. Push and hold the release button (2) on the head restraint support.
2. Lower the head restraint to the desired position (3).





### NOTICE

If you recline the seatback towards the front with the head restraint and seat cushion raised, the head restraint may come in contact with the sunvisor or other parts of the vehicle.

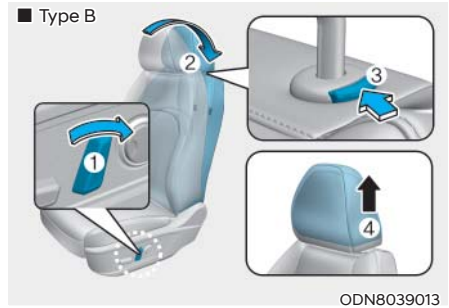
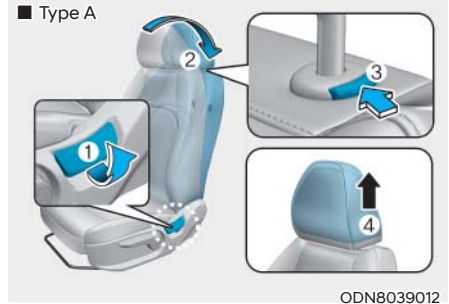

### Removal/Reinstallation

To remove the head restraint:

1. Recline the seatback (2) rearward using the seatback angle lever (1).
2. Raise the head restraint as far as it can go.
3. Press the head restraint release button (3) while pulling the head restraint up (4).

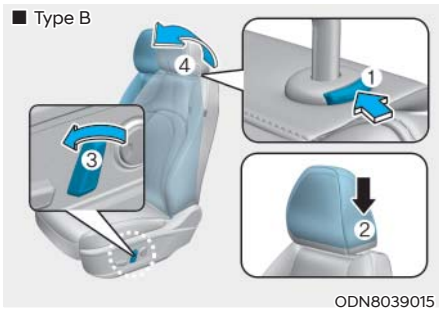
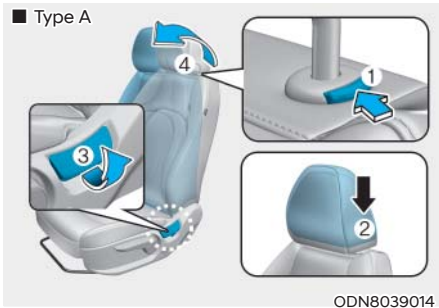

To reinstall the head restraint:

1. Put the head restraint poles (2) into the holes while pressing the release button (1).
2. Adjust the head restraint to the appropriate height.
3. Adjust the seatback (4) forward using the seatback angle lever (3).

### Rear seat head restraints

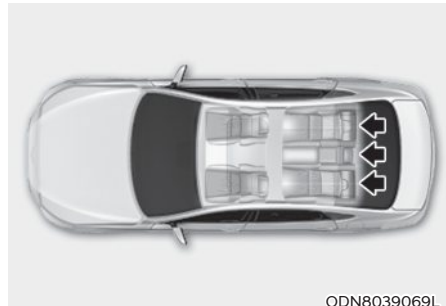

The rear seats are equipped with head restraints in all the seating positions for the passenger's safety and comfort.

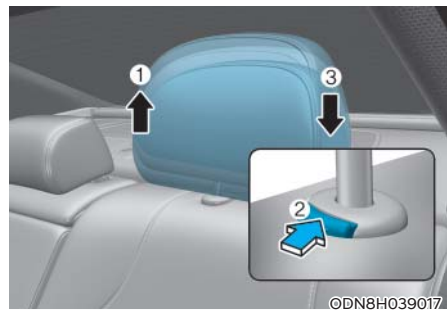

### Adjusting the height up and down

To raise the head restraint:

1. Pull it up to the desired position (1).

To lower the head restraint:

1. Push and hold the release button (2) on the head restraint support.
2. Lower the head restraint to the desired position (3).

## Seat Warmers and Air Ventilation Seats

### *Front seat warmers (if equipped)*

Seat warmers are provided to warm the seats during cold weather.



### **WARNING**

The seat warmers can cause a **SERIOUS BURN**, even at low temperatures and especially if used for long periods of time.

Passengers must be able to feel if the seat is becoming too warm so they can turn it off, if needed.

People who cannot detect temperature change or pain to the skin should use extreme caution, especially the following types of passengers:

- Infants, children, elderly or disabled persons, or hospital outpatients.
- People with sensitive skin or who burn easily.
- Fatigued individuals.
- Intoxicated individuals.
- People taking medication that can cause drowsiness or sleepiness.



### **WARNING**

**NEVER** place anything on the seat that insulates against heat when the seat warmer is in operation, such as a blanket or seat cushion. This may cause the seat warmer to overheat, causing a burn or damage to the seat.

### **NOTICE**

To prevent damage to the seat warmers and seats:

Never use a solvent such as paint thinner, benzene, alcohol or gasoline to clean the seats.

Do not place heavy or sharp objects on seats equipped with seat warmers.

Do not change the seat cover. It may damage the seat warmer or air ventilation system.

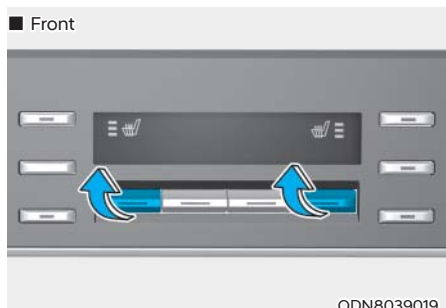

While the engine is running, push either of the switches to warm the driver’s seat or front passenger’s seat.

During mild weather or under conditions where the operation of the seat warmer is not needed, keep the switches in the OFF position.

- Manual temperature control  
Each time you push the switch, the temperature setting of the seat is changed as follows:

- Front seat

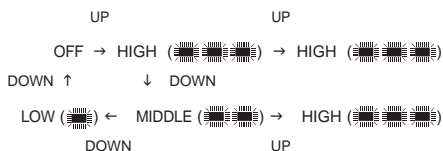

- Automatic temperature control  
The seat warmer starts to automatically control the seat temperature in order to prevent low-temperature burns after being manually turned ON.

- Front seat

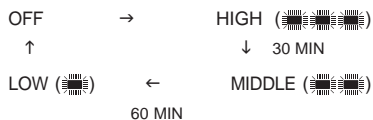

You may manually press the switch to increase seat temperature. However, it soon returns the automatic mode again.

- When pressing the switch for more than 1.5 seconds with the seat warmer operating, the seat warmer will turn OFF.
- The seat warmer defaults to the OFF position whenever the ignition switch is in the ON position. However, if the Auto Comfort Control function is ON, the driver’s seat warmer will turn on and off depending on the ambient temperature.
- Auto Comfort Control (for driver’s seat, if equipped)

The seat warmer automatically controls the seat temperature depending on the ambient temperature when the engine is running. If the seat warmer switch is pushed, the seat warmer will have to be controlled manually. To use this function, it must be activated from the Settings menu in the AVN system screen. For more information, refer to the separately supplied Car Infotainment System manual.

### Front air ventilation seat (if equipped)

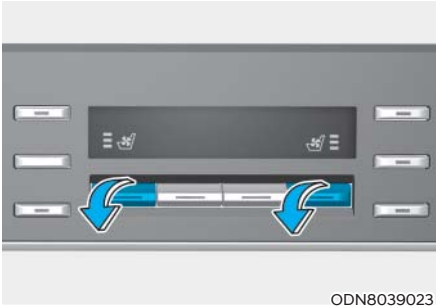

ODN8039023

The air ventilation seats are provided to cool the front seats by blowing air through small vent holes on the surface of the seat cushions and seatbacks.

When the operation of the air ventilation seat is not needed, keep the switches in the OFF position.

While the engine is running, push the switch to cool the driver's seat or the front passenger's seat.

- Each time you push the switch, the airflow changes as follows:

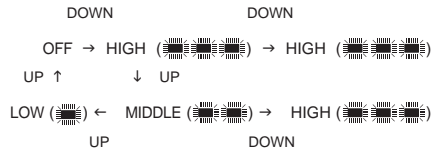

- When pressing the switch for more than 1.5 seconds with the air ventilation seat operating, the operation will turn OFF.
- The air ventilation seat defaults to the OFF position whenever the ignition switch is in the ON position. However, if the Auto Comfort Control function is ON, the driver's air ventilation seat will turn on and off depending on the ambient temperature.
- Auto Comfort Control (for driver's seat, if equipped)  
The air ventilation seat automatically controls the seat temperature depending on the ambient temperature when the engine is running. If the air ventilation seat switch is pushed, the seat warmer will have to be controlled manually. To use this function, it must be activated from the Settings menu in the AVN system screen. For more information, refer to the separately supplied Car Infotainment System manual.

**NOTICE**

To prevent damage to the air ventilation seat:

- Use the air ventilation seat **ONLY** when the climate control system is on. Using the air ventilation seat for prolonged periods of time with the climate control system off could cause the air ventilation seat to malfunction.
- **NEVER** use a solvent such as paint thinner, benzene, alcohol or gasoline to clean the seats.
- Avoid spilling liquids on the surface of the front seats and seatbacks; this may cause the air vent holes to become blocked and not work properly.
- Do not place materials such as plastic bags or newspapers under the seats. They may block the air intake causing the air vents to not work properly.
- Do not change the seat covers. It may damage the air ventilation seat.
- If the air vents do not operate, restart the vehicle. If there is no change, have the vehicle inspected by an authorized HYUNDAI dealer.

## SEAT BELTS

This section describes how to use the seat belts properly. It also describes some of the things to avoid when using seat belts.

### Seat Belt Safety Precautions

Always fasten your seat belt and make sure all passengers have fastened their seat belts before starting any trip. Air bags are designed to supplement the seat belt as an additional safety device, but they are not a substitute. Most states require all occupants of a vehicle to wear seat belts.



#### WARNING

Seat belts must be used by **ALL** passengers whenever the vehicle is moving. Take the following precautions when adjusting and wearing seat belts:

- **ALWAYS** properly restrain children under age 13 in the rear seats.
- **NEVER** allow children to ride in the front passenger seat. If a child age 13 or older must be seated in the front seat, move the seat as far back as possible and properly restrain them in the seat.
- **NEVER** allow an infant or child to be carried on an occupant's lap.
- **NEVER** ride with the seatback reclined when the vehicle is moving.
- Do not allow children to share a seat or seat belt.
- Do not wear the shoulder belt under your arm or behind your back.
- Always wear both the shoulder portion and lap portion of the lap/shoulder belt.
- Do not use the seat belt if it is twisted. A twisted seat belt will not protect you properly in an accident.
- Do not use a seat belt if the webbing or hardware is damaged.

- Do not latch the seat belt into the buckles of other seats.
- **NEVER** unfasten the seat belt while driving. This may cause loss of vehicle control resulting in an accident.
- Make sure there is nothing in the buckle interfering with the seat belt latch mechanism. This may prevent the seat belt from fastening securely.
- No modifications or additions should be made by the user which will either prevent the seat belt adjusting devices from operating to remove slack, or prevent the seat belt assembly from being adjusted to remove slack.



#### WARNING

Damaged seat belts and seat belt assemblies will not operate properly. Always replace:

- Frayed, contaminated, or damaged webbing
- Damaged hardware
- The entire seat belt assembly after it has been worn in an accident, even if damage to webbing or assembly is not apparent

## Seat Belt Warning Light

### Seat belt warning light (for driver's seat)



As a reminder to the driver, the seat belt warning light will illuminate for approximately 6 seconds each time you place the ignition switch to the ON position regardless of belt fastening. However, if the seat belt is Unfastened, a warning chime will sound for approximately 6 seconds.

If you continue not to fasten the seat belt and you drive under 12 mph (20 km/h), the warning light will stay illuminated.

If you continue not to fasten the seat belt and you drive over 12 mph (20 km/h) the seat belt warning chime will sound for approximately 100 seconds and the corresponding warning light will blink.

If you unfasten the seat belt while driving under 12 mph (20 km/h), the seat belt warning light will illuminate until the seat belt is fastened.

If you unfasten the seat belt while driving over 12 mph (20 km/h), the seat belt warning chime will sound for approximately 100 seconds and the corresponding warning light will blink.

### Seat belt warning light (for front passenger's seat)

As a reminder to the front passenger, the front passenger's seat belt warning lights will illuminate for approximately 6 seconds each time you place the ignition switch to the ON position regardless of belt fastening.

If you continue not to fasten the seat belt and you drive under 12 mph (20 km/h), the warning light will stay illuminated.

If you continue not to fasten the seat belt and you drive over 12 mph (20 km/h) the seat belt warning chime will sound for approximately 100 seconds and the corresponding warning light will blink.

If you unfasten the seat belt while driving under 12 mph (20 km/h) the seat belt warning light will illuminate until the seat belt is fastened.

If you unfasten the seat belt while driving over 12 mph (20 km/h), the seat belt warning chime will sound for approximately 100 seconds and the corresponding warning light will blink.

### **WARNING**

**The front passenger's seat belt warning light may not properly operate if the front passenger does not sit properly in the seat.**

If you place an object on the passenger seat or back seat or under the seats, the warning chime may sound. Please remove the object if the chime sounds.



## Seat Belt Restraint System



### WARNING

Improperly positioned seat belts may increase the risk of serious injury in an accident. Take the following precautions when adjusting the seat belt:

- Position the lap portion of the seat belt as low as possible across your hips, not on your waist, so that it fits snugly.
- Position one arm under the shoulder belt and the other over the belt, as shown in the illustration.
- Always position the shoulder belt anchor into the locked position at the appropriate height.
- NEVER position the shoulder belt across your neck or face.

### Seat Belt-Driver's 3-point system with emergency locking retractor

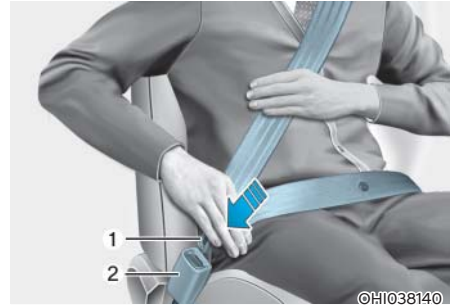

#### To fasten your seat belt:

Pull the seat belt out of the retractor and insert the metal tab (1) into the buckle (2). There will be an audible “click” when the tab locks into the buckle.

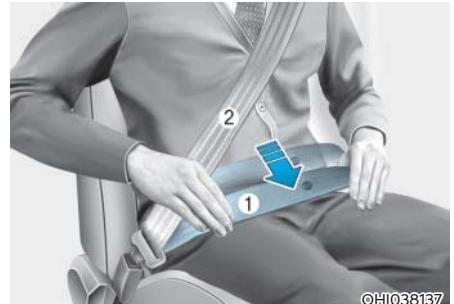

You should place the lap belt (1) portion across your hips and the shoulder belt (2) portion across your chest.

The seat belt automatically adjusts to the proper length after the lap belt portion is adjusted manually so that it fits snugly around your hips. If you lean forward in a slow, easy motion, the belt will extend and move with you.

If there is a sudden stop or impact, the belt will lock into position. It will also lock if you try to lean forward too quickly.

**NOTICE**

If you are not able to smoothly pull enough of the seat belt out from the retractor, firmly pull the seat belt out and release it. After release, you will be able to pull the belt out smoothly.

**Height adjustment**

You can adjust the height of the shoulder belt anchor to one of the three different positions for maximum comfort and safety. The shoulder portion should be adjusted so it lies across your chest and midway over your shoulder nearest the door, not over your neck. To adjust the height of the seat belt anchor, lower or raise the height adjuster into an appropriate position.

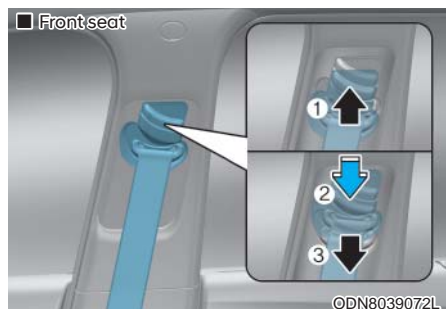

To raise the height adjuster, pull it up (1). To lower it, push it down (3) while pressing the height adjuster button (2). Release the button to lock the anchor into position. Try sliding the height adjuster to make sure that it has locked into position.

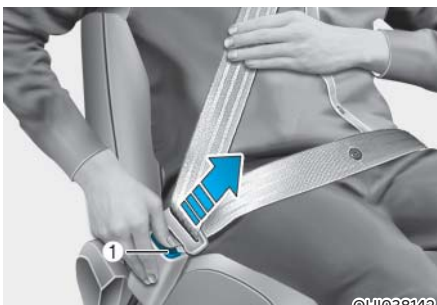

**To release your seat belt:**

Press the release button (1) in the locking buckle.

When it is released, the belt should automatically draw back into the retractor. If this does not happen, check the belt to be sure it is not twisted, then try again.

**Rear Seat Belt – Passenger’s 3-point system with convertible locking retractor**

This type of seat belt combines the features of both an emergency locking retractor seat belt and an automatic locking retractor seat belt. Convertible retractor type seat belts are installed in the rear seat positions to help accommodate the installation of child restraint systems. Although a convertible retractor is also installed in the front passenger seat position, NEVER place any infant/child restraint system in the front seat of the vehicle.

**To fasten your seat belt:**

Pull the seat belt out of the retractor and insert the metal tab into the buckle. There will be an audible “click” when the tab locks into the buckle. When not securing a child restraint, the seat belt operates in the same way as the driver’s seat belt (Emergency Locking Retractor Type). It automatically adjusts to the proper length only after the lap belt portion of the seat belt is adjusted manually so that it fits snugly across your hips.

When the seat belt is fully extended from the retractor to allow the installation of a child restraint system, the seat belt operation changes to allow the belt to retract, but not to extend (Automatic Locking Retractor Type). Refer to the “Using a Child Restraint System” section in this chapter.

**NOTICE**

Although the seat belt retractor provides the same level of protection for seated passengers in either emergency or automatic locking modes, the emergency locking mode allows seated passengers to move freely in their seat while keeping some tension on the belt. During a collision or sudden stop, the retractor automatically locks the belt to help restrain your body.

To deactivate the automatic locking mode, unbuckle the seat belt and allow the belt to fully retract.

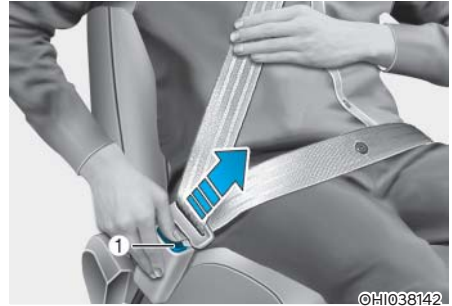
**To release your seat belt:**

Press the release button (1) in the locking buckle.

When it is released, the belt should automatically draw back into the retractor. If this does not happen, check the belt to be sure it is not twisted, then try again.

**Rear center seat belt**

When using the rear center seat belt, the buckle with the “CENTER” mark must be used.

**WARNING**

Make sure that the seatback is locked in place when using the rear center seat belt.

If not, the seatback may move when there is a sudden stop or collision, which could result in serious injury.

### **Pre-tensioner seat belt (Driver and front passenger)**



Your vehicle is equipped with driver's and front passenger's Pre-tensioner Seat Belts (Retractor Pre-tensioner). The purpose of the pre-tensioner is to make sure the seat belts fit tightly against the occupant's body in certain frontal or side collision(s).

When the vehicle stops suddenly, or if the occupant tries to lean forward too quickly, the seat belt retractor will lock into position. In certain frontal or side collision(s), the pre-tensioner will activate and pull the seat belt into tighter contact against the occupant's body.

If the system senses excessive tension on the driver or passenger's seat belt when the pre-tensioner system activates, the load limiter inside the retractor pre-tensioner will release some of the pressure on the affected seat belt.

### **WARNING**

- Always wear your seat belt and sit properly in your seat.
- Do not use the seat belt if it is loose or twisted. A loose or twisted seat belt will not protect you properly in an accident.
- Do not place anything near the buckle. This may adversely affect the buckle and cause it to function improperly.
- Always replace your pre-tensioners after activation or an accident.
- **NEVER** inspect, service, repair or replace the pre-tensioners yourself. This must be done by an authorized HYUNDAI dealer.
- Do not hit the seat belt assemblies.

### **WARNING**

**Do not touch the pre-tensioner seat belt assemblies for several minutes after they have been activated. When the pre-tensioner seat belt mechanism deploys during a collision, the pre-tensioners become hot and can burn you.**

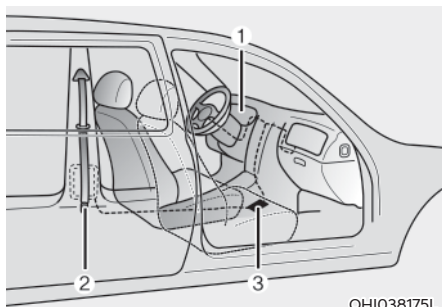

The Pre-Tensioner Seat Belt System consists mainly of the following components. Their locations are shown in the illustration above:

1. SRS air bag warning light
2. Retractor pre-tensioner
3. SRS control module

### NOTICE

The sensor that activates the SRS air bag is connected with the pre-tensioner seat belts. The SRS air bag warning light on the instrument panel will illuminate for approximately 6 seconds after the ignition switch is in the ON position, and then it should turn off.

If the pre-tensioner is not working properly, the warning light will illuminate even if the SRS air bag is not malfunctioning. If the warning light does not illuminate, stays illuminated or illuminates when the vehicle is being driven, have an authorized HYUNDAI dealer inspect the pre-tensioner seat belts and SRS air bags as soon as possible.

### NOTICE

- Both the driver's and front passenger's pre-tensioner seat belts may be activated in certain frontal or side collisions or rollovers.
- When the pre-tensioner seat belts are activated, a loud noise may be heard and fine dust, which may appear to be smoke, may be visible in the passenger compartment. These are normal operating conditions and are not hazardous.
- Although it is non-toxic, the fine dust may cause skin irritation and should not be inhaled for prolonged periods. Wash all exposed skin areas thoroughly after an accident in which the pre-tensioner seat belts were activated.



### WARNING

- Fasten your seat belt while sitting properly in an upright position to maximize the effectiveness of the pre-tensioner seat belt system.
- A pre-tensioner seat belt system is designed to activate only once. Replace the pre-tensioner seat belt system, if it was activated in an accident.

## Additional Seat Belt Safety Precautions

### ***Seat belt use during pregnancy***

The seat belt should always be used during pregnancy. The best way to protect your unborn child is to protect yourself by always wearing the seat belt.

Pregnant women should always wear a lap-shoulder seat belt. Place the shoulder belt across your chest, routed between your breasts and away from your neck. Place the lap belt line so that it fits snugly and as low as possible across the hips, not across the abdomen.



### **WARNING**

- **A pregnant woman or a patient is more vulnerable to any impacts on the abdomen during an abrupt stop or accident. If you are in an accident while pregnant, we recommend you consult your doctor.**
- **To reduce the risk of serious injury or death to an unborn child during an accident, pregnant women should NEVER place the lap portion of the seat belt above or over the area of the abdomen where the unborn child is located.**

### ***Seat belt use and children***

#### **Infant and small children**

All 50 states have child restraint laws which require children to travel in approved child restraint devices, including booster seats. The age at which seat belts can be used instead of child restraints differs among states, so you should be aware of the specific requirements in your state, and where you are travelling. Infant and child restraints must be properly placed and installed in a rear seat. For more information refer to the “Child Restraint Systems” section in this chapter.



### **WARNING**

**ALWAYS** properly restrain infants and small children in a child restraint appropriate for the child’s height and weight.

**To reduce the risk of serious injury or death to a child and other passengers, NEVER hold a child in your lap or arms when the vehicle is moving. The violent forces created during an accident will tear the child from your arms and throw the child against the interior of the vehicle.**

Small children are best protected from injury in an accident when properly restrained in the rear seat by a child restraint system that meets the requirements of the Federal Motor Vehicle Safety Standards. Before buying any child restraint system, make sure that it has a label certifying that it meets Federal Motor Vehicle Safety Standard FMVSS 213. The restraint must be appropriate for your child’s height and weight. Check the label on the child restraint for this information. Refer to the “Child Restraint Systems” section in this chapter.

### Larger children

Children under age 13 and who are too large for a booster seat must always occupy the rear seat and use the available lap/shoulder belts. A seat belt should lie across the upper thighs and be snug across the shoulder and chest to restrain the child safely. Check belt fit periodically. Children are afforded the most safety in the event of an accident when they are restrained by a proper restraint system and/or seat belts in the rear seat. Always have the LATCH system inspected by your authorized HYUNDAI dealer after an accident. An accident can damage the LATCH system and may not properly secure the child restraint.

If a larger child over age 13 must be seated in the front seat, the child must be securely restrained by the available lap/shoulder belt and the seat should be placed in the rearmost position.

If the shoulder belt portion slightly touches the child's neck or face, try placing the child closer to the center of the vehicle. If the shoulder belt still touches their face or neck, they need to be returned to an appropriate booster seat in the rear seat.



### WARNING

- **Always make sure children are wearing their seat belts and that they are properly adjusted before driving.**
- **NEVER allow the shoulder belt to contact the child's neck or face.**
- **Do not allow more than one child to use a single seat belt.**

### Transporting an injured person

A seat belt should be used when an injured person is being transported. Consult a physician for specific recommendations.

### One person per belt

Two people (including children) should never attempt to use a single seat belt. This could increase the severity of injuries in case of an accident.

### Do not lie down

Sitting in a reclined position when the vehicle is in motion can be dangerous. Even when buckled up, the protections of your restraint system (seat belts and air bags) is greatly reduced by reclining your seatback.

To reduce the chance of injuries in the event of an accident and to achieve the maximum effectiveness of the restraint system, all passengers should be sitting up and the front and rear seats should be in an upright position when the car is moving.

A seat belt cannot provide proper protection if the person is lying down in the rear seat or if the front or rear seats are in a reclined position.



### WARNING

- **NEVER ride with a reclined seatback when the vehicle is moving.**
- **Riding with a reclined seatback increases your chance of serious or fatal injuries in the event of a collision or sudden stop.**
- **Drivers and passengers should always sit well back in their seats, properly belted, and with the seatbacks upright.**

### Care of Seat Belts

Seat belt systems should never be disassembled or modified. In addition, care should be taken to assure that seat belts and belt hardware are not damaged by seat hinges, doors or other abuse.

#### ***Periodic inspection***

All seat belts should be inspected periodically for wear or damage of any kind. Any damaged parts should be replaced as soon as possible by an authorized HYUNDAI dealer.

#### ***Keep belts clean and dry***

Seat belts should be kept clean and dry. If belts become dirty, they can be cleaned by using a mild soap solution and warm water. Bleach, dye, strong detergents or abrasives should not be used because they may damage and weaken the fabric.

#### ***When to replace seat belts***

The entire seat belt assembly or assemblies should be replaced if the vehicle has been involved in an accident. This should be done even if no damage is visible. Additional questions concerning seat belt operation should be directed to an authorized HYUNDAI dealer.



## CHILD RESTRAINT SYSTEM (CRS)

### Children Always in the Rear



#### WARNING

**Always properly restrain children in the rear seats of the vehicle.**

**Children of all ages are safer when restrained in the rear seat. A child riding in the front passenger seat can be forcefully struck by an inflating air bag resulting in SERIOUS INJURY or DEATH.**

Children under age 13 must always ride in the rear seats and must always be properly restrained to minimize the risk of injury in an accident, sudden stop or sudden maneuver. According to accident statistics, children are safer when properly restrained in the rear seats than in the front seat. **Even with air bags, children can be seriously injured or killed.** Children too large for a child restraint must use the seat belts provided.

All 50 states have child restraint laws which require children to travel in approved child restraint devices. The laws governing the age or height/weight restrictions at which seat belts can be used instead of child restraints differs among states, so you should be aware of the specific requirements in your state, and where you are travelling.

Child restraint systems must be properly placed and installed in the rear seat. You must use a commercially available child restraint system that meets the requirements of the Federal Motor Vehicle Safety Standards (FMVSS 213).

Child restraint systems are generally designed to be secured in a vehicle seat by lap belt portion of a lap/shoulder belt, or by a LATCH system in the rear seats of the vehicle.

### *Child restraint system (CRS)*

Infants and younger children must be restrained in an appropriate rear-facing or forward-facing CRS that has first been properly secured to the rear seat of the vehicle. Read and comply with the instructions for installation and use provided by the manufacturer of the child restraint.



#### WARNING

**An improperly secured child restraint can increase the risk of SERIOUS INJURY or DEATH in an accident. Always take the following precautions when using a child restraint system:**

- **NEVER install a child or infant restraint in the front passenger's seat.**
- **Always properly secure the child restraint to a rear seat of the vehicle.**
- **Always follow the child restraint system manufacturer's instructions for installation and use.**
- **Always properly restrain your child in the child restraint.**
- **If the vehicle head restraint prevents proper installation of a child seat (as described in the child restraint system manual), the head restraint of the respective seating position shall be readjusted or entirely removed.**
- **Do not use an infant carrier or a child safety seat that "hooks" over a seatback, it may not provide adequate protection in an accident.**
- **After an accident, have a HYUNDAI dealer check the child restraint system, seat belts, tether anchors and lower anchors.**

### Selecting a Child Restraint System (CRS)

When selecting a CRS for your child, always:

- Make sure the CRS has a label certifying that it meets applicable Federal Motor Vehicle Safety Standards (FMVSS 213).
- Select a child restraint based on your child's height and weight. The required label or the instructions for use typically provide this information.
- Select a child restraint that fits the vehicle seating position where it will be used.
- Read and comply with the warnings and instructions for installation and use provided with the child restraint system.

#### **Child restraint system types**

There are three main types of child restraint systems: rear-facing seats, forward-facing seats, and booster seats. They are classified according to the child's age, height and weight.

#### **Rear-facing child seats**



#### **WARNING**

**NEVER install a child or infant restraint in the front passenger's seat.**

**Placing a rear-facing child restraint in the front seat can result in SERIOUS INJURY or DEATH if the child restraint is struck by an inflating air bag.**



A rear-facing child seat provides restraint with the seating surface against the back of the child. The harness system holds the child in place, and in an accident, acts to keep the child positioned in the seat and reduce the stress to the neck and spinal cord.

All children under age one must always ride in a rear-facing infant child restraint.

Convertible and 3-in-1 child seats typically have higher height and weight limits for the rear-facing position, allowing you to keep your child rear-facing for a longer period of time.

Continue to use a rear-facing child seat for as long as your child will fit within the height and weight limits allowed by the child seat manufacturer. It's the best way to keep them safe. Once your child has outgrown the rear-facing child restraint, your child is ready for a forward-facing child restraint with a harness.



### Forward-facing child restraints

A forward-facing child seat provides restraint for the child's body with a harness. Keep children in a forward-facing child seat with a harness until they reach the top height or weight limit allowed by your child restraint's manufacturer.

Once your child outgrows the forward-facing child restraint, your child is ready for a booster seat.

### Booster seats

A booster seat is a restraint designed to improve the fit of the vehicle's seat belt system. A booster seat positions the seat belt so that it fits properly over the lap of your child.

Keep your child in a booster seat until they are big enough to sit in the seat without a booster and still have the seat belt fit properly. For a seat belt to fit properly, the lap belt must lie snugly across the upper thighs, not the stomach. The shoulder belt should lie snug across the shoulder and chest and not across the neck or face. Children under age 13 must always ride in the rear seats and must always be properly restrained to minimize the risk of injury.

## Installing a Child Restraint System (CRS)



### WARNING

Before installing your child restraint system always:

- Read and follow the instructions provided by the manufacturer of the child restraint.
- Read and follow the instructions regarding child restraint systems in this manual.

Failure to follow all warnings and instructions could increase the risk of the **SERIOUS INJURY** or **DEATH** if an accident occurs.



### WARNING

If the vehicle head restraint prevents proper installation of a child seat (as described in the child seat system manual, the head restraint of the respective seating position shall be readjusted or entirely removed.

After selecting a proper child seat for your child, check to make sure it fits properly in your vehicle. Follow the instructions provided by the manufacturer when installing the child seat. Note these general steps when installing the seat to your vehicle:

- **Properly secure the child restraint to the vehicle.** All child restraints must be secured to the vehicle with the lap part of a lap/shoulder belt or with the LATCH system.
- **Make sure the child restraint is firmly secured.** After installing a child restraint to the vehicle, push and pull the seat forward-and-back and side-to-side to verify that it is securely attached to the seat. A child restraint secured with a seat belt should be installed as firmly as possible. However, some side-to-side movement can be expected.
- **Secure the child in the child restraint.** Make sure the child is properly strapped in the child restraint according to the manufacturer instructions.



### CAUTION

A child restraint in a closed vehicle can become very hot. To prevent burns, check the seating surface and buckles before placing your child in the child restraint.

### **Lower Anchors and Tether for Children (LATCH System)**

The LATCH system holds a child restraint during driving and in an accident. This system is designed to make installation of the child restraint easier and reduce the possibility of improperly installing your child restraint. The LATCH system uses anchors in the vehicle and attachments on the child restraint. The LATCH system eliminates the need to use seat belts to secure the child restraint to the rear seats.

Lower anchors are metal bars built into the vehicle. There are two lower anchors for each LATCH seating position that will accommodate a child restraint with lower attachments.

To use the LATCH system in your vehicle, you must have a child restraint with LATCH attachments.

The child seat manufacturer will provide you with instructions on how to use the child seat with its attachments for the LATCH lower anchors.

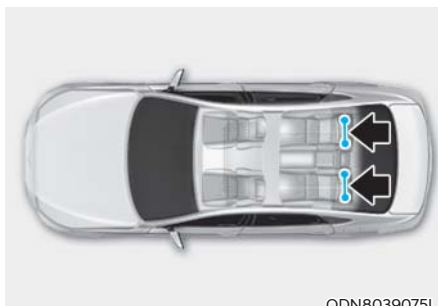

ODN8039075L

LATCH anchors have been provided in the left and right outboard rear seating positions. Their locations are shown in the illustration. There are no LATCH anchors provided for the center rear seating position.

## WARNING

Do not attempt to install a child restraint system using LATCH anchors in the rear center seating position. There are no LATCH anchors provided for this seat. Using the outboard seat anchors can damage the anchors which may break or fail in a collision resulting in serious injury or death.

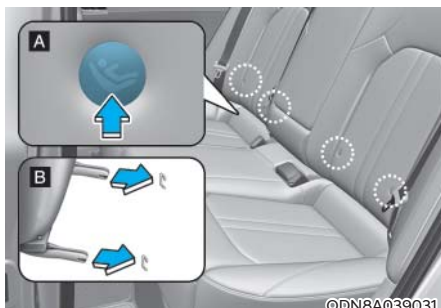

[A]: ISOFIX Anchorage Position Indicator,  
[B]: ISOFIX Anchorage

The lower anchor position indicator symbols are located on the left and right rear seat backs to identify the position of the lower anchors in your vehicle (see arrows in illustration).

The LATCH anchors are located between the seatback and the seat cushion of the rear seat left and right outboard seating positions.

## **Securing a child restraint with the LATCH anchors system**

To install a LATCH-compatible child restraint in either of the rear outboard seating positions:

1. Move the seat belt buckle away from the lower anchors.
2. Move any other objects away from the anchors that could prevent a secure connection between the child restraint and the lower anchors.
3. Place the child restraint on the vehicle seat, then attach the seat to the lower anchors according to the instructions provided by the child restraint manufacturer.
4. Follow the child restraint instructions for properly adjusting and tightening the lower attachments on the child restraint to the lower anchors.

## WARNING

Take the following precautions when using the LATCH system:

- Read and follow all installation instructions provided with your child restraint system.
- To prevent the child from reaching and taking hold of unretracted seat belts, buckle all unused rear seat belts and retract the seat belt webbing behind the child. Children can be strangled if a shoulder belt becomes wrapped around their neck and the seat belt tightens.
- NEVER attach more than one child restraint to a single anchor. This could cause the anchor or attachment to come loose or break.
- Always have the LATCH system inspected by your authorized HYUNDAI dealer after an accident. An accident can damage the LATCH system and may not properly secure the child restraint.

**NOTICE**

The recommended weight for the LATCH system is under 65 lb (30 kg). How to determine an appropriate child restraint weight:

$$\text{Child weight} + \text{Child restraint weight} < 65 \text{ lb (30kg)}$$

**Securing a child restraint seat with “Tether Anchor” system**

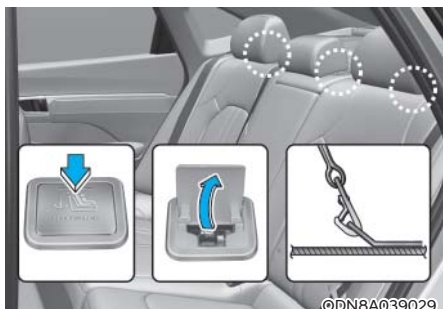

First secure the child restraint with the LATCH lower anchors or the seat belt. If the child restraint manufacturer recommends that the top tether strap be attached, attach and tighten the top tether strap to the top tether strap anchor.

Child restraint hook holders are located on the rear of the seatbacks.

**WARNING**

Take the following precautions when installing the tether strap:

- Read and follow all installation instructions provided with your child restraint system.
- NEVER attach more than one child restraint to a single tether anchor. This could cause the anchor or attachment to come loose or break.
- Do not attach the tether strap to anything other than the correct tether anchor. It may not work properly if attached to something else.
- Do not use the tether anchors for adult seat belts or harnesses, or for attaching other items or equipment to the vehicle.



To install the tether anchor:

1. Route the child restraint tether strap over the child restraint seatback. Route the tether strap under the head restraint and between the head restraint posts, or route the tether strap over the top of the vehicle seatback. Make sure the strap is not twisted.
2. Connect the tether strap hook to the tether anchor, then tighten the tether strap according to the child seat manufacturer's instructions to firmly secure the child restraint to the seat.

3. Check that the child restraint is securely attached to the seat by pushing and pulling the seat forward-and-back and side-to-side.

### **Securing a child restraint with lap/shoulder belt**

When not using the LATCH system, all child restraints must be secured to a vehicle rear seat with the lap part of a lap/shoulder belt.



### **WARNING**

**ALWAYS** place a rear-facing child restraint in the rear seat of the vehicle.

**Placing a rear-facing child restraint in the front seat can result in serious injury or death if the child restraint is struck by an inflating air bag.**

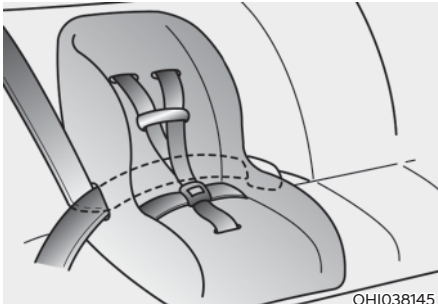

### **Automatic locking mode**

Since all passenger seat belts move freely under normal conditions and only lock under extreme or emergency conditions (emergency locking mode), you must manually pull the seat belt all the way out to shift the retractor to the “Automatic Locking” mode to secure a child restraint.

The “Automatic Locking” mode will help prevent the normal movement of the child in the vehicle from causing the seat belt to loosen and compromise the child restraint system. To secure a child restraint system, use the following procedure.

To install a child restraint system on the rear seats, do the following:

1. Place the child restraint system on a rear seat and route the lap/shoulder belt around or through the child restraint, following the restraint manufacturer’s instructions. Be sure the seat belt webbing is not twisted.

### **i Information**

**When using the rear center seat belt, you should also refer to the “Rear Seat Belt – Passenger’s 3-point system” section in this chapter.**

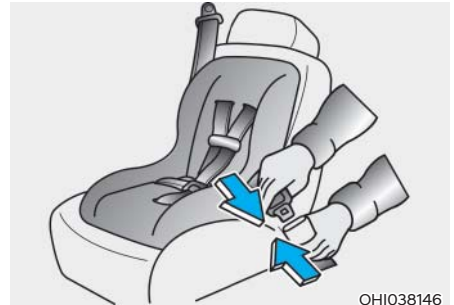

2. Fasten the lap/shoulder belt latch into the buckle. Listen for the distinct “click” sound.

**i** Information

**Position the release button so that it is easy to access in case of an emergency.**



3. Pull the shoulder portion of the seat belt all the way out. When the shoulder portion of the seat belt is fully extended, it will shift the retractor to the “Automatic Locking” (child restraint) mode.



4. Slowly allow the shoulder portion of the seat belt to retract and listen for an audible “clicking” or “ratcheting” sound. This indicates that the retractor is in the “Automatic Locking” mode. If no distinct sound is heard, repeat steps 3 and 4.

5. Remove as much slack from the belt as possible by pushing down on the child restraint system while feeding the shoulder belt back into the retractor.
6. Push and pull on the child restraint system to confirm that the seat belt is holding it firmly in place. If it is not, release the seat belt and repeat steps 2 through 6.
7. Double check that the retractor is in the “Automatic Locking” mode by attempting to pull more of the seat belt out of the retractor. If you cannot, the retractor is in the “Automatic Locking” mode.

If your CRS (child restraint system) manufacturer instructs or recommends you to use a tether anchor with the lap/shoulder belt, refer to the previous pages for more information.

**i** Information

**When the seat belt is allowed to retract to its fully stowed position, the retractor will automatically switch from the “Automatic Locking” mode to the emergency lock mode for normal adult usage.**

**⚠** WARNING

**If the retractor is not in the “Automatic Locking” mode, the child restraint can move when your vehicle turns or stops suddenly. A child can be seriously injured or killed if the child restraint is not properly anchored in the car, including manually pulling the seat belt all the way out to shift the retractor to the “Automatic Locking” mode.**

To remove the child restraint, press the release button on the buckle and then pull the lap/shoulder belt out of the restraint and allow the seat belt to retract fully.



## AIR BAG - ADVANCED SUPPLEMENTAL RESTRAINT SYSTEM

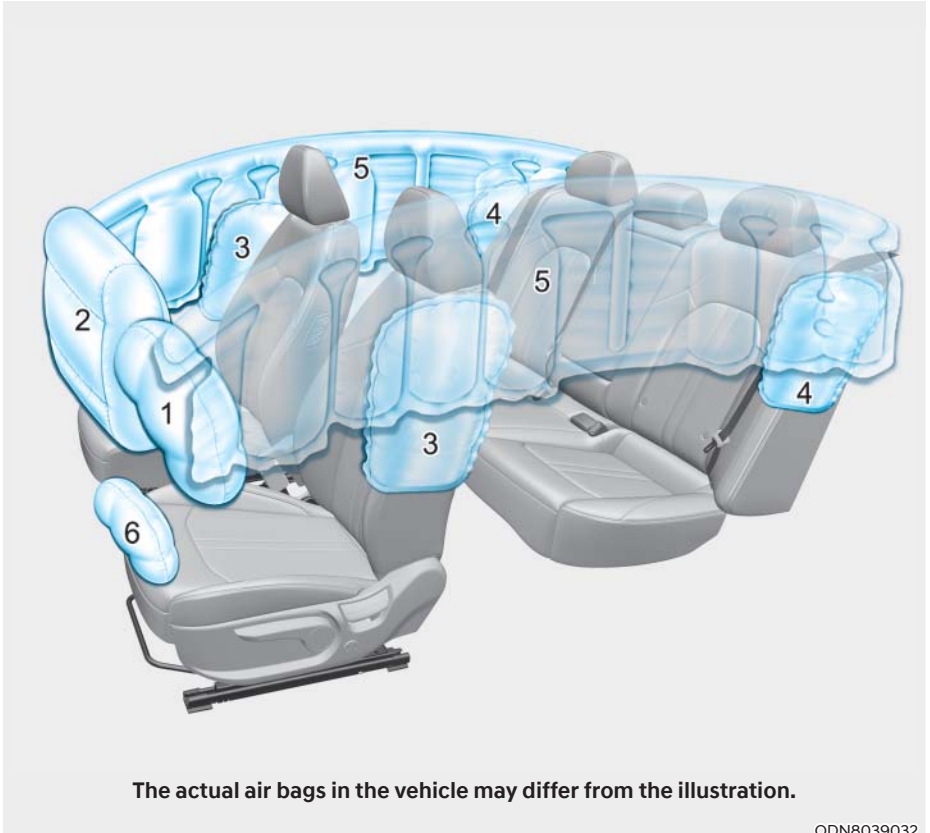

1. Driver's front air bag
2. Passenger's front air bag
3. Side air bag (front)
4. Side air bag (rear)
5. Curtain air bag
6. Driver's knee air bag

This vehicle is equipped with an Advanced Supplemental Air Bag System for the driver's seat and front passenger's seats.

The front air bags are designed to supplement the three-point seat belts. For these air bags to provide protection, the seat belts must be worn at all times when driving.

You can be severely injured or killed in an accident if you are not wearing a seat belt. Air bags are designed to supplement seat belts, but do not replace them. Also, air bags are not designed to deploy in every collision. In some accidents, the seat belts are the only restraint protecting you.



### **WARNING**

#### **AIR BAG SAFETY PRECAUTIONS**

**ALWAYS** use seat belts and child restraints - every trip, every time, everyone! Even with air bags, you can be seriously injured or killed in a collision if you are improperly belted or not wearing your seat belt when the air bag inflates.

**NEVER** place a child in any child restraint or booster seat in the front passenger seat. An inflating air bag could forcefully strike the infant or child causing serious or fatal injuries.

**ABC - Always Buckle Children** under age 13 in the back seat. It is the safest place for children of any age to ride. If a child age 13 or older must be seated in the front seat, he or she must be properly belted and the seat should be moved as far back as possible.

All occupants should sit upright with the seatback in an upright position, centered on the seat cushion with their seat belt on, legs comfortably extended and their feet on the floor until the vehicle is parked and is turned off. If an occupant is out of position during an accident, the rapidly deploying air bag may forcefully contact the occupant causing serious or fatal injuries.

You and your passengers should never sit or lean unnecessarily close to the air bags or lean against the door or center console.

Move your seat as far back as possible from front air bags, while still maintaining control of the vehicle. The U.S. National Highway Traffic Safety Administration (NHTSA) recommends that drivers allow at least 10 inches (25 cm) between the center of the steering wheel and the chest.

## Where Are the Air Bags?

### **Driver's and passenger's front air bags**

Your vehicle is equipped with an Advanced Supplemental Restraint System (SRS) and lap/shoulder belts at both the driver and passenger seating positions.

The SRS consists of air bags which are located in the center of the steering wheel, in the driver's side lower crash pad below the steering wheel column and the passenger's side front panel pad above the glove box.

The air bags are labeled with the letters "AIR BAG" embossed on the pad covers.



■ Passenger's front air bag



The purpose of the SRS is to provide the vehicle's driver and front passengers with additional protection than that offered by the seat belt system alone. The SRS uses sensors to gather information about the driver's and front passenger's seat belt usage and impact severity. The seat belt buckle sensors determine if the driver and front passenger's seat belts are fastened. These sensors provide the ability to control the SRS deployment based on whether or not the seat belts are fastened, and how severe the impact is. The advanced SRS offers the ability to control the air bag inflation within two levels. A first stage level is provided for moderate-severity impacts. A second stage level is provided for more severe impacts. According to the impact severity, and seat belt usage, the SRS Control Module (SRSCM) controls the air bag inflation. Failure to properly wear seat belts can increase the risk or severity of injury in an accident.

 **WARNING**

To reduce the risk of serious injury or death from inflating front air bags, take the following precautions:

- Seat belts must be worn at all times to help keep occupants positioned properly.
- Move your seat as far back as possible from front air bags, while still maintaining control of the vehicle.
- Never lean against the door or center console.
- Do not allow the front passenger to place their feet or legs on the dashboard.
- No objects (such as crash pad cover, cellular phone holder, cup holder, perfume or stickers) should be placed over or near the air bag modules on the steering wheel, instrument panel, windshield glass, and the front passenger's panel above the glove box. Such objects could cause harm if the vehicle is in a crash severe enough to cause the air bags to deploy.

**Side air bags**

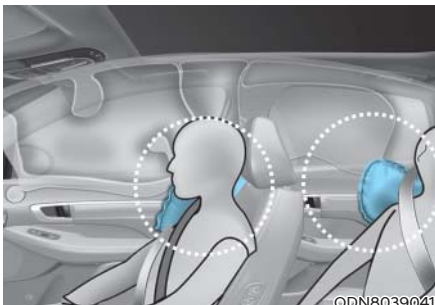
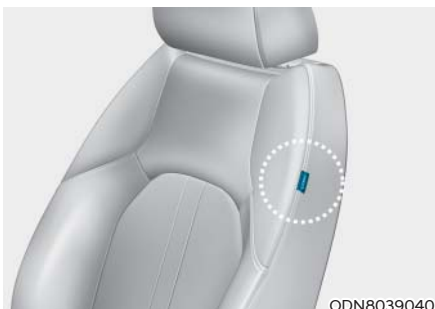

Your vehicle is equipped with a side air bag in each front seat and outboard rear seats. The purpose of the air bag is to provide the vehicle's driver and the front passenger with additional protection than that offered by the seat belt alone.

The side air bags are designed to deploy only during certain side impact collisions, depending on the crash severity. The side and curtain air bags on both sides of the vehicle may deploy if a rollover or possible rollover is detected. For vehicles equipped with a rollover sensor the side air bags and pre-tensioners on both sides of the vehicle may deploy if a rollover or possible rollover is detected. However, the side air bags are not designed to deploy in all side impact or rollover situations.

## WARNING

To reduce the risk of serious injury or death from an inflating side air bag, take the following precautions:

- Seat belts must be worn at all times to help keep occupants positioned properly.
- Do not allow passengers to lean their heads or bodies onto doors, put their arms on the doors, stretch their arms out of the window, or place objects between the doors and seats.
- Hold the steering wheel at the 9 o'clock and 3 o'clock positions, to minimize the risk of injuries to your hands and arms.
- Do not use any accessory seat covers. This could reduce or prevent the effectiveness of the system.
- Do not place any objects over the air bag or between the air bag and yourself. Also, do not attach any objects around the area the air bag inflates such as the door, side door glass, front and rear pillar.
- Do not place any objects between the door and the seat. They may become dangerous projectiles if the side air bag inflates.
- Do not install any accessories on the side or near the side air bags.
- Do not put any objects between the side airbag label and seat cushion. It could cause harm if the vehicle is in a crash severe enough to cause the air bags to deploy.
- Do not cause impact to the doors when the ignition switch button is in the ON position as this may cause the side air bags to inflate.
- If the seat or seat cover is damaged, have the vehicle checked and repaired by an authorized HYUNDAI dealer.

## Curtain air bags

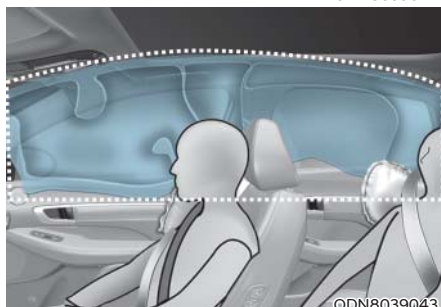
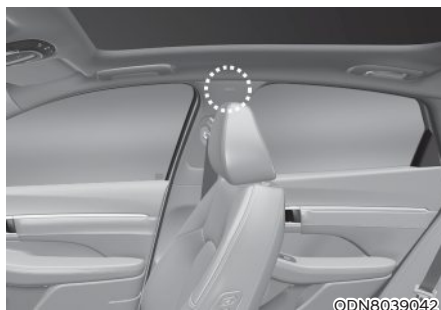

Curtain air bags are located along both sides of the roof rails above the front and rear doors.

They are designed to help protect the heads of the front seat occupants and the rear outboard seat occupants in certain side impact collisions.

The curtain air bags are designed to deploy during certain side impact collisions, depending on the crash severity.

The side and curtain air bags on both sides of the vehicle may deploy if a rollover or possible rollover is detected.

The curtain air bags are not designed to deploy in all side impact or rollover situations.



## WARNING

To reduce the risk of serious injury or death from an inflating curtain air bag, take the following precautions:

- All seat occupants must wear seat belts at all times to help keep occupants positioned properly.
- Properly secure child restraints as far away from the door as possible.
- Do not place any objects over the air bag. Also, do not attach any objects around the area the air bag inflates such as the door, side door glass, front and rear pillar, roof side rail.
- Do not hang other objects except clothes, especially hard or breakable objects. In an accident, it may cause vehicle damage or personal injury.
- Do not allow passengers to lean their heads or bodies onto doors, put their arms on the doors, stretch their arms out of the window, or place objects between the doors and seats.
- Do not open or repair the side curtain air bags.

## How Does the Air Bag System Operate?

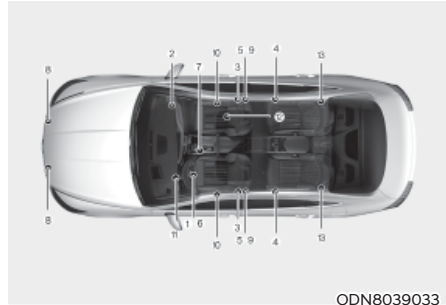

ODN8039033

The SRS consists of the following components:

1. Driver's front air bag module
2. Passenger's front air bag module
3. Side air bag modules (front)
4. Curtain air bag modules
5. Retractor pre-tensioner assemblies
6. Air bag warning light
7. SRS control module (SRSCM) / Rollover sensor
8. Front impact sensors
9. Side impact sensor (speed)
10. Side impact sensor (pressure)
11. Driver's knee air bag module
12. Occupant classification system
13. Side air bag modules (rear)

The SRSCM (Supplemental Restraint System Control Module) continually monitors all SRS components while the Engine Start/Stop button is in the ON or START position to determine if a crash impact is severe enough to require air bag deployment or pre-tensioner seat belt deployment.



### SRS warning light

The SRS (Supplement Restraint System) air bag warning light on the instrument panel displays the air bag symbol depicted in the illustration. The system checks the air bag electrical system for malfunctions. The light indicates that there is a potential malfunction with your air bag system, which could include your side and curtain air bags used for rollover protection.



### WARNING

**If your SRS malfunctions, the air bag may not inflate properly during an accident increasing the risk of serious injury or death.**

**If any of the following conditions occur, your SRS is malfunctioning:**

- **The light does not turn on for approximately six seconds when the Engine Start/Stop button is in the ON position.**
- **The light stays on after illuminating for approximately six seconds.**
- **The light comes on while the vehicle is in motion.**
- **The light blinks when the engine is running.**

**Have an authorized HYUNDAI dealer inspect the SRS as soon as possible if any of these conditions occur.**

During a frontal collision, sensors will detect the vehicle's deceleration. If the rate of deceleration is high enough, the control unit will inflate the front air bags.

The front air bags help protect the driver and front passenger by responding to frontal impacts in which seat belts alone cannot provide adequate restraint. When needed, the side air bags help provide protection in the event of a side impact or rollover.

- Air bags are activated (able to inflate if necessary) when the Engine Start/Stop button is in the ON position or approximately within 3 minutes after ignition off.
- Air bags inflate in the event of certain frontal or side collisions to help protect the occupants from serious physical injury.
- Generally, air bags are designed to inflate based upon the severity of a collision, its direction, etc. These two factors determine whether the sensors produce an electronic deployment/inflation signal.
- The front air bags will completely inflate and deflate in an instant. It is virtually impossible for you to see the air bags inflate during an accident. It is much more likely that you will simply see the deflated air bags hanging out of their storage compartments after the collision.

- In addition to inflating in certain side collisions, vehicles equipped with a rollover sensor, side and curtain air bags will inflate if the sensing system detects a rollover.

When a rollover is detected, side and curtain air bags will remain inflated longer to help provide protection from ejection, especially when used in conjunction with the seat belts.

- To help provide protection, the air bags must inflate rapidly. The speed of air bag inflation is a consequence of extremely short time in which to inflate the air bag between the occupant and the vehicle structures before the occupant impacts those structures. This speed of inflation reduces the risk of serious or life-threatening injuries and is thus a necessary part of air bag design.

However, the rapid air bag inflation can also cause injuries which can include facial abrasions, bruises and broken bones because the inflation speed also causes the air bags to expand with a great deal of force.

- There are even circumstances under which contact with the air bag can cause fatal injuries, especially if the occupant is positioned excessively close to the air bag.

You can take steps to help reduce the risk of being injured by an inflating air bag. The greatest risk is sitting too close to the air bag. An air bag needs about 10 inches (25 cm) of space to inflate. NHTSA recommends that drivers allow at least 10 inches (25 cm) between the center of the steering wheel and the chest.



### WARNING

To reduce the risk of serious injury or death from an inflating air bag, take the following precautions:

- **NEVER** place a child restraint in the front passenger seat.

Always properly restrain children under age 13 in the rear seats of the vehicle.

- **Adjust the front passenger's and driver's seats as far to the rear as possible while allowing you to maintain full control of the vehicle.**
- **Hold the steering wheel with hands at the 9 o'clock and 3 o'clock positions.**
- **NEVER** place anything or anyone between the air bag and the seat occupant.
- **Do not allow the front passenger to place their feet or legs on the dashboard.**



■ Driver's front air bag (1)

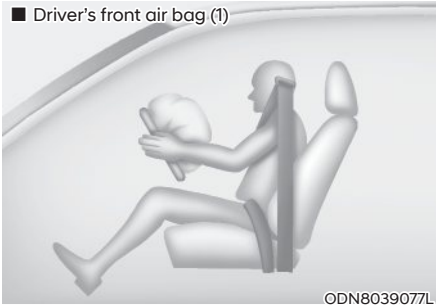

ODN8039077L

When the SRSCM detects a sufficiently severe impact to the front of the vehicle, it will automatically deploy the front air bags.

■ Driver's front air bag (2)

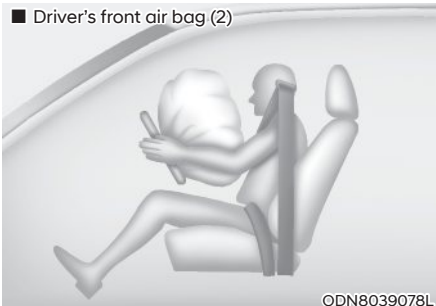

ODN8039078L

Upon deployment, tear seams molded directly into the pad covers will separate under pressure from the expansion of the air bags. Further opening of the covers allows full inflation of the air bags.

A fully inflated air bag, in combination with a properly worn seat belt, slows the driver or the front passenger forward motion, reducing the risk of head and chest injury.

■ Driver's front air bag (3)

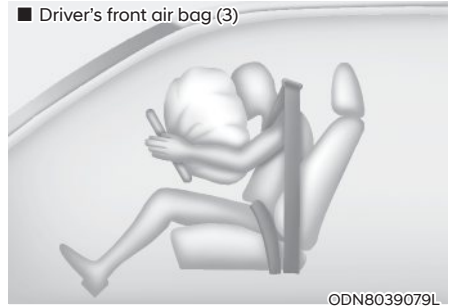

ODN8039079L

■ Passenger's front air bag



ODN8039080L

After complete inflation, the air bag immediately starts deflating, enabling the driver to maintain forward visibility and the ability to steer or operate other controls.

### **WARNING**

**To prevent objects from becoming dangerous projectiles when the passenger's air bag inflates:**

- Do not install or place any objects (drink holder, CD holder, stickers, etc.) on the front passenger's panel above the glove box where the passenger's air bag is located.
- Do not install a container of liquid air freshener near the instrument cluster or on the instrument panel surface.

## What to Expect After an Air Bag Inflates

After a frontal or side air bag inflates, it will deflate very quickly. Air bag inflation will not prevent the driver from seeing out of the windshield or being able to steer. Curtain air bags may remain partially inflated for some time after they deploy.



### WARNING

**After an air bag inflates, take the following precautions:**

- **Open your windows and doors as soon as possible after impact to reduce prolonged exposure to the smoke and powder released by the inflating air bag.**
- **Do not touch the air bag storage area's internal components immediately after an air bag has inflated. The parts that come into contact with an inflating air bag may be very hot.**
- **Always wash exposed skin areas thoroughly with cold water and mild soap.**
- **Always have an authorized HYUNDAI dealer replace the air bag immediately after deployment. Air bags are designed to be used only once.**

## **Noise and smoke from inflating air bag**

When the air bags inflate, they make a loud noise and may produce smoke and powder in the air inside of the vehicle. This is normal and is a result of the ignition of the air bag inflator. After the air bag inflates, you may feel substantial discomfort in breathing because of the contact of your chest with both the seat belt and the air bag, as well as from breathing the smoke and powder. The powder may aggravate asthma for some people. If you experience breathing problems after an air bag deployment, seek medical attention immediately.

Though the smoke and powder are nontoxic, they may cause irritation to the skin, eyes, nose, throat, etc. If this is the case, wash and rinse with cold water immediately and seek medical attention if the symptoms persist.

## Occupant Classification System (OCS)



Your vehicle is equipped with an Occupant Classification System (OCS) in the front passenger's seat.

### **Main components of the Occupant Classification System**

- A detection device located within the front passenger seat cushion.
- Electronic system to determine whether the passenger air bag systems should be activated or deactivated.
- An indicator light located on the instrument panel which illuminates the words "PASSENGER AIR BAG OFF" indicating the front passenger air bag system is deactivated.
- The instrument panel air bag indicator light is interconnected with the OCS.

The OCS is designed to help detect the presence of a properly-seated front passenger and determine if the passenger's front air bag should be enabled (may inflate) or not.

The purpose is to help reduce the risk of injury or death from an inflating air bag to certain front passenger seat occupants, such as children, by requiring the air bag to be automatically turned OFF.

For example, if a child restraint of the type specified in the regulations is on the seat, the occupant classification sensor can detect it and cause the air bag to turn OFF.

Front passenger seat adult occupants who are properly seated and wearing the seat belt properly, should not cause the passenger air bag to be automatically turned OFF. For small adults it may be turned OFF, however, if the occupant does not sit in the seat properly (for example, by not sitting upright, by sitting on the edge of the seat, or by otherwise being out of position), this could cause the sensor to turn the air bag OFF.

You will find the "PASSENGER AIR BAG OFF" indicator on the center fascia panel. This system detects the conditions 1-4 in the following table and activates or deactivates the front passenger air bag based on these conditions.

Always be sure that you and all vehicle occupants are seated properly and wearing the seat belt properly for the most effective protection by the air bag and the seat belt.

The OCS may not function properly if the passenger takes actions which can affect the classification system. These include:

- Failing to sit in an upright position.
- Leaning against the door or center console.
- Sitting towards the sides of the front of the seat.
- Putting their legs on the dashboard or resting them on other locations which reduce the passenger weight on the front seat.
- Wearing the seat belt improperly.
- Reclining the seatback.
- Wearing a thick cloth like ski wear or hip protection wear.
- Putting an additional thick cushion on the seat.
- Putting electrical devices (e.g. notebook, satellite radio) on the seat with inverter charging.

**Condition and operation in the front passenger Occupant Classification System**

Condition detected by the occupant classification system	Indicator/Warning light		Devices
	“PASSENGER AIR BAG OFF” indicator light	SRS warning light	Front passenger air bag
1. Adult *1	Off	Off	Activated
2. Infant *2 or child restraint system with 12 months old *3 *4	On	Off	Deactivated
3. Unoccupied	On	Off	Deactivated
4. Malfunction in the system	Off	On	Activated

\*1: The system judges a person of adult size as an adult. When a smaller adult sits in the front passenger seat, the system may recognize him/her as a child depending on his/her physique and posture.

\*2: Do not allow children to ride in the front passenger seat. When a larger child who has outgrown a child restraint system sits in the front passenger seat, the system may recognize him/her as an adult depending upon his/her physique or sitting position.

\*3: Never install a child restraint system on the front passenger seat.

\*4: The PASSENGER AIR BAG “OFF” indicator may turn on or off when a child above 12 months to 12 years old (with or without child restraint system) sits in the front passenger seat. This is a normal condition.



## WARNING

Riding in an improper position or placing weight on the front passenger's seat when it is unoccupied by a passenger adversely affects the OCS. To reduce the risk of serious injury or death:



- **NEVER** put a heavy load in the front seat or seatback pocket, or hang any items on the front passenger seat.



- **NEVER** place your feet on the front passenger seatback.



- **NEVER** sit with your hips shifted towards the front of the seat.



- **NEVER** ride with the seatback reclined when the vehicle is moving.



- **NEVER** place your feet or legs on the dashboard.



- **NEVER lean on the door or center console or sit on one side of the front passenger seat.**



- **Do not sit on the passenger seat wearing heavily padded clothes such as ski wear and hip protector.**



- **Do not use car seat accessories such as thick blankets and cushions which cover up the car seat surface.**



- **Do not place electronic devices such as laptops, DVD player, or conductive materials such as water bottles on the passenger seat.**
- **Do not use electronic devices such as laptops and satellite radios which use inverter chargers.**



- **If large quantity of liquid has been spilled on the passenger seat, the air bag warning light may illuminate or malfunction. Therefore, make sure the seat has been completely dried before driving the vehicle.**

- **Do not place sharp objects on the front passenger seat. These may damage the occupant detection system, if they puncture the seat cushion.**
- **Do not place any items under the front passenger seat.**
- **When changing or replacing the seat or seat cover, use original items only. The OCS has been developed based on using original HYUNDAI car seats only. Altering or changing the authentic parts may result in system malfunction and increase risk of injury when in collision. Any of the above could interfere with the proper operation of the OCS sensor thereby increasing the risk of an injury in an accident.**

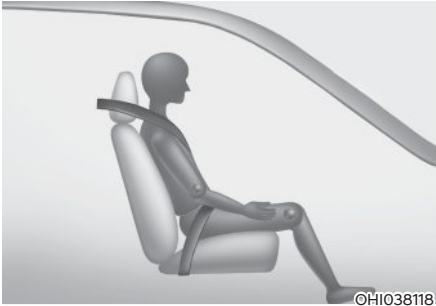

### Proper seated position for OCS

If the “PASSENGER AIR BAG OFF” indicator is on when an adult is seated in the front passenger seat, place the Engine Start/Stop button in the OFF position and ask the passenger to sit properly (sitting upright with the seat back in an upright position, centered on the seat cushion with their seat belt on, legs comfortably extended and their feet on the floor). Restart the engine and have the person remain in that position. This will allow the system to detect the person and to enable the passenger air bag. If the “PASSENGER AIR BAG OFF” indicator is still on, ask the passenger to move to the rear seat.



### WARNING

**NEVER** allow an adult passenger to ride in the front passenger seat when the “PASSENGER AIR BAG OFF” indicator is illuminated. During a collision, the air bag will not inflate if the indicator is illuminated. Have your passenger reposition themselves in the seat. If the “PASSENGER AIR BAG OFF” indicator remains illuminated after the passenger repositions themselves properly and the vehicle is restarted, have the passenger move to the rear seat because the air bag will not inflate.

### NOTICE

The “PASSENGER AIR BAG OFF” indicator illuminates for approximately 4 seconds after the Engine Start/Stop button is in the ON position or after the engine is started. If the front passenger seat is occupied, the OCS will then classify the front passenger after several more seconds.

### **Do Not Install a Child Restraint in the Front Passenger's Seat**



Even though your vehicle is equipped with the OCS, never install a child restraint in the front passenger's seat. An inflating air bag can forcefully strike a child or child restraint resulting in serious or fatal injury.

#### **WARNING**

- **NEVER** place a rear-facing or front-facing child restraint in the front passenger's seat of the vehicle.
- An inflating frontal air bag could forcefully strike a child resulting in serious injury or death.
- Always properly restrain children in an appropriate child restraint in the rear seat of the vehicle.

### **Why Didn't My Air Bag Go Off in a Collision?**

Air bags are not designed to inflate in every collision. There are certain types of accidents in which the air bag would not be expected to provide additional protection. These include rear impacts, second or third collisions in multiple impact accidents, as well as low speed impacts. Damage to the vehicle indicates a collision energy absorption, and is not an indicator of whether or not an air bag should have inflated.

#### **WARNING**

**To reduce the risk of an air bag deploying unexpectedly and causing serious injury or death:**

- Do not hit or allow any objects to impact the locations where air bags or sensors are installed.
- Do not perform maintenance on or around the air bag sensors. If the location or angle of the sensors is altered, the air bags may deploy when they should not or may not deploy when they should.
- Do not install bumper guards or replace the bumper with a non-genuine HYUNDAI parts. This may adversely affect the collision and air bag deployment performance.
- Place the ignition switch in the LOCK/OFF or ACC position when the vehicle is being towed to prevent inadvertent air bag deployment.
- Have all air bag repairs conducted by an authorized HYUNDAI dealer.



### Air bag collision sensors



ODN8A039044/ODN8039045/ODN8A039046/ODN8A039047/ODN8039061

1. SRS control module/Rollover sensor
2. Front impact sensor
3. Side pressure sensor
4. Side impact sensor

### Air bag inflation conditions



### Front air bags

Front air bags are designed to inflate in a frontal collision depending on the severity of impact of the front collision.

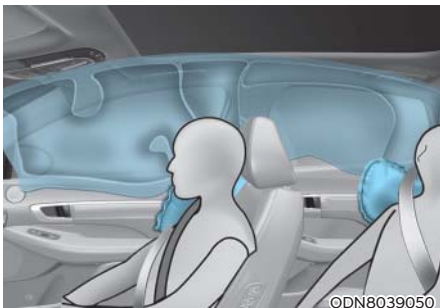

### Side and curtain air bags

Side and curtain air bags are designed to inflate when an impact is detected by side collision sensors depending on the severity of impact resulting from a side impact collision.

Although the driver's and front passenger's air bags are designed to inflate only in frontal collisions, they also may inflate in other types of collisions if the front impact sensors detect a sufficient impact. Side and curtain air bags are designed to inflate only in side impact collisions or rollover situations, but they may inflate in other collisions if the side impact sensors detect a sufficient impact.

If the vehicle chassis is impacted by bumps or objects on unimproved roads, the air bags may deploy. Drive carefully on unimproved roads or on surfaces not designed for vehicle traffic to prevent unintended air bag deployment.

### Air bag non-inflation conditions



In certain low-speed collisions the air bags may not deploy. The air bags are designed not to deploy in such cases because they may not provide benefits beyond the protection of the seat belts.



Front air bags are not designed to inflate in rear collisions, because occupants are moved backward by the force of the impact. In this case, inflated air bags would not provide any additional benefit.



In an angled collision, the force of impact may direct the occupants in a direction where the air bags would not be able to provide any additional benefit, and thus the sensors may not deploy any air bags.

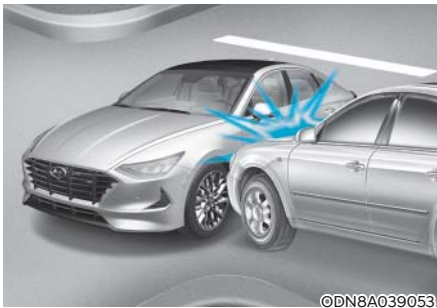

Front air bags may not inflate in side impact collisions, because occupants move in the direction of the collision, and thus in side impacts, front air bag deployment would not provide additional occupant protection.

However, side and curtain air bags may inflate depending on the severity of impact.

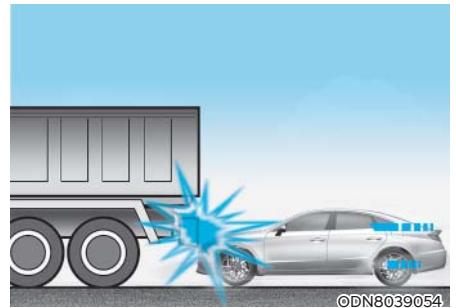

Just before impact, drivers often brake heavily. Such heavy braking lowers the front portion of the vehicle causing it to “ride” under a vehicle with a higher ground clearance. Air bags may not inflate in this “underride” situation because deceleration forces that are detected by sensors may be significantly reduced by such “underride” collisions.

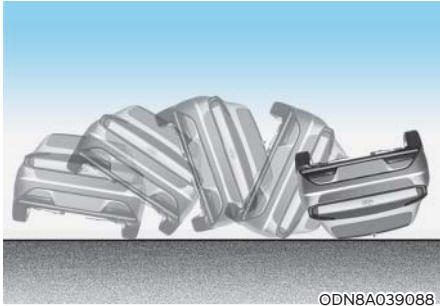

Front air bags may not inflate in rollover accidents because air bag deployment may not provide protection to the occupants.

However, side and curtain air bags may inflate when the vehicle is rolled over by a side impact collision.

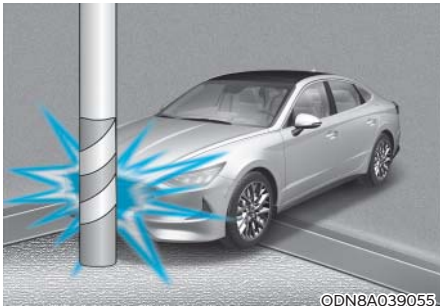

Air bags may not inflate if the vehicle collides with objects such as utility poles or trees, where the point of impact is concentrated and the collision energy is absorbed by the vehicle structure.

### SRS Care

The SRS is virtually maintenance-free and there are no parts you can safely service by yourself. If the SRS air bag warning light does not illuminate when the ignition switch is in the ON position, or continuously remains on, have your vehicle immediately inspected by an authorized HYUNDAI dealer.

Any work on the SRS system, such as removing, installing, repairing, or any work on the steering wheel, the front passenger's panel, front seats and roof rails must be performed by an authorized HYUNDAI dealer. Improper handling of the SRS system may result in serious personal injury.



### WARNING

To reduce the risk of serious injury or death, take the following precautions:

- Do not attempt to modify or disconnect the SRS components or wiring, including the addition of any kind of badges to the pad covers or modifications to the body structure.
- Do not place objects over or near the air bag modules on the steering wheel, instrument panel, or the front passenger's panel above the glove box.
- Clean the air bag pad covers with a soft cloth moistened with plain water. Solvents or cleaners could adversely affect the air bag covers and proper deployment of the system.
- Always have inflated air bags replaced by an authorized HYUNDAI dealer.
- If components of the air bag system must be discarded, or if the vehicle must be scrapped, certain safety precautions must be observed. Consult an authorized HYUNDAI dealer for the necessary information. Failure to follow these precautions could increase the risk of personal injury.

## Additional Safety Precautions

**Passengers should not move out of or change seats while the vehicle is moving.** A passenger who is not wearing a seat belt during a crash or emergency stop can be thrown against the inside of the vehicle, against other occupants, or be ejected from the vehicle.

**Do not use any accessories on seat belts.** Devices claiming to improve occupant comfort or reposition the seat belt can reduce the protection provided by the seat belt and increase the chance of serious injury in a crash.

**Do not modify the front seats.** Modification of the front seats could interfere with the operation of the supplemental restraint system sensing components or side air bags.

**Do not place items under the front seats.** Placing items under the front seats could interfere with the operation of the supplemental restraint system sensing components and wiring harnesses.

**Do not cause impact to the doors.** Impact to the doors when the Engine Start/Stop button is in the ON position may cause the air bags to inflate.

**Modifications to accommodate disabilities.** If you require modification to your vehicle to accommodate a disability, contact the HYUNDAI Customer Connect Center at 800-633-5151.

### ***Adding equipment to or modifying your air bag equipped vehicle***

If you modify your vehicle by changing your vehicle's frame, bumper system, front end or side sheet metal or ride height, this may affect the operation of your vehicle's air bag system.

## Air Bag Warning Labels



ODN8A039057

Air bag warning labels, required by the U.S. National Highway Traffic Safety Administration (NHTSA), are attached to alert the driver and passengers of potential risks of the air bag system. Be sure to read all of the information about the air bags that are installed on your vehicle in this Owners Manual.

# 4. Instrument Cluster

Instrument Cluster .....	4-2
Instrument Cluster Control .....	4-3
Gauges and Meters .....	4-3
Transmission Shift Indicator .....	4-6
Warning and Indicator Lights .....	4-7
LCD Display Messages .....	4-15
LCD Display (TYPE A, B) .....	4-19
LCD Display Control .....	4-19
LCD Display Modes .....	4-20
Trip Computer .....	4-31
LCD Display (TYPE C) .....	4-34
LCD Display Control .....	4-34
View Modes .....	4-35
Utility View Mode .....	4-36
Option Menu .....	4-38
User Settings Mode .....	4-39

## INSTRUMENT CLUSTER

■ Type A



■ Type B



■ Type C

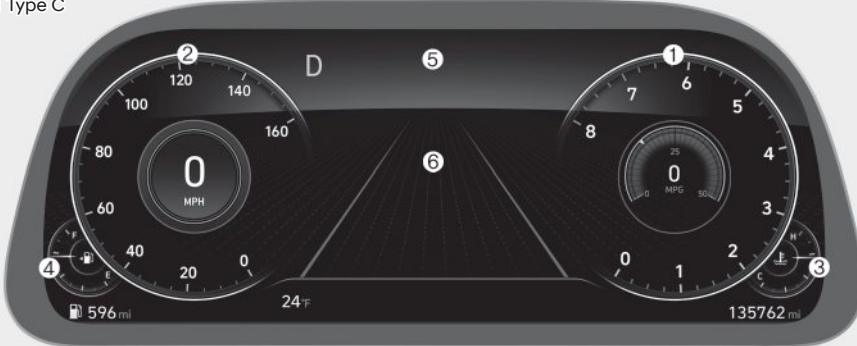

ODN8A049039/Odn8a049032/ODN8A049002

1. Tachometer
2. Speedometer
3. Engine coolant temperature gauge
4. Fuel gauge
5. Warning and indicator lights
6. LCD display (including trip computer)

**The actual cluster in the vehicle may differ from the illustration.**

**For more information, refer to the "Gauges and Meters" in this chapter.**

## Instrument Cluster Control

### Adjusting instrument cluster illumination

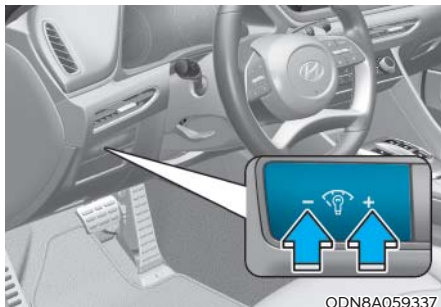

ODN8A059337

When the vehicle's parking lamps or headlamps are on, press the illumination control button to adjust the brightness of the instrument panel illumination.

When pressing the illumination control button, the interior switch illumination intensity is also adjustable.

- The brightness of the instrument panel illumination is displayed.
- If the brightness reaches the maximum or minimum level, a chime will sound.



### WARNING

**Never adjust the instrument cluster while driving. Doing so could lead to driver distraction which may cause an accident and lead to vehicle damage, serious injury, or death.**

## Gauges and Meters

### Speedometer

■ Type A, B



OLX2048102L

■ Type C



ODN8049004L

The speedometer indicates the speed of the vehicle and is calibrated in miles per hour (MPH) and/or kilometers per hour (km/h).

### Tachometer

■ Type A, B



OLX2048105

■ Type C



ODN8049005

The tachometer indicates the approximate number of engine revolutions per minute (RPM).

Use the tachometer to select the correct shift points and to prevent lugging and/or over-revving the engine.

### NOTICE

**Do not operate the engine within the tachometer's RED ZONE. This may cause severe engine damage.**



### Engine coolant temperature gauge



This gauge indicates the temperature of the engine coolant when the ignition switch is in the ON position.

#### NOTICE

If the gauge pointer moves beyond the normal range area toward the "H" position, it indicates overheating that may damage the engine.

Do not continue driving with an overheated engine. If your engine overheats, refer to "If the Engine Overheats" in chapter 7.

#### WARNING

Never remove the radiator cap or reservoir cap when the engine is hot. The engine coolant is under pressure and could severely burn. Wait until the engine is cool before adding coolant to the reservoir.

### Fuel gauge



This gauge indicates the approximate amount of fuel remaining in the fuel tank.

#### Information

- The fuel tank capacity is given in chapter 2.
- The fuel gauge is supplemented by a low fuel warning light, which will illuminate when the fuel tank is nearly empty.
- On inclines or curves, the fuel gauge pointer may fluctuate or the low fuel warning light may come on earlier than usual due to the movement of fuel in the tank.



## WARNING

Running out of fuel can expose vehicle occupants to danger.

You must stop and obtain additional fuel as soon as possible after the warning light comes on or when the gauge indicator comes close to the "E (Empty)" level.

## NOTICE

Avoid driving with an extremely low fuel level. Running out of fuel could cause the engine to misfire and damage the catalytic converter.

### Outside temperature gauge

■ Type A, B

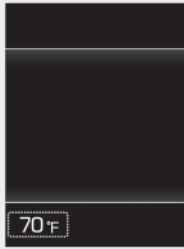

OTMA04812

□ Type C

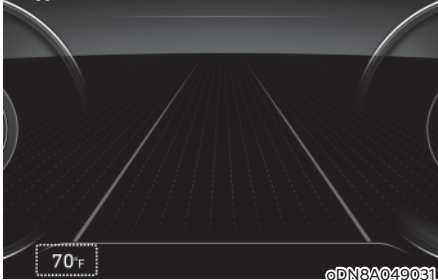

©DN8A049031

This gauge indicates the current outside air temperature by 1°F (1°C).

- Temperature range: -40°F ~ 140°F (40°C ~ 60°C)

Note that the temperature indicated on the LCD display may not change as quickly as the outside temperature (there may be a slight delay before the temperature changes.)

You can change the temperature unit from °F to °C or °C to °F in the User Settings mode in the cluster:

- Go to User Settings Mode → Other → Temperature Unit.

For vehicles equipped with Automatic Climate Control, you can also:

- Press and hold the AUTO and OFF buttons on the climate control unit for 3 seconds

Both the temperature unit on the cluster LCD display and climate control screen will change.

### Odometer

■ Type A, B



OTMA048183

□ Type C



©DN8A049037

The odometer indicates the total distance that the vehicle has been driven and should be used to determine when periodic maintenance should be performed.

### Range

■ Type A, B

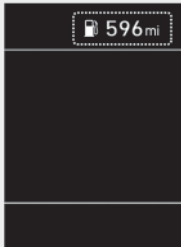

OAD048563L

□ Type C

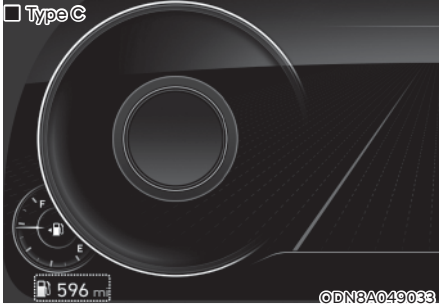

©DN8A049033

- The range is the estimated distance the vehicle can be driven with the remaining fuel.
- If the estimated distance is below 1 mi. (1 km), the trip computer will display "----" as range.

### Information

- **If the vehicle is not on level ground or the battery power has been interrupted, the range function may not operate correctly.**
- **The range may differ from the actual driving distance as it is only an estimate of the available driving range for the vehicle and driving conditions.**
- **The trip computer may not register additional fuel if less than 1.6 gallon (6 liters) of fuel are added to the vehicle.**
- **The range may vary significantly based on driving conditions, driving habits, and condition of the vehicle.**

### Transmission Shift Indicator (if equipped)

#### Automatic transmission shift indicator

■ Type A



OIG046112

□ Type B



©DN8A049009

This indicator displays which shift button position is selected.

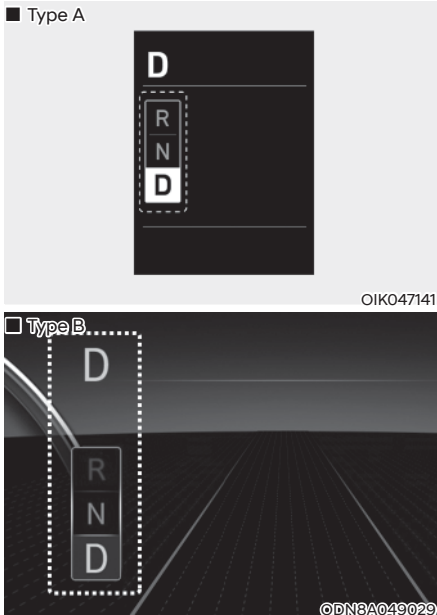

### Shift Indicator Pop-up

The pop-up that indicates the current gear position is displayed in the cluster for about 2 seconds when shifting into other positions (P/R/N/D).

The shift indicator pop-up function can be activated or deactivated from the User Settings mode in the cluster LCD display.

## Warning and Indicator Lights

### **i** Information

Make sure that all warning lights are OFF after starting the engine. If any light is still ON, this indicates a situation that needs attention.

### **Air Bag Warning Light**



This warning light illuminates:

- When you place the ignition switch to the ON position.
  - The air bag warning light illuminates for about 6 seconds and then turns off when all checks have been performed
- The air bag warning light will remain illuminated if there is a malfunction with the Safety Restraint System (SRS) air bag operation.

In this case, have the vehicle inspected by an authorized HYUNDAI dealer.

### **Seat Belt Warning Light**



This warning light informs the driver that the seat belt is not fastened.

**For more information, refer to “Seat Belts” in chapter 3.**

### **Parking Brake & Brake Fluid Warning Light**



**This warning light illuminates:**

- When you place the ignition switch to the ON position.
  - The parking brake light illuminates for about 3 seconds and will then turn off once the parking brake is released.
- Whenever the parking brake is applied.
- Whenever the brake fluid level in the reservoir is low.
  - If the warning light illuminates with the parking brake released, it indicates that the brake fluid level in the reservoir is low.

**If the brake fluid level in the reservoir is low:**

1. Drive carefully to the nearest safe location and stop your vehicle.
2. With the engine stopped, check the brake fluid level immediately and add fluid as required (**For more information, refer to "Brake Fluid" in chapter 8**). After adding brake fluid, check all brake components for fluid leaks. If a brake fluid leak is found, or if the warning light remains on, or if the brakes do not operate properly, do not drive the vehicle. Have the vehicle inspected by an authorized HYUNDAI dealer.

### **Dual-diagonal braking system**

Your vehicle is equipped with dual-diagonal braking systems. This means you still have braking on two wheels even if one of the dual systems should fail.

With only one of the dual systems working, more than normal pedal travel and greater pedal pressure is required to stop the vehicle.

If the brakes fail while you are driving, shift to a lower gear for additional engine braking and stop the vehicle as soon as it is safe to do so.



### **WARNING**

#### **Parking Brake & Brake Fluid Warning Light**

**Driving the vehicle with a warning light ON is dangerous. If the Parking Brake & Brake Fluid Warning Light illuminates with the parking brake released, it indicates that the brake fluid level is low.**

**In this case, have the vehicle inspected by an authorized HYUNDAI dealer.**

### **Anti-lock Brake System (ABS) Warning Light**



This warning light illuminates:

- When you place the ignition switch to the ON position.
  - The ABS warning light illuminates for about 3 seconds and then turns off.
- Whenever there is a malfunction with the ABS.
 

Note that the hydraulic braking system will still be operational even if there is a malfunction with the ABS.

### **Electronic Brake Force Distribution (EBD) System Warning Light**



These two warning lights illuminate at the same time while driving:

When the ABS and regular brake system may not work normally.

In this case, have the vehicle inspected by an authorized HYUNDAI dealer.



### **WARNING**

#### **Electronic Brake Force Distribution (EBD) System Warning Light**

When both ABS and Parking Brake & Brake Fluid Warning Lights are on, the brake system will not work normally and you may experience an unexpected and dangerous situation during sudden braking.

In this case, avoid high speed driving and abrupt braking.

Have the vehicle inspected by an authorized HYUNDAI dealer as soon as possible.

### **i Information - Electronic Brake Force Distribution (EBD) System Warning Light**

When the ABS Warning Light is on or both ABS and Parking Brake & Brake Fluid Warning Lights are on, the speedometer, odometer, or tripmeter may not work. Also, the EPS Warning Light may illuminate and the steering effort may increase or decrease.

In this case, have the vehicle inspected by an authorized HYUNDAI dealer as soon as possible.

### **Electronic Parking Brake (EPB) Warning Light**

### **EPB**

This warning light illuminates:

- When you place the Engine Start/Stop button to the ON position.
  - The EPB warning light illuminates for approximately 3 seconds and then turns off.
- Whenever there is a malfunction with the EPB.

If this occurs, have the vehicle inspected by an authorized HYUNDAI dealer.

### **i Information**

The Electronic Parking Brake (EPB) Warning Light may illuminate when the Electronic Stability control (ESC) Indicator Light comes on to indicate that the ESC is not working properly (This does not indicate malfunction of the EPB).

**AUTO HOLD Indicator Light  
(if equipped)**



This indicator light illuminates:

- [White] When you activate the auto hold system by pressing the AUTO HOLD button.
- [Green] When you stop the vehicle completely by depressing the brake pedal with the auto hold system activated.
- [Yellow] When there is a malfunction with the auto hold system.  
In this case, have the vehicle inspected by an authorized HYUNDAI dealer.

For more information, refer to “Auto Hold” in chapter 6.

**Electric Power Steering (EPS)  
Warning Light**



This warning light illuminates:

- When you place the ignition switch to the ON position.
  - The Electric Power Steering Warning light illuminates for about 3 seconds and then goes off.
- Whenever there is a malfunction with the EPS.  
If this occurs, have the vehicle inspected by an authorized HYUNDAI dealer.

**Malfunction Indicator Lamp  
(MIL)**



This warning light illuminates:

- When you place the ignition switch to the ON position.
  - The malfunction indicator light illuminates for about 3 seconds and then goes off.
- Whenever there is a malfunction with either the emission control system or the engine or the vehicle powertrain.  
If this occurs, have the vehicle inspected by an authorized HYUNDAI dealer.

**NOTICE**

Driving with the Malfunction Indicator Lamp (MIL) on may cause damage to the emission control system which could affect drivability and/or fuel economy.

**NOTICE**

If the Malfunction Indicator Lamp (MIL) illuminates, potential catalytic converter damage is possible which could result in loss of engine power.  
In this case, have the vehicle inspected by an authorized HYUNDAI dealer as soon as possible.

### Charging System Warning Light



When this warning light illuminates while the engine is running, the battery is not being charged. Immediately turn OFF all electrical accessories. Try not to use electrically operated controls, such as the power windows. Keep the engine running.

Have the vehicle inspected by an authorized HYUNDAI dealer as soon as possible.

### Engine Oil Pressure Warning Light



**This warning light illuminates:**

When the engine oil pressure is low.

**If the engine oil pressure is low:**

1. Drive carefully to the nearest safe location and stop your vehicle.
2. Turn the engine off and check the engine oil level (**For more information, refer to "Engine Oil" in chapter 8**). If the level is low, add oil as required.

If the warning light remains on after adding oil or if oil is not available, have the vehicle inspected by an authorized HYUNDAI dealer as soon as possible.

### NOTICE

- If the engine is not turned OFF immediately after the Engine Oil Pressure Warning Light is illuminated, severe damage could occur.
- If the warning light stays on while the engine is running, it indicates that there may be serious engine damage or malfunction. In this case:
  1. Stop the vehicle as soon as it is safe to do so.
  2. Turn off the engine and check the oil level. If the oil level is low, fill the engine oil to the proper level.
  3. Start the engine again. If the warning light stays on after the engine has started, turn the engine off immediately. In this case, have the vehicle inspected by an authorized HYUNDAI dealer.

### Low Fuel Level Warning Light



**This warning light illuminates:**

When the fuel tank is nearly empty. Add fuel as soon as possible.

### NOTICE

Driving with the Low Fuel Level warning light on or with the fuel level below "E" can cause the engine to misfire and damage the catalytic converter.



### Master Warning Light



#### This indicator light illuminates:

When there is a malfunction in operation in any of the following systems:

- Forward Collision-Avoidance Assist system malfunction (if equipped)
- Forward Collision-Avoidance Assist radar blocked (if equipped)
- Blind-Spot Collision Warning system malfunction (if equipped)
- Blind-Spot Collision Warning radar blocked (if equipped)
- High Beam Assist malfunction (if equipped)
- Lamp malfunction (if equipped)
- Smart Cruise Control malfunction (if equipped)
- Tire Pressure Monitoring System (TPMS) malfunction (if equipped)

To identify the details of the warning, look at the LCD display.

### Low Tire Pressure Warning Light (if equipped)



#### This warning light illuminates:

- When you place the ignition in the ON position.
  - It illuminates for approximately 3 seconds and then goes off.
- When one or more of your tires are significantly underinflated. (The location of the underinflated tires is displayed on the LCD display.)

**For more information, refer to "Tire Pressure Monitoring System (TPMS)" in chapter 7.**

**This warning light remains ON after blinking for approximately 60 seconds, or repeatedly blinks ON and OFF in 3 second intervals:**

When there is a malfunction with the TPMS.

In this case, have the vehicle inspected by an authorized HYUNDAI dealer as soon as possible.

**For more information, refer to "Tire Pressure Monitoring System (TPMS)" in chapter 7.**

### WARNING

#### Safe Stopping

- **The TPMS cannot alert you to severe and sudden tire damage caused by external factors.**
- **If you notice any vehicle instability, immediately take your foot off the accelerator pedal, apply the brakes gradually with light force, and slowly move to a safe position off the road.**

### Electronic Stability Control (ESC) Indicator Light



#### This indicator light illuminates:

- When you place the ignition switch to the ON position.
  - The Electronic Stability Control indicator light illuminates for about 3 seconds and then goes off.
- Whenever there is a malfunction with the ESC system.

If this occurs, have the vehicle inspected by an authorized HYUNDAI dealer.

#### This indicator light blinks:

While the ESC is operating.

**For more information, refer to "Electronic Stability Control (ESC)" in chapter 6.**

### **Electronic Stability Control (ESC) OFF Indicator Light**



**This indicator light illuminates:**

- When you place the ignition switch to the ON position.
  - It illuminates for approximately 3 seconds and then goes off.
- When you deactivate the ESC system by pressing the ESC OFF button.

**For more information, refer to “Electronic Stability Control (ESC)” in chapter 6.**

### **Immobilizer Indicator Light**



**This indicator light illuminates:**

- When the vehicle detects the immobilizer in the key with the ignition switch in the ON position.
  - At this time, you can start the engine.
  - The indicator light goes off after starting the engine.

**This indicator light blinks:**

- When there is a malfunction with the immobilizer system.

If this occurs, have the vehicle inspected by an authorized HYUNDAI dealer.

### **Immobilizer Indicator Light (with smart key) (if equipped)**



**This indicator light illuminates for up to 30 seconds:**

When the vehicle detects the smart key in the vehicle with the Engine Start/Stop button in the ACC or ON position.

- Once the smart key is detected, you can start the engine.
- The indicator light goes off after starting the engine.

**This indicator light blinks for a few seconds:**

When the smart key is not in the vehicle.

- If the smart key is not detected, you cannot start the engine.

**This indicator light illuminates for 2 seconds and goes off:**

If the smart key is in the vehicle and the Engine Start/Stop button is ON, but the vehicle cannot detect the smart key.

In this case, have the vehicle inspected by an authorized HYUNDAI dealer.

**This indicator light blinks:**

When there is a malfunction with the immobilizer system.

In this case, have the vehicle inspected by an authorized HYUNDAI dealer.

### Turn Signal Indicator Light



**This indicator light blinks:**

When you operate the turn signal indicator stalk.

If any of the following occur, there may be a malfunction with the turn signal system.

- The turn signal indicator light illuminates but does not blink
- The turn signal indicator light blinks rapidly
- The turn signal indicator light does not illuminate at all

If any of these conditions occur, have your vehicle inspected by an authorized HYUNDAI dealer.

### Headlamp Warning Light (if equipped)



**This warning light illuminates:**

If one of the exterior bulbs (headlamp, stop lamp, high mounted stop lamp) is not operating properly. One of the bulbs may need to be replaced. If the vehicle is equipped with LED headlamps, have the vehicle inspected by an authorized HYUNDAI dealer.

### Information

**When replacing the bulb, use the same wattage bulb.**

**For more information, refer to "Light bulbs" in chapter 8.**

### High Beam Indicator Light



**This indicator light illuminates:**

- When the headlights are on and in the high beam position.
- When the turn signal lever is pulled into the Flash-to-Pass position.

### Light ON Indicator Light



**This indicator light illuminates:**

When the tail lights or headlamps are on.

### High Beam Assist indicator light (if equipped)



**This indicator light illuminates:**

- When the High Beam is on with the light switch in the AUTO light position.
- If your vehicle detects oncoming or preceding vehicles, High Beam Assist system will switch the high beam to low beam automatically.

**For more information, refer to "High Beam Assist (HBA)" in chapter 5.**

### **Forward Collision-Avoidance Assist Warning Light (if equipped)**



This warning light illuminates:

- When you set the ignition switch or Engine Start/Stop button to the ON position.
  - It illuminates for approximately 3 seconds and then goes off.
- When there is a malfunction with FCA. In this case, have your vehicle inspected by an authorized dealer of HYUNDAI.

**For more information, refer to "Forward Collision-Avoidance Assist (FCA)" in chapter 6.**

### **Lane Keep Assist Indicator Light (if equipped)**



This indicator light illuminates:

- [Green] When you activate the lane departure warning system by pressing the LKA button and all of the system operating conditions are satisfied.
- [White] When system operating conditions are not satisfied or when the sensor does not detect the lane line.
- [Yellow] When there is a malfunction with Lane Keeping Assist system.

In this case, have your vehicle inspected by an authorized HYUNDAI dealer.

**For more information, refer to "Lane Keeping Assist (LKA)" in chapter 6.**

## **LCD Display Messages**

### **Shift to P or N to start engine (for smart key system)**

This warning message is displayed if you try to start the engine with the shift button not in the P (Park) or N (Neutral) position.

#### **i Information**

**You can start the engine with the shift button in the N (Neutral) position. But, for your safety, we recommend that you start the engine with the shift button in the P (Park) position.**

### **Shift to P (for smart key system)**

This message is displayed if you try to turn off the engine without the shift button in P (Park) position.

If this occurs, the Engine Start/Stop button turns to the ACC position (If you press the Engine Start/Stop button once more, it will turn to the ON position).

### **Low key battery (for smart key system)**

This warning message is displayed if the battery of the smart key is discharged while changing the Engine Start/Stop button to the OFF position.

### **Press brake pedal to start engine (for smart key system)**

This warning message is displayed if the Engine Start/Stop button changes to the ACC position twice by pressing the button repeatedly without depressing the brake pedal.

You can start the vehicle by depressing the brake pedal and then pressing the Engine Start/Stop button.

***Key not in vehicle  
(for smart key system)***

This warning message is displayed if the smart key is not in the vehicle when you press the Engine Start/Stop button.

When attempting to start the vehicle, always have the smart key with you.

***Key not detected  
(for smart key system)***

This warning message is displayed if the smart key is not detected when you press the Engine Start/Stop button.

***Press START button again  
(for smart key system)***

This message is displayed if you were unable to start the vehicle when the Engine Start/Stop button was pressed.

If this occurs, attempt to start the engine by pressing the Engine Start/Stop button again.

If the warning message appears each time you press the Engine Start/Stop button, have your vehicle inspected by an authorized HYUNDAI dealer.

***Battery discharging due to external electrical devices (if equipped)***

This message is displayed if the battery voltage is weak due to any non-factory electrical accessories (ex. dashboard camera) while parking. Be careful that the battery is not discharged.

If the warning message appears after removing the non-factory electrical accessories, have the vehicle inspected by an authorized HYUNDAI dealer.

***Press START button with key  
(for smart key system)***

This warning message is displayed if you press the Engine Start/Stop button while the warning message "Key not detected" is displayed.

At this time, the immobilizer indicator light blinks.

***Check BRAKE SWITCH fuse  
(for smart key system)***

This warning message is displayed if the brake switch fuse is disconnected.

You need to replace the fuse with a new one before starting the engine.

If that is not possible, you can start the engine by pressing the Engine Start/Stop button for 10 seconds in the ACC position.

### Door, Hood, Trunk Open Indicator

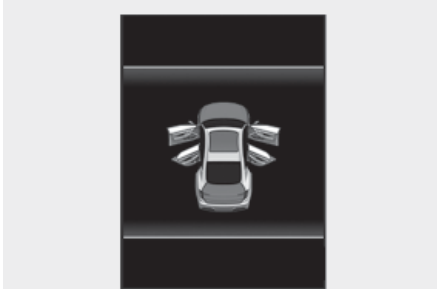

ODN8049012

This warning is displayed if any door or the hood or the liftgate is left open. The warning will indicate which door is open in the display.



#### CAUTION

Before driving the vehicle, you should confirm that the door/hood/liftgate is fully closed. Also, check there is no door/hood/liftgate open warning light or message displayed on the instrument cluster.

### Sunroof Open (if equipped)

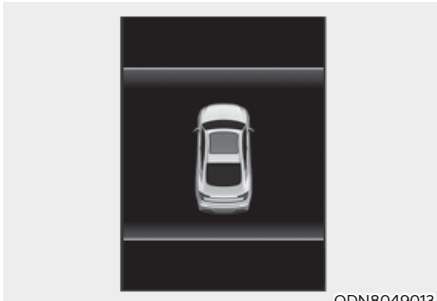

ODN8049013

This warning is displayed if you turn off the engine when the sunroof is open. Close the sunroof securely before leaving your vehicle.

### Low Pressure



ODN8049019L

This warning message is displayed if the tire pressure is low. The corresponding tire on the vehicle will be illuminated.

**For more information, refer to "Tire Pressure Monitoring System (TPMS)" in chapter 7.**

### Lights Mode

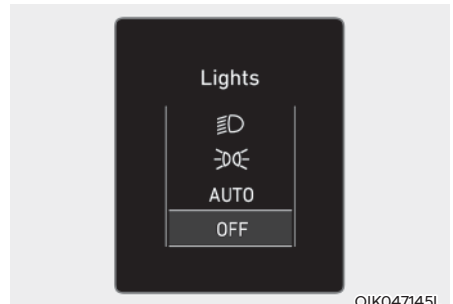

OIK047145L

This indicator displays which exterior light is selected using the lighting control.

**Wiper**

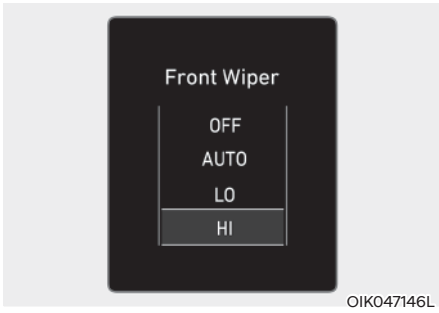

This indicator displays which wiper speed is selected using the wiper control.



## LCD DISPLAY (TYPE A, B)

### LCD Display Control







ODN8A069203

The LCD display modes can be changed by using the control buttons.

1. : MODE button for changing modes
2. : MOVE switch for changing items
3. OK : Push the SELECT/RESET button for setting or resetting the selected item



### LCD Display Modes

Modes	Symbol	Explanation
Trip Computer		This mode displays driving information such as the tripmeter, fuel economy, etc.
Turn By Turn (TBT)		This mode displays the state of the navigation.
Drive Assist (if equipped)		This mode displays the state of: - Smart Cruise Control system Lane Following Assist system Lane Keeping Assist system - Driver Attention Warning system - Tire pressure
User Settings		The User Settings menu provides user options for a variety of settings including door lock/unlock features, convenience features, driver assistance settings, etc.
Master Warning		The Warning mode displays warning messages related to the vehicle when one or more systems is not operating normally.

**The information provided may differ depending on which functions are applicable to your vehicle.**

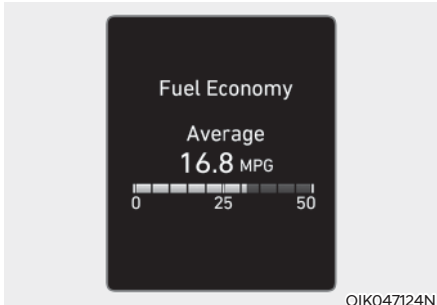
**Trip computer mode**

The trip computer mode displays information related to vehicle driving parameters including fuel economy, trip meter information and vehicle speed.

**For more information, refer to "Trip Computer" in this chapter.**

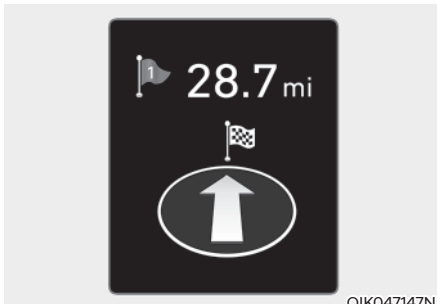
**Turn By Turn (TBT) mode**

This mode displays the state of the navigation.

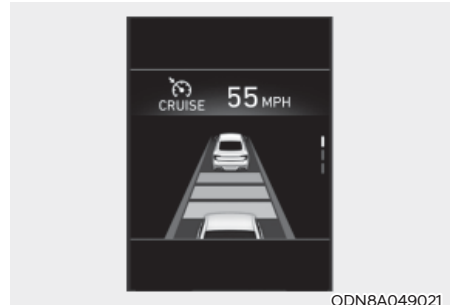
**Driving Assist mode****SCC/LFA/LKA, DAW**

This mode displays the state of Smart Cruise Control system, Lane Following Assist system, Lane Keeping Assist system and Driver Attention Warning system.

**For more information, refer to each system information in chapter 6.**

**Tire Pressure**

This mode displays information related to Tire Pressure.

**For more information, refer to "Tire Pressure Monitoring System (TPMS)" in chapter 7.**

### Master warning mode

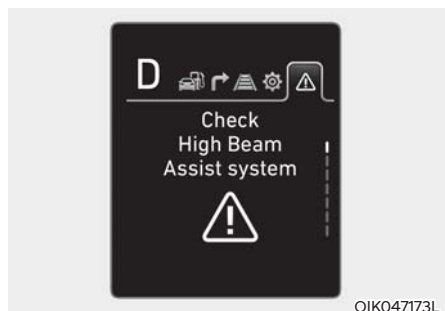

This warning light informs the driver the following situations.

- Forward Collision-Avoidance Assist system malfunction (if equipped)
- Forward Collision-Avoidance Assist radar blocked (if equipped)
- Blind-Spot Collision Warning system malfunction (if equipped)
- Blind-Spot Collision Warning radar blocked (if equipped)
- High Beam Assist malfunction (if equipped)
- Lamp malfunction (if equipped)
- Smart Cruise Control malfunction (if equipped)
- Tire Pressure Monitoring System (TPMS) malfunction (if equipped)

The Master Warning Light illuminates if one or more of the above warning situations occur. At this time, a Master Warning icon (⚠️) will appear beside the User Settings icon (⚙️), on the LCD display.

If the warning situation is solved, the master warning light will be turned off and the Master Warning icon will disappear.

### User settings mode

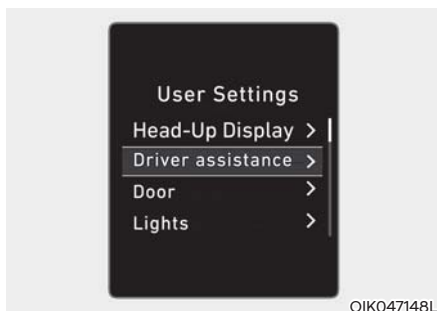

In this mode, you can change the settings of the instrument cluster, doors, lamps, etc.

1. Head-Up Display
2. Driver Assistance
3. Door
4. Lights
5. Sound
6. Convenience
7. Service interval
8. Other
9. Language
10. Reset

**The information provided may differ depending on which functions are applicable to your vehicle.**



### **Shift to P to edit settings**

This warning message appears if you try to adjust the User Settings while driving. For your safety, change the User Settings after parking the vehicle, applying the parking brake and shifting to P (Park).

### **Quick guide help**

This mode provides quick guides for the systems in the User Settings mode. Select an item, press and hold the OK button.

**For more information, about each system, refer to this Owner's Manual.**

### 1. Head-Up Display

Items	Explanation
Enable Head-Up Display	To activate or deactivate the Head-up display function.
Display Height	To adjust the height of the image displayed
Rotation	To adjust the angle of the image displayed.
Brightness	To adjust the brightness of the image displayed.
Content Selection	To select the content to be displayed.
Speed Size	To select the speedometer size displayed. - Large/Medium/Small
Speed Color	To select the speedometer color displayed. - White/Orange/Green

**For more information, refer to "Head-Up Display" in this chapter**

\* The information provided may differ depending on which functions are applicable to your vehicle.

## 2. Driver Assistance

Items	Explanation
Driving Assist	<ul style="list-style-type: none"> <li>• Highway Driving Assist To activate or deactivate the Highway Driving Assist (HDA). <b>For more information, refer to the "Highway Driving Assist (HDA)" in chapter 6.</b></li> <li>• Highway Auto Curve Slowdown To activate or deactivate the Highway Auto Curve Slowdown (NSCC). <b>For more information, refer to the Highway "Auto Curve Slowdown (NSCC)" in chapter 6.</b></li> </ul>
Warning Timing	To adjust the warning timing of the driver assistance system. <ul style="list-style-type: none"> <li>• Normal / Late</li> </ul>
Warning Volume	To adjust the warning volume of the driver assistance system. <ul style="list-style-type: none"> <li>• High / Medium / Low</li> </ul>
Driver Attention Warning	<ul style="list-style-type: none"> <li>• Leading Vehicle Departure Alert. To activate or deactivate the Leading vehicle departure alert.</li> <li>• Inattentive Driving Warning To activate or deactivate the Driver Attention Warning (DAW). <b>For more information, refer to the "Driver Attention Warning (DAW)" in chapter 6</b></li> </ul>
Forward safety	To adjust the Forward Collision-Avoidance Assist function. <ul style="list-style-type: none"> <li>• Active Assist</li> <li>• Warning only</li> <li>• Off</li> </ul> <b>For more information, refer to the "Forward Collision-Avoidance Assist (FCA)" in chapter 6.</b>

2. Driver Assistance

Items	Explanation
Lane Safety	To adjust Lane Keeping Assist system function. <ul style="list-style-type: none"> <li>• Lane Keeping Assist</li> <li>• Lane Departure Warning</li> <li>• Off</li> </ul> <b>For more information, refer to the “Lane Keeping Assist (LKA)” in chapter 6.</b>
Blind-Spot Safety	<ul style="list-style-type: none"> <li>• Blind-Spot View</li> </ul> To activate or deactivate the Blind-Spot View. <ul style="list-style-type: none"> <li>• Active assist</li> <li>• Warning only</li> <li>• Off</li> </ul> <b>For more information, refer to “Blind-Spot Collision Warning (BCW)” or “Blind-Spot Collision-Avoidance Assist (BCA)” in chapter 6.</b>
Parking Safety	<ul style="list-style-type: none"> <li>• Surround View Monitor Auto On</li> <li>• Parking Distance Warning Auto ON</li> <li>• Rear Cross-Traffic Safety</li> </ul> To Activate or deactivate the Rear Cross-Traffic Collision-Avoidance Assist function. <ul style="list-style-type: none"> <li>• Active Assist</li> <li>• Warning only</li> <li>• Off</li> </ul> <b>For more information, refer to “Rear Cross-Traffic Collision-Avoidance Assist (RCCA) system” in chapter 6.</b>

### 3. Door

Items	Explanation
Auto Lock	<ul style="list-style-type: none"> <li>• Disable : The auto door lock operation will be deactivated.</li> <li>• Enable on Speed: All doors will be automatically locked when the vehicle speed exceeds 9 mph (15 km/h).</li> <li>• Enable on Shift: All doors will be automatically locked if the automatic transmission shift button is pressed from the P (Park) position to the R (Reverse), N (Neutral), or D (Drive) position.</li> </ul>
Auto Unlock	<ul style="list-style-type: none"> <li>• Disable : The auto door unlock operation will be canceled.</li> <li>• On key out/Vehicle Off : All doors will be automatically unlocked when the ignition key is removed from the ignition switch or the Engine Start/Stop button is set to the OFF position.</li> <li>• On Shift to P: All doors will be automatically unlocked if the automatic transmission shift button is pressed to P (Park) position.</li> </ul>
Two Press Unlock	<ul style="list-style-type: none"> <li>• Off: The two press unlock function will be deactivated. Therefore, all doors will unlock if the door unlock button is pressed.</li> <li>• On: Only the driver's door will unlock if the door unlock button is pressed. When the door unlock button is pressed again within 4 seconds, the remaining doors will unlock.</li> </ul>
Horn Feedback	To activate or deactivate the horn feedback. If the horn feedback is activated, after locking the door by pressing the lock button on the remote key, and pressing it again within 4 seconds, the horn feedback sound will operate once to indicate that all doors are locked (if equipped with remote key).
Smart Trunk	To activate or deactivate the smart trunk. <b>For more information, refer to “Smart trunk” in chapter 5.</b>

### 4. Lights

Items	Explanation
One Touch Turn Signal	<ul style="list-style-type: none"> <li>• Off: The one touch turn signal function will be deactivated.</li> <li>• 3, 5, 7 Flashes: The turn signal indicator will blink 3, 5, or 7 times when the turn signal lever is moved slightly.</li> </ul> <b>For more information, refer to “Lighting” in chapter 5.</b>
Ambient Light Brightness	To adjust the brightness of the ambient light.
Ambient Light Color	To select the ambient light color.
Headlight Delay	<ul style="list-style-type: none"> <li>• To activate or deactivate the headlamp delay function.</li> </ul> <b>For more information, refer to “Lighting” in chapter 5.</b>
High Beam Assist	<ul style="list-style-type: none"> <li>• To activate or deactivate the High Beam Assist (HBA) function.</li> </ul> <b>For more information, refer to “High Beam Assist (HBA)” in chapter 5.</b>



## 5. Sound

Items	Explanation
Cluster Voice Guidance Volume	To adjust the cluster voice guidance volume.
Welcome sound	To activate or deactivate the welcome sound.

## 6. Convenience

Items	Explanation
Seat Easy Access	<ul style="list-style-type: none"> <li>• Off: The seat easy access function is deactivated.</li> <li>• Normal/Extended: When you turn off the engine, the driver's seat will automatically move rearward short (Normal) or long (Extended) for you to enter or exit the vehicle more comfortably.</li> </ul> <b>For more information, refer to "Driver Position Memory System" in chapter 5.</b>
Rear Occupant Alert	To activate or deactivate the rear occupant alert.
Welcome Light	<ul style="list-style-type: none"> <li>• On driver approach: The welcome light turns on automatically when the vehicle is approached with the smart key.</li> </ul> <b>For more information, refer to "Welcome System" in chapter 5.</b>
Wireless Charging System	To activate or deactivate the wireless charging system in the front seat. <b>For more information, refer to "Wireless cellular phone charging system" in chapter 5.</b>
Wiper/Lights Display	To activate or deactivate the Wiper/ Light mode. When activated, the LCD display shows the selected Wiper/Light mode whenever you changed the mode.
Gear Position Pop-up	To activate or deactivate the gear position pop-up. When activated, the gear position will be displayed on the LCD display.
Vehicle Auto-Shut Off	The feature is to turn off the vehicle automatically after a certain amount of time (30 or 60 mins), to prevent CO toxication when the vehicle is on and parked in a garage for a long time.  Select the time to delay automatic shut off when the vehicle is parked with the engine on.

## 7. Service interval

Items	Explanation
Enable Service Interval	To activate or deactivate the service interval function.

### Information

**To use the service interval menu, consult an authorized HYUNDAI dealer.**

If the service interval is activated and the time and distance is adjusted, messages are displayed in the following situations each time the vehicle is turned on.

- Service in  
: Displayed to inform the driver the remaining mileage and days to service.
- Service required  
: Displayed when the mileage and days to service has been reached or passed.

### Information

**If any of the following conditions occur, the mileage and number of days to service may be incorrect.**

- **The battery cable is disconnected.**
- **The fuse switch is turned off.**
- **The battery is discharged.**

## 8. Other

Items	Explanation
Fuel Econ. Reset	<ul style="list-style-type: none"> <li>• Off: The average fuel economy will not reset automatically whenever refueling.</li> <li>• After ignition: When the engine has been OFF for 4 hours or longer the average fuel economy will reset automatically.</li> <li>• After refueling: The average fuel economy will reset automatically after adding 1.6 gallons (6 liters) of fuel or more and after driving speed exceeds 1 mph (1 km/h).</li> </ul> <p><b>For more information, refer to “Trip Computer” in this chapter.</b></p>
Fuel Econ. Unit	To select the fuel economy unit.
Temperature Unit	To select the temperature unit. (°C, °F)
Tire Pressure Unit	To select the tire pressure unit. (psi, kPa, bar)

## 9. Language (if equipped)

Items	Explanation
Language	Choose the language. You can choose the language in infotainment system. (if equipped)

## 10. Reset

Items	Explanation
Reset	You can reset the menus in the User Settings Mode. All menus in the User Settings Mode are reset to factory settings, except language and service interval.

## Trip Computer

The trip computer is a microcomputer-controlled driver information system that displays information related to driving.

### **i** Information

Some driving information stored in the trip computer (for example Average Vehicle Speed) resets if the battery is disconnected.

#### Trip modes

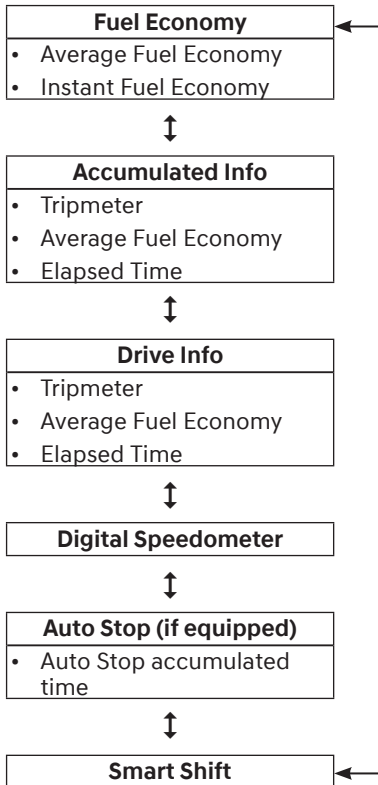

ODN8A069203

To change the trip mode, toggle the “^, v” switch on the steering wheel.

#### **Average fuel economy/ Instant fuel economy**

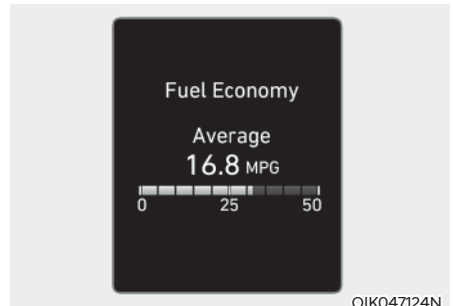

OIK047124N

#### **Average Fuel Economy (1)**

- The average fuel economy is calculated by the total driving distance and fuel consumption since the last average fuel economy reset.
- The average fuel economy can be reset both manually and automatically.

#### **Manual reset**

To clear the average fuel economy manually, press the OK button on the steering wheel for more than 1 second when the average fuel economy is displayed.

### Automatic reset

To automatically reset the average fuel economy after refueling, select the "Fuel Econ. Reset" mode in the User Settings menu on the LCD display.

- After Ignition: When the engine has been OFF for 4 hours or longer the average fuel economy will reset automatically.
- After Refueling: The average fuel economy will reset automatically after adding 1.6 gallons (6 liters) of fuel or more and after driving speed exceeds 1 mph (1 km/h).

### **i** Information

The vehicle must be driven for a minimum of 0.19 miles (300 meters) since the last ignition key cycle before the average fuel economy will be recalculated.

### Instant Fuel Economy (2)

The instantaneous fuel economy is displayed according to the bar graph in the LCD display while driving.

### Accumulated Info display

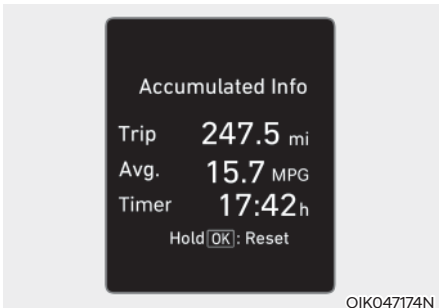

This display shows the accumulated trip distance (1), the average fuel economy (2), and the total driving time (3).

The information is accumulated starting from the last reset.

To reset the information, press and hold the OK button when viewing the Accumulated driving info. The trip distance, the average fuel economy, and total driving time will reset simultaneously.

The accumulated driving information will continue to be counted while the engine is still running (EX: when the vehicle is in traffic or stopped at a stop light).

### **i** Information

The vehicle must be driven for a minimum of 300 meters (0.19 miles) since the last ignition key cycle before the average fuel economy will be recalculated.

### Drive Info display

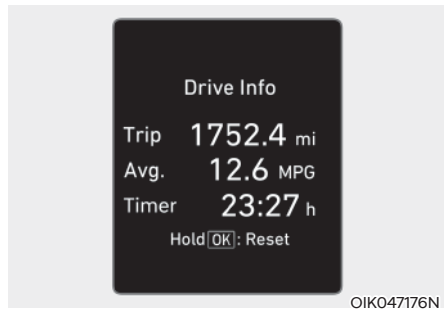

This display shows the trip distance (1), the average fuel economy (2), and the total driving time (3).

The information is combined for each ignition cycle. However, when the engine has been OFF for 4 hours or longer the Drive Info screen will reset.

To manually reset the information, press and hold the OK button when viewing the Drive Info. The trip distance, the average fuel economy, and total driving time will reset simultaneously.

The driving information will continue to be counted while the engine is still running (for example, when the vehicle is in traffic or stopped at a stop light).

### **i** Information

The vehicle must be driven for a minimum of 0.19 miles (300 meters) since the last ignition key cycle before the average fuel economy will be recalculated.

#### **Digital speedometer**

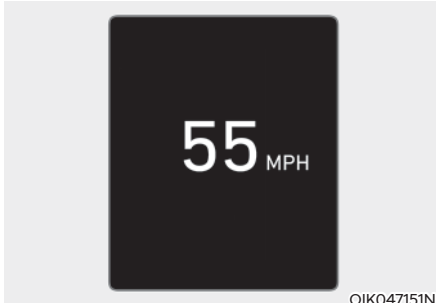

The digital speedometer display shows the speed of the vehicle.

#### **Auto Stop accumulated time**

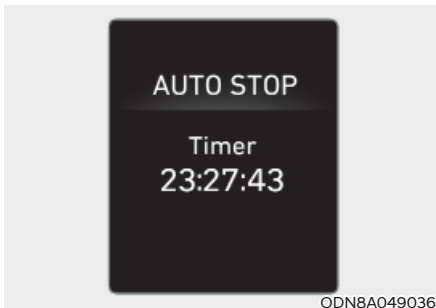

This mode displays the Auto Stop accumulated time within ISG vehicles.

#### **Smart shift**



This mode displays the currently selected drive mode.



**For more information, refer to "Drive Mode Integrated Control System" in chapter 6.**

## LCD DISPLAY (TYPE C) LCD Display Control



ODN8A069203

The LCD display modes can be changed by using the control buttons.

Switch	Operation	Function
	Tap	MODE button for changing view modes
	Tap	MOVE switch for changing items
OK	Tap	SELECT/RESET button for setting the selected item
	Tap and hold	SELECT/RESET button for retrieving assist information or resetting the selected item

## View Modes

View Modes	Explanation
Utility	The Utility view mode displays driving information such as the trip distance, fuel economy and etc.
Driving Assist	The Driving Assist mode displays the driving status.
Turn By Turn (TBT)	This mode displays the state of the navigation.
Parking Assist	The Parking Assist mode displays the parking status.
Driving Info.	Display for 4 seconds when the vehicle mode changes from IGN ON to OFF.

**The information provided may differ depending on which functions are applicable to your vehicle.**



### Utility View Mode

The Utility view mode displays information related to vehicle driving parameters including fuel economy and trip distance information.

#### Utility Items

The utility items appear as well in utility view mode, driving assist view mode and turn by turn view mode. The utility items in utility view mode display in the center of the instrument cluster but the items in other modes show up on the right side of the instrument cluster.

The information provided may differ depending on which functions are applicable to your vehicle.

#### Fuel Economy Information

The average fuel economy and instant fuel economy are displayed

- Manual reset: Press and hold OK button to initialize set up
- Automatic reset: Automatically reset the average fuel economy when the set-up conditions are satisfied in User Settings menu.

#### Driving Information

The trip distance for each ignition cycle, fuel economy (undisplayed item in fuel economy: driving speed), trip time are shown. Press and hold OK button to initialize set up. When the engine has been OFF for 4 hours or longer the average fuel economy will reset automatically.

#### Information after Refueling

The vehicle information such as trip distance, fuel economy (undisplayed item in fuel economy: driving speed) and trip time is displayed after refueling. Press and hold OK button to initialize set up.

#### Accumulated Information

The vehicle information such as trip distance, fuel economy (undisplayed item in fuel economy: driving speed) and trip time is displayed after manual initialization.

#### Digital Speed Display

It shows current vehicle speed.

#### Driver Attention Warning

Display the status of the Driver Attention Warning system. When the engine is off or the vehicle comes to a stop, the system is reset. Press and hold OK button to initialize set up.

#### Smart Shift

#### Tire pressure

#### Digital RPM

### *Driving Assist view mode*

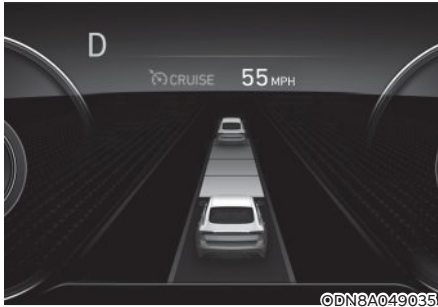

#### **LKA, DAW, LFA, SCC**

This mode displays the state of Lane Keeping Assist, Driver Attention Warning, Lane Following Assist, Smart Cruise Control systems.

**For more information, refer to each system information in chapter 6.**

### *Turn By Turn (TBT) view mode*

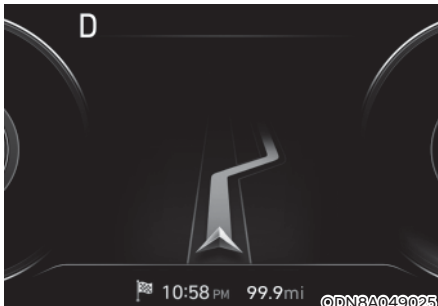

It shows the information by interworking with the navigation

### *Parking Assist view mode*

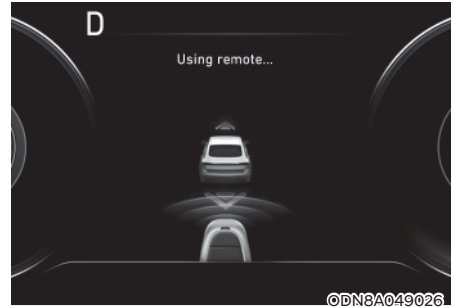

It displays the information related to the parking assist system movement.

**Other Information Display**

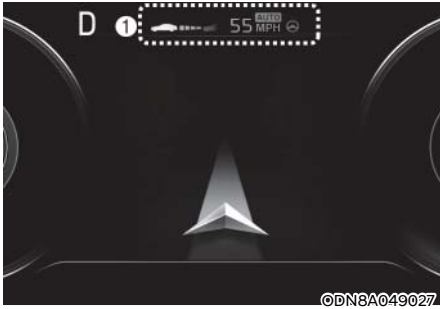

**Driving information summary (1)**

The current operation conditions of the Cruise Control mode, Smart Cruise Control, Navigation-based Smart Cruise Control, Highway Driving Assist modes. It does not show Cruise Control and Smart Cruise Control information while driving assist mode is working.

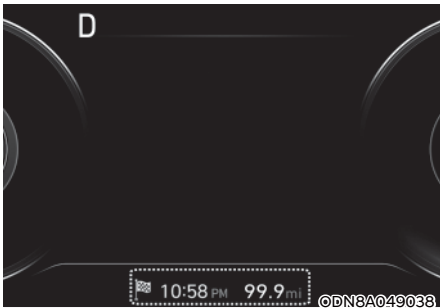

**Driving information summary (2)**

While interworking with the navigation, it displays the distance to the destinations or stops, the time to destinations or stops and the estimated time of arrival. Assist messages appear while set up.

**Option Menu**

**WARNING**

While driving, please do not change the setting mode. It may distract your attention and cause the accident.

**NOTICE**

Displayed items may differ from the content in this owner's manual since the contents vary with the vehicle's technical specifications.

List	Set-up messages
Service Interval	Check the service message
Head-up Display	To activate or deactivate head-up display Set up the height, rotation and brightness (if equipped)
Warning Time	• Normal/Later To select when to provide a warning for all driver assistance

### Warning message mode

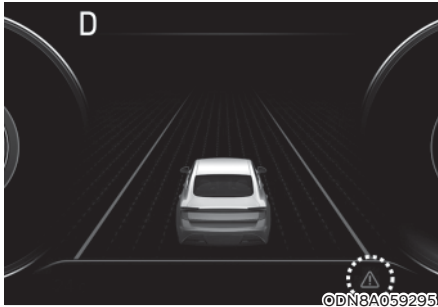

When the warning message light appears in the option menu, press the OK button and check the detailed information.

### User Settings Mode

In this mode, you can change the settings of the instrument cluster, doors, lamps, etc.

1. Head-up display
2. Driver assistance
3. Door
4. Lights
5. Sound
6. Convenience
7. Service interval
8. Other
9. Language
10. Reset

**The information provided may differ depending on which functions are applicable to your vehicle.**

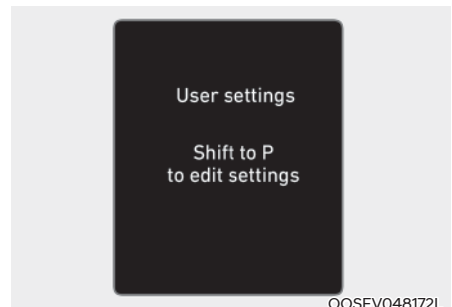

#### Shift to P to edit settings

This warning message appears if you try to adjust the User Settings while driving. For your safety, change the User Settings after parking the vehicle, applying the parking brake and shifting to P (Park).

#### Quick guide help

This mode provides quick guides for the systems in the User Settings mode.

Select an item, press and hold the OK button.

**For more information, about each system, refer to this Owner's Manual.**

**1. Head-Up Display**

Items	Explanation
Enable Head-Up Display	To activate or deactivate the Head-up display function.
Display Height	To adjust the height of the image displayed.
Rotation	To adjust the angle of the image displayed.
Brightness	To adjust the brightness of the image displayed.
Content Selection	To select the content to be displayed.
Speed Size	To select the speedometer size displayed. - Large/Medium/Small
Speed Color	To select the speedometer color displayed. - White/Orange/Green

**For more information, refer to "Head-Up Display" in this chapter.**

\* The information provided may differ depending on which functions are applicable to your vehicle.

## 2. Driver Assistance

Items	Explanation
Driving Assist	<ul style="list-style-type: none"> <li>• Highway Driving Assist To activate or deactivate the Highway Driving Assist (HDA). <b>For more information, refer to the “Highway Driving Assist (HDA)” in chapter 6.</b></li> <li>• Highway Auto Curve Slowdown To activate or deactivate the Highway Auto Curve Slowdown (NSCC). <b>For more information, refer to the Highway “Auto Curve Slowdown (NSCC)” in chapter 6.</b></li> </ul>
Warning Timing	<ul style="list-style-type: none"> <li>To adjust the warning timing of the driver assistance system.</li> <li>• Normal / Late</li> </ul>
Warning Volume	<ul style="list-style-type: none"> <li>To adjust the warning volume of the driver assistance system.</li> <li>• High / Medium / Low</li> </ul>
Driver Attention Warning	<ul style="list-style-type: none"> <li>• Leading Vehicle Departure Alert To activate or deactivate the Leading vehicle departure alert.</li> <li>• Inattentive Driving Warning To activate or deactivate the Driver Attention Warning (DAW). <b>For more information, refer to the “Driver Attention Warning (DAW)” in chapter 6.</b></li> </ul>
Forward safety	<ul style="list-style-type: none"> <li>To adjust the Forward Collision-Avoidance Assist function.</li> <li>• Active Assist</li> <li>• Warning only</li> <li>• Off</li> <li><b>For more information, refer to the “Forward Collision-Avoidance Assist (FCA)” in chapter 6.</b></li> </ul>
Lane Safety	<ul style="list-style-type: none"> <li>To adjust Lane Keeping Assist system function.</li> <li>• Lane Keeping Assist</li> <li>• Lane Departure Warning</li> <li>• Off</li> <li><b>For more information, refer to the “Lane Keeping Assist (LKA)” in chapter 6.</b></li> </ul>
Blind-Spot Safety	<ul style="list-style-type: none"> <li>• Blind-Spot View To activate or deactivate the Blind-Spot View.</li> <li>• Active assist</li> <li>• Warning only</li> <li>• Off</li> <li><b>For more information, refer to “Blind-Spot Collision-Avoidance Assist (BCA)” in chapter 6.</b></li> </ul>
Parking Safety	<ul style="list-style-type: none"> <li>• Parking Distance Warning Auto ON</li> <li>• Rear Cross-Traffic Safety To Activate or deactivate the Rear Cross-Traffic Collision-Avoidance Assist function.</li> <li>• Active Assist</li> <li>• Warning only</li> <li>• Off</li> <li><b>For more information, refer to “Rear Cross-Traffic Collision-Avoidance Assist (RCCA) system” in chapter 6.</b></li> </ul>

### 3. Door

Items	Explanation
Auto Lock	<ul style="list-style-type: none"> <li>• Disable : The auto door lock operation will be deactivated.</li> <li>• Enable on Speed: All doors will be automatically locked when the vehicle speed exceeds 9 mph (15 km/h).</li> <li>• Enable on Shift: All doors will be automatically locked if the automatic transmission shift button is pressed from the P (Park) position to the R (Reverse), N (Neutral), or D (Drive) position.</li> </ul>
Auto Unlock	<ul style="list-style-type: none"> <li>• Disable : The auto door unlock operation will be canceled.</li> <li>• On key out/Vehicle Off : All doors will be automatically unlocked when the ignition key is removed from the ignition switch or the Engine Start/Stop button is set to the OFF position.</li> <li>• On Shift to P: All doors will be automatically unlocked if the automatic transmission shift button is pressed to P (Park) position.</li> </ul>
Two Press Unlock	<ul style="list-style-type: none"> <li>• Off: The two press unlock function will be deactivated. Therefore, all doors will unlock if the door unlock button is pressed.</li> <li>• On: Only the driver's door will unlock if the door unlock button is pressed. When the door unlock button is pressed again within 4 seconds, the remaining doors will unlock.</li> </ul>
Horn Feedback	To activate or deactivate the horn feedback. If the horn feedback is activated, after locking the door by pressing the lock button on the remote key, and pressing it again within 4 seconds, the horn feedback sound will operate once to indicate that all doors are locked (if equipped with remote key).
Smart Trunk	To activate or deactivate the smart trunk. <b>For more information, refer to “Smart trunk” in chapter 5.</b>

### 4. Lights

Items	Explanation
One Touch Turn Signal	<ul style="list-style-type: none"> <li>• Off: The one touch turn signal function will be deactivated.</li> <li>• 3, 5, 7 Flashes: The turn signal indicator will blink 3, 5, or 7 times when the turn signal lever is moved slightly.</li> </ul> <b>For more information, refer to “Lighting” in chapter 5.</b>
Ambient Light Brightness	To adjust the brightness of the ambient light.
Ambient Light Color	To select the ambient light color.
Headlight Delay	<ul style="list-style-type: none"> <li>• To activate or deactivate the headlamp delay function.</li> </ul> <b>For more information, refer to “Lighting” in chapter 5.</b>
High Beam Assist	<ul style="list-style-type: none"> <li>• To activate or deactivate the High Beam Assist (HBA) function.</li> </ul> <b>For more information, refer to “High Beam Assist (HBA)” in chapter 5.</b>

## 5. Sound

Items	Explanation
Cluster Voice Guidance Volume	To adjust the cluster voice guidance volume.
Welcome sound	To activate or deactivate the welcome sound.

## 6. Convenience

Items	Explanation
Seat Easy Access	<ul style="list-style-type: none"> <li>• Off: The seat easy access function is deactivated.</li> <li>• Normal/Extended: When you turn off the engine, the driver's seat will automatically move rearward short (Normal) or long (Extended) for you to enter or exit the vehicle more comfortably.</li> </ul> <b>For more information, refer to “Driver Position Memory System” in chapter 5.</b>
Rear Occupant Alert	To activate or deactivate the rear occupant alert.
Welcome Light	<ul style="list-style-type: none"> <li>• On driver approach: The welcome light turns on automatically when the vehicle is approached with the smart key.</li> </ul> <b>For more information, refer to “Welcome System” in chapter 5.</b>
Wireless Charging System	To activate or deactivate the wireless charging system in the front seat. <b>For more information, refer to “Wireless cellular phone charging system” in chapter 5.</b>
Wiper/Lights Display	To activate or deactivate the Wiper/ Light mode. When activated, the LCD display shows the selected Wiper/Light mode whenever you changed the mode.
Gear Position Pop-up	To activate or deactivate the gear position pop-up. When activated, the gear position will be displayed on the LCD display.
Vehicle Auto-Shut Off	<p>The feature is to turn off the vehicle automatically after a certain amount of time (30 or 60 mins), to prevent CO toxication when the vehicle is on and parked in a garage for a long time.</p> <p>Select the time to delay automatic shut off when the vehicle is parked with the engine on.</p>



7. Service interval

Items	Explanation
Enable Service Interval	To activate or deactivate the service interval function.

 **Information**

To use the service interval menu, consult an authorized HYUNDAI dealer.

If the service interval is activated and the time and distance is adjusted, messages are displayed in the following situations each time the vehicle is turned on.

- Service in : Displayed to inform the driver the remaining mileage and days to service.
- Service required : Displayed when the mileage and days to service has been reached or passed.

 **Information**

If any of the following conditions occur, the mileage and number of days to service may be incorrect.

- **The battery cable is disconnected**
- **The fuse switch is turned off.**
- **The battery is discharged.**

## 8. Other

Items	Explanation
Fuel Econ. Reset	<ul style="list-style-type: none"> <li>• Off: The average fuel economy will not reset automatically whenever refueling.</li> <li>• After ignition: When the engine has been OFF for 4 hours or longer the average fuel economy will reset automatically.</li> <li>• After refueling: The average fuel economy will reset automatically after adding 1.6 gallons (6 liters) of fuel or more and after driving speed exceeds 1 mph (1 km/h).</li> </ul> <p><b>For more information, refer to “Trip Computer” in this chapter.</b></p>
Fuel Econ. Unit	To select the fuel economy unit.
Temperature Unit	To select the temperature unit. (°C, °F)
Tire Pressure Unit	To select the tire pressure unit. (psi, kPa, bar)

## 9. Language (if equipped)

Items	Explanation
Language	Choose the language. You can choose the language in infotainment system. (if equipped)

## 10. Reset

Items	Explanation
Reset	You can reset the menus in the User Settings Mode. All menus in the User Settings Mode are reset to factory settings, except language and service interval.

# 5. Convenient Features

Accessing Your Vehicle.....	5-4
Remote Key .....	5-4
Smart Key .....	5-7
Immobilizer System .....	5-14
Hyundai Digital Key.....	5-15
Door Locks.....	5-31
Operating Door Locks from Outside the Vehicle .....	5-31
Operating Door Locks from Inside the Vehicle .....	5-32
Automatic Door Lock and Unlock Features.....	5-34
Child-Protector Rear Door Locks .....	5-35
Rear Occupant Alert (ROA) System.....	5-36
Theft-Alarm System.....	5-38
Driver Position Memory System .....	5-39
Storing Positions into Memory .....	5-39
Recalling Positions from Memory .....	5-40
Resetting the Driver's Seat Memory System.....	5-40
Easy Access Function.....	5-41
Steering Wheel.....	5-42
Electric Power Steering (EPS).....	5-42
Tilt Steering / Telescope Steering .....	5-43
Heated Steering Wheel.....	5-44
Horn.....	5-45
Mirrors .....	5-46
Inside Rearview Mirror .....	5-46
Side View Mirrors .....	5-53
Reverse Parking Aid Function.....	5-55
Windows.....	5-56
Power Windows.....	5-57
Panoramic Sunroof .....	5-60
Sunshade .....	5-61
Sliding the Sunroof.....	5-61
Tilting the Sunroof .....	5-61
Closing the Sunroof .....	5-62
Resetting the Sunroof .....	5-63
Sunroof Open Warning .....	5-63
Exterior Features.....	5-64
Hood.....	5-64
Trunk.....	5-65
Emergency Trunk Safety Release.....	5-66
Fuel Filler Door .....	5-70

Head Up Display (HUD) .....	5-72
Lighting.....	5-74
Exterior Lights .....	5-74
Interior Lights .....	5-80
Welcome System .....	5-83
Wipers and Washers .....	5-84
Windshield Wipers .....	5-84
Windshield Washers.....	5-85
Rear View Monitor (RVM) .....	5-86
Rear View Monitor with Parking Guidance.....	5-86
Rear View Monitor - Top View .....	5-86
Surround View Monitor (SVM) .....	5-88
Reverse Parking Collision-Avoidance Assist .....	5-89
System Setting and Operation .....	5-89
Warning and System Control.....	5-90
Detecting Sensor.....	5-92
System Malfunction .....	5-93
Limitations of the System.....	5-93
Reverse Parking Distance Warning (PDW) .....	5-95
Operation of Reverse Parking Distance Warning System.....	5-95
To Turn Off Reverse Parking Distance Warning System .....	5-97
Non-Operational Conditions of Reverse Parking Distance Warning System.....	5-97
Reverse Parking Distance Warning System Precautions.....	5-98
Forward/Reverse Parking Distance Warning (PDW) .....	5-99
Operation of Forward/Reverse Parking Distance Warning System .....	5-100
Non-Operational Conditions of Forward/Reverse Parking Distance Warning System.....	5-102
Forward/Reverse Parking Distance Warning System Precautions .....	5-103
Remote Smart Parking Assist (RSPA) .....	5-104
Operating Condition .....	5-105
How Remote Smart Parking Assist System Works.....	5-108
Additional Instructions.....	5-113
Display Operation Status .....	5-114
How the Remote Moving Forward/Backward System Works.....	5-115
Manual Climate Control System .....	5-118
Heating and Air Conditioning.....	5-119
System Operation.....	5-124
System Maintenance .....	5-125

# 5. Convenient Features

Automatic Climate Control System .....	5-127
Automatic Heating and Air Conditioning .....	5-128
Manual Temperature Control Mode.....	5-129
System Operation.....	5-135
System Maintenance .....	5-136
Windshield Defrosting and Defogging .....	5-138
Manual Climate Control System.....	5-138
Automatic Climate Control System.....	5-139
Defogging Logic .....	5-140
Auto Defogging System (Only for Automatic Climate Control System).....	5-141
Defroster .....	5-142
Climate Control Additional Features .....	5-143
Sunroof Inside Air Recirculation .....	5-143
Automatic Ventilation .....	5-143
Storage Compartment.....	5-144
Center Console Storage.....	5-144
Glove Box.....	5-144
Interior Features.....	5-145
Cup Holder.....	5-145
Sunvisor .....	5-146
Power Outlet.....	5-146
USB Charger .....	5-147
Wireless Cellular Phone Charging System .....	5-148
Clock .....	5-150
Clothes Hanger.....	5-150
Floor Mat Anchor(S) .....	5-151
Infotainment System .....	5-152
USB And Ipad® Port.....	5-152
Antenna.....	5-152
Steering Wheel Audio Control.....	5-153
Bluetooth® Wireless Technology Hands-Free .....	5-154
Audio (Display Audio) / Video / Navigation System (AVN) .....	5-154

## ACCESSING YOUR VEHICLE

### Remote Key (if equipped)



Your HYUNDAI uses a remote key, which you can use to lock or unlock the driver and passenger doors or the rear trunk.

- (1) Door Lock
- (2) Door Unlock
- (3) Trunk Unlock
- (4) Panic

#### **Locking your vehicle**

To lock your vehicle:

1. Make sure all doors, the engine hood and the trunk are closed.
2. Press the Door Lock button (1) on the remote key to lock all doors.
3. If the Door Lock button (1) is pressed once more within four seconds, the horn will beep once and the hazard warning lights will blink.
4. Make sure the doors are locked by checking the position of the door lock button inside the vehicle.



#### **WARNING**

**Do not leave the keys in your vehicle with unsupervised children. Unattended children could place the key in the ignition switch and may operate power windows or other controls, or even make the vehicle move, which could result in serious injury or death.**

#### **Unlocking your vehicle**

To unlock your vehicle:

1. Press the Door Unlock button (2) on the remote key.
2. The driver's door will unlock. The hazard warning lights will blink two times.

- Two press unlock setting:

If you press the Door Unlock button on the remote key again within four seconds, then all the doors will unlock.

Two press unlock setting can be changed according to owner's preference in the cluster User Settings mode or with the remote key.

- User settings mode method:

Select or deselect the 'Two Press Unlock' feature in the User Settings mode on the cluster LCD display (User Settings → Door → Two Press Unlock).



#### **Information**

**After unlocking the doors, the doors will automatically relock after 30 seconds unless a door is opened.**

### Trunk unlocking

To unlock the trunk :

1. Press and hold the Trunk Unlock button (3) on the remote key for more than one second.
2. The hazard warning lights will blink two times and the trunk will be unlocked.
3. Once the trunk is opened and then closed, the trunk will automatically re-lock after 30 seconds.



### Information

The word “**HOLD**” is written on the button to inform you that you must press and hold the button for more than one second.

### Panic button (4)

Press and hold the Panic button (4) for more than one second. The horn sounds and hazard warning lights flash for about 30 seconds.

To cancel the panic mode, press any button on the remote key.

### Start-up

For information, refer to the “Key Ignition Switch” section in chapter 6.

### NOTICE

To prevent damaging the remote key:

- **Keep the remote key away from water or any liquid and fire. Internal circuits may malfunction if the inside of the remote key gets damp (from liquids or moisture) or if it is heated. This can exclude the remote key from being covered under warranty.**
- **Avoid dropping or throwing the remote key.**
- **Protect the remote key from extreme temperatures.**

### Mechanical key



If the remote key does not operate normally, you can lock or unlock the driver's door by using the mechanical key.

To unfold the mechanical key, press the release button on the remote.

To return the key to its stored position, press the release button and fold the key back into the remote.

### Remote key precautions

The remote key will not work if any of the following occur:

- The key is in the ignition switch.
- You exceed the operating distance limit (about 90 feet [30 m]).
- The remote key battery is weak.
- Other vehicles or objects may be blocking the signal.
- The weather is extremely cold.
- The remote key is close to a radio transmitter such as a radio station or an airport which can interfere with normal operation of the remote key.

If the remote key does not work correctly, open and close the door with the mechanical key. If you have a problem with the remote key contact an authorized HYUNDAI dealer.

If the remote key is in close proximity to your mobile phone, the signal could be blocked by your mobile phone's normal operational signals. This is specifically relevant when the phone is active such as making and receiving calls, text messaging, and/or sending/receiving emails.

When possible, avoid placing the remote key and your mobile phone in the same location such as a pants or jacket pocket in order to avoid interference between the two devices.

### **i** Information

This device complies with Part 15 of the FCC rules.

Operation is subject to the following three conditions:

1. This device may not cause harmful interference.
2. This device must accept any interference received, including interference that may cause undesired operation.
3. Changes or modifications not expressly approved by the party responsible for compliance could void the user's authority to operate the device.

### **NOTICE**

Keep the remote key away from electromagnetic materials that block electromagnetic waves to the key surface.

### **Battery replacement**



If the remote key is not working properly, try replacing the battery with a new one.

Battery Type: CR2032

To replace the battery:

1. Insert a slim tool into the slot and gently pry open the cover.
2. Using a screw driver, remove the battery cover.
3. Remove the old battery and insert the new battery. Make sure the battery position is correct.
4. Reinstall the battery cover and key cover in the reverse order of removal.

If you suspect your remote key might have sustained some damage, or you feel your remote key is not working correctly contact an authorized HYUNDAI dealer.

### **i** Information



An inappropriately disposed battery can be harmful to the environment and human health. Dispose of the battery according to your local law(s) or regulation.



## Smart Key (if equipped)

### ■ Type A



ODN8059006

### ■ Type B



ODN8059007

Your HYUNDAI uses a smart key, which you can use to lock or unlock a door (and trunk) and even start the engine even just carrying the key.

- (1) Door Lock
- (2) Door Unlock
- (3) Trunk Open
- (4) Panic
- (5) Remote Smart Parking Assist (rearward)
- (6) Remote Smart Parking Assist (forward)
- (7) Remote Start

## Locking your vehicle (Button type)

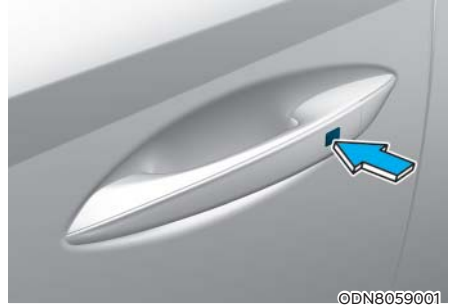

©DN8059001

1. Close all of the doors, the hood and the trunk.
2. Make sure you have the smart key in your possession and press either the button on the door handle or the Door Lock button (1) on the smart key.
3. The doors, the hood and the trunk are locked. The chime will sound once and the hazard warning lights will blink.
  - The door handle button will only operate when the smart key is within 28~40 inches (0.7~1 m) from the outside door handle.
  - Make sure the doors are locked by pulling the door handle.

### **Locking your vehicle (Touch sensor type)**



1. Close all of the doors, the hood and the trunk.
2. Make sure you have the smart key in your possession and touch either the touch sensor on the door handle (the engraved part) or press the Door Lock button (1) on the smart key.
3. The doors, hood and trunk are locked. The chime will sound once and the hazard warning lights will blink.
  - The door handle button will only operate when the smart key is within 28~40 inches (0.7~1 m) from the outside door handle.
  - Make sure the doors are locked by pulling the door handle.
  - If you locked the door with the touch sensor on the door handle, the doors cannot be unlocked with the sensor within 3 seconds.

Even though you press the outside door handle button or touch the touch sensor, the doors will not be locked and the chime will sound for 3 seconds if any of the following occurs:

- The Smart Key is in the vehicle
- The Engine Start/Stop button is in ACC or ON position.
- Any door except the trunk is opened.

### **CAUTION**

When you leave your vehicle with the smart key, make sure to press the button on the front door handle or touch the touch sensor on the front door handle to lock the doors after close all of the doors, the hood and the trunk. If you do not press the button or touch the touch sensor firmly, the doors might not be locked so please use caution.

### **WARNING**

**Do not leave the Smart Key in your vehicle with unsupervised children. Unattended children could press the Engine Start/ Stop button and may operate power windows or other controls, or even make the vehicle move, which could result in serious injury or death.**

### Unlocking your vehicle (When the Two Press Unlock feature is off)

#### ■ Button type

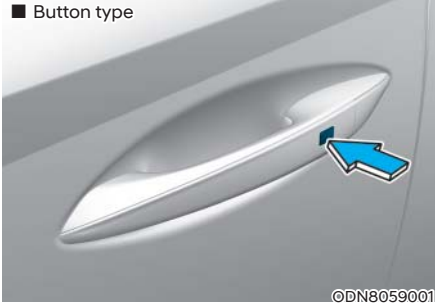

#### ■ Touch sensor type

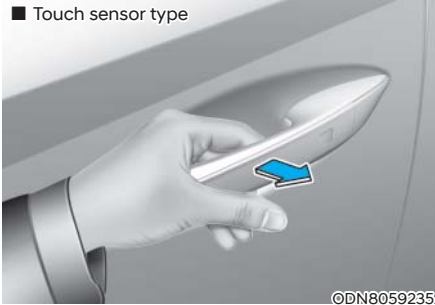

1. Make sure you have the smart key in your possession.
2. Press the Door Unlock button (2) on the smart key, press the button on the front door handle or touch the door unlock sensor inside of the front door handle to unlock the doors.
3. All of the doors will unlock. When the doors unlock, the hazard warning lights will blink two times and the chime will sound.
  - The door handle button will only operate when the smart key is within 28~40 inches (0.7~1 m) from the outside door handle.
  - If you do not open the door after unlocking within 30 seconds, it will return to the lock mode.
  - If you unlocked the door with the door handle, the doors cannot be locked with the sensor within 2 seconds.

### Unlocking your vehicle (When the Two Press Unlock feature is on)

1. Make sure you have the smart key in your possession.
2. Press the Door Unlock button (2) on the smart key, press the button on the front door handle or touch the door unlock sensor inside of the front door handle to unlock the doors.
3. The driver's door will unlock.
4. If you press the button on the front door handle or touch the door unlock sensor inside of the front door handle to unlock the doors within 4 seconds, all of the doors unlock. When the doors unlock, the hazard warning lights will blink two times and the chime will sound.
  - The door handle button will only operate when the smart key is within 28~40 inches (0.7~1 m) from the outside door handle.
  - If you do not open the door after unlocking within 30 seconds, it will return to the lock mode.
  - The factory default setting is in off mode so you should set in the User's Settings mode.
  - If you unlocked the door with the door handle, the doors cannot be unlocked with the sensor within 2 seconds.

### Two Press Unlock Feature

The priority for unlocking the driver door only, or unlocking all the doors with one press may be adjusted in the User Settings mode in the cluster LCD display.

The Two Press Unlock feature, when enabled, will require the user to press the door unlock button once for driver door only and twice for unlocking all the doors.

Select or Deselect the Two Press Unlock feature in the User Settings mode in the cluster LCD display. The option can be found under the following menu:

User Settings → Door → Two Press Unlock

The Two Press Unlock feature can also be enabled or disabled by pressing the door lock and unlock buttons simultaneously on the Key FOB:

Press and hold both the Door Lock button and the Door Unlock button simultaneously until the hazard warning lights blink.

This will enable or disable the Two Press Unlock feature. Repeat this procedure to enable/disable the mode again.



### Information

**If you press the front passenger outside door handle with the smart key in your possession, all the doors will unlock.**

### Smart Key Reminder

If the smart key is in the vehicle and any door is opened, the doors will not lock even though the lock button of the central door lock switch is pressed.

### Trunk opening

To open:

1. Make sure you have the smart key in your possession and either press inside the trunk emblem or press the Trunk Unlock button (3) on the smart key for more than one second.
2. Once the trunk is opened, the hazard warning lights will blink two times.
  - The trunk handle button will only operate when the smart key is within 28~40 inches (0.7 ~1 m) from the trunk handle.
  - Once the trunk is opened and then closed, the trunk will automatically re-lock and the hazard warning will blink once.
  - If you leave the smart key and close the trunk, the chime will sound for 5 seconds. In the case, the trunk cannot be locked so open it with the trunk handle button.

### Panic button

Press and hold the Panic button (4) for more than one second. The horn sounds and hazard warning lights blink for about 30 seconds. To cancel the panic mode, press any button on the Smart Key.

### **Start-up**

You can start the vehicle without inserting the key.

**For information, refer to the “Engine Start/Stop Button” section in chapter 6.**

### **NOTICE**

**To prevent damaging the smart key:**

- **Keep the smart key in a cool, dry place to avoid damage or malfunction. Exposure to moisture or high temperature may cause the internal circuit of the smart key to malfunction which may not be covered under warranty.**
- **Avoid dropping or throwing the smart key.**
- **Protect the smart key from extreme temperatures.**

### **Remote start**

You can start the vehicle using the Remote Start button (7) of the smart key.

To start the vehicle remotely:

- Lock the doors by pressing the door lock button within 32 feet (10 m) distance from the vehicle.
- Press the remote start button for over 2 seconds within 4 seconds after locking the doors and the hazard warning will blink.

To turn off the remote start function, press the remote start button once. In case of the manual operation, the climate control system will be maintained even when the engine is turned OFF. However, the automatic operation is set to 72°F (22°C).

### **Remote smart parking assist (RSPA) (if equipped)**

The Remote smart parking assist (RSPA) system helps the drivers park their vehicle by using sensors to measure parking spaces and control the steering wheel, gear shift and vehicle speed to semi-automatically park the vehicle. With the smart key, the driver can move the vehicle forward or backward using the rearward /forward buttons (5, 6) on the smart key.

**For information, refer to “Remote smart parking assist (RSPA)” in this chapter.**

### **Mechanical key**

If the Smart Key does not operate normally, you can lock or unlock the driver's door by using the mechanical key.



To remove the mechanical key from the smart key FOB, slide the release lever in the direction of the arrow (1) and then pull the mechanical key (2) outward.

To unlock the vehicle using the mechanical key, insert the mechanical key into the key hole in the driver door.

To reinstall the mechanical key into the FOB, insert the key in the top of the key FOB and push inward until a click sound is heard.

### **Loss of a smart key**

A maximum of two Smart Keys can be registered to a single vehicle. If you happen to lose your smart key, you should immediately take the vehicle and remaining keys to your authorized HYUNDAI dealer or tow the vehicle, if necessary.

### **Smart key precautions**

The smart key may not work if any of the following occur:

- The smart key is close to a radio transmitter such as a radio station or an airport which can interfere with normal operation of the transmitter.
- The smart key is near a mobile two way radio system or a cellular phone.

- Another vehicle's smart key is being operated close to your vehicle.

If the smart key does not work correctly, open and close the door with the mechanical key. If you have a problem with the smart key, contact an authorized HYUNDAI dealer.

If the smart key is in close proximity to your mobile phone, the signal could be blocked by your mobile phone's normal operational signals. This is specifically relevant when the phone is active such as making and receiving calls, text messaging, and/or sending/receiving emails. When possible, avoid keeping the smart key and your mobile phone in the same location such as a pants or jacket pocket in order to avoid interference between the two devices.

### **i Information**

**This device complies with Part 15 of the FCC rules.**

**Operation is subject to the following three conditions:**

- 1. This device may not cause harmful interference, and**
- 2. This device must accept any interference received, including interference that may cause undesired operation.**
- 3. Changes or modifications not expressly approved by the party responsible for compliance could void the user's authority to operate the device.**

### **NOTICE**

**Keep the smart key away from electromagnetic materials that blocks electromagnetic waves to the key surface.**

### **NOTICE**

**Always have the smart key with you when leaving the vehicle. If the smart key is left near the vehicle, the vehicle battery may be discharged.**

## Battery replacement



OFE048009



ODN8059266

If the Smart Key is not working properly, try replacing the battery with a new one.

Battery Type: CR2032

To replace the battery:

1. Remove the mechanical key.
2. Use a slim tool to pry open the rear cover of the smart key.
3. Remove the old battery and insert the new battery. Make sure the battery position is correct.
4. Reinstall the rear cover of the smart key.

If you suspect your smart key might have sustained some damage, or you feel your smart key is not working correctly, contact an authorized HYUNDAI dealer.

## Information



An inappropriately disposed battery can be harmful to the environment and human health. Dispose of the battery according to your local law(s) or regulation.

### Immobilizer System

The immobilizer system protects your vehicle from theft. If an improperly coded key (or other device) is used, the engine's fuel system is disabled.

When the ignition switch is placed in the ON position, the immobilizer system indicator should come on briefly, then go off. If the indicator starts to blink, the system does not recognize the coding of the key.

Turn the ignition switch to the LOCK/OFF position, then turn the ignition switch to the ON position again.

In some circumstances, the vehicle may not recognize your smart key if another smart key device is nearby or a metal object such as a key chain is causing interference with the smart key.

If this occurs, your vehicle may not start. Remove any metal objects or additional keys near the smart key before attempting to start the vehicle again.

If the system repeatedly does not recognize the coding of the key, it is recommended that you contact your HYUNDAI dealer.

Do not attempt to alter this system or add other devices to it. Electrical problems could result that may make your vehicle inoperable.



### WARNING

**In order to prevent theft of your vehicle, do not leave spare keys anywhere in your vehicle. Your immobilizer password is a customer unique password and should be kept confidential.**

### NOTICE

**The transponder in your key is an important part of the immobilizer system. It is designed to give years of trouble-free service, however you should avoid exposure to moisture, static electricity and rough handling. Immobilizer system malfunction could occur.**



### Information

**This device complies with Part 15 of the FCC rules.**

**Operation is subject to the following three conditions:**

- 1. This device may not cause harmful interference.**
- 2. This device must accept any interference received, including interference that may cause undesired operation.**
- 3. Changes or modifications not expressly approved by the party responsible for compliance could void the user's authority to operate the device**



## Hyundai Digital Key Digital Key Application

To use Hyundai Digital Key mobile app, you should install Hyundai digital key application. Search 'Hyundai digital key' in the Google Play Store and download the app. Please refer to the detailed manual of the digital key app. The option can be found under the following app menu:

### Menu → Application Info → Tutorial

Please note the manual before using the app.

- \* This service is only available for Android smartphones. Please confirm supported/compatible devices on our website.



## WARNING

### For used vehicle

If any of the digital key (smartphone key or card key) is already registered when you press ON button after unlocking the doors, the message 'Digital key(s) active' appears on the instrument cluster once. If you buy a used vehicle, you should confirm the message and delete the registered smartphone key and card key. In addition, please notify the Hyundai Customer Care Center.

If the card key does not work properly, please delete the card key and register the smartphone key and re-register the card key.

### For vehicle maintenance

If you need to have your Digital Key System repaired or replaced please ensure you Smartphone Key is still active. You may have to pair your phone again.

In the case, re-initialize your Digital Keys using the Hyundai Digital Key mobile app.

## Digital key (smartphone) NFC function

You can use the Digital Key NFC (Near Field Communication) function after turn your smartphone NFC settings on. And you should unlock & turn on smartphone screen to use it.

- \* To change the NFC mode of the smartphone, please refer to the smartphone manual or contact to the customer service center of smartphone manufacturers.

### Digital key (smartphone)

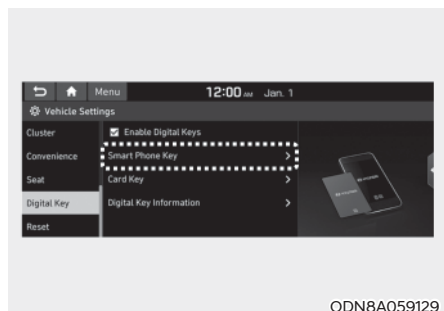

ODN8A059129



ODN8A059240

#### Hyundai Digital Key (Smartphone) Pairing

1. Turn the vehicle on with the Smart key and make sure to keep the smart key inside the vehicle during digital key registration.
2. Register your Digital key from the vehicle user setting menu as follows.
  - \* With Navigation screen :  
From the infotainment screen menu, go to [Setup] - [Vehicle] - [Digital Key] - [Smart Phone Key] then select the [Save] from submenu.
  - \* Without navigation screen :  
From cluster menu, go to [Digital Key] - [Smart Phone Key] and select [Save].

### **i** Information

The [Save] button will be disabled if the digital key (Smartphone key) is already saved.

Please refer to “Digital Key Delete” in this manual and follow the digital key delete procedure in your car before Digital key save.

Please refer to the ‘Tutorial’ on your Digital key app and delete the previous saved key in your smartphone before save.

3. Select the vehicle to save on your Digital key application and activate the save mode.
- \* Save mode is available only on the vehicle owner’s Digital key application.
4. Place the backside of smartphone onto the wireless charging pad (in-vehicle authentication pad). The saving process will begin automatically.
5. Once the digital key save is complete, a message will be shown on the infotainment screen or cluster.
6. Remove the smartphone from the pad and complete the saving process.



©DN8059267

[A] : Wireless Charging Pad (In-vehicle Authentication Pad)

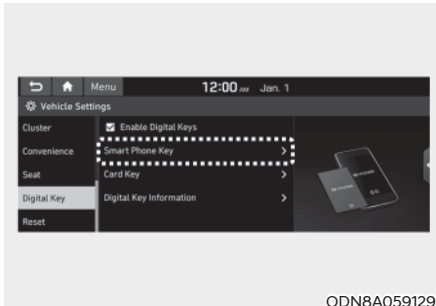

ODN8A059129



ODN8A059130

### Hyundai Digital Key (Smartphone Key) Deletion

1. Turn the vehicle on with the Smart key and make sure to keep the smart key inside the vehicle during delete process.
2. Delete your Digital key from the vehicle user setting menu as follows.
  - \* With Navigation screen :  
From the infotainment screen menu, go to [Setup] - [Vehicle] - [Digital Key] - [Smart Phone Key] then select the [Delete] from submenu.
  - \* Without navigation screen :  
From cluster menu, go to [Digital Key] - [Smart Phone Key] and select [Delete].

### **i** Information

The [Delete] button will be disabled if there is no digital key (Smartphone key) saved.

3. Once the digital key delete is complete, a message will be shown on the infotainment screen or cluster.
4. Go to [Initialize Digital Key] menu on the digital key application and select the vehicle to delete the digital key information.
  - Open the Hyundai Digital Key app → Menu → Initialize Digital Key
  - \* If the saved digital key information in your car is deleted due to vehicle maintenance, the digital key in your smartphone should be deleted as well.
  - \* For more information, please refer to the 'Tutorial' on your Digital key app.



### CAUTION

- If the smartphone is removed from the interior authentication pad during enrollment, the saving process will be cancelled.
- If the infotainment or instrument cluster screen is changed during enrollment, the saving process will be cancelled.
- If the vehicle is turned off during enrollment, the saving process will be cancelled.
- If the gear is shifted, the saving process will be cancelled.
- If you try to save the smartphone which is not logged in with the vehicle owner's ID or if you try to save the Card key, the saving process will not begin.
- If the NFC setting on your smartphone is off, the saving process will not begin.
- If the smartphone screen is changed to off or locked status, the saving process will be cancelled.
- If there is no Smart key during the save process, the saving process will not begin.

### Set up main vehicle

You can manage multiple digital keys from the Digital key app. From the list of digital keys you own, select the vehicle you want to make your priority vehicle.

**For more information, please refer to the 'Tutorial' on your Digital key app.**

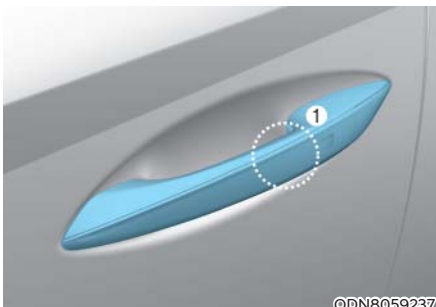

©DN8059237

[1] : Door handle authentication pad

### NFC door lock/unlock

You should contact your smartphone's NFC antenna (backside of phone) to door handle authentication pad (1) marked position near by the lock button) of driver's (or front passenger's) outside door for 2 seconds to lock or unlock the doors. If the Two Press Unlock feature is applied (press twice for unlocking), driver's seat door will be unlocked by contacting the digital key (smartphone key). In this state, if you contact one more time within 4 seconds, all the doors unlock. Please make sure the doors are locked. If you do not open any of the doors after unlocking, it automatically re-lock after 30 seconds.

Note that you cannot lock your vehicle when you contact NFC antenna in the smartphone to the door handle pad if any of the following occurs:

- The Proximity / Smart Key is in the vehicle.
- The POWER button is in ACC or ON position.
- Any of the doors, hood and trunk is opened.

If the smartphone digital key does not work, please remove the smartphone more than 4 inches (0.1 m) from the door handle authentication pad and try it again.

After unlock the door or start up the vehicle with digital key, even though the driver tries to lock the doors by the central door lock switch, the door lock will be once locked and immediately released at the moment of door closed.

### Start-up with Digital Key

1. After placing your registered smartphone onto the interior authentication pad (wireless charger), step on the brake and press the Engine Start/Stop button.
2. After start-up, the digital key data will be automatically updated. It takes 5 to 20 seconds, after that, the smartphone can be go into the wireless charging mode automatically. Once the engine started, you can remove the smartphone from the pad.



[A] : Wireless Charging Pad (In-vehicle Authentication Pad)

### **i** Information

**After reconnecting the vehicle battery power supply or charging the battery, it may take time to operate due to remote renewal of security information. When you lock or unlock the door with NFC, please contact and hold your smartphone on the door handle until it works.**

**The solution allows for offline mode usage when the mobile data connection of the smartphone is weak. When you are in the place where the mobile data connection of your smartphone is available and place your smartphone on the interior authentication pad (wireless charger) and start up your vehicle or contact the digital key on the door handle to lock or unlock the door, the remote renewal of security information starts automatically. Even though the engine is turned on, please wait until the remote renewal process is completed and wireless charger is converted to charging mode.**



### CAUTION

**The engine can be turned on if the registered smartphone or card key is placed on the interior authentication pad (wireless charger). Do not leave unsupervised children or people who are not aware of the system since it can result in serious injury or death. Always have the registered digital key (smartphone) or card key with you to prevent vehicle theft when leaving the vehicle.**

**For more information, refer to the Engine Start/Stop button in chapter 6.**

### Remote Control with Digital Key

To use the remote control function with your android smartphone, Bluetooth must be turned on.

#### *Remote Control Connection with Digital Key*

1. Open Hyundai digital key application on the smartphone. Select the vehicle to activate the remote control function as a main vehicle.
2. Approach with the activated smartphone app to your vehicle and you can check whether the connection is available. If it enables your smartphone to connect, connect with your vehicle by pressing the connect button. The remote control function is activated after completing the process.

#### *Remote Control Operation with Digital Key*

You can execute the remote control operation including door lock/unlock, panic on/off, remote start / remote stop and trunk opening. The icon for each function will be highlighted and alarm/vibration also provided when the operation is performed.

Note that you cannot lock your vehicle using the Hyundai digital key app if any of the following occurs:

- The POWER button is in ACC or ON position.
- Any doors are open.

When the smartphone and the vehicle are connected by the Bluetooth function but the remote control command cannot be received over 5 minutes, the remote control connection is cancelled automatically.



### CAUTION

- If metallic window tint was applied to your vehicle, it may cause bad Bluetooth connection or performance degradation of the digital key.
- If multiple users operate the remote control function simultaneously, the connection between the digital key and the vehicle might result in failed commands. Please connect and operate the remote control function only the necessary user.
- When using the remote control operation, the driver (the remote control user) should leave the vehicle after confirming the door lock (the chime sounds once and the hazard warning lights blink).
- The remote functions of the Digital Key app enables the vehicle to be controlled from a set distance. If the digital key or the vehicle goes beyond the operable distance, the remote control function might be disconnected or cancelled.
- If the digital key (smartphone) is connected with the vehicle for the remote control, the driver with the key goes far away from the vehicle, the function might not work.
- If the remote control operation is executed where the mobile connection is weak, Bluetooth connection is poor due to several Bluetooth devices or there is an object such as metal or concrete, it might be delayed or the operable distance might decrease. You should not cover the smartphone with your hand or place other devices which can cause frequency interference. It may result in poor performance.
- If the remote control function is not available, please use NFC function to lock or unlock the doors.

### *Remote Start with Digital Key*

- When the shift button of your vehicle is in P (Park) and all of the doors including trunk and hood is locked and the vehicle is off, press the Door Lock button in the Hyundai Digital Key app then press the Remote Start button within 4 seconds.  
You can confirm the engine is on if the hazard warning lights blinks two times and the chime sounds.
- If you want to turn off the engine, press Remote Engine Stop. Air Conditioner / Heating system maintains the same status as when you last used the vehicle.
- Unless you put the registered digital key (smartphone) on the interior authentication pad (wireless charger) when the remote start function is on, the engine will turn off.
- If you do not get on the vehicle within 10 minutes after the engine turns on, the vehicle will turn off.

**For more information, refer to the Engine Start/Stop button in chapter 6.**

### *Vehicle information Display*

The digital key application displays the vehicle information such as driving or door conditions through the communication with the vehicle.

- How to check : Select the vehicle what you want to check and touch the vehicle image, then vehicle information display page will be shown.
- Contents : accumulated odometer, latest fuel economy, driving range, fuel remaining, tire pressure, doors lock/unlock status and last data updated time.
- \* Displayed vehicle date could be differed from the current vehicle condition.
- \* **For more information, please refer to the 'Tutorial' on your Digital key app.**

### **Smartphone change/App deletion**

If you change your smartphone or delete the Hyundai Digital Key App, please refer to the following to set up your Digital Key:

#### *Smartphone Change/ Reset*

If you change or reset the smartphone, the registered digital key in your previous smartphone may not be used. Please refer to following procedure to use the digital key.

1. Install the digital key application and log in.
2. If you are the owner, retry the Digital key save process.
3. If you are the sharer, need to re-share the key from owner.

#### *App delete & reinstall/ Delete App data*

You can re-download the digital key from server in these cases as follow procedure.

1. Reinstall the application and log in.
2. Input the PIN number for user verification.
3. If PIN is correct, digital key data will be re-downloaded to your smartphone and you can use it without any further registration or sharing.

#### *Smartphone operability with Digital Key*

The digital key application may not be available to old type smartphones. Please check the available smartphone models with your dealer. NFC antenna position on the smartphone can be confirmed on each smartphone's manual or contact to customer service center of the smartphone manufacture.



### CAUTION

- Do not leave the registered digital key (smartphone) and card key in your vehicle. Please carry around your keys all the times.
- If you happen to lose your digital key (smartphone) or card key registered as a main user's key, you should immediately delete the key on the vehicle's key menu. For more information, refer to the Digital Key Deletion in this chapter.
- If you registered your digital key (smartphone) or card key in the vehicle, a message appears on the instrument cluster and let you know the key is registered. (Message: Digital key(s) active.)
- If you buy a used vehicle, you should confirm the message and delete the registered smartphone key and card key. In this case, you should carry your smart key.
- If you keep place the NFC card of the digital key on the interior authentication pad (wireless charger) while driving, it may cause a malfunction of the NFC card.
- You should remove your NFC card of the digital key on the interior authentication pad after turning on the engine.
- Hyundai digital key app may not work properly when the NFC or Bluetooth communication between smartphone and car is not good.
- If the remote control operation is executed where the mobile connection is weak, Bluetooth connection is poor due to lots of Bluetooth devices or there is an object such as metal or concrete, it might be delayed or the operable distance might decrease. Especially, you should not cover the smartphone with your hand or place other devices which can cause frequency interference. It may result in poor

performance.

- If the remote control function is not activated, please use NFC function to lock or unlock the doors
- You should be careful not to press the remote control button on the digital key (smartphone) accidentally.
- If the digital key (smartphone) is discharged or defective or you cannot use the digital key since the vehicle battery is discharged, use the inside door lock button to lock all of the doors.



### CAUTION

- Hyundai digital key app on the smartphone and card key may not work if any of the following occurs:
  - Hyundai digital key app on the smartphone is deleted. (Required to reinstall the app)
  - Account log in information of Hyundai digital key app is expired. (Required to re-log in)
  - When you try to log in to another smartphone instead of the registered smartphone with same user account.
  - Smartphone rooting or app hacking is detected.
  - Smartphone battery or the vehicle battery is discharged.
  - Smartphone's screen is off or locked.
  - NFC or Bluetooth is turned off on the smartphone settings.
  - Smartphone's mobile network setting is off or airplane mode is activated.
  - A credit card is overlapped in the back of your smartphone or metal or thick case is used.
  - Use the card key with insert it into the wallet or card holder or overlapping with other cards.



- \* If you change the smartphone number, you should modify the user account information on the HYUNDAI customer web site to use the digital key app.
- \* If the vehicle owner changes the smartphone device, the new smartphone should be registered in the car after deleting the registered digital key (smartphone).
- \* If a sharer changes or reset the smartphone, the key should be re-shared from owner.
- \* Some of the old smartphone may not work properly. Please check the available smartphone models with your dealer.
- \* NFC antenna position on the smartphone can be confirmed on each smartphone's manual or contact to customer service center of the smartphone manufacture.

### Digital key (Card key)

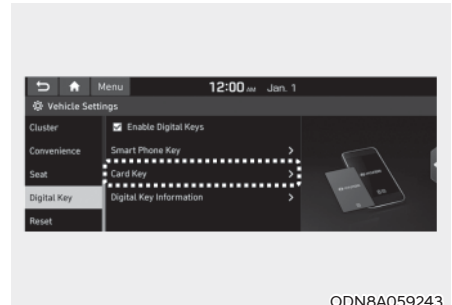

ODN8A059243

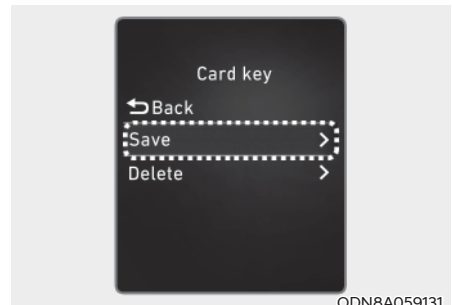

ODN8A059131

### Digital key (Card key) save

1. Install Hyundai digital key app in main user's smartphone and register the digital key (smartphone). Please refer to the registration method of the digital key (smartphone).
  2. Using the [Pair Card Key] menu on the digital key application, you can activate the Card Key registration mode.
- \* NFC authentication : enter the NFC authentication menu and contact the smartphone on the outside door handle.
  - \* Bluetooth authentication : enter the Bluetooth authentication menu and press the [OK] button for activation.  
If you activate the registration mode, you should complete the Card saving process with in 5 minutes.

3. Register the NFC card key on the User's Settings menu after turning on the vehicle.

\* With Navigation screen : From the infotainment screen menu, go to [Setup] - [Vehicle] - [Digital Key] - [Card Key] then select the [Save] from submenu.

\* Without navigation screen : From cluster menu, go to [Digital Key] - [Card Key] and select [Save].

The [Save] button will be disabled if the digital key (Card key) is already saved.

Please refer to "Digital Key Delete" in this manual and follow the digital key delete procedure in your car before Digital key save.

4. Place the NFC card key onto the interior authentication pad (wireless charger). The saving process will begin automatically.

5. If the key is enrolled, the message will be displayed on the infotainment screen or instrument cluster.

- Once the card key registration mode is activated, the process should be completed within 5 minutes. After then, you should reactivate once again for registration.
- For the digital key(card key) saving, the smart key(fob) must be exist inside of vehicle.
- Once a Card key is registered, it cannot be reuse onto another vehicle.

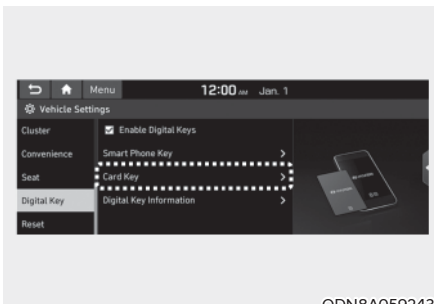

ODN8A059243

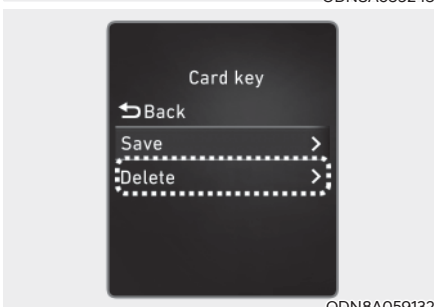

ODN8A059132

### Digital key (Card key) deletion

You should have the smart key to delete the digital key (card key) so please carry around the key.

1. Get on the vehicle with the smart key.
  2. Delete the NFC card key on the User's Settings menu after turning on the engine.
- \* With Navigation screen : From the infotainment screen menu, go to [Setup] - [Vehicle] - [Digital Key] - [Card Key] then select the [Delete] from submenu.
- \* Without navigation screen : From cluster menu, go to [Digital Key] - [Card Key] and select [Delete].

If there is no saved digital key(card key), [Delete] menu will not be activated.

- To delete the saved digital key (card key), the smart key must exist inside the vehicle.
- The deleted digital key (card key) can be re-registered before registering a new digital key (card key).
- If you try to register a new digital key (card key), the previously registered digital key (card key) cannot be used again.

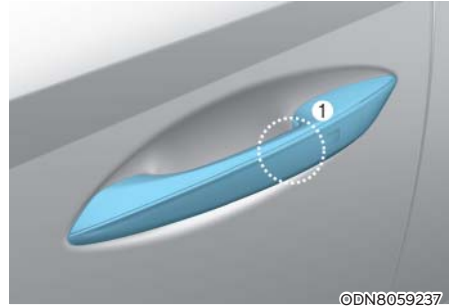

©DN8059237

[1] : Door handle authentication pad

### **NFC door lock/unlock**

You should contact digital key (card key) to door handle authentication pad (1, marked position near by the lock button) of driver's (or front passenger's) outside door for 2 seconds to lock or unlock the doors. If the Two Press Unlock feature is applied (press twice for unlocking), driver's seat door will be unlocked by contacting the digital key (card key). In this state, if you contact one more time within 4 seconds, all the doors unlock.

### *Inoperable condition*

If you do not contact the digital key (card key) to the center of the door handle authentication pad accurately, it may not work. In addition, if you overlap and use the key with NFC-enabled cards such as transportation card or credit card, it does not work.

Note that if you try to lock your vehicle with digital key (card key) in following cases, the doors will not be locked and chime will sound for 3 seconds.

- The Smart Key is in the vehicle.
- The POWER button is in ACC or ON position.
- Any of the doors, hood and trunk are open

If the digital key (card key) does not work, please detach the key around 4 inches (0.1 m) from the handle authentication pad and retry to contact. The card key may be damaged by the impact. It would not work properly if the key is damaged. You should buy a new card and register again. Long-time exposure to high temperature may cause the card key to malfunction. Please be careful not to expose the key to direct sunlight or high temperature.

After unlock the door or start up the vehicle with digital key, even though the driver tries to lock the doors by the central door lock switch, the door lock will be once locked and immediately released at the moment of door closed.

### Start-up with Card key

After placing your registered card key onto the interior authentication pad (wireless charger), step on the brake and press the Engine Start/Stop button.



### WARNING

- **If you do not place the digital key (card key) onto the center of the interior authentication pad (wireless charger) exactly, the card key may not be recognized. If the engine is not turned on, adjust and place the key again.**
- **If you overlap and use the key with NFC-enabled cards such as transportation card or credit card, the card key may not be recognized.**
- **If the digital key (card key) does not work, please detach the key around 4 inches (0.1 m) from the handle authentication pad and retry to contact.**
- **The card key may be damaged due to impact. It would not work properly if the key is damaged. You should buy a new card and register again.**

**For more information, refer to the Engine Start/Stop button in chapter 6.**

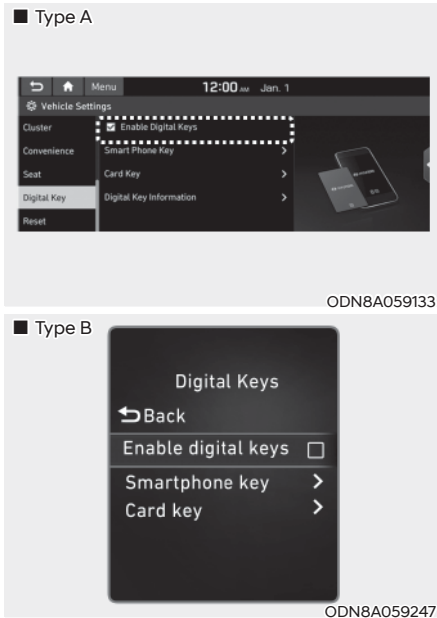

### Digital key application/cancellation

If you do not want to use the digital key (smartphone and card key), you can disable the function temporarily. You should have the smart key when you change the settings

- \* With Navigation screen :  
From the infotainment screen menu,  
go to [Setup] - [Vehicle] - [Digital Key]  
- [Enable Digital Keys] (deselect)
- \* Without navigation screen :  
From cluster menu, go to [Digital Key]  
- [Enable Digital Keys] (deselect)

### Information

**For the digital key disable, the smart key must be exist inside the car. For the digital key enable, the smart key does not need.**



### CAUTION

If you uncheck Enable digital keys, it is impossible to lock or unlock the doors or start up the vehicle with digital keys such as smartphone and card key. If you check Enable digital keys again, the registered digital keys (smartphone and card key) are available. Even though you stop the digital key function, the registered keys (smartphone and card key) are not deleted.

### *Personalized profile and vehicle settings*

Connect the registered digital key with personalized profile. Then in case you lock or unlock the door with the digital key NFC function or unlock the door remotely by digital key application Bluetooth connection, the vehicle will play the personalized user profile settings. Profile connection and personalization are available for Driver 1 and Driver 2.

### Profile link/unlinked

#### Profile link

1. Select Setup → User Profile → Profile Settings → Link Digital Key (Smartphone) on the infotainment system menu.
2. Unlock and place your smartphone on the wireless charger according to a message and it automatically starts to interwork.
3. It begins the profile link with a message.
4. If you select Link, the registered phone number's digital key and the user's profile are linked.
5. The interconnection process is completed with a message.

#### Profile unlink

1. Select Digital Key information on infotainment Vehicle Settings menu. It is possible to unlink only if the profile is interconnected.
2. Profile unlink is completed with a message.

### Information

**If you connect both Driver 1 and Driver 2 with a single smartphone, the smartphone digital key always works as Driver 1.**

**If you unlink the Driver 1, personalization function will operate as Driver 2.**

### *PRECAUTION for vehicle profile link and unlink*

When you link or unlink the profile of digital key, you should be careful of the following.

- Profile link is possible to use with the digital key. (Infotainment Vehicle Settings Mode → Digital Key → Enable Digital Keys)
- Profile link information remains even when you set the digital key function disable.
- Only the smart phone with digital key app enables you to link your profile. (Impossible to link with NFC card)
- Profile link works only when the smart phone and the digital key are registered to the vehicle. The smart phone with another vehicle's digital key cannot link profile.
- If you remove the smart phone from the wireless charger before completing the profile link, it does not work.
- To unlink the profile, the smart phone does not need to be on the wireless charger.

### Vehicle personalization operation

The personalization function linked with digital key works as following conditions:

- Contact the driver's door handle with the profile linked smart phone to lock or unlock the doors (Personalization does not operate when locking or unlocking the front passenger door.)
- Remote door unlock with the profile linked smartphone digital key app.

The profile linked with digital key can be changed manually in the infotainment system setup screen.

### Precaution for digital key profile link and unlink

Profile operation according to door lock/unlock system is as follows.

Item	Personalization Operation
Initial value	Guest
Profile linked smart phone key	Linked profile
Profile unlinked smart phone key	Recently activated profile
NFC card key	
Smart key	

- The personalization function using the digital key can be operated after linking the digital key on the infotainment system profile menu.
- You should use the personalization function during stopping your vehicle safely.

**Vehicle personalization with digital key**

The available personalization function in the vehicle is as follows.

System	Personalization Item	
USM	HUD	Position adjustment of image, Information display selection, Size and color of speedometer
	Lamp	Blink number of one-touch signal lamps
	Cluster	Information display on the cluster, Voice volume, Welcome sound
	Seat/Mirror	Seat position, O/S mirror position, Easy Access
		Intelligent driving posture assist (Smart IMS)
Door	Automatic door lock/unlock	
AVN	Navigation	Preferred volume of the navigation system, Recent destination
	User preset	My menu list settings, Radio preset
	Phone connectivity	Bluetooth preferential connect CarPlay/Android Auto/MirrorLink On/Off
Air conditioning	Operating condition	Latest operation setup of the following functions: Temperature, AUTO, air flow direction, air volume, air conditioner, air intake control, SYNC, Front windshield defroster, OFF

**For more information of personalization, refer to the infotainment system manual.**

 **CAUTION**

**If you leave the digital key after locking or unlocking the doors or starting up the vehicle with the smart key, the doors can be locked by the central door lock. Please carry around the digital key all the time.**



## DOOR LOCKS

### Operating Door Locks from Outside the Vehicle

#### Mechanical key

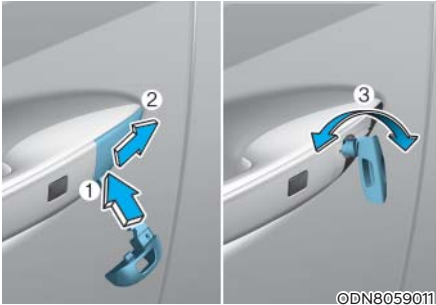

If you lock the driver's door with a mechanical key, all vehicle doors will lock. If you unlock the driver's door with a mechanical key, you can open and close the driver's door only.

Once the doors are unlocked, they may be opened by pulling the door handle. When closing the door, push the door by hand. Make sure that doors are closed securely.

#### Remote key

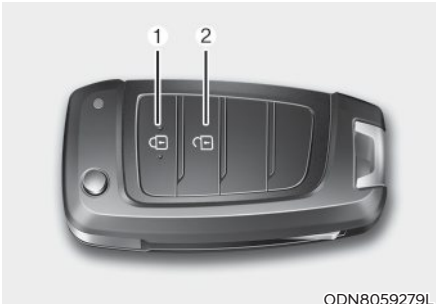

To lock the doors, press the Door Lock button (1) on the remote key.

Press the Door Unlock button (2) on the remote key, the driver's door will unlock. If you press the Door Unlock button on the remote key again within four seconds, then all the doors will unlock.

Once the doors are unlocked, they may be opened by pulling the door handle.

When closing the door, push the door by hand. Make sure that doors are closed securely.

#### Smart key

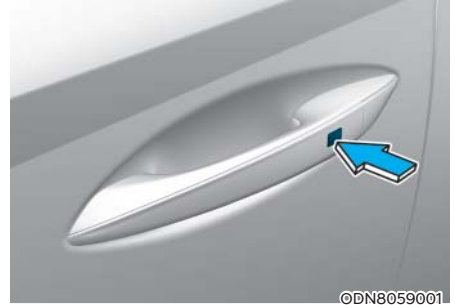

Press the button on the driver's outside door handle or touch the touch sensor on the door handle (the engraved part) while carrying the Smart Key with you or press the Door Unlock button on the Smart Key, the driver's door will unlock.

If you press the button on the front passenger's outside door, all doors will unlock.

Once the doors are unlocked, they may be opened by pulling the door handle.

When closing the door, push the door by hand. Make sure that doors are closed securely.

### **i** Information

- In cold and wet climates, door lock and door mechanisms may not work properly due to freezing conditions.
- If the door is locked/unlocked multiple times in rapid succession with either the vehicle key or door lock switch, the system may stop operating temporarily in order to protect the circuit and prevent damage to system components.
- Two press unlock setting can be changed in the User Settings mode on the cluster.

### ***In case of an emergency***



If the electrical power door lock switch is not operating (ex. dead car battery) the only way to lock the door(s) is with the mechanical key from the outside key hole.

Doors without an outside key hole can be locked as follows:

1. Open the door.
2. Insert the key into the emergency door lock hole and turn the key horizontally to lock.
3. Close the door securely.

### ***i* Information**

**If the electrical power to door lock switch is not operating (ex. dead car battery) and the trunk is closed, you will not be able to open the trunk until power is restored.**

### **Operating Door Locks from Inside the Vehicle With the door handle**



#### **Front door**

If the inner door handle is pulled when the door is locked, the door will unlock and open.

#### **Rear door**

If the inner door handle is pulled once when the door is locked, the door will unlock. If the inner door handle is pulled once more, the door will open.

### ***i* Information**

**If a power door lock ever fails to function while you are in the vehicle try one or more of the following techniques to exit:**

- Operate the door unlock feature repeatedly (both electronic and manual) while simultaneously pulling on the door handle.
- Operate the other door locks and handles, front and rear.
- Lower a front window and use the mechanical key to unlock the door from outside.

### With the central door lock switch

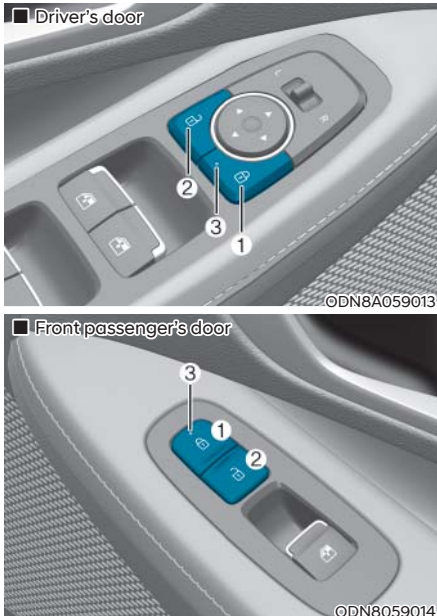

- When pressing the (🔒) portion (1) of the switch, all vehicle doors will lock.
  - If the key is in the ignition switch and any door is opened, the doors will not lock even though the lock button (1) of the central door lock switch is pressed.
  - If the smart key is in the vehicle and any door is opened, the doors will not lock even though the lock button (1) of the central door lock switch is pressed.
- When pressing the (🔓) portion (2) of the switch, all vehicle doors will unlock.
- Doors indicating light (3)  
When all vehicle doors are locked, the indicating lights on the driver's door and passenger's door will turn on. If any door is unlocked, it would go off.

### WARNING

- The doors should always be fully closed and locked while the vehicle is in motion. If the doors are unlocked, the risk of being thrown from the vehicle in a crash is increased.
- Do not pull the inner door handle of the driver's or passenger's door while the vehicle is moving.

### WARNING

Do not leave children or animals unattended in your vehicle. An enclosed vehicle can become extremely hot, causing death or serious injury to unattended children or animals who cannot escape the vehicle.

Children might operate features of the vehicle that could injure them, or they could encounter other harm, possibly from someone gaining entry to the vehicle.

### WARNING

**Always secure your vehicle.**

Leaving your vehicle unlocked increases the potential risk to you or others from someone hiding in your vehicle.

To secure your vehicle, while depressing the brake, move the shift button to the P (Park) position, engage the parking brake, and place the ignition switch in the LOCK/OFF position, close all windows, lock all doors, and always take the key with you.

### CAUTION

Opening a door when something is approaching may cause damage or injury. Be careful when opening doors and watch for vehicles, motorcycles, bicycles or pedestrians approaching the vehicle in the path of the door.



**WARNING**

If you stay in the vehicle for a long time while the weather is very hot or cold, there are risks of injuries or danger to life. Do not lock the vehicle from the outside when someone is in the vehicle.



**WARNING**

Opening a door when something is approaching may cause damage or injury. Be careful when opening doors and watch for vehicles, motorcycles, bicycles or pedestrians approaching the vehicle in the path of the door.

## Automatic Door Lock and Unlock Features

Your vehicle is equipped with features that will automatically lock or unlock your vehicle based on settings you select in the LCD cluster display.

### ***Auto LOCK - Enable on Speed***

When this feature is set in the LCD cluster display, all the doors will be locked automatically when the vehicle exceeds 9 mph (15 kph).

### ***Auto LOCK - Enable on Shift***

When this feature is set in the LCD cluster display, all the doors will be locked automatically when the vehicle is shifted out of P (Park) while the engine is running.

### ***Auto UNLOCK - Enable on Shift***

When this feature is set in the LCD cluster display, all the doors will be unlocked automatically when the vehicle is shifted back into P (Park).

**For more information on these features, refer to the LCD Display section later in this chapter.**

### ***Additional Unlock Safety Feature - Air Bag Deployment***

As an additional safety feature, all doors will be automatically unlocked when an impact causes the air bags to deploy.

## Child-Protector Rear Door Locks



The child safety lock is provided to help prevent children seated in the rear from accidentally opening the rear doors. The rear door safety locks should be used whenever children are in the vehicle.

The child safety lock is located on the edge of each rear door. When the child safety lock is in the lock position, the rear door will not open if the inner door handle is pulled.

To lock the child safety lock, insert a small flat blade tool (like a screwdriver or similar) (1) into the slot and turn it to the lock position as shown.

To allow a rear door to be opened from inside the vehicle, unlock the child safety lock.



### WARNING

If children accidentally open the rear doors while the vehicle is in motion, they could fall out of the vehicle. The rear door safety locks should always be used whenever children are in the vehicle.

## Rear Occupant Alert (ROA) System

The Rear Occupant Alert (ROA) system is provided to help prevent exiting the vehicle with the rear passenger left in the vehicle. When you open the front door after opening and closing the rear door and turning off the engine, the “Check rear seats” warning message appears on the cluster.

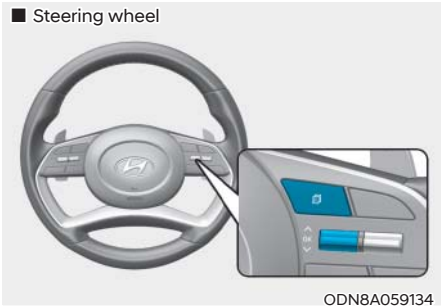

### CAUTION

- The system does not actually detect objects or people in the rear seat. By using a rear door opened and closed history, the system indicates that there may be something in the rear seat.
- The rear door opened and closed history will be initialized only when the doors are locked after turning off the engine. Therefore, there could be alarms even though the back doors are locked.

ex) When you get in and drive your vehicle without locking the doors after the alarm sounds, there could be the alarm sounds if you turn off the engine and open the driver's seat door.

### WARNING

It does not use the actual sensors but it provides the alarm sounds by checking the rear door lock/unlock status as a reminder.

## Vehicle Auto-Shut Off Function

If your parked vehicle in a garage is on for a period of time, the engine turns off automatically to prevent carbon monoxide poisoning.

### System setting

Select 'User Settings → Convenience → Vehicle Auto-Shut Off' in the LCD display.



ODN8A059340

### Operating conditions

Vehicle Auto-Shut Off timer activates when the following conditions are met.

- Ignition [ON] or engine running
- Shift button is in P (Park) position
- Unfastened driver's seat belt
- Even one of the doors opens

### Deactivations

- In case of selecting "Disable" for Vehicle Auto-Shut Off in the User Settings mode (30 min. based timer is reset automatically if you restart.)
- Gear shift other than P
- Fastened driver's seat belt
- Step on the brake or accelerator

### System operation

At the set time on Vehicle Auto-Shut Off timer, the engine turns off automatically.

## THEFT-ALARM SYSTEM

This system helps to protect your vehicle and valuables. The horn will sound and the hazard warning lights will blink continuously if any of the following occur:

- A door is opened without using the remote key or smart key.
- The trunk is opened without using the remote key or smart key.
- The engine hood is opened.

The alarm continues for 30 seconds, then the system resets. To turn off the alarm, unlock the doors with the remote key or smart key.

The Theft Alarm System automatically sets 30 seconds after you lock the doors and the trunk. For the system to activate, you must lock the doors and the trunk from outside the vehicle with the remote key or smart key or by pressing the button on the outside of the door handle with the smart key in your possession.

The hazard warning lights will blink and the chime will sound once to indicate the system is armed.

Once the security system is set, opening any door, the trunk, or the hood without using the remote key or smart key will cause the alarm to activate.

The Theft Alarm System will not set if the hood, the trunk, or any door is not fully closed. If the system will not set, check the hood, the trunk, or the doors are fully closed.

Do not attempt to alter this system or add other devices to it.

### Information

- **Do not lock the doors until all passengers have left the vehicle. If the remaining passenger leaves the vehicle when the system is armed, the alarm will be activated.**
- **If the vehicle is not disarmed with the remote key or smart key, open the doors by using the mechanical key and place the ignition switch in the ON position (for remote key) or start the engine (for smart key) by directly pressing the ignition switch with the smart key.**
- **If the system is disarmed by unlocking the vehicle, but neither a door or the trunk is opened within 30 seconds, the doors will relock and the system will rearm automatically.**



## DRIVER POSITION MEMORY SYSTEM (IF EQUIPPED)

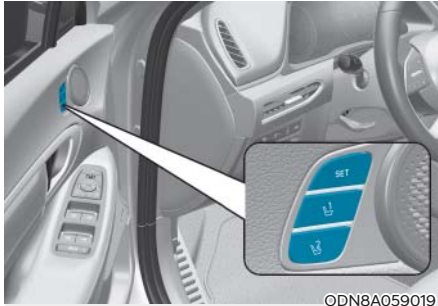

The Driver Position Memory System is provided to store and recall the following memory settings with a simple button operation.

- Driver's seat position (Power seat)
- Side view mirror position
- Instrument panel illumination intensity
- Head Up Display (HUD) position and brightness (if equipped)



### WARNING

**Never attempt to operate the driver position memory system while the vehicle is moving.**

**This could result in loss of control, and an accident causing death, serious injury, or property damage.**



### Information

- **If the battery is disconnected, the memory settings will be erased.**
- **If the Driver Position Memory System does not operate normally, have the system checked by an authorized HYUNDAI dealer.**

### Storing Positions into Memory

1. Shift to P (Park) while the ignition switch is in the ON position.
2. Adjust the driver's seat position, side view mirror position, instrument panel illumination intensity and head-up display height/brightness to positions comfortable for the driver.
3. Press the SET button. The system will beep once and notify you "Press button to save settings" on the cluster LCD display.
4. Press one of the memory buttons (1 or 2) within 4 seconds. The system will beep twice when the memory has been successfully stored.
5. "Settings 1 (or 2) saved" will appear on the cluster LCD display.

### Recalling Positions from Memory

1. Shift to P (Park) while the ignition switch is in the ON position.
2. Press the desired memory button (1 or 2). The system will beep once, and then the driver's seat position, side view mirror position, instrument panel illumination intensity and head-up display height/brightness will automatically adjust to the stored positions.
3. "Settings 1 (or 2) applied" will appear on the cluster LCD display.

If your vehicle is equipped with additional navigation, please refer to the infotainment system manual separately supplied.



#### Information

- **While recalling the "1" memory position, pressing the SET or 1 button temporarily stops the adjustment of the recalled memory position. Pressing the 2 button recalls the "2" memory position.**
- **While recalling the "2" memory position, pressing the SET or 2 button temporarily stops the adjustment of the recalled memory position. Pressing the 1 button recalls the "1" memory position.**
- **While recalling the stored positions, pressing one of the control buttons for the driver's seat, side view mirror, instrument panel illumination or head-up display will cause the movement of that component to stop and move in the direction that the control button is pressed.**

### Resetting the Driver's Seat Memory System

Take the following procedures to reset the driver's seat memory system, when it does not operate properly.

#### *To reset the driver's seat memory system*

1. Place the ignition switch to the ON position, shift to P (Park), and open the driver's door.
2. Operate the control switch to set the driver's seat and seatback to the foremost position.
3. Simultaneously press the SET button and push forward the seat movement switch over 2 seconds.

#### *While resetting the driver's seat memory system*

1. It starts with the notification sound.
2. The driver's seat and seatback is adjusted to the rearward position with the notification sound.
3. The driver's seat and seatback is re-adjusted to the default position (central position) with the notification sound.

However, in the following cases, the resetting procedure and the notification sound may stop.

- The memory button is pressed.
- The control switch is operated.
- The gear is shifted out of P (Park) .
- The driving speed exceeds 2 mph (3 km/h).
- The driver's door is closed.

**NOTICE**

- **Reattempt to do the resetting procedure again, when the resetting procedure incompletely stops or the notification sound do not stop.**
- **Make sure that there is no obstacle around the driver's seat in advance of resetting the driver's seat memory system.**

**Easy Access Function**

The system will move the driver's seat automatically as follows:

- It will move the driver's seat rearward when the Engine Start/Stop button is pressed to the OFF position.
- It will move the driver's seat forward when the Engine Start/Stop button is pressed to the ACC or START position.

You can activate or deactivate the Easy Access Function from the User Settings mode in the cluster LCD display.

'Convenience → Seat Easy Access → Off/Normal/Extended'.

**For more information, refer to "LCD Display" in chapter 4. If your vehicle is equipped with additional navigation, please refer to the infotainment system manual separately supplied.**

**CAUTION**

**Driver should be cautious when using this function to assure no injury to passenger or child on the back seat. In case of emergency the driver has to stop movement of front seat (when easy access feature is activated) by pressing SET button or any of the driver seat control switches.**

## STEERING WHEEL

### Electric Power Steering (EPS)

The system assists you with steering the vehicle. If the vehicle is turned off or if the power steering system becomes inoperative, you may still steer the vehicle, but it will require increased steering effort.

Also, the steering effort becomes heavier as the vehicle's speed increases and becomes lighter as the vehicle's speed decreases for better control of the steering wheel.

Should you notice any change in the effort required to steer during normal vehicle operation, have the system checked by an authorized HYUNDAI dealer.



### CAUTION

- If the Electric Power Steering System does not operate normally, the warning light (⚠) will illuminate on the instrument cluster. You may steer the vehicle, but it will require increased steering efforts. Take your vehicle to an authorized HYUNDAI dealer and have the system checked as soon as possible.
- When an abnormality is detected in the electric power steering system, to prevent an accident, the steering assist function may become inoperative. At this time, the warning light turns on or blinks on the cluster. The steering wheel may become difficult to control or operate. Have your vehicle checked immediately, after moving the vehicle to a safe area.



### Information

The following symptoms may occur during normal vehicle operation:

- The steering effort may be high immediately after placing the ignition switch in the ON position.  
**This happens as the system performs the EPS system diagnostics. When the diagnostics are completed, the steering wheel effort will return to its normal condition.**
- When the battery voltage is low, you might have to put more steering effort. However, it is a temporary condition so that it will return to normal condition after charging the battery.
- A click noise may be heard from the EPS relay after the ignition switch is in the ON or LOCK/OFF position.
- Motor noise may be heard when the vehicle is at a stop or at a low driving speed.
- When you operate the steering wheel in low temperatures, abnormal noise may occur. If the temperature rises, the noise will disappear. This is a normal condition.
- When an error is detected from the EPS, the steering effort assist function may become inoperative in order to prevent fatal accidents. Instrument cluster warning lights may be on or the steering effort may be high. If these symptoms occur, drive the vehicle to a safe area as soon as it is safe to do so. Have the system checked by an authorized HYUNDAI dealer as soon as possible.

## Tilt Steering / Telescope Steering

When adjusting the steering wheel to a comfortable position, adjust the steering wheel so that it points toward your chest, not toward your face. Make sure you can see the instrument cluster warning lights and gauges. After locking the lever, push the steering wheel both up and down to be certain it is locked in position. Always adjust the position of the steering wheel before driving.



### WARNING

**NEVER** adjust the steering wheel while driving. This may cause loss of vehicle control resulting in an accident.



To adjust the steering wheel angle and height:

1. Pull down the lock-release lever (1).
2. Adjust the steering wheel to the desired angle (2) and distance forward/back (3).
3. Pull up the lock-release lever to lock the steering wheel in place.



### Information

Sometimes the lock release lever may not engage completely. This may occur when the gears of the locking mechanism do not completely mesh. If this occurs, pull down on the lock release lever, readjust the steering wheel again, and then pull back up on the release lever to lock the steering wheel in place.



### CAUTION

While adjusting the steering wheel height, please do not push or pull it hard since the fixture can be damaged.

## Heated Steering Wheel (if equipped)

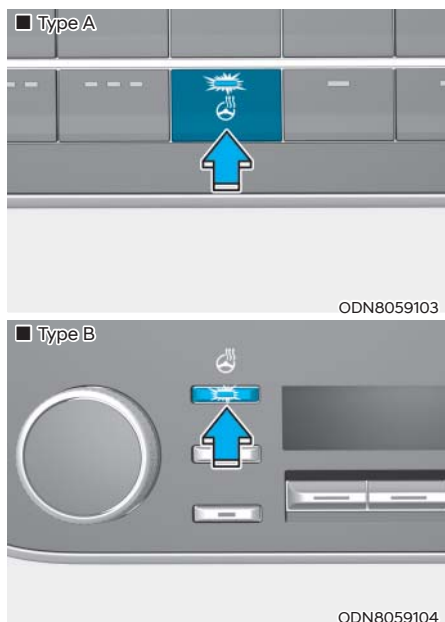

When the ignition switch is in the ON position or when the engine is running, press the heated steering wheel button to warm the steering wheel. The indicator on the button will illuminate.

To turn the heated steering wheel off, press the button again. The indicator on the button will turn off.

- The heated steering wheel defaults to the OFF position whenever the ignition switch is in the ON position. However, if the Auto Comfort Control function is ON, the heated steering wheel will turn on and off depending on the outside temperature.
- Auto Comfort Control (for driver's seat) (if equipped)

The heated steering wheel automatically controls the steering wheel temperature depending on the ambient temperature when the engine is running. If the heated steering wheel switch is pushed, the heated steering wheel will have to be controlled manually.

To use this function, it must be activated from the Settings menu in the infotainment system screen.

**For more information, refer to the separately supplied manual with your vehicle.**

### **i** Information

**The heated steering wheel will turn off automatically approximately 30 minutes after the heated steering wheel is turned on.**

### **NOTICE**

**Do not install any cover or accessory on the steering wheel. This cover or accessory could cause damage to the heated steering wheel system.**

## Horn



ODN8059022

To sound the horn, press the area indicated by the horn symbol on your steering wheel (see illustration). The horn will operate only when this area is pressed.

### **NOTICE**

**Do not strike the horn severely to operate it, or hit it with your fist. Do not press on the horn with a sharp-pointed object.**

## MIRRORS

### Inside Rearview Mirror

Before driving your vehicle, check to see that your inside rearview mirror is properly positioned. Adjust the rearview mirror so that the view through the rear window is properly centered.

#### WARNING

Make sure your line of sight is not obstructed. Do not place objects in the rear seat, cargo area, or behind the rear head restraints which could interfere with your vision through the rear window.

#### WARNING

To prevent serious injury during an accident or deployment of the air bag, do not modify the rearview mirror and do not install a wide mirror.

#### WARNING

NEVER adjust the mirror while driving. This may cause loss of vehicle control resulting in an accident.

#### NOTICE

When cleaning the mirror, use a paper towel or similar material dampened with glass cleaner. Do not spray glass cleaner directly on the mirror as this may cause the liquid cleaner to enter the mirror housing.

### Day/night rearview mirror (if equipped)

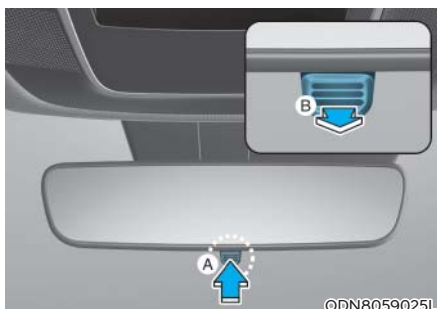

[A] : Day, [B] : Night

Make this adjustment before you start driving and while the day/night lever is in the day position.

Pull the day/night lever towards you to reduce glare from the headlamps of the vehicles behind you during night driving.

*Remember that you lose some rearview clarity in the night position.*



### ***Electrochromic Mirror (ECM) (if equipped)***

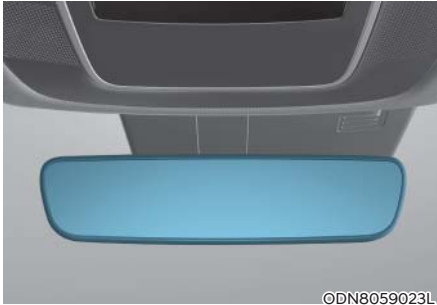

©DN8059023L

The electric rearview mirror automatically controls the glare from the headlamp of the vehicle behind you in nighttime or low light driving conditions.

When the engine is running, the glare is automatically controlled by the sensor mounted in the rearview mirror. The sensor detects the light level around the vehicle, and automatically adjusts to control the headlamp glare from vehicles behind you.

Whenever the shift button is placed in R (Reverse), the mirror will automatically go to the brightest setting in order to improve the driver's view behind the vehicle.

### ***Electrochromic mirror (ECM) with HomeLink® system (if equipped)***

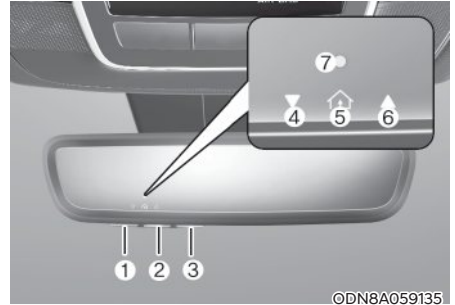

©DN8A059135

Your vehicle may be equipped with a Gentex Automatic-Dimming Mirror with an Integrated HomeLink® Wireless Control System.

During nighttime driving, this feature will automatically detect and reduce rearview mirror glare. The HomeLink® Universal Transceiver allows you to activate your garage door(s), electric gate, home lighting, etc.

- (1) HomeLink Channel 1
- (2) HomeLink Channel 2
- (3) HomeLink Channel 3
- (4) Garage Door Opener Status Indicator :  
Closing or Closed
- (5) HomeLink Operation Indicator
- (6) Garage Door Opener Status Indicator :  
Opening or Opened
- (7) HomeLink User Interface Indicator

### **Automatic-Dimming Night Vision Safety™ (NVS®) Mirror (if equipped)**

The NVS® Mirror automatically reduces glare by monitoring light levels in the front and the rear of the vehicle. Any object that obstructs either light sensor will degrade the automatic dimming control feature.

**For more information regarding NVS® mirrors and other applications, please refer to the Gentex website:**

**[www.gentex.com](http://www.gentex.com)**

Your mirror will automatically dim upon detecting glare from the vehicles traveling behind you.

The mirror defaults to the ON position each time the vehicle is started.

### **Integrated HomeLink® Wireless Control System**

The HomeLink® Wireless Control System can replace up to three hand-held radio-frequency (RF) transmitters with a single built-in device. This innovative feature will learn the radio frequency codes of most current transmitters to operate devices such as gate operators, garage door openers, entry door locks, security systems, even home lighting. Both standard and rolling code-equipped transmitters can be programmed by following the outlined procedures.

Additional HomeLink® information can be found at: [www.homelink.com](http://www.homelink.com), [www.youtube.com/HomeLinkGentex](http://www.youtube.com/HomeLinkGentex) or by calling 1-800-355-3515.

Retain the original transmitter of the RF device you are programming for use in other vehicles as well as for future HomeLink® programming. It is also suggested that upon the sale of the vehicle, the programmed HomeLink® buttons be erased for security purposes.



### **WARNING**

**Before programming HomeLink® to a garage door opener or gate operator, make sure people and objects are out of the way of the device to prevent potential harm or damage. Do not use the HomeLink® with any garage door opener that lacks the safety stop and reverse features required by U.S. federal safety standards (this includes any garage door opener model manufactured before April 1, 1982). A garage door that cannot detect an object - signaling the door to stop and reverse - does not meet current U.S. federal safety standards. Using a garage door opener without these features increases the risk of serious injury or death.**

### **Programming HomeLink®**

Please note the following:

- When programming a garage door opener, it is advised to park the vehicle outside of the garage.
- It is recommended that a new battery be placed in the hand-held transmitter of the device being programmed to HomeLink® for quicker training and accurate transmission of the radio-frequency signal.
- Some vehicles may require the Engine Start/Stop button to be in the ACC (or “Accessories”) position for programming and/or operation of HomeLink®.
- In the event that there are still programming difficulties or questions after following the programming steps listed below, contact HomeLink® at: [www.homelink.com](http://www.homelink.com), [www.youtube.com/HomeLinkGentex](http://www.youtube.com/HomeLinkGentex) or by calling 1-800-355-3515.

## Programming

To program most devices, follow these instructions:

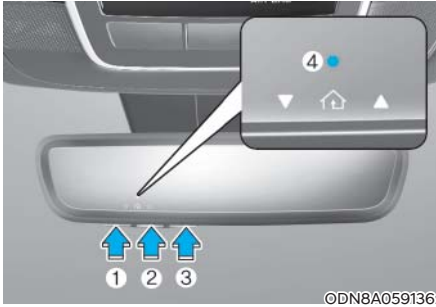

1. Press and release (1), (2) or (3) button.
  - If the indicator (4) is turned ON in Orange, go to Step 3) since it is a new programming.
  - If the indicator (4) is continuously turned ON or flashes in Green rapidly several times, go to Step 2) since it is a programmed button.
2. Press and hold the button you wish to program for approximately 15-25 seconds until the LED flashes in Orange for several times.
3. Hold the Garage Door Opener Original Transmitter near the HomeLink Mirror.

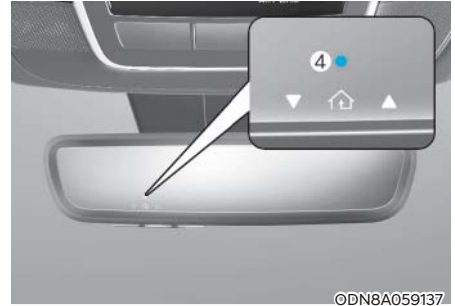

4. Press the Original Transmitter button until the indicator (4) is turned continuously ON or flashes in Green for approximately 10 seconds and it indicates the programming is completed.
5. However, the indicator (4) flashes in Green continuously, but if the garage door opener does not operate, please continue to follow the step 6 and 7 ("Rolling Code Programming" procedures).
6. Firmly press and release the "Learn," "Smart," or "Program" button while the indicator (4) flashes in Green. Once the button is pressed, you have approximately 30 seconds to initiate the next step.

## **i** Information

**At the garage door opener motor, (security gate motor, etc.) locate the "Learn," "Smart," or "Program" button. This can usually be found where the hanging antenna wire is attached to the motor-head unit (see the device's manual to identify this button). The name and color of the button may vary by manufacturer. A ladder and/or second person may simplify the following steps.**

- Return to the vehicle and firmly press, hold for two seconds and release the HomeLink button up to three times. Do not press the HomeLink button rapidly. At this point programming is complete and your device should operate when the HomeLink button is pressed and released.

### **i** Information

- Some garage door openers require to press the programmed button on the mirror up to three times right after the programming is just completed to operate the garage door.
- The indicator (4) is turned ON in Orange and flashes for about 60 seconds, during the programming mode and if a programming is not succeeded within the 60 seconds, the programming mode will be abort.

HomeLink® should now activate your rolling code equipped device.

### *Gate operator & Canadian programming*

During programming, your handheld transmitter may automatically stop transmitting. Continue to press the Integrated HomeLink® Wireless Control System button while you press and re-press (“cycle”) your handheld transmitter every two seconds until the frequency signal has been learned. The indicator light will flash slowly and then rapidly after several seconds upon successful training.

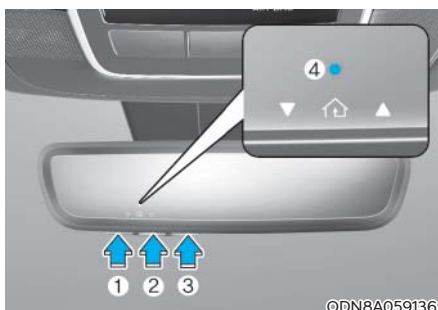

### *Operating HomeLink®*

- Press and release one of the HomeLink buttons (1, 2 or 3) that programmed.
- The HomeLink indicator (4) will operate as below:
  - Indicates Green and is continuously ON (Fixed Code Garage Door Opener)
  - Flashes in Green rapidly (Rolling Code Garage Door Opener)

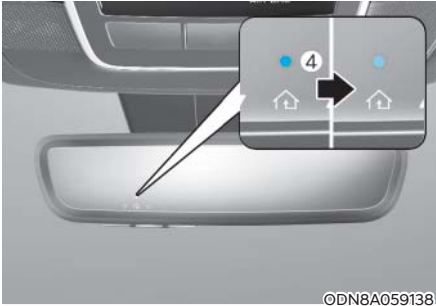

#### Erasing HomeLink® buttons

1. Press and hold the button (1) and (3) simultaneously.
2. The indicator (4) is turned continuously ON in orange for about 10 seconds.
3. Then the indicator (4) color changes to Green and flashes rapidly. Release the buttons once the green indicator flashes.
4. Now HomeLink button (1), (2) and (4) memories are all cleared.

NVS® is a registered trademark and Z-Nav™ is a trademark of the Gentex Corporation, Zeeland, Michigan. HomeLink® is a registered trademark owned by Johnson Controls, Incorporated, Milwaukee, Wisconsin.

**FCC ID: NZLUAHL5A**

**IC: 4112A-UAHL5A**



#### Information

**This device complies with Part 15 of the FCC Rules.**

**Operation is subject to the following three conditions:**

1. **This device may not cause harmful interference, and**
2. **This device must accept any interference received, including interference that may cause undesired operation.**

3. **The transceiver has been tested and complies with FCC and Industry Canada rules. Changes or modifications not expressly approved by the party responsible for compliance could void the user's authority to operate the device.**

#### Two Way Communication Programing

1. Complete the HomeLink "Programming" first.
2. Before the first 10 times HomeLink button is pressed after the programming, the following steps **MUST** occur to program two way communication. (only for some older garage doors)



3. Press and release the programmed HomeLink button to activate the garage door.
4. Once the garage door is stopped, press and release the "Learn" or "Smart" button on the Garage door opener within 1 minute from the time of pressing the programmed HomeLink button on mirror.

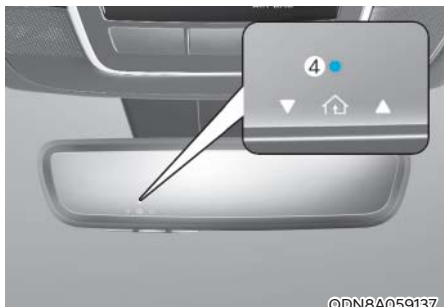

5. If the both indicator (4) and (6) are flashing rapidly for about 5 seconds, the two way synchronization is completed.

**i Information**

Some newer garage door openers provide two-way communication synchronizing when programming the original transmitter.



*Operating Two Way Communication*

1. Press and release (1), (2) or (3) button.



2. The indicator (4) and (6) operates as below:

- If the indicator (4) flashes in Orange, it indicates that the garage door is “closing”.
- If the indicator (4) is ON continuously in Green, it indicates that the garage door is “closed”.
- If the indicator (6) flashes in Orange, it indicates that the garage door is “Opening”.
- If the indicator (6) is ON continuously in Green, it indicates that the garage door is “Opened”.
- If the indicator (4) or (6) does not turn to Green, it indicates that the last status of garage door was not received properly. The HomeLink mirror tries to receive the last known status of the garage door for a few seconds.

*Recalling Garage Door Status*

Homelink mirror with two way communication provides a way to view the last stored message from the garage door opener. In order to recall the last known status of the last activated device, press the buttons “1 and 2” OR “2 and 3” simultaneously.

- If the indicator (4) is ON continuously in Green, it indicates that the last activated device was “closed” properly.
- If the indicator (6) is ON continuously in Green, it indicates that the last activated device was “open” properly.

## **i** Information

Two way communication range distance between “vehicle” and “garage door opener” is 100m.

The range may be reduced or increased a little due to obstacle conditions around the garage door opener, such as houses or trees.

## Side View Mirrors



©DN8059024

Make sure to adjust the side view mirrors to your desired position before you begin driving.

Your vehicle is equipped with both left-hand and right-hand side view mirrors. The mirrors can be adjusted remotely with the remote switch. The side view mirrors can be folded to help prevent damage when going through an automatic car wash or when passing through a narrow street.

The right side view mirror is convex. Objects seen in the mirror are closer than they appear.

Use the inside rear view mirror or look back directly to determine the actual distance of other vehicles prior to changing lanes.

## **⚠** WARNING

Do not adjust or fold the side view mirrors while driving. This may cause loss of vehicle control resulting in an accident.

## **NOTICE**

- Do not scrape ice off the mirror face; this may damage the surface of the glass.
- If the mirror is jammed with ice, do not adjust the mirror by force. Use an approved spray de-icer (not radiator antifreeze) spray, or a sponge or soft cloth with very warm water, or move the vehicle to a warm place and allow the ice to melt.

### Side View Mirror Adjustment

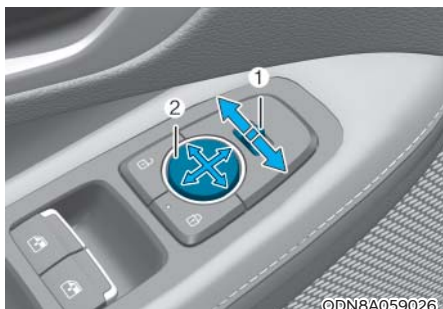

Adjusting the side view mirrors:

1. Press either the L (driver's side) or R (passenger's side) button (1) to select the side view mirror you would like to adjust.
2. Use the mirror adjustment control switch to position the selected mirror up, down, left or right.
3. After adjustment, put the button into neutral (center) position to prevent inadvertent adjustment.

#### **NOTICE**

- **The mirrors stop moving when they reach the maximum adjusting angles, but the motor continues to operate while the switch is pressed. Do not press the switch longer than necessary, because this can damage the motor.**
- **Do not attempt to adjust the side view mirrors by hand, because this can damage the motor.**

### Folding the side view mirrors



To fold the side view mirrors, grasp the housing of the mirror and then fold it inwards.



## Reverse Parking Aid Function (if equipped)

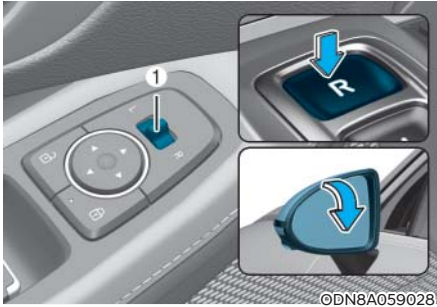

When you press the R (Reverse) button, the side view mirror(s) will rotate downwards to aid with driving in reverse. The position of the side view mirror switch (1) determines whether or not the mirrors will move:

**Left/Right :** When either the L (Left) or R (Right) switch is selected, both side view mirrors will move.

**Neutral :** When neither switch is selected, the side view mirrors will not move.

The side view mirrors will automatically revert to their original positions if any of the following occur:

- The ignition switch is placed to either the LOCK/OFF position or the ACC position.
- The shift button is selected to any position except R (Reverse).
- The remote control side view mirror switch is not selected.

## WINDOWS

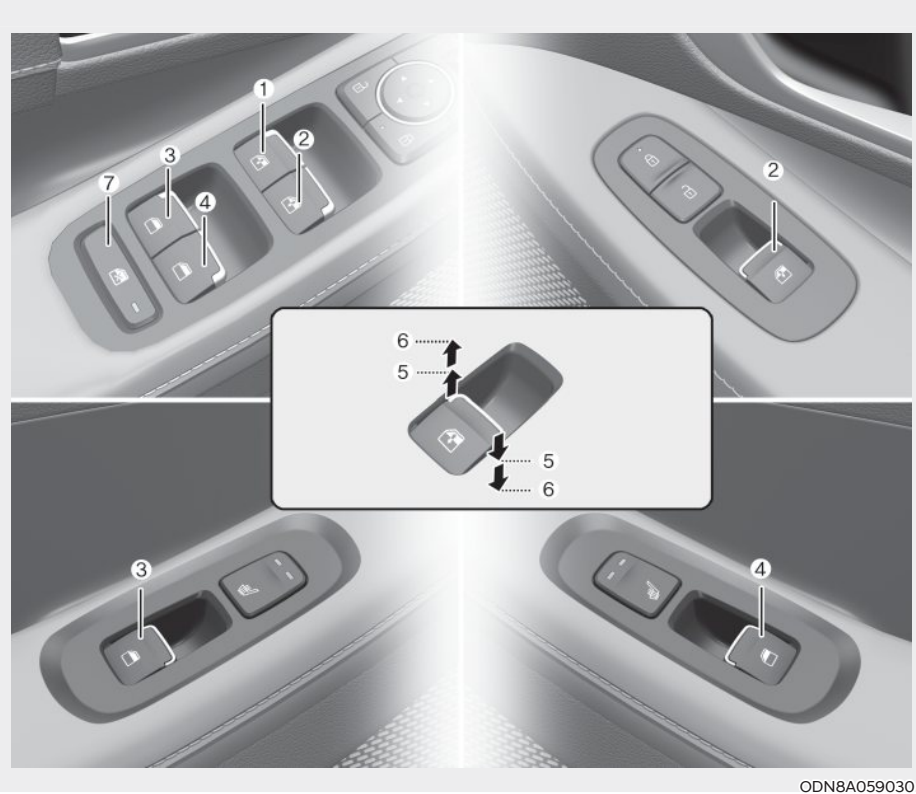

ODN8A059030

- (1) Driver's door power window switch
- (2) Front passenger's door power window switch
- (3) Rear door (left) power window switch
- (4) Rear door (right) power window switch
- (5) Window opening and closing
- (6) Automatic power window
- (7) Power window lock switch

## Power Windows

The ignition switch must be in the ON position to be able to raise or lower the windows. Each door has a Power Window switch to control that door's window. The driver has a Power Window Lock switch which can block the operation of passenger windows. The power windows will operate for approximately 30 seconds after the ignition switch is placed in the ACC or LOCK/OFF position. However, if the front doors are opened, the Power Windows will not operate even within the 30 second period.



### WARNING

**To avoid serious injury or death, do not extend your head, arms or body outside the windows while driving.**



### Information

- In cold and wet climates, power windows may not work properly due to freezing conditions.
- While driving with the rear windows down or with the sunroof (if equipped) opened (or partially opened), your vehicle may demonstrate a wind buffeting or pulsation noise. This noise is normal and can be reduced or eliminated by taking the following actions. If the noise occurs with one or both of the rear windows down, partially lower both front windows approximately one inch. If you experience the noise with the sunroof open, slightly close the sunroof.

## Window opening and closing

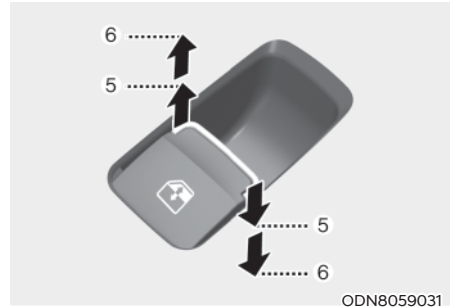

To open:

Press the window switch down to the first detent position (5). Release the switch when you want the window to stop.

To close:

Pull the window switch up to the first detent position (5). Release the window switch when you want the window to stop.

### **Auto down window (if equipped)**

Pressing the power window switch down momentarily to the second detent position (6) completely lowers the window even when the switch is released. To stop the window at the desired position while the window is in operation, pull up or press down and release the switch.

### **Auto up/down window (if equipped)**

Pressing or pulling up the power window switch momentarily to the second detent position (6) completely lowers or lifts the window even when the switch is released. To stop the window at the desired position while the window is in operation, pull up or press down and release the switch.

### To reset the power windows

If the power windows do not operate normally, the automatic power window system must be reset as follows:

1. Place the ignition switch to the ON position.
2. Close the window and continue pulling up on the power window switch for at least one second.

If the power windows do not operate properly after resetting, have the system checked by an authorized HYUNDAI dealer.

### WARNING

**The automatic reverse feature doesn't activate while resetting the power window system. Make sure body parts or other objects are safely out of the way before closing the windows to avoid injuries or vehicle damage.**

### Automatic reverse (if equipped)



If a window senses any obstacle while it is closing automatically, it will stop and lower approximately 12 inches (30 cm) to allow the object to be cleared.

If the window detects the resistance while the power window switch is pulled up continuously, the window will stop upward movement then lower approximately 1 inch (2.5 cm).

If the power window switch is pulled up continuously again within 5 seconds after the window is lowered by the automatic window reverse feature, the automatic window reverse will not operate.

### Information

**The automatic reverse feature is only active when the “Auto Up” feature is used by fully pulling up the switch to the second detent.**

### WARNING

**Make sure body parts or other objects are safely out of the way before closing the windows to avoid injuries or vehicle damage.**

**Objects less than 0.16 inch (4 mm) in diameter caught between the window glass and the upper window channel may not be detected by the automatic reverse window and the window will not stop and reverse direction.**

**NOTICE**

Do not install any accessories on the windows. The automatic reverse feature may not operate.

**Power window lock switch**

The driver can disable the power window switches on the rear passenger doors by pressing the power window lock switch.

When the power window lock switch is pressed:

- The rear passenger control will not be able to operate the rear passenger power window
- Note that the front passenger control is still able to operate the front passenger window, and that the driver master control can still operate all the power windows.

**WARNING**

Do not allow children to play with the power windows. Keep the driver's door power window lock switch in the LOCK position. Serious injury or death can result from unintentional window operation by a child.

**NOTICE**

- To prevent possible damage to the power window system, do not open or close two windows or more at the same time. This will also ensure the longevity of the fuse.
- Never try to operate the main switch on the driver's door and the individual door window switch in opposite directions at the same time. If this is done, the window will stop and cannot be opened or closed.

## PANORAMIC SUNROOF (IF EQUIPPED)

If your vehicle is equipped with a sunroof, you can slide or tilt your sunroof with the sunroof control switch located on the overhead console.



The sunroof can only be opened, closed, or tilted when the ignition switch is in the ON position.

The sunroof is operable for 30 seconds, after the ignition switch is placed in the OFF or ACC position. However, if the front doors are opened, the sunroof cannot be operated even within 30 seconds.

### **i** Information

- In cold and wet climates, the sunroof may not work properly due to freezing conditions.
- After the vehicle is washed or in a rainstorm, be sure to wipe off any water that is on the sunroof before operating it.

### **!** WARNING

- Never adjust the sunroof or sunshade while driving. This could result in loss of control and an accident that may cause death, serious injury, or property damage.
- Make sure heads, hands, arms or any other body parts or objects are out of the way before operating the sunroof.
- Do not extend your head, arms or body outside the sunroof while driving, to avoid serious injury.
- Do not leave the engine running and the key in your vehicle with unsupervised children. Unattended children could operate the sunroof, which could result in serious injury.
- Do not sit on the top of the vehicle. It may cause injury or vehicle damage.

### **NOTICE**

- Do not continue to move the sunroof control lever after the sunroof is fully opened, closed, or tilted. Damage to the motor or system components could occur.
- Make sure the sunroof is closed fully when leaving your vehicle.

If the sunroof is left open, rain or snow may wet the interior of the vehicle. Also, leaving the sunroof open when the vehicle is unattended may invite theft.

## Sunshade



- To open the sunshade, pull the sunroof control lever (1) backward to the first detent position.
- To close the sunshade when the sunroof glass is closed, push the sunroof control lever (1) forward.

To stop the sunroof movement at any point, push the sunroof control lever either forward or backward momentarily.

### **i** Information

Activating the control lever to the first detent requires only a very light touch.

## Sliding the Sunroof



### **When the sunshade is closed**

If you push the sunroof control lever (1) backward past the first detent, the sunshade will slide all the way open and then the sunroof glass will slide all the way open.

To stop the sunroof movement at any point, push the sunroof control lever (1) either forward or backward momentarily.

### **When the sunshade is opened**

If you pull the sunroof control lever backward, the sunroof glass will slide all the way open. To stop the sunroof movement at any point, pull or push the sunroof control lever momentarily.

### **i** Information

Only the front glass of the sunroof opens and closes.

## Tilting the Sunroof



### **When the sunshade is closed**

If you push the sunroof control lever upward towards the roof of the vehicle, the sunshade will slide open then the sunroof glass will tilt open.

To stop the sunroof movement at any point, push the sunroof control lever either forward or backward momentarily.

### **When the sunshade is opened**

If you push the sunroof control lever upward, the sunroof glass will tilt open.

To stop the sunroof movement at any point, push the sunroof control lever either forward or backward momentarily.

## Closing the Sunroof

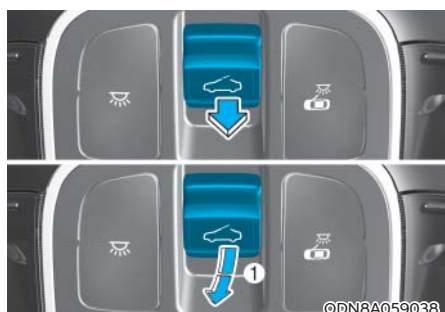

### To close sunroof glass

Push the sunroof control lever (1) forward to the first detent position.

### To close sunroof glass with sunshade

Push the sunroof control lever (1) forward to the second detent position.

The sunroof glass will close, then the sunshade will close automatically.

To stop the sunroof movement at any point, push the sunroof control lever (1) either forward or backward momentarily.

## Automatic reverse (if equipped)

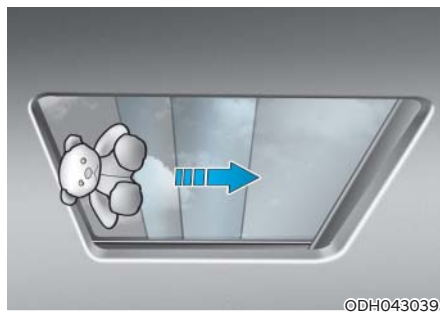

If the sunroof senses any to an obstacle while it is closing automatically, it will reverse direction then stop to allow the object to be cleared.

## WARNING

Small objects that can get caught between the sunroof glass and the front glass channel may not be detected by the automatic reverse system. In this case, the sunroof glass will not detect the object and will not reverse direction.

## NOTICE

- Periodically remove any dirt that may accumulate on the sunroof guide rail or between the sunroof and roof panel which can make a noise.
- Do not try to open the sunroof when the temperature is below freezing or when the sunroof is covered with snow or ice, otherwise the motor could be damaged. In cold and wet climates, the sunroof may not work properly.



## Resetting the Sunroof



The sunroof may need to be reset if the following conditions occur:

- The battery is discharged or disconnected or the sunroof fuse has been replaced or disconnected
- The sunroof control lever is not operating correctly

To reset the sunroof, perform the following steps:

1. Turn the engine on and close the sunroof glass and sunshade completely.
2. Release the control lever.
3. Push and hold the sunroof control lever (1) forward (to close the sunshade) for about 10 seconds until the sunroof moves slightly, then release the control lever.
4. Push and hold the sunroof control lever forward until the sunroof operates as follows:  
TILT DOWN → SLIDE OPEN → SLIDE CLOSE

Then, release the control lever.

When this is complete, the sunroof system is reset.

For more information, contact an authorized HYUNDAI dealer.

## **i** Information

**If you do not reset the sunroof, it may not work properly.**

## Sunroof Open Warning (if equipped)

- If the driver turns off the engine when the sunroof is not fully closed, the warning chime will sound for approximately 3 seconds and the sunroof open warning will appear on the cluster LCD display.
- If the driver turns off the engine and opens the door when the sunroof is not fully closed, the sunroof open warning will appear on the cluster LCD display until the door is closed or the sunroof is fully closed.

Close the sunroof securely when leaving your vehicle.

## EXTERIOR FEATURES

### Hood

#### Opening the hood

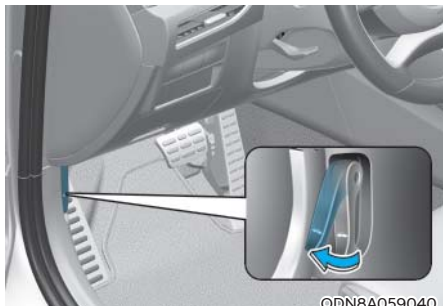

1. Park the vehicle and set the parking brake.
2. Pull the release lever to unlatch the hood. The hood should pop open slightly.

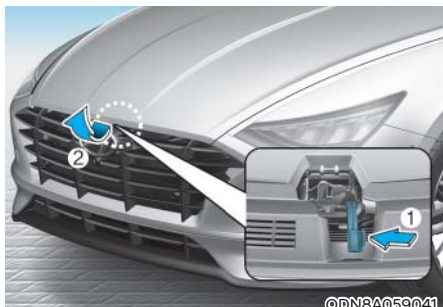

3. Go to the front of the vehicle, raise the hood slightly, push up the secondary latch (1) inside of the hood center and lift the hood (2). After it has been raised about halfway, it will raise completely by itself.

#### Closing the hood

1. Before closing the hood, check in and around the engine compartment to ensure the following:
  - Any tools or other loose objects are removed from the engine room area or hood opening area
  - All glove, rags, or other combustible material is removed from the engine compartment
  - All filler caps are tightly and correctly installed
2. Lower the hood halfway (lifted approximately 12 inches (30 cm) from the closed position) and push down to securely lock in place. Then double check to be sure the hood is secure. If the hood can be raised slightly, it is not securely locked. Open it again and close it with more force.

#### WARNING

- Before closing the hood, ensure all obstructions are removed from around the hood opening.
- Always double check to be sure that the hood is firmly latched before driving away. Check there is no hood open warning light or message displayed on the instrument cluster. Driving with the hood opened may cause a total loss of visibility, which might result in an accident.
- Do not move the vehicle with the hood in the raised position, as vision is obstructed, which might result in an accident, and the hood could fall or be damaged.

## Trunk

### Opening the trunk

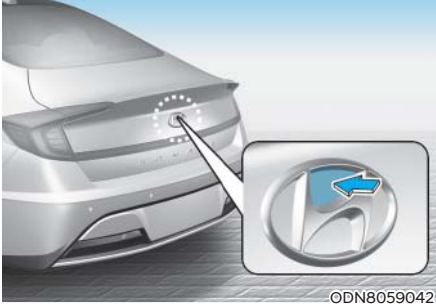

1. Make sure the shift button is in P (Park).
2. Then do one of the following :
  - Press the button on the trunk handle after locking or unlocking the door by remote key or smart key.
  - Press the trunk unlock button of remote key or smart key for more than 1 second.
  - Press the button on the trunk itself with the Smart Key in your possession.



### WARNING

The button on the trunk handle is made of the rubber. Do not press it with the sharp objects such as the key, screwdriver or drill.

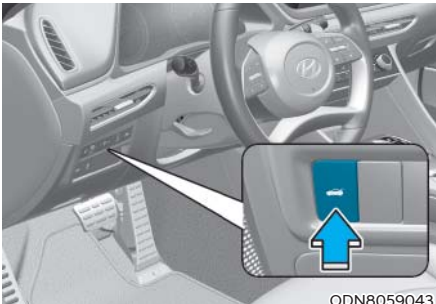

- Use the trunk release button.

3. Lift the trunk lid up.

### Closing the trunk

Lower the trunk lid and press down until it locks.



### WARNING

Always keep the trunk lid completely closed while the vehicle is in motion. If it is left open or ajar, poisonous exhaust gases containing carbon monoxide (CO) may enter the vehicle and serious illness or death may result.



### WARNING

Make sure there are no people or objects around the trunk before opening or closing the Power Trunk. Wait until the trunk is open fully and stopped before loading or unloading cargo from the vehicle.

### NOTICE

To prevent damage to the trunk lift cylinders and the attached hardware, always close the trunk before driving.



### Information

In cold and wet climates, trunk lock and trunk mechanisms may not work properly due to freezing conditions.



### WARNING

Always be careful to open and close the trunk.

- To prevent serious injury and damage, you should check and keep your body parts such as hands or head away from the path of the trunk while closing or opening the trunk.
- Your body parts or an object might be damaged by sharp edges so you should be careful while opening/closing the trunk or taking the thing out from the trunk. Especially, a child can hit the face or head around the trunk so you should be cautious all the time.

## Emergency Trunk Safety Release Inside the trunk



Your vehicle is equipped with an Emergency Trunk Safety Release lever located inside the trunk. When someone is inadvertently locked in the trunk, the trunk can be opened by moving the lever in the direction of the arrow and pushing the trunk open.

### **WARNING**

- **You and your passengers must be aware of the location of the Emergency Trunk Safety Release lever in this vehicle and how to open the trunk in case you are accidentally locked in the trunk.**
- **NEVER** allow anyone to occupy the trunk of the vehicle at any time. If the trunk is partially or totally latched and the person is unable to get out, serious injury or death could occur due to lack of ventilation, exhaust fumes and rapid heat build-up, or because of exposure to cold weather conditions. The trunk is also a highly dangerous location in the event of a crash because it is not a protected occupant space but is a part of the vehicle's crush zone.
- **Your vehicle should be kept locked and the Smart Key should be kept out of the reach of children. Parents should teach their children about the dangers of playing in trunks.**

- **Use the release lever for emergencies only.**

## Inside the vehicle

When you can not unlock the trunk due to battery discharge or other reasons, you can unlock the trunk inside the vehicle.

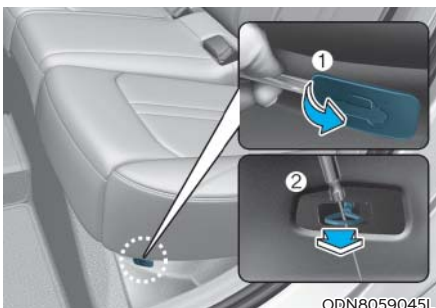

Open the cable cover(1) under the rear seat with a mechanical key and pull the cable (2) for unlocking the trunk.

The cable is firmly fixed so it may hard to pull. Therefore, please use a tool such as a screwdriver to assist in pulling the loop for the emergency release.

## Smart Trunk with Auto Open (if equipped)

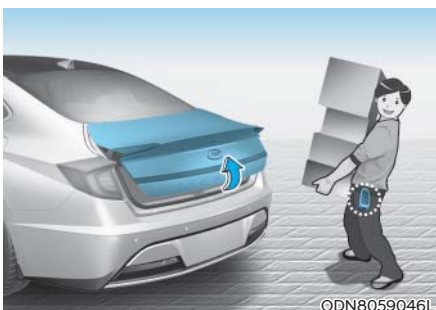

On a vehicle equipped with a smart key, the trunk can be opened using the Smart Trunk with Auto Open system.

### How to use the Smart Trunk with Auto Open

The trunk can be opened with no-touch activation satisfying all the conditions below.

- After 15 seconds when all doors are closed and locked
- Positioned in the detecting area for more than 3 seconds.

#### **i** Information

- **The Smart Trunk with Auto Open does not operate when:**
  - **The smart key is detected within 15 seconds after the doors are closed and locked, and is continuously detected.**
  - **The smart key is detected within 15 seconds after the doors are closed and locked, and within 60 inches (1.5 m) from the front door handles. (for vehicles equipped with Welcome Light)**
  - **A door is not locked or closed.**
  - **The smart key is in the vehicle.**

#### 1. Setting

To activate the Smart Trunk with Auto Open, go to User Settings Mode and select Smart Trunk on the LCD display.

**For more information, refer to the “LCD Display” section in this chapter. If your vehicle is equipped with additional navigation, please refer to the infotainment system manual separately supplied.**

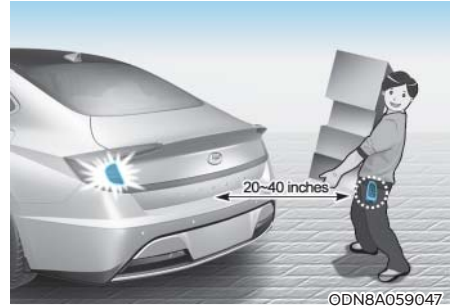

#### 2. Detect and Alert

If you are positioned in the detecting area (20~40 inches (50 ~100 cm) behind the vehicle) carrying a smart key, the hazard warning lights will blink and chime will sound to alert you the smart key has been detected and the trunk will open.

#### **i** Information

**Do not approach the detecting area if you do not want the trunk to open. If you have unintentionally entered the detecting area and the hazard warning lights and chime starts to operate, leave the detecting area with the smart key. The trunk will stay closed.**

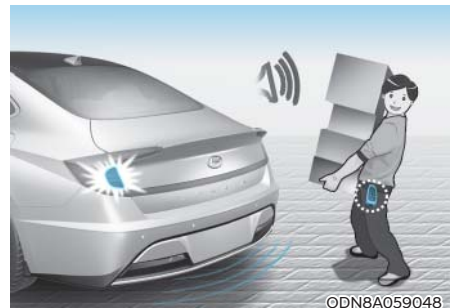

#### 3. Automatic opening

The hazard warning lights will blink and chime will sound 6 times and then the trunk will open.



**WARNING**

- Make sure you close the trunk before driving your vehicle.
- Make sure there are no people or objects around the trunk before opening or closing the trunk.
- Make sure objects in the trunk do not come out when opening the trunk on a slope. It may cause serious injury.
- Make sure to deactivate the Smart Trunk when washing your vehicle. Otherwise, the trunk may open inadvertently.
- The key should be kept out of reach of children. Children may inadvertently open the Smart Trunk while playing around the rear area of the vehicle.

**How to deactivate the Smart Trunk with Auto Open function using the smart key**

■ Type A



ODN8A059006

■ Type B



ODN8A059007

- (1) Door lock
- (2) Door unlock
- (3) Trunk open

If you press any button of the smart key during the Detect and Alert stage, the Smart Trunk with Auto Open function will be deactivated.

Make sure to be aware of how to deactivate the Smart Trunk with Auto open function for emergency situations.

### **i** Information

- If you press the door unlock button (2), the Smart Trunk with Auto Open function will be deactivated temporarily. But, if you do not open any door for 30 seconds, the Smart Trunk with Auto Open function will be activated again.
- If you press the trunk open button (3) for more than 1 second, the trunk opens.
- If you press the door lock button (1) or trunk open button (3) when the Smart Trunk with Auto Open in the Detect and Alert stage, the Smart Trunk with Auto Open function will not be deactivated.
- In case you have deactivated the Smart Trunk with Auto Open function by pressing the smart key button and opened a door, the Smart Trunk with Auto Open function can be activated again by closing and locking all doors.

### *Detecting area*



- The Smart Trunk with Auto Open operates with a welcome alert if the smart key is detected within 20~40 inches (50~100 cm) from the trunk.
- The alert stops at once if the smart key is positioned outside the detecting area during the Detect and Alert stage.

### **i** Information

- The Smart Trunk with Auto Open function will not work if any of the following occurs:
  - The smart key is close to a radio transmitter such as a radio station or an airport which can interfere with normal operation of the transmitter.
  - The smart key is near a mobile two way radio system or a cellular phone.
  - Another vehicle's smart key is being operated close to your vehicle.
- The detecting range may decrease or increase when :
  - One side of the tire is raised to replace a tire or to inspect the vehicle.
  - The vehicle is parked on a slope or unpaved road, etc.

## Fuel Filler Door

### Opening the fuel filler door



1. Turn the engine off.
2. Ensure the driver's door is unlocked.
3. Push the fuel filler door near the 3 o'clock position.

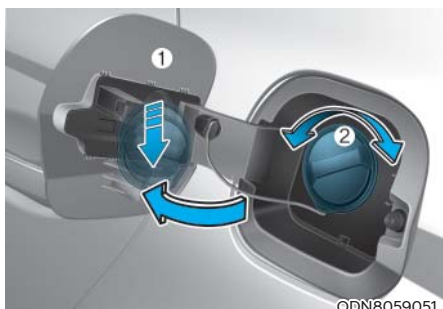

3. Pull the fuel filler door (1) outward to access the fuel tank cap.
4. To remove the fuel tank cap (2), turn it counterclockwise. You may hear a hissing noise as the pressure inside the tank equalizes.
5. Place the cap on the fuel filler door.

## **i** Information

If the fuel filler door does not open because ice has formed around it, tap lightly or push on the door to break the ice and release the door. Do not pry on the door. If necessary, spray around the door with an approved deicer fluid (do not use radiator antifreeze) or move the vehicle to a warm place and allow the ice to melt.

### Closing the fuel filler door

1. To install the fuel tank cap, turn it clockwise until it "clicks" one time.
2. Close the fuel filler door until it is latched securely.

## **!** WARNING

Gasoline is highly flammable and explosive. Failure to follow these guidelines may result in **SERIOUS INJURY** or **DEATH**:

- Read and follow all warnings posted at the gas station.
- Before refueling, note the location of the Emergency Gasoline Shut-Off, if available, at the gas station.
- Before touching the fuel nozzle, you should eliminate the potential build-up of static electricity by touching a metal part of the vehicle, a safe distance away from the fuel filler neck, nozzle, or other gas source, with your bare hand.
- Do not use cellular phones while refueling. Electric current and/or electronic interference from cellular phones can potentially ignite fuel vapors and cause a fire.



- Do not get back into a vehicle once you have begun refueling. You can generate a buildup of static electricity by touching, rubbing or sliding against any item or fabric capable of producing static electricity. Static electricity discharge can ignite fuel vapors causing a fire. If you must re-enter the vehicle, you should once again eliminate potentially dangerous static electricity discharge by touching a metal part of the vehicle, away from the fuel filler neck, nozzle or other gasoline source, with your bare hand.
- When using an approved portable fuel container, be sure to place the container on the ground prior to refueling. Static electricity discharge from the container can ignite fuel vapors causing a fire. Once refueling has begun, contact between your bare hand and the vehicle should be maintained until the filling is complete.
- Use only approved portable plastic fuel containers designed to carry and store gasoline.
- When refueling, always move the shift button to the P (Park) position, set the parking brake, and place the ignition switch to the LOCK/OFF position. Sparks produced by electrical components related to the engine can ignite fuel vapors causing a fire.
- Do not use matches or a lighter and do not smoke or leave a lit cigarette in your vehicle while at a gas station, especially during refueling.
- Do not over-fill or top-off your vehicle tank, which can cause gasoline spillage.
- If a fire breaks out during refueling, leave the vicinity of the vehicle, and immediately contact the manager of the gas station and then contact the local fire department. Follow any safety instructions they provide.
- If pressurized fuel sprays out, it can cover your clothes or skin and thus subject you to the risk of fire and burns. Always remove the fuel cap carefully and slowly. If the cap is venting fuel or if you hear a hissing sound, wait until the condition stops before completely removing the cap.
- Always check that the fuel cap is installed securely to prevent fuel spillage in the event of an accident.

### Information

Make sure to refuel your vehicle according to the “Fuel Requirements” suggested in the Introduction chapter.

### **NOTICE**

- Do not spill fuel on the exterior surfaces of the vehicle. Any type of fuel spilled on painted surfaces may damage the paint.
- If the fuel filler cap requires replacement, use only a genuine HYUNDAI cap or the equivalent specified for your vehicle. An incorrect fuel filler cap can result in a serious malfunction of the fuel system or emission control system.

## HEAD UP DISPLAY (HUD) (IF EQUIPPED)



The Head-Up Display is an optional feature that allows the driver to view information projected onto a transparent screen while still keeping your eyes safely on the road ahead while driving.

### ***Precautions while using the head up display***

It may sometimes be difficult to read information on the head up display in the following situations.

- The driver is improperly positioned in the driver's seat.
- The driver wears polarizing-filter sunglasses.
- An object is located above the head up display cover.
- The vehicle is driven on a wet road.
- Any improper lighting accessory is installed inside the vehicle, or there is incoming light from outside of the vehicle.
- The driver wears glasses.
- The driver wears contact lenses.

When it is difficult to read the head up display information, adjust the head up display angle or the head up display brightness level in the User Settings mode. For more information, refer to "LCD Display" in this chapter.



### **WARNING**

- Do not tint the front windshield glass or add other types of metallic coating. Otherwise, the head up display image may be invisible.
- Do not place any accessories on the crash pad or attach any objects on the windshield glass.
- The Blind-spot Collision Warning system warnings on the head up display are supplemental. Do not solely depend on them to change lanes. Always take a look around before changing lanes.

### **NOTICE**

When replacing the front windshield glass of the vehicle equipped with the head up display, replace it with a windshield glass designed for the head up display operation. Otherwise, duplicated images may be displayed on the windshield glass.

### ***Head-up display ON/OFF***

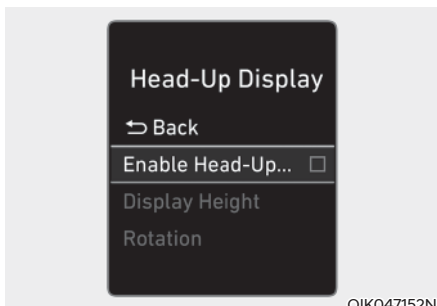

To activate the head up display, select 'Enable Head-Up Display' on the User Settings mode on the instrument cluster LCD display.

If you do not select 'Enable Head-Up Display', the head up display will be deactivated.

If your vehicle is equipped with additional navigation, please refer to the infotainment system manual separately supplied.

### Head-up display information

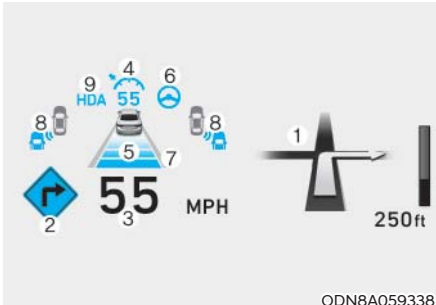

1. Turn-by-turn (TBT) navigation information
2. Road information
3. Speedometer
4. Cruise system set speed
5. Smart Cruise Control information
6. Lane Following Assist system information
7. Lane Keeping Assist system information
8. Blind-spot Collision Warning system information
9. Highway Driving Assist system information

The information provided may differ depending on which functions are applicable to your vehicle.

### **i** Information

**If you select the Turn By Turn (TBT) navigation information as Head-Up Display contents, the Turn By Turn (TBT) navigation information will not be displayed in the instrument cluster LCD display.**

### Head-up display setting

On the LCD display, you can change the head up display settings as follows.

- Enable Head-up display
- Display Height
- Rotation
- Brightness
- Content Selection
- Speed Size
- Speed Color

**For more information, refer to “LCD Display” in chapter 4. If your vehicle is equipped with additional navigation, please refer to the infotainment system manual separately supplied.**

## LIGHTING

### Exterior Lights

#### Lighting control

To operate the lights, turn the knob at the end of the control lever to one of the following positions:



1. OFF position
2. AUTO headlamp position
3. Parking lamp position
4. Headlamp position

#### Daytime running light (DRL)

The Daytime Running Lights (DRL) can make it easier for others to see the front of your vehicle during the day, especially after dawn and before sunset.

The DRL system will turn the dedicated lamp OFF when:

- The headlamps are ON.
- The parking lamps are ON.
- The vehicle is turned off.
- The parking brake is engaged.

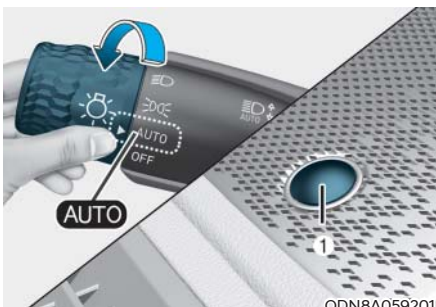

#### AUTO headlamp position

The parking lamp and headlamp will be turned ON or OFF automatically depending on the amount of daylight as measured by the ambient light sensor on the center dash (1).

Even with the AUTO headlamp feature in operation, it is recommended to manually turn ON the headlamps when driving at night or in a fog, driving in the rain, or when you enter dark areas, such as tunnels and parking facilities.

#### NOTICE

- **Do not cover or spill anything on the sensor (1) located in front of the instrument panel.**
- **Do not clean the sensor using a window cleaner, the cleanser may leave a light film which could interfere with sensor operation.**
- **If your vehicle has window tint or other types of metallic coating on the front windshield, the AUTO headlamp system may not work properly.**

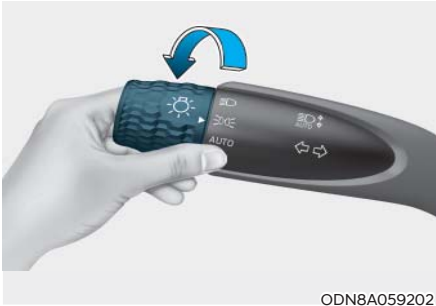

ODN8A059202

### Parking lamp position (D)

The parking lamp, license plate lamp and instrument panel lamp are turned ON.



ODN8A059203

### Headlamp position (3/VE)

The headlamp, parking lamp, license plate lamp and instrument panel lamp are turned ON.

## **i** Information

The ignition switch must be in the ON position to turn on the headlamp.

## High beam operation



ODN8A059205

To turn on the high beam headlamp, push the lever away from you. The lever will return to its original position.

The high beam indicator will light when the headlamp high beams are switched on.

To turn off the high beam headlamp, pull the lever towards you. The low beams will turn on.

## **!** WARNING

Do not use high beam when there are other vehicles approaching you. Using high beam could obstruct the other driver's vision.



To flash the high beam headlamp, pull the lever towards you, then release the lever. The high beams will remain ON as long as you hold the lever towards you.

### High Beam Assist (HBA)



High Beam Assist is a system that automatically adjusts the headlamp range (switches between high beam and low beam) according to the brightness of other vehicles and road conditions.

### System setting

The driver can activate HBA by placing the ignition switch to the ON position and by selecting:

'User Settings → Lights → High Beam Assist'. If you disable this setting, HBA will not work.

The setting of the HBA will be maintained, as selected, when the engine is re-started.

### Operating condition

1. Place the headlamp switch in the AUTO position.
2. Turn on the high beam by pushing the lever away from you.  
High Beam Assist (HBA) indicator will illuminate.
3. High Beam Assist system will turn on when vehicle speed is above 25 mph (40 km/h).

- If the headlamp switch is pushed away when High Beam Assist system is operating, High Beam Assist system will turn off and the high beam will be on continuously.
- If the headlamp switch is pulled towards you when the high beam is OFF, the high beam will turn ON without High Beam Assist system canceled. When you let go of the light switch, the lever will move to the middle and the high beam will turn OFF.
- If the headlamp switch is pulled towards you when the high beam is on by High Beam Assist system, the low beam will be on and High Beam Assist system will turn OFF.
- If the headlamp switch is placed to the headlamp ON position, High Beam Assist system will turn off and the low beam will be on continuously.

When High Beam Assist system is operating, the high beam switches to low beam if any of the following conditions occur:

- When the headlamp of an on-coming vehicle is detected.
- When the tail lamp of a vehicle in front is detected.
- When the headlamp or tail lamp of a motorcycle or a bicycle is detected.
- When the surrounding ambient light is bright enough that high beams are not required.
- When streetlights or other lights are detected.
- When the headlamp switch is not in the AUTO position.
- When High Beam Assist system is off.
- When vehicle speed is below 15 mph (24 km/h).

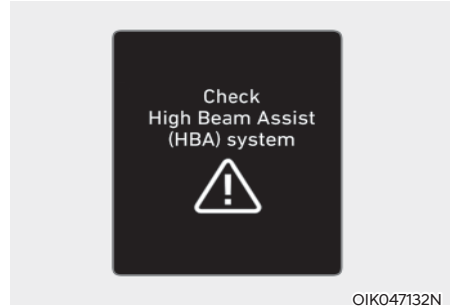

#### Warning light and message

When High Beam Assist system is not working properly, the Check High Beam Assist warning message will come on for a few seconds. After the message disappears, the master warning light (⚠) will illuminate. Take your vehicle to an authorized HYUNDAI dealer and have the system checked.



#### CAUTION

**The system may not operate normally if any of the following conditions should occur:**

1. **When the illumination from an on-coming vehicle or a vehicle in front is dim. Such examples may include:**
  - **When the headlamps of an on-coming vehicle or the tail lamps of a vehicle in front is covered with dust, snow, or water.**
  - **When the headlamps on an on-coming vehicle are OFF, but the fog lamps are ON.**

2. When the High Beam Assist camera is adversely affected by an external condition. Such examples may include:

- When the vehicle's headlamps have been damaged or not repaired properly.
- When the vehicle headlamps are not aimed properly.
- When the vehicle is driven on a narrow curved road or rough road
- When the vehicle is driven on an uphill road or downhill road
- When only part of the vehicle in front is visible on a crossroad or curved road.
- When there is a traffic light, reflecting sign, flashing sign or mirror.
- When the road conditions are bad such as being wet or covered with snow.
- When a vehicle suddenly appears from a curve.
- When the vehicle is tilted from a flat tire or being towed.
- When Lane Keeping Assist system warning light illuminates.
- When the light from the on-coming or front vehicle is not detected because of exhaust fume, smoke, fog, snow, etc.
- When the front window is covered with foreign matters such as ice, dust, fog, or is damaged.

3. When the forward visibility is poor. Such examples may include:

- When the headlamps of an on-coming vehicle or a vehicle in front is not detected due to poor outside visibility (smog, smoke, dust, fog, heavy rain, snow, etc.).
- When the windshield visibility is poor.



## WARNING

- Do not attempt to disassemble the front view camera without the assistance of an authorized HYUNDAI dealer technician. If the front camera is removed for any reason, the system may need to be re-calibrated. Have the system inspected by an authorized HYUNDAI dealer.
- If the windshield of your vehicle is replaced, most likely the front view camera will need to be re-calibrated. If this occurs, have your vehicle inspected and have the system re-calibrated by an authorized HYUNDAI dealer.
- Be careful that water doesn't get into High Beam Assist unit and do not remove or damage related parts of High Beam Assist system.
- Do not place objects on the crash pad that reflect light such as mirrors, white paper, etc. The system may malfunction if sunlight is reflected.
- At times, High Beam Assist system may not work properly. The system is for your convenience only. It is the responsibility of the driver for safe driving practices and always check the road conditions for your safety.
- When the system does not operate normally, change the headlamp position manually between the high beam and low beam.



### Turn signals and lane change signals

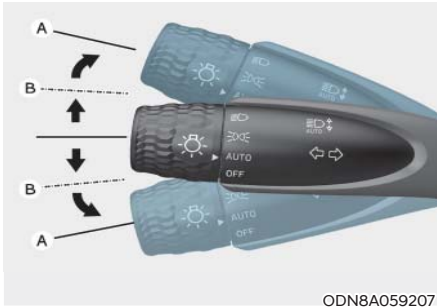

To signal a turn, push down on the lever for a left turn or push up for a right turn in position (A).

If an indicator stays on and does not flash or if it flashes abnormally, one of the turn signal bulbs may be burned out and will require replacement.

#### One touch turn signal function

To activate the One Touch Turn Signal function, push the turn signal lever up or down to position (B) and then release it.

The lane change signals will blink 3, 5 or 7 times.

You can activate or deactivate the One Touch Turn Signal function or choose the number of blinks (3, 5, or 7) from the User Settings mode in the LCD display.

### Battery saver function

The purpose of this feature is to prevent the battery from being discharged.

The system automatically turns off the parking lamp when the driver turns the vehicle off and opens the driver-side door.

With this feature, the parking lamps will turn off automatically if the driver parks on the side of road at night.

If necessary, to keep the lamps on when the vehicle is turned off, perform the following:

- (1) Open the driver-side door.
- (2) Turn the parking lamps OFF and ON again using the headlamp switch on the steering column.

### Headlamp delay function

If the key is removed from the ignition switch or placed in the ACC position or the LOCK/OFF position with the headlamps ON, the headlamps (and/or parking lamps) remain on for about 5 minutes. However, if the driver's door is opened and closed, the headlamps are turned off after 15 seconds. Also, with the engine off if the driver's door is opened and closed, the headlamps (and/or parking lamps) are turned off after 15 seconds.

The headlamps (and/or parking lamps) can be turned off by pressing the lock button on the remote key or smart key twice or turning the headlamp switch to the OFF or AUTO position.

You can activate or deactivate the Headlamp Delay function from the User Settings Mode in the LCD display.

### **NOTICE**

If the driver exits the vehicle through another door besides the driver door, the battery saver function does not operate and the headlamp delay function does not turn OFF automatically.

This may cause the battery to discharge. To avoid battery discharge, turn OFF the headlamps manually from the headlamp switch before exiting the vehicle.

### **Headlamp leveling device**

It automatically adjusts the headlamp beam level according to the number of passengers and loading weight in the luggage area.

And it offers proper headlamp beam under various conditions.



### **WARNING**

If the function does not work properly, have the vehicle inspected by an authorized HYUNDAI dealer. Do not attempt to inspect or replace the wiring yourself.

## Interior Lights



### **WARNING**

Do not use the interior lights when driving in the dark. The interior lights may obscure your view and cause an accident.

### **NOTICE**

Do not use the interior lights for extended periods when the vehicle is turned off or the battery will discharge.

### **Interior lamp AUTO cut**

The interior lamps will automatically go off approximately 20 minutes after the engine is turned off and the doors are closed. If a door is opened, the lamp will go off 40 minutes after the engine is turned off. If the doors are locked by the remote key or smart key and the vehicle enters the armed stage of the theft alarm system, the lamps will go off five seconds later.

## Front lamps

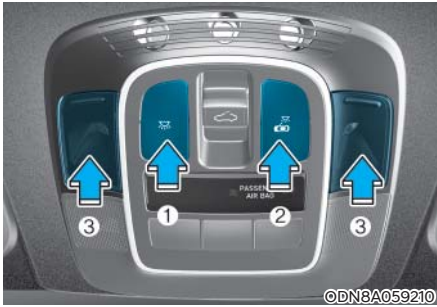

### Front Map Lamp (1):

Press either lenses to turn the map lamp on or off. This light produces a spot beam for convenient use as a map lamp at night or as a personal lamp for the driver and the front passenger.

### Front Door Lamp (2) (🚗):

The front or rear room lamps come on when the front or rear doors are opened if the engine is running or not. When doors are unlocked by the remote key or smart key, the front and rear lamps come on for approximately 30 seconds as long as any door is not opened. The front and rear room lamps go out gradually after approximately 30 seconds when the door is closed. However, if the ignition switch is in the ON position or all doors are locked, the front and rear lamps will turn off. If a door is opened with the ignition switch in the ACC position or the OFF position, the front and rear lamps stay on for about 20 minutes.

### Front room lamp (3) (🏠):

Press the button to turn ON the room lamp for the front/rear seats.

## Rear lamp

### ■ Type A (without sunroof)

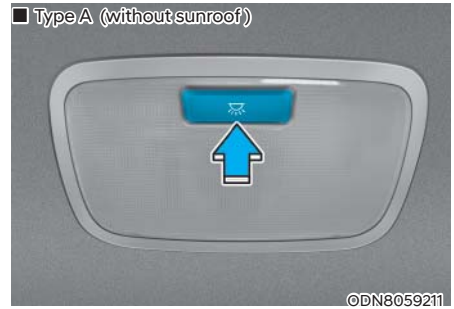

### ■ Type B (with sunroof)



### Rear Room Lamp (🏠):

Press this switch to turn the rear room lamp on and off.

## NOTICE

**Do not leave the lamp switches on for an extended period of time when the engine is turned off.**

### Luggage compartment lamp

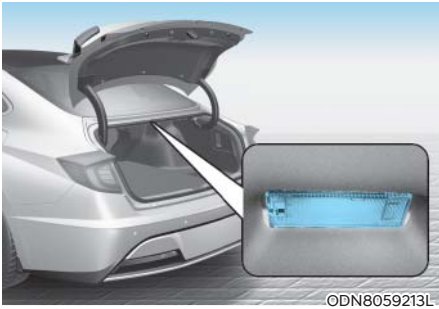

The luggage compartment lamp comes on when the trunk is opened.



#### **NOTICE**

The luggage compartment lamp comes on as long as the trunk is open. To prevent unnecessary battery system drain, close the trunk securely after using the luggage compartment.

### Vanity mirror lamp



Push the switch to turn the light on or off.

-  : The lamp will turn on if this button is pressed.
-  : The lamp will turn off if this button is pressed.

#### **NOTICE**

Always have the switch in the off position when the vanity mirror lamp is not in use. If the sunvisor is closed without the lamp off, it may discharge the battery or damage the sunvisor.

## Welcome System (if equipped)

### Welcome light



ODN8A059099

### Door handle lamp

When all the doors (and trunk) are closed and locked, the door handle lamp will come on for about 15 seconds if any of the below is performed.

- When the door unlock button is pressed on the remote key or smart key.
- When the button of the outside door handle is pressed.
- When the vehicle is approached with the smart key in possession.

### Headlamp

When the headlamp (lamp switch in the headlamp or AUTO position) is on and all doors (and trunk) are locked and closed, the headlamp will come on for 15 seconds if/or any of the below is performed.

- When the door unlock button is pressed on the remote key or smart key.

At this time, if you press the door lock or unlock button, the headlamp will turn off immediately.

You can activate or deactivate the Welcome Light from the User Settings Mode on the LCD display.

**For more information, refer to “LCD Display” in chapter 4. If your vehicle is equipped with additional navigation, please refer to the infotainment system manual separately supplied.**

### Interior lamp

When the interior lamp switch is in the DOOR position and all doors (and trunk) are closed and locked, the room lamp will come on for 30 seconds if any of the below is performed.

- When the door unlock button is pressed on the remote key or smart key.
- When the button of the outside door handle is pressed.

At this time, if you press the door lock or unlock button, the room lamp will turn off immediately.

## WIPERS AND WASHERS

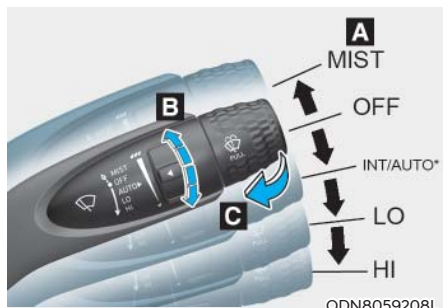

### A. Wiper speed control

- MIST – Single wipe
- OFF – Off
- INT / - - - – Intermittent wipe  
AUTO – Auto control wipe
- LO– Low wiper speed
- HI – High wiper speed

### B. Intermittent control wipe time adjustment

### C. Wash with brief wipes (pull lever towards you)

## Windshield Wipers

Operates as follows when the ignition switch is in the ON position.

**MIST:** For a single wiping cycle, push the lever upward and release. The wipers will operate continuously if the lever is held in this position.

**OFF:** Wiper is not in operation.

**INT:** Wiper operates intermittently at the same wiping intervals. To vary the speed setting, move the speed control lever. The top most setting will run the wipers most frequently (for more rain). The bottom setting will run the wipers the least frequently (for less rain).

**AUTO:** The rain sensor located on the upper end of the windshield glass senses the amount of rainfall and controls the wiping cycle for the proper interval. The more it rains, the faster the wiper operates. When the rain stops, the wiper stops. To vary the speed setting, turn the speed control knob (B).

**LO:** The wiper runs at a lower speed.

**HI:** The wiper runs at a higher speed.

## **i** Information

**If there is heavy accumulation of snow or ice on the windshield, defrost the windshield for about 10 minutes, or until the snow and/or ice is removed before using the windshield wipers to ensure proper operation.**

**If you do not remove the snow and/or ice before using the wiper and washer, it may damage the wiper and washer system.**

## **i** Information

If the wiper switch is set in AUTO mode when Engine Start/Stop button is in the ON position, the wiper will operate once to perform a self-check of the system. Set the wiper to the OFF position when the wiper is not in use.

## **!** WARNING

To avoid personal injury from the windshield wipers, when the engine is running and the windshield wiper switch is placed in the AUTO mode:

- Do not touch the upper end of the windshield glass facing the rain sensor.
- Do not wipe the upper end of the windshield glass with a damp or wet cloth.
- Do not put pressure on the windshield glass.

## Windshield Washers



In the OFF position, pull the lever gently toward you to spray washer fluid on the windshield and to run the wipers 1-3 cycles. The spray and wiper operation will continue until you release the lever. If the washer does not work, you may need to add washer fluid to the washer fluid reservoir.

## **!** WARNING

When the outside temperature is below freezing, ALWAYS warm the windshield using the defroster to help prevent the washer fluid from freezing on the windshield and obscuring your vision which could result in an accident and serious injury or death.

## **NOTICE**

- To prevent possible damage to the washer pump, do not operate the washer when the fluid reservoir is empty.
- To prevent possible damage to the wipers or windshield, do not operate the wipers when the windshield is dry.
- To prevent damage to the wiper arms and other components, do not attempt to move the wipers manually.
- To prevent possible damage to the wipers and washer system, use anti-freezing washer fluids in the winter season or cold weather.

## REAR VIEW MONITOR (RVM) (IF EQUIPPED)

Rear View Monitor system is a supplemental system that shows the area behind the vehicle on the infotainment system screen to assist you when parking or driving.

### Rear View Monitor with Parking Guidance

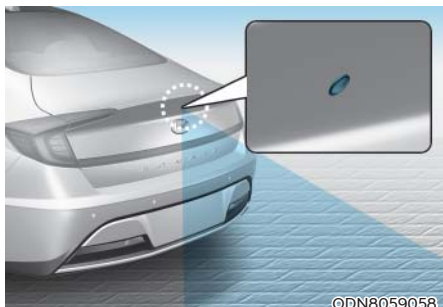

- Rear View Monitor with parking guidance will activate when the engine is running and the shift into R (Reverse) position.
- To assist in parking, the rear view is shown (the parking guide line disappears) on the screen when the shift button is shifted from R (Reverse) to D (Drive) with vehicle speed below 6 mph (10 km/h).

### Rear View Monitor - Top View



When you touch the icon (1), the top view is displayed on the screen and shows the distance from the vehicle in the back of your vehicle. Touch the icon (1) again, to switch back to the previous screen.

#### WARNING

Rear View Monitor is not a safety device. It only serves to assist the driver in identifying objects directly behind the middle of the vehicle. The camera does NOT cover the complete area behind the vehicle.

#### WARNING

- Never rely solely on the rear camera display when backing-up.
- **ALWAYS** look around your vehicle to make sure there are no objects or obstacles before moving the vehicle in any direction to prevent a collision.
- Always pay close attention when the vehicle is driven close to objects, particularly pedestrians, and especially children.



**NOTICE**

- Do not spray the camera or its surrounding area directly with a high pressure washer. Shock applied from high pressure water may cause the device to not operate normally.
- Do not use any cleanser containing acid or alkaline detergents when cleaning the lens. Use only a mild soap or neutral detergent, and rinse thoroughly with water.
- Always keep the camera lens clean. The camera may not work normally if the lens is covered with dirt, water or snow.

## SURROUND VIEW MONITOR (SVM) (IF EQUIPPED)



Surround View Monitor system can assist in parking by allowing the driver to see around the vehicle.

### Operating Conditions

- The engine is running.
- The Surround View Monitor button (1) is pressed (indicator ON).
- The gear status is on D (Drive), N (Neutral), R (Reverse). (On P (Park), it doesn't work.)
- Vehicle speed is under 10 mph (15 km/h).

### Deactivations

- The Surround View Monitor button (1) is pressed again (indicator OFF).
- Vehicle speed is over 10 mph (15 km/h).

### System operation

- When vehicle speed is over 10 mph (15 km/h), the system will turn off. The system will not automatically turn on again, even though vehicle speed gets below 10 mph (15 km/h). Press the button (1, indicator ON) again, to turn on the system.

- When the vehicle is backing up, the system will turn ON regardless of vehicle speed or button status. However, if vehicle speed is over 10 mph (15 km/h) when driving forward, Surround View Monitor system will turn off.
- An indicator on the screen appears when:
  - The trunk is opened
  - The driver/passenger's door is opened
  - The side view mirror is folded
- When you set up 'Surround View Monitor Auto On' on the user setting menu, you can choose the Surround View Monitor system to turn on automatically in case of the parking alarm sounds.
- If the system is not operating normally, have the vehicle inspected by an authorized HYUNDAI dealer.



### CAUTION

- **Surround View Monitor system is a parking assist system. Because the images of the four cameras on the front, rear, left, and right are synthesized, the SVM view and parking guidelines may differ from the actual vehicle location. So, check all directions for safety.**
- **Always keep the camera lenses on the front, rear, left and right clean. If lenses are covered with foreign matter, the camera may not operate normally.**

## REVERSE PARKING COLLISION-AVOIDANCE ASSIST

Reverse Parking Collision-Avoidance Assist (PCA) is a supplemental system that can warn the driver or apply braking force to reduce the possibility of collision with pedestrians when the vehicle is reversing.



### WARNING

- **Always look around your vehicle to make sure there are no objects or pedestrian before moving the vehicle in any direction to prevent a collision.**
- **Do not solely rely on Reverse Parking Collision-Avoidance Assist system. The system might not assist the driver leading to pedestrian injury or vehicle damage.**
- **Be aware that some objects may not be visible on the screen or be detected by the rear ultrasonic sensors, due to the objects' distance, size or material, all of which can limit the effectiveness of the sensors.**

## System Setting and Operation

### System setting

Parking Collision-Avoidance Assist-Reverse (PCA-R) can be activated from the Settings menu in the LCD display or infotainment system display by following the procedure below.

1. Set the Engine Start/Stop button to the ON or START position.
2. Select 'User Settings → Driver Assistance → Parking Safety → Active Assist / Warning Only / Off' in the LCD display or infotainment system display.
  - The system is ready for operation when 'Active Assist' is selected. In the event of an imminent collision with a pedestrian or an object, the system warns the driver or applies braking force to help avoid the collision.
  - The system is ready for operation when 'Warning Only' is selected. In the event of an imminent collision with a pedestrian, the system warns the driver but does not assist in braking.
  - The system deactivates when 'Off' is selected.

### Operating conditions

Reverse Parking Collision-Avoidance Assist system enters the ready status, when 'Active Assist' or 'Warning Only' is selected in the AVN system screen and the following conditions are satisfied:

- The trunk is closed
- The shift lever is in R (Reverse)
- Vehicle speed is below 6 mph (10 km/h)
- System components such as the rear view camera and the rear ultrasonic sensors are in normal conditions

The driver needs to select 'Active Assist' on the LCD display or infotainment system display for collision-avoidance assist.

The solid lines behind the vehicle in the cluster LCD display indicates that the system is ready to assist the driver.

Note that the system assists the driver only once. The driver has to shift the gear to R (Reverse) from another gear position to reactivate the system.

The performance of Reverse Parking Collision-Avoidance Assist system may vary under certain conditions. If the vehicle speed exceeds 2 mph (3 km/h), the system can assist only pedestrian collision avoidance.

As always, be careful when backing up your vehicle and be aware of your surroundings.

### Warning and System Control

#### Active assist

■ Cluster LCD display



ODN8A049043

■ Infotainment system display

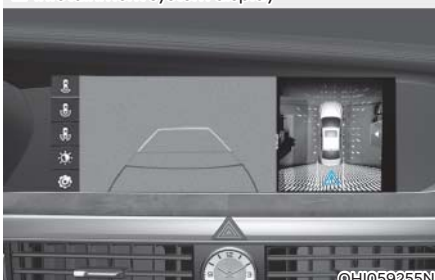

©HI059255NI

- If the system detects a risk of collision with a pedestrian or an object behind the vehicle, the system will warn the driver with audible warning, steering wheel vibration, and warnings on the cluster LCD display and the infotainment system display.
- If the system detects imminent collision with a pedestrian or an object behind the vehicle, the system may apply braking power. The driver needs to pay attention as the brake will release within 2 seconds. The driver must immediately depress the brake pedal and check surroundings.

The brake assist will turn off when:

- The driver shifts the gear to P (Park) or D (Drive)
- The driver depresses the brake pedal with sufficient power
- The braking has been assisted for approximately 2 seconds

The warning will turn off when:

- The driver shifts the gear to P (Park), N (Neutral), or D (Drive)

The brake control may not operate properly depending on the status of the ESC (Electronic Stability Control). There will only be a warning when:

- The ESC (Electronic Stability Control) warning light is on
- The ESC (Electronic Stability Control) is engaged in a different function

### **Warning only**

- If the system detects a risk of collision with a pedestrian or an object, the system will warn the driver with audible warning and warnings on the cluster LCD display or infotainment system display.
- If 'Warning Only' is selected, braking will not be assisted.

The warning will turn off when:

- The driver shifts the gear to P (Park), N (Neutral), or D (Drive)



### **WARNING**

- **Reverse Parking Collision-Avoidance Assist system may not operate properly or may operate unnecessarily in some circumstances.**
- **Always pay extreme caution while driving. The driver is responsible for controlling the brake appropriately.**



### **CAUTION**

- **Always pay attention to road and traffic conditions while driving, whether or not there is a warning.**
- **Playing the vehicle audio system at high volume may prevent occupants from hearing Reverse Parking Collision-Avoidance Assist system warning sounds.**
- **If any other warning sound, such as seat belt warning chime, is already generated, Reverse Parking Collision-Avoidance Assist system warning may not sound.**



### **Information**

The system can detect a pedestrian or an object when:

- **A pedestrian is standing behind the vehicle.**
- **A large obstacle, such as a vehicle, is parked in the rear center of the vehicle.**

## Detecting Sensor



### Rear view camera

The rear view camera acquires images for rear pedestrian detection. If the camera lens is covered with snow, rain, or a foreign substance, the system may not work properly. Always keep the camera lens clean.

### Rear ultrasonic sensors

The rear ultrasonic sensors detect objects. The sensors are installed in the rear bumper. If the rear ultrasonic sensor(s) is covered with snow, rain, or a foreign substance, the system may not work properly. Always keep the rear bumper clean.

## NOTICE

- The system may turn off if interfered by electromagnetic waves.
- Always keep the rear view camera and the ultrasonic sensors clean.
- Do not use any cleanser containing acid or alkaline detergents when cleaning the rear view camera lens. Use only a mild soap or neutral detergent, and rinse thoroughly with water.
- NEVER disassemble the rear view camera or the ultrasonic sensor components or apply any impact on the rear view camera or the ultrasonic sensor components.
- Do not apply unnecessary force on the rear view camera or the ultrasonic sensors. The system may not operate properly if the rear view camera or the ultrasonic sensor(s) is forcibly moved out of proper alignment. Have the vehicle inspected by an authorized HYUNDAI dealer.
- Do not spray the rear view camera or the ultrasonic sensors or their surrounding area directly with a high pressure washer. Shock applied from high pressure water may cause the device to malfunction.
- The system may not work properly if the bumper has been damaged, or if the rear bumper has been replaced or repaired.
- Do not apply foreign objects, such as a bumper sticker or a bumper guard, near the camera or sensors or apply paint to the bumper. Doing so may adversely affect the performance of the system.

## Warning message

### ■ Rear view camera



ODN8A049044

### ■ Rear ultrasonic sensor



ODN8A049045

### Rear camera error or blockage/ Parking sensor error or blockage

This warning message may appear when:

- The rear view camera or the ultrasonic sensor(s) is blocked by dirt, snow, or a foreign object.
- There is inclement weather, such as heavy snow, rain, etc.

If any of these conditions occur, the system may turn off automatically or not operate properly.

When the warning message is displayed in the cluster, make sure that the rear view camera and the rear ultrasonic sensors are clean.

## System Malfunction



ODN8A049046

### Check Parking Collision-Avoidance Assist system

If there is a problem with Reverse Parking Collision-Avoidance Assist system or other related systems, a warning message will appear and the system will turn off automatically. Have the vehicle inspected by an authorized HYUNDAI dealer.

### Limitations of the System

Reverse Parking Collision-Avoidance Assist system may not assist braking or alert the driver under the following conditions even if there are pedestrians or objects.

- Any non-factory equipment or accessories have been installed.
- The condition of the vehicle is unstable due to an accident or other causes.
- The height of the bumper or the sensor installation has been modified.
- The rear view camera or the ultrasonic sensor(s) is damaged.
- The rear view camera or the ultrasonic sensor(s) is stained with foreign matter, such as snow, dirt, etc.
- The rear view camera is obscured by a light source or by bad weather conditions, such as heavy rain, fog, snow, etc.
- The surrounding is either too dark or too bright.

- Outside air temperature is hot or cold.
  - The wind is either strong (over 12 mph (20 km/h)) or blowing perpendicular to the rear bumper.
  - Objects generating excessive noise, such as vehicle horns, loud motorcycle engines, or truck air brakes, are near the vehicle.
  - An ultrasonic sensor with a similar frequency is near the vehicle.
  - There is ground height difference between the vehicle and the pedestrian.
  - The image of the pedestrian in the rear view camera is indistinguishable from the background.
  - The pedestrian is near the rear edge of the vehicle.
  - The pedestrian is not standing upright.
  - The pedestrian is either too short or too tall for the system to recognize.
  - The pedestrian is wearing clothes that are hard for the system to recognize.
  - The pedestrian is wearing a cloth that does not reflect ultrasound well.
  - The size, thickness, height, or shape of the object does not reflect ultrasound well (e.g., pole, bush, curbs, carts, edge of a wall, etc.).
  - The pedestrian or the object is moving.
  - The pedestrian or the object is very close to the rear of the vehicle.
  - A wall is behind the pedestrian or the object.
  - The object is not at the rear center of the vehicle.
  - The plane of the obstacle is not parallel to the rear bumper.
  - The road is slippery or inclined.
  - The driver backs up the vehicle immediately after shifting to R (Reverse).
  - The driver accelerates or turns the vehicle.
- Reverse Parking Collision-Avoidance Assist system may alert the driver or apply brake power unnecessarily under the following conditions even if there are “no” pedestrians or objects.
- Any non-factory equipment or accessories have been installed.
  - The condition of the vehicle is unstable due to an accident or other causes.
  - The height of the bumper or the sensor installation has been modified.
  - The bumper height has changed due to heavy loads, tire pressure change, etc.
  - The rear view camera or the ultrasonic sensor(s) is stained with foreign matter, such as snow, dirt, etc.
  - The pattern on the road is mistaken for a pedestrian.
  - There is a shadow or a light reflecting on the ground.
  - Pedestrians or objects are around the path of the vehicle.
  - Objects generating excessive noise, such as vehicle horns, loud motorcycle engines, or truck air brakes, are near the vehicle.
  - The vehicle is backing towards a narrow passage or parking space.
  - The vehicle is backing towards an uneven road surface, such as unpaved road, gravel, bump, gradient, etc.
  - A trailer is attached to the vehicle



## REVERSE PARKING DISTANCE WARNING (PDW) (IF EQUIPPED)

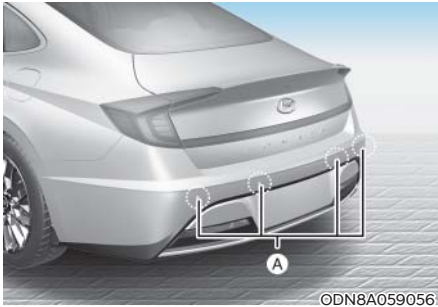

[A] : Rear Sensor

Reverse Parking Distance Warning system assists the driver during reverse movement of the vehicle by chiming if an object is sensed within the distance of 48 in (120 cm) behind the vehicle.

This system is a supplemental system that senses objects within the range and location of the sensors, it cannot detect objects in other areas where sensors are not installed.



### WARNING



- **ALWAYS** look around your vehicle to make sure there are not any objects or obstacles before moving the vehicle in any direction to prevent a collision.
- Always pay close attention when the vehicle is driven close to objects, particularly pedestrians, and especially children.
- Be aware that some objects may not be visible on the screen or be detected by the sensors, due to the objects distance, size or material, all of which can limit the effectiveness of the sensor.

### Operation of Reverse Parking Distance Warning System

#### **Operating condition**

- This system will activate when backing up with the ignition switch in the ON position. However, if vehicle speed exceeds 3 mph (5 km/h), the system may not detect objects.
- If vehicle speed exceeds 6 mph (10 km/h), the system will not warn you even though objects are detected.
- When more than two objects are sensed at the same time, the closest one will be recognized first.

**Types of warning sound and indicator**

Types of warning sound	Indicator
When an object is 24 in to 48 in (60 cm to 120 cm) from the rear bumper : Buzzer beeps intermittently.	
When an object is 12 in to 24 in (30 cm to 60 cm) from the rear bumper : Buzzer beeps more frequently.	
When an object is within 12 in (30 cm) of the rear bumper : Buzzer beeps continuously.	

**NOTICE**

- The indicator may differ from the illustration depending on objects or sensors status. If the indicator blinks, have the vehicle inspected by an authorized HYUNDAI dealer.
- If the audible warning does not sound or if the buzzer sounds intermittently when shifting into R (Reverse) position, this may indicate a malfunction with Reverse Parking Distance Warning system. If this occurs, have the vehicle inspected by an authorized HYUNDAI dealer.

### To Turn off Reverse Parking Distance Warning System (if equipped)

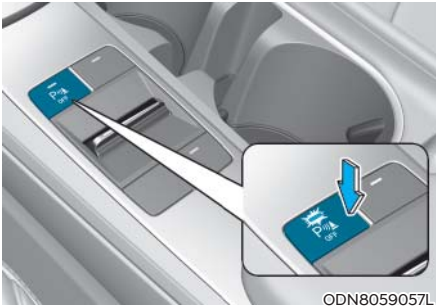

Push the button to turn off Reverse Parking Distance Warning system. The indicator light on the button will turn on.

### Non-Operational Conditions of Reverse Parking Distance Warning System

Reverse Parking Distance Warning system may not operate normally when:

- Moisture is frozen to the sensor.
- Sensor is covered with foreign matter, such as snow or water, or the sensor cover is blocked.

#### ***There is a possibility of Reverse Parking Distance Warning system malfunction when:***

- Driving on uneven road surfaces such as unpaved roads, gravel, bumps, or gradient.
- Objects generating excessive noise such as vehicle horns, loud motorcycle engines, or truck air brakes can interfere with the sensor.
- Heavy rain or water spray is present.
- Wireless transmitters or mobile phones are present near the sensor.
- The sensor is covered with snow.
- Any non-factory equipment or accessories have been installed, or if the vehicle bumper height or sensor installation has been modified.

#### ***Detecting range may decrease when:***

Outside air temperature is extremely hot or cold.

### ***The following objects may not be recognized by the sensor:***

- Sharp or slim objects such as ropes, chains or small poles.
- Objects, which tend to absorb sensor frequency such as clothes, spongy material or snow.
- Undetectable objects smaller than 40 in (100 cm) and narrower than 6 in (14 cm) in diameter.



### **WARNING**

**Your new vehicle warranty does not cover any accidents or damage to the vehicle or injuries to its occupants related to Reverse Parking Distance Warning system. Always drive safely and cautiously.**

### **Reverse Parking Distance Warning System Precautions**

- Reverse Parking Distance Warning system may not sound consistently depending on the speed and shapes of the objects detected.
- Reverse Parking Distance Warning system may malfunction if the vehicle bumper height or sensor installation has been modified or damaged. Any non-factory installed equipment or accessories may also interfere with the sensor performance.
- The sensor may not recognize objects less than 12 in (30 cm) from the sensor, or it may sense an incorrect distance. Use caution.
- When the sensor is frozen or stained with snow, dirt, or water, the sensor may be inoperative until the stains are removed using a soft cloth.
- Do not push, scratch or strike the sensor with any hard objects that could damage the surface of the sensor. Sensor damage could occur.
- Do not spray the sensors or its surrounding area directly with a high pressure washer. Shock applied from high pressure water may cause the device to not operate normally.

## FORWARD/REVERSE PARKING DISTANCE WARNING (PDW) (IF EQUIPPED)

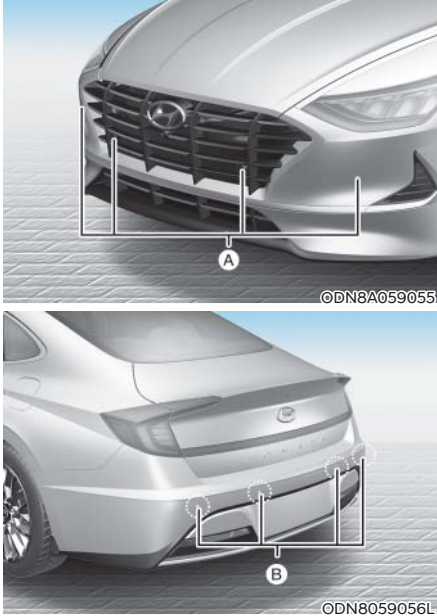

[A] : Front sensor, [B] : Rear sensor

Forward/Reverse Parking Distance Warning system assists the driver during movement of the vehicle by chiming if an object is sensed within the distance of 40 in (100 cm) in front and 48 in (120 cm) behind the vehicle.

This system is a supplemental system that senses objects within the range and location of the sensors, it cannot detect objects in other areas where sensors are not installed.

### WARNING





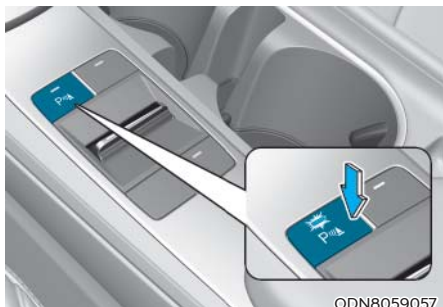

- **ALWAYS** look around your vehicle to make sure there are no objects or obstacles before moving the vehicle in any direction to prevent a collision.
- Always pay close attention when the vehicle is driven close to objects, particularly pedestrians, and especially children.
- Be aware that some objects may not be visible on the screen or be detected by the sensors, due to the objects distance, size or material, all of which can limit the effectiveness of the sensor.
- Do not tamper with the location or size of the license plate discretionally.

## Operation of Forward/Reverse Parking Distance Warning System

### *Operating condition*



- If 'Parking Distance Warning Auto On' is set from the cluster or infotainment system setup menu, the system will not turn off even if vehicle speed exceeds 12 mph (20 km/h, Non RSPA and PCA) / 24 mph (30 km/h, Applied RSPA or PCA). Also if vehicle speed belows 6 mph (10 km/h) will resume warning when objects are detected.
- This system will activate when Forward/Reverse Parking Distance Warning system button is pressed with the engine running.
- Forward/Reverse Parking Distance Warning system button turns on automatically and activates Forward/Reverse Parking Distance Warning system when you press the R(Reverse) button. However, if vehicle speed exceeds 6 mph (10 km/h), the system will not warn you even though objects are detected, and if vehicle speed exceeds 12 mph (20 km/h), the system will turn off automatically. To turn on the system, press Forward/Reverse Parking Distance Warning system button.
- When more than two objects are sensed at the same time, the closest one will be recognized first.

Distance from object in (cm)		Warning indicator		Warning sound
		When driving forward	When driving rearward	
24 ~ 40 (60 ~ 100)	Front		-	Buzzer beeps intermittently
24 ~ 48 (60 ~ 120)	Rear	-		Buzzer beeps intermittently
12 ~ 24 (30 ~ 60)	Front			Buzzer beeps frequently
	Rear	-		Buzzer beeps frequently
~ 12 (~ 30)	Front			Buzzer sounds continuously
	Rear	-		Buzzer sounds continuously

**NOTICE**

- The indicator may differ from the illustration depending on objects or sensors status. If the indicator blinks, have the vehicle inspected by an authorized HYUNDAI dealer.
- If the audible warning does not sound or if the buzzer sounds intermittently when shifting into R (Reverse) position, this may indicate a malfunction with Forward/Reverse Parking Distance Warning system. If this occurs, have the vehicle inspected by an authorized HYUNDAI dealer.

## Non-Operational Conditions of Forward/Reverse Parking Distance Warning System

### **Forward/Reverse Parking Distance Warning system may not operate normally when:**

- Moisture is frozen to the sensor.
- Sensor is covered with foreign matter, such as snow or water, or the sensor cover is blocked.

### **There is a possibility of Forward/Reverse Parking Distance Warning system malfunction when:**

- Driving on uneven road surfaces such as unpaved roads, gravel, bumps, or gradient.
- Objects generating excessive noise such as vehicle horns, loud motorcycle engines, or truck air brakes can interfere with the sensor.
- Heavy rain or water spray is present.
- Wireless transmitters or mobile phones are present near the sensor.
- The sensor is covered with snow.
- Any non-factory equipment or accessories have been installed, or if the vehicle bumper height or sensor installation has been modified.

### **Detecting range may decrease when:**

Outside air temperature is extremely hot or cold.

### **The following objects may not be recognized by the sensor:**

- Sharp or slim objects such as ropes, chains or small poles.
- Objects, which tend to absorb sensor frequency such as clothes, spongy material or snow.
- Undetectable objects smaller than 40 in (100 cm) and narrower than 6 in (14 cm) in diameter.



## **WARNING**

**Your new vehicle warranty does not cover any accidents or damage to the vehicle or injuries to its occupants related to Forward/Reverse Parking Distance Warning system. Always drive safely and cautiously.**



## Forward/Reverse Parking Distance Warning System Precautions

- Forward/Reverse Parking Distance Warning system may not sound consistently depending on the speed and shapes of the objects detected.
- Forward/Reverse Parking Distance Warning system may malfunction if the vehicle bumper height or sensor installation has been modified or damaged. Any non-factory installed equipment or accessories may also interfere with the sensor performance.
- The sensor may not recognize objects less than 12 in (30 cm) from the sensor, or it may sense an incorrect distance. Use caution.
- When the sensor is frozen or stained with snow, dirt, or water, the sensor may be inoperative until the stains are removed using a soft cloth.
- Do not push, scratch or strike the sensor. Sensor damage could occur.
- Do not spray the sensors or its surrounding area directly with a high pressure washer. Shock applied from high pressure water may cause the device to not operate normally.

## REMOTE SMART PARKING ASSIST (RSPA) (IF EQUIPPED)



Remote Smart Parking Assist system helps drivers recognize surrounding objects by using sensors to detect parking spaces control the steering wheel, shift the gear and adjust vehicle speed automatically.

Remote moving forward and backward function provides assistance for forward and backward movement as well as taking the vehicle out of the parking space with driver outside the vehicle.

The driver should check the distance between the parking space and the objects in direct and be careful to operate.

Due to the surrounding environment and array or shape of the parked vehicles, the vehicle may not be parked or exit at the exact spot you have wished.

\* RSPA stands for Remote Smart Parking Assist.

	Remote Smart Parking Assist system button
	Parking Distance Warning system button

Function	
Remote Moving Forward/ Backward	Available

Deactivate Remote Smart Parking Assist system and park/exit your vehicle manually if it is necessary. While using Remote Smart Parking Assist system, Parking Distance Warning system activates as well. Remote Smart Parking Assist system will be cancelled if Parking Distance Warning system is cancelled by pressing the button to the OFF position.

For operation of Parking Distance Warning system, refer to the relevant description in this manual.



### WARNING

- Remote Smart Parking Assist system may not operate normally if the vehicle needs wheel alignment adjustment. Have the vehicle checked by an authorized HYUNDAI dealer.
- If you use a different tire or wheel size rather than the size recommended by the HYUNDAI dealer, Remote Smart Parking Assist system may not work properly. Always use the same size tire and wheel.
- Do not use Remote Smart Parking Assist system when under the influence of alcohol or drugs.
- Remote Smart Parking Assist system may not operate properly depending on the surrounding environment and other conditions.
- Remote Smart Parking Assist system may not recognize the object too close to the vehicle.
- When operating Remote Smart Parking Assist system, be careful of the objects such as flower pots or parking blocks located above or below the sensor position. Such object may damage the vehicle or other objects.
- Remote Smart Parking Assist system should only be considered as a supplementary function. The driver must check the front and rear view for objects. The operational function of the system can be affected by many factors and conditions of the surroundings, so the responsibility rests always with the driver.
- Do not let children or other person to use the smart key.

## Operating Condition

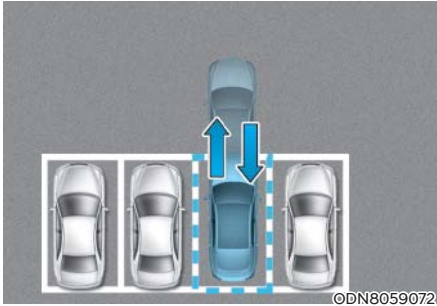

### **Use Remote Smart Parking Assist system when all the below conditions are met**

- When the parking space is a straight line
- When there is enough space to move or exit the vehicle

## **Non-operating Condition**

In the following conditions, Remote Smart Parking Assist system may not operate properly or cancelled. Drive the vehicle manually in the below conditions.

- Curved or diagonal parking space
- An obstacle such as a trash can, bicycle, motorcycle, shopping cart, narrow pillar etc. is near
- Near a circular pillar or narrow pillar, or a pillar surrounded by objects such as fire extinguisher, etc.
- Heavy snow, rain or wind
- Bumpy roads
- A vehicle equipped with a snow chain or spare tire
- Tire pressure lower or higher than the standard tire pressure
- Slippery or uneven road
- A vehicle loaded with longer or wider cargo compared to the vehicle or a trailer connected to the vehicle
- The sensor is positioned incorrectly by an impact to the bumper
- Inclined roads parking
- A problem with the wheel alignment
- Vehicle leaned severely to one side
- Front or rear distance sensors are malfunction or not working properly. (Refer to Parking Distance Warning system in this chapter)
- Low battery level of the smart key that requires battery replacement.

**Limitations of the system**

- When the vehicle has been parked/ stopped for a long time in a cold environment, the Remote Moving Forward/Backward may be delayed depending on the vehicle condition when the vehicle is turned on remotely.
- Remote Smart Parking Assist system may suddenly apply brake to avoid collision against stationary or moving object.
- The performance of the system may be degraded and frequently stop when driving in strong electric field area.
- When there is any obstacle within the blind-spot area, drive out of the parking space manually
- Remote Smart Parking Assist system may not recognize the object that appears suddenly.

**⚠ WARNING**

**Do not use Remote Smart Parking Assist system in the following conditions for unexpected results may occur and cause a serious accident.**

1. Parking on inclines



Park and exit manually when you park on inclines.

2. Parking in snow



Snow may interfere with sensor operation or Remote Smart Parking Assist system may cancel if the road is slippery while parking.

3. Parking diagonal

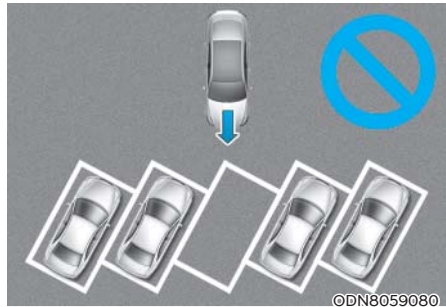

Remote Smart Parking Assist system is not a supplemental for diagonal parking. Even if the vehicle is able to enter the space, do not operate the system.

#### 4. Parking in uneven road



Remote Smart Parking Assist system may cancel when the vehicle slips or the vehicle could not move due to road condition such as pebbles or fragmented stones.

#### 5. Parking behind a truck



An accident may occur when parking behind a vehicle higher than yours. For example, bus, truck, etc. Do not use the system in that case.

#### 6. Parking in the blind-spot or near a circular pillar or narrow pillar



If you want to park your vehicle in the blind spot or near a circular pillar and narrow pillar or a pillar surrounded by objects such as fire extinguisher and the parking distance warning chime sounds three times continuously, the vehicle should not be parked in the area.

#### 7. Parking in a parking place with a vehicle on the right or left side only

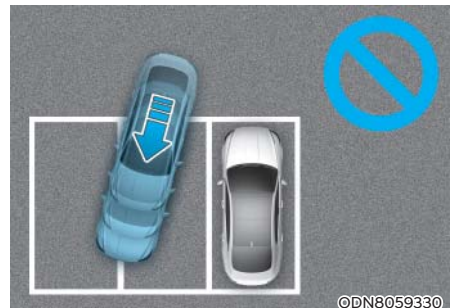

If there is a vehicle on the right or left side only when you park a vehicle, the vehicle may cross the parking line.



#### CAUTION





- Always check for obstacles around your vehicle before driving.
- Remote Smart Parking Assist system may be cancelled if you attach something (cover, etc.) to the steering wheel.

## How Remote Smart Parking Assist System Works

### Remote Moving Forward/Backward

Remote Moving Forward/Backward is available with the driver outside the vehicle. Make sure the conditions are met before activating Remote Moving Forward/Backward function. With the function, you can park or exit the vehicle and the procedure is as follows.

1. Remote Moving Forward/Backward ready:
  - (1) With the vehicle off: Remotely turn on the vehicle.
  - (2) With the vehicle on: with shift button is in P (Park) position, then press Remote Smart Parking Assist system button. Then exit the vehicle possessing the smart key.
2. Remote Moving Forward/Backward assist: Press and hold the Moving Forward/Backward button of the smart key to provide the Remote Moving Forward/Backward assist through steering wheel, gear shift and vehicle speed control.
3. Remote Moving Forward/Backward complete: When the vehicle reaches the desired position, release the smart key button. Then complete the Remote Moving Forward/Backward by entering the vehicle possessing the smart key or by pressing the remote start button of the smart key.

	Remote Smart Parking Assist system button
	Parking Distance Warning system button
	Remote start button
	Moving forward button
	Moving backward button



ODN8059332



OFE048422

1. Remote Moving Ready
 

You can activate Remote Moving Forward/Backward in 2 ways.

    - (1) With the vehicle turned off, press the door lock button of the smart key and then within 4 seconds press the remote start button for over 2 seconds to start up the vehicle. The hazard warning light blinks and displays the status of the function.
- \* For the details of remote start up, refer to Remote Start in this chapter.



- (2) Park the vehicle in front of the space where you desire to use the Remote Moving Forward/Backward. Press Remote Smart Parking Assist system button and select the Remote Moving Forward/Backward. Exit the vehicle possessing the smart key and check whether all the doors are closed. The hazard warning light blinks and Remote Moving Forward/Backward displays whether the vehicle is movable or not.

- \* You will hear frequent beep sounds if the driver gets off the vehicle after the Remote Moving Forward/Backward is ready.

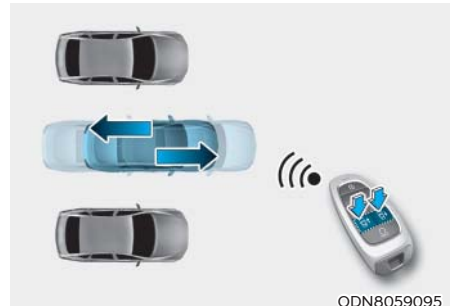

## 2. Remote Moving Forward/Backward Assist

With the vehicle stopped, press and hold one of the moving forward/backward button on the smart key and then steering wheel, gear shift and vehicle speed are controlled automatically. If the driver releases the moving forward/backward button while the Remote Moving Forward/Backward button is in activation, the control will stop temporarily. Press the button again to resume the control.

For your safety, the assist is activated only when the smart key is within about 10-16 ft. (3-5 m) from the vehicle.

The vehicle can travel up to 23 ft. (7 m) per move. Press the moving forward/backward button to make additional movement.

- \* Press the moving forward/backward button again after checking the distance from the vehicles if the vehicle didn't move after pressing and holding the smart key button for about 5 seconds.
- \* Under cold weather, take enough time before pressing the moving forward/backward button of the smart key after turning on the vehicle remotely. It may take more time until the vehicle moves.

- \* When the Remote Moving Forward is ready by the above No. (1) method, the vehicle recognizes the condition as exit. After confirming the surroundings within 13 ft. (4 m), it allows to operate the steering wheel up to the conditions ahead.
- \* When Remote Moving Forward is ready by the above No. (2) method, the vehicle recognizes the condition as entering to the parking space. According to the front condition, it immediately allows the vehicle to enter to the parking space and line up with the steering wheel control. However, the function performance can be degraded up to the shape or position of the surrounding objects.
- \* If you select the remote moving backward, both of the No. (1) and (2) methods make the vehicle go straight after lining up.
- \* While Remote Moving Forward/Backward assist is operating, the brake light turns on.



### 3. Remote Moving Forward/Backward Complete

When the vehicle reaches the desired position, Remote Moving Forward/Backward is completed as follows:

- (1) If the driver enters the vehicle with the smart key, Remote Moving Forward/Backward is completed. In this case, the vehicle stays on.
- (2) If the driver pushes the Remote control button of the smart key, Remote Moving Forward/Backward is completed. In this case, the vehicle stays off.

- \* The parking complete sound (frequent beep) is generated.
- \* When Remote Moving Forward/Backward assist is complete, the gear in P (Park) and Electronic Parking Brake (EPB) are engaged automatically.

### **WARNING**

**Always be careful of unexpected approach of the other vehicles or pedestrians during operation.**

**While the remote moving forward function works, the vehicle is controlled by the steering wheel control so that the obstacles in the blind spots cannot be detected.**

**Always check for obstacles around your vehicle to prevent the accidents.**



**CAUTION**

- The driver should check for obstacles directly around the vehicle.
- The function may be cancelled if you attach something (cover, etc.) to the steering wheel.
- Make sure all the passengers exit the vehicle when the Remote Moving Forward/Backward is in activation.
- Make sure all the smart keys are outside the vehicle when the Remote Moving Forward/Backward assist is in activation.
- The detection range of the smart key can be differed by the surroundings (ex: Indoor/outdoor, strong electric field area)
- If the parking distance warning sounds three consecutive times during operating the Remote Moving Forward/Backward system, you should not move your vehicle in that direction since the objects are too close. The driver should operate the vehicle manually.

***To cancel the Remote Moving Forward/Backward while in operation***

1. Press the remote start button on the smart key.
2. The driver should press Remote Smart Parking Assist system button while Remote Moving Forward/Backward is instructed.
3. The driver should shift the gear besides P (parking) while Remote Moving Forward/Backward is instructed.
4. The driver should press Parking Distance Warning system button while the Remote Moving Forward/Backward is instructed.
5. During Remote Moving Forward/Backward operation, the vehicle turns off when the driver presses the remote start button on the smart key.
6. The function is cancelled but the vehicle stays on when the driver enters the vehicle with the smart key and all the doors are open.

### ***The Remote Moving Forward/Backward assist will stop temporarily when:***

7. An obstacle is detected at the direction the vehicle is heading.
8. The door or trunk is opened.
9. The moving forward/backward button on the smart key is released.
10. Multiple buttons on the smart key are pressed at the same time.
11. The distance between the smart key and vehicle is over 13 ft. (4 m).
12. A button on the other smart key is pressed during operation.
13. Rear Cross-Traffic Collision-Avoidance Assist system is activated while reserving.
14. The vehicle moves 23 ft. (7 m) with the Remote Moving Forward/Backward while the smart key is pressed. (Maximum travel distance per move)

\* The vehicle stops when the Remote Smart Parking Assist system will stop temporarily and the function will resume when the above condition is cleared.

### ***The Remote Moving Forward/Backward assist is cancelled while in operation when:***

1. The driver holds the steering wheel while the steering wheel is controlled.
2. The gear is shifted or the Electronic Parking Brake (EPB) is activated.
3. The hood opens.
4. The vehicle speed exceeds 3 mph (5km/h).
5. The vehicle accelerates suddenly.
6. The vehicle slips back while controlling the vehicle speed.
7. The wheel is stuck and the vehicle is unable to move.
8. About 3 minutes and 50 seconds have passed after the Remote Moving Forward/Backward assist starts.

9. The gradient of the road exceeds the range supported by the Remote Moving Forward/Backward assist.
10. The steering, shifting gear and drive assist are difficult.
11. The suspended status lasts for over 1 minute.
12. The driver continuously presses and releases the smart key's moving forward/backward button over 10 times.
13. The Traction Control System (TCS) is activated while controlling the vehicle speed.
14. The smart key is damaged.
15. The accelerator/brake pedal is depressed while all the doors are closed.
16. The brake pedal is depressed while the driver's door is open and the smart key is outside the vehicle.
17. The vehicle travels more than 46 ft. (14 m) after the Remote Moving Forward/Backward assist is activated.
18. The theft alarm system is activated.

\* When the Remote Moving Forward/Backward is completed, the gear in P(Park) and Electronic Parking Brake (EPB) are engaged automatically and the vehicle turns off.

\* The frequent beep sounds are generated to show the deactivation status.

## Additional Instructions

When the Remote Smart Parking Assist system is in operation, the system may be cancelled regardless of the instruction order.

The appeared messages could be differed according to the circumstances. Follow the instructions provided while driving your vehicle with the Remote Smart Parking Assist system in activation.

When the function works, please follow the displayed messages and the driver should be cautious for safety.

## Malfunction warning



If there is a problem with Remote Smart Parking Assist system, the above message will appear when the system is turned on.

In addition, the indicator on Remote Smart Parking Assist system button will blink and the warning sound will beep three times. (The Parking Distance Warning system can be operable depending on the failure type.)

If you recognize any problem, have the vehicle checked by an authorized HYUNDAI dealer.

## Parking assist conditions not met



When Remote Smart Parking Assist system is not getting ready for activation, the above message will appear when Remote Smart Parking Assist system button is pressed.

Press the button again after a while and check whether the function operates properly.

- \* Remote Smart Parking Assist system is on standby for a while, you should not use the Remote Smart Parking Assist system and have your vehicle checked by an authorized HYUNDAI dealer.

### Display Operation Status

#### **While Remote Smart Parking Assist system is on, Smart key / Hazard lamp status is displayed**

The LED on the smart key and hazard warning light indicate the vehicle status as follows.

\* The status is displayed when the Remote Moving Forward/Backward function works.

Vehicle status	Hazard lamp	Smart key LED
Remote Moving Forward/Backward function in activation	-	Green LED blinks continuously
Remote Moving Forward/Backward function temporarily stopped/in stand by	Blinking	Red LED blinks continuously
Remote Moving Forward/Backward function deactivated	Off after blinking 3 times	Red LED illuminates for 4 seconds and then light-out
Remote Moving Forward/Backward function completed	Off after one blinking	Green LED illuminates for 4 seconds and then light-out



\* When the distance between the smart key and vehicle is over 13 ft. (4 m), the smart key LED may not display normally. You should use it within the operable range.

### Link with other systems

Activation of other systems may be restricted according to the circumstances while Remote Smart Parking Assist system is in activation. The systems linked to the Remote Smart Parking Assist system are as follows:

1. Idle Stop & Go
  - (1) While Remote Smart Parking Assist system is operating, ISG is deactivated.
  - (2) If Remote Smart Parking Assist system is completed or cancelled, ISG can be activated.
2. Auto Hold
  - (1) The activated Auto Hold is switched to deactivation status when Remote Smart Parking Assist system starts.
  - (2) The Auto Hold button will not respond while Remote Smart Parking Assist system is in activation.
  - (3) After Remote Smart Parking Assist system is completed or deactivated, the Auto Hold will return to the status before Remote Smart Parking Assist system was activated.
3. Electronic Stability Control (ESC)
  - (1) Electronic Stability Control (ESC) system switches from OFF to activation status (ESC OFF button turns off) when Remote Smart Parking Assist system is activated.
  - (2) The ESC OFF button will not respond while Remote Smart Parking Assist system is in activation.
  - (3) The ABS/TCS/ESC system activates while Remote Smart Parking Assist system is in activation.
  - (4) After Remote Smart Parking Assist system is completed or deactivated, the ESC maintains the ON status.

### How the Remote Moving Forward/Backward System Works

#### Backward Parking

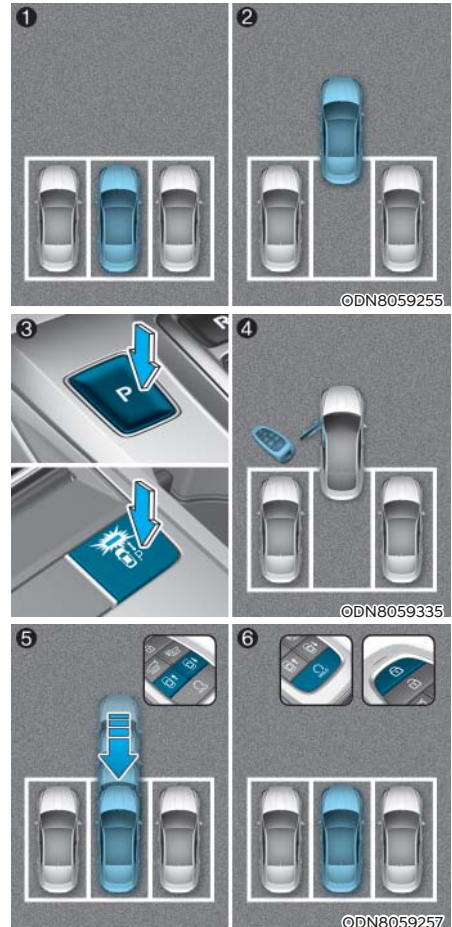

- (1) Search for parking space and line up the vehicle.
- (2) Move until the spot where the passengers can get off the vehicle with ease.
- (3) Press the Remote Moving Forward/Backward button with the shift button placed in P (Park).

- (4) Get out of the vehicle with the smart key and close all of the doors.
- (5) While you press and hold the backward button of the smart key within the operable distance, the vehicle stays moving.
- (6) Complete the Remote Moving Forward/Backward with the remote control button and press the Door Lock button after parking the vehicle to the desired position and releasing the backward button of the smart key

### Forward Parking

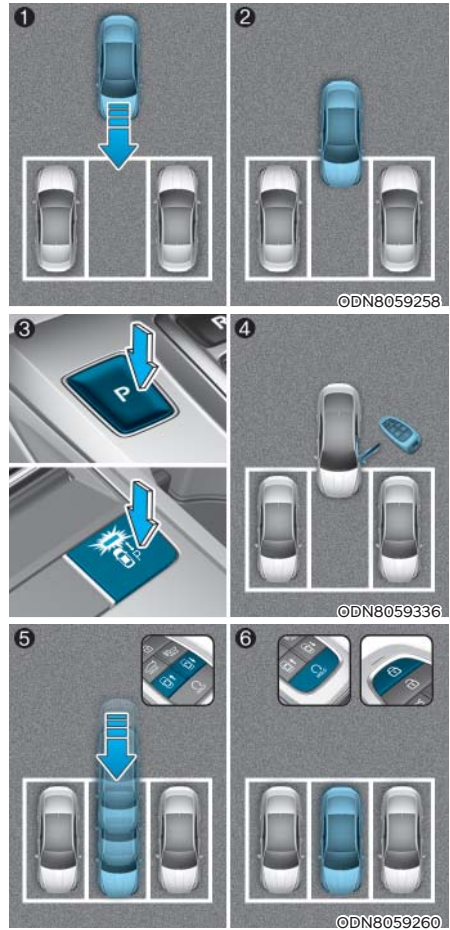

- (1) Search for parking space and line up the vehicle.
- (2) Move until the spot where the passengers can get off the vehicle with ease.
- (3) Press the Remote Moving Forward/Backward button with the shift button placed in P (Park).
- (4) Get out of the vehicle with the smart key and close all of the doors.

- (5) While you press and hold the forward button of the smart key within the operable distance, the vehicle stays moving.
- (6) Complete the Remote Moving Forward/Backward with the remote control button and press the Door Lock button after parking the vehicle to the desired position and releasing the forward button of the smart key.

## MANUAL CLIMATE CONTROL SYSTEM (IF EQUIPPED)

■ Type A



ODN8A059100

■ Type B





ODN8A059101

- |                                      |                                  |
|--------------------------------------|----------------------------------|
| 1. Fan speed control knob            | 5. Rear window defroster button  |
| 2. Temperature control knob          | 6. A/C (Air conditioning) button |
| 3. Mode selection buttons            | 7. Air intake control button     |
| 4. Front windshield defroster button | 8. Max A/C selection button      |



## Heating and Air Conditioning

1. Start the engine.
2. Set the mode to the desired position.  
To improve the effectiveness of heating and cooling, select the mode according to the following:
  - Heating: 
  - Cooling: 
3. Set the temperature control to the desired position.
4. Set the air intake control to fresh mode or recirculation mode position.
5. Set the fan speed control to the desired speed.
6. If air conditioning is desired, turn the air conditioning system on.

When starting the vehicle in cold weather a more efficient way to heat the passenger compartment is to do the following.

- Turn off or lower the blower, right after starting the engine.
- Engine temperature is still low and the air flow from the heater is still cold.
- After a few minutes of engine warm up, turn on or set the fan to a higher level and with adjust the temperature setting to hot.

**Mode selection**

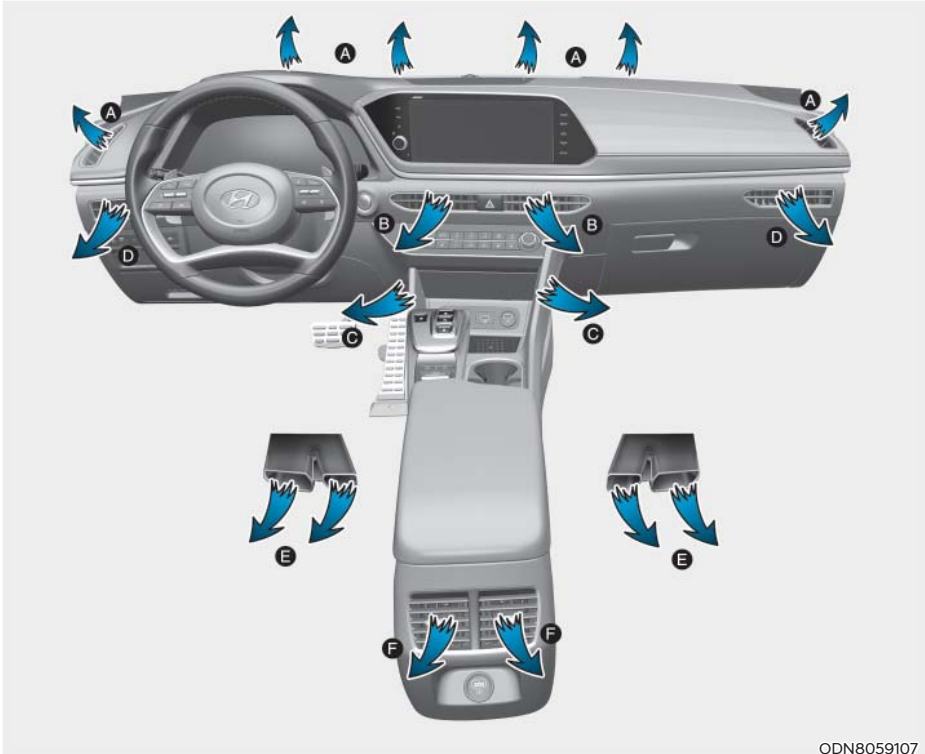

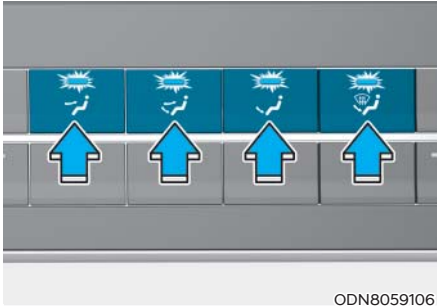

ODN8059106

The mode selection button controls the direction of the air flow through the ventilation system.



**Face-Level (B, D, F)**

Air flow is directed toward the upper body and face. Additionally, each outlet can be controlled to direct the air discharged from the outlet.



**Bi-Level (B, C, D, E, F)**

Air flow is directed towards the face and the floor.



**Floor-Level (A, C, D, E)**

Most of the air flow is directed to the floor, with a small amount of the air being directed to the windshield and side window defrosters.



**Floor & Defrost (A, C, D, E)**

Most of the air flow is directed to the floor and the windshield with a small amount directed to the side window defrosters.



**Defrost-Level (A, D)**

Most of the air flow is directed to the windshield with a small amount of air directed to the side window defrosters.

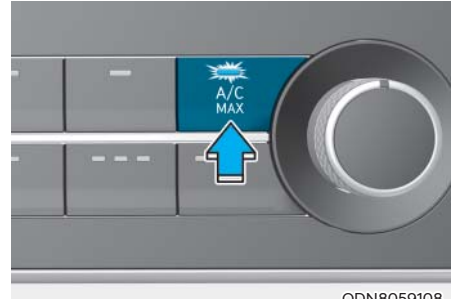

ODN8059108

**MAX A/C-Level (B, D, F)**

The MAX A/C mode is used to cool the inside of the vehicle faster. Air flow is directed toward the upper body and face.

In this mode, the A/C button and the Recirculation mode button cannot be selected. Turn the fan speed mode to adjust.

After the interior cabin has cooled sufficiently, move the temperature knob away from the MAX A/C setting and adjust the knob to the desired position.

If you wish to continue using A/C ON, make sure the A/C button LED is illuminated.

### Instrument panel vents

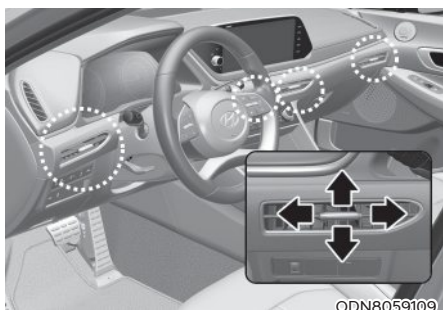

The instrument panel vent air flow can be directed up/down or left/right using the vent adjustment lever.

To close the vent adjustment lever, rotate it to the outer side till the end. To open the vent, rotate it to the inner side.

### Temperature control

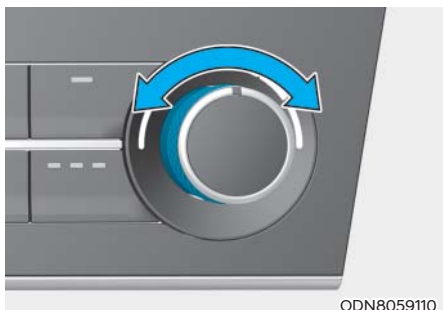

The temperature will increase by turning the knob to the right.

The temperature will decrease by turning the knob to the left.

### Air intake control

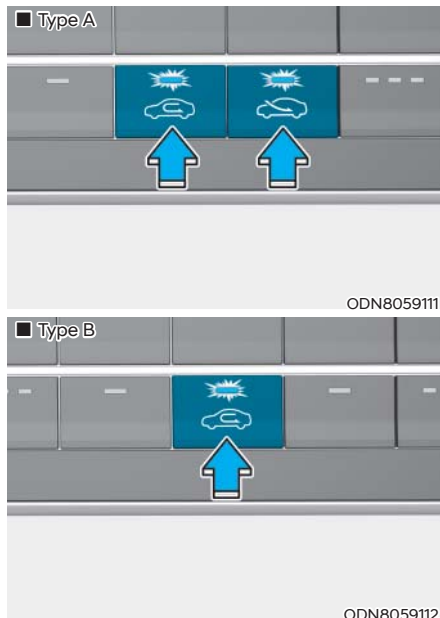

The air intake control button is used to select either Fresh mode (outside air) or Recirculation mode (cabin air).

#### Recirculation mode



When Recirculation mode is selected, air from the passenger compartment will be recirculated through the system and heated or cooled according to the function selected.

#### Fresh mode

■ Type A When Fresh mode is selected, air enters the vehicle from outside and is heated or cooled according to the function selected.



■ Type B

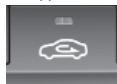

### **i** Information

Using the system primarily in Fresh mode and Recirculation mode only when needed is recommended for best results.

Prolonged operation of the heater in Recirculation mode and without the A/C ON can cause fogging of the windshield.

In addition, prolonged use of the A/C ON in Recirculation mode may result in excessively dry, dehumidified air in the cabin.

### **!** WARNING

- Continued use of the climate control system operation in Recirculation mode for a prolonged period of time may cause drowsiness to the occupants in the cabin. This may lead to loss of vehicle control which may lead to an accident.
- Continued use of the climate control system operation in Recirculation mode with the A/C OFF may allow humidity to increase inside the cabin. This may cause condensation to accumulate on the windshield and obscure visibility.
- Do not sleep in your vehicle or remain parked in your vehicle with the windows up and either the heater or the air conditioning ON for prolonged periods of time. Doing so may increase the levels of carbon dioxide in the cabin which may lead to serious injury or death.

### Fan speed control

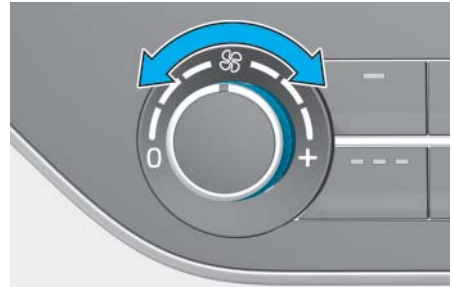

ODN8A059113

Turn the knob to the right to increase the fan speed and airflow. Turn the knob to the left to decrease fan speed and airflow.

Setting the fan speed control knob to the "0" position turns off the fan.

### **NOTICE**

Operating the fan speed when the ignition switch is in the ON position could cause the battery to discharge. Operate the fan speed when the engine is running.

### Air conditioning

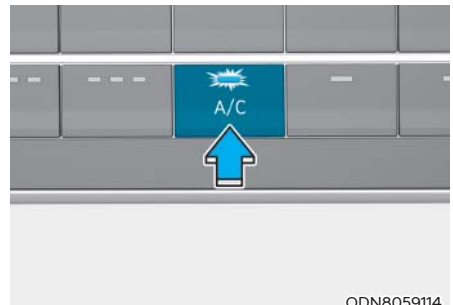

ODN8059114

Push the A/C button to turn the system on (indicator light will illuminate) and off.



### System Operation

#### Cooling / Ventilation

1. Select the Face Level  mode.
2. Set the air intake control to fresh mode.
3. Set the temperature control to the desired position.
4. Set the fan speed control to the desired speed.

#### Heating

1. Select the Floor Level  mode.
2. Set the air intake control to fresh mode.
3. Set the temperature control to the desired position.
4. Set the fan speed control to the desired speed.
5. If desired, turn the air conditioning ON with the temperature control knob set to heat in order to dehumidify the air before it enters into the cabin.

If the windshield fogs up, select the Floor & Defrost  mode or press the Front Defrost  mode.

#### Operation Tips

- To keep dust or unpleasant fumes from entering the vehicle through the ventilation system, temporarily set the air intake control to recirculation mode. Return the control to Fresh mode when the unpleasant air outside has diminished. This will help keep the driver alert and comfortable.
- To help prevent the inside of the windshield from fogging, set the air intake control to fresh mode and fan speed to the desired position, turn on the air conditioning system, and adjust the temperature control to the desired temperature.

#### Air conditioning

Your HYUNDAI vehicle air conditioning system is filled with R-1234yf refrigerant.

1. Start the engine.
2. Press the air conditioning button.
3. Set the mode to the Face Level  mode.
4. Set the air intake control to Recirculation mode temporarily to allow the cabin to cool quickly. When the desired temperature in the cabin is reached, change the air intake control back to Fresh mode.
5. Adjust the fan speed control and temperature control to maintain maximum comfort.

When maximum cooling is desired, set the temperature control to the MAX A/C position, then set the fan speed control to the highest setting.

#### NOTICE

**When using the air conditioning system, monitor the engine temperature gauge closely while driving up hills or in heavy traffic when outside temperatures are high. Air conditioning system operation when climbing a steep grade or in high outside ambient temperatures can cause engine overheating.**

**Continue to use the fan, but turn the air conditioning system off if the engine temperature gauge indicates engine overheating.**

### Air conditioning system operation tips

- If the vehicle has been parked in direct sunlight during hot weather, open the windows for a short time to let the hot air inside the vehicle escape.
- After sufficient cooling has been achieved, switch back from the recirculated air to the fresh outside air position.
- To help reduce moisture inside of the windows on rainy or humid days, decrease the humidity inside the vehicle by operating the air conditioning system with the windows and sunroof closed.
- Use the air conditioning system every month only for a few minutes to ensure maximum system performance.
- If you operate air conditioner excessively, the difference between the temperature of the outside air and that of the windshield could cause the outer surface of the windshield to fog up, causing loss of visibility. In this case, set the mode selection knob or button to the  position and fan speed control to the lower speed.

## System Maintenance

### Cabin air filter

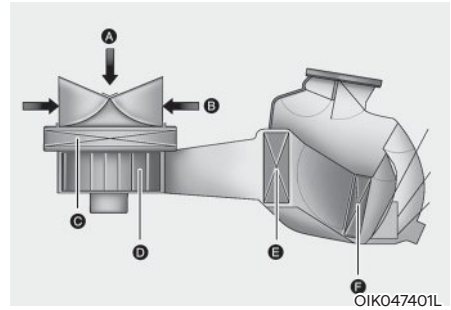

[A] : Outside air, [B] : Recirculated air  
[C] : Cabin air filter, [D] : Blower  
[E] : Evaporator core, [F] : Heater core

The cabin air filter is installed behind the glove box. It filters the dust or other pollutants that enter the vehicle through the heating and air conditioning system.

Have the cabin air filter replaced by an authorized HYUNDAI dealer according to the maintenance schedule. If the vehicle is being driven in severe conditions such as dusty or rough roads, more frequent cabin air filter inspections and changes are required.

If the air flow rate suddenly decreases, the system should be checked at an authorized HYUNDAI dealer.

### Checking the amount of air conditioner refrigerant and compressor lubricant

When the amount of refrigerant is low, the performance of the air conditioning is reduced. Overfilling also reduces the performance of the air conditioning system.

Therefore, if abnormal operation is found, have the system inspected by an authorized HYUNDAI dealer.

**NOTICE**

It is important that the correct type and amount of oil and refrigerant is used. Otherwise, damage to the compressor and abnormal system operation may occur. To prevent damage, the air conditioning system in your vehicle should only be serviced by trained and certified technicians.

**WARNING**

Vehicles equipped with R-1234yf



Since the refrigerant is mildly flammable and operated at high pressure, the air conditioning system should only be serviced by trained and certified technicians. It is important that the correct type and amount of oil and refrigerant are used.



All refrigerants should be reclaimed with proper equipment.

Venting refrigerants directly to the atmosphere is harmful to individuals and environment. Failure to heed these warnings can lead to serious injuries.



©DN8A079026

**Air conditioning refrigerant label**

You can find out which air conditioning refrigerant is applied to your vehicle on the label located inside of the hood.

■ Example



OHYK059001

Each symbols and specification on the air conditioning refrigerant label is represented as below:

1. Classification of refrigerant
2. Amount of refrigerant
3. Classification of Compressor lubricant
4. Caution
5. Flammable refrigerant
6. To require registered technician to service air conditioning system



## AUTOMATIC CLIMATE CONTROL SYSTEM (IF EQUIPPED)



ODN8059102L

1. Driver's temperature control knob
2. Passenger's temperature control knob
3. AUTO (automatic control) button
4. SYNC button
5. OFF button
6. Front windshield defroster button
7. Air conditioning button
8. Air intake control button
9. Rear window defroster button
10. Fan speed control toggle switch
11. Mode selection toggle switch
12. Climate control information screen

## Automatic Heating and Air Conditioning



1. Press the AUTO button.

The modes, fan speeds, air intake and air-conditioning will be controlled automatically according to the temperature setting you select.

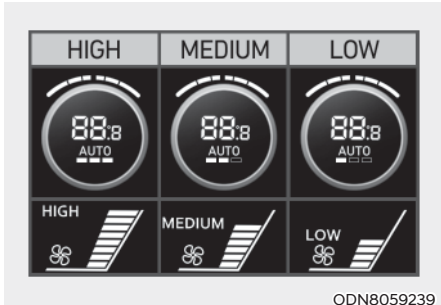

You can control the wind strength in three stages by pushing the AUTO button during automatic operation.

- HIGH : Provide rapid air conditioning and heating with strong wind
- MEDIUM : Provide air conditioning and heating with medium strength wind
- LOW : It is suitable for drivers who prefer to soft wind.

When you select the temperature to HI or LO in AUTO mode, the wind strength is set to 'HIGH'.

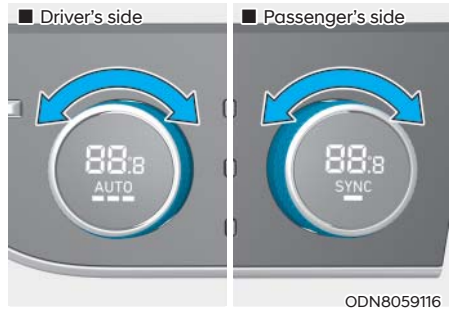

2. Turn the temperature control knob to set the desired temperature. If the temperature is set to the lowest setting (Lo), the air conditioning system will operate continuously.

- To turn the automatic operation off, select any button of the following:
  - Mode selection button
  - Front windshield defroster button (Press the button one more time to deselect the front windshield defroster function. The 'AUTO' sign will illuminate on the information screen once again.)
  - Fan speed control toggle switch

The selected function will be controlled manually while other functions operate automatically.

- For your convenience and improved operating efficiency, use the AUTO button and set the temperature to 72 °F (22°C).

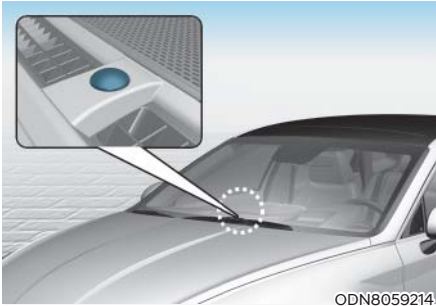

### NOTICE

**Never place anything near the ambient light/solar sensor to ensure better control of the heating and cooling system.**

## Manual Temperature Control Mode

The heating and cooling system can be controlled manually by pushing buttons other than the AUTO button. In this case, the system works sequentially according to the order of buttons selected.

When pressing any button except the AUTO button while using automatic operation, the functions not selected will be controlled automatically.

1. Start the engine.
2. Set the mode to the desired position.

To improve the effectiveness of heating and cooling, select the mode according to the following:

- Heating:
- Cooling:

3. Set the temperature control to the desired position.
4. Set the air intake control to Fresh mode position.
5. Set the fan speed control to the desired speed.
6. If air conditioning is desired, turn the air conditioning system on.
7. Press the AUTO button to convert to full automatic control of the system.

When starting the vehicle in cold weather using manual temperature control, operate the system in the following method to improve heating.

- Turn off or lower the blower, right after starting the engine.
- Allow the engine to warm up during this time since the air flow from the heater is still cold.
- After a few minutes of engine warm up, turn on or set the fan to a higher level and adjust the temperature setting to hot.
- Using AUTO temperature control mode set to 72 °F (22°C) will perform the above steps automatically.

**Mode selection**

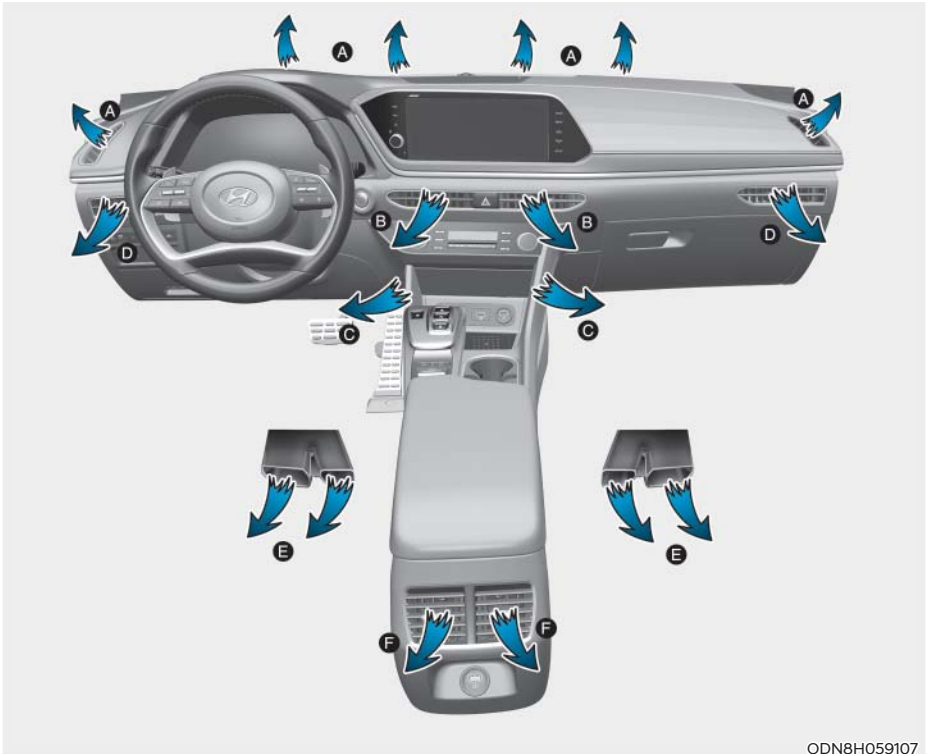

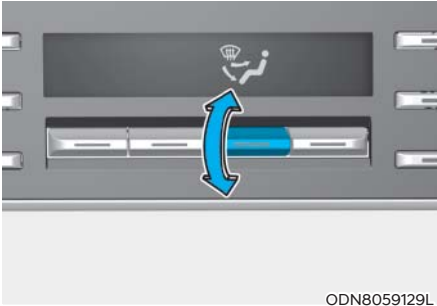

ODN8059129L

The mode selection button controls the direction of the air flow through the ventilation system.

The air flow outlet direction is cycled as follows:



**Face-Level (B, D, F)**

Air flow is directed toward the upper body and face. Additionally, each outlet can be controlled to direct the air discharged from the outlet.



**Bi-Level (B, C, D, E, F)**

Air flow is directed towards the face and the floor.



**Floor & Defrost (A, C, D, E)**

Most of the air flow is directed to the floor and the windshield with a small amount directed to the side window defrosters.



**Floor-Level (A, C, D, E)**

Most of the air flow is directed to the floor, with a small amount of the air being directed to the windshield and side window defrosters.



**Floor & Defrost (A, C, D, E)**

Most of the air flow is directed to the floor and the windshield with a small amount directed to the side window defrosters.

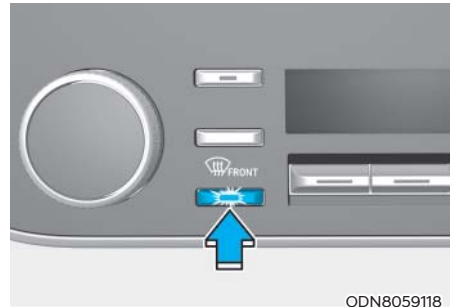

ODN8059118

**Defrost-Level (A, D)**

Most of the air flow is directed to the windshield with a small amount of air directed to the side window defrosters.

### Instrument panel vents

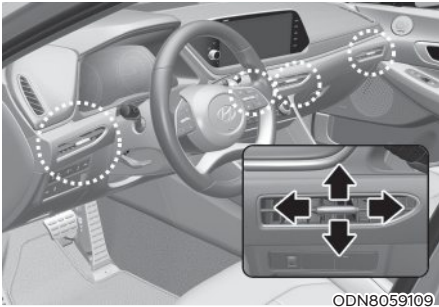

The instrument panel vent air flow can be directed up/down or left/right using the vent adjustment lever.

To close the vent adjustment lever, rotate it to the outer side till the end. To open the vent, rotate it to the inner side.

### Temperature control

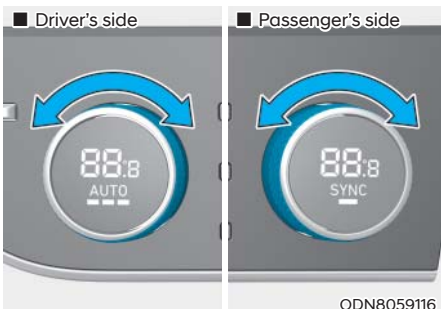

The temperature will increase by turning the knob to the right.

The temperature will decrease by turning the knob to the left.

The temperature will increase or decrease by 1 °F (0.5 °C) for each incremental location. When set to the lowest temperature setting, the air conditioning will operate continuously.



### Adjusting the driver and passenger side temperature equally

- Press the "SYNC" button to adjust the driver and passenger side temperature equally.
- The passenger side temperature will be set to the same temperature as the driver side temperature.
- Turn the driver side temperature control knob. The driver and passenger side temperature will be adjusted equally.
- If you rotate the passenger's temperature control knob, the SYNC button is off and the passenger side temperature can be operated individually.

### Adjusting the driver and passenger side temperature individually

Press the "SYNC" button again to adjust the driver and passenger side temperature individually. The button indicator will turn off.

### Temperature conversion

If the battery has been discharged or disconnected, the temperature mode display will reset to Centigrade.

To change the temperature unit from °C to °F or °F to °C :

- Automatic climate control system  
Press the AUTO button for 3 seconds while pressing the OFF button.
- Instrument cluster  
Go to User Settings → Other → Temperature Unit.

The temperature unit on both the cluster LCD display and the climate control screen will change.

### Air intake control

This is used to select the outside (fresh) air position or recirculated air position.

To change the air intake control position, push the control button.

#### Recirculated air position



With the recirculated air position selected, air from the passenger compartment will be drawn through the heating system and heated or cooled according to the function selected.

#### Outside (fresh) air position



With the outside (fresh) air position selected, air enters the vehicle from outside and is heated or cooled according to the function selected.

### Information

Using the system primarily in Fresh mode and Recirculation mode only when needed is recommended for best results.

**Prolonged operation of the heater in Recirculation mode and without the A/C ON can cause fogging of the windshield.**

**In addition, prolonged use of the A/C ON in Recirculation mode may result in excessively dry, dehumidified air in the cabin.**

### WARNING

- Continued use of the climate control system operation in Recirculation mode for a prolonged period of time may cause drowsiness to the occupants in the cabin. This may lead to loss of vehicle control which may lead to an accident.
- Continued use of the climate control system operation in Recirculation mode with the A/C OFF may allow humidity to increase inside the cabin. This may cause condensation to accumulate on the windshield and obscure visibility.
- Do not sleep in your vehicle or remain parked in your vehicle with the windows up and either the heater or the air conditioning ON for prolonged periods of time. Doing so may increase the levels of carbon dioxide in the cabin which may lead to serious injury or death.

### Fan speed control

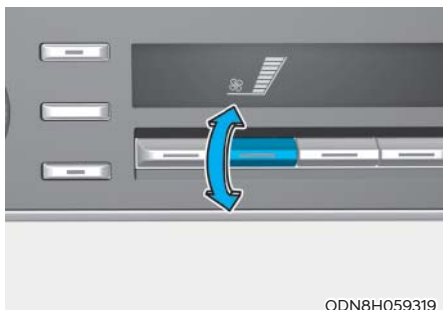

The fan speed can be set to the desired speed by using the fan speed control toggle switch.

More air is delivered with higher fan speeds.

Pressing the OFF button turns off the fan.

### **i** Information

For better sound quality, fan speed may automatically slow down for a couple of minutes when you activate voice recognition or hands free.

### **NOTICE**

Operating the fan when the ignition switch is in the ON position could cause the battery to discharge. Operate the fan when the engine is running.

### Air conditioning



Push the A/C button to manually turn the air conditioning system on (indicator light will illuminate).

Push the button again to turn the air conditioning system off.

### OFF mode



Push the OFF button of the front to turn off the air climate control system. However, you can still operate the mode and air intake buttons as long as the ignition switch is in the ON position.





## System Operation

### Cooling / Ventilation

1. Select the Face Level  mode.
2. Set the air intake control to fresh mode.
3. Set the temperature control to the desired position.
4. Set the fan speed control to the desired speed.

### Heating

1. Select the Floor Level  mode.
2. Set the air intake control to fresh mode.
3. Set the temperature control to the desired position.
4. Set the fan speed control to the desired speed.
5. If desired, turn the air conditioning ON with the temperature control knob set to heat in order to dehumidify the air before it enters into the cabin.

If the windshield fogs up, select the Floor & Defrost  mode or press the Front Defrost  mode.

### Operation Tips

- To keep dust or unpleasant fumes from entering the car through the ventilation system, temporarily set the air intake control to the recirculation mode. Return the control to the to Fresh mode when the unpleasant air outside has diminished. This will help keep the driver alert and comfortable.
- To help prevent the inside of the windshield from fogging, set the air intake control to fresh mode and the fan speed to the desired position, turn on the air conditioning system, and adjust the temperature control to the desired temperature.

### Air conditioning

Your HYUNDAI vehicle air conditioning system is filled with R-1234yf refrigerant.

1. Start the engine.
2. Press the air conditioning button.
3. Set the mode to the Face Level  mode.
4. Set the air intake control to Recirculation mode temporarily to allow the cabin to cool quickly. When the desired temperature in the cabin is reached, change the air intake control back to Fresh mode.
5. Adjust the fan speed control and temperature control to maintain maximum comfort.

When maximum cooling is desired, set the temperature control to the MAX A/C position, then set the fan speed control to the highest setting.

### NOTICE

**When using the air conditioning system, monitor the engine temperature gauge closely while driving up hills or in heavy traffic when outside temperatures. Air conditioning system operation when climbing a steep grade or in high outside ambient temperatures can cause engine overheating. Continue to use the fan, but turn the air conditioning system off if the engine temperature gauge indicates engine overheating.**

### Air conditioning system operation tips

- If the vehicle has been parked in direct sunlight during hot weather, open the windows for a short time to let the hot air inside the vehicle escape.
- After sufficient cooling has been achieved, switch back from the recirculated air to the fresh outside air position.
- To help reduce moisture inside of the windows on rainy or humid days, decrease the humidity inside the vehicle by operating the air conditioning system with the windows and sunroof closed.
- Use the air conditioning system every month only for a few minutes to ensure maximum system performance.
- If you operate air conditioner excessively, the difference between the temperature of the outside air and that of the windshield could cause the outer surface of the windshield to fog up, causing loss of visibility. In this case, set the mode selection knob or button to the  position and fan speed control to the lower speed.

## System Maintenance

### Cabin air filter

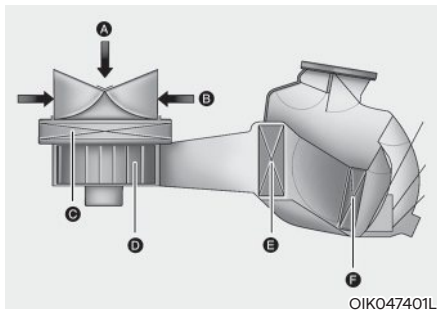

[A] : Outside air, [B] : Recirculated air

[C] : Cabin air filter, [D] : Blower

[E] : Evaporator core, [F] : Heater core

The cabin air filter is installed behind the glove box. It filters the dust or other pollutants that enter the vehicle through the heating and air conditioning system.

Have the cabin air filter replaced by an authorized HYUNDAI dealer according to the maintenance schedule. If the vehicle is being driven in severe conditions such as dusty or rough roads, more frequent cabin air filter inspections and changes are required.

If the air flow rate suddenly decreases, the system should be checked at an authorized HYUNDAI dealer.

### Checking the amount of air conditioner refrigerant and compressor lubricant

When the amount of refrigerant is low, the performance of the air conditioning is reduced. Overfilling also reduces the performance of the air conditioning system.

Therefore, if abnormal operation is found, have the system inspected by an authorized HYUNDAI dealer.

#### NOTICE

It is important that the correct type and amount of oil and refrigerant is used. Otherwise, damage to the compressor and abnormal system operation may occur. To prevent damage, the air conditioning system in your vehicle should only be serviced by trained and certified technicians.



#### WARNING

Vehicles equipped with R-1234yf



Since the refrigerant is mildly flammable and operated at high pressure, the air conditioning system should only be serviced by trained and certified technicians. It is important that the correct type and amount of oil and refrigerant are used.

All refrigerants should be reclaimed with proper equipment.

Venting refrigerants directly to the atmosphere is harmful to individuals and environment. Failure to heed these warnings can lead to serious injuries.



©DN8A079026

#### Air conditioning refrigerant label

You can find out which air conditioning refrigerant is applied to your vehicle on the label located inside of the hood.

■ Example



OHYK059001



Each symbols and specification on the air conditioning refrigerant label is represented as below:

1. Classification of refrigerant
2. Amount of refrigerant
3. Classification of Compressor lubricant
4. Caution
5. Flammable refrigerant
6. To require registered technician to service air conditioning system

## WINDSHIELD DEFROSTING AND DEFOGGING

### WARNING

#### Windshield heating

Do not use the  or  position during cooling operation in extremely humid weather. The difference between the temperature of the outside air and that of the windshield could cause the outer surface of the windshield to fog up, causing loss of visibility could cause an accident resulting in serious injury or death. In this case, set the mode selection knob or button to the  position and fan speed control knob or button to a lower speed.

- For maximum defrost performance, set the temperature control knob to the highest temperature setting (rotated all the way to the right) and the fan speed control to the highest setting.
- If warm air to the floor is desired while defrosting or defogging, set the mode to the floor-defrost position.
- Before driving, clear all snow and ice from the windshield, rear window, side view mirrors, and all side windows.
- Clear all snow and ice from the hood and air inlet in the cowl grill to improve heater and defroster efficiency and to reduce the probability of fogging up the inside of the windshield.

### NOTICE

If you start the vehicle when the weather is cold, more adequate way to heat the cabin is described below.

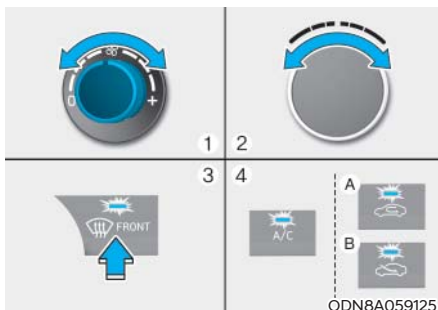

1. Turn off or lower the blower, right after engine starting, because engine temperature is still low and the air flow is cold.
2. After few minutes of engine warm up, turn the blower to low to medium speed and set the temperature control to Hot.

### Manual Climate Control System To defog inside windshield



ODN8A059125

[A] : Type A, [B] : Type B

1. Select any fan speed except “0” position.
2. Select desired temperature.
3. Select the  or  position.
4. Fresh mode air will be selected automatically. Additionally, the air conditioning (if equipped) will automatically operate if the mode is selected to the  position.

If the air conditioning and fresh mode are not selected automatically, press the corresponding button manually.

### To defrost outside windshield

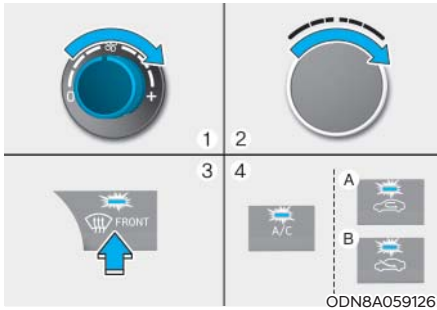

[A] : Type A, [B] : Type B

1. Set the fan speed to the highest setting (knob rotated all the way to the right).
2. Set the temperature control to the highest temperature setting.
3. Select the position.
4. Fresh mode air and air conditioning (if equipped) will be selected automatically.

### Automatic Climate Control System

#### To defog inside windshield

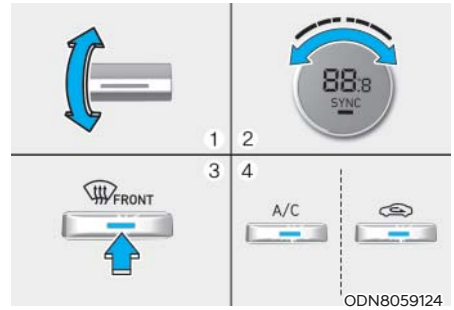



1. Select desired fan speed.
2. Select desired temperature.
3. Press the defroster button ().
4. The air-conditioning will turn on according to the detected ambient temperature, fresh mode and higher fan speed will be selected automatically.

If the air-conditioning, fresh mode and higher fan speed are not selected automatically, adjust the corresponding button or knob manually.

If the position is selected, lower fan speed is controlled to higher fan speed.

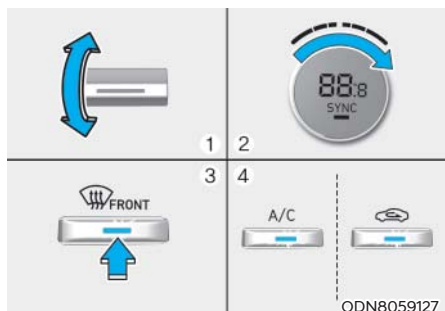

### To defrost outside windshield





1. Set fan speed to the highest position.
2. Set temperature to the extreme hot (HI) position.
3. Press the defroster button (  ).
4. The air-conditioning will turn on according to the detected ambient temperature and fresh mode will be selected automatically.

If the  position is selected, lower fan speed is controlled to higher fan speed.

### Defogging Logic

To reduce the probability of fogging up the inside of the windshield, the air intake or air conditioning are controlled automatically according to certain conditions such as  or  position. To cancel or return the defogging logic, do the following.

#### Manual climate control system

1. Turn the ignition switch to the ON position.
2. Select defroster mode (  ).
3. Press the air intake control button at least 5 times within 3 seconds. The process should be completed within 10 seconds after the defroster mode (  ) is selected.

The LED indicator on the air intake button will blink 3 times to indicate that the defogging logic has been disabled.

Repeat the steps again to re-enable the defogging logic.

If the battery has been discharged or disconnected, it resets to the defog logic status.

#### Automatic climate control system

1. Turn the ignition switch to the ON position.
2. Press the defroster button (  ).
3. While pressing the air conditioning button (A/C), press the air intake control button at least 5 times within 3 seconds.

The automatic climate control information screen will blink 3 times to indicate that the defogging logic has been disabled.

Repeat the steps again to re-enable the defogging logic.

If the battery has been discharged or disconnected, it resets to the defog logic status.

## Auto Defogging System (Only for Automatic Climate Control System, if equipped)

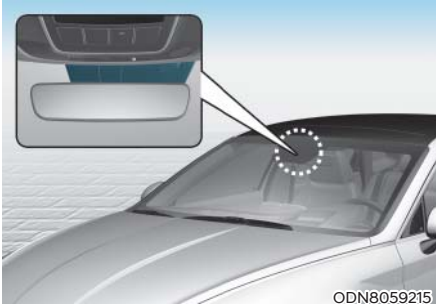

Auto defogging helps reduce the possibility of fogging up the inside of the windshield by automatically sensing the moisture on inside the windshield.

The auto defogging system operates when the heater or air conditioning is on.



When the Auto Defogging System operates, the indicator will illuminate.

If a high amount of humidity is detected in the vehicle, the Auto Defogging System will be enabled.

The following steps will be performed automatically:

- Step 1) The A/C button will turn ON.
- Step 2) The air intake control will change to Fresh mode under low outside temperature.
- Step 3) The mode will be changed to defrost to direct airflow to the windshield.
- Step 4) The fan speed will be increased.

### To cancel or reset the Auto Defogging System

Press the front windshield defroster button for 3 seconds when the ignition switch is in the ON position.

When the Auto Defogging System is canceled, defrost button indicator will blink 3 times.

When the Auto Defogging System is reset, defrost button indicator will blink 6 times without a signal.

### **i** Information

- When the air conditioning is turned on by Auto defogging system, if you try to turn off the air conditioning, the indicator will blink 3 times and the air conditioning will not be turned off.
- To maintain the effectiveness and efficiency of the Auto Defogging System, do not select Recirculation mode while the system is operating.
- When the Auto Defogging System is operating, the fan speed adjustment knob, the temperature adjustment knob, and the air intake control button are all disabled.

### **NOTICE**

**Do not remove the sensor cover located on the upper end of the driver side windshield glass.**

**Damage to system parts could occur and may not be covered by your vehicle warranty.**

## Defroster

### NOTICE

To prevent damage to the conductors bonded to the inside surface of the rear window, never use sharp instruments or window cleaners containing abrasives to clean the window.

### **i** Information

If you want to defrost and defog the front windshield, refer to “Windshield Defrosting and Defogging” in this chapter.

#### Rear window defroster



ODN8059284L



ODN8059283L

The defroster heats the window to remove frost, fog and thin ice from the interior and exterior of the rear window, while engine is running.

- To activate the rear window defroster, press the rear window defroster button located in the center facia switch panel. The indicator on the rear window defroster button illuminates when the defroster is ON.
- To turn off the defroster, press the rear window defroster button again.

### **i** Information

- If there is heavy accumulation of snow on the rear window, brush it off before operating the rear defroster.
- The rear window defroster automatically turns off after approximately 20 minutes or when the ignition switch is in the LOCK/OFF position.

#### Outside mirror defroster (if equipped)

If your vehicle is equipped with the outside mirror defrosters, they will operate at the same time you turn on the rear window defroster.



## CLIMATE CONTROL ADDITIONAL FEATURES

### Sunroof Inside Air Recirculation (if equipped)

When the sunroof is opened, outside (fresh) air will be automatically selected. At this time, if you press the air intake control button, recirculated air position will be selected but will change back to outside (fresh) air after 3 minutes. When the sunroof is closed, the air intake position will return to the original position that was selected.

### Automatic Ventilation

The system automatically selects the fresh mode when the climate control system operates Floor-Level or Bi-Level for more than 5 minutes and the outdoor temperature is under 59°F (15°C).

## STORAGE COMPARTMENT

### WARNING

Never store cigarette lighters, propane cylinders, or other flammable/explosive materials in the vehicle. These items may catch fire and/or explode if the vehicle is exposed to hot temperatures for extended periods.

### WARNING

ALWAYS keep the storage compartment covers closed securely while driving. Items inside your vehicle are moving as fast as the vehicle. If you have to stop or turn quickly, or if there is a crash, the items may fly out of the compartment and may cause an injury if they strike the driver or a passenger.

### NOTICE

To avoid possible theft, do not leave valuables in the storage compartments.

## Center Console Storage



To open:

Grab and hold the latch on the arm rest then lift the lid.

## Glove Box

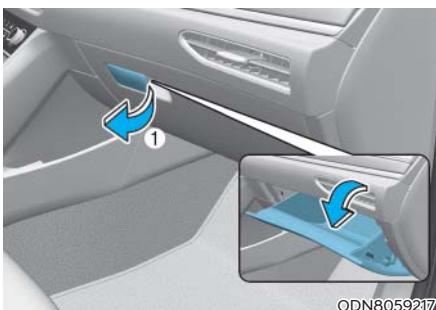

To open:

Pull the lever (1).

### WARNING

ALWAYS close the glove box door after use.

An open glove box door can cause serious injury to the passenger in an accident, even if the passenger is wearing a seat belt.

## INTERIOR FEATURES

### Cup Holder

#### Front



#### Rear

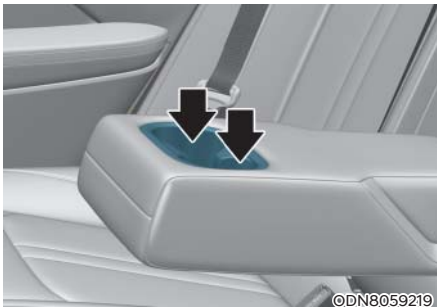

Cups or small beverages cups may be placed in the cup holders.



### WARNING

Keep cans or bottles out of direct sun light and do not put them in a hot vehicle. It may explode.

### NOTICE

- Keep your drinks sealed while driving to prevent spilling your drink. If liquid spills, it may get into the vehicle's electrical/electronic system and damage electrical/electronic parts.
- When cleaning spilled liquids do not use hot air to blow out or dry the cup holder. This may damage the interior.



### WARNING

- Avoid abrupt starting and braking when the cup holder is in use to prevent spilling your drink. If hot liquid spills, you could be burned. Such a burn to the driver could cause loss of vehicle control resulting in an accident.
- Do not place uncovered or unsecured cups, bottles, cans, etc., in the cup holder containing hot liquid while the vehicle is in motion. Injuries may result in the event of a sudden stop or collision.
- Only use soft cups in the cup holders. Hard objects can injure you in an accident.

### Sunvisor

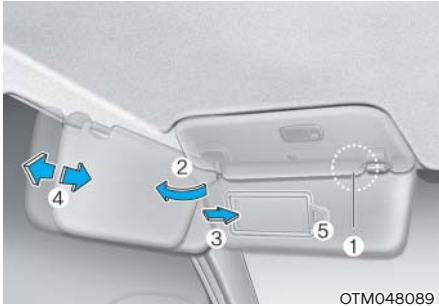

To use a sunvisor, pull it downward.  
To use a sunvisor for a side window, pull it downward, unsnap it from the bracket (1) and swing it to the side (2).  
To use the vanity mirror, pull down the sunvisor and slide the mirror cover (3).  
Adjust the sunvisor forward or backward (4, if equipped) as needed.  
Use the ticket holder (5) to hold tickets.  
Close the vanity mirror cover securely and return the sunvisor to its original position after use.

#### NOTICE

Close the vanity mirror cover securely and return the sunvisor to its original position after use.



#### WARNING

For your safety, do not block your view when using the sunvisor.

#### NOTICE

Do not put several tickets in the ticket holder at one time. This could cause damage to the ticket holder.

### Power Outlet



The power outlet is designed to provide power for mobile telephones or other devices designed to operate with vehicle electrical systems. The devices should draw less than 180 W with the engine running.



#### WARNING

Avoid electrical shocks. Do not place your fingers or foreign objects (pin, etc.) into a power outlet or touch the power outlet with a wet hand.

**NOTICE**

To prevent damage to the Power Outlets:

- Use the power outlet only when the engine is running and remove the accessory plug after use. Using the accessory plug for prolonged periods of time with the engine off could cause the battery to discharge.
- Only use 12V electric accessories which are less than 180 W in electric capacity.
- Adjust the air-conditioner or heater to the lowest operating level when using the power outlet.
- Close the cover when not in use.
- Some electronic devices can cause electronic interference when plugged into a vehicle's power outlet. These devices may cause excessive audio static and malfunctions in other electronic systems or devices used in your vehicle.
- Push the plug in as far as it will go. If good contact is not made, the plug may overheat and the fuse may open.
- Plug in battery equipped electrical/electronic devices with reverse current protection. The current from the battery may flow into the vehicle's electrical/electronic system and cause system malfunction.

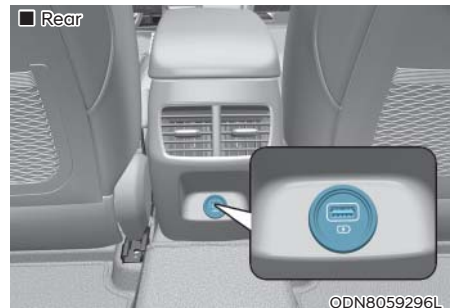
**USB Charger (if equipped)**

The USB charger is designed to recharge batteries of small size electrical devices using a USB cable.

The electrical devices can be recharged when the ignition switch or the Engine Start/Stop button is in the ACC, ON or START position.

The battery charging state may be monitored on the electrical device.

Disconnect the USB cable from the USB port after use.

- A smart phone or a tablet PC may get warmer during the re-charging process. It does not indicate any malfunction with the charging system.
- A smart phone or a tablet PC, which adopts a different re-charging method, may not be properly re-charged. In this case, use an exclusive charger of your device.
- The charging terminal is only to recharge a device. Do not use the charging terminal either to turn ON an audio or to play media on the AVN.

## Wireless Cellular Phone Charging System (if equipped)

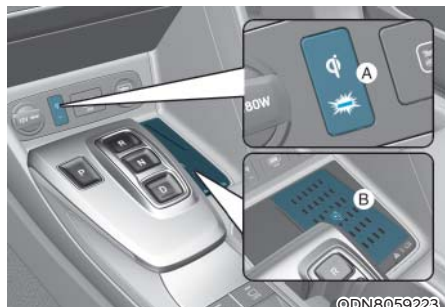

[A]: Indicator light, [B]: Charging pad

On certain models, the vehicle comes equipped with a wireless cellular phone charger.

The system is available when all doors are closed, and when the ignition switch is ON.

### To charge a cellular phone

The wireless cellular phone charging system charges only the Qi-enabled cellular phones. Read the label on the cellular phone accessory cover or visit your cellular phone manufacturer's website to check whether your cellular phone supports the Qi technology.

The wireless charging process starts when you put a Qi-enabled cellular phone on the wireless charging unit.

1. Remove other items, including the smart key, from the wireless charging unit. If not, the wireless charging process may be interrupted. Place the cellular phone on the center of the charging pad (  ).
2. The indicator light is orange when the cellular phone is charging. The indicator light turns green when phone charging is complete.
3. You can turn ON or OFF the wireless charging function in the user settings mode on the instrument cluster. For further information, refer to the "LCD Display Modes" in this chapter.

If your cellular phone is not charging:

- Slightly change the position of the cellular phone on the charging pad.
- Make sure the indicator light is orange.

The indicator light will blink orange for 10 seconds if there is a malfunction in the wireless charging system.

In this case, temporarily stop the charging process, and re-attempt to charge your cellular phone again.

The system warns you with a message on the LCD display if the cellular phone is still on the wireless charging unit after the engine is turned OFF and the front door is opened.

### Information

**For some manufacturers' cellular phones, the system may not warn you even though the cellular phone is left on the wireless charging unit. This is due to the particular characteristic of the cellular phone and not a malfunction of the wireless charging.**

### NOTICE

- **The wireless cellular phone charging system may not support certain cellular phones, which are not verified for the Qi specification (  ).**
- **When placing your cellular phone on the charging mat, position the phone in the middle of the mat for optimal charging performance. If your cellular phone is off to the side, the charging rate may be less and in some cases the cellular phone may experience higher heat conduction.**
- **In some cases, the wireless charging may stop temporarily when the Remote Key or Smart Key is used, either when starting the vehicle or locking/unlocking the doors, etc.**
- **When charging certain cellular phones, the charging indicator may not change to green when the cellular phone is fully charged.**

- The wireless charging process may temporarily stop, when temperature abnormally increases inside the wireless cellular phone charging system. Stop the charging cellular phone and wait until temperature falls to a certain level.
- The wireless charging process may temporarily stop when there is any metallic item, such as a coin, between the wireless cellular phone charging system and the cellular phone.
- When charging some cellular phones with a self-protection feature, the wireless charging speed may decrease and the wireless charging may stop.
- If the cellular phone has a thick cover, the wireless charging may not be possible.
- If the cellular phone is not completely contacting the charging pad, wireless charging may not operate properly.
- Some magnetic items like credit cards, phone cards or rail tickets may be damaged if left with the cellular phone during the charging process.
- When any cellular phone without a wireless charging function or a metallic object is placed on the charging pad, a small noise may sound. This small sound is due to the vehicle discerning compatibility of the object placed on the charging pad. It does not affect your vehicle or the cellular phone in any way.

### **i** Information

If the ignition switch is in the OFF position, the charging also stops.

### **i** Information

This device complies with part 15 of the FCC Rules.

Operation is subject to the following two conditions:

1. This device may not cause harmful interference, and
2. This device must accept any interference received, including interference that may cause undesired operation.

## Clock



### WARNING

Do not attempt to adjust the clock while driving. Doing so may result in distracted driving which may lead to an accident involving personal injury or death.

For more information, please refer to the manual that was supplied with your vehicle.

## Clothes Hanger



These hangers are not designed to hold large or heavy items.



### WARNING

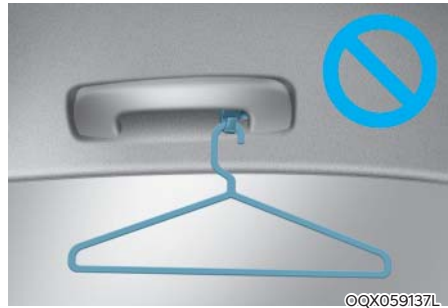

Do not hang other objects such as hangers or hard objects except clothes. Also, do not put heavy, sharp or breakable objects in the clothes pockets. In an accident or when the curtain air bag is inflated, it may cause vehicle damage or personal injury.



## Floor Mat Anchor(s)

ALWAYS use the Floor Mat Anchors to attach the front floor mats to the vehicle. The anchors on the front floor carpet keep the floor mats from sliding forward.



### WARNING

Do not overlay additional mats or liners over the floor mats. If using All Weather mats, remove the carpeted floor mats before installing them. Only use floor mats designed to connect to the anchors.



### WARNING

The following must be observed when installing ANY floor mat to the vehicle.

- Ensure to remove a protective film attached on the carpet before attaching a floor mat on the front floor carpet. Otherwise, the floor mat may move freely on the protective film and it could result in unintentional braking or accelerating.
- Ensure that the floor mats are securely attached to the vehicle's floor mat anchor(s) before driving the vehicle.
- Do not use ANY floor mat that cannot be firmly attached to the vehicle's floor mat anchors.
- Do not stack floor mats on top of one another (e.g. all-weather rubber mat on top of a carpeted floor mat). Only a single floor mat should be installed in each position.

**IMPORTANT** - Your vehicle was manufactured with driver's side floor mat anchors that are designed to securely hold the floor mat in place. To avoid any interference with pedal operation, HYUNDAI recommends that the HYUNDAI floor mat designed for use in your vehicle be installed.

## INFOTAINMENT SYSTEM

### NOTICE

- If you install an aftermarket HID head lamp, your vehicle's audio and electronic devices may not function properly.
- Prevent chemicals such as perfume, cosmetic oil, sunscreen, hand cleaner, and air freshener from contacting the interior parts because they may cause damage or discoloration.

### USB and iPod® Port



You can use an AUX or USB cable to connect audio devices to the vehicle AUX or USB port.

### **i** Information

When using a portable audio device connected to the power outlet, noise may occur during playback. If this happens, use the portable audio device's power source.

\* iPod® is a trademark of Apple Inc.

### Antenna

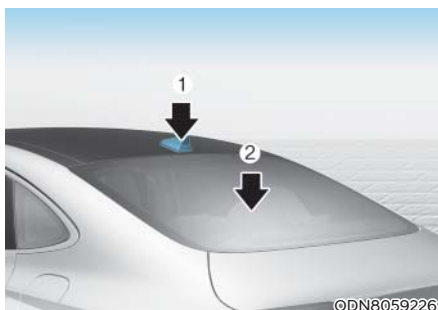

#### **Shark fin antenna (1, if equipped)**

The shark fin antenna receives transmitted data. (for example : GPS)

#### **Glass antenna (2)**

Your vehicle uses a glass antenna to receive both AM and FM signals.

### **!** WARNING

- Do not clean the inside of the rear window glass with a cleaner or scraper to remove foreign deposits as this may cause damage to the antenna elements.
- To prevent damage to the rear glass antenna, never use sharp instruments or window cleaner containing abrasives to clean the window. Clean the inside surface of the rear glass window with a piece of soft cloth.
- Avoid adding metallic coatings such as Ni, Cd, etc. These can degrade the receiving AM and FM broadcast signals.
- When putting a sticker on the inside surface of the rear window, be careful not to damage the rear glass antenna.
- Do not put sharp instruments nearby the rear glass antenna.

## Steering Wheel Audio Control



### NOTICE

**Do not operate multiple audio remote control buttons simultaneously.**

### VOLUME (VOL + / -) (1)

- Press the VOLUME switch up to increase volume.
- Press the VOLUME switch down to decrease volume.

### SEEK/PRESET (^ / ∨) (2)

If the SEEK/PRESET switch is pressed up or down and held for 0.8 second or more, it will function in the following modes:

- **RADIO mode**  
It will function as the AUTO SEEK select button. It will SEEK until you release the button.
- **MEDIA mode**  
It will function as the FF/RW button.

If the SEEK/PRESET switch is pressed up or down, it will function in the following modes:

- **RADIO mode**  
It will function as the PRESET STATION UP/DOWN button.
- **MEDIA mode**  
It will function as the TRACK UP/DOWN button.

### MODE (⊙) (3)

Press the MODE button to toggle through Radio, SXM, or AUX modes.

### MUTE (🔇) (4)

- Press the MUTE button to mute the sound.
- Press the MUTE button again to activate the sound.

### **i** Information

**Detailed information for audio control buttons are described in a separately supplied manual with the vehicle.**

### **Bluetooth® Wireless Technology Hands-Free**

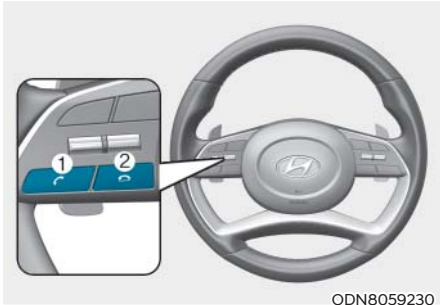

With the *Bluetooth*® Wireless Technology in the vehicle, you can use the phone wireless.

- (1) Call / Answer button
- (2) Call end button

Detailed information for the *Bluetooth*® Wireless Technology hands-free is described in the Vehicle Infotainment User's Manual.

### **Blue Link® center (if equipped)**



For details, refer to the Blue Link® Owner's Guide or Navigation Manual.

### **Audio (Display Audio) / Video / Navigation System (AVN) (if equipped)**

Detailed information for the AVN system is described in the Vehicle Infotainment User's Manual.

# 6. While Driving

Before Driving .....	6-5
Before Entering the Vehicle.....	6-5
Before Starting .....	6-5
Ignition Switch .....	6-6
Key Ignition Switch.....	6-6
Engine Start/Stop Button .....	6-9
Remote Start.....	6-12
Automatic Transmission .....	6-13
Automatic Transmission Operation.....	6-13
Parking .....	6-16
LCD Display Message.....	6-17
Good Driving Practices .....	6-18
Paddle Shifter (Manual Shift Mode) .....	6-19
Brake System.....	6-20
Power Brakes .....	6-20
Disc Brakes Wear Indicator.....	6-20
Electronic Parking Brake (EPB).....	6-21
Auto Hold .....	6-24
Anti-lock Brake System (ABS) .....	6-27
Electronic Stability Control (ESC) .....	6-29
Vehicle Stability Management (VSM) .....	6-31
Hill-Start Assist Control (HAC).....	6-32
Good Braking Practices .....	6-32
ISG (Idle Stop and Go) system.....	6-33
To Activate the ISG System.....	6-33
To Deactivate the ISG System .....	6-35
ISG System Malfunction .....	6-35
Battery Sensor Deactivation.....	6-36
Drive Mode Integrated Control System.....	6-37
Drive Mode .....	6-37

Forward Collision – Avoidance Assist (FCA) - Sensor Fusion .....	6-40
System Setting and Activation .....	6-40
FCA Warning Message and Brake Control.....	6-42
FCA Sensor .....	6-45
System Malfunction .....	6-47
Limitations of the System.....	6-48
Forward Collision-Avoidance Assist - Junction Turning.....	6-55
Lane Keeping Assist (LKA).....	6-59
LKA Operation .....	6-61
LKA System Function Change .....	6-61
Warning Light and Message .....	6-64
Limitations of the System.....	6-65
Blind-Spot Collision Warning (BCW) /	
Blind-Spot Collision-Avoidance Assist (BCA).....	6-67
System Description .....	6-67
System Setting and Activation .....	6-68
Warning and System Control.....	6-70
Detecting Sensors (Front view camera and Rear corner radar).....	6-72
Limitations of the System.....	6-75
Driver Attention Warning (DAW) .....	6-79
System Setting and Operation .....	6-79
Resetting the System .....	6-81
System Standby.....	6-82
System Malfunction .....	6-82
Leading Vehicle Departure Alert .....	6-84
Blind-Spot View Monitor (BVM).....	6-87
Smart cruise control (SCC) .....	6-88
Smart Cruise Control Switch .....	6-89
To Convert to Cruise Control Mode .....	6-89
Smart Cruise Control Speed.....	6-90
Smart Cruise Control Vehicle-to-Vehicle Distance.....	6-96
Limitations of the System.....	6-101

# 6. While Driving

Navigation-Based Smart Cruise Control .....	6-105
System Setting and Operation .....	6-106
Lane Following Assist (LFA).....	6-109
LFA Operation.....	6-111
Warning Message.....	6-111
Limitations of the System.....	6-113
Highway Driving Assist (HDA).....	6-115
System Setting and Operation .....	6-116
Warning Message.....	6-118
Rear Cross-Traffic Collision Warning (RCCW) /	
Rear Cross-Traffic Collision-Avoidance Assist (RCCA) .....	6-121
System Description .....	6-121
System Setting and Activation .....	6-122
Warning and System Control.....	6-124
Detecting Sensors .....	6-127
Limitations of the System .....	6-128
Special Driving Conditions .....	6-133
Hazardous Driving Conditions .....	6-133
Rocking the Vehicle .....	6-133
Smooth Cornering.....	6-134
Driving at Night .....	6-134
Driving in the Rain .....	6-134
Driving in Flooded Areas.....	6-135
Highway Driving .....	6-135
Winter Driving .....	6-136
Snow or Icy Conditions .....	6-136
Winter Precautions.....	6-137
Vehicle load limit.....	6-139
Tire Loading Information Label .....	6-139
Trailer Towing .....	6-144



**WARNING**

**Carbon monoxide (CO) gas is toxic. Breathing CO can cause unconsciousness and death.**

Engine exhaust contains carbon monoxide which cannot be seen or smelled.

**Do not inhale engine exhaust.**

If at any time you smell engine exhaust inside the vehicle, open the windows immediately. Exposure to CO can cause unconsciousness and death by asphyxiation.

**Be sure the exhaust system does not leak.**

The exhaust system should be checked whenever the vehicle is raised to change the oil or for any other purpose. If you hear a change in the sound of the exhaust or if you drive over something that strikes the underneath side of the vehicle, have the exhaust system checked as soon as possible by an authorized HYUNDAI dealer.

**Do not run the engine in an enclosed area.**

Letting the engine idle in your garage, even with the garage door open, is a hazardous practice. Run the engine only long enough to start the engine and to move the vehicle out of the garage.

**Avoid idling the engine for prolonged periods with people inside the vehicle.**

If it is necessary to idle the engine for a prolonged period with people inside the vehicle, be sure to do so only in an open area with the air intake set at "Fresh" and fan control set to high so fresh air is drawn into the interior.

**Keep the air intakes clear.**

To assure proper operation of the ventilation system, keep the ventilation air intakes located in front of the windshield clear of snow, ice, leaves, or other obstructions.

**If you must drive with the trunk open:**

Close all windows.

Open instrument panel air vents.

Set the air intake control at "Fresh", the air flow control at "Floor" or "Face", and the fan control set to high.



**WARNING**

**CALIFORNIA PROPOSITION 65 WARNING**

**Engine exhaust and a wide variety of automobile components including components found in the interior furnishings in a vehicle, contain or emit harmful chemicals known to the State of California to cause cancer and birth defects and reproductive harm. In addition, certain fluids contained in vehicles and certain products of components contain or emit chemicals known to the State of California to cause cancer and birth defects or other reproductive harm.**



## BEFORE DRIVING

### Before Entering the Vehicle

- Be sure all windows, outside mirror(s), and outside lights are clean and unobstructed.
- Remove frost, snow, or ice.
- Visually check the tires for uneven wear and damage.
- Check under the vehicle for any sign of leaks.
- Be sure there are no obstacles behind you if you intend to back up.

### Before Starting

- Make sure the hood, the trunk, and the doors are securely closed and locked.
- Adjust the position of the seat and steering wheel.
- Adjust the inside and side view mirrors.
- Verify all the lights work.
- Fasten your seatbelt. Check that all passengers have fastened their seatbelts.
- Check the gauges and indicators in the instrument panel and the messages on the instrument display when the ignition switch is in the ON position.
- Check that any items you are carrying are stored properly or fastened down securely.



### WARNING

To reduce the risk of **SERIOUS INJURY** or **DEATH**, take the following precautions:

- **ALWAYS** wear your seat belt. All passengers must be properly belted whenever the vehicle is moving. For more information, refer to "Seat Belts" in chapter 3.
- Always drive defensively. Assume other drivers or pedestrians may be careless and make mistakes.
- Stay focused on the task of driving. Driver distraction can cause accidents.
- Leave plenty of space between you and the vehicle in front of you.



### WARNING

**NEVER** drink alcohol or take drugs and drive.

Drinking alcohol or taking drugs and driving is dangerous and may result in an accident and **SERIOUS INJURY** or **DEATH**.

Drunk driving is the number one contributor to the highway death toll each year. Even a small amount of alcohol will affect your reflexes, perceptions and judgment. Just one drink can reduce your ability to respond to changing conditions and emergencies and your reaction time gets worse with each additional drink.

Driving while under the influence of drugs is as dangerous or more dangerous than driving under the influence of alcohol.

You are much more likely to have a serious accident if you drink or take drugs and drive. If you are drinking or taking drugs, don't drive. Do not ride with a driver who has been drinking or taking drugs. Choose a designated driver or call a taxi.

## IGNITION SWITCH

### Key Ignition Switch (if equipped)

#### WARNING

To reduce the risk of **SERIOUS INJURY** or **DEATH**, take the following precautions:

- **NEVER** allow children or any person who is unfamiliar with the vehicle to touch the ignition switch or related parts. Unexpected and sudden vehicle movement can occur.
- **NEVER** reach through the steering wheel for the ignition switch, or any other control, while the vehicle is in motion. The presence of your hand or arm in this area may cause a loss of vehicle control resulting in an accident.

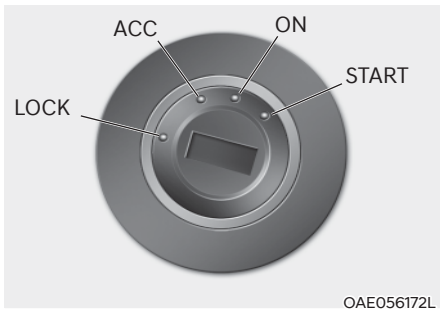

OAE056172L

Whenever the front door is opened, the ignition switch will illuminate, provided the ignition switch is not in the ON position. The light will go off immediately when the ignition switch is turned on or go off after about 30 seconds when the door is closed. (if equipped)

#### WARNING

**NEVER** turn the ignition switch to the **LOCK** or **ACC** position while the vehicle is in motion except in an emergency. This will result in the engine turning off and loss of power assist for the steering and brake systems. This may lead to loss of directional control and braking function, which could cause an accident.

Before leaving the driver's seat, always make sure the shift button is in P (Park) position, apply the parking brake, and turn ignition switch to the **LOCK** position.

Unexpected vehicle movement may occur if these precautions are not followed.

**Key ignition switch positions**

Switch Position	Action	Notice
<b>LOCK</b>	To turn the ignition switch to the LOCK position, put the key in at the ACC position and turn the key towards the LOCK position. The ignition key can be removed in the LOCK position. (The shift button must be in the P (Park) position)	
<b>ACC</b>	Electrical accessories are usable. The steering wheel unlocks.	
<b>ON</b>	This is the normal key position when the engine has started. All features and accessories are usable. The warning lights can be checked when you turn the ignition switch from ACC to ON.	Do not leave the ignition switch in the ON position when the engine is not running in order to prevent the battery from discharging.
<b>START</b>	To start the engine, turn the ignition switch to the START position. The switch returns to the ON position when you let go of the key.	The engine will crank until you release the key.

### Starting the engine



#### WARNING

Always wear appropriate shoes when operating your vehicle.

Unsuitable shoes, such as high heels, ski boots, sandals, flip-flops, etc., may interfere with your ability to use the brake and accelerator pedals.

1. Make sure the parking brake is applied.
2. Make sure the gear is in P (Park).
3. Depress the brake pedal.
4. Turn the ignition switch to the START position. Hold the key (maximum of 10 seconds) until the engine starts and release it.

#### Information

- It is best to maintain a moderate engine speed until the vehicle engine comes up to normal operating temperature. Avoid harsh or abrupt acceleration or deceleration while the engine is still cold.
- Whether the engine is cold or warm, always start the vehicle with your foot on the brake pedal. Do not depress the accelerator while starting the vehicle. Do not rev the engine while warming it up.

#### **NOTICE**

To prevent damage to the vehicle:

- Do not hold the ignition key in the START position for more than 10 seconds. Wait 5 to 10 seconds before trying again.
- Do not push or tow your vehicle to start the engine.

### Turning off the engine

1. Stop the vehicle and depress the brake pedal fully.
2. Shift the gear to P (Park).
3. Turn the ignition switch to the off position and apply the parking brake.

## Engine Start/Stop Button (if equipped)

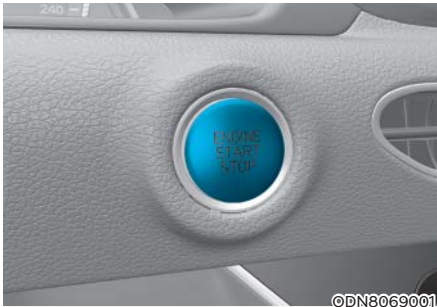

Whenever the front door is opened, the Engine Start/Stop button will illuminate and will go off 30 seconds after the door is closed.

### WARNING

To reduce risk of serious injury or death, **NEVER** allow children or any person who is unfamiliar with the vehicle to touch the Engine Start/Stop button or related parts. Unexpected and sudden vehicle movement can occur.

### WARNING

To turn the engine off in an emergency: Press and hold the Engine Start/Stop button for more than two seconds **OR** rapidly press and release the Engine Start/Stop button three times (within three seconds).

If the vehicle is still moving, you can restart the engine without depressing the brake pedal by pressing the Engine Start/Stop button with the shift button in the N (Neutral) position.

### WARNING

- **NEVER** press the Engine Start/Stop button while the vehicle is in motion except in an emergency. This will result in the engine turning off and loss of power assist for the steering and brake systems.  
This may lead to loss of directional control and braking function, which could cause an accident.
- Before leaving the driver's seat, always make sure the shift button is in the P (Park) position, set the parking brake, press the Engine Start/Stop button to the OFF position, and take the Smart Key with you. Unexpected vehicle movement may occur if these precautions are not followed.
- **NEVER** reach through the steering wheel for the Engine Start/Stop button or any other control while the vehicle is in motion. The presence of your hand or arm in this area may cause a loss of vehicle control resulting in an accident.

**Engine Stop/Start button positions**

Button Position	Action	Notice
<b>OFF</b>	To turn off the engine, press the Engine Start/Stop button with shift button in P (Park). When you press the Engine Start/Stop button without the shift button in P (Park), the Engine Start/Stop button does not turn to the OFF position, but turns to the ACC position.	
<b>ACC</b>	Press the Engine Start/Stop button when the button is in the OFF position without depressing the brake pedal. Electrical accessories are usable.	If you leave the Engine Start/Stop button in the ACC position for more than one hour, the battery power will turn off automatically to prevent the battery from discharging.
<b>ON</b>	Press the Engine Start/Stop button while it is in the ACC position without depressing the brake pedal. The warning lights can be checked before the engine is started.	Do not leave the Engine Start/Stop button in the ON position when the engine is not running to prevent the battery from discharging.
<b>START</b>	To start the engine, depress the brake pedal and press the Engine Start/Stop button with the shift button in the P (Park) or in the N (Neutral) position. For your safety, start the engine with the shift button in the P (Park) position.	If you press the Engine Start/Stop button without depressing the brake pedal, the engine does not start and the Engine Start/Stop button changes as follows: <b>OFF → ACC → ON → OFF or ACC</b> However, the engine may start if you depress the brake pedal within 0.5 second after pressing the Engine Start/Stop button from the OFF position.

## Starting the engine



### WARNING

- Always wear appropriate shoes when operating your vehicle.  
Unsuitable shoes, such as high heels, ski boots, sandals, flip-flops, etc., may interfere with your ability to use the brake and accelerator pedals.
- Do not start the vehicle with the accelerator pedal depressed. The vehicle can move and lead to an accident.
- Wait until the engine rpm is normal. The vehicle may suddenly move if the brake pedal is released when the rpm is high.



### Information

- The engine will start by pressing the Engine Start/Stop button, only when the smart key is in the vehicle.
- Even if the smart key is in the vehicle, if it is far away from the driver, the engine may not start.
- When the Engine Start/Stop button is in the ACC or ON position, if any door is open, the system checks for the smart key. If the smart key is not in the vehicle, the “” indicator will blink and the warning “Key not in vehicle” will come on and if all doors are closed, the chime will also sound for about 5 seconds. Keep the smart key in the vehicle when using the ACC position or if the vehicle engine is ON.

1. Always carry the smart key with you.
2. Make sure the parking brake is applied.
3. Make sure the gear is in P (Park).
4. Depress the brake pedal.
5. Press the Engine Start/Stop button.



### Information

- Do not wait for the engine to warm up while the vehicle remains stationary. Start driving at moderate engine speeds. (Aggressive accelerating and decelerating should be avoided.)
- Always start the vehicle with your foot on the brake pedal. Do not depress the accelerator while starting the vehicle. Do not rev the engine while warming it up.

### NOTICE

To prevent damage to the vehicle:

- If the engine stalls while you are in motion, do not attempt to move the shift button to the P (Park) position.  
If traffic and road conditions permit, you may put the shift button in the N (Neutral) position while the vehicle is still moving and press the Engine Start/Stop button in an attempt to restart the engine.
- Do not push or tow your vehicle to start the engine.

**NOTICE**

To prevent damage to the vehicle:

When the stop lamp switch fuse is blown, you can't start the engine normally. Replace the fuse with a new one. If you are not able to replace the fuse, you can start the engine by pressing and holding the Engine Start/Stop button for 10 seconds with the Engine Start/Stop button in the ACC position.

Do not press the Engine Start/Stop button for more than 10 seconds except when the stop lamp switch fuse is blown.

For your safety always depress the brake pedal before starting the engine.



**i Information**

If the smart key battery is weak or the smart key does not work correctly, you can start the engine by pressing the Engine Start/Stop button with the smart key in the direction of the picture above.

**Remote Start**



You can start the vehicle using the Remote Start button of the smart key.

To start the vehicle remotely:

- Lock the doors by pressing the door lock button within 32 feet (10 m) distance from the vehicle.
- Press the remote start button for over 2 seconds within 4 seconds after locking the doors and the hazard warning will blink.

To turn off the remote start function, press the remote start button once. In case of the manual operation, the climate control system will be maintained even when the engine is turned OFF. However, the automatic operation is set to 72°F(22°C).



## AUTOMATIC TRANSMISSION



### Automatic Transmission Operation

The automatic transmission has eight forward speeds and one reverse speed. The individual speeds are selected automatically in the D (Drive) position.



#### **WARNING**

The automatic transmission shift button or interior parts might get hot when a vehicle is parked outside during hot weather. Always be careful when the vehicle is hot.

### Transmission ranges

The indicator in the instrument cluster displays the gear position when the ignition switch is in the ON position.



#### WARNING

To reduce the risk of serious injury or death:

- **ALWAYS** check the surrounding areas near your vehicle for people, especially children, before shifting a vehicle into D (Drive) or R (Reverse).
- Before leaving the driver's seat, always make sure the gear is in the P (Park) position, then set the parking brake, and place the ignition switch in the LOCK/OFF position. Unexpected and sudden vehicle movement can occur if these precautions are not followed.
- If equipped, do not use the engine brake (shifting from a high gear to lower gear using the paddle shifters) rapidly on slippery roads.

#### P (Park)

Always come to a complete stop before shifting into P (Park).

To shift from P (Park), you must depress firmly on the brake pedal and make sure your foot is off the accelerator pedal.

The gear must be in P (Park) before turning the engine off.



#### WARNING

- Shifting into P (Park) while the vehicle is in motion may cause you to lose control of the vehicle.
- After the vehicle has stopped, always make sure the gear is in P (Park), apply the parking brake, and turn the engine off.
- Do not use the P (Park) position in place of the parking brake.

#### R (Reverse)

Use this position to drive the vehicle backward.

#### NOTICE

**Always come to a complete stop before shifting into or out of R (Reverse); you may damage the transmission if you shift into R (Reverse) while the vehicle is in motion.**

When the vehicle is stopped in R (Reverse) position, if you open the driver's door with the seat belt unfastened, the gear is shifted to P (Park) position automatically.

However when the vehicle moves in R (Reverse) position, if you open the driver's door with the seat belt unfastened, the gear may be not shifted to P (Park) position automatically for protecting the automatic transmission.

#### N (Neutral)

The wheels and transmission are not engaged.

Use N (Neutral) if you need to restart a stalled engine, or if it is necessary to stop with the engine ON. Shift into P (Park) if you need to leave your vehicle for any reason.

Always depress the brake pedal when you are shifting from N (Neutral) to another gear.



#### WARNING

**Do not shift into gear unless your foot is firmly on the brake pedal. Shifting into gear when the engine is running at high speed can cause the vehicle to move very rapidly. You could lose control of the vehicle and hit people or objects.**

### D (Drive)

This is the normal driving position. The transmission will automatically shift through a 8-gear sequence, providing the best fuel economy and power.

To start the vehicle forward, push the D (Drive) button by depressing the brake pedal with the engine ON. Then depress the accelerator pedal smoothly.

For extra power when passing another vehicle or driving uphill, depress the accelerator fully. The transmission will automatically downshift to the next lower gear (or gears, as appropriate).

When the vehicle is stopped in D (Drive) position, if you open the driver's door with the seat belt unfastened, the gear is shifted to P (Park) position automatically.

However when the vehicle moves in D (Drive) position, if you open the driver's door with the seat belt unfastened, the gear may not shift to P (Park) position automatically to protect the automatic transmission.

### Shift-lock system

For your safety, the automatic transmission has a shift-lock system which prevents shifting the gear from P (Park) or N (Neutral) to R (Reverse) or D (Drive) unless the brake pedal is depressed.

To shift the gear from P (Park) or N (Neutral) to R (Reverse) or D (Drive):

1. Depress and hold the brake pedal.
2. Start the engine or place the ignition switch in the ON position.
3. Depress the brake pedal and push the R (Reverse) or D (Drive) button.

### Stay in N (Neutral) position when engine is Off



ODN8069006



ODN8069008

If you want to keep the N (Neutral) position after the engine is OFF, do the following.

1. Deactivate the AUTO HOLD and release the parking brake when the ignition switch is ON.
2. Start the engine. Push the N (neutral) button while depressing the brake pedal. If the message ("Press and hold OK button to stay in Neutral when vehicle is OFF") appears on the cluster LCD display, press and hold the OK button on the steering wheel for more than 1 second.
3. When the message ("Vehicle will stay in (N). Change gear to cancel") appears on the cluster LCD display, turn off the engine.

In this situation, if you unfasten the driver's seat belt and open the driver's door within 3 minutes, the gear stays in the N (Neutral) position and the ignition switch is turned off.

### ***When the battery is discharged:***

You cannot shift the gear when the battery is discharged.

In emergencies, do the following to move the shift button to N (Neutral) on a level ground.

1. Connect the battery cables from another vehicle or from a another battery to the jump-starting terminals inside the engine compartment.

**For more information refer to "Jump Starting" in chapter 7.**

2. Release the parking brake with the Engine Start/Stop button in the ON position.
3. Shift the gear to the N(Neutral) position. Refer to the "Stay in Neutral when vehicle is Off" in this chapter.

### **Parking**

Always come to a complete stop and continue to depress the brake pedal. Press the P button, apply the parking brake, and place the ignition switch in the LOCK/OFF position. Take the Key with you when exiting the vehicle.

- The gear is shifted to P (Park) position automatically for safety under the following conditions.
  - When the driver unfastens the seat belt and opens the driver's door.
  - When the engine is turned off with the gear shifted to R (Reverse), D (Drive) or N (Neutral).



### **WARNING**

**When you stay in the vehicle with the engine running, be careful not to depress the accelerator pedal for a long period of time. The engine or exhaust system may overheat and start a fire.**

**The exhaust gas and the exhaust system are very hot. Keep away from the exhaust system components.**

**Do not stop or park over flammable materials, such as dry grass, paper or leaves. They may ignite and cause a fire.**

## LCD Display Message

### ***Shifting conditions not met***

The warning message appears on the LCD display, when engine RPM is too high, or when driving speed is too fast to shift the gear.

We recommend you decrease the engine speed or slow down before shifting the gear.

### ***Press brake pedal to change gear***

The warning message appears on the LCD display, when the brake pedal is not depressed while shifting the gear.

We recommend you to depress the brake pedal and then shift the gear.

### ***Shift to P after stopping***

The warning message appears on the LCD display, when the gear is shifted to P (Park) while the vehicle is moving.

Stop the vehicle before shifting to P (Park).

### ***PARK engaged***

The warning message appears on the LCD display, when the gear is shifted to P (Park) while the vehicle is moving.

Stop the vehicle before shifting to P (Park).

### ***Press and hold OK button to stay in Neutral when vehicle is Off***

The warning message appears on the LCD display, when pushing the N (Neutral) button. If you want to stay N (Neutral) after turning off the engine, press and hold the "OK" button on the steering wheel more than 1 second.

### ***Vehicle will stay in (N). Change gear to cancel***

The warning message appears on the LCD display, when depressing the "OK" button on the steering wheel after the message ("Press and hold OK button to stay in Neutral when vehicle is Off") appears on the cluster LCD display. The gear stays in N(Neutral) position after turning off the engine.

### ***NEUTRAL engaged***

The message appears on the LCD display, when the N (Neutral) position is engaged.

### ***Gear already selected***

The message appears on the LCD display, when pushing the current shift button again.

### ***Shift button held down***

The warning message appears on the LCD display, when the shift button is pressed continuously or the shift button does not properly operate. Clean the surroundings of gear shift button.

If this message appears again, have the vehicle inspected by an authorized HYUNDAI dealer.

### ***Shifter system malfunction***

The warning message appears on the LCD display, when the transmission or the shift button does not properly operate in the P (Park) position.

In this case, have the vehicle inspected by an authorized HYUNDAI dealer.

### ***Check shift controls***

The warning message appears on the LCD display, when there is a malfunction with transmission shift button.

In this case, have the vehicle inspected by an authorized HYUNDAI dealer.

### Good Driving Practices

- Never shift the gear from P (Park) or N (Neutral) to any other position with the accelerator pedal depressed.
- Never shift the gear into P (Park) when the vehicle is in motion.
- Be sure the vehicle is completely stopped before you attempt to shift into R (Reverse) or D (Drive).
- Do not shift the gear to N (Neutral) when driving. Doing so may result in an accident because of a loss of engine braking and the transmission could be damaged.
- Do not drive with your foot resting on the brake pedal. Even light, but consistent pedal pressure can result in the brakes overheating, brake wear and possibly even brake failure.
- When driving in the manual shift mode, slow down before shifting to a lower gear. Otherwise, the lower gear may not be engaged if the engine rpms are outside of the allowable range.
- Always apply the parking brake when leaving the vehicle. Do not depend on placing the transmission in P (Park) to keep the vehicle from moving.
- Exercise extreme caution when driving on a slippery surface. Be especially careful when braking, accelerating or shifting gears. On a slippery surface, an abrupt change in vehicle speed can cause the drive wheels to lose traction and may cause loss of vehicle control resulting in an accident
- Optimum vehicle performance and economy is obtained by smoothly depressing and releasing the accelerator.



### WARNING

To reduce the risk of **SERIOUS INJURY** or **DEATH**:

- **ALWAYS wear your seatbelt. In a collision, an unbelted occupant is significantly more likely to be seriously injured or killed than a properly belted occupant.**
- **Avoid high speeds when cornering or turning.**
- **Do not make quick steering wheel movements, such as sharp lane changes or fast, sharp turns.**
- **The risk of rollover is greatly increased if you lose control of your vehicle at highway speeds.**
- **Loss of control often occurs if two or more wheels drop off the roadway and the driver over steers to reenter the roadway.**
- **In the event your vehicle leaves the roadway, do not steer sharply. Instead, slow down before pulling back into the travel lanes.**
- **HYUNDAI recommends you follow all posted speed limits.**

## Paddle Shifter (Manual Shift Mode) (if equipped)

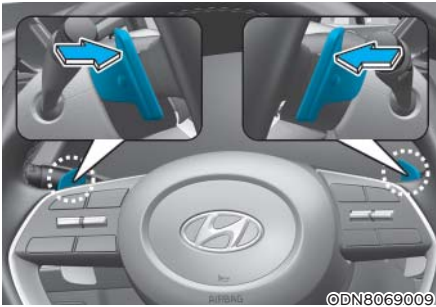

The paddle shifter is available when the gear is in the D (Drive) position.

Pull the [+] or [-] paddle shifter once to shift up or down one gear and the system changes from automatic shift mode to manual shift mode.

To change back to the automatic shift mode from manual shift mode, do one of the following:

- Gently depress the accelerator pedal for more than 5 seconds.
- Drive the vehicle under 6 mph (10 km/h).
- Pull and hold the right side paddle shifter.

### **i** Information

**If the [+] and [-] paddle shifters are pulled at the same time, gear shift may not occur.**

## BRAKE SYSTEM

### Power Brakes

Your vehicle has power-assisted brakes that adjust automatically through normal usage.

If the engine is not running or is turned off while driving, the power assist for the brakes will not work. You can still stop your vehicle by applying greater force to the brake pedal than typical. The stopping distance, however, will be longer than with power brakes.

When the engine is not running, the reserve brake power is partially depleted each time the brake pedal is applied. Do not pump the brake pedal when the power assist has been interrupted.

Only pump the brakes on slippery surfaces if the power assist has been interrupted to maintain steering control. Do not pump the brakes on slippery surfaces if the brakes are operating normally.



### WARNING

Take the following precautions:

- **Do not drive with your foot resting on the brake pedal. This will create abnormal high brake temperatures, excessive brake lining and pad wear, and increased stopping distances.**
- **When descending down a long or steep hill, move the gear shift button to Manual Shift Mode and manually downshift to a lower gear in order to control your speed without using the brake pedal excessively. Applying the brakes continuously will cause the brakes to overheat and could result in a temporary loss of braking performance.**

- **Wet brakes may impair the vehicle's ability to safely slow down; the vehicle may also pull to one side when the brakes are applied. Applying the brakes lightly will indicate whether they have been affected in this way. Always test your brakes in this fashion after driving through deep water. To dry the brakes, lightly tap the brake pedal to heat up the brakes while maintaining a safe forward speed until brake performance returns to normal. Avoid driving at high speeds until the brakes function correctly.**

### Disc Brakes Wear Indicator

When your brake pads are worn and new pads are required, you will hear a high pitched warning sound from your front or rear brakes. You may hear this sound come and go or it may occur whenever you depress the brake pedal.

Note that some driving conditions or climates may cause a brake squeal when you first apply (or lightly apply) the brakes. This is normal and does not indicate a problem with your brakes.

### NOTICE

**To avoid costly brake repairs, do not continue to drive with worn brake pads.**



### Information

**Always replace brake pads as complete front or rear axle sets.**



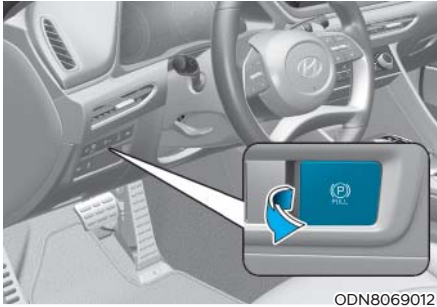

## Electronic Parking Brake (EPB) Applying the parking brake



**To apply the EPB (Electronic Parking Brake):**

1. Depress the brake pedal.
2. Pull up the EPB switch.

  Make sure the parking brake warning light comes on.  
**BRAKE**

### **WARNING**

**To reduce the risk of SERIOUS INJURY or DEATH, do not operate the EPB while the vehicle is moving except in an emergency situation. It could damage the brake system and lead to an accident.**

## Releasing the parking brake

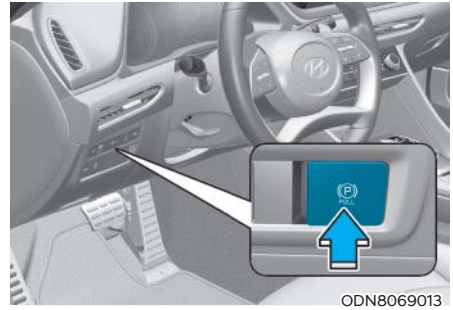

**To release the EPB (Electronic Parking Brake):**

- Place the ignition switch in the ON position.
- Depress and hold the brake pedal.
- Press the EPB switch.

Make sure the Parking Brake Warning Light goes off.

**To release EPB (Electronic Parking Brake) automatically:**

- Satisfy the following conditions
  1. Ensure seat belts are fastened and the doors, hood and trunk are closed.
  2. With the engine running, depress the brake pedal and shift out of P (Park) to R (Reverse), D (Drive) or Manual shift mode.
  3. Depress the accelerator pedal.

Make sure the parking brake warning light goes off.

### **EPB (Electronic Parking Brake) may be automatically applied when:**

- Requested by other systems
- The driver turns the engine off while Auto Hold is operating.
- The vehicle is parked on the slope and the Engine Start/Stop button is in the OFF position.
- The Engine is turned off when the driver tries to park but the vehicle still moves a bit.

### **Warning messages**

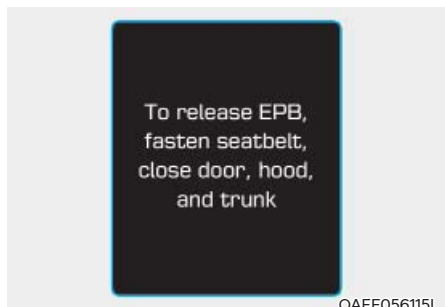

To release EPB, fasten seatbelt, close door, hood and trunk

- If you try to drive with the EPB applied, a warning will sound and a message will appear.

- If the driver's seat belt is unfastened and the engine hood or trunk is opened, a warning will sound and a message will appear.
- If there is a problem with the vehicle, a warning may sound and a message may appear.

If the situation occurs, depress the brake pedal and release EPB by pressing the EPB switch.

### **WARNING**

- **Whenever leaving the vehicle or parking, always come to a complete stop and continue to depress the brake pedal.**

**Shift the gear into the P (Park) position, press the EPB switch, and set the ignition switch to the OFF position. Take the Key with you when exiting the vehicle.**

**Vehicles not fully engaged in P (Park) with the parking brake set are at risk for moving inadvertently and causing injury to yourself or others.**

- **NEVER allow anyone who is unfamiliar with the vehicle to touch the EPB switch. If the EPB is released unintentionally, serious injury may occur.**
- **Only release the EPB when you are seated inside the vehicle with your foot firmly on the brake pedal.**

### **NOTICE**

- **Do not apply the accelerator pedal while the parking brake is engaged. If you depress the accelerator pedal with the EPB engaged, a warning will sound and a message will appear. Damage to the parking brake may occur.**
- **Driving with the parking brake on can overheat the braking system and cause premature wear or damage to brake parts. Make sure the EPB is released and the Parking Brake Warning Light is off before driving.**

## **i** Information

- A clicking sound may be heard while operating or releasing the EPB. These conditions are normal and indicate that the EPB is functioning properly.
- When leaving your keys with a parking attendant or assistant, make sure to inform him/her how to operate the EPB.

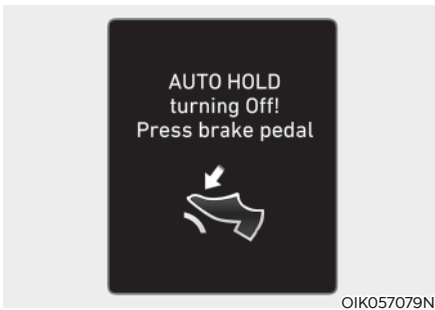

OIK057079N

### **AUTO HOLD turning Off! Press brake pedal**

When the conversion from Auto Hold to EPB is not working properly a warning will sound and a message will appear.

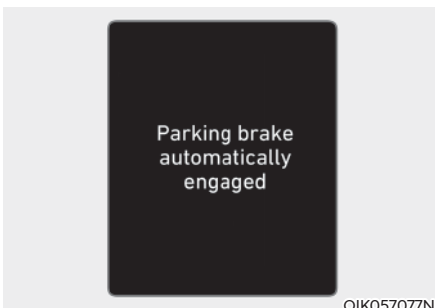

OIK057077N

### **Parking brake automatically engaged**

If the EPB is applied while Auto Hold is activated, a warning will sound and a message will appear.

## **EPB malfunction indicator**



©DN8069014

This warning light illuminates if the ignition switch is set to the ON position and goes off in approximately 3 seconds if the system is operating normally.

If the EPB malfunction indicator remains on, comes on while driving, or does not come on when the ignition switch is changed to the ON position, this indicates that the EPB may have malfunctioned.

If this occurs, have the system checked by an authorized HYUNDAI dealer.

The EPB malfunction indicator may illuminate when the ESC indicator comes on to indicate that the ESC is not working properly, but it does not indicate a malfunction of the EPB.

## **NOTICE**

- If the EPB warning light is still on, have the system checked by an authorized HYUNDAI dealer.
- If the parking brake warning light does not illuminate or blinks even though the EPB switch was pulled up, the EPB may not be applied.
- If the parking brake warning light blinks when the EPB warning light is on, press the switch, and then pull it up. Repeat this one more time. If the EPB warning does not go off, have the system checked by an authorized HYUNDAI dealer.

### Parking brake warning light

 Check the parking brake warning light by placing the ignition switch to the ON position (do not start the engine).

This light will be illuminated when the parking brake is applied with the ignition switch in the START or ON position.

If the parking brake warning light remains on after the parking brake is released while engine is running, there may be a malfunction in the brake system. Immediate attention is necessary.

If at all possible, cease driving the vehicle immediately. If that is not possible, use extreme caution while operating the vehicle and only continue to drive the vehicle until you can reach a safe location.

### Emergency braking

If there is a problem with the brake pedal while driving, emergency braking is possible by pulling up and holding the EPB switch. Braking is possible only while you are holding the EPB switch. However, braking distance will be longer than normal.

### WARNING

**Do not operate the parking brake while the vehicle is moving except in an emergency situation. It could damage the brake system and lead to a severe accident.**

### Information

**During emergency braking, the parking brake warning light will illuminate to indicate that the system is operating.**

### NOTICE

**If you continuously notice a noise or burning smell when the EPB is used for emergency braking, have system checked by an authorized HYUNDAI dealer.**

### When the EPB (Electronic Parking Brake) does not release

If the EPB does not release normally, contact an authorized HYUNDAI dealer by loading the vehicle on a flatbed tow truck and have the system checked.

### Auto Hold

The Auto Hold maintains the vehicle in a standstill even though the brake pedal is not depressed after the driver brings the vehicle to a complete stop by depressing the brake pedal.

### To apply :

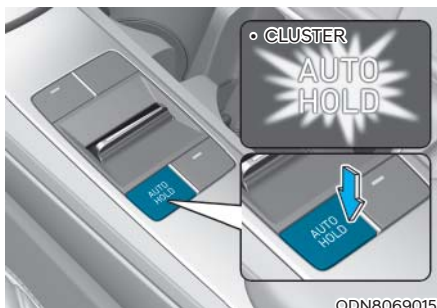

1. With the driver's door and engine hood closed, depress the brake pedal and then press the [AUTO HOLD] switch. The white AUTO HOLD indicator will come on and the system will be in the standby position.



ODN8069016

- When you stop the vehicle completely by depressing the brake pedal, the Auto Hold maintains the brake pressure to hold the vehicle stationary. The indicator changes from white to green.
- The vehicle will remain stationary even if you release the brake pedal.
- If EPB is applied, Auto Hold will be released.

#### To release :

- If you press the accelerator pedal with the gear in D (Drive), R (Reverse) or Manual shift mode, the Auto Hold will be released automatically and the vehicle will start to move. The AUTO HOLD indicator changes from green to white.
- If the vehicle is restarted using the cruise control toggle switch (RES+ or SET-) while Auto Hold and cruise control is operating, the Auto Hold will be released regardless of accelerator pedal operation. The AUTO HOLD indicator changes from green to white.



#### WARNING

When the AUTO HOLD is automatically released by depressing the accelerator pedal, always take a look around your vehicle.

Slowly depress the accelerator pedal for a smooth start.

#### To cancel :

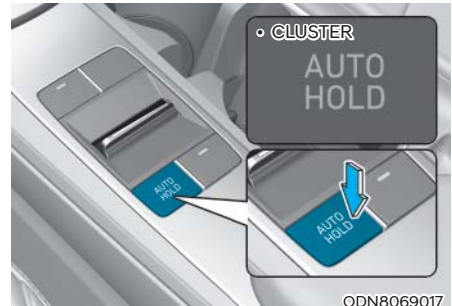

ODN8069017

- Depress the brake pedal.
  - Press the [AUTO HOLD] switch.
- The AUTO HOLD indicator will turn off.



#### Information

- The Auto Hold does not operate when:**
  - The driver's door is opened
  - The engine hood is opened
  - The gear is in P (Park)
  - The EPB is applied
- For your safety, the Auto Hold automatically switches to EPB when:**
  - The driver's door is opened with the gear in D (Drive) or N (Neutral)
  - The trunk is opened with the gear in R (Reverse)
  - The engine hood is opened with the gear in D (Drive) or N (Neutral)
  - The vehicle stops for more than 10 minutes
  - The vehicle stands on a steep slope
  - The vehicle moves several times

In these cases, the parking brake warning light comes on, the AUTO HOLD indicator changes from green to white, and a warning sound and a message will appear to inform you that EPB has been automatically engaged. Before driving off again, press foot brake pedal, check the surrounding area near your vehicle and release parking brake manually with the EPB switch.

- While operating Auto Hold, you may hear mechanical noise. However, it is normal operating noise.

**NOTICE**

If the AUTO HOLD indicator changes to yellow, the Auto Hold is not working properly. Contact an authorized HYUNDAI dealer.

**WARNING**

- Depress the accelerator pedal slowly when you start the vehicle.
- For your safety, cancel the Auto Hold when you drive downhill, back up the vehicle or park the vehicle.

**NOTICE**

If there is a malfunction with the driver's door or engine hood open detection system, the Auto Hold may not work properly. Contact an authorized HYUNDAI dealer.

**Warning messages**

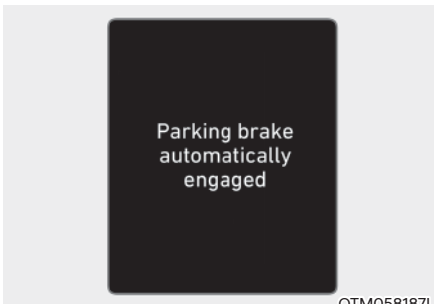

OTM058187L

**Parking brake automatically engaged**

When the EPB is applied from Auto Hold, a warning will sound and a message will appear.

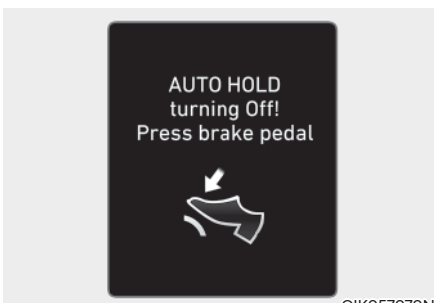

OIK057079N

**AUTO HOLD turning Off!  
Press brake pedal**

When the conversion from Auto Hold to EPB is not working properly a warning will sound and a message will appear. When this message is displayed, the Auto Hold and EPB may not operate. For your safety, depress the brake pedal.

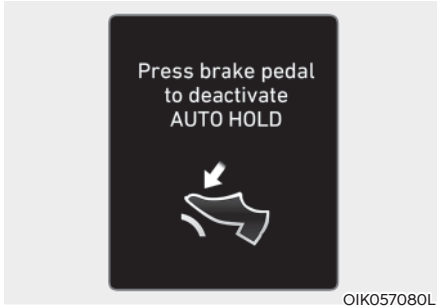

OIK057080L

### Press brake pedal to deactivate **AUTO HOLD**

If you did not apply the brake pedal when you release the Auto Hold by pressing the [AUTO HOLD] switch, a warning will sound and a message will appear.

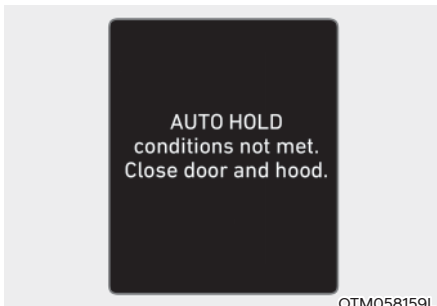

OTM058159L

### **AUTO HOLD** conditions not met. Close door and hood.

When you press the [AUTO HOLD] switch, if the driver's door and engine hood are not closed, a warning will sound and a message will appear on the cluster LCD display.

Press the [AUTO HOLD] switch after closing the driver's door and hood.

## Anti-lock Brake System (ABS)

### **WARNING**

An Anti-Lock Braking System (ABS) or an Electronic Stability Control (ESC) system will not prevent accidents due to improper or dangerous driving maneuvers. Even though vehicle control is improved during emergency braking, always maintain a safe distance between you and objects ahead of you. Vehicle speeds should always be reduced during extreme road conditions. The braking distance for cars equipped with ABS or ESC may be longer than for those without these systems in the following road conditions.

Drive your vehicle at reduced speeds during the following conditions:

- Rough, gravel or snow-covered roads.
- On roads where the road surface is pitted or has different surface height.
- Tire chains are installed on your vehicle.

The safety features of an ABS or ESC equipped vehicle should not be tested by high speed driving or cornering. This could endanger the safety of yourself or others.

ABS is an electronic braking system that helps prevent a braking skid. ABS allows the driver to steer and brake at the same time.

### Using ABS

To obtain the maximum benefit from your ABS in an emergency situation, do not attempt to modulate your brake pressure and do not try to pump your brakes. Depress your brake pedal as hard as possible.

When you apply your brakes under conditions which may lock the wheels, you may hear sounds from the brakes, or feel a corresponding sensation in the brake pedal. This is normal and it means your ABS is active.

ABS does not reduce the time or distance it takes to stop the vehicle.

Always maintain a safe distance from the vehicle in front of you.

ABS will not prevent a skid that results from sudden changes in direction, such as trying to take a corner too fast or making a sudden lane change. Always drive at a safe speed for the road and weather conditions.

ABS cannot prevent a loss of stability. Always steer moderately when braking hard. Severe or sharp steering wheel movement can still cause your vehicle to veer into oncoming traffic or off the road.

On loose or uneven road surfaces, operation of the anti-lock brake system may result in a longer stopping distance than for vehicles equipped with a conventional brake system.

The ABS warning light () will stay on for several seconds after the ignition switch is in the ON position. During that time, the ABS will go through self-diagnosis and the light will go off if everything is normal. If the light stays on, you may have a problem with your ABS. Contact an authorized HYUNDAI dealer as soon as possible.



### WARNING

If the ABS warning light () is on and stays on, you may have a problem with the ABS. Your power brakes will work normally. To reduce the risk of serious injury or death, contact your HYUNDAI dealer as soon as possible.



### CAUTION

When you drive on a road having poor traction, such as an icy road, and apply your brakes continuously, the ABS will be active continuously and the ABS warning light () may illuminate. Pull your car over to a safe place and turn the engine off.

Restart the engine. If the ABS warning light is off, then your ABS system is normal.

Otherwise, you may have a problem with your ABS system. Contact an authorized HYUNDAI dealer as soon as possible.



### Information

When you jump start your vehicle because of a drained battery, the ABS warning light () may turn on at the same time. This happens because of the low battery voltage. It does not mean your ABS is malfunctioning. Have the battery recharged before driving the vehicle.



## Electronic Stability Control (ESC)

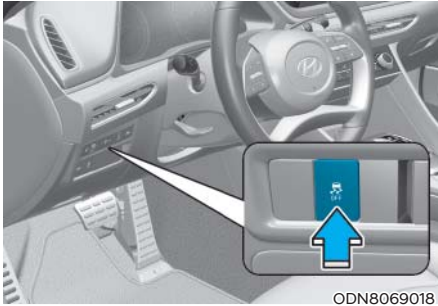

The Electronic Stability Control (ESC) system helps to stabilize the vehicle during cornering maneuvers. ESC checks where you are steering and where the vehicle is actually going. ESC applies braking pressure to any one of the vehicle's brakes and intervenes in the engine management system to assist the driver with keeping the vehicle on the intended path. It is not a substitute for safe driving practices. Always adjust your speed and driving to the road conditions.



### WARNING

**Never drive too fast for the road conditions or too quickly when cornering. The ESC system will not prevent accidents.**

**Excessive speed in turns, abrupt maneuvers, and hydroplaning on wet surfaces can result in severe accidents.**

## ESC operation

### ESC ON condition

When the ignition switch is in the ON position, the ESC and the ESC OFF indicator lights illuminate for approximately three seconds. After both lights go off, the ESC is enabled.

### When operating



When the ESC is in operation, the ESC indicator light blinks:

- When you apply your brakes under conditions which may lock the wheels, you may hear sounds from the brakes, or feel a corresponding sensation in the brake pedal. This is normal and it means your ESC is active.
- When the ESC activates, the engine may not respond to the accelerator as it does under routine conditions.
- If the Cruise Control was in use when the ESC activates, the Cruise Control automatically disengages. The Cruise Control can be reengaged when the road conditions allow. See "Cruise Control System" later in this chapter. (if equipped)
- When moving out of the mud or driving on a slippery road, the engine RPM (revolutions per minute) may not increase even if you press the accelerator pedal deeply. This is to maintain the stability and traction of the vehicle and does not indicate a problem.

### ESC OFF condition

To cancel ESC operation:

- **State 1**

Press the ESC OFF button briefly. The ESC OFF indicator light and message "Traction Control disabled" will illuminate. In this state, the traction control function of ESC (engine management) is disabled, but the brake control function of ESC (braking management) still operates.

- **State 2**

Press and hold the ESC OFF button continuously for more than 3 seconds. The ESC OFF indicator light and message "Traction and Stability Control disabled" illuminates and a warning chime sounds. In this state, both the traction control function of ESC (engine management) and the brake control function of ESC (braking management) are disabled. If the ignition switch is placed to the LOCK/OFF position when ESC is off, ESC remains off. Upon restarting the engine, the ESC will automatically turn on again.

### Indicator lights

■ ESC indicator light (blinks)



■ ESC OFF indicator light (comes on)



When the ignition switch is placed to the ON position, the ESC indicator light illuminates, then goes off if the ESC system is operating normally.

The ESC indicator light blinks whenever the ESC is operating.

If ESC indicator light stays on, your vehicle may have a malfunction with the ESC system. When this warning light illuminates have your vehicle checked by an authorized HYUNDAI dealer as soon as possible.

The ESC OFF indicator light comes on when the ESC is turned off.

### **WARNING**

**When the ESC is blinking, this indicates the ESC is active:**

**Drive slowly and NEVER attempt to accelerate. NEVER turn the ESC off while the ESC indicator light is blinking or you may lose control of the vehicle resulting in an accident.**

### **NOTICE**

**Driving with wheels and tires with different sizes may cause the ESC system to malfunction. Before replacing tires, make sure all four tires and wheels are the same size. Never drive the vehicle with different sized wheels and tires installed.**

### ESC OFF usage

#### When Driving

The ESC OFF mode should only be used briefly to help free the vehicle if stuck in snow by temporarily stopping operation of the ESC to maintain wheel torque.

To turn ESC off while driving, press the ESC OFF button while driving on a flat road surface.

#### NOTICE

To prevent damage to the transmission:

- Do not allow wheel(s) of one axle to spin excessively while the ESC, ABS, and parking brake warning lights are displayed. The repairs would not be covered by the vehicle warranty. Reduce engine power and do not spin the wheel(s) excessively while these lights are displayed.
- When operating the vehicle on a dynamometer, make sure the ESC is turned off (ESC OFF light illuminated).



### Information

Turning the ESC off does not affect ABS or standard brake system operation.

### Vehicle Stability Management (VSM)

The Vehicle Stability Management (VSM) is a function of the Electronic Stability Control (ESC) system. It helps ensure the vehicle stays stable when accelerating or braking suddenly on wet, slippery and rough roads where traction over the four tires can suddenly become uneven.



### WARNING

Take the following precautions when using the Vehicle Stability Management (VSM):

- ALWAYS check the speed and the distance to the vehicle ahead. The VSM is not a substitute for safe driving practices.
- Never drive too fast for the road conditions. The VSM system will not prevent accidents. Excessive speed in bad weather, slippery and uneven roads can result in severe accidents.

### VSM operation

#### VSM ON condition

The VSM operates when:

- The Electronic Stability Control (ESC) is on.
- Vehicle speed is approximately above 9 mph (15 km/h) on curve roads.
- Vehicle speed is approximately above 12 mph (20 km/h) when the vehicle is braking on rough roads.

#### When operating

When you apply your brakes under conditions which may activate the ESC, you may hear sounds from the brakes, or feel a corresponding sensation in the brake pedal. This is normal and it means your VSM is active.

#### NOTICE

The VSM does not operate when:

- Driving on a banked road such as gradient or incline.
- Driving rearward.
- ESC OFF indicator light is on.
- EPS (Electric Power Steering) warning light (⚠) is on or blinks.



### WARNING

If ESC indicator light (🚗) or EPS warning light (⚠️) stays on or blinks, your vehicle may have a malfunction with the VSM system. When the warning light illuminates, have your vehicle checked by an authorized HYUNDAI dealer as soon as possible.

Driving with wheels and tires with different sizes may cause the ESC system to malfunction. Before replacing tires, make sure all four tires and wheels are the same size. Never drive the vehicle with different sized tires and wheels installed.

### Hill-Start Assist Control (HAC)

The Hill-Start Assist Control (HAC) helps prevent the vehicle from rolling backwards when starting a vehicle from a stop on a hill. The system operates the brakes automatically for approximately 2 seconds and releases the brake after 2 seconds or when the accelerator pedal is depressed.



### WARNING

**Always be ready to depress the accelerator pedal when starting off on an incline. The HAC activates only for approximately 2 seconds.**

### NOTICE

- The HAC does not operate when the shift button is in P (Park) or N (Neutral)
- The HAC activates even though the ESC (Electronic Stability Control) is off but does not activate when the ESC has malfunctioned.

### Good Braking Practices



### WARNING

**Whenever leaving the vehicle or parking, always come to a complete stop and continue to depress the brake pedal. Move the shift button into P (Park) position, then apply the parking brake, and place the ignition switch in the LOCK/OFF position.**

**Vehicles parked with the parking brake not applied or not fully engaged may roll inadvertently and may cause injury to the driver and others. ALWAYS apply the parking brake before exiting the vehicle.**

Wet brakes can be dangerous! The brakes may get wet if the vehicle is driven through standing water or if it is washed. Your vehicle will not stop as quickly if the brakes are wet. Wet brakes may cause the vehicle to pull to one side.

To dry the brakes, apply the brakes lightly until the braking action returns to normal, taking care to keep the vehicle under control at all times. If the braking action does not return to normal, stop as soon as it is safe to do so and call an authorized HYUNDAI dealer for assistance.

DO NOT drive with your foot resting on the brake pedal. Even light, but constant pedal pressure can result in the brakes overheating, brake wear, and possibly even brake failure.

If a tire goes flat while you are driving, apply the brakes gently and keep the vehicle pointed straight ahead while you slow down. When you are moving slowly enough for it to be safe to do so, pull off the road and stop in a safe location.

Keep your foot firmly on the brake pedal when the vehicle is stopped to prevent the vehicle from rolling forward.

## ISG (IDLE STOP AND GO) SYSTEM (IF EQUIPPED)

The Idle Stop and Go (ISG) system automatically and temporarily shuts down the engine when the vehicle is stopped and idling to improve fuel efficiency and reduce exhaust gas emissions. (i.e. red stop light, stop sign, and traffic jam).

The engine is automatically started upon satisfying the starting conditions.

The ISG system is always active, when the engine is running.



### Information

**When the engine is automatically started by the ISG system, some warning lights (i.e. ABS, ESC, ESC OFF, EPS, and parking brake warning light) may illuminate for a few seconds due to the low battery voltage. However, it does not indicate a malfunction with the ISG system.**

### To Activate the ISG System

#### Prerequisite for activation

The ISG system operates in the following situations.

- The driver's seatbelt is fastened
- The driver's door and hood are closed
- The brake vacuum pressure is adequate
- The battery sensor is activated and the battery is sufficiently charged
- Outside temperature is not too low or too high
- The vehicle is driven over a constant speed and stops
- The climate control system satisfies the conditions
- The vehicle is sufficiently warmed up
- The incline is gradual
- The steering wheel is turned less than 180 degrees and then the vehicle stops



### Information

-  **The ISG system is not activated, when the prerequisites to activate the ISG system are unsatisfied. In this case, the ISG OFF button indicator illuminates, and the auto stop indicator ((A)) illuminates in yellow on the instrument cluster.**
- **When the above indicator remains illuminated on the instrument cluster, have the IGS system checked by an authorized HYUNDAI dealer.**

### Auto stop

To stop the engine in idle stop mode

1. Decrease the vehicle speed to 0 mph.
2. Depress the brake pedal with the shift button in D (Drive) or N (Neutral).

The auto stop indicator ((A)) illuminates in green on the instrument cluster, when the engine stops.



### Information

**The driving speed must reach at least 3 mph (5 km/h) after an idle stop to stop the engine in idle stop mode again.**

In auto stop mode, when the driver opens the hood, the ISG system will be deactivated.

When the system is deactivated:

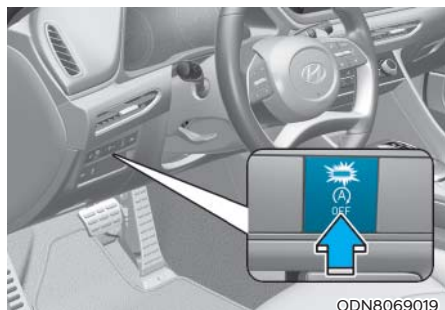

The ISG OFF button indicator illuminates. If the message "Auto Stop is Off."

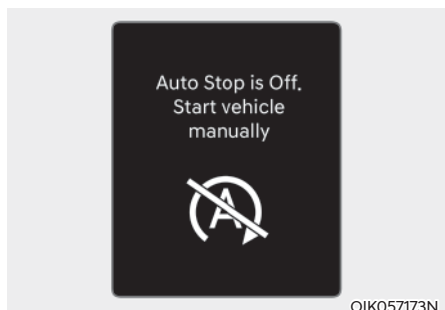

"Start vehicle manually", appears on the LCD display with a beep sound, restart the vehicle manually by depressing the brake pedal with the vehicle shifted to P (Park) or N (Neutral). For your safety, restart the vehicle in the P (Park) position.

### Auto start

To restart the engine in the auto stop mode

Release the brake pedal.

- When Auto Hold is activated, if you release the brake pedal, the engine will be in the auto stop state. However, if you depress the accelerator pedal, the engine will start again.

The auto stop indicator ((A)) goes OFF on the instrument cluster, when the engine is restarted.

### The engine is automatically restarted in the following situations.

- The brake vacuum pressure is low
- The engine has stopped for about 5 minutes
- The air conditioning is ON with the fan speed set to the highest position
- The front defroster is ON
- The battery is weak
- The cooling and heating performance of the climate control system is unsatisfactory
- The vehicle is shifted to P (Park) when Auto Hold is activated
- The door is opened or the seatbelt is unfastened when Auto Hold is activated
- The EPB switch is pressed when Auto Hold is activated

The auto stop indicator ((A)) blinks in green for 5 seconds on the instrument cluster.

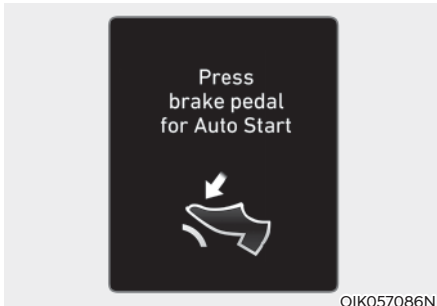

The auto start is temporarily deactivated in the following situations.

When the gear is shifted from N (Neutral) to R (Reverse), D (Drive) or Manual shift mode without the brake pedal depressed. A message "Press brake pedal for Auto Start" will appear on the LCD display. To activate auto start, depress the brake pedal.

### To Deactivate the ISG System

- Press the ISG OFF button to deactivate the ISG system. Then, the ISG OFF button indicator illuminates.
- Press the ISG OFF button again to reactivate the ISG system. Then, the ISG OFF button indicator turns OFF.

### ISG System Malfunction

The ISG system may not operate:

When there is a malfunction with the ISG sensors or the ISG system.

The followings occur, when there is a malfunction with the ISG system:

- The auto stop indicator (Ⓐ) will blink in yellow on the instrument cluster.
- The light on the ISG OFF button will illuminate.

### **i** Information

- **When you cannot turn OFF the ISG OFF button indicator by pressing the ISG OFF button, or when the malfunction with the ISG system persists, contact an authorized HYUNDAI dealer.**
- **You can turn off the ISG OFF button indicator by driving over 50 mph (80 km/h) for up to 2 hours with the fan speed below the 2nd position. If the ISG OFF button indicator remains ON, contact an authorized HYUNDAI dealer.**

### **⚠** WARNING

When the engine is in auto stop mode, the engine may restart. Before leaving the vehicle or checking the engine compartment, stop the engine placing the ignition switch to the LOCK/OFF position or remove the ignition key.

## Battery Sensor Deactivation



[A] : Battery sensor

The battery sensor is deactivated, when the battery is disconnected from the negative pole for maintenance purpose.

In this case, the ISG system is limitedly operated due to the battery sensor deactivation. Thus, the driver needs to take the following procedures to reactivate the battery sensor after disconnecting the battery.

### ***Prerequisites to reactivate the battery sensor***

Switch "ON" and "OFF" the ignition one time. Park the vehicle for a minimum of 4 hours with the hood and all doors closed.

Pay extreme caution not to connect any accessories (i.e. navigation and black box) to the vehicle with the engine in the OFF status. If not, the battery sensor may not be reactivated.

## **i** Information

The ISG system may not operate in the following situations.

- There is a malfunction with the ISG system.
- The battery is weak.
- The brake vacuum pressure is low.

If this occurs, have the ISG system checked by an authorized HYUNDAI dealer.

## **NOTICE**

- Use only a genuine HYUNDAI Absorbent Glass Mat (AGM) battery for replacement. If not, the ISG system may not operate normally.
- Do not recharge the Absorbent Glass Mat (AGM) battery with a general battery charger. It may damage or explode the Absorbent Glass Mat (AGM) battery.
- Do not remove the battery cap. The battery electrolyte, which is harmful to the human body, may leak out.



## DRIVE MODE INTEGRATED CONTROL SYSTEM (IF EQUIPPED)

### Drive Mode

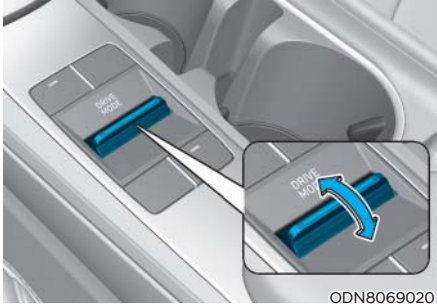

ODN8069020

The drive mode may be selected according to the driver's preference or road condition.

### **i** Information

**If there is a problem with the instrument cluster, the drive mode will be in COMFORT mode and may not change to NORMAL mode or SPORT mode.**

The mode changes when you toggle the DRIVE MODE button.

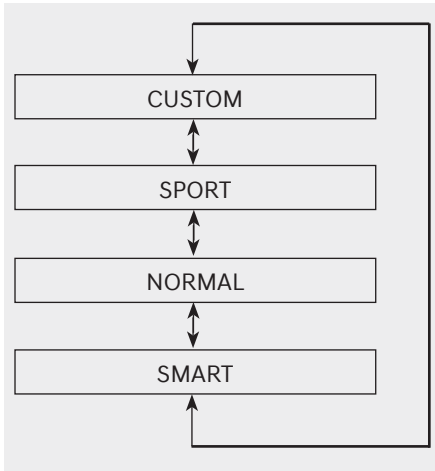

When COMFORT mode is selected, it is not displayed on the instrument cluster.

- **NORMAL mode :**  
NORMAL mode helps provide smooth driving and comfortable riding.
- **SPORT mode :**  
SPORT mode helps provide sporty but firm riding.
- **CUSTOM mode :**  
The driver can separately adjust modes of each driving system.
- **SMART mode :**  
SMART mode automatically adjusts the driving mode (NORMAL « SPORT) in accordance with the driver's driving habits.

The drive mode will change to NORMAL mode when the engine is restarted.

When changing the drive mode setting, the responsiveness of Smart Cruise Control changes.

Drive Mode	SCC Reaction
NORMAL	Normal
SMART	Normal
SPORT	Fast

In CUSTOM mode, SCC Reaction operates according to the mode set in the Engine/Transmission.

(e.g. in CUSTOM mode, the driver select mode of Engine/Transmission as SPORT, SCC Reaction operates as Fast)

### **CUSTOM mode**

CUSTOM

In CUSTOM mode, the driver can select separate modes and combine them on the infotainment system screen.

- Engine/Transmission: NORMAL/SPORT
- Steering wheel: NORMAL/SPORT

**For more information, refer to the separately supplied manual with your vehicle.**

- When CUSTOM mode is selected by using the DRIVE MODE button, the CUSTOM mode indicator will illuminate.

### **SPORT mode**

SPORT

SPORT mode manages the driving dynamics by automatically adjusting the steering effort, the engine and transmission control logic for enhanced driver performance.

- When SPORT mode is selected by using the DRIVE MODE button, the SPORT indicator will illuminate.
- Whenever the engine is restarted, the Drive Mode will revert back to NORMAL mode. If SPORT mode is desired, re-select SPORT mode from the DRIVE MODE button.
- When SPORT mode is activated:
  - The engine rpm will tend to remain raised over a certain length of time even after releasing the accelerator
  - Upshifts are delayed when accelerating

### **i Information**

**In SPORT mode, the fuel efficiency may decrease.**

### **SMART mode**

SMART

SMART mode selects the proper driving mode among NORMAL and SPORT by judging the driver's driving habits (i.e. Economic or Aggressive (Sportive)) from the brake pedal depression or the steering wheel operation.

- Toggle the DRIVE MODE button to select SMART mode. When SMART mode is selected, the indicator illuminates on the instrument cluster.
- SMART mode automatically controls the vehicle driving, such as gear shifting patterns and engine torque, in accordance with the driver's driving habits.

### **i Information**

**When you dynamically drive the vehicle in SMART mode by abruptly decelerating or sharply turning the driving mode changes to SPORT mode. However, it may adversely affect fuel economy.**

### Various driving situations, which you may encounter in SMART mode

- The driving mode automatically changes to SMART SPORT, when you abruptly accelerate the vehicle or repetitively operate the steering wheel (Your driving is categorized to be sporty.). In this mode, your vehicle drives in a lower gear for abrupt accelerating/decelerating and increases the engine brake performance.
- You may still sense the engine braking performance, even when you release the accelerator pedal in SMART SPORT mode. It is because your vehicle remains in lower gear over a certain period of time for next acceleration. Thus, it is a normal driving situation, not indicating any malfunction.
- The driving mode automatically changes to SMART SPORT mode only in harsh driving situations. In most of the normal driving situations, the driving mode sets to be in SMART NORMAL mode.

### Limitation of SMART mode

The SMART mode may be limited in following situations. (The OFF indicator illuminates in those situations.)

- The driver uses the paddle shifter (manual shift mode) :  
It deactivates SMART mode. The vehicle drives, as the driver manually changes gear with the paddle shifter.
- The cruise control is activated :  
The cruise control system may deactivate the SMART mode when the vehicle is controlled by the set speed of Smart Cruise Control system. (SMART mode is not deactivated just by activating the cruise control system.)
- The transmission oil temperature is either extremely low or extremely high :  
The SMART mode can be active in most of the normal driving situations. However, an extremely high/ low transmission oil temperature may temporarily deactivate the SMART mode, because the transmission condition is out of normal operation condition.

## FORWARD COLLISION – AVOIDANCE ASSIST (FCA) - SENSOR FUSION (IF EQUIPPED)

Forward Collision-Avoidance Assist system is designed to detect the vehicle, a pedestrian or cyclist ahead (if equipped) in the roadway through front radar signals and front view camera recognition to warn the driver that a collision is imminent, and if necessary, apply emergency braking.

### WARNING

Take the following precautions when using Forward Collision-Avoidance Assist system:

- **This system is only a supplemental system and it is not intended to, nor does it replace the need for extreme care and attention of the driver. The sensing range and objects detectable by the sensors are limited. Pay attention to the road conditions at all times.**
- **Drive at posted speed limits and accordance to road conditions.**
- **Always drive cautiously to prevent unexpected and sudden situations from occurring. FCA does not always stop the vehicle completely.**

## System Setting and Activation

### System setting



- Setting Forward Safety function  
The driver can activate FCA by placing the ignition switch to the ON position and by selecting:  
'User Settings → Driver Assistance → Forward Safety'
  - If you select 'Active Assist', FCA system activates. FCA produces warning messages and warning alarms in accordance with the collision risk levels. Braking assist will be applied in accordance with the collision risk.
  - If you select 'Warning Only', FCA system activates and produces only warning alarms in accordance with the collision risk levels. Braking assist will not be applied in this setting.
  - If you select 'Off', FCA system deactivates. If you turn the ESC off stage 2, FCA deactivates and the warning light comes on.

- 
 The warning light illuminates on the instrument cluster, when you cancel FCA system.

The driver can monitor the FCA ON/OFF status on the LCD display or infotainment system display (if equipped). Also, the warning light illuminates when ESC (Electronic Stability Control) is turned off. If the warning light remains ON when FCA is activated, have the vehicle inspected by an authorized HYUNDAI dealer.



- Selecting Warning Timing  
 The driver can select the initial warning activation time from the User Settings in the LCD display or infotainment system display (if equipped) by selecting 'User Settings → Driver Assistance → Warning Timing → Normal/Later'.

The options for the initial Forward Collision Warning includes the following:

- Normal:  
 When this option is selected, the initial Forward Collision Warning is activated sensitively. If you feel the warning activates too early, set Forward Collision Warning to 'Later'. Even though, 'Normal' is selected if the front vehicle suddenly stops the initial warning activation time may not seem fast.

- Later:

When this option is selected, the initial Forward Collision Warning is activated later than normal. This setting reduces the amount of distance between the vehicle, pedestrian or cyclist (if equipped) ahead before the initial warning occurs.

Select 'Later' when traffic is light and when driving speed is slow.

When you accelerate suddenly to the vehicle ahead, the warning may seem to activate earlier even if 'Later' is selected.

### Information

**If you change the warning timing, the warning timing of other systems may change.**

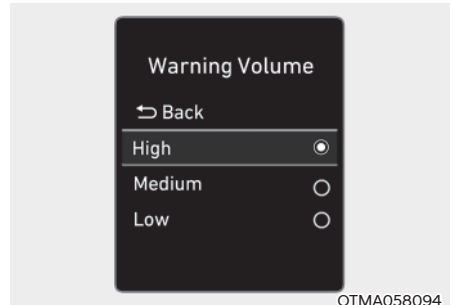

- The driver can select the warning volume of Forward Collision Warning in the User Settings in the LCD display or infotainment system display by selecting 'User Settings → Driver Assistance → Warning Volume → High/Medium/Low'.

### Information

**If you change the warning volume, the warning volume of other systems may change. Always be aware before changing the warning volume.**

### Prerequisite for activation

FCA gets ready to be activated, when 'Active Assist' or 'Warning Only' under Forward Safety is selected in the cluster LCD display, and when the following prerequisites are satisfied.

- ESC (Electronic Stability Control) is on.
- Vehicle speed is over 6 mph (10 km/h ). (FCA is only activated within a certain speed range.)
- The system detects a pedestrian, cyclist or a vehicle in front, which may collide with your vehicle. However, FCA may not be activated or may only sound a warning alarm depending on the driving or vehicle conditions.

FCA may not operate properly according to the frontal situation, condition of the vehicle, the direction of pedestrian or cyclist or speed. If you select "Warning Only", only warnings occur.

### WARNING

**To avoid driver distractions, do not attempt to set or cancel FCA while driving the vehicle. Always completely stop the vehicle at a safe place before setting or canceling the system.**

**FCA automatically activates upon placing the ignition switch to the ON position. The driver can deactivate FCA by canceling the system setting on the cluster LCD display or infotainment system display (if equipped).**

**FCA automatically deactivates upon canceling ESC (Electronic Stability Control). When ESC is canceled, FCA cannot be activated in the LCD display or infotainment system display (if equipped). In this situation, the FCA warning light will illuminate which is normal.**

### FCA Warning Message and Brake Control

FCA produces warning messages, warning alarms, and emergency braking based on the level of risk of a frontal collision, such as when a vehicle ahead suddenly brakes, or the system detects that a collision with a pedestrian or cyclist is imminent.

#### Collision warning (First warning)

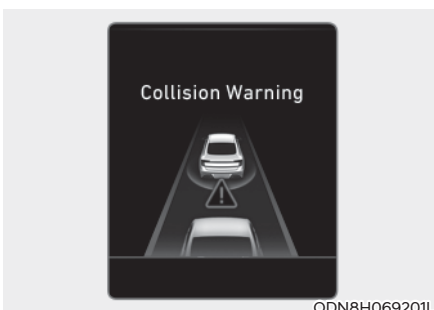

ODN8H069201L

This warning message appears on the LCD display with a warning chime. Additionally, some vehicle system intervention occurs by the engine management system to help decelerate the vehicle.

- Your vehicle speed may decelerate moderately.
- If FCA detects a vehicle in front, the system operates when your vehicle speed is between 6 mph (10 km/h) and 112 mph (180 km/h). Maximum vehicle speed may decrease depending on the condition of the vehicle ahead and surroundings.
- If FCA detects a pedestrian or cyclist in front, the system operates when your vehicle speed is between 6 mph (10 km/h) and 53 mph (85 km/h). Maximum vehicle speed may decrease depending on the condition of the pedestrian or cyclist ahead and surroundings.
- If you select 'Warning Only' for the system setting, FCA system activates and produces only warning alarms in accordance with the collision risk levels. You should control the brake directly because FCA system will not control the brake.

### ***Emergency braking (Second warning)***



This warning message appears on the LCD display with a warning chime. Additionally, some vehicle system intervention occurs by the engine management system to help decelerate the vehicle.

- FCA system limitedly controls the brakes to preemptively mitigate impact in a collision. The brake control is maximized just before a collision.
- If FCA detects a vehicle in front, the system operates when your vehicle speed is above 6 mph (10 km/h) and 47 mph (75 km/h) or under. Maximum vehicle speed may decrease depending on the condition of the vehicle ahead and surroundings.
- If FCA detects a pedestrian or cyclist in front, the system operates when your vehicle speed is between 6 mph (10 km/h) or above and under 40 mph (65 km/h). Maximum vehicle speed may decrease depending on the condition of the pedestrian or cyclist ahead or surroundings.
- If you select 'Warning Only' for the system setting, FCA system activates and produces only warning alarms in accordance with the collision risk levels. You should control the brake directly because FCA system will not control the brake.

### Brake operation

- In an urgent situation, the braking system enters into the ready status for prompt reaction against the driver's depressing the brake pedal.
- FCA provides additional braking power for optimum braking performance, when the driver depresses the brake pedal.
- The braking control is automatically deactivated, when the driver sharply depresses the accelerator pedal, or when the driver abruptly operates the steering wheel.
- FCA brake control is automatically canceled, when risk factors disappear.



### CAUTION

- **The driver should always use extreme caution while operating the vehicle, whether or not there is a warning message or alarm from FCA system.**
- **After the brake control is activated, the driver must immediately depress the brake pedal and check the surroundings. The brake activation by the system lasts for about 2 seconds.**
- **If any other warning sound such as seat belt warning chime is already generated, Forward Collision-Avoidance Assist system warning may not sound.**
- **Playing the vehicle audio system at high volume may prevent occupants from hearing the system warning sounds.**



### WARNING

**The braking control cannot completely stop the vehicle nor avoid all collisions. The driver should hold the responsibility to safely drive and control the vehicle.**



### WARNING

**The FCA system logic operates within certain parameters, such as the distance from the vehicle, pedestrian or cyclist (if equipped) ahead, the speed of the vehicle ahead, and the driver's vehicle speed. Certain conditions such as inclement weather and road conditions may affect the operation of FCA system.**



### WARNING

**Never deliberately drive dangerously to activate the system.**



### Information

**Exceptional operation of the braking assist system**

- The vehicle drives on a slope or curve.
- The vehicle drives by a pedestrian or cyclist at the crossroads, traffic signals or structure.
- The vehicle drives through a tunnel or near a railroad.
- The vehicle drives where steam, smoke or shadow is on the road.
- The vehicle drives the road tree planted or streetlamps installed.
- There is interference by electromagnetic waves or electric noise.



## FCA Sensor

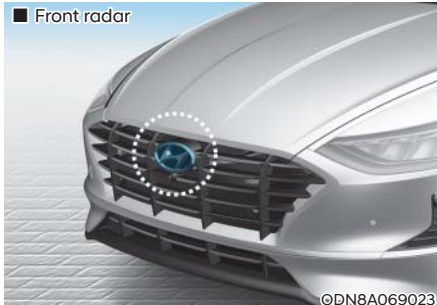
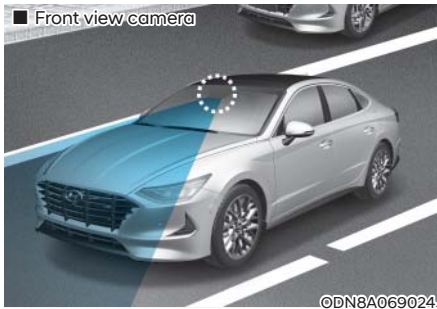

These sensors detect frontal vehicles, pedestrian and cyclist.

In order for FCA system to operate properly, always make sure the sensor cover or sensor is clean and free of dirt, snow, and debris.

Dirt, snow, or foreign substances on the sensor cover or sensor may adversely affect the sensing performance of the sensor. Always keep these clean.

※ Refer to “Lane Keeping Assist (LKA)” for cautions for the front camera.

## NOTICE

- Do not apply license plate frame or foreign objects such as a bumper sticker or a bumper guard near the radar sensor. Doing so may adversely affect the sensing performance of the radar.
- Always keep the radar sensor and cover clean and free of dirt and debris.
- Use only a soft cloth to wash the vehicle. Do not spray pressurized water directly on the sensor or sensor cover.
- Be careful not to apply unnecessary force on the radar sensor or sensor cover. If the sensor is forcibly moved out of proper alignment, FCA system may not operate correctly. In this case, a warning message may not be displayed. Have the vehicle inspected by an authorized HYUNDAI dealer.
- If the front bumper becomes damaged in the area around the radar sensor, FCA system may not operate properly. Have the vehicle inspected by an authorized HYUNDAI dealer.
- Use only genuine parts to repair or replace a damaged sensor or sensor cover. Do not apply paint to the sensor cover.

**NOTICE**

**NEVER** install any accessories or stickers on the front windshield, or tint the front windshield.

**NEVER** place any reflective objects (i.e. white paper, mirror) over the dashboard. Any light reflection may prevent the system from functioning properly.

Pay extreme caution to keep the camera dry.

**NEVER** disassemble the camera assembly, or apply any impact on the camera assembly.

**i Information**

Have the vehicle inspected by an authorized HYUNDAI dealer when:

- The windshield glass is replaced.
- The radar sensor or cover gets damaged or replaced.

**Warning message and warning light**

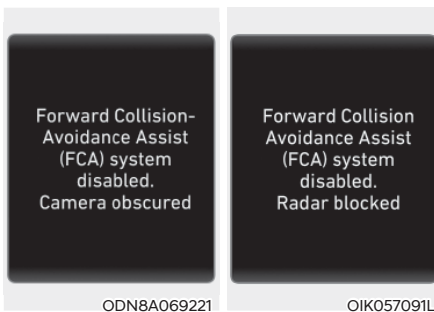

**Forward Collision-Avoidance Assist (FCA) system disabled. Camera obscured / Radar blocked**

When the sensor cover is blocked with dirt, snow, or debris, FCA system may not detect other vehicles. If this occurs, a warning message will appear on the LCD display.

The system will operate normally when such dirt, snow or debris is removed.

FCA may not properly operate in an area (e.g. open terrain), where any substances are not detected after turning ON the vehicle.

Also, even though a warning message does not appear on the LCD display, FCA may not properly operate.

**! WARNING**

**FCA system may not activate according to the road conditions, inclement weather, driving conditions or traffic conditions.**

## System Malfunction

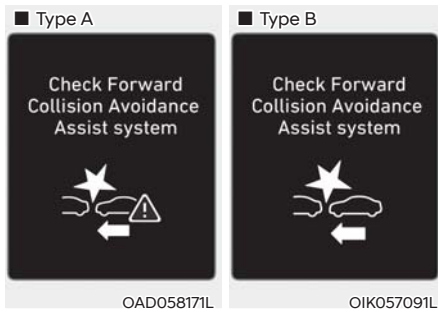

### Check Forward Collision Avoidance Assist system

When FCA is not working properly, FCA warning light (⚠) will illuminate and the warning message will appear for a few seconds. After the message disappears, the master warning light (⚠) will illuminate. In this case, have the vehicle inspected by an authorized HYUNDAI dealer.

The FCA warning message may appear along with the illumination of the ESC (Electronic Stability Control) warning light. Both FCA warning light and warning message will disappear once the ESC warning light issue is resolved.



## WARNING

- FCA is only a supplemental system for the driver's convenience. The driver should hold the responsibility to control the vehicle operation. Do not solely depend on FCA system. Rather, maintain a safe braking distance, and, if necessary, depress the brake pedal to reduce the driving speed or to stop the vehicle.
- In certain instances and under certain driving conditions, FCA system may activate unintentionally. This initial warning message appears on the LCD display with a warning chime.
 

Also due to sensing limitations, in certain situations, the front radar sensor or camera recognition system may not detect the vehicle, pedestrian or cyclist (if equipped) ahead. FCA system may not activate and the warning message may not be displayed.
- Even if there is any problem with the brake control function of FCA system, the vehicle's basic braking performance will operate normally. However, brake control function for avoiding collision will not activate.

- If the vehicle in front stops suddenly, you may have less control of the brake system. Therefore, always keep a safe distance between your vehicle and the vehicle in front of you.
- FCA system may activate during braking and the vehicle may stop suddenly shifting loose objects toward the passengers. Always keep loose objects secured and fasten the seat belt.
- FCA system may not activate if the driver applies the brake pedal to avoid collision.
- The brake control may be insufficient, possibly causing a collision, if a vehicle in front abruptly stops. Always pay extreme caution.
- Occupants may get injured, if the vehicle abruptly stops by the activated FCA system. Pay extreme caution.
- FCA system operates only when the system detect vehicles, pedestrian or cyclist in front of the vehicle.
- FCA system may not activate according to road conditions, inclement weather, driving conditions or traffic conditions.
- FCA system may not work for all vehicles, passengers or cyclists.



## WARNING

- FCA system does not operate when the vehicle is in reverse.
- FCA system is not designed to detect other objects on the road such as animals.
- FCA system does not detect vehicles in the opposite lane.
- FCA system does not detect cross traffic vehicles that are approaching.
- FCA system cannot detect vehicles that are stopped vertically to your vehicle at a intersection or dead end street.
- FCA system cannot detect the cross traffic cyclist that are approaching.

In these cases, you must maintain a safe braking distance, and if necessary, depress the brake pedal to reduce the driving speed in order to maintain a safe distance or to stop the vehicle.

## Limitations of the System

Forward Collision avoidance assist system is designed to monitor the vehicle ahead or a pedestrian or cyclist in the roadway through radar signals and camera recognition to warn the driver that a collision is imminent, and if necessary, apply emergency braking.

In certain situations, the radar sensor or the camera may not be able to detect the vehicle, pedestrian or cyclist ahead. In these cases, FCA system may not operate normally. The driver must pay careful attention in the following situations where FCA operation may be limited.

### ***Detecting vehicle, pedestrian and cyclist***

The sensor may be limited when:

- The system may not operate for 15 seconds after the vehicle is started or the camera is initialized
- The radar sensor or camera is covered with a foreign object or debris
- The camera lens is contaminated due to tinted, filmed or coated windshield, damaged glass, or stuck of foreign matter (sticker, bug, etc.) on the glass
- Inclement weather such as heavy rain or snow obscures the field of view of the radar sensor or camera
- There is interference by electromagnetic waves
- There is severe irregular reflection from the radar sensor
- The radar/camera sensor recognition is limited
- The vehicle in front is too small to be detected (for example a motorcycle etc.)
- The vehicle in front is an oversize vehicle or trailer that is too big to be detected by the camera recognition system (for example a tractor trailer, etc.)
- The camera's field of view is not well illuminated (either too dark or too much reflection or too much backlight that obscures the field of view)
- The vehicle in front does not have their rear lights or their rear lights does not turned ON or their rear lights are located unusually
- The outside brightness changes suddenly, for example when entering or exiting a tunnel
- Light coming from a street light or an oncoming vehicle is reflected on a wet road surface such as a puddle in the road
- The field of view in front is obstructed by sun glare or head light of oncoming vehicle
- The windshield glass is fogged up; a clear view of the road is obstructed
- The vehicle in front is driving erratically
- The vehicle is on unpaved or uneven rough surfaces, or road with sudden gradient changes
- The vehicle is driven near areas containing metal substances as a construction zone, railroad, etc.
- The vehicle drives inside a building, such as a basement parking lot
- The camera does not recognize the entire vehicle in front
- The camera is damaged
- The brightness outside is too low such as when the headlamps are not on at night or the vehicle is going through a tunnel
- The shadow is on the road by a median strip, trees, etc.
- The vehicle drives through a tollgate
- The windshield glass is fogged up; a clear view of the road is obstructed
- The rear part of the vehicle in front is not normally visible (the vehicle turns in other direction or the vehicle is overturned.)
- The adverse road conditions cause excessive vehicle vibrations while driving
- The sensor recognition changes suddenly when passing over a speed bump
- The vehicle in front is moving vertically to the driving direction
- The vehicle in front is stopped vertically
- The vehicle in front is driving towards your vehicle or reversing
- You are on a roundabout and the vehicle in front circles

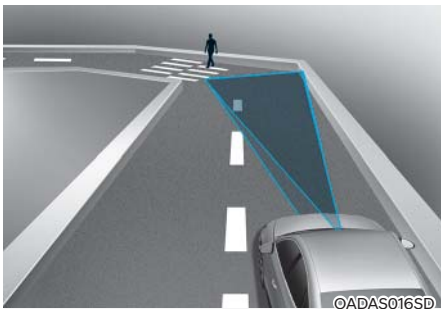
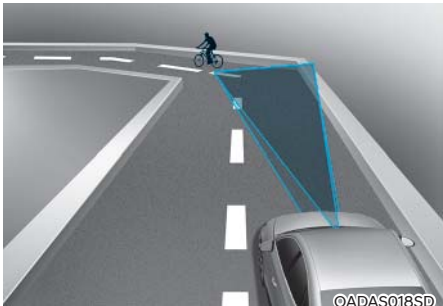
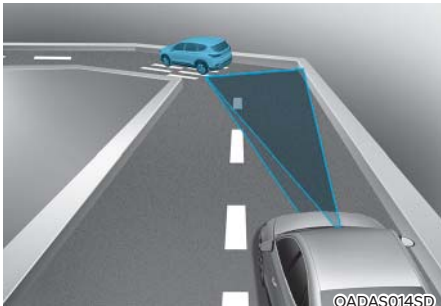

- Driving on a curve  
The performance of Forward Collision-Avoidance Assist system may be limited when driving on a curved road. The front view camera or radar sensor recognition system may not detect the vehicle, pedestrian or cyclist traveling in front on a curved road. This may result in no alarm and braking when necessary.  
Always pay attention to road and driving conditions, and if necessary, depress the brake pedal to reduce your driving speed in order to maintain a safe distance.

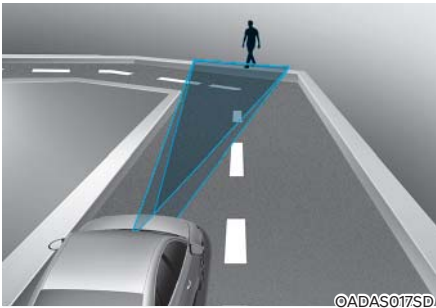
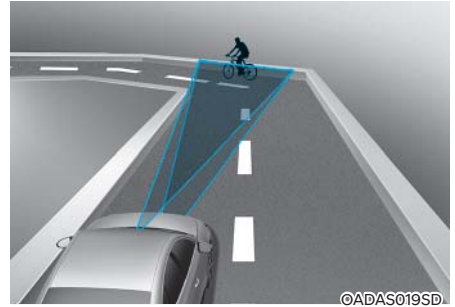
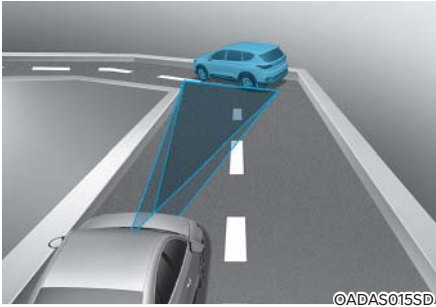

Forward Collision-Avoidance Assist system may recognize a vehicle or pedestrian or cyclist in the next lane or outside the lane when driving on a curved road.

If this occurs, the system may unnecessarily alarm the driver and apply the brake.

Always pay attention to road and driving conditions, while driving.

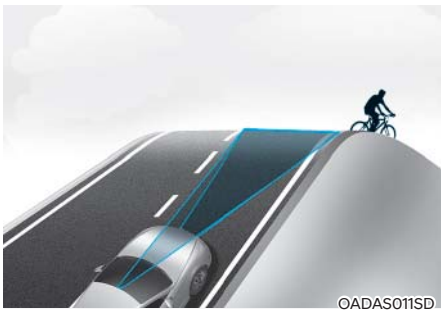
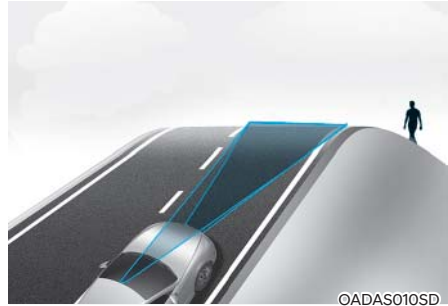
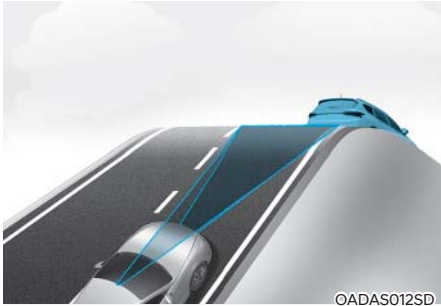

- Driving on a slope  
The performance of Forward Collision-Avoidance Assist system may be decreased while driving upward or downward on a slope.  
The front view camera or front radar sensor recognition may not detect the vehicle, pedestrian or cyclist in front.  
This may result in unnecessary alarm and braking or no alarm and braking when necessary.  
When the system suddenly recognizes the vehicle, pedestrian or cyclist in front while passing over a slope, you may experience sharp deceleration.  
Always keep your eyes forward while driving upward or downward on a slope, and, if necessary, depress the brake pedal to reduce your driving speed in order to maintain distance.



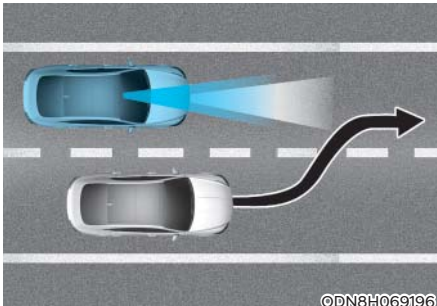

©DN8H069196

- Changing lanes

When a vehicle changes lanes in front of you, FCA system may not immediately detect the vehicle, especially if the vehicle changes lanes abruptly. In this case, you must maintain a safe braking distance, and if necessary, depress the brake pedal to reduce your driving speed in order to maintain a safe distance.



©H1058308L

When driving in stop-and-go traffic, and a vehicle in front of you merges out of the lane, FCA system may not immediately detect the new vehicle that is now in front of you. In this case, you must maintain a safe braking distance, and if necessary, depress the brake pedal to reduce your driving speed in order to maintain a safe distance.



©DN8A069200

- Detecting the vehicle in front of you  
If the vehicle in front of you has cargo that extends rearward from the cab, or when the vehicle in front of you has higher ground clearance, additional special attention is required. FCA system may not be able to detect the cargo extending from the vehicle. In these instances, you must maintain a safe braking distance from the rearmost object, and if necessary, depress the brake pedal to reduce your driving speed in order to maintain distance.

- The pedestrian or cyclist is not fully detected by the camera recognition system, for example, if the pedestrian is leaning over or is not fully walking upright
- The pedestrian or cyclist is moving very quickly or appears abruptly in the camera detection area
- The pedestrian or cyclist is wearing clothing that easily blends into the background, making it difficult to be detected by the camera recognition system
- The outside lighting is too bright (e.g. when driving in bright sunlight or in sun glare) or too dark (e.g. when driving on a dark rural road at night)
- It is difficult to detect and distinguish the pedestrian or cyclist from other objects in the surroundings, for example, when there is a group of pedestrians, cyclists or a large crowd
- There is an item similar to a person's body structure
- The pedestrian or cyclist is small
- The pedestrian has impaired mobility
- The sensor recognition is limited
- The radar sensor or camera is blocked with a foreign object or debris
- Inclement weather such as heavy rain or snow obscures the field of view of the radar sensor or camera
- When light coming from a street light or an oncoming vehicle is reflected on a wet road surface such as a puddle in the road
- The field of view in front is obstructed by sun glare
- The windshield glass is fogged up; a clear view of the road is obstructed
- The adverse road conditions cause excessive vehicle vibrations while driving
- The sensor recognition changes suddenly when passing over a speed bump
- You are on a roundabout
- The pedestrian or cyclist suddenly interrupts in front of the vehicle
- The cyclist in front is riding intersected with the driving direction
- There is any other electromagnetic interference
- The construction area, rail or other metal object is near the cyclist
- The bicycle material is not reflected well on the radar



### **WARNING**

**Turn off Forward Collision avoidance Assist system through cluster or infotainment system before towing a vehicle. Application of FCA system while towing may adversely affect the safety of your vehicle or the towing vehicle.**

**Use extreme caution when the vehicle in front of you has cargo that extends rearward from the cab, or when the vehicle in front of you has higher ground clearance.**

FCA system may work when it recognizes objects similar in shape or property to a vehicle, pedestrian or cyclist.

FCA system is designed to help detect and monitor the vehicle ahead or detect a pedestrian or cyclist in the roadway through radar signals and camera recognition. It is not designed to detect bicycles, motorcycles, or smaller wheeled objects such as luggage bags, shopping carts, or strollers.

Never try to test the operation of FCA system. Doing so may cause severe injury or death.

If the front bumper, front glass, radar or camera have been replaced or repaired, have the vehicle inspected by an authorized HYUNDAI dealer.



### Information

In some instances, FCA system may be cancelled when subjected to electromagnetic interference.



### Information

This device complies with Part 15 of the FCC rules.

Operation is subject to the following two conditions:

1. This device may not cause harmful interference.
2. This device must accept any interference received, including interference that may cause undesired operation.

## Forward Collision-Avoidance Assist - Junction Turning (if equipped)

FCA-Junction Turning function is designed to reduce the risk of collision by detecting and monitoring the oncoming vehicle ahead. When the vehicle turns to the left at a junction, the system recognises the oncoming vehicle ahead in advance with the front view camera and the front radar. It produces warning messages or haptic warning alarms in accordance with the collision risk levels.

### System setting

FCA-Junction Turning function can be activated from the User Settings menu by following the procedure below.

1. Set the Engine Start/Stop button to the ON or START position.
2. Select 'User settings → Driver assistance → Forward safety'.

For more details, refer to "Forward Collision-Avoidance Assist (FCA)" in this chapter.

### Prerequisite for activation

FCA system is on and ready if you select “Active assist” or “Warning only” on the infotainment system and when the following prerequisites are satisfied:

- The system detects an oncoming vehicle in front, which may collide with your vehicle. It may be activated when the system recognises the collision risk at a junction in each situation.
- The ESC (Electronic Stability Control) is on.
- The vehicle speed moving toward your vehicle exceeds approximately 19 mph (30 km/h) or decreases under 44 mph (70 km/h).
- Driving speed exceeds approximately 6 mph (10 km/h) or decreases under 19 mph (30 km/h)
- Direction signals turn on.

### CAUTION

- **FCA system may not work or only some part of the warning system may perform according to the condition, driving direction or speed of the vehicle moving toward your vehicle.**
- **If you select “Warning only”, FCA system activates and produces only warning alarms.**

### WARNING

- **FCA system may not produce the warning alarm or be activated too late due to the unexpected driving caused by the approaching vehicles.**
- **While turning left, only when the turn signal is on along with the driving direction, FCA system is activated toward the approaching vehicles.**

### FCA warning message and function control

FCA produces warning messages and warning alarms as well as vibrates the steering wheel in accordance with the collision risk levels whilst the vehicle turns left at the crossroads. In addition, the system controls the brakes according to the collision risk levels.

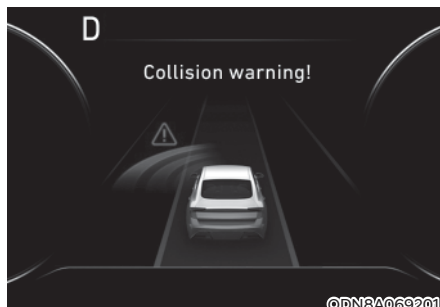

### Collision warning (First warning)

- The warning message appears on the LCD display with a warning chime and the steering wheel vibrates.
- The vehicle may slow down slightly.
- The system works when the vehicle speed is under 19 mph (30 km/h). (The operable speed range might be reduced according to the condition and surroundings of the approaching vehicles.)
- If you select “Warning only” on the LCD display or infotainment system, the system does not control the brake so you should control the brake directly.

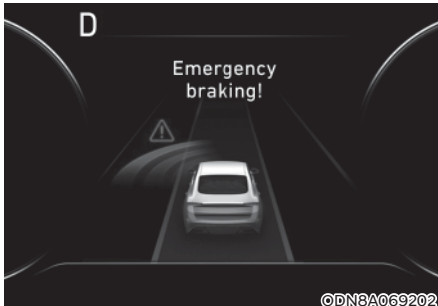

#### Emergency braking (Second warning)

- The warning message appears on the LCD display with a warning chime and the steering wheel vibrates.
- FCA system limitedly controls the brakes to preemptively mitigate impact in collision. The brake control is maximised just before a collision.
- The system works when the vehicle speed is under 19 mph (30 km/h). (The operable speed range might be reduced according to the condition and surroundings of the approaching vehicles.)
- If you select “Warning only” on the LCD display or infotainment system, the system does not control the brake so you should control the brake directly.

#### WARNING

FCA-Junction Turning function only activates for vehicles except pedestrians, two wheel vehicles, animals or obstacles.

#### WARNING

FCA braking control cannot completely stop the vehicle nor avoid all collisions. The driver should hold the responsibility to safely drive and control the vehicle.

#### WARNING

FCA-Junction Turning function operates in accordance with the collision risk levels based on certain parameters such as the condition, driving direction and speed of the approaching vehicle. **Never deliberately drive dangerously to activate the system.**

### **Limitations of the system**

FCA-Junction Turning function is only a supplemental system for driver's safety whilst turning left on the crossroads. The driver should hold the responsibility to control the vehicle. The system monitors the oncoming vehicle ahead the road through the front view camera and radar. In certain situations, the front view camera and radar may not be able to detect the oncoming vehicles properly. The driver must pay careful attention in the following situations where the system operation may be limited or it may activate unintentionally.

#### **The sensor may be limited when:**

- The radar sensor or camera recognizes the approaching vehicle too late.
- The radar sensor or camera is blocked with a foreign object or debris.
- The driving direction of the approaching vehicle is irregular or frontal.
- The approaching vehicle changes lanes too late or decelerates suddenly.
- The angle of the approaching vehicle is out of range.
- Whilst circling, the sensor (the front view camera or front radar) does not detect the approaching vehicle.
- The driving speed of the approaching vehicle is too fast or slow.
- The head lamps of the approaching vehicle are turned off or asymmetrical.

- The approaching vehicle stops whilst turning left.
- The vehicle moves out of its lane or returns to its lane.
- The vehicle changes lanes suddenly at a low speed whilst there is an approaching vehicle.
- The brightness outside is too so it does not detect the vehicle.
- Inclement weather such as heavy rain or snow obscures the field of view of the front view camera or front radar.
- The approaching vehicle is covered with snow.
- The field of view in front is obstructed by sun glare.
- The shape of approaching vehicle is unusual.
- Whilst driving upward or downward on a slope.

**For more information, refer to “Forward Collision-Avoidance Assist (FCA)” in this chapter.**

## LANE KEEPING ASSIST (LKA) (IF EQUIPPED)

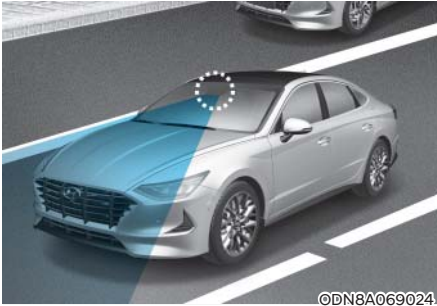

Lane Keeping Assist system detect lane markers on the road with a camera at the front windshield, and assists the driver's steering to help keep the vehicle between lanes.

When the system detects the vehicle straying from its lane, it alerts the driver with a visual and audible warning, while applying a counter-steering torque, trying to help prevent the vehicle from moving out of its lane.

### **WARNING**

Lane Keeping Assist system is not a substitute for safe driving practices, but a convenience function only. It is the responsibility of the driver to always be aware of the surroundings and steer the vehicle.

### **WARNING**

Take the following precautions when using Lane Keeping Assist system:

- Do not turn the steering wheel suddenly when the steering wheel is being assisted by the system.
- LKA system helps to prevent the driver from moving out of the lane (or road) unintentionally by assisting the driver's steering. However, the driver should not solely rely on the system but always pay attention on the steering wheel to stay in the lane.
- The operation of LKA system can be cancelled or not work properly according to road condition and surroundings. Always be cautious when driving.
- Do not disassemble LKA system camera temporarily to tint the window or attach any types of coatings and accessories. If you disassemble the camera and assemble it again, have the vehicle inspected by an authorized HYUNDAI dealer and have the system checked for calibration.

- When you replace the windshield glass, LKA system camera or related parts of the steering wheel, have the vehicle inspected by an authorized HYUNDAI dealer and have the system checked for calibration.
- The system detects lane markers and controls the steering wheel by a camera, therefore, if the lane markers are hard to detect, the system may not work properly. Please refer to “Limitations of the System”.
- Do not remove or damage the related parts of LKA system.
- You may not hear a warning sound of LKA system if the audio volume is high.
- Do not place objects on the dashboard that reflects light such as mirrors, white paper, etc. This may prevent LKA system from functioning properly.
- Always have your hands on the steering wheel while LKA system is activated. If you continue to drive with your hands off the steering wheel after the “Keep hands on steering wheel” warning message appears, the system will stop controlling the steering wheel.
- The steering wheel is not continuously controlled so if the vehicle speed is at a higher rate when leaving a lane the vehicle may not be controlled by the system. The driver must always follow the speed limit when using the system.
- If you attach objects to the steering wheel, the system may not assist steering or the hands off alarm may not work properly.



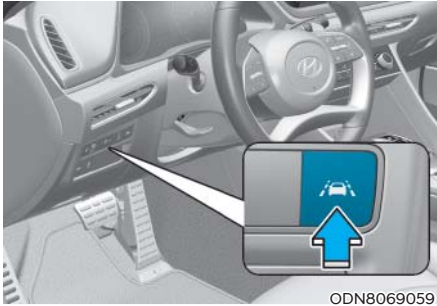

## LKA Operation



To activate/deactivate LKA system:

With the ignition switch in the ON position, press LKA system button located on the instrument panel on the left hand side of the steering wheel.

The  indicator in the cluster display will initially illuminate white. This indicates LKA system is in the READY but NOT ENABLED state.

 Note that the vehicle speed must be at least approximately 40 mph (64 km/h) to ENABLE LKA system. The indicator in the cluster display will illuminate green.

- White: Sensor does not detect lane markers or vehicle speed is under 40 mph (64 km/h).
- Green: Sensor detects lane markers and the system is able to control vehicle steering.

### Information

**If the indicator (white) is activated from the previous ignition cycle, the system will turn ON without any additional control. If you press the LKA button again, the indicator on the cluster goes off.**

## LKA System Function Change

The driver can change LKA to Lane Departure Warning or Lane Keeping Assist from the LCD display or infotainment system display (if equipped). Go to the 'User Settings → Driver Assistance → Lane Safety → Lane Keeping Assist/Lane Departure Warning/Off'. The system is automatically set to Lane Keeping Assist if a function is not changed.

### **Lane Keeping Assist**

The LKA mode guides the driver to help keep the vehicle within the lanes. It rarely controls the steering wheel, when the vehicle drives well inside the lanes. However, it starts to control the steering wheel, when the vehicle is about to deviate out of the lanes.

### **Lane Departure Warning**

LDW alerts the driver with a visual warning and a warning alarm when the system detects the vehicle departing the lane. The steering wheel will not be controlled.

### **LKA system operation**

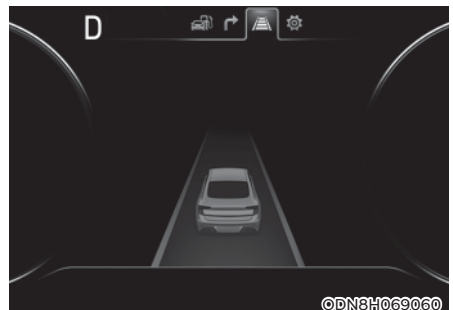

To see LKA screen on the LCD display in the cluster, select Driving Assist mode . For more information, refer to "LCD Display Modes" section in chapter 4.

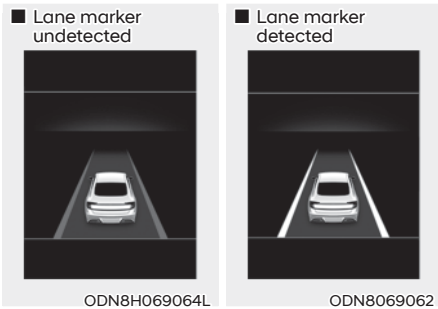

- If vehicle speed is over 40 mph (64 km/h) and the system detects lane markers, the color changes from gray to white.
- If your vehicle speed exceeds 40 mph (64 km/h) and LKA system button is ON, the system is enabled. If your vehicle departs from the projected lane in front of you, LKA system operates as follows:

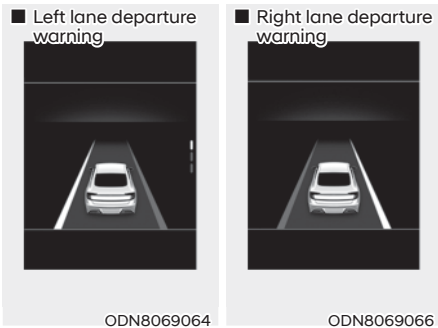

1. A visual warning appears on the cluster LCD display. Either the left lane marker or the right lane marker in the cluster LCD display will blink depending on which direction the vehicle is veering.

2. LKA system will help control the vehicle's steering to prevent the vehicle from crossing the lane maker in below conditions.

- Vehicle speed is over 40 mph (64 km/h)
- The system detects both lane markers
- When driving, the vehicle is located between both lanes normally.
- The steering wheel is not turned suddenly.

When lanes are detected and all the conditions to activate LKA system are satisfied, LKA system indicator light (🚗) will change from white to green. This indicates that LKA system is in the ENABLED state and the steering wheel will be controlled.



ODN8069068L

### Keep hands on steering wheel

If the driver takes their hands off the steering wheel for several seconds while LKA system is activated, the system will warn the driver.

### Information

**If the steering wheel is held very lightly the message may still appear because LKA system may not recognize that the driver has their hands on the wheel.**

### WARNING

The warning message may appear late according to road conditions. Therefore, always have your hands on the steering wheel while driving.



OOSH069085L

### Driver's hands not detected. LKA system is disabled temporarily

If the driver still does not have their hands on the steering wheel after the message “Keep hands on steering wheel”, the system will not control the steering wheel and warn the driver only when the driver crosses the lane markers.

However, if the driver has their hands on the steering wheel again, the system will start controlling the steering wheel.

### WARNING

- LKA system is a supplemental system only. It is the responsibility of the driver to safely steer the vehicle and to maintain it in its lane.
- Turn off LKA system and drive without using the system in the following situations:
  - In bad weather
  - In bad road conditions
  - When the steering wheel needs to be controlled by the driver frequently

### Information

Even though the steering is assisted by the system, the driver can still steer to control the steering wheel.

The steering wheel may feel heavier when the steering wheel is assisted by the system than when it is not.

## Warning Light and Message

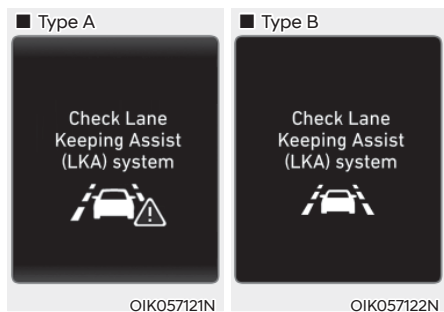

### Check LKA (Lane Keep Assist) system

If there is a problem with the system a message will appear for a few seconds. If the problem continues LKA system failure indicator will illuminate.

### LKA system indicator



The LKA system indicator (yellow) will illuminate if LKA system is not working properly.

Have the vehicle inspected by an authorized HYUNDAI dealer.

### When there is a problem with the system do one of the following:

- Turn the system on after turning the vehicle off and on again.
- Check if the ignition switch is in the ON position.
- Check if the system is affected by the weather. (ex: fog, heavy rain, etc.)
- Check if there is foreign matter on the camera lens.

If the problem is not solved, have the vehicle inspected by an authorized HYUNDAI dealer.

### LKA system will not be in the ENABLED state and the steering wheel will not be assisted when:

- The turn signal is turned on before changing a lane. If you change lanes without the turn signal on, the steering wheel might be controlled.
- The vehicle is not driven in the middle of the lane when the system is turned on or right after changing a lane.
- ESC (Electronic Stability Control) or VSM (Vehicle Stability Management) is activated.
- The vehicle is driven on a sharp curve.
- Vehicle speed is below 40 mph (64 km/h) and over 110 mph (177 km/h).
- The vehicle makes sharp lane changes.
- The vehicle brakes suddenly.
- Only one lane marker is detected.
- The lane (or road width) is very wide or narrow.
- There are more than two lane markers on the road. (e.g. construction area)
- The vehicle is driven on a steep incline.
- The steering wheel is turned suddenly.
- The system may not operate for 15 seconds after the engine is started or the camera is initialized.

## Limitations of the System

LKA system may operate prematurely even if the vehicle does not depart from the intended lane, OR, LKA system may not assist your steering or warn you if the vehicle leaves the intended lane under the following circumstances:

### When the lane and road conditions are poor

- It is difficult to distinguish the lane marking from the road surface or the lane marking is faded or not clearly marked.
- It is difficult to distinguish the color of the lane marker from the road.
- There are markings on the road surface that look like a lane marker that is inadvertently being detected by the camera.
- The lane marker is indistinct or damaged.
- The lane marker is merged or divided (e.g. tollgate).
- The lane number increases or decreases or the lane marker are crossing complicatedly.
- There are more than two lane markers on the road in front of you.
- The lane marker is very thick or thin.
- The lane is very wide or narrow.
- The lane ahead is not visible due to rain, snow, water on the road, damaged or stained road surface, or other factors.
- The shadow is on the lane marker by a median strip, trees, guardrail, noise barriers, etc.
- The lane markers are complicated or a structure substitutes for the lines such as a construction area.
- There are crosswalk signs or other symbols on the road.
- The lane marker in a tunnel is stained with oil, etc.
- The lane suddenly disappears such as at the intersection.

### **When external condition is intervened**

- The brightness outside changes suddenly such as when entering or exiting a tunnel, or when passing under a bridge.
- The brightness outside is too low such as when the headlamps are not on at night or the vehicle is going through a tunnel.
- There is a boundary structure in the roadway such as a concrete barrier, guardrail and reflector post that is inadvertently being detected by the camera.
- When light coming from a street light or an oncoming vehicle is reflected on a wet road surface such as a puddle in the road.
- The field of view in front is obstructed by sun glare.
- There is not enough distance between you and the vehicle in front to be able to detect the lane marker or the vehicle ahead is driving on the lane marke.
- Driving on a steep grade, over a hill, or when driving on a curved road.
- The adverse road conditions cause excessive vehicle vibrations while driving.
- The surrounding of the inside rear view mirror temperature is high due to direct sunlight, etc.
- Road surface is not even.

### **When front visibility is poor**

- The windshield or the camera lens is blocked with dirt or debris.
- The windshield glass is fogged up; a clear view of the road is obstructed.
- Placing objects on the dashboard, etc.
- The sensor cannot detect the lane marker because of fog, heavy rain or snow.

## BLIND-SPOT COLLISION WARNING (BCW) / BLIND-SPOT COLLISION-AVOIDANCE ASSIST (BCA) (IF EQUIPPED)

### System Description

#### **Blind-Spot Collision Warning**

Blind-Spot Collision Warning system uses rear corner radar sensors to monitor and warn the driver of an approaching vehicle in the driver's blind spot area.

#### (1) Blind-spot vehicle warning

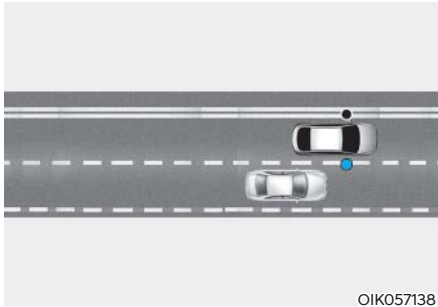

BCW system detects and warns vehicles in blind-spot.

The blind spot detection range varies relative to vehicle speed.

Note that if your vehicle is traveling much faster than the vehicles around you, the warning will not occur.

#### (2) Fast approach vehicle warning

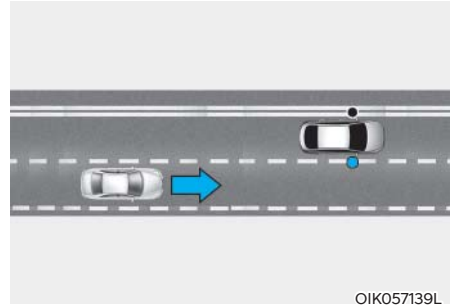

BCW system will alert you when a vehicle is detected approaching in an adjacent lane at a high rate of speed. If the driver activates the turn signal when the system detects an oncoming vehicle, the system sounds an audible alert.

#### **Blind-Spot Collision-Avoidance Assist**

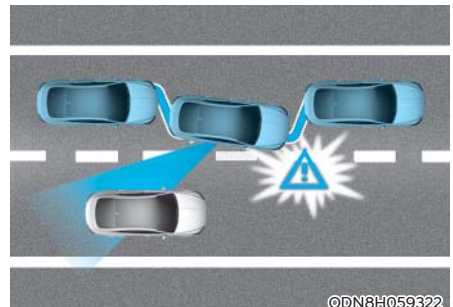

Blind-Spot Collision-Avoidance Assist system detects the front lane through the front view camera installed on the upper front windshield and detects the side/rear areas through rear corner radars.

Blind-Spot Collision-Avoidance Assist system may activate the Electronic Stability Control (ESC) in accordance with a colliding possibility with an approaching vehicle while changing lanes. It is to lower the colliding risk or help mitigate the colliding damage.



### **WARNING**

- **Always be aware of road conditions while driving and be alert for unexpected situations even though the Blind-Spot Collision Warning system and Blind-Spot Collision-Avoidance Assist system are operating.**
- **Blind-Spot Collision Warning system and Blind-Spot Collision-Avoidance Assist system are supplemental systems to assist you. Always pay attention, while driving, for your safety. Do not entirely rely on the systems or an accident may occur.**
- **Blind-Spot Collision Warning system and Blind-Spot Collision-Avoidance Assist system are not substitutes for proper and safe driving. Always drive safely and use caution when changing lanes or backing up the vehicle.**  
**Blind-Spot Collision Warning system and Blind-Spot Collision-Avoidance Assist system may not detect every object alongside the vehicle.**

## System Setting and Activation

### **System setting**

- The driver can activate the system by placing the ignition switch to the ON position and by selecting 'User Settings → Driver Assistance → Blind-Spot Safety'
  - BCA and BCW turn on and get ready to be activated when 'Active assist' is selected. Then, if a vehicle approaches the driver's blind spot area a warning sounds or braking power is applied.
  - BCW turns on and gets ready to be activated when 'Warning only' is selected. Then, if a vehicle approaches the driver's blind spot area a warning sounds. Braking assist will not be applied in this setting.
  - If you select "Off", BCW system deactivates.
- If the engine is turned off then on again, the system maintains the previous state.
- The driver can select the initial warning activation time in the User Settings in the LCD display or infotainment system display by selecting 'User Settings → Driver Assistance → Warning Timing'.



- The options for the initial Blind-Spot Collision Warning includes the following:
  - Normal:
 

When this condition is selected, the initial Blind-Spot Collision Warning is activated normally. If this setting feels sensitive change the option to 'Later'.

The warning activation time may feel late if a vehicle at the side or rear abruptly accelerates.
  - Later:
 

Select this warning activation time when the traffic is light and you are driving in a low speed.

### Information

**If you change the warning timing, the warning time of other systems may change. Always be aware before changing the warning timing.**

- The driver can select the warning volume of Blind-Spot Collision Warning in the User Settings in the LCD display or infotainment system display by selecting 'User Settings → Driver Assistance → Warning Volume → High/Medium/Low'.

### Information

**If you change the warning volume, the warning volume of other systems may change. Always be aware before changing the warning volume.**

### **Operating Conditions**

The system enters the ready status, when 'Active Assist' or 'Warning Only' is selected and the following conditions are satisfied:

- Active Assist
    - (1) Blind-Spot Collision-Avoidance Assist system will activate when:
      - Vehicle speed is between 40 mph and 112 mph (60 km/h and 180 km/h).
      - The system detects both of the lane lines.
      - An approaching vehicle is detected next to or behind your vehicle.
    - (2) Blind-Spot Collision Warning system will activate when:
 

The vehicle speed is above about 20 mph (30 km/h).
  - Warning Only
    - (1) Blind-Spot Collision Warning system will activate when:
      - The vehicle speed is above 20 mph (30 km/h).
- ※ Blind-Spot Collision-Avoidance Assist system is not activated.

## Warning and System Control Blind-Spot Collision Warning

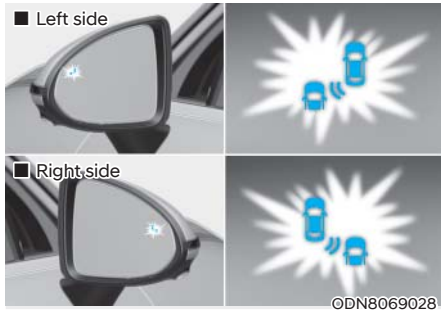

### First stage alert

If a vehicle is detected within the boundary of the system, a warning light will illuminate on the side view mirror and the head up display (if equipped).

Once the detected vehicle is no longer within the blind spot area, the warning will turn off according to the driving conditions of the vehicle.

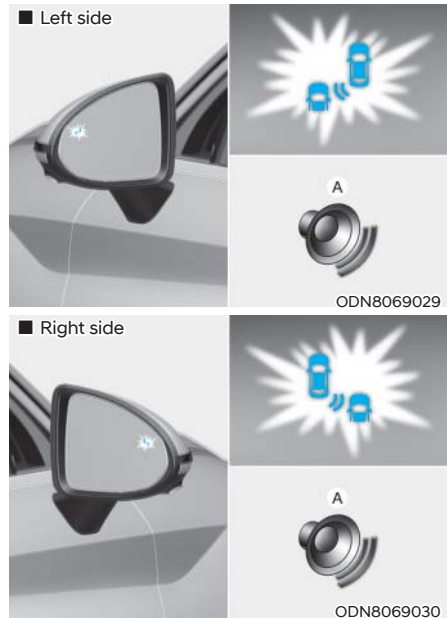

[A] : Warning sound

### Second stage alert

A warning chime to alert the driver will activate when:

1. A vehicle has been detected in the blind spot area by the radar system AND.
2. The turn signal is applied (same side as where the vehicle is being detected).

When this alert is activated, the warning light on the side view mirror and the head up display (if equipped) will also blink. And a warning chime will sound.

If you turn off the turn signal indicator, the second stage alert will be deactivated.

Once the detected vehicle is no longer within the blind spot area, the warning will turn off according to the driving conditions of the vehicle.



## WARNING

- The warning light on the side view mirror will illuminate whenever a vehicle is detected at the rear side by the system.  
To avoid accidents, do not focus only on the warning light and neglect to see the surrounding of the vehicle.
- Drive safely even though the vehicle is equipped with Blind-Spot Collision-Avoidance Assist system. Do not solely rely on the system but check your surrounding before changing lanes or backing the vehicle up.
- The system may not alert the driver in some conditions so always check your surroundings while driving.



## CAUTION

- The driver should always use extreme caution while operating the vehicle, whether or not the warning light on the side view mirror illuminates or there is a warning alarm.
- Playing the vehicle audio system at high volume may offset the Blind-Spot Collision Warning system warning sounds.
- The warning of Blind-Spot Collision-Avoidance Assist system may not sound while other system's warning sounds.

## **Blind-Spot Collision-Avoidance Assist**

Blind-Spot Collision-Avoidance Assist system may apply braking power, when an approaching vehicle is detected within a certain distance next to or behind your vehicle.

It gently applies braking power on the tire, which is located in the opposite side of the possibly-colliding point. The instrument cluster will inform the driver of the system activation.

Blind-Spot Collision-Avoidance Assist system is automatically deactivated when:

- The vehicle drives a certain distance away
- The vehicle direction is changed against the possible-colliding point
- The steering wheel is abruptly moved
- The brake pedal is depressed
- After a certain period of time

The driver should drive the vehicle in the middle of the vehicle lanes to keep the system in the ready status.

When the vehicle drives too close to one side of the vehicle lanes, the system may not properly operate.

In addition, the system may not properly control your vehicle in accordance with driving situations. Thus, always pay close attention to road situations.

 **WARNING**

- The driver is responsible for accurate steering.
- Do not unnecessarily operate the steering wheel, when Blind-Spot Collision-Avoidance Assist system is in operation.
- Always pay extreme caution while driving. The Blind-Spot Collision-Avoidance Assist system may not operate or unnecessarily operate in accordance with your driving situations.
- Blind-Spot Collision-Avoidance Assist system is not a substitute for safe driving practices, but a convenience function only. It is the responsibility of the driver to always drive cautiously to prevent unexpected and sudden situations from occurring. Pay attention to the road conditions at all times.

### Detecting Sensors (Front view camera and Rear corner radar)

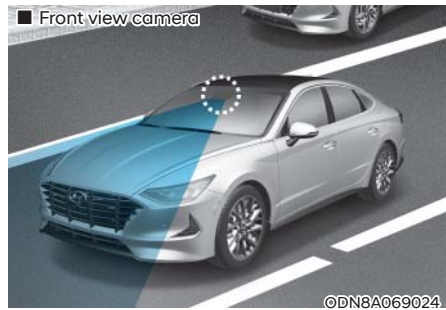

#### **Front view camera**

The front view camera is a sensor detecting the lane. If the sensors are covered with snow, rain or foreign substance, the system may temporarily be cancelled and not work properly until the system is cancelled due to the degradation of the sensor's detection performance. Always keep the sensor clean.

※ Refer to Lane Keeping Assist (LKA) for cautions for the front view camera.

### **Rear corner radar**

The rear corner radars are the sensors inside the rear bumper for detecting the side and rear areas. Always keep the rear bumper clean for proper operation of the system.



#### **CAUTION**

- The system may not work properly when the bumper has been damaged, or if the rear bumper has been replaced or repaired.
  - The sensing range differs somewhat according to the width of the road. When the road is narrow, the system may detect other vehicles in the next lane. On the other hand, when the road is wide, the system may not detect vehicles on both lanes and may not warn.
  - The system may turn off due to strong electromagnetic waves.
  - Always keep the sensors clean.
  - NEVER arbitrarily disassemble the sensor component nor apply any impact on the sensor component.
  - Be careful not to apply unnecessary force on the radar sensor or sensor cover. If the sensor is forcibly moved out of proper alignment, the system may not operate correctly. In this case, a warning message may not be displayed. Have the vehicle inspected by an authorized HYUNDAI dealer.
- Do not apply foreign objects such as a bumper sticker or a bumper guard near the radar sensor or apply paint to the sensor area. Doing so may adversely affect the performance of the sensor.
  - NEVER install any accessories or stickers on the front windshield, nor tint the front windshield.
  - Pay extreme caution to keep the front view camera out of water.
  - NEVER locate any reflective objects (i.e. white paper, mirror) over the crash pad. Any light reflection may cause a malfunction of the system.

### Warning message

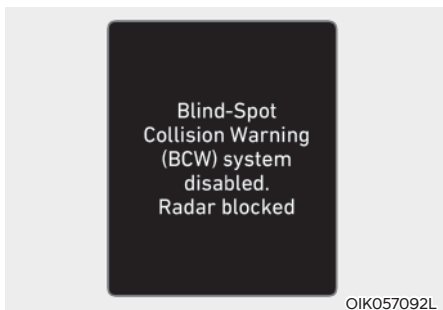

#### Blind-Spot Collision Warning (BCW) system disabled. Radar blocked

This warning message may appear when:

- One or both of the sensors on the rear bumper is blocked by dirt or snow or a foreign object.
- Driving in rural areas where the sensor does not detect another vehicle for an extended period of time.
- When there is inclement weather such as heavy snow or rain.
- A trailer or carrier or another object is installed around the rear view radars.

If any of these conditions occur, the system will turn off automatically.

When BCW canceled warning message is displayed in the cluster, check to make sure that the rear bumper is free from any dirt or snow in the areas where the sensors are located. Remove any dirt, snow, or foreign material that could interfere with the radar sensors.

After any dirt or debris is removed, the system should operate normally after about 10 minutes of driving the vehicle.

If the system still does not operate normally have your vehicle inspected by an authorized HYUNDAI dealer.

### **i** Information

Turn off BCW, BCA and RCCW, RCCA system (if equipped) when a trailer or carrier is installed.

- Deactivate BCW, BCA system by deselecting 'User Settings → Driver Assistance → Blind-Spot Safety → Off'
- Deactivate RCCW, RCCA system by deselecting 'User Settings → Driver Assistance → Parking Safety → Rear Cross-Traffic Safety'

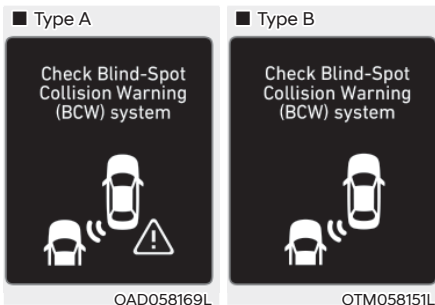

#### Check Blind-Spot Collision Warning (BCW) system

If there is a problem with BCW system, a warning message will appear. The system will turn off automatically. BCA will not operate also if BCW system turns off due to malfunction. Have the vehicle inspected by an authorized HYUNDAI dealer.

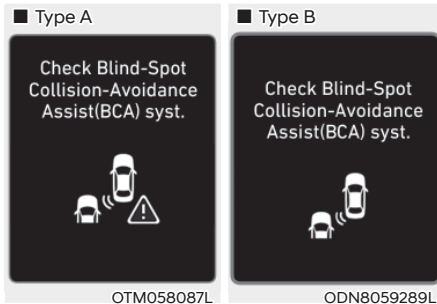

### Check Blind-Spot Collision-Avoidance Assist (BCA) system

If there is a problem with BCA system, a warning message will appear. The system will turn off automatically. BCW will still operate even if BCA system turns off due to malfunction. Have the vehicle inspected by an authorized HYUNDAI dealer.

### Limitations of the System

The driver must be cautious in the below situations, because the system may not detect other vehicles or objects in certain circumstances.

- The system may not work around 15 seconds after starting the vehicle or the initialization or rebooting of the front view camera.
- When a trailer or carrier is installed.
- The vehicle drives in inclement weather such as heavy rain or snow.
- The sensors are polluted with rain, snow, mud, etc.
- The rear bumper where the sensors are located is covered with a foreign object such as a bumper sticker, a bumper guard, a bike rack, etc.
- The rear bumper is damaged, or the sensor is out of the original default position.
- The vehicle height gets lower or higher due to heavy loading in a trunk, abnormal tire pressure, etc.
- When the temperature of the rear bumper is high.
- When the sensors are blocked by other vehicles, walls or parking-lot pillars.
- The vehicle drives on a curved road.
- The vehicle drives through a tollgate.
- The road pavement (or the peripheral ground) abnormally contains metallic components (i.e. possibly due to subway construction).
- There is a fixed object near the vehicle, such as a guardrail.

- While going down or up a steep road where the height of the lane is different.
- Driving on a narrow road where trees or grass or overgrown.
- Driving in rural areas where the sensor does not detect another vehicle or structure for an extended period of time.
- Driving on a wet road.
- Driving on a road where the guardrail or wall is in double structure.
- A big vehicle is near such as a bus or truck.
- When the other vehicle approaches very close.
- When the other vehicle passes at a very fast speed.
- While changing lanes.
- If the vehicle has started at the same time as the vehicle next to you and has accelerated.
- When the vehicle in the next lane moves two lanes away from you OR when the vehicle two lanes away moves to the next lane from you.
- A motorcycle or bicycle is near.
- A flat trailer is near.
- If there are small objects in the detecting area such as a shopping cart or a baby stroller.
- If there is a low height vehicle such as a sports car.
- The brake pedal is depressed.
- ESC (Electronic Stability Control) is activated.
- ESC (Electronic Stability Control) malfunctions.
- The tire pressure is low or a tire is damaged.
- The brake is reworked.
- The vehicle abruptly changes driving direction.
- The vehicle makes sharp lane changes.
- The vehicle sharply stops.
- Temperature is extremely low around the vehicle.
- The vehicle severely vibrates while driving over a bumpy road, uneven/ bumpy road, or concrete patch.
- The vehicle drives on a slippery surface due to snow, water puddle, or ice.
- Lane Keeping Assist does not operate normally. (if equipped)
- For more information, refer to “Lane Keeping Assist (LKA)” in this chapter.





- **Driving on a curve**  
BCW and BCA systems may not operate properly when driving on a curved road. In certain instances, the system may not detect the vehicle in the next lane.  
Always pay attention to road and driving conditions, while driving.



- BCW and BCA systems may not operate properly when driving on a curved road. In certain instances, the system may recognize a vehicle in the same lane.
- Always pay attention to road and driving conditions, while driving.

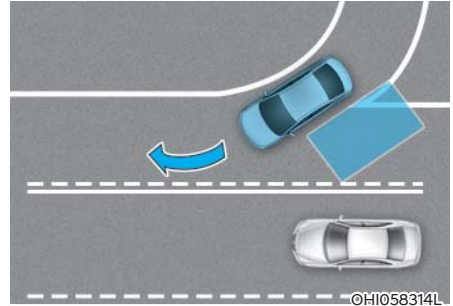

- **Driving where the road is merging/dividing**  
BCW and BCA systems may not operate properly when driving where the road is merging/dividing. In certain instances, the system may not detect the vehicle in the next lane.  
Always pay attention to road and driving conditions, while driving.

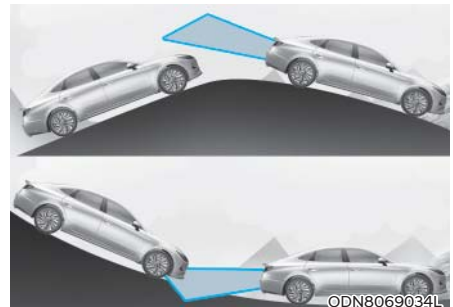

- **Driving on a slope**  
BCW and BCA systems may not operate properly when driving on a slope. In certain instances the system may not detect the vehicle in the next lane.  
Also, in certain instances, the system may wrongly recognize the ground or structures.  
Always pay attention to road and driving conditions, while driving.

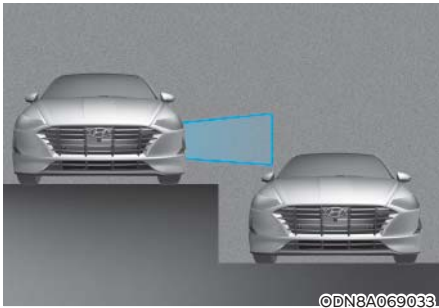

- Driving where the heights of the lanes are different

BCW and BCA systems may not operate properly when driving where the heights of the lanes are different.

In certain instances, the system may not detect the vehicle on a road with different lane heights (i.e. underpass joining section, grade separated intersections, etc.).

Always pay attention to road and driving conditions, while driving.

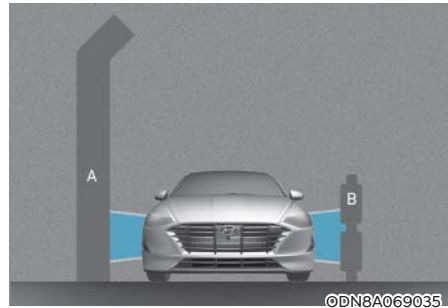

[A] : Noise barrier, [B] : Guardrail

- Driving where there is a structure beside the road

BCW and BCA systems may not operate properly when driving where there is structure beside the road.

In certain instances, the system may wrongly recognize the structures (i.e. noise barriers, guardrail, double guardrail, median strip, bollard, street light, road sign, tunnel wall, etc.) beside the road.

Always pay attention to road and driving conditions, while driving.

### **i** Information

**This device complies with Part 15 of the FCC rules.**

**Operation is subject to the following two conditions:**

- 1. This device may not cause harmful interference.**
- 2. This device must accept any interference received, including interference that may cause undesired operation.**

## DRIVER ATTENTION WARNING (DAW) (IF EQUIPPED)

Driver Attention Warning system displays the condition of the driver's fatigue level and inattentive driving practices.

### System Setting and Operation

#### System setting

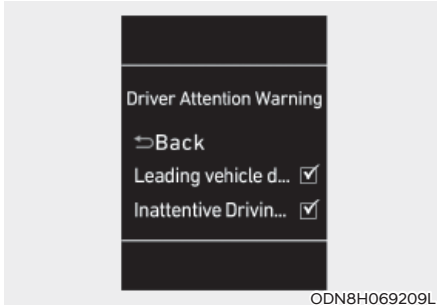

- Selecting Driver Attention Warning function

Driver Attention Warning can be activated from the Users Settings mode in the cluster LCD display or infotainment system display(if equipped) by following the procedure below.

1. Set the ignition switch to the ON position.
  2. Select "User Settings → Driver Assistance → Driver Attention Warning → Inattentive Driving Warning" on the LCD display or infotainment system display. Deselect the setting to turn off the system.
- If the vehicle is turned off then on again, the system maintains the last setting.



- Selecting Warning Timing  
The driver can select the initial warning activation time from the User Settings in the cluster LCD display or infotainment system display(if equipped) by selecting 'User Settings → Driver Assistance → Warning Timing → Normal/Later'.

The options for the initial Driver Attention Warning includes the following:

- Normal:

When this option is selected, the initial Driver Attention Warning is activated normally. If this setting feels sensitive, change the option to 'Later'.

The warning activation time may feel late if a vehicle at the side or rear abruptly accelerates.







- Later:

Select this warning activation time when the traffic is light and you are driving at low speeds.

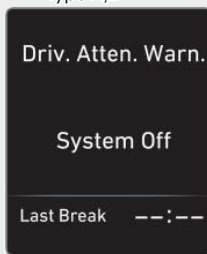
### **i** Information

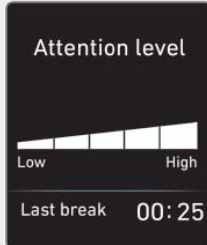
**If you change the warning timing, the warning time of other systems may change.**

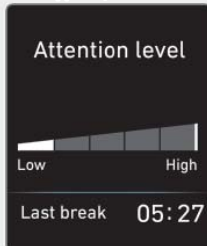
### Display of the driver's attention level

<p>■ System off • Type A,B</p>  <p>OIK057129N</p>	<p>• Type C</p>  <p>ODN8H069074L</p>
<p>■ Attentive driving • Type A,B</p>  <p>OIK057130L</p>	<p>• Type C</p>  <p>ODN8A069075</p>
<p>■ Inattentive driving • Type A,B</p>  <p>OIK057131L</p>	<p>• Type C</p>  <p>ODN8A069076</p>

The DAW screen will appear when you select the Driving Assist mode tab  on the LCD display if the system is activated. **(For more information, refer to “LCD Display Modes” section in chapter 4.)**

- The driver's attention level is displayed on the scale of 1 to 5. The lower the level is, the more inattentive the driver is.
- The level decreases when the driver does not take a break for a certain period of time.
- The level increases when the driver attentively drives for a certain period of time.
- When the driver turns on the system while driving, it displays 'Last Break time' and level.

The driver can monitor his/her driving conditions on the cluster LCD display.

### Take a break



- The “Consider taking a break” message appears on the cluster LCD display and a warning sounds to suggest that the driver take a break, when the driver’s attention level is below 1.
- Driver Attention Warning system will not suggest a break, when the total driving time is shorter than 10 minutes.
- System will not suggest a break, if “Consider taking a break” message appears within 10 minutes.
- Depending on the driver’s driving style and habits, system can be suggest to rest even when driver is not tired.



### CAUTION

**If any other warning sound such as seat belt warning chime is already generated, Driver Attention Warning system warning may not sound.**

### Resetting the System

- The last break time is set to 00:00 and the driver’s attention level is set to 5 (very attentive) when the driver resets Driver Attention Warning system.
- Driver Attention Warning system resets the last break time to 00:00 and the driver’s attention level to 5 in the following situations.
  - The engine is turned OFF.
  - The driver unfastens the seat belt and then opens the driver’s door.
  - The vehicle is stopped for more than 10 minutes.
- Driver Attention Warning system operates again, when the driver restarts driving.

### System Standby



Driver Attention Warning system enters the ready status and displays the 'Standby' screen in the following situations.

- Driving speed is over 110 mph (180 km/h).

### System Malfunction

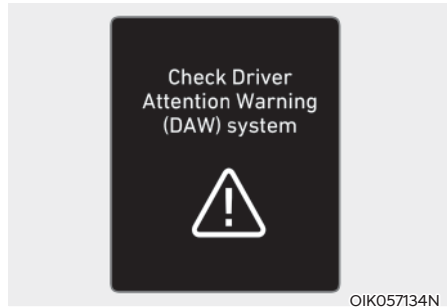

#### Check Driver Attention Warning (DAW) system

When the "Check Driver Attention Warning (DAW) system" warning message appears, the system is not working properly. In this case, have the vehicle inspected by an authorized HYUNDAI dealer.

#### **WARNING**

- **Driver Attention Warning system is not a substitute for safe driving practices, but a convenience function only. It is the responsibility of the driver to always drive cautiously to prevent unexpected and sudden situations from occurring. Pay attention to the road conditions at all times.**
- **The driver who feels fatigued should take a break, even though there is no break suggestion by Driver Attention Warning system.**



## Information

The system may suggest a break according to the driver's driving pattern or habits even if the driver doesn't feel fatigue.

### NOTICE

- Driver Attention Warning system utilizes the camera sensor on the front windshield for its operation. To keep the camera sensor in the best condition, you should observe the followings:
- Never install any accessories or stickers on the front windshield, or tint the front windshield.
- NEVER place any reflective objects (i.e. white paper, mirror) over the dashboard. Any light reflection may cause a malfunction of Driver Attention Warning system.
- Pay extreme caution to keep the camera sensor dry.
- Never disassemble the camera assembly, or apply any impact on the camera assembly.

If the sensor is forcibly moved out of proper alignment, the system may not operate correctly. Have the vehicle inspected by an authorized HYUNDAI dealer.



## CAUTION

- Driver Attention Warning system may not provide alerts in the following situations:
- Driver Attention Warning system is using the front view camera. To optimize the function of the front view camera, the driver should manage carefully. For detailed information, please refer to the warning statements in Lane Keeping Assist system section.
- The lane detection performance is limited. (For more information, refer to "Lane Keeping Assist (LKA)" section in this chapter.)
- The vehicle is erratically driven or is abruptly turned for obstacle avoidance (e.g. construction area, other vehicles, fallen objects, bumpy road).
- Forward drivability of the vehicle is severely undermined (possibly due to wide variation in tire pressures, uneven tire wear-out, toe-in/toe-out alignment).
- The vehicle is driven on a curvy road.
- The vehicle is driven through a windy area.
- The vehicle is driven on a bumpy road.
- The vehicle is controlled by the following driving assist systems:
  - Forward Collision-Avoidance Assist system
  - Lane Keeping Assist system
  - Smart Cruise Control system
  - Lane Following Assist system



## CAUTION

Playing the vehicle audio system at high volume may prevent occupants from hearing Driver Attention Warning system warning sounds.

## Leading Vehicle Departure Alert (if equipped)

After the vehicle in front departs an alert informs the driver.

### System setting

With the engine ON, Leading Vehicle Departure Alert function turns on and gets ready to be activated when the 'User Settings → Driver Assistance → Driver Attention Warning → Leading Vehicle Departure Alert' is selected on the cluster. The function stops operation when the setting is deactivated. However, if the engine is turned off then on again, the function maintains the previous state.

### Operating conditions



After the vehicle in front departs, the message is displayed on the cluster with the alarm.



### CAUTION

- **Leading Vehicle Departure Alert function is using the front view camera. To optimize the function of the front view camera, the driver should manage carefully. For detailed information, please refer to the warning statements in Lane Keeping Assist system section.**
- **Leading Vehicle Departure Alert function will not be in the ENABLED state when:**
  - **The vehicle stops on a speed bump or on a slope.**
  - **The vehicle stops during turning right or driving on a curve.**
  - **The function may not work around 15 seconds after starting the vehicle or the initialization or rebooting of the front view camera.**



### WARNING

- **Leading Vehicle Departure Alert function only assists the driver and the function may not sound the alarm even the vehicle in front departs.**
- **Even though the function allows the driver to recognize the departure of the vehicle in front, the driver should always be aware of the surroundings and operate the vehicle.**



## Limitations

The leading Vehicle Departure Alert function may not properly operate with limited alerting in the following situations:

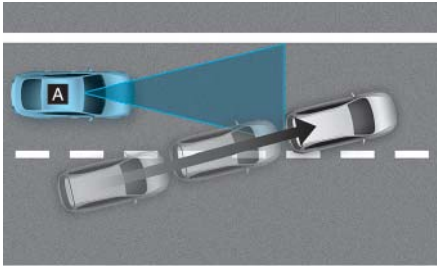

©ADAS021SD

[A] : Your vehicle

- **When a vehicle cuts in front of your vehicle (No vehicle ahead)**

If a vehicle cuts in front of your vehicle within the sensor to detect distance to the vehicle ahead, it may not operate to alert.

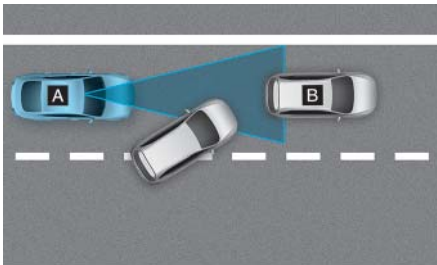

©ADAS022SD

[A] : Your vehicle, [B] : Vehicle in front

- **When a vehicle cuts in front of your vehicle (vehicle ahead)**

According to the cut-in position, the function may operate to alert the driver or it may not alert the driver of the departure of the vehicle in front or the vehicle cut in.

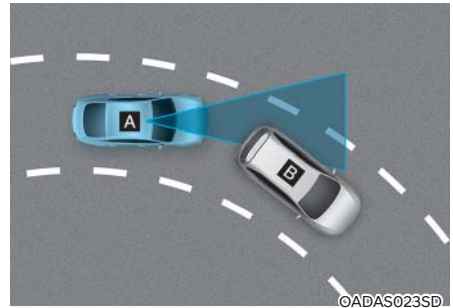

©ADAS023SD

[A] : Your vehicle, [B] : Vehicle in front

- **When a vehicle in front turns right or left or makes a U-turn**

If a vehicle in front turns the steering wheel rapidly and drives away from a closer distance, it may not operate to alert the driver.

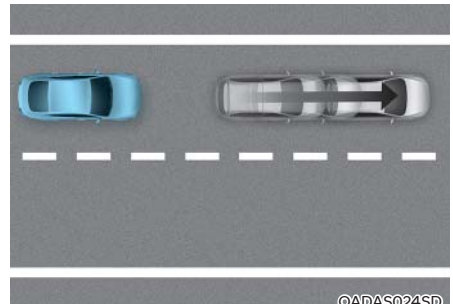

©ADAS024SD

- **When a vehicle in front makes a quick start**

If a vehicle in front makes a quick start, the function may alert earlier or it may not alert to the driver.



- **When there is a pedestrian or bicycle between your vehicle and a vehicle ahead**
  - The function may misrecognize and alert to you if a pedestrian or bicycle moves around between your vehicle and a vehicle ahead.
  - It may not alert to the driver for the safety of pedestrians or bicycles that pass around your vehicle even though the vehicle in front departs.

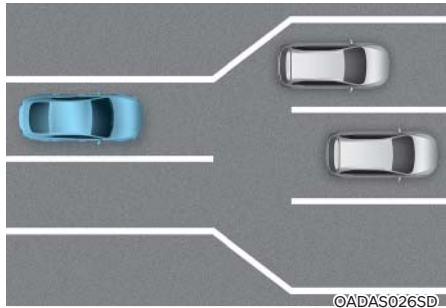

- **When driving a road with lots of vehicles in front**

If you pass a tollgate or intersection with lots of vehicles or you drive where lanes are merged or divided frequently, it may not alert or alert in a wrong way since the function cannot specify a vehicle in front.

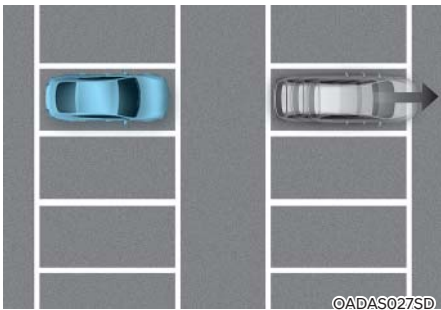

- **When parking your vehicle at a parking lot, rest area or shoulder**

If a vehicle in front tries to park and moves far from your vehicle, the function may alert.

## BLIND-SPOT VIEW MONITOR (BVM) (IF EQUIPPED)

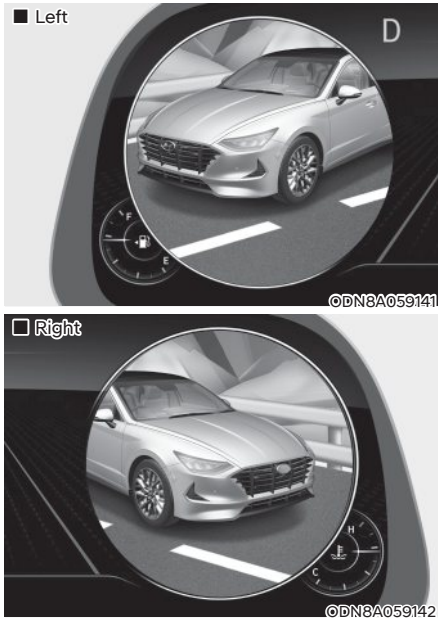

Blind-Spot View Monitor system displays the left or right side of the rear blind spot area of your vehicle in the instrument cluster when the left or right turn signal is on. This function helps you when changing lanes.

- The system is activated when the following steps are performed.
  1. The engine is running.
  2. The turn signal is turned on.

- The system is deactivated when one of the following is performed.
  - The Engine Start/Stop button is in the OFF position.
  - The turn signal is turned off
  - The hazard warning flasher is on
  - A warning screen pops up and takes priority over Blind-Spot View Monitor system.

### WARNING

- **This system is a supplemental system only. It is the responsibility of the driver to always check the area around the vehicle before and while making turns or changing lanes.**
- **ALWAYS** look around your vehicle to make sure there are no objects or obstacles before moving the vehicle in any direction to prevent a collision.
- **Objects are closer than they appear. Failure to visually confirm that view the blind spot area is safe to change the lane before doing so may result in crash and serious injury or death.**
- **Always keep the camera lens clean. The camera may not work normally if the lens is covered with foreign substance.**

## SMART CRUISE CONTROL (SCC) (IF EQUIPPED)

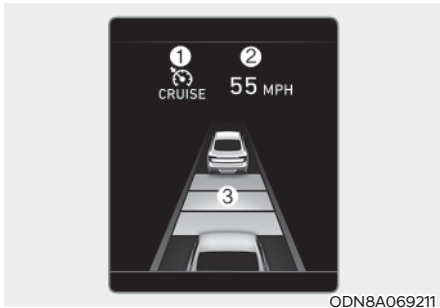

- (1) Cruise indicator
- (2) Set speed
- (3) Vehicle-to-vehicle distance

To see the SCC screen on the LCD display in the cluster, select Driving Assist mode (⚙️). For more information, refer to "LCD Display Modes" section in chapter 4.

Smart Cruise Control system allows you to program the vehicle to help maintain the desired speed and minimum distance between the vehicle ahead.

Smart Cruise Control system will automatically adjust your vehicle speed to maintain your programmed speed and following distance without requiring you to depress the accelerator or brake pedals.

### WARNING

For your safety, please read the owner's manual before using Smart Cruise Control system.

### WARNING

Smart Cruise Control system is not a substitute for safe driving practices, but a convenience function only. It is the responsibility of the driver to always check the speed and distance to the vehicle ahead.

### WARNING

Take the following precautions:

- Always set the vehicle speed under the speed limit in your country.
- If Smart Cruise Control is left on, (cruise (⚙️) CRUISE) indicator light in the instrument cluster is illuminated) Smart Cruise Control can be activated unintentionally. Keep Smart Cruise Control system off (cruise (⚙️) CRUISE) indicator light OFF) when Smart Cruise Control is not in use, to avoid inadvertently setting a speed.
- Use Smart Cruise Control system only when traveling on open highways in good weather.

- **Do not use Smart Cruise Control when it may not be safe to keep the vehicle at a constant speed:**
  - **When driving in heavy traffic or when traffic conditions make it difficult to drive at a constant speed**
  - **When driving on rainy, icy, or snow-covered roads**
  - **When driving on a steep downhill or uphill**
  - **When driving in windy areas**
  - **When driving in parking lots**
  - **When driving near crash barriers**
  - **When driving on a sharp curve**
  - **When driving with limited view (possibly due to bad weather, such as fog, snow, rain or sandstorm)**
  - **When the vehicle sensing ability decreases due to vehicle modification resulting level difference of the vehicle's front and rear**
- **Unexpected situations may lead to possible accidents. Pay attention continuously to road conditions and driving even when smart cruise control system is being operated.**

## Smart Cruise Control Switch

CRUISE/ : Turns cruise control system on or off.

RES+: Resumes or increases cruise control speed.

SET-: Sets or decreases cruise control speed.

: Sets vehicle-to-vehicle distance.

CANCEL (CNCL): Cancels cruise control operation.

## To Convert to Cruise Control Mode

The driver may choose to only use the conventional Cruise Control mode (speed control function) by doing as follows:

1. Turn Smart Cruise Control system on (the cruise indicator light will be on but the system will not be activated).
2. Push and hold the Vehicle-to-Vehicle Distance button for more than 2 seconds.
3. Choose between “Smart Cruise Control” and “Cruise Control”.

When the system is canceled using the CRUISE/  button or the CRUISE button is used after the engine is turned on, the Smart Cruise Control mode will turn on.





## WARNING

**When using the Cruise Control mode, you must manually adjust the distance to other vehicles by depressing the brake pedal. The system does not automatically adjust the distance to vehicles in front of you.**

## Smart Cruise Control Speed

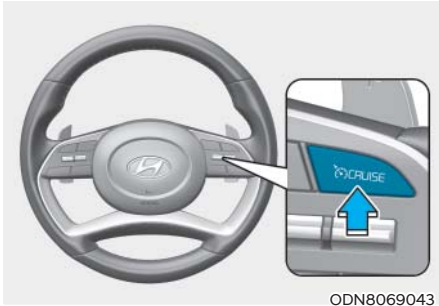
### To set Smart Cruise Control speed



1. Push the CRUISE/  button on the steering wheel to turn the system on. The cruise indicator will illuminate.
2. Accelerate to the desired speed.

The Smart Cruise Control speed can be set as follows :

- 5 ~ 110 mph (10 ~ 180 km/h) : when there is no vehicle in front
- 0 ~ 110 mph (0 ~ 180 km/h) : when there is a vehicle in front



3. Push the toggle switch down (SET-). The Set Speed and Vehicle-to-Vehicle Distance on the LCD display will illuminate.
4. Release the accelerator pedal. The desired speed will automatically be maintained.

If there is a vehicle in front of you, the speed may decrease to maintain the distance to the vehicle ahead.

On a steep grade, the vehicle may slow down or speed up slightly while going uphill or downhill.

### Information

- **Vehicle speed may decrease on an upward slope and increase on a downward slope.**
- **When you are setting the cruise control speed, with a vehicle in front and your vehicle speed is between 0 ~ 20 mph (0 ~ 30 km/h), the speed will set to 20 mph (30 km/h).**

### To increase Smart Cruise Control set speed

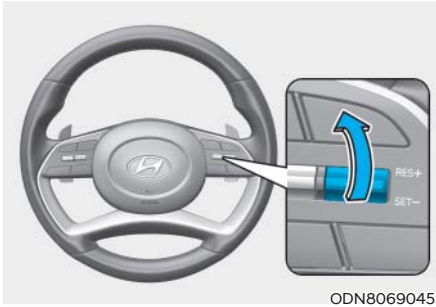

Follow either of these procedures:

- Push the toggle switch up (RES+), and release it immediately. The cruising speed will increase by 1 mph (1 km/h) each time you move the toggle switch up in this manner.
- Push the toggle switch up (RES+), and hold it. Your vehicle set speed will increase by 5 mph (10 km/h). Release the toggle switch at the speed you want.
- You can set the speed to 110 mph (180 km/h).



### CAUTION

**Check the driving condition before using the toggle switch. Driving speed sharply increases, when you push up and hold the toggle switch.**

### To decrease the Smart Cruise Control set speed

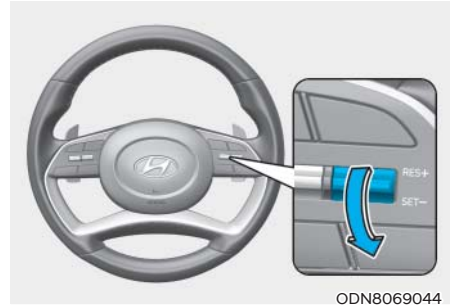

Follow either of these procedures:

- Push the toggle switch down (SET-), and release it immediately. The cruising speed will decrease by 1 mph (1 km/h) each time you move the toggle switch down in this manner.
- Push the toggle switch down (SET-), and hold it. Your vehicle set speed will decrease by 5 mph (10 km/h). Release the toggle switch at the speed you want.
- You can set the speed to 20 mph (30 km/h).

**To temporarily accelerate with Smart Cruise Control on**

If you want to speed up temporarily when Smart Cruise Control is on, depress the accelerator pedal. Increased speed will not interfere with Smart Cruise Control operation or change the set speed.

To return to the set speed, take your foot off the accelerator pedal.

If you push the toggle switch down (SET-) at increased speed, the set speed is updated.

**i Information**

**Be careful when accelerating temporarily, because the speed is not controlled automatically at this time even if there is a vehicle in front of you.**

**Smart Cruise Control will be temporarily canceled when:**

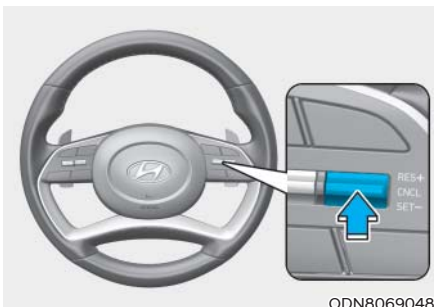

**Cancelled manually**

- Depressing the brake pedal.
- Pushing the CANCEL (CNCL) button located on the steering wheel.

Smart Cruise Control turns off temporarily when the Set Speed and Vehicle-to-Vehicle Distance indicator on the LCD display turns off.

The cruise indicator (Ⓢ) is illuminated continuously.

**Cancelled automatically**

- The driver's door is opened.
- The vehicle is shifted to N (Neutral), R (Reverse) or P (Park).
- The parking brake is applied.
- The vehicle speed is over 120 mph (190 km/h).
- The ESC (Electronic Stability Control), TCS (Traction Control System) or ABS is operating.
- The ESC is turned off.
- The sensor or the cover is dirty or blocked with foreign matter.
- The vehicle is stopped for a certain period of time.



- The vehicle is stopped for more than 5 minutes.
- The vehicle stops and goes repeatedly for a long period of time.
- The accelerator pedal is continuously depressed for a long period of time.
- The accelerator pedal is continuously depressed for more than one minute.
- The engine performance is abnormal.
- Engine rpm is in the red zone.
- The driver starts driving by pushing the toggle switch up (RES+)/down (SET-) or depressing the accelerator pedal, after the vehicle is stopped by Smart Cruise Control system with no other vehicle ahead.
- The driver starts driving by pushing the toggle switch up (RES+)/down (SET-) or depressing the accelerator pedal, after stopping the vehicle with a vehicle stopped far away in front.
- Forward Collision-Avoidance Assist is activated.
- The engine speed is in dangerous range.
- When engine is stopped by ISG (Idle Stop & Go).

Each of these actions will cancel the Smart Cruise Control operation. The Set Speed and Vehicle-to-Vehicle Distance on the LCD display will go off.

In a condition Smart Cruise Control is cancelled automatically, Smart Cruise Control will not resume even though the RES+ or SET- toggle switch is pushed.

### **i** Information

**If Smart Cruise Control is cancelled by other than the reasons mentioned, have the vehicle inspected by an authorized HYUNDAI dealer.**

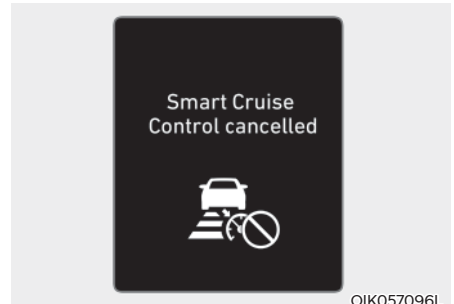

#### **Smart Cruise Control cancelled**

If the system is cancelled, the warning chime will sound and a message will appear for a few seconds.

You must adjust the vehicle speed by depressing the accelerator or brake pedal according to the road condition ahead and driving condition.

Always check the road conditions. Do not rely on the warning chime.

### To resume Smart Cruise Control set speed

If any method other than the cruise toggle switch was used to cancel cruising speed and the system is still activated, the cruising speed will automatically resume when you push the toggle switch up (RES+) or down (SET-).



If you push the toggle switch up (RES+), the speed will resume to the recently set speed. However, if vehicle speed drops below 5 mph (10 km/h), it will resume when there is a vehicle in front of your vehicle.

### Information

Always check the road conditions when you push the toggle switch up (RES+) to resume speed.



### To turn Cruise Control off



- Pushing the CRUISE/  button. The cruise indicator will go off. If you wish not to use the cruise control system, always turn the system off by pushing the CRUISE/  button.

### WARNING

Take the following precautions :

- Always set the vehicle speed under the speed limit in your country.
- If Smart Cruise Control is left on,  CRUISE indicator light in the instrument cluster is illuminated) Smart Cruise Control can be activated unintentionally. Keep Smart Cruise Control system off ( CRUISE indicator light OFF) when Smart Cruise Control is not in use, to avoid inadvertently setting a speed.
- Use Smart Cruise Control system only when traveling on open highways in good weather.

- **Do not use Smart Cruise Control when it may not be safe to keep the vehicle at a constant speed:**
  - When driving in heavy traffic or when traffic conditions make it difficult to drive at a constant speed
  - When driving on rainy, icy, or snow-covered roads
  - When driving on a steep downhill or uphill
  - When driving in windy areas
  - When driving in parking lots
  - When driving near crash barriers
  - When driving on a sharp curve
  - When driving with limited view (possibly due to bad weather, such as fog, snow, rain or sandstorm)
  - When the vehicle sensing ability decreases due to vehicle modification resulting level difference of the vehicle's front and rear
- **Unexpected situations may lead to possible accidents. Pay attention continuously to road conditions and driving even when Smart Cruise Control system is being operated.**

When changing the Drive mode setting, the responsiveness of Smart Cruise Control changes. (If equipped)

Drive Mode	SCC Reaction
NORMAL	Normal
SMART	Normal
SPORT	Fast

In CUSTOM mode, SCC Reaction operates according to the mode set in the Engine/Transmission.

(e.g. in CUSTOM mode, the driver select mode of Engine/Transmission as SPORT, SCC Reaction operates as Fast)

## Smart Cruise Control Vehicle-to-Vehicle Distance

### To set Vehicle-to-Vehicle Distance

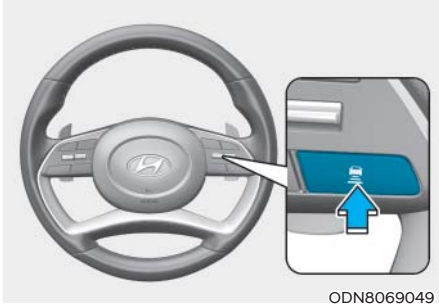

When Smart Cruise Control system is ON, you can set and maintain the distance from the vehicle ahead of you without pressing the accelerator or brake pedal.

Each time the button is pressed, the vehicle to vehicle distance changes as follows:

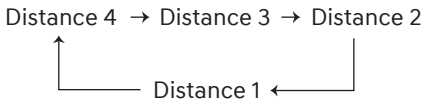

For example, if you drive at 56 mph (90 km/h), the distance is maintained as follows:

- Distance 4 - approximately 172 feet
- Distance 3 - approximately 130 feet
- Distance 2 - approximately 160 feet
- Distance 1 - approximately 82 feet

### When the lane ahead is clear:

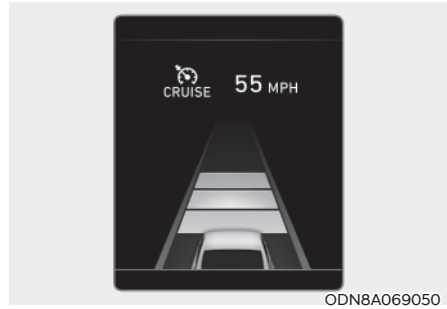

The vehicle speed will maintain the set speed.

**When there is a vehicle ahead of you in your lane:**

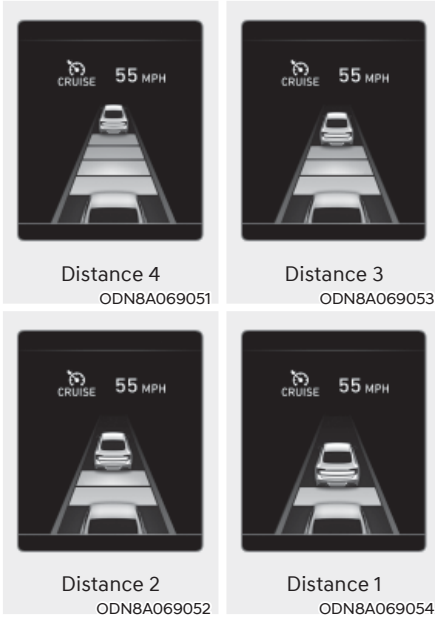

Your vehicle speed will slow down or speed up to maintain the selected distance.

If the vehicle ahead speeds up, your vehicle will travel at a steady cruising speed after accelerating to the set speed.

If distance from the front vehicle has been changed due to accelerating or decelerating of the front vehicle, the distance on the LCD display may change.

 **WARNING**



**When using Smart Cruise Control system:**

- The warning message appears and warning chime sounds if the vehicle is unable to maintain the selected distance from the vehicle ahead.
- If the warning message appears and warning chime sounds, depress the brake pedal to actively adjust the vehicle speed, and the distance to the vehicle ahead.
- Even if the warning message does not appear and warning chime does not sound, always pay attention to the driving conditions to prevent dangerous situations from occurring.
- Playing the vehicle audio system at high volume may prevent occupants from hearing the system warning sounds.

 CAUTION



If the vehicle ahead (vehicle speed: less than 20 mph (30 km/h)) disappears to the next lane, the warning chime will sound and a message "Watch for surrounding vehicles" will appear. Adjust your vehicle speed for vehicles or objects that can suddenly appear in front of you by depressing the brake pedal.

Always pay attention to the road condition ahead.

*In traffic situation*

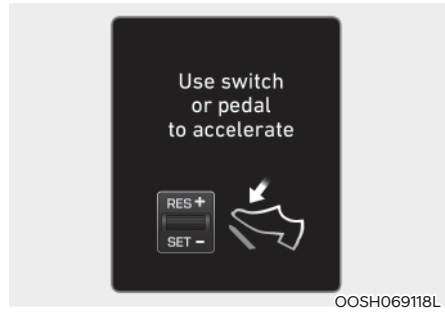

**Use switch or pedal to accelerate**

- In traffic, your vehicle will stop if the vehicle ahead of you stops. Also, if the vehicle ahead of you starts moving, your vehicle will start as well. However, if the vehicle stops for more than 3 seconds, you must depress the accelerator pedal or push up the toggle switch (RES+) to start driving.
- If you push Smart Cruise Control toggle switch (RES+ or SET-) while Auto Hold and smart cruise control is operating the Auto Hold will be released regardless of accelerator pedal operation and the vehicle will start to move. The AUTO HOLD indicator changes from green to white.

### Sensor to detect distance to the vehicle ahead (Front view camera and Front Radar)

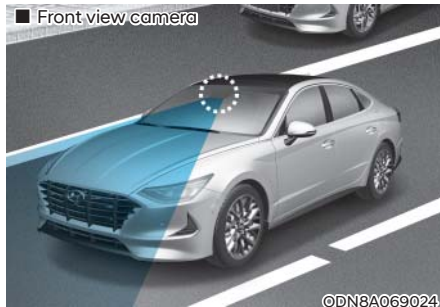

#### Front view camera

The front view camera is a sensor detecting the lane. If the sensors are covered with snow, rain or foreign substance, the system may temporarily be cancelled and not work properly until the system is cancelled due to the degradation of the sensor's detection performance. Always keep the sensor clean.

※ Refer to “Lane Keeping Assist (LKA)” for cautions for the front camera.

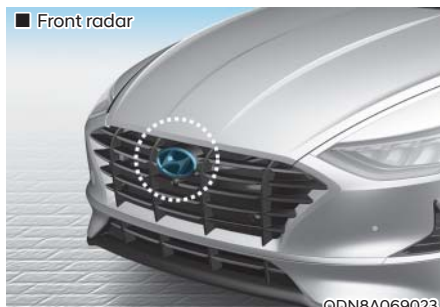

#### Front radar

The front radar is a sensor detecting vehicles in front and maintains the distance between them.

If the sensors are covered with snow, rain or foreign substance, the system may temporarily be cancelled and not work properly until the system is cancelled due to the degradation of the sensor's detection performance. Always keep the sensor clean.



#### CAUTION

- Do not apply license plate frame or foreign objects such as a bumper sticker or a bumper guard near the radar sensor. Doing so may adversely affect the sensing performance of the radar.
- Always keep the radar sensor and lens cover clean and free of dirt and debris.
- Use only a soft cloth to wash the vehicle. Do not spray pressurized water directly on the sensor or sensor cover.
- Be careful not to apply unnecessary force on the radar sensor or sensor cover. If the sensor is forcibly moved out of proper alignment, Smart Cruise Control system may not operate correctly. In this case, a warning message may not be displayed. Have the vehicle inspected by an authorized HYUNDAI dealer.
- If the front bumper becomes damaged in the area around the radar sensor, Smart Cruise Control system may not operate properly. Have the vehicle inspected by an authorized HYUNDAI dealer.
- Use only genuine HYUNDAI parts to repair or replace a damaged sensor or sensor cover. Do not apply paint to the sensor cover.

### Warning message

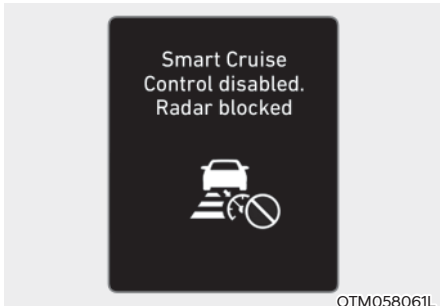

#### Smart Cruise Control disabled. Radar blocked

When the sensor lens cover is blocked with dirt, snow, or debris, Smart Cruise Control system operation may stop temporarily. If this occurs, a warning message will appear on the cluster LCD display. Remove any dirt, snow, or debris and clean the radar sensor lens cover before operating Smart Cruise Control system. Smart Cruise Control system may not properly activate, if the radar is totally covered, or if any substance is not detected after turning on the engine (e.g. in an open terrain).

### **i** Information

**For the SCC operation is temporarily stopped if the radar is blocked, but you wish to use cruise control mode (speed control function), you must convert to the cruise control mode (refer to "To convert to Cruise Control mode" in the following page).**



#### Check Smart Cruise Control System

The message will appear when the vehicle to vehicle distance control system is not functioning normally. Have the vehicle inspected by an authorized HYUNDAI dealer.



## Limitations of the System

Smart Cruise Control system may have limits to its ability to detect distance to the vehicle ahead due to road and traffic conditions.

### ***On curves***

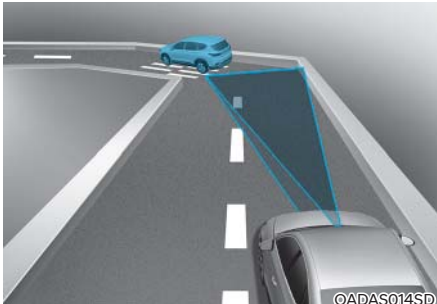

- Smart Cruise Control system may not detect a moving vehicle in your lane, and then your vehicle could accelerate to the set speed. Also, the vehicle speed will decrease when the vehicle ahead is recognized suddenly.
- Select the appropriate set speed on curves and apply the brakes or accelerator pedal if necessary.

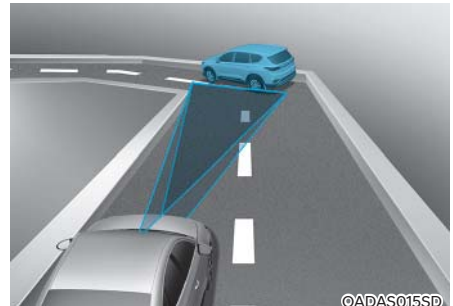

Your vehicle speed can be reduced due to a vehicle in the adjacent lane.

Apply the accelerator pedal and select the appropriate set speed. Check to be sure that the road conditions permit safe operation of Smart Cruise Control.

### ***On inclines***

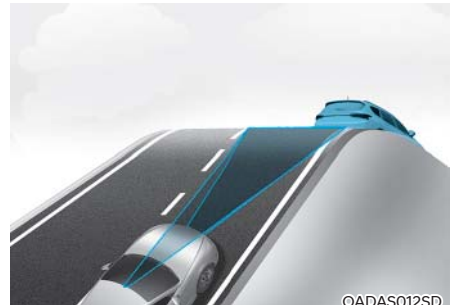

- During uphill or downhill driving, Smart Cruise Control system may not detect a moving vehicle in your lane, and cause your vehicle to accelerate to the set speed. Also, the vehicle speed will rapidly decrease when the vehicle ahead is recognized suddenly.
- Select the appropriate set speed on inclines and apply the brake or accelerator pedal if necessary.

### Lane changing

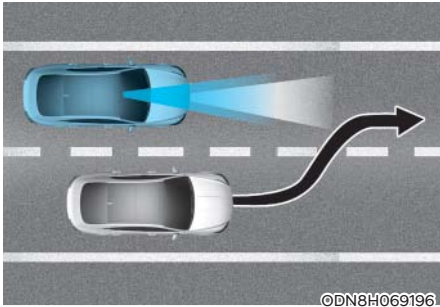

- A vehicle which moves into your lane from an adjacent lane cannot be recognized by the sensor until it is in the sensor's detection range.
- The radar may not detect immediately when a vehicle cuts in suddenly. Always pay attention to the traffic, road and driving conditions.
- If a slower vehicle moves into your lane, your speed may decrease to maintain the distance to the vehicle ahead.
- If a faster vehicle which moves into your lane, your vehicle will accelerate to the set speed.

### Vehicle recognition

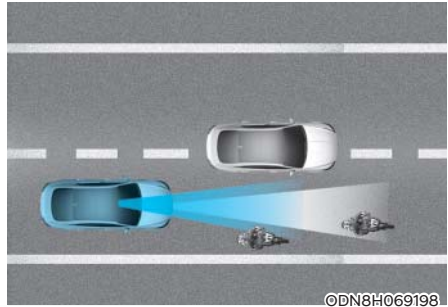

- Some vehicles in your lane cannot be recognized by the sensor:
  - Narrow vehicles such as motorcycles or bicycles
  - Vehicles offset to one side
  - Slow-moving vehicles or sudden-decelerating vehicles
  - Stopped vehicles
  - Vehicles with small rear profile such as trailers with no loads
- A vehicle ahead cannot be recognized correctly by the sensor if any of following occurs:
  - When the vehicle is pointing upwards due to overloading in the luggage compartment
  - While the steering wheel is operating
  - When driving to one side of the lane
  - When driving on narrow lanes or on curves

Apply the brake or accelerator pedal if necessary.

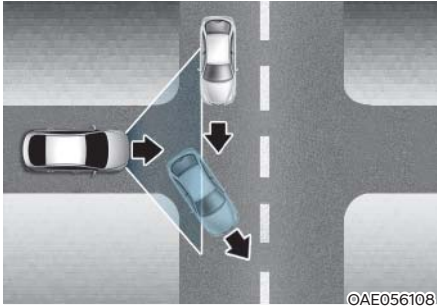

- Your vehicle may accelerate when a vehicle ahead of you disappears.
- When you are warned that the vehicle ahead of you is not detected, drive with caution.

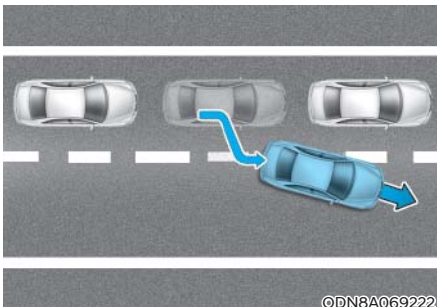

- When driving in stop-and-go traffic, and a vehicle in front of you merges out of the lane, the system may not immediately detect the new vehicle that is now in front of you. In this case, you must maintain a safe braking distance, and if necessary, depress the brake pedal to reduce your driving speed in order to maintain a safe distance.

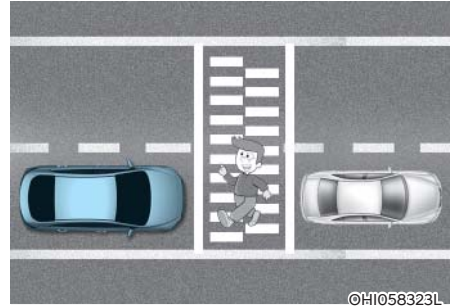

- Always look out for pedestrians when your vehicle is maintaining a distance with the vehicle ahead.

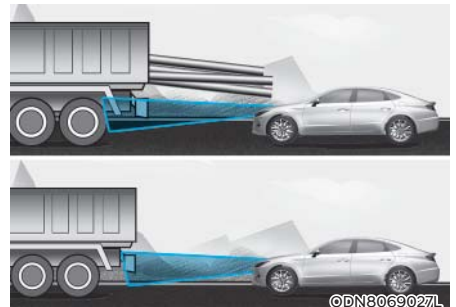

- Always be cautious for vehicles with higher height or vehicles carrying loads that sticks out from the back of the vehicle.



## WARNING

When using Smart Cruise Control take the following precautions:

- If an emergency stop is necessary, you must apply the brakes. The vehicle cannot be stopped at every emergency situation by using Smart Cruise Control system.
- Keep a safe distance according to road conditions and vehicle speed. If the vehicle to vehicle distance is too close during a high-speed driving, a serious collision may result.
- Always maintain sufficient braking distance and decelerate your vehicle by applying the brakes if necessary.
- Smart Cruise Control system cannot recognize a stopped vehicle, pedestrians or an oncoming vehicle. Always look ahead cautiously to prevent unexpected and sudden situations from occurring.
- Vehicles moving in front of you with a frequent lane change may cause a delay in the system's reaction or may cause the system to react to a vehicle actually in an adjacent lane. Always drive cautiously to prevent unexpected and sudden situations from occurring.
- Always be aware of the selected speed and vehicle to vehicle distance. The driver should not solely rely on the system but always pay attention to driving conditions and control your vehicle speed.
- Smart Cruise Control system may not recognize complex driving situations so always pay attention to driving conditions and control your vehicle speed.

- Smart Cruise Control system may recognize a pedestrian, bicycle, motorcycle, etc. as a vehicle. Always, look ahead cautiously to prevent unexpected and sudden situations from occurring.
- Turn off Smart Cruise Control system when the vehicle is being towed.

## NOTICE

Smart Cruise Control system may not operate temporarily due to:

- Electrical interference
- Modifying the suspension
- Differences of tire abrasion or tire pressure
- Installing different type of tires

The brake control using Smart Cruise Control system may make a sound.

## Information

This device complies with Part 15 of the FCC rules.

Operation is subject to the following two conditions:

1. This device may not cause harmful interference.
2. This device must accept any interference received, including interference that may cause undesired operation.

## NAVIGATION-BASED SMART CRUISE CONTROL (IF EQUIPPED)

Navigation-based Smart Cruise Control system will help automatically adjust your speed when a curved road is ahead by receiving road information from the navigation while the Smart Cruise Control is operating.



### WARNING

- Navigation-based Smart Cruise Control system is not a substitute for safe driving practices, but a convenience function. It is the responsibility of the driver to always be aware of the surroundings and drive safely.
- Navigation-based Smart Cruise Control system relies entirely on the road information provided by the navigation system and may accelerate above speed limit. It is the responsibility of the driver to follow traffic laws and avoid accidents.
- For your safety, please read the owner's manual before using the system.

### **i** Information

- Navigation-based Smart Cruise Control system is available only on controlled access road of certain highways.
  - × Controlled access road indicates roads with limited entrances and exits that allow uninterrupted high speed traffic flow. Only passenger cars and motorcycles are allowed on controlled access roads.

Available highway (Controlled access road)	
USA	Select Interstate Highway and U.S. (Federal) and State Highways
Canada	Select Provincial and Territorial Highways

- Additional highways may be expanded by navigation updates.

## System Setting and Operation

### System setting

- With the Engine Start/Stop button in the ON or START position, Navigation-based Smart Cruise Control can be activated by selecting 'Driver Assistance → Highway Auto Curve Slowdown' from the User Settings mode on the infotainment system. For detailed information, please refer to the infotainment system manual separately supplied.
- If the engine is turned off then on again, the system maintains the last setting.

### Operating conditions

Select 'Highway Auto Curve Slowdown' from the Settings menu in the infotainment system screen and satisfy the following conditions for the system to operate.

- Driving on the highway main line
- Smart Cruise Control is operating

If all the mentioned conditions are satisfied, the system is ENABLED and the 'AUTO' symbol on the cluster will illuminate white.

### System operation



### System standby

If the system is ENABLED, the **AUTO** symbol on the cluster will illuminate white.

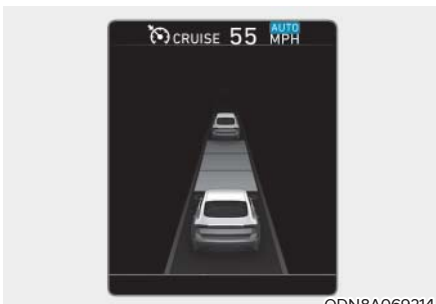

### System in operation

If the vehicle decelerates in a curve, the **AUTO** symbol on the cluster will illuminate green.

- This system works only for curved sections located on highway main lines.
- Depending on the curve ahead on the road, the vehicle will decelerate, and after passing curve, the vehicle will accelerate to Smart Cruise Control set speed.
- The higher the driving speed, the faster the vehicle is decelerated.
- The system responds to curves located on the destination set in the navigation. If the destination is not set, the system will respond to road information of the expected route.

## **i** Information

- Navigation-based Smart Cruise Control is limited in other countries.
- The system may not operate due to the existence of leading vehicles and the driving situations of the vehicle.
- The system operates regardless of whether the sharp curve warning appears on the navigation, but the time gap could occur between the warning and system operation.
- The navigation only provides curve information within permitted speed ranges so that the system may not decrease its speed during extreme over-speed driving.
- The system is not designed to work on highways other than mentioned as a controlled access road.
- The system automatically cancels when you leave the highway.
- Highway Driving Assist and Navigation-based Smart Cruise Control uses the same **AUTO** symbol that indicates the status of the system. Therefore, even if Navigation-based Cruise Control is off, the **AUTO** symbol may be displayed.
- If there is a problem with Navigation-based Smart Cruise Control, the system cannot be activated in the AVN system screen, and the **AUTO** symbol will turn off. However, if Highway Driving Assist is activated, the **AUTO** symbol will be displayed.
- After you pass through a tollgate on a highway, the system operates based on the first lane. If you enter one of the other lanes, the system might not properly decelerate.
- If you over speed, the system may not decelerate the vehicle in a curve.
- Deceleration by the system may not be sufficient if the driver accelerates while the system is operating,
- Deceleration by the system may not be sufficient due to road conditions such as uneven road surfaces, narrow lanes, etc.
- If the road is controlled, due to construction or holiday events, the system might not work properly.



### CAUTION

Navigation-based Cruise Control system may not function properly in the following situations:

- The navigation is not working properly.
- The navigation is not updated.
- The real-time GPS or map information provided has errors.
- The navigation is overloaded by performing functions such as route search, video playback, voice recognition, etc. are performing simultaneously.
- GPS signals are blocked in areas such as a tunnel.
- The driver goes off course or the route to the destination is changed or canceled by resetting the navigation.
- The vehicle enters a service station or rest area.
- A section of the highway's shape has changed.
- Android Auto or Car Play is operating.
- The navigation cannot detect the current vehicle position (ex: elevated roads including overpass adjacent to general roads or nearby roads exist in a parallel way).
- The navigation is being updated while driving.
- The navigation is being reset while driving.
- The road is slippery due to bad weather such as rain or snow.



### Information

This device complies with Part 15 of the FCC rules.

Operation is subject to the following three conditions:

1. This device may not cause harmful interference, and
2. This device must accept any interference received, including interference that may cause undesired operation.
3. Changes or modifications not expressly approved by the party responsible for compliance could void the user's authority to operate the device.



### Information

Radio frequency radiation exposure information:

This equipment complies with FCC radiation exposure limits set forth for an uncontrolled environment.

This equipment should be installed and operated with minimum distance of 8 in. (20 cm) between the radiator (antenna) and your body.

This transmitter must not be co-located or operating in conjunction with any other antenna or transmitter.



## LANE FOLLOWING ASSIST (LFA) (IF EQUIPPED)

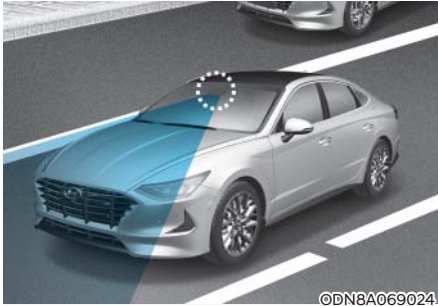

Lane Following Assist system helps detect lane markers on the road with a front view camera at the front windshield, and assists the driver's steering to help keep the vehicle between lanes.



### WARNING

Lane Following Assist system is not a substitute for safe driving practices, but a convenience function. It is the responsibility of the driver to always be aware of the surroundings and steer the vehicle.



### WARNING

Take the following precautions when using Lane Following Assist system:

- Do not turn the steering wheel suddenly when the steering wheel is being assisted by the system.
- LFA system helps the driver to keep the vehicle in the center of the lane by assisting the driver's steering. However, the driver should not solely rely on the system but always pay attention on the steering wheel to stay in the lane.
- The operation of LFA system can be canceled or not work properly according to road condition and surroundings. Always be cautious when driving.
- Do not disassemble LFA system camera temporarily to tint the window or attach any types of coatings and accessories. If you disassemble the camera and assemble it again, have the vehicle inspected by an authorized HYUNDAI dealer.

- When you replace the windshield glass, LFA system camera or related parts of the steering wheel, have the vehicle inspected by an authorized HYUNDAI dealer.
- The system helps detect lane markers and controls the steering wheel by a camera, therefore, if the lane markers are hard to detect, the system may not work properly.
- Please refer to “Limitations of the System”.
- Do not remove or damage the related parts of LFA system.
- You may not hear a warning sound of LFA system if the audio volume is high.
- Do not place objects on the dashboard that reflects light such as mirrors, white paper, etc. This may prevent LFA system from functioning properly.
- Always have your hands on the steering wheel while LFA system is activated. If you continue to drive with your hands off the steering wheel after the “Keep hands on steering wheel” warning message appears, the system will turn off automatically.  
However, if the driver has their hands on the steering wheel again, the system will start controlling the steering wheel.
- The steering wheel is not continuously controlled so if the vehicle speed is at a higher rate when leaving a lane the vehicle may not be controlled by the system. The driver must always follow the speed limit when using the system.
- If you attach objects to the steering wheel, the system may not assist steering or the hands off alarm may not work properly.

## LFA Operation

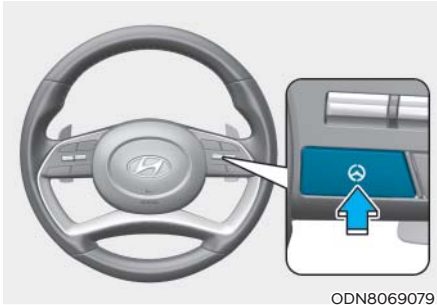

With the Engine Start/Stop button in the ON or START position, Lane Following Assist can be activated by pressing the button.

### Operating conditions

When the system is activated, the indicator (🚘) on the cluster will illuminate. The color of the indicator will change depending on the condition of LFA system.

- Green: Steering assist mode is ON
- White: Steering assist mode is OFF

### LFA system operation

- If the vehicle is inside the lane with both lanes detected by the system (lane color changes from gray to white), and there is no abrupt steering made by the driver, LFA system changes to steering assist mode. The 🚘 indicator light will come on green, and the system helps the vehicle stay in line by controlling the steering wheel. When the steering wheel is not controlled temporarily, the 🚘 indicator light will flash green and change to white.

## Warning Message



### Keep hands on steering wheel

If the driver takes their hands off the steering wheel for several seconds while LFA system is activated, the system will warn the driver.

### **i** Information

**Hold the steering wheel tight. Otherwise, LFA system could misjudge that the driver's hands are off the steering wheel, and the above warning may occur.**

### **⚠** WARNING

**The warning message may appear late according to road conditions. Therefore, always have your hands on the steering wheel while driving.**



**Driver's hands not detected.  
LFA system is disabled temporarily**

If the driver still does not have their hands on the steering wheel after the message “Keep hands on steering wheel”, the system will not control the steering wheel and warn the driver only when the driver crosses the lane markers.

However, if the driver has their hands on the steering wheel again, the system will start controlling the steering wheel.

 **WARNING**

- **LFA system is a supplemental system only. It is the responsibility of the driver to safely steer the vehicle and to maintain it in its lane.**
- **Turn off LFA system and drive without using the system in the following situations:**
  - In bad weather
  - In bad road conditions
  - When the steering wheel needs to be controlled by the driver frequently
  - A trailer or carrier is installed.

 **Information**

- **Even though the steering is assisted by the system, the driver may control the steering wheel.**
- **The steering wheel may feel heavier when the steering wheel is assisted by the system than when it is not.**



**Check LFA (Lane Following Assist) system**

If there is a problem with the system a message will appear for a few seconds. If the problem continues LFA system failure indicator will illuminate.

**LFA system will not be in the ENABLED state and/or the steering wheel will not be assisted when:**

- The turn signal is turned on before changing a lane. If you change lanes without the turn signal on, the steering wheel might be controlled.
- The vehicle is not driven in the middle of the lane when the system is turned on or right after changing a lane.
- ESC (Electronic Stability Control) or VSM (Vehicle Stability Management) is activated.
- The vehicle is driven on a sharp curve.
- If vehicle speed is over 95 mph (153 km/h)
- The vehicle makes sharp lane changes.
- The vehicle brakes suddenly.
- Only one lane marker is detected.
- The lane is very wide or narrow.
- There are more than two lane markers on the road (e.g. construction area).
- Radius of a curve is too small.
- The vehicle is driven on a steep incline.
- The steering wheel is turned suddenly.
- The system may not operate for 15 seconds after the engine is started or the camera is initialized.

## Limitations of the System

LFA system may operate prematurely even if the vehicle does not depart from the intended lane, OR, LFA system may not assist your steering or warn you if the vehicle leaves the intended lane under the following circumstances:

### When the lane and road conditions are poor

- It is difficult to distinguish the lane marking from the road surface or the lane marking is faded or not clearly marked.
- It is difficult to distinguish the color of the lane marker from the road.
- There are markings on the road surface that look like a lane marker that is inadvertently being detected by the camera.
- The lane marker is indistinct or damaged.
- The lane marker is merged or divided (e.g. tollgate).
- The lane number increases or decreases or the lane marker are crossing complicatedly.
- There are more than two lane markers on the road in front of you.
- The lane marker is very thick or thin.
- The lane is very wide or narrow.
- The lane marker ahead is not visible due to rain, snow, water on the road, damaged or stained road surface, or other factors.

- The shadow is on the lane marker by a median strip, trees, guardrail, noise barriers, etc.
- The lane markers are complicated or a structure substitutes for the lines such as a construction area.
- There are crosswalk signs or other symbols on the road.
- The lane marker in a tunnel is stained with oil, etc.
- The lane suddenly disappears such as at the intersection.
- Driving the shared lane usage (bicycle lane, pedestrians lane, etc.)

### **When external condition is intervened**

- The brightness outside changes suddenly such as when entering or exiting a tunnel, or when passing under a bridge.
- The brightness outside is too low such as when the headlamps are not on at night or the vehicle is going through a tunnel.
- There is a boundary structure in the roadway such as a concrete barrier, guardrail and reflector post that is inadvertently being detected by the camera.
- When light coming from a street light or an oncoming vehicle is reflected on a wet road surface such as a puddle in the road.
- The field of view in front is obstructed by sun glare.

- There is not enough distance between you and the vehicle in front to be able to detect the lane marker or the vehicle ahead is driving on the lane marker.
- Driving on a steep grade, over a hill, or when driving on a curved road.
- The adverse road conditions cause excessive vehicle vibrations while driving.
- The surrounding of the inside rear view mirror temperature is high due to direct sunlight, etc.
- The sensor recognition changes suddenly when passing over a speed bump or driving on a steep up/down or right/left grade

### **When front visibility is poor**

- The windshield or the camera lens is blocked with dirt or debris.
- The windshield glass is fogged up; a clear view of the road is obstructed.
- Placing objects on the dashboard, etc.
- The sensor cannot detect the lane because of fog, heavy rain or snow.

## HIGHWAY DRIVING ASSIST (HDA) (IF EQUIPPED)

Highway Driving Assist system helps keep the vehicle between lanes, maintain a distance with the vehicle ahead, and automatically adjusts the vehicle speed to the speed limit while driving on the highway.



### WARNING

- Highway Driving Assist system is not a substitute for safe driving practices, but a convenience function. It is the responsibility of the driver to always be aware of the surroundings and drive safely.
- Highway Driving Assist system relies entirely on the road information provided by the navigation system. It is the responsibility of the driver to follow traffic laws and avoid accidents.
- For your safety, please read the owner's manual before using the system.

### **i** Information

- Highway Driving Assist system is available only on controlled access road of certain highways.
  - × Controlled access road indicates roads with limited entrances and exits that allow uninterrupted high speed traffic flow. Only passenger cars and motorcycles are allowed on controlled access roads.

Available highway (Controlled access road)	
USA	Select Interstate Highway and U.S. (Federal) and State Highways
Canada	Select Provincial and Territorial Highways

- Additional highways may be expanded by navigation updates.

## System Setting and Operation

### System setting

- With the Engine Start/Stop button in the ON or START position, Highway Driving Assist can be activated by selecting 'Driver Assistance → Highway Driving Assist' from the User Settings mode on the infotainment system. For detailed information, please refer to the infotainment system manual separately supplied.
- If the engine is turned off then on again, the system maintains the last setting.

### Operating conditions

Select 'Highway Driving Assist' from the Settings menu in the infotainment system screen and satisfy the following conditions for the system to operate.

- Driving on the highway main line
  - Smart Cruise Control is operating
    - If Smart Cruise Control is in the READY state the Highway Driving Assist will be in the READY state.
- The  **AUTO** indicator on the cluster will illuminate white.
- Vehicle speed is under 95 mph (153 km/h)

If all the mentioned conditions are satisfied, the system is ENABLED and the  **AUTO** indicator on the cluster will illuminate green.

### Steering wheel control



### Steering control

If the vehicle detects both lane markers (lane color white), the  indicator light will change from white to green. This indicates that the steering wheel is being controlled.



### Temporary deactivation

The  indicator light changes from green to white when the steering wheel control is temporarily deactivated. Even if the steering wheel is not controlled, the distance between the vehicle ahead will be maintained.



## Speed setting



### Automatic speed setting mode

The system enters the automatic speed setting mode when:

1. The operating conditions are satisfied
  -  **AUTO** indicator will illuminate green
2. Smart Cruise Control set speed and the highway speed limit matches

If the system changes to the automatic speed mode, the **AUTO** symbol will turn green and a chime will sound.

When the highway speed limit changes, the set speed automatically changes to the changed speed limit.

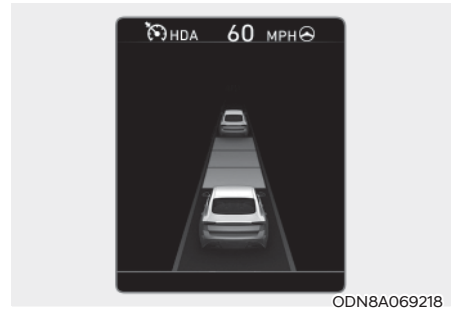

### Manual speed setting mode

If the speed is set manually using the RES+ or SET- toggle switch on the steering wheel, the set speed on the cluster will turn white and the 'AUTO' symbol will disappear.

## Warning Message

### Hands-off warning



#### Keep hands on steering wheel

If the driver takes their hands off the steering wheel for several seconds while HDA system is activated, the system will warn the driver.

#### Information

If the steering wheel is held with a light grip, the message may appear because HDA system may not recognize that the driver has their hands on the steering wheel.

#### WARNING

The warning message may appear late according to road conditions. Therefore, always have your hands on the steering wheel while driving.

#### Highway Driving Assist (HDA) system canceled

If the driver still does not have their hands on the steering wheel after the message "Keep hands on steering wheel", HDA system will be canceled. However, if Lane Following Assist is reactivated manually by the driver, Highway Driving Assist System will reactivate.

To activate Lane Following Assist, refer to "Lane Following Assist" in this chapter.

#### HDA system will not be in the ENABLED state and/or the steering wheel will not be assisted when:

- The turn signal is turned on before changing a lane. If you change lanes without the turn signal on, the steering wheel might be controlled.
- The vehicle is not driven in the middle of the lane when the system is turned on or right after changing a lane.
- ESC (Electronic Stability Control) or VSM (Vehicle Stability Management) is activated.
- The vehicle is driven on a sharp curve.
- Vehicle speed is over 95 mph (153 km/h).
- The vehicle makes sharp lane changes.
- The vehicle brakes suddenly.
- Only one lane marker is detected.
- The lane is very wide or narrow.
- There are more than two lane markers on the road (e.g. construction area).
- Radius of a curve is too small.
- The vehicle is driven on a steep incline.
- The steering wheel is turned suddenly.

## System malfunction



### Check Highway Driving Assist (HDA) system

If there is a problem with the system, a message will appear for a few seconds. If the problem continues, have the vehicle inspected by an authorized HYUNDAI dealer.



## Information

- **High Driving Assist is limited in other countries.**
  - **High Driving Assist only operates based on the speed limits of the highway but it does not work with the speed cameras.**
  - **The time gap could occur between the navigation speed warning and system operation.**
  - **The system is not designed to work on highways other than mentioned as a controlled access road. The system automatically cancels when you leave the highway.**
  - **If there is a problem with Highway Driving Assist, the system cannot be activated in the infotainment system screen.**
  - **If your vehicle is 1640 ft. (500 m) ahead and behind of an open tollgate, the system is automatically canceled. Also, it is converted to Smart Cruise Control automatically with a pop-up message on the navigation.**
- **In the automatic speed setting mode, the vehicle automatically accelerates or decelerates when the highway speed limit changes.**
  - **If your vehicle speed exceeds 95 mph (153 km/h), Highway Driving Assist is automatically canceled. Also, it is converted to Smart Cruise Control automatically with a pop-up message on the navigation.**
  - **If you enter a rest area on the highway or a IC/JC (intersection/junction) without a destination set, the system is canceled later than when the vehicle actually leaves the highway.**



### CAUTION

Highway Driving Assist system may not function properly in the following situations:

- The navigation is not working properly.
- The navigation is not updated.
- The real-time GPS or map information provided has errors.
- The navigation is overloaded by performing functions such as route search, video playback, voice recognition, etc. are performing simultaneously.
- GPS signals are blocked in areas such as a tunnel.
- The driver goes off course or the route to the destination is changed or canceled by resetting the navigation.
- The vehicle enters a service station or rest area
- Android Auto or Car Play is operating.
- The navigation cannot detect the current vehicle position (ex: elevated roads including overpass adjacent to general roads or nearby roads exist in a parallel way).
- The navigation is being updated while driving.
- The navigation is being reset while driving.
- The road is slippery due to bad weather such as rain or snow.



### Information

- For information's on vehicle to vehicle distance control and the front radar, refer to "Smart Cruise Control (SCC)" in this chapter.
- For information's on steering control and distance control and the front camera, refer to "Lane Following Assist (LFA)" in this chapter.



### Information

This device complies with Part 15 of the FCC rules.

Operation is subject to the following three conditions:

1. This device may not cause harmful interference, and
2. This device must accept any interference received, including interference that may cause undesired operation.
3. Changes or modifications not expressly approved by the party responsible for compliance could void the user's authority to operate the device.



### Information

Radio frequency radiation exposure information:

This equipment complies with FCC radiation exposure limits set forth for an uncontrolled environment.

This equipment should be installed and operated with minimum distance of 8 in. (20 cm) between the radiator (antenna) and your body.

This transmitter must not be co-located or operating in conjunction with any other antenna or transmitter.

## REAR CROSS-TRAFFIC COLLISION WARNING (RCCW) / REAR CROSS-TRAFFIC COLLISION-AVOIDANCE ASSIST (RCCA) (IF EQUIPPED)

### System Description

#### *Rear Cross-Traffic Collision Warning*

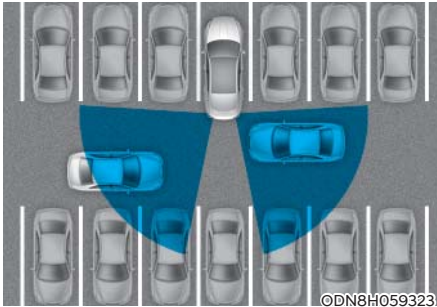

Rear Cross-Traffic Collision Warning system uses rear radar to monitor the approaching cross traffic from the left and right side of the vehicle when your vehicle is in reverse.

The warning distance varies relative to the approaching vehicle speed.

#### *Rear Cross-Traffic Collision-Avoidance Assist*

Rear Cross-Traffic Collision-Avoidance Assist system monitors approaching cross traffic from the left and right side of the vehicle when your vehicle is approaching.

Rear Cross-Traffic Collision-Avoidance Assist system may activate the Electronic Stability Control (ESC) in accordance with a colliding possibility with an approaching vehicle. It is to lower the colliding risk or mitigate the colliding damage.



## **WARNING**

- **Always be aware of road conditions while driving and be alert for unexpected situations even though Rear Cross-Traffic Collision Warning system and Rear Cross-Traffic Collision-Avoidance Assist system are operating.**
- **Rear Cross-Traffic Collision Warning system and Rear Cross-Traffic Collision-Avoidance Assist system are supplemental systems to assist you. Do not entirely rely on the systems. Always pay attention, while driving, for your safety.**
- **Rear Cross-Traffic Collision Warning system and Rear Cross-Traffic Collision-Avoidance Assist system are not substitutes for proper and safe driving. Always drive safely and use caution when backing up the vehicle.**

## **System Setting and Activation**

### **System setting**

- The driver can activate the systems by placing the ignition switch to the ON position and by selecting "User Settings → Driver Assistance → Parking Safety → Rear Cross-Traffic Safety". RCCW and RCCA turn on and get ready to be activated when 'Rear Cross-Traffic safety' is selected.
- When the engine is turned off then on again, the systems are always ready to be activated.
- When the system is initially turned on and when the engine is turned off then on again, the warning light will illuminate for 3 seconds on the side view mirror.

The driver can select the initial warning activation time in the User Settings in the LCD display or infotainment system display by selecting 'User Settings → Driver Assistance → Warning Timing'.

The options for the initial Rear Cross-Traffic Collision Warning includes the following:

- Normal:  
When this condition is selected, the initial Rear Cross-Traffic Collision Warning is activated normally. If this setting feels sensitive, change the option to 'Later'.  
The warning activation time may feel late if the a vehicle at the side or rear abruptly accelerates.
- Later:  
Select this warning activation time when the traffic is light and you are driving at a low speed.



### Information

**If you change the warning timing, the warning time of other systems may change. Always be aware before changing the warning timing.**

The driver can select the warning volume of Rear Cross-Traffic Collision Warning by selecting 'User Settings → Driver Assistance → Warning Volume → High/Medium/Low'.



### Information

**If you change the warning volume, the warning volume of other systems may change. Always be aware before changing the warning volume.**

### Operating conditions

To operate:

Go to the "User Settings → Driver Assistance → Parking Safety → Rear Cross-Traffic Safety" on the LCD display or infotainment system display. The system will turn on and standby to activate.

The system will activate when vehicle speed is below 7 mph (10 km/h) and with the shift button in R (Reverse).

- ※ The system will not activate when the vehicle speed exceeds 7 mph (10 km/h). The system will activate again when the speed is below 5 mph (8 km/h).

The system's detecting range is approximately 1 ~ 65 ft (0.5 ~ 20 m). An approaching vehicle will be detected if their vehicle speed is within 5 ~ 22.5 mph (8 ~ 36 km/h).

Note that the detecting range and operating speed may vary under certain conditions. As always, use caution and pay close attention to your surroundings when backing up your vehicle.

## Warning and System Control

### Rear Cross-Traffic Collision Warning (RCCW) system

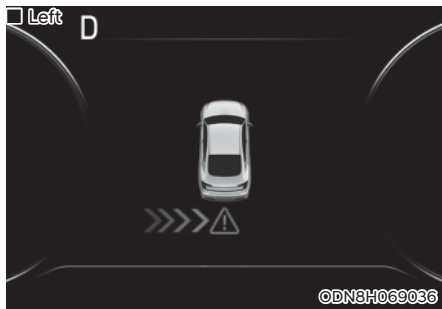

If the vehicle detected by the radar sensors approaches from the rear left/right side of your vehicle, the warning chime will sound, the warning light on the side view mirror will blink and a message will appear on the LCD display or infotainment system display. If the rear view monitor system is in activation, a message will also appear on the infotainment system screen.

The warning will stop when:

- The detected vehicle moves out of the sensing area or
- when the vehicle is right behind your vehicle or
- when the vehicle is not approaching your vehicle or
- when the other vehicle slows down.
- The vehicle's approaching speed is decreased.



## Rear Cross-Traffic Collision-Avoidance Assist (RCCA) system

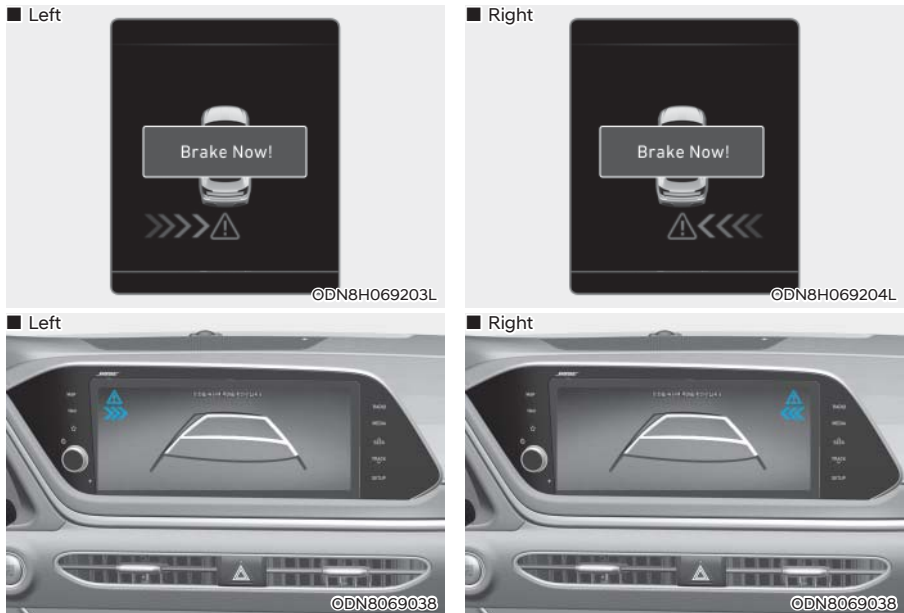

If the risk of collision is detected while RCCW is generated, brake is controlled. The instrument cluster will inform the driver of the brake control. If the rear view monitor system is in activation, a message will also appear on the infotainment system screen. After the brake control, the driver must immediately depress the brake pedal and check the surroundings.

- The brake activation by the system lasts for about 2 seconds.  
The driver must pay attention as the brake is disengaged after 2 seconds.
- The brake control by the system is cancelled if the driver depresses the brake pedal with sufficient power.
- Brake control is activated once for each right/left approach after shifting the shift button to R (Reverse).

The brake control may not operate properly according to the status of the ESC (Electronic Stability Control). The same warning message is displayed on the instrument cluster for this case also.

- When the ESC (Electronic Stability Control) warning light is on.
- When the ESC (Electronic Stability Control) is engaged in a different function.



### CAUTION

- When the operation condition of Rear Cross-Traffic Collision Warning system is satisfied, the warning will occur every time a vehicle approaches the side or rear of your stopped (0 mph (0 km/h) vehicle speed) vehicle.
- The system's warning or brake may not operate properly if the left or right of your vehicle's rear bumper is blocked by a vehicle or obstacle.
- The driver should always use extreme caution while operating the vehicle, whether or not the warning light on the side view mirror illuminates or there is a warning alarm.
- Playing the vehicle audio system at high volume may offset the system's warning sounds.
- The warning of Rear Cross-Traffic Collision Warning System may not sound while other system's warning sounds.
- If any other warning sound such as seat belt warning chime is already generated, Rear Cross-Traffic Collision Warning system warning may not sound.



### WARNING

- Drive safely even though the vehicle is equipped with Rear Cross-Traffic Collision Warning system and Rear Cross-Traffic Collision-Avoidance Assist system. Do not solely rely on the system but check your surrounding when backing the vehicle up.
- The driver is responsible for accurate brake control.
- Always pay extreme caution while driving. Rear Cross-Traffic Collision Warning system and Rear Cross-Traffic Collision-Avoidance Assist system may not operate properly or unnecessarily operate in accordance with your driving situations.
- Rear Cross-Traffic Collision-Avoidance Assist system is not a substitute for safe driving practices, but a convenience function only. It is the responsibility of the driver to always drive cautiously to prevent unexpected and sudden situations from occurring. Pay attention to the road conditions at all times.

## Detecting Sensors



The rear corner radars are the sensors inside the rear bumper for detecting the side and rear areas. Always keep the rear bumper clean for proper operation of the system.



### CAUTION

- **The system may not work properly when the bumper has been damaged, or if the rear bumper has been replaced or repaired.**
- **The system may turn off due to strong electromagnetic waves.**
- **Always keep the sensors clean.**
- **NEVER arbitrarily disassemble the sensor component nor apply any impact on the sensor component.**
- **Be careful not to apply unnecessary force on the radar sensor or sensor cover. If the sensor is forcibly moved out of proper alignment, the system may not operate correctly. In this case, a warning message may not be displayed. Have the vehicle inspected by an authorized HYUNDAI dealer.**
- **Do not apply foreign objects such as a bumper sticker or a bumper guard near the radar sensor or apply paint to the sensor area. Doing so may adversely affect the performance of the sensor.**

## Warning message

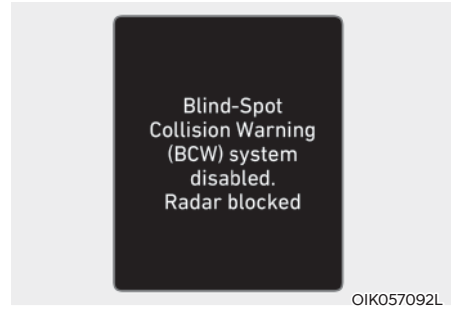

### Blind-Spot Collision Warning (BCW) system disabled. Radar blocked

This warning message may appear when:

One or both of the sensors on the rear bumper is blocked by dirt or snow or a foreign object.

Driving in rural areas where the sensor does not detect another vehicle for an extended period of time.

When there is inclement weather such as heavy snow or rain.

If any of these conditions occur, the system will turn off automatically.

When BCW canceled warning message is displayed in the cluster, check to make sure that the rear bumper is free from any dirt or snow in the areas where the sensor is located. Remove any dirt, snow, or foreign material that could interfere with the radar sensors.

After any dirt or debris is removed, the system should operate normally after about 10 minutes of driving the vehicle.

If the system still does not operate normally have your vehicle inspected by an authorized HYUNDAI dealer.

### Information

**Turn off BCW, BCA and RCCA system when a trailer or carrier is installed.**

**Deactivate BCW and BCA system by selecting “User Settings → Driver Assistance → Blind-Spot Safety → Off”**

**Deactivate RCCW and RCCA system by deselecting “User Settings → Driver Assistance → Parking Safety → Rear Cross-Traffic Safety”.**

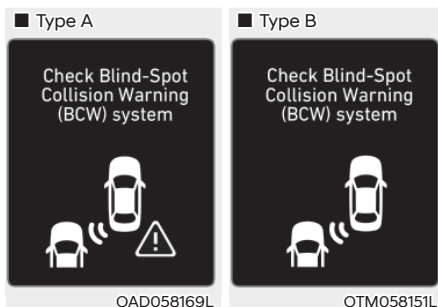

### Check Blind-Spot Collision Warning (BCW) system

If there is a problem with BCW system, a warning message will appear. The system will turn off automatically. RCCW and RCCA will not operate also if BCW system turns off due to malfunction. Have the vehicle inspected by an authorized HYUNDAI dealer.

### Limitations of the System

The driver must be cautious in the below situations, because the system may not detect other vehicles or objects in certain circumstances.

- When a trailer or carrier is installed.
- The vehicle drives in inclement weather such as heavy rain or snow.
- The radar sensor is polluted with rain, snow, mud, etc.
- The rear bumper where the radar sensors are located is covered with a foreign object such as a bumper sticker, a bumper guard, a bike rack, etc.
- The rear bumper is damaged, or the sensor is out of the original default position.

- The vehicle height gets lower or higher due to heavy loading in a trunk, abnormal tire pressure, etc.
- When the temperature of the rear bumper is high.
- When the sensors are blocked by other vehicles, walls or parking-lot pillars.
- The vehicle drives on a curved road.
- The road pavement (or the peripheral ground) abnormally contains metallic components (i.e. possibly due to subway construction).
- There is a fixed object near the vehicle, such as a guardrail.
- While going down or up a steep road where the height of the lane is different.
- Driving on a narrow road where trees or grass or overgrown.
- Driving in rural areas where the sensor does not detect another vehicle for an extended period of time.
- Driving on a wet road.
- Driving on a road where the guardrail or wall is in double structure.
- A big vehicle is near such as a bus or truck.
- When the other vehicle approaches very close.
- When the other vehicle passes at a very fast speed.
- While changing lanes.
- If the vehicle has started at the same time as the vehicle next to you and has accelerated.
- When the vehicle in the next lane moves two lanes away from you or when the vehicle two lanes away moves to the next lane from you.
- A motorcycle or bicycle is near.
- A flat trailer is near.
- If there are small objects in the detecting area such as a shopping cart or a baby stroller.
- If there is a low height vehicle such as a sports car.
- The brake pedal is depressed.
- ESC (Electronic Stability Control) is activated.
- ESC (Electronic Stability Control) malfunctions.
- The tire pressure is low or a tire is damaged.
- The brake is reworked.
- The vehicle sharply stops.
- Temperature is extremely low around the vehicle.
- The vehicle severely vibrates while driving over a bumpy road, uneven/ bumpy road, or concrete patch.
- The vehicle drives on a slippery surface due to snow, water puddle, or ice.
- If the vehicle moves backward after the vehicle is parked with a diagonal line

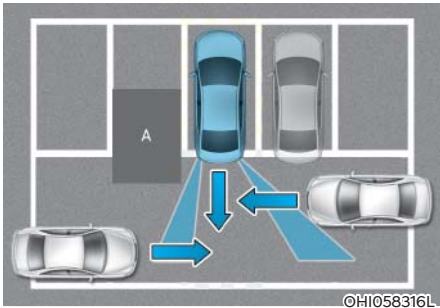

[A] : Structure

- Driving where there is a vehicle or structure near

The system may not operate properly when driving where there is a vehicle or structure near.

In certain instances, the system may not detect the vehicle approaching from behind and the warning or brake may not operate properly.

Always pay attention to your surrounding while driving.

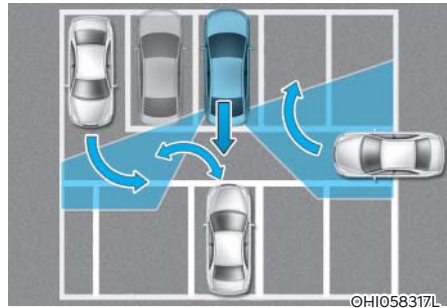

- When the vehicle is in a complex parking environment

The system may not operate properly when the vehicle is in a complex parking environment.

In certain instances, the system may not be able to exactly determine the risk of collision for the vehicles which are parking or pulling out near your vehicle (e.g. a vehicle escaping beside your vehicle, a vehicle parking or pulling out in the rear area, a vehicle approaching your vehicle making a turn, etc.).

In this case, the warning or brake may not operate properly.

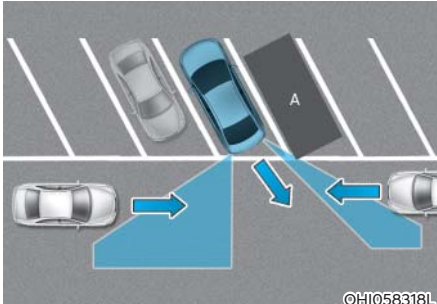

©HI058318L

[A] : Vehicle

- When the vehicle is parked diagonally  
The system may not operate properly when the vehicle is parked diagonally. In certain instances, when the diagonally parked vehicle is pulled out of the parking space, the system may not detect the vehicle approaching from the rear left/right of your vehicle. In this case, the warning or brake may not operate properly.  
Always pay attention to your surrounding while driving.

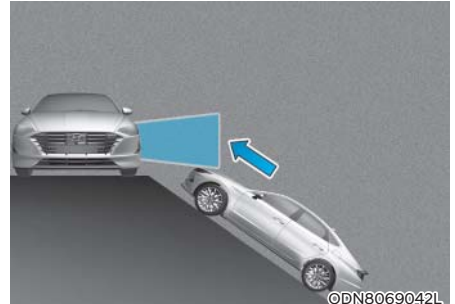

©DN8069042L

- When the vehicle is on/near a slope  
The system may not operate properly when the vehicle is on/near a slope. In certain instances, the system may not detect the vehicle approaching from the rear left/right and the warning or brake may not operate properly.  
Always pay attention to your surrounding while driving.

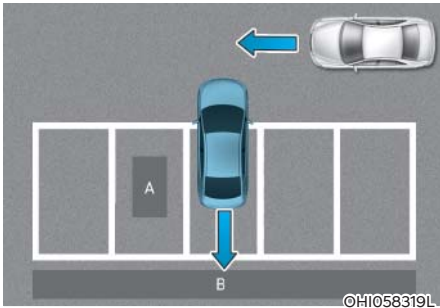

[A] : Structure, [B] : Wall

- Pulling into the parking space where there is a structure

The system may not operate properly when pulling in the vehicle to the parking space where there is a structure at the back or side of your vehicle.

In certain instances, when backing into the parking space, the system may not detect the vehicle moving in front of your vehicle. In this case, the warning or brake may not operate properly.

Always pay attention to the parking space while driving.

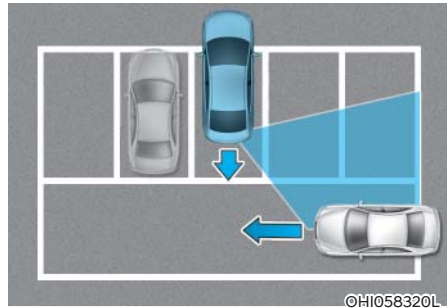

- When the vehicle is parked rearward  
If the vehicle is parked rearward and the radar sensor detects the another vehicle in the rear area of the parking space, the system can warn or control braking. Always pay attention to the parking space while driving.

### **i** Information

**This device complies with Part 15 of the FCC rules.**

**Operation is subject to the following two conditions:**

- 1. This device may not cause harmful interference.**
- 2. This device must accept any interference received, including interference that may cause undesired operation.**



## SPECIAL DRIVING CONDITIONS

### Hazardous Driving Conditions

When hazardous driving elements are encountered such as water, snow, ice, mud and sand, take the below suggestions:

- Drive cautiously and keep a longer braking distance.
- Avoid abrupt braking or steering.
- When your vehicle is stuck in snow, mud, or sand, use second gear. Accelerate slowly to avoid unnecessary wheel spin.
- Put sand, rock salt, tire chains or other non-slip materials under the wheels to provide additional traction while the vehicle becomes stuck in ice, snow, or mud.



#### WARNING

**Downshifting with an automatic transmission while driving on slippery surfaces can cause an accident. The sudden change in tire speed could cause the tires to skid. Be careful when downshifting on slippery surfaces.**

### Rocking the Vehicle

If it is necessary to rock the vehicle to free it from snow, sand, or mud, first turn the steering wheel right and left to clear the area around your front wheels. Then, shift back and forth between R (Reverse) and a forward gear.

Try to avoid spinning the wheels, and do not race the engine.

To prevent transmission wear, wait until the wheels stop spinning before shifting gears. Release the accelerator pedal while shifting, and press lightly on the accelerator pedal while the transmission is in gear. Slowly spinning the wheels in forward and reverse directions causes a rocking motion that may free the vehicle.



#### WARNING

**If the vehicle is stuck and excessive wheel spin occurs, the temperature of the tires can increase very quickly. If the tires become damaged, a tire blow out or tire explosion can occur. This condition is dangerous - you and others may be injured. Do not attempt this procedure if people or objects are anywhere near the vehicle.**

**If you attempt to free the vehicle, the vehicle can overheat quickly, possibly causing an engine compartment fire or other damage. Try to avoid spinning the wheels as much as possible to prevent overheating of either the tires or the engine. DO NOT allow the vehicle to spin the wheels above 35 mph (56 km/h).**



#### Information

The ESC system must be turned OFF before rocking the vehicle.

#### NOTICE

**If you are still stuck after rocking the vehicle a few times, have the vehicle pulled out by a tow vehicle to avoid engine overheating, possible damage to the transmission, and tire damage. See "Towing" in chapter 7.**

### Smooth Cornering

Avoid braking or gear changing in corners, especially when roads are wet. Ideally, corners should always be taken under gentle acceleration.

### Driving at Night

Night driving presents more hazards than driving in the daylight. Here are some important tips to remember:

- Slow down and keep more distance between you and other vehicles, as it may be more difficult to see at night, especially in areas where there may not be any street lights.
- Adjust your mirrors to reduce the glare from other driver's headlamps.
- Keep your headlamps clean and properly aimed. Dirty or improperly aimed headlamps will make it much more difficult to see at night.
- Avoid staring directly at the headlamps of oncoming vehicles. You could be temporarily blinded, and it will take several seconds for your eyes to readjust to the darkness.

### Driving in the Rain

Rain and wet roads can make driving dangerous. Here are a few things to consider when driving in the rain or on slick pavement:

- Slow down and allow extra following distance. A heavy rainfall makes it harder to see and increases the distance needed to stop your vehicle.
- Turn OFF your Cruise Control.
- Replace your windshield wiper blades when they show signs of streaking or missing areas on the windshield.
- Tires should be properly maintained with at least 2/32nds of an inch of tread depth. If your tires do not have enough tread, making a quick stop on wet pavement can cause a skid and possibly lead to an accident. **See "Tire Tread" in chapter 8.**
- Turn on your headlamps to make it easier for others to see you.
- Driving too fast through large puddles can affect your brakes. If you must go through puddles, try to drive through them slowly.
- If you believe your brakes may be wet, apply them lightly while driving until normal braking operation returns.

### Hydroplaning

If the road is wet enough and you are going fast enough, your vehicle may have little or no contact with the road surface and actually ride on the water. The best advice is SLOW DOWN when the road is wet.

**The risk of hydroplaning increases as the depth of tire tread decreases, refer to "Tire Tread" in chapter 8.**

## Driving in Flooded Areas

Avoid driving through flooded areas unless you are sure the water is no higher than the bottom of the wheel hub. Drive through any water slowly. Allow adequate stopping distance because brake performance may be reduced.

After driving through water, dry the brakes by gently applying them several times while the vehicle is moving slowly.

## Highway Driving

### **Tires**

Adjust the tire inflation, as specified. Under-inflation may overheat or damage the tires.

Do not install worn-out or damaged tires, which may reduce traction or adversely affect vehicle handling. This could lead to sudden tire failure that may cause loss of vehicle control resulting in an accident.

## **i** Information

**Never over-inflate your tires above the maximum inflation pressure, as specified on your tires.**

### ***Fuel, engine coolant and engine oil***

Driving at higher speeds on the highway consumes more fuel and is less efficient than driving at a slower, more moderate speed. Maintain a moderate speed in order to conserve fuel when driving on the highway.

Be sure to check both the engine coolant level and the engine oil before driving.

### ***Drive belt***

A loose or damaged drive belt may overheat the engine.

## WINTER DRIVING

The severe weather conditions of winter quickly wear out tires and cause other problems. To minimize winter driving problems, you should take the following suggestions:

### Snow or Icy Conditions

You need to keep sufficient distance between your vehicle and the vehicle in front of you.

Apply the brakes gently. Speeding, rapid acceleration, sudden brake applications, and sharp turns are potentially very hazardous practices. During deceleration, use engine braking to the fullest extent. Sudden brake applications on snowy or icy roads may cause the vehicle to skid.

To drive your vehicle in deep snow, it may be necessary to use snow tires or to install tire chains on your tires.

Always carry emergency equipment. Some of the items you may want to carry include tire chains, tow straps or chains, a flashlight, emergency flares, sand, a shovel, jumper cables, a window scraper, gloves, ground cloth, coveralls, a blanket, etc.

### Snow tires

#### WARNING

**Snow tires should be equivalent in size and type to the vehicle's standard tires. Otherwise, the safety and handling of your vehicle may be adversely affected.**

If you mount snow tires on your vehicle, make sure to use radial tires of the same size and load range as the original tires. Mount snow tires on all four wheels to balance your vehicle's handling in all weather conditions. The traction provided by snow tires on dry roads may not be as high as your vehicle's original equipment tires. Check with the tire dealer for maximum speed recommendations.

#### Information

**Do not install studded tires without first checking local, state and municipal regulations for possible restrictions against their use.**

### Tire chains



ODN8069077L

Since the sidewalls of radial tires are thinner than other types of tires, they may be damaged by mounting some types of tire chains on them. Therefore the use of snow tires is preferred over the use of tire chains.

If the road and weather conditions require the use of tire chains, be sure to use tire chains that have been properly selected for the size of tire on your HYUNDAI vehicle.

Be sure to follow the guidelines and installation instructions provided from the tire chain manufacturer.

Damage to your vehicle caused by improper tire chain use is not covered by your vehicle manufacturer's warranty.



## WARNING

The use of tire chains may adversely affect vehicle handling:

- Drive less than 20 mph (30 km/h) or the chain manufacturer's recommended speed limit, whichever is lower.
- Drive carefully and avoid bumps, holes, sharp turns, and other road hazards, which may cause the vehicle to bounce.
- Avoid sharp turns or locked wheel braking.



## Information

- Install tire chains on both left and right front tires. It should be noted that installing tire chains on the tires will provide a greater driving force, but will not prevent side skids.
- Do not install studded tires without first checking local, state and municipal regulations for possible restrictions against their use.

### Chain installation

When installing tire chains, follow the manufacturer's instructions and mount them as tightly possible. Drive slowly (less than 20 mph (30 km/h)) with chains installed. If you hear the chains contacting the body or chassis, stop and tighten them. If they still make contact, slow down until the noise stops. Remove the tire chains as soon as you begin driving on cleared roads.

When mounting snow chains, park the vehicle on level ground away from traffic. Turn on the vehicle Hazard Warning Flasher and place a triangular emergency warning device behind the vehicle (if available). Always place the vehicle in P (Park), apply the parking brake and turn off the engine before installing snow chains.

## NOTICE

When using tire chains:

- Wrong size chains or improperly installed chains can damage your vehicle's brake lines, suspension, body and wheels.
- Use SAE "S" class or wire chains.
- If you hear noise caused by chains contacting the body, retighten the chain to prevent contact with the vehicle body.
- To prevent body damage, retighten the chains after driving 0.3–0.6 miles (0.5–1.0 km).
- Do not use tire chains on vehicles equipped with aluminum wheels. If unavoidable, use a wire type chain.
- Use wire chains less than 0.59 inch (15mm) wide to prevent damage to the chain's connection.

## Winter Precautions

### *Use high quality ethylene glycol coolant*

Your vehicle is delivered with high quality ethylene glycol coolant in the cooling system. It is the only type of coolant that should be used because it helps prevent corrosion in the cooling system, lubricates the water pump and prevents freezing. Be sure to replace or replenish your coolant in accordance with the maintenance schedule in chapter 8. Before winter, have your coolant tested to assure that its freezing point is sufficient for the temperatures anticipated during the winter.

***Change to "winter weight" oil if necessary***

In some climates it is recommended that a lower viscosity "winter weight" oil be used during cold weather. See chapter 8 for recommendations. If you aren't sure what weight oil you should use, consult an authorized HYUNDAI dealer.

***Check battery and cables***

Winter puts additional burdens on the battery system. Visually inspect the battery and cables as described in chapter 8. The level of charge in your battery can be checked by an authorized HYUNDAI dealer or a service station.

***Check spark plugs and ignition system***

Inspect your spark plugs as described in chapter 8 and replace them if necessary. Also check all ignition wiring and components to be sure they are not cracked, worn or damaged in any way.

***Use approved window washer anti-freeze in system***

To keep the water in the window washer system from freezing, add an approved window washer anti-freeze solution in accordance with instructions on the container. Window washer anti-freeze is available from an authorized HYUNDAI dealer and most auto parts outlets. Do not use engine coolant or other types of antifreeze as these may damage the paint finish.

***Do not let your parking brake freeze***

Under some conditions your parking brake can freeze in the engaged position. This is most likely to happen when there is an accumulation of snow or ice around or near the rear brakes or if the brakes are wet. If there is a risk the parking brake may freeze, apply it only temporarily while you put the gear selector lever in P and block the rear wheels so the car cannot roll. Then release the parking brake.

***Do not let ice and snow accumulate underneath***

Under some conditions, snow and ice can build up under the fenders and interfere with the steering. When driving in severe winter conditions where this may happen, you should periodically check underneath the car to be sure the movement of the front wheels and the steering components is not obstructed.

***Don't place foreign objects or materials in the engine compartment***

Placement of foreign object or materials which prevent cooling of the engine, in the engine compartment, may cause a failure or combustion. The manufacturer is not responsible for the damage caused by such placement.

***To keep locks from freezing***

To keep the locks from freezing, squirt an approved de-icer fluid or glycerine into the key opening. If a lock is covered with ice, squirt it with an approved de-icing fluid to remove the ice. If the lock is frozen internally, you may be able to thaw it out by using a heated key. Handle the heated key with care to avoid injury.

## VEHICLE LOAD LIMIT

Two labels on your driver's door sill show how much weight your vehicle was designed to carry: the Tire and Loading Information Label and the Certification Label.

Before loading your vehicle, familiarize yourself with the following terms for determining your vehicle's weight ratings, from the vehicle's specifications and the Certification Label:

### Base Curb Weight

This is the weight of the vehicle including a full tank of fuel and all standard equipment. It does not include passengers, cargo, or optional equipment.

### Vehicle Curb Weight

This is the weight of your new vehicle when you picked it up from your dealer plus any aftermarket equipment.

### Cargo Weight

This figure includes all weight added to the Base Curb Weight, including cargo and optional equipment.

### GAW (Gross Axle Weight)

This is the total weight placed on each axle (front and rear) - including vehicle curb weight and all payload.

### GAWR (Gross Axle Weight Rating)

This is the maximum allowable weight that can be carried by a single axle (front or rear). These numbers are shown on the Certification Label. The total load on each axle must never exceed its GAWR.

### GVW (Gross Vehicle Weight)

This is the Base Curb Weight plus actual Cargo Weight plus passengers.

### GVWR (Gross Vehicle Weight Rating)

This is the maximum allowable weight of the fully loaded vehicle (including all options, equipment, passengers and cargo). The GVWR is shown on the Certification Label located on the driver's door sill.

## Tire Loading Information Label

### ■ Type A

TIRE AND LOADING INFORMATION RENSEIGNEMENTS SUR LES PNEUS ET LE CHARGEMENT			
SEATING CAPACITY NOMBRE DE PLACES		TOTAL 5	FRONT 2   REAR 3
The combined weight of occupants and cargo should never exceed 300 kg or 660 lbs. Le poids total des occupants et du chargement ne doit jamais dépasser 300 kg ou 660 lbs.			
TIRE PNEU	SIZE DIMENSIONS	COLD TIRE PRESSURE PRESSION DES PNEUS À FROID	SEE OWNER'S MANUAL FOR ADDITIONAL INFORMATION
FRONT AVANT	205/55R16	248kPa, 35psi	VOIR LE MANUEL DE L'USAGER POUR PLUS DE RENSEIGNEMENTS
REAR ARRIÈRE	205/55R16	248kPa, 35psi	
SPARE DE SECOURS	T125/80D16	423kPa, 60psi	

ODN8A069205

### ■ Type B

TIRE AND LOADING INFORMATION RENSEIGNEMENTS SUR LES PNEUS ET LE CHARGEMENT			
SEATING CAPACITY NOMBRE DE PLACES		TOTAL 5	FRONT 2   REAR 3
The combined weight of occupants and cargo should never exceed 300 kg or 660 lbs. Le poids total des occupants et du chargement ne doit jamais dépasser 300 kg ou 660 lbs.			
TIRE PNEU	SIZE DIMENSIONS	COLD TIRE PRESSURE PRESSION DES PNEUS À FROID	SEE OWNER'S MANUAL FOR ADDITIONAL INFORMATION
FRONT AVANT	215/55R17	248kPa, 35psi	VOIR LE MANUEL DE L'USAGER POUR PLUS DE RENSEIGNEMENTS
REAR ARRIÈRE	215/55R17	248kPa, 35psi	
SPARE DE SECOURS	T125/80D16	423kPa, 60psi	

ODN8A069206

### ■ Type C

TIRE AND LOADING INFORMATION RENSEIGNEMENTS SUR LES PNEUS ET LE CHARGEMENT			
SEATING CAPACITY NOMBRE DE PLACES		TOTAL 5	FRONT 2   REAR 3
The combined weight of occupants and cargo should never exceed 300 kg or 660 lbs. Le poids total des occupants et du chargement ne doit jamais dépasser 300 kg ou 660 lbs.			
TIRE PNEU	SIZE DIMENSIONS	COLD TIRE PRESSURE PRESSION DES PNEUS À FROID	SEE OWNER'S MANUAL FOR ADDITIONAL INFORMATION
FRONT AVANT	215/55R17	248kPa, 35psi	VOIR LE MANUEL DE L'USAGER POUR PLUS DE RENSEIGNEMENTS
REAR ARRIÈRE	215/55R17	248kPa, 35psi	
SPARE DE SECOURS	T135/80D17	423kPa, 60psi	

ODN8A069207

■ Type D

TYRE AND LOADING INFORMATION RENSEIGNEMENTS SUR LES PNEUS ET LE CHARGEMENT				
SEATING CAPACITY NOMBRE DE PLACES		TOTAL 5	FRONT AVANT 2	REAR ARRIERE 3
The combined weight of occupants and cargo should never exceed 1000 kg or 2200 lbs. Le poids total des occupants et du chargement ne doit jamais dépasser 1000 kg ou 2200 lbs.				
TYRE PNEU	SIZE DIMENSIONS	COLD TYRE PRESSURE PRESSION DES PNEUS À FROID	SEE OWNER'S MANUAL FOR ADDITIONAL INFORMATION VOIR LE MANUEL DE L'USAGER POUR PLUS DE RENSEIGNEMENTS	
FRONT AVANT	235/45R18	249kPa, 35psi		
REAR ARRIERE	235/45R18	249kPa, 35psi		
SPARE DE SECOURS	T125/80D16	429kPa, 60psi		

ODN8A069208

■ Type E

TYRE AND LOADING INFORMATION RENSEIGNEMENTS SUR LES PNEUS ET LE CHARGEMENT				
SEATING CAPACITY NOMBRE DE PLACES		TOTAL 5	FRONT AVANT 2	REAR ARRIERE 3
The combined weight of occupants and cargo should never exceed 1000 kg or 2200 lbs. Le poids total des occupants et du chargement ne doit jamais dépasser 1000 kg ou 2200 lbs.				
TYRE PNEU	SIZE DIMENSIONS	COLD TYRE PRESSURE PRESSION DES PNEUS À FROID	SEE OWNER'S MANUAL FOR ADDITIONAL INFORMATION VOIR LE MANUEL DE L'USAGER POUR PLUS DE RENSEIGNEMENTS	
FRONT AVANT	235/45R18	249kPa, 35psi		
REAR ARRIERE	235/45R18	249kPa, 35psi		
SPARE DE SECOURS	T125/80D17	429kPa, 60psi		

ODN8A069209

■ Type F

TYRE AND LOADING INFORMATION RENSEIGNEMENTS SUR LES PNEUS ET LE CHARGEMENT				
SEATING CAPACITY NOMBRE DE PLACES		TOTAL 5	FRONT AVANT 2	REAR ARRIERE 3
The combined weight of occupants and cargo should never exceed 1000 kg or 2200 lbs. Le poids total des occupants et du chargement ne doit jamais dépasser 1000 kg ou 2200 lbs.				
TYRE PNEU	SIZE DIMENSIONS	COLD TYRE PRESSURE PRESSION DES PNEUS À FROID	SEE OWNER'S MANUAL FOR ADDITIONAL INFORMATION VOIR LE MANUEL DE L'USAGER POUR PLUS DE RENSEIGNEMENTS	
FRONT AVANT	235/45R18	249kPa, 35psi		
REAR ARRIERE	235/45R18	249kPa, 35psi		
SPARE DE SECOURS	T125/80R18	429kPa, 60psi		

ODN8A069210

The label located on the driver's door sill gives the original tire size, cold tire pressures recommended for your vehicle, the number of people that can be in your vehicle and vehicle capacity weight.

**Vehicle capacity weight  
904 lbs. (410 kg)**

Vehicle capacity weight is the maximum combined weight of occupants and cargo. If your vehicle is equipped with a trailer, the combined weight includes the tongue load.

**Seating capacity**

Total: 5 persons  
(Front seat : 2 persons,  
Rear seat : 3 persons)

Seating capacity is the maximum number of occupants including a driver, your vehicle may carry. However, the seating capacity may be reduced based upon the weight of all of the occupants, and the weight of the cargo being carried or towed. Do not overload the vehicle as there is a limit to the total weight, or load limit including occupants and cargo, the vehicle can carry.

**Towing capacity**

We do not recommend using this vehicle for trailer towing.

**Cargo capacity**

The cargo capacity of your vehicle will increase or decrease depending on the weight and the number of occupants and the tongue load, if your vehicle is equipped with a trailer.









### **Steps for determining correct load limit**

1. Locate the statement "The combined weight of occupants and cargo should never exceed XXX kg or XXX lbs." on your vehicle's placard.
2. Determine the combined weight of the driver and passengers that will be riding in your vehicle.
3. Subtract the combined weight of the driver and passengers from XXX kg or XXX lbs.
4. The resulting figure equals the available amount of cargo and luggage load capacity. For example, if the "XXX" amount equals 1400 lbs. and there will be five 150 lb. passengers in your vehicle, the amount of available cargo and luggage load capacity is 650 lbs. (1400 - 750 (5 x 150) = 650 lbs.)
5. Determine the combined weight of luggage and cargo being loaded on the vehicle. That weight may not safely exceed the available cargo and luggage load capacity calculated in Step 4.
6. If your vehicle will be towing a trailer, load from your trailer will be transferred to your vehicle. Consult this manual to determine how this reduces the available cargo and luggage load capacity of your vehicle.



### **WARNING**

**Do not overload the vehicle as there is a limit to the total weight, or load limit, including occupants and cargo, the vehicle can carry. Overloading can shorten the life of the vehicle. If the GVWR or the GAWR is exceeded, parts on the vehicle can break, and it can change the handling of your vehicle. These could cause you to lose control and result in an accident.**

<p><b>Example 1</b></p>	<p><b>Vehicle Capacity</b></p> <p>Maximum Load (1400 lbs.) (635 kg)</p>	<p>≥</p>	<p> +</p> <p>Passenger Weight (150 lbs. × 2 = 300 lbs.) (68 kg × 2 = 136 kg)</p>	<p> +</p> <p>Cargo Weight (1100 lbs.) (499 kg)</p>
<p><b>Example 2</b></p>	<p><b>Vehicle Capacity</b></p> <p>Maximum Load (1400 lbs.) (635 kg)</p>	<p>≥</p>	<p> +</p> <p>Passenger Weight (150 lbs. × 5 = 750 lbs.) (68 kg × 5 = 340 kg)</p>	<p> +</p> <p>Cargo Weight (650 lbs.) (295 kg)</p>
<p><b>Example 3</b></p>	<p><b>Vehicle Capacity</b></p> <p>Maximum Load (1400 lbs.) (635 kg)</p>	<p>≥</p>	<p> +</p> <p>Passenger Weight (172 lbs. × 5 = 860 lbs.) (78 kg × 5 = 390 kg)</p>	<p> +</p> <p>Cargo Weight (540 lbs.) (245 kg)</p>

## Certification label



The certification label is located on the driver's door sill at the center pillar and shows the maximum allowable weight of the fully loaded vehicle. This is called the GVWR (Gross Vehicle Weight Rating). The GVWR includes the weight of the vehicle, all occupants, fuel and cargo.

This label also tells you the maximum weight that can be supported by the front and rear axles, called Gross Axle Weight Rating (GAWR).

The total weight of the vehicle, including all occupants, accessories, cargo, and trailer tongue load must not exceed the Gross Vehicle Weight Rating (GVWR) or the Gross Axle Weight Rating (GAWR). To find out the actual loads on your front and rear axles, you need to go to a weigh station and weigh your vehicle. Be sure to spread out your load equally on both sides of the centerline.

## WARNING

### Overloading

- Never exceed the GVWR for your vehicle, the GAWR for either the front or rear axle and vehicle capacity weight. Exceeding these ratings can affect your vehicle's handling and braking ability, and cause an accident.
- Do not overload your vehicle. Overloading your vehicle can cause heat buildup in your vehicle's tires and possible tire failure, increased stopping distances and poor vehicle handling—all of which may result in a crash.

## **NOTICE**

Overloading your vehicle may cause damage. Repairs would not be covered by your warranty. Do not overload your vehicle.

## WARNING

If you carry items inside your vehicle (e.g., suitcases, tools, packages, or anything else), they are moving as fast as the vehicle. If you have to stop or turn quickly, or if there is a crash, the items will keep going and can cause an injury if they strike the driver or a passenger.

- Put items in the cargo area of your vehicle. Try to spread the weight evenly.
- Do not stack items, like suitcases, inside the vehicle above the tops of the seats.
- Do not leave an unsecured child restraint in your vehicle.
- When you carry something inside the vehicle, secure it.

## **TRAILER TOWING**

We do not recommend using this vehicle for trailer towing.

# 7. Emergency Situations

Hazard Warning Flasher .....	7-2
In Case of an Emergency While Driving .....	7-2
If the Engine Stalls While Driving .....	7-2
If the Engine Stalls at a Crossroad or Crossing .....	7-2
If you Have a Flat Tire While Driving .....	7-3
If the Engine Will not Start .....	7-3
If the Engine Doesn't Turn Over or Turns Over Slowly .....	7-3
If the Engine Turns Over Normally but Doesn't Start.....	7-3
Jump Starting .....	7-4
If the Engine Overheats.....	7-6
Tire Pressure Monitoring System (TPMS).....	7-7
Check Tire Pressure.....	7-7
Tire Pressure Monitoring System .....	7-8
Low Tire Pressure Telltale .....	7-9
Low Tire Pressure LCD Display with Position Indicator .....	7-9
TPMS Malfunction Indicator.....	7-10
Changing a Tire with TPMS .....	7-10
If you Have a Flat Tire (With Spare Tire) .....	7-12
Jack and Tools .....	7-12
Changing Tires.....	7-13
Towing .....	7-18
Towing Service .....	7-18
Emergency Towing.....	7-19

## HAZARD WARNING FLASHER

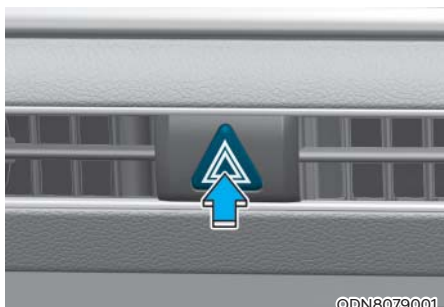

The hazard warning flasher serves as a warning to other drivers to exercise extreme caution when approaching, overtaking, or passing your vehicle.

It should be used whenever emergency repairs are being made or when the vehicle is stopped near the edge of a roadway.

To turn the hazard warning flasher on or off, press the hazard warning flasher button. The button is located in the center fascia panel. Both the left and right turn signal lights will flash simultaneously.

- The hazard warning flasher operates whether your vehicle is running or not.
- The turn signals do not work when the hazard flasher is on.

## IN CASE OF AN EMERGENCY WHILE DRIVING

### If the Engine Stalls While Driving

- Reduce your speed gradually, keeping a straight line. Move cautiously off the road to a safe place.
- Turn on your hazard warning flasher.
- Try to start the engine again. If your vehicle will not start, contact an authorized HYUNDAI dealer or seek other qualified assistance.

### If the Engine Stalls at a Crossroad or Crossing

If the engine stalls at a crossroads or crossing, if safe to do so, move the shift button to the N (Neutral) position and then push the vehicle to a safe location.

## If you Have a Flat Tire While Driving

If a tire goes flat while you are driving:

- Take your foot off the accelerator pedal and let the vehicle slow down while driving straight ahead. Do not apply the brakes immediately or attempt to pull off the road as this may cause loss of vehicle control resulting in an accident. When the vehicle has slowed to such a speed that it is safe to do so, brake carefully and pull off the road. Drive off the road as far as possible and park on firm, level ground. If you are on a divided highway, do not park in the median area between the two traffic lanes.
- When the vehicle is stopped, press the hazard warning flasher button, move the shift button into P (Park), and apply the parking brake, and place the ignition switch in the LOCK/OFF position.
- Have all passengers get out of the vehicle. Be sure they all get out on the side of the vehicle that is away from traffic.
- When changing a flat tire, follow the instructions provided later in this chapter.

## IF THE ENGINE WILL NOT START

### If the Engine Doesn't Turn Over or Turns Over Slowly

- Be sure the shift button is in N (Neutral) or P (Park). The engine starts only when the shift button is in N (Neutral) or P (Park).
- Check the battery connections to be sure they are clean and tight.
- Turn on the interior light. If the light dims or goes out when you operate the starter, the battery is drained.

Do not push or pull the vehicle to start it. This could cause damage to your vehicle. See instructions for "Jump Starting" provided in this chapter.



### CAUTION

**Push or pull starting the vehicle may cause the catalytic converter to overload which can lead to damage to the emission control system.**

### If the Engine Turns Over Normally but Doesn't Start

Check the fuel level and add fuel if necessary.

If the engine still does not start, have your vehicle checked by an authorized HYUNDAI dealer.

## JUMP STARTING

Jump starting can be dangerous if done incorrectly. Follow the jump starting procedure in this section to avoid serious injury or damage to your vehicle. If in doubt about how to properly jump start your vehicle, we strongly recommend that you have a service technician or towing service do it for you.



### WARNING

To prevent **SERIOUS INJURY** or **DEATH** to you or bystanders, always follow these precautions when working near or handling the battery:



Always read and follow instructions carefully when handling a battery.



Wear eye protection designed to protect the eyes from acid splashes.



Keep all flames, sparks, or smoking materials away from the battery.



Hydrogen is always present in battery cells, is highly combustible, and may explode if ignited.



Keep batteries out of reach of children.



Batteries contain sulfuric acid which is highly corrosive. Do not allow acid to contact your eyes, skin or clothing.

If acid gets into your eyes, flush your eyes with clean water for at least 15 minutes and get immediate medical attention. If acid gets on your skin, thoroughly wash the area. If you feel pain or a burning sensation, get medical attention immediately.

- When lifting a plastic-cased battery, excessive pressure on the case may cause battery acid to leak. Lift with a battery carrier or with your hands on opposite corners.
- Do not attempt to jump start your vehicle if your battery is frozen.
- NEVER attempt to recharge the battery when the vehicle's battery cables are connected to the battery.
- The electrical ignition system works with high voltage. NEVER touch these components with the engine running or when the ignition switch is in the ON position.



### Information



An inappropriately disposed battery can be harmful to the environment and human health. Dispose of the battery according to your local law(s) or regulations.

### NOTICE

To prevent damage to your vehicle:

- Only use a 12-volt power supply (battery or jumper system) to jump start your vehicle.
- Do not attempt to jump start your vehicle by push-starting.



### ***Jump starting procedure***

1. Position the vehicles close enough that the jumper cables will reach, but do not allow the vehicles to touch.
2. Avoid fans or any moving parts in the engine compartment at all times, even when the vehicles are turned off.
3. Turn off all electrical devices such as radios, lights, air conditioning, etc. Put the vehicles in P (Park) and set the parking brakes. Turn both vehicles OFF.

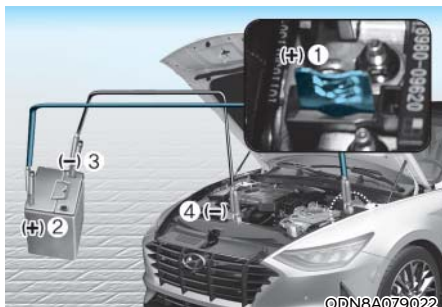

4. Connect the jumper cables in the exact sequence shown in the illustration. First connect one jumper cable to the red, positive (+) jumper terminal of your vehicle (1).
5. Connect the other end of the jumper cable to the red, positive (+) battery/ jumper terminal of the assisting vehicle (2).
6. Connect the second jumper cable to the black, negative (-) battery/chassis ground of the assisting vehicle (3).
7. Connect the other end of the second jumper cable to the black, negative (-) chassis ground of your vehicle (4).

Do not allow the jumper cables to contact anything except the correct battery or jumper terminals or the correct ground. Do not lean over the battery when making connections.

8. Start the engine of the assisting vehicle and let it run at approximately 2,000 rpm for a few minutes. Then start your vehicle.

If your vehicle will not start after a few attempts, it probably requires servicing. In this event please seek qualified assistance. If the cause of your battery discharging is not apparent, have your vehicle checked by an authorized HYUNDAI dealer.

Disconnect the jumper cables in the exact reverse order you connected them:

1. Disconnect the jumper cable from the black, negative (-) chassis ground of your vehicle (4).
2. Disconnect the other end of the jumper cable from the black, negative (-) battery/chassis ground of the assisting vehicle (3).
3. Disconnect the second jumper cable from the red, positive (+) battery/ jumper terminal of the assisting vehicle (2).
4. Disconnect the other end of the jumper cable from the red, positive (+) jumper terminal of your vehicle (1).

## IF THE ENGINE OVERHEATS

If your temperature gauge indicates overheating, you experience a loss of power, or hear loud pinging or knocking, the engine may be overheating. If this happens, you should:

1. Pull off the road and stop as soon as it is safe to do so.
2. Place the shift button in P (Park) and set the parking brake. If the air conditioning is ON, turn it OFF.
3. If engine coolant is running out under the vehicle or steam is coming out from the hood, stop the engine. Do not open the hood until the coolant has stopped running or the steaming has stopped. If there is no visible loss of engine coolant and no steam, leave the engine running and check to be sure the engine cooling fan is operating. If the fan is not running, turn the engine off.



### WARNING



**While the engine is running, keep hands, clothing and tools away from the moving parts such as the cooling fan and drive belt to prevent serious injury.**



4. Check for coolant leaking from the radiator, hoses or under the vehicle. (If the air conditioning had been in use, it is normal for cold water to be draining from it when you stop.)
5. If engine coolant is leaking out, stop the engine immediately and call the nearest authorized HYUNDAI dealer for assistance.



### WARNING



**Your vehicle is equipped with a pressurized coolant reserve tank. NEVER remove the engine coolant reservoir tank/radiator cap or the drain plug while the engine and radiator are HOT. Hot coolant and steam may blow out under pressure, causing serious injury.**

**Turn the engine off and wait until the engine cools down. Use extreme care when removing the engine coolant reservoir tank/radiator cap. Wrap a towel or thick rag around it, and turn it counterclockwise slowly to release some of the pressure from the system. Step back while the pressure is released.**

**When you are sure all the pressure has been released, continue turning the cap counterclockwise to remove it.**

6. If you cannot find the cause of the overheating, wait until the engine temperature has returned to normal. Then, if coolant has been lost, carefully add coolant to the reservoir to bring the fluid level in the reservoir up to the halfway mark.
7. Proceed with caution, keeping alert for further signs of overheating. If overheating happens again, call an authorized HYUNDAI dealer for assistance.



### CAUTION

**Serious loss of coolant indicates a leak in the cooling system and should be checked as soon as possible by an authorized HYUNDAI dealer.**

## TIRE PRESSURE MONITORING SYSTEM (TPMS) (IF EQUIPPED)

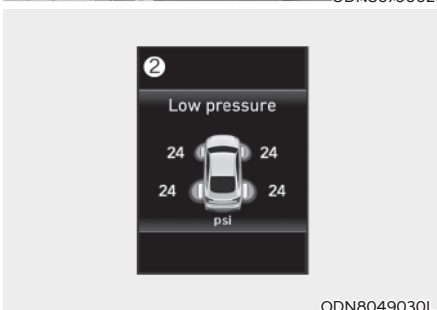

- (1) Low Tire Pressure / TPMS Malfunction Indicator Lamp
- (2) Low Tire Pressure / Tire Pressure Monitor / TPMS Malfunction Display (shown on the cluster LCD display)

### Check Tire Pressure



- You can check the tire pressure in the Assist mode on the cluster.
  - Refer to the “LCD Display Mode” section in chapter 4.**
- A “Drive to display” message will appear for the first few minutes of driving after initial engine start up. If the tire pressure is not displayed after a few minutes of driving, check the tire pressures.
- The displayed tire pressure values may differ from those measured with a tire pressure gauge.
- You can change the tire pressure unit in the User Settings mode on the cluster.
  - psi, kpa, bar (**Refer to the “User Settings Mode” section in chapter 4.**)

## Tire Pressure Monitoring System



### WARNING

**Over-inflation or under-inflation can reduce tire life, adversely affect vehicle handling, and lead to sudden tire failure that may cause loss of vehicle control resulting in an accident.**

Each tire, including the spare (if provided), should be checked monthly when cold and inflated to the inflation pressure recommended by the vehicle manufacturer on the vehicle placard or tire inflation pressure label. If your vehicle has tires of a different size than the size indicated on the vehicle placard or tire inflation pressure label, you should determine the proper tire inflation pressure for those tires.

As an added safety feature, your vehicle has been equipped with a tire pressure monitoring system (TPMS) that illuminates a low tire pressure telltale when one or more of your tires is significantly under-inflated. Accordingly, when the low tire pressure telltale illuminates, you should stop and check your tires as soon as possible, and inflate them to the proper pressure. Driving on a significantly under-inflated tire causes the tire to overheat and can lead to tire failure.

Under-inflation also reduces fuel efficiency and tire tread life, and may affect the vehicle's handling and stopping ability.

Please note that the TPMS is not a substitute for proper tire maintenance, and it is the driver's responsibility to maintain correct tire pressure, even if under-inflation has not reached the level to trigger illumination of the TPMS low tire pressure telltale.

Your vehicle has also been equipped with a TPMS malfunction indicator to indicate when the system is not operating properly. The TPMS malfunction indicator is combined with the low tire pressure telltale. When the system detects a malfunction, the telltale will flash for approximately one minute and then remain continuously illuminated. This sequence will continue upon subsequent vehicle start-ups as long as the malfunction exists.

When the malfunction indicator is illuminated, the system may not be able to detect or signal low tire pressure as intended. TPMS malfunctions may occur for a variety of reasons, including the installation of replacement or alternate tires or wheels on the vehicle that prevent the TPMS from functioning properly.

Always check the TPMS malfunction telltale after replacing one or more tires or wheels on your vehicle to ensure that the replacement or alternate tires and wheels allow the TPMS to continue to function properly.

### NOTICE

**If any of the below happens, have the system checked by an authorized HYUNDAI dealer.**

- 1. The Low Tire Pressure TPMS Malfunction Indicator does not illuminate for 3 seconds when the ignition switch is placed to the ON position or engine is running.**
- 2. The TPMS Malfunction Indicator remains illuminated after blinking for approximately 1 minute.**
- 3. The Low Tire Pressure LCD display remains illuminated**



## Low Tire Pressure Telltale

### Low Tire Pressure LCD Display with Position Indicator



ODN8049019L

When the tire pressure monitoring system warning indicators are illuminated and the warning message is displayed on the cluster LCD display, one or more of your tires is significantly under-inflated. The LCD position indicator will indicate which tire is significantly under-inflated by illuminating the corresponding position light.

If any of your tire pressures are indicated as being low, immediately reduce your speed, avoid hard cornering, and anticipate increased stopping distances. You should stop and check your tires as soon as possible. Inflate the tires to the proper pressure as indicated on the vehicle's placard or tire inflation pressure label located on the driver's side center pillar outer panel.

If you cannot reach a service station or if the tire cannot hold the newly added air, replace the low pressure tire with the spare tire. (if equipped)

The Low Tire Pressure LCD position indicator will remain on and the TPMS Malfunction Indicator may blink for one minute and then remain illuminated until you have the low pressure tire repaired and replaced on the vehicle.

### NOTICE

The spare tire is not equipped with a tire pressure sensor.



### CAUTION

In winter or cold weather, the Low Tire Pressure Telltale may be illuminated if the tire pressure was adjusted to the recommended tire inflation pressure in warm weather. It does not mean your TPMS is malfunctioning because the decreased temperature leads to a proportional lowering of tire pressure.

When you drive your vehicle from a warm area to a cold area or from a cold area to a warm area, or the outside temperature is greatly higher or lower, you should check the tire inflation pressure and adjust the tires to the recommended tire inflation pressure.



### WARNING

#### Low pressure damage

Significantly low tire pressure makes the vehicle unstable and can contribute to loss of vehicle control and increased braking distances.

Continued driving on low pressure tires can cause the tires to overheat and fail.



### TPMS Malfunction Indicator

The TPMS Malfunction Indicator will illuminate after it blinks for approximately one minute when there is a problem with the Tire Pressure Monitoring System.

Have the system checked by an authorized HYUNDAI dealer as soon as possible.

#### **NOTICE**

**If there is a malfunction with the TPMS, the individual tire pressures in the cluster LCD display will not be available. Have the system checked by an authorized HYUNDAI dealer as soon as possible.**

#### **NOTICE**

**The TPMS Malfunction Indicator may illuminate after blinking for one minute if the vehicle is near electric power supply cables or radio transmitters such as police stations, government and public offices, broadcasting stations, military installations, airports, transmitting towers, etc.**

**Additionally, the TPMS Malfunction Indicator may illuminate if snow chains are used or electronic devices such as computers, chargers, remote starters, navigation, etc. This may interfere with normal operation of the TPMS.**

### Changing a Tire with TPMS

If you have a flat tire, the Low Tire Pressure and LCD position indicator will come on. Have the flat tire repaired by an authorized HYUNDAI dealer as soon as possible or replace the flat tire with the spare tire. (if equipped)



#### **CAUTION**

**It is recommended that you do not use a puncture-repairing agent not approved by HYUNDAI dealer to repair and/or inflate a low pressure tire. Tire sealant not approved by HYUNDAI dealer may damage the tire pressure sensor.**

The spare tire does not come with a tire pressure monitoring sensor. When the low pressure tire or the flat tire is replaced with the spare tire, the Low Tire Pressure LCD position indicator will remain on. Also, the TPMS Malfunction Indicator will illuminate after blinking for one minute if the vehicle is driven at speed above 15.5 mph (25 km/h) for approximately 20 minutes.

Once the original tire equipped with a tire pressure monitoring sensor is reinflated to the recommended pressure and reinstalled on the vehicle, the Low Tire Pressure LCD position indicator and TPMS Malfunction Indicator will go off within a few minutes of driving.

If the indicators do not disappear after a few minutes, please visit an authorized HYUNDAI dealer.

Each wheel is equipped with a tire pressure sensor mounted inside the tire behind the valve stem (except for the spare tire). You must use TPMS specific wheels. It is recommended that you always have your tires serviced by an authorized HYUNDAI dealer.

You may not be able to identify a tire with low pressure by simply looking at it. Always use a good quality tire pressure gauge to measure the tire's inflation pressure. Please note that a tire that is hot (from being driven) will have a higher pressure measurement than a tire that is cold.

A cold tire means the vehicle has been sitting for 3 hours and driven for less than 1 mile (1.6 km) in that 3 hour period.

Allow the tire to cool before measuring the inflation pressure. Always be sure the tire is cold before inflating to the recommended pressure.



## WARNING

- **The TPMS cannot alert you to severe and sudden tire damage caused by external factors such as nails or road debris.**
- **If you feel any vehicle instability, immediately take your foot off the accelerator, apply the brakes gradually with light force, and slowly move to a safe position off the road.**



## WARNING

**Tampering with, modifying, or disabling the Tire Pressure Monitoring System (TPMS) components may interfere with the system's ability to warn the driver of low tire pressure conditions and/or TPMS malfunctions. Tampering with, modifying, or disabling the Tire Pressure Monitoring System (TPMS) components may void the warranty for that portion of the vehicle.**



## Information

**This device complies with Part 15 of the FCC rules.**

**Operation is subject to the following three conditions:**

- 1. This device may not cause harmful interference.**
- 2. This device must accept any interference received, including interference that may cause undesired operation.**
- 3. Changes or modifications not expressly approved by the party responsible for compliance could void the user's authority to operate the equipment.**

## IF YOU HAVE A FLAT TIRE (WITH SPARE TIRE)



### WARNING

Changing a tire can be dangerous. Follow the instructions in this section when changing a tire to reduce the risk of serious injury or death.



### CAUTION

Be careful as you use the jack handle to stay clear of the flat end. The flat end has sharp edges that could cause cuts.

### Jack and Tools

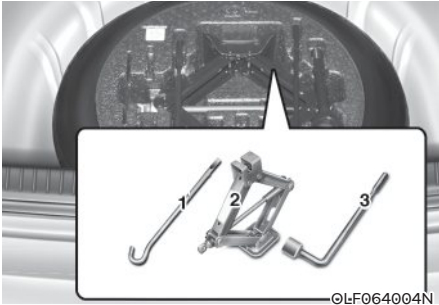

- (1) Jack handle
- (2) Jack
- (3) Wheel lug nut wrench

The jack, jack handle, and wheel lug nut wrench are stored in the luggage compartment under the luggage box cover.

The jack is provided for emergency tire changing only.



Turn the winged hold down bolt counterclockwise to remove the spare tire.

Store the spare tire in the same compartment by turning the winged hold down bolt clockwise.

To prevent the spare tire and tools from “rattling”, store them in their proper location.



If it is hard to loosen the tire hold-down wing bolt by hand, you can loosen it easily using the jack handle.

1. Put the jack handle (1) inside of the tire hold-down wing bolt.
2. Turn the tire hold-down wing bolt counterclockwise with the jack handle.



## Changing Tires



### WARNING

A vehicle can slip or roll off of a jack causing serious injury or death to you or those nearby. Take the following safety precautions:

- Never place any portion of your body under a vehicle that is supported by a jack.
- NEVER attempt to change a tire in the lane of traffic. ALWAYS move the vehicle completely off the road on level, firm ground away from traffic before trying to change a tire. If you cannot find a level, firm place off the road, call a towing service for assistance.
- Be sure to use the jack provided with the vehicle.
- ALWAYS place the jack on the designated jacking positions on the vehicle and NEVER on the bumpers or any other part of the vehicle for jacking support.
- Do not start or run the engine while the vehicle is on the jack.
- Do not allow anyone to remain in the vehicle while it is on the jack.
- Keep children away from the road and the vehicle.

Follow these steps to change your vehicle's tire:

1. Park on a level, firm surface.
2. Move the shift button into P (Park) or into R (Reverse) if equipped with a manual transmission, apply the parking brake, and place the ignition switch in the LOCK/OFF position.
3. Press the hazard warning flasher button.
4. Remove the wheel lug nut wrench, jack, jack handle, and spare tire from the vehicle.



[A] : Block

5. Block both the front and rear of the tire diagonally opposite of the tire you are changing.



ODN8069090L

6. Loosen the wheel lug nuts counterclockwise one turn each in the order shown above, but do not remove any lug nuts until the tire has been raised off of the ground.

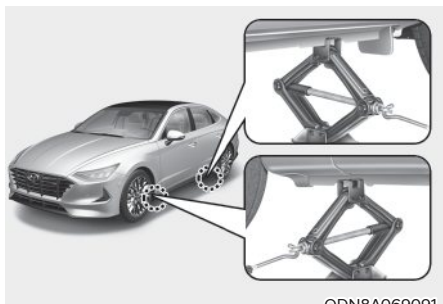

ODN8A069091

7. Place the jack at the designated jacking position under the frame closest to the tire you are changing. The jacking positions are plates welded to the frame with two notches. Never jack at any other position or part of the vehicle. Doing so may damage the side sill molding or other parts of the vehicle.



ODN8A069092

8. Insert the jack handle into the jack and turn it clockwise, raising the vehicle until the tire clears the ground. Make sure the vehicle is stable on the jack.
9. Loosen the lug nuts with the wheel lug nut wrench and remove them with your fingers. Remove the wheel from the studs and lay it flat on the ground out of the way. Remove any dirt or debris from the studs, mounting surfaces, and wheel.
10. Install the spare tire onto the studs of the hub.

11. Tighten the lug nuts with your fingers onto the studs with the smaller end of the lug nuts closest to the wheel.
12. Lower the vehicle to the ground by turning the jack handle counterclockwise.



ODN8069090L

13. Use the wheel lug nut wrench to tighten the lug nuts in the order shown. Double-check each lug nut until they are tight. After changing tires, have an authorized HYUNDAI dealer tighten the lug nuts to their proper torque as soon as possible. **The wheel lug nut should be tightened to 79~94 lbf-ft (11~13 kgf-m).**

If you have a tire gauge, check the tire pressure (see “Tires and Wheels” in chapter 2 for tire pressure instructions.). If the pressure is lower or higher than recommended, drive slowly to the nearest service station and adjust it to the recommended pressure. Always reinstall the valve cap after checking or adjusting tire pressure. If the cap is not replaced, air may leak from the tire. If you lose a valve cap, buy another and install it as soon as possible. After changing tires, secure the flat tire and return the jack and tools to their proper storage locations. If it is hard to secure the flat tire, put the flat tire in the luggage compartment.

### NOTICE

- **Check the tire pressure as soon as possible after installing a spare tire. Adjust it to the recommended pressure.**
- **Check and tighten the wheel lug nuts after driving over 30 miles (50 km), after the spare tire is installed. Recheck the tire wheel lug nuts after driving over 620 miles (1,000 km) after the replaced tire is reinstalled.**



### CAUTION

**Your vehicle has metric threads on the studs and lug nuts. Make certain during tire changing that the same nuts that were removed are reinstalled. If you have to replace your lug nuts make sure they have metric threads to avoid damaging the studs and ensure the wheel is properly secured to the hub. Consult an authorized HYUNDAI dealer for assistance.**

If any of the equipment such as the jack, lug nuts, studs, or other equipment is damaged or in poor condition, do not attempt to change the tire and call for assistance.

### Use of compact spare tires (if equipped)

Compact spare tires are designed for emergency use only. Drive carefully on the compact spare tire and always follow the safety precautions.



### WARNING

**To prevent compact spare tire failure and loss of control possibly resulting in an accident:**

- **Use the compact spare tire only in an emergency.**
- **NEVER operate your vehicle over 50 mph (80 km/h).**
- **Do not exceed the vehicle's maximum load rating or the load carrying capacity shown on the sidewall of the compact spare tire.**
- **Do not use the compact spare tire continuously. Repair or replace the original tire as soon as possible to avoid failure of the compact spare tire.**

When driving with the compact spare tire mounted to your vehicle:

- Check the tire pressure after installing the compact spare tire. The compact spare tire should be inflated to 60 psi (420 kPa).
- Do not take this vehicle through an automatic car wash while the compact spare tire is installed.
- Do not use the compact spare tire on any other vehicle because this tire has been designed especially for your vehicle.
- The compact spare tire's tread life is shorter than a regular tire. Inspect your compact spare tire regularly and replace worn compact spare tires with the same size and design, mounted on the same wheel.
- Do not use more than one compact spare tire at a time.

### **NOTICE**

**When the original tire and wheel are repaired and reinstalled on the vehicle, the lug nut torque must be set correctly. The correct lug nut tightening torque is 79–94 lbf-ft (11–13 kgf-m).**



### **CAUTION**

**To prevent damaging the compact spare tire and your vehicle:**

- **Drive slowly enough for the road conditions to avoid all hazards, such as a potholes or debris.**
- **Avoid driving over obstacles. The compact spare tire diameter is smaller than the diameter of a conventional tire and reduces the ground clearance approximately 1 inch (25 mm).**
- **Do not use tire chains on the compact spare tire. Because of the smaller size, a tire chain will not fit properly.**
- **Do not use the compact spare tire on any other wheels, nor should standard tires, snow tires, wheel covers or trim rings be used with the compact spare wheel.**

## Jack label

### ■ Example

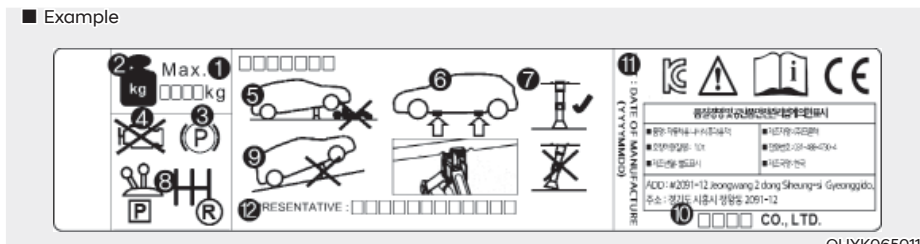

OHYK065011

The actual Jack label in the vehicle may differ from the illustration.

**For more detailed specifications, refer to the label attached to the jack.**

1. Model Name
2. Maximum allowable load
3. When using the jack, set your parking brake.
4. When using the jack, stop the engine.
5. Do not get under a vehicle that is supported by a jack.
6. The designated locations under the frame
7. When supporting the vehicle, the base plate of jack must be vertical under the lifting point.
8. Shift into Reverse gear on vehicles with manual transmission or move the shift button to the P (Park) position on vehicles with automatic transmission.
9. The jack should be used on firm level ground.
10. Jack manufacture
11. Production date
12. Representative company and address

## TOWING

### Towing Service

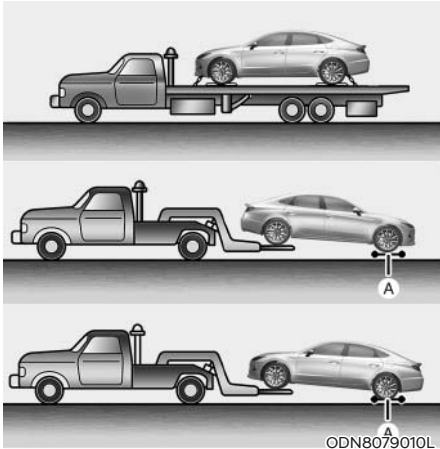

[A] : Dollies

If emergency towing is necessary, we recommend having it done by an authorized HYUNDAI dealer or a commercial tow-truck service. Proper lifting and towing procedures are necessary to prevent damage to the vehicle. The use of wheel dollies or flatbed is recommended.

On 2WD vehicles, it is acceptable to tow the vehicle with the rear wheels on the ground (without dollies) and the front wheels off the ground. If any of the loaded wheels or suspension components are damaged or the vehicle is being towed with the front wheels on the ground, use a towing dolly under the front wheels.

When being towed by a commercial tow truck and wheel dollies are not used, the front of the vehicle should always be lifted, not the rear.

### CAUTION

- Do not tow the vehicle with the front wheels on the ground as this may cause damage to the vehicle.



- Do not tow with sling-type equipment. Use a wheel lift or flatbed equipment.





## WARNING

**If your vehicle is equipped with a rollover sensor, place the ignition switch in the LOCK/OFF or ACC position when the vehicle is being towed. The side impact and curtain air bag may deploy if the sensor detects the situation as a rollover.**

When towing your vehicle in an emergency without wheel dollies:

1. Place the ignition switch in the ACC position.
2. Place the shift button in N (Neutral).
3. Release the parking brake.



## CAUTION

**Failure to place the shift button in N (Neutral) when being towed with the front wheels on the ground can cause internal damage to the transmission.**

## Emergency Towing

If towing is necessary, we recommend you have it done by an authorized HYUNDAI dealer or a commercial tow truck service.

# 8. Maintenance

Engine Compartment .....	8-3
Maintenance Services .....	8-4
Owner's Responsibility .....	8-4
Owner Maintenance Precautions.....	8-4
Owner Maintenance .....	8-5
Owner Maintenance Schedule.....	8-5
Scheduled Maintenance Services .....	8-7
Normal Maintenance Schedule (Smartstream G1.6 T-GDi).....	8-8
Maintenance Under Severe Usage Conditions (Smartstream G1.6 T-GDi) .....	8-11
Severe Driving Conditions.....	8-11
Normal Maintenance Schedule (Smartstream G2.5 GDi).....	8-12
Maintenance Under Severe Usage Conditions (Smartstream G2.5 GDi).....	8-15
Severe Driving Conditions .....	8-15
Explanation of Scheduled Maintenance Items.....	8-16
Engine Oil .....	8-19
Checking the Engine Oil Level.....	8-19
Checking the Engine Oil and Filter .....	8-20
Engine Coolant.....	8-21
Checking the Engine Coolant Level.....	8-21
Engine Coolant .....	8-21
Changing Engine Coolant.....	8-23
Brake fluid .....	8-24
Checking the Brake Fluid Level.....	8-24
Washer Fluid.....	8-25
Checking the Washer Fluid Level.....	8-25
Air Cleaner .....	8-26
Filter Replacement.....	8-26
Climate Control Air Filter.....	8-28
Filter Inspection.....	8-28
Filter Replacement.....	8-28
Wiper Blades .....	8-29
Blade Inspection .....	8-29
Blade Replacement.....	8-29
Battery .....	8-31
For Best Battery Service .....	8-32
Battery Recharging .....	8-32
Reset Features.....	8-33



Tires and Wheels.....	8-34
Tire Care.....	8-34
Recommended Cold Tire Inflation Pressures.....	8-34
Check Tire Inflation Pressure.....	8-35
Tire Rotation .....	8-36
Wheel Alignment and Tire Balance.....	8-36
Tire Replacement .....	8-37
Wheel Replacement.....	8-38
Tire Traction .....	8-38
Tire Maintenance.....	8-38
Tire Sidewall Labeling .....	8-38
Tire Terminology and Definitions .....	8-42
All Season Tires.....	8-44
Summer Tires .....	8-44
Snow Tires.....	8-44
Radial-Ply Tires.....	8-45
Low Aspect Ratio Tires.....	8-45
Fuses.....	8-46
Instrument Panel Fuse Replacement.....	8-47
Engine Compartment Panel Fuse Replacement.....	8-48
Fuse/Relay Panel Description.....	8-49
Light Bulbs.....	8-55
Headlamp, Parking Lamp, Daytime Running Light, Turn Signal Lamp, Cornering Lamp and Side Marker .....	8-55
Side Repeater Lamp Replacement .....	8-56
Rear Combination Light Bulb Replacement.....	8-56
High Mounted Stop Lamp Replacement .....	8-58
License Plate Light Bulb Replacement .....	8-58
Interior Light Bulb Replacement.....	8-59
Appearance Care .....	8-61
Exterior Care .....	8-61
Interior Care.....	8-65
Emission Control System.....	8-67
California Perchlorate Notice.....	8-70
Consumer Information .....	8-71
Reporting Safety Defects .....	8-72

## ENGINE COMPARTMENT

### ■ Smartstream G1.6 T-GDi

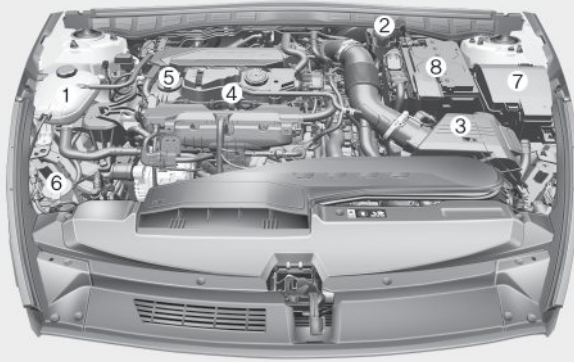

### ■ Smartstream G2.5 GDi

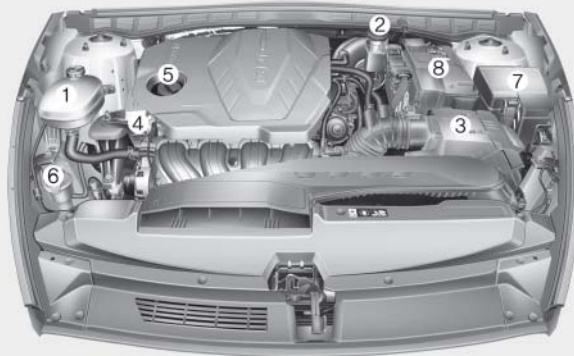

**The actual engine room in the vehicle may differ from the illustration.**

ODN8089103/ ODN8089048L

- |                             |                                      |
|-----------------------------|--------------------------------------|
| 1. Engine coolant reservoir | 5. Engine oil filler cap             |
| 2. Brake fluid reservoir    | 6. Windshield washer fluid reservoir |
| 3. Air cleaner              | 7. Fuse box                          |
| 4. Engine oil dipstick      | 8. Battery                           |

## MAINTENANCE SERVICES

You should exercise the utmost care to prevent damage to your vehicle and injury to yourself whenever performing any maintenance or inspection procedures.

We recommend you have your vehicle maintained and repaired by an authorized HYUNDAI dealer. An authorized HYUNDAI dealer meets HYUNDAI's high service quality standards and receives technical support from HYUNDAI in order to provide you with a high level of service satisfaction.

### Owner's Responsibility

Maintenance service and record retention are the owner's responsibility.

You should retain documents that show proper maintenance has been performed on your vehicle in accordance with the scheduled maintenance service charts shown on the following pages. You need this information to establish your compliance with the servicing and maintenance requirements of your vehicle warranties.

Detailed warranty information is provided in your Owner's Handbook & Warranty Information booklet.

Repairs and adjustments required as a result of improper maintenance or a lack of required maintenance are not covered.

### Owner Maintenance Precautions

Inadequate, incomplete or insufficient servicing may result in operational problems with your vehicle that could lead to vehicle damage, an accident, or personal injury. This chapter provides instructions only for the maintenance items that are easy to perform. Several procedures can be done only by an authorized HYUNDAI dealer with special tools.

Your vehicle should not be modified in any way. Such modifications may adversely affect the performance, safety or durability of your vehicle and may, in addition, violate conditions of the limited warranties covering the vehicle.

Certain modifications may also be in violation of regulations established by the U.S. Department of Transportation and other federal or state agencies.

### NOTICE

**Improper owner maintenance during the warranty period may affect warranty coverage. For details, read the separate Owner's Handbook & Warranty Information booklet provided with the vehicle. If you're unsure about any service or maintenance procedure, have it done by an authorized HYUNDAI dealer.**

## OWNER MAINTENANCE



### WARNING

Performing maintenance work on a vehicle can be dangerous. If you lack sufficient knowledge and experience or the proper tools and equipment to do the work, have it done by an authorized HYUNDAI dealer.

**ALWAYS** follow these precautions for performing maintenance work:

- Park your vehicle on level ground, move the shift button into the P (Park) position, place the ignition switch in the LOCK/OFF position.
- Block the tires (front and back) to prevent the vehicle from moving. Remove loose clothing or jewelry that can become entangled in moving parts.
- If you must run the engine during maintenance, do so out doors or in an area with plenty of ventilation.
- Keep flames, sparks, or smoking materials away from the battery and fuel-related parts.

The following lists are vehicle checks and inspections that should be performed by the owner or an authorized HYUNDAI dealer at the frequencies indicated to help ensure safe, dependable operation of your vehicle.

Any adverse conditions should be brought to the attention of your dealer as soon as possible.

These Owner Maintenance vehicle checks are generally not covered by warranties and you may be charged for labor, parts and lubricants used.

### Owner Maintenance Schedule

#### *When you stop for fuel:*

- Check the engine oil level.
- Check the coolant level in the engine coolant reservoir.
- Check the windshield washer fluid level.
- Check the for low or under-inflated tires.



### WARNING

Be careful when checking your engine coolant level when the engine is hot. This may result in coolant being blown out of the opening and cause serious burns and other injuries.

### ***While operating your vehicle:***

- Note any changes in the sound of the exhaust or any smell of exhaust fumes in the vehicle.
- Check for vibrations in the steering wheel. Notice if there is any increased steering effort or looseness in the steering wheel, or change in its straight-ahead position.
- Notice if your vehicle constantly turns slightly or “pulls” to one side when traveling on smooth, level road.
- When stopping, listen and check for unusual sounds, pulling to one side, increased brake pedal travel or “hard-to-push” brake pedal.
- If any slipping or changes in the operation of your transmission occurs, check the transmission fluid level.
- Check the automatic transmission P (Park) function.
- Check the parking brake.
- Check for fluid leaks under your vehicle (water dripping from the air conditioning system during or after use is normal).

### ***At least monthly:***

- Check coolant level in the engine coolant reservoir.
- Check the operation of all exterior lights, including the brake lights, turn signals and hazard warning flashers.
- Check the inflation pressures of all tires including the spare for tires that are worn, show uneven wear, or are damaged.
- Check for loose wheel lug nuts.

### ***At least twice a year: (i.e., every Spring and Autumn)***

- Check radiator, heater and air conditioning hoses for leaks or damage.
- Check windshield washer spray and wiper operation. Clean wiper blades with a clean cloth dampened with washer fluid.
- Check headlamp alignment.
- Check muffler, exhaust pipes, shields and clamps.
- Check the seat belts for wear and function.

### ***At least once a year:***

- Clean body and door drain holes.
- Lubricate door hinges and hood hinges.
- Lubricate door and hood locks and latches.
- Lubricate door rubber weather strips.
- Lubricate door checker.
- Check the air conditioning system.
- Inspect and lubricate automatic transmission linkage and controls.
- Clean the battery and terminals.
- Check the brake fluid level.

## SCHEDULED MAINTENANCE SERVICES

Follow Normal Maintenance Schedule if the vehicle is usually operated where none of the following conditions apply. If any of the following conditions apply, you must follow the Maintenance Under Severe Usage Conditions.

- Repeated short distance driving.
- Driving in dusty conditions or sandy areas.
- Extensive use of brakes.
- Driving in areas where salt or other corrosive materials are used.
- Driving on rough or muddy roads.
- Driving in mountainous areas.
- Extended periods of idling or low speed operation.
- Driving for a prolonged period in cold temperatures and/or extremely humid climates.
- More than 50% driving in heavy city traffic during hot weather above 90°F (32°C).

For additional information or assistance see your authorized HYUNDAI dealer.

**Normal Maintenance Schedule (Smartstream G1.6 T-GDi)**

MAINTENANCE INTERVALS	MAINTENANCE SCHEDULE																
	Months	12	24	36	48	60	72	84	96	108	120	132	144	156	168	180	
MAINTENANCE ITEM	Miles×1,000	6	12	18	24	30	36	42	48	54	60	66	72	78	84	90	
	Km×1,000	10	20	30	40	50	60	70	80	90	100	110	120	130	140	150	
Drive belts *1		At first, inspect at 60,000 miles or 72 months. Thereafter, inspect every 12,000 miles or 24 months															
Engine oil and engine oil filter		R	R	R	R	R	R	R	R	R	R	R	R	R	R	R	
Fuel additives *2		Add fuel additives every 6,000 miles or 12 months															
Air cleaner filter		I	I	I	R	I	I	I	R	I	I	I	I	R	I	I	
Spark plugs		Replace every 42,000 miles															
Valve clearance *3		Inspect every 60,000 miles or 72 months															
Rotate tires		Rotate tires every 6,000 miles															
Climate control air filter		Replace every 12 months															
Vacuum hose		I	I	I	I	I	I	I	I	I	I	I	I	I	I	I	
Engine coolant		At first, replace at 120,000 miles or 120 months. Thereafter, replace every 30,000 miles or 24 months															

R: Replace or change.

I: Inspect and if necessary, adjust, correct, clean or replace.

\*1: The drive belt should be replaced when cracks occur or tension is reduced excessively.

\*2: If TOP TIER Detergent Gasoline is not available, one bottle of additive is recommended. Additives are available from your authorized HYUNDAI dealer along with information on how to use them. Do not mix other additives.

\*3: Inspect for excessive valve noise and/or engine vibration and adjust if necessary. Have an authorized HYUNDAI dealer perform the operation.

## Normal Maintenance Schedule (Smartstream G1.6 T-GDi) (CONT)

MAINTENANCE INTERVALS MAINTENANCE ITEM	Months		12	24	36	48	60	72	84	96	108	120	132	144	156	168	180
	Miles×1,000		6	12	18	24	30	36	42	48	54	60	66	72	78	84	90
	Km×1,000		10	20	30	40	50	60	70	80	90	100	110	120	130	140	150
Battery condition			I	I	I	I	I	I	I	I	I	I	I	I	I	I	I
Brake lines, hoses and connections			I	I	I	I	I	I	I	I	I	I	I	I	I	I	I
Disc brakes and pads			I	I	I	I	I	I	I	I	I	I	I	I	I	I	I
Driveshaft and boots			I	I	I	I	I	I	I	I	I	I	I	I	I	I	I
Suspension mounting bolts			I	I	I	I	I	I	I	I	I	I	I	I	I	I	I
Air conditioner refrigerant			I	I	I	I	I	I	I	I	I	I	I	I	I	I	I
Air conditioner compressor			I	I	I	I	I	I	I	I	I	I	I	I	I	I	I
Exhaust pipe and muffler			I	I	I	I	I	I	I	I	I	I	I	I	I	I	I
Automatic transmission fluid (if equipped)																	

No check, No service required

R: Replace or change.

I : Inspect and if necessary, adjust, correct, clean or replace.



Normal Maintenance Schedule (Smartstream G1.6 T-GDi) (CONT)

MAINTENANCE INTERVALS	Months	12	24	36	48	60	72	84	96	108	120	132	144	156	168	180
	MAINTENANCE ITEM	Miles×1,000	6	12	18	24	30	36	42	48	54	60	66	72	78	84
	Km×1,000	10	20	30	40	50	60	70	80	90	100	110	120	130	140	150
Intercooler, in/out hose, air intake hose		I	I	I	I	I	I	I	I	I	I	I	I	I	I	I
Steering gear rack, linkage and boots		I	I	I	I	I	I	I	I	I	I	I	I	I	I	I
Vapor hose, fuel filler cap and fuel tank		I	I	I	I	I	I	I	I	I	I	I	I	I	I	I
Fuel tank air filter *4		I	I	I	I	I	I	I	I	I	I	I	I	I	I	I
Fuel filter *4		I	I	I	I	I	I	I	I	I	I	I	I	I	I	I
Fuel lines, hoses and connections		I	I	I	I	I	I	I	I	I	I	I	I	I	I	I
Parking brake		I	I	I	I	I	I	I	I	I	I	I	I	I	I	I
Brake fluid		I	I	I	I	I	I	I	I	I	I	I	I	I	I	I

R: Replace or change.

I : Inspect and if necessary, adjust, correct, clean or replace.

\*4 : Fuel filter & Fuel tank air filter are considered to be maintenance free but periodic inspection is recommended for this maintenance schedule depends on fuel quality. If there are some important safety matters like fuel flow restriction, surging, loss of power, hard starting problem, etc. replace the fuel filter immediately regardless of maintenance schedule and consult an authorized HYUNDAI dealer for details

## Maintenance Under Severe Usage Conditions (Smartstream G1.6 T-GDi)

The following items must be serviced more frequently on cars normally used under severe driving conditions. Refer to the chart below for the appropriate maintenance intervals.

R: Replace or change.

I : Inspect and if necessary, adjust, correct, clean or replace.

MAINTENANCE ITEM	MAINTENANCE OPERATION	MAINTENANCE INTERVALS	DRIVING CONDITION
Engine oil and filter	R	Every 3,000 miles or 6 months	A, B, C, D, E, F, G, H, I, J, K
Air cleaner filter	R	More frequently	C, E
Spark plugs	R	More frequently	A, B, H, I, K
Automatic transmission fluid (if equipped)	R	Every 60,000 miles	A, C, E, F, G, I
Front brake disc/pads, calipers	I	More frequently	C, D, G, H
Rear brake shoes or disc/pads	I	More frequently	C, D, G, F
Parking brake	I	More frequently	C, D, G, H
Steering gear box, linkage & boots/ lower arm ball joint, upper arm ball joint	I	More frequently	C, D, E, F, G, H, I
Suspension mounting bolts	I	More frequently	C, D, E, F, G, H, I
Drive shafts and boots	I	Every 3,000 miles or 6 months	C, D, E, F, G, H, I
Climate control air filter (for evaporator and blower unit)	R	More frequently	C, E

### Severe Driving Conditions

- A. Repeatedly driving short distances of less than 5 miles (8 km) in normal temperature or less than 10 miles (16 km) in freezing temperature
- B. Extensive engine idling or low speed driving for long distances
- C. Driving on rough, dusty, muddy, unpaved, graveled or salt- spread roads
- D. Driving in areas using salt or other corrosive materials or in very cold weather
- E. Driving in sandy areas
- F. Driving in heavy traffic area over 90°F (32°C)
- G. Driving on uphill, downhill, or mountain road
- H. Towing a Trailer, or using a camper, or roof rack
- I. Driving as a patrol car, taxi, other commercial use or vehicle towing
- J. Driving over 106 mph (170 km/h)
- K. Frequently driving in stop-and-go conditions

**Normal Maintenance Schedule (Smartstream G2.5 GDI)**

MAINTENANCE INTERVALS	MAINTENANCE SCHEDULE															
	Months	12	24	36	48	60	72	84	96	108	120	132	144	156	168	180
Miles×1,000	7.5	15	22.5	30	37.5	45	52.5	60	67.5	75	82.5	90	97.5	105	112.5	
Km×1,000	12	24	36	48	60	72	84	96	108	120	132	144	156	168	180	
Drive belts *1	At first, inspect at 60,000 miles or 72 months. Thereafter, inspect every 15,000 miles or 24 months															
Engine oil and engine oil filter	R	R	R	R	R	R	R	R	R	R	R	R	R	R	R	R
Fuel additives *2	Add fuel additives every 7,500 miles or 12 months															
Air cleaner filter	I	I	I	R	I	I	I	R	I	I	I	R	I	I	I	I
Spark plugs	Replace every 97,500 miles															
Rotate tires	Rotate tires every 7,500 miles															
Climate control air filter	Replace every 12 months															
Vacuum hose	I	I	I	I	I	I	I	I	I	I	I	I	I	I	I	I
Engine coolant	At first, replace at 120,000 miles or 120 months. Thereafter, replace every 30,000 miles or 24 months															

R: Replace or change.

I : Inspect and if necessary, adjust, correct, clean or replace.

\*1: The drive belt should be replaced when cracks occur or tension is reduced excessively.

\*2: If TOP TIER Detergent Gasoline is not available, one bottle of additive is recommended. Additives are available from your authorized HYUNDAI dealer along with information on how to use them. Do not mix other additives.

### Normal Maintenance Schedule (Smartstream G2.5 GDi) (CONT)

MAINTENANCE INTERVALS MAINTENANCE ITEM	Months		12		24		36		48		60		72		84		96		108		120		132		144		156		168		180	
	Miles×1,000	Km×1,000	7.5	15	22.5	30	37.5	45	52.5	60	67.5	75	82.5	90	97.5	105	112.5	120	127.5	135	142.5	150	157.5	165	172.5	180	187.5	195	202.5	210		
Battery condition			I	I	I	I	I	I	I	I	I	I	I	I	I	I	I	I	I	I	I	I	I	I	I	I	I	I	I	I	I	
Brake lines, hoses and connections			I	I	I	I	I	I	I	I	I	I	I	I	I	I	I	I	I	I	I	I	I	I	I	I	I	I	I	I	I	
Disc brakes and pads			I	I	I	I	I	I	I	I	I	I	I	I	I	I	I	I	I	I	I	I	I	I	I	I	I	I	I	I	I	
Driveshaft and boots			I	I	I	I	I	I	I	I	I	I	I	I	I	I	I	I	I	I	I	I	I	I	I	I	I	I	I	I	I	
Suspension mounting bolts			I	I	I	I	I	I	I	I	I	I	I	I	I	I	I	I	I	I	I	I	I	I	I	I	I	I	I	I	I	
Air conditioner refrigerant			I	I	I	I	I	I	I	I	I	I	I	I	I	I	I	I	I	I	I	I	I	I	I	I	I	I	I	I	I	
Air conditioner compressor			I	I	I	I	I	I	I	I	I	I	I	I	I	I	I	I	I	I	I	I	I	I	I	I	I	I	I	I	I	
Exhaust pipe and muffler			I	I	I	I	I	I	I	I	I	I	I	I	I	I	I	I	I	I	I	I	I	I	I	I	I	I	I	I	I	
Automatic transmission fluid (if equipped)			No check, No service required																													
Steering gear rack, linkage and boots						I																										

R: Replace or change.

I : Inspect and if necessary, adjust, correct, clean or replace.

**Normal Maintenance Schedule (Smartstream G2.5 GDI) (CONT)**

MAINTENANCE INTERVALS	MAINTENANCE INTERVALS		12	24	36	48	60	72	84	96	108	120	132	144	156	168	180
	Months	Miles×1,000	7.5	15	22.5	30	37.5	45	52.5	60	67.5	75	82.5	90	97.5	105	112.5
MAINTENANCE ITEM	Km×1,000		12	24	36	48	60	72	84	96	108	120	132	144	156	168	180
Vapor hose, fuel filler cap and fuel tank			I			I		I		I		I		I		I	
Fuel tank air filter *3			I			I		I		I		I		I		I	
Fuel filter *3			I			I		I		I		I		I		I	
Fuel lines, hoses and connections						I		I		I		I		I		I	
Parking brake			I			I		I		I		I		I		I	
Brake fluid			I			I		I		I		I		I		I	

R: Replace or change.

I: Inspect and if necessary, adjust, correct, clean or replace.

\*3 : Fuel filter & Fuel tank air filter are considered to be maintenance free but periodic inspection is recommended for this maintenance schedule depends on fuel quality. If there are some important safety matters like fuel flow restriction, surging, loss of power, hard starting problem, etc. replace the fuel filter immediately regardless of maintenance schedule and consult an authorized HYUNDAI dealer for details.

## Maintenance Under Severe Usage Conditions (Smartstream G2.5 GDi)

The following items must be serviced more frequently on cars normally used under severe driving conditions. Refer to the chart below for the appropriate maintenance intervals.

R: Replace or change.

I : Inspect and if necessary, adjust, correct, clean or replace.

MAINTENANCE ITEM	MAINTENANCE OPERATION	MAINTENANCE INTERVALS	DRIVING CONDITION
Engine oil and filter	R	Every 3,750 miles or 6 months	A, B, C, D, E, F, G, H, I, J, K
Air cleaner filter	R	More frequently	C, E
Spark plugs	R	More frequently	A, B, H, I, K
Automatic transmission fluid (if equipped)	R	Every 60,000 miles	A, C, E, F, G, I
Front brake disc/pads, calipers	I	More frequently	C, D, G, H
Rear brake shoes or disc/pads	I	More frequently	C, D, G, F
Parking brake	I	More frequently	C, D, G, H
Steering gear box, linkage & boots/ lower arm ball joint, upper arm ball joint	I	More frequently	C, D, E, F, G, H, I
Suspension mounting bolts	I	More frequently	C, D, E, F, G, H, I
Drive shafts and boots	I	Every 3,750 miles or 6 months	C, D, E, F, G, H, I
Climate control air filter (for evaporator and blower unit)	R	More frequently	C, E

### Severe Driving Conditions

- A. Repeatedly driving short distances of less than 5 miles (8 km) in normal temperature or less than 10 miles (16 km) in freezing temperature
- B. Extensive engine idling or low speed driving for long distances
- C. Driving on rough, dusty, muddy, unpaved, graveled or salt- spread roads
- D. Driving in areas using salt or other corrosive materials or in very cold weather
- E. Driving in sandy areas
- F. Driving in heavy traffic area over 90°F (32°C)
- G. Driving on uphill, downhill, or mountain road
- H. Towing a Trailer, or using a camper, or roof rack
- I. Driving as a patrol car, taxi, other commercial use or vehicle towing
- J. Driving over 106 mph (170 km/h)
- K. Frequently driving in stop-and-go conditions

## EXPLANATION OF SCHEDULED MAINTENANCE ITEMS

### Engine Oil and Filter

The engine oil and filter should be changed at the intervals specified in the maintenance schedule. If the vehicle is being driven in severe conditions, more frequent oil and filter changes are required.

### Drive Belts

Inspect all drive belts for evidence of cuts, cracks, excessive wear or oil saturation and replace if necessary. Drive belts should be checked periodically for proper tension and adjusted as necessary.

### Fuel Filter

A clogged-up fuel filter may limit the vehicle driving speed, damage the emission system, and cause the hard starting. When a considerable amount of foreign substances are accumulated in the fuel tank, the fuel filter should be replaced.

Upon installing a new fuel filter, operate the engine for several minutes, and check the connections for any leakages. Fuel filters should be installed by an authorized HYUNDAI dealer.

### Fuel Lines, Fuel Hoses and Connections

Check the fuel lines, fuel hoses and connections for leakage and damage. Have an authorized HYUNDAI dealer replace any damaged or leaking parts immediately.

### Vapor Hose and Fuel Filler Cap

The vapor hose and fuel filler cap should be inspected at those intervals specified in the maintenance schedule. Make sure a new vapor hose or fuel filler cap is correctly replaced.

### Air Cleaner Filter

A genuine HYUNDAI air cleaner filter is recommended when the filter is replaced.

### Spark Plugs

Make sure to install new spark plugs of the correct heat range.

### Cooling System

Check cooling system components, such as radiator, coolant reservoir, hoses and connections for leakage and damage. Replace any damaged parts.

## Engine Coolant

The coolant should be changed at the intervals specified in the maintenance schedule.

## Automatic Transmission Fluid

Automatic transmission fluid should not be checked under normal usage conditions. But in severe conditions, the fluid should be changed at an authorized HYUNDAI dealer in accordance to the scheduled maintenance at the beginning of this chapter.



### Information

**Automatic transmission fluid color is red when new.**

**As the vehicle is driven, the automatic transmission fluid will begin to look darker. This is a normal condition and you should not judge the need to replace the fluid based upon the changed color.**

### NOTICE

**The use of a non-specified fluid could result in transmission malfunction and failure. Use only the specified automatic transmission fluid (refer to “Recommended Lubricants and Capacities” in chapter 2).**

## Brake Hoses and Lines

Visually check for proper installation, chafing, cracks, deterioration and any leakage. Replace any deteriorated or damaged parts immediately.

## Brake Fluid

Check the brake fluid level in the brake fluid reservoir. The level should be between the MIN and the MAX marks on the side of the reservoir. Use only hydraulic brake fluid conforming to DOT 4 specification.

## Parking Brake

Inspect the parking brake system including the parking brake pedal and cables.

## Brake Discs, Pads, Calipers and Rotors

Check the pads for excessive wear, discs for run out and wear, and calipers for fluid leakage.

## Exhaust Pipe and Muffler

Visually inspect the exhaust pipes, muffler and hangers for cracks, deterioration, or damage. Start the engine and listen carefully for any exhaust gas leakage. Tighten connections or replace parts as necessary.



### **Suspension Mounting Bolts**

Check the suspension connections for looseness or damage. Retighten to the specified torque.

### **Steering Gear Box, Linkage & Boots/Lower Arm Ball Joint**

With the vehicle stopped and the engine off, check for excessive freeplay in the steering wheel. Check the linkage for bends or damage. Check the dust boots and ball joints for deterioration, cracks, or damage.

Replace any damaged parts.

### **Drive Shafts and Boots**

Check the drive shafts, boots and clamps for cracks, deterioration, or damage.

Replace any damaged parts and, if necessary, repack the grease.

### **Air Conditioning Refrigerant**

Check the air conditioning lines and connections for leakage and damage.

## ENGINE OIL

### Checking the Engine Oil Level

1. Follow all of the oil manufacturer's precautions.
2. Be sure the vehicle is on the level ground in P (Park) with the parking brake set. If possible, block the wheels.
3. Turn the engine on and allow the engine to reach normal operating temperature.
4. Turn the engine off and wait about five minutes for the oil to return to the oil pan.
5. Pull the dipstick out, wipe it clean, and re-insert it fully.

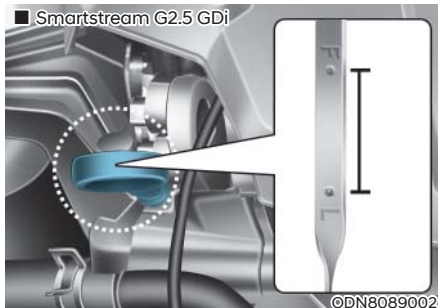
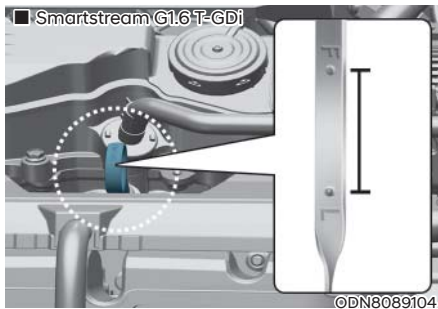

6. Pull the dipstick out again and check the level. The level should be between F and L.

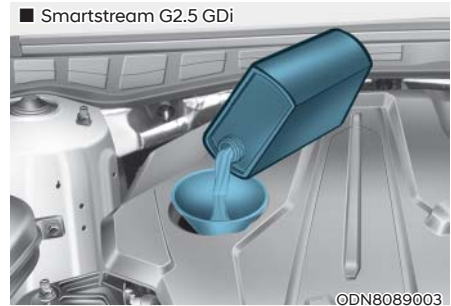
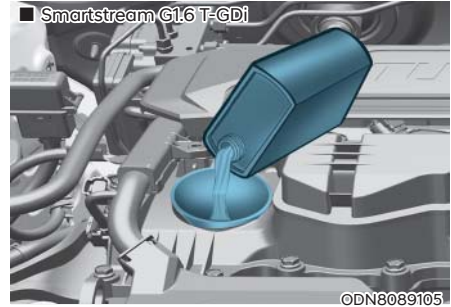

7. If it is near or at L, add enough oil to bring the level to F.

Use only the specified engine oil. (refer to “Recommended Lubricants and Capacities” in chapter 2).

### NOTICE

To prevent damage to your engine:

- Do not overfill with engine oil. Add oil in small quantities and recheck level to ensure engine is not overfilled.
- Do not spill engine oil when adding or changing engine oil. Use a funnel to help prevent oil from being spilled on engine components. Wipe off spilled oil immediately.

## Checking the Engine Oil and Filter



Have engine oil and filter changed by an authorized HYUNDAI dealer according to the Maintenance Schedule at the beginning of this chapter.



### **WARNING**

#### **CALIFORNIA PROPOSITION 65 WARNING**

Engine oil contains chemicals known to the State of California to cause cancer, birth defects and reproductive harm. Used engine oil may cause irritation or cancer of the skin if left in contact with the skin for prolonged periods of time. Always protect your skin by washing your hands thoroughly with soap and warm water as soon as possible after handling used oil.

## ENGINE COOLANT

The high-pressure cooling system has a reservoir filled with year-round antifreeze coolant. The reservoir is filled at the factory.

Check the antifreeze protection and coolant level at least once a year, at the beginning of the winter season and before traveling to a colder climate.

### NOTICE

- **When the engine overheats from low engine coolant, suddenly adding engine coolant may cause cracks in the engine. To prevent damage, add engine coolant slowly in small quantities.**
- **Do not drive with no engine coolant. It may cause water pump failure and engine seizure, etc.**

### Checking the Engine Coolant Level



Check the condition and connections of all cooling system hoses and heater hoses. Replace any swollen or deteriorated hoses.

The coolant level should be filled between the F and the L marks on the side of the coolant reservoir when the engine is cool.

If the coolant level is low, add enough distilled (deionized) water to bring the level to the F mark, but do not overfill. If frequent additions are required, see an authorized HYUNDAI dealer for a cooling system inspection.

### Recommended engine coolant

- When adding coolant, use only distilled (deionized) water for your vehicle and never mix hard water in the coolant filled at the factory.
- An improper coolant mixture can result in severe malfunction or engine damage.
- The engine in your vehicle has aluminum engine parts and must be protected by an ethylene-glycol with phosphate based coolant to prevent corrosion and freezing.
- Do not use alcohol or methanol coolant or mix them with the specified coolant.
- Do not use a solution that contains more than 60% antifreeze or less than 35% antifreeze, which would reduce the effectiveness of the solution.

For mixing percentage, refer to the following table:

Ambient Temperature	Mixture Percentage (volume)	
	Antifreeze	Water
5°F (-15°C)	35	65
-13°F (-25°C)	40	60
-31°F (-35°C)	50	50
-49°F (-45°C)	60	40

**i Information**

If in doubt about the mix ratio, a 50% water and 50% antifreeze mix is the easiest to mix together as it will be the same quantity of each. It is suitable to use for most temperature ranges of - 31°F and higher.

**! WARNING**

Make sure the coolant cap is properly closed after refilling coolant. Otherwise the engine could be overheated while driving.

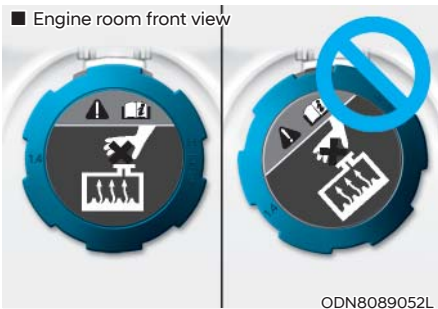

1. Check if the coolant cap label is straight In front.
2. Make sure that the tiny protrusions inside the coolant cap is securely interlocked.

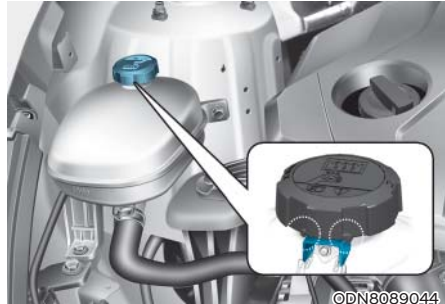

**! WARNING**



Never remove the engine coolant reservoir tank/radiator cap or the drain plug while the engine and radiator are hot.

Hot coolant and steam may blow out under pressure, causing serious injury.

Turn the engine off and wait until the engine cools down. Use extreme care when removing the engine coolant reservoir tank/radiator cap. Wrap a thick towel around it, and turn it counterclockwise slowly to the first stop. Step back while the pressure is released from the cooling system. When you are sure all the pressure has been released, press down on the cap, using a thick towel, and continue turning counterclockwise to remove it.



## WARNING



The electric motor for the cooling fan may continue to operate or start up when the engine is not running and can cause serious injury. Keep hands, clothing and tools away from the rotating fan blades of the cooling fan.

The electric motor for the cooling fan is controlled by engine coolant temperature, refrigerant pressure and vehicle speed. As the engine coolant temperature decreases, the electric motor will automatically shut off. This is a normal condition. If your vehicle is equipped with GDI, the electric motor for the cooling fan may begin to operate at any time and continue to operate until you disconnect the negative battery cable.

## Changing Engine Coolant

Have coolant changed by an authorized HYUNDAI dealer according to the Maintenance Schedule at the beginning of this chapter.



## WARNING

Do not use engine coolant or antifreeze in the washer fluid reservoir.

Engine coolant can severely obscure visibility when sprayed on the windshield and may cause loss of vehicle control resulting in an accident.

Engine coolant may also cause damage to paint and body trim.

## NOTICE

To prevent damage to engine parts, put a thick towel around the radiator cap before refilling the coolant to prevent the coolant from overflowing into engine parts, such as the alternator.

## BRAKE FLUID

### Checking the Brake Fluid Level

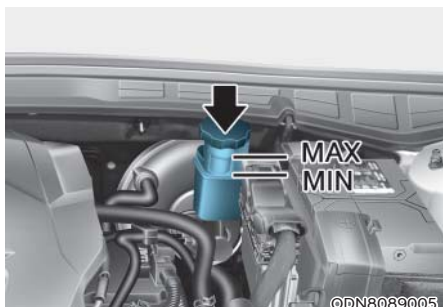

Check the fluid level in the reservoir periodically. The fluid level should be between MAX and MIN marks on the side of the reservoir.

Before removing the reservoir cap and adding brake fluid, clean the area around the reservoir cap thoroughly to prevent brake fluid contamination.

If the level is low, add the specified brake fluid to the MAX level. The level will fall with accumulated mileage. This is a normal condition associated with the wear of the brake linings. If the fluid level is excessively low, have the brake system checked by an authorized HYUNDAI dealer.

#### **WARNING**

If the brake system requires frequent additions of fluid this could indicate a leak in the brake system. Have the vehicle inspected by an authorized HYUNDAI dealer.

#### **WARNING**

Do not allow brake fluid to come in contact with your eyes. If brake fluid comes in contact with your eyes, flush your eyes with clean water for at least 15 minutes and get immediate medical attention.

#### **NOTICE**

- Do not allow brake fluid to contact the vehicle's body paint, as paint damage will result.
- Brake fluid, which has been exposed to open air for an extended time should NEVER be used as its quality cannot be guaranteed. It should be disposed of properly.
- Do not use the wrong kind of brake fluid. A few drops of mineral based oil, such as engine oil, in your brake system can damage brake system parts.

#### **Information**

Use only the specified brake fluid (refer to “Recommended Lubricants and Capacities” in chapter 2).

## WASHER FLUID

### Checking the Washer Fluid Level

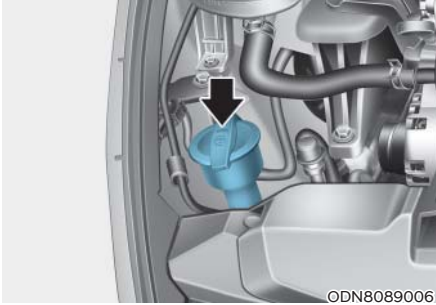

Check the fluid level in the washer fluid reservoir and add fluid if necessary. Plain water may be used if washer fluid is not available. However, use washer solvent with antifreeze characteristics in cold climates to prevent freezing.



### WARNING

To prevent serious injury or death, take the following safety precautions when using washer fluid:

- Do not use engine coolant or antifreeze in the washer fluid reservoir.

Engine coolant can severely obscure visibility when sprayed on the windshield and may cause loss of vehicle control resulting in an accident or damage to paint and body trim.

- Do not allow sparks or flames to contact the washer fluid or the washer fluid reservoir. Washer fluid may contain alcohol and can be flammable.
- Do not drink washer fluid and avoid contact with skin. Washer fluid is harmful to humans and animals.
- Keep washer fluid away from children and animals.



## AIR CLEANER

### Filter Replacement

The air cleaner filter can be cleaned for inspection using compressed air.

Do not attempt to wash or to rinse it, as water will damage the filter.

If soiled, the air cleaner filter must be replaced.

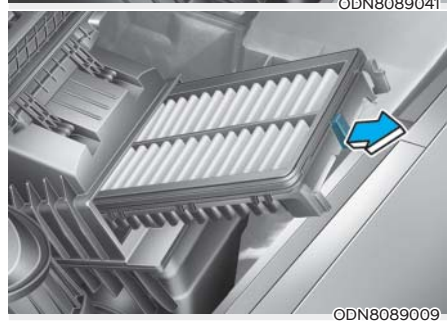
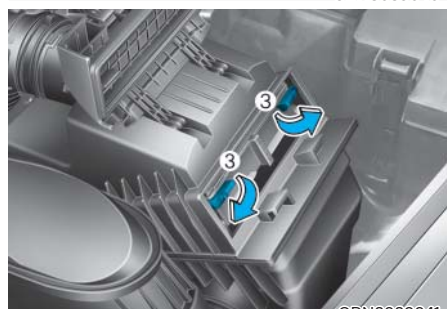
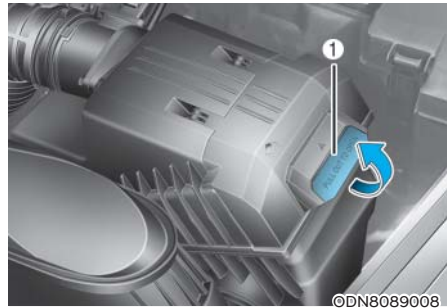
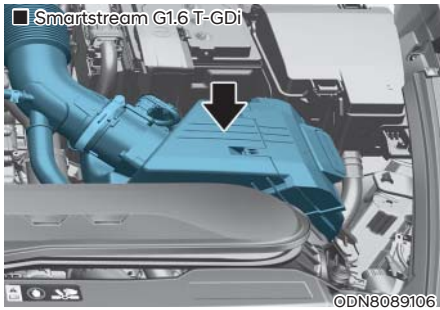

1. Pull up the lever (1) on the air cleaner cover and release the lock.
2. Pull up the air cleaner cover (2) and open.
3. Rotate the fixed lever (3) on the filter and loosen the lock.
4. Replace the air cleaner filter.
5. Assemble in reverse order.

### Information

**If the vehicle is operated in extremely dusty or sandy areas, replace the element more often than the usual recommended intervals (refer to “Maintenance Under Severe Usage Conditions” in this chapter).**

### **NOTICE**

- **Do not drive with the air cleaner filter removed. This will result in excessive engine wear.**
- **When removing the air cleaner filter, be careful that dust or dirt does not enter the air intake, or damage may result.**
- **Use HYUNDAI genuine parts. Use of non-genuine parts could damage the air flow sensor.**

## CLIMATE CONTROL AIR FILTER

### Filter Inspection

The climate control air filter should be replaced according to the Maintenance Schedule. If the vehicle is operated in severely air-polluted cities or on dusty rough roads for a long period, it should be inspected more frequently and replaced earlier. When you replace the climate control air filter, replace it performing the following procedure, and be careful to avoid damaging other components.

### Filter replacement

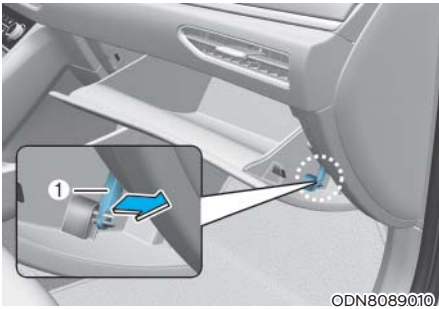

1. Remove the support rod (1).

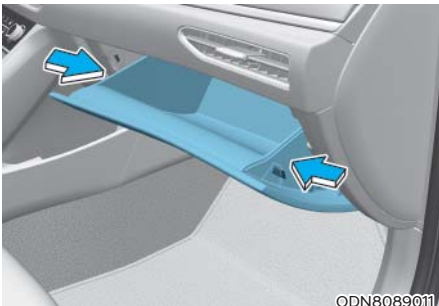

2. Push in both sides of the glove box as shown. This will ensure that the glove box stopper pins will get released from its holding location allowing the glove box to hang.



3. Remove the climate control air filter case while pressing the lock on the right side of the cover.

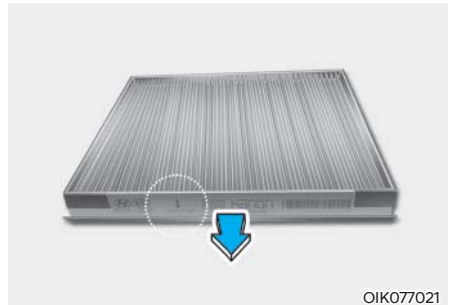

4. Replace the climate control air filter.  
5. Reassemble in the reverse order of disassembly.

### NOTICE

**Install a new climate control air filter in the correct direction with the arrow symbol (⇩) facing downwards, otherwise, it may be noisy and the effectiveness of the filter may be reduced.**

## WIPER BLADES

### Blade Inspection

Contamination of either the windshield or the wiper blades with foreign matter can reduce the effectiveness of the windshield wiper functionality. Common sources of contamination are insects, tree sap, and hot wax treatments used by some commercial car washes. If the blades are not wiping properly, clean both the window and the blades with a clean cloth dampened with washer fluid.

#### NOTICE

To prevent damage to the wiper blades, arms or other components, do not:

- Use gasoline, kerosene, paint thinner, or other solvents on or near them.
- Attempt to move the wipers manually.
- Use non-specified wiper blades.



### Information

Commercial hot waxes applied by automatic car washes have been known to make the windshield difficult to clean.

### Blade Replacement

When the wipers no longer clean adequately, the blades may be worn or cracked, and require replacement.

#### NOTICE

- In order to prevent damage to the hood and the wiper arms, the wiper arms should only be lifted when in the top wiping position.
- Always return the wiper arms to the windshield before driving.

#### NOTICE

The use of a non-specified wiper blade could result in wiper malfunction and failure.

### Front windshield wiper service positions

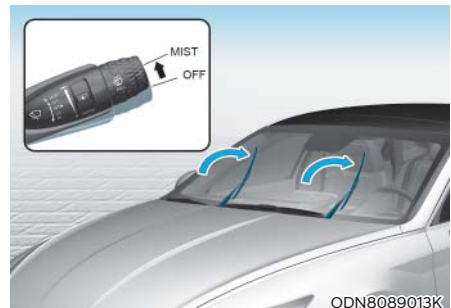

1. Within 20 seconds of turning off the engine, lift and hold the wiper lever up to the MIST position for about 2 seconds until the wipers move to the top wipe position.
2. At this time you can lift the wipers off the windshield.
3. Gently put the wipers back down onto the windshield.
4. Turn the wipers to any ON position to return the wipers to the bottom resting position.

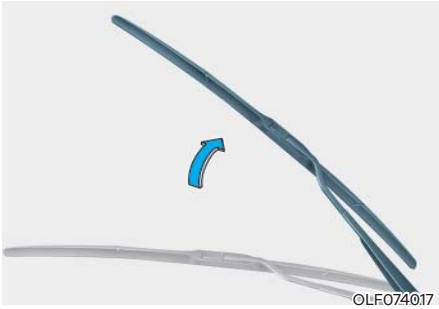

1. Raise the wiper arm.

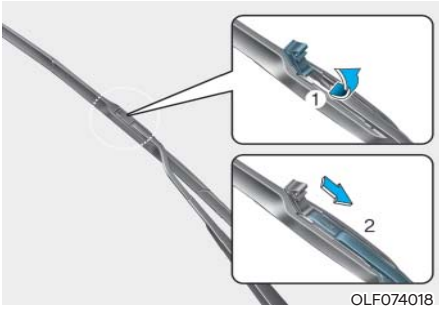

2. Lift the wiper blade clip. Then push down the blade body.



3. Install the new blade assembly in the reverse order of removal.  
4. Return the wiper arm on the windshield.

## BATTERY



### WARNING

To prevent **SERIOUS INJURY** or **DEATH** to you or bystanders, always follow these precautions when working near or handling the battery:



Always read and follow instructions carefully when handling a battery.



Wear eye protection designed to protect the eyes from acid splashes.



Keep all flames, sparks, or smoking materials away from the battery.



Hydrogen is always present in battery cells, is highly combustible, and may explode if ignited.



Keep batteries out of reach of children.



Batteries contain sulfuric acid which is highly corrosive. Do not allow acid to contact your eyes, skin or clothing.

If acid gets into your eyes, flush your eyes with clean water for at least 15 minutes and get immediate medical attention. If acid gets on your skin, thoroughly wash the area. If you feel pain or a burning sensation, get medical attention immediately.

- When lifting a plastic-cased battery, excessive pressure on the case may cause battery acid to leak. Lift with a battery carrier or with your hands on opposite corners.
- Do not attempt to jump start your vehicle if your battery is frozen.
- NEVER attempt to recharge the battery when the vehicle's battery cables are connected to the battery.
- The electrical ignition system works with high voltage. NEVER touch these components with the engine running or when the ignition switch is in the ON position.



### WARNING

#### CALIFORNIA PROPOSITION 65 WARNING

Battery posts, terminals, and related accessories contain lead and lead compounds, chemicals known to the State of California to cause cancer, birth defects and reproductive harm. Batteries also contain other chemicals known to the State of California to cause cancer. Wash hands after handling.

### NOTICE

- When you do not use the vehicle for a long time in a low temperature area, disconnect the battery and keep it indoors.
- Always charge the battery fully to prevent battery case damage in low temperature areas.

## For Best Battery Service

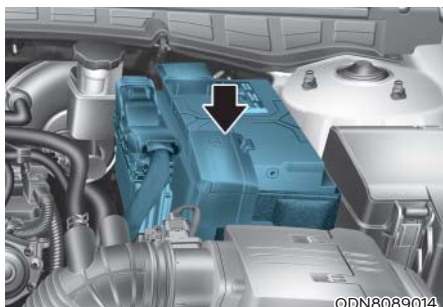

- Keep the battery securely mounted.
- Keep the battery top clean and dry.
- Keep the terminals and connections clean, tight, and coated with petroleum jelly or terminal grease.
- Rinse any spilled acid from the battery immediately with a solution of water and baking soda.

## Battery Recharging

### **WARNING**

Always follow these instructions when recharging your vehicle's battery to avoid the risk of **SERIOUS INJURY** or **DEATH** from explosions or acid burns:

- Before performing maintenance or recharging the battery, turn off all accessories and place the ignition switch to the **LOCK/OFF** position.
- Keep all flames, sparks, or smoking materials away from the battery.
- Always work outdoors or in an area with plenty of ventilation.
- Wear eye protection when checking the battery during charging.
- The battery must be removed from the vehicle and placed in a well ventilated area.
- Watch the battery during charging, and stop or reduce the charging rate if the battery cells begin boiling violently.
- Vehicle is equipped with the **Absorbent Glass Mat (AGM) battery**. Do not charge the AGM battery with a general charger. It may damage or explode the AGM battery. Only charge the AGM battery with a charger that has AGM battery setting.

- The negative battery cable must be removed first and installed last when the battery is disconnected. Disconnect the battery charger in the following order:
  1. Turn off the battery charger main switch.
  2. Unhook the negative clamp from the negative battery terminal.
  3. Unhook the positive clamp from the positive battery terminal.
- Always use a genuine HYUNDAI approved battery when you replace the battery.

### ***By jump starting***

After a jump start from a good battery, drive the vehicle for 20-30 minutes before it is shutoff. The vehicle may not restart if you shut it off before the battery had a chance to adequately recharge. See “Jump Starting” in chapter 7 for more information on jump starting procedures.



### **Information**



An inappropriately disposed battery can be harmful to the environment and human health. Dispose of the battery according to your local law(s) or regulations.

### **Reset Features**

The following items may need to be reset after the battery has been discharged or the battery has been disconnected. See chapter 3 or 4 for:

- Power Windows
- Trip Computer
- Climate Control System
- Clock
- Audio System
- Sunroof



## TIRES AND WHEELS



### WARNING

Tire failure may cause loss of vehicle control resulting in an accident. To reduce risk of **SERIOUS INJURY** or **DEATH**, take the following precautions:

- Inspect your tires monthly for proper inflation as well as wear and damage.
- The recommended cold tire pressure for your vehicle can be found in this manual and on the tire label located on the driver's side center pillar. Always use a tire pressure gauge to measure tire pressure. Tires with too much or too little pressure wear unevenly causing poor handling.
- Check the pressure of the spare every time you check the pressure of the other tires on your vehicle.
- Replace tires that are worn, show uneven wear, or are damaged. Worn tires can cause loss of braking effectiveness, steering control, or traction.
- **ALWAYS** replace tires with the same type, size, brand, construction and tread pattern as each tire that was originally supplied with this vehicle. Using tires and wheels other than the recommended sizes could cause unusual handling characteristics, poor vehicle control, or negatively affect your vehicle's Anti-Lock Brake System (ABS) resulting in a serious accident.

### Tire Care

For proper maintenance, safety, and maximum fuel economy, you must always maintain recommended tire inflation pressures and stay within the load limits and weight distribution recommended for your vehicle.



ODN8H019025L

All specifications (sizes and pressures) can be found on a label attached to the driver's side center pillar.

### Recommended Cold Tire Inflation Pressures

All tire pressures (including the spare) should be checked when the tires are cold. "Cold tires" means the vehicle has not been driven for at least three hours or has been driven for less than one mile (1.6 km).

Warm tires normally exceed recommended cold tire pressures by 4 to 6 psi (28 to 41 kPa). Do not release air from warm tires to adjust the pressure or the tires will be under-inflated. For recommended inflation pressure, refer to "Tire and Wheels" in chapter 2.



## WARNING

Recommended pressures must be maintained for the best ride, vehicle handling, and minimum tire wear.

Over-inflation or under-inflation can reduce tire life, adversely affect vehicle handling, and lead to sudden tire failure that could result in loss of vehicle control resulting in an accident.

Severe under-inflation can lead to severe heat build-up, causing blowouts, tread separation and other tire failures that can result in the loss of vehicle control resulting in an accident. This risk is much higher on hot days and when driving for long periods at high speeds.



## CAUTION

- Under-inflation results in excessive wear, poor handling and reduced fuel economy. Wheel deformation is also possible. Keep your tire pressures at the proper levels. If a tire frequently needs refilling, have it checked by an authorized HYUNDAI dealer.
- Over-inflation produces a harsh ride, excessive wear at the center of the tire tread, and a greater possibility of damage from road hazards.

## Check Tire Inflation Pressure

Check your tires, including the spare tire, once a month or more.

### How to check

Use a good quality tire pressure gauge to check tire pressure. You can not tell if your tires are properly inflated simply by looking at them. Radial tires may look properly inflated when they are under-inflated.

Remove the valve cap from the tire valve stem. Press the tire gauge firmly onto the valve to get a pressure measurement. If the cold tire inflation pressure matches the recommended pressure on the tire label located on the driver's side center pillar or in this manual. No further adjustment is necessary. If the pressure is low, add air until you reach the recommended pressure. Make sure to put the valve caps back on the valve stems. Without the valve cap, dirt or moisture could get into the valve core and cause air leakage. If a valve cap is missing, install a new one as soon as possible.

If you overfill the tire, release air by pushing on the metal stem in the center of the tire valve. Recheck the tire pressure with the tire gauge. Be sure to put the valve caps back on the valve stems. Without the valve cap, dirt or moisture could get into the valve core and cause air leakage. If a valve cap is missing, install a new one as soon as possible.

A cold tire means the vehicle has been sitting for 3 hours and driven for less than 1 mile (1.6 km) in that 3 hour period.

Allow the tire to cool before measuring the inflation pressure. Always be sure the tire is cold before inflating to the recommended pressure.

## Tire Rotation

To equalize tread wear, HYUNDAI recommends that the tires be rotated according to the maintenance schedule or sooner if irregular wear develops.

During rotation, check the tires for correct balance.

When rotating tires, check for uneven wear and damage. Abnormal wear is usually caused by incorrect tire pressure, improper wheel alignment, out-of-balance wheels, severe braking or severe cornering. Look for bumps or bulges in the tread or side of the tire. Replace the tire if you find any of these conditions. Replace the tire if fabric or cord is visible. After rotation, be sure to bring the front and rear tire pressures to specification and check lug nut tightness (proper torque is 79–94 lbf-ft [11–13 kgf-m]).

■ Without a spare tire

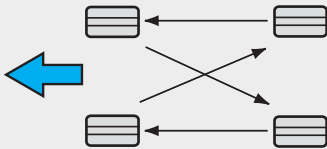

ODH073802

Disc brake pads should be inspected for wear whenever tires are rotated.

## **i** Information

**Tires that are asymmetrical or directional can only be installed on the wheel in one direction. The outside and inside of an asymmetrical tire is not easily distinguishable. Pay careful attention to the markings on the sidewalls of the tires, noting the “outside” marking and also the rotating direction before installing them on the vehicle.**

## **!** WARNING

- **Do not use the compact spare tire for tire rotation.**
- **Do not mix bias ply and radial ply tires under any circumstances. This may cause unusual handling characteristics that may cause loss of vehicle control resulting in an accident.**

## Wheel Alignment and Tire Balance

The wheels on your vehicle were aligned and balanced carefully at the factory to give you the longest tire life and best overall performance.

In most cases, you will not need to have your wheels aligned again. However, if you notice unusual tire wear or your vehicle pulling one way or the other, the alignment may need to be reset.

If you notice your vehicle vibrating when driving on a smooth road, your wheels may need to be rebalanced.

## **NOTICE**

**Improper wheel weights can damage your vehicle’s aluminum wheels. Use only approved wheel weights.**

## Tire Replacement



If the tire is worn evenly, a tread wear indicator will appear as a solid band across the tread. This shows there is less than 2/32 inch (1.6 mm) of tread left on the tire. Replace the tire when this happens.

Do not wait for the tread surface to become level with the tread wear indicators before replacing the tire.



### WARNING

To reduce the risk of **DEATH** or **SERIOUS INJURY**:

- Replace tires that are worn, show uneven wear, or are damaged. Worn tires can cause loss of braking effectiveness, steering control, and traction.
- Always replace tires with the same size as each tire that was originally supplied with this vehicle. Using tires and wheels other than the recommended sizes could cause unusual handling characteristics, poor vehicle control, or negatively affect your vehicle's Anti-Lock Brake System (ABS) resulting in a serious accident.
- Tires degrade over time, even when they are not being used. Regardless of the remaining tread, **HYUNDAI** recommends that tires be replaced after six (6) years of normal service.
- When replacing tires, it is recommended to replace the two front or two rear tires as a pair. Replacing just one tire can seriously affect your vehicle's handling. If only replacing one pair of tires, it is recommended to install the pair of new tires on the rear axle.
- Heat caused by hot climates or frequent high loading conditions can accelerate the aging process. Failure to follow this warning may cause sudden tire failure, which could lead to a loss of vehicle control resulting in an accident.

### **Compact spare tire replacement**

A compact spare tire has a shorter tread life than a regular size tire. Replace it when you can see the tread wear indicator bars on the tire. The replacement compact spare tire should be the same size and design tire as the one provided with your new vehicle and should be mounted on the same compact spare tire wheel. The compact spare tire is not designed to be mounted on a regular size wheel, and the compact spare tire wheel is not designed for mounting a regular size tire.



### **WARNING**

**The original tire should be repaired or replaced as soon as possible to avoid failure of the spare and loss of vehicle control resulting in an accident. The compact spare tire is for emergency use only. Do not operate your vehicle over 50 mph (80 km/h) when using the compact spare tire.**

### **Wheel Replacement**

When replacing the metal wheels for any reason, make sure the new wheels are equivalent to the original factory units in diameter, rim width and offset.

### **Tire Traction**

Tire traction can be reduced if you drive on worn tires, tires that are improperly inflated or on slippery road surfaces. Tires should be replaced when the tread depth is at least 2/32 inch (1.6 mm). To reduce the possibility of losing control, slow down whenever there is rain, snow or ice on the road.

### **Tire Maintenance**

In addition to proper inflation, correct wheel alignment helps to decrease tire wear. If you find a tire is worn unevenly, have your dealer check the wheel alignment.

When you have new tires installed, make sure they are balanced. This will increase vehicle ride comfort and tire life. Additionally, a tire should always be rebalanced if it is removed from the wheel.

### **Tire Sidewall Labeling**

This information identifies and describes the fundamental characteristics of the tire and also provides the tire identification number (TIN) for safety standard certification. The TIN can be used to identify the tire in case of a recall.

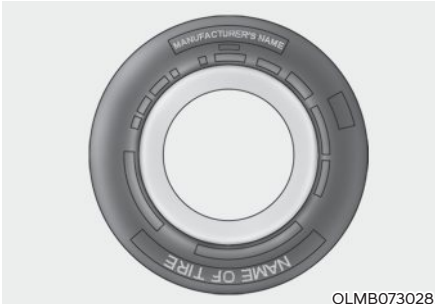

OLMB073028

### 1. **Manufacturer or brand name**

Manufacturer or brand name is shown.

### 2. **Tire size designation**

A tire's sidewall is marked with a tire size designation. You will need this information when selecting replacement tires for your car. The following explains what the letters and numbers in the tire size designation mean.

Example tire size designation:

(These numbers are provided as an example only; your tire size designator could vary depending on your vehicle.)

#### **205/65R16 95H**

205 - Tire width in millimeters.

65 - Aspect ratio. The tire's section height as a percentage of its width.

R - Tire construction code (Radial).

16 - Rim diameter in inches.

95 - Load Index, a numerical code associated with the maximum load the tire can carry.

H - Speed Rating Symbol. See the speed rating chart in this section for additional information.

### Wheel size designation

Wheels are also marked with important information that you need if you ever have to replace one. The following explains what the letters and numbers in the wheel size designation mean.

Example wheel size designation:

#### **6.5J X 16**

6.5 - Rim width in inches.

J - Rim contour designation.

16 - Rim diameter in inches.

### Tire speed ratings

The chart below lists many of the different speed ratings currently being used for passenger vehicle tires. The speed rating is part of the tire size designation on the sidewall of the tire. This symbol corresponds to that tire's designed maximum safe operating speed.

Speed Rating Symbol	Maximum Speed
S	112 mph (180 km/h)
T	118 mph (190 km/h)
H	130 mph (210 km/h)
V	149 mph (240 km/h)
W	168 mph (270 km/h)
Y	186 mph (300 km/h)

### **3. Checking tire life (TIN : Tire Identification Number)**

Any tires that are over six years old, based on the manufacturing date, (including the spare tire) should be replaced by new tires. You can find the manufacturing date on the tire sidewall (possibly on the inside of the wheel), displaying the DOT Code. The DOT Code is a series of numbers on a tire consisting of numbers and English letters. The manufacturing date is designated by the last four digits (characters) of the DOT code.

#### **DOT : XXXX XXXX OOOO**

The front part of the DOT shows a plant code number, tire size and tread pattern and the last four numbers indicate week and year manufactured.

For example:

DOT XXXX XXXX 1419 represents that the tire was produced in the 14th week of 2019.

### **4. Tire ply composition and material**

The number of layers or plies of rubber-coated fabric in the tire. Tire manufacturers also must indicate the materials in the tire, which include steel, nylon, polyester, and others. The letter “R” means radial ply construction; the letter “D” means diagonal or bias ply construction; and the letter “B” means belted-bias ply construction.

### **5. Maximum permissible inflation pressure**

This number is the greatest amount of air pressure that should be put in the tire. Do not exceed the maximum permissible inflation pressure. Refer to the Tire and Loading Information label for recommended inflation pressure.

### **6. Maximum load rating**

This number indicates the maximum load in kilograms and pounds that can be carried by the tire. When replacing the tires on the vehicle, always use a tire that has the same load rating as the factory installed tire.

### **7. Uniform tire quality grading**

Quality grades can be found where applicable on the tire sidewall between tread shoulder and maximum section width.

For example:

TREAD WEAR 200

TRACTION AA

TEMPERATURE A

### Tread wear

The tread wear grade is a comparative rating based on the wear rate of the tire when tested under controlled conditions on a specified government test course. For example, a tire graded 150 would wear one-and-a-half times (1½) as well on the government course as a tire graded 100.

The relative performance of tires depends upon the actual conditions of their use, however, and may depart significantly from the norm due to variations in driving habits, service practices and differences in road characteristics and climate.

These grades are molded on the sidewalls of passenger vehicle tires. The tires available as standard or optional equipment on your vehicle may vary with respect to grade.

### Traction AA, A, B & C

The traction grades, from highest to lowest, are AA, A, B and C. Those grades represent the tire's ability to stop on wet pavement as measured under controlled conditions on specified government test surfaces of asphalt and concrete. A tire marked C may have poor traction performance.



### WARNING

**The traction grade assigned to this tire is based on straight-ahead braking traction tests, and does not include acceleration, cornering, hydroplaning, or peak traction characteristics.**

### Temperature A, B & C

The temperature grades are A (the highest), B and C representing the tire's resistance to the generation of heat and its ability to dissipate heat when tested under controlled conditions on a specified indoor laboratory test wheel.

Sustained high temperature can cause the material of the tire to degenerate and reduce tire life, and excessive temperature can lead to sudden tire failure. Grade C responds to a level of performance which all passenger car tires must meet under the Federal Motor Vehicle Safety Standard No. 109. Grades B and A represent higher levels of performance on the laboratory test wheel than the minimum required by law.



### WARNING

**The temperature grade for this tire is established for a tire that is properly inflated and not overloaded. Excessive speed, under-inflation, over-inflation, or excessive loading, either separately or in combination, can cause heat build-up and possible sudden tire failure. This may cause loss of vehicle control resulting in an accident.**



## Tire Terminology and Definitions

### **Air Pressure**

The amount of air inside the tire pressing outward on the tire. Air pressure is expressed in pounds per square inch (psi) or kilopascal (kPa).

### **Accessory Weight**

This means the combined weight of optional accessories. Some examples of optional accessories are automatic transmission, power seats, and air conditioning.

### **Aspect Ratio**

The relationship of a tire's height to its width.

### **Belt**

A rubber coated layer of cords that is located between the plies and the tread. Cords may be made from steel or other reinforcing materials.

### **Bead**

The tire bead contains steel wires wrapped by steel cords that hold the tire onto the rim.

### **Bias Ply Tire**

A pneumatic tire in which the plies are laid at alternate angles less than 90 degrees to the centerline of the tread.

### **Cold Tire Pressure**

The amount of air pressure in a tire, measured in pounds per square inch (psi) or kilopascals (kPa) before a tire has built up heat from driving.

### **Curb Weight**

This means the weight of a motor vehicle with standard and optional equipment including the maximum capacity of fuel, oil and coolant, but without passengers and cargo.

### **DOT Markings**

A code molded into the sidewall of a tire signifying that the tire is in compliance with the U.S. Department of Transportation motor vehicle safety standards. The DOT code includes the Tire Identification Number (TIN), an alphanumeric designator which can also identify the tire manufacturer, production plant, brand and date of production.

### **GVWR**

Gross Vehicle Weight Rating

### **GAWR FRT**

Gross Axle Weight Rating for the Front Axle.

### **GAWR RR**

Gross Axle Weight Rating for the Rear axle.

### **Intended Outboard Sidewall**

The side of an asymmetrical tire, that must always face outward when mounted on a vehicle.

### **Kilopascal (kPa)**

The metric unit for air pressure.

### **Light truck (LT) tire**

A tire designated by its manufacturer as primarily intended for use on lightweight trucks or multipurpose passenger vehicles.

### **Load ratings**

The maximum load that a tire is rated to carry for a given inflation pressure.

### **Load Index**

An assigned number ranging from 1 to 279 that corresponds to the load carrying capacity of a tire.

**Maximum Inflation Pressure**

The maximum air pressure to which a cold tire may be inflated. The maximum air pressure is molded onto the sidewall.

**Maximum Load Rating**

The load rating for a tire at the maximum permissible inflation pressure for that tire.

**Maximum Loaded Vehicle Weight**

The sum of curb weight; accessory weight; vehicle capacity weight; and production options weight.

**Normal Occupant Weight**

The number of occupants a vehicle is designed to seat multiplied by 150 pounds (68 kg).

**Occupant Distribution**

Designated seating positions.

**Outward Facing Sidewall**

An asymmetrical tire has a particular side that faces outward when mounted on a vehicle. The outward facing sidewall bears white lettering or bears manufacturer, brand, and/or model name molding that is higher or deeper than the same moldings on the inner facing sidewall.

**Passenger (P-Metric) tire**

A tire used on passenger cars and some light duty trucks and multipurpose vehicles.

**Ply**

A layer of rubber-coated parallel cords.

**Pneumatic tire**

A mechanical device made of rubber, chemicals, fabric and steel or other materials, that, when mounted on an automotive wheel provides the traction and contains the gas or fluid that sustains the load.

**Pneumatic options weight**

The combined weight of installed regular production options weighing over 5 lb. (2.3 kg) in excess of the standard items which they replace, not previously considered in curb weight or accessory weight, including heavy duty breaks, ride levelers, roof rack, heavy duty battery, and special trim.

**Recommended Inflation Pressure**

Vehicle manufacturer's recommended tire inflation pressure as shown on the tire placard.

**Radial Ply Tire**

A pneumatic tire in which the ply cords that extend to the beads are laid at 90 degrees to the centerline of the tread.

**Rim**

A metal support for a tire and upon which the tire beads are seated.

**Sidewall**

The portion of a tire between the tread and the bead.

**Speed Rating**

An alphanumeric code assigned to a tire indicating the maximum speed at which a tire can operate.

**Traction**

The friction between the tire and the road surface. The amount of grip provided.

### **Tread**

The portion of a tire that comes into contact with the road.

### **Treadwear Indicators**

Narrow bands, sometimes called “wear bars”, that show across the tread of a tire when only 1/16 inch of tread remains.

### **UTQGS**

Uniform Tire Quality Grading Standards is a tire information system that provides consumers with ratings for a tire’s traction, temperature and treadwear. Ratings are determined by tire manufacturers using government testing procedures. The ratings are molded into the sidewall of the tire.

### **Vehicle Capacity Weight**

The number of designated seating positions multiplied by 150 lbs. (68 kg) plus the rated cargo and luggage load.

### **Vehicle Maximum Load on the Tire**

Load on an individual tire due to curb and accessory weight plus maximum occupant and cargo weight.

### **Vehicle Normal Load on the Tire**

Load on an individual tire that is determined by distributing to each axle its share of the curb weight, accessory weight, and normal occupant weight and dividing by 2.

### **Vehicle Placard**

A label permanently attached to a vehicle showing the original equipment tire size and recommended inflation pressure.

## **All Season Tires**

HYUNDAI specifies all season tires on some models to provide good performance for use all year round, including snowy and icy road conditions. All season tires are identified by ALL SEASON and/or M+S (Mud and Snow) on the tire sidewall. Snow tires have better snow traction than all season tires and may be more appropriate in some areas.

## **Summer Tires**

HYUNDAI specifies summer tires on some models to provide superior performance on dry roads. Summer tire performance is substantially reduced in snow and ice. Summer tires do not have the tire traction rating M+S (Mud and Snow) on the tire side wall. If you plan to operate your vehicle in snowy or icy conditions, HYUNDAI recommends the use of snow tires or all season tires on all four wheels.

## **Snow Tires**

If you equip your car with snow tires, they should be the same size and have the same load capacity as the original tires. Snow tires should be installed on all four wheels; otherwise, poor handling may result. Snow tires should carry 4 psi (28 kPa) more air pressure than the pressure recommended for the standard tires on the tire label on the driver’s side of the center pillar, or up to the maximum pressure shown on the tire sidewall, whichever is less. Do not drive faster than 75 mph (120 km/h) when your vehicle is equipped with snow tires.

## Radial-Ply Tires

Radial-ply tires provide improved tread life, road hazard resistance and smoother high speed ride. The radial-ply tires used on this vehicle are of belted construction, and are selected to complement the ride and handling characteristics of your vehicle.

Radial-ply tires have the same load carrying capacity, as bias-ply or bias belted tires of the same size, and use the same recommended inflation pressure. Mixing of radial-ply tires with bias-ply or bias belted tires is not recommended. Any combinations of radial-ply and bias-ply or bias belted tires when used on the same vehicle will seriously deteriorate vehicle handling. The best rule to follow is: Identical pairs of radial-ply tires should always be used as a set for the front tires and a set for the rear tires.

Longer wearing tires can be more susceptible to irregular tread wear. It is very important to follow the tire rotation interval in this chapter to achieve the tread life potential of these tires. Cuts and punctures in radial-ply tires are repairable only in the tread area, because of sidewall flexing. Consult your tire dealer for radial-ply tire repairs.



### WARNING

**Do not mix bias ply and radial ply tires under any circumstances. This may cause unusual handling characteristics that may cause loss of vehicle control resulting in an accident.**

## Low Aspect Ratio Tires

The aspect ratio is lower than 50 on low aspect ratio tires.

Because low aspect ratio tires are optimized for handling and braking, their sidewall is a little stiffer than a standard tire. Also low aspect ratio tires tend to be wider and consequently have a greater contact patch with the road surface. In some instances they may generate more road noise compared with standard tires.



### CAUTION

**Because the sidewall of a low aspect ratio tire is shorter than a standard tire, the rim of the wheel and the tire itself is more easily susceptible to damage. Use caution when driving and follow the guidelines below to help minimize damage to the wheel and tire:**

- **When driving on a rough road or off road, drive cautiously because tires and wheels may be damaged. And after driving, inspect tires and wheels.**
- **When passing over a pothole, speed bump, manhole, or curb stone, drive slowly so that the tires and wheels are not damaged.**
- **If the tire is subjected to a severe impact, have the tire and wheel inspected by an authorized HYUNDAI dealer.**
- **Inspect the tire condition and pressure every 1,800 miles (3,000km).**



### CAUTION

- **It is not easy to recognize tire damage with your own eyes. But if there is the slightest hint of tire damage, have the tire checked or replaced because the tire damage may cause air leakage from the tire.**
- **If the tire is damaged by driving on a rough road, off road, pothole, manhole, or curb stone, it will not be covered by the warranty.**

## FUSES

### ■ Blade type



Normal



Blown

### ■ Cartridge type



Normal



Blown

### ■ Multi fuse

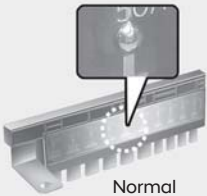

Normal

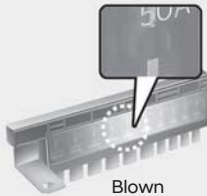

Blown

OTM078035

A vehicle's electrical system is protected from electrical overload damage by fuses.

This vehicle has 2 (or 3) fuse panels, one located in the driver's side panel bolster, the other in the engine compartment near the battery.

If any of your vehicle's lights, accessories, or controls do not work, check the appropriate circuit fuse. If a fuse has blown, the element inside the fuse will be melted or broken.

If the electrical system does not work, first check the driver's side fuse panel. Before replacing a blown fuse, turn the engine and all switches off, and then disconnect the negative battery cable. Always replace a blown fuse with one of the same rating.

If the replacement fuse blows, this indicates an electrical problem. Avoid using the system involved and immediately consult an authorized HYUNDAI dealer.

### **WARNING**

**NEVER** replace a fuse with anything but another fuse of the same rating.

- A higher capacity fuse could cause damage and possibly cause a fire.
- Do not install a wire or aluminum foil instead of the proper fuse - even as a temporary repair. It may cause extensive wiring damage and possibly a fire.

### **NOTICE**

Do not use a screwdriver or any other metal object to remove fuses because it may cause a short circuit and damage the system.

## Instrument Panel Fuse Replacement

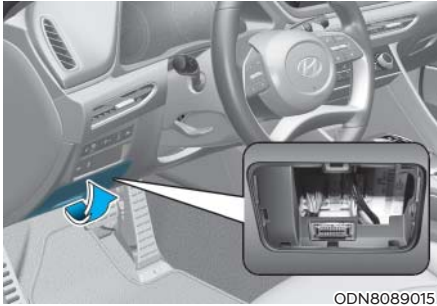

1. Turn the engine off.
2. Turn all other switches OFF.
3. Open the fuse panel cover.
4. Refer to the label on the inside of the fuse panel cover to locate the suspected fuse location.

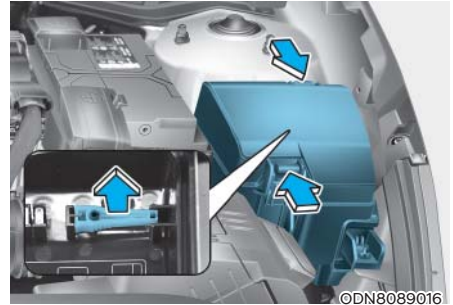

5. Pull the suspected fuse straight out. Use the removal tool provided in the engine compartment fuse panel.
6. Check the removed fuse; replace it if it is blown. Spare fuses are provided in the instrument panel fuse panels (or in the engine compartment fuse panel).
7. Push in a new fuse of the same rating, and make sure it fits tightly in the clips. If it fits loosely, consult an authorized HYUNDAI dealer.

In an emergency, if you do not have a spare fuse, use a fuse of the same rating from a circuit you may not need for operating the vehicle.

If the headlamps or other electrical components do not work and the fuses are undamaged, check the fuse panel in the engine compartment. If a fuse is blown, it must be replaced with the same rating.

## Engine Compartment Panel Fuse Replacement

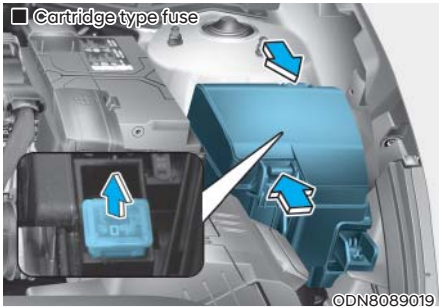
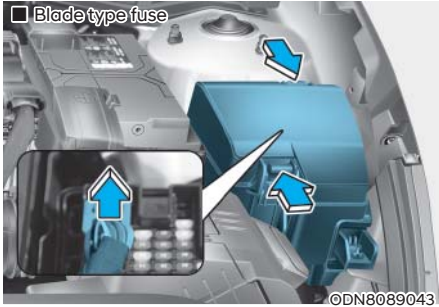

1. Turn the engine off.
2. Turn all other switches OFF.
3. Remove the fuse panel cover by pressing the tap and pulling up.
4. Check the removed fuse; replace it if it is blown. To remove or insert the fuse, use the fuse puller in the engine compartment fuse panel.
5. Push in a new fuse of the same rating, and make sure it fits tightly in the clips. If it fits loosely, consult an authorized HYUNDAI dealer.

### CAUTION

After checking the fuse box in the engine compartment securely close the fuse box cover inside the engine compartment, until it clicks.

If the fuse box is not closed properly, water may leak in side, possibly causing a malfunction with the electrical system.

### Multi fuse (Main fuse)

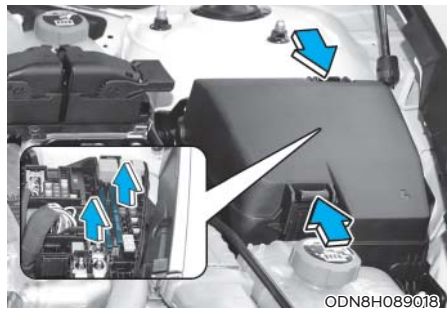

If the multi fuse is blown, it must be removed as follows:

1. Turn off the engine.
2. Disconnect the negative battery cable.
3. Remove the fuse panel cover by pressing the tab and pulling it up.
4. Remove the nuts shown in the picture above.
5. Replace the fuse with a new one of the same rating.
6. Reinstall in the reverse order of removal.

### Information

If the multi fuse is blown, consult an authorized HYUNDAI dealer.





**Instrument panel fuse panel**

Fuse Name	(A)	Circuit Protected
S/HEATER (FRT)	25A	Front Seat Warmer Control Module, Front Air Ventilation Seat Control Module
TRUNK	10A	ICU Junction Block (Trunk Lid Relay)
DOOR LOCK	20A	ICU Junction Block (Door Lock Relay, Door Unlock Relay, Two Turn Unlock Relay)
MODULE1	7.5A	Key Solenoid
MODULE3	10A	Driver Door Module, Passenger Seat Relax Unit, Hazard Switch, Crash Pad Switch (Up), Front Mood Lamp Unit, Start/stop Button Switch, Driver/Passenger Smart Key Outside Handle
S/HEATER (RR)	25A	Rear Seat Warmer Control Module
P/SEAT (PASS)	30A	Passenger Seat Manual Switch, Passenger Seat Relax Unit
MODULE6	10A	Driver Door Module
SAFETY P/WINDOW (RH)	30A	Passenger Safety Power Window Module, Rear Power Window Switch RH
P/SEAT (DRV)	30A	Driver Seat Manual Switch, Driver IMS Module
IBU1	15A	IBU, Driver/Passenger Door NFC Module, IAU, BLE Unit, Ignition Switch
AMP	25A	AMP, DC-DC Converter (AMP)
SAFETY P/WINDOW (LH)	30A	Driver Safety Power Window Module, Rear Power Window Switch LH
BRAKE SWITCH	10A	IBU, Stop Lamp Switch
SUNROOF2	20A	Panorama Sunroof, Data Link Connector
AIR BAG2	10A	SRS Control Module
AIR BAG1	15A	SRS Control Module, Passenger Occupant Detection Sensor
E-SHIFTER1	10A	SCU, Electronic ATM Shift Lever
MEMORY	10A	Driver IMS Module, Security Indicator, A/C Switch, Driver/Passenger Power Outside Mirror, A/C Control Module, Instrument Cluster, Rain Sensor, Head-Up Display

## Driver's side fuse panel

Fuse Name	(A)	Circuit Protected
MULTI MEDIA	15A	Audio, A/V & Navigation Head Unit, DC-DC Converter (AMP/Audio)
SUNROOF1	20A	Panorama Sunroof
MODULE7	10A	Front Console Switch, Lane Keeping Assist Unit, IBU, Crash Pad Switch (Up/Down), Parking Collision Avoidance Assist Unit, Remote Control Smart Parking Assist Unit
MODULE5	10A	Stop Lamp Switch
MODULE8	10A	Front Seat Warmer Control Module, Front Air Ventilation Seat Control Module, Passenger Seat Relax Unit, AMP, Rear Seat Warmer Control Module, Driver IMS Module, Audio, A/V & Navigation Head Unit
E-SHIFTER2	10A	SCU, Electronic ATM Shift Lever
MODULE2	10A	IAU, Parking Collision Avoidance Assist Unit, Cooling Fan Motor, Passenger Seat Relax Unit, Rear Seat Warmer Control Module
MDPS	7.5A	MDPS Unit
A/C	7.5A	A/C Control Module, A/C Switch, E/R Junction Block (Blower Relay, PTC Heater Relay)
MODULE4	10A	Front USB Charger, Rear USB Charger, AMP, IBU, IAU, Parking Collision Avoidance Assist Unit, Audio, DC-DC Converter (AMP/Audio), A/V & Navigation, Head Unit, Surround View Monitor Unit
MODULE9	7.5A	IBU
CLUSTER	10A	Instrument Cluster, Head-Up Display
WASHER	15A	Multifunction Switch
START	7.5A	PCM/ECM, E/R Junction Block (Start Relay), ICU Junction Block (B/Alarm Relay)
POWER OUTLET	20A	Front Power Outlet
IBU2	7.5A	IBU
A/BAG IND	7.5A	Instrument Cluster, Overhead Console Lamp (Lamp)

**Engine compartment fuse panel**

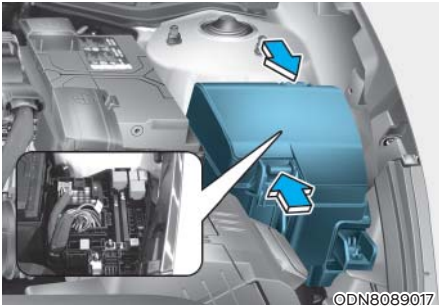

Inside the fuse/relay box cover, you can find the fuse/relay label describing fuse/relay names and ratings.

**i Information**

Not all fuse panel descriptions in this manual may be applicable to your vehicle; the information is accurate at the time of printing. When you inspect the fuse panel in your vehicle, refer to the fuse panel label.

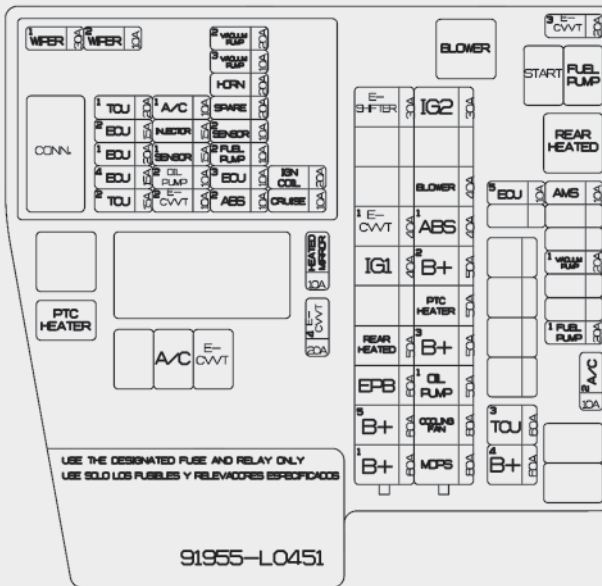

ODN8A089022

### Engine compartment fuse panel

Fuse Name		(A)	Circuit Protected
MULTI FUSE-1	IG2	30A	E/R Junction Block (Start Relay), PCB Block (IG2 Relay)
	BLOWER	40A	E/R Junction Block (Blower Relay)
	ABS1	40A	ESC Module
	B+2	50A	ICU Junction Block (IPS4, IPS3, IPS1, Fuse - AMP, IBU1)
	PTC HEATER	50A	E/R Junction Block (PTC Heater Relay)
	B+3	50A	ICU Junction Block (IPS5, IPS7, IPS9, IPS10, IPS8, IPS6)
	OIL PUMP1	50A	Electronic Oil Pump
	COOLING FAN	80A	Cooling Fan Motor
	MDPS	80A	MDPS Unit
MULTI FUSE-2	E-SHIFTER	30A	SCU
	E-CVVT1	40A	[G4FN] CVVD ACTUATOR [====] E/R Junction Block (E-CVVT Relay)
	IG1	40A	PCB Block (IG1 Relay, ACC Relay)
	REAR HEATED	50A	E/R Junction Block (Rear Heated Relay)
	EPB	60A	ESC Module
	B+5	60A	PCB Block (Engine Control Relay, Fuse - A/C1, WIPER1, TCU1, HORN, ECU2)
	B+1	60A	ICU Junction Block (Fuse - P/SEAT (DRV), P/SEAT (PASS), MODULE1, SAFETY P/WINDOW (LH), SAFETY P/WINDOW (RH), S/HEATER (RR))

**Engine compartment fuse panel**

Fuse Name		(A)	Circuit Protected
FUSE	HEATED MIRROR	10A	Driver/Passenger Power Outside Mirror, A/C Switch, A/C Control Module, ECM
	ECU5	10A	[G4FN] ECM
	AMS	10A	Battery Sensor
	FUEL PUMP 1	20A	E/R Junction Block (Fuel Pump Relay)
	A/C 2	10A	A/C Control Module
	B+4	60A	ICU Junction Block (Long Term Load Latch Relay, Fuse - MODULE3, AIR BAG2, E-SHIFTER1, SUNROOF1, SUNROOF2, S/HEATER (FRT), TRUNK, BRAKE SWITCH, DOOR LOCK)

## LIGHT BULBS

Consult an authorized HYUNDAI dealer to replace most vehicle light bulbs. It is difficult to replace vehicle light bulbs because other parts of the vehicle must be removed before you can get to the bulb. This is especially true for removing the headlamp assembly to get to the bulb(s).

Removing/installing the headlamp assembly can result in damage to the vehicle.

### **i** Information

The headlamp and tail lamp lenses could appear frosty if the vehicle is washed after driving or the vehicle is driven at night in wet weather. This condition is caused by temperature difference between the lamp inside and outside and, it does not indicate a problem with your vehicle. When moisture condenses in the lamp, it will be removed after driving with the headlamp on. The removable level may differ depending on lamp size, lamp position and environmental condition. However, if moisture is not removed, we recommend that your vehicle is inspected by an authorized HYUNDAI dealer.

### **!** WARNING

- Prior to replacing a lamp, depress the foot brake, move the shift button into P (Park) apply the parking brake, place the ignition switch to the LOCK/OFF position, and take the key with you when leaving the vehicle to avoid sudden movement of the vehicle and to prevent possible electric shock.
- Be aware the bulbs may be hot and may burn your fingers.

## Headlamp, Parking Lamp, Daytime Running Light, Turn Signal Lamp, Cornering Lamp and Side Marker

### Type A (LED)

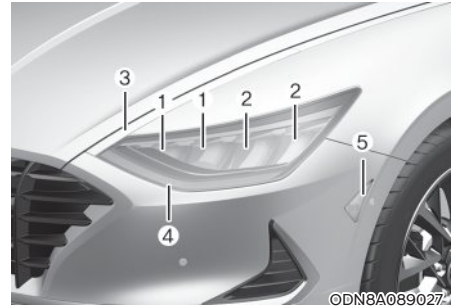

- (1) Headlamp (High)
- (2) Headlamp (Low)
- (3) Auxiliary lamp
- (4) Daytime running lamp (DRL)/Parking lamp/Turn signal lamp
- (5) Side marker

### Type B (LED)

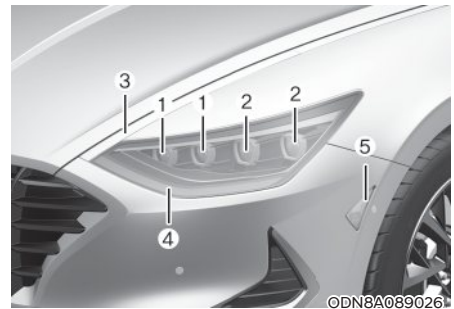

- (1) Headlamp (High) (with sub LOW)
- (2) Headlamp (Low)
- (3) Auxiliary lamp
- (4) Daytime running lamp (DRL)/Parking lamp/Turn signal lamp
- (5) Side marker

### Lamps

If the LED lamp does not operate, have the system checked by an authorized HYUNDAI dealer.

The LED lamps cannot be replaced as a single unit because it is an integrated unit. The LED lamps has to be replaced with the unit.

A skilled technician should check or repair the LED lamp, for it may damage related parts of the vehicle.

### Side Repeater Lamp Replacement (if equipped)



If the LED lamp (1) does not operate, have the system checked by an authorized HYUNDAI dealer.

The LED lamps cannot be replaced as a single unit because it is an integrated unit. The LED lamps has to be replaced with the unit.

A skilled technician should check or repair the LED lamp, for it may damage related parts of the vehicle.

### Rear Combination Light Bulb Replacement

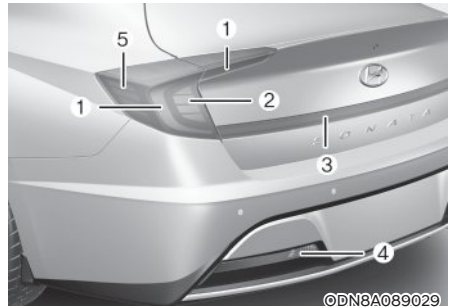

- (1) Tail lamp
- (2) Stop lamp & Turn signal lamp
- (3) Tail lamp
- (4) Back-up lamp
- (5) Side marker

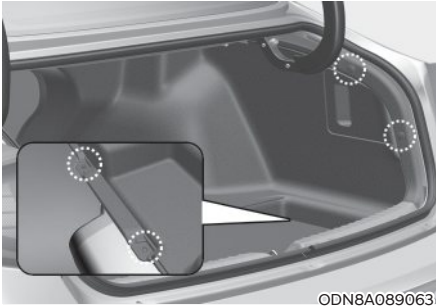

ODN8A089063

### Stop lamp (Bulb)

1. Open trunk lid and disconnect the negative battery cable.
2. Remove the luggage side trim.



ODN8089032

3. Remove the socket from the assembly by turning the socket counterclockwise until the tabs on the socket align with the slots on the assembly.
4. Remove the bulb from the socket by pressing it in and rotating it counterclockwise until the tabs on the bulb align with the slots in the socket. Pull the bulb out of the socket.
5. Insert a new bulb by inserting it into the socket and rotating it until it locks into place.
6. Install the socket in the assembly by aligning the tabs on the socket with the slots in the assembly. Push the socket into the assembly and turn the socket clockwise.

### Stop/Tail/Backup lamp and rear side marker (LED type)

If the LED lamp does not operate, have the vehicle checked by an authorized HYUNDAI dealer.

### Back up (bulb type)

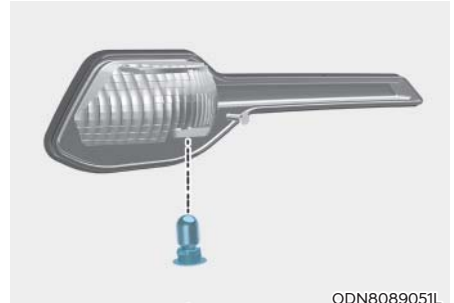

ODN8089051L

1. Disconnect the negative battery cable.
2. Remove the side under cover.
3. Remove the socket from the assembly by turning the socket counterclockwise until the tabs on the socket align with the slots on the assembly.
4. Remove the bulb from the socket by pulling it straight out.
5. Insert a new bulb by pushing it in into the socket.
6. Install the socket into the assembly by aligning the tabs on the socket with the slots in the assembly. Push the socket into the assembly and turn the socket clockwise.
7. Reinstall the lamp assembly to the body of the vehicle.



## High Mounted Stop Lamp Replacement

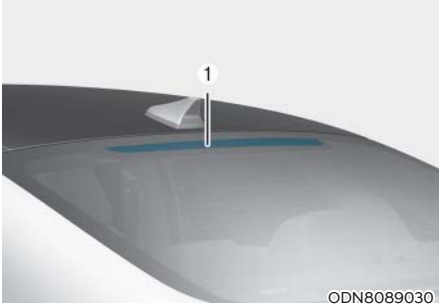

ODN8089030

If the LED lamp (1) does not operate, have the system checked by an authorized HYUNDAI dealer.

The LED lamps cannot be replaced as a single unit because it is an integrated unit. The LED lamps has to be replaced with the unit.

A skilled technician should check or repair the LED lamp, for it may damage related parts of the vehicle.

## License Plate Light Bulb Replacement

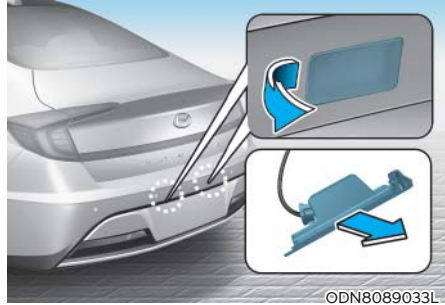

ODN8089033L

1. Loosen the lens retaining screws with a philips head screwdriver.
2. Remove the lens.
3. Remove the bulb by pulling it straight out.
4. Install a new bulb.
5. Reinstall the lens securely with the lens retaining screws.

## Interior Light Bulb Replacement

Map lamp, Room lamp, Vanity mirror lamp and trunk lamp (Bulb type)

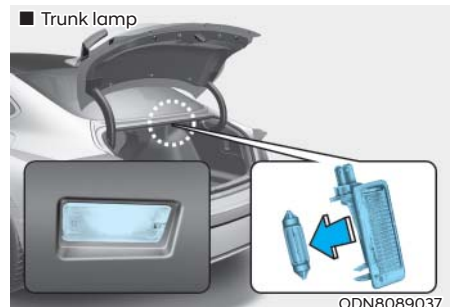
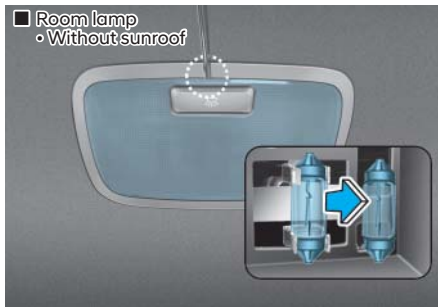
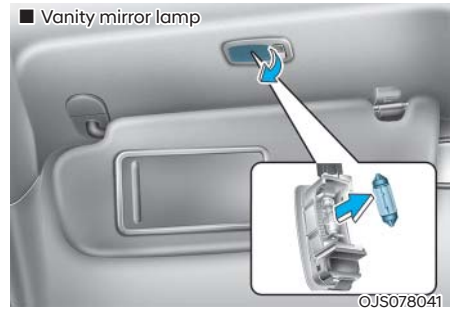
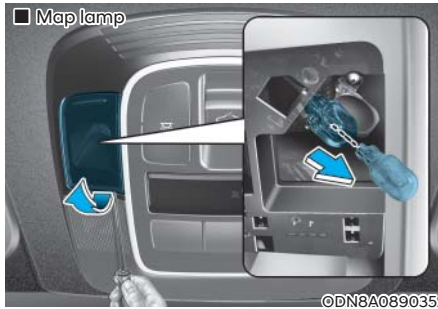

1. Using a flat-blade screwdriver, gently pry the lens from the interior lamp housing.
2. Remove the bulb by pulling it straight out.

### WARNING

Prior to working on the Interior Lights, ensure that the “OFF” button is depressed to avoid burning your fingers or receiving an electric shock.

3. Install a new bulb in the socket.
4. Align the lens tabs with the interior lamp housing notches and snap the lens into place.

### NOTICE

Use care not to dirty or damage lens, lens tab, and plastic housings.

### Map lamp and Room lamp (LED type)



If the LED lamp (1) does not operate, have the system checked by an authorized HYUNDAI dealer.

The LED lamps cannot be replaced as a single unit because it is an integrated unit. The LED lamps has to be replaced with the unit.

A skilled technician should check or repair the LED lamp, for it may damage related parts of the vehicle.

## APPEARANCE CARE

### Exterior Care

#### **Exterior general caution**

It is very important to follow the label directions when using any chemical cleaner or polish. Read all warning and caution statements that appear on the label.

#### **High-pressure washing**

- When using high-pressure washers, make sure to maintain sufficient distance from the vehicle. Insufficient clearance or excessive pressure can lead to component damage or water penetration.
- Do not spray the camera, sensors or its surrounding area directly with a high pressure washer. Shock applied from high pressure water may cause the device to not operate normally.
- Do not bring the nozzle tip close to boots (rubber or plastic covers) or connectors as they may be damaged if they come into contact with high pressure water.
- Do not use any high-pressure nozzles, which induce either one-direct water stream or water swirling.

#### **Protecting your vehicle's finish**

##### Washing

To help protect your vehicle's finish from rust and deterioration, wash it thoroughly and frequently at least once a month with lukewarm or cold water.

If you use your vehicle for off-road driving, you should wash it after each off-road trip. Pay special attention to the removal of any accumulation of salt, dirt, mud, and other foreign materials. Make sure the drain holes in the lower edges of the doors and rocker panels are kept clear and clean.

Insects, tar, tree sap, bird droppings, industrial pollution and similar deposits can damage your vehicle's finish if not removed immediately.

Even prompt washing with plain water may not completely remove all these deposits. A mild soap, safe for use on painted surfaces, should be used.

After washing, rinse the vehicle thoroughly with lukewarm or cold water. Do not allow soap to dry on the finish.



#### **WARNING**

**After washing the vehicle, test the brakes while driving slowly to see if they have been affected by water before getting on the road. If braking performance is impaired, dry the brakes by applying them lightly while maintaining a slow forward speed.**

#### **NOTICE**

- **Do not use strong soap, chemical detergents or hot water, and do not wash the vehicle in direct sunlight or when the body of the vehicle is warm.**
- **Be careful when washing the side windows of your vehicle. Especially, with high-pressure water, water may leak through the windows and wet the interior.**
- **To prevent damage to the plastic parts, do not clean with chemical solvents or strong detergents.**



**NOTICE**

- **Water washing in the engine compartment including high pressure water washing may cause the failure of electrical circuits located in the engine compartment.**
- **Never allow water or other liquids to come in contact with electrical/electronic components inside the vehicle as this may damage them.**

**NOTICE**

**Matte paint finish vehicle (if equipped)**  
Automatic car wash which uses rotating brushes should not be used as this can damage the surface of your vehicle. A steam cleaner which washes the vehicle surface at high temperature may cause oil to adhere and leave stains that is difficult to remove.

Use a soft cloth (e.g. microfiber towel or sponge) when washing your vehicle and dry with a microfiber towel. When you hand wash your vehicle, you should not use a cleaner that finishes with wax. If the vehicle surface is too dirty (sand, dirt, dust, contaminant, etc.), clean the surface with water before washing the car.

**Waxing**

A good coat of wax provides a barrier between your paint and environmental contamination.

Keeping a good coat of wax on your vehicle will help protect it.

Wax the vehicle when water will no longer bead on the paint.

Always wash and dry the vehicle before waxing. Use a good quality liquid or paste wax, and follow the manufacturer's instructions. Wax all metal trim to protect it and to maintain its luster.

Removing oil, tar, and similar materials with a spot remover will usually strip the wax from the finish. Be sure to re-wax these areas even if the rest of the vehicle does not yet need waxing.

**NOTICE**

- **Wiping dust or dirt off the body with a dry cloth will scratch the finish.**
- **Do not use steel wool, abrasive cleaners, or strong detergents containing highly alkaline or caustic agents on chrome-plated or anodized aluminum parts. This may result in damage to the protective coating and cause discoloration or paint deterioration.**

**NOTICE**

**Matte paint finish vehicle (if equipped)**  
Do not use any polish protector such as a detergent, an abrasive and a polish. In case wax is applied, remove the wax immediately using a silicon remover and if any tar or tar contaminant is on the surface use a tar remover to clean. However, be careful not to apply too much pressure on the painted area.

### **Repairing your vehicle's finish**

Deep scratches or stone chips in the painted surface must be repaired promptly. Exposed metal will quickly rust and may develop into a major repair expense.

#### **NOTICE**

**If your vehicle is damaged and requires any metal repair or replacement, be sure the body shop applies anti-corrosion materials to the parts repaired or replaced.**

#### **NOTICE**

**Matte paint finish vehicle (if equipped)**

**In case of matte paint finish vehicles, it is impossible to modify only the damaged area and repair of the whole part is necessary. If the vehicle is damaged and painting is required, we recommend that you have your vehicle maintained and repaired by an authorized HYUNDAI dealer. Take extreme care, as it is difficult to restore the quality after the repair.**

### **Bright-metal maintenance**

- To remove road tar and insects, use a tar remover, not a scraper or other sharp object.
- To protect the surfaces of bright metal parts from corrosion, apply a coating of wax or chrome preservative and rub to a high luster.
- During winter weather or in coastal areas, cover the bright metal parts with a heavier coating of wax or preservative. If necessary, coat the parts with non-corrosive petroleum jelly or other protective compound.

### **Underbody maintenance**

Corrosive materials used for ice and snow removal and dust control may collect on the underbody. If these materials are not removed, accelerated rusting can occur on underbody parts such as the fuel lines, frame, floor pan and exhaust system, even though they have been treated with rust protection.

Thoroughly flush the vehicle underbody and wheel openings with lukewarm or cold water once a month, after off-road driving and at the end of each winter. Pay special attention to these areas because it is difficult to see all the mud and dirt. It will do more harm than good to wet down the road grime without removing it. The lower edges of doors, rocker panels, and frame members have drain holes that should not be allowed to clog with dirt; trapped water in these areas can cause rusting.



#### **WARNING**

**After washing the vehicle, test the brakes while driving slowly to see if they have been affected by water. If braking performance is impaired, dry the brakes by applying them lightly while maintaining a slow forward speed.**

### **Aluminum wheel maintenance**

The aluminum wheels are coated with a clear protective finish.

### **NOTICE**

- **Do not use abrasive cleaner, polishing compound, solvent, or wire brushes on aluminum wheels.**
- **Clean the wheel when it has cooled.**
- **Use only a mild soap or neutral detergent, and rinse thoroughly with water. Also, clean the wheels after driving on salted roads.**
- **Do not wash the wheels with high-speed car wash brushes.**
- **Do not use any cleaners containing acid or alkaline detergents.**

### **Corrosion protection**

#### **Protecting your vehicle from corrosion**

By using the most advanced design and construction practices to combat corrosion, HYUNDAI produces vehicles of the highest quality. However, this is only part of the job. To achieve the long-term corrosion resistance your vehicle can deliver, the owner's cooperation and assistance is also required.

#### **Common causes of corrosion**

The most common causes of corrosion on your vehicle are:

- Road salt, dirt and moisture that is allowed to accumulate underneath the vehicle.
- Removal of paint or protective coatings by stones, gravel, abrasion or minor scrapes and dents which leave unprotected metal exposed to corrosion.

#### **High-corrosion areas**

If you live in an area where your vehicle is regularly exposed to corrosive materials, corrosion protection is particularly important. Some of the common causes of accelerated corrosion are road salts, dust control chemicals, ocean air and industrial pollution.

#### **Moisture breeds corrosion**

Moisture creates the conditions in which corrosion is most likely to occur. For example, corrosion is accelerated by high humidity, particularly when temperatures are just above freezing. In such conditions, the corrosive material is kept in contact with the car surfaces by moisture that is slow to evaporate.

Mud is particularly corrosive because it is slow to dry and holds moisture in contact with the vehicle. Although the mud appears to be dry, it can still retain the moisture and promote corrosion.

High temperatures can also accelerate corrosion of parts that are not properly ventilated so the moisture can be dispersed. For all these reasons, it is particularly important to keep your vehicle clean and free of mud or accumulations of other materials. This applies not only to the visible surfaces but particularly to the underside of the vehicle.

#### **To help prevent corrosion**

##### *Keep your vehicle clean*

The best way to prevent corrosion is to keep your vehicle clean and free of corrosive materials. Attention to the underside of the vehicle is particularly important.

- If you live in a high-corrosion area — where road salts are used, near the ocean, areas with industrial pollution, acid rain, etc.—, you should take extra care to prevent corrosion. In winter, hose off the underside of your vehicle at least once a month and be sure to clean the underside thoroughly when winter is over.

- When cleaning underneath the vehicle, pay particular attention to the components under the fenders and other areas that are hidden from view. Do a thorough job; just dampening the accumulated mud rather than washing it away will accelerate corrosion rather than prevent it. Water under high pressure and steam are particularly effective in removing accumulated mud and corrosive materials.
- When cleaning lower door panels, rocker panels and frame members, be sure that drain holes are kept open so that moisture can escape and not be trapped inside to accelerate corrosion.

#### *Keep your garage dry*

Don't park your vehicle in a damp, poorly ventilated garage. This creates a favorable environment for corrosion. This is particularly true if you wash your vehicle in the garage or drive it into the garage when it is still wet or covered with snow, ice or mud. Even a heated garage can contribute to corrosion unless it is well ventilated so moisture is dispersed.

#### *Keep paint and trim in good condition*

Scratches or chips in the finish should be covered with "touch-up" paint as soon as possible to reduce the possibility of corrosion. If bare metal is showing through, the attention of a qualified body and paint shop is recommended.

Bird droppings are highly corrosive and may damage painted surfaces in just a few hours. Always remove bird droppings as soon as possible.

## Interior Care

### **Interior general precautions**

Prevent caustic solutions such as perfume and cosmetic oil, from contacting the interior parts because they may cause damage or discoloration. If they do contact the interior parts, wipe them off immediately. See the instructions for the proper way to clean vinyl.

#### **NOTICE**

- **Never allow water or other liquids to come in contact with electrical/electronic components inside the vehicle as this may damage them.**
- **When cleaning leather products (steering wheel, seats etc.), use neutral detergents or low alcohol content solutions. If you use high alcohol content solutions or acid/alkaline detergents, the color of the leather may fade or the surface may get stripped off.**

### **Cleaning the upholstery and interior trim**

#### **Vinyl (if equipped)**

Remove dust and loose dirt from vinyl with a whisk broom or vacuum cleaner. Clean vinyl surfaces with a vinyl cleaner.

#### **Fabric (if equipped)**

Remove dust and loose dirt from fabric with a whisk broom or vacuum cleaner. Clean with a mild soap solution recommended for upholstery or carpets. Remove fresh spots immediately with a fabric spot cleaner. If fresh spots do not receive immediate attention, the fabric can be stained and its color can be affected. Also, its fire-resistant properties can be reduced if the material is not properly maintained.



### **NOTICE**

**Using anything but recommended cleaners and procedures may affect the fabric's appearance and fire-resistant properties.**

#### **Leather (if equipped)**

- Features of seat leather
  - Leather is made from the outer skin of an animal, which goes through a special process to be available for use. Since it is a natural product, each part differs in thickness or density.  
Wrinkles may appear as a natural result of stretching and shrinking depending on the temperature and humidity.
  - The seat is made of stretchable fabric to improve comfort.
  - The parts contacting the body are curved and the side supporting area is high which provides driving comfort and stability.
  - Wrinkles may appear naturally from usage. It is not a fault of the products.



### **CAUTION**

- **Wrinkles or abrasions which appear naturally from usage are not covered by warranty.**
  - **Belts with metallic accessories, zippers or keys inside the back pocket may damage the seat fabric.**
  - **Make sure not to wet the seat. It may change the nature of natural leather.**
  - **Jeans or clothes which could bleach may contaminate the surface of the seat covering fabric.**
- Caring for the leather seats
    - Vacuum the seat periodically to remove dust and sand on the seat. It will prevent abrasion or damage of the leather and maintain its quality.
    - Wipe the natural leather seat cover often with dry or soft cloth.
    - Use of proper leather protector may prevent abrasion of the cover and helps maintain the color. Be sure to read the instructions and consult a specialist when using leather coating or protective agent.
    - Light colored (beige, cream beige) leather is easily contaminated and the stain is noticeable. Clean the seats frequently.
    - Avoid wiping with wet cloth. It may cause the surface to crack.
  - Cleaning the leather seats
    - Remove all contaminations instantly. Refer to instructions below for removal of each contaminant.
    - Cosmetic products (sunscreen, foundation, etc.)  
Apply cleansing cream on a cloth and wipe the contaminated spot. Wipe off the cream with a wet cloth and remove water with a dry cloth.
    - Beverages (coffee, soft drink, etc.)  
Apply a small amount of neutral detergent and wipe until contaminations do not smear.
    - Oil  
Remove oil instantly with absorbable cloth and wipe with stain remover used only for natural leather.
    - Chewing gum  
Harden the gum with ice and remove gradually.

***Cleaning the seat belt webbing***

Clean the belt webbing with any mild soap solution recommended for cleaning upholstery or carpet. Follow the instructions provided with the soap. Do not bleach or re-dye the webbing because this may weaken the seat belt.

***Cleaning the interior window glass***

If the interior glass surfaces of the vehicle become hazy (that is, covered with an oily, greasy or waxy film), they should be cleaned with glass cleaner. Follow the directions on the glass cleaner container.

**NOTICE**

**Do not scrape or scratch the inside of the rear window. This may result in damage to the rear window defroster grid.**

**EMISSION CONTROL SYSTEM**

The emission control system of your vehicle is covered by a written limited warranty. Please see the warranty information contained in the Owner's Handbook & Warranty Information booklet in your vehicle.

Your vehicle is equipped with an emission control system to meet all applicable emission regulations. There are three emission control systems, as follows.

- (1) Crankcase emission control system
- (2) Evaporative emission control system
- (3) Exhaust emission control system

In order to ensure the proper function of the emission control systems, it is recommended that you have your vehicle inspected and maintained by an authorized HYUNDAI dealer in accordance with the maintenance schedule in this manual.

**NOTICE****For the Inspection and Maintenance Test (with Electronic Stability Control (ESC) system)**

- To prevent the vehicle from misfiring during dynamometer testing, turn the Electronic Stability Control (ESC) system off by pressing the ESC switch (ESC OFF light illuminated).
- After dynamometer testing is completed, turn the ESC system back on by pressing the ESC switch again.

## 1. Crankcase Emission Control System

The positive crankcase ventilation system is employed to prevent air pollution caused by blow-by gases being emitted from the crankcase. This system supplies fresh filtered air to the crankcase through the air intake hose. Inside the crankcase, the fresh air mixes with blow-by gases, which then pass through the PCV valve into the induction system.

## 2. Evaporative Emission Control System Including Onboard Refueling Vapor Recovery (ORVR)

The Evaporative Emission Control System is designed to prevent fuel vapors from escaping into the atmosphere. The ORVR system is designed to allow the vapors from the fuel tank to be loaded into a canister while refueling at the gas station, preventing the escape of fuel vapors into the atmosphere.

### **Canister**

Fuel vapors generated inside the fuel tank are absorbed and stored in the onboard canister. When the engine is running, the fuel vapors absorbed in the canister are drawn into the surge tank through the purge control solenoid valve.

### **Purge Control Solenoid Valve (PCSV)**

The purge control solenoid valve is controlled by the Engine Control Module (ECM); when the engine coolant temperature is low during idling, the PCSV closes so that evaporated fuel is not taken into the engine. After the engine warms-up during ordinary driving, the PCSV opens to introduce evaporated fuel to the engine.

## 3. Exhaust Emission Control System

The Exhaust Emission Control System is a highly effective system which controls exhaust emissions while maintaining good vehicle performance.

When the engine starts or fails to start, excessive attempts to restart the engine may cause damage to the emission system.

### **Engine exhaust (carbon monoxide) precautions**

- Carbon monoxide can be present with other exhaust fumes. If you smell exhaust fumes of any kind in your vehicle, drive with all the windows fully open. Have your vehicle checked and repaired immediately.

### **WARNING**

**Engine exhaust gases contain carbon monoxide (CO). Though colorless and odorless, it is dangerous and could be lethal if inhaled. Follow the instructions on this page to avoid CO poisoning.**

### **WARNING**

#### **CALIFORNIA PROPOSITION 65 WARNING**

**Engine exhaust and a wide variety of automobile components and parts, including components found in the interior furnishings in a vehicle, contain or emit chemicals known to the State of California to cause cancer and birth defects and reproductive harm. In addition, certain fluids contained in vehicles and certain products of component wear contain or emit chemicals known to the State of California to cause cancer and birth defects or other reproductive harm.**

- Do not operate the engine in confined or closed areas (such as garages) any more than what is necessary to move the vehicle in or out of the area.
- When the vehicle is stopped in an open area for more than a short time with the engine running, adjust the ventilation system (as needed) to draw outside air into the vehicle.
- Never sit in a parked or stopped vehicle for any extended time with the engine running.
- When the engine stalls or fails to start, excessive attempts to restart the engine may cause damage to the emission control system.

### ***Operating precautions for catalytic converters (if equipped)***



#### **WARNING**

**The exhaust system and catalytic converter are very hot during and immediately after the engine has been running. To avoid SERIOUS INJURY or DEATH:**

- **Do not park, idle, or drive the vehicle over or near flammable objects, such as grass, vegetation, paper, leaves, etc. A hot exhaust system can ignite flammable items under your vehicle.**
- **Keep away from the exhaust system and catalytic converter or you may get burned.**

**Also, do not remove the heat sink around the exhaust system, do not seal the bottom of the vehicle, and do not coat the vehicle for corrosion control. It may present a fire risk under certain conditions.**

Your vehicle is equipped with a catalytic converter emission control device.

To prevent damage to the catalytic converter and to your vehicle, take the following precautions:

- Use only UNLEADED FUEL for gasoline engines.
- Do not operate the vehicle when there are signs of engine malfunction, such as misfire or a noticeable loss of performance.
- Do not misuse or abuse the engine. Examples of misuse are coasting with the engine off and descending steep grades in gear with the engine off.
- Do not operate the engine at high idle speed for extended periods (5 minutes or more).
- Do not modify or tamper with any part of the engine or emission control system. All inspections and adjustments must be made by an authorized HYUNDAI dealer.
- Avoid driving with extremely low fuel level. If you run out of gasoline, it could cause the engine to misfire and result in excessive loading of the catalytic converter.

## **CALIFORNIA PERCHLORATE NOTICE**

Perchlorate Material-special handling may apply, See:  
[www.dtsc.ca.gov/hazardouswaste/perchlorate](http://www.dtsc.ca.gov/hazardouswaste/perchlorate).

Notice to California Vehicle Dismantlers:

Perchlorate containing materials, such as air bag inflators, seatbelt pretensioners and keyless remote entry batteries, must be disposed of according to Title 22 California Code of Regulations Section 67384.10 (a).

## CONSUMER INFORMATION

This consumer information has been prepared in accordance with regulations issued by the National Highway Traffic Safety Administration of the U.S. Department of Transportation. Your HYUNDAI dealer will help answer any questions you may have as you read this information.

HYUNDAI motor vehicles are designed and manufactured to meet or exceed all applicable safety standards.

For your safety, however, we strongly urge you to read and follow all directions in this Owner's Manual, particularly the information under the headings "**NOTICE**", "**CAUTION**" and "**WARNING**".

If, after reading this manual, you have any questions regarding the operation of your vehicle, please contact your nearest HYUNDAI Motor America Regional Office as listed in the following:

### **Eastern Region:**

Connecticut, Maine, Massachusetts,  
New Hampshire, New Jersey, New York,  
Pennsylvania, Rhode Island, Vermont.  
Eastern Region  
1122 Cranbury South River Road  
Jamesburg, NJ 08831  
(800) 633-5151

### **Mid Atlantic Region:**

Delaware, Maryland, North Carolina,  
Virginia, West Virginia  
Mid Atlantic  
1753 Pinnacle Drive, South Tower, Floor 11  
McLean, VA 22102  
(800) 633-5151

### **Southern Region:**

Alabama, Florida, Georgia, South  
Carolina, Tennessee  
West Virginia.  
Southern Region  
3025 Chastain Meadows Parkway Suite  
100 Marietta, GA 30066  
(800) 633-5151

### **South Central Region:**

Arkansas, Louisiana, Kansas, Mississippi,  
Missouri, Oklahoma, Texas.  
South Central Region  
1421 South Beltline Road, Suite 400  
Coppell, TX 75019  
(800) 633-5151

### **Central Region:**

Illinois, Indiana, Iowa, Kentucky,  
Michigan, Minnesota, Ohio, Wisconsin  
Central Region  
2 Trans Am Plaza Dr #500 Oakbrook  
Terrace, IL 60181  
(800) 633-5151

### **Western Region:**

Alaska, Hawaii, California,  
Nevada, Oregon, Washington  
Western Region  
10550 Talbert Avenue P.O.Box  
Fountain Valley, CA(800) 633-5151

### **Mountain States Region:**

Arizona, Colorado, Idaho, Montana,  
Nebraska, North Dakota, New Mexico,  
South Dakota, Utah, Wyoming  
(800) 633-5151

## REPORTING SAFETY DEFECTS

If you believe that your vehicle has a defect which could cause a crash or could cause injury or death, you should immediately inform the National Highway Traffic Safety Administration (NHTSA) in addition to notifying HYUNDAI MOTOR AMERICA.

To contact NHTSA, you may call the Vehicle Safety Hotline toll-free at 1-888-327-4236 (TTY: 1-800-424-9153);

go to <http://www.safercar.gov>;

download the SaferCar mobile application;

or write to: Administrator, NHTSA

1200 New Jersey Ave, SE,

West Building Washington, D.C. 20590.

You can also obtain other information about motor vehicle safety from <http://www.safercar.gov>.

If NHTSA receives similar complaints, it may open an investigation, and if it finds that a safety defect exists in a group of vehicles, it may order a recall and remedy campaign. However, NHTSA cannot become involved in individual problems between you, your dealer, or HYUNDAI MOTOR AMERICA.

# Index

---



**A**

Air bag warning labels.....	3-57
Air bags.....	3-37
Driver's air bag .....	3-39
Passenger's front air bag .....	3-39
Side air bags .....	3-40
Curtain air bags .....	3-41
How does the air bags system operate?.....	3-42
SRS components and functions.....	3-42
SRS warning light .....	3-43
What to expect after an air bag inflates.....	3-46
Occupant Classification System (OCS) .....	3-47
Why didn't my air bag go off in a collision .....	3-52
Air bag collision sensors .....	3-53
Air bag inflation conditions .....	3-54
Air bag non-inflation conditions .....	3-54
SRS Care .....	3-56
Additional safety precautions.....	3-57
Air bag warning labels .....	3-57
Air cleaner .....	8-26
Air cleaner filter replacement .....	8-26
Air conditioning system specification .....	2-10
Antenna.....	5-152
Anti-lock Brake System (ABS) .....	6-27
Appearance care.....	8-61
Exterior care .....	8-61
Interior care .....	8-65
Armrest .....	3-11
Audio / Video / Navigation system.....	5-154
Auto defogging system.....	5-141
AUTO headlamp position.....	5-74
Auto LOCK - Enable on shift.....	5-34
Auto LOCK - Enable on speed.....	5-34
Auto UNLOCK - Enable on shift .....	5-34
Auto UNLOCK -Air bag deployment .....	5-34
Automatic climate control system .....	5-127
Automatic heating and air conditioning.....	5-128
Manual temperature control mode .....	5-129

Mode selection .....	5-130
Instrument panel vents .....	5-132
Temperature control .....	5-132
Air intake control .....	5-133
Fan speed control .....	5-134
Air conditioning .....	5-134
OFF mode.....	5-134
System operation.....	5-135
System maintenance.....	5-136
Air conditioning refrigerant label.....	5-137
Automatic transmission .....	6-13
Transmission ranges.....	6-14
Paddle shifter (manual shift mode) .....	6-19
Shift-lock system.....	6-15
Good driving practices .....	6-18
Parking .....	6-16
Automatic ventilation .....	5-143
AUX, USB and iPod® port .....	5-152

## B

Battery .....	8-31
Battery recharging.....	8-32
Battery saver function.....	5-79
Before driving.....	6-5
Blind-Spot Collision Warning (BCW).....	6-67
Blind-Spot Collision-Avoidance Assist (BCA) .....	6-67
Blind-Spot View Monitor (BVM) .....	6-87
Blue Link® center.....	5-154
Bluetooth® Wireless Technology hands-free .....	5-154
Brake fluid .....	8-24
Brake system.....	6-20
Power brakes .....	6-20
Disc brakes wear indicator .....	6-20
Electronic Parking Brake (EPB) .....	6-21
Auto Hold.....	6-24
Anti-lock Brake System (ABS).....	6-27
Electronic Stability Control (ESC).....	6-29
Vehicle Stability Management (VSM).....	6-31
Good braking practices .....	6-32

Bulb replacement .....	8-55
Headlamp .....	8-55
Parking lamp .....	8-55
Daytime running light .....	8-55
Turn signal lamp.....	8-55
Cornering lamp .....	8-55
Side marker .....	8-55
Auxiliary lamp .....	8-55
Side repeater lamp.....	8-56
Rear combination light bulb.....	8-56
High mounted stop lamp .....	8-58
License plate light .....	8-58
Interior light .....	8-59
Bulb wattage .....	2-8

## C

California perchlorate notice .....	8-70
Capacities (Lubricants).....	2-11
Care	
Tire care.....	8-34
Exterior care .....	8-61
Interior care .....	8-65
Center console storage.....	5-144
Central door lock/unlock switch.....	5-33
Certification label .....	2-13
Check tire inflation pressure.....	8-35
Child restraint system (CRS).....	3-29
Selecting a child restraint system (CRS).....	3-30
Rearward-facing child restraint system.....	3-30
Forward-facing child restraint system.....	3-31
Booster seats.....	3-31
Installing a child restraint system (CRS) .....	3-31
Lower anchors and tether for Children (LATCH System).....	3-32
Lower anchors .....	3-33
Tether anchors .....	3-34
Lap/shoulder belt.....	3-35
Child-protector rear door lock .....	5-35
Climate control air filter .....	8-28

Clock.....	5-150
Clothes hanger.....	5-150
Crankcase emission control system.....	8-68
Cup holder.....	5-145
Curtain air bags.....	3-41

## D

Daytime running light (DRL).....	5-74
Defroster.....	5-142
Dimensions.....	2-7
Door locks.....	5-31
Central door lock/unlock switch.....	5-33
Child-protector rear door lock.....	5-35
Auto door lock/unlock features.....	5-34
Operating door locks from outside the vehicle.....	5-31
Operating door locks from inside the vehicle.....	5-32
Rear Occupant Alert (ROA) system.....	5-36
Drive mode integrated control system.....	6-37
Drive mode.....	6-37
Driver Attention Warning (DAW).....	6-79
Leading vehicle departure alert.....	6-84
Driver position memory system.....	5-39
Storing positions into memory.....	5-39
Easy access function.....	5-41
Driver's air bag.....	3-39
Driving at night.....	6-134
Driving in flooded areas.....	6-135
Driving in the rain.....	6-134

## E

Electric Power Steering (EPS).....	5-42
Electronic Stability Control (ESC).....	6-29
Emergency towing.....	7-19
Emergency trunk safety release.....	5-66

Emission control system.....	8-67
Crankcase emission control system .....	8-68
Evaporative emission control System .....	8-68
Exhaust emission control system .....	8-68
Engine compartment.....	2-6, 8-3
Engine compartment panel fuse replacement .....	8-48
Engine coolant .....	8-21
Engine coolant temperature gauge.....	4-4
Engine number.....	2-14
Engine oil.....	8-19
Engine specification.....	2-7
Engine Start/Stop button.....	6-9
Evaporative emission control System.....	8-68
Event Data Recorder (EDR) .....	1-8
Exhaust emission control system.....	8-68
Explanation of scheduled maintenance items.....	8-16
Exterior care.....	8-61
Exterior features.....	5-64
Hood.....	5-64
Trunk .....	5-65
Emergency trunk safety release.....	5-66
Fuel Filler Door.....	5-70
Exterior overview	
Front view .....	2-2
Rear view .....	2-3
<b>F</b>	
Flat tire.....	7-12
Changing spare tire .....	7-12
Floor mat anchor(s).....	5-151
Fluid	
Brake fluid.....	8-24
Washer fluid .....	8-25
Forward Collision-Avoidance Assist (FCA) .....	6-40
FCA-Junction Turning function .....	6-55
Forward/Reverse Parking Distance Warning (PDW) .....	5-99

Front seat adjustment.....	3-5
Manual adjustment.....	3-5
Power adjustment.....	3-7
Reclining seatback.....	3-8
Front seat head restraints	
Adjusting the height up and down.....	3-12
Removal/Reinstallation.....	3-13
Fuel Filler Door.....	5-70
Fuel gauge.....	4-4
Fuel requirements.....	1-5
Fuel additives.....	1-6
Fuses.....	8-46
Instrument panel fuse replacement.....	8-47
Engine compartment panel fuse replacement.....	8-48
Fuse/relay panel description.....	8-49

## G

Gauges and meters.....	4-3
Glove box.....	5-144
Guide to Hyundai genuine parts.....	1-3

## H

Hazard warning flasher.....	7-2
Hazardous driving conditions.....	6-133
Head restraints.....	3-11
Front seat head restraints.....	3-12
Rear seat restraints.....	3-14
Headlamp delay function.....	5-79
Headlamp leveling device.....	5-80
Headlamp position.....	5-75
Head-up display (HUD).....	5-72
Heated steering wheel.....	5-44
High Beam Assist (HBA).....	5-76
High beam operation.....	5-75
Highway driving.....	6-135
Highway Driving Assist (HDA).....	6-115
Hill-start assist control (HAC).....	6-32
HomeLink® system.....	5-47
Hood.....	5-64

Horn .....	5-45
How to use this manual .....	1-4
Hyundai digital key.....	5-15
Digital key application .....	5-15
Digital key (smartphone) NFC function .....	5-15
Digital key (smartphone).....	5-16
Digital key (card key).....	5-23

**I**

If the engine doesn't turn over or turns over slowly.....	7-3
If the engine overheats.....	7-6
If the engine stalls at a crossroad or crossing .....	7-2
If the engine stalls while driving .....	7-2
If the engine turns over normally but doesn't start.....	7-3
If the engine will not start.....	7-3
If you have a flat tire while driving .....	7-3
Ignition switch .....	6-6
Key ignition switch .....	6-6
Engine Start/Stop button .....	6-9
Remote start .....	6-12
Immobilizer system .....	5-14
Important safety precautions.....	3-2
Always wear your seat belt .....	3-2
Restrain all children .....	3-2
Air bag hazards .....	3-2
Driver distraction .....	3-2
Control your speed.....	3-2
Keep your vehicle in safe condition.....	3-2
In case of emergency while driving.....	7-2
Infotainment system.....	5-152
AUX, USB and iPod® port.....	5-152
Antenna .....	5-152
Steering wheel audio controls .....	5-153
Bluetooth® Wireless Technology hands-free.....	5-154
Audio / Video / Navigation system .....	5-154
Blue Link® center .....	5-154
Inside rearview mirror .....	5-46

Instrument cluster .....	4-2
Instrument cluster illumination .....	4-3
Gauges and meters .....	4-3
Transmission shift indicator .....	4-6
Warning and indicator lights .....	4-7
LCD display messages .....	4-15
LCD display (Type A, B) .....	4-19
LCD display (Type C) .....	4-34
Instrument panel fuse replacement .....	8-47
Instrument panel overview .....	2-5
Interior care .....	8-65
Interior features .....	5-145
Cup holder .....	5-145
Sunvisor .....	5-146
Power outlet .....	5-146
USB charger .....	5-147
Wireless cellular phone charging system .....	5-148
Clock .....	5-150
Clothes hanger .....	5-150
Floor mat anchor(s) .....	5-151
Interior lights .....	5-80
Front lamps .....	5-81
Rear lamps .....	5-81
Luggage compartment lamp .....	5-82
Vanity mirror lamp .....	5-82
Interior overview .....	2-4
ISG (Idle Stop and Go) system .....	6-33

## J

Jack and tools .....	7-12
Jump starting .....	7-4

## K

Key ignition switch .....	6-6
---------------------------	-----



## L

Label	
Vehicle certification label.....	2-13
Tire specification and pressure label.....	2-14
Refrigerant label.....	2-15
Lane change signals.....	5-79
Lane Following Assist (LFA).....	6-109
Lane Keeping Assist (LKA).....	6-59
LCD display (Type A, B).....	4-19
LCD display control.....	4-19
LCD display modes.....	4-20
Trip computer.....	4-31
LCD display (Type C).....	4-34
LCD display control.....	4-34
View modes.....	4-35
Utility view mode.....	4-36
Option menu.....	4-38
User settings mode.....	4-39
LCD display messages.....	4-15
Shift to P or N to start engine.....	4-15
Shift to P.....	4-15
Low key battery.....	4-15
Press brake pedal to start engine.....	4-15
Key not in vehicle.....	4-16
Key not detected.....	4-16
Press START button again.....	4-16
Press START button with key.....	4-16
Battery discharging due to external electrical devices.....	4-16
Check BRAKE SWITCH fuse.....	4-16
Door, Hood, Trunk open indicator.....	4-17
Sunroof open indicator.....	4-17
Lights mode.....	4-17
Wiper mode.....	4-18
Low pressure.....	4-17

LCD display modes .....	4-20
Trip computer mode .....	4-21
Turn By Turn (TBT) mode .....	4-21
Driving assist mode .....	4-21
Master warning mode .....	4-22
User settings mode .....	4-22
Light .....	5-74
AUTO headlamp position .....	5-74
Daytime running light (DRL) .....	5-74
Parking lamp position .....	5-75
Headlamp position .....	5-75
High beam operation .....	5-75
High Beam Assist (HBA) .....	5-76
Turn signals .....	5-79
Lane change signals .....	5-79
Battery saver function .....	5-79
Headlamp delay function .....	5-79
Headlamp leveling device .....	5-80
Light bulbs .....	8-55
Lubricants and capacities .....	2-11
Luggage compartment lamp .....	5-82

## M

Maintenance	
Maintenance services .....	8-4
Owner maintenance .....	8-5
Scheduled maintenance services .....	8-7
Normal maintenance schedule .....	8-8,12
Maintenance under severe usage conditions .....	8-11,15
Explanation of scheduled maintenance items .....	8-16
Tire maintenance .....	8-38
Maintenance services .....	8-4

Manual climate control system.....	5-118
Heating and air conditioning.....	5-119
Mode selection.....	5-120
Instrument panel vents.....	5-122
Temperature control.....	5-122
Air intake control.....	5-122
Fan speed control.....	5-123
Air conditioning.....	5-123
System operation.....	5-124
System maintenance.....	5-125
Air conditioning refrigerant label.....	5-126
Mirrors.....	5-46
Inside rearview mirror.....	5-46
HomeLink® system.....	5-47
Side view mirrors.....	5-53
Adjusting the side view mirrors.....	5-54
Folding the side view mirrors.....	5-54
Reverse parking aid function.....	5-55

## N

Navigation-based Smart Cruise Control (NSCC).....	6-105
---	-------

## O

Occupant Classification System (OCS).....	3-47
Odometer.....	4-5
Oil (Engine).....	8-19
Outside temperature gauge.....	4-5
Owner maintenance.....	8-5

## P

Panoramic sunroof.....	5-60
Parking lamp position.....	5-75
Passenger's front air bag.....	3-39
Power brakes.....	6-20
Power outlet.....	5-146
Power window lock switch.....	5-59
Pre-tensioner seat belt.....	3-24
Retractor pretensioner.....	3-24

**R**

Range .....	4-6
Rear Cross-Traffic Collision Warning (RCCW).....	6-121
Rear Cross-Traffic Collision Avoidance Assist (RCCA).....	6-121
Rear Occupant Alert (ROA) system .....	5-36
Rear seat adjustment .....	3-10
Folding the rear seat .....	3-10
Rear seat head restraints .....	3-14
Adjusting the height up and down .....	3-14
Rear View Monitor (RVM).....	5-86
Recommended cold tire inflation pressures.....	8-34
Recommended lubricants and capacities .....	2-11
Refrigerant label .....	2-15
Remote key .....	5-4
Locking .....	5-4
Unlocking .....	5-4
Trunk unlocking .....	5-5
Mechanical key .....	5-5
Battery replacement .....	5-6
Remote Smart Parking Assist (RSPA) .....	5-104
Remote start .....	6-12
Reverse Parking Collision-Avoidance Assist (PCA).....	5-89
Reverse Parking Distance Warning (PDW).....	5-95
Rocking the vehicle .....	6-133
Rotation (Tire) .....	8-36

**S**

Safety messages .....	1-4
Scheduled maintenance services.....	8-7
Seat belt warning light	
Driver's seat .....	3-20
Front passenger's seat .....	3-20

Seat belts .....	3-19
Seat belt safety precautions .....	3-19
Seat belt warning light .....	3-20
Emergency locking retractor .....	3-21
Convertible locking retractor .....	3-22
Rear center seat belt .....	3-23
Pre-tensioner seat belt .....	3-24
Additional seat belt safety precautions .....	3-26
Seat belt use during pregnancy .....	3-26
Seat belt use and children.....	3-26
Transporting an injured person .....	3-27
One person per belt .....	3-27
Do not lie down.....	3-27
Care of seat belts .....	3-28
Periodic inspection.....	3-28
Keep belts clean and dry .....	3-28
When to replace seat belts.....	3-28
Seat warmers and air ventilation seats.....	3-14
Front seat warmers .....	3-15
Front air ventilation seat.....	3-17
Seatback pocket .....	3-9
Seats .....	3-3
Safety precautions .....	3-4
Front seat adjustment .....	3-5
Rear seat adjustment .....	3-10
Head restraints.....	3-11
Front seat warmers .....	3-14
Side air bags.....	3-40
Side view mirrors.....	5-53
Smart Cruise Control (SCC).....	6-88
Smart key .....	5-7
Locking .....	5-7
Unlocking.....	5-9
Trunk opening .....	5-10
Mechanical key .....	5-12
Battery replacement .....	5-13

Smooth cornering .....	6-134
Snow tires .....	6-136
Spare tire .....	7-12
Special driving conditions	
Hazardous driving conditions .....	6-133
Rocking the vehicle .....	6-133
Smooth cornering .....	6-134
Driving at night .....	6-134
Driving in the rain .....	6-134
Driving in flooded areas .....	6-135
Highway driving .....	6-135
Speedometer .....	4-3
Steering wheel .....	5-42
Electric Power Steering (EPS) .....	5-42
Tilt steering / Telescope steering .....	5-43
Heated steering wheel .....	5-44
Horn .....	5-45
Steering wheel audio controls .....	5-153
Storage compartment .....	5-144
Center console storage .....	5-144
Glove box .....	5-144
Sunroof inside air recirculation .....	5-143
Sunvisor .....	5-146
Surround View Monitor (SVM) .....	5-88

## T

Tachometer .....	4-3
Theft-alarm system .....	5-38
Tilt steering / Telescope steering .....	5-43
Tire chains .....	6-136
Tire pressure monitoring system (TPMS) .....	7-7
Tire rotation .....	8-36
Tire specification and pressure label .....	2-14

Tires and wheels .....	2-9, 8-34
Tire care.....	8-34
Recommended cold tire inflation pressures .....	8-34
Check tire inflation pressure .....	8-35
Tire rotation.....	8-36
Wheel alignment and tire balance .....	8-36
Tire replacement.....	8-37
Wheel replacement.....	8-38
Tire maintenance .....	8-38
Tire traction .....	8-38
Tire sidewall labeling .....	8-38
Tire terminology and definitions.....	8-42
All Season Tires .....	8-44
Summer Tires .....	8-44
Snow Tires.....	8-44
Radial-Ply Tires.....	8-45
Low Aspect Ratio Tires.....	8-45
Towing .....	7-18
Trailer towing .....	6-144
Trip computer .....	4-31
Average fuel economy.....	4-31
Instant fuel economy .....	4-31
Accumulated Info display .....	4-32
Driving Info display .....	4-32
Digital speedometer .....	4-33
Auto Stop accumulated time .....	4-33
Smart shift .....	4-33
Trunk.....	5-65
Turn signals.....	5-79

**U**

USB charger.....	5-147
------------------	-------

## V

Vanity mirror lamp.....	5-82
Vehicle break-in process.....	1-7
Vehicle certification label.....	2-13
Vehicle identification number (VIN).....	2-13
Vehicle load limit.....	6-139
Tire loading information label.....	6-139
Vehicle modification.....	1-7
Vehicle Stability Management (VSM).....	6-31
Vehicle weight and luggage volume.....	2-10

## W

Warning and indicator lights.....	4-7
Air bag warning light.....	4-7
Seat belt warning light.....	4-7
Parking brake & brake fluid warning light.....	4-8
Anti-lock Brake System (ABS) warning light.....	4-9
Electronic brake force distribution (EBD) system warning light.....	4-9
Electric Power Steering (EPS) warning light.....	4-9
AUTO HOLD indicator light.....	4-10
Electric Power Steering (EPS) warning light.....	4-10
Malfunction Indicator lamp (MIL).....	4-10
Charging system warning light.....	4-11
Engine oil pressure warning light.....	4-11
Low fuel level warning light.....	4-11
Master warning light.....	4-11
Low tire pressure warning light.....	4-11
Electronic stability control (ESC) indicator light.....	4-11
Electronic stability control (ESC) OFF indicator light.....	4-13
Immobilizer indicator light.....	4-13
Turn signal indicator light.....	4-14
Headlamp warning light.....	4-14
High beam indicator light.....	4-14
High Beam Assist (HBA) indicator light.....	4-14
Light ON indicator light.....	4-14
Forward Collision-Avoidance Assist warning light.....	4-15
Lane Keeping Assist indicator light.....	4-15
Washer fluid.....	8-25



Welcome system .....	5-83
Welcome light .....	5-83
Interior lamp.....	5-83
Wheel alignment and tire balance.....	8-36
Wheel replacement .....	8-38
Windows .....	5-56
Power windows .....	5-56
Auto up/down window.....	5-56
Automatic reverse .....	5-58
Power window lock switch .....	5-59
Windshield defrosting and defogging.....	5-138
Windshield washers .....	5-85
Windshield wipers .....	5-84
Winter driving.....	6-136
Snow tires.....	6-136
Tire chains.....	6-136
Winter Precautions.....	6-137
Wiper blades replacement.....	8-29
Wipers and washers .....	5-84
Windshield wipers .....	5-84
Windshield washers .....	5-85
Wireless cellular phone charging system.....	5-148