

# FORD **BRONCO** Owner's Manual

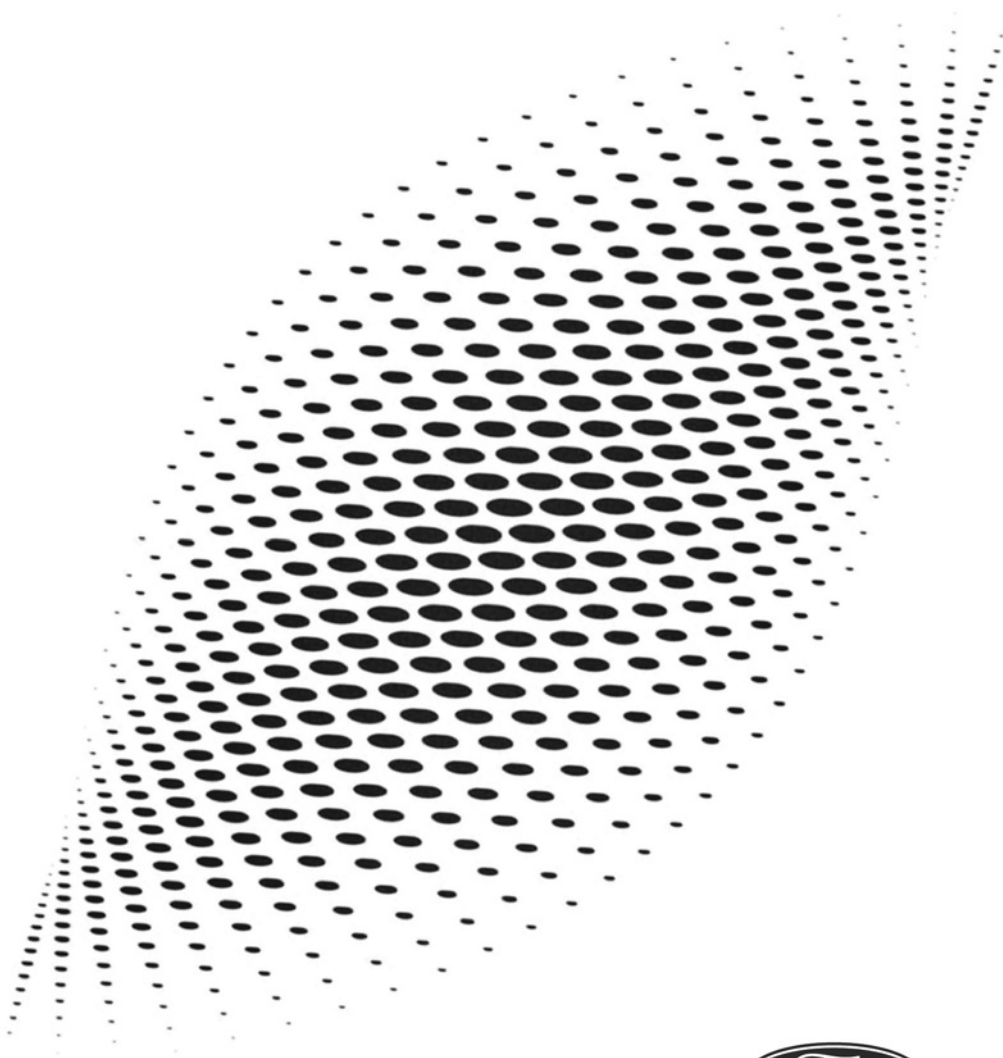



The information contained in this publication was correct at the time of release. In the interest of continuous development, we reserve the right to change specifications, design or equipment at any time without notice or obligation. No part of this publication may be reproduced, transmitted, stored in a retrieval system or translated into any language in any form by any means without our written permission. Errors and omissions excepted.

© Ford Motor Company 2024

All rights reserved.

Part Number: -202408-20240822172031

## California Proposition 65



**WARNING:** Operating, servicing and maintaining a passenger vehicle or off-highway motor vehicle can expose you to chemicals including engine exhaust, carbon monoxide, phthalates, and lead, which are known to the State of California to cause cancer and birth defects or other reproductive harm. To minimize exposure, avoid breathing exhaust, do not idle the engine except as necessary, service your vehicle in a well-ventilated area and wear gloves or wash your hands frequently when servicing your vehicle. For more information go to [www.P65Warnings.ca.gov/passenger-vehicle](http://www.P65Warnings.ca.gov/passenger-vehicle).



**WARNING:** Battery posts, terminals and related accessories contain lead and lead compounds, chemicals known to the State of California to cause cancer and reproductive harm.  
**Wash your hands after handling.**



# Table of Contents

## About Us - Raptor

SVT .....	15
Team RS .....	15
Ford Performance .....	15

## Contacting Us

Contacting Us .....	16
---------------------	----

## Introduction

About This Publication .....	18
Using This Publication .....	19

## Symbols Glossary

Symbols Used on Your Vehicle .....	20
Symbols Used On Your Instrument Cluster .....	22

## Data Privacy

Data Privacy .....	26
Service Data .....	27
Event Data .....	27
Settings Data .....	28
Connected Vehicle Data .....	28
Mobile Device Data .....	29
Emergency Call System Data .....	29

## Environment

Protecting the Environment .....	30
----------------------------------	----

## Visual Search

Interior Overview .....	31
Exterior Overview - Excluding: Raptor .....	32
Exterior Overview - Raptor .....	33

## Unique Features - Raptor

Unique Features .....	34
-----------------------	----

## Child Safety

Child Safety Precautions .....	36
--------------------------------	----

Child Restraint Anchor Points .....	37
Child Restraints .....	38
Installing Child Restraints .....	40
Booster Seats .....	44
Child Safety Locks - 5-Door .....	46

## Seatbelts

Seatbelt Precautions .....	48
Fastening and Unfastening the Seatbelts .....	49
Sensitive Locking Mode .....	50
Automatic Locking Mode .....	50
Adjusting the Seatbelts During Pregnancy .....	51
Seatbelt Reminder .....	51
Checking the Seatbelts .....	53
Seatbelt Extensions .....	53

## Personal Safety System™

What Is the Personal Safety System .....	55
How Does the Personal Safety System Work .....	55
Personal Safety System Components .....	55

## Airbags

How Do the Front Airbags Work .....	56
How Do the Side Airbags Work .....	56
How Does the Safety Canopy™ Work .....	57
Airbag Precautions .....	58
Properly Adjusting the Driver and Front Passenger Seats .....	59
Children and Airbags .....	59
Front Passenger Sensing System .....	60
Crash Sensors and Airbag Indicator .....	63
Disposing of Airbags .....	64

## 911 Assist

What Is 911 Assist .....	65
--------------------------	----

# Table of Contents

---

How Does 911 Assist Work .....	65
Emergency Call Requirements .....	65
Emergency Call Limitations .....	66

## Keys and Remote Controls

Remote Control Limitations .....	67
Using the Remote Control .....	67
Removing the Key Blade .....	68
Sounding the Panic Alarm .....	68
Locating Your Vehicle .....	68
Changing the Remote Control Battery .....	68
Replacing a Lost Key or Remote Control .....	69
Programming the Remote Control .....	70
Keys and Remote Controls – Troubleshooting .....	70

## Doors and Locks

Operating the Doors From Outside Your Vehicle .....	71
Operating the Doors From Inside Your Vehicle .....	71
Autounlock .....	71
Autolock .....	71
Mislock .....	72
Doors and Locks – Troubleshooting .....	72

## Keyless Entry

What Is Keyless Entry .....	74
Keyless Entry Limitations .....	74
Keyless Entry Settings .....	74
Using Keyless Entry .....	74
Keyless Entry – Troubleshooting .....	75

## Tailgate

Tailgate Precautions .....	76
Opening the Tailgate .....	76
Closing the Tailgate .....	76
Locking and Unlocking the Tailgate .....	76

Slide Out Tailgate .....	78
Tailgate – Troubleshooting .....	78

## Security

Passive Anti-Theft System .....	80
Anti-Theft Alarm System .....	80
Security – Troubleshooting .....	81

## Steering Wheel

Adjusting the Steering Wheel .....	83
Horn .....	83
Switching the Heated Steering Wheel On and Off - Vehicles With: Heated Steering Wheel .....	83

## Wipers and Washers

Wipers .....	84
Switching the Rear Window Wiper On and Off .....	84
Reverse Wipe .....	84
Checking the Wiper Blades .....	85
Replacing the Front Wiper Blades .....	85
Replacing the Rear Wiper Blades .....	86
Washers .....	86
Wipers and Washers Videos .....	88
Wipers and Washers – Troubleshooting .....	88

## Exterior Lighting

Exterior Lighting Control .....	89
Headlamps .....	89
Headlamps – Troubleshooting .....	90
Autolamps .....	90
Exterior Lamps .....	91
Exterior Zone Lighting .....	93
Automatic High Beam Control .....	94
Automatic High Beam Control – Troubleshooting .....	96
Exterior Lighting Videos .....	96

# Table of Contents

## Interior Lighting

Switching All of the Interior Lamps On and Off .....	97
Switching the Front Interior Lamps On and Off .....	97
Switching the Rear Interior Lamps On and Off .....	97
Interior Lamp Function .....	97
Adjusting the Instrument Panel Lighting Brightness .....	98
Ambient Lighting - Vehicles With: Ambient Lighting .....	98
Interior Lighting – Troubleshooting .....	98

## Windows

Opening and Closing the Windows .....	99
Global Opening .....	100
Window Bounce-Back .....	100
Locking the Rear Window Controls .....	100
Using Short Drop Windows .....	101

## Interior Mirror

Interior Mirror Precautions .....	102
Manually Dimming the Interior Mirror .....	102
Auto-Dimming Interior Mirror .....	102
Digital Interior Mirror - Vehicles With: Digital Interior Mirror .....	102

## Exterior Mirrors

Adjusting the Exterior Mirrors .....	104
Folding the Exterior Mirrors .....	104

## Instrument Cluster

Instrument Cluster Overview - Excluding: Raptor .....	105
Instrument Cluster Overview - Raptor .....	106
Tachometer .....	106
Speedometer .....	106
Fuel Gauge .....	106

Engine Coolant Temperature Gauge .....	107
Transmission Fluid Temperature Gauge - Automatic Transmission .....	107
Turbo Boost Gauge .....	107
12V Battery Gauge .....	107

## Instrument Cluster Display

Using the Instrument Cluster Display Controls .....	108
Instrument Cluster Display Main Menu - Excluding: Raptor .....	108
Instrument Cluster Display Main Menu - Raptor .....	109
Customizing the Instrument Cluster Display .....	109

## Trip Computer

Accessing the Trip Computer .....	110
Resetting the Trip Computer .....	110

## Remote Start

Using Remote Start .....	111
Remote Start Settings .....	111

## Climate Control - Vehicles With: Automatic Temperature Control

Identifying the Climate Control Unit .....	112
Switching Climate Control On and Off .....	112
Switching Recirculated Air On and Off .....	112
Switching Air Conditioning On and Off .....	112
Switching Maximum Defrost On and Off .....	112
Switching Maximum Cooling On and Off .....	112
Switching the Heated Rear Window On and Off .....	113
Setting the Blower Motor Speed .....	113

# Table of Contents

Switching the Heated Mirrors On and Off .....	113
Setting the Temperature .....	113
Directing the Flow of Air .....	114
Auto Mode .....	114
Climate Control Hints .....	115
Air Conditioning System Refrigerant .....	116

## Climate Control - Vehicles With: Manual Temperature Control

Identifying the Climate Control Unit .....	117
Switching Climate Control On and Off .....	117
Switching Recirculated Air On and Off .....	117
Switching Air Conditioning On and Off .....	117
Switching Maximum Defrost On and Off .....	117
Switching Maximum Cooling On and Off .....	117
Switching the Heated Rear Window On and Off .....	118
Setting the Blower Motor Speed .....	118
Switching the Heated Mirrors On and Off .....	118
Setting the Temperature .....	118
Directing the Flow of Air .....	119
Climate Control Hints .....	119

## Interior Air Quality

What Is the Cabin Air Filter .....	121
Replacing the Cabin Air Filter .....	121

## Front Seats

Front Seat Precautions .....	122
Sitting in the Correct Position .....	122
Manual Seats .....	123
Power Seats .....	125
Heated Seats .....	128

## Rear Seats

Manual Seats .....	129
--------------------	-----

## Rear Occupant Alert System

What is the Rear Occupant Alert System - 5-Door, Excluding: Raptor .....	132
What is the Rear Occupant Alert System - Raptor, 3-Door .....	132
How Does the Rear Occupant Alert System Work - 3-Door, Excluding: Raptor .....	132
How Does the Rear Occupant Alert System Work - 5-Door, Excluding: Raptor .....	132
How Does the Rear Occupant Alert System Work - Raptor .....	133
Rear Occupant Alert System Precautions .....	133
Rear Occupant Alert System Limitations - 3-Door, Excluding: Raptor .....	133
Rear Occupant Alert System Limitations - 5-Door, Excluding: Raptor .....	133
Rear Occupant Alert System Limitations - Raptor .....	133
Switching Rear Occupant Alert System On and Off - 3-Door, Excluding: Raptor .....	134
Switching Rear Occupant Alert System On and Off - Raptor .....	134
Rear Occupant Alert System Settings - 5-Door, Excluding: Raptor .....	134
Rear Occupant Alert System Indicators - Excluding: Raptor .....	135
Rear Occupant Alert System Indicators - Raptor .....	135
Rear Occupant Alert System Audible Warnings - 3-Door, Excluding: Raptor .....	135
Rear Occupant Alert System Audible Warnings - 5-Door, Excluding: Raptor .....	136
Rear Occupant Alert System Audible Warnings - Raptor .....	136



# Table of Contents

---

## Garage Door Opener

Garage Door Opener Introduction .....	137
Garage Door Opener Precautions and Frequencies .....	137
Programming the Garage Door Opener .....	138
Garage Door Opener Additional Assistance .....	140

## USB Ports

Locating the USB Ports .....	141
Playing Media Using the USB Port .....	141
Charging a Device .....	141

## Power Outlet - Vehicles With: 120V Power Outlet

What Is the Power Outlet .....	143
Power Outlet Precautions .....	143
Power Outlet Limitations .....	143
Locating the Power Outlets .....	143
Power Outlet Indicators .....	143

## Power Outlet - Vehicles With: 12V Power Outlet

What Is the Power Outlet .....	145
Power Outlet Precautions .....	145
Locating the Power Outlets .....	145

## Storage

Glove Compartment .....	146
Center Console .....	146
Under Floor Storage .....	147
Map Pocket .....	147

## Starting and Stopping the Engine

Starting and Stopping the Engine – Precautions .....	148
Push Button Ignition Switch .....	148
Starting the Engine .....	149

Engine Block Heater .....	150
Stopping the Engine .....	151
Automatic Engine Stop .....	152
Accessing the Passive Key Backup Position .....	153
Starting and Stopping the Engine – Troubleshooting .....	153

## Start in Gear - Manual Transmission

What Is Start in Gear .....	157
Start in Gear Precautions .....	157
Start in Gear Limitations .....	157
Using Start in Gear .....	157
Start in Gear – Troubleshooting .....	158

## Auto-Start-Stop

What Is Auto-Start-Stop .....	159
Auto-Start-Stop Precautions - Manual Transmission .....	159
Auto-Start-Stop Precautions - Automatic Transmission .....	159
Switching Auto-Start-Stop On and Off .....	159
Stopping the Engine - Manual Transmission .....	160
Stopping the Engine - Automatic Transmission .....	160
Restarting the Engine - Manual Transmission .....	160
Restarting the Engine - Automatic Transmission .....	161
Auto-Start-Stop Indicators .....	161
Auto-Start-Stop – Troubleshooting .....	161

## Fuel and Refueling

Fuel and Refueling Precautions .....	164
Fuel Quality .....	164
Locating the Fuel Filler Funnel .....	165
Running Out of Fuel .....	165
Refueling .....	167

# Table of Contents

Fuel Tank Capacity .....	169
Fuel and Refueling – Troubleshooting .....	169

## Catalytic Converter

What Is the Catalytic Converter .....	170
Catalytic Converter Precautions .....	170
Catalytic Converter – Troubleshooting .....	170

## Manual Transmission

Manual Transmission Precautions .....	171
Shifting Into Reverse .....	171
Crawler Gear .....	171
Recommended Shift Speeds .....	172
Checking the Manual Transmission Fluid Level .....	173
Checking the Clutch Fluid Level .....	173
Manual Transmission Fluid Capacity and Specification .....	173
Clutch Fluid Capacity and Specification .....	174
Manual Transmission – Troubleshooting .....	174

## Automatic Transmission

Automatic Transmission Positions .....	176
Manually Shifting Gears - Excluding: Raptor .....	177
Manually Shifting Gears - Raptor .....	178
Shifting Your Immobile Vehicle Out of Park (P) .....	179
Automatic Transmission Audible Warnings .....	180
Using Progressive Range Selection - Excluding: Raptor .....	180
Automatic Transmission Fluid Capacity and Specification .....	180

## Four-Wheel Drive

How Does Four-Wheel Drive Work - 4x4 with Part Time Engagement .....	182
--	-----

How Does Four-Wheel Drive Work - Advanced 4x4 with 4A Mode .....	182
Four-Wheel Drive Precautions .....	182
Four-Wheel Drive Limitations .....	183
Switching Four-Wheel Drive On and Off .....	184
Selecting a Four-Wheel Drive Mode - 4x4 with Part Time Engagement .....	184
Selecting a Four-Wheel Drive Mode - Advanced 4x4 with 4A Mode .....	185
Four-Wheel Drive Modes .....	186
Four-Wheel Drive Indicators .....	187
Transfer Case Fluid Capacity and Specification .....	187
Four-Wheel Drive – Troubleshooting .....	188
Four-Wheel Drive Videos .....	190

## Front Axle

Front Axle Fluid Capacity and Specification - Excluding: Raptor .....	191
Front Axle Fluid Capacity and Specification - Raptor .....	191

## Rear Axle

Rear Axle Fluid Capacity and Specification .....	193
--	-----

## Electronic Locking Differential

What Is the Electronic Locking Differential .....	194
Switching the Electronic Locking Differential On and Off - Excluding: Raptor .....	194
Switching the Electronic Locking Differential On and Off - Raptor .....	196
Electronic Locking Differential Indicators .....	197
Electronic Locking Differential – Troubleshooting .....	198
Electronic Locking Differential Videos .....	199

# Table of Contents

## Brakes

Brake Precautions .....	200
Brake Over Accelerator .....	200
Locating the Brake Fluid Reservoir - 2.3L EcoBoost™ .....	200
Locating the Brake Fluid Reservoir - 2.7L EcoBoost™/3.0L EcoBoost™ .....	200
Checking the Brake Fluid .....	200
Brake Fluid Specification .....	201
Brakes – Troubleshooting .....	201

## Electric Parking Brake

What Is the Electric Parking Brake .....	203
Applying the Electric Parking Brake .....	203
Applying the Electric Parking Brake in an Emergency .....	203
Manually Releasing the Electric Parking Brake .....	203
Automatically Releasing the Electric Parking Brake .....	203
Electric Parking Brake Audible Warning .....	204
Releasing the Electric Parking Brake if the Vehicle Battery Has Run Out of Charge .....	204
Electric Parking Brake – Troubleshooting .....	204
Electric Parking Brake Videos .....	205

## Hill Start Assist

What Is Hill Start Assist .....	206
How Does Hill Start Assist Work .....	206
Hill Start Assist Precautions .....	206
Switching Hill Start Assist On and Off - Manual Transmission .....	206
Switching Hill Start Assist On and Off - Automatic Transmission .....	206
Hill Start Assist – Troubleshooting .....	206

## Traction Control

What Is Traction Control .....	207
How Does Traction Control Work .....	207

Switching Traction Control On and Off .....	207
Traction Control Indicator .....	207
Traction Control – Troubleshooting .....	208

## Stability Control

How Does Stability Control Work .....	209
Switching Stability Control On and Off .....	210
Stability Control Indicator .....	211

## Trail Control

What Is Trail Control .....	212
Trail Control Limitations .....	212
Switching Trail Control On and Off .....	212
Setting the Trail Control Speed .....	212
Canceling the Set Speed .....	213
Trail Control Indicators .....	213
Trail One Pedal Drive .....	213
Trail One Pedal Drive – Troubleshooting .....	215
Trail Control – Troubleshooting .....	216

## Trail Turn Assist

What Is Trail Turn Assist .....	217
Trail Turn Assist Precautions .....	217
Trail Turn Assist Limitations .....	217
Switching Trail Turn Assist On and Off .....	217
Trail Turn Assist Indicators .....	217
Trail Turn Assist – Troubleshooting .....	218

## Stabilizer Bar Disconnect - Vehicles With: Front Stabilizer Bar Disconnect

What Is the Stabilizer Bar Disconnect .....	219
Stabilizer Bar Disconnect Precautions .....	219
Switching the Stabilizer Bar Disconnect On and Off - Excluding: Raptor .....	219

# Table of Contents

---

Switching the Stabilizer Bar Disconnect On and Off - Raptor .....	220
Stabilizer Bar Disconnect Indicators .....	221
Stabilizer Bar Disconnect – Troubleshooting .....	222

## Hill Descent Control - Vehicles With: Hill Descent Control

What Is Hill Descent Control .....	225
How Does Hill Descent Control Work .....	225
Hill Descent Control Precautions .....	225
Switching Hill Descent Control On and Off .....	225
Setting the Hill Descent Speed .....	225
Hill Descent Control Indicator .....	225
Hill Descent Control – Troubleshooting .....	226

## Steering

Electric Power Steering .....	227
Steering – Troubleshooting .....	228

## Parking Aids

Parking Aid Precautions .....	229
Switching Parking Aid On and Off .....	229
Rear Parking Aid .....	230
Front Parking Aid .....	230
Parking Aid Indicators .....	232
Parking Aids – Troubleshooting .....	233
Parking Aids Videos .....	233

## Rear View Camera

What Is the Rear View Camera .....	234
Rear View Camera Precautions .....	234
Locating the Rear View Camera .....	234
Rear View Camera Guide Lines .....	234
Rear View Camera Object Distance Indicators .....	235
Rear View Camera Settings .....	235

## 360 Degree Camera

What Is the 360 Degree Camera .....	236
How Does the 360 Degree Camera Work .....	236
360 Degree Camera Precautions .....	236
Locating the 360 Degree Cameras .....	236
360 Degree Camera Guide Lines .....	237
360 Degree Camera Settings .....	238

## Cruise Control

What Is Cruise Control .....	239
Switching Cruise Control On and Off .....	239
Setting the Cruise Control Speed .....	239
Canceling the Set Speed .....	240
Resuming the Set Speed .....	240
Cruise Control Indicators .....	240

## Adaptive Cruise Control

How Does Adaptive Cruise Control Work .....	241
Adaptive Cruise Control Precautions .....	241
Adaptive Cruise Control Limitations .....	242
Switching Adaptive Cruise Control On and Off .....	244
Setting the Adaptive Cruise Control Speed .....	244
Setting the Adaptive Cruise Control Gap .....	245
Canceling the Set Speed .....	246
Resuming the Set Speed .....	246
Overriding the Set Speed .....	246
Adaptive Cruise Control Indicators .....	246
Switching From Adaptive Cruise Control to Cruise Control .....	247
Adaptive Cruise Control – Troubleshooting .....	247

## G.O.A.T. Mode Control

What Is G.O.A.T. Mode Control .....	249
-------------------------------------	-----

# Table of Contents

---

How Does G.O.A.T. Mode Control Work .....	249
Selecting a G.O.A.T. Mode - Excluding: Raptor .....	249
Selecting a G.O.A.T. Mode - Raptor .....	250
G.O.A.T. Modes .....	252
G.O.A.T. Mode Control – Troubleshooting .....	258
G.O.A.T. Mode Control Videos .....	260
Switching Blind Spot Information System On and Off .....	268
Locating the Blind Spot Information System Sensors .....	268
Locating the Blind Spot Information System Sensors .....	269
Blind Spot Information System Indicators .....	269
Blind Spot Information System – Troubleshooting .....	270

## **Lane Keeping System**

What Is the Lane Keeping System .....	261
How Does the Lane Keeping System Work .....	261
Lane Keeping System Precautions .....	261
Lane Keeping System Limitations .....	261
Switching the Lane Keeping System On and Off .....	262
Switching the Lane Keeping System Mode .....	262
Lane Keeping System Settings .....	262
Alert Mode .....	262
Aid Mode .....	263
Alert and Aid Mode .....	263
Lane Keeping System Indicators .....	264
Lane Keeping System – Troubleshooting .....	265

## **Blind Spot Information System**

What Is Blind Spot Information System .....	267
How Does Blind Spot Information System Work .....	267
Blind Spot Information System Precautions .....	267
Blind Spot Information System Limitations .....	267
Blind Spot Information System Requirements .....	267
Blind Spot Information System Requirements .....	268

## **Cross Traffic Alert**

What Is Cross Traffic Alert .....	271
How Does Cross Traffic Alert Work .....	271
Cross Traffic Alert Precautions .....	271
Cross Traffic Alert Limitations .....	272
Switching Cross Traffic Alert On and Off .....	273
Locating the Cross Traffic Alert Sensors .....	273
Locating the Cross Traffic Alert Sensors .....	274
Cross Traffic Alert Indicators .....	274
Cross Traffic Alert – Troubleshooting .....	275

## **Pre-Collision Assist**

What Is Pre-Collision Assist .....	276
How Does Pre-Collision Assist Work .....	276
Pre-Collision Assist Precautions .....	276
Pre-Collision Assist Limitations .....	277
Switching Pre-Collision Assist On and Off .....	278
Locating the Pre-Collision Assist Sensors .....	278
Automatic Emergency Braking .....	279
Evasive Steering Assist .....	279
Pre-Collision Assist – Troubleshooting .....	280

## **Driver Alert**

What Is Driver Alert .....	282
----------------------------	-----

# Table of Contents

---

How Does Driver Alert Work .....	282
Driver Alert Precautions .....	282
Driver Alert Limitations .....	282
Switching Driver Alert On and Off .....	283
Driver Alert Indicators .....	283
Driver Alert – Troubleshooting .....	283

## Load Carrying

Load Carrying Precautions .....	284
Locating the Safety Compliance Certification Labels .....	285
What Is the Gross Axle Weight Rating .....	285
What Is the Gross Vehicle Weight Rating .....	285
What Is the Maximum Loaded Trailer Weight .....	286
What Is the Gross Combined Weight Rating .....	286
Calculating Payload .....	286
Calculating the Load Limit .....	287
Roof Rack .....	288
Fender Anchor Points .....	291

## Rear Cargo Area

Rear Cargo Area Anchor Points .....	292
-------------------------------------	-----

## Connecting a Trailer

Connecting a Trailer Precautions .....	293
Connecting a Trailer .....	293
Connecting a Trailer – Troubleshooting .....	295

## Towing a Trailer

Towing a Trailer Precautions .....	296
Trailer Brake Precautions .....	296
Towing a Trailer Limitations .....	297
Loading Your Trailer .....	297
Trailer Towing Hints - Manual Transmission .....	297

Trailer Towing Hints - Automatic Transmission .....	298
Launching or Retrieving a Boat or Personal Watercraft .....	299
Towing Weights and Dimensions .....	300
Towing a Trailer – Troubleshooting .....	301

## Trailer Sway Control

How Does Trailer Sway Control Work .....	302
Trailer Sway Control Precautions .....	302
Switching Trailer Sway Control On and Off .....	302

## Winching - Everglades

Winching Overview .....	303
Winching Precautions .....	303
Winching Requirements .....	304
Winching Limitations .....	305
Winching Your Vehicle .....	305
Winching – Troubleshooting .....	306

## Driving Hints

Off-Road Driving .....	307
Cold Weather Precautions .....	315
Breaking-In .....	315
Driving Economically .....	315
Floor Mats .....	316

## Crash and Breakdown Information

Roadside Assistance .....	317
Switching the Hazard Flashers On and Off .....	318
Jump Starting the Vehicle .....	318
Post-Crash Alert System .....	320
Post-Collision Braking .....	321
Automatic Crash Shutoff .....	321
Recovery Towing .....	322
Transporting the Vehicle .....	325
Fail-Safe Cooling .....	325

# Table of Contents

## Towing Your Vehicle

Towing Your Vehicle Precautions .....	327
Recreationally Towing Your Vehicle - Manual Transmission .....	327
Recreationally Towing Your Vehicle - Automatic Transmission .....	329
Emergency Towing .....	330
Towing Your Vehicle – Troubleshooting .....	331

## Fuses

Fuse Precautions .....	332
Under Hood Fuse Box .....	332
Body Control Module Fuse Box .....	336
Identifying Fuse Types .....	339
Fuses – Troubleshooting .....	339

## Maintenance

Maintenance Precautions .....	340
Opening and Closing the Hood - Excluding: Raptor .....	340
Opening and Closing the Hood - Raptor .....	341
Under Hood Overview - 2.3L EcoBoost™ .....	342
Under Hood Overview - 2.7L EcoBoost™ .....	343
Under Hood Overview - 3.0L EcoBoost™ .....	344
Engine Oil .....	345
Engine Air Filter .....	352
Coolant .....	354
Drive Belt Routing Overview - 2.3L .....	358
Drive Belt Routing Overview - 2.7L/3.0L .....	358
12V Battery .....	359
12V Battery – Troubleshooting .....	361
Adjusting the Headlamps .....	363
Exterior Bulbs .....	364
Interior Bulbs .....	367

## Vehicle Specifications

Engine Specifications - 2.3L .....	368
Engine Specifications - 2.7L .....	369
Engine Specifications - 3.0L, Raptor .....	370
Motorcraft Parts - 2.3L .....	371
Motorcraft Parts - 2.7L .....	372
Motorcraft Parts - 3.0L, Raptor .....	373

## Removable Vehicle Components

Removable Windows .....	374
Removable Doors .....	378
Removable Roof Panels .....	386
Removable Hard Top .....	395
Removable Soft Top .....	396
Removable Fenders .....	400
Removable Running Boards .....	401
Removable Front Bumper End Caps - Raptor .....	403
Storing the Doors and the Roof Panels - 4-Door, Excluding: Raptor .....	410
Storing the Doors and the Roof Panels - Raptor .....	416
Storing the Roof Panels - 2-Door .....	422
Removable Vehicle Components Videos .....	422

## Vehicle Care

Cleaning Products .....	423
Cleaning the Exterior .....	424
Cleaning the Interior .....	426
Repairing Minor Paint Damage .....	428
Waxing Your Vehicle .....	428

## Storing Your Vehicle

Preparing Your Vehicle for Storage .....	429
Removing Your Vehicle From Storage .....	430

# Table of Contents

---

## Wheel and Tire Information

Locating the Tire label .....	431
Department of Transportation Uniform Tire Quality Grades .....	431
Information on the Tire Sidewall .....	432
Glossary of Tire Terminology .....	437
Tire Replacement Requirements .....	438
Using Snow Chains .....	440

## Tire Care

Checking the Tire Pressures .....	442
Inflating the Tires .....	442
Inspecting the Tire for Wear .....	443
Inspecting the Tire for Damage .....	444
Inspecting the Wheel Valve Stems .....	448
Tire Rotation .....	448

## Tire Pressure Monitoring System

What Is the Tire Pressure Monitoring System .....	450
Tire Pressure Monitoring System Overview .....	450
Tire Pressure Monitoring System Precautions .....	451
Tire Pressure Monitoring System Limitations .....	451
Viewing the Tire Pressures .....	452
Tire Pressure Monitoring System – Troubleshooting .....	452

## Changing a Road Wheel

Changing a Flat Tire - Excluding: Raptor .....	454
Changing a Flat Tire - Raptor .....	458
Wheel Nuts - Excluding: Raptor .....	463
Wheel Nuts - Raptor .....	464

## Vehicle Identification

Vehicle Identification Number .....	465
-------------------------------------	-----

## Connected Vehicle - Vehicles With: Modem

What Is a Connected Vehicle .....	466
Connected Vehicle Requirements .....	466
Connected Vehicle Limitations .....	466
Connecting the Vehicle to a Mobile Network .....	466
Connecting the Vehicle to a Wi-Fi Network .....	466
Connected Vehicle Settings .....	467
Connected Vehicle – Troubleshooting .....	467

## Vehicle Hotspot

Setting Up a Vehicle Hotspot .....	469
Vehicle Hotspot Settings .....	469
Vehicle Hotspot – Troubleshooting .....	470

## Audio System

Audio System Precautions .....	471
Identifying the Audio Unit .....	471
Switching the Audio Unit On and Off .....	471
Selecting the Audio Source .....	471
Media Control Buttons .....	471
Adjusting the Volume .....	472
Setting a Memory Preset .....	472
Muting the Audio .....	472
Adjusting the Sound Settings .....	472
Setting the Clock and Date .....	472
AM/FM Radio .....	472
Switching the Display On and Off .....	473
Digital Radio .....	473
Satellite Radio .....	474
Audio System – Troubleshooting .....	477

## Center Display

Center Display Overview .....	481
Status Bar .....	481
Information On Demand Screen .....	482



# Table of Contents

---

Feature Bar .....	482	Setting a Destination .....	497
Settings .....	483	Waypoints .....	497
Driver Assistance Menu .....	483	Route Guidance .....	498
Rebooting the Center Display .....	483		
<b>Voice Interaction</b>		<b>Vehicle Software Updates</b>	
Ford Assistant .....	485	Vehicle Software Updates .....	499
		Software Update Settings .....	499
		Software Update Indicators .....	500
<b>Alexa Built-In</b>		<b>Vehicle System Reset</b>	
What is Alexa Built-In .....	487	Performing a System Reset .....	501
Alexa Built-In Requirements .....	487		
Signing In to Your Account .....	487	<b>Accessories</b>	
Using Alexa Built-In .....	487	Accessories .....	502
Alexa Built-In Settings .....	487		
<b>Phone</b>		<b>Auxiliary Switches</b>	
Phone Precautions .....	489	What Are the Auxiliary Switches .....	504
Connecting Your Phone .....	489	Locating the Auxiliary Switches .....	504
Phone Menu .....	489		
Making and Receiving a Phone Call .....	491	<b>Ford Protect</b>	
Sending and Receiving a Text Message .....	492	What Is Ford Protect .....	505
Switching Text Message Notification On and Off .....	493		
Enabling Apps on a Mobile Device .....	493	<b>Scheduled Maintenance</b>	
Switching Apple CarPlay On and Off .....	493	Scheduled Maintenance .....	507
Switching Android Auto™ On and Off .....	494	General Maintenance Information .....	509
<b>Bluetooth®</b>		<b>Customer Information</b>	
Connecting a Bluetooth® Device .....	495	Rollover Warning .....	514
Playing Media Using Bluetooth® .....	495	The Better Business Bureau Auto Line Program .....	514
		The Mediation and Arbitration Program .....	515
<b>Navigation</b>		Reporting Safety Defects in the United States .....	515
Connected Navigation .....	496	Reporting Safety Defects in Canada .....	516
Accessing Navigation .....	496	Third Party Software Copyright Acknowledgment .....	517
Navigation Map Updates .....	496	Radio Frequency Certification Labels .....	517
Adjusting the Map .....	496	Perchlorate .....	555
Live Traffic .....	496		

# Table of Contents

---

Replacement Parts Recommendation .....	555
Mobile Communications Equipment .....	556
Federal Highway Administration Regulation .....	556
End User License Agreement .....	557
Emission Law .....	582
Export Unique Options .....	583
Warranty Information .....	583

## **Appendices**

Electromagnetic Compatibility .....	586
-------------------------------------	-----

# About Us - Raptor

---

## SVT

The Ford Special Vehicle Team (SVT) was established in 1991 to polish the Ford Oval by creating low-volume, factory-produced vehicles designed for those select few whose idea of driving is a high-powered, passionate experience – not just a means of getting from point A to point B.

In a move to support this spirited enthusiasm, Ford Motor Company carefully integrated the wide array of talent in the company into a small, cross-functional group of engineers and product planners, housed together under one roof with a common mission: to create vehicles specifically designed to meet the unique needs and desires of the knowledgeable driving enthusiast.

More than 400,000 SVT and Ford Performance vehicles were produced since the 1993 model year. These include the SVT Mustang Cobra and the Cobra R, the SVT F-150 Lightning, the SVT Contour, the SVT Focus, Ford GT, Shelby GT350, Shelby GT500, GT500KR and the F-150 SVT Raptor.

## TEAM RS

Team RS traces its roots back nearly 60 years from the Lotus Ford Cortina and Twin Cam Escorts of the mid 1960's, through the first RS branded Escorts of the 1970's to the founding of Special Vehicle Engineering (SVE) in 1980. Through the 1980s and 90s, SVE delivered a breadth of vehicles from exciting XR and RS branded road going performance cars through homologation specials such as the iconic Sierra Cosworth RS500. The first ST (Sport Technology) vehicle appeared in 1996 as the ST24 Mondeo. The first collaboration between Ford's European and North American performance teams appeared in 2002 as the ST170 in Europe

and SVT Focus in North America. In 2003, Team RS replaced SVE in Europe as performance car and motorsport personnel were brought together as one team. Team RS subsequently created the 2004 Fiesta ST, 2005 Focus ST and 2009 Focus RS.

## FORD PERFORMANCE

Welcome to the Ford Performance family!

SVT and Team RS officially began working together as one team in 2009. In 2015, these two teams, along with Ford Racing, were formally combined establishing Ford Performance as a single team responsible for all performance and racing oriented products and activities worldwide at Ford Motor Company. Your Ford Performance vehicle represents the best of what Ford Performance has to offer from around the globe. Your vehicle has been designed and developed with the four hallmarks of Ford Performance in mind: Performance, Substance, Exclusivity and Value. We are proud and passionate about what we do, and we are glad you have made us your choice.

# Contacting Us

---

If you require assistance or clarification on policies or procedures, please contact the customer relationship center.

## United States

Ford Motor Company  
Customer Relationship Center  
PO Box 6248  
Dearborn, MI 48126  
1-800-392-3673 (FORD)  
TDD for the hearing impaired:  
7-1-1 (where offered by your telephone  
service provider)  
[www.ford.com/help/contact/](http://www.ford.com/help/contact/)

## Ford Credit - US Only

Ford Credit offers a full range of financing and lease plans to help you acquire your vehicle. If you have financed or leased your vehicle through Ford Credit, thank you for your business.

For assistance call 1-800-727-7000, or for more information about Ford Credit and access to an account manager, visit [www.ford.com/finance](http://www.ford.com/finance).

## Canada

Customer Relationship Centre  
Ford Motor Company of Canada Limited  
P.O. Box 2000  
Oakville, Ontario L6J 5E4  
1-800-565-3673 (FORD)  
TDD for the hearing impaired:  
7-1-1 (where offered by your telephone  
service provider)  
[www.ford.ca](http://www.ford.ca)

## Australia

Ford Motor Company of Australia Pty Ltd.  
Customer Relationship Centre  
Private Mail Bag 5  
Campbellfield, Victoria, 3061  
Telephone: (13 FORD) 13 3673  
E-mail: [foacust1@ford.com](mailto:foacust1@ford.com)

## New Zealand

Ford Motor Company  
Attention: Customer Relationship Centre  
Private Bag 76912  
Manukau City 2241  
Telephone: 0800 367 369 (FORDNZ)  
E-mail: [fnzcust@ford.com](mailto:fnzcust@ford.com)

## China - Imported Vehicle

Customer Relationship Center  
Telephone: 400-690-1886  
Website: <https://www.ford.com.cn/>

## China - Chang'An Ford

Customer Relationship Center  
Telephone: 800-810-8168  
Mobile: 400-887-7766  
Website: <https://www.ford.com.cn/>

## Asia Pacific Direct Markets (APDM)

E-mail: [apemcrc@ford.com](mailto:apemcrc@ford.com)

## Caribbean, Central America and Israel

Ford Motor Company  
Ford Export Operations  
Attention: Owner Relations  
1555 Fairlane Drive  
Fairlane Business Park #3  
Allen Park, MI 48101  
Fax: (313) 390-0804  
Telephone: (800) 841-3673  
E-mail: [atnclien@ford.com](mailto:atnclien@ford.com)

## U.S. Virgin Islands and Puerto Rico

Ford Motor Company  
Ford Export Operations  
Attention: Owner Relations  
1555 Fairlane Drive  
Fairlane Business Park #3  
Allen Park, MI 48101  
Telephone: (800) 841-3673  
E-mail: [atnclien@ford.com](mailto:atnclien@ford.com)

# Contacting Us

---

## **Argentina**

Telephone: 0800-888-3673

## **Brazil**

Website: [www.ford.com.br](http://www.ford.com.br)  
Telephone: 0800-703-3673  
E-mail: [central@ford.com](mailto:central@ford.com)

## **North Africa**

E-mail: [nafcrc@ford.com](mailto:nafcrc@ford.com)

## **South Africa**

Telephone: 0860011022  
Email: [fordcrc2@ford.com](mailto:fordcrc2@ford.com)

## **Sub-Saharan Africa**

E-mail: [ssacrc@ford.com](mailto:ssacrc@ford.com)

## **Puerto Rico**

Ford International Business Development,  
Inc.  
P.O. Box 11957  
Caparra Heights Station  
San Juan, PR 00922-1957  
1-800-392-3673 (FORD)  
Fax: (313) 390-0804  
E-mail: [prcac@ford.com](mailto:prcac@ford.com)  
[www.ford.com.pr](http://www.ford.com.pr)

## **Middle East**

Ford Middle East Customer Relationship  
Center  
P.O. Box 21740  
Dubai, United Arab Emirates  
Telephone: 80004441066  
Toll-free number for the Kingdom of Saudi  
Arabia: 8008443673  
Mobily and Zain cell phone users in Saudi  
Arabia: 800850078  
Kuwait: 22280384  
Local telephone number for Kuwait: +965  
1 898900  
Fax: +971 4 3327266  
E-mail: [menacac@ford.com](mailto:menacac@ford.com)  
[www.me.ford.com](http://www.me.ford.com)

## **South Korea**

Customer Relationship Center  
Telephone: +82-02-1600-6003  
E-mail: [infokr1@ford.com](mailto:infokr1@ford.com)  
Emergency Dispatch Service call:  
080-300-3673

## **Philippines**

Telephone: 02-88669408  
Email: [emailus@ford.com](mailto:emailus@ford.com)

## **Taiwan**

Telephone: 0800-032100  
705 Zhonghua Rd., Sec. 1  
Zhongli District, Taoyuan, Taiwan, 32068

## **Thailand**

Telephone: 1383  
E-mail: [fordthai@ford.com](mailto:fordthai@ford.com)

## **Vietnam**

Telephone: 1800588888  
E-mail: [fordvn@ford.com](mailto:fordvn@ford.com)

# Introduction

## ABOUT THIS PUBLICATION



**WARNING:** Driving while distracted can result in loss of vehicle control, crash and injury. We strongly recommend that you use extreme caution when using any device that may take your focus off the road. Your primary responsibility is the safe operation of your vehicle. We recommend against the use of any hand-held device while driving and encourage the use of voice-operated systems when possible. Make sure you are aware of all applicable local laws that may affect the use of electronic devices while driving.



**WARNING:** You risk death, fire, or serious injury to yourself and others if you do not follow the instruction highlighted by the warning symbol.

Thank you for choosing Ford. We recommend that you take some time to get to know your vehicle in order to benefit from greater safety and pleasure from driving it. Use this publication, whether in-vehicle center display screen, print, in Ford mobile app or online, to familiarize yourself with the features on your vehicle.

**Note:** Use and operate your vehicle in line with all applicable laws and regulations.

**Note:** Pass on all printed owner's information when selling this vehicle.

## Features and Options

This publication describes product features and options available throughout the range of available models, sometimes even before they are generally available. It could describe options that are not available on the vehicle you have purchased.

## Providing Feedback

If you would like to provide feedback to the Owner's Manual team, please email us at [OWNERMANUALFEEDBACK@ford.com](mailto:OWNERMANUALFEEDBACK@ford.com).

You will not receive a direct email response. Your submission will be investigated and necessary changes will be made to the Owner's Manual content.

To help investigate your submission, please include the following information:

- Your vehicle model
- The country in which your vehicle was purchased
- The Owner's Manual section needing investigation

## Illustrations

**Note:** Some of the illustrations in this publication could show features as used in different models, so could appear different to you on your vehicle.

## Location of Components

This manual may qualify the location of a component as left-hand side or right-hand side. The side is determined when facing forward in the seat.

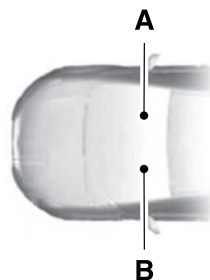

- A Right-hand side.  
B Left-hand side.

# Introduction

---

## Accessing the Digital Owner's Manual

The online version of the Owner's Manual may contain the very latest information, which may vary slightly from the in-vehicle digital Owner's Manual originally provided with your vehicle. We recommend updating the in-vehicle digital Owner's Manual when prompted using Over The Air updates.

## Vehicles with a Portrait Center Display Screen

The Owner's Manual application is located in the Apps list.

## Vehicles with a Landscape Center Display Screen

Depending on your vehicle, the Owner's Manual application is located in either the Apps list or the Features list.

## Accessing the Online and Printed Owner's Manual

### Online Owner's Manual

- Through your device's app store, you can download the Ford mobile app.
- You can visit the local Ford Website.

**Note:** To find the local Ford website, visit <https://corporate.ford.com/operations/locations/global-links.html>.

**Note:** We strongly recommend downloading a copy of the Owner's Manual and having it with you whenever you drive, and to view the information if you are unable to be inside the vehicle.

### Printed Owner's Manual

In U.S. and Canada, visit [www.helminc.com](http://www.helminc.com) or see an authorized dealer.

In Europe, visit [www.z-order.de](http://www.z-order.de) or see an authorized dealer.

For all other Countries, see your authorized dealer.

## USING THIS PUBLICATION















To quickly locate information about your vehicle, use the word search within the Owner's Manual application.

# Symbols Glossary

## SYMBOLS USED ON YOUR VEHICLE

These are some of the symbols you may see on your vehicle.

	Airbag
	Air conditioning system
	Air conditioning system lubricant type
	Anti-lock braking system
	Avoid smoking, flames or sparks
	Battery
	Battery acid
	Blower motor
	Brake fluid - non petroleum based
	Brake system
	Brake system
	Cabin air filter
	Check fuel cap

	Child safety door lock or unlock
	Child seat lower anchor
	Child seat tether anchor
	Cruise control
	Do not open when hot
	Electric Parking brake
	Engine air filter
	Engine coolant
	Engine coolant temperature
	Engine oil
	Explosive gas
	Fan warning
	Fasten seatbelt
	Flammable
	Front fog lamps



# Symbols Glossary



Fuel pump reset



Fuse compartment



Hazard flashers



Headlamp high beams



Headlamps on



Heated rear window



Hill descent control



Horn control



Interior luggage compartment release



Jack



Keep out of reach of children



Lighting control



Low fuel level



Low tire pressure warning



Maintain correct fluid level



Malfunction Indicator Lamp (MIL)



Note operating instructions



Panic alarm



Parking aid



Parking lamps



Passenger airbag activated



Passenger airbag deactivated



Power steering fluid



Power windows front/rear



Power window lockout



Requires registered technician



Safety alert



See Owner's Manual



See Service Manual



Side airbag

# Symbols Glossary



Shield the eyes



Stability control



Stability control off



Trail control



Turn Signal



Windshield defrosting system



Windshield wiping system



Windshield wash and wipe

## SYMBOLS USED ON YOUR INSTRUMENT CLUSTER

Depending on your vehicle options, market, and instrument cluster type, not all symbols shown are available.

### Lighting and Signaling



High beams. See **Headlamp Indicators** (page 89).



Auto high beams. See **Automatic High Beam Control Indicators** (page 95).



Front fog lamps. See **Using the Front Fog Lamps** (page 92).



Rear fog lamps.



Turn signal - right. See **Using the Turn Signal Lamps** (page 91).



Turn signal - left. See **Using the Turn Signal Lamps** (page 91).



Positioning/side lights. See **Headlamp Indicators** (page 89).



Exterior bulb failure. See **Exterior Bulb Specification Chart** (page 364).

### Brakes



Brake failure. See **Brakes – Warning Lamps** (page 201).



Brake failure. See **Brakes – Warning Lamps** (page 201).



Electric parking brake fault. See **Electric Parking Brake – Warning Lamps** (page 204).



Anti-lock brake system malfunction. See **Brakes – Warning Lamps** (page 201).



Automatic brake hold.



Automatic brake hold off or unavailable.

### Visibility



Windshield washer fluid level. See **Wipers and Washers – Warning Lamps** (page 88).

### Engine



Check engine. See **Coolant – Warning Lamps** (page 358).

# Symbols Glossary



Engine oil pressure. See **Starting and Stopping the Engine – Warning Lamps** (page 153).



Engine oil temperature. See **Starting and Stopping the Engine – Warning Lamps** (page 153).



Engine coolant temperature. See **Coolant – Warning Lamps** (page 358).



Auto Start/Stop. See **Auto-Start-Stop Indicators** (page 161).



Auto Start/Stop off or unavailable. See **Auto-Start-Stop Indicators** (page 161).



Turbocharger. See **Turbo Boost Gauge** (page 107).

## Fuel



Fuel. See **Fuel and Refueling – Warning Lamps** (page 169).



Fuel and fuel filler door location - left. See **Refueling Your Vehicle** (page 167).

## Transmission



Non-emission powertrain fault. See **Starting and Stopping the Engine – Warning Lamps** (page 153). See **Four-Wheel Drive – Warning Lamps** (page 188).

## Vehicle Handling



Selectable drive mode - normal. See **Normal** (page 253).



Selectable drive mode - ECO. See **Eco** (page 253).



Selectable drive mode - sport. See **Sport** (page 257).



Selectable drive mode - slippery. See **Slippery** (page 255).



Selectable drive mode - mud/ruts. See **Mud/Ruts** (page 253).



Selectable drive mode - rock crawl. See **Rock Crawl** (page 254).



Selectable drive mode - baja. See **Baja** (page 252). See **Baja** (page 252).



Selectable drive mode - sand. See **Sand** (page 255).



Selectable drive mode - normal. See **Normal** (page 253).



Selectable drive mode - Off-road. See **Off-Road** (page 254).



Selectable drive mode - rock crawl. See **Rock Crawl** (page 255).



Selectable drive mode - slippery. See **Slippery** (page 256).



Selectable drive mode - tow/haul. See **Tow/Haul** (page 257).



MyMode. See **Selecting a G.O.A.T. Mode** (page 250).



Differential lock - front axle. See **Electronic Locking Differential Indicators** (page 197).

# Symbols Glossary



Differential lock - rear axle. See **Electronic Locking Differential Indicators** (page 197).



Off road turn assist - right. See **Trail Turn Assist Indicators** (page 217).



Off road turn assist - left. See **Trail Turn Assist Indicators** (page 217).



Electronic sway bar disconnect. See **Stabilizer Bar Disconnect Indicators** (page 221).



4X2. See **Four-Wheel Drive Indicators** (page 187).



4X4 auto. See **Four-Wheel Drive Indicators** (page 187).



4X4 high. See **Four-Wheel Drive Indicators** (page 187).



4x4 low. See **Four-Wheel Drive Indicators** (page 187).

## Driver Assistance



Cruise control. See **Cruise Control Indicators** (page 240).



Adaptive cruise control. See **Adaptive Cruise Control Indicators** (page 246).



Hill descent control. See **Hill Descent Control Indicator** (page 225).



Trail control. See **Trail Control Indicators** (page 213).



One pedal drive. See **Trail One Pedal Drive Indicators** (page 215).



Lane keeping assist. See **Lane Keeping System Indicators** (page 264).

## Safety



Seatbelt. See **Seatbelt Reminder Indicators** (page 51).



Airbag. See **Crash Sensors and Airbag Indicator** (page 63).



Stability control system active or not available. See **Stability Control Indicator** (page 211).



Stability control system off. See **Stability Control Indicator** (page 211).



Tire failure/Low tire pressure. See **Tire Pressure Monitoring System – Warning Lamps** (page 452).



Forward collision warning system off or unavailable. See **Pre-Collision Assist – Warning Lamps** (page 280).



Blind spot information system off or unavailable. See **Switching Blind Spot Information System On and Off** (page 268).



Door(s) ajar. See **Doors and Locks – Warning Lamps** (page 72).



Swing gate release/ajar. See **Tailgate – Warning Lamps** (page 78).

## Security



Hood release/ajar. See **Opening and Closing the Hood** (page 340).

# Symbols Glossary

---



Liftglass release/ajar. See **Opening and Closing the Windows** (page 99).

## Electrical Systems



Battery charge level. See **12V Battery – Warning Lamps** (page 361).

# Data Privacy



**WARNING:** Do not connect wireless plug-in devices to the data link connector. Unauthorized third parties could gain access to vehicle data and impair the performance of safety related systems. Only allow repair facilities that follow our service and repair instructions to connect their equipment to the data link connector.

We respect your privacy and are committed to protecting it. The information contained in this publication was correct at the time of release, but as technology rapidly changes, we recommend that you visit the local Ford website for the latest information.

Your vehicle has electronic control units that have data recording functionality and the ability to permanently or temporarily store data. This data could include information on the condition and status of your vehicle, vehicle maintenance requirements, events and malfunctions. The types of data that can be recorded are described in this section. Some of the data recorded is stored in event logs or error logs.

**Note:** *Error logs are reset following a service or repair.*

**Note:** *We may provide information in response to requests from law enforcement, other government authorities and third parties acting with lawful authority or through a legal process. Such information could be used by them in legal proceedings.*

Data recorded includes, for example:

- Operating states of system components, for example fuel level, tire pressure and battery charge level.
- Vehicle and component status, for example wheel speed, deceleration, lateral acceleration and seatbelt status.

- Events or errors in essential systems, for example headlamps and brakes.
- System responses to driving situations, for example airbag deployment and stability control.
- Environmental conditions, for example temperature.

Some of this data, when used in combination with other information, for example an accident report, damage to a vehicle or eyewitness statements, could be associated with a specific person.

## Services That We Provide

If you use our services, we collect and use data, for example account information, vehicle location and driving characteristics, that could identify you. We transmit this data through a dedicated, protected connection. We only collect and use data to enable your use of our services to which you have subscribed, with your consent or where permitted by law. For additional information, see the terms and conditions of the services to which you have subscribed.

For additional information about our privacy policy, refer to the local Ford website.

## Services That Third Parties Provide

We recommend that you review the terms and conditions and data privacy information for any services equipped with your vehicle or to which you subscribe. We take no responsibility for services that third parties provide.

Where equipped, SiriusXM with 360L could use the modem. To disable, turn off the SiriusXM with 360L or Vehicle Connectivity setting. See **Enabling and Disabling the Modem** (page 466).

# Data Privacy

---

## SERVICE DATA

Service data recorders in your vehicle are capable of collecting and storing diagnostic information about your vehicle. This potentially includes information about the performance or status of various systems and modules in the vehicle, such as engine, throttle, steering or brake systems. In order to properly diagnose and service your vehicle, Ford Motor Company (Ford of Canada in Canada), and service and repair facilities may access or share among them vehicle diagnostic information received through a direct connection to your vehicle when diagnosing or servicing your vehicle. Additionally, Ford Motor Company (Ford of Canada, in Canada) may, where permitted by law, use vehicle diagnostic information for vehicle improvement or with other information we may have about you, for example, your contact information, to offer you products or services that may interest you. Data may be provided to our service providers such as part suppliers that may help diagnose malfunctions, and who are similarly obligated to protect data. We retain this data only as long as necessary to perform these functions or to comply with law. We may provide information where required in response to official requests to law enforcement or other government authorities or third parties acting with lawful authority or court order, and such information may be used in legal proceedings. For U.S. only (if equipped), if you choose to use connected apps and services, you consent that certain diagnostic information may also be accessed electronically by Ford Motor Company and Ford authorized service facilities, and that the diagnostic information may be used to provide services to you, personalizing your experience, troubleshoot, and to improve products and services and offer you products and services that may interest

you, where permitted by law. For Canada only, for more information, please review the Ford of Canada privacy policy at [www.ford.ca](http://www.ford.ca), including our U.S. data storage and use of service providers in other jurisdictions who may be subject to legal requirements in Canada, the United States and other countries applicable to them, for example, lawful requirements to disclose personal information to governmental authorities in those countries.

## EVENT DATA

This vehicle is equipped with an event data recorder. The main purpose of an event data recorder is to record, in certain crash or near crash-like situations, such as an airbag deployment or hitting a road obstacle; this data will assist in understanding how a vehicle's systems performed. The event data recorder is designed to record data related to vehicle dynamics and safety systems for a short period of time, typically 30 seconds or less.

The event data recorder in this vehicle is designed to record such data as:

- How various systems in your vehicle were operating.
- Whether or not the driver and passenger seatbelts were buckled/fastened.
- How far (if at all) the driver was depressing the accelerator and/or the brake pedal.
- How fast the vehicle was traveling.
- Where the driver was positioning the steering wheel.

This data can help provide a better understanding of the circumstances in which crashes and injuries occur.

# Data Privacy

---

**Note:** *Event data recorder data is recorded by your vehicle only if a non-trivial crash situation occurs; no data is recorded by the event data recorder under normal driving conditions and no personal data or information (for example name, gender, age, and crash location) is recorded. However, parties, such as law enforcement, could combine the event data recorder data with the type of personally identifying data routinely acquired during a crash investigation.*

To read data recorded by an event data recorder, special equipment is required, and access to the vehicle or the event data recorder is needed. In addition to the vehicle manufacturer, other parties, such as law enforcement, that have such special equipment, can read the information if they have access to the vehicle or the event data recorder.

## SETTINGS DATA

Your vehicle has electronic control units that have the ability to store data based on your personalized settings. The data is stored locally in the vehicle or on devices that you connect to it, for example, a USB drive or digital music player. You can delete some of this data and also choose whether to share it through the services to which you subscribe.

## Comfort and Convenience Data

Data recorded includes, for example:

- Seat and steering wheel position.
- Climate control settings.
- Radio presets.

## Entertainment Data

Data recorded includes, for example:

- Music, videos or album art.
- Contacts and corresponding address book entries.
- Navigation destinations.

## CONNECTED VEHICLE DATA



The modem has a SIM. The modem was enabled when your vehicle was built and periodically sends messages to stay connected to the cell phone network, receive automatic software updates and send vehicle-related information to us, for example diagnostic information. These messages could include information that identifies your vehicle, the SIM and the electronic serial number of the modem. Cell phone network service providers could have access to additional information, for example cell phone network tower identification. For additional information about our privacy policy, visit [www.FordConnected.com](http://www.FordConnected.com) or refer to your local Ford website.

**Note:** *The modem continues to send this information unless you disable the modem or stop the modem from sharing vehicle data by changing the modem settings. See **Connected Vehicle** (page 466).*

**Note:** *The service can be unavailable or interrupted for a number of reasons, for example environmental or topographical conditions and data plan coverage.*

**Note:** *To find out if your vehicle has a modem, visit [www.FordConnected.com](http://www.FordConnected.com).*



# Data Privacy

---

## MOBILE DEVICE DATA

If you connect a mobile device to your vehicle, you can display data from your device on the touchscreen for example, music and album art. You can share your vehicle data with mobile apps on your device through the system. See **Enabling Apps on a Mobile Device** (page 493).

The mobile apps function operates by your connected device sending data to us in the United States. The data is encrypted and includes, for example, the vehicle identification number of your vehicle, the SYNC module serial number, odometer, enabled apps, usage statistics and debugging information. We retain it only as long as necessary to provide the service, to troubleshoot, for continuous improvement and to offer you products and services that may be of interest to you according to your preferences and where allowed by law.

If you connect a cell phone to the system, the system creates a profile that links to that cell phone. The cell phone profile enables more mobile features and efficient operation. The profile contains, for example data from your phonebook, read and unread text messages and call history, including history of calls when your cell phone was not connected to the system.

If you connect a media device, the system creates and retains a media device index of supported media content. The system also records a short diagnostic log of approximately 10 minutes of all recent system activity.

The cell phone profile, media device index and diagnostic log remain in your vehicle unless you delete them and are generally accessible only in your vehicle when you connect your cell phone or media device. If you no longer plan to use the system or your vehicle, we recommend you use the system reset function to erase the stored information. See **Performing a System Reset** (page 501).

System data cannot be accessed without special equipment and access to your vehicle's module.

For additional information about our privacy policy, refer to the local Ford website.

**Note:** *To find out if your vehicle has connectivity technology, visit [www.FordConnected.com](http://www.FordConnected.com).*

## EMERGENCY CALL SYSTEM DATA

When the emergency call system is active, it may disclose to emergency services that your vehicle has been in a crash involving the deployment of an airbag or activation of the fuel pump shut-off. Certain versions or updates to the emergency call system may also be capable of electronically or verbally disclosing to emergency services operators your vehicle location or other details about your vehicle or crash to assist emergency services operators to provide the most appropriate emergency services. If you do not want to disclose this information, do not activate the emergency call system.

**Note:** *You cannot deactivate emergency call systems that are required by law.*

# Environment

---

## **PROTECTING THE ENVIRONMENT**

Sustainability is a priority at Ford. We are constantly looking for ways to reduce our impact on the planet while providing customers with great products and delivering a strong business. You should play your part in protecting the environment. Correct vehicle usage and the authorized disposal of waste, cleaning and lubrication materials are significant steps toward this aim.

For additional information about our sustainability progress and initiatives, visit [www.sustainability.ford.com](http://www.sustainability.ford.com).

# Visual Search

## INTERIOR OVERVIEW

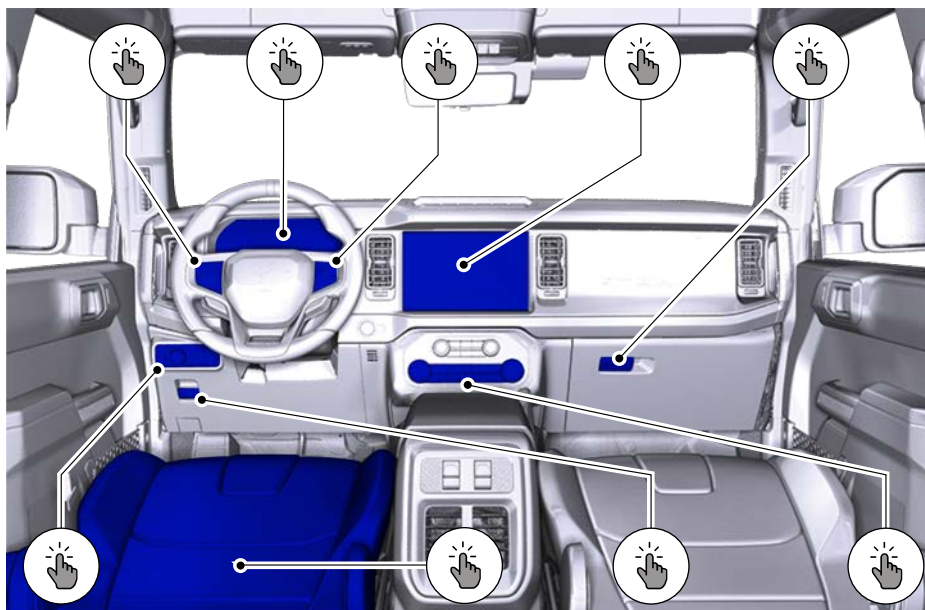

- A See **Switching Cruise Control On and Off** (page 239). See **Switching Adaptive Cruise Control On and Off** (page 244).
- B See **Instrument Cluster Overview** (page 105). See **Instrument Cluster Overview** (page 106).
- C See **Using the Instrument Cluster Display Controls** (page 108).
- D See **Center Display Overview** (page 481).
- E See **Opening the Glove Compartment** (page 146).
- F See **Identifying the Climate Control Unit** (page 112). See **Identifying the Climate Control Unit** (page 117).
- G See **Applying the Electric Parking Brake** (page 203).
- H See **Sitting in the Correct Position** (page 122).
- I See **Exterior Lighting Control** (page 89).

# Visual Search

## EXTERIOR OVERVIEW - EXCLUDING: RAPTOR

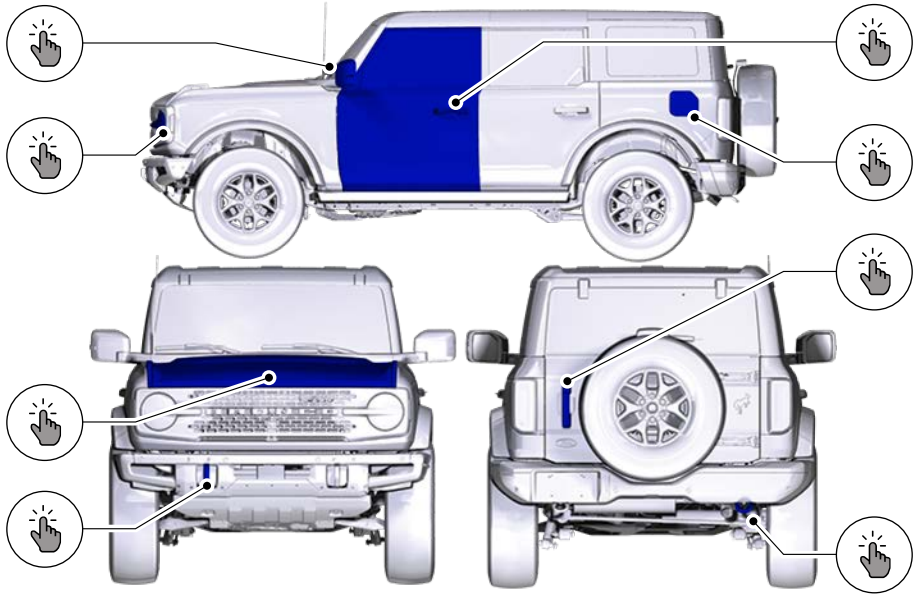

- A See **Folding the Exterior Mirrors** (page 104).
- B See **Removing and Installing the Doors** (page 378). See **Removing and Installing the Doors** (page 383).
- C See **Refueling Your Vehicle** (page 167).
- D See **Opening the Tailgate From Outside Your Vehicle** (page 76).
- E See **Accessing the Rear Towing Point** (page 323).
- F See **Accessing the Front Towing Point** (page 322).
- G See **Opening and Closing the Hood** (page 340).
- H See **Using the High Beam Headlamps** (page 89).

# Visual Search

## EXTERIOR OVERVIEW - RAPTOR

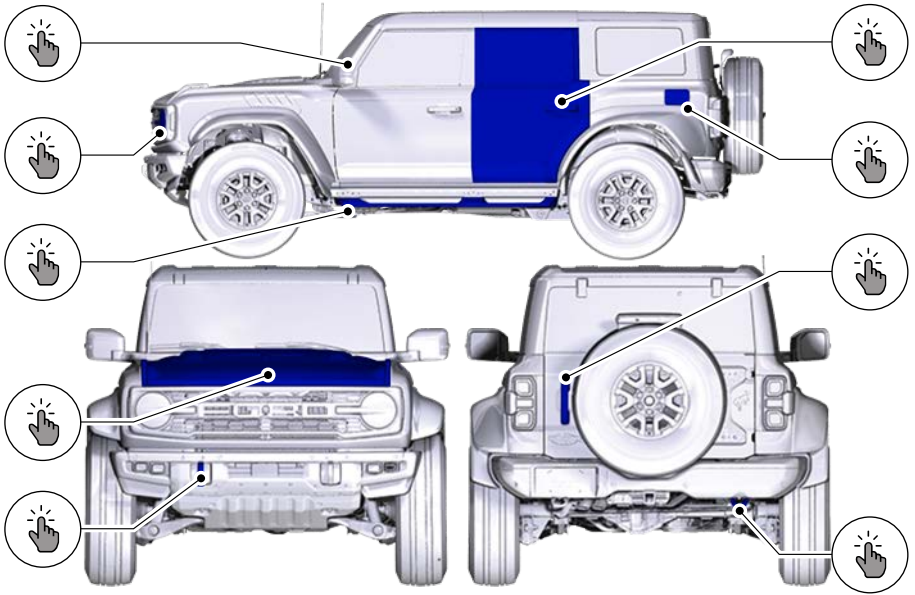

- A See **Folding the Exterior Mirrors** (page 104).
- B See **Removing and Installing the Doors** (page 378). See **Removing and Installing the Doors** (page 383).
- C See **Refueling Your Vehicle** (page 167).
- D See **Opening the Tailgate From Outside Your Vehicle** (page 76).
- E See **Accessing the Rear Towing Point** (page 323).
- F See **Accessing the Front Towing Point** (page 323).
- G See **Opening and Closing the Hood** (page 341).
- H See **Removing and Installing the Running Boards** (page 401).
- I See **Using the High Beam Headlamps** (page 89).

# Unique Features - Raptor

## UNIQUE FEATURES

### Pillar Braces



**WARNING:** Do not remove or modify the B-Pillar brace or trim. Doing so could affect safety system

performance, including safety canopy and front seat mounted side airbags, during a crash or rollover.

Do not remove or modify the C-pillar brace. Your vehicle has additional braces added for structural support.

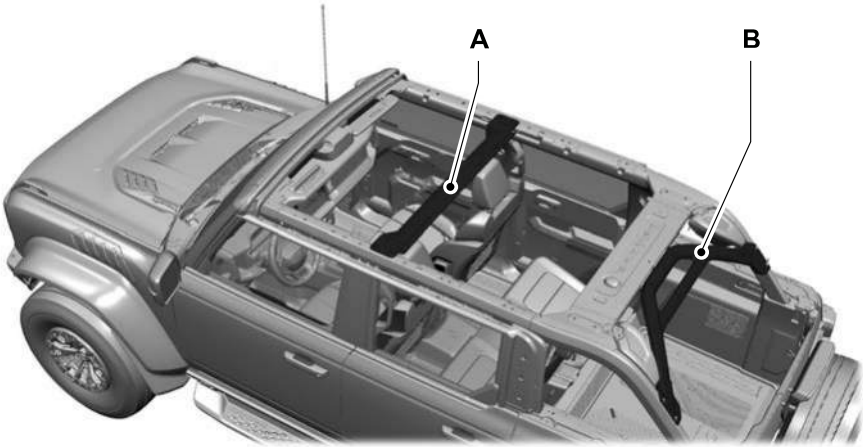

- A B-pillar brace and interior trim.
- B C-pillar brace.



The B-pillar brace and interior trim contains the following symbols.



### Accessory Mounting Points

Your vehicle has built in accessory mounting points.

**Note:** Remove the *plugs* before use.

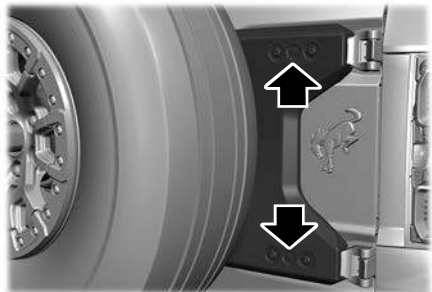

# Unique Features - Raptor

## Spare Tire Carrier Reinforcement

Your vehicle comes with a spare tire carrier reinforcement that has an accessory-ready spot to add your own gear to the rear swing gate. This is intended for light accessories such as a flagpole, a camera or a light.

One attachment point is intended for up to 1.4 kg (3 lb) loads.

The attachment hole is an M6x1mm with 35 mm (1.38 in) thread depth. Select a fastener that equals the thickness of your mounting bracket plus 20–30 mm (0.79–1.18 in) into the accessory mounting hole.

We recommend at least a Grade 10.9 fastener when selecting a mounting fastener. Please use at least 10 Nm (7.4 lb.ft) of torque when installing.

## Guidance for Door Swing

The rear swing gate opens to 120°, which leaves very limited space when fully opened. Make sure items fit within the space provided otherwise tail lamp damage can occur.

## Rear Wheel Stone Guard

The rear wheel flares on your vehicle have replaceable stone guard panels on the forward lower portion of the wheel flare on each side of the vehicle. Replacing the complete wheel flare assembly is not necessary if the stone guard is damaged during use. See your authorized dealer for more information.

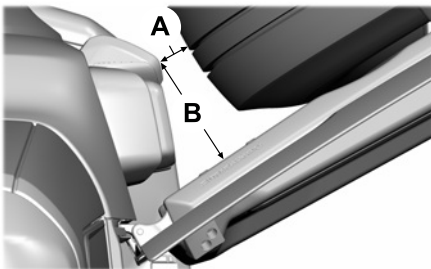

- A 1.57 in (40 mm).
- B 7.87 in (200 mm).

# Child Safety

## CHILD SAFETY PRECAUTIONS



**WARNING:** Always make sure your child is secured properly in a device that is appropriate for their height, age and weight. Child safety restraints must be bought separately from your vehicle. Failure to follow these instructions and guidelines may result in an increased risk of serious injury or death to your child.



**WARNING:** All children are shaped differently. The National Highway Traffic Safety Administration and other safety organizations, base their recommendations for child restraints on probable child height, age and weight thresholds, or on the minimum requirements of the law. We recommend that you check with a NHTSA Certified Child Passenger Safety Technician (CPST) to make sure that you properly install the child restraint in your vehicle and that you consult your pediatrician to make sure you have a child restraint appropriate for your child. To locate a child restraint fitting station and CPST, contact NHTSA toll free at 1-888-327-4236 or go to [www.nhtsa.dot.gov](http://www.nhtsa.dot.gov). In Canada, contact Transport Canada toll free at 1-800-333-0371 or go to [www.tc.gc.ca](http://www.tc.gc.ca) to find a Child Car Seat Clinic in your area. Failure to properly restrain children in child restraints made especially for their height, age and weight, may result in an increased risk of serious injury or death to your child.



**WARNING:** On hot days, the temperature inside the vehicle can rise very quickly. Exposure of people or animals to these high temperatures for even a short time can cause death or serious heat related injuries, including brain damage. Small children are particularly at risk.



**WARNING:** Do not place a rearward facing child restraint in front of an active airbag. Failure to follow this instruction could result in personal injury or death.



**WARNING:** Properly secure children 12 years old and under in a rear seating position whenever possible. If you are unable to properly secure all children in a rear seating position, properly secure the largest child on the front seat. If you must use a forward facing child restraint on the front seat, move the seat as far back as possible. Failure to follow these instructions could result in personal injury or death.



**WARNING:** Always carefully follow the instructions and warnings provided by the manufacturer of any child restraint to determine if the restraint device is appropriate for your child's size, height, weight, or age. Follow the child restraint manufacturer's instructions and warnings provided for installation and use in conjunction with the instructions and warnings provided by your vehicle manufacturer. A safety seat that is improperly installed or utilized, is inappropriate for your child's height, age, or weight or does not properly fit the child may increase the risk of serious injury or death.



# Child Safety

**WARNING:** Do not allow a passenger to hold a child on their lap when your vehicle is moving. Failure to follow this instruction could result in personal injury or death in the event of a sudden stop or crash.

**WARNING:** Do not use pillows, books or towels to boost your child's height. Failure to follow this instruction could result in personal injury or death.

**WARNING:** Properly secure child restraints or booster seats when they are not in use. They could become projectiles in a sudden stop or crash. Failure to follow this instruction could result in personal injury or death.

**WARNING:** Do not put the shoulder section of the seatbelt or allow the child to put the shoulder section of the seatbelt under their arm or behind their back. Failure to follow this instruction could reduce the effectiveness of the seatbelt and increase the risk of injury or death in a crash.

**WARNING:** Do not leave children or pets unattended in your vehicle. Failure to follow this instruction could result in personal injury or death.

When installing a child restraint with seatbelts:

- Place the vehicle seat in the upright position before you install the child restraint.
- Use the correct seatbelt buckle for that seating position.
- Insert the belt tongue into the buckle. Make sure the tongue is securely fastened in the buckle.

- Keep the buckle release button pointing up and away from the child restraint, with the tongue between the child restraint and the release button, to prevent accidental unbuckling.
- Put the seatbelt in the automatic locking mode.

## CHILD RESTRAINT ANCHOR POINTS

### WHAT ARE THE CHILD RESTRAINT ANCHOR POINTS

Anchor points allow you to quickly and safely install a child restraint.

### LOCATING THE CHILD RESTRAINT LOWER ANCHOR POINTS

#### 2-Door

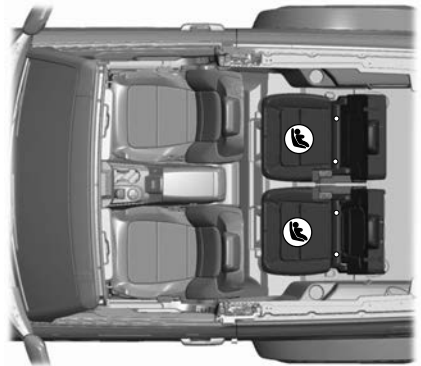

# Child Safety

4-Door

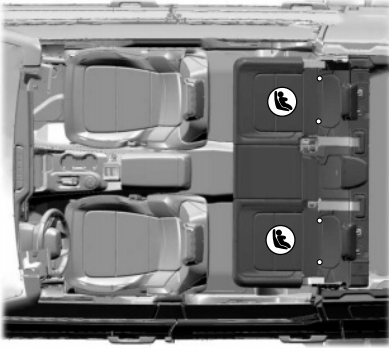

4-Door

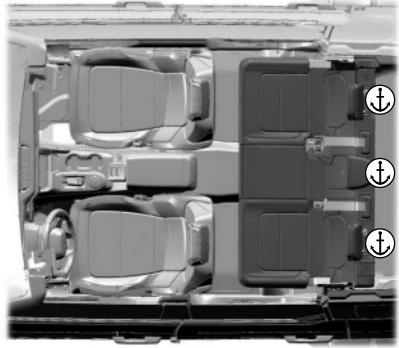

## LOCATING THE CHILD RESTRAINT TOP TETHER ANCHOR POINTS

2-Door

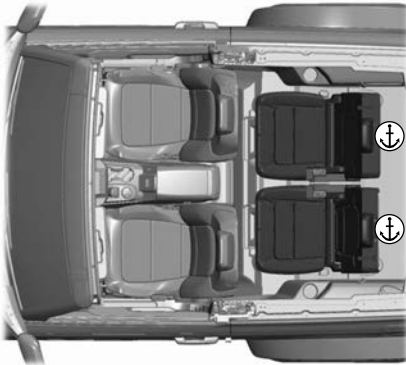

## CHILD RESTRAINTS

### CHILD RESTRAINT POSITION INFORMATION

Install the child restraint tightly against the vehicle seat. It may be necessary to lift or remove the head restraint.

### Rear Facing Child Restraints

Combined Weight of Child and Child Restraint	LATCH (Lower Anchors Only)	Seatbelt Only
Up to 29 kg (65 lb)	<b>X</b>	<b>X</b>
Over 29 kg (65 lb)		<b>X</b>

# Child Safety

---

## Forward Facing Child Restraints

<b>Combined Weight of Child and Child Restraint</b>	<b>LATCH (Lower Anchors and Top Tether Anchor)</b>	<b>Seatbelt and Top Tether Anchor</b>	<b>Seatbelt and LATCH (Lower Anchors and Top Tether Anchor)</b>
Up to 29 kg (65 lb)	<b>X</b>	<b>X</b>	<b>X</b>
Over 29 kg (65 lb)		<b>X</b>	<b>X</b>

# Child Safety

## CHILD RESTRAINTS RECOMMENDATION

Child Size, Height, Weight, or Age	Recommended Restraint Type
Children weighing 18 kg (40 lb) or less (generally age four or younger).	Use a child restraint (sometimes called an infant carrier, convertible seat, or toddler seat).
Children who have outgrown or no longer properly fit in a child restraint (generally children who are less than 1.45 m (57 in) tall, are greater than age four and less than age 12, and between 18 kg (40 lb) and 36 kg (80 lb) and upward to 45 kg (100 lb) if recommended by your child restraint manufacturer).	Use a belt-positioning booster seat.
Children who have outgrown or no longer properly fit in a belt-positioning booster seat (generally children who are at least 1.45 m (57 in) tall or greater than 36 kg (80 lb) or 45 kg (100 lb) if recommended by child restraint manufacturer).	Use a vehicle seatbelt having the lap belt snug and low across the hips, shoulder belt centered across the shoulder and chest, and seat backrest upright.

You are required by law to properly use child restraints for infants and toddlers in the United States, Canada and Mexico.

Many states and provinces require that small children use approved booster seats until they reach age eight, a height of 1.45 m (57 in) tall, or 36 kg (80 lb). Check your local and state or provincial laws for specific requirements about the safety of children in your vehicle.

When possible, properly restrain children 12 years of age and under in a rear seating position of your vehicle. Accident statistics suggest that children are safer when properly restrained in the rear seating positions than in a front seating position.

When installing a rear facing child restraint, adjust the vehicle seats to avoid interference between the child restraint and the vehicle seat in front of the child restraint.

## INSTALLING CHILD RESTRAINTS

### USING SEATBELTS



**WARNING:** Depending on where you secure a child restraint, and depending on the child restraint design, you may block access to certain seatbelt buckle assemblies and LATCH lower anchors, rendering those features potentially unusable. To avoid risk of injury, make sure occupants only use seating positions where they are able to be properly restrained.

**Note:** *Although the child restraint illustrated is a forward facing child restraint, the steps are the same for installing a rear facing child restraint.*

Perform the following steps when installing a child restraint with seatbelts.

# Child Safety

1. Position the child restraint in a seat with a seatbelt.



2. Pull down on the shoulder belt and then grasp the shoulder belt and lap belt together.



3. While holding the shoulder and lap belt portions together, route the tongue through the child restraint according to the child restraint manufacturer's instructions. Make sure you did not twist the belt webbing.

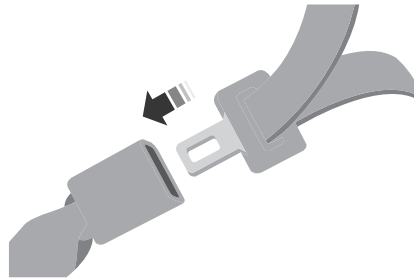

4. Insert the belt tongue into the proper buckle for that seating position until the latch engages. Make sure the tongue is latched securely by pulling on it.



5. To put the retractor in the automatic locking mode, grasp the shoulder portion of the belt and pull downward until you pull all of the seatbelt out.

**Note:** *The automatic locking mode is available on the front passenger and rear seats. This vehicle does not require the use of a locking clip.*

6. Allow the belt to retract to remove slack. The seatbelt clicks as it retracts to indicate it is in the automatic locking mode.

# Child Safety

7. Pull the seatbelt out of the retractor to make sure the retractor is in the automatic locking mode. You should not be able to pull more belt out. If the retractor is not locked, unbuckle the belt and repeat Steps 5 and 6.



8. Remove remaining slack from the belt. Force the seat down with extra weight, for example, by pressing down or kneeling on the child restraint while pulling up on the shoulder belt in order to force slack from the belt. This is necessary to remove the remaining slack that exists once you add the extra weight of the child to the child restraint. It also helps to achieve the proper snugness of the child restraint to your vehicle. Sometimes, a slight lean toward the buckle helps to remove remaining slack from the belt.
9. If the child restraint has a tether strap, attach it.

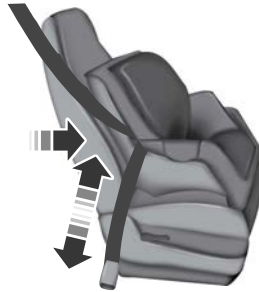

10. Before placing the child in the seat, forcibly move the seat forward and back to make sure the seat is securely held in place.

To check this, grab the seat at the belt path and attempt to move it side to side and forward and back. There should be no more than 2.5 cm (1 in) of movement.

We recommend checking with a NHTSA Certified Child Passenger Safety Technician to make certain the child restraint is properly installed. In Canada, check with Transport Canada for referral to a Child Car Seat Clinic.

## USING LOWER ANCHORS AND TETHERS FOR CHILDREN



**WARNING:** Do not attach two child safety restraints to the same anchor. In a crash, one anchor may not be strong enough to hold two child safety restraint attachments and may break, causing serious injury or death.

# Child Safety



**WARNING:** Depending on where you secure a child restraint, and depending on the child restraint design, you may block access to certain seatbelt buckle assemblies and LATCH lower anchors, rendering those features potentially unusable. To avoid risk of injury, make sure occupants only use seating positions where they are able to be properly restrained.

The Lower Anchors and Tethers for CHildren (LATCH) system has three vehicle anchor points:

- Two lower anchors where the vehicle seat backrest and seat cushion meet, called the seat bight.
- One top tether anchor behind that seating position.

LATCH compatible child restraints have two rigid or webbing mounted attachments. These attachments connect to the two lower anchors at the LATCH equipped seating positions in your vehicle. This type of attachment method eliminates the need to use seatbelts to attach the child restraint.

However, you can still use the seatbelt to attach the child restraint if the lower anchors are not used. For forward facing child restraints, you must also attach the top tether strap to the proper top tether anchor if a top tether strap has been provided with your child restraint.

Follow the instructions later in this chapter on attaching child restraints with tether straps.

## INSTALLING A CHILD RESTRAINT IN A CENTER SEAT



**WARNING:** The standardized spacing for LATCH lower anchors is 280 mm (11 in) center to center. Do not use LATCH lower anchors for the center seating position unless the child restraint manufacturer's instructions permit and specify using anchors spaced at least as far apart as those in this vehicle.

You cannot install a child restraint with rigid LATCH attachments at the center seating position. You can only use LATCH compatible child restraints, with attachments on belt webbing, at this seating position provided that the child restraint manufacturer's instructions permit use with the anchor spacing stated. Do not attach a child restraint to any lower anchor if another child restraint is attached to that anchor.

Each time you use the child restraint, check that the seat is properly attached to the lower anchors and tether anchor, if applicable. Tug the child restraint from side to side and forward and back where it is secured to the vehicle. The seat should move less than 2.5 cm (1 in).

If you did not properly anchor the child restraint, the risk of a child being injured in a crash greatly increases.

## COMBINING THE SEATBELT AND LOWER ANCHORS FOR ATTACHING CHILD RESTRAINTS

When used in combination, you may attach the seatbelt or the LATCH lower anchors first, provided a proper installation is achieved. Attach the tether strap afterward if it is included with the child restraint.

# Child Safety

## USING TETHER STRAPS

Many forward-facing child restraints include a tether strap which extends from the back of the child restraint and hooks to an anchoring point called the top tether anchor. Tether straps are available as an accessory for many older child restraints.

Contact the manufacturer of your child restraint for information about ordering a tether strap, or to obtain a longer tether strap if the tether strap on your child restraint does not reach the appropriate top tether anchor in your vehicle.

Attach the tether strap only to the appropriate tether anchor. The tether strap may not work properly if attached somewhere other than the correct tether anchor.

**Note:** *If you install a child restraint with rigid LATCH attachments, do not tighten the tether strap enough to lift the child restraint off the vehicle seat cushion when the child is seated in it. Keep the tether strap just snug without lifting the front of the child restraint. Keeping the child restraint just touching the vehicle seat gives the best protection in a severe crash.*

Once you have installed the child restraint using either the seatbelt, the lower anchors of the LATCH system, or both, you can attach the top tether strap.

1. Route the child restraint tether strap over the back of the seat. For the outermost seating positions, route the tether strap under the head restraint and between the head restraint posts. For vehicles with a center seating position, route the tether strap over the top of the head restraint. If needed, you can also remove the head restraints.

**Note:** *The head restraints are not removable on 2-door vehicles.*

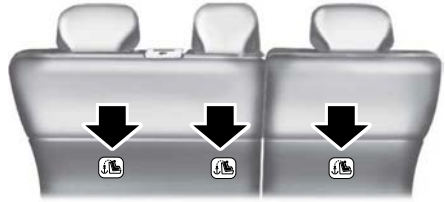

2. Locate the correct anchor behind the gap cover for the selected seating position.



3. Clip the tether strap to the anchor as shown.
4. Tighten the child restraint tether strap according to the manufacturer's instructions.

If your child restraint system has a tether strap, and the child restraint manufacturer recommends its use, we also recommend its use.

## BOOSTER SEATS

Use a belt-positioning booster seat for children who have outgrown or no longer properly fit in a child restraint and meet the following criteria.



# Child Safety

- Generally children who are less than 1.45 m (57 in) tall.
- Are greater than age four (4) and less than age twelve (12).
- Are between 18 kg (40 lb) and 36 kg (80 lb) and upward to 45 kg (100 lb).

Many state and provincial laws require that children use approved booster seats until they reach age eight, a height of 1.45 m (57 in) tall, or 36 kg (80 lb).

Booster seats should be used until you can answer yes to all of these questions when seated without a booster seat:

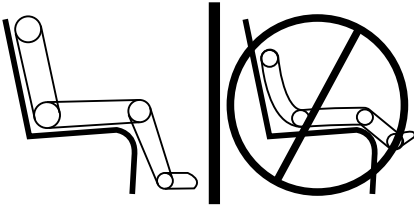

- Can the child sit all the way back against their vehicle seat backrest with knees bent comfortably at the edge of the seat cushion?
- Can the child sit without slouching?
- Does the lap belt rest low across the hips?
- Is the shoulder belt centered on the shoulder and chest?
- Can the child stay seated like this for the whole trip?

Always use booster seats in conjunction with your vehicle lap and shoulder belt.

## Types of Booster Seats



- Backless booster seats

If your backless booster seat has a removable shield, remove the shield.

If a vehicle seating position has a low seat backrest or no head restraint, a backless booster seat may place your child's head, as measured at the tops of the ears, above the top of the seat. In this case, move the backless booster to another seating position with a higher seat backrest or head restraint and lap and shoulder belts, or consider using a high-back booster seat.



- High-back booster seats

If, with a backless booster seat, you cannot find a seating position that adequately supports your child's head, a high-back booster seat would be a better choice.

# Child Safety

Children and booster seats vary in size and shape. Choose a booster that keeps the lap belt low and snug across the hips, never up across the stomach, and lets you adjust the shoulder belt to cross the chest and rest snugly near the center of the shoulder.

The following drawings compare the ideal fit to a shoulder belt uncomfortably close to the neck and a shoulder belt that could slip off the shoulder. The drawings also show how the lap belt should be low and snug across the child's hips.



If the booster seat slides on the vehicle seat upon which it is being used, placing a rubberized mesh sold as shelf or carpet liner under the booster seat may improve this condition. Do not use any item thicker than this under the booster seat. Check with the booster seat manufacturer's instructions.

## CHILD SAFETY LOCKS - 5-DOOR



**WARNING:** You cannot open the rear doors from inside if you have put the child safety locks on.

# Child Safety

---

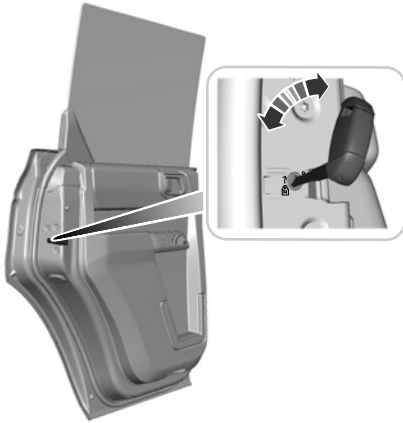

A child safety lock is on the rear edge of each rear door. Switch the child safety lock separately on each door.

## Left-Hand Side

Turn the key clockwise to switch the child lock on and counterclockwise to switch it off.

## Right-Hand Side

Turn the key counterclockwise to switch the child lock on and clockwise to switch it off.

**Note:** To make sure the child safety lock is on, pull the inside door handle twice to verify the door does not open.

**Note:** To open the rear doors from inside the vehicle when the child lock is engaged, roll down the rear window and use the outside door handle. Or have someone outside the vehicle open the door.

# Seatbelts

## SEATBELT PRECAUTIONS



**WARNING:** Always drive and ride with your seatback upright and the lap belt snug and low across the hips.



**WARNING:** Children must always be properly restrained.



**WARNING:** Do not allow a passenger to hold a child on their lap when your vehicle is moving. Failure to follow this instruction could result in personal injury or death in the event of a sudden stop or crash.



**WARNING:** All occupants of your vehicle, including the driver, should always properly wear their seatbelts, even when an airbag supplemental restraint system is provided. Failure to properly wear your seatbelt could seriously increase the risk of injury or death.



**WARNING:** It is extremely dangerous to ride in a cargo area, inside or outside of a vehicle. In a crash, people riding in these areas are more likely to be seriously injured or killed. Do not allow people to ride in any area of your vehicle that is not equipped with seats and seatbelts. Make sure everyone in your vehicle is in a seat and properly using a seatbelt. Failure to follow this warning could result in serious personal injury or death.



**WARNING:** In a rollover crash, an unbelted person is significantly more likely to die than a person wearing a seatbelt.



**WARNING:** Each seating position in your vehicle has a specific seatbelt assembly made up of one buckle and one tongue designed to be used as a pair. Use the shoulder belt on the outside shoulder only. Never wear the shoulder belt under the arm. Never use a single seatbelt for more than one person.



**WARNING:** Even with advanced restraints systems, properly restrain children 12 and under in a rear seating position. Failure to follow this could seriously increase the risk of injury or death.



**WARNING:** Seatbelts and seats may be hot in a vehicle that is in the sunshine. The hot seatbelts or seats may burn a small child. Check seat covers and buckles before you place a child anywhere near them.



**WARNING:** If your vehicle is involved in a crash, have the seatbelts and associated components inspected as soon as possible. Failure to follow this instruction could result in personal injury or death.

All seating positions in this vehicle have lap and shoulder seatbelts. All occupants of the vehicle should properly wear their seatbelts, even when an airbag supplemental restraint system is provided.

The seatbelt system consists of:

- Lap and shoulder seatbelts.
- A shoulder seatbelt with automatic locking mode, except driver seatbelt.
- Seatbelt pretensioners at the front outermost and rear outermost seating positions.



• A seatbelt warning light and chime.

# Seatbelts

- Crash sensors and monitoring system with readiness indicator.

The seatbelt pretensioners are designed to tighten the seatbelts when activated. In frontal and near-frontal crashes, the seatbelt pretensioners may be activated alone or, if the crash is of sufficient severity, together with the front airbags. In side crashes and rollovers, the pretensioners will be activated when the Safety Canopy is activated.

## FASTENING AND UNFASTENING THE SEATBELTS

All seatbelts in your vehicle are a three-point combination lap and shoulder seatbelt.

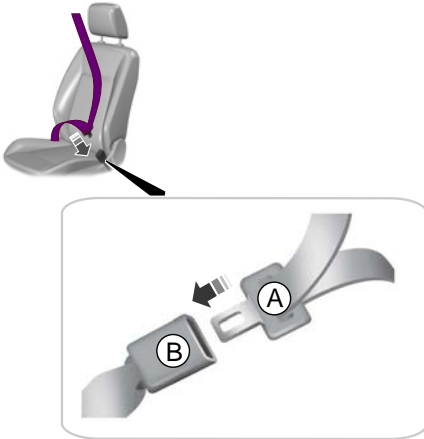

- A Seatbelt tongue.
- B Seatbelt buckle.

1. Pull the seatbelt out steadily.

**Note:** It may lock if you pull it sharply or if the vehicle is on a slope.

2. Insert the tongue into the buckle.
3. Pull the seatbelt tight to remove any slack.

## Unfastening the Seatbelts

1. Press the red button on the buckle to release the seatbelt.
2. Hold the seatbelt tongue and let it retract completely and smoothly to its stowed position.

## Using a Sliding Clip (If Equipped)

Your vehicle may have a seatbelt sliding clip to enhance seatbelt tongue accessibility for your vehicle. The recommended stowed position to ease access to the tongue is to locate the sliding clip to the highest position as shown.

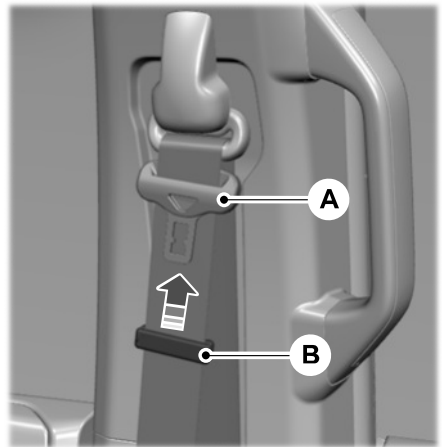

- A Seatbelt tongue.
- B Seatbelt sliding clip.

# Seatbelts

Slide the clip away from the tongue so there is no loose webbing when an occupant or child seat is buckled up. You can also use the sliding clip to raise the tongue and prevent it from rattling or to ease access to the tongue.

## SENSITIVE LOCKING MODE

### WHAT IS SENSITIVE LOCKING MODE

Sensitive locking mode is a seatbelt retractor feature that allows shoulder belt length adjustment according to your movements and locking in response to vehicle movement.

### HOW DOES SENSITIVE LOCKING MODE WORK

If the driver suddenly brakes, turns a corner sharply, or the vehicle receives an impact of about 8 km/h (5 mph) or more, the seatbelts lock to help reduce forward movement of the driver and passengers.

In addition, the seatbelt retractor locks if you pull the seatbelt webbing out too quickly. If the retractor does not unlock, pull the seatbelt out slowly then feed a small length of webbing back toward the stowed position.

**Note:** *When driving off-road or at a severe angle, the seatbelt mechanism locks. It does not allow you to pull the seatbelt webbing out until your vehicle is on nearly level ground.*

## AUTOMATIC LOCKING MODE

### WHAT IS AUTOMATIC LOCKING MODE

This is a safety feature built into the seatbelt retractors that keeps the seatbelts pre-locked.

### ENGAGING AUTOMATIC LOCKING MODE



1. Fasten the combination lap and shoulder belt.
2. Grasp the shoulder portion and pull downward until you pull the entire belt out.
3. Allow the belt to retract. As the belt retracts, you will hear a clicking sound. This indicates the seatbelt is now in the automatic locking mode.

### DISENGAGING AUTOMATIC LOCKING MODE

Unbuckle the combination lap and shoulder belt and allow it to retract completely to disengage the automatic locking mode and activate the vehicle sensitive locking mode.

# Seatbelts

## ADJUSTING THE SEATBELTS DURING PREGNANCY



**WARNING:** Always ride and drive with your seatback upright and properly fasten your seatbelt. Fit the lap portion of the seatbelt snugly and low across the hips. Position the shoulder portion of the seatbelt across your chest. Pregnant women must follow this practice. See the following figure.

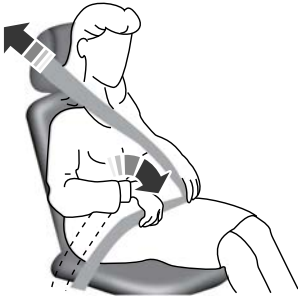

Pregnant women should always wear their seatbelt. Position the lap belt portion of a combination lap and shoulder belt low across the hips below the belly and worn as tight as comfort allows. Position the shoulder belt to cross the middle of the shoulder and the center of the chest.

## SEATBELT REMINDER

### HOW DOES THE SEATBELT REMINDER WORK



**WARNING:** The system will only provide protection when you use the seatbelt correctly.

This system monitors all seating positions and provides audio and graphic feedback.

## SEATBELT REMINDER INDICATORS



This lamp illuminates if you do not fasten your seatbelt when you switch the ignition on. The lamp switches off when you fasten your seatbelt or about one minute has elapsed.

When the initial warning expires for the driver, more warnings are provided for the driver and front passenger. This lamp illuminates if you or your front passenger do not fasten the seatbelt buckle and the vehicle speed exceeds 9.7 km/h (6 mph).

**Note:** To avoid inadvertent warnings, do not place large objects on the seat.



This lamp illuminates when you switch the ignition on, identifying the number of seating positions with fastened buckles. It illuminates again when a seating position changes from unfastened to fastened.

# Seatbelts

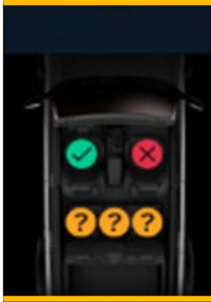

This warning displays if an occupant unfastens the rear seatbelt buckle or it becomes unfastened.

**Note:** If a rear seat is unoccupied, or an occupant never fastens the seatbelt buckle to begin with, the warning will not display.

**Note:** Front seating positions appear in this warning display. Warnings for unfastened front seatbelt buckles appear in the initial warning lamp.

**Note:** Vehicles with two doors do not have a rear center seating position.

## Checking Seatbelt Status

To view the seatbelt status, use the instrument cluster display controls on the steering wheel.

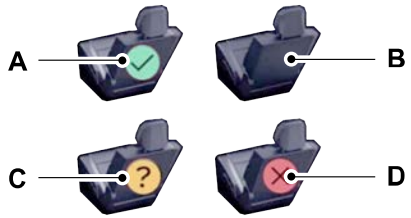
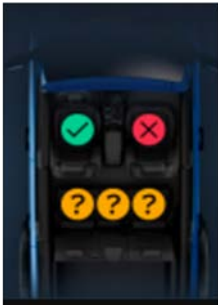

- A Seatbelt fastened.
- B Seatbelt not fastened.
- C Fault.
- D Seatbelt recently unfastened, or seatbelt unfastened when vehicle is started for driver and for seats with occupant presence detection.

## SWITCHING THE SEATBELT REMINDER ON AND OFF



**WARNING:** While the system allows you to deactivate it, this system is designed to improve your chances of being safely belted and surviving an accident. We recommend you leave the system activated for yourself and others who may use the vehicle.

**Note:** The driver and front passenger warnings switch off independently. When you perform this procedure for one seating position and the other seat is occupied, buckle the other seat.

Read Steps 1 - 4 before proceeding with the programming procedure.

Make sure that:

- You set the parking brake.
- You place the transmission in park (P).
- The ignition is off.



# Seatbelts

- You close all vehicle doors.
  - You unfasten the driver and front passenger seatbelts.
1. Switch the ignition to RUN.
  2. Wait a short period of time until the seatbelt warning tone switches off. After Step 2, you must complete Step 3 within 30 seconds after you start your vehicle.
  3. For the seating position you are switching off, fasten then unfasten the seatbelt four times at a moderate speed, ending in the unfastened state. After each unfasten, the seatbelt warning light switches on and off with each fasten.
  4. The seatbelt warning light flashes for confirmation.

This switches the feature off for that seating position if it is currently on.

This switches the feature on for that seating position if it is currently off.

## CHECKING THE SEATBELTS

Check the seatbelts and child restraints periodically to make sure they work properly and are not damaged. Make sure there are no nicks, tears or cuts. Replace if necessary.

Check all of the following seatbelt assemblies after a crash.

- Retractors.
- Buckles.
- Front seatbelt buckle assemblies.
- Buckle support assemblies.
- Child restraint LATCH and tether anchors.
- Attaching hardware.

Read the child restraint manufacturer's instructions for additional inspection and maintenance information specific to the child restraint.

We recommend that all seatbelt assemblies in use in vehicles involved in a crash be replaced. However, if the crash was minor and an authorized dealer finds that the belts do not show damage and continue to operate properly, they do not need to be replaced. Seatbelt assemblies not in use during a crash should also be checked and replaced if either damage or improper operation is noted.

Properly care for seatbelts. See **Cleaning the Interior** (page 428).

## SEATBELT EXTENSIONS



**WARNING:** Persons who fit into the vehicle's seatbelt should not use an extension. Unnecessary use could result in serious personal injury in the event of a crash.



**WARNING:** Only use extensions provided free of charge by our dealers. The dealer will provide an extension designed specifically for this vehicle, model year and seating position. The use of an extension intended for another vehicle, model year or seating position may not offer you the full protection of your vehicle's seatbelt restraint system.



**WARNING:** Never use seatbelt extensions to install child restraints.



**WARNING:** Do not use extensions to change the way the seatbelt fits across the torso, over the lap or to make the seatbelt buckle easier to reach.

## Seatbelts

---

If, because of body size or driving position, it is not possible to properly fasten the seatbelt over your lap and shoulder, an extension that is compatible with the seatbelts is available free of charge from our dealers. Only use our seatbelt extensions made by the original equipment seatbelt manufacturer with our seatbelts. Ask your authorized dealer if your extension is compatible with your vehicle restraint system.

# Personal Safety System™

---

## WHAT IS THE PERSONAL SAFETY SYSTEM

An advanced safety system that protects occupants in frontal crashes.

## HOW DOES THE PERSONAL SAFETY SYSTEM WORK

This system provides an improved level of frontal crash protection to front seat occupants and is designed to reduce the risk of airbag-related injuries. The system analyzes occupant conditions and crash severity before activating the appropriate safety devices. During a crash, the restraints control module may deploy the seatbelt pretensioners, and one or both stages of the dual-stage airbags based on crash severity and occupant conditions.

## PERSONAL SAFETY SYSTEM COMPONENTS

- Driver and passenger dual-stage airbag supplemental restraints.
- Front seat outermost seatbelts with pretensioners, energy management retractors and seatbelt usage sensors.
- Front passenger sensing system.
- Passenger airbag off and on indicators.
- Front crash severity sensors.
- Restraints control module with impact and safing sensors.
- Restraint system warning light and tone.
- The electrical wiring for the airbags, crash sensors, seatbelt pretensioners, front seatbelt usage sensors, front passenger sensing system and indicator lights.

# Airbags

## HOW DO THE FRONT AIRBAGS WORK

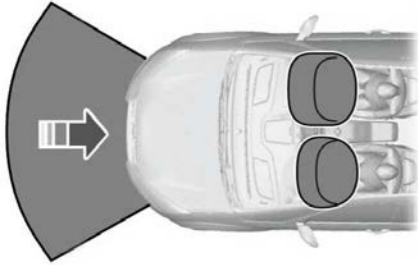

The driver and front passenger airbags deploy during significant frontal and near frontal crashes.

The driver and passenger front airbag system consists of:

- Driver and passenger airbag modules.
- Front passenger sensing system.
- Crash sensors and monitoring system with readiness indicator. See **Crash Sensors and Airbag Indicator** (page 63).

The airbags are a supplemental restraint system and are designed to work with the seatbelts to help protect the driver and right front passenger from certain upper body injuries. Airbags do not inflate slowly; there is a risk of injury from a deploying airbag.

**Note:** *You will hear a loud bang and see a cloud of harmless powdery residue if an airbag deploys. This is normal.*

The airbags inflate and deflate rapidly upon activation. After airbag deployment, it is normal to notice a smoke-like, powdery residue or smell the burnt propellant. This may consist of cornstarch, talcum powder (to lubricate the bag) or sodium

compounds (for example, baking soda) that result from the combustion process that inflates the airbag. Small amounts of sodium hydroxide may be present which may irritate the skin and eyes, but none of the residue is toxic.

Contact with a deploying airbag may cause abrasions or swelling. Temporary hearing loss is also a possibility as a result of the noise associated with a deploying airbag.

Because airbags must inflate rapidly and with considerable force, there is the risk of death or serious injuries such as fractures, facial and eye injuries or internal injuries, particularly to occupants who are not properly restrained or are otherwise out of position at the time of airbag deployment. Thus, it is extremely important that occupants be properly restrained as far away from the airbag module as possible.

Routine maintenance of the airbags is not required.

## HOW DO THE SIDE AIRBAGS WORK



**WARNING:** Do not place objects or mount equipment on or near the airbag cover, on the side of the front or rear seatbacks, or in areas that may come into contact with a deploying airbag. Failure to follow these instructions may increase the risk of personal injury in the event of a crash.



**WARNING:** Accessory seat covers not released by Ford Motor Company could prevent the deployment of the airbags and increase the risk of injuries in a crash.

# Airbags



**WARNING:** Do not lean your head on the door. The side airbag could injure you as it deploys from the side of the seatback.

The side airbags are on the outermost side of each front seat backrest. In certain sideways crashes or rollovers, the airbags will be inflated.

The airbag was designed to inflate between the door panel and occupant to further enhance the protection provided occupants in side impact crashes.



The system consists of the following:

- A label or embossed side panel indicating that your vehicle has side airbags.
- Side airbags inside the driver and front passenger seat backrests.
- Crash sensors and monitoring system with a readiness indicator. See **Crash Sensors and Airbag Indicator** (page 63).

## HOW DOES THE SAFETY CANOPY™ WORK



**WARNING:** Do not lean your head on the door. The curtain airbag could injure you as it deploys from the side rail trim or A-pillar. Failure to follow this instruction could result in personal injury or death.



**WARNING:** To reduce risk of injury, do not obstruct or place objects in the deployment path of the airbag.

The Safety Canopy deploys during significant side crashes or when a certain likelihood of a rollover event is detected by the rollover sensor. The Safety Canopy is mounted to the roof side rail sheet metal, behind the side rail trim, above each row of seats. In certain sideways crashes or rollover events, the Safety Canopy activates, regardless of which seats are occupied. The Safety Canopy inflates between the side window area and occupants to further enhance protection provided in side impact crashes and rollover events.

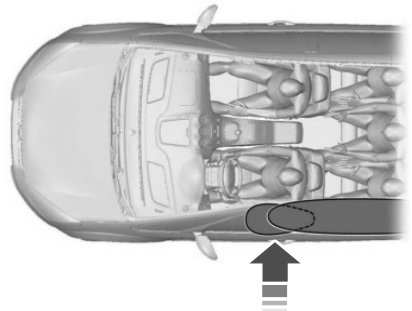

# Airbags

The system consists of the following:

- Safety Canopy curtain airbags above the trim panels over the front and rear side windows identified by a label or wording on the side rail trim or the roof-pillar trim.
- Side rail trim which opens above the side doors to allow air curtain deployment



• Crash sensors and monitoring system with a readiness indicator. See **Crash Sensors and Airbag Indicator** (page 63).

Properly restrain children 12 years old and under in the rear seats. The Safety Canopy will not interfere with children restrained using a properly installed child or booster seat because it is designed to inflate downward from the side rail trim above the doors along the side window opening.



**WARNING:** Do not place objects or mount equipment on or near the side rail trim or A-pillar that may come into contact with a deploying curtain airbag. Failure to follow this instruction could result in personal injury or death.

## 4-Door

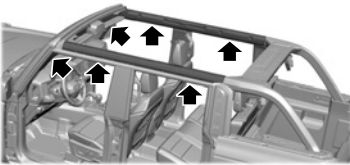

## 2-Door

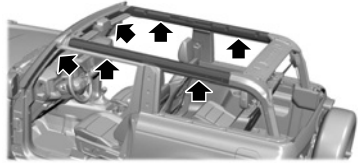

## AIRBAG PRECAUTIONS



**WARNING:** Airbags do not inflate slowly or gently, and the risk of injury from a deploying airbag is the greatest close to the trim covering the airbag module.



**WARNING:** All occupants of your vehicle, including the driver, should always properly wear their seatbelts, even when an airbag supplemental restraint system is provided. Failure to properly wear your seatbelt could seriously increase the risk of injury or death.



**WARNING:** Properly secure children 12 years old and under in a rear seating position whenever possible. If you are unable to properly secure all children in a rear seating position, properly secure the largest child on the front seat. If you must use a forward facing child restraint on the front seat, move the seat as far back as possible. Failure to follow these instructions could result in personal injury or death.



**WARNING:** Do not place your arms on the airbag cover or through the steering wheel. Failure to follow this instruction could result in personal injury.

# Airbags



**WARNING:** Keep the areas in front of the airbags free from obstruction. Do not affix anything to or over the airbag covers. Objects could become projectiles during airbag deployment. Failure to follow this instruction could result in personal injury or death.



**WARNING:** To reduce risk of injury, do not obstruct or place objects in the deployment path of the airbag.



**WARNING:** Do not place a rearward facing child restraint in front of an active airbag. Failure to follow this instruction could result in personal injury or death.



**WARNING:** Do not attempt to service, repair, or modify the supplementary restraint system or associated components. Failure to follow this instruction could result in personal injury or death.



**WARNING:** Several airbag system components get hot after inflation. To reduce the risk of injury, do not touch them after inflation.



**WARNING:** If a supplementary restraint system component has deployed, it will not function again. Have the system and associated components inspected as soon as possible. Failure to follow this instruction could result in personal injury or death.

## PROPERLY ADJUSTING THE DRIVER AND FRONT PASSENGER SEATS



**WARNING:** National Highway Traffic Safety Administration (NHTSA) recommends a minimum distance of at least 25 cm (10 in) between an occupant's chest and the driver airbag module.

To properly position yourself away from the airbag:

- Move your seat to the rear as far as you can while still reaching the pedals comfortably.
- Recline the seat slightly one or two degrees from the upright position.

After all occupants have adjusted their seats and put on seatbelts, it is very important that they continue to sit properly. Properly seated occupants sit upright, lean against the seat backrest, and center themselves on the seat cushion, with their feet comfortably extended on the floor. Sitting improperly can increase the chance of injury in a crash event. For example, if an occupant slouches, lies down, turns sideways, sits forward, leans forward or sideways, or puts one or both feet up, the chance of injury during a crash greatly increases.

## CHILDREN AND AIRBAGS



**WARNING:** Do not place a rearward facing child restraint in front of an active airbag. Failure to follow this instruction could result in personal injury or death.

# Airbags



Children must always be properly restrained. Accident statistics suggest that children are safer when properly restrained in the rear seating positions than in the front seating position. Failure to follow these instructions may increase the risk of injury in a crash.

## FRONT PASSENGER SENSING SYSTEM

### WHAT IS THE FRONT PASSENGER SENSING SYSTEM

This system detects a properly seated occupant and determines if the front passenger airbag should be enabled.

### HOW DOES THE FRONT PASSENGER SENSING SYSTEM WORK

The system uses a passenger airbag status indicator which illuminates indicating that the front passenger frontal airbag is either enabled or disabled.

**Note:** *When you first switch the ignition on, the passenger airbag status indicator off and on lamps illuminate for a short period to confirm they are functional.*

The passenger airbag status indicator lamps are on the overhead console.

The front passenger sensing system is designed to disable the front passenger frontal airbag under these conditions:

- The front passenger seat is unoccupied.
- The system determines an infant is present in a child restraint.
- A passenger takes their weight off of the seat for a period of time.
- If there is a problem with the airbag system or the passenger sensing system.

**Note:** *Even with this technology, parents are strongly encouraged to always properly restrain children in the rear seat.*

- When the front passenger sensing system disables the front passenger frontal airbag, the passenger airbag status indicator illuminates the off lamp.
- If you have installed the child restraint and the passenger airbag status indicator illuminates the on lamp, switch your vehicle off, remove the child restraint from your vehicle and reinstall the restraint following the child restraint manufacturer's instructions.

The front passenger sensing system works with sensors that are part of the front passenger seat and seatbelt. The sensors are designed to detect the presence of a properly seated occupant and determine if the front passenger frontal airbag should be enabled.



# Airbags

- When the front passenger sensing system enables the front passenger frontal airbag, the passenger airbag status indicator illuminates the on lamp.

If a person of adult size is sitting in the front passenger seat, but the passenger airbag status indicator off lamp is illuminated, it is possible that the person is not sitting properly in the seat. If this happens:

- Switch your vehicle off and ask the person to place the seat backrest in an upright position.
- Have the person sit upright in the seat, centered on the seat cushion, with the person's legs comfortably extended.
- Restart your vehicle and have the person remain in this position for about two minutes. This allows the system to detect that person and enable the passenger frontal airbag.
- If the passenger airbag status indicator off lamp remains illuminated even after this, you should advise the person to ride in the rear seat.

After all occupants have adjusted their seats and put on seatbelts, it is very important that they continue to sit upright, leaning against the seat backrest, and centered on the seat cushion, with their feet comfortably extended on the floor.

Sitting improperly can increase the chance of injury in a crash event. For example, if an occupant slouches, lies down, turns sideways, sits forward, leans forward or sideways, or puts one or both feet up, the chance of injury during a crash greatly increases.

If you think that the state of the passenger airbag status indicator lamp is incorrect, check for the following:

- Objects lodged underneath the seat.
- Objects between the seat cushion and the center console.

- Objects hanging off the seat backrest.
- Objects stowed in the seat backrest map pocket.
- Objects placed on the occupant's lap.
- Cargo interference with the seat
- Other passengers pushing or pulling on the seat.
- Rear passenger feet and knees resting or pushing on the seat.

The listed conditions could cause the weight of a properly seated occupant to be incorrectly interpreted by the front passenger sensing system. The person in the front passenger seat could appear heavier or lighter due to the conditions listed.



Make sure the front passenger sensing system is operating properly.

If the airbag readiness light is on, do the following:

- Pull your vehicle over.
- Switch your vehicle off.
- Check for any objects lodged underneath the front passenger seat or cargo interfering with the seat.
- Remove the obstruction if found.
- Restart your vehicle.
- Wait at least two minutes and verify that the airbag readiness light in the instrument cluster is no longer illuminated.
- If the airbag readiness light in the instrument cluster remains illuminated, there may be a problem due to the front passenger sensing system.

Do not attempt to repair or service the system. Take your vehicle in for service immediately.

# Airbags

If it is necessary to modify an advanced front airbag system to accommodate a person with disabilities, contact your Customer Relationship Center.

## FRONT PASSENGER SENSING SYSTEM PRECAUTIONS



**WARNING:** Sitting improperly, out of position or with the seatback reclined too far can take weight off the seat cushion and affect the decision of the passenger sensing system, resulting in serious injury or death in the event of a crash. Always sit upright against your seat back, with your feet on the floor.



**WARNING:** Any alteration or modification to the front passenger seat may affect the performance of the front passenger sensing system. This could seriously increase the risk of injury or death.



**WARNING:** Do not place objects under the front passenger seat or between the seat and the center console. Failure to follow this instruction may interfere with the front passenger seat sensing system and increase the risk of injury or death in a crash.



**WARNING:** Check the passenger airbag indicator lamp for proper airbag status. Failure to follow this instruction could result in personal injury or death.

## FRONT PASSENGER SENSING SYSTEM INDICATORS

Occupant	Passenger Airbag Status Indicator	Passenger Airbag
Empty	OFF: Illuminated	Disabled
	ON: Not Illuminated	
Child	OFF: Illuminated	Disabled
	ON: Not Illuminated	
Adult	OFF: Not Illuminated	Enabled
	ON: Illuminated	

# Airbags

## CRASH SENSORS AND AIRBAG INDICATOR



**WARNING:** Modifying or adding equipment to the front of your vehicle could affect the performance of the airbag system, increasing the risk of injury. This includes the hood, bumper system, frame, front body structure, tow hooks, hood pins, push bar and snowplows.

Your vehicle is equipped with multiple crash and occupant sensors. These sensors provide information to the restraints control module which in the event of a crash activates the following:

- Front and rear seatbelt pretensioners.
- Driver airbag.
- Passenger airbag.
- Seat mounted side airbags.
- Safety Canopy.

Based on the type of crash, the restraints control module deploys the appropriate safety devices.

The restraints control module also monitors the readiness of the above safety devices plus the crash and occupant sensors. The readiness of the safety system is indicated by a warning indicator in the instrument cluster or by a backup tone if the warning indicator is not working. Routine maintenance of the airbag is not required.

A difficulty with the system is indicated by one or more of the following:



The readiness light will not illuminate immediately after you switch the ignition on.

- The readiness light either flashes or stays on.
- You hear a series of five tones. The tone pattern repeats periodically until the problem, the light or both are repaired.

If any of these things happen, even intermittently, have the supplemental restraint system serviced immediately. Unless serviced, the system may not function properly in the event of a crash.

The fact the seatbelt pretensioners or front airbags did not activate for both front seat occupants in a crash does not mean that something is wrong with the system. Rather, it means the restraints control module determined the accident conditions (crash severity, seatbelt usage) were not appropriate to activate these safety devices.

- The front airbags activate only in frontal and near-frontal crashes. Front airbags may activate in rollovers, side impacts or rear impacts if the crash causes sufficient frontal deceleration.
- The seatbelt pretensioners activate in frontal, near-frontal and side crashes, and in rollovers.
- The side airbags inflate in certain side impact crashes or rollover events. Side airbags may activate in other types of crashes if the vehicle experiences sufficient sideways motion or deformation.
- The Safety Canopy inflates in certain side impact crashes or rollover events. The Safety Canopy may activate in other types of crashes if the vehicle experiences sufficient sideways motion or deformation, or a certain likelihood of rollover.

# Airbags

---

## **DISPOSING OF AIRBAGS**

Contact your authorized dealer as soon as possible. Airbags must be disposed of by qualified personnel.

# 911 Assist (If Equipped)

## WHAT IS 911 ASSIST

911 Assist is a SYNC system feature that can call for help.

For more information, visit [www.owner.ford.com](http://www.owner.ford.com).

## HOW DOES 911 ASSIST WORK

If a crash deploys an airbag, excluding knee airbags and rear inflatable seatbelts, or activates the fuel pump shut-off, your vehicle may be able to contact emergency services by dialing 911 through a paired and connected **Bluetooth**® enabled phone.

Not all crashes deploy an airbag or activate the fuel pump shut-off. If a connected cell phone sustains damage or loses its connection to SYNC during a crash, SYNC searches for and tries to connect to a previously paired cell phone. SYNC then attempts to call the emergency services.

Before making the call:

- SYNC provides about 10 seconds to cancel the call. If you fail to cancel the call, SYNC attempts to dial 911.
- SYNC says the following, or a similar message: SYNC will attempt to call 911, to cancel the call, press Cancel on your screen or press and hold the phone button on your steering wheel.

If you do not cancel the call and SYNC makes a successful call a pre-recorded message plays for the 911 operator. The occupants in your vehicle are able to talk with the operator. Be prepared to provide your name, phone number and location immediately because not all 911 systems are capable of receiving this information electronically.

During an emergency call the system transmits vehicle data to the emergency service.

## EMERGENCY CALL REQUIREMENTS



**WARNING:** Do not wait for 911 Assist to make an emergency call if you can do it yourself. Dial emergency services immediately to avoid delayed response time which could increase the risk of serious injury or death after a crash. If you do not hear 911 Assist within five seconds of the crash, the system or phone may be damaged or non-functional.



**WARNING:** Always place your phone in a secure location in your vehicle so it does not become a projectile or get damaged in a crash. Failure to do so may cause serious injury to someone or damage the phone which could prevent 911 Assist from working properly.



**WARNING:** Unless the 911 Assist setting is set on before a crash, the system will not dial for help which could delay response time, potentially increasing the risk of serious injury or death after a crash.

- SYNC must be powered and working properly at the time of the incident and throughout feature activation and use.
- The 911 Assist feature must be set on before the incident.
- You must pair and connect a **Bluetooth**® enabled and compatible cell phone to SYNC.
- A connected **Bluetooth**® enabled phone must have the ability to make and maintain an outgoing call at the time of the incident.

## 911 Assist (If Equipped)

---

- A connected **Bluetooth**® enabled phone must have adequate network coverage, battery power and signal strength.
- The vehicle must have battery power and be located in the U.S., Canada or in a territory in which 911 is the emergency number.

**Note:** *If any user sets 911 Assist to on or off, that setting applies for all paired phones. If 911 Assist is switched off and the phone is connected to SYNC, an icon displays on the status bar.*

**Note:** *Every phone operates differently. While SYNC 911 Assist works with most cellular phones, some may have trouble using this feature.*

### EMERGENCY CALL LIMITATIONS

The SYNC 911 Assist feature only operates in the U.S., Canada or in a territory in which 911 is the emergency number.

- Your cellular phone or 911 Assist hardware sustains damage in a crash.
- The vehicle's battery or the SYNC system has no power.
- The phone(s) thrown from your vehicle are the ones paired and connected to the system.

# Keys and Remote Controls

## REMOTE CONTROL LIMITATIONS



**WARNING:** Changes or modifications not expressly approved by the party responsible for compliance could void the user's authority to operate the equipment. The term "IC:" before the radio certification number only signifies that Industry Canada technical specifications were met.

This device complies with Part 15 of the FCC Rules and with Industry Canada license-exempt RSS standard(s). Operation is subject to the following two conditions: (1) This device may not cause harmful interference, and (2) This device must accept any interference received, including interference that may cause undesired operation.

Make sure a valid remote control is within 1 m (3 ft) from the front door handles and rear of vehicle.

The system may not function if:

- The remote control remains stationary for about a minute.
- The vehicle battery has no charge.
- The remote control battery has no charge.
- There is interference causing issues with the remote control frequencies.
- The remote control is too close to metal objects or electronic devices, for example keys or a cell phone.

## USING THE REMOTE CONTROL



**WARNING:** Do not leave a key or remote control unattended in the vehicle. Children or pets could operate the power windows, moonroof or other controls. Failure to follow this instruction could result in personal injury or death.

Use your remote control to access various vehicle systems.

**Note:** *The buttons on your remote may vary depending on the vehicle region or options.*

### Unlock



Press the button to unlock all doors. See **Unlocking and Locking the Doors Using the Remote Control** (page 71).

### Lock



Press the button to lock all doors. See **Unlocking and Locking the Doors Using the Remote Control** (page 71).

### Remote Start (If Equipped)



Press the button within three seconds to remote start. See **Using Remote Start** (page 111).

### Panic Alarm (If Equipped)



Press the button to sound the panic alarm.

# Keys and Remote Controls

## REMOVING THE KEY BLADE



Push the release button on your passive key and pull the key blade out.

## SOUNDING THE PANIC ALARM



Press the button to sound the panic alarm. Press the button again or switch the ignition on to turn it off.

**Note:** *The panic alarm only operates when the ignition is off.*

## LOCATING YOUR VEHICLE



Press the lock button twice within three seconds. The turn signal lamps flash. We recommend you use this method to locate your vehicle.

## CHANGING THE REMOTE CONTROL BATTERY



**WARNING:** Keep batteries away from children to prevent ingestion. Failure to follow this instruction could result in personal injury or death. If ingested, immediately seek medical attention.



**WARNING:** If the battery compartment does not securely close, stop using the remote control and replace it as soon as possible. In the meantime, keep the remote control away from children. Failure to follow this instruction could result in personal injury or death.

The remote control uses one coin-type 3-volt lithium battery CR2450 or equivalent.



1. Push the release button and pull the key blade out.



## Keys and Remote Controls

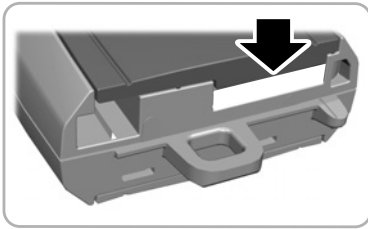

2. Twist a thin coin under the tab hidden behind the key blade head to remove the battery cover.
- 
- A diagram showing the battery cover being twisted off the transmitter housing. A white arrow points up from the cover, and a black arrow points down from the transmitter housing, indicating the direction of removal.

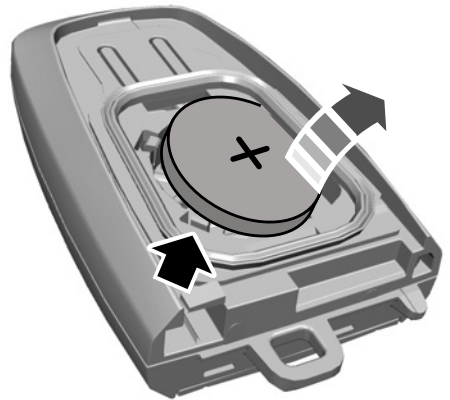

3. Insert a screwdriver, and carefully remove the battery.
4. Install a new battery with the + facing upward.
5. Reinstall the battery housing cover onto the transmitter and install the key blade.



Dispose of old batteries in an environmentally friendly way. Seek advice from your local authority about recycling old batteries.

**Note:** Do not wipe off any grease on the battery terminals or on the back surface of the circuit board.

**Note:** Replacing the battery does not erase the programmed key from your vehicle. The remote control should operate normally.

## REPLACING A LOST KEY OR REMOTE CONTROL

You can purchase replacement keys or remote controls from an authorized dealer. Authorized dealers can program remote controls for your vehicle.

# Keys and Remote Controls

## PROGRAMMING THE REMOTE CONTROL

You must have two previously programmed remote controls inside your vehicle and the new, unprogrammed remote controls readily accessible. Contact an authorized dealer to have the spare remote control programmed if two previously programmed remote controls are not available. Make sure that your vehicle is off before beginning this procedure.

Make sure that you close all the doors before beginning and that they remain closed throughout the procedure. Perform all steps within 30 seconds of starting the sequence. Stop and wait for at least one minute before starting again if you perform any steps out of sequence.

**Note:** You can program a maximum of four remote controls to your vehicle.

**Note:** If your programmed remote controls get lost or stolen and you do not have an extra coded remote, you need to have your vehicle towed to an authorized dealer. Store an extra programmed remote away from your vehicle in a safe place to help prevent any inconvenience. Contact an authorized dealer to purchase additional spare or replacement remote controls.

Read and understand the entire procedure before you begin.

1. Place the first programmed remote in the backup slot. See **Accessing the Passive Key Backup Position** (page 153). With your foot off the brake pedal, press and release the push button ignition switch.
2. Wait five seconds and then press and release the push button ignition switch again.
3. Remove the remote control.
4. Within 10 seconds, place a second programmed remote control in the backup slot. Press and release the push button ignition switch.
5. Wait five seconds and then press and release the push button ignition switch again. Keep the ignition on for at least 3 seconds, but no more than 10 seconds.
6. Remove the remote control.
7. Place the unprogrammed remote control in the backup slot and press and release the push button ignition switch.

Programming is now complete. With your foot on the brake pedal, press the push button ignition switch to verify the remote control functions operate and your vehicle starts with the new remote control.

If programming was not successful, wait 10 seconds and repeat Steps 1 through 7. If you are still unsuccessful, take your vehicle to an authorized dealer.

## KEYS AND REMOTE CONTROLS – TROUBLESHOOTING

### KEYS AND REMOTE CONTROLS – INFORMATION MESSAGES

Message	Action
Key Battery Low Replace Soon	Displays when the remote control battery requires replacing.

# Doors and Locks

## OPERATING THE DOORS FROM OUTSIDE YOUR VEHICLE

### UNLOCKING AND LOCKING THE DOORS USING THE REMOTE CONTROL

You can only use the remote control when your vehicle is stationary.

#### Unlocking the Doors



Press the button to unlock all doors. One long flash of the turn signal lamps confirms that your vehicle has unlocked.

#### Locking the Doors



Press the button to lock all doors. One short flash of the turn signal lamps confirms that your vehicle has locked.

## OPERATING THE DOORS FROM INSIDE YOUR VEHICLE

### UNLOCKING AND LOCKING THE DOORS USING THE CENTRAL LOCKING

The power door lock control is on the front doors.



Press the button to unlock all doors.



Press the button to lock all doors.

**Note:** *The central locking only operates if the front doors are fully closed.*

## OPENING THE DOORS FROM INSIDE YOUR VEHICLE

Pull the interior door handle twice to unlock and open a rear door. The first pull unlocks the door and the second pull opens the door.

## AUTOUNLOCK

### WHAT IS AUTOUNLOCK

Autounlock is a feature that centrally unlocks the vehicle doors when your vehicle comes to a stop and you open the driver door.

### AUTOUNLOCK REQUIREMENTS

Autounlock unlocks all the doors after:

1. The vehicle speed exceeds 20 km/h (12 mph).
2. Your vehicle comes to a stop.
3. You open the driver door.

**Note:** *Autounlock operates for only 10 minutes after the ignition is switched off.*

### SWITCHING AUTOUNLOCK ON AND OFF

1. From the settings menu, press Vehicle.
2. Press Locks.
3. Switch Autounlock on or off.

## AUTOLOCK

### WHAT IS AUTOLOCK

Autolock is a locking feature that centrally locks your vehicle doors when driving.

# Doors and Locks

## AUTOLOCK REQUIREMENTS

Autolock locks all the doors after:

1. All doors are closed and the ignition is on.
2. Your vehicle speed exceeds 20 km/h (12 mph).

Autolock repeats if:

1. Your vehicle is stopped.
2. Any door is opened and closed again.
3. Your vehicle speed exceeds 20 km/h (12 mph).

## SWITCHING AUTOLOCK ON AND OFF (If Equipped)

1. From the settings menu, press Vehicle.
2. Press Locks.
3. Switch Autolock on or off.

## MISLOCK

### WHAT IS MISLOCK

Mislock is a locking feature that warns you if your vehicle has not locked.

## MISLOCK LIMITATIONS

When you press the lock button once, the turn signals do not flash if:

- Any door or the tailgate is open.
- The hood is open.

If you switch mislock off, the horn does not sound if you press the lock button on the remote control when a door is open.

## SWITCHING MISLOCK ON AND OFF

1. From the settings menu, press Vehicle.
2. Press Locks.
3. Switch Mislock on or off.

## DOORS AND LOCKS – TROUBLESHOOTING

### DOORS AND LOCKS – WARNING LAMPS

#### Door Ajar Warning Lamp



Illuminates when you switch the ignition on and remains on if any door or the hood is open.

## DOORS AND LOCKS – INFORMATION MESSAGES

Message	Details
Driver Door Ajar	Displays if a door is open. Fully close the door.
Passenger Door Ajar	
Rear Left Door Ajar	
Rear Right Door Ajar	
Hood Ajar	Displays if a hood is open. Fully close the hood.

# Doors and Locks

---

## **DOORS AND LOCKS – FREQUENTLY ASKED QUESTIONS**

### **Can accessories such as steps or handles be used with the latch assembly?**

- Do not use the door latch assembly to attach any accessory, such as handles or steps, as this can cause damage to your vehicle.

# Keyless Entry

## WHAT IS KEYLESS ENTRY

The system allows you to lock and unlock your vehicle without taking the passive key out of your pocket or purse.

## KEYLESS ENTRY LIMITATIONS

Make sure your remote control is within 1 m (3 ft) from the front door handles and the tailgate.

The system could not function if:

- The remote control remains stationary for about a minute.
- The vehicle battery has no charge.
- The remote control battery has no charge.
- There is interference causing issues with the remote control frequencies.
- The remote control is too close to metal objects or electronic devices, for example keys or a cell phone.

## KEYLESS ENTRY SETTINGS

### Reprogramming the Unlocking Function (If Equipped)

You can enable the two-stage unlocking function allowing you to unlock only the driver door when you touch the unlock sensor.

Press and hold both the lock and unlock buttons on the remote control for four seconds to disable or enable two-stage unlocking.

If you program the unlocking function so that only the driver door unlocks, you can unlock all of the other doors from inside your vehicle using the power door lock control. You can unlock individual doors by pulling the interior door handles on those doors.

## Key Detection Alert

Displays a message in the instrument cluster if no valid key is detected, when you exit your vehicle with a key, after the last front door is closed and your keyless vehicle is in run, indicating your vehicle is still on. An audible alert sounds if you have driven the vehicle and reached a speed of 25 km/h (16 mph) and the above mentioned conditions are met.

You can switch the audible alert on or off.

1. From the settings menu, press Vehicle.
2. Switch Key Detection Alert On or Off.

## USING KEYLESS ENTRY

### Unlocking the Doors



With your passive key within 1 m (3 ft) of your vehicle, touch the unlock sensor on the back of the door handle for a brief period and then pull on the door handle to unlock, being careful not to touch the lock sensor at the same time or pull on the door handle too quickly. The intelligent access system requires a brief delay to authenticate your passive key.

### Locking the Doors



# Keyless Entry

---

With your passive key within 1 m (3 ft) of your vehicle, touch the outer door handle lock sensor for approximately one second to lock, being careful not to touch the unlock sensor on the back of the door handle at the same time. After locking, you can immediately pull on the door handle to confirm locking occurred without inadvertently unlocking.

## KEYLESS ENTRY – TROUBLESHOOTING

### KEYLESS ENTRY – FREQUENTLY ASKED QUESTIONS

#### Why does the keyless entry system not function?

If the system does not function it may be limited. See **Keyless Entry Limitations** (page 74). If the system still does not function use the remote control or the key blade to lock and unlock your vehicle.

#### Why can I not lock my vehicle?

If you electronically lock your vehicle with a rear door or the tailgate open, the system searches for a passive key inside your vehicle after you close the last door. If the system detects a key, all doors unlock indicating that a key is inside. Your vehicle locks if another passive key is within the detection range after you close the last door.

# Tailgate

## TAILGATE PRECAUTIONS



**WARNING:** It is extremely dangerous to ride in a cargo area, inside or outside of a vehicle. In a crash, people riding in these areas are more likely to be seriously injured or killed. Do not allow people to ride in any area of your vehicle that is not equipped with seats and seatbelts. Make sure everyone in your vehicle is in a seat and properly using a seatbelt. Failure to follow this warning could result in serious personal injury or death.

## OPENING THE TAILGATE

### OPENING THE TAILGATE FROM OUTSIDE YOUR VEHICLE

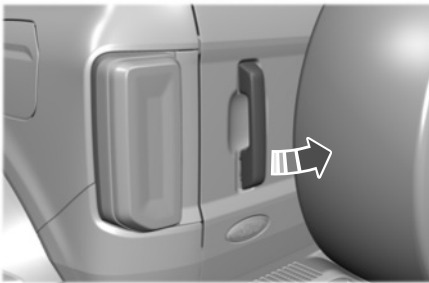

1. Unlock the vehicle with the remote control or power door unlock control.

**Note:** If a passive key is within 1 m (3 ft) of the tailgate, the tailgate unlocks when you touch the inside of the tailgate handle.

2. Pull the handle to release the tailgate.

**Note:** An open tailgate could obstruct the right-hand side tail lamp. Make sure you take the necessary precautions while parked on the side of the road with the tailgate open. Do not drive with the tailgate open.

## CLOSING THE TAILGATE

### CLOSING THE TAILGATE FROM OUTSIDE YOUR VEHICLE

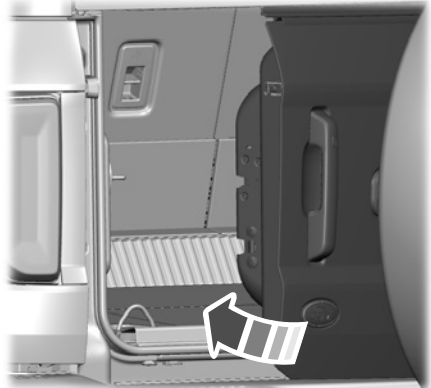

Push the tailgate until fully closed.

## LOCKING AND UNLOCKING THE TAILGATE

You can lock or unlock your vehicle with the remote control or power door lock control.

### Locking

If a passive key is within 1 m (5 ft) of the tailgate, touch the lock button on the tailgate handle to lock.



# Tailgate

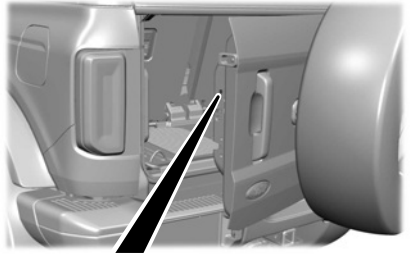
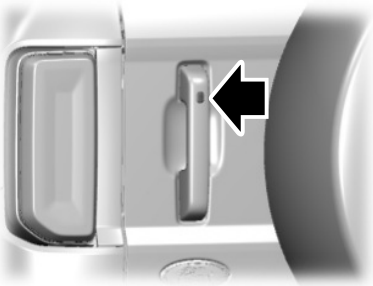

## Unlocking

If a passive key is within 1 m (5 ft) of the tailgate, touch the back of the tailgate handle to unlock.

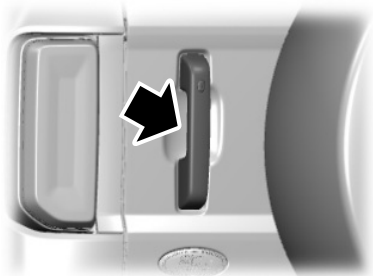

## Emergency Unlocking

If there is a power door lock fault you can use the release lever to unlock the tailgate door.

## Emergency Locking

If there is a power door lock fault you can use the key blade to lock the tailgate door.

# Tailgate

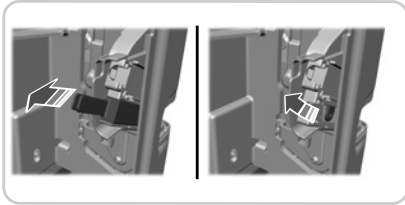
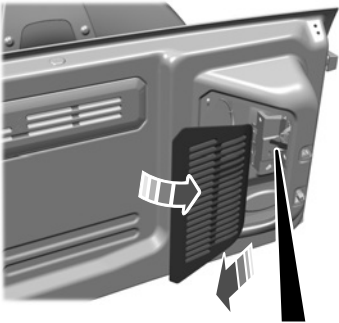

1. Remove the tailgate trim panel.
2. Remove the inside release lever cover.
3. Using a small tool, pull the release lever to open the tailgate.
4. Reinstall the inside release lever cover and trim panel after unlocking the tailgate.

## SLIDE OUT TAILGATE (IF EQUIPPED)



**WARNING:** Do not use or sit on the slide out tailgate when the vehicle is moving. Failure to follow this instruction could result in personal injury or death.

The slide out tailgate is a durable and functional surface that slides out from the rear load floor.

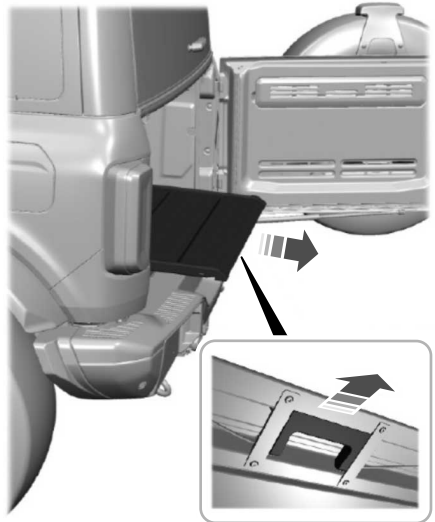

1. Fully open the tailgate.
2. Locate the release handle.
3. Pull the release handle to unlock and slide out the tailgate.

**Note:** The slide out tailgate can hold a maximum of 272 kg (599.66 lb).

4. To close the slide out tailgate, squeeze the handle and push forward until locked in place.

**Note:** Do not drive with the slide out tailgate in the extended position.

## TAILGATE – TROUBLESHOOTING

### TAILGATE – WARNING LAMPS



Illuminates when the tailgate is not completely closed.

# Tailgate

---

## TAILGATE – INFORMATION MESSAGES

### Tailgate

<b>Message</b>	<b>Details</b>
Tailgate Ajar	The tailgate is not completely closed.

# Security

---

## PASSIVE ANTI-THEFT SYSTEM

### WHAT IS THE PASSIVE ANTI-THEFT SYSTEM

The passive anti-theft system prevents someone from starting your vehicle with an incorrectly coded key.

**Note:** *Do not leave a duplicate coded key in your vehicle. Always take the keys and lock all the doors when leaving your vehicle.*

### HOW DOES THE PASSIVE ANTI-THEFT SYSTEM WORK

The passive anti-theft system arms when you switch your vehicle off.

It disarms when you switch your vehicle on with a correctly coded key.

**Note:** *The system is not compatible with non-Ford aftermarket remote start systems.*

**Note:** *Do not leave a duplicate coded key in your vehicle. Always take the keys and lock all doors when leaving your vehicle.*

## ANTI-THEFT ALARM SYSTEM

### WHAT IS THE ANTI-THEFT ALARM SYSTEM

The anti-theft alarm system warns you of an unauthorized entry to your vehicle.

### HOW DOES THE ANTI-THEFT ALARM SYSTEM WORK

When armed, the anti-theft alarm is triggered in any of the following ways:

- Opening a door, the tailgate or hood without a correctly coded key or remote control.
- If you turn the power on without a correctly coded key.
- Disconnecting the battery.

Any further attempts to carry out one of the above, sounds the alarm again.

If the anti-theft alarm is triggered, the alarm horn sounds for 30 seconds and the turn signals flash for five minutes.

### WHAT IS THE PERIMETER ALARM

The perimeter alarm is designed to detect unauthorized access to your vehicle.

### ARMING THE ANTI-THEFT ALARM SYSTEM

The alarm is ready to arm when you switch your vehicle off.

Lock your vehicle with your remote control to arm the alarm.

### DISARMING THE ANTI-THEFT ALARM SYSTEM

Disarm the alarm by performing any of the following actions:

- Unlock the doors or luggage compartment with the remote control.
- Switch your vehicle on or start your vehicle.

# Security

---

## SECURITY – TROUBLESHOOTING

### SECURITY – INFORMATION MESSAGES

Message	Details
No Key Detected	The system has not detected a correctly coded key.
Starting System Fault	The system has malfunctioned. Have your vehicle checked as soon as possible.
Vehicle Alarm To Stop Alarm, Start Vehicle.	Displays when the alarm has been triggered due to unauthorized entry.
Alarm	

# Security

---

## **SECURITY – FREQUENTLY ASKED QUESTIONS**

### **What should I do if there is a potential alarm problem with my vehicle?**

- Take all remote controls to an authorized dealer if there is a potential alarm problem with your vehicle.

### **What should I do if my vehicle is unable to start with a correctly coded key?**

- Have your vehicle checked as soon as possible.

# Steering Wheel

## ADJUSTING THE STEERING WHEEL



**WARNING:** Do not adjust the steering wheel when your vehicle is moving.

**Note:** Make sure that you are sitting in the correct position. See **Sitting in the Correct Position** (page 122).

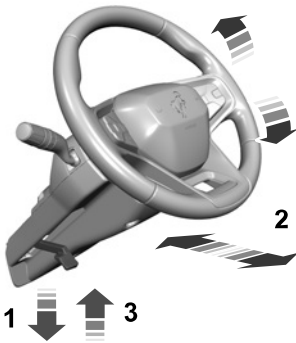

1. Unlock the steering column.
2. Adjust the steering wheel to the position you prefer.
3. Lock the steering column.

## HORN



Press on the center of the steering wheel near the horn icon to activate the horn.

## SWITCHING THE HEATED STEERING WHEEL ON AND OFF - VEHICLES WITH: HEATED STEERING WHEEL



**WARNING:** Use caution when using the heated steering wheel if you are unable to feel pain to your skin because of advanced age, chronic illness, diabetes, spinal cord injury, medication, exhaustion or other physical conditions. Failure to follow this instruction could result in personal injury, especially if the heated steering wheel is used for long periods of time.



To activate the heated steering wheel, press the button on the climate control unit. An indicator illuminates when the heated steering wheel is on. To turn it off, press the heated steering wheel button again.

**Note:** The engine must be running to use the heated steering wheel.

**Note:** A sensor regulates the temperature of the steering wheel.

**Note:** The heated steering wheel may remain on after remote starting your vehicle, depending on the remote start settings. It may also turn on when you start your vehicle if it was on the last time the engine was switched off.

**Note:** In warm temperatures, the steering wheel quickly reaches its maximum temperature and the system reduces the current to the heating element. This could cause you to think that the system has stopped working but it has not. This is normal.

# Wipers and Washers

## WIPERS

### WIPER PRECAUTIONS

The vehicle is equipped with protection features to prevent damage to the wiper motor in case of overheating, usage on dry windshields or obstructions to the wiper blade due to snow or ice accumulation on the windshield.

In such conditions, the wiper motor may restrict its speed, reduce area of cleaning or completely stop operation. System returns back to normal operation mode once conditions are resolved.

Do not operate the wipers on a dry windshield. This could scratch the glass or damage the wiper blades. Use the windshield washers before wiping a dry windshield.

Fully defrost the windshield before you switch the windshield wipers on.

Switch the windshield wipers off before entering a car wash.

### SWITCHING WINDSHIELD WIPERS ON AND OFF

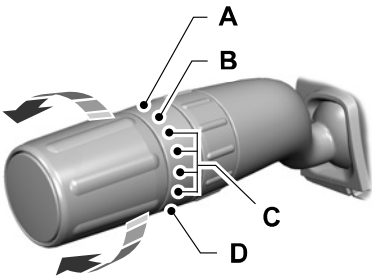

- A High-speed wipe.
- B Low-speed wipe.

- C Auto Wipe/Intermittent wipe.
- D Off.



Use the rotary control.

### SWITCHING THE REAR WINDOW WIPER ON AND OFF



Rotate the control away from you for a long wipe interval.

Rotate the control toward you for a short wipe interval.

### REVERSE WIPE

#### WHAT IS REVERSE WIPE

Reverse wipe turns on the rear window wiper when you shift into reverse (R) and the windshield wipers are on.

#### REVERSE WIPE SETTINGS

1. From the settings menu, press Vehicle.
2. Press Wipers.
3. Switch Rear wiper on or off.



# Wipers and Washers

## CHECKING THE WIPER BLADES



Run the tip of your fingers over the edge of the blade to check for roughness.

## REPLACING THE FRONT WIPER BLADES

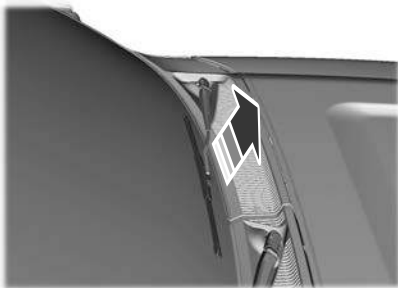

1. Pull the wiper blade and arm away from the glass.

**Note:** Do not hold the wiper blade to lift the wiper arm.

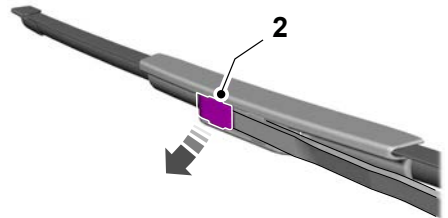

2. Lift the wiper blade primary locking clip.

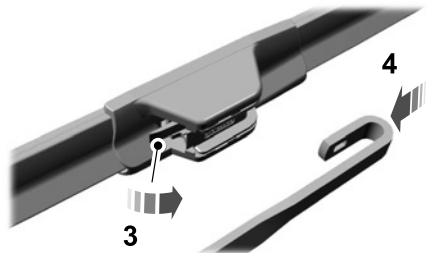

3. Press the wiper blade secondary locking clip.
4. Remove the wiper blade.

**Note:** Make sure that the wiper arm does not spring back against the glass when the wiper blade is not attached.

5. To install, reverse the removal procedure.

**Note:** Make sure that the wiper blade locks into place.

# Wipers and Washers

## REPLACING THE REAR WIPER BLADES

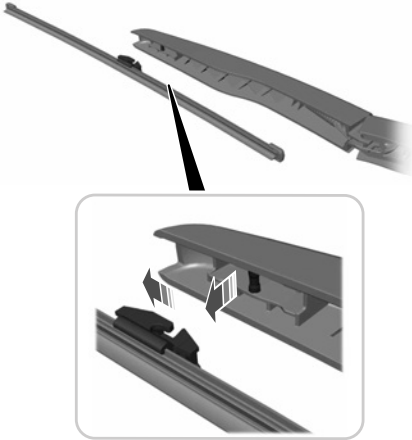

1. Lift the wiper arm.

**Note:** Do not hold the wiper blade to lift the wiper arm.

**Note:** Do not lift the wiper arm beyond the limited service-up position, as this might cause damage to the wiper arm. The limited service-up position is intended to protect the wiper arm against car washes.

2. Remove the wiper blade.

**Note:** Make sure that the wiper arm does not spring back against the glass when the wiper blade is not attached.

3. To install, reverse the removal procedure.

**Note:** Make sure that the wiper blade locks into place.

## WASHERS

### WASHER PRECAUTIONS



**WARNING:** If you operate your vehicle in temperatures below 5°C (41°F), use washer fluid with antifreeze protection. Failure to use washer fluid with antifreeze protection in cold weather could result in impaired windshield vision and increase the risk of injury or accident.

Do not operate the washers when the washer reservoir is empty. This could cause the washer pump to overheat.

Keep the outside of the windshield clean. The rain sensor is very sensitive and the wipers may operate if dirt, mist or insects hit the windshield.

### USING THE WINDSHIELD WASHER



Press and hold the button at the end of the lever to operate the windshield washer.

**Note:** A courtesy wipe occurs a short time after the wipers stop to clear any remaining washer fluid when switched on. See **Switching the Courtesy Wipe On and Off** (page 87).

# Wipers and Washers

## SWITCHING THE COURTESY WIPE ON AND OFF

1. From the settings menu, press Vehicle.
2. Press Wipers.
3. Switch Courtesy Wipe on or off.

**Note:** When you switch the feature on, the wipers make an additional single wipe at the end of the washer request. When you switch it off, the wipers finish the current washer request.

## USING THE REAR WINDOW WASHER



Rotate the control to the top or bottom position and hold it to operate the rear window washer.

## ADDING WASHER FLUID

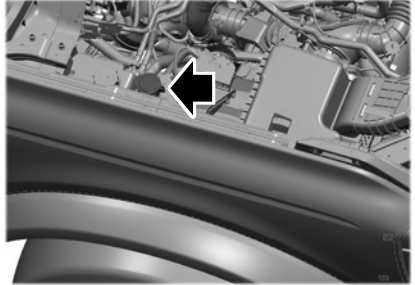

## WASHER FLUID SPECIFICATION

### Capacities

Variant	Quantity
All.	Fill as required.

### Materials

Name	Specification
Motorcraft® Premium Windshield Wash Concentrate with Bitterant (U.S.) Motorcraft® Premium Quality Windshield Washer Fluid -35 °C / Liquide lave-glace de haute qualité -35 °C Motorcraft® (Canada) ZC-32-B2 (U.S.) CXC-37-M (Canada)	WSS-M14P19-A

# Wipers and Washers

---

## WIPERS AND WASHERS VIDEOS

[Improving Your Windshield Wiper  
Performance Video Link](#)

[Courtesy Wipe Video Link](#)

## WIPERS AND WASHERS – TROUBLESHOOTING

### WIPERS AND WASHERS – WARNING LAMPS



Illuminates when the windshield washer fluid is low.

### WIPERS AND WASHERS – FREQUENTLY ASKED QUESTIONS

#### Why are there streaks and smears on the windshield?

- The wiper blades could be dirty, worn or damaged. Check the wiper blades. See **Checking the Wiper Blades** (page 85). If the wiper blades are dirty, clean them with washer fluid or water applied with a soft sponge or cloth. If the wiper blades are worn or damaged, install new ones. See **Replacing the Front Wiper Blades** (page 85).

# Exterior Lighting

## EXTERIOR LIGHTING CONTROL

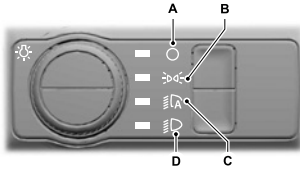

- A Lamps off.
- B Parking lamps on.
- C Autolamps on.
- D Headlamps on.

Rotate the control to make a selection.

**Note:** The lighting control defaults to autolamps every time you switch your vehicle on.

## HEADLAMPS

### USING THE HIGH BEAM HEADLAMPS

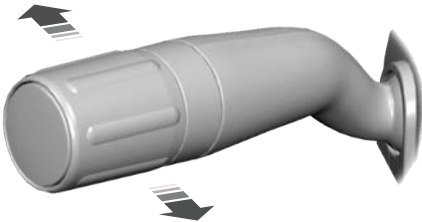

 Push the lever away from you to switch the high beams on.

Push the lever forward again or pull the lever toward you to switch the high beams off.

Slightly pull the lever toward you and release it to flash the headlamps.

**Note:** Continuous activation only occurs with the headlamps on.

### SWITCHING HEADLAMP EXIT DELAY ON AND OFF

To switch headlamp exit delay on, pull the turn signal lever toward you when the headlamps are off and the ignition is off. A short tone sounds when the system is on.

To switch headlamp exit delay off, pull the turn signal lever toward you again or switch your vehicle on.

**Note:** The headlamps turn off after three minutes with any door open or 30 seconds after the last door closes.

## HEADLAMP INDICATORS

### Lamps On



Illuminates when you switch the low beam headlamps or the parking lamps on.

### Headlamp High Beam



Illuminates when you switch the high beam headlamps on.

# Exterior Lighting

## HEADLAMPS – TROUBLESHOOTING

### HEADLAMPS – FREQUENTLY ASKED QUESTIONS

#### Why is there condensation in the headlamps?

- Headlamps have vents to accommodate normal changes in air pressure. Condensation can be a natural by-product of this design. When moist air enters the lamp assembly through the vents, there is a possibility that condensation can occur when the temperature is cold. When normal condensation occurs, a fine mist can form on the interior of the lens. The fine mist eventually clears and exits through the vents during normal operation.

#### How much condensation is acceptable?

- The presence of a fine mist, for example no streaks, drip marks or large droplets. A fine mist covers less than 50% of the lens.

#### How long does it take for the acceptable condensation to clear?

- Clearing time can take as long as 48 hours under dry weather conditions.

#### How much condensation is unacceptable?

- A water puddle inside the lamp. Streaks, drip marks or large droplets present on the interior of the lens.

#### What should I do if unacceptable condensation is present?

- Have your vehicle checked as soon as possible.

#### Why do my headlamps turn off when I have them switched on when I switch my vehicle off?

- The battery saver turns the headlamps off after a short period of time after you switch your vehicle off.

## AUTOLAMPS

### WHAT ARE AUTOLAMPS



**WARNING:** The system does not relieve you of your responsibility to drive with due care and attention. You may need to override the system if it does not turn the headlamps on in low visibility conditions, for example daytime fog.

Autolamps turn the headlamps on in low light situations or when the windshield wipers operate.

### AUTOLAMP SETTINGS

#### Autolamp Exit Delay

You can adjust the amount of time the autolamps remain on after you switch off your vehicle. Use the touchscreen to choose a delay setting.

1. From the settings menu, press Vehicle.
2. Press Lighting.
3. Press Autolamp Delay.
4. Select a setting.

**Note:** If the setting is off, the external lamps switch off immediately when you shut down your vehicle.

**Note:** You can pull the turn signal toward you to manually switch off the autolamp exit delay.

# Exterior Lighting

## EXTERIOR LAMPS

### USING THE TURN SIGNAL LAMPS

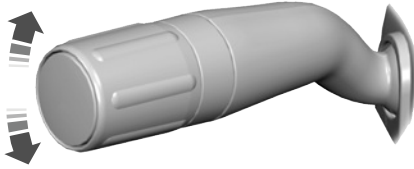

Push the lever up or down to switch the turn signal lamps on.

Set the lever to the middle position to switch the turn signal lamps off.

**Note:** Tap the lever up or down to make the turn signal lamps flash three times.

### Turn Signal Lamp Indicator



It flashes when you switch the turn signal lamps on.

**Note:** An increase in the rate of flashing warns of a failed turn signal lamp.

### SWITCHING THE DAYTIME RUNNING LAMPS ON AND OFF - VEHICLES WITH: CONFIGURABLE DAYTIME RUNNING LAMPS



**WARNING:** The daytime running lamps system may not activate the rear lamps and may not provide adequate lighting during low visibility driving conditions. Make sure you switch the headlamps on, as appropriate, during all low visibility conditions. Failure to do so may result in a crash.

1. Press **Settings** on the touchscreen.
2. Press **Vehicle Settings**.
3. Press **Lighting**.
4. Switch **Daytime Running Lights** on or off.

The daytime running lamps turn on when all of the following occur:

- You switch the system on.
- You switch your vehicle on.
- The transmission is not in park (P) for vehicles with automatic transmissions or you release the parking brake for vehicles with manual transmissions.
- The lighting control is in the autolamps position.
- The headlamps are off.

**Note:** Other lighting control positions do not turn on the daytime running lamps.

# Exterior Lighting

## SWITCHING THE DAYTIME RUNNING LAMPS ON AND OFF - VEHICLES WITH: DAYTIME RUNNING LAMPS (DRL)



**WARNING:** The daytime running lamps system may not activate the rear lamps and may not provide adequate lighting during low visibility driving conditions. Make sure you switch the headlamps on, as appropriate, during all low visibility conditions. Failure to do so may result in a crash.

Daytime running lamps are always on unless you switch on the headlamps or your vehicle is in park (P).

## USING THE FRONT FOG LAMPS (If Equipped)

To switch the lamps on or off:

1. Set the lighting control to the parking lamps, headlamps or autolamps position.

**Note:** When the lighting control is in the autolamps position, you cannot switch the fog lamps on unless the low beam headlamps are on.



Press the button on the lighting control to switch the front fog lamps on or off.

**Note:** Only switch the front fog lamps on during reduced visibility.

**Note:** The brightness of the daytime running lamps may decrease when the front fog lamps are switched on.

**Note:** The front fog lamps lights switch off automatically when high beams are activated.

## Front Fog Lamps Indicator



It illuminates when you switch the front fog lamps on.

## SWITCHING THE SPOT LAMPSON AND OFF (If Equipped)

The spot lamp buttons are near the lighting control.



Press the button to switch on the left-hand spot lamp.



Press the button to switch on the right-hand spot lamp.

Move the position of the exterior mirrors to adjust the aim.

**Note:** Make sure you switch your vehicle on, with the vehicle in accessory mode or running.

**Note:** The spot lamps turn off after 10 km/h (6 mph).

**Note:** The spot lamps illuminate the area in front of and to the side of your vehicle.

## USING THE OFF-ROAD DRIVING LAMPS (If Equipped)

The off-road driving lamps switch is connected to the AUX 1 switch on the auxiliary switch panel. When the switch is turned on, the indicator light on the switch illuminates and the circuit provides power to the off-road driving lights



# Exterior Lighting



**Note:** Off-road driving lamps are for off-road use only. Use on public roads may violate local laws.

**Note:** Only switch the off-road driving lamps on during reduced visibility in off-road conditions.

**Note:** The off-road driving lamps only operate when accessory mode is active, and the engine is in the on or off position. Leave the engine running to maintain battery charge when using the off-road driving lamps.

## EXTERIOR LAMPS ON AUDIBLE WARNING

Sounds when you open the driver door and the exterior lamps are on.

## EXTERIOR ZONE LIGHTING (IF EQUIPPED)

### WHAT IS EXTERIOR ZONE LIGHTING

Exterior zone lighting divides the exterior lighting into zones and allows you to switch them on and off to provide lighting around the perimeter of your vehicle.

### USING THE EXTERIOR ZONE LIGHTING

1. Press **Features** on the touchscreen.

2. Press **Zone Lighting**.

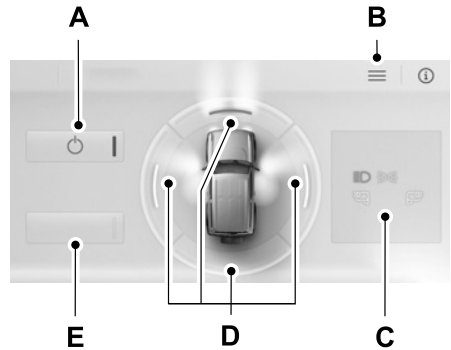

- A On and off button.
- B Settings menu.
- C Exterior lamp indicators.
- D Individual zones on and off.
- E All zones on and off.

You can use zone lighting when your vehicle is on or off. When it is off, the lighting turns off after a certain period of time.

You can also use individual zone controls to switch on each zone.

**Note:** Make sure to remove exterior lighting covers when using zone lighting.

**Note:** When your vehicle is off and the timer has one minute remaining, the turn signals flash six times.

**Note:** Indicators on the touchscreen illuminate when the lights outside of the zone lighting control are on.

**Note:** You can remotely control the zone lighting using the Ford mobile app.

**Note:** Vehicles without spot lamps only have two zones.

# Exterior Lighting

## EXTERIOR ZONE LIGHTING SETTINGS

1. Press **Features** on the touchscreen.
2. Press **Zone Lighting**.
3. Press the settings menu in the upper right-hand corner.
4. Press a setting.

### Enable Autolamp Override

This setting allows your vehicle to override the autolamps when using zone lighting.

When you access zone lighting for the first time, you can choose this setting. You can change this setting at any time.

### Include Reverse Lamps

This setting turns the reverse lamps on when you switch the rear lighting zone on.

Switch this setting off if you have a backup alarm installed to prevent the reverse lamps from turning on and sounding the alarm when using zone lighting.

## AUTOMATIC HIGH BEAM CONTROL

### HOW DOES AUTOMATIC HIGH BEAM CONTROL WORK

Automatic high beam control turns the high beams on if it is dark enough and no other traffic is present. If it detects an approaching vehicle's headlamps or tail lamps, or street lighting ahead, the system turns the high beams off.

A camera sensor, centrally mounted behind the windshield of your vehicle, continuously monitors conditions to turn the high beams on and off.

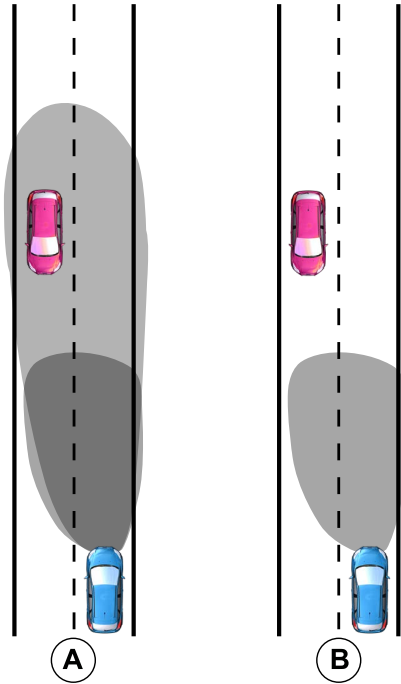

- A Without automatic high beam control.
- B With automatic high beam control.

## AUTOMATIC HIGH BEAM CONTROL PRECAUTIONS



**WARNING:** The system does not relieve you of your responsibility to drive with due care and attention. You may need to override the system if it does not turn the high beams on or off.

# Exterior Lighting



**WARNING:** The system may not switch the high beams off if the lights of oncoming vehicles are hidden by obstacles, for example guard rails.



**WARNING:** You may need to override the system when approaching other road users.



**WARNING:** In situations with poor visibility, such as fog, heavy rain or other inclement weather, you may need to override or completely switch off the system.

## AUTOMATIC HIGH BEAM CONTROL REQUIREMENTS

The system turns the high beams on if all of the following occur:

- You switch the system on.
- You set the lighting control to the autolamps position.
- The ambient light level is low enough that you require high beams.
- There is no traffic in front of your vehicle.
- The vehicle speed is greater than approximately 52 km/h (32 mph).

## AUTOMATIC HIGH BEAM CONTROL LIMITATIONS

The system turns the high beams off if any of the following occur:

- You switch the system off.
- You set the lighting control to any position except autolamps.
- The ambient light level is high enough that you do not require high beams.
- The system detects an approaching vehicle's headlamps or a leading vehicle's tail lamps.

- The system detects severe rain, snow or fog.
- The system detects street lighting.
- The camera has reduced visibility.
- The vehicle speed falls below approximately 44 km/h (27 mph).

**Note:** The deactivation speed may be lower on curves.

## SWITCHING AUTOMATIC HIGH BEAM CONTROL ON AND OFF

1. From the Settings menu, press Vehicle.
2. Press Lighting.
3. Switch auto high beam on or off.

## AUTOMATIC HIGH BEAM CONTROL INDICATORS



Illuminates to confirm when the system is ready to assist.

## OVERRIDING AUTOMATIC HIGH BEAM CONTROL

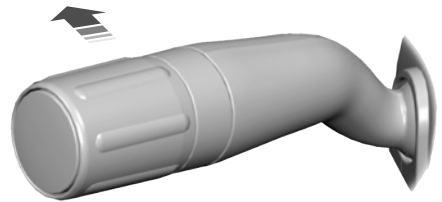

Push the lever away from you to switch the high beams on.

Push the lever away from you again to switch the high beams off.

# Exterior Lighting

---

Push the lever away from you for a third time to switch automatic high beam control back on.

## **AUTOMATIC HIGH BEAM CONTROL – TROUBLESHOOTING**

### **AUTOMATIC HIGH BEAM CONTROL – INFORMATION MESSAGES**

<b>Message</b>	<b>Details</b>
Front Camera Low Visibility Clean Screen	The camera has reduced visibility. Clean the windshield. If the message continues to appear, have your vehicle checked as soon as possible.
Front Camera Temporarily Not Available	The camera has malfunctioned. Wait a short period of time for the camera to cool down. If the message continues to appear, have your vehicle checked as soon as possible.
Front Camera Malfunction Service Required	The camera has malfunctioned. Have your vehicle checked as soon as possible.

## **EXTERIOR LIGHTING VIDEOS**

[Intelligent Three Blink Turn Signal Video Link](#)

[Auto High Beams](#)

# Interior Lighting

## SWITCHING ALL OF THE INTERIOR LAMPS ON AND OFF

The lamps turn on under the following conditions:

- You open any door.
- You press a button on the remote control.
- You press the all lamps on button on the overhead console.



Press to switch all interior lamps on or off.

## SWITCHING THE FRONT INTERIOR LAMPS ON AND OFF



The front interior lamp switches are on the overhead console.

**Note:** The position of each button on the overhead console depends on your vehicle.

### Individual Map Lamps



Press to switch the left-hand individual dome lamp on and off.



Press to switch the right-hand individual dome lamp on and off.

## SWITCHING THE REAR INTERIOR LAMPS ON AND OFF



The rear interior lamps may be above the rear seat or above the rear windows.



Press to switch the lamps on or off.

**Note:** If you switch the rear lamps on through the overhead console, you cannot switch them off with the rear lamp switch.

## INTERIOR LAMP FUNCTION

### WHAT IS THE INTERIOR LAMP FUNCTION

The interior lamp function switches the courtesy and door lamps on or off.

### SWITCHING THE INTERIOR LAMP FUNCTION ON AND OFF



Press to switch the interior lamp function on and off.

**Note:** The indicator lamp illuminates amber when the door function is off.

# Interior Lighting

---

## ADJUSTING THE INSTRUMENT PANEL LIGHTING BRIGHTNESS

The instrument lighting dimmer buttons are on the lighting control.



Repeatedly press one of the buttons to adjust the brightness.



**Note:** *There are six levels of brightness adjustments available during the day and twelve levels of brightness adjustments available at night.*

## AMBIENT LIGHTING - VEHICLES WITH: AMBIENT LIGHTING

### SWITCHING AMBIENT LIGHTING ON AND OFF

1. From the settings menu, press Ambient Lighting. See **Center Display** (page 481).
2. Press a color.

### ADJUSTING AMBIENT LIGHTING

Drag the selected color up or down.

## INTERIOR LIGHTING – TROUBLESHOOTING

### INTERIOR LIGHTING – FREQUENTLY ASKED QUESTIONS

#### **Why do my courtesy lamps or interior lamps turn off when I have them switched on when I switch my vehicle off?**

- The battery saver turns the courtesy lamps and interior lamps off after a short period of time after you switch your vehicle off.

# Windows

## OPENING AND CLOSING THE WINDOWS



**WARNING:** Do not leave children or pets unattended in your vehicle and do not let children play with the power windows. Failure to follow this instruction could result in personal injury or death.



**WARNING:** When closing the power windows, verify that they are free of obstructions and make sure children and pets are not in the proximity of the window openings. Failure to follow this instruction could result in personal injury or death.



**WARNING:** If an obstruction is detected, release the switch and reverse the window immediately. Failure to follow this instruction could result in personal injury or death.



**WARNING:** Do not leave a key or remote control unattended in the vehicle. Children or pets could operate the power windows and could become trapped in a closing window. Failure to follow this instruction could result in personal injury or death.



Press the control to open the window. Lift the control to close the window.

**Note:** *The power windows operate with the ignition on, and for several minutes after you switch the ignition off or until you open a front door.*

To reduce wind noise or pulsing noise when one window is open, slightly open the opposite window.

### One-Touch Open (If Equipped)

Fully press the window control and release it. Press again or lift it to stop the window.

### One-Touch Close (If Equipped)

Fully lift the window control and release it. Press again or lift it to stop the window.

### Resetting One-Touch Close

Carry out all steps within 30 seconds of starting the sequence.

1. Fully open the window.
2. Lift and hold the window control until the window is fully closed. Keep the window control held for a two seconds
3. Press and hold the window control until the window is fully open. Keep the window control pressed for two seconds.
4. Lift and hold the window control until the window is fully closed. Keep the window control held for a two seconds

**Note:** *Repeat the procedure if the window does not close when you use one-touch.*

### Tailgate Window

To open the window, do the following:

1. Open the tailgate. See **Opening the Tailgate From Outside Your Vehicle** (page 76).
2. Lift the window.

To close the window, do the following:

1. Push the window down.
2. Close the tailgate. See **Closing the Tailgate From Outside Your Vehicle** (page 76).

# Windows

## GLOBAL OPENING

### WHAT IS GLOBAL OPENING

You can use the remote control to open the windows with the ignition off.

### USING GLOBAL OPENING

1. Press and release the unlock button on the remote control.
2. Press and hold the unlock button on the remote control.
3. Release the button when the windows start to open.

Press the lock or the unlock button on the remote control to stop global opening.

**Note:** You can use global opening for a short period of time when you unlock your vehicle using the remote control.

### SWITCHING GLOBAL OPENING ON AND OFF

1. From the settings menu, press Vehicle.
2. Press Windows.
3. Switch Remote Open on or off.

## WINDOW BOUNCE-BACK

### WHAT IS WINDOW BOUNCE-BACK

The window stops and reverses if it detects an obstruction when closing.

## OVERRIDING WINDOW BOUNCE-BACK



**WARNING:** If you override bounce-back, the window does not reverse if it detects an obstacle. Take care when closing the windows to avoid personal injury or damage to your vehicle.

1. Close the window until it reaches the point of resistance and let it reverse.
2. Lift and hold the window control switch within two seconds to override bounce-back and close the window. Bounce-back is now disabled and you can close the window manually.

**Note:** The window goes past the point of resistance and you can fully close it.

**Note:** If the window does not close, have your vehicle checked as soon as possible.

## LOCKING THE REAR WINDOW CONTROLS



**WARNING:** When children and pets are in the rear seat, use the power window lockout button to prevent accidental operation of the power windows.



Press the window control switch to lock or unlock the rear window controls. It illuminates when you lock the rear window controls.



# Windows

---

## USING SHORT DROP WINDOWS

This feature lowers the window by a short distance to move the window out of the seal so you can open the door. It also raises the window a short distance, then back to the fully closed position as soon as you close the door.

### Short drop windows requirements

Short drop windows only activate when all of the following occur:

- You open and close the door from the outside and inside of your vehicle.
- The vehicle speed falls below approximately 20 km/h (12.4 mph) from the external trigger and approximately 3 km/h (1.9 mph) from the internal trigger.
- During abnormal operation such as anti-pinch or over temperature conditions, short drop windows open when you interact with the trigger element.
- It allows the window to only move down if the current window position is greater than the short drop position.
- This feature allows the window to move up from the short drop position, when more than 30 seconds have elapsed with no door opened.

**Note:** Use the door handle with the unlock button from your remote control and interior trim switch to use the short drop window feature.

**Note:** Short drop windows do not work if the vehicle speed exceeds 20 km/h (12.4 mph) from the external trigger and 3 km/h (1.9 mph) from the internal trigger.

**Note:** The short drop windows do not work in dry and wet conditions between -20°C (-4.0°F) and -40°C (-39.9°F) so that you can clear the ice from the windows and seals or activate the remote start to heat the chamber.

**Note:** The short drop window feature works for all doors.

### Resetting Short Drop Windows

Carry out all steps within 30 seconds of starting the sequence.

1. Close the window.
2. Press and hold the window control switch until the window is fully open. Continue to press the window control switch for a few seconds.
3. Lift and hold the window control switch until the window is fully closed. Continue to hold the window control switch for a few seconds.
4. Press and hold the window control switch until the window is fully open. Continue to press the window control switch for a few seconds.
5. Lift and hold the window control switch until the window is fully closed. Continue to hold the window control switch for a few seconds.

**Note:** Repeat the procedure if the short drop windows do not work.

# Interior Mirror

## INTERIOR MIRROR PRECAUTIONS



**WARNING:** Do not adjust the mirrors when your vehicle is moving. This could result in the loss of control of your vehicle, serious personal injury or death.

**Note:** Do not clean the mirror housing or glass with harsh abrasives, fuel or other petroleum-based cleaning products.

## MANUALLY DIMMING THE INTERIOR MIRROR

Pull the tab below the mirror toward you to reduce glare at night.

## AUTO-DIMMING INTERIOR MIRROR (IF EQUIPPED)

### WHAT IS THE AUTO-DIMMING INTERIOR MIRROR

The mirror dims to reduce the effect of bright light from behind. It returns to normal when the bright light from behind is no longer present or if you shift into reverse (R), to make sure you have a clear view when backing up.

### AUTO-DIMMING INTERIOR MIRROR LIMITATIONS

Do not block the sensors on the front and back of the mirror.

**Note:** A rear center passenger or raised rear center head restraint could prevent light from reaching the sensor.

## DIGITAL INTERIOR MIRROR - VEHICLES WITH: DIGITAL INTERIOR MIRROR (IF EQUIPPED)

### WHAT IS THE DIGITAL INTERIOR MIRROR

The digital interior mirror provides a normal rear view and a panoramic rear view.

When in normal rear view, the mirror functions as a regular auto-dimming mirror and dims in response to bright light from behind. When it is switched to camera view, it displays a clear panoramic rear view using a camera at the back of your vehicle.

### DIGITAL INTERIOR MIRROR LIMITATIONS

The system may not function, or may function with reduced performance, if the exterior camera is dirty or obstructed. If dirty, clean the camera. Optimal system performance requires a clear view by the camera lens.

### SWITCHING BETWEEN NORMAL VIEW AND CAMERA VIEW



Push the tab away from you to activate the normal view. Pull the tab toward you to switch to camera view.

# Interior Mirror



This indicates that the camera view is active.



This indicates that the camera view has stopped working due to a system error. In such cases, the mirror display turns off and automatically resumes operation as a normal mirror.



This displays for a few seconds when the camera view mode is inoperable indicating you should switch to normal mode. Move the tab away from you to activate this mode with auto-dimming feature. Auto-dimming feature does not resume until the normal mode is activated.

If the fault persists, have your system checked.

## Locating the Digital Interior Mirror Camera

The camera is in the rear lamp assembly above the spare tire.

## DIGITAL INTERIOR MIRROR SETTINGS

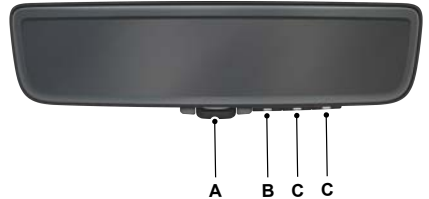

- A Tab.
- B Menu.
- C Adjustment controls.

1. Start your vehicle.
2. Press the menu button to select any of the desired settings and modify them with the adjustment controls.

**Note:** *The mirror, while in camera view, allows to adjust screen brightness and horizon height. The normal view allows no adjustments.*

# Exterior Mirrors

## ADJUSTING THE EXTERIOR MIRRORS



**WARNING:** Do not adjust the mirrors when your vehicle is moving. This could result in the loss of control of your vehicle, serious personal injury or death.

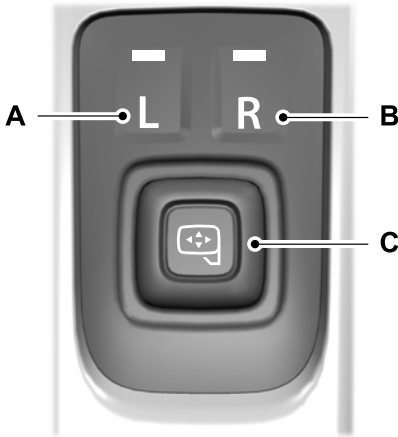

- A Left-hand mirror.
- B Right-hand mirror.
- C Adjustment control.

To adjust your mirrors, switch your vehicle on, with the ignition in accessory mode or the engine running.

1. Select the mirror you want to adjust. The control light turns on.
2. Use the adjustment control to adjust the position of the mirror.
3. Press the mirror control again. The control light turns off.

## FOLDING THE EXTERIOR MIRRORS

Push the mirror toward the door window glass. Make sure that you fully engage the mirror in its support when returning it to its original position.

### Heated Exterior Mirrors

See **Switching the Heated Mirrors On and Off** (page 113).

### Puddle Lamps

The puddle lamps turn on when you approach your vehicle with a remote control or phone.

### 360 Degree Cameras

See **Locating the 360 Degree Cameras** (page 236).

### Blind Spot Information System

See **What Is Blind Spot Information System** (page 267).

# Instrument Cluster

## INSTRUMENT CLUSTER OVERVIEW - EXCLUDING: RAPTOR

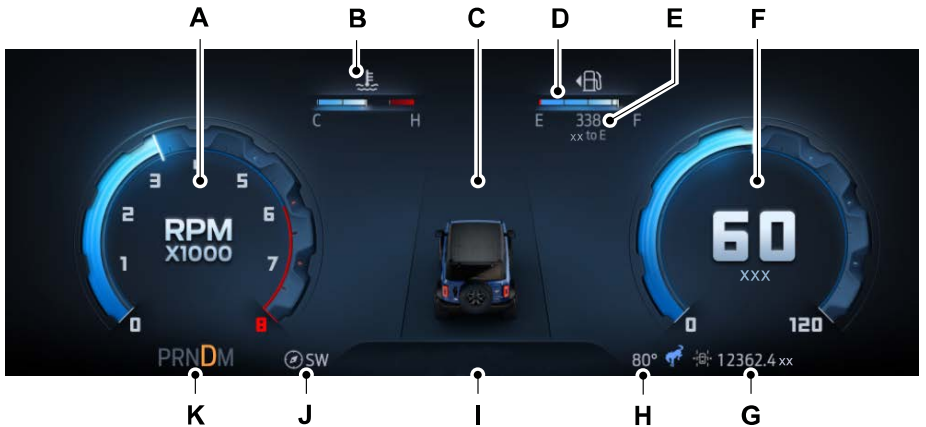

- A Tachometer.
- B Engine coolant temperature gauge.
- C Information on demand areas.
- D Fuel gauge.
- E Distance to empty.
- F Speedometer.
- G Odometer.
- H Outside air temperature.
- I Information bar.
- J Compass.
- K Transmission position indicator.

# Instrument Cluster

## INSTRUMENT CLUSTER OVERVIEW - RAPTOR

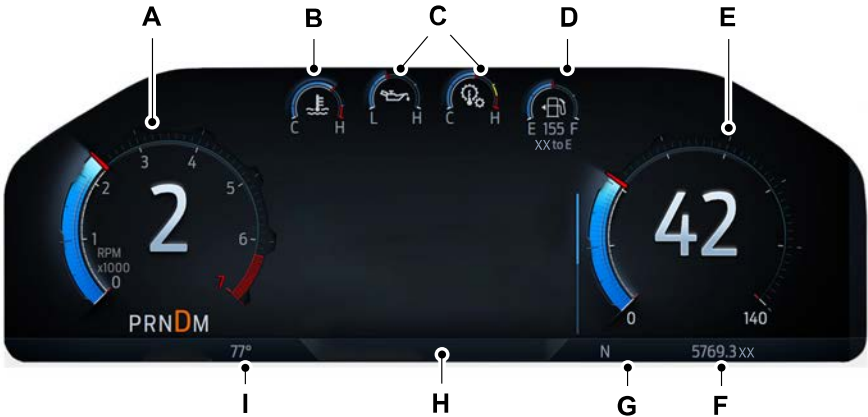

- A Tachometer.
- B Engine coolant temperature gauge.
- C Configurable gauges.
- D Fuel gauge.
- E Speedometer.
- F Odometer.
- G Compass.
- H Information bar.
- I Ambient temperature.

### TACHOMETER

Indicates the engine speed.

### SPEEDOMETER

Indicates the vehicle speed.

### FUEL GAUGE

#### WHAT IS THE FUEL GAUGE

Indicates approximately how much fuel is in the fuel tank.

# Instrument Cluster

---

## FUEL GAUGE LIMITATIONS

The fuel gauge may not provide an accurate reading when your vehicle is on an incline.

## LOCATING THE FUEL FILLER DOOR

The arrow adjacent to the fuel pump symbol indicates on which side of your vehicle the fuel filler door is located.

## WHAT IS THE LOW FUEL REMINDER

A low fuel level reminder displays and sounds when the distance to empty reaches 80 km (50 mi), 40 km (25 mi), 20 km (10 mi) and 0 km (0 mi).

**Note:** *The low fuel reminder can appear at different fuel gauge positions depending on fuel economy conditions. This variation is normal.*

## WHAT IS DISTANCE TO EMPTY

Indicates the approximate distance your vehicle can travel on the fuel remaining in the tank. Changes in driving pattern can cause the value to not only decrease but also increase or stay constant for periods of time.

## ENGINE COOLANT TEMPERATURE GAUGE

Indicates the engine coolant temperature.

## TRANSMISSION FLUID TEMPERATURE GAUGE - AUTOMATIC TRANSMISSION

Indicates the transmission fluid temperature.

Special operating conditions can cause higher than normal operating temperatures. See **General Maintenance Information** (page 509).

**Note:** *This is a configurable gauge.*

## TURBO BOOST GAUGE

Indicates the amount of manifold air pressure in the engine.

**Note:** *This is a configurable gauge.*

## 12V BATTERY GAUGE

Indicates the power of the 12-volt battery.

**Note:** *This is a configurable gauge.*

# Instrument Cluster Display

## USING THE INSTRUMENT CLUSTER DISPLAY CONTROLS



**WARNING:** Driving while distracted can result in loss of vehicle control, crash and injury. We strongly recommend that you use extreme caution when using any device that may take your focus off the road. Your primary responsibility is the safe operation of your vehicle. We recommend against the use of any hand-held device while driving and encourage the use of voice-operated systems when possible. Make sure you are aware of all applicable local laws that may affect the use of electronic devices while driving.

The controls are on the steering wheel.

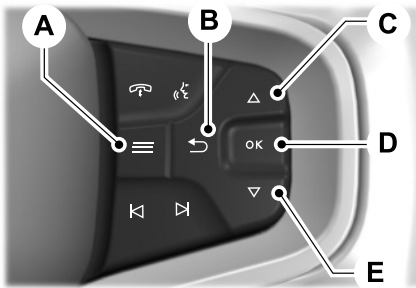

- A Menu button.
- B Return button.
- C Up button.
- D OK toggle button.
- E Down toggle button

### Return Button

Press to go back or to exit a menu.

### OK Button

Press to make a selection. Press the toggle button up or down to scroll through menu items.

### Menu Button

Press to display the submenus.

### Toggle Buttons

Used to navigate the menus.

### Status Indicator



Menu items with a check box indicates a feature's status. A check in the box indicates the feature is on, and unchecked indicates the feature is off.

## INSTRUMENT CLUSTER DISPLAY MAIN MENU - EXCLUDING: RAPTOR

Depending on your vehicle options, some menu items may appear different or not at all.

**Note:** For your safety, some features are speed-dependent and could be unavailable when your vehicle is above a certain speed.

Menu Item
MyView
Trip/Fuel
Bronco Information
Navigation
Phone
Audio
Settings



# Instrument Cluster Display

## INSTRUMENT CLUSTER DISPLAY MAIN MENU - RAPTOR

Depending on your vehicle options, some menu items can appear different or not at all.

**Note:** For your safety, some features are speed-dependent and could be unavailable when your vehicle is above a certain speed.

Menu Item
MyView
Trip/Fuel
Raptor Information
Navigation
Phone
Audio
Settings

## CUSTOMIZING THE INSTRUMENT CLUSTER DISPLAY

### Adding Screens Using MyView

1. Using the instrument cluster display controls on the steering wheel, select MyView.
2. Select Configure MyView.
3. Select a screen.
4. Press the OK button.

**Note:** The number of screens you can add is limited. If the selected screen does not appear you must deselect screens from the MyView menu.

### Adding Screens Using Select Screens

1. Select Select Screens.
2. Use the controls on the steering wheel to highlight a screen to add.
3. Press the OK button.

**Note:** The number of screens you can add is limited. If the selected screen does not appear you must deselect screens from the Select Screens menu.

### Configuring Gauges

1. Select Settings.
2. Select Configure Gauges.
3. Select to swap or change the additional gauges shown in the instrument cluster.
4. Select to swap or change left-hand side and right-hand side gauges.

**Note:** The menu and some additional gauges can be accessed only when the vehicle is in Off-road or performance drive modes. See **G.O.A.T. Mode Control** (page 249). The number of additional gauges is limited to two.

# Trip Computer

---

## ACCESSING THE TRIP COMPUTER

1. Use the instrument cluster display controls to navigate to the main menu.
2. Select **Trip/Fuel**.
3. Select **Trip 1** or **Trip 2**.

## RESETTING THE TRIP COMPUTER

1. Use the instrument cluster display controls to navigate to the main menu.
2. Select **Trip/Fuel**.
3. Select **Trip 1** or **Trip 2**.
4. Press and hold the **OK** button for a few seconds.

# Remote Start (If Equipped)

## USING REMOTE START





**WARNING:** Do not start the engine in a closed garage or in other enclosed areas. Exhaust fumes are toxic. Always open the garage door before you start the engine. Failure to follow this instruction could result in personal injury or death.



**WARNING:** Do not keep electrical devices plugged in the power outlet whenever the device is not in use. Power outlets power up during remote start.

The system allows you to remotely start your vehicle to heat or cool the interior to a preset temperature.

1.  Press the button on the remote control.
2.  Press the button twice within a few seconds.

When you successfully remote start your vehicle:

- The vehicle doors lock.
- The turn signal lamps flash twice.
- The parking lamps turn on when the vehicle is running.
- The vehicle remains secured when you have remotely started the vehicle. A valid key must be inside your vehicle to switch your vehicle on and drive your vehicle.
- All other vehicle systems remain off when you have remotely started the vehicle.

The horn sounds if the system fails to start.

**Note:** You cannot adjust any comfort settings until you switch your vehicle on from inside your vehicle.

Remote start does not work under the following conditions:

- Remote start is not enabled.
- The alarm horn is sounding.
- The hood is open.
- The transmission is not in park (P).
- Your vehicle is already on.

**Note:** Do not use remote start if your fuel level is low.

**Note:** A maximum of two remote starts are allowed. After that you have to switch your vehicle on and off before you can use remote start again.



To remotely stop your vehicle, press the button.

## REMOTE START SETTINGS

1. From the settings menu, press Vehicle.
2. Press Remote Start Setup.

You can adjust the following in the remote start settings menu:

- Enable or disable remote start.
- Climate control settings.
- Heated seat settings.
- Heated steering wheel settings.
- Remote start duration.

# Climate Control - Vehicles With: Automatic Temperature Control

## IDENTIFYING THE CLIMATE CONTROL UNIT



Depending on your vehicle options, the controls could look different than what you see here.

## SWITCHING CLIMATE CONTROL ON AND OFF



Press the button.

## SWITCHING RECIRCULATED AIR ON AND OFF



Press the button to recirculate air currently in the passenger compartment.

**Note:** Recirculated air may turn off automatically, or prevent you from switching on in all air flow modes except MAX A/C to reduce the risk of fogging. Recirculation may also turn on and off automatically in various air distribution control combinations to improve heating or cooling efficiency.

## SWITCHING AIR CONDITIONING ON AND OFF



Press the button.

**Note:** Under certain conditions, the air conditioning compressor could continue to operate after you switch air conditioning off.

**Note:** To keep the system and its components fully functional, switch air conditioning on and let your vehicle idle at least once per month for a minimum of two minutes.

## SWITCHING MAXIMUM DEFROST ON AND OFF



Press the button.

Air flows through the windshield air vents, the temperature is set to the highest setting, and the blower motor adjusts to the highest speed.

You can also use this setting to defog and clear the windshield of a thin covering of ice.

**Note:** To prevent window fogging, you cannot select recirculated air when maximum defrost is on.

**Note:** The heated rear window and heated mirrors also turn on when you select maximum defrost.

**Note:** When maximum defrost is on, the air conditioning compressor may continue to operate even though you switch off the A/C.

## SWITCHING MAXIMUM COOLING ON AND OFF



Press the button.

Air flows through the instrument panel air vents, the temperature is set to the lowest setting, and the blower motor adjusts to the highest speed.

**Note:** When you switch maximum cooling off, air conditioning remains on.

# Climate Control - Vehicles With: Automatic Temperature Control

## SWITCHING THE HEATED REAR WINDOW ON AND OFF (IF

EQUIPPED)



Press the button to clear the rear window of thin ice and fog. The heated rear window turns off after a short period of time.

**Note:** This button also activates the heated mirrors.

**Note:** Do not use harsh chemicals, razor blades or other sharp objects to clean or remove decals from the inside of the heated rear window as this could cause damage to the heated rear window grid lines not covered by the vehicle Warranty.

## SETTING THE BLOWER MOTOR SPEED



Press up or down on the blower motor control to select the blower motor speed.

**Note:** Lights on the control illuminate to indicate the blower motor speed.

**Note:** When you switch the blower motor off the air conditioning turns off and the windows could fog up.

**Note:** In certain conditions, for example, when the vehicle is travelling at a higher speed, the blower motor fan may change speed due to the air pressure built up near the windshield cowl area. This concentrated air is forced through the A/C vents into the cabin resulting in a change of blower speed. This is normal operation.

## SWITCHING THE HEATED MIRRORS ON AND OFF

When you switch the heated rear window on, the heated exterior mirrors turn on. See **Switching the Heated Rear Window On and Off** (page 113).

**Note:** Do not remove ice from the mirrors with a scraper or adjust the mirror glass when it is frozen in place.

**Note:** Do not clean the mirror housing or glass with harsh abrasives, fuel or other petroleum-based cleaning products. The vehicle warranty may not cover damage caused to the mirror housing or glass.

**Note:** The engine must be running or your vehicle must be ready to drive to switch the system on.

## SETTING THE TEMPERATURE

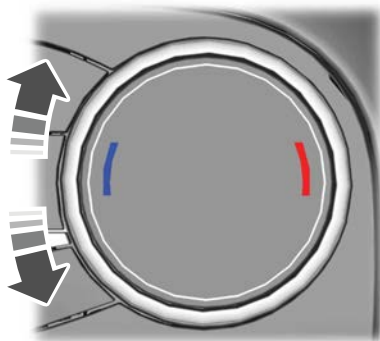

Turn the control on the left-hand side of the climate control to set the left-hand temperature.

**Note:** This control also sets the right-hand side temperature when you switch off dual zone mode.

# Climate Control - Vehicles With: Automatic Temperature Control

Turn the control on the right-hand side of the climate control to set the right-hand temperature.



Press the button on the touchscreen.

## DIRECTING THE FLOW OF AIR

### Directing Air to the Windshield Air Vents



Press the button to activate the selection screen.



Press the button on the touchscreen.

### Directing Air to the Instrument Panel Air Vents



Press the button to activate the selection screen.



Press the button on the touchscreen.

### Directing Air to the Footwell Air Vents



Press the button to activate the selection screen.

## AUTO MODE

### SWITCHING AUTO MODE ON AND OFF



Press the button to switch auto mode on. Repeatedly press the button to adjust auto mode.

**Note:** When you switch auto mode on, lights on the blower motor control do not illuminate to indicate the blower motor speed.

Adjust the blower motor control or air distribution control to switch auto mode off.

### AUTO MODE INDICATORS

The indicators are on the Auto Mode button.

Auto Mode Indicator Status	Description
One indicator illuminated.	The blower motor speed is reduced. Use this setting to minimize the amount of noise from the blower motor. This setting increases the time taken to cool the interior.
Two indicators illuminated.	The blower motor speed is moderate.
Three indicators illuminated.	The blower motor speed is increased. Use this setting to reduce the time taken to cool the interior. This setting increases the amount of noise from the blower motor.

# Climate Control - Vehicles With: Automatic Temperature Control

## SWITCHING DUAL MODE ON AND OFF



Press the button to activate the selection screen.



Press the button.

**Note:** When dual mode is off, setting the temperature using the driver side controls, sets the temperature for both sides.

**Note:** Setting the temperature using the passenger side controls, sets the passenger temperature and switches dual mode on.

## CLIMATE CONTROL HINTS

### General Hints

- Prolonged use of recirculated air may cause the windows to fog up.
- You may feel a small amount of air from the footwell air vents regardless of the air distribution setting.
- To reduce humidity build-up inside your vehicle, do not drive with the system switched off or with recirculated air always switched on.
- Do not place objects under the front seats as this may interfere with the airflow to the rear seats.
- Remove any snow, ice or leaves from the air intake area at the base of the windshield.
- To improve the time to reach a comfortable temperature in hot weather, drive with the windows open until you feel cold air through the air vents.

## Automatic Climate Control

- Adjusting the settings when your vehicle interior is extremely hot or cold is not necessary. Automatic mode is best recommended to maintain set temperature.
- The system adjusts to heat or cool the interior to the temperature you select as quickly as possible.
- For the system to function efficiently, the instrument panel and side air vents should be fully open.
- If you press **AUTO** during cold outside temperatures, the system directs air flow to the windshield and side window air vents. In addition, the blower motor may run at a slower speed until the engine warms up.
- If you press **AUTO** during hot temperatures and the inside of the vehicle is hot, the system uses recirculated air to maximize interior cooling. Blower motor speed may also reduce until the air cools.

## Quickly Heating the Interior

1. Press **AUTO**.
2. Adjust the temperature function to the setting you prefer.

## Recommended Settings for Heating

1. Press **AUTO**.
2. Adjust the temperature function to the setting you prefer. Use 22°C (72°F) as a starting point, then adjust the setting as necessary.

## Quickly Cooling the Interior

1. Press **MAX A/C**.
2. Drive with the windows open for a short period of time.

# Climate Control - Vehicles With: Automatic Temperature Control

## Recommended Settings for Cooling

1. Press **AUTO**.
2. Adjust the temperature function to the setting you prefer. Use 22°C (72°F) as a starting point, then adjust the setting as necessary.

## Defogging the Side Windows in Cold Weather

1. Press and release defrost or maximum defrost.
2. Adjust the temperature control to the setting you prefer. Use 22°C (72°F) as a starting point, then adjust the setting as necessary.

## AIR CONDITIONING SYSTEM REFRIGERANT



**WARNING:** The air conditioning refrigerant system contains refrigerant under high pressure. Only qualified personnel should service the air conditioning refrigerant system. Opening the air conditioning refrigerant system can cause personal injury.

Your vehicle has an under hood label that identifies the refrigerant used by the air conditioning system.

**Note:** Only allow a trained and certified technician service the refrigerant system to ensure proper and safe operation, per the society of automotive engineers J2845.

**Note:** Never repair or replace the air conditioning evaporator with one from a salvage vehicle. Only replace it with a new evaporator to ensure proper and safe operation.

The meaning of each symbol on the under hood label are as follows:



Caution



Air conditioning system.



System lubricant type.



See vehicle service manual for service information.



Requires registered technician to service.



Flammable refrigerant.



Replace safety system components. Do not repair, reuse or try to salvage.



# Climate Control - Vehicles With: Manual Temperature Control

## IDENTIFYING THE CLIMATE CONTROL UNIT



Depending on your vehicle options, the controls could look different than what you see here.

## SWITCHING CLIMATE CONTROL ON AND OFF



Press the button.

## SWITCHING RECIRCULATED AIR ON AND OFF



Press the button to recirculate air currently in the passenger compartment.

**Note:** Recirculated air may turn off automatically, or prevent you from switching on in all air flow modes except MAX A/C to reduce the risk of fogging. Recirculation may also turn on and off automatically in various air distribution control combinations to improve heating or cooling efficiency.

## SWITCHING AIR CONDITIONING ON AND OFF



Press the button.

**Note:** Under certain conditions, the air conditioning compressor could continue to operate after you switch air conditioning off.

**Note:** To keep the system and its components fully functional, switch air conditioning on and let your vehicle idle at least once per month for a minimum of two minutes.

## SWITCHING MAXIMUM DEFROST ON AND OFF



Turn the temperature control clockwise past the highest setting to maximize defrosting.

**Note:** The temperature control springs back to the highest setting.

Air flows through the windshield air vents, and the blower motor adjusts to the highest speed.

**Note:** To prevent window fogging, you cannot select recirculated air when maximum defrost is on.

**Note:** The heated rear window also turns on when you select maximum defrost.

## SWITCHING MAXIMUM COOLING ON AND OFF



Turn the temperature control counterclockwise past the lowest setting to maximize cooling.

**Note:** The temperature control springs back to the lowest setting.

**Note:** When you switch maximum cooling off, air conditioning remains on.

# Climate Control - Vehicles With: Manual Temperature Control

## SWITCHING THE HEATED REAR WINDOW ON AND OFF (IF

EQUIPPED)



Press the button to clear the rear window of thin ice and fog. The heated rear window turns off after a short period of time.

**Note:** Do not use harsh chemicals, razor blades or other sharp objects to clean or remove decals from the inside of the heated rear window as this could cause damage to the heated rear window grid lines not covered by the vehicle Warranty.

## SETTING THE BLOWER MOTOR SPEED



Turn the blower motor control counterclockwise for a lower blower setting.

Turn the blower motor control clockwise for a higher blower setting.

**Note:** Lights on the control illuminate to indicate the blower motor speed.

**Note:** When you switch the blower motor off, air conditioning turns off and the windows could fog up.

## SWITCHING THE HEATED MIRRORS ON AND OFF

When you switch the heated rear window on, the heated exterior mirrors turn on. See **Switching the Heated Rear Window On and Off** (page 113).

**Note:** Do not remove ice from the mirrors with a scraper or adjust the mirror glass when it is frozen in place.

**Note:** Do not clean the mirror housing or glass with harsh abrasives, fuel or other petroleum-based cleaning products. The vehicle warranty may not cover damage caused to the mirror housing or glass.

**Note:** The engine must be running or your vehicle must be ready to drive to switch the system on.

## SETTING THE TEMPERATURE

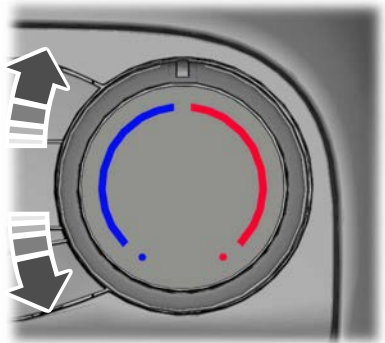

Turn the temperature control counterclockwise for cooler temperature settings.

# Climate Control - Vehicles With: Manual Temperature Control

Turn the temperature control clockwise for warmer temperature settings.

## DIRECTING THE FLOW OF AIR

### Directing Air to the Windshield Air Vents



Press the button.

### Directing Air to the Instrument Panel Air Vents



Press the button.

### Directing Air to the Footwell Air Vents



Press the button.

## CLIMATE CONTROL HINTS

### General Hints

- Prolonged use of recirculated air may cause the windows to fog up.
- You may feel a small amount of air from the footwell air vents regardless of the air distribution setting.
- To reduce humidity build-up inside your vehicle, do not drive with the system switched off or with recirculated air always switched on.
- Do not place objects under the front seats as this may interfere with the airflow to the rear seats.

- Remove any snow, ice or leaves from the air intake area at the base of the windshield.
- To improve the time to reach a comfortable temperature in hot weather, drive with the windows open until you feel cold air through the air vents.

### Quickly Heating the Interior

1. Adjust the blower motor speed to the highest speed setting.
2. Adjust the temperature control to the highest setting.
3. Direct air to the footwell air vents.

### Recommended Settings for Heating

1. Adjust the blower motor speed to the center setting.
2. Adjust the temperature control to the midway point of the hot settings.
3. Direct air to the footwell air vents.

### Quickly Cooling the Interior

1. Press **MAX A/C**.
2. Drive with the windows open for a short period of time.

### Recommended Settings for Cooling

1. Adjust the blower motor speed to the center setting.
2. Adjust the temperature control to the midway point of the cold settings.
3. Direct air to the instrument panel air vents.

### Defogging the Side Windows in Cold Weather

1. Direct air to the instrument panel and windshield air vents.

## Climate Control - Vehicles With: Manual Temperature Control

---

2. Press and release **A/C**.
3. Adjust the temperature control to the setting you prefer.
4. Adjust the blower motor speed to the highest setting.
5. Direct air toward the side windows.
6. Close the instrument panel air vents.

# Interior Air Quality

---

## WHAT IS THE CABIN AIR FILTER

The cabin air filter improves the quality of air in your vehicle by trapping dust, pollen and other particles.

## REPLACING THE CABIN AIR FILTER

Replace the filter at regular intervals.

**Note:** *Make sure you have a cabin air filter installed at all times. This prevents foreign objects from entering the system. Running the system without a filter in place could result in degradation or damage to the system.*

**Note:** *Using an aftermarket cabin air filter could reduce cabin air filtration and climate control performance.*

# Front Seats

## FRONT SEAT PRECAUTIONS



**WARNING:** Sitting improperly, out of position or with the seatback reclined too far can take weight off the seat cushion and affect the decision of the passenger sensing system, resulting in serious injury or death in the event of a crash. Always sit upright against your seat back, with your feet on the floor.



**WARNING:** Do not recline the seat backrest too far as this can cause the occupant to slide under the seatbelt, resulting in personal injury in the event of a crash.



**WARNING:** Do not place objects higher than the top of the seat backrest. Failure to follow this instruction could result in personal injury or death in the event of a sudden stop or crash.



**WARNING:** Do not adjust the driver seat or seat backrest when your vehicle is moving. This may result in sudden seat movement, causing the loss of control of your vehicle.

## SITTING IN THE CORRECT POSITION

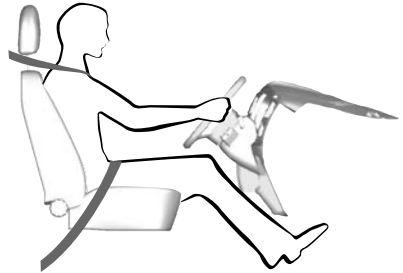

When you use them properly, the seat, head restraint, seatbelt and airbags will provide optimum protection in the event of a crash.

We recommend that you follow these guidelines:

- Sit in an upright position with the base of your spine as far back as possible.
- Do not recline the seat backrest so that your torso is more than 30 degrees from the upright position.
- Adjust the head restraint so that the top of it is level with the top of your head and as far forward as possible. Make sure that you remain comfortable.
- Keep sufficient distance between yourself and the steering wheel. We recommend a minimum of 25 cm (10 in) between your breastbone and the airbag cover.
- Hold the steering wheel with your arms slightly bent.

# Front Seats

- Bend your legs slightly so that you can press the pedals fully.
- Position the shoulder strap of the seatbelt over the center of your shoulder and position the lap strap tightly across your hips.

Make sure that your driving position is comfortable and that you can maintain full control of your vehicle.

## MANUAL SEATS

### HEADRESTRAINT COMPONENTS

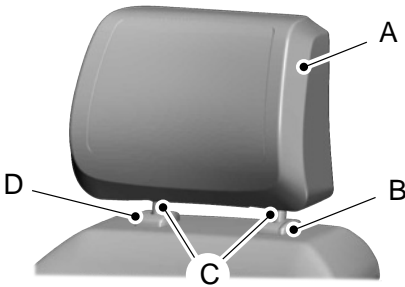



The head restraints consist of:

- A An energy absorbing head restraint.
- B Guide sleeve adjust and release button.
- C Two steel stems.
- D Guide sleeve unlock and remove button (If equipped).

### ADJUSTING THE HEAD RESTRAINT

 **WARNING:** Fully adjust the head restraint before you sit in or operate your vehicle. This will help minimize the risk of neck injury in the event of a crash. Do not adjust the head restraint when your vehicle is moving.

 **WARNING:** The head restraint is a safety device. Whenever possible it should be installed and properly adjusted when the seat is occupied. Failure to adjust the head restraint properly could reduce its effectiveness during certain impacts.

 **WARNING:** Adjust the head restraints for all passengers before you drive your vehicle. This will help minimize the risk of neck injury in the event of a crash. Do not adjust the head restraints when your vehicle is moving.

**Note:** *Adjust the seat backrest to an upright driving position before adjusting the head restraint. Adjust the head restraint so that the top of it is level with the top of your head and as far forward as possible. Make sure that you remain comfortable. If you are extremely tall, adjust the head restraint to its highest position.*

Pull the head restraint up to raise it.

To lower the head restraint:

1. Press and hold the adjust and release button.
2. Push the head restraint down.

## Front Seats



1. Pull up the head restraint until it reaches the highest adjustment position.
2. Press and hold the button.
3. Pull up the head restraint.

### INSTALLING THE HEAD RESTRAINT

Align the steel stems into the guide sleeves and push the head restraint down until it locks.

For vehicles with tilting head restraints:

1. Adjust the seat backrest to an upright driving or riding position.
2. Pivot the head restraint forward toward your head to the preferred position.

After the head restraint reaches the forward-most tilt position, pivot it forward again to release it to the rearward, untilted position.

**Note:** Do not attempt to force the head restraint backward after it is tilted. Instead, continue tilting it forward until the head restraint releases to the upright position.

### MOVING THE SEAT BACKWARD AND FORWARD



**WARNING:** Make sure the seat fully locks into place by rocking it backward and forward. Not securing the seat into the locked position can be dangerous in a crash and could cause serious personal injury or death.

### REMOVING THE HEAD RESTRAINT

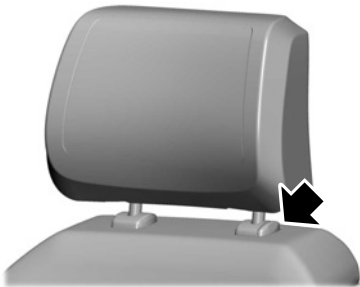



# Front Seats

## ADJUSTING THE SEAT BACKREST



**WARNING:** Always drive and ride with your seatback upright and the lap belt snug and low across the hips.



**WARNING:** Do not place cargo or any objects behind the seat backrest before returning it to the original position. Pull on the seat backrest to make sure that it has fully latched after returning the seat backrest to its original position. An unlatched seat may become dangerous if you stop suddenly or have a crash.



## POWER SEATS (IF EQUIPPED)

### HEADRESTRAINT COMPONENTS

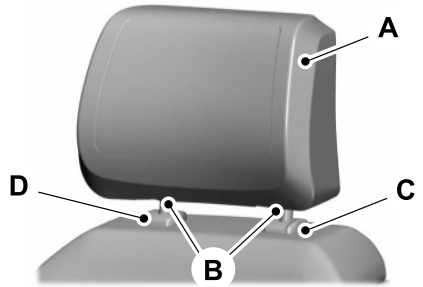

The head restraints consist of:

- A An energy absorbing head restraint.
- B Two steel stems.
- C Guide sleeve adjust and release button.
- D Guide sleeve unlock and remove button (If equipped).

### ADJUSTING THE HEAD RESTRAINT



**WARNING:** Fully adjust the head restraint before you sit in or operate your vehicle. This will help minimize the risk of neck injury in the event of a crash. Do not adjust the head restraint when your vehicle is moving.

# Front Seats



**WARNING:** The head restraint is a safety device. Whenever possible it should be installed and properly adjusted when the seat is occupied. Failure to adjust the head restraint properly could reduce its effectiveness during certain impacts.



**WARNING:** Adjust the head restraints for all passengers before you drive your vehicle. This will help minimize the risk of neck injury in the event of a crash. Do not adjust the head restraints when your vehicle is moving.

To raise the head restraint, pull the head restraint up.

To lower the head restraint:

1. Press and hold the adjust and release button.
2. Push the head restraint down.

## Tilting the Head Restraint (If Equipped)



1. Adjust the seat backrest to an upright driving or riding position.
2. Pivot the head restraint forward toward your head to the preferred position.

After the head restraint reaches the forward-most tilt position, pivot it forward again to release it to the rearward, untilted position.

**Note:** Do not attempt to force the head restraint backward after it is tilted. Instead, continue tilting it forward until the head restraint releases to the upright position.

## REMOVING THE HEADRESTRAINT

1. Pull up the head restraint until it reaches its highest position.
2. Press and hold the adjust and release button.
3. Pull up the head restraint.

## INSTALLING THE HEAD RESTRAINT

Align the steel stems into the guide sleeves and push the head restraint down until it locks.

## MOVING THE SEAT BACKWARD AND FORWARD

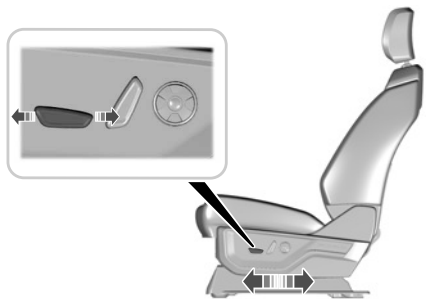

# Front Seats

## ADJUSTING THE SEAT CUSHION

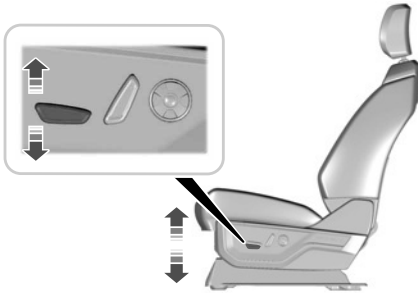

## ADJUSTING THE SEAT HEIGHT



## ADJUSTING THE SEAT BACKREST

**WARNING:** Do not place cargo or any objects behind the seatback before returning it to the original position.



## ADJUSTING THE LUMBAR SUPPORT

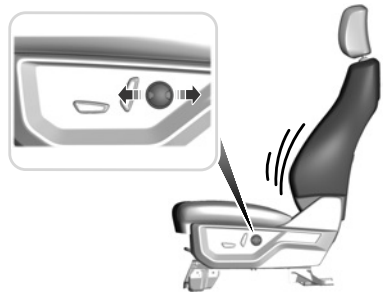

# Front Seats

## HEATED SEATS (IF EQUIPPED)

### HEATED SEAT PRECAUTIONS



**WARNING:** Use caution when using the heated seat if you are unable to feel pain to your skin because of advanced age, chronic illness, diabetes, spinal cord injury, medication, alcohol use, exhaustion or other physical conditions. The heated seat could cause burns even at low temperatures, especially if used for long periods of time. Failure to follow this instruction could result in personal injury.



**WARNING:** Do not poke sharp objects into the seat cushion or seat backrest. This could damage the heated seat element and cause it to overheat. Failure to follow this instruction could result in personal injury.



**WARNING:** Do not place anything on the seat that blocks the heat, for example a seat cover or a cushion. This could cause the seat to overheat. Failure to follow this instruction could result in personal injury.

Press the heated seat symbol to cycle through the various heat settings and off. The more indicators that display, the warmer the temperature of the seat.

**Note:** *The heated seats may remain on after you remote start your vehicle, based on your remote start settings. The heated seats may also turn on when you start your vehicle if they were on when you switched your vehicle off.*

Do not:

- Place heavy objects on the seat.
- Operate the heated seat if water or any other liquid spills on the seat. Allow the seat to dry.

### SWITCHING THE HEATED SEATS ON AND OFF

The vehicle must be running to use this feature.

# Rear Seats

## MANUAL SEATS

### HEADRESTRAINT COMPONENTS

#### Rear Seat Outermost Head Restraints (4-Door)

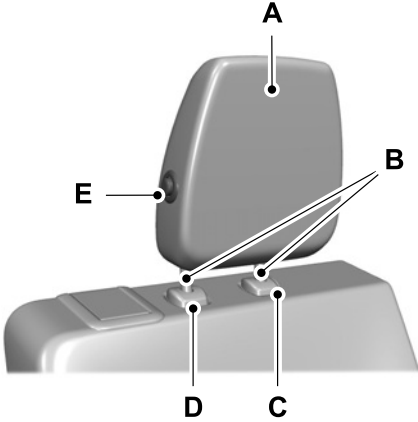

- C Guide sleeve adjust and release button.
- D Guide sleeve unlock and remove button (If equipped).
- E Fold button (If equipped).

#### Rear Seat Outermost Head Restraints (2-Door)

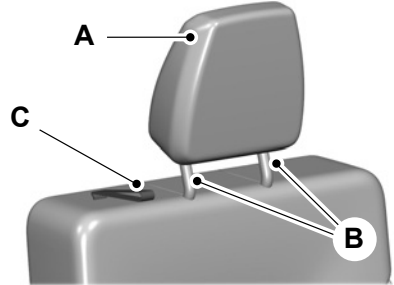

The head restraints consist of:

- A An energy absorbing head restraint.
- B Two steel stems.
- C Fold strap.

#### Rear Seat Center Head Restraint (4-Door)

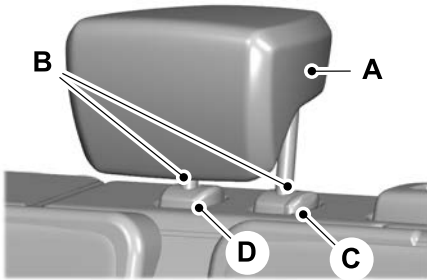

The head restraints consist of:

- A An energy absorbing head restraint.
- B Two steel stems.

### ADJUSTING THE HEAD RESTRAINT

 **WARNING:** Fully adjust the head restraint before you sit in or operate your vehicle. This will help minimize the risk of neck injury in the event of a crash. Do not adjust the head restraint when your vehicle is moving.

# Rear Seats



**WARNING:** The head restraint is a safety device. Whenever possible it should be installed and properly adjusted when the seat is occupied. Failure to adjust the head restraint properly could reduce its effectiveness during certain impacts.



**WARNING:** Adjust the head restraints for all passengers before you drive your vehicle. This will help minimize the risk of neck injury in the event of a crash. Do not adjust the head restraints when your vehicle is moving.

## 4-Door

Pull the head restraint up to raise it.

To lower the head restraint:

1. Press and hold the adjust and release button.
2. Push the head restraint down.

Press the fold button to fold the head restraint.

## 2-Door

Pull the strap to fold the head restraint rearward.

## REMOVING THE HEAD RESTRAINT

1. Pull up the head restraint until it reaches its highest position.
2. Press and hold the adjust and release button and the unlock and remove button.
3. Pull up the head restraint.

**Note:** The head restraints are not removable on 2-door vehicles.

## INSTALLING THE HEAD RESTRAINT

Align the steel stems into the guide sleeves and push the head restraint down until it locks.

## ADJUSTING THE SEAT BACKREST



**WARNING:** Do not place cargo or any objects behind the seat backrest before returning it to the original position. Pull on the seat backrest to make sure that it has fully latched after returning the seat backrest to its original position. An unlatched seat may become dangerous if you stop suddenly or have a crash.

**Note:** The rear seats are not adjustable on 2-door vehicles.

## 4-Door

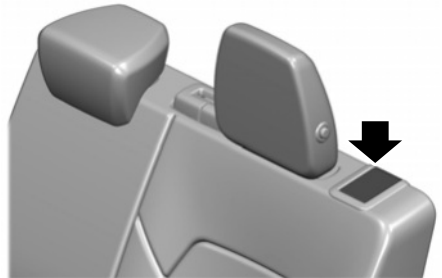

Pull the lever up to fold the seat backrest fully forward.

**Note:** Make sure that the area under the seat is free of objects before folding the backrest.

To return the seat backrest to the upright position, rotate it up until it locks.

# Rear Seats

**Note:** To store the removable doors, the seat backrest must be in the upright position.

To recline the seat backrest to the optimal seating position, pull the lever up and push the backrest rearward.

## FOLDING THE SEATS



**WARNING:** Do not drive your vehicle with a seat that is unlatched or in the folded position. Failure to follow this instruction could result in personal injury or death in the event of a sudden stop or crash.



**WARNING:** Do not adjust a seat or release a seat floor latch when the vehicle is moving. Failure to follow this instruction could result in personal injury or death in a sudden stop or crash.

### 2-Door



1. Pull the strap at the front of the seat cushion. Then, flip the seat cushion up to the vertical position.

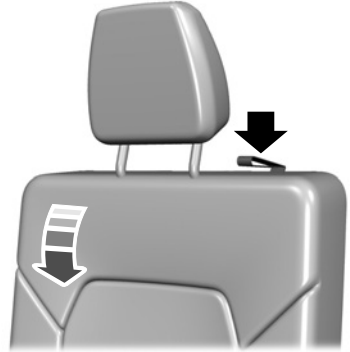

2. Pull the strap on the top of the seat backrest to fold it forward.

## UNFOLDING THE SEATS



**WARNING:** Make sure that cargo and other objects are not trapped under the seat cushion and that you return the seat cushion to the full-down position. Failure to do so may prevent the seat from operating properly, which could increase the risk of serious injury in a crash.

For 2-door vehicles, rotate the seat backrest upright until it locks in the seating position. Then, move the seat cushion back to the seating position.

# Rear Occupant Alert System

---

## WHAT IS THE REAR OCCUPANT ALERT SYSTEM - 5-DOOR, EXCLUDING: RAPTOR

The rear occupant alert system monitors vehicle conditions and notifies you to check for rear seat occupants when you switch the ignition off. The notifications can be in the form of warnings inside the vehicle and sounding of the horn if activated for a short period of time.

## WHAT IS THE REAR OCCUPANT ALERT SYSTEM - RAPTOR, 3-DOOR

The rear occupant alert system monitors the vehicle conditions and notifies you to check for rear seat occupants when you switch the ignition off. The notifications are in the form of warnings inside the vehicle.

## HOW DOES THE REAR OCCUPANT ALERT SYSTEM WORK - 3-DOOR, EXCLUDING: RAPTOR

The system monitors the activity of turning the ignition on and off to indicate the potential presence of an occupant in the rear seat.

A message displays in the touchscreen and an audible warning sounds when you switch the ignition off.

## HOW DOES THE REAR OCCUPANT ALERT SYSTEM WORK - 5-DOOR, EXCLUDING: RAPTOR

The system monitors the activity of the buckle on the rear seatbelt and the opening and closing of the rear doors to indicate the potential presence of an occupant in the rear seat.

When **Child Seat Installed** is selected, the system monitors only the opening and closing of the rear doors to indicate the potential presence of an occupant in the rear seat.

When **Child Seat Installed** is not selected, the system monitors the rear seatbelt buckle activity and the opening and closing of the rear doors to indicate the potential presence of an occupant in the rear seat.

A message displays in the touchscreen and an audible warning sounds when you switch the ignition off after any of the following conditions have been met:

- A rear door is opened or closed while the ignition is on.
- You switch the ignition on within 15 minutes of a rear door opening and closing.
- You switch the ignition on within 15 minutes of the alert having displayed or sounded.

If you do not open a rear door within a short period of time of the message appearing in the center display, the first audible warning sounding and driver door open to close, the horn sounds for a short period of time.

**Note:** *Horn sounds only when the **Rear Occupant Alert** is set to **Alert & Horn**. If you change the setting, then there is no horn sound.*



# Rear Occupant Alert System

## HOW DOES THE REAR OCCUPANT ALERT SYSTEM WORK - RAPTOR

The system monitors when rear doors have been opened and closed to indicate the potential presence of an occupant in the rear seat.

A message displays in the information and entertainment display screen and an audible warning sounds when you switch the ignition off after any of the following conditions have been met:

- A rear door is opened or closed while the ignition is on.
- You switch the ignition on within 15 minutes of a rear door opening and closing.
- You switch the ignition on within 15 minutes of the alert having displayed or sounded.

## REAR OCCUPANT ALERT SYSTEM PRECAUTIONS



**WARNING:** On hot days, the temperature inside the vehicle can rise very quickly. Exposure of people or animals to these high temperatures for even a short time can cause death or serious heat related injuries, including brain damage. Small children are particularly at risk.



**WARNING:** Do not leave children or pets unattended in your vehicle. Failure to follow this instruction could result in personal injury or death.

## REAR OCCUPANT ALERT SYSTEM LIMITATIONS - 3-DOOR, EXCLUDING: RAPTOR

The system does not detect the presence of objects or passengers in the rear seat. It monitors the activity of turning the ignition on and off.

**Note:** *It is possible to receive an alert when there is no rear seat occupant, but alert conditions are met.*

## REAR OCCUPANT ALERT SYSTEM LIMITATIONS - 5-DOOR, EXCLUDING: RAPTOR

The system does not detect the presence of objects or passengers in the rear seat. It monitors the activity of the buckle on the rear seatbelt and the opening and closing of the rear doors.

**Note:** *It is possible to receive an alert when there is no rear seat occupant, but alert conditions are met.*

**Note:** *It is possible to receive no alert when there is an occupant in the rear seat, if alert conditions are not met. For example, if a rear seat occupant does not enter the vehicle through a rear door.*

## REAR OCCUPANT ALERT SYSTEM LIMITATIONS - RAPTOR

The system does not detect the presence of objects or passengers in the rear seat. It monitors when rear doors are opened and closed.

**Note:** *It is possible to receive an alert when there is no rear seat occupant, but alert conditions are met.*

# Rear Occupant Alert System

---

**Note:** It is possible to receive no alert when there is an occupant in the rear seat, if alert conditions are not met. For example, if a rear seat occupant does not enter the vehicle through a rear door.

**Note:** The audible warning does not sound when the front door is opened before you switch the vehicle off.

## SWITCHING REAR OCCUPANT ALERT SYSTEM ON AND OFF - 3-DOOR, EXCLUDING: RAPTOR

1. From the settings menu, press Vehicle
2. Switch Rear Occupant Alert on or off.

**Note:** The default setting is on.

**Note:** Performing a system reset causes the system to switch on again.

### Semiannual Reminder

When you switch the system off, a message appears every six months as a reminder that the system is off. You can switch the system back on or leave it off.

## SWITCHING REAR OCCUPANT ALERT SYSTEM ON AND OFF - RAPTOR

1. Press **Settings** on the touchscreen.
2. Press **Vehicle**.
3. Switch **Rear Occupant Alert** on or off.

**Note:** The default setting is on.

**Note:** Performing a system reset causes the system to switch on again.

### Semiannual Reminder (If Equipped)

When you switch the system off, a message appears every six months as a reminder that the system is off. You can switch the system back on or leave it off.

## REAR OCCUPANT ALERT SYSTEM SETTINGS - 5-DOOR, EXCLUDING: RAPTOR

1. From the settings menu, press Vehicle.
2. Press Rear Occupant Alert.
3. Select Alert & Horn or Alert Only or Off.

**Note:** The default setting is Alert Only.

**Note:** If you choose Alert only, the horn does not sound even when the alert conditions are met.

**Note:** Performing a system reset causes the system to switch on again.

## Switching Child Seat Installed On and Off

When the system is switched on, it monitors the opening and closing of the rear doors to indicate the potential presence of an occupant in the rear seat.

1. From the settings menu, press Vehicle.
2. Press Rear Occupant Alert.
3. Switch Child Seat Installed on or off.

**Note:** The default setting is on.

Switch the system on when the child restraint is mounted on any of the following:

- Forward facing seat.
- Rear facing seat.
- Toddler in a LATCH system child seat.

Switch the system off when the child is using any of the following:

- Seatbelt.
- Booster seat.

## Semiannual Reminder

When you switch the system off, a message appears every six months as a reminder that the system is off. You can switch the system back on or leave it off.

# Rear Occupant Alert System

## REAR OCCUPANT ALERT SYSTEM INDICATORS - EXCLUDING: RAPTOR



Message
Check rear seats for occupants.

Displays when you switch the power off after the alert conditions are met.

The message displays for a short period of time. Press **Close** to acknowledge and remove the message.

**Note:** Depending on your center display system version, the graphic may look different from what you see here.

## REAR OCCUPANT ALERT SYSTEM INDICATORS - RAPTOR



Message
Check rear seats for occupants.

Displays when you switch your vehicle off after the alert conditions are met.

The message displays for a short period of time. Press **Close** to acknowledge and remove the message.

**Note:** The graphic may be different for your vehicle.

## REAR OCCUPANT ALERT SYSTEM AUDIBLE WARNINGS - 3-DOOR, EXCLUDING: RAPTOR

The audible warning is an alert tone within the vehicle, which sounds when you switch your vehicle off. The warning sounds for a short period of time.

# Rear Occupant Alert System

---

## **REAR OCCUPANT ALERT SYSTEM AUDIBLE WARNINGS - 5-DOOR, EXCLUDING: RAPTOR**

The first audible warning is an alert tone within the vehicle, which sounds when you switch your vehicle off after the alert conditions are met. The warning sounds for a short period of time.

The second audible warning is from the horn. It sounds when you do not open a rear door within a short period of time of the message appearing in the center display, the first audible warning sounding, and driver door open to close. The warning sounds for a short period of time.

## **REAR OCCUPANT ALERT SYSTEM AUDIBLE WARNINGS - RAPTOR**

Sounds when you switch your vehicle off after the alert conditions are met.

The warning sounds for a short period of time.

# Garage Door Opener (If Equipped)

## GARAGE DOOR OPENER INTRODUCTION

### HomeLink Wireless Control System

The universal garage door opener replaces the common handheld garage door opener with a three-button transmitter integrated into the driver-side sun visor.



### How Does The Garage Door Opener Work

The system includes two primary features, a garage door opener and a platform for remote activation of devices within the home. You can program garage doors as well as entry gate operators, security systems, entry door locks and home or office lighting.

### Garage Door Opener Limitations

Canadian radio-frequency laws require transmitter signals to time out, or quit, after several seconds – which may not be long enough for HomeLink to pick up the signal. U.S. gate operators time-out in the same manner.

## GARAGE DOOR OPENER PRECAUTIONS AND FREQUENCIES

### Garage Door Opener Precautions

**WARNING:** Do not use the system with any garage door opener that does not have the safety stop and reverse feature as required by U.S. Federal Safety Standards (this includes any garage door opener manufactured before April 1, 1982). A garage door opener which cannot detect an object, signaling the door to stop and reverse, does not meet current federal safety standards. Using a garage door opener without these features increases the risk of serious injury or death.

### FCC and RSS-210 Industry Canada Compliance

**WARNING:** Changes or modifications not expressly approved by the party responsible for compliance could void the user's authority to operate the equipment. The term "IC:" before the radio certification number only signifies that Industry Canada technical specifications were met.

This device complies with Part 15 of the FCC Rules and with RSS-210 of Industry Canada. Operation is subject to the following two conditions: (1) this device may not cause harmful interference, and (2) this device must accept any interference received, including interference that may cause undesired operation.

## Garage Door Opener (If Equipped)

This equipment complies with FCC radiation exposure limits set forth for an uncontrolled environment. End Users must follow the specific operating instructions for satisfying RF exposure compliance. This transmitter must be at least 20 cm (8 in) from the user and must not be co-located or operating in conjunction with any other antenna or transmitter.

### PROGRAMMING THE GARAGE DOOR OPENER

To clear all stored codes in the garage door opener in your vehicle, use the **clear** function. To override one button, use the **reprogram** function.

**Note:** Make sure that the garage door and security device are free from obstruction when you are programming. Do not program the system with the vehicle in the garage.

#### Clearing the Garage Door Opener

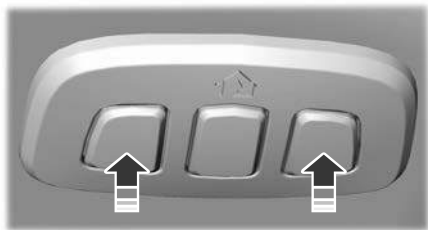

To clear all stored codes in the garage door opener in the vehicle:

1. Press and hold the outer two function buttons simultaneously for approximately 10 seconds until the indicator above the buttons flashes rapidly.
2. When the indicator flashes, release the buttons.

**Note:** This clears all stored codes. You cannot erase individual buttons.

**Note:** You can program a maximum of three devices. To change or replace any of the three devices after they have been initially programmed, you must either clear all codes, or reprogram each individual button.

**Note:** We recommend that upon the sale or lease termination of your vehicle, you erase the programmed function buttons for security reasons.

#### Reprogramming the Garage Door Opener

If a button on your garage door opener has already been programmed, you can override it. To program a device to a previously trained button:

1. Press and hold the desired button for approximately 20 seconds until the indicator begins to flash.
2. Without releasing the button, proceed to Step 3 of **Programming the Garage Door Opener to your Handheld Transmitter**.

#### Programming the Garage Door Opener to your Handheld Transmitter

**Note:** The programming steps below assume you are programming a HomeLink that was not previously programmed. If your HomeLink was previously programmed, you may need to **clear** or **reprogram** your HomeLink buttons.

**Note:** Put a new battery in the handheld transmitter. This allows for quicker training and accurate transmission of the radio-frequency signal.

**Note:** Make sure that the garage door and security device are free from obstruction when you are programming. Do not program the system with the vehicle in the garage.

## Garage Door Opener (If Equipped)

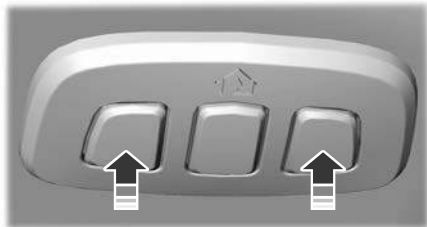

To program your in-vehicle HomeLink function button with your handheld transmitter:

1. With your vehicle parked outside of the garage, switch your vehicle on, but do not start your vehicle.
2. Press and release one of the three HomeLink function buttons that you would like to program.

**Note:** The indicator should begin to flash. If the indicator does not flash, press and hold the function button for 20 seconds until the indicator begins to flash.

3. Hold your handheld garage door transmitter 2–8 cm (1–3 in) away from the HomeLink button you want to program.
4. Press and hold the handheld transmitter button you want to program while watching the indicator on HomeLink. Continue to hold the handheld button until the HomeLink indicator flashes rapidly or is continuously on.

**Note:** You may need to use a different method if you live in Canada or have difficulties programming your gate operator or garage door opener.

5. Press and hold the HomeLink button you programmed for two seconds, then release. You may need to do this twice to activate the door.

**Note:** If the indicator stays on, the programming is complete.

**Note:** If the HomeLink indicator flashes rapidly, repeat Step 5.

**Note:** If your device still does not operate, you must program your garage door.

6. To program additional buttons, repeat Steps 1–4.

**Note:** Make sure you keep the original remote control transmitter for use in other vehicles as well as for future system programming.

### Programming the Garage Door Opener to your Garage Door Opener Motor

**Note:** Make sure that the garage door and security device are free from obstruction when you are programming. Do not program the system with the vehicle in the garage.



1. Press the learn button on the garage door opener motor and then you have 30 seconds to complete the next two steps.
2. Return to your vehicle.

## Garage Door Opener (If Equipped)

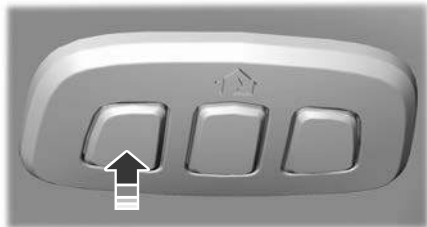

3. Press and hold one of the three HomeLink function buttons you want to program for two seconds, then release.
4. Repeat Step 3. Depending on your brand of garage door opener, you may need to repeat this sequence a third time.

### Programming the Garage Door Opener to your Gate Opener Motor

#### Gate Operator / Canadian Programming

Canadian radio-frequency laws require transmitter signals to time-out (or quit) after several seconds of transmission – which may not be long enough for HomeLink to pick up the signal during programming. Similar to this Canadian law, some U.S. gate operators are designed to time-out in the same manner.

**Note:** *If programming a garage door opener or gate operator, it is advised that you unplug the device during the **cycling** process to prevent possible overheating.*

1. Press and release your handheld transmitter, **every two seconds**, until the HomeLink indicator flashes rapidly or is continuously on.
2. Release the handheld transmitter button.

3. Press and hold the HomeLink function button you want to program for two seconds, then release. You may need to do this twice to activate the door.

**Note:** *If the indicator stays on, the programming is complete.*

**Note:** *If the HomeLink indicator flashes rapidly, repeat Step 3.*

4. To program additional buttons, repeat Steps 1–4.

## GARAGE DOOR OPENER ADDITIONAL ASSISTANCE

### Video Setup Instructions

[Universal Garage Door Opener: HomeLink](#)

[Universal Garage Door Opener: HomeLink for Genie Intellicode 2](#)

[Universal Garage Door Opener HomeLink for Genie Intellicode](#)

Additional assistance can be found online at [www.homelink.com/Ford](http://www.homelink.com/Ford) or by calling the toll-free help line at 1-800-355-3515.



# USB Ports

## LOCATING THE USB PORTS

### Data Transfer USB Ports



The USB ports could be in the following locations:

- On the lower instrument panel.
- Inside the center console.

**Note:** *These USB ports can also charge devices.*

**Note:** *Not all USB ports in your vehicle have data transfer capabilities.*

**Note:** *We recommend using only USB-IF certified cables and adapters. Non-certified cables and adapters may not work.*

### Charge Only USB Ports



The USB ports could be in the following locations:

- On the lower instrument panel.
- On the upper instrument panel.
- Inside the media bin.
- Inside the center console.
- On the rear of the center console.
- Behind the first row seats.
- In the cargo area.

## PLAYING MEDIA USING THE USB PORT

 **WARNING:** Driving while distracted can result in loss of vehicle control, crash and injury. We strongly recommend that you use extreme caution when using any device that may take your focus off the road. Your primary responsibility is the safe operation of your vehicle. We recommend against the use of any hand-held device while driving and encourage the use of voice-operated systems when possible. Make sure you are aware of all applicable local laws that may affect the use of electronic devices while driving.

Connect your device to a data transfer USB port.



Press the audio button on the feature bar.

Select **Sources**.



Select the USB option.



Press to play a track. Press again to pause the track.



Press to skip to the next track.

Press and hold to fast forward through the track.



Press once to return to the beginning of a track. Repeatedly press to return to previous

tracks.

Press and hold to fast rewind.

## CHARGING A DEVICE

Connect your device to the USB port.

# USB Ports

---

## Data Transfer USB Ports



You can charge your device through the data transfer USB port when SYNC is on.

## Charge Only USB Ports



You can charge your device through the charge only USB port when the vehicle is in accessory mode or when the vehicle is running.

# Power Outlet - Vehicles With: 120V Power Outlet

## WHAT IS THE POWER OUTLET

The power outlet is a socket that connects an electrical device to your vehicle's power supply.

## POWER OUTLET PRECAUTIONS



**WARNING:** Do not keep electrical devices plugged into the power outlet whenever the device is not in use. The outlet provides power when the vehicle is on. Failure to follow this instruction could result in personal injury.



**WARNING:** Do not use an extension cord or connect multiple devices to the power outlet. Doing so could result in overloading the power outlet. Failure to follow this instruction could result in fire, personal injury or property damage.

**Note:** *The vehicle provides up to 400 Watts when in park and up to 300 Watts when in drive mode. This wattage is divided between multiple outlets when in use at the same time.*

## POWER OUTLET LIMITATIONS

Some devices could exceed their capacity when first plugged in. If the device exceeds 400 Watts, the power outlet temporarily shuts off. If this occurs, unplug the device and switch the ignition off and then on to reset the system.

Do not use the power outlet for these types of devices:

- Cathode ray tube type televisions.
- Motor loads, for example vacuum cleaners, electric saws and other electric power tools, or compressor-driven refrigerators.
- Measuring devices which process precise data, for example medical equipment or measuring equipment.
- Other appliances requiring an extremely stable power supply, for example microcomputer-controlled electric blankets or touch sensor lamps.

## LOCATING THE POWER OUTLETS

The power outlet is on the rear of the center console.

### Rear of the Center Console



## POWER OUTLET INDICATORS

The power outlet indicator illuminates to let you know the status of the system.

## Power Outlet - Vehicles With: 120V Power Outlet

---

Indicator Status	Description
On	When the indicator light is on, the outlet is providing power.
Off	When the indicator light is off, there is no power to the outlet.
Flashing	When the indicator light is flashing, the outlet is in a fault mode.

### Fault mode

The power outlet temporarily turns off power if the device exceeds the watt limit.

1. Unplug your device.
2. Switch your vehicle off to let the system cool and reset the fault mode.
3. Switch your vehicle back on, but do not plug your device back in.
4. With your vehicle on, make sure the indicator light remains on.
5. Make sure your device does not exceed the power limits and then plug in your device.

**Note:** *If a fault occurs again, your device may exceed the capacity available from the power outlet.*

# Power Outlet - Vehicles With: 12V Power Outlet

## WHAT IS THE POWER OUTLET

The power outlet can power devices using a 12 V outlet adapter.

## POWER OUTLET PRECAUTIONS



**WARNING:** Do not plug electrical devices into the power outlets that exceed the maximum power rating. Incorrect use of the power outlets can cause damage not covered by the vehicle warranty, and can result in fire or personal injury.

When you switch the vehicle on, you can use the power outlets to power 12 V appliances with a maximum current rating of 15 A.

To prevent damage to the vehicle's battery:

- Do not use the power outlets over the vehicle capacity of 12 V DC 180 W or a fuse could blow.
- Do not plug in any device that supplies power to the vehicle through the power outlets. This could result in damage to vehicle systems.
- Do not hang any accessory from the accessory plug. Always keep the power outlets caps closed when not in use.
- Do not insert objects other than an accessory plug into the power outlets.

To prevent the battery from running out of charge:

- Do not use the power outlets longer than necessary when the vehicle is off.
- Do not leave devices plugged in overnight or when you park your vehicle for extended periods.
- Using devices for extended periods may require starting and running the engine to recharge the battery.

## LOCATING THE POWER OUTLETS

Power outlets may be in the following locations:

- On the lower instrument panel.
- Inside the center console.
- On the front of the center console.
- On the rear of the center console.
- In the cargo area.
- On the passenger side floor panel.
- 3rd row on the quarter trim panels.

# Storage

## GLOVE COMPARTMENT

### OPENING THE GLOVE COMPARTMENT



Pull the latch to the left to open.

### LOCKING THE GLOVE COMPARTMENT

You can lock lower glove compartment using the key.

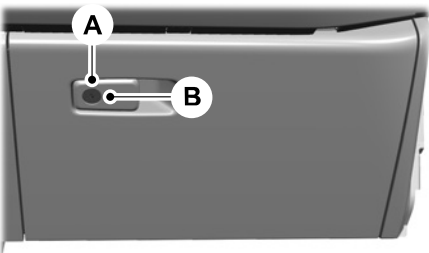

- A Unlock.
- B Lock.

## CENTER CONSOLE

### OPENING THE CENTER CONSOLE



Push the latch to open the center console.

### LOCKING THE CENTER CONSOLE

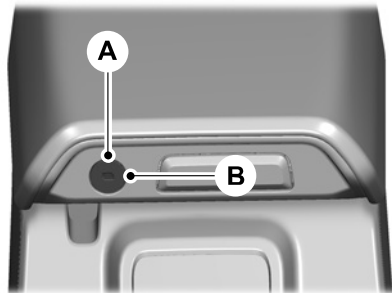

- A Unlock.
- B Lock.

You can lock the center console using the key.

# Storage

## UNDER FLOOR STORAGE

### LOCATING THE LUGGAGE COMPARTMENT UNDER FLOOR STORAGE

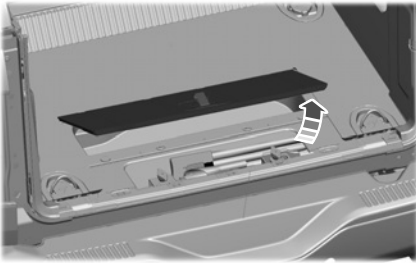

Lift the strap to access the under floor storage in the luggage compartment.

## MAP POCKET

### LOCATING THE MAP POCKET

A map pocket and optional hook and MOLLE system are on the backs of the front seats.

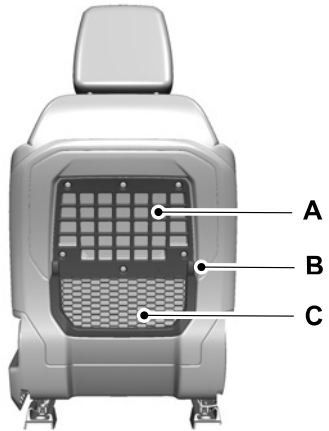

- A. MOLLE system (if equipped).
- B. Hooks (if equipped).
- C. Map pocket.

**Note:** *The recommended weight limit for this system is 3 kg (7 lb).*

# Starting and Stopping the Engine

## STARTING AND STOPPING THE ENGINE – PRECAUTIONS



**WARNING:** Extended idling at high engine speeds can produce very high temperatures in the engine and exhaust system, creating the risk of fire or other damage.



**WARNING:** Do not park, idle or drive your vehicle on dry grass or other dry ground cover. The emission system heats up the engine compartment and exhaust system, creating the risk of fire.



**WARNING:** Do not start the engine in a closed garage or in other enclosed areas. Exhaust fumes are toxic. Always open the garage door before you start the engine. Failure to follow this instruction could result in personal injury or death.



**WARNING:** Do not use starting fluid, for example ether, in the air intake system. Such fluid could cause immediate explosive damage to the engine and possible personal injury.



**WARNING:** Exhaust leaks may result in entry of harmful and potentially lethal fumes into the passenger compartment. If you smell exhaust fumes inside your vehicle, have your vehicle inspected immediately. Do not drive if you smell exhaust fumes.

The powertrain control system meets all Canadian interference-causing equipment standard requirements regulating the impulse electrical field or radio noise.

If you stop your vehicle and leave the engine idling for long periods, we recommend that you do one of the following:

- Open the windows at least 2.5 cm (1 in).
- Set your climate control to outside air.

## PUSH BUTTON IGNITION SWITCH

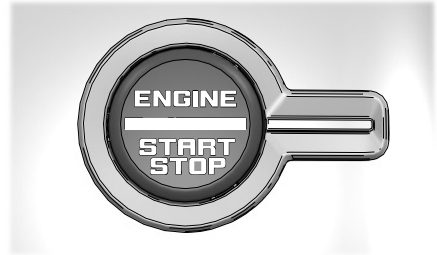

### Switching the Ignition Off

When the ignition is on or in accessory mode, press the push button ignition switch once without your foot on the brake pedal.

### Switching the Ignition to Accessory Mode

When the ignition is off, press the push button ignition switch once without your foot on the brake pedal.

All electrical circuits and accessories are operational and the warning lamps and indicators illuminate.

**Note:** Your vehicle has a battery saver feature that shuts your vehicle off when it detects a certain amount of battery drain, or after about 30 minutes of inactivity in accessory mode.



# Starting and Stopping the Engine

**Note:** The system may not function if the remote control is close to metal objects or electronic devices, for example keys or a cell phone.

**Note:** You need a valid key inside your vehicle to switch the ignition on and start the engine.

## STARTING THE ENGINE

### STARTING A GASOLINE ENGINE - MANUAL TRANSMISSION

Before starting your vehicle, check the following:

- Make sure the headlamps and electrical accessories are off.
- Make sure the parking brake is on.
- Make sure the transmission is in neutral.

1. Fully press the clutch pedal.

**Note:** Do not touch the accelerator pedal.

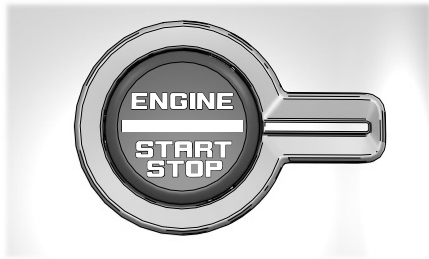

2. Press the push button ignition switch.

**Note:** The engine may continue cranking for up to 15 seconds or until it starts.

**Note:** The engine takes longer to start at lower temperatures. It may crank for several seconds when very cold.

### STARTING A GASOLINE ENGINE - AUTOMATIC TRANSMISSION

Before starting your vehicle, check the following:

- Make sure that the headlamps and electrical accessories are off.
- Make sure that the parking brake is on.
- Make sure that the transmission is in park (P).

1. Fully press the brake pedal.

**Note:** Do not touch the accelerator pedal.

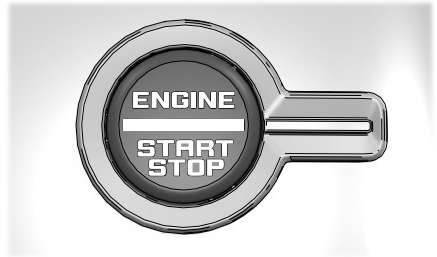

2. Press the push button ignition switch.

**Note:** The engine may continue cranking for up to 15 seconds or until it starts.

**Note:** The engine takes longer to start at lower temperatures. It may crank for several seconds when very cold.

### RESTARTING THE ENGINE AFTER STOPPING IT

The system allows you to start the engine within 10 seconds of switching it off, even if it does not detect a valid passive key.

Within 10 seconds of switching the engine off, fully press the brake or clutch pedal and press the push button ignition switch. After 10 seconds, you can no longer start the engine if the system does not detect a valid passive key.

# Starting and Stopping the Engine

When you start the engine, it remains running until you press the push button ignition switch, even if your vehicle does not detect a valid passive key. If you open and close a door when the engine is running, the system searches for a valid passive key.

## ENGINE BLOCK HEATER (IF

EQUIPPED)

## ENGINE BLOCK HEATER PRECAUTIONS



**WARNING:** Failure to follow engine block heater instructions could result in property damage or serious personal injury.



**WARNING:** Do not use your heater with ungrounded electrical systems or two-pronged adapters. There is a risk of electrical shock.



**WARNING:** Do not fully close the hood, or allow it to drop under its own weight when using the engine block heater. This could damage the power cable and may cause an electrical short resulting in fire, injury and property damage.

We recommend that you do the following for a safe and correct operation:

- Use a 16-gauge outdoor extension cord that is product certified by Underwriter's Laboratory (UL) or Canadian Standards Association (CSA). This extension cord must be suitable for use outdoors, in cold

temperatures, and be clearly marked Suitable for Use with Outdoor Appliances. Do not use an indoor extension cord outdoors. This could result in an electric shock or become a fire hazard.

- Use as short an extension cord as possible.
- Do not use multiple extension cords.
- Make sure that when in operation, the extension cord plug and heater cord plug connections are free and clear of water. This could cause an electric shock or fire.
- If the block heater cord is under the hood, do not remove the wiring from its original location. Do not close the hood on the extension wiring.
- Make sure your vehicle is parked in a clean area, clear of combustibles.
- Make sure the heater, heater cord and extension cord are firmly connected.
- Check for heat anywhere in the electrical hookup once the system has been operating for about 30 minutes.
- Make sure the system is unplugged and properly stowed before starting and driving your vehicle. Make sure the protective cover seals the prongs of the block heater cord plug when not in use.
- Make sure the heater system is checked for proper operation before winter.

## HOW DOES THE ENGINE BLOCK HEATER WORK

The engine block heater warms the engine coolant. This allows the climate control system to quickly respond. The equipment includes a heater element installed in the engine block and a wire harness. You can connect the system to a grounded 110 volt AC electrical source.

# Starting and Stopping the Engine

**Note:** The engine block heater is most effective when outdoor temperatures are below  $-18^{\circ}\text{C}$  ( $0^{\circ}\text{F}$ ). We recommend the use of engine block heater to improve engine cold start performance.

## USING THE ENGINE BLOCK HEATER

Make sure the receptacle terminals are clean and dry prior to use. Clean them with a dry cloth if necessary.

The heater uses 0.4 to 1.0 kilowatt-hours of energy per hour of use. The system does not have a thermostat. It achieves maximum temperature after approximately three hours of operation. Using the heater longer than three hours does not improve system performance and unnecessarily uses electricity.

## STOPPING THE ENGINE

### STOPPING THE ENGINE WHEN YOUR VEHICLE IS STATIONARY - MANUAL TRANSMISSION

1. Shift into neutral.
2. Apply the parking brake.
3. Wait until the engine reaches idle speed.

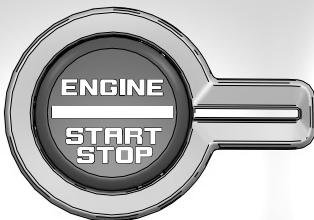

4. Press the push button ignition switch.

### STOPPING THE ENGINE WHEN YOUR VEHICLE IS STATIONARY - AUTOMATIC TRANSMISSION

1. Shift into park (P).
2. Apply the parking brake.
3. Wait until the engine reaches idle speed.

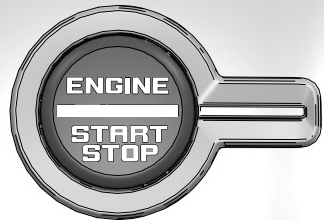

4. Press the push button ignition switch.

### STOPPING THE ENGINE WHEN YOUR VEHICLE IS MOVING - MANUAL TRANSMISSION



**WARNING:** Switching off the engine when your vehicle is still moving results in a significant decrease in braking assistance. Higher effort is required to apply the brakes and to stop your vehicle. A significant decrease in steering assistance could also occur. The steering does not lock, but higher effort could be required to steer your vehicle. When you switch the ignition off, some electrical circuits, for example airbags, also turn off. If you unintentionally switch the ignition off, shift into neutral (N) and restart the engine.

# Starting and Stopping the Engine

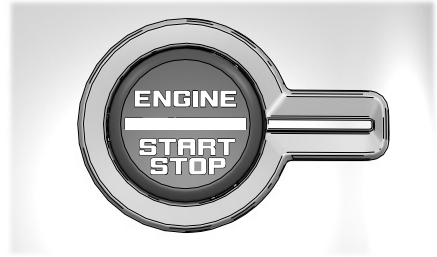
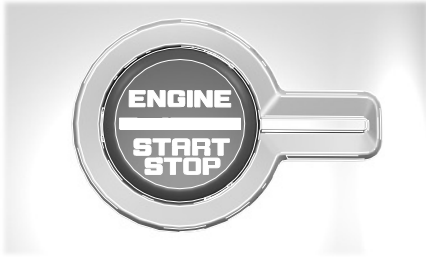

1. Press and hold the push button ignition switch until the engine stops, or press it three times within two seconds.
2. Shift into neutral and use the brakes to bring your vehicle to a safe stop.
3. Apply the parking brake.

1. Press and hold the push button ignition switch until the engine stops, or press it three times within two seconds.
2. Shift into neutral (N) and use the brakes to bring your vehicle to a safe stop.
3. Shift into park (P).
4. Apply the parking brake.

## STOPPING THE ENGINE WHEN YOUR VEHICLE IS MOVING - AUTOMATIC TRANSMISSION



**WARNING:** Switching off the engine when your vehicle is still moving results in a significant decrease in braking assistance. Higher effort is required to apply the brakes and to stop your vehicle. A significant decrease in steering assistance could also occur. The steering does not lock, but higher effort could be required to steer your vehicle. When you switch the ignition off, some electrical circuits, for example airbags, also turn off. If you unintentionally switch the ignition off, shift into neutral (N) and restart the engine.

## AUTOMATIC ENGINE STOP

### WHAT IS AUTOMATIC ENGINE STOP

Automatic engine stop switches the engine off if it has been idling for an extended period to help you save fuel.

### HOW DOES AUTOMATIC ENGINE STOP WORK

Automatic engine stop turns the engine off. The ignition also turns off to save battery power. Before the engine shuts down, a message appears in the instrument cluster display showing a timer counting down. If you do not intervene within 30 seconds, the engine shuts down. Another message appears in the instrument cluster display to inform you that the engine has shut down to save fuel. Start your vehicle as you normally do.

# Starting and Stopping the Engine

## SWITCHING AUTOMATIC ENGINE STOP ON AND OFF

1. From the settings menu, press Vehicle.
2. Switch 30min Max Idle on or off.

**Note:** You cannot permanently switch off the automatic shutdown. If you switch it off, it turns on each time you switch the ignition on.

## OVERRIDING AUTOMATIC ENGINE STOP

**Note:** You cannot permanently switch off the automatic engine stop feature. When you switch it off temporarily, it turns on at the next ignition cycle.

You can stop the engine shutdown, or reset the timer, at any point before the 30-second countdown has expired by doing any of the following:

- Pressing the brake pedal or accelerator pedal.
- Pressing the **OK** or **RESET** button during the countdown.

## ACCESSING THE PASSIVE KEY BACKUP POSITION

If you are unable to start the engine, do the following:

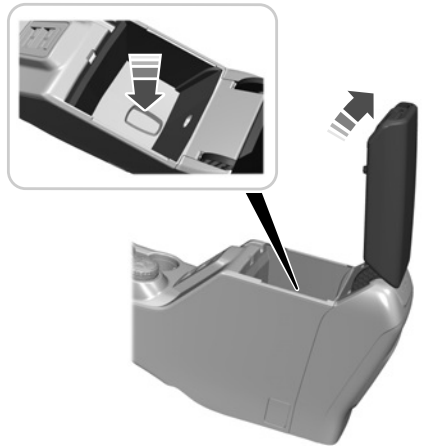

1. Open the center console storage compartment lid.
2. With the buttons facing upward and the unlock button facing the front of your vehicle, place the passive key into the backup slot.
3. With the key in this position, press the brake pedal then press the push button ignition switch to switch the ignition on and start your vehicle.

## STARTING AND STOPPING THE ENGINE – TROUBLESHOOTING

### STARTING AND STOPPING THE ENGINE – WARNING LAMPS

#### Malfunction Indicator Lamp



If it illuminates when the engine is running, the on-board diagnostics system is detecting a malfunction of the vehicle emission control system.

# Starting and Stopping the Engine

If it flashes, engine misfire could be occurring. Increased exhaust gas temperatures could damage the catalytic converter or other vehicle components. Avoid heavy acceleration and deceleration, and have your vehicle checked as soon as possible.

## Powertrain Warning Lamp



If it illuminates when the engine is running, this indicates a powertrain or four-wheel drive fault. If it flashes when you are driving, immediately reduce the vehicle speed. Avoid heavy acceleration and deceleration, and have your vehicle checked as soon as possible.

If both lamps illuminate when the engine is running, stop your vehicle as soon as it is safe to do so. Continuing to drive your vehicle could cause reduced power or the engine to stop. Switch the ignition off and attempt to restart the engine. Have your vehicle checked as soon as possible.

## Oil Pressure Warning Lamp



It illuminates when you switch the ignition on. If it illuminates when the engine is running, this indicates a malfunction. Stop your vehicle and switch the engine off. Check the engine oil level. If the oil level is sufficient, this indicates a system malfunction. Have your vehicle checked as soon as possible.

## STARTING AND STOPPING THE ENGINE – INFORMATION MESSAGES

Message	Action
Cranking Time Exceeded	Displays if you exceed the starting time limit. You cannot attempt to start the engine for 15 minutes. If you cannot start the engine after 15 minutes passes, have your vehicle immediately checked.
Starting System Fault	Displays if you are unable to start your vehicle with a correctly coded key. The system has detected a fault that requires service. Have your vehicle checked as soon as possible.
No Key Detected	Displays if the system does not detect a valid passive key.

# Starting and Stopping the Engine

## STARTING AND STOPPING THE ENGINE – FREQUENTLY ASKED QUESTIONS

### Why is the engine idle speed high when I start the engine?

- The speed the engine idles immediately after starting is optimized to minimize vehicle emissions and maximize cabin comfort and fuel economy.

### Why is the engine not cranking?

The engine will not crank if:

- The system does not detect a valid passive key.
- The passive key battery has no charge.
- The vehicle battery does not have sufficient charge.
- The brake pedal is not pressed for automatic transmissions or the clutch pedal is not pressed for manual transmissions.
- The transmission is not in the park (P) or neutral (N) for automatic transmissions.
- The starting system has been disabled after multiple attempts of starting the engine.

### What should I do if the starting system is disabled?

- You can only attempt to start the engine for a set number of times before the starting system temporarily disables. If you exceed the limit, a message may appear and you need to wait at least 15 minutes to start the engine again.

### What should I do if the engine does not start?

- If you cannot start the engine after three attempts, wait 10 seconds and do the following:
  1. Fully press the brake pedal for automatic transmissions or clutch pedal for manual transmissions.

**Note:** Make sure that the parking brake is applied.

**Note:** Make sure that the transmission is in park (P) or neutral (N) for automatic transmissions.

2. Fully press and hold the accelerator pedal.
3. Press the push button ignition switch. See **Push Button Ignition Switch** (page 148).

**Note:** The engine cranks for a short period of time and then stops.

4. Release the accelerator pedal.
5. Press the push button ignition switch. See **Push Button Ignition Switch** (page 148).

### Why do I experience different driving characteristics?

- If you disconnect the battery, your vehicle may exhibit some unusual driving characteristics for about 8 km (5 mi) after you reconnect it. This is because the engine management system must realign itself with the engine. You can disregard any unusual driving characteristics during this period.

# Starting and Stopping the Engine

---

## Why does the system not detect a passive key?

- If the system does not detect a passive key and you are unable to start the engine, insert the passive key into the backup position and press the push button ignition switch to start the engine. See **Accessing the Passive Key Backup Position** (page 153).



# Start in Gear - Manual Transmission

---

## WHAT IS START IN GEAR

Start in gear allows the driver to restart the engine and drive the vehicle after stalling in four-wheel drive low (4L). The instrument cluster display directs you when to apply the brake and push the start button. While driving off road, it is possible to stall the engine trying to maneuver the terrain.

**Note:** *While attempting to start in gear, do not press the clutch pedal unless another gear is desired for the start in gear process. Press and hold down the brake pedal when changing gears to prevent unwanted vehicle movement.*

Trying to restart your vehicle by using the clutch or shifting into neutral to restart the engine can be difficult and cause potential rollback situations when driving uphill.

## START IN GEAR PRECAUTIONS

Always press the brake pedal when starting the vehicle to prevent unwanted vehicle movement, and release after starting to drive away. Start in gear is only possible with the brake pedal pressed.

## START IN GEAR LIMITATIONS

You can only use start in gear in four-wheel drive low (4L).

## USING START IN GEAR

When driving difficult terrains in four-wheel drive low (4L), it is possible to stall the engine when your vehicle is not able to maintain speed. To easily start the engine and launch your vehicle, perform the following steps:

1. After the vehicle stalls, an information message displays in the cluster. **To start in gear select YES and press OK.**
2. Firmly press the brake pedal when in gear and press and hold the **Start** button.
3. When the engine cranks and the vehicle begins to move, release the brake pedal.

# Start in Gear - Manual Transmission

## START IN GEAR – TROUBLESHOOTING

### START IN GEAR – INFORMATION MESSAGES

Message	Details
Do you want to start in gear?	After stalling your vehicle, a message can display prompting you that start in gear is now available.
Press Brake and Hold Start Button to Start in Gear	For use with push button vehicles, press the brake pedal and press the push button ignition switch to begin start in gear.
Start in Gear Canceled	After stalling in four-wheel drive low (4L), if your vehicle does not meet all the requirements or you make any other inputs, a message can display in the instrument cluster.
Start in Gear Limit Reached Normal Start Available	After stalling in four-wheel drive low (4L), a message can display if you have incorrectly attempted a start in gear situation or have attempted too many times.

## START IN GEAR – FREQUENTLY ASKED QUESTIONS

### Can I use start in gear in reverse?

- You can use start in gear in any forward or reverse gear.

**Note:** *Start in gear may not be possible in the higher gears. If another gear is desired, you can hold the brake pedal down and press the clutch to change into another forward or reverse gear. Releasing the clutch pedal once again prompts you to start in gear.*

### Will this start my vehicle?

- Following the procedure, the engine could start and drive the vehicle in gear.

### If my vehicle stalls, do I have to use start in gear?

- After your vehicle stalls in four-wheel drive low (4L), you do not have to use start in gear. You can still start your vehicle normally using the clutch.

### How hard does the brake need pressing for start in gear?

- Fully press the brake pedal at the time you press the push button ignition switch. Releasing the brake pedal allows the vehicle to move.

# Auto-Start-Stop

## WHAT IS AUTO-START-STOP

The system helps reduce fuel consumption by stopping and restarting the engine when your vehicle has stopped. The engine restarts when you release the brake pedal.

In some situations, your vehicle could restart before you release the brake pedal, for example:

- To maintain interior comfort.
- To recharge the battery.

## AUTO-START-STOP PRECAUTIONS - MANUAL TRANSMISSION



**WARNING:** Apply the parking brake, shift into neutral, switch the ignition off and remove the key before you leave your vehicle. Failure to follow this instruction could result in personal injury or death.



**WARNING:** Apply the parking brake, shift into neutral, switch the ignition off and remove the key before you open the hood or have any service or repair work completed. If you do not switch the ignition off, the engine could restart at any time. Failure to follow this instruction could result in personal injury or death.

## AUTO-START-STOP PRECAUTIONS - AUTOMATIC TRANSMISSION



**WARNING:** Apply the parking brake, shift into park (P), switch the ignition off and remove the key before you leave your vehicle. Failure to follow this instruction could result in personal injury or death.



**WARNING:** Apply the parking brake, shift into park (P), switch the ignition off and remove the key before you open the hood or have any service or repair work completed. If you do not switch the ignition off, the engine could restart at any time. Failure to follow this instruction could result in personal injury or death.

## SWITCHING AUTO-START-STOP ON AND OFF

The system turns on when you switch the ignition on.



Press the button to switch the system off.

**Note:** *OFF* illuminates in the switch.

**Note:** *Deactivating the system using the button lasts only one key cycle.*

Press the button again to switch the system back on.

**Note:** *The system turns off if it detects a malfunction. If the system malfunctions, have your vehicle checked as soon as possible.*

# Auto-Start-Stop

## STOPPING THE ENGINE - MANUAL TRANSMISSION

1. Stop your vehicle.
2. Shift into neutral.
3. Release the clutch pedal and the accelerator pedal.

**Note:** *To obtain maximum benefit from the system, shift into neutral and release the clutch pedal whenever you stop your vehicle for more than three seconds.*

## STOPPING THE ENGINE - AUTOMATIC TRANSMISSION

Stop your vehicle, keep your foot on the brake pedal and the transmission in drive (D).

## RESTARTING THE ENGINE - MANUAL TRANSMISSION

Press the clutch pedal.

A message appears in the instrument cluster display if the system requires you to take action.

Message	Condition	Action
Auto StartStop Press a Pedal to Start Engine	The system needs to restart the engine but requires your confirmation.	Press the accelerator pedal, brake pedal or clutch pedal to restart the engine.
Auto StartStop Select Neutral To Start Engine	The system needs to restart the engine but cannot because the transmission is in gear.	Shift into neutral to restart the engine.

# Auto-Start-Stop

## RESTARTING THE ENGINE - AUTOMATIC TRANSMISSION

Release the brake pedal or press the accelerator pedal.

A message appears in the instrument cluster display if the system requires you to take action.



The auto-start-stop indicator illuminates green when the engine stops. It flashes amber and a message appears when you need to take action.



The auto-start-stop indicator illuminates gray with a strikethrough when the system is not available.

## AUTO-START-STOP INDICATORS



**WARNING:** The system may require the engine to automatically restart when the auto-start-stop indicator illuminates green or flashes amber. Failure to follow this instruction could result in personal injury.

## AUTO-START-STOP – TROUBLESHOOTING

### AUTO-START-STOP – INFORMATION MESSAGES - MANUAL TRANSMISSION

Message	Condition	Action
Auto StartStop Manual Restart Required	The system is not functioning.	Restart the engine yourself.

# Auto-Start-Stop

## **AUTO-START-STOP – INFORMATION MESSAGES - AUTOMATIC TRANSMISSION**

A message appears in the information display if the system requires you to take action.

<b>Message</b>	<b>Condition</b>	<b>Action</b>
Auto StartStop Press Brake to Start Engine	The system needs to restart the engine but requires your confirmation.	Press the brake pedal to restart the engine.
Auto StartStop Press a Pedal to Start Engine	The system needs to restart the engine but requires your confirmation.	Press the brake pedal or the accelerator pedal to restart the engine.
Auto StartStop Shift to P, then Restart Engine	The System is not functioning.	Shift in park (P) and restart the engine.

# Auto-Start-Stop

---

## **AUTO-START-STOP – FREQUENTLY ASKED QUESTIONS**

### **Why does the engine not always stop when I expect it to?**

The system is designed to work in a way that complements other vehicle systems, allowing them to operate at optimum performance.

The system does not stop the engine if:

- The driver door is open.
- Your vehicle is at high altitude.
- The heated windshield is on.
- The engine is warming up.
- The outside temperature is too low or too high.
- The battery charge is low.
- The battery temperature is outside the optimal operating range.
- The engine is required to run to maintain interior climate and reduce fogging.

### **Why does the engine sometimes restart when I do not expect it to?**

The system is designed to work in a way that complements other vehicle systems, allowing them to operate at optimum performance.

The system restarts the engine if:

- You switch the heated windshield on.
- You switch maximum defrost on.
- Your vehicle starts to roll downhill in neutral.
- The engine is required to run to maintain adequate brake system assistance.
- The engine is required to run to maintain interior climate and reduce fogging.

### **Can I permanently switch the system off?**

No. The system plays an important role in reducing the fuel consumption and the CO<sub>2</sub> emissions.

### **Will the frequent engine starts cause parts to wear out?**

Your vehicle has an enhanced battery and starter motor that are designed for the increased number of engine starts.

# Fuel and Refueling

## FUEL AND REFUELING PRECAUTIONS

 **WARNING:** Fuels can cause serious injury or death if misused or mishandled.

 **WARNING:** Fuel may contain benzene, which is a cancer-causing agent.

 **WARNING:** Read and follow all the instructions on the pump island.

 **WARNING:** When refueling always shut the engine off and never allow sparks or open flames near the fuel tank filler valve. Never smoke or use a cell phone while refueling. Fuel vapor is extremely hazardous under certain conditions. Avoid inhaling excess fumes.

- Avoid getting fuel in your eyes. If you splash fuel in your eyes, immediately remove contact lenses, if worn, flush with water for 15 minutes and seek medical attention. Failure to seek proper medical attention could lead to permanent injury.
- Fuels can be harmful if absorbed through the skin. If you splash fuel on your skin, clothing or both, promptly remove contaminated clothing and thoroughly wash your skin with soap and water. Repeated or prolonged skin contact causes skin irritation.
- Be particularly careful if you are taking Antabuse or other forms of Disulfiram for the treatment of alcoholism. Breathing fuel vapors could cause an adverse reaction, serious personal injury or sickness. Immediately call a physician if you experience any adverse reactions.

Follow these guidelines when refueling:

- Extinguish all smoking materials and any open flames before refueling your vehicle.
- Switch the engine off before refueling.
- Automotive fuels can be harmful or fatal if swallowed. Fuel is highly toxic and if swallowed can cause death or permanent injury. If fuel is swallowed immediately call a physician, even if no symptoms are immediately apparent. The toxic effects of fuel may not be apparent for hours.
- Avoid inhaling fuel vapors. Inhaling fuel vapor can lead to eye and respiratory tract irritation. In severe cases, excessive or prolonged breathing of fuel vapor can cause serious illness and permanent injury.

## FUEL QUALITY

### SELECTING THE CORRECT FUEL

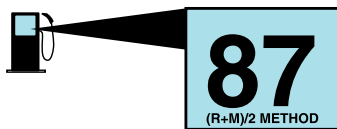

Your vehicle operates on regular unleaded gasoline with a minimum pump (R+M)/2 octane rating of 87.

Some fuel stations, particularly those in high altitude areas, offer fuels posted as regular unleaded gasoline with an octane rating below 87. The use of these fuels could result in engine damage that will not be covered by the vehicle Warranty.



# Fuel and Refueling

For best overall vehicle and engine performance, premium fuel with an octane rating of 91 or higher is recommended. The performance gained by using premium fuel is most noticeable in hot weather as well as other conditions, for example when towing a trailer. See **Towing a Trailer** (page 296).

Do not be concerned if the engine sometimes knocks lightly. However, if the engine knocks heavily while using fuel with the recommended octane rating, contact an authorized dealer to prevent any engine damage.

We recommend Top Tier detergent gasolines, where available to help minimize engine deposits and maintain optimal vehicle and engine performance.

For additional information, visit [www.toptiergas.com](http://www.toptiergas.com).

**Note:** *Use of any fuel for which the vehicle was not designed can impair the emission control system, cause loss of vehicle performance, and cause damage to the engine which may not be covered by the vehicle Warranty.*

Do not use:

- Diesel fuel.
- Fuels containing kerosene or paraffin.
- Fuel containing more than 15% ethanol (E15) or E85 fuel.
- Fuels containing methanol.
- Fuels containing metallic-based additives, including manganese-based compounds.
- Fuels containing the octane booster additive, methylcyclopentadienyl manganese tricarbonyl (MMT).
- Leaded fuel, using leaded fuel is prohibited by law.

The use of fuels with metallic compounds such as methylcyclopentadienyl manganese tricarbonyl, which is a manganese-based fuel additive, will impair engine performance and affect the emission control system.

## LOCATING THE FUEL FILLER FUNNEL

The fuel filler funnel is in the rear floor compartment with the jack and tools.

## RUNNING OUT OF FUEL

### FILLING A PORTABLE FUEL CONTAINER

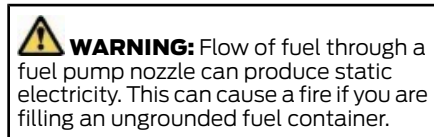



Use the following guidelines to avoid electrostatic charge build-up, which can produce a spark, when filling an ungrounded fuel container:

- Only use an approved fuel container to transfer fuel to your vehicle. Place the container on the ground when filling it.
- Do not fill a fuel container when it is inside your vehicle (including the cargo area).
- Keep the fuel pump nozzle in contact with the fuel container when filling it.
- Do not use a device that holds the fuel pump nozzle lever in the fill position.

# Fuel and Refueling

## ADDING FUEL FROM A PORTABLE FUEL CONTAINER

 **WARNING:** Do not insert the nozzle of a fuel container or an aftermarket funnel into the fuel filler neck. This may damage the fuel system filler neck or its seal and cause fuel to run onto the ground.

 **WARNING:** Do not pry open the fuel tank filler valve. This could damage the fuel system. Failure to follow this instruction could result in fire, personal injury or death.

 **WARNING:** Do not dispose of fuel in the household refuse or the public sewage system. Use an authorized waste disposal facility.

When refueling the vehicle fuel tank from a fuel container, use the fuel filler funnel included with your vehicle. See **Locating the Fuel Filler Funnel** (page 165).

**Note:** Do not use aftermarket funnels as they may not work with the capless fuel system and can damage it.

When refueling the vehicle fuel tank from a fuel container, do the following:

1. Fully open the fuel filler door.



2. Fully insert the fuel filler funnel into the fuel filler inlet.
3. Add fuel to your vehicle from the fuel container.
4. Remove the fuel filler funnel.
5. Fully close the fuel filler door.
6. Clean the fuel filler funnel and place it back in your vehicle or correctly dispose of it.

**Note:** If your vehicle runs out of fuel add a minimum of 5 L (1.3 gal) of fuel to restart the engine.

**Note:** You may need to switch the ignition from off to on several times after refueling to allow the fuel system to pump the fuel from the tank to the engine. When restarting, cranking time takes a few seconds longer than normal.

**Note:** Extra funnels can be purchased from an authorized dealer if you choose to dispose of the funnel.

# Fuel and Refueling

## REFUELING

### REFUELING SYSTEM OVERVIEW

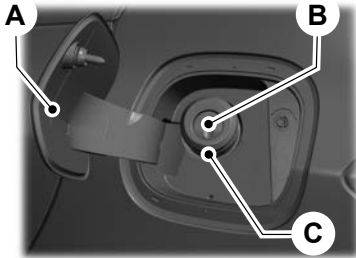

- A Fuel filler door.
- B Fuel filler inlet.
- C Fuel tank filler pipe.

### REFUELING YOUR VEHICLE

**WARNING:** When refueling always shut the engine off and never allow sparks or open flames near the fuel tank filler valve. Never smoke or use a cell phone while refueling. Fuel vapor is extremely hazardous under certain conditions. Avoid inhaling excess fumes.

**WARNING:** Fuel vapor burns violently and a fuel fire can cause severe injuries.

**WARNING:** The fuel system may be under pressure. If you hear a hissing sound near the fuel filler inlet, do not refuel until the sound stops. Otherwise, fuel may spray out, which could cause serious personal injury.

**WARNING:** Keep children away from the fuel pump. Never let children pump fuel.

**WARNING:** Do not pry open the fuel tank filler valve. This could damage the fuel system. Failure to follow this instruction could result in fire, personal injury or death.

**WARNING:** Stay outside your vehicle and do not leave the fuel pump unattended when refueling your vehicle.

**WARNING:** Do not remove the fuel pump nozzle from its fully inserted position when refueling.

**WARNING:** Stop refueling when the fuel pump nozzle automatically shuts off for the first time. Failure to follow this will fill the expansion space in the fuel tank and could lead to fuel overflowing.

**WARNING:** Do not overfill the fuel tank. The pressure in an overfilled tank may cause leakage and lead to fuel spray and fire.

**WARNING:** Wait at least five seconds before removing the fuel pump nozzle to allow any residual fuel to drain into the fuel tank.

1. Fully open the fuel filler door.
2. Select the correct fuel pump nozzle for your vehicle.

## Fuel and Refueling

4. Hold the fuel pump nozzle in position A when refueling. Holding the fuel pump nozzle in position B can affect the flow of fuel and shut off the fuel pump nozzle before the fuel tank is full.

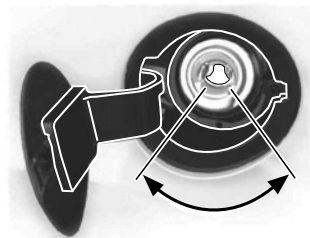
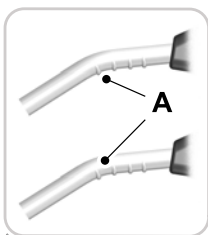

3. Insert the fuel pump nozzle up to the first notch. Keep the fuel pump nozzle resting on the fuel tank filler pipe.

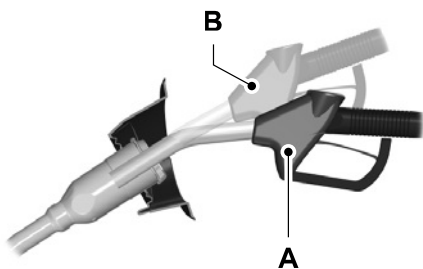

5. Operate the fuel pump nozzle within the area shown.

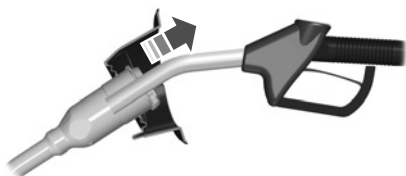

6. When the pump shuts off, wait five seconds, then raise the fuel pump nozzle and slowly remove it.
7. Fully close the fuel filler door.

**Note:** Do not attempt to start the engine if you have filled the fuel tank with incorrect fuel. Incorrect fuel use could cause damage not covered by the vehicle Warranty. Have your vehicle immediately checked.

# Fuel and Refueling

## FUEL TANK CAPACITY

### Capacities

Variant	Quantity
Long wheelbase.	80 L (21.1 gal)
Short wheelbase.	66 L (17.4 gal)

### Advertised Capacity

The advertised capacity is the maximum amount of fuel that you can add to the fuel tank when the fuel gauge indicates empty.

In addition, the fuel tank contains an empty reserve. The empty reserve is an unspecified amount of fuel that remains in the fuel tank when the fuel gauge indicates empty.

**Note:** *When refueling your vehicle after the fuel gauge indicates empty, you might not be able to refuel the full amount of the advertised capacity due to the empty reserve still present in the fuel tank.*

## FUEL AND REFUELING – TROUBLESHOOTING

### FUEL AND REFUELING – WARNING LAMPS



If it illuminates when you are driving, refuel as soon as possible.

### FUEL AND REFUELING – INFORMATION MESSAGES

#### Refueling System Warning

If the fuel tank filler valve does not fully close, a message could appear in the instrument cluster display.

#### Message

Check Fuel Fill Inlet

If the message appears, do the following:

1. Stop your vehicle as soon as it is safe to do so and switch the engine off.
2. Shift into park (P) or neutral (N).
3. Apply the parking brake.
4. Fully open the fuel filler door.
5. Check the fuel tank filler valve for any debris that may be restricting its movement.
6. Remove any debris from the fuel tank filler valve.
7. Fully insert a fuel pump nozzle or the fuel filler funnel provided with your vehicle into the fuel filler pipe. See **Locating the Fuel Filler Funnel** (page 165). This action should dislodge any debris that may be preventing the fuel tank filler valve from fully closing.
8. Remove the fuel pump nozzle or fuel filler funnel from the fuel filler pipe.
9. Fully close the fuel filler door.

**Note:** *The message may not immediately reset. If the message continues to appear and a warning lamp illuminates, have your vehicle checked as soon as possible.*

# Catalytic Converter

## WHAT IS THE CATALYTIC CONVERTER

The catalytic converter is part of your vehicle's emissions system and filters harmful pollutants from the exhaust gas.

## CATALYTIC CONVERTER PRECAUTIONS



**WARNING:** Do not park, idle or drive your vehicle on dry grass or other dry ground cover. The emission system heats up the engine compartment and exhaust system, creating the risk of fire.



**WARNING:** The normal operating temperature of the exhaust system is very high. Never work around or attempt to repair any part of the exhaust system until it has cooled. Use special care when working around the catalytic converter. The catalytic converter heats up to a very high temperature after only a short period of engine operation and stays hot after the engine is switched off.



**WARNING:** Exhaust leaks may result in entry of harmful and potentially lethal fumes into the passenger compartment. If you smell exhaust fumes inside your vehicle, have your vehicle inspected immediately. Do not drive if you smell exhaust fumes.

To avoid damaging the catalytic converter:

- Do not crank the engine for more than 10 seconds at a time.
- Do not run the engine with a spark plug lead disconnected.
- Do not push-start or tow-start your vehicle. Use booster cables. See **Jump Starting the Vehicle** (page 319).

- Use the correct fuel. See **Fuel and Refueling** (page 164).
- Do not switch the ignition off when your vehicle is moving.
- Avoid running out of fuel.
- Have the items listed in scheduled maintenance information performed according to the specified schedule.

**Note:** Do not make any unauthorized changes to your vehicle or engine. By law, vehicle owners and anyone who manufactures, repairs, or services a fleet of vehicles are not permitted to intentionally remove an emission control device or prevent it from working.

## CATALYTIC CONVERTER – TROUBLESHOOTING

### CATALYTIC CONVERTER – WARNING LAMPS

Your vehicle has an on-board diagnostics system that monitors the emission control system. If any of the following warning lamps illuminate, this may indicate that the on-board diagnostics system has detected an emission control system malfunction.



Continuing to drive your vehicle may cause reduced power or the engine to stop. Failure to respond to a warning lamp may cause damage that your vehicle Warranty may not cover. Have your vehicle checked as soon as possible.

# Manual Transmission

## MANUAL TRANSMISSION PRECAUTIONS



**WARNING:** Always set the parking brake fully and make sure you shift the gearshift lever to first gear. Switch the ignition off and remove the key whenever you leave your vehicle.

Failure to fully press the clutch pedal to the floor may cause increased shift efforts, premature wear to transmission components or damage the transmission.

Do not drive with your foot resting on the clutch pedal or use the clutch pedal to hold your vehicle at a standstill when waiting on a hill. These actions reduce the life of the clutch and could nullify a clutch warranty claim.

## SHIFTING INTO REVERSE

### Reverse (R)

1. Press the clutch pedal to the floor to disengage the clutch.
2. Shift into reverse (R) by raising the collar below the gearshift knob up, then moving the lever fully to the left, then forward.

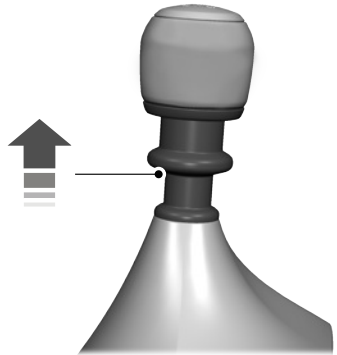

**Note:** You can only move the gearshift lever to reverse (R) by raising the collar below the gearshift knob up before shifting to reverse. This is a lockout feature which protects the transmission from accidentally engaging reverse (R) when intending to select first (1).

If reverse (R) is not fully engaged press the clutch pedal, return the gearshift to the neutral position, then release the clutch pedal. Reapply the clutch pedal, then lift the gearshift collar and shift into reverse (R) again.

**Note:** Do not move the transmission selector lever to reverse (R) gear when your vehicle is moving. This can cause damage to the transmission.

**Note:** Make sure that your vehicle is at a complete stop before you shift into reverse (R). Failure to do so could damage the transmission.

## CRAWLER GEAR

### WHAT IS CRAWLER GEAR

Allows you to cruise at ultra low speeds with the clutch fully engaged, when driving through obstacles and jagged terrain.

# Manual Transmission

## USING CRAWLER GEAR

### Crawler (C)

Shifting into crawler gear:

1. Press the clutch pedal to the floor to disengage the clutch.
2. Shift into the crawler (C) by raising the collar below the gearshift knob up, then moving the lever fully to the left, then backward.

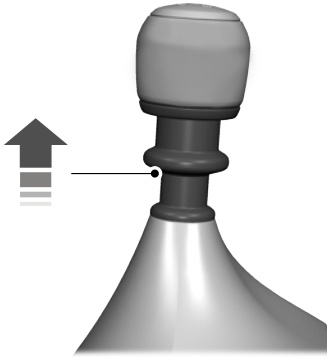

**Note:** You can only move the gearshift lever to crawler (C) by raising the collar below the gearshift knob up before shifting to crawler. This is a lockout feature which protects the transmission from accidentally engaging crawler (C) when intending to select second (2).

If crawler (C) is not fully engaged press the clutch pedal down, return the gearshift to the neutral position, then release the clutch pedal. Reapply the clutch pedal, then lift the gearshift collar and shift into crawler (C) again.

The crawler gear enables an easier start in unusual conditions or terrain. You should change up to first (1) when possible and refrain from using crawler (C) at high engine speeds as transmission damage could result. See **Manual Transmission Precautions** (page 171).

In normal use, make sure your vehicle is stationary before selecting crawler (C) as it is primarily a starting gear. If you change down to crawler (C) from first (1) while the vehicle is moving, make sure the engine speed is below 1500 rpm, and that the clutch pedal is fully pressed for a smooth transition to crawler gear.

## RECOMMENDED SHIFT SPEEDS

### Recommended Shift Speeds

For best fuel efficiency when driving your vehicle, shift to the next gear by 3000 RPM.

Shifting at a higher RPM such as 3000-6000 RPM can increase the performance capabilities of the vehicle. However, higher engine and transmission speeds can increase wear and reduce fuel economy.

When downshifting your vehicle, always shift at the lowest engine RPM possible to match your driving conditions. This is usually under 2000 RPM for all forward gears, except for downshifting into the crawler (C) gear which you should do below 1500 RPM. See **Manual Transmission Precautions** (page 171).

**Note:** Always fully press the clutch pedal between gear shifts.



# Manual Transmission

## CHECKING THE MANUAL TRANSMISSION FLUID LEVEL

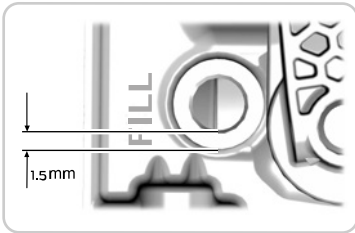
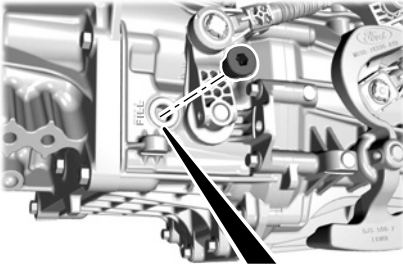

Transmission fill level is 1.5 mm (0.06 in) from oil fill plug.

## CHECKING THE CLUTCH FLUID LEVEL



1. Check the system for any visual leaks before continuing.
2. Make sure the clutch pedal is in the most upward position.
3. Remove the cap and diaphragm and inspect the fluid level. To avoid contamination, make sure the reservoir cap remains in place and fully tightened unless you are checking the fluid level.
4. Reinstall the reservoir cap and diaphragm.

Only use fluid that meets our specifications. See **Manual Transmission** (page 171).

**Note:** A fluid level on the step line in the reservoir is within the normal operating range and there is no need to add fluid. A fluid level not in the normal operating range could compromise the performance of the system. Have your vehicle checked immediately.

## MANUAL TRANSMISSION FLUID CAPACITY AND SPECIFICATION

Use fluid that meets the defined specification and viscosity grade.

If you do not use fluid that meets the defined specification and viscosity grade, it could result in:

- Component damage that your vehicle warranty does not cover.
- Reduced vehicle performance.
- Reduced fuel economy.

# Manual Transmission

## Capacities

Variant	Quantity
All.	2.4 L (2.5 qt) <sup>1</sup>

<sup>1</sup> Approximate total oil volume/capacity. Actual amount could vary between fluid changes.

**Note:** *Transmission oil is filled-for-life. No requirement to service the transmission oil.*

## Materials

Name	Specification
Motorcraft® Dual Clutch Transmission Fluid(U.S.) Motorcraft® Dual Clutch Transmission Fluid / Huile pour boîtes embrayage double Motorcraft®(Canada) XT-11-QDC(U.S. & Canada)	WSS-M2C200-D2

## CLUTCH FLUID CAPACITY AND SPECIFICATION

The clutch and brake systems share the same fluid reservoir. See **Brake Fluid Specification** (page 201).

## MANUAL TRANSMISSION – TROUBLESHOOTING

## MANUAL TRANSMISSION – FREQUENTLY ASKED QUESTIONS

### Using Crawler Gear



# Manual Transmission

---

When shifting into crawler (C), make sure your vehicle is completely stationary and that the engine speed is below 1500 RPM.

Shift out of crawler (C) as soon as possible. Prolonged use of crawler (C) can cause transmission wear and increased fuel consumption.

# Automatic Transmission (If Equipped)

## AUTOMATIC TRANSMISSION POSITIONS

### AUTOMATIC TRANSMISSION PRECAUTIONS

 **WARNING:** Apply the parking brake, shift into park (P), switch the vehicle off and remove the key or remote control before you leave your vehicle. Failure to follow this instruction could result in personal injury or death.

 **WARNING:** When your vehicle is stationary, keep the brake pedal fully pressed when shifting gears. Failure to follow this instruction could result in personal injury, death or property damage.

 **WARNING:** Do not apply the brake pedal and accelerator pedal simultaneously. Applying both pedals simultaneously for more than a few seconds limits vehicle performance, which may result in difficulty maintaining speed in traffic and could lead to serious injury.

### SHIFTING YOUR VEHICLE INTO GEAR

The selector is on the center console.



1. Press and hold the brake pedal.
2. Press and hold the button on the selector lever to move to a selected position.

### PARK (P)

 **WARNING:** Shift into park (P) only when your vehicle is stationary.

In park (P) power is not transmitted to the driven wheels.

**Note:** A tone sounds if you attempt to exit your vehicle without the vehicle in park (P).

**Note:** Your vehicle may not shift out of park (P) if the 12 V battery has run out of charge.

**Note:** Your vehicle may not shift out of park (P) if a fuse is blown.

**Note:** Your vehicle may not shift out of park (P) unless the key or remote control is inside your vehicle.

**Note:** The electronic parking brake could apply when you power your vehicle on with the selector in park (P).

# Automatic Transmission (If Equipped)

**Note:** The electronic parking brake could apply if you shift to park (P) without fully pressing the brake pedal.

**Note:** The electronic parking brake could apply if you shift to park (P) on a slope.

**Note:** Do not manually release the parking brake when the selector is in park (P). See **Automatically Releasing the Electric Parking Brake** (page 203).

## REVERSE (R)



**WARNING:** Shift into reverse (R) only when your vehicle is stationary.

In reverse (R) power is transmitted to the driven wheels.

## NEUTRAL (N)



**WARNING:** In neutral (N) your vehicle is free to roll.

In neutral (N) power is not transmitted to the driven wheels.

## DRIVE (D) - EXCLUDING: RAPTOR

In drive (D) power is transmitted to the driven wheels.

**Note:** Progressive range selection is available in drive (D). See **Using Progressive Range Selection** (page 180).

## DRIVE (D) - RAPTOR

In drive (D) power is transmitted to the driven wheels.

## MANUAL (M)

In manual (M) you can select a specific gear. See **Manually Shifting Gears** (page 177).

**Note:** We recommend using this mode for driving on hilly or mountainous roads or when towing a trailer. See **Towing a Trailer** (page 296).

## AUTOMATIC TRANSMISSION POSITION INDICATORS

The instrument cluster displays the current position.



**Note:** The position could illuminate on the transmission selector.

## MANUALLY SHIFTING GEARS - EXCLUDING: RAPTOR

### Shifting Using the Buttons on the Selector Lever

The instrument cluster displays the current gear. The current gear flashes when your vehicle cannot shift into the requested gear. Your vehicle does not shift if the requested gear raises or lowers the engine speed beyond the limit.

Your vehicle could shift when you fully press the accelerator or brake pedal.

**Note:** Prolonged driving with high engine speed could cause vehicle damage not covered by the vehicle warranty.

## Automatic Transmission (If Equipped)

**Note:** Drive modes could affect when the vehicle shifts into the requested gear.



- Shift to manual (M) to switch the feature on.
- Press the upper (+) button to upshift.
- Press the lower (-) button to downshift.
- Shift to drive (D) or press the manual (M) button again to switch the feature off.

### MANUALLY SHIFTING GEARS - RAPTOR

#### Shifting Using the Paddle Shifters

The instrument cluster displays the current gear. The current gear flashes when your vehicle cannot shift into the requested gear. Your vehicle will not shift if the requested gear raises or lowers the engine speed beyond the limit.

Your vehicle could shift when you fully press the accelerator or brake pedal.

**Note:** Prolonged driving with high engine speed could cause vehicle damage not covered by the vehicle warranty.

**Note:** Drive modes could affect when the vehicle shifts into the requested gear.

#### Manually Shifting Gears in Drive (D)

Use this feature to temporarily change gears.

**Note:** We recommend using this feature for engine braking or driving on hilly or mountainous roads.

- Press any button to switch the feature on.
- Press the upper (+) button to upshift.
- Press the lower (-) button to downshift.
- Hold the upper (+) button for a few seconds to switch the feature off.

**Note:** The feature switches off after a short period of time if neither button is pressed.

#### Manually Shifting Gears in Manual (M)

Use this feature to select a specific gear.

**Note:** We recommend using this feature for engine braking, driving on hilly or mountainous roads, or when towing a trailer. See **Towing a Trailer** (page 296).



#### Manually Shifting Gears in Drive (D)

Use this feature to temporarily change gears.

**Note:** We recommend using this feature for engine braking or driving on hilly or mountainous roads.

## Automatic Transmission (If Equipped)

- Pull either paddle to switch the feature on.
- Pull the right (+) paddle to upshift.
- Pull the left (-) paddle to downshift.
- Hold the right (+) paddle for a few seconds to switch the feature off.

**Note:** The feature switches off after a short period of time if neither paddle is pulled.

### Manually Shifting Gears in Manual (M)

Use this feature to select a specific gear.

**Note:** We recommend using this feature for engine braking, driving on hilly or mountainous roads, or when towing a trailer. See **Towing a Trailer** (page 296).

- Shift to manual (M) to switch the feature on.
- Pull the right (+) paddle to upshift.
- Pull the left (-) paddle to downshift.
- Shift to drive (D) or press the manual (M) button again to switch the feature off.

## SHIFTING YOUR IMMOBILE VEHICLE OUT OF PARK (P)



**WARNING:** When doing this procedure, you need to take your vehicle out of park (P) which means your vehicle can roll freely. To avoid unwanted vehicle movement, apply the parking brake prior to doing this procedure. Use wheel chocks if appropriate.



**WARNING:** If the parking brake is fully released, but the brake warning lamp remains illuminated, the brakes may not be working properly. Have your vehicle checked as soon as possible.



**WARNING:** Do not drive your vehicle until you verify that the stoplamps are working.

Use this procedure to shift your vehicle out of park (P) in the event of an electrical malfunction or emergency.

### Shifting Your Vehicle Out of Park

1. Apply the parking brake.
2. Insert a screwdriver between the shifter boot material and trim ring to access the retainer tabs from the top panel trim ring.
3. Sit in the drivers seat

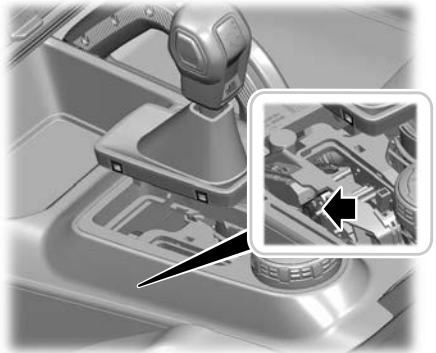

4. Press and hold the brake pedal.
5. Lift the shifter upward.
6. Locate the release lever on the side of the transmission selector lever.
7. Using a screwdriver, move the release lever toward the front of the transmission selector lever.
8. When holding the release lever in the forward position, move the transmission selector lever out of the park (P) position and into another gear.

## Automatic Transmission (If Equipped)

### Returning Your Vehicle to Normal Mode

1. Press the brake pedal.
2. Shift into park (P).

### AUTOMATIC TRANSMISSION AUDIBLE WARNINGS

#### Transmission Not In Park(P) Audible Warning

Sounds if any of the following occur:

- You switch your vehicle off before shifting into park (P).
- You open the driver door before shifting into park (P).
- You unlatch your seatbelt before shifting into park (P) when the driver door is removed.

### USING PROGRESSIVE RANGE SELECTION - EXCLUDING: RAPTOR

Progressive range selection gives you the ability to lock out gears from the automatic shifting range. This could provide you with an improved driving experience by reducing transmission shifts, for example, in slippery conditions, when driving on hilly or mountainous roads, or when towing a trailer. See **Towing a Trailer** (page 296).

1. With the selector in drive (D), press the minus (-) button to switch the feature on.
2. Press the minus (-) button to lock out the highest gear.
3. Press the minus (-) button again to continue locking out higher gears.

**Note:** *The instrument cluster displays the current gear and the highest gear available.*

**Note:** *Your vehicle automatically shifts within the available gear range.*

4. Hold the plus (+) button for a few seconds to switch the feature off and allow shifts to higher gears.

### AUTOMATIC TRANSMISSION FLUID CAPACITY AND SPECIFICATION

#### Materials

Name	Specification
Motorcraft® MERCON® ULV Automatic Transmission Fluid(U.S.) Motorcraft® MERCON® ULV Automatic Transmission Fluid / MERCON® ULV huile pour boîtes automatique Motorcraft®(Canada) XT-12-QULV(U.S. & Canada)	WSS-M2C949-A,



## Automatic Transmission (If Equipped)

---

**Note:** *Only use transmission fluid that conforms to the defined specification. Use of other fluids could result in vehicle damage not covered by the vehicle warranty.*

# Four-Wheel Drive

## HOW DOES FOUR-WHEEL DRIVE WORK - 4X4 WITH PART TIME ENGAGEMENT

### 4x4 With Part Time Engagement (If Equipped)

This system offers the driver two-wheel drive high, four-wheel drive high, and four-wheel drive low as available modes of operation. When you select either four-wheel drive high or four-wheel drive low, the system provides mechanically locked four-wheel drive power to both the front and rear wheels for use in off-road or slippery conditions such as deep snow, sand or mud. Selecting four-wheel drive low also provides additional gearing for increased torque multiplication for conditions like deep sand, steep slopes, or pulling heavy objects.

Additionally, the system is capable of recreational flat towing by putting the transfer case into neutral (N). See **Recreationally Towing Your Vehicle** (page 329).

## HOW DOES FOUR-WHEEL DRIVE WORK - ADVANCED 4X4 WITH 4A MODE

### Advanced 4x4 With Automatic On Demand Engagement

This system monitors various vehicle sensory inputs to provide an increased level of performance. This system offers two-wheel drive high, four-wheel drive auto, four-wheel drive high, and four-wheel drive low as available modes of operation. When you select four-wheel drive auto, the system continuously varies power to the front wheels for optimum performance for all on-road conditions. When you select either four-wheel drive high or four-wheel

drive low, the system provides electronically locked power to the front and rear wheels for use in off-road or slippery conditions such as deep snow, sand or mud. Selecting four-wheel drive low also provides additional gearing for increased torque multiplication for conditions like deep sand, steep slopes, or pulling heavy objects.

Additionally, the system is capable of recreational flat towing by putting the transfer case into neutral (N). See **Recreationally Towing Your Vehicle** (page 329).

## FOUR-WHEEL DRIVE PRECAUTIONS



**WARNING:** Do not become overconfident in the ability of four-wheel drive vehicles. Although a four-wheel drive vehicle may accelerate better than a two-wheel drive vehicle in low traction situations, it won't stop any faster than two-wheel drive vehicles. Always drive at a safe speed.



**WARNING:** Vehicles with a higher center of gravity (utility and four-wheel drive vehicles) handle differently than vehicles with a lower center of gravity (passenger cars). Avoid sharp turns, excessive speed and abrupt steering in these vehicles. Failure to drive cautiously increases the risk of losing control of your vehicle, vehicle rollover, personal injury and death.

# Four-Wheel Drive

## FOUR-WHEEL DRIVE LIMITATIONS

Do not use four-wheel drive high or four-wheel drive low mode on dry, hard surfaced roads. Doing so can produce excessive noise, increase tire wear and can damage driveline components. Four-wheel drive high or four-wheel drive low mode is only for use on consistently slippery or loose surfaces. Use of four-wheel drive low mode on these surfaces could produce some noise, such as occasional clunks, but should not damage driveline components.

For vehicles with an electronic shift-on-the-fly transfer case, the driveline could become mechanically blocked when attempting to shift out of a four-wheel drive mode on dry, hard surfaced roads.

**Note:** *When your vehicle comes with the 4x4 part-time selectable engagement transfer case and you are transitioning from consistently loose or slippery surfaces, be sure the four-wheel drive system is not mechanically blocked once you are on dry, hard surfaced roads in two-wheel drive high.*

**Note:** *In certain scenarios, where the four-wheel drive system has difficulty engaging, a **To Engage 4x4 Slow to 3 MPH** or **To Engage 4x4 Slow to 5 km/h** message could appear in the instrument cluster. You can also see this message when engaging the four-wheel drive system in extreme cold climates at the beginning of the drive cycle. Once the driveline warms up, shifting to four-wheel drive can resume as normal.*

## Operating Four-Wheel Drive with a Spare or Mismatched Tires

On four-wheel drive vehicles, the size of the spare tire can affect the four-wheel drive system.

If there is a significant difference between the size of the spare tire and the remaining tires, you could have limited four-wheel drive functionality, added noise, discomfort and driveline damage.

Due to normal tire wear, your spare tire is not necessarily the same size as your on-road tires, which makes your spare tire a dissimilar size. Use the spare tire on a limited basis only.

When driving with a dissimilar wheel and tire assembly do not:

- Exceed 80 km/h (50 mph) when operating in a four-wheel drive mode.
- Select a four-wheel drive mode unless the vehicle is stationary.
- Use a four-wheel drive mode on dry pavement.

You could have limited four-wheel drive functionality when driving with a dissimilar wheel and tire assembly, especially when driving in a mechanically locked four-wheel drive mode. You can experience the following:

- Additional noise from the transfer case or other drive components.
- Difficulty shifting in and out of a mechanically locked four-wheel drive mode.
- Driveline component damage.

## Mechanical Shift Blocking

On vehicles with an electronic shift-on-the-fly transfer case, the transfer case distributes torque to the front wheels by mechanically interlocking the front and rear driveshafts together. Various external factors can affect shifting performance of this type of system including, but not limited to:

- Vehicle acceleration.
- Dissimilar tire sizes.
- High steering input.

# Four-Wheel Drive

For vehicles with an electronic shift-on-the-fly transfer case, when shifting into two-wheel drive high on dry, hard surfaced roads, we recommend that you follow the following procedure to reduce the likelihood of a mechanical shift block:

1. When driving straight, come to a complete stop on a flat, horizontal surface.
2. For vehicles with an automatic transmission, shift into park (P). For vehicles with a manual transmission, press the clutch.
3. Select 2H and wait for the 2H LED to become solid.
4. For vehicles with an automatic transmission, shift into reverse (R). For vehicles with a manual transmission, select reverse (R) and release the clutch. Let the vehicle roll backward up to 1 m (3 ft) and press the brake.
5. For vehicles with an automatic transmission, shift into drive (D). For vehicles with a manual transmission, press the clutch in again, select a forward gear and release the clutch. Let the vehicle roll forward up to 1 m (3 ft).

If the system is mechanically blocked, one or more of the following actions can relieve the mechanical shift block:

- Momentary acceleration.
- Momentary braking.
- Bringing the vehicle to a stop.
- Shifting the transmission to neutral and back to drive.
- Shifting the transmission to reverse and back to drive.
- Driving the vehicle around a tight turn at a slow speed.

## SWITCHING FOUR-WHEEL DRIVE ON AND OFF

A vehicle that comes with four-wheel drive, when selected, has the ability to use all four wheels to power itself. This increases traction, which may enable you to safely drive over terrain and road conditions that a conventional two-wheel drive vehicle cannot.

On some four-wheel drive models, the initial shift from two-wheel drive to four-wheel drive while the vehicle is moving can cause a momentary clunk and ratcheting sound. These sounds are normal as the front drivetrain comes up to speed and are not cause for concern.

## SELECTING A FOUR-WHEEL DRIVE MODE - 4X4 WITH PART TIME ENGAGEMENT



To select a four-wheel drive mode, push the button.

# Four-Wheel Drive

- 2H - Two-wheel drive high.
- 4H - Four-wheel drive high. See **Four-Wheel Drive High** (page 186).
- 4L - Four-wheel drive low. See **Four-Wheel Drive Low** (page 187).

**Note:** Do not perform this operation when you have cruise control or trail control selected and active. The system may not shift as expected.

**Note:** Do not perform this operation if the rear wheels are slipping or when applying the accelerator pedal or when driving in a tight turn.

**Note:** Momentarily releasing the accelerator pedal when a shift in progress message displays can improve engagement or disengagement performance.

**Note:** When the light is solid, the system has achieved the desired four-wheel drive mode. When a selected four-wheel drive mode light is blinking, the system is attempting to shift to that specific four-wheel drive mode.

**Note:** When you achieve recreational towing, all lights are off and Neutral Tow Enabled Leave Transmission in Neutral appears in the instrument cluster display.

## Shifting to or from Four-Wheel Drive Low

1. Bring your vehicle to a stop.
2. For vehicles with an automatic transmission, place in neutral (N). For vehicles with a manual transmission, fully press the clutch pedal.
3. Push 4L on the four-wheel drive mode selector.

**Note:** A **4x4 Shift in Progress** message appears in the instrument cluster display indicating the shift is in progress. If any of the previous shift conditions are not met, the shift should not occur and the instrument cluster display can guide you through the proper shifting procedures.

**Note:** If **Shift Delayed Drive Forward** displays in the instrument cluster display, place the transmission in a forward gear, move your vehicle forward approximately 1.5 m (5 ft), and shift the transmission back to neutral (N) to allow the transfer case to complete the range shift.

## SELECTING A FOUR-WHEEL DRIVE MODE - ADVANCED 4X4 WITH 4A MODE



To select a four-wheel drive mode, push the button.

- 2H - Two-wheel drive high.
- 4A - Four-wheel drive Auto. See **Four-Wheel Drive Auto** (page 186).

# Four-Wheel Drive

- 4H - Four-wheel drive high. See **Four-Wheel Drive High** (page 186).
- 4L - Four-wheel drive low. See **Four-Wheel Drive Low** (page 187).

**Note:** Do not perform this operation when you have cruise control or trail control selected and active. The system may not shift as expected.

**Note:** Do not perform this operation if the rear wheels are slipping or when applying the accelerator pedal.

**Note:** When the light is solid, the system has achieved the desired four-wheel drive mode. When a selected four-wheel drive mode LED is blinking, the system is attempting to shift to that specific four-wheel drive mode.

**Note:** When all lights are blinking, have your vehicle serviced as soon as possible.

**Note:** When you achieve recreational towing, all lights are off and Neutral Tow Enabled Leave Transmission in Neutral appears in the instrument cluster display.

## Shifting to or from Four-Wheel Drive Low

1. Bring your vehicle to a stop.
2. For vehicles with an automatic transmission, place in neutral (N). For vehicles with a manual transmission, fully press the clutch pedal.
3. Push 4L on the four-wheel drive mode selector.

**Note:** A **4x4 Shift in Progress** message appears in the instrument cluster display indicating the shift is in progress. If any of the previous shift conditions are not met, the shift should not occur and the instrument cluster display can guide you through the proper shifting procedures.

**Note:** If **Shift Delayed Drive Forward** displays in the instrument cluster display, place the transmission in a forward gear, move your vehicle forward approximately 1.5 m (5 ft), and shift the transmission back to neutral (N) to allow the transfer case to complete the range shift.

## FOUR-WHEEL DRIVE MODES

### TWO-WHEEL DRIVE HIGH

Two-wheel drive high is for general on-road driving. Power is sent to the rear wheels only.

**Note:** Two-wheel drive high can turn on or off based on Drive Mode selection. See **Selecting a G.O.A.T. Mode** (page 249).

### FOUR-WHEEL DRIVE AUTO

Four-wheel drive auto provides electronically controlled four-wheel drive power to both the front and rear wheels, as required, for increased traction in varying on-road conditions. The four-wheel drive auto tuning varies based on selected Drive Mode. See **Selecting a Four-Wheel Drive Mode** (page 184).

**Note:** Four-wheel drive auto can turn on or off automatically based on Drive Mode selection. See **Selecting a Four-Wheel Drive Mode** (page 184).

### FOUR-WHEEL DRIVE HIGH

Four-wheel drive high provides electronically or mechanically locked four-wheel drive power to both the front and rear wheels for use in off-road or winter conditions such as deep snow, sand or mud. This mode is not for use on dry pavement.

# Four-Wheel Drive

**Note:** Four-wheel drive high can turn on or off automatically based on Drive Mode selection.

## FOUR-WHEEL DRIVE LOW

Four-wheel drive low provides electronically or mechanically locked four-wheel drive power to both the front and rear wheels for use on low traction surfaces, but does so with additional gearing for increased torque multiplication. This mode is only for off-road conditions such as deep sand, steep slopes, or pulling heavy objects.

**Note:** Four-wheel drive low can turn on or off automatically based on drive mode selection.

## FOUR-WHEEL DRIVE INDICATORS

### Two-wheel Drive High

**2H** Illuminates briefly when two-wheel drive high is selected.

### Four-wheel Drive Auto (If Equipped)

**4A** Illuminates when four-wheel drive auto is selected.

### Four-wheel Drive High

**4H** Illuminates when four-wheel drive high is selected.

### Four-wheel Drive Low

**4L** Illuminates when four-wheel drive low is selected.

## TRANSFER CASE FLUID CAPACITY AND SPECIFICATION

Use fluid that meets the defined specification and viscosity grade.

If you do not use fluid that meets the defined specification and viscosity grade, it could result in:

- Component damage that your vehicle warranty does not cover.
- Reduced vehicle performance.

## Capacities

Variant	Quantity
4x4 with part time engagement.	1.2 L (1.3 qt)
Advanced 4x4 with 4A mode.	1.55 L (1.6 qt)

# Four-Wheel Drive

## Materials

Name	Specification
Motorcraft® MERCON® LV Automatic Transmission Fluid(U.S.) Motorcraft® MERCON® LV Automatic Transmission Fluid / Huile pour boîte automatique MERCON® LV Motorcraft®(Canada) XT-10-QLVC(U.S.) CXT-10-LV6(Canada)	WSS-M2C938-A

## FOUR-WHEEL DRIVE – TROUBLESHOOTING

### FOUR-WHEEL DRIVE – WARNING LAMPS



Illuminates when a four-wheel drive or power train fault is present.

**Note:** When a system fault is present, the system can typically remain in whichever mode was selected prior to the fault condition occurring. It does not default to two-wheel drive in all circumstances. When this warning displays, have your vehicle serviced by an authorized dealer.

## FOUR-WHEEL DRIVE – INFORMATION MESSAGES

Message	Details
For 4L slow to a stop	Displays when the driver attempts to shift into four-wheel drive low when traveling at too high of a speed.
For 4L Shift to N	Displays when the driver attempts to shift into four-wheel drive low without the transmission in neutral (N).
For 4L press Clutch	Displays when the driver attempts to shift into four-wheel drive low without the clutch pedal pressed.
To exit 4L slow to a stop	Displays when the driver attempts to shift out of four-wheel drive low when traveling at too high of a speed.
To Exit 4L Shift to N	Displays when the driver attempts to shift out of four-wheel drive low without the transmission in neutral (N).
To exit 4L Press Clutch	Displays when the driver attempts to shift out of four-wheel drive low without the clutch pedal pressed.



## Four-Wheel Drive

<b>Message</b>	<b>Details</b>
4x4 Shift in Progress	Displays when the four-wheel drive system is shifting into and out of two-wheel drive high or between high and low ranges.
4X4 Temporarily Locked	Displays when the four-wheel drive system detects a driving condition which temporarily requires greater four-wheel drive performance. The system resumes normal function after the system no longer detects these driving conditions.
4x4 Temporarily Disabled	Displays when the four-wheel system detects elevated system temperature and temporarily stops providing power to the front wheels. The system resumes normal function when the system temperature returns to normal.
4x4 Restored	Displays when the four-wheel drive system resumes normal function.
Shift Delayed Drive Forward	Displays when the transfer case is not able to complete a shift and requires forward motion to complete the shift.
4x4 OFF	Displays when the system has become disabled due to mismatched tires or an external fault.
Neutral Tow Enabled Leave Transmission in Neutral	Displays when neutral tow mode has been successfully engaged.
Neutral Tow Disabled	Displays when neutral tow mode has been successfully disengaged.
Selected 4x4 Mode Not Available in Current Drive Mode	Displays when the driver selects a four-wheel drive mode that is disallowed in the currently selected drive mode.
To Engage 4x4 Slow to 3 MPH	Displays when the system is unable to engage four-wheel drive high and requires the driver to slow down before attempting to engage.
To Engage 4x4 Slow to 5 km/h	Displays when the system is unable to engage four-wheel drive high and requires the driver to slow down before attempting to engage.
To Engage 4x4 Release Accelerator Pedal	Displays when the four-wheel drive system requires the accelerator pedal to be released to perform the shift into four-wheel drive mode.

## Four-Wheel Drive

---

<b>Message</b>	<b>Details</b>
4x4 Performance Reduced See Manual	Displays when the system has entered a degraded mode due to mismatched tires.
Check 4x4	A four-wheel drive system fault is present. Have your vehicle checked as soon as possible.
Shift to Neutral	Displays when the system requires an additional transmission shift to neutral (N) to complete a transfer case shift.

### **FOUR-WHEEL DRIVE VIDEOS**

[Bronco 4x4 Systems](#)

# Front Axle

## FRONT AXLE FLUID CAPACITY AND SPECIFICATION - EXCLUDING: RAPTOR

Use fluid that meets the defined specification and viscosity grade.

If you do not use fluid that meets the defined specification and viscosity grade, it could result in:

- Component damage that your vehicle warranty does not cover.
- Reduced vehicle performance.

### Capacities

Variant	Quantity
With electronic locking differential.	775 ± 25 ml (26.2 ± 0.8 fl oz)
Without electronic locking differential and without front axle disconnect.	865 ± 25 ml (29.2 ± 0.8 fl oz)
Without electronic locking differential and with front axle disconnect.	900 ± 25 ml (30.4 ± 0.8 fl oz)

### Materials

Name	Specification
Motorcraft® SAE 75W-85 Premium Synthetic Hypoid Gear Lubricant (U.S.) Motorcraft® SAE 75W-85 Premium Synthetic Hypoid Gear Lubricant / Huile synthétique de haute qualité pour engrenages hypoides SAE 75W-85 Motorcraft® (Canada) XY-75W85-QL (U.S. & Canada)	WSS-M2C942-A

## FRONT AXLE FLUID CAPACITY AND SPECIFICATION - RAPTOR

Use fluid that meets the defined specification and viscosity grade.

If you do not use fluid that meets the defined specification and viscosity grade, it could result in:

- Component damage that your vehicle warranty does not cover.
- Reduced vehicle performance.

### Capacities

Variant	Quantity
With electronic locking differential.	850 ml (28.7 fl oz)

# Front Axle

---

## Materials

Name	Specification
Motorcraft® SAE 75W-85 Premium Synthetic Hypoid Gear Lubricant(U.S.) Motorcraft® SAE 75W-85 Premium Synthetic Hypoid Gear Lubricant / Huile synthétique de haute qualité pour engrenages hypoides SAE 75W-85 Motorcraft®(Canada) XY-75W85-QL(U.S. & Canada)	WSS-M2C942-A

# Rear Axle

## REAR AXLE FLUID CAPACITY AND SPECIFICATION

Use fluid that meets the defined specification and viscosity grade.

If you do not use fluid that meets the defined specification and viscosity grade, it could result in:

- Component damage that your vehicle warranty does not cover.
- Reduced vehicle performance.

### Capacities

Variant	Quantity
With electronic locking differential.	1.88 L (63.6 fl oz)
Without electronic locking differential.	1.93 L (65.3 fl oz)

### Materials

Name	Specification
Motorcraft® SAE 75W-85 Premium Synthetic Hypoid Gear Lubricant(U.S.) Motorcraft® SAE 75W-85 Premium Synthetic Hypoid Gear Lubricant / Huile synthétique de haute qualité pour engrenages hypoides SAE 75W-85 Motorcraft®(Canada) XY-75W85-QL(U.S. & Canada)	WSS-M2C942-A

# Electronic Locking Differential

## WHAT IS THE ELECTRONIC LOCKING DIFFERENTIAL

The electronic locking differential is a device housed in the front or rear axle and, when activated allows both wheels on that axle to turn at the same speed. The electronic locking differential can provide additional traction should your vehicle become stuck. You can activate the differential electronically and shift it on the fly within the operating speed range. The electronic differential automatically disengages when the vehicle speed exceeds a set value and it automatically reengages when the vehicle speed goes below a set value. See **Switching the Electronic Locking Differential On and Off** (page 194). It also automatically engages based on certain selected G.O.A.T modes. See **G.O.A.T. Mode Control** (page 249). The electronic locking differential is for use in mud, rocks, sand, or any off-road condition where you need maximum traction. It is not for use on dry pavement.

**Note:** *The electronic locking differentials are for off-road use only and not for use on dry pavement. Using the electronic locking differentials on dry pavement results in increased tire wear, noise and vibration or driveline damage.*

**Note:** *The front electronic locking differential is only available in four-wheel drive low (4L).*

**Note:** *Locking the front differential reduces your ability to make tight turning maneuvers and creates additional resistance to steering inputs.*

**Note:** *Switching the electronic locking differentials off while turning results in disengagement difficulties. If the electronic locking differential has difficulty disengaging, release the accelerator pedal and turn the steering wheel back and forth in small increments while maintaining control and following a straight line.*

## SWITCHING THE ELECTRONIC LOCKING DIFFERENTIAL ON AND OFF - EXCLUDING: RAPTOR

### Activating the Electronic Locking Differential

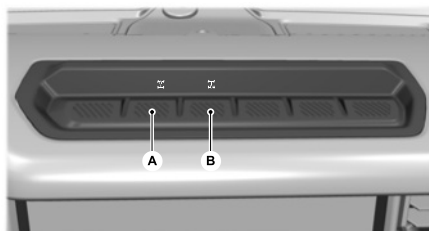

- A Front locking differential switch
- B Rear locking differential switch

You can activate the front or rear locking differential by pressing the switch on the center stack.

**Note:** *Do not perform this operation when cruise control or trail control is selected and active. The differential could have difficulty engaging.*

# Electronic Locking Differential

## Front Electronic Locking Differential Engagement Speed and Availability

Four-Wheel Drive Mode	Maximum Engagement Speed	Automatic Disengagement Speed	Automatic Re-Engagement Speed
Four-Wheel Drive Low (4L)	32 km/h (20 mph)	41 km/h (25 mph)	32 km/h (20 mph)

## Rear Electronic Locking Differential Engagement Speed and Availability

G.O.A.T Modes (Four-Wheel Drive Modes)	Maximum Engagement Speed	Automatic Disengagement Speed	Automatic Re-Engagement Speed
Normal (2H, 4A <sup>2</sup> , 4H)	32 km/h (20 mph)	41 km/h (25 mph)	32 km/h (20 mph)
Eco (2H, 4A <sup>2</sup> , 4H)	32 km/h (20 mph)	41 km/h (25 mph)	32 km/h (20 mph)
Sport (2H, 4A <sup>2</sup> , 4H)	32 km/h (20 mph)	41 km/h (25 mph)	32 km/h (20 mph)
Slippery (2H, 4A <sup>2</sup> , 4H)	32 km/h (20 mph)	41 km/h (25 mph)	32 km/h (20 mph)
Sand (4H) <sup>1</sup>	No speed limit	No speed limit	No speed limit
Mud/Rut (4H) <sup>1</sup>			
Baja (2H, 4H)			
Rock Crawl(4L) <sup>1</sup>			

<sup>1</sup>Automatically engages when you select these G.O.A.T modes. You have the ability to manually override the automatic engagement by pressing the electronic locking differential switch.

<sup>2</sup>If available for 4A drive modes.

Four-Wheel Drive Mode	Maximum Engagement Speed	Automatic Disengagement Speed	Automatic Re-Engagement Speed
Four-Wheel Drive Low (4L)	No speed limit	No speed limit	No speed limit

# Electronic Locking Differential

## SWITCHING THE ELECTRONIC LOCKING DIFFERENTIAL ON AND OFF - RAPTOR

### Activating the Electronic Locking Differential

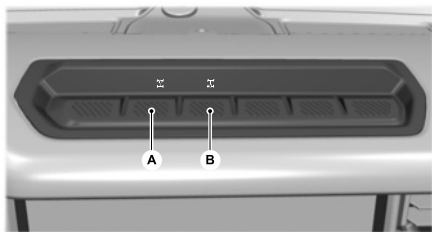

- A Front locking differential switch
- B Rear locking differential switch

You can activate the front or rear locking differential by pressing the switch on the center stack.

**Note:** Do not perform this operation when cruise control or trail control is selected and active. The differential could have difficulty engaging.

### Front Electronic Locking Differential Engagement Speed and Availability

Four-Wheel Drive Mode	Maximum Engagement Speed	Automatic Disengagement Speed	Automatic Re-Engagement Speed
Four-Wheel Drive Low (4L)	32 km/h (20 mph)	41 km/h (25 mph)	32 km/h (20 mph)

### Rear Electronic Locking Differential Engagement Speed and Availability

G.O.A.T Modes (Four-Wheel Drive Modes)	Maximum Engagement Speed	Automatic Disengagement Speed	Automatic Re-Engagement Speed
Normal (2H, 4A, 4H)	32 km/h (20 mph)	41 km/h (25 mph)	32 km/h (20 mph)
Sport (2H, 4A, 4H)	32 km/h (20 mph)	41 km/h (25 mph)	32 km/h (20 mph)
Slippery (4A, 4H)	32 km/h (20 mph)	41 km/h (25 mph)	32 km/h (20 mph)
Tow/Haul (2H, 4A, 4H)	32 km/h (20 mph)	41 km/h (25 mph)	32 km/h (20 mph)
Off-Road(4H) <sup>1</sup>			



# Electronic Locking Differential

G.O.A.T Modes (Four-Wheel Drive Modes)	Maximum Engagement Speed	Automatic Disengagement Speed	Automatic Re-Engagement Speed
Baja (2H, 4H)	No speed limit	No speed limit	No speed limit
Rock Crawl (4L) <sup>1</sup>			

<sup>1</sup>Automatically engages when you select these G.O.A.T modes. You have the ability to manually override the automatic engagement by pressing the electronic locking differential switch.

<sup>2</sup>If available for 4A drive modes.

Four-Wheel Drive Mode	Maximum Engagement Speed	Automatic Disengagement Speed	Automatic Re-Engagement Speed
Four-Wheel Drive Low (4L)	No speed limit	No speed limit	No speed limit

## ELECTRONIC LOCKING DIFFERENTIAL INDICATORS



Rear locking differential Indicator.



Front locking differential Indicator.

If the front or rear indicator in the cluster is amber, both wheels of the indicated axle are locked together providing additional traction.

If the electronic locking differential is selected and the indicator in the cluster is gray or turns from amber to gray while driving, one of the following has occurred:

- Your vehicle speed is too high.
- The accelerator pedal is too high during an engagement attempt.

- Your vehicle is experiencing an anti-lock brake activation.
- The left and right wheel speed difference is too high during an engagement attempt.

If the electronic locking differential is selected and the indicator in the cluster does not illuminate, one of the following has occurred:

# Electronic Locking Differential

- The electronic locking differential is not allowed in the current G.O.A.T mode and is accompanied by **SELECTED LOCKING DIFFERENTIAL NOT AVAILABLE IN CURRENT Drive Mode** in the instrument cluster display.
- The electronic locking differential is not allowed in the current 4x4 mode and is accompanied by **SELECTED LOCKING DIFFERENTIAL NOT AVAILABLE IN CURRENT 4x4 MODE** in the instrument cluster display.
- The system has malfunctioned and is accompanied by **CHECK LOCKING DIFFERENTIAL** in the instrument cluster display. See your authorized dealer for assistance.

## ELECTRONIC LOCKING DIFFERENTIAL – TROUBLESHOOTING

### ELECTRONIC LOCKING DIFFERENTIAL – INFORMATION MESSAGES

Message	Details
Selected Locking Differential Not Available in Current Drive Mode	The selected electronic locking differential is not available in current G.O.A.T mode. See <b>G.O.A.T. Mode Control</b> (page 249).
Selected Locking Differential Not Available in Current 4x4 Mode	The selected electronic locking differential is not available in your current four-wheel drive mode. See <b>Four-Wheel Drive</b> (page 182).
To Engage Locking Differential Release Accelerator Pedal	The selected electronic locking differential requires that you release the accelerator pedal in order to engage.
Check Locking Differential	An electronic locking differential system fault is present. See your authorized dealer as soon as possible.

The following conditions affect the electronic locking differential:

- Based on G.O.A.T mode selection, the rear electronic locking differential does not engage if your vehicle speed is above 32 km/h (20 mph).
- The front electronic locking differential does not engage if your vehicle speed is above 32 km/h (20 mph) in four-wheel drive low (4L).
- Based on G.O.A.T mode selection, the electronic locking differential automatically disengages at speeds above 41 km/h (25 mph) and automatically re-engages at speeds below 32 km/h (20 mph).
- The electronic locking differential may not engage if you press your accelerator pedal during an engagement attempt. A message may display in the instrument display guiding you to release the accelerator pedal.

# Electronic Locking Differential

---

- In four-wheel drive low (4L), the front electronic locking differential automatically disengages at speeds above 41 km/h (25 mph) and automatically re-engages at speeds below 32 km/h (20 mph).
- The AdvanceTrac system has the ability to take over control of the electronic locking differential and disable it during driving maneuvers when necessary.

## **Operating Electronic Locking Differential With a Spare or Mismatched Tires**

On vehicles with an electronic locking differential, the size of the spare tire can affect performance of the system. If there is a significant difference between the two rear tires or two front tires, you may have limited electronic locking differential functionality. If the electronic locking differential has difficulty disengaging, release the accelerator pedal and turn the steering wheel in the opposite direction when rolling. We recommend engaging and disengaging the electronic locking differential at a stop when you mount a spare or mismatched tire on either axle.

## **ELECTRONIC LOCKING DIFFERENTIAL VIDEOS**

[Bronco 4x4 Systems](#)

# Brakes

## BRAKE PRECAUTIONS

Wet brakes result in reduced braking efficiency. Gently press the brake pedal a few times when leaving a car wash or driving from standing water to dry the brakes.

**Note:** *Depending on applicable laws and regulations in the country for which your vehicle was originally built, your brake lamps may flash during heavy braking. Following this, your hazard lights may also flash when your vehicle comes to a stop.*

## BRAKE OVER ACCELERATOR

In the event the accelerator pedal becomes stuck or entrapped, apply steady and firm pressure to the brake pedal to slow the vehicle and reduce engine power. If you experience this condition, apply the brakes and bring your vehicle to a safe stop. Move the transmission to park (P), switch the engine off and apply the parking brake. Inspect the accelerator pedal for any interference. If none are found and the condition persists, have your vehicle towed to the nearest authorized dealer.

## LOCATING THE BRAKE FLUID RESERVOIR - 2.3L ECOBOOST™

- See **Under Hood Overview** (page 342).

## LOCATING THE BRAKE FLUID RESERVOIR - 2.7L ECOBOOST™/3.0L ECOBOOST™

- See **Under Hood Overview** (page 343).

## CHECKING THE BRAKE FLUID



**WARNING:** Do not use any fluid other than the recommended brake fluid as this will reduce brake efficiency. Use of incorrect fluid could result in the loss of vehicle control, serious personal injury or death.



**WARNING:** Only use brake fluid from a sealed container. Contamination with dirt, water, petroleum products or other materials may result in brake system damage or failure. Failure to adhere to this warning could result in the loss of vehicle control, serious personal injury or death.



**WARNING:** Do not allow the fluid to touch your skin or eyes. If this happens, rinse the affected areas immediately with plenty of water and contact your physician.



**WARNING:** The brake system could be affected if the brake fluid level is below the **MIN** mark or above the **MAX** mark on the brake fluid reservoir.

1. Park your vehicle on a level surface.

# Brakes



2. Look at the brake fluid reservoir to see where the brake fluid level is relative to the **MIN** and the **MAX** marks on the reservoir.

**Note:** To avoid fluid contamination, the reservoir cap must remain in place and fully tight, unless you are adding fluid.

Only use fluid that meets our specifications. See **Brake Fluid Specification** (page 201).

## BRAKE FLUID SPECIFICATION

See **Brake Fluid Specification** (page 201).

## BRAKES – TROUBLESHOOTING

### BRAKES – WARNING LAMPS

 **WARNING:** Driving your vehicle with the warning lamp on is dangerous. A significant decrease in braking performance may occur. It may take you longer to stop your vehicle. Have your vehicle checked as soon as possible. Driving extended distances with the parking brake engaged can cause brake failure and the risk of personal injury.



If the ABS indicator illuminates when you are driving, this indicates a malfunction. Your vehicle continues to have normal braking without the anti-lock braking system function. See an authorized dealer.

It also momentarily illuminates when you switch the ignition on to confirm the lamp is functional. If it does not illuminate when you switch the ignition on, or begins to flash at any time, have the system checked by an authorized dealer.

### BRAKE



The brake indicator momentarily illuminates when you switch the ignition on to confirm the lamp is functional. It may also illuminate when you apply the parking brake and the ignition is on. If it illuminates when your vehicle is moving, make sure the parking brake is disengaged. If the parking brake is disengaged, this indicates low brake fluid level or a brake system fault. See an authorized dealer.

**Note:** Lamps may vary depending on region.

# Brakes

---

## BRAKES – INFORMATION MESSAGES

Message	Details
Brake Fluid Level Low	The brake fluid level is low, check the brake system immediately. See <b>Checking the Brake Fluid</b> (page 200).
Check Brake System	Have the system checked as soon as possible.

# Electric Parking Brake

## WHAT IS THE ELECTRIC PARKING BRAKE

The electric parking brake is used to hold your vehicle on slopes and flat roads.

## APPLYING THE ELECTRIC PARKING BRAKE



**WARNING:** Always fully apply the parking brake. Failure to follow this instruction could result in personal injury or death.



**WARNING:** If you drive extended distances with the parking brake applied, you could cause damage to the brake system.



The switch is on the lower part of the instrument panel.

Pull the electric parking brake switch.

The red warning lamp flashes during operation and illuminates when the parking brake is applied.

**Note:** You can apply the electric parking brake when the ignition is off.

**Note:** The electric parking brake could apply when the transmission selector is in park (P). See **Park (P)** (page 176).

## APPLYING THE ELECTRIC PARKING BRAKE IN AN EMERGENCY

You can use the electric parking brake to slow or stop your vehicle in an emergency.

Pull and hold the electric parking brake switch.

The electric parking brake continues to slow your vehicle down unless you release the switch.

The red warning lamp illuminates, a tone sounds and the stoplamps turn on when you use the electric parking brake in an emergency.

**Note:** Do not apply the electric parking brake when your vehicle is moving, except in an emergency. If you repeatedly use the electric parking brake to slow or stop your vehicle, you could cause damage to the brake system.

## MANUALLY RELEASING THE ELECTRIC PARKING BRAKE

1. Switch the ignition on.
2. Apply and hold the brake pedal.
3. Push the electric parking brake switch.

The red warning lamp turns off.

## Pulling Away on a Hill When Towing a Trailer

1. Apply and hold the brake pedal.
2. Pull and hold the electric parking brake switch.
3. Shift the vehicle into gear.
4. Apply the accelerator pedal until the engine has developed sufficient torque to prevent your vehicle from rolling down the hill.
5. Release the switch and pull away in a normal manner.

## AUTOMATICALLY RELEASING THE ELECTRIC PARKING BRAKE

**Note:** If the driver door is removed, buckle the driver seatbelt and proceed to step 2.

# Electric Parking Brake

1. Close the driver door.
2. Shift into gear.
3. Press the accelerator pedal and pull away in a normal manner.

## ELECTRIC PARKING BRAKE AUDIBLE WARNING

Sounds when the parking brake is on and your vehicle is moving. If the warning tone continues after you have released the parking brake, this indicates a malfunction. Have your vehicle checked as soon as possible.

## RELEASING THE ELECTRIC PARKING BRAKE IF THE VEHICLE BATTERY HAS RUN OUT OF CHARGE



**WARNING:** The electric parking brake does not operate if the vehicle battery has run out of charge.

Connect a booster battery to the vehicle battery to release the electric parking brake if the vehicle battery has run out of charge. See **Jump Starting the Vehicle** (page 319).

## ELECTRIC PARKING BRAKE – TROUBLESHOOTING

### ELECTRIC PARKING BRAKE – WARNING LAMPS

#### Brake System



It illuminates red when you apply the parking brake and your vehicle is on. If the lamp flashes when the parking brake has been released, this indicates the parking brake system requires service. Have your vehicle checked as soon as possible.



**Note:** Lamps may vary depending on region.

#### Electric Parking Brake



When the lamp illuminates yellow, it indicates a malfunction in the electric parking brake.

Have your vehicle checked as soon as possible.

**Note:** Lamps may vary depending on region.



# Electric Parking Brake

## ELECTRIC PARKING BRAKE – INFORMATION MESSAGES

Message	Details
Park Brake Malfunction Service Now	The electric parking brake has malfunctioned. Have your vehicle checked as soon as possible.
Park Brake Not Released	The electric parking brake has not released. Manually release the electric parking brake. If the message continues to appear, have your vehicle checked as soon as possible.
Park Brake Not Applied	The electric parking brake has not applied. Apply the electric parking brake. If the message continues to appear, have your vehicle checked as soon as possible.
Park Brake Use Switch to Release	The electric parking brake has not automatically released. Manually release the electric parking brake.
To Release: Press Brake and Switch	You have not pressed the brake pedal. Press the brake pedal to release the parking brake.
Park Brake Limited Function Service Required	The electric parking brake has malfunctioned. Have your vehicle checked as soon as possible.
Park Brake Maintenance Mode	The electric parking brake system has been put into a special mode that is used to allow service of the brakes. Have your vehicle checked as soon as possible.
Park Brake System Overheated	The electric parking brake has overheated. Wait for the electric parking brake to cool down.
Park Brake Released	The electric parking brake is released.
Release Park Brake	The electric parking brake has not released. Manually release the electric parking brake. If the message continues to appear, have your vehicle checked as soon as possible.
Park Brake Applied	The electric parking brake is applied.

## ELECTRIC PARKING BRAKE VIDEOS

[\*Electric Parking Brake\*](#)

# Hill Start Assist (If Equipped)

## WHAT IS HILL START ASSIST

Hill Start Assist applies the brakes to hold your vehicle after you bring it to a stop on a slope. This makes it easier for you to pull away without using the parking brake.

## HOW DOES HILL START ASSIST WORK

When the system activates, your vehicle remains stationary for a few seconds after you release the brake pedal. This gives you time to move your foot from the brake pedal to the accelerator pedal. The brakes release when you apply the accelerator pedal and the vehicle begins to move forward, or the vehicle is stationary beyond the Hill Start Assist hold time.

The system activates when your vehicle is in any forward gear and facing uphill, or when your vehicle is in reverse (R) and facing downhill.

## HILL START ASSIST PRECAUTIONS



**WARNING:** The system does not replace the parking brake. When you leave your vehicle, always apply the parking brake.



**WARNING:** You must remain in your vehicle when the system turns on. At all times you are responsible for controlling your vehicle, supervising the system, and intervening if required. Failure to follow this instruction could result in the loss of control of your vehicle, personal injury or death.



**WARNING:** The system turns off if there is a malfunction.

## SWITCHING HILL START ASSIST ON AND OFF - MANUAL TRANSMISSION

You can switch hill start assist on and off on the touchscreen:

1. From the driver assistance menu, press Hill Start Assist. See **Driver Assistance Menu** (page 483).
2. Switch the feature on or off.

**Note:** *The system remembers the last setting when you start your vehicle.*

## SWITCHING HILL START ASSIST ON AND OFF - AUTOMATIC TRANSMISSION

Hill start assist is active when you switch the ignition on. You cannot switch the system on or off.

## HILL START ASSIST – TROUBLESHOOTING

### HILL START ASSIST – INFORMATION MESSAGES

Message	Details
Hill Start Assist Not Available	Displays when system is not available. Have your vehicle checked as soon as possible.

# Traction Control

## WHAT IS TRACTION CONTROL

The traction control system helps to avoid drive wheel spin and loss of traction.

## HOW DOES TRACTION CONTROL WORK

If your wheels begin to spin, the loss of traction can compromise steering control and stability of the vehicle. The traction control system applies the brakes to individual wheels and when needed, reduces engine power at the same time to increase traction.

## SWITCHING TRACTION CONTROL ON AND OFF



**WARNING:** Operating your vehicle with the traction control disabled could lead to an increased risk of loss of vehicle control, vehicle rollover, personal injury and death.

The system turns on each time you switch the ignition on.

If your vehicle is stuck in mud or snow, switching traction control off may be beneficial as this allows the wheels to spin.

### Switching the System Off



The switch for the stability and traction control system is on the instrument panel.

When you switch the system off, a message and an illuminated icon appear on the instrument cluster.

Use the switch again to return the traction control system to normal operation.

**Note:** When you switch traction control off, stability control remains fully active.

**Note:** When you place your vehicle into four-wheel drive low (4L), the traction control disables. Traction control resumes when you put your vehicle back into two-wheel drive or four-wheel drive high (4H).

**Note:** For additional information on the traction and stability control systems. See **Stability Control** (page 209).

## TRACTION CONTROL INDICATOR

### Stability and Traction Control Indicator



If the indicator does not illuminate when you switch the ignition on, or remains on when the engine is running, this indicates a malfunction. Have your vehicle checked as soon as possible.



The traction control off indicator illuminates when you switch the traction control system off, or when an alternative stability control mode is selected that requires the traction control off depending on the drive mode selected.

# Traction Control

---

## TRACTION CONTROL – TROUBLESHOOTING

### TRACTION CONTROL – INFORMATION MESSAGES

Message	Details
Traction Control Off	The status of the traction control system after you switched it off.
Traction Control On	The status of the traction control system after you switched it on.

# Stability Control

## HOW DOES STABILITY CONTROL WORK



**WARNING:** Vehicle modifications involving braking system, aftermarket roof racks, suspension, steering system, tire construction and wheel and tire size may change the handling characteristics of your vehicle and may adversely affect the performance of the electronic stability control system. In addition, installing any stereo speakers may interfere with and adversely affect the electronic stability control system. Reducing the effectiveness of the electronic stability control system could lead to an increased risk of loss of vehicle control, vehicle rollover, personal injury and death.



**WARNING:** Remember that even advanced technology cannot defy the laws of physics. It's always possible to lose control of a vehicle due to inappropriate driver input for the conditions. Aggressive driving on any road condition can cause you to lose control of your vehicle increasing the risk of personal injury or property damage. Activation of the electronic stability control system is an indication that at least some of the tires have exceeded their ability to grip the road; this could reduce the operator's ability to control the vehicle potentially resulting in a loss of vehicle control, vehicle rollover, personal injury and death.



**WARNING:** You are responsible for controlling your vehicle at all times. The system is designed to be an aid and does not relieve you of your responsibility to drive with due care and attention. Failure to follow this instruction could result in the loss of control of your vehicle, personal injury or death.

If a driving condition activates either the stability control or traction control you may experience the following conditions:

- The stability and traction control light flashes.
- Your vehicle slows down.
- Reduced engine power.

The stability control system has several features built into it to help you maintain control of your vehicle:

### Electronic Stability Control

Electronic stability control enhances your vehicle's ability to prevent skids or lateral slides by applying brakes to one or more of the wheels individually and, if necessary, reducing engine power.

### Roll Stability Control

Roll stability control enhances your vehicle's ability to prevent rollovers by detecting your vehicle's roll motion and the rate at which it changes by applying the brakes to one or more wheels individually.

### Curve Control

Curve control enhances your vehicle's ability to follow the road when cornering severely or avoiding objects in the roadway. Curve control operates by reducing engine power and, if necessary, applying brakes to one or more of the wheels individually.

# Stability Control

## Side Wind Stabilization

Side wind stabilization is an advanced feature that works by carefully applying the brakes on one side of the vehicle to reduce the effect of a side wind gust on the vehicle's path.

## Torque Vectoring by Brakes

Torque vectoring control applies brake torque on the inner driven wheel in a curve for better traction to avoid an understeer, or oversteer situation. Unlike electronic stability control, enhanced torque vectoring control does not slow the vehicle. It helps control excessive wheel slip and gives the vehicle improved cornering agility.

## Traction Control

Traction control enhances your vehicle's ability to maintain traction of the wheels by detecting and controlling wheel spin. See **What Is Traction Control** (page 207).

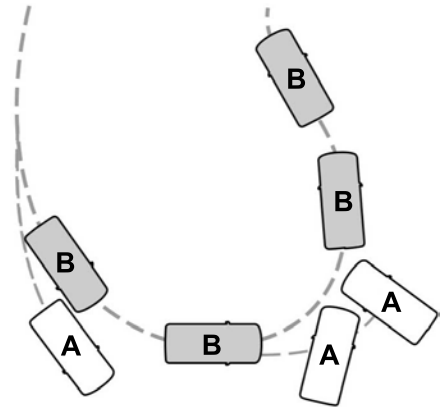

- A Vehicle without stability control skidding off its intended route.
- B Vehicle with stability control maintaining control on a slippery surface.

## SWITCHING STABILITY CONTROL ON AND OFF

The system turns on each time you switch the ignition on.

The electronic stability control system is disabled when the transmission selector is in reverse (R).

You can switch the traction control independently. See **Switching Traction Control On and Off** (page 207).

**Note:** When you place your vehicle into four-wheel drive low (4L), the stability control disables. Stability control resumes when you put your vehicle back into two-wheel drive or four-wheel drive high (4H).

# Stability Control

ESC Features				
Button Functions	Mode	Stability Control Off Light	Electronic Stability Control	Traction Control Systems
Default at start-up	Default - Traction Control On and Normal Advancetrac	On during bulb check	Enabled	Enabled
Button momentarily pressed - single press	Traction Control Off	On	Enabled	Disabled
Button pressed and held for five seconds	AdvanceTrac Off	On	Disabled	Disabled
Button pressed when Traction Control Off or Advance Trac Off	Return to Default	Off	Enabled	Enabled

**Note:** Do not use the AdvanceTrac Off setting on public roadways.

If a fault occurs in either the stability control or the traction control system, you may experience the following conditions:

- The stability and traction control light illuminates steadily.
- The stability control and traction control systems do not enhance your vehicle's ability to maintain traction of the wheels.

If a driving condition activates either the stability control or the traction control system you may experience the following conditions

- The stability and traction control light flashes.
- Your vehicle slows down.
- Reduced engine power.
- A vibration in the brake pedal.

- The brake pedal is stiffer than usual.
- If the driving condition is severe and your foot is not on the brake, the brake pedal may move as the system applies higher brake force.

## STABILITY CONTROL INDICATOR



If the indicator does not illuminate when you switch the power on, or remains on, this indicates a malfunction. Have your vehicle checked as soon as possible.

## Trail Control (If Equipped)

### WHAT IS TRAIL CONTROL



**WARNING:** The system does not control speed in low traction conditions or extremely steep slopes. The system is designed to be an aid and does not relieve you of your responsibility to drive with due care and attention. Failure to follow this instruction could result in personal injury.



**WARNING:** The system does not replace the parking brake. When you leave your vehicle, always apply the parking brake.

Trail control lets you focus on steering during low-speed and off-road use by controlling your vehicle's acceleration and braking to maintain the speed that you set.

You may hear a noise from the anti-lock brake system pump motor when you use the system. This is normal.

### TRAIL CONTROL LIMITATIONS

Trail control is unavailable when any of the following occur:

- Your vehicle speed is greater than 32 km/h (20 mph) in two-wheel drive high (2H) or four-wheel drive high (4H) modes.
- Your vehicle speed is greater than 15 km/h (9 mph) in four-wheel drive low (4L) mode.
- Your vehicle speed is greater than 8 km/h (5 mph) in reverse (R).
- The transmission is in park (P).
- The driver side door is open or your seatbelt is off when the driver side door is removed.
- Cruise control is on.

- Pro trailer backup assist is on.
- The parking brake is applied.

### SWITCHING TRAIL CONTROL ON AND OFF

Press the button on the center console.



**Note:** If your vehicle is equipped with trail one pedal drive, this will activate trail one pedal drive if you are in four wheel drive high (4H) or four wheel drive low (4L) mode, until you set a speed for trail control.

The system switches off if you press the button again or exceed 64 km/h (40 mph).

### SETTING THE TRAIL CONTROL SPEED

**Note:** The buttons are on the steering wheel.

Drive to the speed you prefer.



# Trail Control (If Equipped)

**SET+** Press the button to set or increase the set speed. Press and hold to adjust the speed in larger increments.

**SET-** Press the button to set or decrease the set speed. Press and hold to adjust the speed in larger increments.

**Note:** *The indicator changes color.*

You can also adjust the set speed by braking, then pressing the + or - button.

**Note:** *Pressing the brake pedal does not switch off the system.*

## CANCELING THE SET SPEED

**CAN RES** Press the button on the steering wheel to cancel the set speed.

**Note:** *If your vehicle has trail one pedal drive and you are in four-wheel drive high (4H) or four-wheel drive low (4L) mode, canceling the set speed activates this feature.*

## TRAIL CONTROL INDICATORS



When trail control is active, the indicator illuminates green in the instrument cluster. When the system is switched on but is unavailable or in standby mode, it illuminates gray.

## TRAIL ONE PEDAL DRIVE (IF EQUIPPED)

### WHAT IS TRAIL ONE PEDAL DRIVE

Trail one pedal drive allows you to accelerate and brake using only the accelerator pedal. The system assists when driving through difficult off-road terrain. Pressing the accelerator pedal down accelerates your vehicle and releasing pressure on the accelerator pedal, with your foot still on the pedal, slows your vehicle down. Releasing the accelerator pedal may allow your vehicle to come to a complete stop, some situations may require you to press the brake pedal to come to a complete stop.

### TRAIL ONE PEDAL DRIVE PRECAUTIONS



**WARNING:** This system does not automatically brake your vehicle. This system is an extra driving aid. It does not replace your attention and judgment, or the need to apply the brakes. If you do not apply the brakes when necessary, you may collide with another vehicle or other objects.

Shifting into drive (D) or reverse (R) does not cause the vehicle to move.

You can press the brake pedal to increase braking. This does not turn the system off.

Trail one pedal drive could apply the parking brake when your vehicle is not moving and not in park (P).

**Note:** *Always check the transmission selection before accelerating.*

## Trail Control (If Equipped)

**Note:** Only use trail one pedal drive on slippery or loose surfaces. Using trail one pedal drive on dry, hard surfaces could produce some vibration, driveline bind up and potential excessive tire and vehicle wear.

**Note:** Trail one pedal drive helps get the most from your vehicle in off road situations. On high performance trim levels, trail one pedal drive may feel more aggressive.

### TRAIL ONE PEDAL DRIVE LIMITATIONS

Trail one pedal drive is unavailable when any of the following occur:

- Your vehicle is not in four-wheel drive high (4H) or four-wheel drive low (4L) modes.
- Using cruise control.
- Using trail control.
- You exceed 48 km/h (30 mph).

Releasing the accelerator pedal may allow your vehicle to come to a complete stop, some situations may require you to press the brake pedal to come to a complete stop.

### SWITCHING TRAIL ONE PEDAL DRIVE ON AND OFF



#### Switching Trail One Pedal Drive On

Press the trail features button when in four-wheel drive high (4H) or four-wheel drive low (4L) to activate trail one pedal drive.

#### Switching Trail One Pedal Drive Off

Press the trail features button again to switch trail one pedal drive off.

Selecting a driveline mode other than four-wheel drive high (4H) or four-wheel drive low (4L) switches trail one pedal drive off.

If you exceed 68 km/h (42 mph) trail one pedal drive switches off.

**SET+**

Pressing either button when trail one pedal drive is active turns trail control on and places trail one pedal drive into standby mode.

**SET-**

# Trail Control (If Equipped)

## Switching from Trail Control to Trail One Pedal Drive

**CAN RES** When using trail control in four-wheel drive high (4H) or four-wheel drive low (4L) modes, you can switch to trail one pedal drive by pressing the button on the steering wheel.

## TRAIL ONE PEDAL DRIVE INDICATORS



When trail one pedal drive is active, the indicator displays green in the instrument cluster. When the system is switched on but is unavailable or in standby mode, it displays grey.

## TRAIL ONE PEDAL DRIVE – TROUBLESHOOTING

### TRAIL ONE PEDAL DRIVE – INFORMATION MESSAGES

Message	Action
Trail 1-Pedal Drive Active Use SET Button for Trail Control	Displays when trail one pedal drive is active, use the SET+ or SET- to switch to trail control.
Trail Control with Trail 1- Pedal Drive Off	Displays when you switch trail one pedal drive off.
Trail Control Enabled Use SET button to Set Speed Trail 1-Pedal Drive Available in 4H or 4L	Trail control is in a driveline state not supported for trail one pedal drive. Set a speed to activate trail control or change the driveline state to four-wheel drive high (4H) or four-wheel drive low (4L) modes to active trail one pedal drive.
Trail Control Active Use CANCEL button to resume Trail 1-Pedal Drive	Displays when trail control is active and allows you to resume using trail one pedal drive when you press the CANCEL button.

## Trail Control (If Equipped)

### TRAIL CONTROL – TROUBLESHOOTING

### TRAIL CONTROL – INFORMATION MESSAGES

Message	Details
Reduce Speed To Enter Trail Control	Displays when you must reduce your vehicle speed to use trail control.
Trail Control Not Available with Park Brake Applied	Displays when you must release the park brake to use trail control.
Trail Control Not Available While Pro Trailer Backup Assist™ Active	Displays when you must switch off the trailer backup assist to use trail control.
Trail Control Enabled Use SET Button to Set Speed	Displays when you successfully enabled trail control and can set a speed with the Set+ or Set- control.
Trail Control Off Driver Resume Control	Displays when a system fault has occurred when trail control was active and the driver must resume control.
Trail Control Off	Displays when the system has turned off.
Trail Control Fault See Manual	Displays when a system fault is present. See the trail control section in your Owner's Manual. See your authorized dealer for diagnosis.
Trail Control To Activate Select Gear	Displays when you must be in drive (D), neutral (N) or reverse (R) to use trail control.
Trail Control Not Available with Cruise Control Active	Displays when you must switch the cruise control off to use trail control.
Trail Control Not Available with Driver Door Open	Displays when you must close the driver door to use trail control.
Set Trail Control to 1MPH to Aid in Getting Unstuck in Sand	Displays when the system detects you may be stuck in sand and recommends using trail control on to the lowest set speed. Doing this could slowly pull sand under the tires to free the vehicle.
Set Trail Control to 2 km/h to Aid in Getting Unstuck in Sand	
Descent Control Now Active Press Trail Control Switch To Exit	Due to some driver action, Trail Control propulsion was turned off but the vehicle will still brake if descending a hill. The driver must press the Trail Control switch to turn the feature OFF, they can then turn it back on.
Trail Control Not Available with Seatbelt Off	Displays when you must have the seatbelt on to use trail control.

# Trail Turn Assist (If Equipped)

## WHAT IS TRAIL TURN ASSIST

Trail turn assist can reduce the turning radius of your vehicle by applying the brakes to the inside rear wheel in low-speed, high steering-angle maneuvers.

## TRAIL TURN ASSIST PRECAUTIONS

**Note:** Do not use trail turn assist on dry, hard surfaced roads. Doing so can produce excessive noise, increase tire wear and may damage drive line, or braking components. Trail turn assist is only intended for slippery, or loose surfaces.

You may hear noise from the anti-lock brake system while trail turn assist is active. This is normal operation.

## TRAIL TURN ASSIST LIMITATIONS

You can only use trail turn assist when the system is in four-wheel drive high (4H), or four-wheel drive low (4L) mode.

You cannot use trail turn assist with the rear differential engaged. If the system detects that the rear differential has recently been engaged, it may not activate trail turn assist until it can confirm that the rear differential is disengaged.

If the vehicle's rear differential is engaged when pressing the trail turn assist button, the rear differential will attempt to disengage to allow for trail turn assist operation.

## SWITCHING TRAIL TURN ASSIST ON AND OFF

While in four-wheel drive high (4H) or four-wheel drive low (4L), press the trail turn assist button to turn the feature on. trail turn assist will be on at this time but will not activate until:

- Vehicle speed is less than 19.3 km/h (12 mph).
- Rear differential is fully unlocked.
- Steering wheel is almost fully turned to the left or right.

You can turn off trail turn assist by doing any of the following:

- Pressing the trail turn assist button again.
- Selecting a two-wheel drive high (2H), or four-wheel drive auto (4A).
- Turning on the rear locking differential.

## TRAIL TURN ASSIST INDICATORS



When trail turn assist is on, one of these two indicators will be displayed, depending on the direction of the vehicle's last turn. When the feature is available but not in use, the indicator will be gray. When the feature is active the indicator will be green.

# Trail Turn Assist (If Equipped)

## TRAIL TURN ASSIST – TROUBLESHOOTING

### TRAIL TURN ASSIST – INFORMATION MESSAGES

Message	Details
Trail Turn Assist Available in 4L or 4H	Switch to four-wheel drive low (4L) or four-wheel drive high (4H) to activate trail turn assist. See <b>Selecting a Four-Wheel Drive Mode</b> (page 184).
Trail Turn Assist Not Available See Manual	Trail turn assist system malfunction could be present. If this condition persists, have your vehicle serviced.
Trail Turn Assist ON	You have activated trail turn assist.
Trail Turn Assist OFF	You have switched trail turn assist off.

### TRAIL TURN ASSIST – FREQUENTLY ASKED QUESTIONS

#### Why does Trail Turn Assist not activate after unlocking the rear differential?

The rear differential may not be fully disengaged. When possible, turn off the rear axle locker while driving straight before using trail turn assist. If you are already in a tight turn when you encounter this situation, driving the vehicle for a short distance in reverse could allow the differential to fully disengage.

# Stabilizer Bar Disconnect - Vehicles With: Front Stabilizer Bar Disconnect

## WHAT IS THE STABILIZER BAR DISCONNECT

Stabilizer bar disconnect is a feature that allows the front stabilizer bar to be disconnected for off-road use. This allows for increased front wheel articulation to improve capability and comfort on off-road terrain.

## STABILIZER BAR DISCONNECT PRECAUTIONS



**WARNING:** If the stabilizer bar disconnect warning lamp illuminates red, a fault could be detected and the stabilizer bar could not be connected. Do not drive your vehicle above 32 km/h (20 mph) and have the system checked as soon as possible. Driving your vehicle above 32 km/h (20 mph) could reduce vehicle stability.



**WARNING:** Do not get under a vehicle that is switched on as the stabilizer bar disconnect could activate and the vehicle could unexpectedly drop. Failure to follow this instruction could result in personal injury or death.

If an amber warning message appears in the cluster indicating that the system requires service, the stabilizer bar disconnect will not be available. Have your vehicle checked by an authorized dealer as soon as possible.

## SWITCHING THE STABILIZER BAR DISCONNECT ON AND OFF - EXCLUDING: RAPTOR

### Switching the Stabilizer Bar Disconnect On

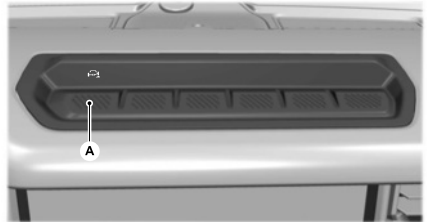

A Stabilizer bar disconnect switch.



Switch the system on by pressing the button on the instrument panel. The stabilizer bar disconnects when the vehicle speed is below 32 km/h (20 mph). An amber indicator illuminates to show that the stabilizer bar disconnects.

When the vehicle speed exceeds 32 km/h (20 mph), the stabilizer bar reconnects and a gray indicator illuminates, indicating the system is in standby mode. The stabilizer bar disconnects again once the vehicle speed is below 32 km/h (20 mph).

If the vehicle speed is above 32 km/h (20 mph) and the system is on, the request is stored and a gray indicator illuminates to indicate the system is in standby mode. When the vehicle speed falls below 32 km/h (20 mph), the stabilizer bar disconnects and the amber indicator illuminates, indicating the stabilizer bar has disconnected.

# Stabilizer Bar Disconnect - Vehicles With: Front Stabilizer Bar Disconnect

**Note:** The gray indicator remains illuminated until either the vehicle speed reduces and the stabilizer bar disconnects, or the system turns off.

The stabilizer bar system also turns on and disconnects when you select the Rock Crawl or Mud/Ruts drive modes. See **Selecting a G.O.A.T. Mode** (page 249).

**Note:** The stabilizer bar disconnect is not available in certain drive modes. See **Selecting a G.O.A.T. Mode** (page 249).

**Note:** The stabilizer bar disconnect could be delayed during wheel slippage, dynamic maneuvers, dynamic cornering or when there is an anti-lock brake system or electronic stability control event in progress.

## Switching the Stabilizer Bar Disconnect Off

Switch the system off by pressing the stabilizer bar disconnect button, which reconnects the stabilizer bar if currently disconnected.

The stabilizer bar disconnect system also turns off when any of the following occur:

- The engine is switched off.
- You switch out of four-wheel drive low (4L) or four-wheel drive high (4H).
- You select a drive mode that does not allow the stabilizer bar to disconnect.

**Note:** The stabilizer bar can be reconnected at any time. It is not necessary for the vehicle to be on a level surface as the stabilizer bar self-aligns.

## SWITCHING THE STABILIZER BAR DISCONNECT ON AND OFF - RAPTOR

### Switching the Stabilizer Bar Disconnect On



A Stabilizer bar disconnect switch.



Switch the system on by pressing the button on the instrument panel. The stabilizer bar disconnects when the vehicle speed is below 48 km/h (30 mph) or 80 km/h (50 mph) depending your vehicle's G.O.A.T. mode. An amber indicator illuminates to show that the stabilizer bar disconnected.

When the vehicle speed exceeds 48 km/h (30 mph) or 80 km/h (50 mph) depending your vehicle's G.O.A.T. mode, the stabilizer bar reconnects and a gray indicator illuminates, indicating the system is in standby mode. The stabilizer bar disconnects again once the vehicle speed is below the system's threshold.



## Stabilizer Bar Disconnect - Vehicles With: Front Stabilizer Bar Disconnect

If the system is on and the vehicle speed is above 48 km/h (30 mph) or 80 km/h (50 mph) depending on your vehicle's G.O.A.T. mode, the request is stored and a gray indicator illuminates to indicate the system is in standby mode. When the vehicle speed meets the requirements, the stabilizer bar disconnects and the amber indicator illuminates, indicating the stabilizer bar has disconnected.

**Note:** *The stabilizer bar reconnects at 48 km/h (30 mph) or 80 km/h (50 mph) depending on selected G.O.A.T. mode.*

**Note:** *The gray indicator remains illuminated until either the vehicle speed reduces and the stabilizer bar disconnects, or the system turns off.*

The stabilizer bar system also turns on and disconnects when you select the Rock Crawl drive mode. See **Selecting a G.O.A.T. Mode** (page 249).

**Note:** *The stabilizer bar disconnect is not available in certain drive modes. See **Selecting a G.O.A.T. Mode** (page 249).*

**Note:** *The stabilizer bar disconnect could be delayed during wheel slippage, dynamic maneuvers, dynamic cornering or when there is an anti-lock brake system or electronic stability control event in progress.*

### Switching the Stabilizer Bar Disconnect Off

Switch the system off by pressing the stabilizer bar disconnect button, which reconnects the stabilizer bar if currently disconnected.

The stabilizer bar disconnect system also turns off when any of the following occur:

- The engine is switched off.
- You switch out of four-wheel drive low (4L) or four-wheel drive high (4H).
- You select a drive mode that does not allow the stabilizer bar to disconnect.

**Note:** *The stabilizer bar can be reconnected at any time. It is not necessary for the vehicle to be on a level surface as the stabilizer bar self-aligns.*

### STABILIZER BAR DISCONNECT INDICATORS



An indicator illuminates when you switch the stabilizer bar disconnect system on. The color of the indicator changes to indicate the system status.

Amber indicates that the stabilizer bar is disconnected.

Grey indicates that the stabilizer bar is connected and in standby.

Red indicates that there is a fault with the system, have the system checked as soon as possible.

# Stabilizer Bar Disconnect - Vehicles With: Front Stabilizer Bar Disconnect

## STABILIZER BAR DISCONNECT – TROUBLESHOOTING

Message

Action

### STABILIZER BAR DISCONNECT – INFORMATION MESSAGES - EXCLUDING: RAPTOR

Message	Action
Sta-Bar Disconnect Not Available In Selected Drive Mode	The selected drive mode does not allow you to turn on the stabilizer bar disconnect feature. See <b>G.O.A.T. Mode Control</b> (page 249).
Sta-Bar Disconnected Sta-Bar Reconnects over 20 MPH	The stabilizer bar has been disconnected.
Sta-Bar Disconnected Sta-Bar Reconnects over 32 km/h	
Sta-Bar Disconnect Available Below 20 MPH	The stabilizer bar disconnect is available below 32 km/h (20 mph).
Sta-Bar Disconnect Available Below 32 km/h	
Sta-Bar Disconnect Available in 4L or 4H	The selected 4WD mode does not allow you to turn on the stabilizer bar disconnect feature.

## Stabilizer Bar Disconnect - Vehicles With: Front Stabilizer Bar Disconnect

Message	Action
Sta-Bar Disconnect Not Available See Manual	Stabilizer bar disconnect is not available. See <b>Stabilizer Bar Disconnect – Frequently Asked Questions</b> (page 223).
Sta-Bar Disconnect Drive Below 32 km/h Service Now	Stabilizer bar disconnect fault detected, drive below 32 km/h (20 mph). Have your vehicle checked by an authorized dealer as soon as possible.
Sta-Bar Disconnect Drive Below 20 MPH Service Now	

Message	Action
	G.O.A.T. mode.
Sta-Bar Disconnect Available in 4L or 4H	The selected 4WD mode does not allow you to turn on the stabilizer bar disconnect feature.
Sta-Bar Disconnect Not Available See Manual	Stabilizer bar disconnect is not available. See <b>Stabilizer Bar Disconnect – Frequently Asked Questions</b> (page 223).
Sta-Bar Disconnect Drive below 48 km/h Service now	Stabilizer bar disconnect fault detected, drive below 48 km/h (30 mph). Have your vehicle checked as soon as possible.
Sta-Bar Disconnect Drive below 30 MPH Service now	

### STABILIZER BAR DISCONNECT – INFORMATION MESSAGES - RAPTOR

Message	Action
Sta-Bar Disconnect Not Available In Selected Drive Mode	The selected drive mode does not allow you to switch on the stabilizer bar disconnect feature. See <b>G.O.A.T. Mode Control</b> (page 249).
Sta-Bar Disconnected	The stabilizer bar has been disconnected.
Reduce Speed to Disconnect Sta-Bar	The stabilizer bar disconnect is available below 48 km/h (30 mph) or 80 km/h (50 mph) depending your vehicles selected

### STABILIZER BAR DISCONNECT – FREQUENTLY ASKED QUESTIONS

#### Why is the stabilizer bar disconnect not disconnecting?

The engine is turned off and needs to be turned on.

#### Why is the stabilizer bar disconnect not disconnecting?

The vehicle is not in four-wheel drive low (4L) or four-wheel drive high (4H), and needs to be switched to either mode.

# Stabilizer Bar Disconnect - Vehicles With: Front Stabilizer Bar Disconnect

---

## Why is the stabilizer bar disconnect not disconnecting?

Vehicle speed is above 32 km/h (20 mph) and needs to be reduced in order for the stabilizer bar to disconnect.

## Why is the stabilizer bar disconnect not disconnecting?

The vehicle is on a very significant lateral incline, and needs to be moved to more level ground.

## Why is the stabilizer bar disconnect not disconnecting?

The vehicle's battery charge is low and needs to be changed or charged.

## Why is the stabilizer bar disconnect not disconnecting?

There is a fault active in another system on the vehicle, have the system checked as soon as possible.

## Why is the stabilizer bar disconnect not disconnecting?

The vehicle is in a drive mode that does not allow the stabilizer bar to disconnect and needs to be switched to a different drive mode.

## STABILIZER BAR DISCONNECT – FREQUENTLY ASKED QUESTIONS - RAPTOR

## Why is the stabilizer bar disconnect not disconnecting?

The engine is turned off. Switch the engine on.

## Why is the stabilizer bar disconnect not disconnecting?

Your vehicle is not in four-wheel drive low (4L) or four-wheel drive high (4H), switch it to either mode.

## Why is the stabilizer bar disconnect not disconnecting?

Vehicle speed is above 48 km/h (30 mph) or 80 km/h (50 mph) depending on G.O.A.T. mode. Reduce your speed in order for the stabilizer bar to disconnect.

## Why is the stabilizer bar disconnect not disconnecting?

Your vehicle is on a very significant lateral incline. Move it to more level ground.

## Why is the stabilizer bar disconnect not disconnecting?

The vehicle's battery charge is low. Change or charge the battery.

## Why is the stabilizer bar disconnect not disconnecting?

There is a fault active in another system on the vehicle, have the system checked as soon as possible.

## Why is the stabilizer bar disconnect not disconnecting?

The vehicle is in a G.O.A.T. mode that does not allow the stabilizer bar to disconnect. Switch to a different G.O.A.T. mode.

# Hill Descent Control - Vehicles With: Hill Descent Control

## WHAT IS HILL DESCENT CONTROL

Hill descent control allows the driver to set and maintain vehicle speed while descending steep slopes in various surface conditions.

## HOW DOES HILL DESCENT CONTROL WORK

Hill descent control can maintain vehicle speeds on downhill slopes between 3–32 km/h (2–20 mph). Above 32 km/h (20 mph), the system remains on but the descent speed cannot be set or maintained.

**Note:** *The system does not function below 3 km/h (2 mph).*

The system requires a cool down interval after a period of sustained use. Hill descent control provides a warning in the message center and a tone sounds when the system is about to disengage for cooling. At this time, manually apply the brakes as needed to maintain descent speed.

**Note:** *The amount of time that the system can remain active before cooling varies with conditions.*

## HILL DESCENT CONTROL PRECAUTIONS



**WARNING:** The system does not control speed in low traction conditions or extremely steep slopes. The system is designed to be an aid and does not relieve you of your responsibility to drive with due care and attention. Failure to follow this instruction could result in personal injury.



**WARNING:** The system does not replace the parking brake. When you leave your vehicle, always apply the parking brake.

## SWITCHING HILL DESCENT CONTROL ON AND OFF



Press the button on the center console. A light in the instrument cluster illuminates when the system is active.

## SETTING THE HILL DESCENT SPEED

To increase or decrease the descent speed, press the accelerator or brake pedal, or use the SET + and SET - buttons on the steering wheel. Once you reach the preferred speed remove your feet from the pedals.

## HILL DESCENT CONTROL INDICATOR



Illuminates when you switch hill descent control on.

# Hill Descent Control - Vehicles With: Hill Descent Control

---

## HILL DESCENT CONTROL – TROUBLESHOOTING

### HILL DESCENT CONTROL – INFORMATION MESSAGES

<b>Message</b>	<b>Details</b>
Hill Descent Control OFF	Displays when you deactivate hill descent control mode.
For Hill Descent Reduce Speed	Displays when the speed exceeds 32 km/h (20 mph) and hill descent control is unavailable.
Hill Descent Control Not Available With Cruise Control Active	Displays when Cruise Control is Active and driver attempts to turn on hill descent control.
Hill Descent Driver Resume Control	Displays when the hill descent control mode requires you to resume control.
Hill Descent Control Fault	Displays when a hill descent system fault is present.
Hill Descent Control Off System Cooling	Displays when the hill descent control turns off to cool the brake system.
Hill Descent Control Ready	Displays when you activate the hill descent control mode.

# Steering

## ELECTRIC POWER STEERING

### HOW DOES ELECTRIC POWER STEERING WORK

The electric power steering system uses an electric motor to provide assistance when turning the steering wheel to steer your vehicle. If your vehicle detects a steering concern when you are driving, a warning message appears and the system reduces steering assistance. If your vehicle loses electrical power, the steering system still operates and you can manually steer your vehicle. Manually steering your vehicle requires more effort.

**Note:** *When the battery is disconnected or a new battery is installed, you must drive your vehicle a short distance before the system relearns the strategy and reactivates all systems.*

### Steering Tips

If the steering wanders or pulls, check for:

- An improperly inflated tire.
- Uneven tire wear.
- Loose or worn suspension components.
- Improper vehicle alignment.

**Note:** *A high crown in the road or high crosswinds could also make the steering wander or pull.*

### ELECTRIC POWER STEERING PRECAUTIONS



**WARNING:** The electric power steering system has diagnostic checks that continuously monitor the system. If a fault is detected, a message displays in the information display. Stop your vehicle as soon as it is safe to do so.

Switch the vehicle off. After at least 10 seconds, switch the vehicle on and watch the information display for a steering system warning message. If a steering system warning message returns, have the system checked as soon as possible.



**WARNING:** If the system detects an error, you may not feel a difference in the steering, however a serious condition may exist. Have your vehicle checked as soon as possible. Failure to do so may result in loss of steering control.

Adapt your speed and driving behavior according to reduced steering assist.

Extreme continuous steering may increase the effort to steer. This occurs to prevent internal overheating and damage to the steering system. If this occurs, you will not lose the ability to steer your vehicle manually nor will it cause damage to the system. Normal steering and driving allows the system to cool down and steering assist returns to normal.

**Note:** *There is no fluid reservoir to check or fill.*

When your vehicle is still moving, a significant decrease in steering assistance or a loss of steering assistance could occur if:

- You switch your vehicle off.
- Your vehicle loses electrical power.
- Your vehicle detects a concern.

When your vehicle is off and your vehicle begins moving, there is no steering assistance.

# Steering

## STEERING – TROUBLESHOOTING

## STEERING – WARNING LAMPS



The electric power steering system indicator illuminates if the system detects a fault during the continuous diagnostic checks.

**Note:** *If a red warning message displays, stop your vehicle as soon as it is safe to do so.*

## STEERING – INFORMATION MESSAGES

Message	Action
Steering Fault Service Now	The power steering system has detected a condition that requires service. Have your vehicle checked as soon as possible.
Steering Loss Stop Safely	The power steering system is not working. Stop your vehicle in a safe place. Have your vehicle checked as soon as possible.
Steering Assist Fault Service Required	The power steering system has detected a condition that requires service. Have your vehicle checked as soon as possible.
Steering Lock Malfunction Service Now	The steering system has detected a condition that could prevent you from starting your vehicle. Have your vehicle checked as soon as possible.



## Parking Aids (If Equipped)

### PARKING AID PRECAUTIONS



**WARNING:** To help avoid personal injury, always use caution when in reverse (R) and when using the sensing system.



**WARNING:** The system may not detect objects with surfaces that absorb reflection. Always drive with due care and attention. Failure to take care may result in a crash.



**WARNING:** Traffic control systems, fluorescent lamps, inclement weather, air brakes, external motors and fans may affect the correct operation of the sensing system. This may cause reduced performance or false alerts.



**WARNING:** The system may not detect small or moving objects, particularly those close to the ground.



**WARNING:** The parking aid system can only assist you to detect objects when your vehicle is moving at parking speeds. To help avoid personal injury you must take care when using the parking aid system.



**WARNING:** The system may not function if the sensor is blocked.



**WARNING:** In cold and severe weather conditions the system may not function. Rain, snow and spray can all limit sensor performance.



**WARNING:** If damage occurs in the immediate area surrounding the sensor, have your vehicle checked as soon as possible.

**Note:** If your vehicle sustains damage leaving the sensors misaligned, this will cause inaccurate measurements or false alerts.

When you connect a trailer to your vehicle, the rear parking aid detects the trailer and provides an alert. Disable the parking aid when you connect a trailer to prevent the alert.

**Note:** Connected trailers might be detected by the vehicle and parking aid turns off automatically in those instances.

**Note:** Certain add-on devices installed around the bumper or fascia may create false alerts. For example, large trailer hitches, bike or surfboard racks, license plate brackets, bumper covers or any other device could block the normal detection zone of the parking aid system. Aftermarket spare tires or spare tire covers mounted to the rear tailgate could cause false alerts from the park aid system. Remove the add-on device to prevent false alerts.

**Note:** Keep the sensors free from snow, ice and large accumulations of dirt. If the sensors are covered, the system's accuracy can be affected.

Do not clean the sensors with sharp objects.

### SWITCHING PARKING AID ON AND OFF



Press the parking aid button to switch the system on and off.

### Switching Parking Aid On and Off Long-Term

The system can be set to stay disabled in between ignition cycles.

1. From the driver assistance menu, press Park Aid sensors. See **Driver Assistance Menu** (page 483).

# Parking Aids (If Equipped)

2. Switch Front Sensors (Always) or Rear Sensors (Always) on or off.

## REAR PARKING AID

### WHAT IS THE REAR PARKING AID

Rear parking sensors detect objects behind your vehicle when in reverse (R).

### REAR PARKING AID LIMITATIONS

There is a decreased coverage area at the outer corners.

The rear parking aid sensors are active when your vehicle is in reverse (R) and the vehicle speed is less than 8 km/h (5 mph).

The sensor coverage area is up to 180 cm (71 in) from the rear bumper.

The rear parking aid detects large objects when you shift into reverse (R) and any of the following occur:

- Your vehicle is moving backward at a low speed.
- Your vehicle is stationary but an object is approaching the rear of your vehicle at a low speed.
- Your vehicle is moving backward at a low speed and an object is moving towards your vehicle, for example another vehicle at a low speed.

The system shall provide no audible warning for the object behind the vehicle when in neutral (N) gear.

## LOCATING THE REAR PARKING AID SENSORS



The rear parking aid sensors are in the rear bumper.

## REAR PARKING AID AUDIBLE WARNINGS

A warning tone sounds when your vehicle approaches an object. As your vehicle moves closer to an object, the rate of the tone increases. The warning tone continuously sounds when an object is 30 cm (12 in) or less from the rear bumper.

If your vehicle remains stationary for a few seconds, the audible warning turns off. If your vehicle moves backward the tone sounds again.

**Note:** *When the parking aid system sounds a tone, the audio system may reduce the set volume.*

## FRONT PARKING AID

### WHAT IS THE FRONT PARKING AID

Front parking sensors detect objects in front of your vehicle.

## Parking Aids (If Equipped)

### FRONT PARKING AID LIMITATIONS

The front parking aid sensors are active when your vehicle is in any position other than park (P) and the vehicle speed is less than 8 km/h (5 mph).

The sensor coverage area is up to 70 cm (28 in) from the front bumper.

If your vehicle is in reverse (R), the front parking aid detects objects and provides an audible warning when your vehicle is moving at a low speed and when an object is moving toward your vehicle, for example, another vehicle at a low speed. If your vehicle remains stationary for a few seconds, the audible warning turns off. Visual indication is always active in reverse (R).

If your vehicle is in any forward gear, the front parking aid provides audible warnings and a visual indication when your vehicle is moving at a speed of 8 km/h (5 mph) or below and the system detects an object within the detection zone. If your vehicle remains stationary for a few seconds, the visual indication and audible warning turns off.

If your vehicle is in neutral (N), the front and rear sensors provide a visual indication only when your vehicle is moving below a speed of 8 km/h (5 mph) and the system detects obstacles inside the detection areas. Once your vehicle stops, the visual indication and audible warning stops after a few seconds.

### LOCATING THE FRONT PARKING AID SENSORS



The front parking aid sensors are in the front bumper.

### FRONT PARKING AID AUDIBLE WARNINGS

A warning tone sounds when there is an object within 70 cm (28 in) from the front bumper. As your vehicle moves closer to an object, the rate of the tone increases.

The warning tone continuously sounds when an object is 30 cm (12 in) or less from the front bumper.

**Note:** *If the detected object is 30 cm (12 in) or less from your vehicle, visual indication remains on.*

# Parking Aids (If Equipped)

## PARKING AID INDICATORS

### Parking Aid Indicators Shown When 360 Degree Camera Views are not Available



The system provides object distance indication through the touchscreen.

- As the distance to an object decreases, the indicators change color. The indicators for closer objects appear closer to the vehicle icon.
- The indicators are green when the object is at the farthest detection point. As the object gets closer, the indicators turn amber. When the object is at the closest detection point, the indicators turn red.
- If there is no object detected, the distance indicators are not activated.

The activated visual indicators continue displaying when your vehicle is stopped in reverse (R). If stopped in drive (D) or neutral (N), the activated visual indicators disappear after four seconds.

**Note:** *If stopped in drive (D) or neutral (N) with rear camera delay mode showing the rear camera view, the activated visual indicators continue displaying.*

Parking aids are not available in the following situations:

- The system is switched off.
- A trailer is connected.
- Sensors are blocked.
- A system fault occurs.

**Note:** *If the parking aids are not available, the distance indicators do not display. See **Parking Aids – Troubleshooting** (page 233).*

**Note:** *Front park aid indicators may not be available.*

### Parking Aid Indicators Shown in 360 Degree Camera Views (If Equipped)



The system provides object distance indication through the touchscreen.

- As the distance to an object decreases, the indicators change color.
- The indicators are green when the object is at the farthest detection point. As the object gets closer, the indicators turn amber. When the object is at the closest detection point, the indicators turn red.
- If there is no object detected, the distance indicators are not activated.

The activated visual indicators continue displaying when your vehicle is stopped in reverse (R). If stopped in drive (D) or neutral (N), the activated visual indicators disappear after four seconds.

## Parking Aids (If Equipped)

**Note:** If stopped in drive (D) or neutral (N) with rear camera delay mode showing the rear camera view, the activated visual indicators continue displaying.

Parking aids are not available in the following situations:

- The system is switched off.
- A trailer is connected.
- Sensors are blocked. The distance indicators appear white.
- A system fault occurs.

**Note:** If the parking aids are not available, the distance indicators do not display. See **Parking Aids – Troubleshooting** (page 233).

### PARKING AIDS – TROUBLESHOOTING

### PARKING AIDS – INFORMATION MESSAGES

If a fault is present in the parking aids, a warning message appears in the instrument cluster or the touchscreen.

Message	Action
Park Aid Fault	The system detects a condition that requires service. Have your vehicle checked as soon as possible. You may be able to resolve by cleaning the sensors and restarting your vehicle.
Parking Sensors Blocked	Inclément weather, ice, mud, or water is blocking the sensor, causing the system to become unavailable. You can typically clean the sensor to resolve.
Trailer Connected	An electrical trailer connection is sensed during a given ignition cycle.

## PARKING AIDS VIDEOS

[Reverse Sensing System Video Link](#)

# Rear View Camera

## WHAT IS THE REAR VIEW CAMERA

The rear view camera provides a video image of the area behind your vehicle when the transmission is in reverse (R).

## REAR VIEW CAMERA PRECAUTIONS



**WARNING:** The rear view camera system is a reverse aid supplement device that still requires the driver to use it in conjunction with the interior and exterior mirrors for maximum coverage.



**WARNING:** Objects that are close to either corner of the bumper or under the bumper, might not be seen on the screen due to the limited coverage of the camera system.



**WARNING:** Objects above the camera may not be visible. Check the area behind your vehicle when necessary.



**WARNING:** Reverse your vehicle slowly. Failure to follow this instruction could result in the loss of control of your vehicle, personal injury or death.



**WARNING:** Use caution when the liftgate or tailgate is ajar. If the liftgate or tailgate is ajar, the camera will be out of position and the video image could be incorrect. All guide lines disappear when the liftgate or tailgate is ajar. Failure to follow this instruction could result in personal injury.



**WARNING:** Do not switch the camera features on or off when your vehicle is moving.

**Note:** When towing, the camera only sees what you are towing. This might not provide adequate coverage and you might not see some objects. In some vehicles, the guidelines may disappear when you connect the trailer tow connector.

## LOCATING THE REAR VIEW CAMERA

The rear view camera is in the spare tire carrier.

## REAR VIEW CAMERA GUIDE LINES

**Note:** Active guide lines and fixed guide lines are only available when the transmission is in reverse (R).

**Note:** The centerline is only available if the active or fixed guide lines are on.

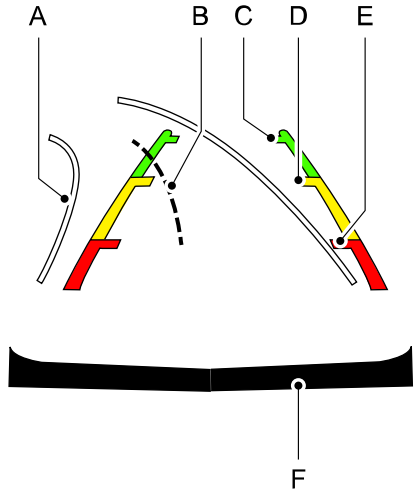

# Rear View Camera

- A. Active guide lines.
- B. Centerline.
- C. Fixed guide line: Green zone.
- D. Fixed guide line: Yellow zone.
- E. Fixed guide line: Red zone.
- F. Rear bumper.

Active guide lines only show with fixed guide lines. To use active guide lines, turn the steering wheel to point the guide lines toward an intended path. If the steering wheel position changes while reversing, your vehicle might deviate from the intended path.

The fixed and active guide lines fade in and out depending on the steering wheel position. The active guide lines do not display when the steering wheel position is straight.

Use caution while reversing. Objects in the red zone are closest to your vehicle and objects in the green zone are farther away. Objects get closer to your vehicle as they move from the green zone to the yellow or red zones. Use the side view mirrors and rear view mirror to get better coverage on both sides and rear of your vehicle.

## REAR VIEW CAMERA OBJECT DISTANCE INDICATORS

The system provides an image of your vehicle and the sensor zones. The zones highlight green, yellow, and red when the parking aid sensors detect an object in the coverage area.

## REAR VIEW CAMERA SETTINGS

### ZOOMING THE REAR VIEW CAMERA IN AND OUT

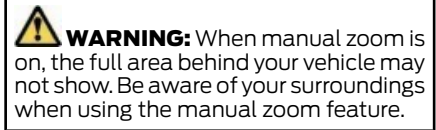

Selectable settings for this feature are zoom in (+) and zoom out (-). Press the symbol on the camera screen to change the view. The default setting is zoom off.

This allows you to get a closer view of an object behind your vehicle. The zoomed image keeps the bumper in the image to provide a reference.

**Note:** *Manual zoom is only available when the transmission is in reverse (R).*

**Note:** *Only the centerline shows when you enable manual zoom.*

### SWITCHING REAR VIEW CAMERA DELAY ON AND OFF

1. From the driver assistance menu, press Rear View Camera. See **Driver Assistance Menu** (page 483).
2. Switch rear view camera delay on or off.

When shifting the transmission out of reverse (R) and into any gear other than park (P), the camera image remains in the display until:

- Your vehicle speed reaches approximately 8 km/h (5 mph).
- You shift your vehicle into park (P).

## 360 Degree Camera (If Equipped)

### WHAT IS THE 360 DEGREE CAMERA

The 360 degree camera system consists of front, side and rear cameras which provide visibility around your vehicle.

### HOW DOES THE 360 DEGREE CAMERA WORK

The 360 degree camera system:

- Allows you to see what is directly in front of or behind your vehicle.
- Helps you when parallel parking and centering in a parking space.
- Provides a cross traffic view in front of and behind your vehicle.
- Allows you to see a top-down view of the area outside your vehicle, including the blind spots and obstacles near your vehicle.

### 360 DEGREE CAMERA PRECAUTIONS

 **WARNING:** The 360 degree camera system still requires the driver to use it in conjunction with looking out of the windows, and checking the interior and exterior mirrors for maximum coverage.

 **WARNING:** Objects that are close to either corner of the bumper or under the bumper, might not be seen on the screen due to the limited coverage of the camera system.

 **WARNING:** Do not switch the camera features on or off when your vehicle is moving.

 **WARNING:** You are responsible for controlling your vehicle at all times. The system is designed to be an aid and does not relieve you of your responsibility to drive with due care and attention. Failure to follow this instruction could result in the loss of control of your vehicle, personal injury or death.

 **WARNING:** Use caution when the tailgate is ajar. If the tailgate is ajar, the camera is out of position and the video image could be incorrect. All guide lines disappear when the tailgate is ajar. Failure to follow this instruction could result in personal injury.

 **WARNING:** When manual zoom is on, the full area behind your vehicle may not show. Be aware of your surroundings when using the manual zoom feature.

### LOCATING THE 360 DEGREE CAMERAS

#### Rear View Camera

The rear view camera is in the spare tire carrier. It provides an image of the area behind your vehicle.

#### Front View Camera

The front video camera is in the grille. It provides a video image of the area in front of your vehicle.

**Note:** *The front camera system switches on when you are in mud/ruts, sand, baja or rock crawl mode.*

#### Side View Camera

The side view cameras are on the outside mirrors. They provide a video image of the area on the sides of your vehicle to aid you when parking.



## 360 Degree Camera (If Equipped)

### 360 DEGREE CAMERA GUIDE LINES

**Note:** Active guidelines are only available when the transmission is in reverse (R).

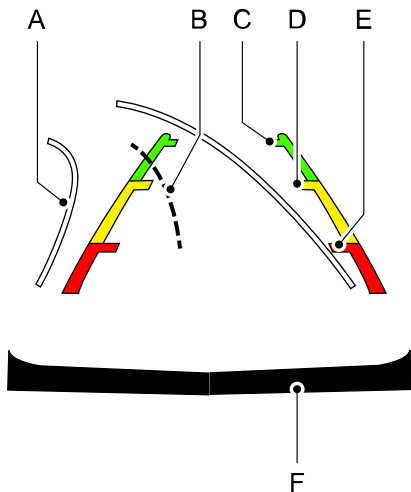

- A Active guidelines.
- B Centerline.
- C Fixed guideline: Green zone.
- D Fixed guideline: Yellow zone.
- E Fixed guideline: Red zone.
- F Rear bumper.

Active guidelines only show with fixed guidelines. Turn the steering wheel to point the guidelines toward an intended path. If the steering wheel position changes when reversing, your vehicle could deviate from the intended path.

The fixed and active guidelines fade in and out depending on the steering wheel position. The active guidelines do not display when the steering wheel position is straight.

Objects in the red zone are closest to your vehicle and objects in the green zone are farther away. Objects get closer to your vehicle as they move from the green zone to the yellow or red zones. Use the side view mirrors and rear view mirror to get better coverage on both sides and rear of your vehicle.

### Keep Out Zone



The keep out zone is represented by the yellow dotted lines running parallel to your vehicle.

## 360 Degree Camera (If Equipped)

### 360 DEGREE CAMERA SETTINGS

#### SWITCHING THE 360 DEGREE CAMERA ON AND OFF



The 360 degree camera system button is on the instrument panel and allows you to toggle the front camera on or off. The front and rear cameras have multiple screens which consist of:

- Normal view.
- Normal view with 360.
- Split view.

**Note:** *The rear view camera activates when you switch into reverse (R). Additional views are then accessible on the touchscreen.*

When in park (P), neutral (N) or drive (D), only the front images display when you press the button. When in reverse (R), only the rear images display when you press the button.

**Note:** *The 360 degree camera system remains on when your vehicle is in motion at low speed. The rear camera views remain on at all speeds when in reverse (R).*

#### SWITCHING THE 360 DEGREE CAMERA VIEW



Press to access the different camera views.



**Normal + 360 view:** Contains the normal camera view next to a 360 degree camera view.



**Normal view:** Provides an image of what is directly in front of or behind your vehicle.



**Split view:** Provides an extended view of what is in front of or behind your vehicle.



**Rock crawl view:** Provides a close-up view of the area around the front and rear tires in off-road drive modes.



Zooms in on the image.

# Cruise Control

## WHAT IS CRUISE CONTROL

Cruise control lets you maintain a set speed without keeping your foot on the accelerator pedal.

### Requirements

Use cruise control when the vehicle speed is greater than 20 km/h in metric units or 15 mph in imperial units.

## SWITCHING CRUISE CONTROL ON AND OFF



**WARNING:** Do not use cruise control on winding roads, in heavy traffic or when the road surface is slippery. This could result in loss of vehicle control, serious injury or death.

The cruise controls are on the steering wheel.

### Switching Cruise Control On



Press the button to activate the system. When the system activates, the set speed is equal to the current vehicle speed or 20 km/h (15 mph), whichever is greater. If the speed is too low, or other conditions are not correct for cruise control activation, the system enters standby mode.

### Switching Cruise Control Off



Press the button when the system is active or switch the ignition off.

**Note:** When you switch cruise control off, the set speed clears.

## SETTING THE CRUISE CONTROL SPEED



**WARNING:** When you are going downhill, your vehicle speed could increase above the set speed. The system does not apply the brakes.

Drive to the speed you prefer.

**SET+**

Press either button to set the current speed.

**SET-**

Take your foot off the accelerator pedal.

**Note:** The indicator changes color in the instrument cluster display.

### Changing the Set Speed

**SET+**

Press and release the button to increase the set speed in small increments.

Press and hold the button to accelerate. Release the button when you reach your preferred speed.

**SET-**

Press and release the button to decrease the set speed in small increments.

Press and hold the button to decelerate. Release the button when you reach your preferred speed.

**Note:** If you accelerate by pressing the accelerator pedal, the set speed does not change. When you release the accelerator pedal, your vehicle returns to the speed that you previously set.

# Cruise Control

---

## CANCELING THE SET SPEED



Press the button, or tap the brake pedal to cancel the set speed.

**Note:** *The system remembers the set speed.*

**Note:** *The system cancels if the vehicle speed drops below 16 km/h (10 mph) under the set speed when driving uphill.*

## RESUMING THE SET SPEED



Press the button.

## CRUISE CONTROL INDICATORS



Illuminates when you switch the system on.

# Adaptive Cruise Control (If Equipped)

## HOW DOES ADAPTIVE CRUISE CONTROL WORK

Adaptive cruise control uses a radar sensor to adjust your vehicle speed to maintain a set gap between you and the vehicle in front of you in the same lane.

## ADAPTIVE CRUISE CONTROL PRECAUTIONS

 **WARNING:** You are responsible for controlling your vehicle at all times. The system is designed to be an aid and does not relieve you of your responsibility to drive with due care and attention. Failure to follow this instruction could result in the loss of control of your vehicle, personal injury or death.

 **WARNING:** Pay close attention to changing road conditions such as entering or leaving a highway, on roads with intersections or roundabouts, roads without visible lanes of travel, roads that are winding, slippery, unpaved, or steep slopes.

 **WARNING:** The system does not control speed in low traction conditions or extremely steep slopes. The system is designed to be an aid and does not relieve you of your responsibility to drive with due care and attention. Failure to follow this instruction could result in personal injury.

 **WARNING:** The system is not a crash warning or avoidance system.

 **WARNING:** Do not use the system when towing a trailer that has aftermarket electronic trailer brake controls. Failure to follow this instruction could result in the loss of control of your vehicle, personal injury or death.

 **WARNING:** Do not use tire sizes other than those recommended because this can affect the normal operation of the system. Failure to do so may result in a loss of vehicle control, which could result in serious injury.

 **WARNING:** Do not use the system with a snow plow blade installed.

 **WARNING:** Do not use the system in poor visibility, for example fog, heavy rain, spray or snow.

## When Following a Vehicle

 **WARNING:** When following a vehicle that is braking, your vehicle does not always decelerate quickly enough to avoid a crash without driver intervention. Apply the brakes when necessary. Failure to follow this instruction could result in personal injury or death.

## Hilly Condition Usage

You should select a lower gear when the system is active in situations such as prolonged downhill driving on steep slopes, for example in mountainous areas. The system needs additional engine braking in these situations to reduce the load on the vehicle's regular brake system to prevent it from overheating.

# Adaptive Cruise Control (If Equipped)

**Note:** An audible alarm sounds and the system shuts down if it applies brakes for an extended period of time. This allows the brakes to cool. The system functions normally again after the brakes cool.

## ADAPTIVE CRUISE CONTROL LIMITATIONS

### Sensor Limitations

**WARNING:** On rare occasions, detection issues can occur due to the road infrastructures, for example bridges, tunnels and safety barriers. In these cases, the system may brake late or unexpectedly. At all times, you are responsible for controlling your vehicle, supervising the system and intervening, if required.

**WARNING:** If the system malfunctions, have your vehicle checked as soon as possible.

**WARNING:** Large contrasts in outside lighting can limit sensor performance.

**WARNING:** The system only warns of vehicles detected by the radar sensor. In some cases there may be no warning or a delayed warning. Apply the brakes when necessary. Failure to follow this instruction could result in personal injury or death.

**WARNING:** The system may not detect stationary or slow moving vehicles below 10 km/h (6 mph).

**WARNING:** The system does not detect pedestrians or objects in the road.

**WARNING:** The system does not detect oncoming vehicles in the same lane.

**WARNING:** The system may not operate properly if the sensor is blocked. Keep the windshield free from obstruction.

**WARNING:** The sensor may incorrectly track lane markings as other structures or objects. This can result in a false or missed warning.

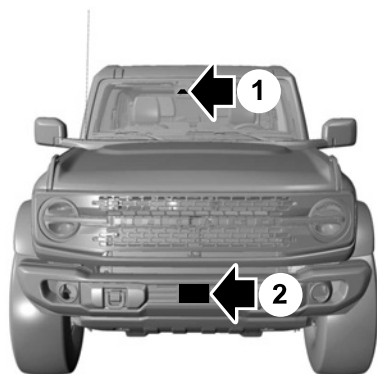

- 1 Camera.
- 2 Radar sensor (if equipped).

**Note:** You cannot see the sensor. It is behind a fascia panel.

**Note:** Keep the front of your vehicle free of dirt, metal badges or objects. Vehicle front protectors, aftermarket lights, additional paint or plastic coatings could also degrade sensor performance.

# Adaptive Cruise Control (If Equipped)

A message displays if something obstructs the camera or the sensor. When something blocks the sensor, the system cannot detect a vehicle ahead and does not function. See **Adaptive Cruise Control – Information Messages** (page 247).

The radar sensor has a limited field of view. It may not detect vehicles at all or detect a vehicle later than expected in some situations. The lead vehicle image does not illuminate if the system does not detect a vehicle in front of you.

## Detection issues can occur:

**A**

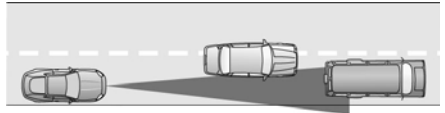

**B**



**C**

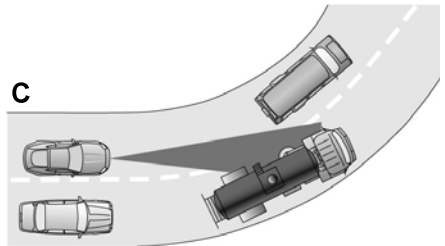

- A When driving on a different line than the vehicle in front.
- B With vehicles that edge into your lane. The system can only detect these vehicles once they move fully into your lane.
- C There may be issues with the detection of vehicles in front when driving into and coming out of a bend or curve in the road.

In these cases, the system may brake late or unexpectedly.

If something hits the front end of your vehicle or damage occurs, the radar-sensing zone could change. This could result in a missed or false vehicle detection.

# Adaptive Cruise Control (If Equipped)

Optimal system performance requires a clear view of the road by the windshield-mounted camera.

Optimal performance may not occur if:

- The camera is blocked.
- There is poor visibility or lighting conditions.
- There are bad weather conditions.

## SWITCHING ADAPTIVE CRUISE CONTROL ON AND OFF

The cruise controls are on the steering wheel. See **Cruise Control** (page 239).

### Switching Adaptive Cruise Control On



Press the button to activate the system. When the system activates, the set speed is equal to the current vehicle speed. If the speed is too low, or other conditions are not correct for adaptive cruise control activation, the system enters standby mode.

**Note:** *The minimum set speed is 15 mph or 20 km/h.*

The indicator, current gap setting and set speed appear in the instrument cluster display.

### Switching Adaptive Cruise Control Off



Press the button when the system is in standby mode or switch the ignition off.

**Note:** *When you switch the system off, the set speed clears.*

## Automatic Cancellation or Deactivation

The system may cancel if:

- The tires lose traction.
- You apply the parking brake.
- Your vehicle speed falls significantly below 15 mph or 20 km/h.

The system may turn off or prevent activating when requested if:

- The vehicle has a blocked sensor.
- The brake temperature is too high.
- There is a failure in the system or a related system.

## SETTING THE ADAPTIVE CRUISE CONTROL SPEED

Drive to the speed you prefer.



Press the button to set the current speed.



Take your foot off the accelerator pedal.

The indicator, current gap setting and set speed appear in the instrument cluster display.





# Adaptive Cruise Control (If Equipped)

A vehicle image illuminates if there is a vehicle detected in front of you.

**Note:** When adaptive cruise control is active, the speedometer may vary slightly from the set speed displayed in the instrument cluster display.

## Manually Changing the Set Speed

**SET+** Press and release the button to increase the set speed in small increments.

Press and hold the button to increase the set speed in large increments. Release the button when the displayed set speed is equal to your desired speed.

**SET-** Press and release the button to decrease the set speed in small increments.

Press and hold the button to decrease the set speed in large increments. Release the button when the displayed set speed is equal to your desired speed.

Press the accelerator or brake pedal until you reach the speed you prefer. Press the button to select the current speed as the set speed.

The system may apply the brakes to slow the vehicle to the new set speed. The set speed displays continuously in the instrument cluster display when the system is active.

## SETTING THE ADAPTIVE CRUISE CONTROL GAP

**Note:** A minimum vehicle speed of 15 mph or 20 km/h must be met, before you can set the gap.

 Press the button to cycle through the four gap settings.



The selected gap appears in the instrument cluster display as shown by the bars in the image.

**Note:** The gap setting is time dependent and therefore, the distance adjusts with your vehicle speed.

**Note:** It is your responsibility to select a gap appropriate to the driving conditions.

## Adaptive Cruise Control Gap Settings

Graphic Display, Bars Indicated Between Vehicles	Gap Distance	Dynamic Behavior
1	Closest.	Sport.
2	Close.	Normal.
3	Medium.	Normal.
4	Far.	Comfort.

Each time you switch the system on, it selects the last chosen gap setting.

## Following a Vehicle

When a vehicle ahead of you enters the same lane or a slower vehicle is ahead in the same lane, the vehicle speed adjusts to maintain the gap setting.

# Adaptive Cruise Control (If Equipped)

**Note:** When you are following a vehicle and you switch on a turn signal lamp, adaptive cruise control may provide a small, temporary acceleration to help you pass.

Your vehicle maintains a consistent gap from the vehicle ahead until:

- The vehicle in front of you accelerates to a speed above the set speed.
- The vehicle in front of you moves out of the lane you are in.
- You set a new gap distance.

The system applies the brakes to slow down your vehicle to maintain a safe gap distance from the vehicle in front of you. The system only applies limited braking. You can override the system by applying the brakes.

**Note:** The brakes may emit noise when applied by the system.

If the system determines that its maximum braking level is not sufficient, an audible warning sounds, a message appears in the instrument cluster display and an indicator flashes when the system continues to brake. Take immediate action.

## CANCELING THE SET SPEED

**CAN RES** Press the button or tap the brake pedal.

The set speed does not erase.

## RESUMING THE SET SPEED

**CAN RES** Press the button.

Your vehicle speed returns to the previously set speed and gap setting. The set speed displays continuously in the instrument cluster display when the system is active.

**Note:** Only use resume if you are aware of the set speed and intend to return to it.

## OVERRIDING THE SET SPEED

 **WARNING:** If you override the system by pressing the accelerator pedal, it does not automatically apply the brakes to maintain a gap from any vehicle ahead.

When you press the accelerator pedal, you override the set speed and gap distance.

Use the accelerator pedal to intentionally exceed the set speed limit.

When you override the system, the green indicator illuminates and the vehicle icon does not appear in the instrument cluster display.

The system resumes operation when you release the accelerator pedal. The vehicle speed decreases to the set speed, or a lower speed if following a slower vehicle.

## ADAPTIVE CRUISE CONTROL INDICATORS

 Illuminates when you switch adaptive cruise control on. The color of the indicator changes to indicate the system status.

White indicates the system is on but inactive.

Green indicates that you set the speed and the system is active.

# Adaptive Cruise Control (if Equipped)

## SWITCHING FROM ADAPTIVE CRUISE CONTROL TO CRUISE CONTROL



**WARNING:** Normal cruise control will not brake when your vehicle is approaching slower vehicles. Always be aware of which mode you have selected and apply the brakes when necessary.

1. From the driver assistance menu, press Cruise Control. See **Driver Assistance Menu** (page 483).
2. Press Normal Cruise Control.



When you select normal cruise control the cruise control indicator replaces the adaptive cruise control indicator. The gap setting does not display, and the system does not respond to lead vehicles. Automatic braking remains active to maintain the set speed. The system remembers the last setting when you start your vehicle.

## ADAPTIVE CRUISE CONTROL – TROUBLESHOOTING

### ADAPTIVE CRUISE CONTROL – INFORMATION MESSAGES

**Note:** Depending on your vehicle options and instrument cluster type, not all messages display or are available.

**Note:** The system could abbreviate or shorten certain messages depending upon which cluster type you have.

Message	Details
Front Sensor Not Aligned	Contact an authorized dealer to have the radar checked for proper coverage and operation.
Cruise Control Not Available	Conditions exist preventing the system from being available.
Adaptive Cruise Control Not Available Sensor Blocked See Manual	You have a blocked radar because of poor radar visibility due to inclement weather or ice, mud, or water in front of the sensor. You can typically clean the sensor to resolve this issue.  Due to the nature of sensor technology, it is possible to get a blockage warning with no actual block. This happens, for example, when driving in sparse rural or desert environments. A false blocked condition either self clears, or clears after you restart your vehicle.

## Adaptive Cruise Control (If Equipped)

---

<b>Message</b>	<b>Details</b>
Normal Cruise Active Adaptive Braking Off	You have selected normal cruise control. The system does not brake or react to traffic.
Adaptive Cruise - Driver Resume Control	Displays when the adaptive cruise control is going to cancel and you must take control.
Cruise Control Speed Too Low to Activate	Displays when the vehicle speed is too slow to activate the adaptive cruise control and there is no lead vehicle in range.

# G.O.A.T. Mode Control

## WHAT IS G.O.A.T. MODE CONTROL

Your vehicle has several goes over any-type of terrain (G.O.A.T.) modes that you can select for different driving conditions. Depending on the mode that you select, the system adjusts various vehicle settings.

This feature connects multiple vehicle systems through a single interface, providing you with enhanced vehicle control and driving dynamics for different driving scenarios, terrains, weather, or various road conditions.

## HOW DOES G.O.A.T. MODE CONTROL WORK

Each selectable mode changes various electronic and mechanical settings within your vehicle to tailor its performance and driving characteristics to on-road or off-road driving conditions. The system may alter steering feel and effort, traction control, stability control, chassis controls, powertrain response, transmission shift points, four-wheel driveline setting, exhaust noise level and suspension dampening to predetermined settings, depending upon the mode that you select.

The system reverts to the normal mode each time you start your vehicle. At startup the system also displays a prompt on the instrument cluster display that gives you the option to return to the previously selected drive mode during the last ignition cycle. If you select yes, the system returns to the last selected drive mode and the default driveline settings associated with that mode. If you select no or do not make a selection within a short time, the system remains in normal mode and the driveline settings remain the same as selected in the prior ignition cycle.

**Note:** Your vehicle has diagnostic checks that continuously monitor all systems for proper operation. If a mode is unavailable due to a system fault, your vehicle defaults to normal mode and the driveline remains in the four-wheel drive setting that you last selected prior to the system fault.

## SELECTING A G.O.A.T. MODE - EXCLUDING: RAPTOR



Rotate the drive mode controller once to activate the drive mode selection menu in the instrument cluster display. Rotate the controller a second time to select and engage the drive mode.

**Note:** Mode changes are not available when the ignition is off or when the engine is not running.

**Note:** Button icons may vary.

**Note:** Do not perform this operation when cruise control or trail control is selected and active. The mode change may not occur as expected.

# G.O.A.T. Mode Control

**Note:** To optimize off-road driving performance, the system disables the brake over accelerator feature when in off-road modes, including Mud/Ruts, Sand, Baja, and Rock Crawl. A message displays in the instrument cluster when you select an off-road mode. See **G.O.A.T. Mode Control – Information Messages** (page 258). Brake over accelerator enables when an Off-Road mode is exited or during the next key cycle. Return to on-road modes, Normal, Eco, Sport or Slippery, when driving on regular roads. See **Brake Over Accelerator** (page 200).

## SELECTING A G.O.A.T. MODE - RAPTOR



Rotate the drive mode controller once to activate the drive mode selection menu in the instrument cluster display. Rotate the controller a second time to select and engage the drive mode.

**Note:** Mode changes are not available when the ignition is off or when the engine is not running.

**Note:** Button icons may vary.

**Note:** Do not perform this operation when cruise control or trail control is selected and active. The mode change may not occur as expected.

**Note:** To optimize off-road driving performance, the system disables the brake over accelerator feature when in off-road modes, including Mud/Ruts, Sand, Baja and Rock Crawl. A message displays in the instrument cluster when you select an off-road mode. See **G.O.A.T. Mode Control – Information Messages** (page 258). Brake over accelerator enables when an off-road mode is exited or during the next key cycle. Return to on-road modes, Normal, Eco, Sport or Slippery, when driving on regular roads. See **Brake Over Accelerator** (page 200).

## Selecting a Steering Mode



To change the steering feel, press the button on the steering wheel. The first press displays a pop-up message in the instrument cluster display for the selected mode and subsequent presses changes the selected mode.

The steering modes displayed and available depend on the current G.O.A.T. mode status:

- G.O.A.T. modes - Normal, Slippery, Sport, and Tow/Haul display Normal, Sport, and Comfort.
- G.O.A.T. modes - Baja, Off-Road, and Rock Crawl display Normal, Sport, Comfort, and Off-Road steering modes.

Modes:

- Normal – Developed to complement vehicle response during daily driving.
- Sport – Slightly less assist and damping for improved steering feel during spirited driving.

# G.O.A.T. Mode Control

- Comfort – Slightly more assist for driver preference and daily driving ease.
- Off-road – Similar assist to Normal with added damping for improved control during off-road driving.
- Baja – Loudest setting for off-road use only. Maximum exhaust noise under all driving conditions.
- Quiet – Quietest setting for maximum comfort under all driving conditions.

After selecting the desired setting, you may feel a soft feedback bump in the steering wheel when the changeover occurs.

**Note:** *If you disconnect or remove the battery, the steering system defaults to normal.*

## Selecting a Suspension Mode



To change the suspension feel, press the button on the steering wheel. The first press displays a pop-up message in the instrument cluster display for the selected mode and subsequent presses changes the selected mode.

Modes:

- Normal – Default factory setting.
- Sport – Slightly stiffer suspension with emphasis on handling and control.
- Off-road – Maximizes shock performance in extreme off-road environments.

## Selecting an Exhaust Mode



To change the exhaust sound, press the button on the steering wheel. The first press displays a pop-up message in the instrument cluster display for the selected mode and subsequent presses changes the selected mode.

Modes:

- Normal – Default setting provides a balance of comfort and feedback.
- Sport – Slightly louder than normal for spirited driving.

## Quiet Start

Quiet start allows you to schedule when the exhaust mode turns on the quiet setting. The time window can be from 1 to 24 hours.

Enabling and disabling quiet start:

1. Press Settings.
2. Press Vehicle.
3. Press Quiet Start.
4. Press Settings.

Setting quiet time:

1. Press Settings.
2. Press Vehicle.
3. Press Quiet Start.
4. Press Set Quiet Time.
5. Set your desired start and end times.

## MyMode



You can use MyMode to create one custom vehicle configuration based on the current state of your vehicle.

When you have your vehicle configured to your desired settings, press and hold the button for a few seconds to save as MyMode.

Double-pressing the button activates your saved MyMode.

You can check the saved MyMode settings with a single press of the button.

You can save the following settings as MyMode:

- Drive mode.
- Steering mode.

# G.O.A.T. Mode Control

- Suspension mode.
- Exhaust mode.
- Four-wheel drive mode.
- Stop and start on or off.
- Rear electronic locking differential on or off.

**Note:** MyMode settings can only be made with configurations that are available to each individual drive mode.

**Note:** You can save or view MyMode at any time, regardless of your vehicle's speed or transmission selection, as long as your vehicle is running and it meets system conditions.

**Note:** When activating MyMode, your vehicle must meet all preconditions for the drive mode and various settings before it activates. A message appears if it does not meet system conditions.

## G.O.A.T. MODES

### BAJA - EXCLUDING: RAPTOR



For high speed off-road driving. Baja mode optimizes the throttle control for better response and torque delivery.

Four-wheel drive high (4H) is the default four-wheel drive mode. Four-wheel drive auto (4A) is not selectable in Baja mode.

The front electronic locking differential is available below 40 km/h (25 mph) when in four-wheel drive low (4L). The rear electronic locking differential is available at any speed in all selectable four-wheel drive modes.

The stabilizer bar disconnect is available in four-wheel drive high (4H) or four-wheel drive low (4L).

**Note:** This mode is for off-road use only. Depending on the four-wheel drive mode selected when using Baja mode on dry/hard pavement, your vehicle could experience vibration, driveline bind up, damage and potential excessive tire and vehicle wear.

### BAJA - RAPTOR



For high speed off-road driving. Baja mode optimizes the throttle control for better response and torque delivery.

Four-wheel drive high (4H) is the default four-wheel drive mode but two-wheel drive high (2H) is available. Four-wheel drive auto (4A) is not available in Baja mode.

Off-Road is the default steering and suspension mode. All steering and suspension modes are available.

Baja is the default exhaust mode. All exhaust modes are available. The system tunes the engine, transmission, stability and traction controls to Baja mode.

The rear electronic locking differential is available at all speeds in four-wheel drive, and the front electronic locking differential is available in four-wheel drive low (4L). See **Switching the Electronic Locking Differential On and Off** (page 194).

The stabilizer bar is connected by default but can be disconnected up to 80 km/h (50 mph).

**Note:** This mode is for off-road use only. Depending on the four-wheel drive mode selected when using Baja mode on dry, hard pavement, your vehicle could experience vibration, driveline bind up, damage and potential excessive tire and vehicle wear.



# G.O.A.T. Mode Control

## ECO - EXCLUDING: RAPTOR



For efficient driving. This mode promotes efficient driving which allows for an extended driving range.

Two-wheel drive high (2H) is the default four-wheel drive mode. Four-wheel drive low (4L) is not selectable in Eco mode.

The front electronic locking differential is not available in Eco mode. The rear electronic locking differential is available below 40 km/h (25 mph).

The stabilizer bar disconnect is not available in Eco mode.

## MUD/RUTS - EXCLUDING: RAPTOR



For off-road driving. This mode enhances vehicle performance to traverse muddy, rutted or uneven terrains.

Four-wheel drive high (4H) is the default four-wheel drive mode. Four-wheel drive low (4L) is selectable in Mud/Ruts mode.

The front electronic locking differential is available below 40 km/h (25 mph) when in four-wheel drive low (4L). The rear electronic locking differential is engaged when in Mud/Ruts mode and is available at any speed in all selectable four-wheel drive modes.

The stabilizer bar disconnect is available in four-wheel drive high (4H) or four-wheel drive low (4L).

**Note:** *This is for off-road use only. Depending on the four-wheel drive mode you select when using Mud/Ruts mode on dry, hard pavement, your vehicle could experience vibration, driveline bind up, damage and potential excessive tire and vehicle wear.*

**Note:** *Automatic disconnect is not available with some vehicle options.*

## NORMAL - EXCLUDING: RAPTOR



For everyday driving. This mode is the perfect balance of excitement, comfort and convenience. The vehicle returns to Normal mode if you do not choose to return to the previous drive mode at each key cycle. Driveline settings remain as they were previously regardless of selection.

Two-wheel drive high (2H) is the default four-wheel drive mode. All four-wheel drive modes are selectable when in Normal mode.

The front electronic locking differential is available below 40 km/h (25 mph) when in four-wheel drive low (4L). The rear electronic locking differential is available below 40 km/h (25 mph).

**Note:** *The rear electronic locking differential is available at any speed when in four-wheel drive low (4L).*

The stabilizer bar disconnect is available in four-wheel drive high (4H) or four-wheel drive low (4L).

## NORMAL - RAPTOR



For everyday driving. This mode is the perfect balance of excitement, comfort and convenience. This is the default mode after each ignition cycle.

Two-wheel drive high (2H) is the default four-wheel drive mode. All four-wheel drive modes are selectable when in Normal mode. Normal is the default for the steering, suspension and exhaust modes. Off-Road steering mode is not available. All suspension and exhaust modes are available.

# G.O.A.T. Mode Control

The system tunes the engine and transmission controls and the stability and traction controls to Normal mode.

The rear electronic locking rear differential is available below 40 km/h (25 mph), and both locking differentials are available below 40 km/h (25 mph) when four-wheel drive low (4L) is selected in the transfer case. See **Switching the Electronic Locking Differential On and Off** (page 194).

The stabilizer bar can be disconnected at speeds below 48 km/h (30 mph). Trail one pedal, trail control, and trail turn assist are also available.

## OFF-ROAD - RAPTOR



For off-road driving through sand, loose gravel, mud or mixed off-road terrain.

This mode optimizes accelerator pedal response, traction and stability controls to enhance vehicle performance in off-road environments. If your vehicle becomes stuck in deep conditions, this mode may be preferred.

Four-wheel drive high (4H) is the default four-wheel drive mode. Four-wheel drive low (4L) is selectable, but two-wheel drive high (2H) and four-wheel drive auto (4A) are not available. Off-road is the default steering and suspension mode. Sport is the default exhaust mode, but all steering, suspension, and exhaust modes are available.

The system tunes the engine, transmission, stability and traction control to off-road mode.

The rear electronic locking differential engages when you select this mode at any speed, and you can disengage it at any time using the button. The front electronic locking differential can be engaged in 4L. See **Switching the Electronic Locking Differential On and Off** (page 194).

The stabilizer bar can be disconnected at speeds below 80 km/h (50 mph). The camera system also turns on.

**Note:** *Do not use this mode when driving on pavement or packed snow. This could cause driveline bind up and damage the system depending on the four-wheel drive mode selection. See **Four-Wheel Drive** (page 182).*

## ROCK CRAWL - EXCLUDING: RAPTOR



For off-road driving and optimum rock-climbing ability. Rock Crawl mode optimizes the throttle and transmission response to provide you additional control of your vehicle.

Four-wheel drive low (4L) is the only driveline configuration available in Rock Crawl, the system prompts you to put your vehicle into four-wheel drive low (4L) upon selection.

The front electronic locking differential is available below 40 km/h (25 mph) when in four-wheel drive low (4L). The rear electronic locking differential is engaged when in Rock Crawl mode and is available at any speed.

The stabilizer bar disconnects when in Rock Crawl mode.

**Note:** *This mode is for off-road use only. When using Rock Crawl mode on dry/hard pavement, your vehicle could experience vibration, driveline bind up, damage and potential excessive tire and vehicle wear.*

# G.O.A.T. Mode Control

## ROCK CRAWL - RAPTOR



For off-road driving and optimum rock-climbing capability.

Rock Crawl mode has the following features:

- Engages both front and rear electronic locking differentials.
- Disconnects the stabilizer bar.
- Turns on the cameras.
- Optimizes throttle response.
- Adjusts transmission shift points to provide additional control of your vehicle.

Four-wheel drive low (4L) is the only transfer case option available in Rock Crawl mode. Off-Road is the default steering setting, but all steering modes are available. Off-Road is the default suspension mode, and Normal is the default exhaust mode. The system tunes the engine and transmission controls to Rock Crawl mode.

The electronic locking differentials engage when you select this mode, and you can disengage them at any time using the buttons. See **Switching the Electronic Locking Differential On and Off** (page 194).

The stabilizer bar can be disconnected at speeds below 80 km/h (50 mph).

**Note:** *This mode is for off-road use only. When using Rock Crawl mode on dry/hard pavement, your vehicle could experience vibration, driveline bind up, damage and potential excessive tire and vehicle wear.*

## SAND - EXCLUDING: RAPTOR



For off-road driving on soft, dry sand or deep snow. This mode may help get your vehicle unstuck from deep snow or sand.

Four-wheel drive high (4H) is the default four-wheel drive mode. Four-wheel drive low (4L) is selectable in Sand mode.

The front electronic locking differential is available below 40 km/h (25 mph) when in four-wheel drive low (4L). The rear electronic locking differential is engaged when in Sand mode and is available at any speed in all selectable four-wheel drive modes.

The stabilizer bar disconnect is available in four-wheel drive high (4H) or four-wheel drive low (4L).

**Note:** *The front camera system switches on when you are in Sand mode and your speed is less than 24 km/h (15 mph). If you exceed 24 km/h (15 mph), the camera shuts off until your vehicle speed is below 20 km/h (12 mph).*

**Note:** *This mode is for off-road use only. When using Sand mode on dry/hard pavement, your vehicle could experience vibration, driveline bind up, damage and potential excessive tire and vehicle wear.*

**Note:** *Sand mode is not intended for use on firm, slippery surfaces, such as paved roads covered with snow or ice. For slippery, firm surfaces use Slippery mode.*

## SLIPPERY - ADVANCED 4X4 WITH 4A MODE, EXCLUDING: RAPTOR



Use this mode for driving on a firm surface that is covered with loose or slippery material, such as snow or ice. Slippery mode lowers throttle response and optimizes shifting for slippery surfaces.

# G.O.A.T. Mode Control

Four-wheel drive auto (4A) is the default four-wheel drive mode. Two-wheel drive high (2H) is not selectable in Slippery mode.

The front electronic locking differential is available below 40 km/h (25 mph) when in four-wheel drive low (4L). The rear electronic locking differential is available below 40 km/h (25 mph).

**Note:** *The rear electronic locking differential is available at any speed when in four-wheel drive low (4L).*

The stabilizer bar disconnect is not available in Slippery mode.

**Note:** *Do not use this mode on dry pavement. Depending on the four-wheel drive mode selected when using Slippery mode on dry/hard pavement, your vehicle could experience vibration, driveline bind up, damage and potential excessive tire and vehicle wear.*

## SLIPPERY - 4X4 WITH PART TIME ENGAGEMENT



Use this mode for driving on a firm surface that is covered with loose or slippery material, such as snow or ice. Slippery mode lowers throttle response and optimizes shifting for slippery surfaces.

Four-wheel drive high (4H) is the default four-wheel drive mode. All four-wheel drive modes are selectable in Slippery mode.

The rear electronic locking differential is available below 40 km/h (25 mph).

**Note:** *The rear electronic locking differential is available at any speed when in four-wheel drive low (4L).*

The stabilizer bar disconnect is not available in Slippery mode.

**Note:** *Do not use this mode on dry pavement. Depending on the four-wheel drive mode selected when using Slippery mode on dry hard pavement, your vehicle could experience vibration, driveline bind up, damage and potential excessive tire and vehicle wear.*

## SLIPPERY - RAPTOR



For less than ideal road conditions such as snow or ice covered roads.

Use this mode for crossing terrain where loose or slippery materials cover a firm surface. Slippery mode lowers throttle response and optimizes shifting for slippery surfaces.

Four-wheel drive auto (4A) is the default four-wheel drive mode. Two-wheel drive high (2H) is not available in Slippery mode.

Normal is the default steering, suspension, and exhaust modes. Off-Road steering mode is not available, but all suspension and exhaust modes are available.

The system tunes the engine, transmission controls and the stability and traction control modes to Normal mode.

The rear electronic locking differential is available below 40 km/h (25 mph), and the front electronic locking differential is available in four-wheel drive (4L). See

**Switching the Electronic Locking Differential On and Off** (page 194).

The stabilizer bar disconnect is not available in Slippery mode.

**Note:** *Do not use this mode on dry pavement. Depending on the four-wheel drive mode selected when using Slippery mode on dry/hard pavement, your vehicle could experience vibration, driveline bind up, damage and potential excessive tire and vehicle wear.*

# G.O.A.T. Mode Control

## SPORT - ADVANCED 4X4 WITH 4A MODE, EXCLUDING: RAPTOR



For sporty driving with improved performance handling and response. This mode increases accelerator pedal response and provides a sportier steering feel. The powertrain system holds onto lower gears longer, helping your vehicle accelerate faster.

Four-wheel drive auto (4A) is the default four-wheel drive mode. Four-wheel drive low (4L) is not selectable in Sport mode.

The front electronic locking differential is not available in Sport mode. The rear electronic locking differential is available below 40 km/h (25 mph).

The stabilizer bar disconnect is not available in Sport mode.

## SPORT - 4X4 WITH PART TIME ENGAGEMENT



For sporty driving with improved performance handling and response. This mode increases accelerator pedal response and provides a sportier steering feel. The powertrain system holds onto lower gears longer, helping your vehicle accelerate faster.

Two-wheel drive high (2H) is the default four-wheel drive mode. Four-wheel drive low (4L) is not selectable in Sport mode.

The front electronic locking differential is not available in Sport mode. The rear electronic locking differential is available below 40 km/h (25 mph).

The stabilizer bar disconnect is not available in Sport mode.

## SPORT - RAPTOR



For sporty driving with improved performance, handling and response.

This mode increases accelerator pedal response and provides a sportier steering feel. The powertrain system holds onto lower gears longer, helping your vehicle accelerate faster.

Two-wheel drive high (2H) is the default four-wheel drive mode. Four-wheel drive low (4L) is not available in Sport mode. Sport is the default steering, suspension and exhaust modes, and the stabilizer bar is connected by default.

The system tunes the engine and transmission controls to Sport mode. The system tunes the stability and traction controls to Normal mode.

The rear electronic locking differential is available below 40 km/h (25 mph), but the front electronic locking differential is not available. See **Switching the Electronic Locking Differential On and Off** (page 194).

## TOW/HAUL - RAPTOR



For improved transmission operation when towing a trailer or a heavy load. This mode moves upshifts to higher engine speeds to reduce the frequency of transmission shifting.

Tow/Haul mode also provides engine braking in all forward gears, which slows your vehicle and assists you in controlling your vehicle when descending a slope. The amount of downshift braking provided varies based on the amount of pressure you apply to the brake pedal.

The following apply to Tow/Haul mode:

# G.O.A.T. Mode Control

- All four-wheel drive modes are selectable. There is no default four-wheel drive mode and the previous selection is maintained when the vehicle is restarted.
- Normal is the default for the steering, exhaust and suspension modes.
- Off-Road steering mode is not available.
- Sport suspension is available.
- Off-Road suspension mode is not available.
- Stabilizer bar cannot be disconnected.

The system tunes the engine and transmission controls to tow mode. The system tunes the stability and traction controls to normal mode.

The rear electronic locking differential is available below 40 km/h (25 mph) and the front electronic locking differential is available in four-wheel drive low (4L). See

**Switching the Electronic Locking Differential On and Off** (page 194).

## G.O.A.T. MODE CONTROL – TROUBLESHOOTING

## G.O.A.T. MODE CONTROL – WARNING LAMPS



Some drive modes reduce traction and stability control performance and the indicator illuminates in the instrument cluster.

## G.O.A.T. MODE CONTROL – INFORMATION MESSAGES

Message	Details
Drive Mode Not Available	Displays when you select a drive mode that is not available. Select a different drive mode.
Drive Mode Preconditions Not Met	Displays when you select a drive mode that is not available. Check the four-wheel drive mode, electronic locking differential and stabilizer bar before selecting a drive mode.
Drive Mode Selection Reduced due to System Fault	Displays when you select a drive mode that is not available. Have the system checked.
Off-Road Use Only	Displays when you select an off-road drive mode.

## G.O.A.T. Mode Control

---

<b>Message</b>	<b>Details</b>
Selected 4x4 Mode Not Available in Current Drive Mode	Displays when you select a four-wheel drive mode that is not available in the current drive mode. Select an available four-wheel drive mode.
Selected Locking Differential Not Available in Current Drive Mode	Displays when you select an electronic locking differential that is not available in the current drive mode. Select an available electric locking differential.
Sta-Bar Disconnect Not Available In Selected Drive Mode	Displays when you attempt to disconnect the stabilizer bar in the current drive mode. Select a different drive mode to disconnect the stabilizer bar.

# G.O.A.T. Mode Control

---

## **G.O.A.T. MODE CONTROL – FREQUENTLY ASKED QUESTIONS**

### **Why did the system default to normal mode?**

- If a mode is unavailable due to a system fault, Normal mode is selected and the driveline settings remain the same as prior to the system fault.

## **G.O.A.T. MODE CONTROL VIDEOS**

[\*Bronco 4x4 Systems\*](#)



# Lane Keeping System (If Equipped)

## WHAT IS THE LANE KEEPING SYSTEM

The lane keeping system alerts you by providing temporary steering assistance or steering wheel vibration when it detects an unintended lane departure.

## HOW DOES THE LANE KEEPING SYSTEM WORK

The lane keeping system uses a forward looking camera mounted on the windshield to monitor vehicle movement within the lane of travel.

When the camera detects a drift out of the lane of travel, the lane keeping system alerts the driver by vibrating the steering wheel, or aids the driver by providing a small steering input to move the vehicle back into the lane of travel.

The driver can select one of three modes:

- Alert (if equipped)
- Aid
- Alert + Aid

## LANE KEEPING SYSTEM PRECAUTIONS



**WARNING:** You are responsible for controlling your vehicle at all times. The system is designed to be an aid and does not relieve you of your responsibility to drive with due care and attention. Failure to follow this instruction could result in the loss of control of your vehicle, personal injury or death.



**WARNING:** The system will not operate if the sensor cannot track the road lane markings.



**WARNING:** The sensor may incorrectly track lane markings as other structures or objects. This can result in a false or missed warning.



**WARNING:** In cold and severe weather conditions the system may not function. Rain, snow and spray can all limit sensor performance.



**WARNING:** The system may not operate properly if the sensor is blocked. Keep the windshield free from obstruction.



**WARNING:** If damage occurs in the immediate area surrounding the sensor, have your vehicle checked as soon as possible.



**WARNING:** The system may not correctly operate if your vehicle is fitted with a suspension kit not approved by us.



**WARNING:** Large contrasts in outside lighting can limit sensor performance.

## LANE KEEPING SYSTEM LIMITATIONS

The lane keeping system only operates when the vehicle speed is greater than 64 km/h (40 mph).

The system works when the camera can detect at least one lane marking or the edge of the road.

The lane keeping system may not correctly operate in any of the following conditions:

- The lane keeping system does not detect at least one lane marking.
- You switch the turn signal on.

# Lane Keeping System (If Equipped)

- You apply direct steering, accelerate fast or brake hard.
- The vehicle speed is less than 64 km/h (40 mph).
- The anti-lock brake, stability control or traction control system activates.
- The lane is too narrow.
- Something is obscuring the camera or it is unable to detect the lane markings due to environment, traffic or vehicle conditions.

The lane keeping system may not correct lane positioning in any of the following conditions:

- High winds.
- Uneven road surfaces.
- Heavy or uneven loads.
- Incorrect tire pressure.

## SWITCHING THE LANE KEEPING SYSTEM ON AND OFF



To activate the lane keeping system, press the button on the steering wheel.

To deactivate the lane keeping system, press the button again.

**Note:** When switching the system on or off a message appears in the instrument cluster display to show the status.

**Note:** The system stores the on or off setting until manually changed. For some markets, the system defaults to the ON setting at every Ignition cycle.

## SWITCHING THE LANE KEEPING SYSTEM MODE

1. From the driver assistance menu, press Lane Keeping System. See **Driver Assistance Menu** (page 483).
2. Press Lane-Keeping Mode.
3. Select a mode.

**Note:** The system remembers the last setting when you start your vehicle.

## LANE KEEPING SYSTEM SETTINGS

### Adjusting the Steering Wheel Vibration Intensity

1. From the driver assistance menu, press Lane Keeping System. See **Driver Assistance Menu** (page 483).
2. Press Lane Keeping Intensity.
3. Select a setting.

**Note:** This setting is not available in all modes.

## ALERT MODE

### WHAT IS ALERT MODE

Alert mode vibrates the steering wheel when it detects an unintended lane departure.

# Lane Keeping System (If Equipped)

## HOW DOES ALERT MODE WORK

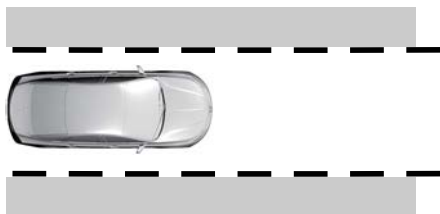

When in alert mode, the lane keeping system alerts you by vibrating the steering wheel. The intensity of the vibration is set through the lane keeping system menu.

## AID MODE

### WHAT IS AID MODE

Aid mode provides temporary steering assistance toward the center of the lane.

### HOW DOES AID MODE WORK

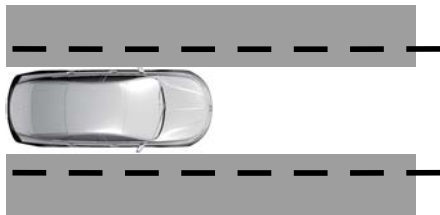

The lane keeping system aids you when an unintentional lane departure occurs. The system provides a small steering input to move the vehicle towards the center of the lane.

## ALERT AND AID MODE

### WHAT IS ALERT AND AID MODE

Alert and aid mode uses multiple features to keep you in your lane. The system first provides a small steering input to bring your vehicle back towards the center of the lane. If your vehicle moves too far from the center of the lane the system alerts you with vibration in the steering wheel.

### HOW DOES ALERT AND AID MODE WORK

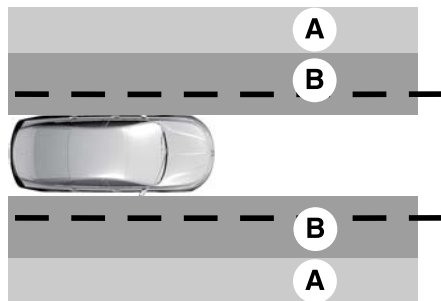

- A Alert.
- B Aid.

The lane keeping system detects a lane departure and provides aid when the vehicles enters **B** and applies the additional alert warning if **A** is entered.

# Lane Keeping System (If Equipped)

## LANE KEEPING SYSTEM INDICATORS



If you switch the lane keeping system on, a graphic with lane markings appears in the information display.

When you switch the system off, the lane marking graphics do not display.

**Note:** *The overhead vehicle graphic may still display if adaptive cruise control is enabled.*

While the lane keeping system is on, the color of the lane markings change to indicate the system status.

Gray	Green	Yellow	Red
Indicates that the system is temporarily unavailable to provide a warning or intervention on the indicated side.	Indicates that the system is available or ready to provide a warning or intervention on the indicated side.	Indicates that the system is providing or has just provided a lane keeping aid intervention.	Indicates that the system is providing or has just provided a lane keeping alert warning.

# Lane Keeping System (If Equipped)

---

## LANE KEEPING SYSTEM – TROUBLESHOOTING

### LANE KEEPING SYSTEM – INFORMATION MESSAGES

<b>Message</b>	<b>Action</b>
Lane Keeping Sys. Malfunction Service Required	The system has malfunctioned. Have your vehicle checked as soon as possible.
Front Camera Temporarily Not Available	The system has detected a condition that has caused the system to be temporarily unavailable.
Front Camera Low Visibility Clean Screen	The system has detected a condition that requires you to clean the windshield in order for it to operate properly.
Front Camera Malfunction Service Required	The system has malfunctioned. Have your vehicle checked as soon as possible.
Keep Hands on Steering Wheel	The system requests that you keep your hands on the steering wheel.

# Lane Keeping System (If Equipped)

---

## LANE KEEPING SYSTEM – FREQUENTLY ASKED QUESTIONS

### Why is the feature not available (lane markings are gray) when I can see the lane markings on the road?

- Your vehicle speed is less than 40 mph (65 km/h).
- The sun is shining directly into the camera lens.
- A quick intentional lane change has occurred.
- You are driving your vehicle too close to the lane markings for an extended interval of time.
- Driving at high speeds in curves.
- The last alert warning or aid intervention occurred a short time ago.
- Ambiguous lane markings, for example, in construction zones.
- Rapid transition from light to dark, or from dark to light.
- Sudden offset in lane markings.
- ABS or AdvanceTrac™ is active.
- There is a camera blockage due to dirt, grime, fog, frost or water on the windshield.
- You are driving too close to the vehicle in front of you.
- Transitioning between no lane markings to lane markings, or vice versa.
- There is standing water on the road.
- Faint lane markings, for example, partial yellow lane markings on concrete roads.
- Lane width is too narrow or too wide.
- You have not calibrated the camera after a windshield replacement.

- Driving on roads with tight curves or uneven surfaces.

### Why does the vehicle not come back toward the middle of the lane, as expected, in the Aid, or Aid + Alert mode?

- High cross winds are present.
- There is a large road crown.
- Rough roads, grooves or shoulder drop-offs.
- Heavy, uneven loading of the vehicle or improper tire inflation pressure.
- You changed the tires or modified the suspension.

# Blind Spot Information System (If Equipped)

## WHAT IS BLIND SPOT INFORMATION SYSTEM

Blind spot information system detects vehicles that may have entered the blind spot zone.

## HOW DOES BLIND SPOT INFORMATION SYSTEM WORK

Blind spot information system uses sensors on both sides of your vehicle, detecting rearward from the exterior mirrors to approximately 4 m (13 ft) beyond the rear bumper. The detection area extends to approximately 18 m (59 ft) beyond the rear bumper when the vehicle speed is greater than 48 km/h (30 mph) to alert you of faster approaching vehicles.

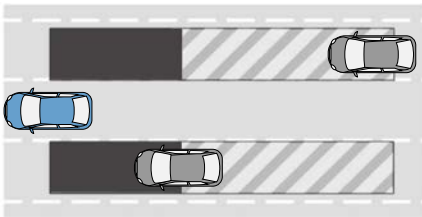

## BLIND SPOT INFORMATION SYSTEM PRECAUTIONS



**WARNING:** Do not use the blind spot information system as a replacement for using the interior and exterior mirrors or looking over your shoulder before changing lanes. The blind spot information system is not a replacement for careful driving.



**WARNING:** The system may not operate properly during severe weather conditions, for example snow, ice, heavy rain and spray. Always drive with due care and attention. Failure to take care may result in a crash.

**Note:** *Blind spot information system does not prevent contact with other vehicles. It does not detect parked vehicles, pedestrians, animals or other infrastructure.*

## BLIND SPOT INFORMATION SYSTEM LIMITATIONS

Blind spot information system does not operate in park (P) or reverse (R).

The system may not alert you if a vehicle quickly passes through the detection zone while overtaking.

**Note:** *For vehicles without the trailer coverage feature, we recommend that you switch the blind spot information system off when you attach a trailer.*

## BLIND SPOT INFORMATION SYSTEM REQUIREMENTS

The blind spot information system turns on when all the following occur:

- You start your vehicle.
- You shift into neutral or any forward gear.
- The vehicle speed is greater than 10 km/h (6 mph).

**Note:** *The system does not operate in reverse (R).*

# Blind Spot Information System (If Equipped)

## BLIND SPOT INFORMATION SYSTEM REQUIREMENTS

Blind spot information system turns on when all the following occur:

- You start your vehicle.
- You shift into drive (D).
- The vehicle speed is greater than 10 km/h (6 mph).

## SWITCHING BLIND SPOT INFORMATION SYSTEM ON AND OFF

1. From the driver assistance menu, press Blind Spot Information System. See **Driver Assistance Menu** (page 483).
2. Switch Blind Spot Information System on or off.

When you switch the blind spot information system off, a warning lamp illuminates. When you switch the system on or off, the alert indicators flash twice. A telltale remains illuminated in the instrument cluster when you switch the blind spot information system off in the settings menu.

**Note:** The system remembers the last setting when you start your vehicle.

## LOCATING THE BLIND SPOT INFORMATION SYSTEM SENSORS

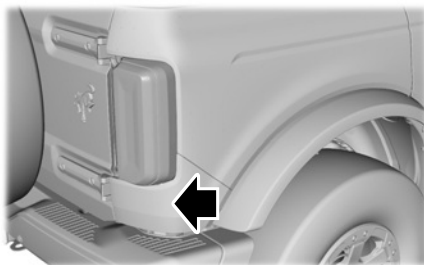

The sensors are behind the rear fascia panel.

Keep the sensors free from snow, ice and large accumulations of dirt.

**Note:** Do not cover the sensors with bumper stickers, repair compound or other objects.

**Note:** Bike and cargo racks could cause false alerts due to obstruction of the sensor. We recommend switching the feature off when using a bike or cargo rack.

**Note:** Blocked sensors may affect system accuracy.

**Note:** Blind spot information system will not function if you attach a trailer to your vehicle.

If the sensors become blocked, a message appears in the instrument cluster display. See **Blind Spot Information System – Information Messages** (page 270). The alert indicators illuminate but the system does not alert you.



## Blind Spot Information System (If Equipped)

### LOCATING THE BLIND SPOT INFORMATION SYSTEM SENSORS

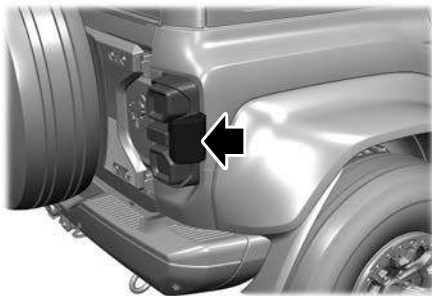

The sensors are behind the rear tail lamps. Keep the sensors free from snow, ice and large accumulations of dirt.

**Note:** Do not cover the sensors with bumper stickers, repair compound or other objects.

**Note:** Bike and cargo racks could cause false alerts due to obstruction of the sensor. We recommend switching the feature off when using a bike or cargo rack.

**Note:** Blocked sensors may affect system accuracy.

**Note:** Blind spot information system will not function if you attach a trailer to your vehicle.

If the sensors become blocked, a message appears in the instrument cluster display. See **Blind Spot Information System – Information Messages** (page 270). The alert indicators illuminate but the system does not alert you.

### BLIND SPOT INFORMATION SYSTEM INDICATORS



When blind spot information system detects a vehicle, an alert indicator illuminates in the exterior mirror on the side the approaching vehicle is coming from. If you turn the turn signal on for that side of your vehicle, the alert indicator flashes.

# Blind Spot Information System (If Equipped)

## BLIND SPOT INFORMATION SYSTEM – TROUBLESHOOTING

### BLIND SPOT INFORMATION SYSTEM – INFORMATION MESSAGES

Message	Action
Blind Spot System Fault	A fault with the system has occurred. Have your vehicle checked as soon as possible.
Blind Spot Not Available Sensor Blocked See Manual	Something is blocking the sensors. Clean the sensors.
Blind Spot Alert Deactivated Trailer Attached	The system automatically turns off and displays this message when you connect a trailer to your vehicle under any of the following conditions: <ul style="list-style-type: none"><li>- Your vehicle does not have blind spot information system with trailer coverage.</li><li>- You switch the blind spot information system off through the touchscreen.</li><li>- Your trailer exceeds the limits for the system. Only appears if your vehicle has blind spot information system with trailer coverage.</li></ul>

**Note:** When connecting a trailer, the system may detect the trailer and turn the system OFF. If the system does not automatically turn OFF, manually switch the blind spot information system OFF. If your vehicle has the blind spot information system with trailer coverage, the system prompts you to set up a trailer that allows the feature to function, if your trailer meets the requirements of the system.

# Cross Traffic Alert (If Equipped)

## WHAT IS CROSS TRAFFIC ALERT

The system is designed to alert you of road users and traffic objects approaching from the rear sides and from behind your vehicle when you shift into reverse (R).

If you continue to reverse after the system alerts you, the system is designed to apply the brakes if it still detects approaching road users or traffic objects. If the system applies the brakes, a message appears in the instrument cluster display.

**Note:** *There could be instances when unexpected or unwanted braking occurs. You can override this by firmly pressing the accelerator pedal.*

## HOW DOES CROSS TRAFFIC ALERT WORK

Cross Traffic Alert is designed to detect road users or traffic objects approaching above a minimum speed of 8 km/h (5 mph). Coverage can decrease when the sensors are partially, mostly or fully obstructed.

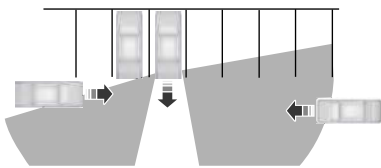

The sensor on the left-hand side is only partially obstructed and zone coverage on the right-hand side is maximized.

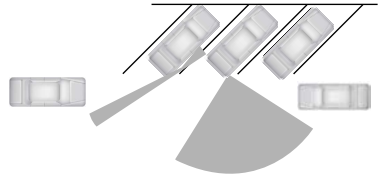

Zone coverage also decreases when parking at narrow angles. The sensor on the left-hand side is mostly obstructed and zone coverage on that side is severely reduced.

**Note:** *Slowly reversing helps increase the coverage area and effectiveness.*

The system only applies the brakes for a short period of time when an event occurs. Take action as soon as you notice the system applying the brakes in order to remain in control of your vehicle, the system does not do this for you.

## CROSS TRAFFIC ALERT PRECAUTIONS

**WARNING:** You are responsible for controlling your vehicle at all times. The system is designed to be an aid and does not relieve you of your responsibility to drive with due care and attention. Failure to follow this instruction could result in the loss of control of your vehicle, personal injury or death.

**WARNING:** If damage occurs in the immediate area surrounding the sensor, have your vehicle checked as soon as possible.

## Cross Traffic Alert (If Equipped)



**WARNING:** To help avoid personal injury, always use caution when in reverse (R) and when using the sensing system.



**WARNING:** The system may not operate properly during severe weather conditions, for example snow, ice, heavy rain and spray. Always drive with due care and attention. Failure to take care may result in a crash.



**WARNING:** The system may not detect objects with surfaces that absorb reflection. Always drive with due care and attention. Failure to take care may result in a crash.



**WARNING:** Traffic control systems, fluorescent lamps, inclement weather, air brakes, external motors and fans may affect the correct operation of the sensing system. This may cause reduced performance or false alerts.



**WARNING:** Some situations and objects prevent hazard detection, for example, inclement weather, unconventional vehicle types and pedestrians. Apply the brakes when necessary. Failure to follow this instruction could result in the loss of control of your vehicle, personal injury or death.



**WARNING:** Do not use the system with accessories that extend beyond the front or rear of your vehicle, for example a trailer hitch or bike rack. The system is not able to make corrections for the additional length of the accessories.



**WARNING:** Do not use the cross traffic alert system as a replacement for using the interior and exterior mirrors or looking over your shoulder before reversing out of a parking space. The cross traffic alert system is not a replacement for careful driving.

**Note:** *Certain add-on devices around the bumper or fascia may cause unexpected system behavior. For example, large trailer hitches, bicycle or surfboard racks, license plate brackets, fuel containers, bumper covers or any other device may block the normal detection zone of the system. Remove the add-on device to prevent unexpected system behavior.*

**Note:** *If your vehicle sustains damage to the bumper or fascia leaving it misaligned or bent, it could alter the sensing zone causing inaccurate measurement of obstacles or false alerts.*

**Note:** *Vehicle loading and suspension changes can impact the angle of the sensors and may change the normal detection zone of the system resulting in inaccurate measurement of obstacles or false alerts.*

**Note:** *You may experience reduced system performance on road surfaces that limit deceleration. For example, roads with ice, loose gravel, mud or sand.*

### CROSS TRAFFIC ALERT LIMITATIONS

The system may not correctly operate when any of the following occur:

- Something is blocking the sensors.
- Adjacently parked vehicles or objects are obstructing the sensors.
- Traffic objects approach at speeds less than 8 km/h (5 mph) or greater than 60 km/h (37 mph).

## Cross Traffic Alert (If Equipped)

- Your vehicle speed is greater than 12 km/h (7 mph).
- You reverse out of an angled parking space.
- If you switch the traction system off, cross traffic alert does not apply the brakes.

**Note:** The system does not alert for small stationary and moving objects.

### Cross Traffic Alert Limitations with a Trailer Attached

The system remains on when you attach a trailer to vehicles with blind spot information system with trailer coverage under the following conditions:

- You connect a bike rack or cargo rack with a maximum length of 1 m (3 ft).
- You set the trailer length to 1 m (3 ft) in the touchscreen.

**Note:** The system may not correctly operate when towing a trailer. For vehicles with an approved trailer tow module and tow bar, the system turns off when you attach a trailer greater than 1 m (3 ft). For vehicles with an aftermarket trailer tow module or tow bar, we recommend that you switch the system off when you attach a trailer.

### SWITCHING CROSS TRAFFIC ALERT ON AND OFF

1. From the driver assistance menu, press Cross Traffic Alert. See **Driver Assistance Menu** (page 483).
2. Switch the feature on or off.

When you switch the system on or off, the alert indicators flash twice.

**Note:** The system switches on every time you switch the ignition on.

### LOCATING THE CROSS TRAFFIC ALERT SENSORS

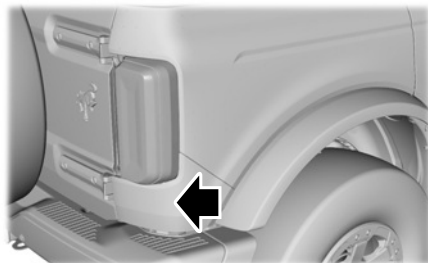

The sensors are behind the rear fascia panel.

**Note:** Keep the sensors free from snow, ice and large accumulations of dirt.

**Note:** Do not cover the sensors with bumper stickers, repair compound or other objects.

**Note:** Bike and cargo racks could cause false alerts due to obstruction of the sensor. We recommend switching the feature off when using a bike or cargo rack.

**Note:** Blocked sensors may affect system accuracy.

If something is blocking the sensors, a message may appear in the information display when you shift into reverse (R).

## Cross Traffic Alert (If Equipped)

### LOCATING THE CROSS TRAFFIC ALERT SENSORS

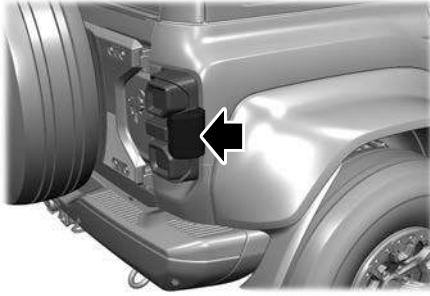

The sensors are behind the rear tail lamps.

**Note:** Keep the sensors free from snow, ice and large accumulations of dirt.

**Note:** Do not cover the sensors with bumper stickers, repair compound or other objects.

**Note:** Bike and cargo racks could cause false alerts due to obstruction of the sensor. We recommend switching the feature off when using a bike or cargo rack.

**Note:** Blocked sensors may affect system accuracy.

If something is blocking the sensors, a message may appear in the instrument cluster display when you shift into reverse (R).

### CROSS TRAFFIC ALERT INDICATORS



When the system detects an approaching vehicle, a tone sounds, an alert indicator illuminates in the relevant exterior mirror and arrows appear in the touchscreen to show from which side the vehicle is approaching.

If the system malfunctions, a message appears. Have your vehicle checked as soon as possible.

**Note:** In exceptional conditions, the system could alert you or apply the brakes, even when there is nothing in the detection zone, for example a vehicle passing further away from your vehicle.

## Cross Traffic Alert (If Equipped)

### CROSS TRAFFIC ALERT – TROUBLESHOOTING

#### CROSS TRAFFIC ALERT – INFORMATION MESSAGES

Message	Details
Cross Traffic Alert	Displays when the system detects a vehicle. Check for approaching traffic.
Cross Traffic Not Available Sensor Blocked See Manual	Displays if the cross traffic alert system sensors are blocked. Clean the sensors. If the message continues to appear, have your vehicle checked as soon as possible.
Cross Traffic System Fault	The system has malfunctioned. Have your vehicle checked as soon as possible.
Cross Traffic Alert Deactivated Trailer Attached	Displays if you attach a trailer to your vehicle.
Cross Traffic Alert Applying Brakes	Displays if the system applies the brakes. Check for approaching traffic.

**Note:** *If your vehicle has reverse brake assist*

# Pre-Collision Assist

## WHAT IS PRE-COLLISION ASSIST

Pre-collision assist detects and warns of approaching hazards in the roadway. If your vehicle is rapidly approaching another stationary vehicle, a vehicle traveling in the same direction as yours, or a pedestrian within your driving path, the system provides multiple levels of assistance to help avoid a collision.

## HOW DOES PRE-COLLISION ASSIST WORK

The system warns the driver of potential hazards by providing three levels of assistance.



If your vehicle is rapidly approaching potential hazards the system provides the following levels of functionality:

1. Alert.
2. Brake support.
3. Automatic emergency braking.



**Alert:** When active, a flashing visual warning appears and an audible warning tone sounds.

**Brake Support:** The system helps reduce the impact speed by preparing the brakes for rapid braking. The system does not automatically apply the brakes. If you press the brake pedal, the system may apply additional braking up to maximum braking force, even if you lightly press the brake pedal.

### **Automatic Emergency Braking:**

Automatic emergency braking may activate if the system determines that a collision is imminent.

**Note:** If the pre-collision assist alerts are too frequent or disturbing, you can reduce the alert sensitivity. Setting the low sensitivity results in fewer and later warnings of a potential forward collision. The manufacturer recommends using the high sensitivity setting where possible.

**Note:** Automatic emergency braking performance is not affected by the sensitivity setting.

Each system has various levels of detection capabilities. See **Pre-Collision Assist Limitations** (page 277).

## PRE-COLLISION ASSIST PRECAUTIONS



**WARNING:** You are responsible for controlling your vehicle at all times. The system is designed to be an aid and does not relieve you of your responsibility to drive with due care and attention. Failure to follow this instruction could result in the loss of control of your vehicle, personal injury or death.



**WARNING:** The system does not detect vehicles moving in a different direction or animals. Apply the brakes when necessary. Failure to follow this instruction could result in the loss of control of your vehicle, personal injury or death.



**WARNING:** The system does not operate during hard acceleration or steering. Failure to take care may lead to a crash or personal injury.



# Pre-Collision Assist



**WARNING:** The system may operate with reduced function during cold and inclement weather conditions. Snow, ice, rain, spray and fog can adversely affect the system. Keep the front camera and radar free of snow and ice. Failure to follow this instruction may result in the loss of control of your vehicle, serious personal injury or death.



**WARNING:** Take additional care if your vehicle is heavily loaded or you are towing a trailer. These conditions could result in reduced performance of this system. Failure to follow this instruction could result in the loss of control of your vehicle, personal injury or death.



**WARNING:** The system may not function properly if your vehicle is fitted with a replacement windshield not approved by us.



**WARNING:** Do not perform windshield repairs around the rear-view mirror. Failure to follow this instruction could limit sensor performance.



**WARNING:** The system cannot help prevent all crashes. Do not rely on this system to replace driver judgment and the need to maintain a safe distance and speed.



**WARNING:** In situations where the vehicle camera has limited detection capability, this may reduce system performance. These situations include but are not limited to direct or low sunlight, vehicles at night without tail lights, unconventional vehicle types, pedestrians with complex backgrounds,

running pedestrians, partly obscured pedestrians, or pedestrians that the system cannot distinguish from a group. Failure to take care may result in the loss of control of your vehicle, serious personal injury or death.

**Note:** *Automatic emergency braking may activate when a collision is imminent. The system cannot prevent all crashes, but may reduce crash severity. Do not test automatic emergency braking or forward collision warning. Testing this system must only be conducted by authorized test facilities using specialized equipment. Do not use automatic emergency braking to replace normal braking for any reason. Relying on automatic emergency braking to stop your vehicle may cause an unexpected accident which could lead to serious injury or death.*

## PRE-COLLISION ASSIST LIMITATIONS

Pre-collision assist depends on the detection ability of its camera and sensors. Any obstructions or damage to these areas can limit detection or prevent the system from functioning. See **Locating the Pre-Collision Assist Sensors** (page 278).

The system is active at 5 km/h (3 mph) and above.

**Note:** *The pre-collision assist system automatically disables when you manually disable AdvanceTrac™, 4X4 low, and Rock Crawl (if available).*

**Note:** *Brake support and automatic emergency braking are active up to the maximum speed of the vehicle.*

### Pedestrian Detection Limitations

Pedestrian detection is active at speeds up to 80 km/h (50 mph).

# Pre-Collision Assist

Pedestrian detection operates optimally when detected hazards are clearly identifiable. System performance may reduce in situations where pedestrians are running, partly obscured, have a complex background, or cannot be distinguished from a group.

## Cyclist Detection Limitations

Cyclist detection is active at speeds up to 80 km/h (50 mph).

Cyclist detection functions optimally when detected hazards are clearly identifiable. System performance may reduce in situations where cyclists are fast-moving, partly obscured, have a complex background, or cannot be distinguished from a group.

## Intersection Assist (If Equipped)

If your vehicle comes with a radar sensor the pre-collision assist system may operate in a scenario where you are turning across the path of an oncoming vehicle, or with crossing pedestrians. Detection of vehicles driving in an oncoming direction is active if your vehicle is driving at speeds up to 30 km/h (19 mph). Detection of crossing pedestrians at an intersection is active if your vehicle is driving at speeds up to 30 km/h (19 mph).

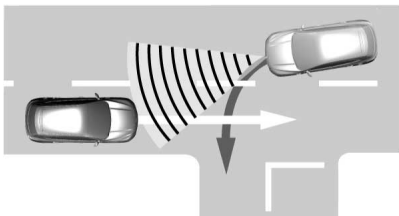

## SWITCHING PRE-COLLISION ASSIST ON AND OFF

1. From the driver assistance menu, press Pre-Collision Assist. See **Driver Assistance Menu** (page 483).
2. Switch the feature on or off.

## Adjusting the Pre-Collision Assist Settings

You can adjust additional feature settings by using the touchscreen controls in the pre-collision assist menu.

**Note:** *Automatic emergency braking switches on every time you switch the ignition on.*

## LOCATING THE PRE-COLLISION ASSIST SENSORS



- 1 Camera.
- 2 Radar sensor (if equipped).

# Pre-Collision Assist

If a message regarding a blocked sensor or camera appears in the instrument cluster display, something is obstructing the radar signals or camera images. If your vehicle has a radar sensor, it is behind the fascia cover in the center of the lower grille. With a blocked sensor or camera, the system may not function, or performance may reduce. See **Pre-Collision Assist – Information Messages** (page 280).

**Note:** *Proper system operation requires a clear view of the road by the camera. Have any windshield damage in the area of the camera's field of view repaired.*

**Note:** *If something hits the front end of your vehicle or damage occurs and your vehicle has a radar sensor, the radar sensing zone could change. This could cause missed or false vehicle detections. Have your vehicle serviced to have the radar checked for proper coverage and operation.*

**Note:** *If your vehicle detects excessive heat at the camera or a potential misalignment condition, a message could appear in the instrument cluster display indicating temporary sensor unavailability. When operational conditions are correct, the message deactivates. For example, when the ambient temperature around the sensor decreases or the sensor recalibrates successfully.*

## AUTOMATIC EMERGENCY BRAKING

### WHAT IS AUTOMATIC EMERGENCY BRAKING

Automatic emergency braking may activate if the system determines that a collision is imminent. The system may help to reduce impact damage or completely avoid the crash.

## SWITCHING AUTOMATIC EMERGENCY BRAKING ON AND OFF

1. From the driver assistance menu, press Pre-Collision Assist. See **Driver Assistance Menu** (page 483).
2. Press Auto Emergency Braking.
3. Switch the feature on or off.

**Note:** *A telltale remains illuminated in the instrument cluster when automatic emergency braking is switched off using the settings menu.*

**Note:** *Automatic emergency braking turns on each time you switch the ignition on.*

**Note:** *If you turn automatic emergency braking off, evasive steering assist also turns off.*

## EVASIVE STEERING ASSIST

### WHAT IS EVASIVE STEERING ASSIST

If your vehicle is rapidly approaching a road user, evasive steering assist helps you steer around the road user.

After you turn the steering wheel in an attempt to avoid a crash with the road user, the system applies additional steering torque to help you steer around the road user. After you pass the road user, the system applies steering torque when you turn the steering wheel to steer back into the lane. The system deactivates after you fully pass the road user.

**Note:** *Road users are defined as another stationary vehicle in your lane or a vehicle in your lane, traveling in the same direction as you. See **Pre-Collision Assist Precautions** (page 276).*

**Note:** *The system does not activate for cyclists or pedestrians.*

# Pre-Collision Assist

## EVASIVE STEERING ASSIST LIMITATIONS

Evasive steering assist only activates when all the following occur:

- Automatic emergency braking and evasive steering assist are on.
- The system detects a road user ahead and starts to apply the brakes.
- You significantly turn the steering wheel to steer around a road user.

**Note:** Evasive steering assist does not automatically steer around a road user. If you do not turn the steering wheel, evasive steering assist does not activate.

**Note:** Evasive steering assist does not activate if the distance to the road user ahead is too small and the system cannot avoid a crash.

## SWITCHING EVASIVE STEERING ASSIST ON AND OFF

1. From the driver assistance menu, press Pre-Collision Assist. See **Driver Assistance Menu** (page 483).
2. Press Evasive Steering Assist.

3. Switch the feature on or off.

**Note:** If you switch automatic emergency braking off, evasive steering assist turns off.

**Note:** Automatic emergency braking and evasive steering assist turn on every time you start your vehicle.

## PRE-COLLISION ASSIST – TROUBLESHOOTING

### PRE-COLLISION ASSIST – WARNING LAMPS



A telltale illuminates in the instrument cluster display to indicate if the system is disabled, unavailable, or temporarily degraded due to external environmental conditions.

**Note:** If the telltale illuminates without a corresponding information message, make sure the setting for automatic emergency braking is switched on. See **Switching Automatic Emergency Braking On and Off** (page 279). No action is needed unless an information message appears. See **Pre-Collision Assist Precautions** (page 276).

## PRE-COLLISION ASSIST – INFORMATION MESSAGES

Message	Action
Pre-Collision Assist Not Available Sensor Blocked	You have a blocked sensor due to bad weather, ice, mud or water in front of the radar sensor. You can typically clean the sensor to resolve.
Pre-Collision Assist Not Available	A fault with the system has occurred. Have your vehicle checked as soon as possible.

# Pre-Collision Assist

---

## **PRE-COLLISION ASSIST – FREQUENTLY ASKED QUESTIONS**

### **What should I do if the windshield in front of the camera is dirty or obstructed?**

- Clean the outside of the windshield in front of the camera.

### **What if the windshield in front of the camera is clean, but the message remains in the instrument cluster display?**

- Wait a short time. It could take several minutes for the camera to detect that there is no obstruction.

### **What should I do if the surface of the radar in the grille is dirty or obstructed?**

- Clean the grille surface in front of the radar or remove the object causing the obstruction.

### **What if the surface of the radar in the grille is clean, but the message remains in the instrument cluster display?**

- Wait a short time. It could take several minutes for the radar to detect that there is no obstruction.

### **Can weather or road conditions interfere with the radar signals?**

- Yes, weather such as heavy rain, spray or fog as well as water, snow or ice on the surface of the road can interfere with the radar signals. In these situations, the system temporarily disables this feature. Pre-collision assist reactivates a short time after the weather conditions improve.

### **What if the radar is out of alignment due to a front end impact?**

- Have your vehicle serviced to have the radar checked for proper coverage and operation.

# Driver Alert (If Equipped)

## WHAT IS DRIVER ALERT

Driver alert alerts you if it determines that you are becoming drowsy or if your driving deteriorates.

## HOW DOES DRIVER ALERT WORK

Driver alert determines your alertness level based on your driving behavior in relation to the lane markings and other factors using the front windshield camera.

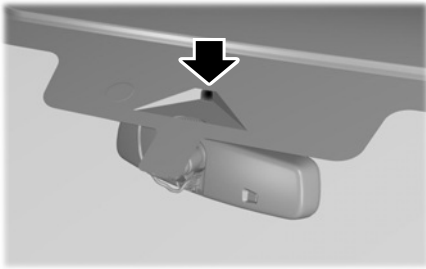

## DRIVER ALERT PRECAUTIONS

**WARNING:** You are responsible for controlling your vehicle at all times. The system is designed to be an aid and does not relieve you of your responsibility to drive with due care and attention. Failure to follow this instruction could result in the loss of control of your vehicle, personal injury or death.

**WARNING:** Take regular rest breaks if you feel tired. Do not wait for the system to warn you.

**WARNING:** Certain driving styles may result in the system warning you even if you are not feeling tired.

**WARNING:** In cold and severe weather conditions the system may not function. Rain, snow and spray can all limit sensor performance.

**WARNING:** The system will not operate if the sensor cannot track the road lane markings.

**WARNING:** If damage occurs in the immediate area surrounding the sensor, have your vehicle checked as soon as possible.

**WARNING:** The system may not correctly operate if your vehicle is fitted with a suspension kit not approved by us.

**WARNING:** The system may not operate properly if the sensor is blocked. Keep the windshield free from obstruction.

**Note:** If something is blocking the camera or damaged the windshield, Driver Alert may not function.

## DRIVER ALERT LIMITATIONS

Driver alert may not function correctly if:

- The sensor cannot track the road lane markings.
- Your vehicle's speed is less than approximately 65 km/h (40 mph).

# Driver Alert (If Equipped)

## SWITCHING DRIVER ALERT ON AND OFF

1. From the driver assistance menu, press Driver Alert. See **Driver Assistance Menu** (page 483).
2. Switch the feature on or off.

## DRIVER ALERT INDICATORS



When the system detects an issue, for example, the camera is blocked or misaligned, an off symbol appears in the instrument cluster display. If the symbol continues to appear, have your vehicle checked as soon as possible.

## System Warnings

The warning system has two stages:

1. A temporary warning is issued to advise you to take a rest. This message only appears for a short time.
2. If you do not rest and the system continues to detect that your driving deteriorates, it issues a further warning. This remains in the instrument cluster display until you cancel it.

**Note:** *The system does not warn you if the vehicle speed falls below approximately 65 km/h (40 mph).*

## DRIVER ALERT – TROUBLESHOOTING

## DRIVER ALERT – INFORMATION MESSAGES

Message	Action
Driver Alert Warning Rest Now	Stop and rest as soon as it is safe to do so.
Driver Alert Warning Rest Suggested	Take a rest soon.

# Load Carrying

## LOAD CARRYING PRECAUTIONS

Keep your loaded vehicle weight within its design rating capability, with or without a trailer. Properly loading your vehicle provides maximum return of vehicle design performance. Before you load your vehicle, become familiar with the following terms for determining your vehicle's weight rating, with or without a trailer, from the vehicle's Tire and Loading Information label or Safety Compliance Certification label.



**WARNING:** The appropriate loading capacity of your vehicle can be limited either by volume capacity (how much space is available) or by payload capacity (how much weight the vehicle should carry). Once you have reached the maximum payload of your vehicle, do not add more cargo, even if there is space available. Overloading or improperly loading your vehicle can contribute to loss of vehicle control and vehicle rollover.



**WARNING:** Exceeding the Safety Compliance Certification label vehicle weight limits can adversely affect the performance and handling of your vehicle, cause vehicle damage and can result in the loss of control of your vehicle, serious personal injury or death.



**WARNING:** Do not use replacement tires with lower load carrying capacities than the original tires because they may lower your vehicle's Gross Vehicle Weight Rating and Gross Axle Weight Rating limitations. Replacement tires with a higher limit than the original tires do not increase the Gross Vehicle Weight Rating and Gross Axle Weight Rating limitations.



**WARNING:** Do not exceed the GVWR or the GAWR specified on the certification label.



**WARNING:** Exceeding any vehicle weight rating can adversely affect the performance and handling of your vehicle, cause vehicle damage and can result in the loss of control of your vehicle, serious personal injury or death.



# Load Carrying



**WARNING:** When loading the roof racks, we recommend you evenly distribute the load, as well as maintain a low center of gravity. Loaded vehicles, with higher centers of gravity, may handle differently than unloaded vehicles. Take extra precautions, such as slower speeds and increased stopping distance, when driving a heavily loaded vehicle.

Load carrying can also impact other systems present in your vehicle. See **Adaptive Cruise Control Precautions** (page 241).

The gross combined weight must never exceed the Gross Combined Weight Rating.

## LOCATING THE SAFETY COMPLIANCE CERTIFICATION LABELS

### Safety Compliance Certification Label Example:

MFD. BY FORD MOTOR CO.  
 DATE: XXXX SERIAL: XXXX KC1 XXXX LB  
 FRONT GVWR: XXXX KG (XXX LB) REAR GVWR: XXXX KG (XXX LB)  
 XXXX KG (XXX LB) WITH XXXX KG (XXX LB) WITH  
 XXXXXXXXXXXXXXXXXXXX TRES XXXXXXXXXXXXXXXXXXXX TRES  
 XXXXXXXX TRES XXXXXXXX TRES  
 AT XXXX KPa/ XXX PSI CO2 AT XXXX KPa/ XXX PSI CO2  
 VIN: XXXXXXXXXXXXXXXXXXXX XXXXX  
 TYPE: XXXX XXXXX  
 THIS VEHICLE CONFORMS TO ALL APPLICABLE FEDERAL MOTOR VEHICLE SAFETY AND THEFT PREVENTION STANDARDS IN EFFECT ON THE DATE OF MANUFACTURE SHOWN ABOVE.

EXTD: XX XXXXXX EC AX 4250 XXXX  
 00 M1T8 1H9S 7E TAGE 7E T88E 7XXX  
 XXX XX XXX X XX X XXX XXXX  
 XXXXXXXXXXXXXXXXXXXX XXX XXXXXXXXXXXXXXXXXXXX

MFD. BY FORD MOTOR CO.  
 DATE: XXXX SERIAL: XXXX LB XXXXXXXX  
 FRONT GVWR: XXXX KG (XXX LB) REAR GVWR: XXXX KG (XXX LB)  
 XXXX KG (XXX LB) WITH XXXX KG (XXX LB) WITH  
 XXXXXXXXXXXXXXXXXXXX TRES XXXXXXXXXXXXXXXXXXXX TRES  
 XXXXXXXX TRES XXXXXXXX TRES  
 AT XXXX KPa/ XXX PSI CO2 AT XXXX KPa/ XXX PSI CO2  
 VIN: XXXXXXXXXXXXXXXXXXXX XXXXX  
 TYPE: XXXX XXXXX  
 THIS VEHICLE CONFORMS TO ALL APPLICABLE FEDERAL MOTOR VEHICLE SAFETY AND THEFT PREVENTION STANDARDS IN EFFECT ON THE DATE OF MANUFACTURE SHOWN ABOVE.

ALL VEHICLE TYPES COLD AIR FRIED XXXXX  
 7/2000/05  
 CHANGES: none/xxx/xxx XXXXX  
 EXTD: XX XXXXXX EC AX 4250 XXXX  
 00 M1T8 1H9S 7E TAGE 7E T88E 7XXX  
 XXX XX XXX X XX X XXX XXXX  
 XXXXXXXXXXXXXXXXXXXX XXX XXXXXXXXXXXXXXXXXXXX

FABRICADO POR FORD MOTOR CO.  
 FECHA: XXXXX PROYECTO: XXXXXXXX  
 PROYECTO: XXXX LB PROYECTO: XXXX LB  
 XXXXX CON XXXXX CON  
 XXXXXXXXXXXXXXXXXXXX LANTAS XXXXXXXXXXXXXXXXXXXX LANTAS  
 XXXXXXXX TRES XXXXXXXX TRES  
 A XXX KPa/ LB EN FRO A XXX KPa/ LB EN FRO

MD: XXXXXXXXXXXXXXXXXXXX XXXXX  
 TPO: US CERT V00-EXPORT XXXXX

PEFEY: XX CA: XX DDV  
 DE: FRO MEXI U: GSO T: X: FLE M: REMO  
 XXX X XX X XX XXX  
 HECHO EN: EE.UU. V: 3534-1520/25-34

The Safety Compliance Certification label is located on the door pillar, door latch post, or the door edge that meets the door latch post, next to the driver seat.

## WHAT IS THE GROSS AXLE WEIGHT RATING

### GAWR (Gross Axle Weight Rating)

GAWR is the maximum allowable weight that a single axle (front or rear) can carry. These numbers are on the Safety Compliance Certification label.

## WHAT IS THE GROSS VEHICLE WEIGHT RATING

GVWR is the maximum allowable weight of the fully loaded vehicle. This includes all options, equipment, passengers and cargo. It appears on the Safety Compliance Certification label.

# Load Carrying

## WHAT IS THE MAXIMUM LOADED TRAILER WEIGHT

Maximum loaded trailer weight is the highest possible weight of a fully loaded trailer the vehicle can tow. Consult an authorized dealer (or the RV and Trailer Towing Guide available at an authorized dealer) for more detailed information. See **Towing a Trailer** (page 296).

## WHAT IS THE GROSS COMBINED WEIGHT RATING

Gross Combined Weight Rating (GCWR) is the maximum allowable weight of the vehicle and the loaded trailer, including all cargo and passengers, that the vehicle can handle without risking damage. (Important: The towing vehicle's braking system is rated for operation at Gross Vehicle Weight Rating, not at Gross Combined Weight Rating.) Separate functional brakes should be used for safe control of towed vehicles and for trailers where the Gross Combined Weight of the towing vehicle plus the trailer exceed the Gross Vehicle Weight Rating of the towing vehicle. See **Recommended Towing Weights** (page 300).

## CALCULATING PAYLOAD

### Tire and Loading Label Information

**Example:**



**TIRE AND LOADING INFORMATION**

SEATING CAPACITY NOMBRE DE PLACES	TOTAL : 5	FRONT: 2	REAR: 3
--------------------------------------	-----------	----------	---------

The combined weight of occupants and cargo should never exceed: **385 kg or 850 lbs.**

TIRE	SIZE	COLD TIRE PRESSURE	SEE OWNERS MANUAL FOR ADDITIONAL INFORMATION
FRONT	235/45R18 94V	235 KPA, 34 PSI	
REAR	235/45R18 94V	235 KPA, 34 PSI	
SPARE	NONE	NONE	



**TIRE AND LOADING INFORMATION**  
**RENSEIGNEMENTS SUR LES PNEUS ET LE CHARGEMENT**

SEATING CAPACITY NOMBRE DE PLACES	TOTAL : 5	FRONT AVANT : 2	REAR ARRIERE : 3
--------------------------------------	-----------	--------------------	---------------------

The combined weight of occupants and cargo should never exceed **396 kg or 875 lbs.**  
Le poids total des occupants et du chargement ne doit jamais dépasser **396 kg ou 875 lb.**

TIRE PNEU	SIZE DIMENSIONS	COLD TIRE PRESSURE PRESSION DES PNEUS A FROID	SEE OWNER'S MANUAL FOR ADDITIONAL INFORMATION VOIR LE MANUEL DE L'USAGER POUR PLUS DE RENSEIGNEMENTS
FRONT AVANT	235/40R19 96V	255 KPA, 37 PSI	
REAR ARRIERE	235/40R19 96V	255 KPA, 37 PSI	
SPARE DE SECOURS	T125/80R16 97M	415 KPA, 60 PSI	

Payload is the combined weight of cargo and passengers that your vehicle is carrying. The maximum payload for your vehicle appears on the Tire and Loading label. The label is either on the B-pillar or the edge of the driver door. Vehicles exported outside the US and Canada may not have a tire and loading label. Look for "The combined weight of occupants and cargo should never exceed XXX kg or XXX lb" for maximum payload. The payload listed on the Tire and Loading Information label

# Load Carrying

is the maximum payload for your vehicle as built by the assembly plant. If you install any additional equipment on your vehicle, you must determine the new payload. Subtract the weight of the equipment from the payload listed on the Tire and Loading label. When towing, trailer tongue weight or king pin weight is also part of payload.

## CALCULATING THE LOAD LIMIT

Steps for determining the correct load limit:

1. Locate the statement "The combined weight of occupants and cargo should never exceed XXX kg or XXX lb." on your vehicle's placard.
2. Determine the combined weight of the driver and passengers that will be riding in your vehicle.
3. Subtract the combined weight of the driver and passengers from XXX kg or XXX lb.
4. The resulting figure equals the available amount of cargo and luggage load capacity. For example, if the "XXX" amount equals 1,400 lb. and there will be five 150 lb. passengers in your vehicle, the amount of available cargo and luggage load capacity is 650 lb.  $(1400 - 750 (5 \times 150) = 650 \text{ lb.})$

5. Determine the combined weight of luggage and cargo being loaded on the vehicle. That weight may not safely exceed the available cargo and luggage load capacity calculated in Step 4.
6. If your vehicle will be towing a trailer, load from your trailer will be transferred to your vehicle. Consult this manual to determine how this reduces the available cargo and luggage load capacity of your vehicle.

## Helpful examples for calculating the available amount of cargo and luggage load capacity

Suppose your vehicle has a 1400-pound (635-kilogram) cargo and luggage capacity. You decide to go golfing. Is there enough load capacity to carry you, four of your friends and all the golf bags? You and four friends average 220 pounds (99 kilograms) each and the golf bags weigh approximately 30 pounds (13.5 kilograms) each. The calculation would be:  $1400 - (5 \times 220) - (5 \times 30) = 1400 - 1100 - 150 = 150$  pounds. Yes, you have enough load capacity in your vehicle to transport four friends and your golf bags. In metric units, the calculation would be:  $635 \text{ kilograms} - (5 \times 99 \text{ kilograms}) - (5 \times 13.5 \text{ kilograms}) = 635 - 495 - 67.5 = 72.5$  kilograms.

# Load Carrying

Suppose your vehicle has a 1400-pound (635-kilogram) cargo and luggage capacity. You and one of your friends decide to pick up cement from the local home improvement store to finish that patio you have been planning for the past two years. Measuring the inside of the vehicle with the rear seat folded down, you have room for twelve 100-pound (45-kilogram) bags of cement. Do you have enough load capacity to transport the cement to your home? If you and your friend each weigh 220 pounds (99 kilograms), the calculation would be:  $1400 - (2 \times 220) - (12 \times 100) = 1400 - 440 - 1200 = -240$  pounds. No, you do not have enough cargo capacity to carry that much weight. In metric units, the calculation would be:  $635 \text{ kilograms} - (2 \times 99 \text{ kilograms}) - (12 \times 45 \text{ kilograms}) = 635 - 198 - 540 = -103$  kilograms. You will need to reduce the load weight by at least 240 pounds (104 kilograms). If you remove three 100-pound (45-kilogram) cement bags, then the load calculation would be:  $1400 - (2 \times 220) - (9 \times 100) = 1400 - 440 - 900 = 60$  pounds. Now you have the load capacity to transport the cement and your friend home. In metric units, the calculation would be:  $635 \text{ kilograms} - (2 \times 99 \text{ kilograms}) - (9 \times 45 \text{ kilograms}) = 635 - 198 - 405 = 32$  kilograms.

The above calculations also assume that the loads are positioned in your vehicle in a manner that does not overload the front or the rear gross axle weight rating specified for your vehicle on the Safety Compliance Certification label.

## ROOF RACK (IF EQUIPPED)

### ROOF RACK PRECAUTIONS



**WARNING:** Read and follow the manufacturer's instructions when you are fitting a roof rack.



**WARNING:** When loading the roof racks, we recommend you evenly distribute the load, as well as maintain a low center of gravity. Loaded vehicles, with higher centers of gravity, may handle differently than unloaded vehicles. Take extra precautions, such as slower speeds and increased stopping distance, when driving a heavily loaded vehicle.

**Note:** *If you use a roof rack, the fuel consumption of your vehicle will be higher and you may experience different driving characteristics.*

**Note:** *Never place loads directly on the roof panel. The roof panel is not designed to directly carry a load.*

Make sure that you securely fasten the load. Check the tightness of the load before driving and at each fuel stop.

# Load Carrying

## REMOVING AND INSTALLING THE ROOF RACK

### Removing the Roof Rack

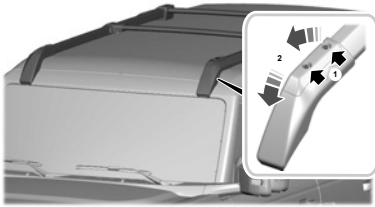

1. Using the provided T30 tool, remove the front roof rack cover fasteners.
2. Remove the front roof rack covers by pulling upward at the rear edge and rotating forward.

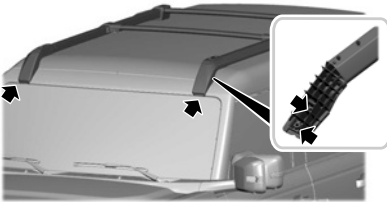

3. Using a 10 mm socket, remove the front roof rack fasteners.

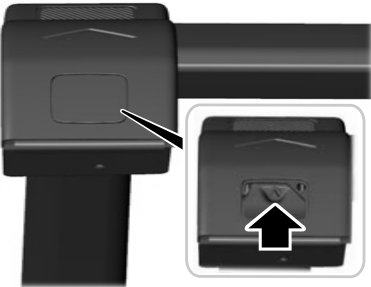

4. Remove the cover to access the rear fastener.

5. Using the supplied special tool, loosen the fastener until you can remove the rack.
6. Remove the rack from the vehicle.

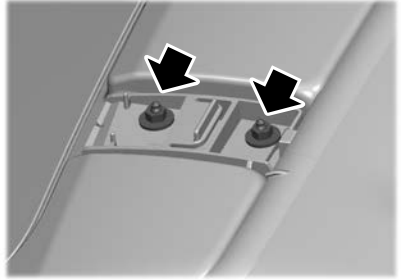

**Note:** The windshield trim cover, retaining plate and fasteners are provided. The trim cover is installed when you remove the roof rack.

7. Locate the trim cover components.
8. Place the trim cover retaining plate over the mounting studs.
9. Install the supplied fasteners. Torque nuts to 10.5 Nm (7.7 lb.ft).
10. Align the cover with the alignment slot at the front of the cover, then rotate rearward and snap into place.

### Installing the Roof Rack

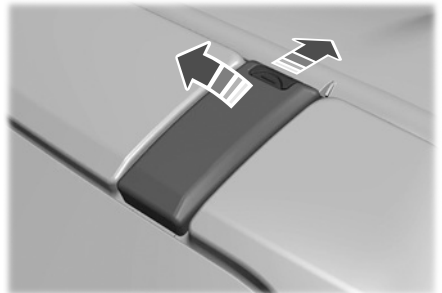

# Load Carrying

1. To remove, press the button on the rear of the trim cover and rotate forward.
2. Remove the fasteners and remove the trim cover retaining plate.
3. Store the trim cover components.

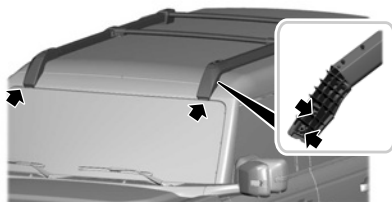

4. Position the roof rack on the vehicle.
5. Hand start the front roof rack fasteners.
6. Using a 10 mm socket, tighten the front roof rack fasteners. Torque bolts to 10.5 Nm (7.7 lb.ft).
7. Align the cover with the alignment slot and rotate rearward.
8. Hand start the front roof rack cover fasteners.
9. Using the provided T30 tool, tighten the front roof rack cover fasteners. Torque bolts to 8 Nm (5.9 lb.ft).

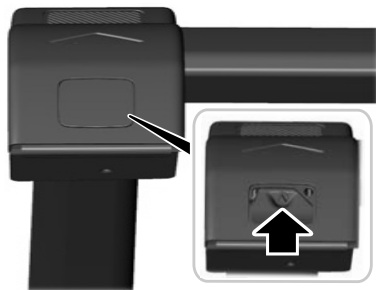

**Note:** The rear crossbar is part of the clamping system. If you removed the crossbar you must install it first for proper attachment to the hard top.

10. Using the supplied special tool, tighten the fastener.

**Note:** The supplied special tool stops turning the fastener when you have proper torque applied.

11. Install the rear roof rack fastener cover.

## ROOF RACK LOAD CAPACITIES



**WARNING:** Do not remove or modify the B-Pillar brace or trim. Doing so could affect safety system performance, including safety canopy and front seat mounted side airbags, during a crash or rollover.

Do not remove or modify the C-Pillar brace.

## Maximum Recommended Load Amounts

Description	Maximum Recommended Load
When in motion	50 kg (110 lb)
When stationary	204 kg (450 lb)
Vehicles with 37x12.50/50R17 Tires	0 kg (0 lb)

# Load Carrying

---

**Note:** *The maximum recommended load is based on the load being evenly distributed on the crossbars.*

## FENDER ANCHOR POINTS

### LOCATING THE FENDER ANCHOR POINTS

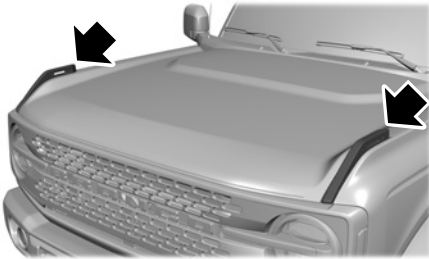

### FENDER ANCHOR POINT LOAD CAPACITIES

The maximum recommended load is 68 kg (150 lb).

## Rear Cargo Area (If Equipped)

### REAR CARGO AREA ANCHOR POINTS

#### REAR CARGO AREA ANCHOR POINT PRECAUTIONS

**WARNING:** Always properly secure cargo to prevent shifting cargo or cargo falling from the vehicle. Failure to do so could result in compromised vehicle stability and serious personal injury to vehicle occupants or others.

**WARNING:** The appropriate loading capacity of your vehicle can be limited either by volume capacity (how much space is available) or by payload capacity (how much weight the vehicle should carry). Once you have reached the maximum payload of your vehicle, do not add more cargo, even if there is space available. Overloading or improperly loading your vehicle can contribute to loss of vehicle control and vehicle rollover.

**WARNING:** It is extremely dangerous to ride in a cargo area, inside or outside of a vehicle. In a crash, people riding in these areas are more likely to be seriously injured or killed. Do not allow people to ride in any area of your vehicle that is not equipped with seats and seatbelts. Make sure everyone in your vehicle is in a seat and properly using a seatbelt. Failure to follow this warning could result in serious personal injury or death.

### LOCATING THE REAR CARGO AREA ANCHOR POINTS

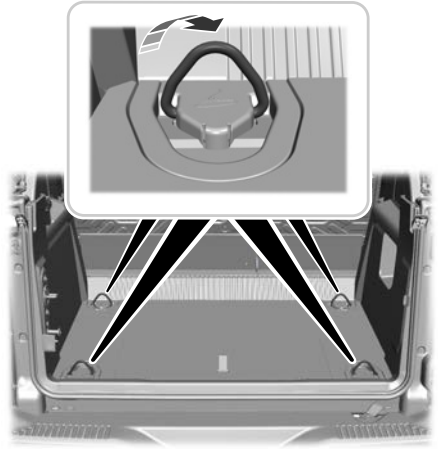

### REAR CARGO AREA ANCHOR POINT LOAD CAPACITIES

Maximum Load Value
907 kg (2,000 lb)



# Connecting a Trailer

## CONNECTING A TRAILER PRECAUTIONS

Do not tow a trailer until you drive your vehicle at least 1,600 km (1,000 mi).

Consult your local motor vehicle laws for towing a trailer.

See the instructions included with towing accessories for the proper installation and adjustment specifications.

Service your vehicle more frequently if you tow a trailer. See **General Maintenance Information** (page 509).

If you use a rental trailer, follow the instructions the rental agency gives you.

When attaching the trailer wiring connector to your vehicle, only use a proper fitting connector that works with the vehicle and trailer functions.

Account for the trailer coupler weight as part of your vehicle load when calculating the total vehicle weight.

Do not exceed the load limits. See **Calculating the Load Limit** (page 287).

## CONNECTING A TRAILER

### Trailer Towing Connector



When attaching the trailer wiring connector to your vehicle, only use a proper fitting connector that works with the vehicle and trailer functions.

### Trailer Lamps

**WARNING:** Never connect any trailer lamp wiring to the vehicle's tail lamp wiring; this may damage the electrical system resulting in fire. Contact your authorized dealer as soon as possible for assistance in proper trailer tow wiring installation. Additional electrical equipment may be required.

Most towed vehicles require trailer lamps. Make sure all running lights, brake lights, turn signals and hazard lights are working.

### Safety Chains

Install trailer safety chains to the trailer hitch as recommended by the manufacturer. Cross the chains under the trailer coupler and allow enough slack for turning tight corners. Do not allow the chains to drag on the ground.

**Note:** Do not attach safety chains to the bumper. Always connect the safety chains to the frame or hook retainers of your trailer hitch.

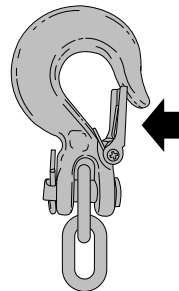

# Connecting a Trailer

---

If the trailer safety chain hook has a latch, make sure to fully close the latch.

## **TRAILER BATTERY CHARGE/ TRAILER POWER FEED**

This feature allows the trailer's battery to charge under the following situations:

- Your vehicle is in the accessory or engine run position.
- If the vehicle's battery voltage is in optimum condition, above 12.5 volts, and the trailer's battery can still hold a charge, or is not too old.

The trailer power feed feature allows for a 12 volt power output on a 7-pin connector when your vehicle is in the accessory or engine run position.

**Note:** *Trailer power feed can provide a maximum output rate of 15 amps.*

**Note:** *Never place more demand than 15 amps of power on the trailer power feed, this may damage the trailer lighting.*

# Connecting a Trailer

## CONNECTING A TRAILER – TROUBLESHOOTING

### CONNECTING A TRAILER – INFORMATION MESSAGES

<b>Message</b>	<b>Description</b>
Trailer Disconnected	The system senses a trailer connection disconnecting, either intentionally or unintentionally, during a given ignition cycle.
Trailer Wiring Fault	There are certain faults in your vehicle wiring and trailer wiring or brake system.
Trailer Left Turn Lamps Fault Check Lamps	The left-hand trailer turn lamps require service.
Trailer Right Turn Lamps Fault Check Lamps	The right-hand trailer turn lamps require service.
Trailer Battery Not Charging See Manual	The vehicle battery voltage is low or there is a fault with your trailer battery. Your trailer battery voltage is below eight volts.
Trailer Lighting Module Fault See Manual	The system detects a short created by the trailer lamps. Inspect and repair the trailer wiring, or have the system checked as soon as possible.
Trailer Brake System Fault See Manual	Verify the trailer brake connections are secure and that the aftermarket trailer brake controller device is correctly installed. Perform a trailer brake and trailer light check if possible. If the message persists, have your vehicle checked as soon as possible.
Trailer Brake Module Fault	Perform a trailer brake and trailer light check if possible. If the message persists, have your vehicle checked as soon as possible.

# Towing a Trailer

## TOWING A TRAILER PRECAUTIONS

 **WARNING:** Do not exceed the GVWR or the GAWR specified on the certification label.

 **WARNING:** Towing trailers beyond the maximum recommended gross trailer weight exceeds the limit of your vehicle and could result in engine damage, transmission damage, structural damage, loss of vehicle control, vehicle rollover and personal injury.

 **WARNING:** Do not exceed the lowest rating capacity for your vehicle or trailer hitch. Overloading your vehicle or trailer hitch can impair your vehicle stability and handling. Failure to follow this instruction could result in the loss of control of your vehicle, personal injury or death.

 **WARNING:** Make sure that the vertical load on the tow ball is between the minimum and maximum recommended weight at all times. Failure to follow this instruction could result in the loss of control of your vehicle, personal injury or death.

 **WARNING:** Do not cut, drill, weld or modify the trailer hitch. Modifying the trailer hitch could reduce the hitch rating.

 **WARNING:** The anti-lock brake system does not control the trailer brakes.

## TRAILER BRAKE PRECAUTIONS

 **WARNING:** Do not connect a trailer's hydraulic brake system directly to your vehicle's brake system. Your vehicle may not have enough braking power and your chances of having a collision greatly increase.

 **WARNING:** Do not tow a trailer fitted with electric trailer brakes unless your vehicle is fitted with a compatible aftermarket electronic trailer brake controller. Failure to follow this instruction could result in the loss of control of your vehicle, personal injury or death. For additional information and assistance, we recommend that you contact an authorized dealer.

Electric brakes and manual, automatic or surge-type trailer brakes are safe if you install them properly and adjust them to the manufacturer's specifications. The trailer brakes must meet local and federal regulations.

The rating for the tow vehicle's braking system operation is at the gross vehicle weight rating, not the gross combined weight rating.

# Towing a Trailer

---

Certain states require functioning trailer brakes for trailers over a specified weight. Be sure to check state regulations for this specified weight.

Ford Motor Company recommends separate functioning brake systems for trailers weighing more than 680 kg (1,500 lb) when loaded.

## TOWING A TRAILER LIMITATIONS

The vehicle's load capacity designation is by weight, not by volume, so you cannot necessarily use all available space when loading a vehicle or trailer.

Towing a trailer also depends on additional systems present in your vehicle. See **Adaptive Cruise Control Precautions** (page 241).

**Note:** *Your vehicle could have reduced performance when operating at high altitudes and when heavily loaded or towing a trailer. When driving at elevation, to match driving performance as perceived at sea level, reduce gross vehicle weight and gross combination weight by 2% per 300 m (1,000 ft) elevation.*

## LOADING YOUR TRAILER

To help minimize how trailer movement affects your vehicle when driving:

- Load the heaviest items closest to the trailer floor.
- Load the heaviest items centered between the left and right side trailer tires.
- Load the heaviest items above the trailer axles or just slightly forward toward the trailer tongue. Do not allow the final trailer tongue weight to go above or below 10-15% of the loaded trailer weight. The trailer tongue weight should never exceed 10% of the maximum towing capacity.
- Select a ball mount with the correct rise or drop. When both the loaded vehicle and trailer are connected, the trailer frame should be level, or slightly angled down toward your vehicle, when viewed from the side.

## TRAILER TOWING HINTS - MANUAL TRANSMISSION

Towing a trailer places an extra load on your vehicle's engine, transmission, axle, brakes, tires and suspension. Periodically inspect these components during and after any towing operation.

When driving with a trailer or payload, a slight takeoff vibration or shudder may be felt due to the increased payload weight.

# Towing a Trailer

---

Your vehicle may have a temporary or conventional spare tire. A temporary spare tire is different in diameter or width, tread type, or from a different manufacturer than the road tires on your vehicle. Consult information on the tire label or Safety Compliance label for limitations when using.

When towing a trailer:

- Obey country specific regulations for towing a trailer.
- Do not drive faster than 113 km/h (70 mph) during the first 800 km (500 mi).
- Do not make full-throttle starts.
- Check your hitch, electrical connections and trailer wheel lug nuts thoroughly after you have traveled 80 km (50 mi).
- Place the transmission in neutral (N) when stopped in congested or heavy traffic during hot weather. This will aid in engine and transmission cooling and to help A/C performance.
- Turn off the speed control with heavy loads or in hilly terrain. The speed control may turn off when you are towing on long, steep slopes.
- Shift to a lower gear when driving down a long or steep hill. Do not continuously apply the brakes, as they may overheat and become less effective.
- Your vehicle has AdvanceTrac with roll stability control. When towing a trailer, additional loads could cause the AdvanceTrac system to engage during cornering maneuvers. Reduce cornering speeds to make sure that you can maintain control of the vehicle and trailer if the AdvanceTrac system engages.

- Allow more distance for stopping with a trailer attached. Anticipate stops and gradually brake.
- Avoid parking on a slope. However, if you must park on a slope. Turn the steering wheel to point your vehicle tires away from traffic flow. Set your vehicle parking brake. Place the transmission in a low gear. Place wheel chocks in front and back of the trailer wheels.

**Note:** *Chocks are not included with your vehicle.*

## TRAILER TOWING HINTS - AUTOMATIC TRANSMISSION

Towing a trailer places an extra load on your vehicle's engine, transmission, axle, brakes, tires and suspension. Periodically inspect these components during and after any towing operation.

When driving with a trailer or payload, a slight takeoff vibration or shudder may be present due to the increased payload weight.

Your vehicle may have a temporary or conventional spare tire. A temporary spare tire is different in diameter or width, tread-type, or is from a different manufacturer than the road tires on your vehicle. Consult information on the tire label or Safety Compliance label for limitations when using.

When towing a trailer:

- Obey country specific regulations for towing a trailer.
- Do not drive faster than 113 km/h (70 mph) during the first 800 km (500 mi).
- Do not make full-throttle starts.
- Check your hitch, electrical connections and trailer wheel lug nuts thoroughly after you have traveled 80 km (50 mi).

# Towing a Trailer

---

- When stopped in congested or heavy traffic during hot weather, place the transmission in park (P) to aid engine and transmission cooling and to help A/C performance.
- Turn off the speed control with heavy loads or in hilly terrain. The speed control may turn off when you are towing on long, steep slopes.
- Shift to a lower gear when driving down a long or steep hill. Do not continuously apply the brakes, as they may overheat and become less effective.
- If your transmission has Grade Assist or Tow/Haul, use this feature when towing. This provides engine braking and helps eliminate excessive transmission shifting for optimum fuel economy and transmission cooling.
- Your vehicle has AdvanceTrac with roll stability control. When towing a trailer, additional loads could cause the AdvanceTrac system to engage during cornering maneuvers. Reduce cornering speeds to make sure that you can maintain control of the vehicle and trailer if the AdvanceTrac system engages.
- Allow more distance for stopping with a trailer attached. Anticipate stops and gradually brake.
- Avoid parking on a slope. However, if you must park on a slope, turn the steering wheel to point your vehicle tires away from traffic flow, set the parking brake, place the transmission in park (P) and place wheel chocks in front and back of the trailer wheels.

**Note:** Chocks are not included with your vehicle.

## LAUNCHING OR RETRIEVING A BOAT OR PERSONAL WATERCRAFT

When backing down a ramp during boat launching or retrieval:

- Do not allow the static water level to rise above the bottom edge of the rear bumper.
- Do not allow waves to break higher than 15 cm (6 in) above the bottom edge of the rear bumper.

Exceeding 15 cm (6 in) could allow water to enter vehicle components, causing internal damage to the components and affecting driveability, emissions and reliability.

**Note:** Replace the rear axle lubricant anytime the rear axle has been submerged in water.

**Note:** Disconnect the trailer wiring connector before backing the trailer into the water.

**Note:** Reconnect the trailer wiring connector after removing the trailer from the water.

# Towing a Trailer

---

## TOWING WEIGHTS AND DIMENSIONS

### RECOMMENDED TOWING WEIGHTS

<b>Market</b>	<b>Website</b>
United States of America	<a href="https://www.fordpro.com/en-us/fleet-vehicles/manuals-and-guides/">https://www.fordpro.com/en-us/fleet-vehicles/manuals-and-guides/</a>
Canada (English)	<a href="https://www.fordpro.ca/en-ca/fleet-vehicles/manuals-and-guides/">https://www.fordpro.ca/en-ca/fleet-vehicles/manuals-and-guides/</a>
Canada (French)	<a href="https://www.fordpro.ca/fr-ca/fleet-vehicles/manuals-and-guides/">https://www.fordpro.ca/fr-ca/fleet-vehicles/manuals-and-guides/</a>



# Towing a Trailer

## WHAT IS THE MAXIMUM LOADED TRAILER WEIGHT

The maximum loaded trailer weight is the highest possible weight of a fully loaded trailer the vehicle can tow.

## CALCULATING THE MAXIMUM LOADED TRAILER WEIGHT FOR YOUR VEHICLE

1. Start with the gross combined weight rating for your vehicle model and axle ratio.
2. Subtract all of the following that apply to your vehicle:
  - Vehicle curb weight.
  - Hitch hardware weight, for example a draw bar, ball, locks or weight distributing hardware.

- Driver weight.
- Passenger weight.
- Payload, cargo and luggage weight.
- Aftermarket equipment weight.

This equals the maximum loaded trailer weight for this combination.

**Note:** *The trailer tongue load is considered part of the payload for your vehicle. Reduce the total payload by the final trailer tongue weight.*

**Note:** *Consult an authorized dealer to determine the maximum trailer weight allowed for your vehicle if you are not sure.*

## TOWING A TRAILER – TROUBLESHOOTING

### TOWING A TRAILER – INFORMATION MESSAGES

Message	Details
Trailer Sway Reduce Speed	The trailer sway control detects trailer sway. Reduce the vehicle's speed.
Trailer brake system fault See manual	Verify the trailer brake connections are secure and that the aftermarket trailer brake controller device is correctly installed. Perform a trailer brake and trailer light check if possible. If the message persists, have your vehicle checked as soon as possible.
Trailer brake module fault	Perform a trailer brake and trailer light check if possible. If the message persists, have your vehicle checked as soon as possible.

# Trailer Sway Control (If Equipped)

## HOW DOES TRAILER SWAY CONTROL WORK

The system applies the brakes to the individual wheels and reduces engine torque to aid vehicle stability.

If the trailer begins to sway, the stability control lamp flashes and the message **Trailer Sway Reduce Speed** appears in the information display.

Stop your vehicle as soon as it is safe to do so. Check the vertical weight on the tow ball and trailer load distribution.

2. Press settings.
3. Switch Trailer Sway Control.

The system turns on each time you start your vehicle.

## TRAILER SWAY CONTROL PRECAUTIONS



**WARNING:** Turning off trailer sway control increases the risk of loss of vehicle control, serious injury or death. Ford does not recommend disabling this feature except in situations where speed reduction may be detrimental (such as hill climbing), the driver has significant trailer towing experience, and can control trailer sway and maintain safe operation.

**Note:** This feature only activates when significant trailer sway occurs.

**Note:** This feature does not prevent trailer sway, but reduces it once it begins.

**Note:** This feature cannot stop all trailers from swaying.

**Note:** In some cases, if vehicle speed is too high, the system may activate multiple times, gradually reducing vehicle speed.

## SWITCHING TRAILER SWAY CONTROL ON AND OFF

1. From the settings menu, press Towing. See **Center Display** (page 481).

# Winching - Everglades

## WINCHING OVERVIEW

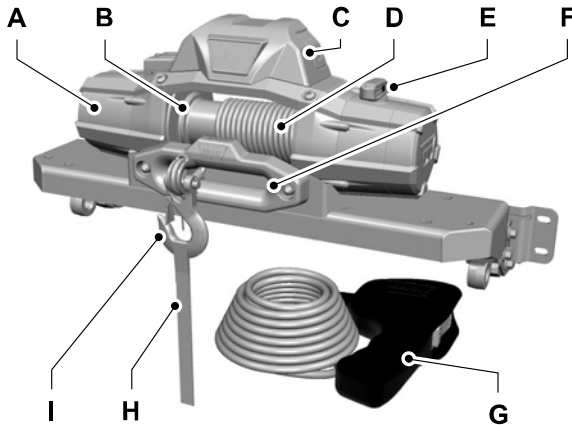

- A Winch motor.
- B Winch drum.
- C Winch control pack.
- D Winch rope.
- E Winch clutch.
- F Fairlead.
- G Remote control.
- H Hook strap.
- I Winch hook.

## WINCHING PRECAUTIONS





**WARNING:** Using winch ropes is dangerous and should only be done by a person familiar with proper vehicle recovery safety practices. Improper use of winch ropes could cause hook failure or separation from the vehicle.



**WARNING:** Slowly remove the slack from the winch rope prior to pulling. Failure to do so can introduce significantly higher loads which could cause the winch rope to break off, or the winch rope to fail.

# Winching - Everglades

 **WARNING:** Never link two winch ropes together with a clevis pin. These heavy metal objects could become projectiles if the winch rope breaks.

 **WARNING:** When using the winch, take care not to get your fingers or hands caught in the mechanism. Failure to follow this instruction could result in personal injury.

 **WARNING:** Avoid wearing loose fitting clothing or jewelry when winching.

 **WARNING:** Make sure to wear eye protection when winching.

 **WARNING:** Do not exceed the winch or winch rope capacity. Failure to follow this instruction could result in personal injury.

 **WARNING:** Wear gloves when handling the winch rope. Failure to follow this instruction could result in personal injury.

 **WARNING:** Do not use the winch to secure loads.

 **WARNING:** Do not use the winch to tow a trailer. This can damage, overload and break the winch rope.

 **WARNING:** Make sure the anchor point can properly support the load and secure the winching equipment. Failure to follow this instruction could result in personal injury.

 **WARNING:** Only use the equipment supplied with the winch when winching.

 **WARNING:** Do not engage or disengage the winch clutch when the winch is in use.

 **WARNING:** The winch and associated components become hot when in use. Let them cool down before removing them.

 **WARNING:** Do not attempt to service, repair or modify the winching system. Failure to follow this instruction could result in personal injury or death.

 **WARNING:** Make sure to properly store the winch rope to the shackle point or fairlead when not in use. Failure to properly store the winch rope could cause it to become a projectile.

## WINCHING REQUIREMENTS

To winch your vehicle, make sure of the following:

- The intended anchor point is secure. The anchor point must be strong enough to hold the weight of your vehicle when winching.
- The intended anchor point allows you to pull your vehicle straight ahead.
- The intended anchor point is as far away as possible, within the 30 m (100 ft) rope length. This allows the greatest pulling power for the winch.
- The winch rope is in good condition and free of visible cuts, tear or damage.
- Use a damper device such as a tarp, heavy blanket or piece of carpet, and place it over the winch rope to help absorb the energy in the event the winch rope breaks.
- Bystanders are to the sides of the vehicle, at a distance of at least twice the length of the winch rope.

# Winching - Everglades

---

## WINCHING LIMITATIONS

The following could impact winch operation:

- Temperatures below 0°C (32°F).
- Low battery charge.
- Winching without the engine running or for sustained pulls of a minute or more.
  - Try winching using shorter pulls with breaks, both to check setup and to allow the vehicle's battery to recharge.
- Exceeding the winch or winch rope rating.

You may see messages on your instrument cluster if the system voltage drops below a set threshold, specifically if battery health is poor, winching occurs in freezing temperatures, and/or a continuous winching cycle. These messages go away once vehicle system voltage returns to normal.

## WINCHING YOUR VEHICLE

For more information, refer to **The Basic Guide to Winching Techniques**.

1. Put on gloves.
2. Switch the clutch to the freespool position.
3. Pull the winch rope to the anchor point.
4. Secure the winch rope to the anchor point using a tree trunk protector or choker chain.
5. Secure the clevis to the tree trunk protector or choker chain and the hook strap by threading the two ends of the tree trunk protector or choker chain and the hook strap loop through the clevis. Do not overtighten the clevis.
6. Switch the clutch to the locked position.
7. Remove the cap from the control box and connect the remote control to the control box.
8. Put the winch rope under tension by slowly winding it with the remote control.
9. Check the anchor and make sure all the connections are secure and free of debris.
10. Make sure the winch rope is neatly wound around the spooling drum.
11. Place an energy absorber, such as a tree limb, heavy jacket, chain or backpack, over the winch rope, halfway between the winch and anchor point.
12. Make sure that everyone in the immediate area is clear of the winching vehicle.
13. With your vehicle switched on, begin winching slowly and steadily with the remote control.
14. Continue winching your vehicle until it is on stable ground.
15. Place your vehicle in park (P).

**Note:** *If your vehicle is manual transmission, place it in first gear.*

16. Disconnect the winch rope from the anchor.
17. Wind the winch rope back onto the winch drum by walking it back with the remote control. Keep tension on the rope when rewinding it onto the drum to evenly distribute the winch rope on the drum.
18. Secure the winch hook to the shackle point or the fairlead.
19. Disconnect the remote control from the control box. Store the remote in a clean, dry place. Place the cap back on the control box.

# Winching - Everglades

---

## **WINCHING – TROUBLESHOOTING**

### **WINCHING – FREQUENTLY ASKED QUESTIONS**

#### **Why does the winch work differently in cold weather than warm weather?**

- The winch is an electrical system and temperatures below 0°C (32°F) affect the vehicle's battery, which supplies power to the winch.

# Driving Hints

## OFF-ROAD DRIVING

### WHAT IS OFF-ROAD DRIVING

Off-road driving is driving your vehicle on unsurfaced roads or trails, made from dirt, rocks, sand and mud.

Your vehicle has been designed and equipped to explore those places where the road cannot take you, whether you choose a forest trail or the open desert.

### OFF-ROAD DRIVING PRECAUTIONS



**WARNING:** If you continue to drive your vehicle when the engine is overheating, the engine could stop without warning. Failure to follow this instruction could result in the loss of control of your vehicle.

Before going off-road, consult with your local governmental agencies to determine designated off-road trails and recreation areas. Also, be sure to understand any off-road vehicle registration requirements for the area in which you plan on driving.

Tread Lightly is an educational program designed to increase public awareness of land-use regulations and responsibilities in our nation's wilderness areas. The U.S. Forest Service and Bureau of Land Management is encouraging you to help preserve our national forest and other public and private lands by treading lightly.

Before taking your vehicle off-road, perform a basic vehicle inspection to make sure the vehicle is in top working condition.

Before you venture off road, have a clear mental picture of the underside of your vehicle. Learn the location of any low hanging items and any skid plates that may be on the vehicle. You can avoid snagging them on rocks and other obstacles if you know where they are.

Memorizing some basic dimensions helps you confidently deal with off-road obstacles. Get to know your vehicle's height and width, its lowest point, its wading depth and angles. Familiarize yourself with your vehicle's on-board technology features.

We recommend driving at least two vehicles when driving off-road. The buddy system helps make sure that help is close at hand should a vehicle become stuck or damaged.

We recommend taking supplies such as a first aid kit, supply of water, tow strap and cell or satellite phone with you any time you plan an off-road excursion.

**Note:** *Remove the front license plate before off-road driving to achieve optimal performance.*

### BASIC OFF-ROAD DRIVING TECHNIQUES

Grip the steering wheel with your thumbs on the outside of the rim. This reduces the risk of injury due to abrupt steering wheel motions that occur when negotiating rough terrain.

Control your throttle, brake and steering inputs in a smooth manner. Sudden inputs to the controls can cause a loss of traction for the vehicle, especially when on sloped terrain or crossing obstacles such as rocks or logs.

# Driving Hints

Look ahead on your route noting upcoming obstacles, surface texture or color changes or any other factors which may indicate a change in available traction. Adjust the vehicle speed and route to avoid a loss in traction. Conditions can change causing the course to vary day to day. Mark obstacles with GPS markers to avoid potential vehicle damage. Where necessary, get out of your vehicle and check the terrain.

When driving off-road, if the front or rear suspension is bottoming-out or excessive contact with the skid-plates is happening, reduce the vehicle's speed to avoid potential damage to your vehicle.

If you are driving in a dusty area, be sure to leave ample distance between your vehicle and any other vehicles to allow for adequate vision.

When driving off-road verify that your wipers and washers are working properly and reduce your speed for better visibility.

When driving in desert conditions, we recommend driving with your headlamps on to help other drivers easily see you.

When convoying with other vehicles, we recommend that communication is used, and the lead vehicle notify other vehicles of upcoming obstacles.

Keep available ground clearance in mind and pick a route that minimizes the risk of catching the underside of the vehicle on an obstacle.

When negotiating low speed obstacles, applying light brake pressure in conjunction with the throttle allows you to negotiate the obstacle in a more controlled manner.

Driving off-road requires a high amount of concentration. Even if your local law does not prohibit drinking alcohol when driving off-road we do not recommend it.

## DRIVING OFF-ROAD

### Driving In Snow and Ice



**WARNING:** If you are driving in slippery conditions that require tire chains or cables, then it is critical that you drive cautiously. Keep speeds down, allow for longer stopping distances and avoid aggressive steering to reduce the chances of a loss of vehicle control which can lead to serious injury or death. If the rear end of your vehicle slides while cornering, steer in the direction of the slide until you regain control of your vehicle.

Four-wheel drive vehicles have advantages over two-wheel drive vehicles in snow and ice but can skid like any other vehicle. If your vehicle slides when driving on snowy or icy roads, turn the steering wheel in the direction of the slide until you regain control. Avoid sudden applications of power and quick changes of direction on snow and ice. Slowly and steadily apply the accelerator when starting from a full stop. Avoid sudden braking.



**WARNING:** Do not become overconfident in the ability of four-wheel drive vehicles. Although a four-wheel drive vehicle may accelerate better than a two-wheel drive vehicle in low traction situations, it won't stop any faster than two-wheel drive vehicles. Always drive at a safe speed.

Make sure you allow sufficient distance between your vehicle and other vehicles for stopping.

In emergency stopping situations, do not pump the brake pedal, apply the brake firmly.



# Driving Hints

## Driving In Sand

When driving over sand, try to keep all four wheels on the most solid area of the trail. Drive through the terrain without varying vehicle speed. Apply the accelerator and avoid excessive wheel slip.

Use the vehicle's momentum to maintain forward motion in sand. Avoid coming to a stop on steep sand slopes as the vehicle may not be able to continue forward after it has stopped.

## Driving In Mud

Be cautious of sudden changes in vehicle speed or direction when you are driving in mud.

Even four-wheel drive vehicles can lose traction in slick mud. If your vehicle does slide, steer in the direction of the slide until you regain control of your vehicle.

After driving through mud, clean off residue stuck to the wheels and tires and rotating driveshafts. Excess mud stuck on the wheels and tires and rotating driveshafts can cause an imbalance that could damage drive components.

**Note:** *The vehicle brakes are less effective when wet or muddy.*

## Driving Over Rocks and Gravel

Gravel is a constantly changing, low-grip surface. Driving at slow speeds on gravel reduces the risk of losing traction when you stop, accelerate or turn a corner.

When approaching large rocks, position the vehicle so that the tires pass over the largest obstacle.

**Note:** *Never attempt to straddle a rock that is large enough to strike your axles or undercarriage.*

**Note:** *Never attempt to drive over a rock which is large enough to contact the door sills if your vehicle does not have rock rails.*

If you lose traction on your wheels facing uphill, stop and choose a more suitable route.

Leave a generous gap between your vehicle and other vehicles to minimize the risk of damage from flying gravel. Avoid dust clouds as they reduce visibility.

Before navigating on uneven ground, secure anything inside the vehicle. If possible, remove any roof-rack items. Use the lowest gear possible and approach the obstacle at a slow speed.

If your vehicle begins to slide down a slope, steer downhill and gently apply the throttle. If you lose traction on your uphill wheels, stop immediately and choose a more suitable route.

Approach logs, rocky steps or ditches diagonally. Keep at least three wheels on the ground at all times.

## Climbing A Hill



**WARNING:** Extreme care should be used when steering the vehicle in reverse down a slope so as not to cause the vehicle to swerve out of control.

Although natural obstacles can make it necessary to travel diagonally up or down a hill or steep incline, try to drive straight up or straight down.

**Note:** *Avoid turning on steep slopes or hills. A danger lies in losing traction, slipping sideways and possible vehicle roll over.*

Whenever driving on a hill, you must first determine the route you can use.

When climbing a steep slope or hill, start in a lower gear rather than downshifting to a lower gear from a higher gear. This reduces strain on the engine and the possibility of stalling.

# Driving Hints

If your vehicle stalls, do not try to turn around because this could cause your vehicle to roll over. It is better to reverse back to a safe location.

Do not drive over the crest of a hill without seeing what conditions are on the other side. Do not drive in reverse over a hill without the aid of an observer.

If the vehicle is unable to make it up the hill, do not attempt to turn back down the slope.

Apply the accelerator just enough for the wheels to climb the hill.

**Note:** *Too much acceleration can cause the tires to slip, spin or lose traction, resulting in loss of vehicle control.*

Descending A Hill:

- Use the same gear you would use to climb the hill.
- Do not descend in neutral.
- Disengage overdrive.
- Avoid sudden and excessive braking.

**Note:** *The front wheels have to be turning in order to steer your vehicle.*

When descending a steep hill in a manual transmission vehicle do not leave the vehicle in gear with the clutch pressed. This could cause damage to your driveline.

## Driving Through Water



**WARNING:** Do not attempt to cross a deep, fast flowing body of water. Failure to follow this instruction could result in the loss of control of your vehicle, personal injury or death.

As the water depth increases, you must reduce your vehicle speed to avoid potential vehicle damage.

The key to a safe crossing is the water depth, current and bottom of the water's condition. On soft bottoms, the vehicle sinks in, effectively increasing the water level on the vehicle. Make sure to consider this when determining the depth of water.

Determine the depth and speed of the current before attempting a water crossing.

Be aware that obstacles and debris may be beneath the water's surface.

**Note:** *Cross flowing water at an angle heading slightly upstream.*

**Note:** *You should tread lightly and avoid damage to the environment.*

Drive slowly when crossing water. Proceed with a constant slow speed lightly pressing on the accelerator.

Drive through the water very slowly when entering, then build up momentum. Keep your vehicle moving at a steady pace.

**Note:** *Do not try to accelerate through the water crossing.*

When driving too fast in water or through deep water, the engine, transmission, transfer case, axles, electrical components or vehicle interior could ingest water. Water can cause permanent damage that may not be covered by your vehicle warranty. See **Driving Through Water Limitations** (page 312).

**Note:** *Failure to follow the recommended speeds can result in vehicle damage.*

Never stop or shut a vehicle off when crossing deep water unless your vehicle ingested water into the engine air intake. If the engine stalls, do not attempt to restart it.

Ease off the accelerator as you reach the other side to diminish the front wave. Apply the accelerator slowly and as necessary to climb out of the other side.

# Driving Hints

Muddy waters can reduce the cooling system effectiveness by depositing debris into the radiator.

Extra care must be taken crossing any type of water. Do not drive into water unless necessary. You should only drive through areas that are designated and approved.

High currents even in shallow water can wash the dirt out from around your tires or push your vehicle across slippery rocks or surfaces.

Never attempt to cross flowing water that is deeper than your vehicles ground clearance. Even in low currents your vehicles body surface area can be pushed downstream and out of control.

Do not cross any body of water that is fast flowing and rising, wait for the flow rate to reduce.

Determine exit points that are downstream of your entry point to allow for drifting.

If there are other vehicles ahead, wait until they've left the water. Unsettled water can make a safe passage more challenging.

Know your vehicle's abilities and be able to recover it if something goes wrong.

Keep the doors fully closed during a water crossing.

Vehicles used to traverse water regularly should be periodically inspected for signs of water ingestion in all of the vehicle's fluids. If water is found inside your vehicle fluids, service your vehicle or see an authorized dealer.

After driving through water and as soon as it is safe to do so, check the brakes, horn, lights, and steering wheel to make sure everything is still in working order.

## Avoid Getting High-Centered

Always keep available ground clearance in mind and pick a route that minimizes the risk of catching the underside of the vehicle on an obstacle and getting high-centered.

## Freeing A Stuck Vehicle



**WARNING:** Do not spin the wheels at over 55 km/h (34 mph). The tires may fail and injure a passenger or bystander.

Recovery hooks are mounted to the vehicle's structure and are used to pull out the vehicle from a surface or location when stuck. Recover your vehicle using various towing apparatus attached to your recovery hook such as winch, open hook, or strap.

**Note:** Do not use recovery hooks to *recreationally tow your vehicle*. See **Recreationally Towing Your Vehicle** (page 329).

If your vehicle gets stuck in mud or snow, you may rock it out by shifting between forward and reverse gears, stopping between shifts in a steady pattern. Press the accelerator in each gear.

**Note:** Do not rock your vehicle if the engine is not at normal operating temperature damage to the transmission may occur.

**Note:** Do not rock your vehicle for more than a minute damage to the transmission and tires may occur or the engine may overheat.

If you are unable to free your vehicle call roadside assistance. See **Roadside Assistance** (page 317).

# Driving Hints

## Crossing A Ravine, Gully, Ditch, Washout Or Rut

Review the path ahead before attempting to cross any obstacle. Review the obstacle from outside the vehicle for an understanding of the terrain condition in front of and behind the obstacle. Approach obstacles slowly and inch the vehicle over. Ditches and washouts should be crossed at a 45 degree angle when possible.

## Driving Over Logs

Review the path ahead before attempting to cross any obstacle. Review the obstacle from outside the vehicle for an understanding of the terrain condition in front of and behind the obstacle.

Approach obstacles slowly and inch the vehicle over, approaching at a 15 degree angle.

**Note:** *It is best to have a front tire on top of the log when the other begins to climb over.*

If a large obstacle near the log such as a rock cannot be avoided, choose a path that places the rock directly under the tire rather than the undercarriage of the vehicle. This helps prevent damage to the vehicle.

## DRIVING YOUR VEHICLE AT HIGH SPEEDS

If you plan on using your vehicle for severe, high speed off-road use, we recommend the following:

- Equipping your vehicle with the safety equipment appropriate for off-road recovery.
- Using personal safety equipment, including a certified helmet and approved neck restraint device.
- Doing a low speed reconnaissance run in unfamiliar areas to become aware of any obstacles that you could encounter.

Your vehicle can incur damage if driven beyond its capabilities. Skid plates, shock guards and running boards are designed to help limit damage to vital components and exterior finishes, but cannot prevent all damage if driven in extreme off-road conditions. Damage to skid plates, shock guards, running boards and exterior finishes as well as bent, cracked or broken body, frame and chassis components may not be covered by warranty.

## DRIVING THROUGH WATER LIMITATIONS

Model	Maximum Wading Depth
Vehicles without the Sasquatch Package.	800 mm (31.5 in)
Vehicles with the Sasquatch Package.	850 mm (33.5 in)
Everglades Variant Vehicles	925 mm (36.4 in)
Raptor Variant Vehicles	940 mm (37.0 in)

# Driving Hints

---

When you are driving through water do not exceed 7 km/h (4 mph).

## OFF-ROAD DRIVING AIDS

### Selecting an Off-Road G.O.A.T Mode

Using the appropriate drive mode increases your vehicle's control. See **G.O.A.T. Mode Control** (page 249).

**Note:** Drive modes are selected by using the *Goes Over Any-type of Terrain G.O.A.T. MODES* controller.

### Using Four-Wheel Drive

Your vehicle has a four-wheel drive system that offers various modes to help you optimize traction on any off-road surface. See **Four-Wheel Drive** (page 182).

### Using the Stabilizer Bar Disconnect

The stabilizer bar disconnect improves suspension articulation, improving traction and comfort in rough terrain.

The vehicle's disconnect system is hydraulically actuated.

Your vehicle is capable of disconnecting under high load. Your vehicle is also capable of reconnecting under all conditions.

It is not necessary for the vehicle to be on level ground in order to reconnect the stabilizer bar. See **Stabilizer Bar Disconnect** (page 219).

### Using the Cameras Off-Road

Use the 360 degree camera to enhance your off-road experience. See **360 Degree Camera** (page 236).

### Using the Front and Rear Differential Lock

When engaged, the front and rear differential lock provides additional traction to your vehicle by forcing either the two rear wheels or two front wheels to turn at the same speed.

You can activate and deactivate the front and rear differential lock on the fly within the operating speed range. See **Electronic Locking Differential** (page 194).

### Using Trail Control

The system works in a similar manner to cruise control in off-road conditions. Trail Control provides you the ability to maneuver the vehicle without using the throttle and brake pedals.

Trail Control allows you to set a speed between 1.6 km/h (1 mph) to 23 km/h (14 mph) in a forward motion and 1.6 km/h (1 mph) to 8 km/h (5 mph) in reverse. The system controls acceleration and braking in difficult off-road environments, which allows you to focus on steering. See **Trail Control** (page 212).

Trail Control Performance:

- Manages wheel slip to maximize traction.
- Removes the need for you to use both feet when driving in off-road situations.
- Provides braking to maximize traction in descents.
- Gives you confidence in difficult environments.

### Using Trail One Pedal Drive

Trail one pedal drive coordinates propulsive and braking torque through your application of the accelerator pedal to simulate a two footed driving technique.

# Driving Hints

Use this when driving over large obstacles, such as rocks or logs, to help maintain a constant vehicle speed.

In 4H, the system offers lift pedal braking and auto hill hold functionality. See **What Is Trail One Pedal Drive** (page 213).

**Note:** *Trail one pedal drive is only available when the vehicle is in 4H or 4L.*

## Using Trail Turn Assist

The feature reduces the turn radius of the vehicle on off-road surfaces.

The system reduces driver effort to negotiate difficult off-road terrain by allowing the vehicle to make a tight turn in a single maneuver that might otherwise require a three point turn. See **Trail Turn Assist** (page 217).

**Note:** *Trail turn assist is only available when the vehicle is in 4H or 4L.*

**Note:** *Trail turn assist cannot activate if the rear differential is locked.*

## What Are Rock Rails (If Equipped)

Rock rails protect the rocker and body side from damage and provide a sliding surface to allow the vehicle to cross boulders and rock ledges.

Rock rails also can act as a pivot point to sharply turn the vehicle in tight spaces with high walls or rocks present.

## AFTER DRIVING YOUR VEHICLE OFF-ROAD



**WARNING:** After off-road use, before returning to the road, check the wheels and tires for damage. Off-road use may cause damage to your wheels and tires that can lead to tire failure, loss of vehicle control, serious injury or death.

Driving off-road places more stress on your vehicle than most on-road driving. After driving off-road, check for damage to the wheels, chassis and underbody.

Inspect the underbody of your vehicle by checking tires, body structure, steering, suspension, and exhaust system for damage.

Inspect the tires for any cuts in the tread or sidewall area. Also inspect the sidewall for any bulge indicating damage to the tire.

Make sure the tires are inflated to proper tire pressure as indicated on the tire placard.

Check the radiator for mud and debris and clean as needed.

Check that the air filter is clean and dry.

Remove accumulations of plants or brush. These things could be a fire hazard or hide damage to the fuel lines, brake hoses and propeller shafts.

Make sure the grille and radiator are clear of any obstructions that may affect cooling.

After extended operation in mud, sand, water, or similar dirty conditions, inspect the wipers and washers to make sure they are working.

**Note:** *Mud caked windows are hard to see through and can damage wiper blades or motor.*

Check wipers for debris or anything that may scratch the windshield.

If you experience unusual vibration after driving in mud, slush or similar conditions, check the wheels for impacted material. Impacted material can cause vibrations when driving and wheel imbalance. Remove the material to reduce the vibration.

# Driving Hints

---

**Note:** *If you have removed the impacted material from the wheels and your vehicle still has a vibration check your vehicle for damage or see an authorized dealer.*

Inspect the exhaust system for damage or looseness.

Make sure that the brakes are in proper working order and free of any mud, stones and debris, which can become trapped around the brake rotor, backing plate and caliper.

Inspect the wheels for dents, cracks, or other damage.

Inspect undercarriage fasteners. If any are loose or damaged, tighten or replace ensuring that the proper torque specification is used.

Inspect for torn or punctured boots on ball joints, half shafts, steering gears.

Refit the front license plate if removed previously.

## COLD WEATHER PRECAUTIONS

The functional operation of some components and systems can be affected at temperatures below approximately -25°C (-13°F).

## BREAKING-IN

Your vehicle requires a break-in period. For the first 1,600 km (1,000 mi), avoid driving at high speeds, heavy braking, aggressive shifting or using your vehicle to tow. During this time, your vehicle may exhibit some unusual driving characteristics.

## DRIVING ECONOMICALLY

The following helps to improve fuel consumption:

- Drive smoothly, accelerate gently and anticipate the road ahead to avoid heavy braking.
- Regularly check your tire pressures and make sure that they are inflated to the correct pressure.
- Follow the recommended maintenance schedule and carry out the recommended checks.
- Plan your journey and check the traffic before you set off. It is more efficient to combine errands into a single trip whenever possible.
- Avoid idling the engine in cold weather or for extended periods. Start the engine only when you are ready to set off.
- Do not carry unnecessary weight in your vehicle as extra weight wastes fuel.
- Do not add unnecessary accessories to the exterior of your vehicle, for example running boards. If you use a roof rack, remember to fold it down or remove it when not in use.
- Do not shift into neutral when you are braking or when your vehicle is slowing down.
- Shut all windows when driving at high speeds.
- Switch off all electric systems when not in use, for example air conditioning. Make sure that you unplug any accessories from the auxiliary power points when not in use.

# Driving Hints

## FLOOR MATS



**WARNING:** Use a floor mat designed to fit the footwell of your vehicle that does not obstruct the pedal area. Failure to follow this instruction could result in the loss of control of your vehicle, personal injury or death.



**WARNING:** Pedals that cannot move freely can cause loss of vehicle control and increase the risk of serious personal injury.



**WARNING:** Secure the floor mat to both retention devices so that it cannot slip out of position and interfere with the pedals. Failure to follow this instruction could result in the loss of control of your vehicle, personal injury or death.



**WARNING:** Do not place additional floor mats or any other covering on top of the original floor mats. This could result in the floor mat interfering with the operation of the pedals. Failure to follow this instruction could result in the loss of control of your vehicle, personal injury or death.



**WARNING:** Always make sure that objects cannot fall into the driver foot well while your vehicle is moving. Objects that are loose can become trapped under the pedals causing a loss of vehicle control.



To install floor mats that have eyelets, position the floor mat eyelet over the retention post and press down to lock in position. Repeat for all eyelets on the floor mat.

To remove the floor mats, reverse the installation procedure.

**Note:** Regularly check the floor mats to make sure they are secure.



# Crash and Breakdown Information

---

## ROADSIDE ASSISTANCE

### Vehicles Sold in the United States: Getting Roadside Assistance

If you have a vehicle concern, Ford Motor Company offers a complimentary roadside assistance program. This program is separate from the New Vehicle Limited Warranty.

The service is available:

- 24 hours a day, seven days a week.
- For the coverage period supplied with your vehicle.

Knowing your vehicle's VIN, mileage and your specific location allows help to get to you faster.

Roadside Assistance covers:

- A flat tire change with a good spare (except vehicles supplied with a tire inflation kit).
- Battery jump start.
- Lock-out assistance (key replacement cost is the customer's responsibility).
- Fuel delivery — independent service contractors, if not prohibited by state, local or municipal law, shall deliver up to 8 L (2 gal) of gasoline or 20 L (5 gal) of diesel fuel to a disabled vehicle. Roadside assistance limits fuel delivery service to two no-charge occurrences within a 12-month period.
- Winch out — available within 30 m (100 ft) of a paved or county maintained road, no recoveries.

- Towing — independent service contractors, if not prohibited by state, local or municipal law, shall tow Ford eligible vehicles to an authorized dealer within 80 km (50 mi) of the disablement location or to the nearest authorized dealer. If a member requests a tow to an authorized dealer that is more than 80 km (50 mi) from the disablement location, the member shall be responsible for any mileage costs in excess of 80 km (50 mi). Warranty towing, non-warranty towing and collision towing are available.
- Roadside Assistance includes up to \$200 for a towed trailer if the disabled eligible vehicle requires service at the nearest authorized dealer. If the towing vehicle is operational but the trailer is not, then the trailer does not qualify for any roadside services.

### Vehicles Sold in the United States: Using Roadside Assistance

United States vehicle customers who require Roadside Assistance, call 1-800-241-3673.

If you need to arrange roadside assistance on your own, Ford Motor Company reimburses a reasonable amount for towing to the nearest dealership within 80 km (50 mi). To obtain reimbursement information, United States vehicle customers call 1-800-241-3673. Customers need to submit their original receipts.

### Vehicles Sold in Canada: Getting Roadside Assistance

If you have a vehicle concern, Ford Motor Company of Canada, Limited offers a complimentary roadside assistance program. This program is eligible within Canada or the continental United States.

The service is available 24 hours a day, seven days a week.

# Crash and Breakdown Information

This program is separate from the New Vehicle Limited Warranty, but the coverage is concurrent with the powertrain coverage period of your vehicle. Canadian roadside coverage and benefits may differ from the U.S. coverage. For complete details, see your Warranty Guide at [www.ford.com/support/warranty/](http://www.ford.com/support/warranty/).

Download the Sykes4Ford Roadside Assistance App for access to your roadside assistance services. For more information, scan here:



If you require more information, please call us in Canada at 1-800-665-2006, or visit our website at [www.ford.ca](http://www.ford.ca).

Ford Motor Company reserves the right to modify or discontinue Roadside Assistance at any time. Certain restrictions apply to Roadside Assistance benefits.

For further details, call  
**1-800-665-2006** (Canada)  
**1-800-241-3673** (United States)

## SWITCHING THE HAZARD FLASHERS ON AND OFF



The hazard flasher button is on the instrument panel. Press the button to switch the hazard flashers on if your vehicle is creating a safety hazard for other road users.

When you switch the hazard flashers on, all front and rear direction indicators flash.

**Note:** *The hazard flashers operate when the ignition is in any position, or if the key is not in the ignition. The battery loses charge and could have insufficient power to restart your vehicle.*

Press the button again to switch them off.

## JUMP STARTING THE VEHICLE

### JUMP STARTING PRECAUTIONS



**WARNING:** Batteries normally produce explosive gases which can cause personal injury. Therefore, do not allow flames, sparks or lighted substances to come near the battery. When working near the battery, always shield your face and protect your eyes. Always provide correct ventilation.



**WARNING:** Keep batteries out of reach of children. Batteries contain sulfuric acid. Avoid contact with skin, eyes or clothing. Shield your eyes when working near the battery to protect against possible splashing of acid solution. In case of acid contact with skin or eyes, flush immediately with water for a minimum of 15 minutes and get prompt medical attention. If acid is swallowed, call a physician immediately.



**WARNING:** Use only adequately sized cables with insulated clamps.





**WARNING:** Make sure that the cables are clear of any moving parts and fuel delivery system parts.





**WARNING:** Connect batteries with only the same nominal voltage.

# Crash and Breakdown Information

 **WARNING:** Using the jump leads incorrectly or completing the jump start procedure incorrectly can cause the battery to explode, which can lead to severe injuries.

 **WARNING:** All work on the vehicle battery and the electrical system can cause serious chemical burns, fire or electric shocks. Always read the warnings and safety information before carrying out any kind of work on the battery.

 **WARNING:** Never charge a 12-volt vehicle battery once it has been frozen. Discharged 12-volt vehicle batteries can even freeze at temperatures of approximately 0°C (+32°F).

 **WARNING:** The battery should be replaced if it is or has ever been frozen.

 **WARNING:** A highly explosive mixture of gases is given off when the vehicle battery is jump started. Always keep fire, sparks, naked flames and lit cigarettes away from the vehicle battery. Never use a mobile telephone when the jump leads are being connected or disconnected.

 **WARNING:** Only charge the battery in a well-ventilated space as the battery emits a highly explosive mixture of gases when the vehicle is being jump started.

 **WARNING:** Never confuse the negative and positive terminals or connect the jump leads incorrectly.

 **WARNING:** Observe the jump lead manufacturer's instructions.

 **WARNING:** If the engine is running while the hood is open, stay clear of moving engine components. Failure to follow this warning could result in serious personal injury or death.

Do not attempt to push-start an automatic transmission vehicle. This could cause transmission damage.

Do not disconnect the battery of the disabled vehicle. This could damage your vehicle's electrical system.

## PREPARING THE VEHICLE

Use only a 12 volt supply to start your vehicle.

Park the booster vehicle close to the hood of the disabled vehicle, making sure the two vehicles do not touch.

## JUMP STARTING THE VEHICLE

### Connecting the Jumper Cables

 **WARNING:** Do not connect the negative jumper cable to any other part of your vehicle. Use the ground point.

**Note:** *If you are using a jump pack or booster box, follow the manufacturer's instructions.*

# Crash and Breakdown Information

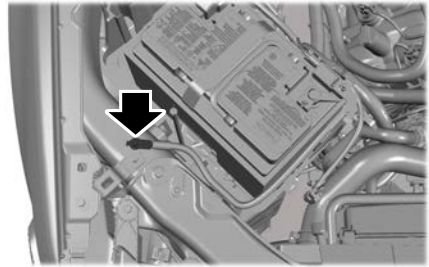
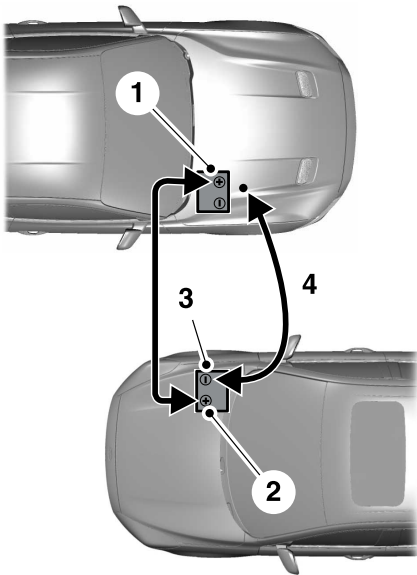

## Starting the Engine

1. Start the engine of the booster vehicle and moderately rev the engine, or gently press the accelerator to keep the engine speed between 2000 and 3000 RPM, as shown in your tachometer.
2. Start the engine of the disabled vehicle.
3. Once you start the disabled vehicle, run both vehicle engines for an additional three minutes before disconnecting the jumper cables.

## Removing the Jumper Cables

Remove the jumper cables in the reverse order that they were connected.

**Note:** Do not switch the headlamps on when disconnecting the cables. The peak voltage could blow the bulbs.

## POST-CRASH ALERT SYSTEM

### WHAT IS THE POST-CRASH ALERT SYSTEM

The system helps draw attention to your vehicle in the event of a serious impact.

1. Pull the red plastic boot backward. Connect the positive (+) jumper cable to the positive (+) terminal of the discharged battery.
2. Connect the other end of the positive (+) jumper cable to the positive (+) terminal of the booster vehicle battery.
3. Connect the negative (-) jumper cable to the negative (-) terminal of the booster vehicle battery.
4. Make the final connection of the negative (-) jumper cable to an exposed metal part of the disabled vehicle's engine, as shown in the following illustration, away from the battery and fuel injection system, or connect the negative (-) jumper cable to a ground connection point if available.

# Crash and Breakdown Information

## HOW DOES THE POST-CRASH ALERT SYSTEM WORK

The system is designed to turn the hazard flashers on, turn the courtesy lamps on, intermittently sound the horn and unlock all doors in the event of a serious impact that deploys an airbag or the seatbelt pretensioners.

## POST-CRASH ALERT SYSTEM LIMITATIONS

Depending on applicable laws in the country your vehicle was built for, the horn does not sound in the event of a serious impact.

## SWITCHING THE POST-CRASH ALERT SYSTEM OFF

Press the hazard flasher switch, the unlock button on the remote control, the panic button on the remote control or cycle the ignition to switch the system off.

**Note:** *The alert turns off when the vehicle battery runs out of charge.*

## POST-COLLISION BRAKING

### How Does Post-Collision Braking Work

In the event of a moderate to severe crash, the braking system reduces the vehicle's speed to prevent or reduce the impact of a potential secondary crash.

### Post-Collision Braking Limitations

Post-collision braking does not activate if any of the following occur:

- The anti-lock braking system is damaged during the collision.
- Electronic stability control is disabled.

## Overriding Post-Collision Braking

You can override post-collision braking by pressing the brake or accelerator pedal.

## Post-Collision Braking Indicators



It flashes when a post-collision braking event is occurring.

## AUTOMATIC CRASH SHUTOFF

### WHAT IS AUTOMATIC CRASH SHUTOFF

The automatic crash shutoff is designed to stop the fuel going to the engine in the event of a moderate or severe crash.

**Note:** *Not every impact causes a shutoff.*

### AUTOMATIC CRASH SHUTOFF PRECAUTIONS

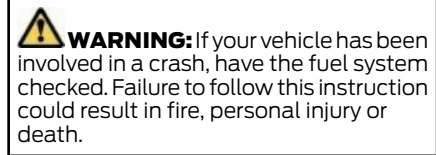

## RE-ENABLING YOUR VEHICLE

1. Switch the ignition off.
2. Attempt to start your vehicle.
3. Switch the ignition off.
4. Attempt to start your vehicle.

**Note:** *If your vehicle does not start after the third attempt, have your vehicle checked as soon as possible.*

# Crash and Breakdown Information

## RECOVERY TOWING

### ACCESSING THE FRONT TOWING POINT - EXCLUDING: RAPTOR



**WARNING:** Using recovery hooks is dangerous and should only be done by a person familiar with proper vehicle recovery safety practices. Improper use of recovery hooks may cause hook failure or separation from the vehicle and could result in serious injury or death.



**WARNING:** Slowly remove the slack from the recovery strap prior to pulling. Failure to do so can introduce significantly higher loads which can cause the recovery hooks to break off, or the recovery strap to fail which can cause serious injury or death.



**WARNING:** Never link two straps together with a clevis pin. These heavy metal objects could become projectiles if the strap breaks and can cause serious injury or death.

**Note:** Do not apply a load to the recovery hooks that is greater than the gross vehicle weight rating of your vehicle.

Before using recovery hooks:

- Make sure all attaching points are secure and capable of withstanding the applied load.
- Do not use chains, cables or tow straps with metal hook ends.
- Only use recovery straps that have a minimum breaking strength two to three times the gross vehicle weight of the stuck vehicle.
- Make sure the recovery strap is in good condition and free of visible cuts, tears or damage.
- Use a damper device such as a tarp, heavy blanket or piece of carpet, and place it over the recovery strap to help absorb the energy in the event the strap breaks.
- Make sure the stuck vehicle is not loaded heavier than its gross vehicle weight rating specified on the certification label.
- Align the tow vehicle and stuck vehicle in a straight line, within 10 degrees.
- Keep bystanders to the sides of the vehicle, at a distance of at least twice the length of the recovery strap. This helps avoid injury from the hazard of a recovery hook or strap breaking, or a vehicle lurching into their path.

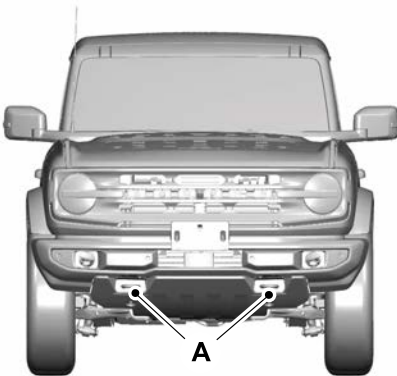

A. Front recovery hooks.

# Crash and Breakdown Information

## ACCESSING THE FRONT TOWING POINT - RAPTOR



**WARNING:** Using recovery hooks is dangerous and should only be done by a person familiar with proper vehicle recovery safety practices. Improper use of recovery hooks may cause hook failure or separation from the vehicle and could result in serious injury or death.



**WARNING:** Slowly remove the slack from the recovery strap prior to pulling. Failure to do so can introduce significantly higher loads which can cause the recovery hooks to break off, or the recovery strap to fail which can cause serious injury or death.



**WARNING:** Never link two straps together with a clevis pin. These heavy metal objects could become projectiles if the strap breaks and can cause serious injury or death.

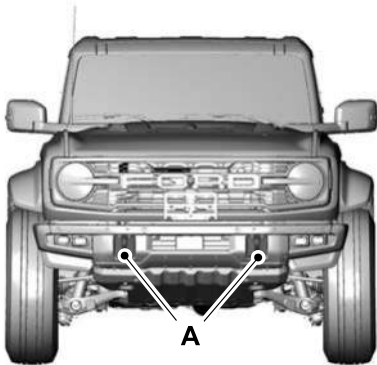

A. Front recovery hooks.

**Note:** Do not apply a load to the recovery hooks that is greater than the gross vehicle weight rating of your vehicle.

Before using recovery hooks:

- Make sure all attaching points are secure and capable of withstanding the applied load.
- Do not use chains, cables or tow straps with metal hook ends.
- Only use recovery straps that have a minimum breaking strength two to three times the gross vehicle weight of the stuck vehicle.
- Make sure the recovery strap is in good condition and free of visible cuts, tears or damage.
- Use a damper device such as a tarp, heavy blanket or piece of carpet, and place it over the recovery strap to help absorb the energy in the event the strap breaks.
- Make sure the stuck vehicle is not loaded heavier than its gross vehicle weight rating specified on the certification label.
- Align the tow vehicle and stuck vehicle in a straight line, within 10 degrees.
- Keep bystanders to the sides of the vehicle, at a distance of at least twice the length of the recovery strap. This helps avoid injury from the hazard of a recovery hook or strap breaking, or a vehicle lurching into their path.

## ACCESSING THE REAR TOWING POINT



**WARNING:** Using recovery hooks is dangerous and should only be done by a person familiar with proper vehicle recovery safety practices. Improper use of recovery hooks may cause hook failure or separation from the vehicle and could result in serious injury or death.

## Crash and Breakdown Information



**WARNING:** Slowly remove the slack from the recovery strap prior to pulling. Failure to do so can introduce significantly higher loads which can cause the recovery hooks to break off, or the recovery strap to fail which can cause serious injury or death.



**WARNING:** Never link two straps together with a clevis pin. These heavy metal objects could become projectiles if the strap breaks and can cause serious injury or death.

**Note:** Depending on your vehicle, you may have a different configuration of rear towing points.

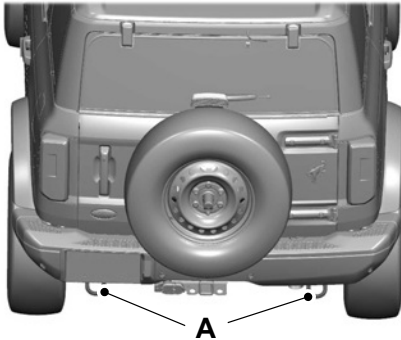

A. Rear recovery hooks.

**Note:** Do not apply a load to the recovery hooks that is greater than the gross vehicle weight rating of your vehicle.

Before using recovery hooks:

- Make sure all attaching points are secure and capable of withstanding the applied load.
- Do not use chains, cables or tow straps with metal hook ends.

- Only use recovery straps that have a minimum breaking strength two to three times the gross vehicle weight of the stuck vehicle.
- Make sure the recovery strap is in good condition and free of visible cuts, tears or damage.
- Use a damper device such as a tarp, heavy blanket or piece of carpet, and place it over the recovery strap to help absorb the energy in the event the strap breaks.
- Make sure the stuck vehicle is not loaded heavier than its gross vehicle weight rating specified on the certification label.
- Align the tow vehicle and stuck vehicle in a straight line, within 10 degrees.
- Keep bystanders to the sides of the vehicle, at a distance of at least twice the length of the recovery strap. This helps avoid injury from the hazard of a recovery hook or strap breaking, or a vehicle lurching into their path.



# Crash and Breakdown Information

## TRANSPORTING THE VEHICLE

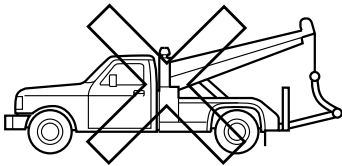
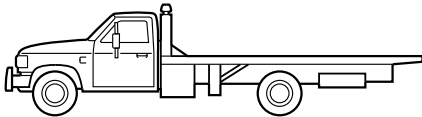
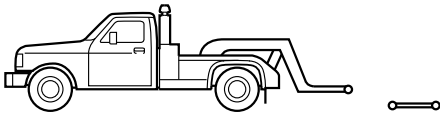

If you need to tow your vehicle, contact a professional towing service or your roadside assistance service provider.

Your manufacturer produces a towing manual for all authorized tow truck operators. Have your tow truck operator refer to this manual for proper hook-up and towing procedures.

All-wheel or four-wheel drive vehicles require that all wheels be off the ground using a wheel lift and dollies or flatbed equipment. This prevents damage to the transmission and drive system.

## FAIL-SAFE COOLING

### WHAT IS FAIL-SAFE COOLING

Fail-safe cooling allows you to temporarily drive your vehicle before any incremental component damage occurs due to overheating.

The fail-safe distance depends on outside temperature, vehicle load and terrain.

### HOW DOES FAIL-SAFE COOLING WORK

If the engine reaches a preset over-temperature condition, the engine automatically switches to alternating cylinder operation. Each disabled cylinder acts as an air pump and cools the engine.

When this occurs, your vehicle still operates, however:

- Engine power is limited.
- The air conditioning system turns off.

Continued operation increases the engine temperature, causing the engine to completely shut down. Your steering and braking effort increases in this situation.

When the engine temperature cools, you can re-start the engine.

**Note:** *Have your vehicle checked as soon as possible to minimize engine damage.*

### DRIVING WHEN FAIL-SAFE MODE IS ACTIVATED



**WARNING:** Fail-safe mode is for use during emergencies only. Operate your vehicle in fail-safe mode only as long as necessary to bring your vehicle to rest in a safe location and seek immediate repairs. When in fail-safe mode, your vehicle will have limited

# Crash and Breakdown Information

power, will not be able to maintain high-speed operation, and may completely shut down without warning, potentially losing engine power, power steering assist, and power brake assist, which may increase the possibility of a crash resulting in serious injury.



**WARNING:** Do not remove the coolant reservoir cap when the engine is on or the cooling system is hot. Wait 10 minutes for the cooling system to cool down. Cover the coolant reservoir cap with a thick cloth to prevent the possibility of scalding and slowly remove the cap. Failure to follow this instruction could result in personal injury.

Continued operation increases the engine temperature, causing the engine to completely shut down. Your steering and braking effort increases in this situation.

When the engine temperature cools, you can re-start the engine. Have your vehicle checked as soon as possible to minimize engine damage.

Your vehicle has limited engine power when in the fail-safe mode, drive your vehicle with caution. Your vehicle does not maintain high-speed operation and the engine may operate poorly.

Remember that the engine is capable of automatically shutting down to prevent engine damage. In this situation:

1. Pull off the road as soon as safely possible and switch the engine off.
2. If you are a member of a roadside assistance program, we recommend that you contact your roadside assistance service provider.
3. If this is not possible, wait for a short period of time for the engine to cool.
4. Check the coolant level. If the coolant level is at or below the minimum mark, add prediluted coolant immediately.

5. When the engine temperature cools, you can re-start the engine. Have your vehicle checked as soon as possible to minimize engine damage.

**Note:** *Driving your vehicle without repair increases the chance of engine damage.*

## FAIL-SAFE COOLING INDICATORS



If the engine begins to overheat, the coolant temperature gauge moves toward the red zone.



A warning lamp illuminates and a message may appear in the instrument cluster display.

# Towing Your Vehicle

## TOWING YOUR VEHICLE PRECAUTIONS

Use the following guidelines when towing your vehicle. Failure to follow this instruction could result in vehicle damage not covered by the vehicle warranty.

**Note:** Make sure you properly secure your vehicle to the tow vehicle.

**Note:** If you are unsure of the vehicle's configuration, contact an authorized dealer.

## RECREATIONALLY TOWING YOUR VEHICLE - MANUAL TRANSMISSION



**WARNING:** Do not disconnect the battery when recreationally towing your vehicle. This prevents the transfer case from shifting properly and could cause the vehicle to roll, even if the transmission is in gear.



**WARNING:** Placing the transfer case in its neutral position could cause your vehicle to freely roll. Make sure you press and hold the brake pedal and the vehicle is in a secure, safe position when you place the transfer case in its neutral position.

Follow these guidelines if you have a need for recreational towing. An example of recreational towing would be towing your vehicle behind a motorhome. These guidelines are to make sure that you do not damage the transmission.

You can only tow your vehicle with all four wheels on the ground by placing the transfer case in its neutral position by engaging the recreational tow feature. Perform the following steps after positioning your vehicle behind the tow vehicle and properly securing them together.

**Note:** Switch the climate control system to recirculated air mode to prevent exhaust fumes from entering your vehicle.

**Note:** Failure to put the transfer case in its neutral position can damage vehicle components.

**Note:** You can check the towing status at any time by opening the driver door or turning the ignition to the accessory or on position. Neutral Tow Enabled Leave Transmission in Neutral appears in the instrument cluster display to confirm you can recreationally tow your vehicle.

**Note:** A tone could sound for up to 30 minutes if you recreationally tow with the doors removed.

**Note:** For vehicles with electric brake booster, enabling neutral tow deactivates the brake booster. The red brake lamp illuminates in the instrument cluster indicating the brake booster is deactivated.

### Switching Neutral Tow On

1. Switch your vehicle to accessory mode by pressing the push button ignition switch without pressing any pedals.
2. Press the 2H button on the four-wheel drive mode control.
3. Leave the gearshift lever in the neutral position and fully press and hold both the clutch and the brake pedal.
4. Using the instrument cluster controls on the steering wheel, select Settings.
5. Select Neutral Tow.

# Towing Your Vehicle

---

6. Press and hold the OK button until a confirmation message appears in the instrument cluster display.
7. If completed successfully, the instrument cluster display shows Neutral Tow Enabled Leave Transmission in Neutral. This indicates that your vehicle is safe to tow with all wheels on the ground.

**Note:** *If you do not see a confirmation message in the instrument cluster display, you must perform the procedure again from the beginning.*

**Note:** *You may hear noise as the transfer case shifts into its neutral position. This is normal.*

8. Release both the clutch and the brake pedals and leave the gearshift lever in the neutral position.
9. Switch your vehicle off by pressing the push button ignition switch once without pressing any pedals.

## Switching Neutral Tow Off

1. With your vehicle properly secured to the tow vehicle, switch your vehicle to accessory mode by pressing the push button ignition switch without pressing any pedals.
2. Starting with both the brake and clutch pedal released, fully press and hold both pedals at the same time for approximately seven seconds. Continue holding both pedals until the instrument cluster display shows 2H and Neutral Tow Disabled.

**Note:** *If completed successfully, the instrument cluster displays 2H and Neutral Tow Disabled.*

**Note:** *You must perform the switching neutral tow on and switching neutral tow off procedures again from the beginning if the indicator and message do not display.*

**Note:** *You may hear a noise as the transfer case shifts out of its neutral position. This is normal.*

3. Release the pedals.
4. Release the parking brake, start your vehicle, and shift into either a forward or a reverse gear to make sure the transfer case is out of the neutral tow position.
5. Apply the parking brake, then disconnect your vehicle from the tow vehicle.
6. If the transfer case did not successfully shift out of its neutral position, set the parking brake. Have your vehicle checked as soon as possible.

## Resolving the Shift Delayed Drive Forward Message

1. Press and hold both the brake and the clutch pedals.
2. Press the push button ignition switch.
3. With the vehicle running, shift into a forward gear and release the clutch. Let the vehicle roll forward up to 1 m (3 ft).

**Note:** *You may hear a noise as the transfer case shifts out of its neutral position. This is normal.*

4. Make sure the instrument cluster displays Neutral Tow Disabled.

# Towing Your Vehicle

## RECREATIONALLY TOWING YOUR VEHICLE - AUTOMATIC TRANSMISSION



**WARNING:** Do not disconnect the battery when recreationally towing your vehicle. This prevents the transfer case from shifting properly and could cause the vehicle to roll, even if the transmission is in park (P).



**WARNING:** Placing the transfer case in its neutral position could cause your vehicle to freely roll. Make sure you press and hold the brake pedal and the vehicle is in a secure, safe position when you place the transfer case in its neutral position.

Follow these guidelines if you have a need for recreational towing. An example of recreational towing would be towing your vehicle behind a motorhome. These guidelines are to make sure that you do not damage the transmission.

You can only tow your vehicle with all four wheels on the ground by placing the transfer case in its neutral position by engaging the recreational tow feature. Perform the following steps after positioning your vehicle behind the tow vehicle and properly securing them together.

**Note:** Switch the climate control system to recirculated air mode to prevent exhaust fumes from entering your vehicle.

**Note:** Failure to put the transfer case in its neutral position can damage vehicle components.

**Note:** You can check the towing status at any time by opening the driver door or turning the ignition to the accessory or on position. Neutral Tow Enabled Leave Transmission in Neutral appears in the instrument cluster display to confirm you can recreationally tow your vehicle.

**Note:** A tone could sound for up to 30 minutes if you recreationally tow with the doors removed.

**Note:** For vehicles with electric brake booster, enabling neutral tow deactivates the brake booster. The red brake lamp illuminates in the instrument cluster indicating the brake booster is deactivated.

### Switching Neutral Tow On

1. Switch your vehicle to accessory mode by pressing the push button ignition switch without pressing any pedals.
2. Press the 2H button on the four-wheel drive mode control.
3. Press and hold the brake pedal and shift the transmission to neutral (N).
4. Using the instrument cluster controls on the steering wheel, select Settings.
5. Select Neutral Tow.
6. Press and hold the OK button until a confirmation message appears in the instrument cluster display.
7. If completed successfully, the instrument cluster display shows Neutral Tow Enabled Leave Transmission in Neutral. This indicates that your vehicle is safe to tow with all wheels on the ground.

**Note:** If you do not see a confirmation message in the instrument cluster display, perform the procedure again from the beginning.

**Note:** You may hear noise as the transfer case shifts into its neutral position. This is normal.

# Towing Your Vehicle

---

8. Release the brake pedal and leave the transmission in neutral (N).
9. Switch your vehicle off by pressing the push button ignition switch once without pressing any pedals.
4. Apply the parking brake, then disconnect your vehicle from the tow vehicle.
5. Release the parking brake, start your vehicle, and shift into either drive (D) or reverse (R) to make sure the transfer case is out of the neutral tow position.

## Switching Neutral Tow Off

1. With your vehicle properly secured to the tow vehicle, switch your vehicle to accessory mode by pressing the push button ignition switch without pressing any pedals.
2. Starting with the brake pedal released and the transmission in neutral (N), fully press and hold the brake pedal for approximately seven seconds and shift the transmission to park (P). Continue holding the brake pedal until the instrument cluster display shows 2H and Neutral Tow Disabled.

**Note:** *If completed successfully, the instrument cluster displays 2H and Neutral Tow Disabled.*

**Note:** *Perform the switching neutral tow on and switching neutral tow off procedures again from the beginning if the indicator and message do not display.*

**Note:** *You could hear a noise as the transfer case shifts out of its neutral position. This is normal.*

3. Release the brake pedal.

6. If the transfer case did not successfully shift out of its neutral position, set the parking brake. Have your vehicle checked as soon as possible.

## Resolving the Shift Delayed Drive Forward Message

1. Press and hold the brake pedal.
2. Press the push button ignition switch.
3. With the vehicle running, shift into drive (D). Let the vehicle roll forward up to 1 m (3 ft).

**Note:** *You could hear a noise as the transfer case shifts out of its neutral position. This is normal.*

4. Make sure the instrument cluster displays Neutral Tow Disabled.

## EMERGENCY TOWING

If you need to tow your vehicle, contact a professional towing service or, if you are a member of a roadside assistance program, your roadside assistance service provider.

# Towing Your Vehicle

---

## TOWING YOUR VEHICLE – TROUBLESHOOTING

### TOWING YOUR VEHICLE – INFORMATION MESSAGES

<b>Message</b>	<b>Description</b>
Neutral Tow Enabled Leave Transmission in Neutral	The transfer case is in the neutral position and your vehicle is safe to tow with all four wheels on the ground.
Shift Delayed Drive Forward	There is a transfer case gear tooth blockage present. With your vehicle on, shift the transmission into drive (D) and let the vehicle roll forward, up to 1 m (3 ft).
Neutral Tow Disabled	The transfer case is not in the neutral position and your vehicle is not safe to tow with all four wheels on the ground.

# Fuses

## FUSE PRECAUTIONS



**WARNING:** Always disconnect the battery before servicing high current fuses.



**WARNING:** To reduce risk of electrical shock, always replace the cover to the power distribution box before reconnecting the battery or refilling fluid reservoirs.



**WARNING:** Always replace a fuse with one that has the specified amperage rating. Using a fuse with a higher amperage rating can cause severe wire damage and could start a fire.

## UNDER HOOD FUSE BOX

### LOCATING THE UNDER HOOD FUSE BOX

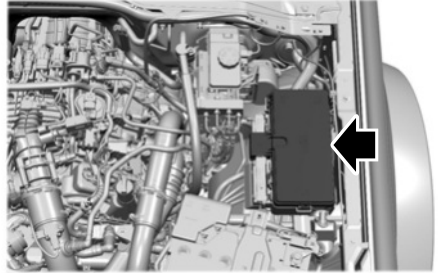

### ACCESSING THE UNDER HOOD FUSE BOX

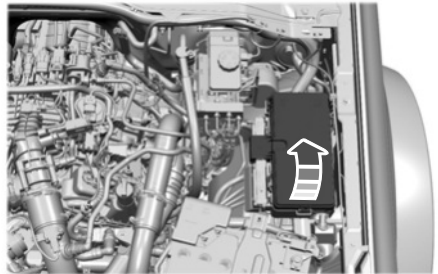



# Fuses

## IDENTIFYING THE FUSES IN THE UNDER HOOD FUSE BOX

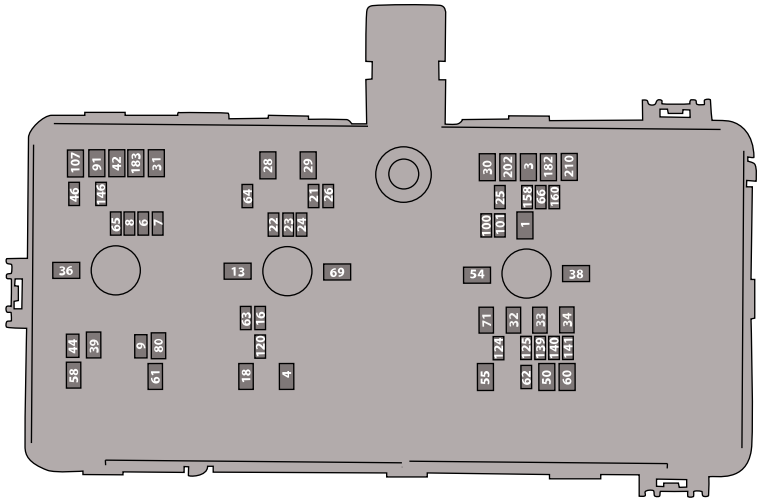

Item	Rating	Protected Component
1	30 A	Body control module - battery power in feed 1.
3	30 A	Body control module - battery power in feed 2.
4	30 A	Fuel pump.
6	25 A	Powertrain control module power.
7	30 A	Powertrain components.
8	20 A	Powertrain components.
9	20 A	Ignition coils.
13	40 A	Blower motor.
16	20 A	Windshield washer.
18	30 A	Starter motor.

# Fuses

Item	Rating	Protected Component
21	10 A	Not used (spare).
22	10 A	360 degree camera module.
23	10 A	Anti-lock brake system run-start feed.
24	10 A	Powertrain control module. Power steering module.
25	20 A	Blind spot information system. Adaptive cruise control. Driveline control module.
26	15 A	Transmission control module.
28	60 A	Anti-lock brake system valves.
29	60 A	Anti-lock brake system pump.
30	30 A	Driver power seat.
31	30 A	Passenger power seat.
32	20 A	Auxiliary power point.
33	20 A	Auxiliary power point.
34	20 A	Center console USB smart charger.
36	40 A	Not used (spare).
38	30 A	Heated seat module.
39	15 A	Vehicle dynamics control module (Raptor).
42	30 A	Trailer brake control module.
44	10 A	Not used (spare).
46	20 A	SYNC module.
50	40 A	Heated rear windshield.

# Fuses

<b>Item</b>	<b>Rating</b>	<b>Protected Component</b>
54	40 A	Driveline control module.
55	30 A	Trailer tow park lamp relay.
58	20 A	Trailer tow backup lamps.
60	30 A	Upfitter switch #1 (Base). Upfitter switch #3 (Raptor).
61	15 A	Upfitter switch #2.
62	10 A	Upfitter switch #3 (Base). Upfitter switch #1 - off-road driving lights (Raptor).
63	10 A	Upfitter switch #4.
64	10 A	Upfitter switch #5.
65	10 A	Upfitter switch #6.
66	10 A	Stability bar disconnect module.
69	30 A	Front windshield wiper.
71	30 A	Rear windshield wiper.
80	10 A	Integrated wheel end (Raptor).
91	40 A	Trailer tow light module.
100	20 A	Left-hand headlamps.
101	20 A	Right-hand headlamps.
107	30 A	Trailer tow battery charge.
120	10 A	Fuel injectors (2.7L, Raptor).
124	5 A	Not used (spare).
125	10 A	Top instrument panel USB smart charger.
139	5 A	Not used (spare).
140	5 A	Not used (spare).
141	5 A	Not used (spare).

# Fuses

Item	Rating	Protected Component
146	20 A	Amplifier.
158	10 A	Stability bar disconnect module run/start.
160	10 A	Smart data link control.
182	60 A	Driver door module.
183	60 A	Passenger door module.
202	60 A	Body control module B+.
210	30 A	Body control module start stop.

## BODY CONTROL MODULE FUSE BOX

### LOCATING THE BODY CONTROL MODULE FUSE BOX

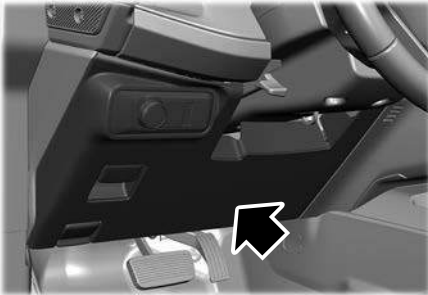

### ACCESSING THE BODY CONTROL MODULE FUSE BOX

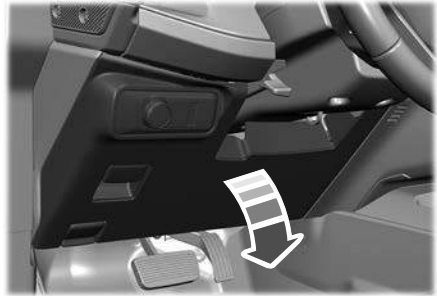

# Fuses

## IDENTIFYING THE FUSES IN THE BODY CONTROL MODULE FUSE BOX

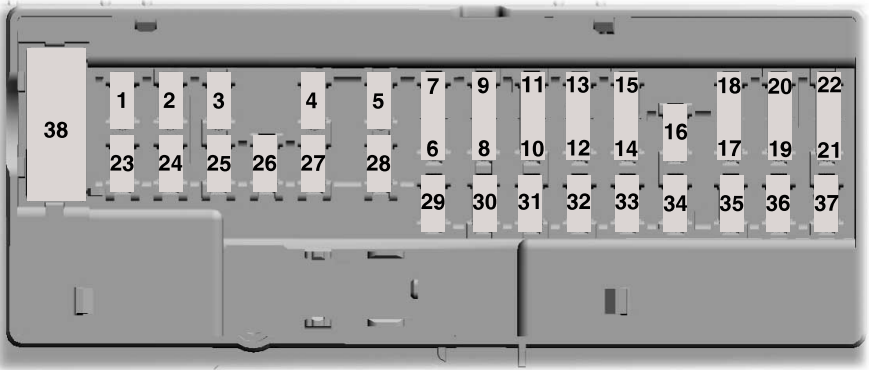

Item	Rating	Protected Component
1	—	Not used.
2	10 A	Power windows. DC/AC inverter. Upfitter switches.
3	7.5 A	Exterior mirrors.
4	20 A	Not used (spare).
5	—	Not used.
6	—	Not used.
7	10 A	Not used.
8	5 A	Not used (spare).
9	5 A	Not used (spare).
10	—	Not used.
11	—	Not used.
12	7.5 A	Climate control. Gateway module.

## Fuses

Item	Rating	Protected Component
13	7.5 A	Steering column control module. Instrument cluster module.
14	15 A	Not used (spare).
15	15 A	Not used (spare).
16	—	Not used.
17	7.5 A	Not used (spare).
18	7.5 A	Not used (spare).
19	5 A	Ignition switch. Headlamps.
20	5 A	Telematics modem.
21	5 A	In-vehicle temperature and humidity sensor.
22	5 A	Not used.
23	30 A	Not used (spare).
24	30 A	Not used (spare).
25	20 A	Not used (spare).
26	30 A	Not used (spare).
27	30 A	Not used (spare).
28	30 A	Not used (spare).
29	15 A	Not used (spare).
30	—	Not used.
31	10 A	Terrain management switch. Integrated control panel switch. Driveline and chassis controls switch panel. 12 inch center display. Radio frequency receiver module.
32	20 A	Audio control module.

# Fuses

Item	Rating	Protected Component
33	—	Not used.
34	—	Not used.
35	5 A	Not used (spare).
36	15 A	Automatic high beam. Image processing module A.
37	20 A	Auto-dimming interior mirror. Parking assist control module. Heated steering wheel.
38	30 A Circuit Breaker	Not used.

## IDENTIFYING FUSE TYPES

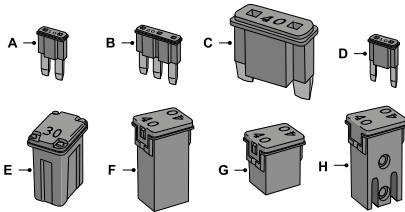

- A Micro 2.
- B Micro 3.
- C Maxi.
- D Mini.
- E M Case.
- F J Case.
- G J Case Low Profile.
- H Slotted M Case.

## FUSES – TROUBLESHOOTING

### FUSES – FREQUENTLY ASKED QUESTIONS

#### When do I need to check a fuse?

- If electrical components in the vehicle are not working.

#### When do I need to replace a fuse?

- If a fuse has blown.

#### How do I identify a blown fuse?

- You can identify a blown fuse by a broken wire within the fuse.

# Maintenance

## MAINTENANCE PRECAUTIONS

Service your vehicle regularly to help maintain its roadworthiness and resale value. There is a large network of authorized dealers that are there to help you with their professional servicing expertise. We believe that their specially trained technicians are best qualified to service your vehicle properly and expertly. They are supported by a wide range of highly specialized tools developed specifically for servicing your vehicle.

If your vehicle requires professional service, an authorized dealer can provide the necessary parts and service. Check your warranty information to find out which parts and services are covered.

Use only recommended fuels, lubricants, fluids and service parts conforming to specifications.

- Do not work on a hot engine.
- Make sure that nothing gets caught in moving parts.
- Do not work on a vehicle with the engine running in an enclosed space, unless you are sure you have enough ventilation.
- Keep all open flames and other burning material, such as cigarettes, away from the battery and all fuel related parts.
- Set the parking brake, shift the transmission to park (P) and block the wheels.

## OPENING AND CLOSING THE HOOD - EXCLUDING: RAPTOR

### Opening the Hood

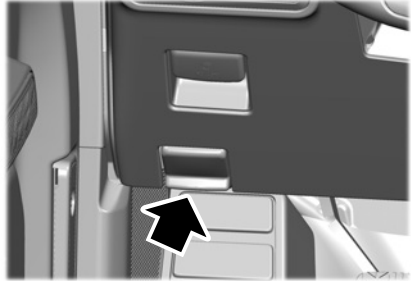

1. Pull the hood release handle under the left-hand side of the instrument panel.

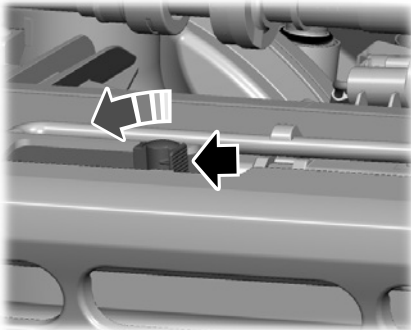

2. Release the hood latch by pushing the secondary release lever to your left-hand side.



# Maintenance

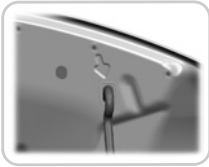

3. Open the hood and support it with the hood strut.

## Closing the Hood



**WARNING:** Make sure that you fully latch the hood before driving. Failure to follow this instruction could result in personal injury or death.

1. Fully stow the strut prior to lowering the hood.
2. To close, lower the hood and make sure that it fully latches.

## OPENING AND CLOSING THE HOOD - RAPTOR

### Opening the Hood

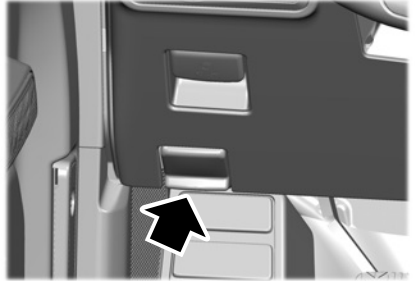

1. Pull the hood release handle under the left-hand side of the instrument panel.

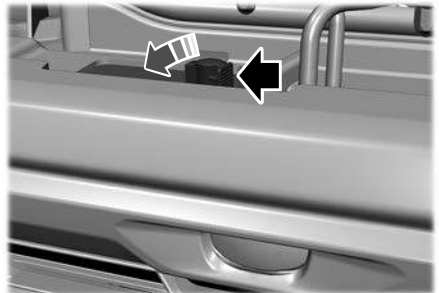

2. Release the hood latch by pushing the secondary release lever to the left.

# Maintenance

3. Raise the hood until the lift cylinders hold it open.

## Closing the Hood



**WARNING:** Make sure that you fully latch the hood before driving. Failure to follow this instruction could result in personal injury or death.

To close, lower the hood and make sure that it fully latches.



## UNDER HOOD OVERVIEW - 2.3L ECOBOOST™

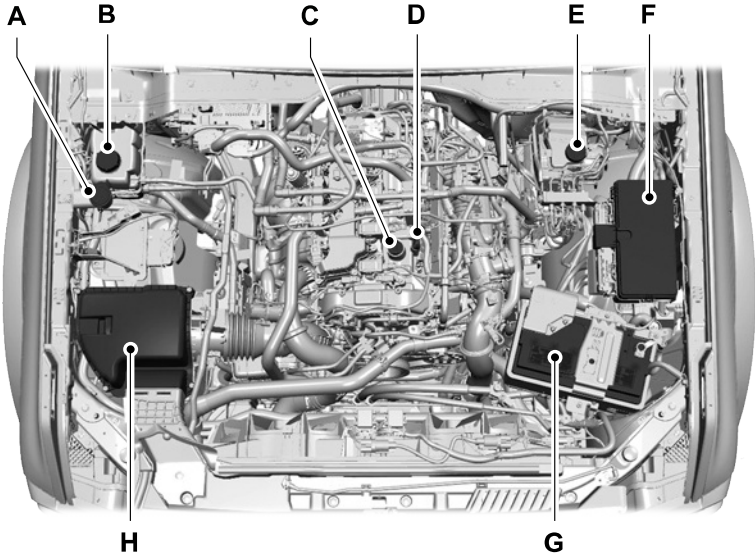

- A Engine coolant reservoir. See **Checking the Coolant Level** (page 354).
- B Windshield washer fluid reservoir. See **Adding Washer Fluid** (page 87).

# Maintenance

- C Engine oil filler cap. See **Adding Engine Oil** (page 345).
- D Engine oil dipstick. See **Engine Oil Dipstick Overview** (page 345).
- E Brake fluid reservoir. See **Locating the Brake Fluid Reservoir** (page 200).
- F Engine compartment fuse box. See **Locating the Under Hood Fuse Box** (page 332).
- G Battery. See **Changing the 12V Battery** (page 360).
- H Air filter assembly. See **Changing the Engine Air Filter** (page 352).

## UNDER HOOD OVERVIEW - 2.7L ECOBOOST™

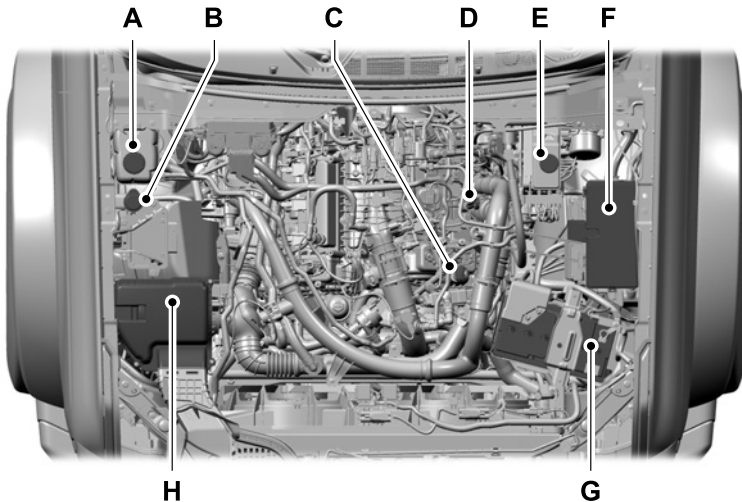

- A Engine coolant reservoir. See **Checking the Coolant Level** (page 354).
- B Windshield washer fluid reservoir. See **Adding Washer Fluid** (page 87).
- C Engine oil filler cap. See **Adding Engine Oil** (page 345).
- D Engine oil dipstick. See **Engine Oil Dipstick Overview** (page 345).
- E Brake fluid reservoir. See **Locating the Brake Fluid Reservoir** (page 200).
- F Engine compartment fuse box. See **Locating the Under Hood Fuse Box** (page 332).

# Maintenance

- G Battery. See **Changing the 12V Battery** (page 360).
- H Air filter assembly. See **Changing the Engine Air Filter** (page 352).

## UNDER HOOD OVERVIEW - 3.0L ECOBOOST™

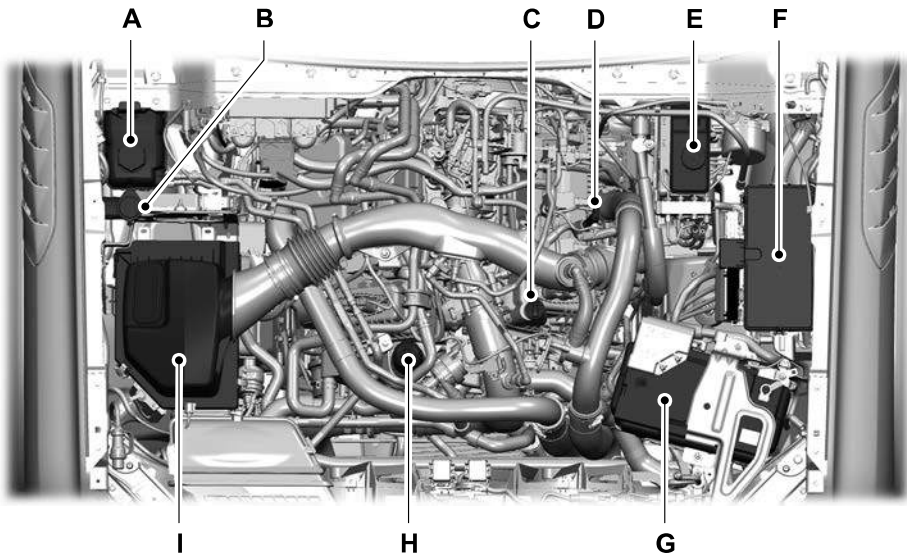

- A Engine coolant reservoir. See **Checking the Coolant Level** (page 354).
- B Windshield washer fluid reservoir. See **Adding Washer Fluid** (page 87).
- C Engine oil filler cap. See **Adding Engine Oil** (page 345).
- D Engine oil dipstick. See **Engine Oil Dipstick Overview** (page 345).
- E Brake fluid reservoir. See **Locating the Brake Fluid Reservoir** (page 200).
- F Engine compartment fuse box. See **Locating the Under Hood Fuse Box** (page 332).
- G Battery. See **Changing the 12V Battery** (page 360).

# Maintenance

- H Engine oil filter. See **Motorcraft Parts** (page 373).
- I Air filter assembly. See **Changing the Engine Air Filter** (page 353).

## ENGINE OIL

### ENGINE OIL DIPSTICK OVERVIEW

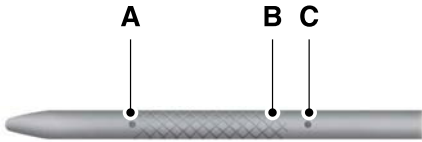

- A Minimum.
- B Nominal.
- C Maximum.

### CHECKING THE ENGINE OIL LEVEL

1. Make sure that your vehicle is on level ground.
2. Check the oil level before starting the engine, or switch the engine off after warm up and wait 15 minutes for the oil to drain into the oil pan.

**Note:** *Checking the oil level too soon could result in an inaccurate reading.*

3. Remove the dipstick and wipe it with a clean, lint-free cloth.
4. Reinstall the dipstick and make sure it is fully seated.
5. Remove the dipstick again to check the oil level.

**Note:** *Read both sides of the dipstick and use the lowest oil level as the correct reading.*

**Note:** *If the oil level is between the maximum and minimum marks, the oil level is acceptable. Do not add oil.*

6. If the oil level is at the minimum mark, immediately add oil.
7. Reinstall the dipstick. Make sure it is fully seated.

**Note:** *The oil consumption of new engines reaches its normal level after approximately 5,000 km (3,000 mi).*

**Note:** *Increases in oil level can occur from frequent short trips that do not allow the engine to get to operating temperature, as well as frequent idling or low speed driving for long periods of time.*

**Note:** *If oil levels are continuously noted above the maximum mark, have your vehicle checked as soon as possible.*

### ADDING ENGINE OIL

 **WARNING:** Do not remove the filler cap when the engine is running.

 **WARNING:** Do not add engine oil when the engine is hot. Failure to follow this instruction could result in personal injury.

Do not use supplemental engine oil additives because they are unnecessary and could lead to engine damage that the vehicle warranty may not cover.

1. Clean the area surrounding the engine oil filler cap before you remove it.
2. Remove the engine oil filler cap.

# Maintenance

3. Add engine oil that meets our specifications. See **Engine Oil** (page 346).
4. Reinstall the engine oil filler cap. Turn it clockwise until you feel a strong resistance.

**Note:** Do not add oil further than the maximum mark. Oil levels above the maximum mark may cause engine damage.

**Note:** Immediately soak up any oil spillage with an absorbent cloth.

## INTELLIGENT OIL LIFE MONITOR

Under certain conditions the vehicle's intelligent oil life monitor may determine your oil requires replacement prior to your general service. Should this occur it is recommended you replace your oil within two weeks or 800 km (500 mi) of being alerted.

Your authorized dealer will be able to advise you whether only an engine oil and filter change is recommended or whether you should complete your general service inclusive of oil and oil Filter.

## RESETTING THE INTELLIGENT OIL LIFE MONITOR

Use the instrument cluster display controls on the steering wheel to reset the oil change reminder.

### From the main menu scroll to:

Message	Action and Description
Settings	Press the right arrow button, then from this menu scroll to the following message.
Vehicle Maintenance	Press the right arrow button, then from this menu scroll to the following message.
Oil Life Reset	Press the right arrow button, then from this menu scroll to the following message.
Hold OK to Reset	Press and hold the <b>OK</b> button until the instrument cluster displays the following message. Reset Successful
	When the oil change reminder resets the instrument cluster displays 100%. Remaining Life {00}%
	If the instrument cluster displays one of the following messages, repeat the process. Not Reset Reset Cancelled

## ENGINE OIL CAPACITY AND SPECIFICATION - 2.3L ECOBOOST™

Use oil that meets the defined specification and viscosity grade.

# Maintenance

If you do not use oil that meets the defined specification and viscosity grade, it could result in:

- Component damage that your vehicle warranty does not cover.
- Longer engine cranking periods.
- Increased emission levels.
- Reduced vehicle performance.
- Reduced fuel economy.



An oil that displays this symbol conforms to current engine, emission system and fuel economy performance standards of ILSAC.

We recommend Motorcraft motor oil for your vehicle. If Motorcraft oil is not available, use motor oils of the recommended viscosity grade that display the API Certification Mark for gasoline engines.

Do not use supplemental engine oil additives because they are unnecessary and could lead to engine damage that your vehicle warranty does not cover.

## Capacities

Variant	Including the Oil Filter
All.	5.3 L (5.6 qt)

## Materials

Name	Specification
Motorcraft® SAE 5W-30 Motor Oil (U.S.) Motorcraft® SAE 5W-30 Motor Oil / Huile moteur SAE 5W-30 Motorcraft® (Canada) XO-5W30-Q1SP, XO-5W30-Q1FS (U.S.) CXO-5W30-LSP6, CXO-5W30-LFS6 (Canada)	WSS-M2C961-A1

# Maintenance

## Alternative Engine Oil for Extremely Cold Climates

To improve engine cold start performance,

we recommend that you use the following alternative engine oil in extremely cold climates, where the ambient temperature reaches  $-30^{\circ}\text{C}$  ( $-22.0^{\circ}\text{F}$ ) or below.

### Materials

Name	Specification
Engine Oil - SAE 0W-30	WSS-M2C963-A1

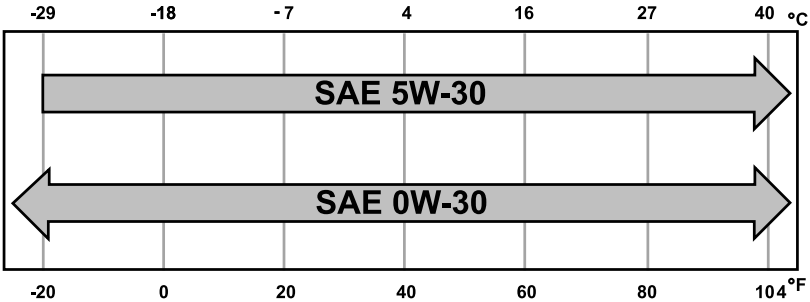

**Note:** If you use your vehicle regularly above the altitude of 1,524 m (5,000 ft) and under the temperature of  $-20^{\circ}\text{C}$  ( $-4.0^{\circ}\text{F}$ ), it is recommended to use the alternative engine oil.

- Reduced vehicle performance.
- Reduced fuel economy.

## ENGINE OIL CAPACITY AND SPECIFICATION - 2.7L ECOBOOST™

Use oil that meets the defined specification and viscosity grade.

If you do not use oil that meets the defined specification and viscosity grade, it could result in:

- Component damage that your vehicle warranty does not cover.
- Longer engine cranking periods.
- Increased emission levels.



An oil that displays this symbol conforms to current engine, emission system and fuel economy performance standards of ILSAC.



# Maintenance

We recommend Motorcraft motor oil for your vehicle. If Motorcraft oil is not available, use motor oils of the recommended viscosity grade that display the API Certification Mark for gasoline

engines.

Do not use supplemental engine oil additives because they are unnecessary and could lead to engine damage that your vehicle warranty does not cover.

## Capacities

Variant	Including the Oil Filter
All.	5.7 L (6.0 qt)

## Materials

Name	Specification
Motorcraft® SAE 5W-30 Motor Oil(U.S.) Motorcraft® SAE 5W-30 Motor Oil / Huile moteur SAE 5W-30 Motorcraft®(Canada) XO-5W30-Q1SP, XO-5W30-Q1FS(U.S.) CXO-5W30-LSP6, CXO-5W30-LFS6(Canada)	WSS-M2C961-A1

## Alternative Engine Oil for Extremely Cold Climates

To improve engine cold start performance, we recommend that you use the following alternative engine oil in extremely cold climates, where the ambient temperature reaches -30°C (-22.0°F) or below.

## Materials

Name	Specification
Engine Oil - SAE 0W-30	WSS-M2C963-A1

# Maintenance

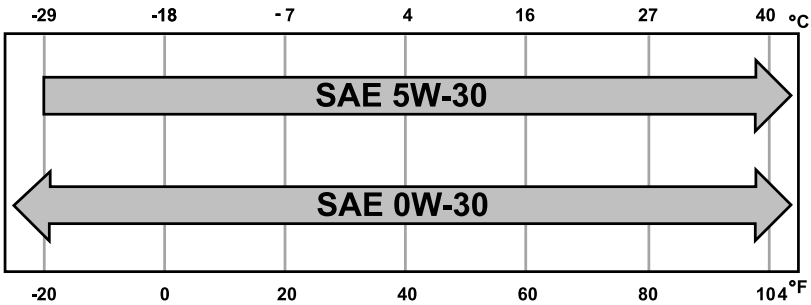

**Note:** If you use your vehicle regularly above the altitude of 1,524 m (5,000 ft) and under the temperature of -20°C (-4.0°F), it is recommended to use the alternative engine oil.

## ENGINE OIL CAPACITY AND SPECIFICATION - 3.0L ECOBOOST™

Use oil that meets the defined specification and viscosity grade.

If you do not use oil that meets the defined specification and viscosity grade, it could result in:

- Component damage that your vehicle warranty does not cover.
- Longer engine cranking periods.
- Increased emission levels.
- Reduced vehicle performance.
- Reduced fuel economy.



An oil that displays this symbol conforms to current engine, emission system and fuel economy performance standards of ILSAC.

We recommend Motorcraft motor oil for your vehicle. If Motorcraft oil is not available, use motor oils of the recommended viscosity grade that display the API Certification Mark for gasoline engines.

Do not use supplemental engine oil additives because they are unnecessary and could lead to engine damage that your vehicle warranty does not cover.

# Maintenance

## Capacities

Variant	Including the Oil Filter
All.	6.62 L (7.0 qt)

## Materials

Name	Specification
Motorcraft® SAE 5W-30 Motor Oil(U.S.) Motorcraft® SAE 5W-30 Motor Oil / Huile moteur SAE 5W-30 Motorcraft®(Canada) XO-5W30-Q1SP, XO-5W30-Q1FS(U.S.) CXO-5W30-LSP6, CXO-5W30-LFS6(Canada)	WSS-M2C961-A1

## Alternative Engine Oil for Extremely Cold Climates

To improve engine cold start performance, we recommend that you use the following alternative engine oil in extremely cold climates, where the ambient temperature reaches -30°C (-22.0°F) or below.

## Materials

Name	Specification
Engine Oil - SAE 0W-30	WSS-M2C963-A1

# Maintenance

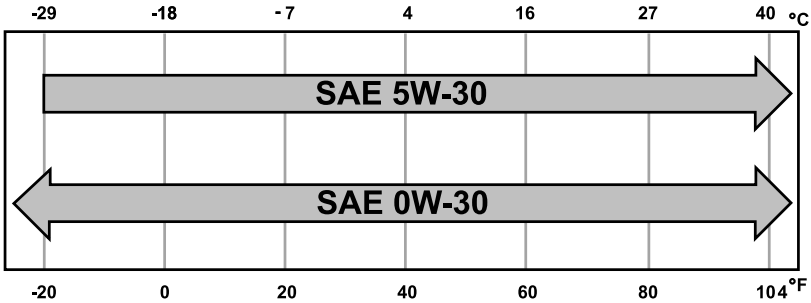

**Note:** If you use your vehicle regularly above the altitude of 1,524 m (5,000 ft) and under the temperature of  $-20^{\circ}\text{C}$  ( $-4.0^{\circ}\text{F}$ ), it is recommended to use the alternative engine oil.

**Note:** When servicing the air cleaner, do not allow foreign material to enter the air induction system. The engine is susceptible to damage from even small particles.

## ENGINE AIR FILTER

### CHANGING THE ENGINE AIR FILTER - 2.3L ECOBOOST™/2.7L ECOBOOST™



**WARNING:** To reduce the risk of vehicle damage and personal burn injuries, do not start your engine with the air cleaner removed and do not remove it while the engine is running.

Change the air filter element at the proper intervals. See **Scheduled Maintenance** (page 507).

When changing the air filter element, use only the air filter element listed. See **Vehicle Specifications** (page 368).

**Note:** Failure to use the correct air filter element could result in severe engine damage that the vehicle warranty may not cover.

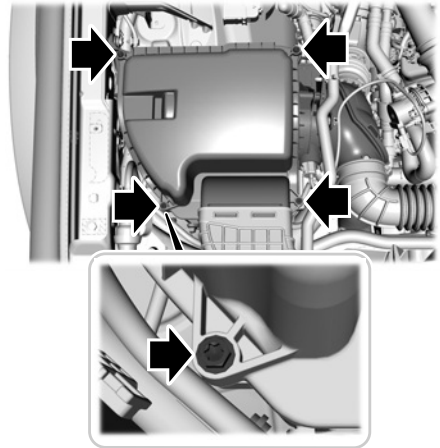

1. Remove the screws from the air filter housing cover.
2. Carefully lift the air filter housing cover.
3. Remove the air filter element from the air filter housing.

# Maintenance

4. To install, reverse the removal procedure.
5. Tighten fasteners to 2.8 Nm (2.07 lb.ft)

## CHANGING THE ENGINE AIR FILTER - 3.0L ECOBOOST™



**WARNING:** To reduce the risk of vehicle damage and personal burn injuries, do not start your engine with the air cleaner removed and do not remove it while the engine is running.

Change the air filter element at the proper intervals. See **Scheduled Maintenance** (page 507).

When changing the air filter element, use only the air filter element listed. See **Motorcraft Parts** (page 371).

**Note:** Failure to use the correct air filter element could result in severe engine damage that the vehicle warranty may not cover.

**Note:** When servicing the air cleaner, do not allow foreign material to enter the air induction system. The engine is susceptible to damage from even small particles.

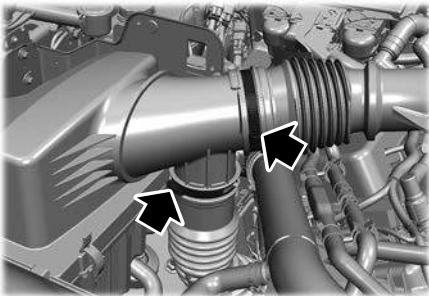

**Note:** Do not disconnect the intake air temperature sensor on the back side of the air duct.

1. Loosen the two clamps from the air ducts.
2. Carefully remove the two air ducts from the air cleaner housing assembly.

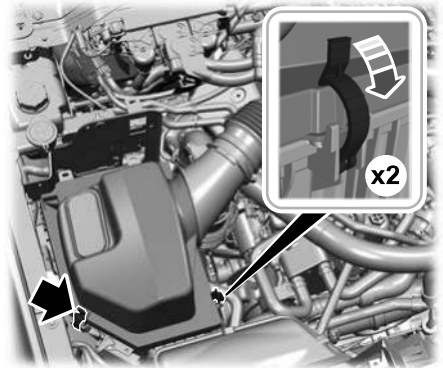



1. Remove the two clips from the air filter housing cover.
2. Carefully lift the air filter housing cover. Do not disconnect or damage the intake air temperature sensor or harness.
3. Remove the air filter element from the air filter housing.
4. To install, reverse the removal procedure.

# Maintenance

## COOLANT

### CHECKING THE COOLANT LEVEL

 **WARNING:** Do not remove the coolant reservoir cap when the engine is on or the cooling system is hot. Wait 10 minutes for the cooling system to cool down. Cover the coolant reservoir cap with a thick cloth to prevent the possibility of scalding and slowly remove the cap. Failure to follow this instruction could result in personal injury.

 **WARNING:** To reduce the risk of personal injury, make sure the engine is cool before unscrewing the coolant pressure relief cap. The cooling system is under pressure. Steam and hot liquid can come out forcefully when you loosen the cap slightly.

When the engine is cold, check the concentration and level of the coolant at the intervals listed in the scheduled maintenance information. See **Scheduled Maintenance** (page 507).

**Note:** Make sure that the coolant level is between the **MIN** and the **MAX** marks on the coolant reservoir.

**Note:** Coolant expands when it is hot. The level may extend beyond the **MAX** mark. This is normal.

Maintain coolant concentration within 48% to 50%, which equates to a freeze point between -34°C (-29°F) and -37°C (-35°F). Coolant concentration should be checked using a refractometer. We do not recommend the use of hydrometers or coolant test strips for measuring coolant concentration.

## ADDING COOLANT

 **WARNING:** Do not add coolant when the vehicle is on or the cooling system is hot. Failure to follow this instruction could result in personal injury.

 **WARNING:** Do not remove the coolant reservoir cap when the engine is on or the cooling system is hot. Wait 10 minutes for the cooling system to cool down. Cover the coolant reservoir cap with a thick cloth to prevent the possibility of scalding and slowly remove the cap. Failure to follow this instruction could result in personal injury.

 **WARNING:** Do not allow the fluid to touch your skin or eyes. If this happens, rinse the affected areas immediately with plenty of water and contact your physician.

 **WARNING:** Do not put coolant in the windshield washer reservoir. If sprayed on the windshield, coolant could make it difficult to see through the windshield.

 **WARNING:** Do not add coolant further than the **MAX** mark.

**Note:** Do not use stop leak pellets, cooling system sealants, or non-specified additives as they can cause damage to the engine cooling or heating systems. Resulting component damage may not be covered by the vehicle Warranty.

**Note:** Automotive fluids are not interchangeable.

# Maintenance

---

It is very important to use prediluted coolant approved to the correct specification in order to avoid plugging the small passageways in the engine cooling system. See **Coolant** (page 356). Do not mix different colors or types of coolant in your vehicle. Mixing of engine coolants or using an incorrect coolant may harm the engine or cooling system components and may not be covered by the vehicle Warranty.

**Note:** *If prediluted coolant is not available, use the approved concentrated coolant diluting it to 50/50 with deionised or distilled water. See **Coolant** (page 356). Using water that has not been deionised may contribute to deposit formation, corrosion and plugging of the small cooling system passageways.*

**Note:** *Coolants marketed for all makes and models may not be approved to our specifications and may cause damage to the cooling system. Resulting component damage may not be covered by the vehicle Warranty.*

If the coolant level is at or below the minimum mark, add prediluted coolant immediately.

To top up the coolant level do the following:

1. Unscrew the cap slowly. Any pressure escapes as you unscrew the cap.
2. Add prediluted coolant approved to the correct specification. See **Coolant** (page 356).
3. Add enough prediluted coolant to reach the correct level.
4. Replace the coolant reservoir cap. Turn the cap clockwise until it contacts the hard stop.

5. Check the coolant level in the coolant reservoir the next few times you drive your vehicle. If necessary, add enough prediluted engine coolant to bring the coolant level to the correct level.

If you have to add more than 1 L (1.1 qt) of engine coolant per month, have your vehicle checked as soon as possible. Operating an engine with a low level of coolant can result in engine overheating and possible engine damage.

In case of emergency, you can add a large amount of water without engine coolant in order to reach a vehicle service location.

Water alone, without engine coolant, can cause engine damage from corrosion, overheating or freezing.

Do not use the following as a coolant substitute:

- Alcohol.
- Methanol.
- Brine.
- Any coolant mixed with alcohol or methanol antifreeze.

Alcohol and other liquids can cause engine damage from overheating or freezing.

Do not add extra inhibitors or additives to the coolant. These can be harmful and compromise the corrosion protection of the coolant.

## CHANGING THE COOLANT

For coolant change, see your authorized dealer.

Changing the coolant is necessary at specific mileage intervals listed in the scheduled maintenance information. See **Scheduled Maintenance** (page 507).

# Maintenance

## MANAGING THE COOLANT TEMPERATURE

If you tow a trailer with your vehicle, the engine may temporarily reach a higher temperature during severe operating conditions, for example ascending a long or steep grade in high ambient temperatures.

At this time, you may notice the coolant temperature gauge moves toward the red zone and a message may appear in the information display.



**WARNING:** To reduce the risk of crash and injury, be prepared that the vehicle speed may reduce and the vehicle may not be able to accelerate with full power until the coolant temperature reduces.



**WARNING:** If you continue to drive your vehicle when the engine is overheating, the engine could stop without warning. Failure to follow this instruction could result in the loss of control of your vehicle.

You may notice a reduction in vehicle speed caused by reduced engine power in order to manage the engine coolant temperature. Your vehicle may enter this mode if certain high-temperature and high-load conditions take place. The amount of speed reduction depends on vehicle loading, grade and outside temperature. If this occurs, there is no need to stop your vehicle. You can continue to drive. See **Fail-Safe Cooling** (page 325).

The air conditioning may automatically turn on and off during severe operating conditions to protect the engine from overheating. When the coolant temperature decreases to the normal operating temperature, the air conditioning turns on.

If the coolant temperature gauge moves fully into the red zone, or if the coolant temperature warning or service engine soon messages appear in your information display, do the following:

1. Stop your vehicle as soon as it is safe to do so. Fully apply the parking brake, shift into park (P) or neutral (N).
2. Leave the engine running until the coolant temperature gauge needle returns to the normal position. If the temperature does not drop after several minutes, follow the remaining steps.
3. Switch the engine off and wait for it to cool. Check the coolant level.
4. If the coolant level is at or below the minimum mark, add prediluted coolant immediately.
5. If the coolant level is normal, restart the engine and continue.

## COOLING SYSTEM CAPACITY AND SPECIFICATION - 2.3L ECOBOOST™

Use coolant that meets the defined specification.

If you do not use coolant that meets the defined specification, it could result in:

- Component damage that your vehicle warranty does not cover.
- Reduced vehicle performance.



# Maintenance

## Capacities

Variant	Quantity
With automatic transmission.	9.9 L (10.5 qt)
With manual transmission.	9.5 L (10.0 qt)

## Materials

Name	Specification
Motorcraft® Yellow Prediluted Antifreeze/ Coolant(U.S.) Motorcraft® Yellow Prediluted Antifreeze/Coolant / Antigel/liquide de refroidissement prédilué jaune Motorcraft®(Canada) VC-13DL-G(U.S.) CVC-13DL-G(Canada)	WSS-M97B57-A2

## COOLING SYSTEM CAPACITY AND SPECIFICATION - 2.7L/3.0L, RAPTOR

Use coolant that meets the defined specification.

If you do not use coolant that meets the defined specification, it could result in:

- Component damage that your vehicle warranty does not cover.
- Reduced vehicle performance.

## Capacities

Variant	Quantity
All.	11.7 L (12.4 qt)

## Materials

Name	Specification
Motorcraft® Yellow Prediluted Antifreeze/ Coolant(U.S.) Motorcraft® Yellow Prediluted Antifreeze/Coolant / Antigel/liquide de refroidissement prédilué jaune Motorcraft®(Canada) VC-13DL-G(U.S.) CVC-13DL-G(Canada)	WSS-M97B57-A2

# Maintenance

## COOLANT – WARNING LAMPS



If the engine begins to overheat, the coolant temperature gauge

moves toward the red zone.



A warning lamp illuminates and a message may appear in the information display.

## COOLANT – INFORMATION MESSAGES

Message	Description and Action
High engine temperature Stop safely	Displays when the engine temperature is too high. Stop your vehicle as soon as it is safe to do so, switch the engine off and allow it to cool. If the problem persists, have your vehicle checked as soon as possible. See <b>Checking the Coolant Level</b> (page 354).

## DRIVE BELT ROUTING OVERVIEW - 2.3L

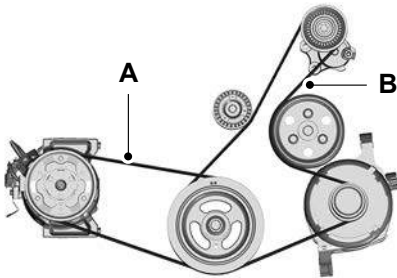

- A. The short drive belt is on the second pulley groove farthest from the engine.
- B. The long drive belt is on the first pulley groove closest to the engine.

## DRIVE BELT ROUTING OVERVIEW - 2.7L/3.0L

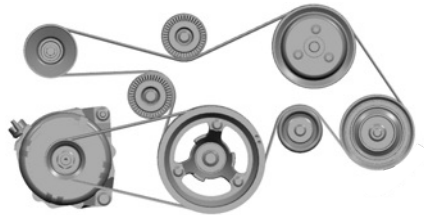

# Maintenance

## 12V BATTERY

### 12V BATTERY PRECAUTIONS



**WARNING:** Batteries normally produce explosive gases which can cause personal injury. Therefore, do not allow flames, sparks or lighted substances to come near the battery. When working near the battery, always shield your face and protect your eyes. Always provide correct ventilation.



**WARNING:** When lifting a plastic-cased battery, excessive pressure on the end walls could cause acid to flow through the vent caps, resulting in personal injury and damage to the vehicle or battery. Lift the battery with a battery carrier or with your hands on opposite corners.



**WARNING:** Keep batteries out of reach of children. Batteries contain sulfuric acid. Avoid contact with skin, eyes or clothing. Shield your eyes when working near the battery to protect against possible splashing of acid solution. In case of acid contact with skin or eyes, flush immediately with water for a minimum of 15 minutes and get prompt medical attention. If acid is swallowed, call a physician immediately.



**WARNING:** Battery posts, terminals and related accessories contain lead and lead compounds, chemicals known to the State of California to cause cancer and reproductive harm. **Wash your hands after handling.**



**WARNING:** This vehicle may have more than one battery. Removing the battery cables from only one battery does not disconnect your vehicle electrical system. Make sure you disconnect the battery cables from all batteries when disconnecting power. Failure to do so may cause serious personal injury or property damage.



**WARNING:** For vehicles with Auto-Start-Stop the battery requirement is different. You must replace the battery with one of exactly the same specification.

### WHAT IS THE BATTERY MANAGEMENT SYSTEM

The battery management system monitors battery conditions and takes actions to extend battery life.

### HOW DOES THE BATTERY MANAGEMENT SYSTEM WORK

If excessive battery drain is detected, the system temporarily disables some electrical systems to protect the battery.

Systems included are:

- Heated rear window.
- Heated seats.
- Climate control.
- Heated steering wheel.
- Audio unit.
- Navigation system.

A message could appear in the information display to alert you that battery protection actions are active. This message is only for notification that an action is taking place, and not intended to indicate an electrical problem or that the battery requires replacement.

# Maintenance

---

## BATTERY MANAGEMENT SYSTEM LIMITATIONS

After battery replacement, or in some cases after charging the battery with an external charger, the battery management system requires eight hours of vehicle sleep time to relearn the battery state of charge. During this time, your vehicle must remain fully locked with the ignition switched off.

**Note:** *Prior to relearning the battery state of charge, the battery management system could temporarily disable some electrical systems.*

## Electrical Accessory Installation

To make sure the battery management system works correctly, do not connect an electrical device ground connection directly to the battery negative post. This can cause inaccurate measurements of the battery condition and potential incorrect system operation.

**Note:** *If you add electrical accessories or components to the vehicle, it could adversely affect battery performance and durability. This could also affect the performance of other electrical systems in the vehicle.*

## CHANGING THE 12V BATTERY

The battery is in the engine compartment. See **Maintenance** (page 340).

Your vehicle has a maintenance-free battery. It does not require additional water during service.

If the vehicle battery has a cover, make sure you correctly install it after cleaning or replacing the battery.

For longer, trouble-free operation, keep the top of the battery clean and dry and the battery cables tightly fastened to the battery terminals. If any corrosion is present on the battery or terminals, remove the cables from the terminals and clean with a wire brush. You can neutralize the acid with a solution of baking soda and water.

We recommend that you disconnect the negative battery cable terminal from the battery if you plan to store your vehicle for an extended period.

**Note:** *If you only disconnect the negative battery cable terminal, make sure it is isolated or placed away from the battery terminal to avoid unintended connection or arcing.*

If you disconnect or replace the battery and your vehicle has an automatic transmission, it must relearn its adaptive strategy. Because of this, the transmission may shift firmly when first driven. This is normal operation while the transmission fully updates its operation to optimum shift feel.

## Removing the Battery

1. Apply the parking brake and switch the ignition off.
2. Switch all electrical equipment off, for example lights and radio.
3. Wait a minimum of two minutes before disconnecting the battery.

**Note:** *The engine management system has a power hold function and remains powered for a period of time after you switch the ignition off. This is to allow diagnostic and adaptive tables to be stored. Disconnecting the battery without waiting can cause damage not covered by the vehicle Warranty.*

4. Disconnect and isolate the negative battery cable terminal.

# Maintenance

5. Disconnect and isolate the positive battery cable terminal.
6. Remove the battery securing clamp.
7. Remove the battery.

If you disconnect or replace the vehicle battery, you must reset the following features:

- Window bounce-back. See **Window Bounce-Back** (page 100).
- Clock Settings.
- Pre-set radio stations.

## Replacing the Battery

**Note:** *Before reconnecting the battery, make sure the ignition remains switched off.*

You must replace the battery with one of exactly the same specification.

To install, reverse the removal procedure.

**Note:** *Make sure that you correctly install the battery terminal covers, battery cover and battery cable terminals.*

## RESETTING THE BATTERY SENSOR

When you install a new battery, reset the battery sensor by doing the following:

1. Switch the ignition on, and leave the engine off.

**Note:** *Complete Steps 2 and 3 within 10 seconds.*

2. Flash the high beam headlamps five times, ending with the high beams off.
3. Press and release the brake pedal three times.

The battery warning lamp flashes three times to confirm that the reset is successful.

## RECYCLING AND DISPOSING OF THE 12V BATTERY



Make sure that you dispose of old batteries in an environmentally friendly way.

Seek advice from your local authority about recycling old batteries.

## 12V BATTERY – TROUBLESHOOTING

### 12V BATTERY – WARNING LAMPS



If it illuminates while driving, it indicates a charging system error. Switch off all unnecessary electrical equipment and have your vehicle immediately checked.

# Maintenance

## 12V BATTERY – INFORMATION MESSAGES

Message	Details
Charging System Service Soon	The charging system needs servicing. If the warning stays on or continues to come on, have your vehicle checked as soon as possible. <sup>1</sup>
Charging System Service Now	The charging system needs servicing. Have your vehicle immediately checked. <sup>1</sup>
Turn Power Off To Save Battery	The battery management system determines that the battery is at a low state of charge. Turn the ignition off as soon as possible to protect the battery. The system clears this message once you start your vehicle and the battery state of charge recovers. Turning off unnecessary electrical loads allows for a faster battery state-of-charge recovery.
Electrical Power Saver Active Some Features Turned Off See Manual	Displays when the battery management system detects an extended low-voltage condition. The system disables various vehicle features to help preserve the battery. Turn off as many of the electrical loads as soon as possible to improve system voltage. If the system voltage recovers, the disabled features will operate again as normal. <sup>1</sup>
12V battery State of charge low	The battery management system determines that the 12V battery is at a low state of charge. Start the engine to charge the battery or charge the battery using an aftermarket battery charger. Always use the vehicle ground point when connecting the negative cable of the external battery charger. See <b>Jump Starting the Vehicle</b> (page 319). This message clears once you restart your vehicle and the battery state of charge has recovered. Do not switch on the ignition when a battery charger is in use to charge the battery. To resolve the issue after the battery reset, start and stop the vehicle three times. See <b>Starting and Stopping the Engine</b> (page 148). <sup>2</sup>

<sup>1</sup>Check Brake System message may also display.

<sup>2</sup>Check Brake System message may also display. Start and stop the vehicle three times or charge the battery to clear the message. If the message still appears, have the system checked as soon as possible.

# Maintenance

## ADJUSTING THE HEADLAMPS

### Vertical Aim Adjustment

The headlamps on your vehicle are properly aimed at the assembly plant. If your vehicle has been in an accident, contact an authorized dealer to have your vehicle headlamps checked for proper alignment.

### Headlamp Aiming Target

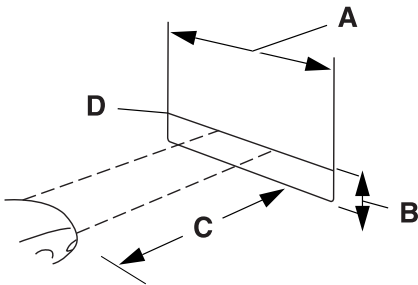

- A 8 ft (2.4 m).
- B Center height of lamp to ground (measurement B is relative to vehicle height).
- C 25 ft (7.6 m).
- D Horizontal reference line.

1. Park your vehicle directly in front of a wall or screen on a level surface, approximately 7.6 m (25 ft) away.
2. Measure the height from the center of your headlamp, indicated by a 3 millimeter circle on the lens, to the ground and mark an 2.4 m (8 ft) horizontal reference line on the vertical wall or screen at this height, a piece of masking tape works well.

3. Switch on the low beam headlamps to illuminate the wall or screen and open the hood. Cover one of the headlamps so no light hits the wall.



4. On the wall or screen, observe a light pattern with a distinct horizontal edge toward the right. If this edge is not at the horizontal reference line, adjust the beam so the edge is at the same height as the horizontal reference line.

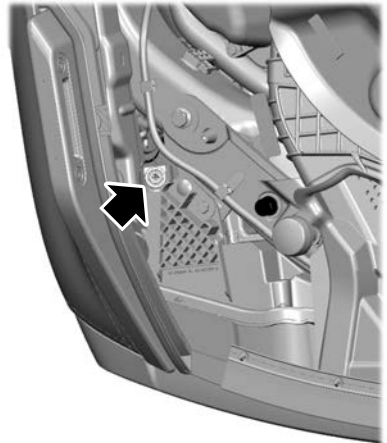

# Maintenance

5. Locate the vertical adjuster on each headlamp. Use a #2 Phillips screwdriver to turn the adjuster either counterclockwise or clockwise to adjust the headlamp.
6. Repeat Steps 3-7 to adjust the other headlamp.
7. Close the hood and switch off the lamps.

## Horizontal Aim Adjustment

Horizontal aim is not required for this vehicle and is not adjustable.

## EXTERIOR BULBS

### EXTERIOR BULB SPECIFICATION CHART

Replacement bulbs are specified in the chart below. Headlamp bulbs must be marked with an authorized D.O.T. marking for North America to make sure they have the proper lamp performance, light brightness, light pattern and safe visibility. The correct bulbs will not damage the lamp assembly or void the lamp assembly warranty and will provide quality bulb illumination time.

Lamp	Specification	Power (Watt)
Center high mounted stop lamp.	LED	LED
Daytime running lamp.	LED	LED
Front turn signal and parking lamp.	LED	LED
Front fog lamp.	LED	LED
Front side marker lamp.	LED	LED
Headlamp low beam.	LED	LED
Headlamp high beam.	LED	LED
Rear turn signal - high series.	LED	LED
Rear lamp, stoplamp, rear side marker lamp and rear turn signal - low series.	WT21W/7W	21/7
Reversing lamp - low series.	WT21W	21
Reversing lamp - high series.	LED	LED
Side turn signal lamp.	LED	LED
Taillamp.	LED	LED

**Note:** LED lamps are not serviceable. See an authorized dealer if they fail.



# Maintenance

## Warning Lamps and Indicators

### Exterior Bulb Failure



It illuminates when the ignition is on and there is an exterior bulb failure.

## REMOVING A REAR LAMP ASSEMBLY

1. Make sure the headlamps are off.

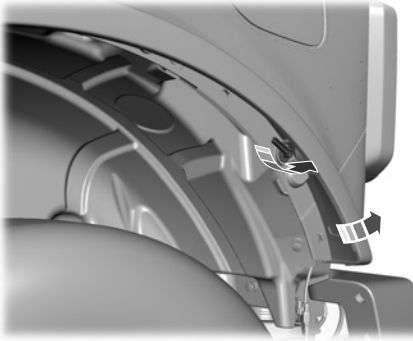

2. Loosen the quarter-turn fastener on the rearmost fender flare.
3. Fully open the tailgate. See **Opening the Tailgate From Outside Your Vehicle** (page 76).

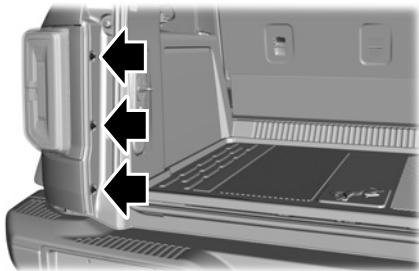

4. Remove the three pushpins from inside the trim panel.



5. Remove the lower trim piece by disengaging the retaining tabs. Pull from the inside edge first, then pull from the outside edge.

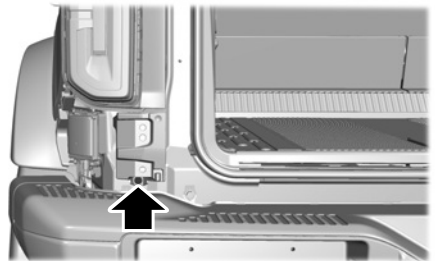

6. Remove the lower retaining bolt from the inside trim piece. Pull on the lower part of the trim piece to disengage the upper retaining clips.

# Maintenance

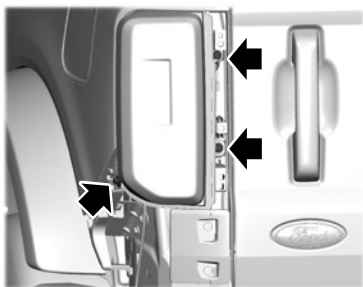

7. Remove the three retaining bolts securing the rear lamp to the body.

**Note:** Remove and install the retaining bolt near the wheel well before the retaining bolts near the luggage compartment.

8. Pull the rear lamp away from the vehicle and disconnect the electrical connectors as needed.
9. To install, reverse the removal procedure.

## CHANGING A REAR LAMP BULB

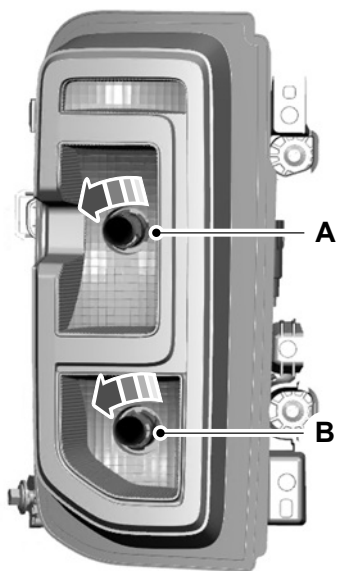

- A. Stoplamp, rear and turn signal bulb.
- B. Reversing lamp bulb.

1. Remove the rear lamp assembly. See **Removing a Rear Lamp Assembly** (page 365).
2. Rotate the bulb socket counterclockwise and remove it from the rear lamp assembly.
3. To install, reverse the removal procedure.

# Maintenance

---

## **INTERIOR BULBS**

### **INTERIOR BULB SPECIFICATION CHART**

Your vehicle has LED lamps. These are not serviceable items. See an authorized dealer if they fail.

# Vehicle Specifications

---

## ENGINE SPECIFICATIONS - 2.3L

<b>Engine</b>	<b>Specification</b>
Compression ratio.	10.0:1
Displacement.	2,261 cm <sup>3</sup> (138 in <sup>3</sup> )
Firing order.	1-3-4-2
Ignition system.	Coil on plug
Spark plug gap.	0.7 mm (0.028 in) - 0.8 mm (0.031 in)

# Vehicle Specifications

---

## ENGINE SPECIFICATIONS - 2.7L

<b>Engine</b>	<b>Specification</b>
Compression ratio.	10.0:1
Displacement.	2,700 cm <sup>3</sup> (165 in <sup>3</sup> )
Firing order.	1-4-2-5-3-6
Ignition system.	Coil on plug
Spark plug gap.	0.7 mm (0.028 in) - 0.8 mm (0.031 in)

# Vehicle Specifications

---

## ENGINE SPECIFICATIONS - 3.0L, RAPTOR

<b>Engine</b>	<b>Specification</b>
Compression ratio.	10.5:1
Displacement.	2,956 cm <sup>3</sup> (180 in <sup>3</sup> )
Firing order.	1-4-2-5-3-6
Ignition system.	Coil on plug
Spark plug gap.	0.7 mm (0.028 in) - 0.8 mm (0.031 in)

# Vehicle Specifications

## MOTORCRAFT PARTS - 2.3L

Component	Motorcraft Part Number
Air filter element.	FA-2022
Battery. <sup>1</sup>	See note below. <sup>2</sup>
Cabin air filter.	FP-93
Engine oil filter. <sup>3</sup>	FL-2127
Spark plug.	SP-597-X
Transmission fluid filter.	FT-202
Windshield wiper blade-front.	WW-1703
Windshield wiper blade-rear.	WW-801-A

<sup>1</sup> Configure your vehicle's battery management system to match the replacement battery. Failure to use an appropriate configuration for your battery management system could result in shortened battery life, features not working correctly, or your vehicle not starting. Consult your local dealer or service provider for further details.

<sup>2</sup> See your dealer for the most current part number.

<sup>3</sup> If a Motorcraft oil filter is not available, use an oil filter that aligns to SAE/USCAR – 36 Performance Specifications. Filter Type B.

We recommend Motorcraft parts that are available at your authorized dealer or at [www.parts.ford.com](http://www.parts.ford.com). We engineer these parts for your vehicle to meet or exceed our specifications. Use of other parts could impact vehicle performance, emissions and durability. Your warranty could be void for any damage related to use of other parts.

# Vehicle Specifications

## MOTORCRAFT PARTS - 2.7L

Component	Motorcraft Part Number
Air filter element.	FA-2022
Battery. <sup>1</sup>	See note below. <sup>2</sup>
Cabin air filter.	FP-93
Engine oil filter.	FL-2062-A
Spark plug.	SP-594
Transmission fluid filter.	FT-202
Windshield wiper blade-front.	WW-1703
Windshield wiper blade-rear.	WW-801-A

<sup>1</sup> Configure your vehicle's battery management system to match the replacement battery. Failure to use an appropriate configuration for your battery management system could result in shortened battery life, features not working correctly, or your vehicle not starting. Consult your local dealer or service provider for further details.

<sup>2</sup> See your dealer for the most current part number.

We recommend Motorcraft parts that are available at your authorized dealer or at [www.parts.ford.com](http://www.parts.ford.com). We engineer these parts for your vehicle to meet or exceed our specifications. Use of other parts could impact vehicle performance, emissions and durability. Your warranty could be void for any damage related to use of other parts.



# Vehicle Specifications

---

## MOTORCRAFT PARTS - 3.0L, RAPTOR

<b>Component</b>	<b>Motorcraft Part Number</b>
Air filter element.	FA-2058
Battery. <sup>1</sup>	See note below. <sup>2</sup>
Cabin air filter.	FP-93
Engine oil filter.	FL-2062-A
Spark plug.	SP-594
Transmission fluid filter.	FT-218
Windshield wiper blade-front.	WW-1703
Windshield wiper blade-rear.	WW-801

<sup>1</sup>Configure your vehicle's battery management system to match the replacement battery. Failure to use an appropriate configuration for your battery management system could result in shortened battery life, features not working correctly, or your vehicle not starting. Consult your local dealer or service provider for further details.

<sup>2</sup>See your dealer for the most current part number.

We recommend Motorcraft parts that are available at your authorized dealer or at [www.parts.ford.com](http://www.parts.ford.com). We engineer these parts for your vehicle to meet or exceed our specifications. Use of other parts could impact vehicle performance, emissions and durability. Your warranty could be void for any damage related to use of other parts.

# Removable Vehicle Components

## REMOVABLE WINDOWS

### REMOVABLE WINDOWS PRECAUTIONS



**WARNING:** Do not drive unless all rear windows are removed or securely installed. Failure to follow these instructions could result in personal injury.

**Note:** Use caution when moving or handling the windows. Do not drop the windows.

**Note:** Do not place the windows directly on hard or sharp surfaces. This could cause damage to the window.

### REMOVING AND INSTALLING THE REAR QUARTER WINDOWS - VEHICLES WITH: SOFT TOP

#### Removing the Rear Quarter Windows

The following procedure shows the driver side rear window, passenger side similar.



1. Release the hook and loop fastener strip along the top of the window.
2. Pull the rear edge out by grabbing the plastic. Do not pull on the fabric.

## Removable Vehicle Components

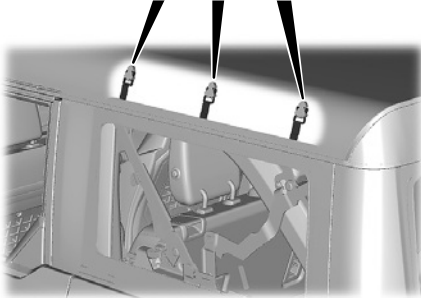
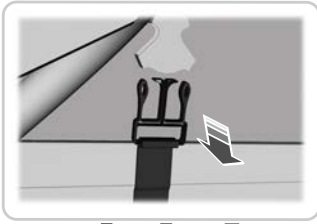

3. Unbuckle the three clips at the top.

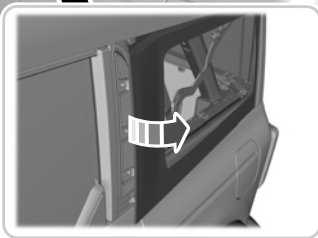
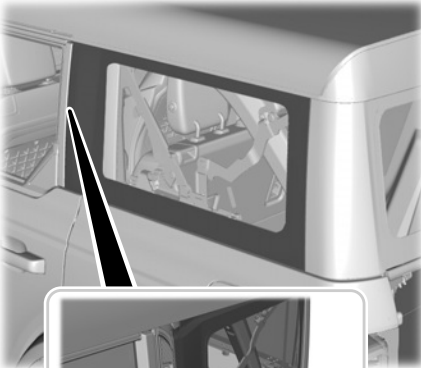

4. Release the front edge of the panel by pulling the panel out of the slot to remove.

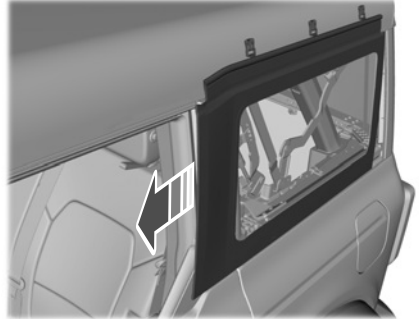

5. Slide the bottom panel forward out of the slot to remove.

### Installing the Rear Quarter Windows

The following procedure shows the driver side rear window, passenger side similar.

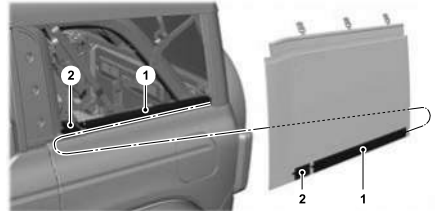

1. Slide the rear quarter window into the window slot, make sure to slide the window all the way in so that the window securely fits into both slots.

**Note:** When installing the rear edge of the rear quarter window into the slot, unlatch the soft top for easier installation. See **Opening and Closing the Soft Top** (page 396).

## Removable Vehicle Components

2. Press to secure the front edge of the window.



3. Press to secure the rear edge of the window. Start at the bottom and work towards the top.

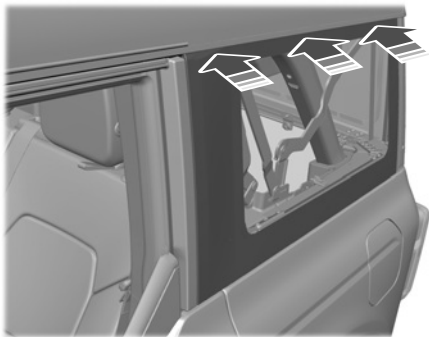

4. Buckle the three clips at the top.

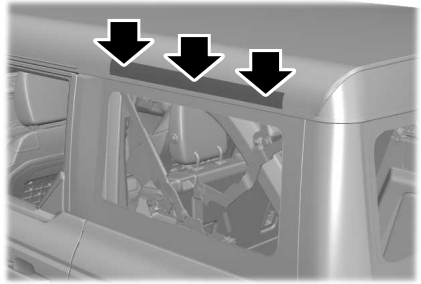

5. Press along the top of the window to secure the hook and loop fastener strips.

**Note:** *The buckles snap together and the windows are flush when correctly installed. If the parts have visible gaps or stick out, they are not correctly secured.*

### REMOVING AND INSTALLING THE REAR WINDOW - VEHICLES WITH: SOFT TOP

1. If not already removed, remove the rear quarter windows. See **Removing and Installing the Rear Quarter Windows** (page 374).
2. Open the tailgate.
3. Release the hook and loop fastener strip along the top of the rear window and flip the fabric upward.

## Removable Vehicle Components

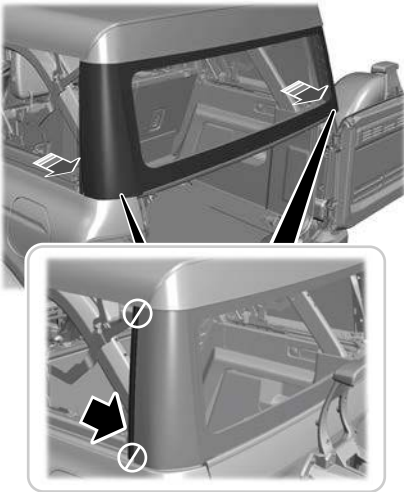

4. Tap both bottom corners of the rear window rearward to disengage the clips.

**Note:** Do not pull on fabric from the top or bottom corners.

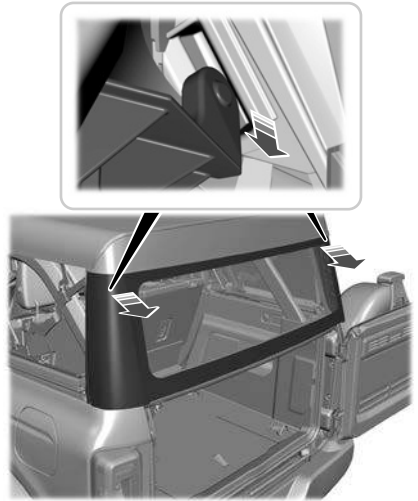

5. Remove both top corners from the slots.

# Removable Vehicle Components

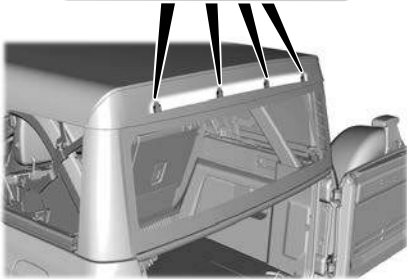
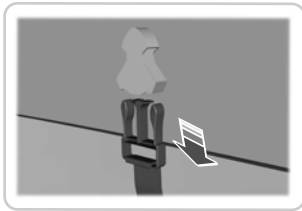

6. Unbuckle the four clips at the top.

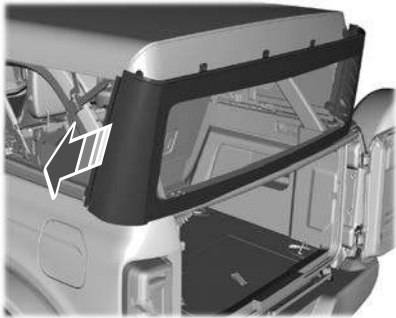

7. Make sure to unbuckle all clips. Grab the plastic behind the fabric at the bottom corners of the rear window and then slide the bottom left or right out of the slot to remove.

8. To install the rear window, perform the above steps in reverse order.

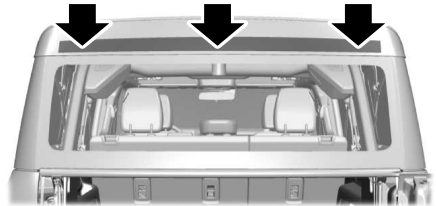

9. After installing the rear window, press along the top of the window to secure the hook and loop fastener strip.

**Note:** *The buckles snap together and the window is flush when correctly installed. If the parts have visible gaps or stick out, they are not correctly secured.*

## REMOVABLE DOORS

### REMOVING AND INSTALLING THE DOORS - VEHICLES WITHOUT TUBE DOORS

#### Removing the Doors



**WARNING:** Removal of doors for off-road use only. Removing the doors from the vehicle will affect protection provided by the doors and may affect safety system performance, including safety canopy and front seat mounted side airbags, during a crash or rollover.



**WARNING:** Always keep hands, feet and other body parts inside the vehicle at all times.

1. Fully open the windows on the doors you are removing.
2. Switch your vehicle off.

## Removable Vehicle Components

3. Fold the mirrors toward the front of your vehicle before removing the front doors.
4. Fully open the door you are removing.

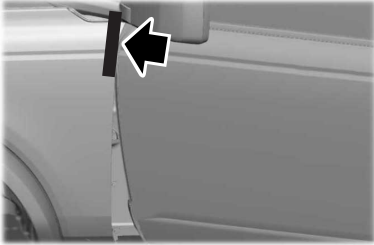

5. Locate the fender protector in the tool pouch and install it over the fender edge near the top door hinge.



6. To release the door harness connector, open the connector door and pull the connector straight out.



7. Make sure to seat the connector door in the closed position.
8. We recommend that you use a door storage bag on the door you are removing.

**Note:** Make sure you fully secure the bag. Make sure the bag contains the edge and corners of the door to prevent accidental door damage before proceeding with the removal of the door.

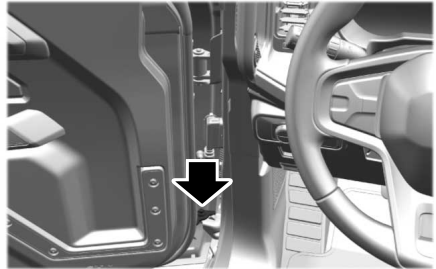

9. Locate the tool pouch and use the hex tool to remove the lower hinge bolt.

## Removable Vehicle Components

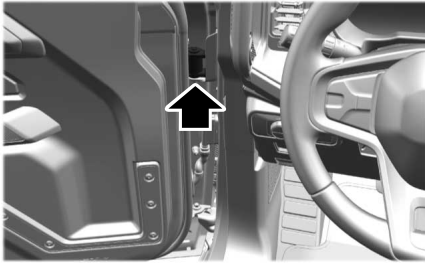

10. Remove the upper hinge bolt.

**Note:** Store the hinge bolts in the pocket of the tool pouch.



12. Use the door handle as the upper lift handle.
13. With the help of another person, lift the door vertically to separate it from the vehicle.

**Note:** Use caution when removing the doors as they are heavy.

**Note:** Store the doors out of the elements to prevent damage.

14. To remove additional doors, repeat Steps 4–13.
15. Return the hex tool to the tool pouch and secure it in the vehicle.
16. Return mirrors to the driving position.

**Note:** When you remove the doors, the rear seat occupant alert no longer functions.

**Note:** When you remove the doors or when you have tube doors installed on the vehicle, a warning message related to the electrical system appears on the instrument cluster display with each ignition cycle. The message no longer displays when all factory doors are re-installed. If the message persists after you install all factory doors, check the wiring connectors on all the doors to confirm that you properly connected them.



11. Locate the lower lift handle.



# Removable Vehicle Components

## Installing the Doors



**WARNING:** Vehicle needs to be turned off before reconnecting doors to verify all electrical connections have been properly connected. Failure to follow these instructions may affect safety system performance, including safety canopy and front seat mounted side airbags, during a crash or rollover.

1. Switch your vehicle off.
2. Fold the mirrors toward the front of the vehicle before installing the front doors.
3. Inspect and clean debris from the bodyside and door hinges.
4. If you are using a storage bag, unzip it far enough to allow access to the hinges.

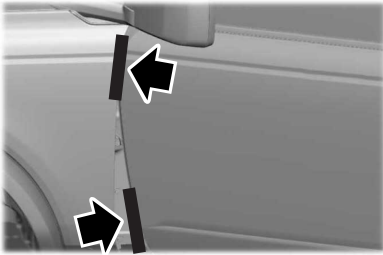

5. Locate the fender and door protectors in the tool pouch. Install one over the fender edge near the upper door hinge and the other on the door edge near the bottom door hinge.



6. Locate the lower bodyside hinge and loosely install alignment pin by hand.

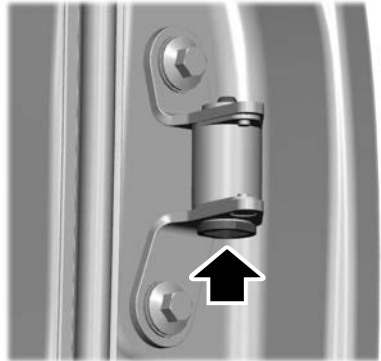

7. Locate the upper door hinge portion.

## Removable Vehicle Components



8. Locate the upper bodyside hinge.

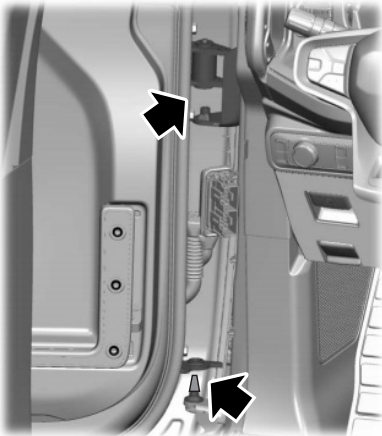

9. With the help of another person, lower the door onto the body hinges, aligning the upper door portion to the upper body pin and the lower door portion to the alignment pin.

**Note:** Make sure you do not pinch the wiring connector harness between the door and the body of the vehicle.

10. Remove the lower alignment pin.

11. Hand start the hinge bolts to the upper and lower door hinges.  
12. Use the hex tool to tighten the bolts.

**Note:** We recommend that you use a torque wrench to tighten the bolts to the required 30 Nm (22 lb.ft) specification.

13. If using a storage bag, remove it from the door.  
14. Open the harness connector door.



15. Insert the door harness into the connector.



16. Open and close the installed door a few times to make sure you aligned it properly and that it operates normally.  
17. To install additional doors, repeat Steps 3–16.

# Removable Vehicle Components

18. Close the doors and switch the ignition on. Check for any warning messages.
19. Return the mirrors to the driving position.

## REMOVING AND INSTALLING THE DOORS - VEHICLES WITH: TUBE DOORS



**WARNING:** Tube doors are for off-road use only. Tube doors are not designed like factory doors. Occupant protection, door system performance, and safety system performance, including safety canopy and front seat mounted side airbags, may be affected during a crash or rollover.



**WARNING:** Always keep hands, feet and other body parts inside the vehicle at all times.

### Installing the Doors

1. If not already removed, remove the factory doors. See **Removing and Installing the Doors** (page 378).
- Note:** *When you remove the doors, the rear seat occupant alert no longer functions.*
2. Switch your vehicle off.
  3. Fold the mirrors completely toward the front of your vehicle before installing the front doors.
  4. Inspect and clean debris from the bodyside and door hinges.



5. Locate the lower bodyside hinge and loosely install the door alignment pin by hand.

**Note:** *The door alignment pin is included with your vehicle's tool kit.*



6. Lower the door on the body hinges.
- Note:** *Make sure the doors are fully open.*
- Note:** *If the door hinge spacing is not adequate, loosen the hinge mounting bolts, adjust, and retighten.*
7. Remove the alignment pin from the lower hinge.

## Removable Vehicle Components

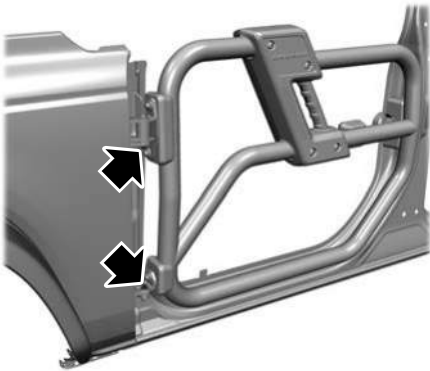

8. Hand start the hinge pin bolts to the upper and lower door hinges.
9. Use the provided hex tool to tighten the hinge pin bolts to 30 Nm (22 lb.ft).

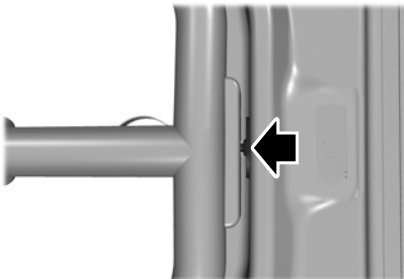

11. Make sure that the door bumper arrow is aligned to the service cover plate mark.

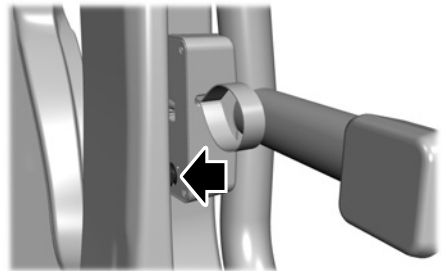

10. Make sure the latch alignment is correct by gently closing the door. If the alignment is not acceptable, make the necessary vertical or horizontal adjustments. See **Latch Alignment Adjustments** later in this section. If the alignment is acceptable, continue to Step 11.

12. Gently close the door to the fully closed position and make sure that the bumper is under slight compression. If the bumper is not slightly compressed while the door is in the fully closed position, adjust the bumper as needed.

**Note:** To avoid body damage, do not slam the door until the bumper adjustments are finalized.

13. Open and close the installed door a few times to make sure it is properly aligned and that it operates normally.
14. To install additional doors, repeat Steps 3-13.

# Removable Vehicle Components

- Return the hex tool and door alignment pin to the tool kit and secure the tool kit in the vehicle's center console.
- Return the mirrors to the driving position.

**Note:** Rear seat occupant alert does not function with tube doors.

## Latch Alignment Adjustments

### Vertical Adjustments

To make vertical adjustments:

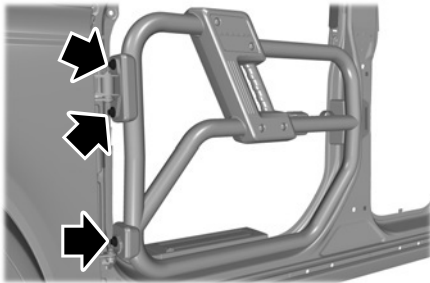

- Loosen the upper and lower hinge mounting bolts.
- Engage the latch on the striker to make sure it is properly aligned.
- Tighten the upper and lower hinge mounting bolts, but do not apply final torque.
- Disengage and reengage the latch from the striker and confirm proper alignment.
- Tighten the upper and lower hinge mounting bolts to 55 Nm (41 lb.ft).

### Horizontal Adjustments

To make horizontal adjustments:

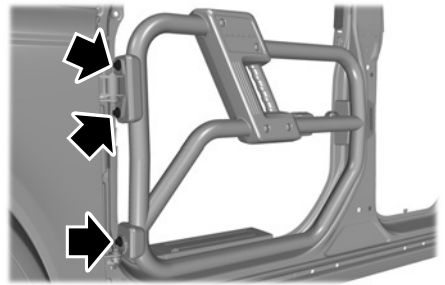

- Loosen the upper and lower hinge mounting bolts.
- Add or remove shims as necessary to attain proper latch alignment, start with no shims.
- Tighten the upper and lower hinge mounting bolts, but do not apply final torque.
- Disengage the latch from the striker and confirm proper alignment.
- Tighten the upper and lower hinge mounting bolts to 55 Nm (41 lb.ft).

## Removing the Doors

**WARNING:** Removal of doors for off-road use only. Removing the doors from the vehicle will affect protection provided by the doors and may affect safety system performance, including safety canopy and front seat mounted side airbags, during a crash or rollover.

- Switch your vehicle off.
- Fold the mirrors completely toward the front of your vehicle before removing the front doors.
- Fully open the door you are removing.
- Use the provided hex tool to loosen and remove the lower hinge bolt.

# Removable Vehicle Components

5. Loosen and remove the upper hinge bolt.

**Note:** You can store the hinge bolts in the tool pouch zipped pocket, if needed.

6. Lift the door vertically to separate it from the vehicle.

**Note:** Use caution when removing the doors as they are heavy.

**Note:** Store the doors in a secure area.

**Note:** Store the doors out of the elements to prevent damage.

7. To remove additional doors, repeat Steps 3-6.
8. Return the hex tool to the tool kit and secure the tool kit in the vehicle's center console.
9. Return the mirrors to the driving position.

**Note:** When you remove the doors, the rear seat occupant alert no longer functions.

**Note:** When you remove the doors or when you have tube doors installed on the vehicle, a warning message related to the electrical system appears on the instrument cluster display with each ignition cycle. The message no longer displays when all factory doors are re-installed. If the message persists after you install all factory doors, check the wiring connectors on all the doors to confirm that you properly connected them.

## Cleaning the Tube Doors

We recommend that you wash the tube doors with mild soap and rinse with a standard pressure water hose. While rinsing, avoid spraying water directly onto the latch mechanism. Dry with a microfiber cloth or leave to air dry.

## DOORS AND LOCKS AUDIBLE WARNINGS

Sounds when a door is not fully closed or removed and your vehicle is moving.

## REMOVABLE ROOF PANELS (IF EQUIPPED)

### REMOVABLE ROOF PANEL PRECAUTIONS - EXCLUDING: RAPTOR



**WARNING:** When opening, closing, removing or installing the removable vehicle components, take care not to get your fingers or hands caught in the mechanism. Failure to follow this instruction could result in personal injury.



**WARNING:** Do not drive your vehicle with only the center or the rear roof panel removed. Failure to follow this instruction could cause unintended separation of the roof panels from your vehicle.



**WARNING:** Do not drive your vehicle unless the installed roof panels are properly secured. Failure to follow this instruction could cause unintended separation of the roof panels from your vehicle.

**Note:** Do not step or kneel on the center console during roof removal or once the roof panels are removed.

Removal of the center and rear roof panels requires two adults.

Do not cut, drill, weld or modify the roof panels or attach anything other than the factory-installed roof rack.

# Removable Vehicle Components

If there is any damage to the roof panels, see an authorized dealer.

Make sure the locating pins on the rear roof panel sit flush in your vehicle when installed.

Failure to follow these instructions could cause interior water damage, stains or mildew:

- Properly position the hard top assembly to seal the top to your vehicle during installation. Clear the hard top panel seals of any dust or debris prior to installation. Improper installation could cause water to leak into the vehicle's interior.
- Properly handle and store the removable roof panels. Improper handling and storage could damage the seals, causing water to leak into the vehicle's interior.
- Do not place anything on top of the rear roof panel when it is removed from the vehicle. This could damage the rear roof panel and its seals.

## REMOVABLE ROOF PANEL PRECAUTIONS - RAPTOR



**WARNING:** When opening, closing, removing or installing the removable vehicle components, take care not to get your fingers or hands caught in the mechanism. Failure to follow this instruction could result in personal injury.



**WARNING:** Do not drive your vehicle with only the center or the rear roof panel removed. Failure to follow this instruction could cause unintended separation of the roof panels from your vehicle.



**WARNING:** Do not drive your vehicle unless the installed roof panels are properly secured. Failure to follow this instruction could cause unintended separation of the roof panels from your vehicle.



**WARNING:** Do not remove or modify the B-Pillar brace or trim. Doing so could affect safety system performance, including safety canopy and front seat mounted side airbags, during a crash or rollover.

Do not remove or modify the C-pillar brace.

Removal of the center and rear roof panels requires two adults.

Do not cut, drill, weld or modify the roof panels or attach anything other than the factory-installed roof rack.

If there is any damage to the roof panels, see an authorized dealer.

Make sure the locating pins on the rear roof panel sit flush in your vehicle when installed.

**Note:** *Do not step or kneel on the center console during roof removal or once the roof panels are removed.*

# Removable Vehicle Components

Failure to follow these instructions could cause interior water damage, stains or mildew:

- Properly position the hard top assembly to seal the top to your vehicle during installation. Clear the hard top panel seals of any dust or debris prior to installation. Improper installation could cause water to leak into the vehicle's interior.
- Properly handle and store the removable roof panels. Improper handling and storage could damage the seals, causing water to leak into the vehicle's interior.
- Do not place anything on top of the rear roof panel when it is removed from the vehicle. This could damage the rear roof panel and its seals.

## REMOVING AND INSTALLING THE FRONT ROOF PANEL - EXCLUDING: RAPTOR

Remove the driver side front roof panel before removing the passenger side front roof panel.

1. Fold down the sun visor against the windshield.

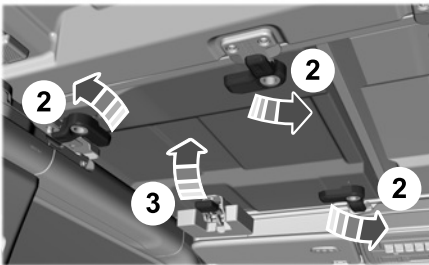

2. Turn the three L-shaped latches on the driver side front roof panel, unlocking them from the roof.

3. Unlatch the driver side header panel latch at the top of the windshield.
4. Remove the driver side front roof panel.
5. Repeat the steps to remove the passenger side panel front roof panel.
6. Store the front roof panels in the storage bag. See **Storing the Roof Panels** (page 422). See **Storing the Doors and the Roof Panels** (page 410).
7. To install, reverse the removal procedure.

## REMOVING AND INSTALLING THE FRONT ROOF PANEL - RAPTOR

**WARNING:** Do not remove or modify the B-Pillar brace or trim. Doing so could affect safety system performance, including safety canopy and front seat mounted side airbags, during a crash or rollover.

Do not remove or modify the C-pillar brace.

Remove the driver side front roof panel before removing the passenger side front roof panel.

1. Fold down the sun visor against the windshield.

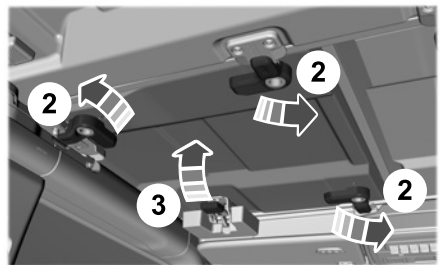



## Removable Vehicle Components

- Turn the three L-shaped latches on the driver side front roof panel, unlocking them from the roof.
- Unlatch the driver side header panel latch at the top of the windshield.
- Remove the driver side front roof panel.
- Repeat the steps to remove the passenger side panel front roof panel.
- Store the front roof panels in the storage bag. See **Storing the Roof Panels** (page 422). See **Storing the Doors and the Roof Panels** (page 410).
- To install, reverse the removal procedure.

### REMOVING AND INSTALLING THE CENTER ROOF PANEL - 4-DOOR, EXCLUDING: RAPTOR

Remove both of the front roof panels before removing the center roof panel.

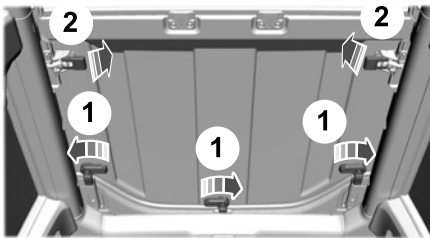

- Turn the three L-shaped latches on the center roof panel, unlocking them from the rear roof panel.
- Unlatch the driver side and passenger side latches of the center roof panel.
- Remove the center roof panel.
- To install, reverse the removal procedure.

### REMOVING AND INSTALLING THE CENTER ROOF PANEL - RAPTOR, 4-DOOR

 **WARNING:** Do not remove or modify the B-Pillar brace or trim. Doing so could affect safety system performance, including safety canopy and front seat mounted side airbags, during a crash or rollover.

Do not remove or modify the C-pillar brace. Remove both of the front roof panels before removing the center roof panel.

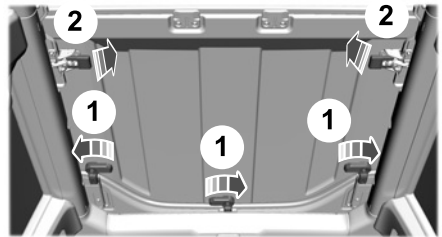

- Turn the three L-shaped latches on the center roof panel, unlocking them from the rear roof panel.
- Unlatch the driver side and passenger side latches of the center roof panel.
- Remove the center roof panel.
- To install, reverse the removal procedure.

### REMOVING AND INSTALLING THE REAR ROOF PANEL - 4-DOOR, EXCLUDING: RAPTOR

Remove the front panels and center panel before removing the rear roof panel.

- Open the rear doors.

## Removable Vehicle Components

2. Open the tailgate window. See **Opening and Closing the Windows** (page 99).
3. Locate the wiring harness and washer hose on the driver side rear inside corner of the vehicle.
4. Release the locking tab by pushing it down.

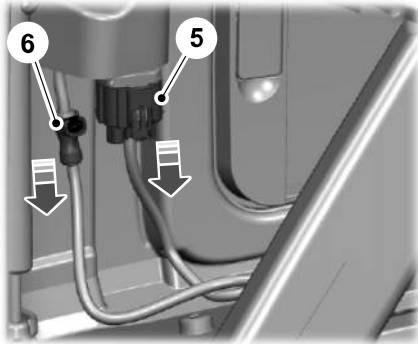

5. Push the tab inward when pulling down to disconnect and remove the wiring harness.
6. Push the release button on the hose connector and pull down to remove the washer hose.

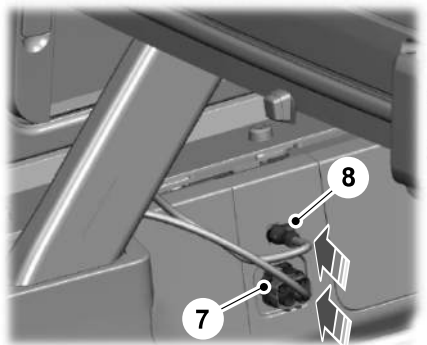

7. Secure the wiring harness to the body side by plugging it into the receptacle and pushing up on the locking tab.
8. Secure the washer hose by snapping it into the top of the body side receptacle.

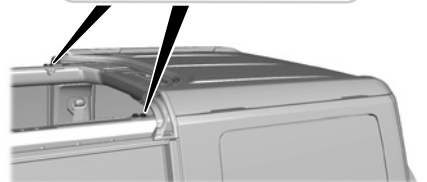
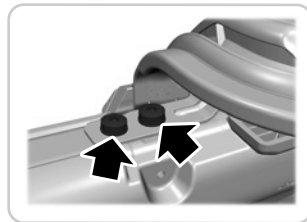

9. Remove the two fasteners that secure the rear roof panel at the C-pillar using the provided head driver and ratchet.

## Removable Vehicle Components

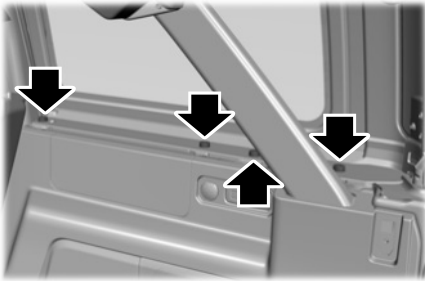

### REMOVING AND INSTALLING THE REAR ROOF PANEL - RAPTOR, 4-DOOR



**WARNING:** Do not remove or modify the B-Pillar brace or trim. Doing so could affect safety system performance, including safety canopy and front seat mounted side airbags, during a crash or rollover.

10. Remove the four fasteners on each side of the vehicle that secure the rear roof panel to the vehicle using the provided head driver and ratchet.
11. With the tailgate window open, grab the opening with one hand and slightly lift with the other hand. Lift the rear roof panel straight up and off. Place the rear roof panel on a soft surface to prevent damage.

**Note:** Store the rear roof panel with the tailgate window open to prevent damage to the glass seal.

12. To install, reverse the removal procedure. Torque the fasteners that secure the rear roof panel to the vehicle to  $25 \pm 3.8$  Nm ( $18 \pm 3$  lb.ft).

**Note:** Make sure the locating pins on the rear roof panel sit flush in the vehicle when installed.

**Note:** Do not overtighten the fasteners. You can strip the fasteners if they are overtightened.

Do not remove or modify the C-pillar brace. Remove the front panels and center panel before removing the rear roof panel.

1. Open the rear doors.
2. Open the tailgate window. See **Opening and Closing the Windows** (page 99).
3. Locate the wiring harness and washer hose on the driver side rear inside corner of the vehicle.
4. Release the locking tab by pushing it down.

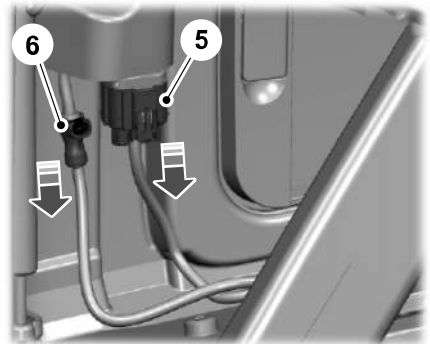

5. Push the tab inward when pulling down to disconnect and remove the wiring harness.

## Removable Vehicle Components

6. Push the release button on the hose connector and pull down to remove the washer hose.

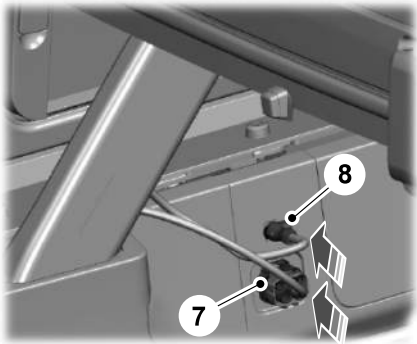

7. Secure the wiring harness to the body side by plugging it into the receptacle and pushing up on the locking tab.
8. Secure the washer hose by snapping it into the top of the body side receptacle.

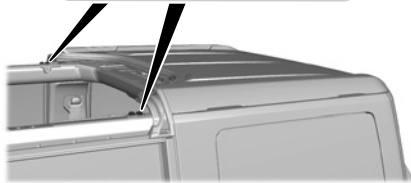
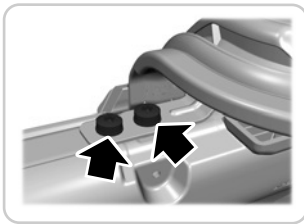

9. Remove the two fasteners that secure the rear roof panel at the C-pillar using the provided head driver and ratchet.

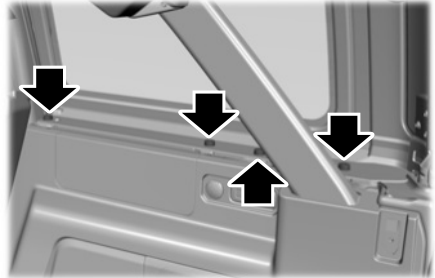

10. Remove the four fasteners on each side of the vehicle that secure the rear roof panel to the vehicle using the provided head driver and ratchet.
11. With the tailgate window open, grab the opening with one hand and slightly lift with the other hand. Lift the rear roof panel straight up and off. Place the rear roof panel on a soft surface to prevent damage.

**Note:** Store the rear roof panel with the tailgate window open to prevent damage to the glass seal.

12. To install, reverse the removal procedure. Torque the fasteners that secure the rear roof panel to the vehicle to  $25 \pm 3.8$  Nm ( $18 \pm 3$  lb.ft).

**Note:** Make sure the locating pins on the rear roof panel sit flush in the vehicle when installed.

**Note:** Do not overtighten the fasteners. You can strip the fasteners if they are overtightened.

### REMOVING AND INSTALLING THE REAR ROOF PANEL - 2-DOOR

Remove the front panels before removing the rear roof panel.

## Removable Vehicle Components

1. Open the rear doors.
2. Open the tailgate window. See **Opening and Closing the Windows** (page 99).
3. Locate the wiring harness and washer hose on the driver side rear inside corner of the vehicle.
4. Release the locking tab by pushing it down.

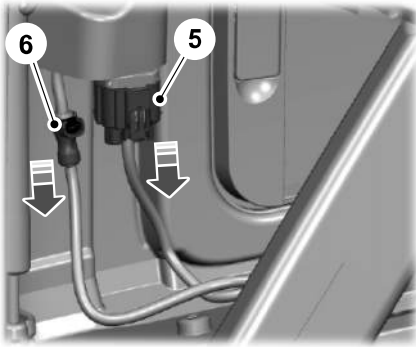

5. Push the tab inward when pulling down to disconnect and remove the wiring harness.
6. Push the release button on the hose connector and pull down to remove the washer hose.

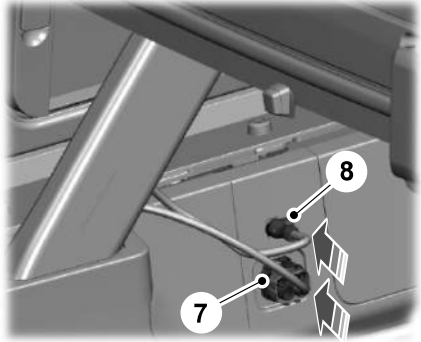

7. Secure the wiring harness to the body side by plugging it into the receptacle and pushing up on the locking tab.
8. Secure the washer hose by snapping it into the top of the body side receptacle.

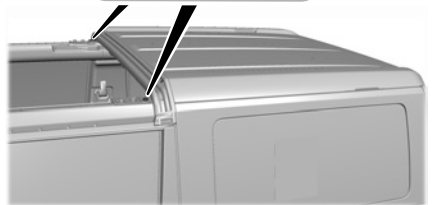
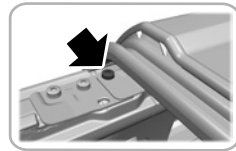

9. Remove the fasteners on each side that secure the rear roof panel at the C-pillar using the provided head driver and ratchet.
10. Install the fasteners back to the C-pillar.

# Removable Vehicle Components

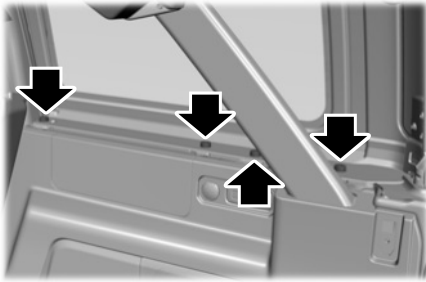

11. Remove the four fasteners on each side of the vehicle that secure the rear roof panel to the vehicle using the provided head driver and ratchet.
12. With the tailgate window open, grab the opening with one hand and slightly lift with the other hand. Lift the rear roof panel straight up and off. Place the rear roof panel on a soft surface to prevent damage.

**Note:** Store the rear roof panel with the tailgate window open to prevent damage to the glass seal.

13. To install, reverse the removal procedure.
14. Remove the fasteners on the C-pillar before attaching the rear roof panel. Place the rear roof panel on the C-pillar and hand start the fasteners.
15. Torque the fasteners that secure the rear roof panel to the vehicle to  $25 \pm 3.8 \text{ Nm}$  ( $18 \pm 3 \text{ lb.ft}$ ).

**Note:** Make sure the locating pins on the rear roof panel sit flush in the vehicle when installed.

**Note:** Do not overtighten the fasteners. You can strip the fasteners if they are overtightened.

## Removing and Installing the Modular Roof Panel (If Equipped)

Store the modular roof panel in a safe place when you remove it to prevent part damage.

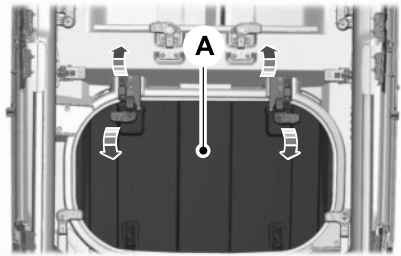

### A. Modular roof panel

1. Pull and hold the spring-loaded slide.
2. Turn the L-shaped latch.
3. Repeat steps 1 and 2 on the other latch to unlock the modular roof panel from the roof.
4. Push up on the front of the panel.
5. Slide the panel forward to remove it from your vehicle.
6. To install, reverse the removal procedure.

**Note:** Make sure the modular roof panel slides back into place and the locating pins sit in the front latch receiver when installing the modular roof panel.

**Note:** You do not need to pull and hold the spring-loaded slides to turn the latches to lock the modular roof panel.

**Note:** When driving with only the modular roof panel removed, make sure to roll down the windows.

# Removable Vehicle Components

## REMOVABLE HARD TOP (IF EQUIPPED)

### REMOVING AND INSTALLING THE HARD TOP - EXCLUDING: RAPTOR

 **WARNING:** When opening, closing, removing or installing the removable vehicle components, take care not to get your fingers or hands caught in the mechanism. Failure to follow this instruction could result in personal injury.

1. Remove the roof panels. See **Removable Roof Panels** (page 386).
2. To install, reverse the removal procedure.

### Removing the Soft Top Trim Piece (If Equipped)

Make sure to remove the soft top trim pieces before installing the hard top.

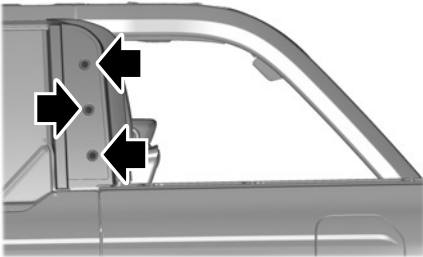

Remove the three fasteners to the soft top trim piece on each side of your vehicle using the provided head driver and ratchet.

## REMOVING AND INSTALLING THE HARD TOP - RAPTOR

 **WARNING:** When opening, closing, removing or installing the removable vehicle components, take care not to get your fingers or hands caught in the mechanism. Failure to follow this instruction could result in personal injury.

 **WARNING:** Do not remove or modify the B-Pillar brace or trim. Doing so could affect safety system performance, including safety canopy and front seat mounted side airbags, during a crash or rollover.

Do not remove or modify the C-pillar brace.

1. Remove the roof panels. See **Removable Roof Panels** (page 386).
2. To install, reverse the removal procedure.

### Removing the Soft Top Trim Piece (If Equipped)

Make sure to remove the soft top trim pieces before installing the hard top.

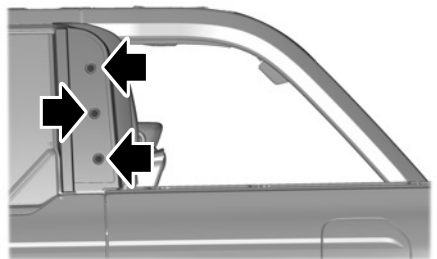

Remove the three fasteners to the soft top trim piece on each side of your vehicle using the provided head driver and ratchet.

# Removable Vehicle Components

## REMOVABLE SOFT TOP (IF EQUIPPED)

### OPENING AND CLOSING THE SOFT TOP



**WARNING:** When opening, closing, removing or installing the removable vehicle components, take care not to get your fingers or hands caught in the mechanism. Failure to follow this instruction could result in personal injury.

#### Partially Opening the Soft Top

Before pulling into a garage, make sure there is enough clearance.



1. Unlatch the two latches at the header.



2. Push the soft top up and rearward.

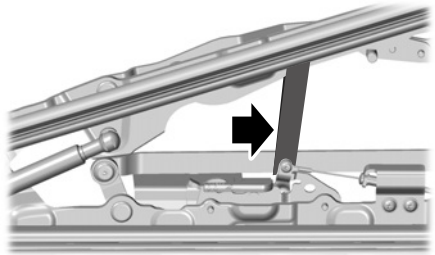

3. Attach the provided straps found in the glove compartment if you are off-road driving or driving on rough roads.

**Note:** Do not drive without the soft top properly latched or fully open.

**Note:** Do not store your vehicle in cold weather with the soft top open.

**Note:** Leaving the soft top in the partially open position can reduce satellite radio reception performance. See **Satellite Radio Limitations** (page 475).

#### Fully Opening the Soft Top

1. Remove the rear quarter windows and the rear window. See **Removable Windows** (page 374).

**Note:** Do not drive unless all rear windows are removed or installed.

2. Open the soft top to the partially open position.



# Removable Vehicle Components

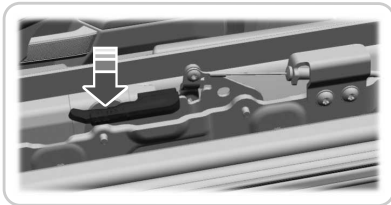
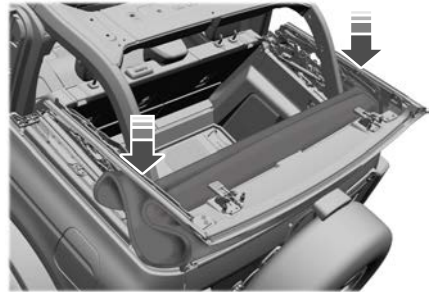
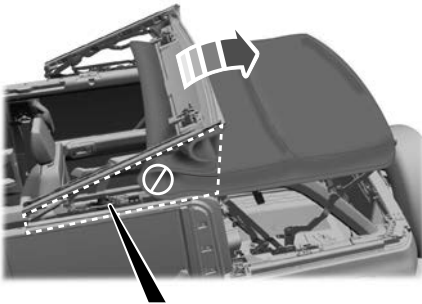

3. Press the handle down on the driver side of your vehicle to unlatch the soft top. Lift and rotate the soft top rearward, making sure to keep your hands and fingers free of the mechanism.

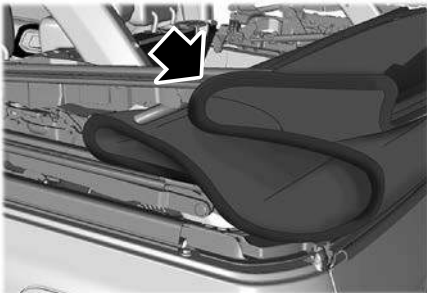

4. Make sure the soft top fabric folds properly and is not touching the mechanism when folding.

5. Press down on the driver side and passenger side of the soft top and make sure both sides latch to fully secure it.

**Note:** Do not store your vehicle in cold weather with the soft top open.

## Closing the Soft Top

### Partial Closing

Before pulling into a garage, make sure there is enough clearance.

1. To return to the partially open position, press the handle down on the driver side of your vehicle to unlatch the soft top.

# Removable Vehicle Components

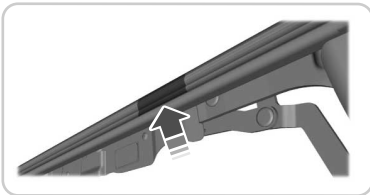
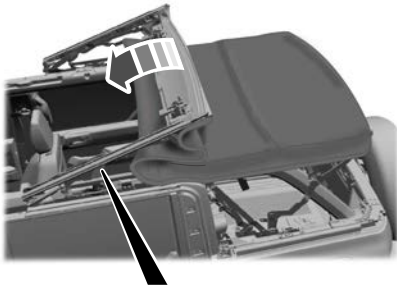

2. Use the side rail to lift and rotate the soft top forward.
3. Make sure to latch both sides.

## Fully Closing

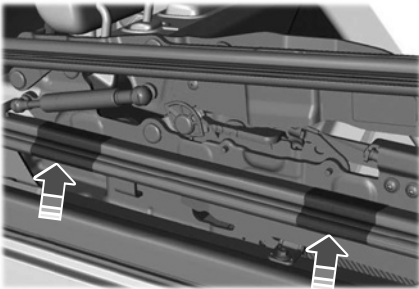

1. Close the soft top to the partially open position.
2. Use the side rail to lift and rotate the soft top forward, making sure it latches in place.

**Note:** Do not lift using the top rail only.

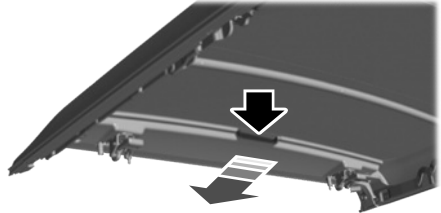

3. From inside your vehicle, pull the header forward to engage latching.
4. Latch the two latches at the header. Make sure both sides fully latch.

**Note:** Do not drive without the soft top properly latched or fully open.

## Accessing the Rear Cargo Area

1. Open the tailgate.

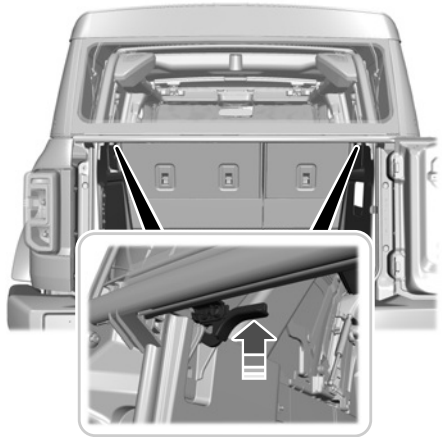

2. Unlatch the soft top.

# Removable Vehicle Components

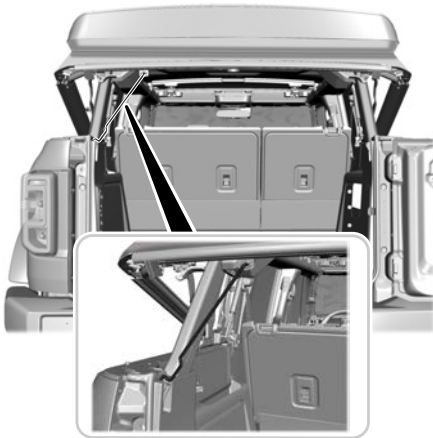

3. Lift the rear of the soft top just high enough to support it with the soft top prop rod.

**Note:** Lifting the soft top higher than the prop rod may damage the soft top.

**Note:** If the temperature is 0°C (32°F) or below or if there is ice build-up on the soft top fabric or windows, do not:

- Open or close the soft top.
- Lift the rear window to access the cargo area.
- Install or remove the rear quarter or rear windows.

Failure to follow these instructions can damage the soft top or windows.

## REMOVING AND INSTALLING THE SOFT TOP

**WARNING:** When opening, closing, removing or installing the removable vehicle components, take care not to get your fingers or hands caught in the mechanism. Failure to follow this instruction could result in personal injury.

1. Fully open the soft top. See **Opening and Closing the Soft Top** (page 396).

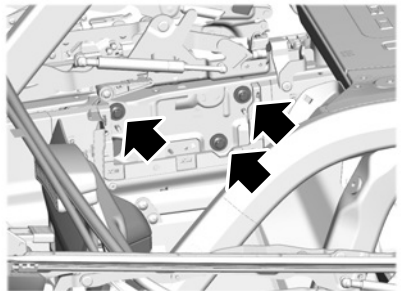

2. Remove the three fasteners on each side in the rear cargo area using the provided head driver and ratchet.
3. Remove the soft top.

**Note:** Safely store the soft top when it is off your vehicle.

4. To install, reverse the removal procedure. Torque the fasteners that secure the soft top to your vehicle to  $20 \pm 3$  Nm ( $15 \pm 2$  lb.ft).

**Note:** Make sure the soft top is set flush on the locating pins.

**Note:** Do not overtighten the fasteners. You can strip the fasteners if you overtighten them.

# Removable Vehicle Components

## Installing the Soft Top Trim Piece (If Equipped)

Make sure to install the soft top trim pieces before installing the soft top.

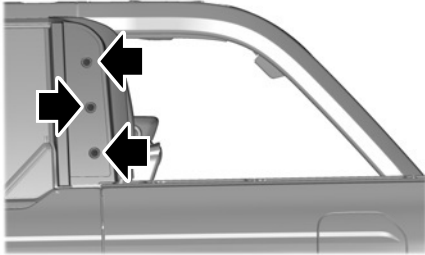

Secure the three fasteners to the soft top trim piece on each side of your vehicle. Hand start the bolts then tighten them to  $7 \pm 1.1$  Nm ( $5.16 \pm 0.81$  lb.ft) using the provided head driver and ratchet.

## REMOVABLE FENDERS

### REMOVABLE FENDER PRECAUTIONS



**WARNING:** Do not drive your vehicle on public roads with fenders removed as you will lose the protection they provide in a crash. Failure to follow this instruction could result in personal injury or death.

## REMOVING THE FENDER FLARES - EXCLUDING: RAPTOR

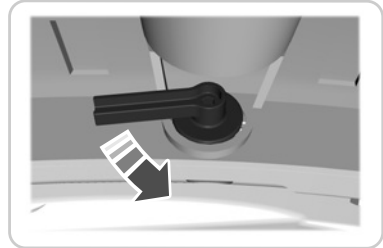
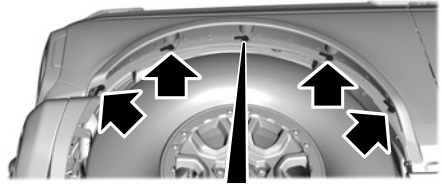

1. Unlock the five quarter turn clips by turning the clips counterclockwise.

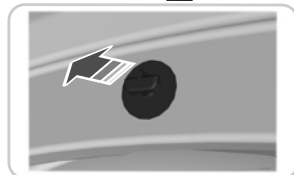
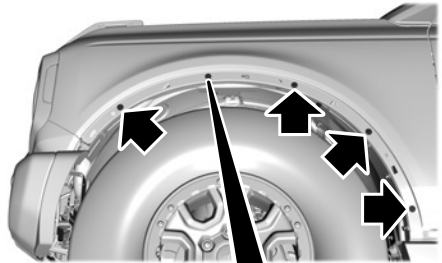

## Removable Vehicle Components

2. Pull outward on the fender flare with your hands to unseat the clips from the sheet metal.

**Note:** Clips should not be removed from fender flare.

### Installing the Fender Flares

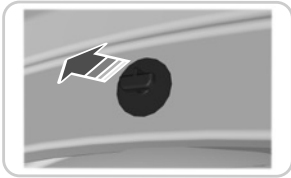
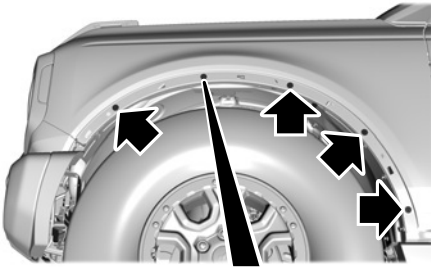

1. Press the five pushpin clips in until they are seated.

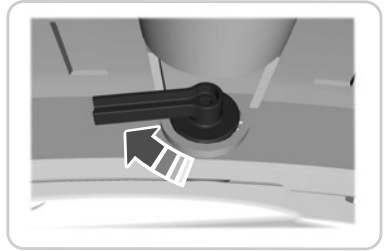
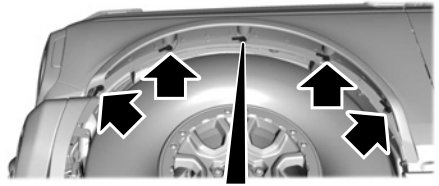

2. Lock the five quarter turn clips by turning the clips clockwise.

### REMOVING THE FENDER FLARES - RAPTOR

The front fender, rear quarter, and fender flares are not designed to be removed. They are to remain on the vehicle at all times.

### REMOVABLE RUNNING BOARDS (IF EQUIPPED)

### REMOVING AND INSTALLING THE RUNNING BOARDS

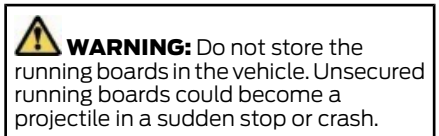

# Removable Vehicle Components

**Note:** Running boards are not rated for rock crawl use or off road conditions where ground contact is likely to occur. We recommend removing the running boards before use in these conditions in order to avoid damage.

**Note:** Removing the running boards increases the possibility of paint damage from road and trail debris such as gravel, loose rocks and sand, especially when driving at higher speeds. The vehicle warranty does not cover paint damage.

## Removing the Running Boards

1. Park your vehicle on level ground and make sure the transmission is in park (P).



2. Locate the hex tool in the tool pouch and use it to remove two bolts each from front, middle, and rear attachment tabs where the running board is mounted to the rock rail.
3. Grab the running board near the front and rear.
4. Lift up and push forward to disengage the temporary support pins on the running board front and middle mounting tabs from keyhole slots in the rock rail.
5. Pull the running board away from the side of the vehicle.
6. Store running board bolts in the pocket of the tool pouch.
7. To remove the additional running board, repeat Steps 1-6 for the opposite side.
8. Return the hex tool to the tool pouch and secure it in the vehicle.

## Installing the Running Boards

1. Park your vehicle on level ground and make sure the transmission is in park (P).
2. Inspect and clean debris from the rock rail at the running board bolt mounting nuts and keyhole slots.

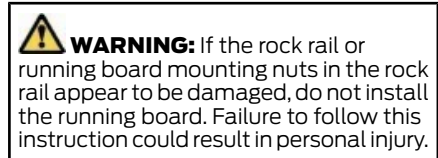

3. Locate the tool pouch and remove the hex tool and the running board mounting bolts.
4. Grab the running board for the appropriate side near the front and rear of the running board.

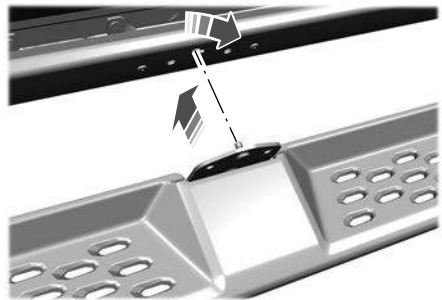

5. Align the temporary support pins on the front and middle mounting tabs to the larger opening of the keyhole slots on the rock rail.
6. Tilt the running board up or down so that the running board mounting tabs are even with the surface of the rock rail.

## Removable Vehicle Components

7. Move the running board toward the vehicle so that the mounting tabs are flat against the rock rail and the temporary support pins go through the larger opening in the keyhole slots.
8. Slide the running board to the rear of the vehicle and down to engage the temporary support pins on the running board into the narrow part of keyhole slot on the rock rail.
9. Make sure that both the front and middle mounting tab temporary support pins have engaged the keyhole slot before letting go of running board.

**Note:** *Mounting nuts in the rock rail should be fully visible through running board mounting tab holes.*

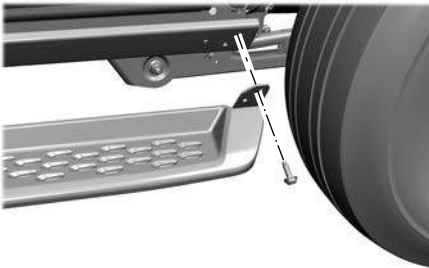

10. Install one of the running board bolts into the rear upper hole on the rear mounting tab of the running board. This ensures all the other mounting tab holes line up.
11. Use the hex tool to tighten the bolt.

**WARNING:** If all running board tabs do not sit flush against the rock rail, do not install the running board. It could be an indication that the rock rail has been damaged. Installation of the remaining bolts could damage running board, mounting brackets, or cause further damage to rock rail. Failure to follow this instruction could result in personal injury.

12. To make sure the temporary mounting pins are properly engaged with the rock rail, the three running board tabs must be flush against the rock rail.
13. Install a bolt on the remaining hole in the rear running board mounting tab and two bolts each on the middle and front running board mounting tabs.
14. Use the hex tool to tighten the bolts.

**Note:** *We recommend that you use a torque wrench to make sure you tighten all the bolts to the required 27 Nm (20 lb.ft) specification.*

15. To install the additional running board, repeat Steps 1-14 for the opposite side
16. Return the hex tool to the tool pouch and secure it in the vehicle.

## REMOVABLE FRONT BUMPER END CAPS - RAPTOR

### REMOVING AND INSTALLING THE FRONT BUMPER END CAPS

**WARNING:** Do not store the bumper end-caps in the vehicle. Unsecured end-caps could become a projectile in a sudden stop or crash.

# Removable Vehicle Components

**Note:** Front bumper end caps are not rated for rock crawl use or off-road conditions where ground contact is likely to occur. We recommend removing the end caps before use on roads under these conditions to avoid damage.

## Removing the Front Bumper End Cap

1. Park your vehicle on level ground and make sure the transmission is in park (P) and the engine is off.

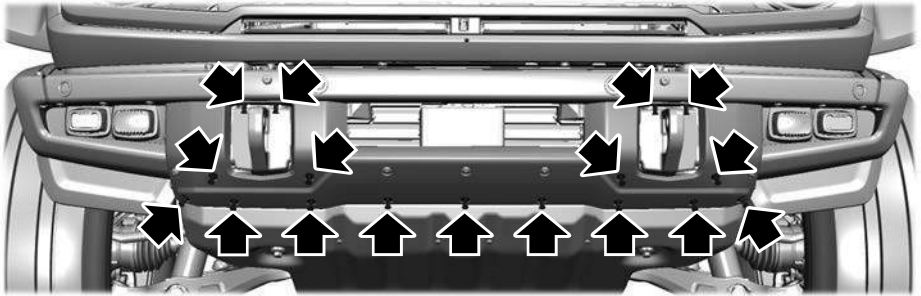

2. Locate the 17 reusable pushpins on the center front bumper cover.
3. Use a suitable tool, such as a flat blade screwdriver in the 2.5 mm (0.10 in) space between the head of the pushpin and the body of the pushpin to pry out the head away from the body to release the locking mechanism.
4. Pull the head of the pushpin out so space between the head and body of the pushpin is about 15.9 mm (0.626 in).

**Note:** The pushpin should now be loose in the bumper cover.

5. Pull the pushpin out from the bumper cover.

**Note:** Complete removal of the pushpin head is not necessary to remove the pushpin. The head and stem of the pushpin may come apart from the body of the pushpin during removal. The pushpin is not broken. The head can be reinserted into the body later during installation. Make sure to remove the body of the pushpin from the bumper cover to allow removal of the bumper cover.

6. Repeat Steps 2-4 to remove the rest of the pushpins.
7. Remove the center front bumper cover.

**Note:** Avoid setting the front bumper cover down on hard or sharp surfaces to prevent damage.



## Removable Vehicle Components

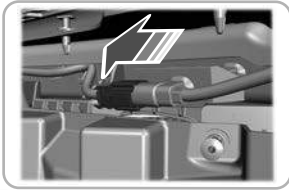

8. From behind the front bumper end cap, disengage the lamp electrical connector by pressing and holding down on the release tab on the vehicle-side connector while pulling the connectors apart.

**Note:** The lamp connector is attached to the lamp housing and you do not need to remove it from the lamp to perform this step.

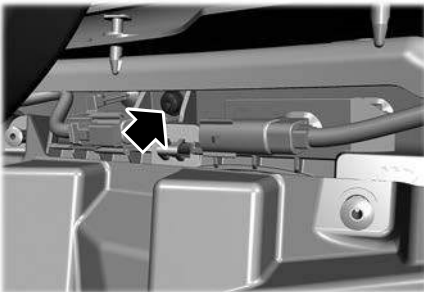

9. Locate the tool pouch and use the hex tool to remove the bolt at the top center of the lamp.

10. Store the lamp bolt in the pocket of the tool pouch.



11. Loosen the top rear bolt of the bumper end cap.

**Note:** Make sure the bolt does not touch the end cap.

**Note:** You do not need to remove the bolt. Removal could cause damage to body panel above the bolt. The end cap at this location has a slot to allow removal in the next step.

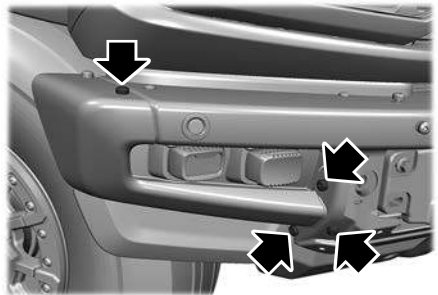

12. Remove the three bolts from the bumper end cap lower attachment and one bolt from the front top attachment.

## Removable Vehicle Components



13. Slide the end cap with the lamp assembly straight out to the side of the vehicle.

**Note:** Avoid setting the end cap down on hard or sharp surfaces to prevent damage to the end cap and lamp housing.

**Note:** Store the end cap out of the elements to prevent damage to the bumper end cap and lamp electrical connector.

14. Using the hex tool, install and tighten the four bolts removed in Step 12.
15. Tighten the bolt loosened in Step 11.

**Note:** We recommend that you use a torque wrench to make sure that you tighten all the bolts to 22 Nm (16 lb.ft).

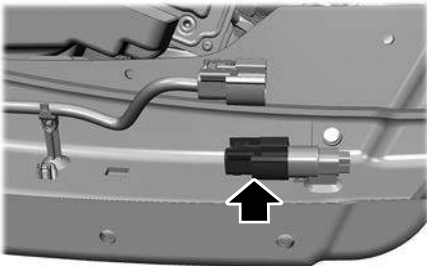

16. Locate the docking plug and cover on the back of the front bumper.

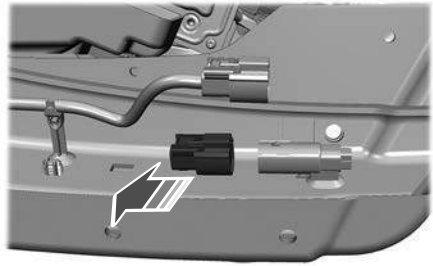

17. Disengage the docking plug protective cover by pressing down and holding the release tab while pulling the docking plug protective cover apart from the docking plug.

**Note:** You do not need to remove the docking plug that is attached to the bumper to perform this step.

18. Store the protective docking cover in the pocket of the tool pouch.

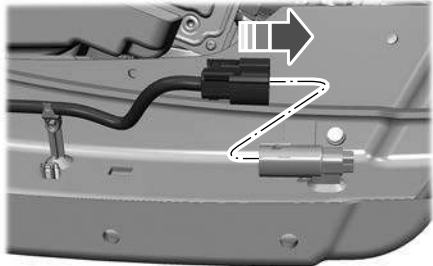

19. Insert the vehicle-side lamp connector into the docking plug attached to the bumper. Push in until you feel it click together.

**Note:** Installation of the vehicle-side lamp connector into the docking plug is important to prevent damage to the vehicle wiring, lighting system, or fuses.

# Removable Vehicle Components

**Note:** Make sure you do not press the release tab on the lamp connector when pushing the connectors together, this way you can feel them click together.

20. To remove additional front bumper end caps, repeat Steps 2-19 on the opposite side.
21. Reinstall the center front bumper cover in the original location.
22. Install the 17 pushpins removed in Steps 2-6. Do not press the pushpin heads in until all pushpins are in place.
23. Lock the pushpins in place by pushing the head in until it stops.

**Note:** There should be a gap of about 2.5 mm (0.10 in) between the head and body of the pushpin.

24. Return the hex tool to the tool pouch with the docking plug protective caps and lamp bolts, and then secure the tool pouch in the vehicle.

## Installing the Front Bumper End Cap

1. Park your vehicle on level ground and make sure to place the transmission in park (P) and that you switch the engine off.

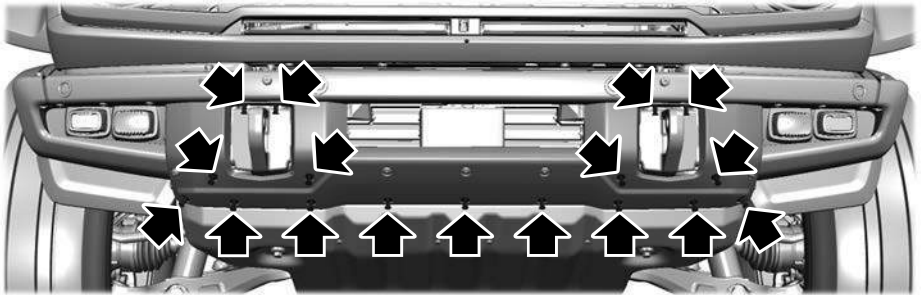

2. Locate the 17 reusable pushpins on the center front bumper cover.
3. Use a suitable tool, such as a flat blade screwdriver in the 2.5 mm (0.10 in) space between the head of the pushpin and the body of the pushpin to pry out the head away from the body to release the locking mechanism.
4. Pull the head of the pushpin out so space between the head and body of the pushpin is about 15.9 mm (0.626 in).

**Note:** The pushpin should now be loose in the bumper cover.

5. Pull the pushpin out from the bumper cover.

**Note:** Complete removal of the pushpin head is not necessary to remove the pushpin. The head and stem of the pushpin may come apart from the body of the pushpin during removal. The pushpin is not broken. You can reinsert the head into the body later during installation. Make sure to remove the body of the pushpin from the bumper cover to allow removal of the bumper cover.

6. Repeat Steps 2-4 to remove the rest of the pushpins.
7. Remove the center front bumper cover.

## Removable Vehicle Components

**Note:** Avoid setting the front bumper cover down on hard or sharp surfaces to prevent damage.

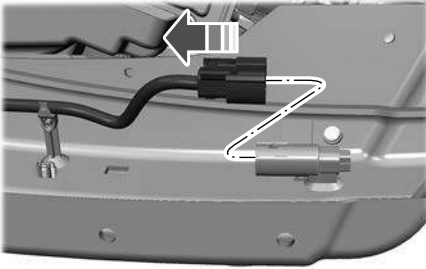

- From behind the front bumper, disengage the lamp electrical connector from the docking plug by pressing and holding down on the release tab on the vehicle-side connector when pulling the connectors apart from the docking plug.

**Note:** The docking plug is attached to the bumper and you do not need to remove it from the vehicle to perform this step.

- Locate the tool pouch and remove the docking plug protective caps stored in the pouch during bumper end cap removal.

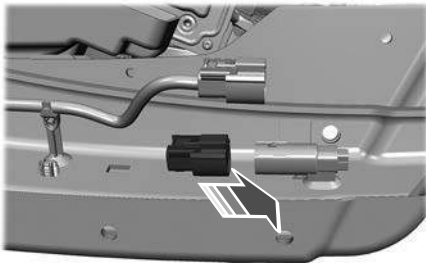

- Insert the docking plug protective cap onto the docking plug attached to the bumper and push together until you feel them click together.

**Note:** It is important to reinstall the docking plug protective cover on the docking plug to prevent damage to the vehicle lamp connector the next time you use the docking plug.

**Note:** Make sure you do not press the release tab on the lamp connector when pushing the connectors together, this way you can feel them click together.

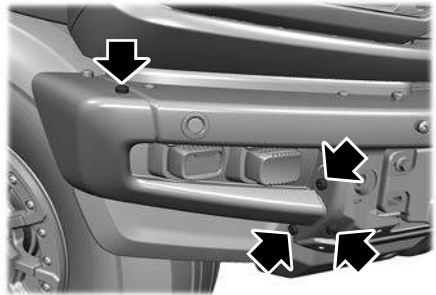

- Use the hex tool to remove the three bolts from the bumper end cap lower attachment and one bolt from the front top attachment.



- Loosen the top rear bolt of the bumper end cap.

## Removable Vehicle Components

**Note:** Make sure the bolt does not touch the end cap

**Note:** You do not need to remove the bolt. Removal could cause damage to the body panel above the bolt. The end cap at this location has a slot to allow removal in the next step.



- Slide the end cap with the lamp assembly straight in from the side of the vehicle.

**Note:** Make sure the front bumper end cap slot is under the top rear bolt head on the bumper.

- Align the holes in the end cap and bumper at the front lower attachment.
- Hand start the three bolts at the front bumper end cap lower attachment and the one bolt from the front top attachment.

**Note:** Do not tighten or torque the bolts.

- Locate the lamp bolt stored in the tool pouch during the front bumper end cap removal.

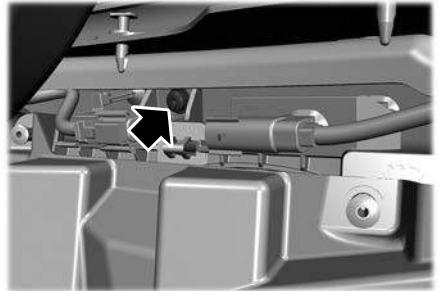

- From behind the bumper, hand start the lamp bolt at the top center of the lamp housing.

**Note:** Do not tighten or torque the bolt.

- Using the hex tool, tighten the four bolts installed in Step 15. Then tighten the bolt loosened in Step 12. Lastly, tighten the bolt installed in Step 17.

**Note:** We recommend that you use a torque wrench to make sure that you tighten all the bolts to 22 Nm (16 lb.ft).

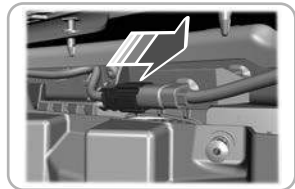

# Removable Vehicle Components

19. Insert the vehicle-side lamp wiring connector onto the lamp plug attached to the lamp housing and push together until you feel it click together.

**Note:** Make sure you do not press the release tab on the lamp connector when pushing the connectors together, this way you can feel them click together.

**Note:** The lamp-side wiring connector is attached to the lamp housing and does not need to be removed to perform this step.

20. To install the additional front bumper cap, repeat Steps 8-19 on the opposite side.
21. Reinstall the center front bumper cover in the original location.
22. Install the 17 pushpins removed in Steps 2-6. Do not press the pushpin heads in until all pushpins are in place.
23. Lock the pushpins in place by pushing the head in until it stops.

**Note:** There should be a gap of about 2.5 mm (0.10 in) between the head and body of the pushpin.

24. Return the hex tool to the tool pouch with the docking plug protective caps and lamp bolts, and then secure the tool pouch in the vehicle.

## STORING THE DOORS AND THE ROOF PANELS - 4-DOOR, EXCLUDING: RAPTOR



**WARNING:** Do not store removed doors or roof panels in vehicle without using the Ford onboard storage kit, and verifying they have been secured per instructions. Failure to follow this instruction could result in personal injury or death.

**Note:** Cargo can shift under severe vehicle use, to reduce the risk of damage, avoid high speed or extreme rock crawl off-road situations when storing the doors in the cargo area.

**Note:** Inspect the bags and harness periodically to make sure they are not damaged. Inspect the door retention harness straps to make sure there are no nicks, tears or cuts. Replace if necessary.

**Note:** Clean the roof panels and doors prior to storing them in the bags as dirt may damage the finish.

## Storing the Front Roof Panels

1. Remove the front roof panels. See **Removing and Installing the Front Roof Panel** (page 388).

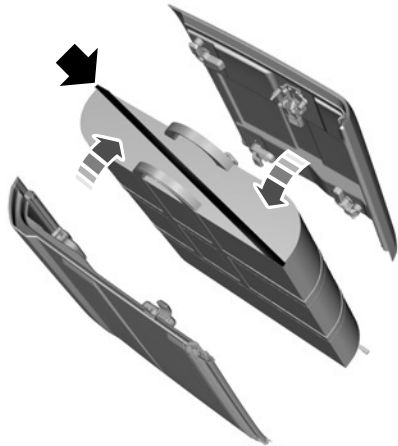

2. Open the bag and pull out the divider. Place the first panel into the bag. Replace the divider before placing the second panel into the bag.
3. Zip the bag closed.
4. Gently slide the roof panel bag into the cargo area.

# Removable Vehicle Components

## Securing the Front Roof Panels Vertically

1. Raise the bag to the vertical position.

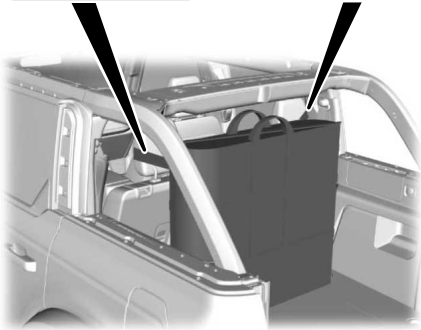
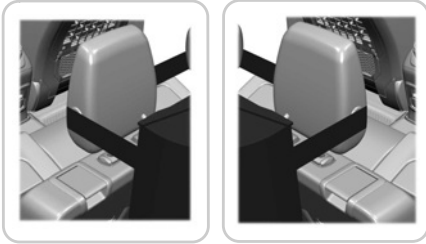

2. Secure the upper roof bag strap around the rear seat headrests. Adjust the tension on the strap until it is snug.

**Note:** Do not overtighten the strap. This may cause damage to the headrest.

3. Secure the lower bag hooks to the forward cargo rings.

**Note:** Some vehicle accessories may prevent vertical storage of the panels.

## Securing the Front Roof Panels Horizontally

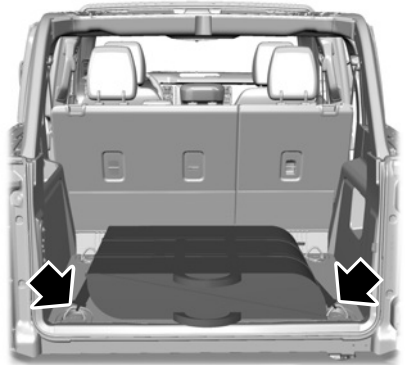

1. Install the loops through the two D-rings and secure the panels.

**Note:** Do not place objects on the roof panel bag to avoid damaging the panels.

# Removable Vehicle Components

## Securing the Door Retention Harness



1. Install the eyebolts located in the Ford onboard storage kit into the rear cargo area pillars.

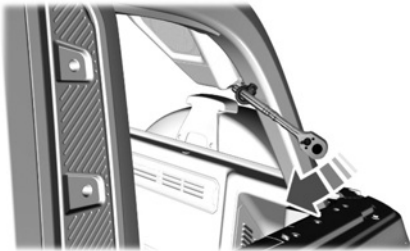

2. Use the ratchet tool provided in the kit to assist in tightening the eyebolts. The eyebolts should rest in the groove of the handle. Using the tool as a lever, apply force until fully tightened.

**Note:** We recommend tightening the eyebolts to 17 Nm (13 lb.ft).

**Note:** The eyebolts can remain installed on the vehicle. Make sure the eyebolts are fully tightened each time they are used.

3. Fully open the tailgate and rear lift glass, or open the soft top cargo access and connect the prop rod to hold open.

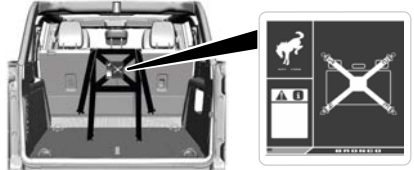

4. Install the door retention harness.

**Note:** Refer to harness label for image.

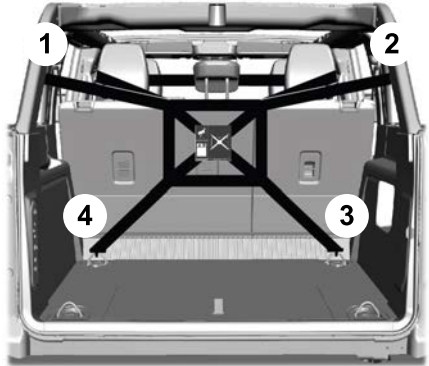

5. Attach upper straps 1 and 2 to the eyebolts. Attach lower straps 3 and 4 to the forward cargo rings.

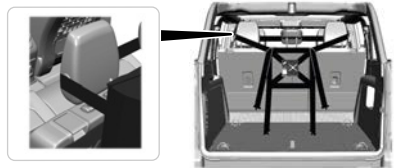



# Removable Vehicle Components

6. Place the narrow strap loop over all the rear headrests and tighten until snug.

**Note:** Do not overtighten the strap. This may cause damage to the headrest.

7. Place the remaining harness over the seat so it is out of the way.

## Storing the Front Doors

1. Adjust the seat backrest to the optimal seating position. Pull the lever up, and push the backrest rearward when storing the two front doors. This creates more space between the front door sail and the upper trim. Make sure the cargo area is clear of any other items. See **Adjusting the Seat Backrest** (page 130).
2. See Securing the Door Retention Harness earlier in this chapter and complete Steps 1-7.
3. Open the passenger side front door and install the door bag. See **Removing and Installing the Doors** (page 378).

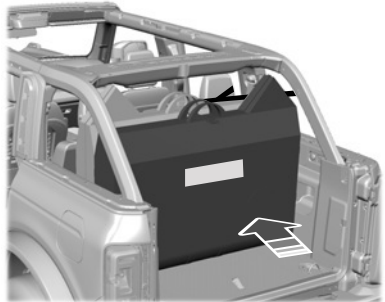
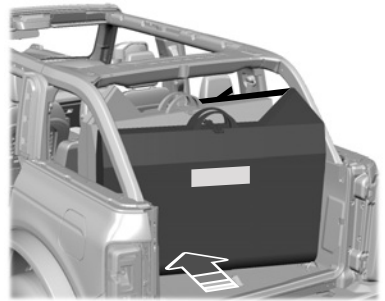

4. Zip the bag fully closed and gently place the door in the cargo area. Avoid contacting the rear pillars, speakers, striker, and trim. For soft tops, take care to avoid contacting the prop rod.
5. Slide the door into position with the bag label facing rearward. Center the door to make sure there is space between the door and cargo box trim panels.
6. Push the lower edge of the door forward until it stops to create space for the door peak.
7. Secure the door bag to the retention harness with the clip.
8. Repeat Steps 3-5 for the driver side front door. Secure the bags using the clips on the bags.

# Removable Vehicle Components

9. Lift the retention harness over the doors. Make sure the straps are straight.
10. Secure the upper straps 5 and 6 to the eyelet bolts and lower straps 7 and 8 to the rear cargo rings.
11. Tighten all adjustable straps to secure the doors.
12. To prevent the doors from moving, fold the unused rear door bags to use as a spacer and place them between the doors and lower cargo hooks as shown.

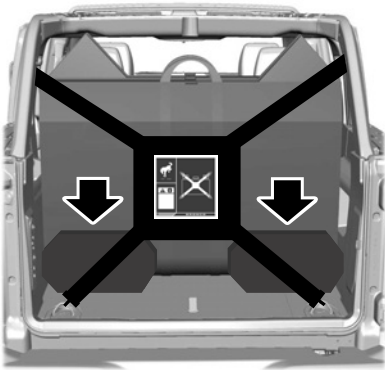
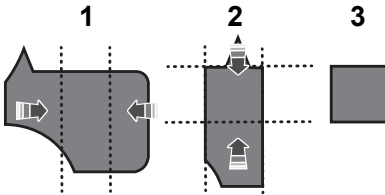

**Note:** The doors should not move when pressure is applied.

## Storing the Front Roof Panels and the Front Doors

1. Adjust the seat backrest to the optimal seating position. Pull the lever up, and push the backrest rearward when storing the two front doors. This creates more space between the front door sail and the upper trim. Make sure the cargo area is clear of any other items. See **Adjusting the Seat Backrest** (page 130).
2. See Securing the Door Retention Harness earlier in this chapter and complete Steps 1-7.
3. Open the passenger side front door and install the door bag. See **Removing and Installing the Doors** (page 378).

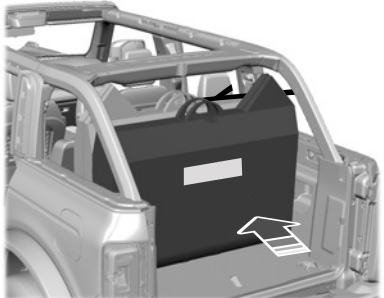
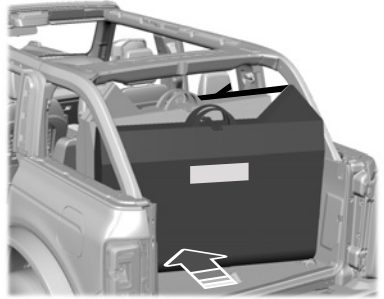

# Removable Vehicle Components

4. Zip the bag fully closed and gently place the door in the cargo area. Avoid contacting the rear pillars, speakers, striker, and trim.
5. Slide the door into position with the bag label facing rearward. Center the door to make sure there is space between the door and cargo box trim panels.
6. Push the lower edge of the door forward until it stops to create space for the door peak.
7. Secure the door bag to the retention harness with the clip.
8. Repeat Steps 3-5 for the driver side front door. Secure the bags using the clips on the bags.
9. Place the front roof panels in the bag, and then into the cargo area. See **Storing the Doors and the Roof Panels** (page 410).

**Note:** Do not use the roof bag retention system in this orientation. Secure the roof panels by the harness.

10. Lift the retention harness over the doors. Make sure the straps are straight.
11. Secure the upper straps 5 and 6 to the eyelet bolts and lower straps 7 and 8 to the rear cargo rings.
12. Tighten all adjustable straps to secure the doors and roof panels.

**Note:** The doors and roof panels should not move when pressure is applied.

## Storing all Four Doors

1. Adjust the rear seat backrest to the upright position and raise the center headrest to the highest position. Pull on the seat backrest to make sure that it has fully latched. Make sure the cargo area is clear of any other items. See **Adjusting the Seat Backrest** (page 130).

**Note:** Four door storage in the cargo area will prevent the soft tops from fully retracting. Limit to the partially open position.

**Note:** Make sure the rear seat headrests are upright.

2. See Securing the Door Retention Harness earlier in this chapter and complete Steps 1-7.
3. Open the driver-side rear door and install the bag. See **Removing and Installing the Doors** (page 378).

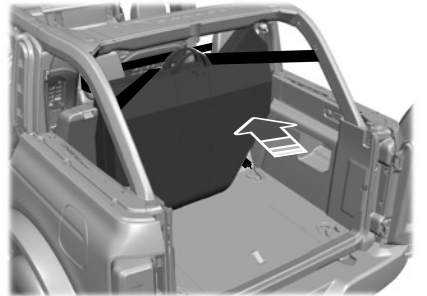
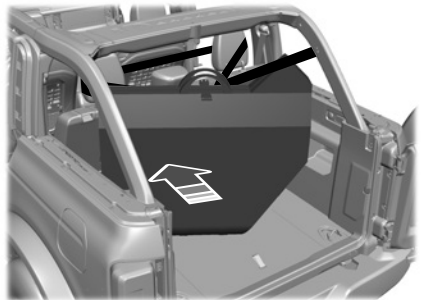

4. Zip the bag fully closed and gently place the door in the cargo area. Avoid contacting the rear pillars, speakers, striker, and trim. For soft tops, take care to avoid contacting the prop rod.
5. Slide the door into position with the bag label facing rearward.

## Removable Vehicle Components

- Align the door peak with the highest point in the upper trim.

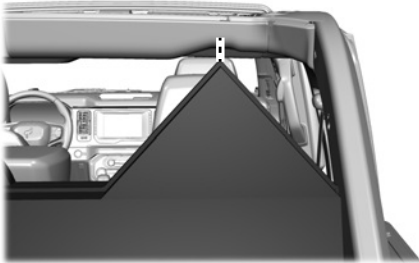

- Secure the door bag to the retention harness with the clip.
- Repeat Steps 3-5 for the remaining doors. Secure the bags with the harness clips.

**Note:** In order to store all four doors onboard, you must store the doors in the following sequence: driver-side rear, driver-side front, passenger-side front, passenger-side rear.

- Lift the retention harness over the doors. Make sure the straps are straight.
- Secure the upper straps 5 and 6 to the eyelet bolts and lower straps 7 and 8 to the rear cargo rings.
- Tighten all adjustable straps to secure the doors.

**Note:** The doors should not move when pressure is applied.

**Note:** When closing the tailgate, make sure the tailgate and glass do not strike the stowed doors.

## STORING THE DOORS AND THE ROOF PANELS - RAPTOR



**WARNING:** Do not store removed doors or roof panels in vehicle without using the Ford onboard storage kit, and verifying they have been secured per instructions. Failure to follow this instruction could result in personal injury or death.



**WARNING:** Do not store the rear doors in the vehicle. The onboard storage kit is for the front doors and roof panels only. Unsecured doors and panels could become a projectile in a sudden stop or crash.



**WARNING:** Do not remove or modify the B-Pillar brace or trim. Doing so could affect safety system performance, including safety canopy and front seat mounted side airbags, during a crash or rollover.

Do not remove or modify the C-pillar brace.

Do not secure or load items on the B-pillar brace when the roof panel is removed.

**Note:** Cargo can shift under severe vehicle use. To reduce the risk of damage, avoid high speed or extreme rock crawl off-road situations when storing the doors in the cargo area.

**Note:** Inspect the bags and harness periodically to make sure they are not damaged. Inspect the door retention harness straps to make sure there are no nicks, tears or cuts. Replace if necessary.

**Note:** Clean the roof panels and doors prior to storing them in the bags as dirt may damage the finish.

# Removable Vehicle Components

## Storing the Front Roof Panels

1. Remove the front roof panels. See **Removing and Installing the Front Roof Panel** (page 388).

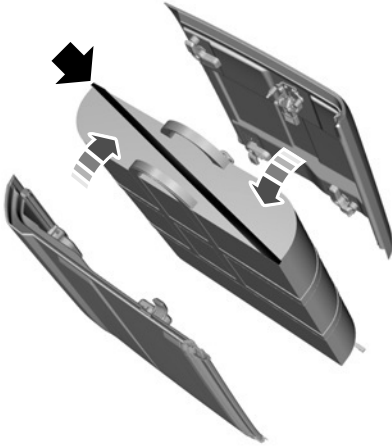

2. Open the bag and pull out the divider. Place the first panel into the bag. Replace the divider before placing the second panel into the bag.
3. Zip the bag closed.
4. Gently slide the roof panel bag into the cargo area.

### Securing the Front Roof Panels Vertically

1. Raise the bag to the vertical position.

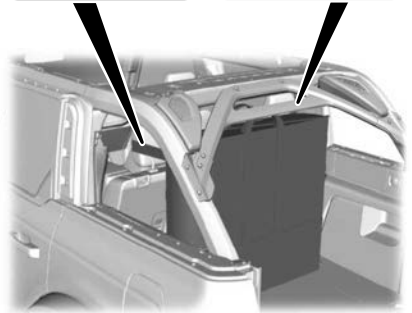
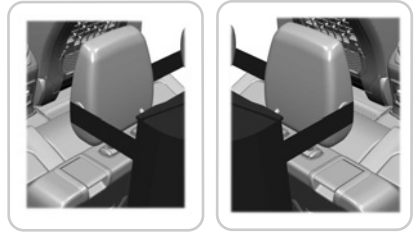

2. Secure the upper roof bag strap around the rear seat headrests. Adjust the tension on the strap until it is snug.

**Note:** Do not overtighten the strap. This may cause damage to the headrest.

3. Secure the lower bag hooks to the forward cargo rings.

**Note:** Some vehicle accessories may prevent vertical storage of the panels.

# Removable Vehicle Components

## Securing the Front Roof Panels Horizontally



1. Install the loops through the two D-rings and secure the panels.

**Note:** Do not place objects on the roof panel bag to avoid damaging the panels.

## Securing the Door Retention Harness



1. Install the eyebolts located in the Ford onboard storage kit into the rear cargo area pillars.



2. Use the ratchet tool provided in the kit to assist in tightening the eyebolts. The eyebolts should rest in the groove of the handle. Using the tool as a lever, apply force until fully tightened.

# Removable Vehicle Components

**Note:** We recommend tightening the eyebolts to 17 Nm (13 lb.ft).

**Note:** The eyebolts can remain installed on the vehicle. Make sure to fully tighten the eyebolts each time you use them.

3. Fully open the tailgate and rear lift glass, or open the soft top cargo access and connect the prop rod to hold open.



4. Install the door retention harness.

**Note:** Refer to harness label for image.

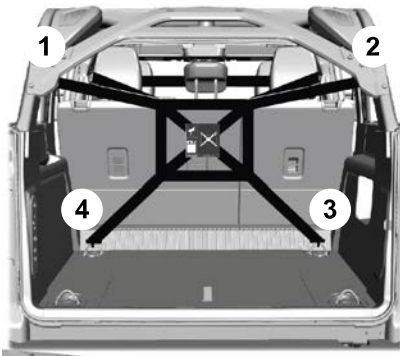

5. Attach upper straps 1 and 2 to the eyebolts. Attach lower straps 3 and 4 to the forward cargo rings.

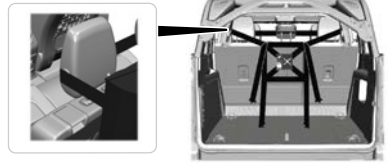

6. Place the narrow strap loop over all the rear headrests and tighten until snug.

**Note:** Do not overtighten the strap. This may cause damage to the headrest.

7. Place the remaining harness over the seat so it is out of the way.

## Storing the Front Doors

1. Adjust the seat backrest to the optimal seating position. Pull the lever up, and push the backrest rearward when storing the two front doors. This creates more space between the front door sail and the upper trim. Make sure the cargo area is clear of any other items. See **Adjusting the Seat Backrest** (page 130).
2. See Securing the Door Retention Harness earlier in this chapter and complete Steps 1-7.
3. Open the passenger side front door and install the door bag. See **Removing and Installing the Doors** (page 378).

# Removable Vehicle Components

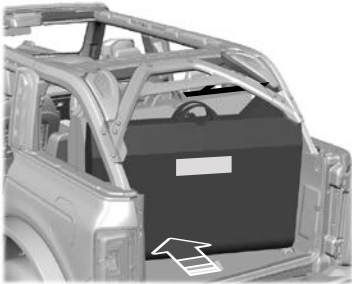

4. Zip the bag fully closed and gently place the door in the cargo area. Avoid contacting the rear pillars, speakers, striker, and trim. For soft tops, take care to avoid contacting the prop rod.
5. Slide the door into position with the bag label facing rearward. Center the door to make sure there is space between the door and cargo box trim panels.
6. Push the lower edge of the door forward until it stops to create space for the door peak.
7. Secure the door bag to the retention harness with the clip.
8. Repeat Steps 3-5 for the driver side front door. Secure the bags using the clips on the bags.

9. Lift the retention harness over the doors. Make sure the straps are straight.
10. Secure the upper straps 5 and 6 to the eyelet bolts and lower straps 7 and 8 to the rear cargo rings.
11. Tighten all adjustable straps to secure the doors.
12. To prevent the doors from moving, fold the unused rear door bags to use as a spacer and place them between the doors and lower cargo hooks as shown.

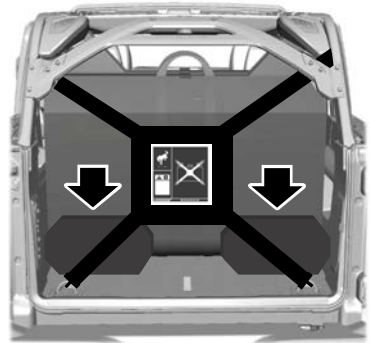
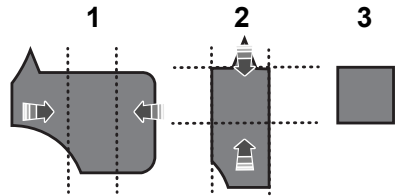

**Note:** The doors should not move when you apply pressure.



# Removable Vehicle Components

## Storing the Front Roof Panels and the Front Doors

1. Adjust the seat backrest to the optimal seating position. Pull the lever up, and push the backrest rearward when storing the two front doors. This creates more space between the front door sill and the upper trim. Make sure the cargo area is clear of any other items. See **Adjusting the Seat Backrest** (page 130).
2. See Securing the Door Retention Harness earlier in this chapter and complete Steps 1-7.
3. Open the passenger side front door and install the door bag. See **Removing and Installing the Doors** (page 378).

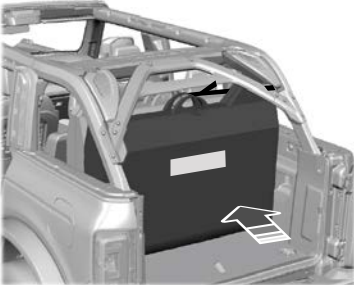
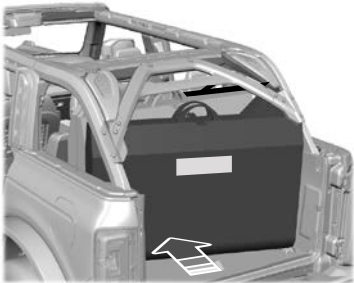

4. Zip the bag fully closed and gently place the door in the cargo area. Avoid contacting the rear pillars, speakers, striker, and trim.
5. Slide the door into position with the bag label facing rearward. Center the door to make sure there is space between the door and cargo box trim panels.
6. Push the lower edge of the door forward until it stops to create space for the door peak.
7. Secure the door bag to the retention harness with the clip.
8. Repeat Steps 3-5 for the driver side front door. Secure the bags using the clips on the bags.
9. Place the front roof panels in the bag, and then into the cargo area. See **Storing the Doors and the Roof Panels** (page 410).

**Note:** Do not use the roof bag retention system in this orientation. Secure the roof panels by the harness.

10. Lift the retention harness over the doors. Make sure the straps are straight.
11. Secure the upper straps 5 and 6 to the eyelet bolts and lower straps 7 and 8 to the rear cargo rings.
12. Tighten all adjustable straps to secure the doors and roof panels.

**Note:** The doors and roof panels should not move when you apply pressure.

# Removable Vehicle Components

## STORING THE ROOF PANELS - 2-DOOR



**WARNING:** Do not store removed doors or roof panels in vehicle without using the Ford onboard storage kit, and verifying they have been secured per instructions. Failure to follow this instruction could result in personal injury or death.

**Note:** The two-door vehicle is not capable of on board storage of the doors. Store the doors in a secure area to avoid damage.

**Note:** Clean the roof panels prior to storing in the bags to prevent dirt from damaging the finish.

1. Remove the front roof panels. See **Removing and Installing the Front Roof Panel** (page 388).

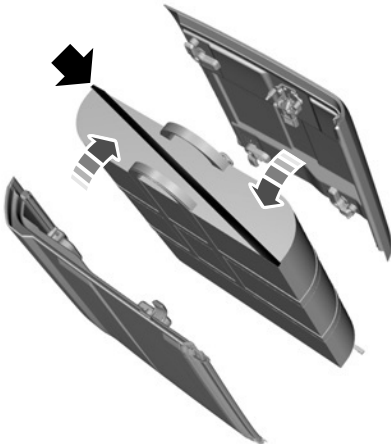

2. Open the bag and pull out the divider. Place the first panel into the bag. Replace the divider before placing the second panel into the bag.

3. Zip the bag closed.
4. Gently slide the roof panel bag into the cargo area in the vertical position.
5. Secure the upper roof bag strap around the rear seat headrests. Adjust the tension on the straps until it is snug.

**Note:** Do not overtighten the strap. This may cause damage to the headrest.

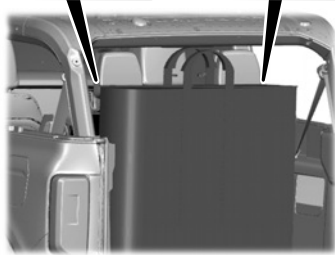
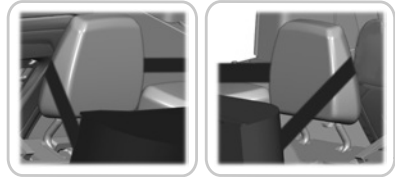

6. Secure the lower bag hooks to the forward cargo rings.

## REMOVABLE VEHICLE COMPONENTS VIDEOS

[Bronco Door Removal and Storage](#)

[Bronco Hard Top Removal, Storage and Reinstallation](#)

[Bronco Soft Top Removal, Storage and Reinstallation](#)

# Vehicle Care

## CLEANING PRODUCTS

### Materials

For best results, use the following products

or products of equivalent quality:

For additional information and assistance, we recommend that you contact an authorized dealer.

Name	Specification
Motorcraft® Bug and Tar Remover, ZC-42 (U.S. & Canada)	
Motorcraft® Custom Bright Metal Cleaner, ZC-15 (U.S. & Canada)	ESR-M5B194-B
Motorcraft® Detail Wash, ZC-3-A (U.S. & Canada)	ESR-M14P4-A
Motorcraft® Engine Shampoo and Degreaser, ZC-20 (U.S.)	ESR-M14P3-A
Motorcraft® Engine Shampoo, CXC-66-A (Canada)	
Motorcraft® Premium Leather and Vinyl Cleaner, ZC-56 (U.S. & Canada)	
Motorcraft® Multi-Purpose Cleaner, CXC-101 (Canada)	
Motorcraft® Premium Windshield Wash Concentrate with Bitterant, ZC-32-B2 (U.S.)	WSS-M14P19-A
Motorcraft® Premium Quality Windshield Washer Fluid, CXC-37-F/M (Canada)	WSS-M14P19-A
Motorcraft® Professional Strength Carpet & Upholstery Cleaner, ZC-54 (U.S. & Canada)	
Motorcraft® Premium Glass Cleaner, CXC-100 (Canada)	ESR-M14P5-A
Motorcraft® Spot and Stain Remover, ZC-14 (U.S.)	
Motorcraft® Ultra-Clear Spray Glass Cleaner, ZC-23 (U.S.)	ESR-M14P5-A
Motorcraft® Wheel and Tire Cleaner, ZC-37-A (U.S. & Canada)	

# Vehicle Care

---

## CLEANING THE EXTERIOR

### CLEANING THE EXTERIOR PRECAUTIONS

Immediately remove fuel spillages, bird droppings, insect deposits and road tar from your vehicle. These items may cause damage to your vehicle's paintwork or trim over time.

Remove any exterior accessories, for example antennas, before entering a car wash.

### CLEANING HEADLAMPS AND REAR LAMPS

We recommend that you only use cold or lukewarm water containing car shampoo to clean the headlamps and the rear lamps.

Do not scrape the lamps.

Do not wipe lamps when they are dry.

### CLEANING WINDOWS AND WIPER BLADES

To clean the windshield and wiper blades:

- Clean the windshield with a non-abrasive glass cleaner.

**Note:** When cleaning the interior of the windshield, avoid getting any glass cleaner on the instrument panel or door panels. Wipe any glass cleaner off these surfaces immediately.

- Clean the wiper blades with washer fluid or water applied with a soft sponge or cloth.

**Note:** Do not use razor blades or other sharp objects to clean or remove decals from the inside of the heated rear window. This can cause damage not covered by the vehicle Warranty.

**Note:** We recommend cleaning the power sliding rear window at regular intervals to avoid dust and debris accumulation to deliver appropriate function.

### CLEANING CHROME, ALUMINIUM OR STAINLESS STEEL

We recommend that you only use a car shampoo, a soft cloth and water on bumpers and other chrome, aluminium or stainless steel parts.

**Note:** For additional information and assistance, we recommend that you contact an authorized dealer.

**Note:** Rinse the area well after cleaning.

**Note:** Do not use abrasive materials, for example steel wool or plastic pads, as they can scratch these surfaces.

**Note:** Do not use chrome cleaner, metal cleaner or polish on wheels or wheel covers.

### CLEANING WHEELS

Only use a recommended wheel and tire cleaner to clean the wheels. For additional information and assistance, we recommend that you contact an authorized dealer.

1. Use a sponge to remove heavy deposits of dirt and brake dust.
2. Rinse well after cleaning.

**Note:** Do not apply a cleaning chemical to warm or hot wheel rims and covers.

If you intend to park your vehicle for an extended period after cleaning the wheels, drive it for few minutes before parking. This reduces the risk of corrosion of the brake discs, brake pads and linings.

Do not clean the wheels when they are hot.

**Note:** Some car washes could damage wheel rims and covers.

# Vehicle Care

---

**Note:** *Using non-recommended cleaners, harsh cleaning products, chrome wheel cleaners or abrasive materials could damage wheel rims and covers.*

## CLEANING THE ENGINE COMPARTMENT

Use a vacuum cleaner to remove debris from the screen area below the windshield.

**Note:** *If you are not familiar with the parts around the engine do not wash the engine compartment. Avoid frequent engine washes.*

When washing the engine compartment:

- Never wash or rinse the engine while it is hot or running.
- Never wash or rinse any ignition coil, spark plug wire or spark plug well.
- Cover the battery, power distribution box, and air filter assembly to prevent water damage.

**Note:** *If your vehicle has an engine cover remove the cover before application of shampoo and degreaser.*

- Spray an approved engine shampoo and degreaser on all parts that require cleaning and rinse with water.

**Note:** *Follow the manufacturer's instructions for using engine shampoo and degreaser.*

## CLEANING STRIPES OR GRAPHICS

It is recommended to wash your vehicle by hand however, pressure washing may be used under the following conditions:

- Use a spray with a minimum of 40° wide spray angle pattern.
- Keep the nozzle 30 cm (12 in) and at a 90° angle to your vehicle.

- Do not use water pressure higher than 6,895 kPa (1,000 psi).
- Do not use water hotter than 23°C (73°F).

We recommend that you only clean vinyl surfaces in the following way:

1. Wipe the surface with a soft, damp cloth and a mild soap and water solution. Dry the area with a clean, soft cloth.
2. For additional information and assistance, we recommend that you contact an authorized dealer.

**Note:** *Immediately clean off fuel spills, then hand wash the affected area. Allowing the spill to stay on the wrap for too long degrades the vinyl.*

**Note:** *Always hand wash your vehicle if you have vinyl stripes.*

**Note:** *For heavy accumulation of debris or dirt, clean with a non-metallic soft bristle car wash brush and warm soapy water as needed.*

**Note:** *Only use car care products specifically formulated to clean and maintain vinyl wraps and satin painted surfaces.*

## CLEANING CAMERA LENSES AND SENSORS

We recommend that you only use lukewarm or cold water and a soft cloth to clean the camera lens and sensors.

**Note:** *Do not pressure wash camera lens and sensors.*

## CLEANING THE HARD TOP

We recommend that you only clean the hard top in the following way:

1. Use a sponge to remove dust and loose dirt on the hard top surface.

# Vehicle Care

2. Wipe the surface with a soft, damp cloth and a mild soap and water solution. Dry the area with a clean, soft cloth.
3. Make sure the surface of your hard top is dry before applying a small amount of conditioner or spray wax.
4. For additional information and assistance, we recommend that you contact an authorized dealer.

**Note:** Test any conditioner or spray wax on an inconspicuous area before applying broadly.

**Note:** Do not use alcohol containing cleaner or any type of solvent on the hard top surface.

**Note:** Do not use power tools, paste wax or polish on the hard top surface.

**Note:** Do not use chemical solvents or strong detergents when cleaning the hard top. If any chemical solvent gets on the hard top surface, remove it immediately from the surface to avoid unrepairable damage.

## CLEANING THE UNDERBODY

Regularly clean the underside of your vehicle using water. Keep body and door drain holes free of debris or foreign material.

## CLEANING THE INTERIOR

### CLEANING THE INSTRUMENT PANEL



**WARNING:** Do not use chemical solvents or strong detergents when cleaning the steering wheel or instrument panel to avoid contamination of the airbag system.

We recommend that you only clean the instrument panel and cluster lens with a damp soft cloth. Dry the area with a clean, soft cloth.

For additional information and assistance, we recommend that you contact an authorized dealer.

**Note:** Avoid cleaners or polishes that increase the gloss of the upper portion of the instrument panel. The dull finish in this area helps protect you from undesirable windshield reflection.

## CLEANING PLASTIC

We recommend that you only use a mild soap and water solution on a soft cloth. Dry the area with a clean, soft cloth.

## CLEANING DISPLAYS AND SCREENS

We recommend that you only use a microfiber cloth in a circular motion to clean off the fingerprint or dust.

**Note:** Do not pour or spray alcohol onto the touchscreen.

**Note:** Do not use detergent or any type of solvent to clean the touchscreen.

## CLEANING FABRIC



**WARNING:** On vehicles equipped with seat-mounted airbags, do not use chemical solvents or strong detergents. Such products could contaminate the side airbag system and affect performance of the side airbag in a crash.

We recommend that you only clean fabric in the following way:

1. Remove dust and loose dirt with a vacuum cleaner.

# Vehicle Care

2. Wipe the surface with a soft, damp cloth and a mild soap and water solution. Dry the area with a clean, soft cloth.
3. For additional information and assistance, we recommend that you contact an authorized dealer.

For heavy stains, spot clean the area. If a ring forms on the fabric, clean the entire area immediately, but do not oversaturate or the ring could set.

## CLEANING LEATHER



**WARNING:** On vehicles equipped with seat-mounted airbags, do not use chemical solvents or strong detergents. Such products could contaminate the side airbag system and affect performance of the side airbag in a crash.

We recommend that you only clean the leather surfaces in the following way:

1. Remove dust and loose dirt with a vacuum cleaner.
2. Wipe the surface with a soft, damp cloth and a mild soap and water solution. Dry the area with a clean, soft cloth.
3. Make sure the leather is dry, then apply a small amount of conditioner to a clean, dry cloth.
4. Rub the conditioner into the leather until it disappears. Allow the conditioner to dry, then repeat the process for the entire interior. If a film appears, wipe it off with a dry, clean cloth.
5. For additional information and assistance, we recommend that you contact an authorized dealer.

## CLEANING VINYL



**WARNING:** On vehicles equipped with seat-mounted airbags, do not use chemical solvents or strong detergents. Such products could contaminate the side airbag system and affect performance of the side airbag in a crash.

We recommend that you only clean vinyl surfaces in the following way:

1. Remove dust and loose dirt with a vacuum cleaner.
2. Wipe the surface with a soft, damp cloth and a mild soap and water solution. Dry the area with a clean, soft cloth.
3. For additional information and assistance, we recommend that you contact an authorized dealer.

## CLEANING CARPETS AND FLOOR MATS

We recommend that you only clean your carpets in the following way:

1. Remove dust and loose dirt with a vacuum cleaner.
2. Wipe the surface with a soft, damp cloth and a mild soap and water solution. Dry the area with a clean, soft cloth.
3. For additional information and assistance, we recommend that you contact an authorized dealer.

For heavy stains, spot clean the area. If a ring forms on the fabric, clean the entire area immediately, but do not over-saturate or the ring could set.

We recommend that you only clean your floor mats in the following way:

# Vehicle Care

1. Remove dust and loose dirt with a vacuum cleaner.
2. Wash rubber floor mats using mild soap and lukewarm or cold water.
3. Completely dry the floor mat before placing them back in your vehicle.

## Cleaning Rubber Floors

1. Remove the floor mats prior to washing out. See **Floor Mats** (page 316).

**Note:** Prior to washing out, remove large debris to prevent clogging the drain.

2. Turn active drain plugs in each passenger compartment counterclockwise to open.
3. Wash out debris using a standard garden style hose.

**Note:** Use caution to not spray seats, console, door interior, electrical connections, instrument cluster display and underside of the instrument panel on both driver and passenger sides.

4. Wipe out remaining water or debris from the floor.
5. Install active drain plugs and turn clockwise to close.
6. Reinstall floor mats.

## CLEANING SEATBELTS



**WARNING:** Do not use cleaning solvents, bleach or dye on the vehicle's seatbelts, as these actions may weaken the belt webbing.

1. Wipe the surface with a soft, damp cloth and a mild soap and water solution. Dry the area with a clean, soft cloth.

## REPAIRING MINOR PAINT DAMAGE

We recommend that you contact an authorized dealer to identify your vehicle color code. Authorized dealers have touch-up paint to match your vehicle's color.

Before repairing minor paint damage, use a cleaner to remove particles such as bird droppings, tree sap, insect deposits, tar spots, road salt and industrial fallout.

Read the instructions before using cleaning products.

## WAXING YOUR VEHICLE

Wax the high-gloss painted surface of your prewashed vehicle once or twice a year.

We recommend that you only use an approved quality wax that does not contain abrasives. Follow the manufacturer's instructions to apply and remove the wax. For additional information and assistance, we recommend that you contact an authorized dealer.

When washing and waxing, park your vehicle in a shaded area out of direct sunlight.

**Note:** Avoid waxing unpainted or low-gloss black colored parts, they discolor over time.



# Storing Your Vehicle

---

## PREPARING YOUR VEHICLE FOR STORAGE

If you plan on storing your vehicle for 30 days or more, the following maintenance recommendations makes sure your vehicle stays in good operating condition.

Under various conditions, long-term storage may lead to degraded engine performance or failure unless you use specific precautions to preserve your vehicle.

### General

- Store all vehicles in a dry, ventilated place.
- If vehicles are stored outside, they require regular maintenance to protect against rust and weather damage.
- Make sure all linkages, cables, levers and pins under your vehicle are covered with grease to prevent rust.
- Move vehicles at least 7.5 m (25 ft) every 15 days to lubricate working parts and prevent corrosion.
- Fill the fuel tank with high-quality fuel until the first automatic shutoff of the fuel pump nozzle.

### Engine

- Change the engine oil and filter prior to storage because used engine oil contains contaminants which may cause engine damage.
- Start the engine every 15 days for a minimum of 15 minutes. Run at fast idle with the climate controls set to defrost until the engine reaches normal operating temperature.
- With your foot on the brake, shift through all the gears while the engine is running.

### Body

- Wash your vehicle thoroughly to remove dirt, grease, oil, tar or mud from exterior surfaces, rear wheel housings and the underside of front fenders.
- Periodically wash your vehicle if it is stored in exposed locations.
- Touch-up exposed or primed metal to prevent rust.
- Cover chrome and stainless steel parts with a thick coat of auto wax to prevent discoloration. Rewax as necessary when you wash your vehicle.
- Lubricate all hood, door and luggage compartment hinges and latches with a light grade oil.
- Cover interior trim to prevent fading.
- Keep all rubber parts free from oil and solvents.

### 12 Volt Battery

- When storing your vehicle for longer than 30 days the battery state of charge should be approximately 50%. Additionally, we recommend to disconnect the 12v battery to reduce system loads on the battery, or you can use a trickle charger for longer storage periods.
- Check and recharge as necessary. Keep connections clean.

**Note:** *It is necessary to reset memory features if you disconnect the battery cables.*

# Storing Your Vehicle

---

## Tires

- Maintain recommended air pressure.
- To minimize flat spots on the tires, inflate all four tires to the recommended cold pressures listed on the Safety Compliance Certification label or Tire Label affixed to your vehicle. When the vehicle is taken out of storage, reset the tire pressures as necessary to the recommended levels listed on the Safety Compliance Certification label or Tire Label affixed to your vehicle.

**Note:** *If you store your vehicle in a location with low ambient temperatures, follow the instructions for care of summer tires.*

## Brakes

Make sure the brakes and parking brake fully release.

**Note:** *If you intend to park your vehicle for an extended period after cleaning, drive it for few minutes before parking. This reduces the risk of corrosion of the brake discs, brake pads and linings.*

## REMOVING YOUR VEHICLE FROM STORAGE

When your vehicle is ready to come out of storage, do the following:

- We recommend that you change the engine oil before you use your vehicle again.
- Wash your vehicle to remove any dirt or grease film build-up on window surfaces.
- Check windshield wipers for any deterioration.
- Check the underhood for any foreign materials such as mice or squirrel nests.

- Check the exhaust for any foreign materials.
- Check tire pressures and set tire inflation per the Tire Label.
- Check brake pedal operation. Corroded brake rotors could cause brake noise. Drive your vehicle and gently apply and release the brakes repeatedly over a 10-minute drive to reduce the corrosion from the brakes.
- Check fluid levels (including coolant, oil and gas) to make sure there are no leaks, and fluids are at recommended levels.
- If you remove the battery, clean the battery cable ends and check for damage.

Contact an authorized dealer if you have any concerns or issues.

# Wheel and Tire Information

## LOCATING THE TIRE LABEL

You will find a Tire Label containing tire inflation pressure by tire size and other important information located on the B-Pillar or the edge of the driver's door. See **Locating the Safety Compliance Certification Labels** (page 285).

## DEPARTMENT OF TRANSPORTATION UNIFORM TIRE QUALITY GRADES



Tire Quality Grades apply to new pneumatic passenger car tires. The Quality grades can be found where applicable on the tire sidewall between tread shoulder and maximum section width. For example: **Treadwear 200 Traction AA Temperature A.**

These Tire Quality Grades are determined by standards that the United States Department of Transportation has set.

Tire Quality Grades apply to new pneumatic passenger car tires. They do not apply to deep tread, winter-type snow tires, space-saver or temporary use spare tires, light truck or LT type tires, tires with nominal rim diameters of 10 to 12 inches or limited production tires as defined in Title 49 Code of Federal Regulations Part 575.104 (c)(2).

**U.S. Department of Transportation Tire quality grades:** The U.S. Department of Transportation requires us to give you the following information about tire grades exactly as the government has written it.

### Treadwear

The treadwear grade is a comparative rating based on the wear rate of the tire when tested under controlled conditions on a specified government test course. For example, a tire graded 150 would wear 1½ times as well on the government course as a tire graded 100. The relative performance of tires depends upon the actual conditions of their use, however, and may depart significantly from the norm due to variations in driving habits, service practices, and differences in road characteristics and climate.

# Wheel and Tire Information

## Traction AA A B C



**WARNING:** The traction grade assigned to this tire is based on straight-ahead braking traction tests, and does not include acceleration, cornering, hydroplaning or peak traction characteristics.

The traction grades, from highest to lowest are AA, A, B, and C. The grades represent the tire's ability to stop on wet pavement as measured under controlled conditions on specified government test surfaces of asphalt and concrete. A tire marked C may have poor traction performance.

## Temperature A B C



**WARNING:** The temperature grade for this tire is established for a tire that is properly inflated and not overloaded. Excessive speed, underinflation, or excessive loading, either separately or in combination, can cause heat buildup and possible tire failure.

The temperature grades are A (the highest), B and C, representing the tire's resistance to the generation of heat and its ability to dissipate heat when tested under controlled conditions on a specified indoor laboratory

test wheel. Sustained high temperature can cause the material of the tire to degenerate and reduce tire life, and excessive temperature can lead to sudden tire failure. The grade C corresponds to a level of performance which all passenger car tires must meet under the Federal Motor Vehicle Safety Standard No. 139. Grades B and A represent higher levels of performance on the laboratory test wheel than the minimum required by law.

## INFORMATION ON THE TIRE SIDEWALL

Both United States and Canada Federal regulations require tire manufacturers to place standardized information on the sidewall of all tires. This information identifies and describes the fundamental characteristics of the tire and also provides a U.S. DOT Tire Identification Number for safety standard certification and in case of a recall.

# Wheel and Tire Information

## Information on P Type Tires

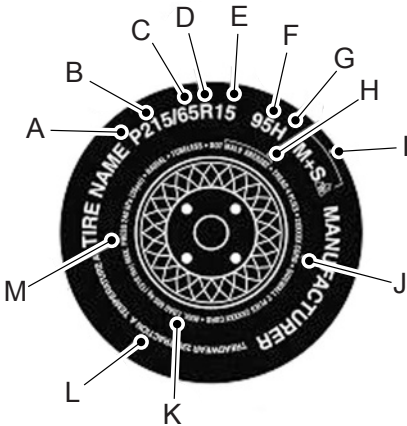

P215/65R15 95H is an example of a tire size, load index and speed rating. The definitions of these items are listed below. (Note that the tire size, load index and speed rating for your vehicle may be different from this example.)

**A. P:** Indicates a tire, designated by the Tire and Rim Association, that may be used for service on cars, sport utility vehicles, minivans and light trucks. **Note:** If your tire size does not begin with a letter this may mean it is designated by either the European Tire and Rim Technical Organization or the Japan Tire Manufacturing Association.

**B. 215:** Indicates the nominal width of the tire in millimeters from sidewall edge to sidewall edge. In general, the larger the number, the wider the tire.

**C. 65:** Indicates the aspect ratio which gives the tire's ratio of height to width.

**D. R:** Indicates a radial type tire.

**E. 15:** Indicates the wheel or rim diameter in inches. If you change your wheel size, you will have to purchase new tires to match the new wheel diameter.

**F. 95:** Indicates the tire's load index. It is an index that relates to how much weight a tire can carry. You may find this information in your owner's manual. If not, contact a local tire dealer.

**Note:** You may not find this information on all tires because it is not required by federal law.

**G. H:** Indicates the tire's speed rating. The speed rating denotes the speed at which a tire is designed to be driven for extended periods of time under a standard condition of load and inflation pressure. The tires on your vehicle may operate at different conditions for load and inflation pressure. These speed ratings may need to be adjusted for the difference in conditions. The ratings range from 130 km/h (81 mph) to 300 km/h (186 mph). These ratings are listed in the following chart.

## Wheel and Tire Information

**Note:** You may not find this information on all tires because it is not required by federal law.

Letter rating	Speed rating
M	130 km/h (81 mph)
N	140 km/h (87 mph)
Q	160 km/h (99 mph)
R	170 km/h (106 mph)
S	180 km/h (112 mph)
T	190 km/h (118 mph)
U	200 km/h (124 mph)
H	210 km/h (130 mph)
V	240 km/h (149 mph)
W	270 km/h (168 mph)
Y	300 km/h (186 mph)

**Note:** For tires with a maximum speed capability over 149 mph (240 km/h), tire manufacturers sometimes use the letters ZR. For those with a maximum speed capability over 186 mph (299 km/h), tire manufacturers always use the letters ZR.

**H. U.S. DOT Tire Identification Number (TIN):** This begins with the letters DOT and indicates that the tire meets all federal standards. The next two numbers or letters are the plant code designating where it was manufactured, the next two are

the tire size code and the last four numbers represent the week and year the tire was built. For example, the numbers 317 mean the 31st week of 1997. After 2000, the numbers go to four digits. For example, 2501 means the 25th week of 2001. The numbers in between are identification codes used for traceability. This information is used to contact customers if a tire defect requires a recall.

**I. M+S or M/S:** Mud and Snow, or

**AT:** All Terrain, or

**AS:** All Season.

**J. Tire Ply Composition and Material Used:** Indicates the number of plies or the number of layers of rubber-coated fabric in the tire tread and sidewall. Tire manufacturers also must indicate the ply materials in the tire and the sidewall, which include steel, nylon, polyester, and others.

**K. Maximum Load:** Indicates the maximum load in kilograms and pounds that can be carried by the tire. See the Safety Compliance Certification Label (affixed to either the door hinge pillar, door-latch post, or the door edge that meets the door-latch post, next to the driver's seating position), for the correct tire pressure for your vehicle.

**L. Treadwear, Traction and Temperature Grades:**

## Wheel and Tire Information

**\*Treadwear:** The treadwear grade is a comparative rating based on the wear rate of the tire when tested under controlled conditions on a specified government test course. For example, a tire graded 150 would wear one and one-half times as well on the government course as a tire graded 100.

**\*Traction:** The traction grades, from highest to lowest are AA, A, B, and C. The grades represent the tire's ability to stop on wet pavement as measured under controlled conditions on specified government test surfaces of asphalt and concrete. A tire marked C may have poor traction performance.

**\*Temperature:** The temperature grades are A (the highest), B and C, representing the tire's resistance to the generation of heat and its ability to dissipate heat when tested under controlled conditions on a specified indoor laboratory test wheel.

**M. Maximum Inflation Pressure:** Indicates the tire manufacturers' maximum permissible pressure or the pressure at which the maximum load can be carried by the tire. This pressure is normally higher than the vehicle manufacturer's recommended cold inflation pressure which can be found on the Safety Compliance Certification Label (affixed to either the door hinge pillar,

door-latch post, or the door edge that meets the door-latch post, next to the driver's seating position), or Tire Label which is located on the B-Pillar or the edge of the driver's door. The cold inflation pressure should never be set lower than the recommended pressure on the vehicle label.

The tire suppliers may have additional markings, notes or warnings such as standard load or radial tubeless.

### Additional Information Contained on the Tire Sidewall for LT Type Tires

**Note:** *Tire Quality Grades do not apply to this type of tire.*

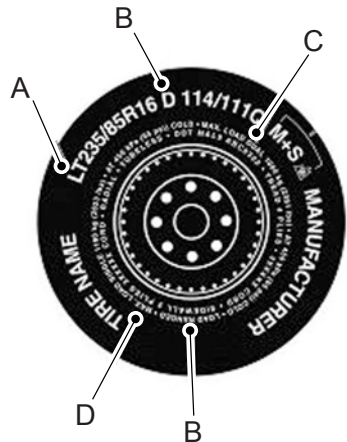

## Wheel and Tire Information

LT type tires have some additional information beyond those of P type tires; these differences are described below.

A. **LT:** Indicates a tire, designated by the Tire and Rim Association, that is intended for service on light trucks.

B. **Load Range and Load Inflation Limits:** Indicates the tire's load-carrying capabilities and its inflation limits.

C. **Maximum Load Dual lb (kg) at psi (kPa) cold:** Indicates the maximum load and tire pressure when the tire is used as a dual, defined as four tires on the rear axle (a total of six or more tires on the vehicle).

D. **Maximum Load Single lb (kg) at psi (kPa) cold:** Indicates the maximum load and tire pressure when the tire is used as a single, defined as two tires (total) on the rear axle.

### Information on T Type Tires

T145/80D16 is an example of a tire size.

**Note:** *The temporary tire size for your vehicle may be different from this example. Tire Quality Grades do not apply to this type of tire.*

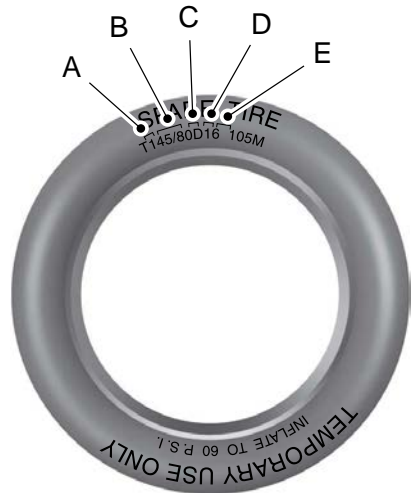

T type tires have some additional information beyond those of P type tires; these differences are described below:

A. **T:** Indicates a type of tire, designated by the Tire and Rim Association, that is intended for temporary service on cars, sport utility vehicles, minivans and light trucks.

B. **145:** Indicates the nominal width of the tire in millimeters from sidewall edge to sidewall edge. In general, the larger the number, the wider the tire.



# Wheel and Tire Information

---

C. **80:** Indicates the aspect ratio which gives the tire's ratio of height to width. Numbers of 70 or lower indicate a short sidewall.

D. **D:** Indicates a diagonal type tire.

**R:** Indicates a radial type tire.

E. **16:** Indicates the wheel or rim diameter in inches. If you change your wheel size, you will have to purchase new tires to match the new wheel diameter.

## GLOSSARY OF TIRE TERMINOLOGY

\***Tire label:** A label showing the original equipment tire sizes, recommended inflation pressure and the maximum weight the vehicle can carry.

\***Tire Identification Number (TIN):** A number on the sidewall of each tire providing information about the tire brand and manufacturing plant, tire size and date of manufacture. Also referred to as DOT code.

\***Inflation pressure:** A measure of the amount of air in a tire.

\***Standard load:** A class of P-metric or Metric tires designed to carry a maximum load at set pressure. For example: For P-metric tires 2.4 bar (35 psi) and for Metric tires 2.5 bar (36 psi). Increasing the inflation pressure beyond this pressure will not increase the tire's load carrying capability.

\***Extra load:** A class of P-metric or Metric tires designed to carry a heavier maximum load at 2.9 bar (42 psi). Increasing the inflation pressure beyond this pressure will not increase the tire's load carrying capability.

\***kPa:** Kilopascal, a metric unit of air pressure.

\***PSI:** Pounds per square inch, a standard unit of air pressure.

\***Cold tire pressure:** The tire pressure when the vehicle has been stationary and out of direct sunlight for an hour or more and prior to the vehicle being driven for 1.6 km (1 mi).

\***Recommended inflation pressure:** The cold inflation pressure found on the Safety Compliance Certification Label (affixed to either the door hinge pillar, door-latch post, or the door edge that meets the door-latch post, next to the driver's seating position), or Tire Label located on the B-Pillar or the edge of the driver door.

\* **B-pillar:** The structural member at the side of the vehicle behind the front door.

\***Bead area of the tire:** Area of the tire next to the rim.

\* **Sidewall of the tire:** Area between the bead area and the tread.

# Wheel and Tire Information

**\*Tread area of the tire:** Area of the perimeter of the tire that contacts the road when mounted on the vehicle.

**\*Rim:** The metal support (wheel) for a tire or a tire and tube assembly upon which the tire beads are seated.

## TIRE REPLACEMENT REQUIREMENTS

### AGE



**WARNING:** Tires degrade over time depending on many factors such as weather, storage conditions, and conditions of use (load, speed, inflation pressure) the tires experience throughout their lives.

In general, tires should be replaced after six years regardless of tread wear. However, heat caused by hot climates or frequent high loading conditions can accelerate the aging process and may require tires to be replaced more frequently.

You should replace your spare tire when you replace the road tires or after six years due to aging even if it has not been used.

## U.S. DOT Tire Identification Number

Both United States and Canada Federal regulations require tire manufacturers to place standardized information on the sidewall of all tires. This information identifies and describes the fundamental characteristics of the tire and also provides a U.S. DOT Tire Identification Number for safety standard certification and in case of a recall.

This begins with the letters DOT and indicates that the tire meets all federal standards. The next two numbers or letters are the plant code designating where it was manufactured, the next two are the tire size code and the last four numbers represent the week and year the tire was built. For example, the numbers 317 mean the 31st week of 1997. After 2000, the numbers go to four digits. For example, 2501 means the 25th week of 2001. The numbers in between are identification codes used for traceability. This information is used to contact customers if a tire defect requires a recall.

## Tire Replacement Requirements

Your vehicle is equipped with tires designed to provide a safe ride and handling capability.

## Wheel and Tire Information



**WARNING:** Only use replacement tires and wheels that are the same size, load index, speed rating, and type as those originally provided for your vehicle. The recommended tire and wheel sizes can be found on the Tire Label on the driver side door frame or the edge of the driver door. If this information is not found in those locations, or for additional options, contact your authorized dealer. Use of any tire or wheel not recommended, could affect the safety and performance of your vehicle, which could result in an increased risk of loss of vehicle control, vehicle rollover, personal injury and death.



**WARNING:** If your vehicle has LT315/70R17 tires, replace them with the exact original brand, and size. Use of any other wheel or tire combinations, even with identical size ratings, could result in insufficient running clearances, tire rubbing and eventual puncture. Failure to follow tire replacement recommendations can lead to tire failure, loss of vehicle control, serious injury or death.



**WARNING:** To reduce the risk of serious injury, when mounting replacement tires and wheels, you should not exceed the maximum pressure indicated on the sidewall of the tire to set the beads without additional precautions listed below. If the beads do not seat at the maximum pressure indicated, re-lubricate and try again.



**WARNING:** For a mounting pressure more than 1.38 bar (20 psi) greater than the maximum pressure, a Ford dealer or other tire service professional should do the mounting.



**WARNING:** Always inflate steel carcass tires with a remote air fill with the person inflating standing at a minimum of 3.66 m (12 ft) away from the wheel and tire assembly.



**WARNING:** When inflating the tire for mounting pressures up to 1.38 bar (20 psi) greater than the maximum pressure on the tire sidewall, the following precautions must be taken to protect the person mounting the tire:

- Make sure that you have the correct tire and wheel size.
- Lubricate the tire bead and wheel bead seat area again.

## Wheel and Tire Information

- Stand at a minimum of 3.66 m (12 ft) away from the wheel and tire assembly.
- Use both eye and ear protection.

**Important:** Remember to replace the wheel valve stems when the road tires are replaced on your vehicle.

If a four tire rotation is being followed, it is recommended that both front tires or both rear tires generally be replaced as a pair if the two remaining worn tires still have usable tread depth. If a five tire rotation is being followed and the fifth tire is used to replace a single unrepairable tire, a four tire rotation should be followed with the undamaged tires. Any replacement for the damaged tire should be used as a dedicated spare until the remaining tires are replaced as a set.

To avoid potential Four-Wheel Drive (4WD) malfunction or (4WD) system damage, it is recommended to replace all tires used in the tire rotation rather than mixing significantly worn tires with new tires.

The tire pressure sensors mounted on the wheels (originally installed on your vehicle) are not designed to be used in aftermarket wheels.

The use of wheels or tires not recommended may affect the operation of your tire pressure monitoring system.

If the tire pressure monitoring system indicator is flashing, your system is malfunctioning. Your replacement tire might be incompatible with your tire pressure monitoring system, or some component of the system may be damaged.

### USING SNOW CHAINS



**WARNING:** Do not exceed 50 km/h (30 mph). Failure to follow this instruction could result in the loss of control of your vehicle, personal injury or death.



**WARNING:** Do not use snow chains on snow-free roads.



**WARNING:** Only fit snow chains to specified tires.



**WARNING:** If your vehicle is fitted with wheel trims, remove them before fitting snow chains.



**WARNING:** If you choose to install snow tires on your vehicle, they must be the same size, construction, and load range as the original tires listed on the tire placard, and they must be installed on all four wheels. Mixing tires of different size or construction on your vehicle can adversely affect your vehicle's handling and braking, and may lead to loss of vehicle control.

Only use snow chains on rear wheels. Install snow chains in pairs. Do not use self-tensioning snow chains.

Only use snow chains on the following specified tire sizes:

# Wheel and Tire Information

- 255/70R16
  - Only install chains that are 15 mm or less.
- 255/75R17
  - Only install chains that are 15 mm or less.

We recommend you use steel wheels of the same size and specification if snow chains are required because chains may chip aluminum wheels.

Follow these guidelines when using snow tires and traction devices:

- If possible, avoid fully loading your vehicle.
- Purchase snow chains from a manufacturer that clearly labels body to tire dimension restrictions.
- When driving with snow chains do not exceed 50 km/h (30 mph) or the maximum speed recommended by the chain manufacturer, whichever is less.
- Drive cautiously. If you hear the snow chains rub or bang against the vehicle, stop and tighten them. If this does not work, remove the snow chains to prevent vehicle damage.
- Remove the snow chains when they are no longer needed. Do not use snow chains on dry roads.
- If a temporary spare wheel is mounted on your vehicle, do not use snow chains on the axle with the temporary spare wheel.

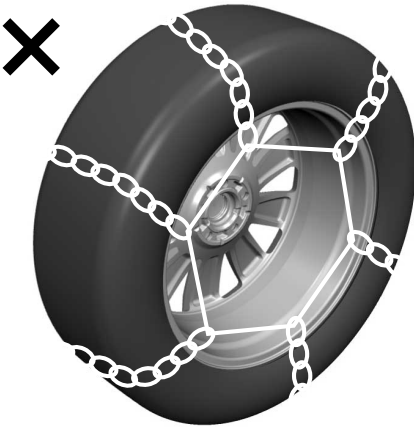

Use snow chains that fit against the sidewall of the tire to prevent the chains from touching the wheel rims or suspension, see following illustration above.

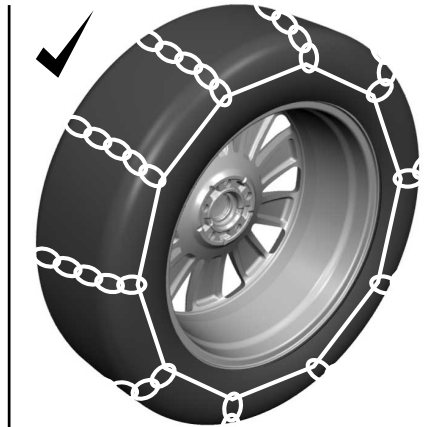

If you have any questions regarding snow chains, please contact your authorized dealer.

# Tire Care

## CHECKING THE TIRE PRESSURES

Safe operation of your vehicle requires that your tires are properly inflated. Every day before you drive, check your tires.

At least once a month and before long trips, inspect each tire and check the tire pressure with a tire gauge. Inflate all tires to the recommended inflation pressure. See **Inflating the Tires** (page 442).

## INFLATING THE TIRES



**WARNING:** Under-inflation is the most common cause of tire failures and may result in severe tire cracking, tread separation or blowout, with unexpected loss of vehicle control and increased risk of injury. Under-inflation increases sidewall flexing and rolling resistance, resulting in heat buildup and internal damage to the tire. It also may result in unnecessary tire stress, irregular wear, loss of vehicle control and accidents. A tire can lose up to half of its air pressure and not appear to be flat!



**WARNING:** Do not use the tire pressure displayed in the information display as a tire pressure gauge. Failure to follow this instruction could result in personal injury or death.

Use the recommended cold inflation pressure for optimum tire performance and wear. Under-inflation or over-inflation may cause uneven treadwear patterns.

Inflate your tires to the recommended inflation pressure even if it is less than the maximum inflation pressure information found on the tire. You can find the tire label with the recommended tire inflation pressure next to the tire size on the B-Pillar or the edge of the driver door.

The recommended tire inflation pressure is also found on the Safety Compliance Certification Label, affixed to either the door hinge pillar, door-latch post, or the door edge that meets the door-latch on the B-pillar, or on the edge of the driver door.

Failure to follow the tire pressure recommendations can cause uneven treadwear patterns and adversely affect the way your vehicle handles.

# Tire Care

## Checking Pressure when tires are hot:

If pressures are checked after tires have been driven for more than three minutes or more than 1 mile, (2 km) the tires become hot and the pressures will increase by approximately 4 psi (27.6 kPa). Therefore when the tire pressure is adjusted under these conditions, it should be increased to a gauge reading of 4 psi (27.6 kPa) greater than the recommended cold inflation pressure.

After inflating the tires while hot, make sure to recheck tire pressure later once the tires are cold.

New hot pressure	36 psi (250 kPa)
------------------	------------------

## INSPECTING THE TIRE FOR WEAR

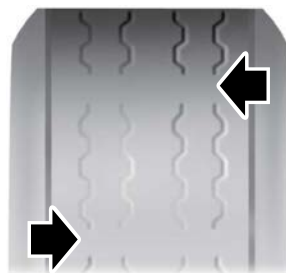

When the tread is worn down to 2/32 inch (1.6 mm), tires must be replaced to help prevent your vehicle from skidding and hydroplaning. Built-in treadwear indicators, or wear bars, which look like narrow strips of smooth rubber across the tread will appear on the tire when the tread is worn down to 2/32 inch (1.6 mm).

When the tire tread wears down to the same height as these wear bars, the tire is worn out and must be replaced.

The tires should also be balanced periodically. An unbalanced tire and wheel assembly may result in irregular tire wear.

## For Example Only

Gauge reading of hot tire	33 psi (230 kPa)
If recommended, cold inflation pressure is	32 psi (220 kPa)

The hot tire pressure is only 1 psi (10 kPa) greater than the recommended cold inflation pressure. Therefore, add 3 psi (20 kPa) more to increase the hot pressure to 4 psi (30 kPa) over the recommended cold inflation pressure.

# Tire Care

Periodically inspect the tire treads for uneven or excessive wear and remove objects such as stones, nails or glass that may be wedged in the tread grooves.

## INSPECTING THE TIRE FOR DAMAGE

Inspect the tire sidewalls for cracking, cuts, bruises and other signs of damage or excessive wear. If internal damage to the tire is suspected, have the tire dismantled and inspected in case it needs to be repaired or replaced. For your safety, tires that are damaged or show signs of excessive wear should not be used because they are more likely to blow out or fail.

Periodically inspect the tire treads and sidewalls for damage, such as bulges in the tread or sidewalls, cracks in the tread groove and separation in the tread or sidewall. If damage is observed or suspected, have the tire inspected by a tire professional.

## Safety Practices



**WARNING:** If your vehicle is stuck in snow, mud or sand, do not rapidly spin the tires; spinning the tires can tear the tire and cause an explosion. A tire can explode in as little as three to five seconds.



**WARNING:** Do not spin the wheels at over 55 km/h (34 mph). The tires may fail and injure a passenger or bystander.

## HIGH SPEED DRIVING CAN BE DANGEROUS

Correct inflation pressure is especially important. However, at high speeds, even with the correct inflation pressure, a road hazard for example is more difficult to avoid and if contact is made, has a greater chance of causing tire damage than at a lower speed. Moreover, driving at high speed reduces the reaction time available to avoid accidents and bring your vehicle to a safe stop.

If you see any damage to a tire or wheel, replace it with the spare at once and visit a participating Tire Retailer.

Exceeding the maximum speeds shown on the following page for each type of tire will cause the tire to build up excessive heat which can cause tire damage that could result in sudden tire destruction and rapid air loss. Failure to control a vehicle when one or more tires experience a sudden air loss can lead to an accident.

**In any case, you should not exceed reasonable speeds as indicated by the legal limits and driving conditions.**



# Tire Care

---

## **DO NOT OVERLOAD: DRIVING ON ANY OVERLOADED TIRE IS DANGEROUS**

The maximum load rating of your tires is molded on the tire sidewall. Do not exceed this rating. Follow the loading instructions of the manufacturer of your vehicle and this will ensure that your tires are not overloaded. Tires which are loaded beyond their maximum allowable loads for the particular application will build up excessive heat that may result in sudden tire destruction. Do not exceed the gross axle weight rating for any axle on your vehicle.

## **TIRE ALTERATIONS**

Do not make or allow to be made any alterations on your tires. Alterations may prevent proper performance, leading to tire damage which can result in an accident. Tires which become unserviceable due to alterations such as truing, whitewall inlays, addition of balancing or sealant liquids, or the use of tire dressing containing petroleum distillates are excluded from warranty coverage.

## **REPAIRS - WHEREVER POSSIBLE, SEE YOUR TIRE RETAILER AT ONCE**

If any tire sustains a puncture, have the tire demounted and thoroughly inspected by a tire retailer for possible damage that may have occurred. A tread area puncture in any passenger or light truck tire can be repaired provided that the puncture hole is not more than 1/4" in diameter, not more than one radial cable per casing ply is damaged, and the tire has not been damaged further by the puncturing object or by running underinflated. Tire punctures consistent with these guidelines should only be repaired by following the US Tire Manufacturers Association (USTMA) recommended repair procedures. Plug-only repairs done on-the-wheel are considered improper and therefore, not recommended. Such repairs are not reliable and may cause further damage to the tire.

## **STORAGE**

Tires contain waxes and emollients to protect their outer surfaces from ozone and weather checking. As the tire rolls and flexes, the waxes and emollients continually migrate to the surface, replenishing this protection throughout the normal use of the tire. Consequently, when tires sit unused for long periods of time (a month or more) their surfaces

## Tire Care

---

become dry and more susceptible to ozone and weather checking and the casing becomes susceptible to flat spotting. **For this reason, tires should always be stored in a cool, dry, clean, indoor environment. If storage is for one month or more, eliminate the weight from the tires by raising the vehicle or by removing the tires from the vehicle. Failure to store tires in accordance with these instructions could result in damage to your tires or premature aging of the tires and sudden tire failure.**

When tires are stored, be sure they are placed away from sources of heat and ozone such as direct sunlight, hot pipes and electric generators. Be sure that surfaces on which tires are stored are clean and free from grease, gasoline or other substances, which could deteriorate the rubber. Failure to store tires in accordance with these instructions could result in damage to your tires or premature aging of the tires and sudden tire failure.

### **FOLLOW THESE MOUNTING RECOMMENDATIONS**

**Tire changing can be dangerous and must be done by professionally trained persons using proper tools and procedures as specified by the US Tire Manufacturers Association (USTMA). Single or dual assemblies must be completely deflated before demounting.**

Your tires should be mounted on wheels of correct size and type and which are in good, clean condition. Wheels that are bent, chipped, rusted (steel wheels) or corroded (alloy wheels) may cause tire damage. The inside of the tire must be free from foreign material. Have your retailer check the wheels before mounting new tires. Mismatched tires and rims can explode during mounting. Also, mismatched tires and rims can result in dangerous tire failure on the road. If a tire is mounted by error on the wrong-sized rim, do not remount it on the proper rim – scrap it. It may have been damaged internally (which is not externally visible) by having been dangerously stretched and could fail on the highway.

# Tire Care

---

**Old valves may leak. When new tubeless tires are mounted, have new valves of the correct type installed. Tubeless tires must only be mounted on wheels designed for tubeless tires i.e., wheels which have safety humps or ledges.**

It is recommended that you have your tires and wheels balanced. Tires and wheels, which are not balanced, may cause steering difficulties, a bumpy ride, and irregular tire wear.

**Be sure that all your valves have suitable valve caps. The valve cap is the primary seal against air loss.**

## **TEMPORARY SPARE TIRES**

When using any temporary spare tire, be sure to follow the vehicle manufacturer's instructions.

**REMEMBER... TO AVOID DAMAGE TO YOUR TIRES AND POSSIBLE ACCIDENT:**

- CHECK TIRE PRESSURE AT LEAST ONCE EACH MONTH WHEN TIRES ARE COLD AND BEFORE LONG TRIPS.
- DO NOT UNDERINFLATE/OVERINFLATE.
- DO NOT OVERLOAD.
- DRIVE AT MODERATE SPEEDS, OBSERVE LEGAL LIMITS.

- AVOID DRIVING OVER POTHOLES, OBSTACLES, CURBS OR EDGES OF PAVEMENT.
- AVOID EXCESSIVE WHEEL SPINNING.
- IF YOU SEE ANY DAMAGE TO A TIRE, REPLACE WITH THE SPARE AND VISIT ANY AUTHORIZED RETAILER AT ONCE.
- IF YOU HAVE ANY QUESTIONS, CONTACT YOUR AUTHORIZED RETAILER.

## **Highway Hazards**

No matter how carefully you drive, there is always the possibility that you could eventually have a flat tire on the highway. Drive slowly to the closest safe area out of traffic. This could further damage the flat tire, but your safety is more important.

If you feel a sudden vibration or ride disturbance while driving, or you suspect your tire or vehicle has been damaged, immediately reduce your speed. Drive with caution until you can safely pull off the road. Stop and inspect the tires for damage. If a tire is under-inflated or damaged, deflate it, remove the wheel and replace it with your spare tire and wheel. If you cannot detect a cause, have the vehicle towed to the nearest repair facility or tire dealer to have the vehicle inspected.

# Tire Care

## Tire and Wheel Alignment

A bad jolt from hitting a curb or pothole can cause the front end of your vehicle to become misaligned or cause damage to your tires. If your vehicle seems to pull to one side when you are driving, the wheels could be out of alignment. Have an authorized dealer check the wheel alignment periodically.

Wheel misalignment in the front or the rear can cause uneven and rapid treadwear of your tires and should be corrected by an authorized dealer.

## INSPECTING THE WHEEL VALVE STEMS

Check the valve stems for holes, cracks, or cuts that could permit air leakage.

## TIRE ROTATION



**WARNING:** If the tire label shows different tire pressures for the front and rear tires and the vehicle has a tire pressure monitoring system, then you need to update the settings for the system sensors. Always

perform the system reset procedure after tire rotation. If you do not reset the system, it may not provide a low tire pressure warning when necessary.

**Note:** *If your tires show uneven wear ask an authorized dealer to check for and correct any wheel misalignment, tire imbalance or mechanical problem involved before tire rotation.*

**Note:** *After having your tires rotated, inflation pressure must be checked and adjusted to the vehicle requirements.*

Rotating your tires at the recommended interval, as indicated in the scheduled maintenance chapter, will help your tires wear more evenly, providing better tire performance and longer tire life.

For the best tire life, a five tire rotation is recommended that includes the matching spare tire mounted on the back of the vehicle. This rotation requires a forced re-learning of your tire pressure monitor system sensors by your vehicle, and should be performed by an authorized dealer or a service center to make sure the tire pressure monitoring system provides proper warning at all times. When performing the tire rotation yourself, a four tire rotation is recommended, without using the spare tire in the rotation,

## Tire Care

---

so that no tire pressure monitor system sensor re-learn is required. If a five tire rotation is performed without a tire pressure monitor system sensor re-learn, the system may not provide a low tire pressure warning when necessary.

Keep in mind that a spare tire that is not used in the tire rotation should only be used temporarily in the event of a flat tire, not as a permanent replacement. The spare tire should always be replaced if it exceeds 6 years of age, regardless of whether it is part of the tire rotation.

Rear-wheel drive vehicles and four-wheel drive vehicles with four tire rotation, front tires at left of diagram.

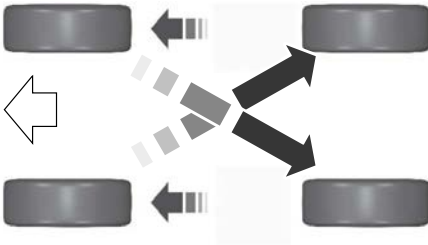

Sometimes irregular tire wear can be corrected by rotating the tires.

# Tire Pressure Monitoring System

## WHAT IS THE TIRE PRESSURE MONITORING SYSTEM



The tire pressure monitoring system measures the vehicle's tire pressures. A warning lamp illuminates if one or more tires are significantly underinflated or if there is a system malfunction.

## TIRE PRESSURE MONITORING SYSTEM OVERVIEW



**WARNING:** Under-inflation is the most common cause of tire failures and may result in severe tire cracking, tread separation or blowout, with unexpected loss of vehicle control and increased risk of injury. Under-inflation increases sidewall flexing and rolling resistance, resulting in heat buildup and internal damage to the tire. It also may result in unnecessary tire stress, irregular wear, loss of vehicle control and accidents. A tire can lose up to half of its air pressure and not appear to be flat!



**WARNING:** To determine the required pressure(s) for your vehicle, see the Safety Compliance Certification Label (on the door hinge pillar, door-latch post or the door edge that meets the door-latch post, next to the driver seat) or the Tire Label on the B-Pillar or the edge of the driver door.

Each tire, including the spare (if provided), should be checked monthly when cold and inflated to the inflation pressure recommended by the vehicle manufacturer on the vehicle placard or tire inflation pressure label. (If your vehicle has tires of a different size than the size indicated on the vehicle placard or tire inflation pressure label, you should determine the proper tire inflation pressure for those tires).

As an added safety feature, your vehicle has been equipped with a Tire Pressure Monitoring System (TPMS) that illuminates a low tire pressure telltale when one or more of your tires is significantly under-inflated. Accordingly, when the low tire pressure telltale illuminates, you should stop and check your tires as soon as possible, and inflate them to the proper pressure. Driving on a significantly under-inflated tire causes the tire to overheat and can lead to tire failure. Under-inflation also reduces fuel efficiency and tire tread life, and may affect the vehicle's handling and stopping ability.

Please note that the TPMS is not a substitute for proper tire maintenance, and it is the driver's responsibility to maintain correct tire pressure, even if under-inflation has not reached the level to trigger illumination of the TPMS low tire pressure telltale.

Your vehicle has also been equipped with a TPMS malfunction indicator to indicate when the system is not operating properly. The TPMS malfunction indicator is combined with the low tire pressure telltale. When the system detects a malfunction, the telltale will flash for approximately one minute and then remain continuously illuminated. This sequence will continue upon subsequent vehicle start-ups as long as the malfunction exists.

# Tire Pressure Monitoring System

When the malfunction indicator is illuminated, the system may not be able to detect or signal low tire pressure as intended. TPMS malfunctions may occur for a variety of reasons, including the installation of replacement or alternate tires or wheels on the vehicle that prevent the TPMS from functioning properly. Always check the TPMS malfunction telltale after replacing one or more tires or wheels on your vehicle to ensure that the replacement or alternate tires and wheels allow the TPMS to continue to function properly.



**WARNING:** Changes or modifications not expressly approved by the party responsible for compliance could void the user's authority to operate the equipment. The term "IC:" before the radio certification number only signifies that Industry Canada technical specifications were met.

This device complies with Part 15 of the FCC Rules and with License exempt RSS Standards of Industry Canada. Operation is subject to the following two conditions:

1. This device may not cause harmful interference, and
2. This device must accept any interference received, including interference that may cause undesired operation.

## TIRE PRESSURE MONITORING SYSTEM PRECAUTIONS



**WARNING:** The tire pressure monitoring system is not a substitute for manually checking tire pressures. You should periodically check tire pressures using a pressure gauge. Failure to correctly maintain tire pressures could increase the risk of tire failure, loss of control, vehicle rollover and personal injury.



**WARNING:** Do not use the tire pressure displayed in the information display as a tire pressure gauge. Failure to follow this instruction could result in personal injury or death.

**Note:** *The use of tire sealants can damage the tire pressure monitoring system.*

**Note:** *If the tire pressure monitor sensor becomes damaged it may not function.*

## TIRE PRESSURE MONITORING SYSTEM LIMITATIONS

When the outside temperature drops significantly, the tire pressure could decrease and activate the low tire pressure warning lamp.

The warning lamp could also illuminate when you use a spare wheel, or tire sealant from the inflator kit.

**Note:** *Regularly checking the vehicle tire pressures can reduce the possibility for the warning lamp to illuminate due to outside air temperature changes.*

**Note:** *After you inflate the tires to the recommended pressure it could take up to two minutes of driving over 32 km/h (20 mph) for the warning indicator to turn off.*

# Tire Pressure Monitoring System

## VIEWING THE TIRE PRESSURES



Using the instrument cluster display arrow keys navigate to the truck info section where you can view the tire pressures.

## TIRE PRESSURE MONITORING SYSTEM – TROUBLESHOOTING

### TIRE PRESSURE MONITORING SYSTEM – WARNING LAMPS



The low tire pressure warning lamp has combined functions, as it warns you when your tires need air, and when the system is no longer capable of functioning as intended.

Warning Lamp	Possible Cause	Action Required
Solid warning lamp	One or more tires are significantly under inflated	After inflating your tires to the manufacturer's recommended pressure as shown on the tire label, on the edge of driver door or the B-pillar, drive your vehicle for at least two minutes over 32 km/h (20 mph) before the light turns off.
Solid warning lamp or flashing warning lamp	Temporary spare wheel in use	Repair the damaged road wheel and tire and refit it to your vehicle to restore operation of the system.
	Tire pressure monitoring system malfunction	If the tires are inflated to the recommended tire pressures and the temporary spare wheel is not in use, the system detected a fault that requires service. Have your vehicle checked as soon as possible.



# Tire Pressure Monitoring System

---

## TIRE PRESSURE MONITORING SYSTEM – INFORMATION MESSAGES

<b>Message</b>	<b>Action</b>
Tire Pressure Low	After inflating your tires to the manufacturer's recommended pressure as shown on the tire label, on the edge of the driver door or the B-pillar, drive your vehicle for at least two minutes over 32 km/h (20 mph) before the light turns off.
Tire Pressure Monitor Fault	The system has detected a fault that requires service. Have your vehicle checked as soon as possible.
Tire Pressure Sensor Fault	The system has detected a fault that requires service or a spare tire is in use. Have your vehicle checked as soon as possible.

# Changing a Road Wheel

## CHANGING A FLAT TIRE - EXCLUDING: RAPTOR

**Note:** You should only use tire sealants in roadside emergencies as they may cause damage to the tire pressure monitoring system sensor.

**Note:** The tire pressure monitoring system indicator light illuminates when the spare tire is in use. To restore the full function of the monitoring system, all road wheels equipped with tire pressure monitoring sensors must be mounted on the vehicle.

If you get a flat tire when driving, do not apply the brake heavily. Instead, gradually decrease your speed, hold the steering wheel firmly, and slowly move to a safe place on the side of the road.

Have your flat serviced by an authorized dealer in order to prevent damage to the tire pressure monitoring system sensors. Replace the spare tire with a road tire as soon as possible. During repairing or replacing of the flat tire, have the authorized dealer inspect the tire pressure monitoring system sensor for damage.

### Tire Change Procedure

 **WARNING:** Failure to follow these guidelines could result in an increased risk of loss of vehicle control, injury or death.

 **WARNING:** Do not get under a vehicle that is supported by a jack.

 **WARNING:** The jack supplied with this vehicle is only intended for changing a flat tire in an emergency. Do not attempt to do any other work on your vehicle when it is supported by the jack, as your vehicle could slip off the jack. Failure to follow this instruction could result in personal injury or death.

 **WARNING:** To help prevent your vehicle from moving when changing a wheel, shift the transmission into park (P), set the parking brake and use an appropriate block or wheel chock to secure the wheel diagonally opposite to the wheel being changed. For example, when changing the front left wheel, place an appropriate block or wheel chock on the right rear wheel.

 **WARNING:** Only use the jack provided as original equipment with your vehicle.

 **WARNING:** Only use the specified jacking points. If you use any other locations you could damage vehicle components, such as brake lines.

 **WARNING:** Never place anything between the vehicle jack and your vehicle.

 **WARNING:** Never place anything between the vehicle jack and the ground.

 **WARNING:** Do not attempt to change a tire on the side of the vehicle close to moving traffic. Pull far enough off the road to not obstruct the flow of traffic and avoid the danger of being hit when operating the jack or changing the wheel.

 **WARNING:** Always fully apply the parking brake. Failure to follow this instruction could result in personal injury or death.

 **WARNING:** The jack should be used on level firm ground wherever possible.

# Changing a Road Wheel



**WARNING:** It is recommended that the wheels of the vehicle be chocked, and that no person should remain in a vehicle that is being jacked.

**Note:** Make sure all passengers are out of your vehicle.

**Note:** Jack at the specified locations to avoid damage to the vehicle.

**Note:** No maintenance or additional lubrication of your jack is required over the service life of your vehicle.

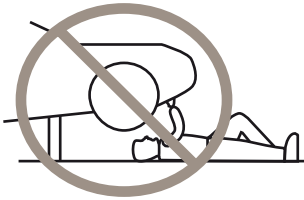

1. Park the vehicle on a level, firm surface and activate the hazard flashers.
2. Apply the parking brake, and place the transmission in park (P) for an automatic transmission or reverse (R) for a manual transmission and turn the engine off.
3. Block the wheel diagonally opposite of the flat tire. For example, if the left front is flat, block the right rear wheel.

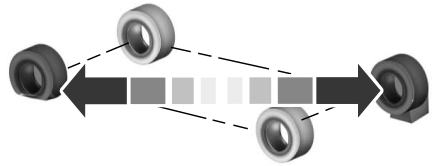

4. Find the jack and tool kit in the rear trunk of the vehicle. Turn the jack retainer counterclockwise to remove the jack and jack extension block.

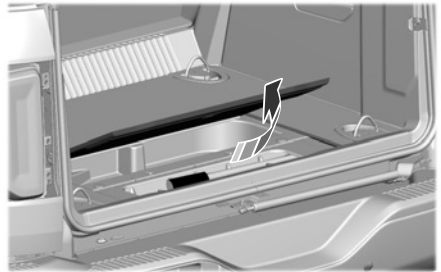

5. Remove the tool bag.

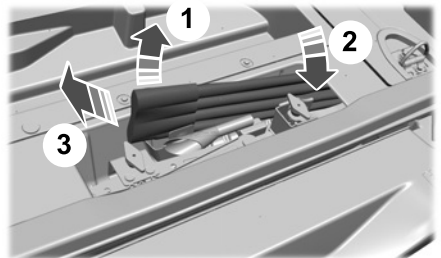

# Changing a Road Wheel

6. Remove the lug wrench from the tool bag. Turn the spare tire fasteners counterclockwise starting with the lowest first, and remove the spare tire from the rear of the vehicle.

**Note:** Insert the wheel lock key into the wheel lock nut before using the lug wrench to loosen the lock nut.

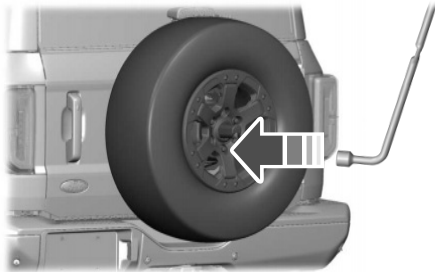

**Note:** Do not lay the wheel face down on the ground, as there is a risk of scratching or marring the wheel if laid down on an uneven surface.

7. Loosen each road wheel nut a half a turn counterclockwise, do not remove them until the flat tire is raised off the ground.

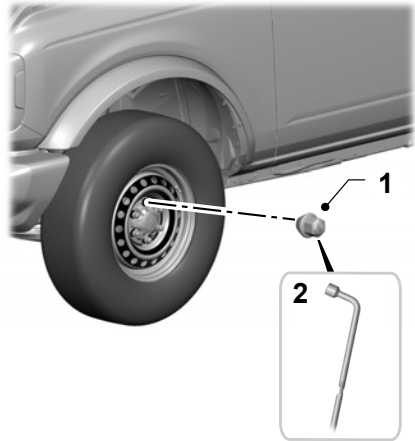

8. When you are changing a flat front tire, connect the extension block to the jack loadrest using the wing bolt as shown. Connect the jack handle to the jack, and use the lug nut wrench to operate the jack.

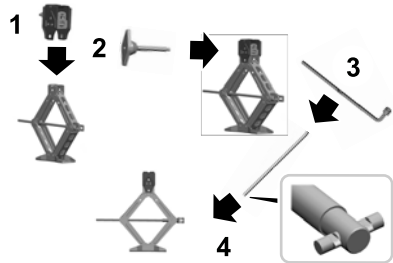

9. Do not use the extension block when you are changing a flat tire on the rear axle of the vehicle. Assemble the jack handle using the extensions as shown to operate the jack when placing under the rear axle.

# Changing a Road Wheel

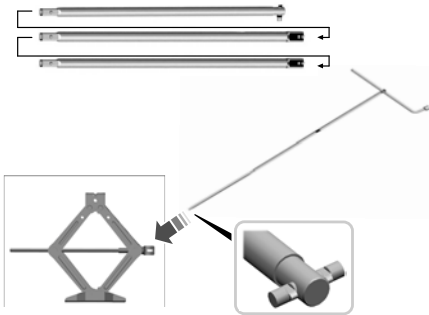

10. The front jacking point location is indicated by an arrow-shaped mark on the frame.

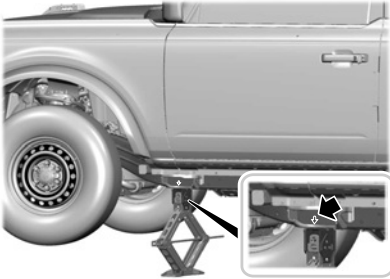

11. Use the rear axle tube for the rear jacking point.

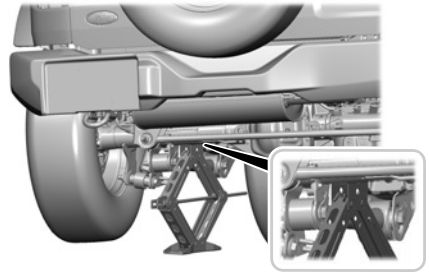

**Note:** Only use the jack on the specified jacking points and as close to the affected wheel as possible.

12. Place the jack at the jacking point closest to the flat tire you are changing. Turn the lug wrench handle clockwise until the flat tire is completely off the ground.
13. Remove the wheel nuts with the wheel nut wrench.
14. Replace the flat tire with the spare wheel. Make sure the wheel is on with the valve stem facing outward.
15. Install the wheel nuts snug against the hub. Do not fully tighten the wheel nuts until the vehicle is lowered back onto the ground.
16. Turn the wrench handle counterclockwise to lower the jack.
17. Remove the jack and fully tighten the lug nuts in the order shown below.

# Changing a Road Wheel

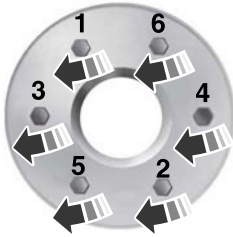

18. Stow the flat tire on the rear of the vehicle and fully tighten the securing nuts.

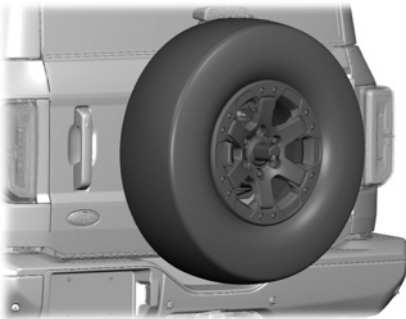

**Note:** We recommend that you use a torque wrench to make sure you tighten all the securing wheel nuts on the spare wheel carrier to the required 55 Nm (41 lb.ft) specification.

19. Remove the wheel blocks.
20. Stow the jack and tools in the original locations shown in the removal section and tighten the retaining screws by turning clockwise.

## CHANGING A FLAT TIRE - RAPTOR

If you get a flat tire when driving, do not apply the brake heavily. Instead, gradually decrease your speed, hold the steering wheel firmly, and slowly move to a safe place on the side of the road.

Have your flat serviced by an authorized dealer to prevent damage to the tire pressure monitoring system sensors. Replace the spare tire with a road tire as soon as possible. During repairing or replacing of the flat tire, have the authorized dealer inspect the tire pressure monitoring system sensor for damage.

**Note:** You should only use tire sealants in roadside emergencies as they may cause damage to the tire pressure monitoring system sensor.

**Note:** The tire pressure monitoring system indicator light illuminates when the spare tire is in use. To restore the full function of the monitoring system, all road wheels equipped with tire pressure monitoring sensors must be mounted on the vehicle.

### Tire Change Procedure



**WARNING:** Failure to follow these guidelines could result in an increased risk of loss of vehicle control, injury or death.





**WARNING:** Do not get under a vehicle that is supported by a jack.



**WARNING:** The jack supplied with this vehicle is only intended for changing a flat tire in an emergency. Do not attempt to do any other work on your vehicle when it is supported by the jack, as your vehicle could slip off the jack. Failure to follow this instruction could result in personal injury or death.

# Changing a Road Wheel

 **WARNING:** To help prevent your vehicle from moving when changing a wheel, shift the transmission into park (P), set the parking brake and use an appropriate block or wheel chock to secure the wheel diagonally opposite to the wheel being changed. For example, when changing the front left wheel, place an appropriate block or wheel chock on the right rear wheel.

 **WARNING:** Only use the jack provided as original equipment with your vehicle.

 **WARNING:** Only use the specified jacking points. If you use any other locations you could damage vehicle components, such as brake lines.

 **WARNING:** Never place anything between the vehicle jack and your vehicle.

 **WARNING:** Never place anything between the vehicle jack and the ground.

 **WARNING:** Do not attempt to change a tire on the side of the vehicle close to moving traffic. Pull far enough off the road to not obstruct the flow of traffic and avoid the danger of being hit when operating the jack or changing the wheel.

 **WARNING:** Always fully apply the parking brake. Failure to follow this instruction could result in personal injury or death.

 **WARNING:** The jack should be used on level firm ground wherever possible.

 **WARNING:** It is recommended that the wheels of the vehicle be chocked, and that no person should remain in a vehicle that is being jacked.

**Note:** Make sure all passengers are out of your vehicle.

**Note:** Jack at the specified locations to avoid damage to the vehicle.

**Note:** No maintenance or additional lubrication of your jack is required over the service life of your vehicle.

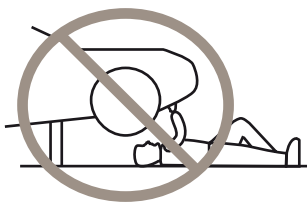

1. Park the vehicle on a level, firm surface and activate the hazard flashers.
2. Apply the parking brake, and place the transmission in park (P) for an automatic transmission or reverse (R) for a manual transmission and turn the engine off.
3. Find the jack and tool kit in the rear trunk of the vehicle. Turn the jack retainer counterclockwise to remove the jack and jack extension block.

# Changing a Road Wheel

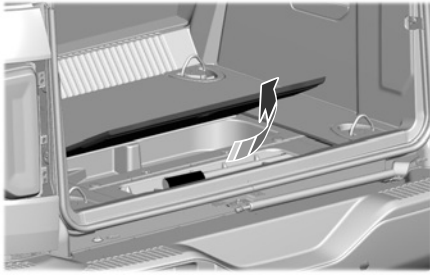

4. Remove the tool bag.

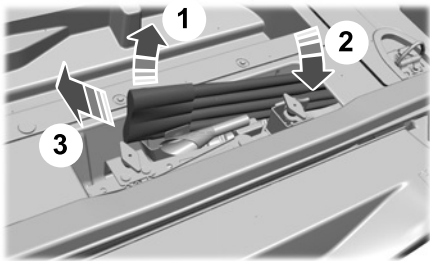

5. Remove foldable wheel chocks from the tool bag.

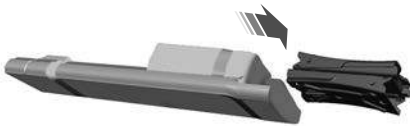

6. Set up wheel chocks on wheel diagonally opposite the flat tire. For example if the left front is flat, block the right rear wheel on both front and back side of tire, as shown in tool kit icon graphic label.

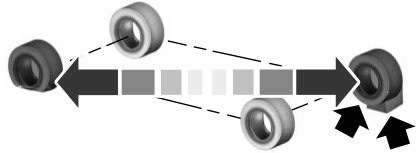

7. Remove the foldable wrench from tool bag and unfold the wrench for use.



8. Turn the spare tire fasteners counterclockwise starting with the lowest first, and remove the spare tire from the rear of the vehicle.

**Note:** Insert the wheel lock key into the wheel lock nut before using the lug wrench to loosen the lock nut.

**Note:** Do not lay the wheel face down on the ground, as there is a risk of scratching or marring the wheel if placed on an uneven surface.



# Changing a Road Wheel

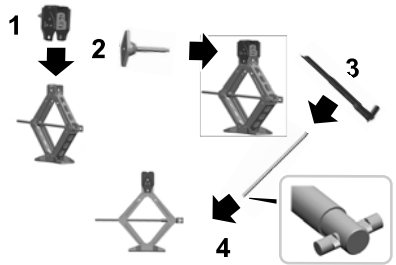
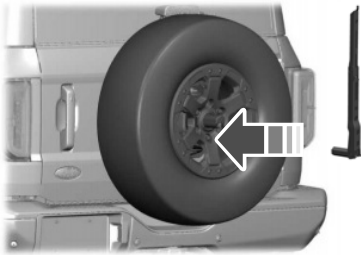

9. Loosen each road wheel nut a half a turn counterclockwise, do not remove them until the flat tire is raised off the ground.

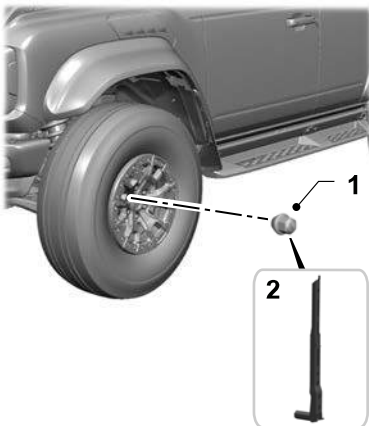

11. Do not use the extension block when you are changing a flat tire on the rear axle of the vehicle. Assemble the jack handle using the extensions as shown to operate the jack when placing under the rear axle.

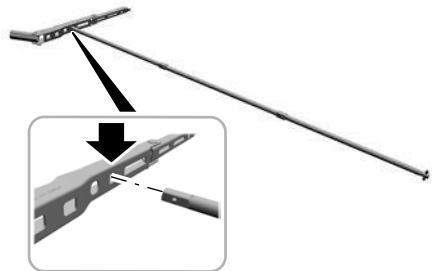

10. When you are changing a flat front tire, connect the extension block to the jack loadrest using the wing bolt as shown. Connect the jack handle to the jack, and use the lug nut wrench to operate the jack.

12. The front jacking point location is indicated by an arrow-shaped mark on the frame.

# Changing a Road Wheel

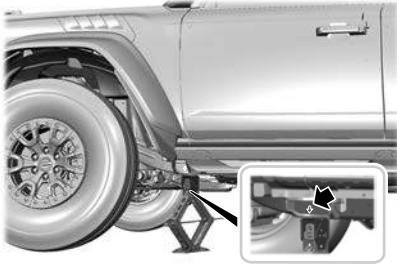

13. Use the rear axle tube for the rear jacking point.

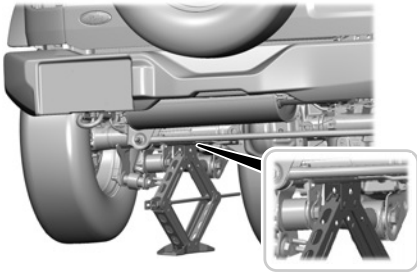

**Note:** Only use the jack on the specified jacking points and as close to the affected wheel as possible.

14. Place the jack at the jacking point closest to the flat tire you are changing. Turn the lug wrench handle clockwise until the flat tire is completely off the ground.
15. Remove the wheel nuts with the wheel nut wrench.
16. Replace the flat tire with the spare wheel. Make sure the wheel is on with the valve stem facing outward.
17. Install the wheel nuts snug against the hub. Do not fully tighten the wheel nuts until the vehicle is lowered back onto the ground.

18. Turn the wrench handle counterclockwise to lower the jack.
19. Remove the jack and fully tighten the lug nuts in the order shown below.

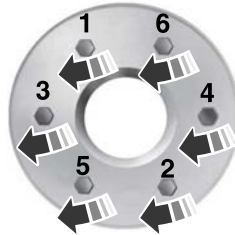

20. Stow the flat tire on the rear of the vehicle and fully tighten the securing nuts.

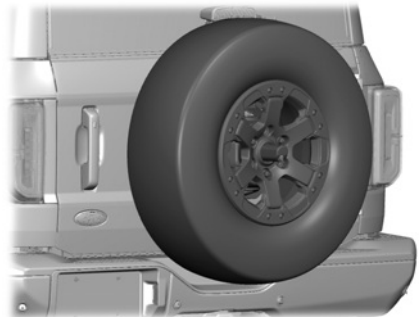

**Note:** We recommend that you use a torque wrench to make sure you tighten all the securing wheel nuts on the spare wheel carrier to the required 90 Nm (66 lb.ft) specification.

21. Remove the wheel blocks.

# Changing a Road Wheel

22. Stow the jack and tools in the original locations shown in the removal section and tighten the retaining screws by turning clockwise.

## WHEEL NUTS - EXCLUDING: RAPTOR

### Wheel Nut Torque Specifications



**WARNING:** When you install a wheel, remove any corrosion, dirt or foreign materials present on the mounting surfaces of the wheel or the surface of the wheel hub, brake drum or brake disc that contacts the wheel. Make sure to secure any fasteners that attach the rotor to the hub so they do not interfere with the mounting surfaces of the wheel. Installing wheels without following these steps can cause the wheel nuts to loosen and the wheel to come off while your vehicle is in motion, resulting in loss of vehicle control, personal injury or death.

Bolt size	Nm ( lb.ft) *
M12 X 1.5	135 Nm (100 lb.ft)

\*Torque specifications are for nut and bolt threads free of dirt and rust. Use only our recommended replacement fasteners.

Retighten the lug nuts to the specified torque within 160 km (100 mi) after any wheel disturbance (such as tire rotation, changing a flat tire, wheel removal).



A Wheel pilot bore

Inspect the wheel pilot bore and mounting surface prior to installation. Remove any visible corrosion or loose particles.

# Changing a Road Wheel

## WHEEL NUTS - RAPTOR

### Wheel Nut Torque Specifications



**WARNING:** When you install a wheel, remove any corrosion, dirt or foreign materials present on the mounting surfaces of the wheel or the surface of the wheel hub, brake drum or brake disc that contacts the wheel. Make sure to secure any fasteners that attach the rotor to the hub so they do not interfere with the mounting surfaces of the wheel. Installing wheels without following these steps can cause the wheel nuts to loosen and the wheel to come off while your vehicle is in motion, resulting in loss of vehicle control, personal injury or death.

Bolt size	Nm ( lb.ft) *
M14 X 1.5	204 Nm (150 lb.ft)

\*Torque specifications are for nut and bolt threads free of dirt and rust. Use only our recommended replacement fasteners.

Retighten the lug nuts to the specified torque within 160 km (100 mi) after any wheel disturbance, such as tire rotation, changing a flat tire or wheel removal.



A Wheel pilot bore

Inspect the wheel pilot bore and mounting surface prior to installation. Remove any visible corrosion or loose particles.

# Vehicle Identification

## VEHICLE IDENTIFICATION NUMBER

### LOCATING THE VEHICLE IDENTIFICATION NUMBER

The vehicle identification number is on the left-hand side of the instrument panel.

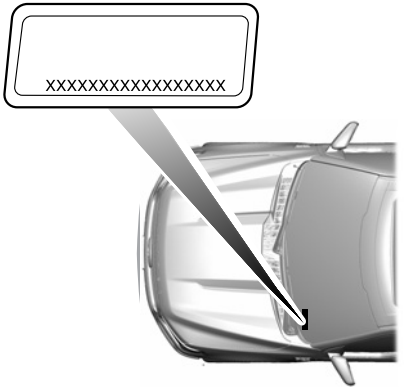

**Note:** In the illustration, XXXX is representative of your vehicle identification number.

### VEHICLE IDENTIFICATION NUMBER OVERVIEW

The vehicle identification number contains the following information:

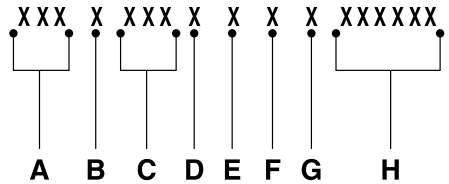

- A World manufacturer identifier.
- B Brake system, gross vehicle weight rating, restraint devices and their locations.
- C Make, vehicle line, series, body type.
- D Engine or motor type.
- E Check digit.
- F Model year.
- G Assembly plant.
- H Production sequence number.

# Connected Vehicle - Vehicles With: Modem

## WHAT IS A CONNECTED VEHICLE

A connected vehicle has technology that allows your vehicle to connect to a mobile network and for you to access a range of features. When used in conjunction with the Ford mobile app, it could allow you to monitor and control your vehicle further, for example checking the tire pressures, the fuel level and the vehicle location. For additional information, refer to the local Ford website.

## CONNECTED VEHICLE REQUIREMENTS

Connected service and related feature functionality requires a compatible vehicle network.

Some remote features require additional service activation. Log in to your Ford account for details. Some restrictions, third party terms and message or data rates may apply.

## CONNECTED VEHICLE LIMITATIONS

Evolving technology, cellular networks, or regulations could affect functionality and availability, or continued provision of some features. These changes could even stop some features from functioning.

## CONNECTING THE VEHICLE TO A MOBILE NETWORK

### WHAT IS THE MODEM



The modem allows access to a range of features built into your vehicle.

## ENABLING AND DISABLING THE MODEM

1. From the settings menu, press Connectivity.
2. Press Connected Vehicle Features.
3. Switch vehicle connectivity on or off.

## CONNECTING FORDPASS TO THE MODEM

1. Make sure that the modem is enabled using the vehicle settings menu.
2. Open the FordPass app on your device and log in.
3. Add your vehicle or select your vehicle if already added.
4. Select the option to activate your vehicle.
5. Make sure that the name on the screen matches the name shown in your FordPass account.
6. Confirm that FordPass account is connected to the modem.

## CONNECTING THE VEHICLE TO A WI-FI NETWORK

1. From the settings menu, press Connectivity.
2. Press Wi-Fi.
3. Switch Wi-Fi on.
4. Press View Available Networks.
5. Select an available Wi-Fi network.

**Note:** Enter the network password to connect to a secure network.

# Connected Vehicle - Vehicles With: Modem

## CONNECTED VEHICLE SETTINGS

You can adjust several settings on the touchscreen under the connected vehicle features menu, such as:

- Vehicle connectivity.
- Share vehicle data.
- Share vehicle location.
- Share driving data.

**Note:** Depending on your vehicle, different options may be available.

**Note:** Editing connectivity settings could result in some features not operating correctly or at all. When you edit connectivity settings, pop-up messages may appear to notify you that services will not work without that setting. If you switch a feature on, pop-up messages could appear informing you of the settings that will be turned on. Some features, for example driver assistance features, use map data. We recommend having all connected vehicle settings enabled to allow the map content to be updated to the latest version.



Press the button next to a menu option for more information.

## CONNECTED VEHICLE – TROUBLESHOOTING

### CONNECTED VEHICLE – FREQUENTLY ASKED QUESTIONS

#### Why is my Ford mobile app not connecting to my vehicle?

- The modem is not enabled. Switch vehicle connectivity on.
- The network signal is weak. Move your vehicle closer to a place where the network signal is not obstructed.

#### Why can I not connect to a Wi-Fi network?

- You entered the wrong network password. Enter the correct password.
- The network signal is weak. Move your vehicle closer to the Wi-Fi router or to a place where the network signal is not obstructed.
- There are multiple access points in range with the same network name. Choose a unique name for your network. Do not use the default name unless it contains a unique identifier, for example as part of the MAC address.

#### Why does the Wi-Fi connection disconnect after successful connection?

- The network signal is weak. Move your vehicle closer to the Wi-Fi router or to a place where the network signal is not obstructed.

#### What can I do if I am close to a Wi-Fi router but the network signal strength is weak?

- If your vehicle has a heated windshield, position your vehicle so that the windshield is not facing the Wi-Fi router.
- If your vehicle has metallic tinting on the windows but not on the windshield, position your vehicle so that the windshield is facing the Wi-Fi router or open the windows that are facing the router.
- If your vehicle has metallic tinting on the windows and the windshield, open the windows that are facing the router.
- If your vehicle is in a garage and you have the garage door closed, open the garage door as it could block the signal.

## Connected Vehicle - Vehicles With: Modem

---

### **Why can I not see a network I expect to see in the list of available networks?**

- The network is hidden. Make the network visible and try again, or manually add a network in the Wi-Fi settings menu.
- Some network security types are not supported, for example WEP.

### **Why do software downloads take too long?**

- The network signal is weak. Move your vehicle closer to the Wi-Fi router or to a place where the network signal is not obstructed.
- Wi-Fi network is in high demand or has a slow Internet connection. Use a more reliable Wi-Fi network.

### **Why does the software not update when the system seems to connect to a Wi-Fi network and the signal strength is excellent?**

- No software update is available at this time.
- Select automatic updates option in the settings menu to enable automatic software update or contact an authorized dealer.
- There could be a connection problem. Test the network using another device.



# Vehicle Hotspot

---

## SETTING UP A VEHICLE HOTSPOT

With a data plan, your hotspot can provide devices in and around your vehicle with Wi-Fi data.

**Note:** *A mobile device is required to complete hotspot setup.*

1. From the settings menu, press Vehicle Hotspot.
2. Press Settings.
3. Press Show Password.
4. Connect your device to the vehicle hotspot by selecting the hotspot from the list of Wi-Fi Networks.
5. When prompted, enter the password.

## Activating a Trial or Purchasing a Data Plan

1. Connect a device to your vehicle hotspot. The vehicle network carrier's service activation website opens on your device.

**Note:** *If the website does not open, open a new website and it redirects to the vehicle network carrier's website.*

2. Follow the instructions on the carrier portal to purchase a plan or start a trial.

**Note:** *Visit the vehicle network carrier's website to purchase more data.*

**Note:** *Hotspot services are subject to your vehicle network carrier agreement, coverage and availability.*

## VEHICLE HOTSPOT SETTINGS

You can change the following in the vehicle hotspot settings menu:

- Vehicle hotspot name or password.
- Vehicle hotspot frequency.

## Changing the Vehicle Hotspot Name or Password

The hotspot information can only be updated once you activate the hotspot.

1. From the settings menu, press Vehicle Hotspot.
2. Press Settings.
3. Press Edit.
4. Press Change Network Name.
5. Enter your required network name.
6. Press enter to save the network name.
7. Press Change Password.
8. Enter your required password.
9. Press enter to save the password.

## Changing the Vehicle Hotspot Frequency

The vehicle hotspot frequency band is selectable depending upon your device capabilities. You cannot connect your device to the vehicle hotspot if it does not support the selected frequency band.

1. From the settings menu, press Vehicle Hotspot.
2. Press Settings.
3. Press Edit.
4. Press Change Frequency Band.
5. Select a frequency.

# Vehicle Hotspot

---

## VEHICLE HOTSPOT – TROUBLESHOOTING

### VEHICLE HOTSPOT – FREQUENTLY ASKED QUESTIONS

#### **Why can I not see the vehicle hotspot name when I search for Wi-Fi networks on my cell phone or other device?**

- Make sure the vehicle hotspot visibility is on.
- Check what frequency the hotspot is transmitting in the vehicle hotspot settings menu. If the frequency is 5 GHz and your device cannot see the network, change the frequency to 2.4 GHz.
- The system does not provide a vehicle hotspot at this time.

#### **How do I remove the vehicle from the vehicle network carrier's account?**

- Contact your vehicle network carrier.

# Audio System

## AUDIO SYSTEM PRECAUTIONS



**WARNING:** Driving while distracted can result in loss of vehicle control, crash and injury. We strongly recommend that you use extreme caution when using any device that may take your focus off the road. Your primary responsibility is the safe operation of your vehicle. We recommend against the use of any hand-held device while driving and encourage the use of voice-operated systems when possible. Make sure you are aware of all applicable local laws that may affect the use of electronic devices while driving.

Listening to loud audio for long periods of time could damage your hearing.

## IDENTIFYING THE AUDIO UNIT



Depending on your vehicle options, the controls may look different from what you see here.

## SWITCHING THE AUDIO UNIT ON AND OFF



Press the button on the volume control.

## SELECTING THE AUDIO SOURCE

Press **Sources** on the touchscreen to open the media source menu.

## MEDIA CONTROL BUTTONS



Press to play a track. Press again to pause the track.

**Note:** *Not all sources can be paused.*



Press the button to skip to the next track.

Press and hold the button to fast forward through the track.



Press the button once to return to the beginning of a track.

Repeatedly press the button to return to previous tracks.

Press and hold the button to fast rewind through the track.



Press the button on the touchscreen to switch shuffle mode on or off.

**Note:** *Not all sources have shuffle mode.*



Press the button on the touchscreen to change repeat mode.

**Note:** *Not all sources have repeat mode.*

# Audio System

## ADJUSTING THE VOLUME

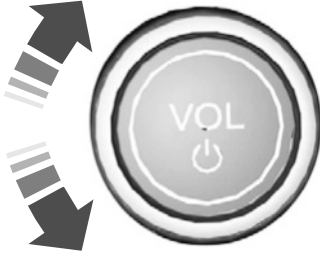

Turn to adjust the volume.

Some vehicles may be able to adjust the volume using buttons on the steering wheel.

## SETTING A MEMORY PRESET

1. Select a station or channel.
2. Press and hold a memory preset button on the touchscreen.

**Note:** The audio mutes briefly while the system saves the preset and returns once it is stored.

**Note:** You can save presets from multiple sources to the memory preset bar.

## MUTING THE AUDIO



Press to mute the signal. Press again to restore the signal.

## ADJUSTING THE SOUND SETTINGS

To access the sound settings menu:

1. From the settings menu, press Sound.

From the menu, you can adjust the following:

- Tone settings.
- Balance and fade.
- Speed compensated volume.
- Volume settings.
- Sound mode/Occupancy mode

**Note:** Depending on your vehicle options, not all settings are available.

## SETTING THE CLOCK AND DATE

1. From the settings menu, press Clock.
2. Set the time.

**Note:** The AM and PM options are not available if 24-hour mode is on.

## Switching Automatic Time Updates On and Off

1. From the settings menu, press Clock.
2. Switch Auto Time Update on or off

## AM/FM RADIO

### AM/FM RADIO LIMITATIONS

The further you travel from an AM or FM station, the weaker the signal and the weaker the reception.

Hills, mountains, tall buildings, bridges, tunnels, freeway overpasses, parking garages, dense tree foliage and thunderstorms can interfere with the reception.

# Audio System

When you pass a ground-based broadcast repeating tower, a stronger signal may overtake a weaker one and result in the audio system muting.

## SELECTING A RADIO STATION

### Manually Selecting a Radio Station

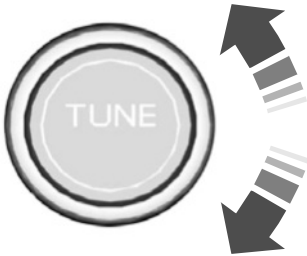

Turn to search through the radio frequency band.

### Using Direct Tune

1. Press **Direct Tune** to open the number pad.
2. Enter the station you prefer.

**Note:** You can only enter a valid station for the audio source you are currently listening to.

### Using Seek

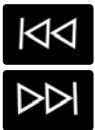

Press either button. The system stops at the first station it finds in that direction.

## Using the Station List

1. Press **Browse**.

**Note:** Available on FM radio only.

2. Press a station.

## SWITCHING THE DISPLAY ON AND OFF

To switch the display off:

1. From the settings menu, press Display. See **Settings** (page 483).
2. Press Display Off.

**Note:** The display defaults to on each time you switch your vehicle on.

To switch the display on, press anywhere on the touchscreen.

## DIGITAL RADIO (IF EQUIPPED)

### WHAT IS DIGITAL RADIO

HD Radio™ technology is the digital evolution of analog AM/FM radio.

For additional information, visit [www.HDRadio.com](http://www.HDRadio.com).

HD Radio Technology is manufactured under license from iBiquity Digital Corporation and foreign patents. HD Radio and the HD and HD Radio logos are proprietary trademarks of XPERI. The vehicle manufacturer and XPERI are not responsible for the content sent using HD Radio technology. Content may be changed, added or deleted at any time at the station owner's discretion.

### HOW DOES DIGITAL RADIO WORK

Your system has a special receiver that allows it to receive digital broadcasts in addition to analog broadcasts.

# Audio System

---

HD1 signifies the main programming status and is available in both analog and digital broadcasts. Other multicast stations are only available digitally and could contain new or different content.

**Note:** *When the system first receives an HD1 station, it plays the station in the analog version until it verifies the station is an HD Radio station. Then it shifts to the digital version.*

**Note:** *There is an audio mute delay when switching to an HD2 or HD3 station because the system has to reacquire and decode the digital signal.*

## DIGITAL RADIO LIMITATIONS

If you are outside the reception area, the system could not work.

If you are on the fringe of the reception area, the station could mute due to weak signal strength.

**Note:** *If you are listening to HD1, the system changes back to the analog broadcast until the digital broadcast is available again. If you are listening to any other multicast channels, the station mutes and stays muted unless it is able to connect to the digital signal again.*

Depending on the station quality, you could hear a slight sound change when the station changes between analog and digital audio.

You cannot access a saved HD station if your vehicle is outside the station's reception area.

## SWITCHING DIGITAL RADIO RECEPTION ON AND OFF

1. From the settings menu, press Radio.
2. Switch HD Radio on or off.

## DIGITAL RADIO INDICATORS

### HD Radio Indicator

The indicator appears when HD Radio is on and you tune to a station broadcasting HD Radio technology.



The color of the indicator changes to indicate the system status.

Gray indicates the system is acquiring a digital station.

Orange indicates digital audio is playing.

### Multicast Indicator

The multicast indicator appears if the current station is broadcasting multiple digital broadcasts. The highlighted numbers indicate additional digital channels available.

**Note:** *For stations that have more than one HD multicast, the HD indicator and radio text appears as a button. Press the button to cycle through all of the HD stations on that specific frequency.*

## SATELLITE RADIO (IF EQUIPPED)

### WHAT IS SATELLITE RADIO

Your factory-installed SiriusXM radio system includes a limited subscription term, which begins on the date of sale or lease of your vehicle. See an authorized dealer for availability.

# Audio System

For additional information about extended subscription terms, visit [www.SiriusXM.com](http://www.SiriusXM.com) in the United States, [www.SiriusXM.ca](http://www.SiriusXM.ca) in Canada, or call SiriusXM at 1-888-539-7474.

**Note:** *SiriusXM reserves the unrestricted right to change, rearrange, add or delete programming including canceling, moving or adding particular channels, and its prices, at any time, with or without notice to you. Neither SiriusXM and its affiliates nor Ford Motor Company and its affiliates will be liable to you or any third party for any such modification, suspension or termination.*

## SATELLITE RADIO LIMITATIONS

For optimal reception performance, keep the antenna clear of snow and ice build-up and keep luggage and other material as far away from the antenna as possible. Placing luggage over the antenna may reduce performance. Factory-installed and aftermarket vehicle structures including, but not limited to, roof racks and soft top roofs in a partially open position could reduce reception performance.

Hills, mountains, tall buildings, bridges, tunnels, freeway overpasses, parking garages, dense tree foliage and thunderstorms can interfere with your reception.

When you pass a ground-based broadcast-repeating tower, a stronger signal may overtake a weaker one and could result in the audio system muting. Your display could show an error message to indicate the interference.

## LOCATING THE SATELLITE RADIO IDENTIFICATION NUMBER

1. Select SiriusXM as the audio source.
2. Tune to channel 0.

## SELECTING A CHANNEL

### Manually Selecting a Channel



Press the button to find the previous or next available radio channel.



### Linear Tuner

The linear tuner is displayed when manually selecting a channel. You can swipe left or right on the linear tuner carousel to navigate through the channel list. Tap on a channel title to listen to it.

### Using Direct Tune

1. Press the channel up or down button to open the linear tuner screen.
2. Press Direct Tune to open the number pad.
3. Enter the channel you prefer.

### Using Seek



Press either button.



### Using the Channel List

1. Press Browse.
2. Select a channel.

## SATELLITE RADIO SETTINGS

### Subscription

Your subscription status is displayed. You can subscribe or manage your subscription directly from the touchscreen.

# Audio System

---

## SiriusXM Favorites

While you are listening to SiriusXM, you can save favorites by:

- Tapping the currently tuned channel or show logo on the SiriusXM audio screen.
- Tuning to a channel or show you want to save as a favorite. Navigate to the SiriusXM Favorites screen and press the Add Current button. The currently tuned channel or show is saved as a favorite.
- Saving a radio preset. This saves the currently tuned SiriusXM channel or show as a favorite

**Note:** *Requires a trial or active subscription to use.*

## Listening History

Listening history is a list of recently listened to SiriusXM content. You can view, manage and reset the listening history using the controls on the touchscreen.

**Note:** *Requires a trial or active subscription to use.*

## Help and Support

You can contact SiriusXM Customer Care directly from the operating system and view information required to manage your SiriusXM account.



# Audio System

## AUDIO SYSTEM – TROUBLESHOOTING

### AUDIO SYSTEM – INFORMATION MESSAGES

#### Satellite Radio Troubleshooting

Error Message	Potential Effects	Recommended Action
Connectivity Disabled	Internet streaming and On Demand shows are unavailable and some SiriusXM features are disabled.	Internet connectivity is turned off. See <b>Connected Vehicle</b> (page 466).
No Internet	Audio system may mute. Switch to Satellite button may be displayed on the SiriusXM audio screen if the channel is also available via satellite.	SYNC attempts to connect. See <b>Satellite Radio Limitations</b> (page 475). Switch to a satellite connection for the current channel if the option is available.
No Satellite Signal	Audio system may mute. Switch to Internet button may be displayed on the SiriusXM audio screen if the channel is also available via streaming.	Antenna may be obstructed or satellite reception is weak in your location. See <b>Satellite Radio Limitations</b> (page 475). Switch to an internet connection for the current channel if the option is available.
Slow Network Connection	Audio system may mute while the audio attempts to load.	Allow some time for the audio to load or tune to a different channel.
Channel Unavailable	Audio system may mute. Radio may tune to a different channel.	A temporary update may be in progress. Allow some time before retrying to tune to the channel. If the issue continues, the channel may no longer be available.
Episode Unavailable	Audio system may mute. Radio may tune to a different channel.	A temporary update may be in progress. Allow some time before retrying to play the episode. If the issue continues, the episode may no longer be available.

# Audio System

Error Message	Potential Effects	Recommended Action
Something went wrong	Audio system may mute. Radio may tune to a different channel.	Allow some time and retry the action.
Subscribe to Listen	Cannot listen to selected content. Content may appear grayed out and some features may be disabled.	<p>Your subscription has expired or you have not yet subscribed for access to the listed content. Navigate to Subscription under the Satellite Radio Settings menu. If you have an active subscription which includes the listed channel or content and you see this error, you may need to refresh your radio. To refresh your SiriusXM radio, visit <a href="http://www.siriusxm.com/refresh">www.siriusxm.com/refresh</a> in the US, or <a href="http://www.siriusxm.ca/refresh">www.siriusxm.ca/refresh</a> in Canada.</p> <p>You may need to provide your SiriusXM Radio identification number. See <b>Locating the Satellite Radio Identification Number</b> (page 475).</p>

# Audio System

Error Message	Potential Effects	Recommended Action
Upgrade to Listen	Cannot listen to selected content. Content may appear grayed out and some features may be disabled.	<p>Your subscription does not include access to the listed content. You may need to upgrade your subscription. Navigate to Subscription under the Satellite Radio Settings menu. If you have an active subscription which includes the listed channel or content and you see this error, you may need to refresh your radio. To refresh your SiriusXM radio, visit <a href="http://www.siriusxm.com/refresh">www.siriusxm.com/refresh</a> in the US, or <a href="http://www.siri-usxm.ca/refresh">www.siri-usxm.ca/refresh</a> in Canada. You may need to provide your SiriusXM Radio identification number. See <b>Locating the Satellite Radio Identification Number</b> (page 475).</p>
Location Restricted Content	Audio may mute. Not available in your location or Unable to determine your location may be displayed.	Content is not available in your location or SiriusXM is unable to determine your location. Tuning to a different channel may resolve the issue.
Channel Blocked	Audio may mute. Radio may tune to a different channel.	<p>The Block Explicit Content filter is turned on. Navigate to Listener Settings under the Satellite Radio Settings menu to access the Block Explicit Content filter. Navigate to Listener Settings. See <b>Satellite Radio Settings</b> (page 475).</p>
Antenna Problem or Hardware Problem	Audio may mute. Access to SiriusXM features may be unavailable.	If issue persists, you may need to visit an authorized dealer for service.

# Audio System

---

<b>Error Message</b>	<b>Potential Effects</b>	<b>Recommended Action</b>
SiriusXM Updating...	Audio may mute.	Allow SiriusXM some time to complete updating.
Loading...	Audio may mute. Content may be temporarily unavailable while loading.	No action necessary. If loading time is longer than usual, See <b>Satellite Radio Settings</b> (page 475).
SiriusXM Loading...	Audio may mute. Content and controls may be temporarily unavailable.	No action necessary. Allow SiriusXM some time to finish loading.

# Center Display

## CENTER DISPLAY OVERVIEW



**WARNING:** Driving while distracted can result in loss of vehicle control, crash and injury. We strongly recommend that you use extreme caution when using any device that may take your focus off the road. Your primary responsibility is the safe operation of your vehicle. We recommend against the use of any hand-held device while driving and encourage the use of voice-operated systems when possible. Make sure you are aware of all applicable local laws that may affect the use of electronic devices while driving.

For your safety, features that are not critical while driving are not available when the vehicle is moving at or above 8 km/h (5 mph).

**Note:** Illustrations are provided for conceptual understanding only and may appear differently on your vehicle.

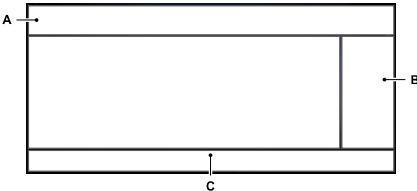

- A Status bar. See **Status Bar** (page 481).
- B Information on demand screen. See **Information On Demand Screen** (page 482).
- C Feature bar. See **Feature Bar** (page 482).

## STATUS BAR

The status bar appears at the top of the display. The following buttons and icons can appear in the status bar.

**Note:** Some buttons and icons may not apply to your vehicle or may not appear exactly as shown.

### Alexa Built-In



Press to set up Alexa. See **Alexa Built-In** (page 487).

### Wireless Charging



Wireless charging active.



Device connected and not charging.

### Traffic Announcements



Traffic announcements are turned on but are not supported by the selected station.



Traffic announcements are turned on and supported by the selected station but are not active.



Traffic announcements are active.

**Note:** If no traffic announcement icons are displayed, traffic announcements are turned off.

### Vehicle Data



Wi-Fi available.



Wi-Fi connected.

# Center Display



Vehicle data sharing on.



Vehicle data sharing off.



Vehicle location sharing on.



Vehicle data and vehicle location sharing on.

## Outside Air Temperature



Outside air temperature is active.

## Audio System



Audio system muted.

## Connected Device



Cell phone microphone muted.



Phone call in progress.



Media player connected using **Bluetooth®**.



Cell phone network signal strength.



Cell phone roaming.



Text message received.



Unread email message.



Automatic crash notification system off.



Cell phone battery status.

## Software Updates



Press to see details about software updates. See **Vehicle Software Updates** (page 499).

## Back Button



Some screens have a back button in the top corner. Press the button to return to the previous screen.

## INFORMATION ON DEMAND SCREEN

The information on demand screen displays cards on the side of the display and allows you to see information from different features.



Press the button to view the next card.



Press the button to view the previous card.



Press the button to view available cards.

On some screens, you can swipe a card toward the center of the screen to move the content into the main screen.

## FEATURE BAR

The feature bar is located on the bottom of the display and allows you to access vehicle features.

# Center Display

## Audio



Press to use the radio, a USB, a media player or a **Bluetooth®** device.

## Phone



Press to make calls and access the phonebook on your cell phone. See **Phone** (page 489).

## Navigation



Press to use the navigation system. See **Navigation** (page 496).

## Favorite



Press to replace this button with a shortcut to a feature or setting.

## Apps



Press to see a list of apps. To open an app, select the app.

## Settings



Press to access the settings menu. See **Settings** (page 483).

## Features



Press to view features.

**Note:** *The icon may be different depending on your vehicle.*

## SETTINGS

1.  Press the button in the feature bar to access the settings menu.

2. Select the required tile to access specific settings.

You can change the display language and other measurement units under the General menu.



If you see this icon next to a menu option, press it for more information.

## Display Settings

From the display menu you can do the following:

- Switch the calm screen on.
- Manually adjust the screen brightness.
- Set the display mode.

## Touchscreen Brightness

To manually adjust the screen brightness, use the plus or minus buttons.

**Note:** *The display brightness is limited if the settings of the instrument panel lighting brightness are set to the highest or lowest setting.*

## DRIVER ASSISTANCE MENU

To access the driver assistance menu:

1.  Press the button in the feature bar to access the features menu.

**Note:** *The icon may be different depending on your vehicle.*

2. Press Driver Assistance.

## REBOOTING THE CENTER DISPLAY

You can reboot the center display using the controls on the steering wheel.

## Center Display

---

1. Simultaneously press and hold the seek forward and audio system power button for 10 seconds.



# Voice Interaction

## FORD ASSISTANT

### USING FORD ASSISTANT

The digital assistant allows you to control vehicle features using conversational requests.

To begin a voice interaction using the wake word, say the selected wake word, then say your command.



Press the voice interaction button on the steering wheel. A tone sounds before you can say your command.

**Note:** You may need to enable your vehicle's modem to use certain voice commands. See **Enabling and Disabling the Modem** (page 466).

### Voice Command Examples

To see examples of what voice commands you can use with different features:



Press the button on the touchscreen.

1. Press **Ford Assistant**.
2. Press **Voice Command Help**.
3. Select a feature.

### FORD ASSISTANT SETTINGS

To access the settings menu:



Press the button on the touchscreen.

1. Press **Ford Assistant**.

From the settings menu you can do the following:

- Switch listen for wake word on or off.
- Set the preferred wake word.
- Switch advanced mode on or off.

- Switch phone confirmation on or off.
- Switch the commands list on or off.
- View the commands help menu.



Press the button next to a menu option for more information.

### FORD ASSISTANT – FREQUENTLY ASKED QUESTIONS

#### Why does the system not understand what I am saying?

- You are speaking too soon. When using the button of the steering wheel, wait for the tone before you speak.

#### Why does the system not understand the name of a track or artist?

- **Bluetooth®** does not support voice commands. Connect your device to a USB port.
- You are not saying the name exactly as it appears on your device. Say the name of the track or artist exactly as it appears on your device. Spell out any abbreviations in the name.
- The system does not recognize some special characters contained in the name of a song or artist, for example \*, - or +. Rename the files on your device or use the touchscreen to select and play the track.

# Voice Interaction

---

## **Why does the system not understand the name of a contact in the phonebook on my device and calls the wrong contact?**

- You are not saying the name exactly as it appears on your device. Say the first and last name of the contact exactly as it appears on your device. Spell out any abbreviations in the name.
- The name contains special characters, for example \*, - or +. Rename the contact on your device or use the touchscreen to select and call the contact.

## **Why does the system not understand foreign names of contacts in the phonebook on my device?**

- The system applies phonetic pronunciation rules of the selected language to the names of contacts in the phonebook on your device. Select the name of the contact on the touchscreen and use the Hear it option to get an idea of how the system expects you to pronounce it.

## **Why do the system voice prompts and the pronunciation of some words not seem accurate?**

- The system uses text-to-speech technology and a synthetically generated voice rather than a pre-recorded human voice.

# Alexa Built-In (If Equipped)

## WHAT IS ALEXA BUILT-IN

Alexa Built-In allows you to use Alexa in your vehicle for auto-specific use cases on the road and gives you access to an ever-evolving number of skills that help to make your life more productive, entertaining, and connected while using your vehicle.

## ALEXA BUILT-IN REQUIREMENTS

To use Alexa, all of the following must occur:

- Your vehicle modem is enabled.
- You are signed in to an existing Amazon account.
- Vehicle location services are enabled.
- Vehicle connectivity and vehicle data sharing is enabled.

**Note:** *Support and functionality may vary based on the country in which your FordPass account is registered.*

## SIGNING IN TO YOUR ACCOUNT



Press the button in the status bar and follow the on-screen prompts.

To sign in using the settings menu:

1. Press **Settings** on the touchscreen.
2. Press **Amazon Alexa**.
3. Press **Get Started**.
4. Sign in to your account by either scanning the QR code or entering the on-screen code into the Amazon website.
5. Once signed in, follow the on-screen prompts.

6. When complete, the vehicle informs you that Alexa is ready to be used in the vehicle.

## Signing Out of Your Account

1. Press **Settings** on the touchscreen.
2. Press **Amazon Alexa**.
3. Press **Sign Out**.

## USING ALEXA BUILT-IN

To use Alexa, say “Alexa” or press the voice interaction button on the steering wheel and then say “Alexa” to invoke Alexa to start listening.

**Note:** *If the wake word is not enabled, you can only use the voice interaction button.*

You can use Alexa for the following and more:

- Entertainment.
- Hands-free calling.
- Traffic and navigation.
- Vehicle controls.
- Smart home device control.
- Weather and news information.

## ALEXA BUILT-IN SETTINGS

### Enabling the Wake Word

1. Press **Settings** on the touchscreen.
2. Press **Amazon Alexa**.
3. Switch **Listen for Wake Word** on or off.

**Note:** *If the wake word is not enabled, you can only use the voice interaction button.*

### Contact List

Displays a list of connected phones and contact sharing status for each phone.

To change the contact sharing status:

## Alexa Built-In (If Equipped)

---

1. Press **Settings** on the touchscreen.
2. Press **Amazon Alexa**.
3. Press **Contact List**.
4. Enable or disable sharing for each phone.

**Note:** *You can share contacts from more than one phone at a time.*

### Things to Try

Learn more about what you can do with Alexa by browsing the things to try.

1. Press **Settings** on the touchscreen.
2. Press **Amazon Alexa**.
3. Press **Things to Try**.

# Phone

## PHONE PRECAUTIONS



**WARNING:** Driving while distracted can result in loss of vehicle control, crash and injury. We strongly recommend that you use extreme caution when using any device that may take your focus off the road. Your primary responsibility is the safe operation of your vehicle. We recommend against the use of any hand-held device while driving and encourage the use of voice-operated systems when possible. Make sure you are aware of all applicable local laws that may affect the use of electronic devices while driving.

## CONNECTING YOUR PHONE

Go to the settings menu on your device and switch **Bluetooth®** on.



Press the phone option on the feature bar.

1. Press **Add Phone**.

**Note:** A prompt alerts you to search for your vehicle on your cell phone.

2. Select your vehicle on your cell phone.

**Note:** A number appears on your cell phone and on the touchscreen.

3. Confirm the number on your cell phone matches the number on the touchscreen.

**Note:** The touchscreen indicates that you have successfully paired your cell phone.

4. Approve phonebook download request on your cell phone.

## PHONE MENU

This menu becomes available after pairing a phone.

### Recent Call List

Display and select an entry from a list of previous calls.

### Contacts

Display a smart search form to look up your contacts. Use the List button to alphabetically sort your contacts.

### Favorites

Display the list of favorite contacts that are set up on your phone.

### Messaging

Displays the list of text messages to read, listen to, or respond to.

### Email

Displays the list of emails to read, listen to, or respond to.

### Phone List

Display the list of paired or connected devices that you can select.

**Note:** Up to 12 devices can be stored.

### Do Not Disturb

Reject incoming calls and switch ring tones and alerts off.

### Phone Keypad

Directly dial a number.

# Phone

---

## Voice Control

Press the button and say a command to use the Google or Siri voice assistant available on your connected phone to access supported features.

**Note:** *Some features under the phone menu may not be available if the feature is not supported through the phone.*

# Phone

## MAKING AND RECEIVING A PHONE CALL

### Making Calls

**To call a number in your contacts, select:**

Menu Item	Action and Description
Contacts	You can then select the name of the contact you want to call. Any numbers stored for that contact display along with any stored contact photos. You can then select the number that you want to call. The system begins the call.

**To call a number from your recent calls, select:**

Menu Item	Action and Description
Recent Call List	You can then select an entry that you want to call. The system begins the call.

**To call a number from your favorites, select:**

Menu Item	Action and Description
Favorites	You can then select an entry that you want to call. The system begins the call.

**To call a number that is not stored in your phone, select:**

Menu Item	Action and Description
Phone Keypad	Select the digits of the number you wish to call.
Call	The system begins the call.

Pressing the backspace button deletes the last digit you typed.

### Receiving Calls

During an incoming call, an audible tone sounds. Caller information appears in the display if it is available.

**To accept the call, select:**

Menu Item
Accept

**Note:** You can also accept the call by pressing the phone button on the steering wheel.

**To reject the call, select:**

Menu Item
Reject

Ignore the call by doing nothing. The system logs it as a missed call.

### During a Phone Call

During a phone call, the contacts name and number display on the screen along with the call duration.

The phone status items are also visible:

- Signal Strength.
- Battery.

You can select any of the following during an active phone call:

# Phone

Item	
End Call	Immediately end a phone call. You can also press the button on the steering wheel.
Keypad	Press this to access the phone keypad.

Item	
Mute	You can switch the microphone off so the caller does not hear you.
Privacy	Transfer the phone call audio to the cell phone or back to the touchscreen.

## SENDING AND RECEIVING A TEXT MESSAGE

Menu Item	Description
Hear It	Hear the text message.
View	View the text message.
Call	Call the sender.
Reply	Reply to the text message with a standard text message.



# Phone

## SWITCHING TEXT MESSAGE NOTIFICATION ON AND OFF

The settings on your device must be enabled to receive text message notifications on the center display. Check your device settings to enable these features.

## ENABLING APPS ON A MOBILE DEVICE

When you start an app through the system for the first time, you could be asked to grant certain permissions. You can review and change the permissions that you have granted at any time when your vehicle is not moving. We recommend that you check your data plan before using your apps through the system. Using them could result in additional charges. We also recommend that you check the app provider's terms and conditions and privacy policy before using their app. Make sure that you have an active account for apps that you want to use through the system. Some apps work with no setup. Others require you to configure some personal settings before you can use them.

### Enabling Apps on an iOS Device



Select the apps option on the feature bar.

1. Select Mobile Apps Help.
2. Follow the instructions to pair and connect your device via **Bluetooth®** or with a USB cable.
3. Start the apps on your device that you want to use.
4. Select the app that you want to use on the touchscreen.

**Note:** Some apps may run through Apple CarPlay if it is enabled.

**Note:** Closing an app on your device closes it on the touchscreen.

**Note:** For troubleshooting assistance select Mobile Apps List under Mobile Apps Help.

### Enabling Apps on an Android Device



Select the apps option on the feature bar.

1. Select Mobile Apps Help.
2. Follow the instructions to pair and connect your device via **Bluetooth®** or with a USB cable.
3. Start the apps on your device that you want to use.
4. Select **Find Mobile Apps**.
5. Select the app that you want to use on the touchscreen.

**Note:** Some devices may lose the ability to play music over USB when Mobile Apps are enabled.

**Note:** Some apps may run through Android Auto if it is enabled.

**Note:** Closing an app on your device closes it on the touchscreen.

**Note:** For troubleshooting assistance select Mobile Apps List under Mobile Apps Help.

## SWITCHING APPLE CARPLAY ON AND OFF

### Enabling Apple CarPlay with USB

1. Connect your device to a USB port.
2. Follow the instructions on your device and the touchscreen.

**Note:** Selecting Enable Wireless CarPlay on your device prepares the device for wireless CarPlay when you reenter the vehicle.

# Phone

## Enabling Apple CarPlay with Wireless

1. Pair your device to **Bluetooth®**.
2. Follow the instructions on your device and the touchscreen.

## Disabling Apple CarPlay



Select the settings option on the feature bar.

1. Press Phone List.
2. Select your device from the list.
3. Press Disable.

## Re-Enabling Apple CarPlay



Select the settings option on the feature bar.

1. Press Phone List.
2. Select your device from the list.
3. Press Connect to Apple CarPlay.

## SWITCHING ANDROID AUTO™ ON AND OFF

### Enabling Android Auto with USB

(If Equipped)

1. Connect your device to a USB port.
2. Follow the instructions on the touchscreen.

**Note:** *Certain features of the system are not available when you are using Android Auto.*

### Enabling Android Auto with Wireless

1. Pair your device to **Bluetooth®**.
2. Follow the instructions on your device and the touchscreen.

**Note:** *Certain Android™ devices do not support Android Auto Wireless. Check your Android OS version for compatibility.*

## Disabling Android Auto



Select the settings option on the feature bar.

1. Press Phone List.
2. Select your device from the list.
3. Press Disable.

## Re-Enabling Android Auto



Select the settings option on the feature bar.

1. Press Phone List.
2. Select your device from the list.
3. Press Connect to Android Auto.

# Bluetooth®

## CONNECTING A BLUETOOTH® DEVICE

1. Make sure **Bluetooth®** is enabled on your device.
2. Press **Settings** on the touchscreen.
3. Press **Connectivity**.
4. Press **Bluetooth**.
5. Press **Add a Bluetooth Device**.

**Note:** A prompt alerts you to search for your vehicle on your device.

6. Select your vehicle on your device.

**Note:** A number appears on your device and on the touchscreen.

7. Confirm that the number on your device matches the number on the touchscreen.

**Note:** The touchscreen indicates that you have successfully paired your device.

The **Bluetooth®** word mark and logos are registered trademarks owned by **Bluetooth SIG, Inc.** and any use of such marks by Ford Motor Company is under license. Other trademarks and trade names are those of their respective owners.

## PLAYING MEDIA USING BLUETOOTH®



**WARNING:** Driving while distracted can result in loss of vehicle control, crash and injury. We strongly recommend that you use extreme caution when using any device that may take your focus off the road. Your primary responsibility is the safe operation of your vehicle. We recommend against the use of any

hand-held device while driving and encourage the use of voice-operated systems when possible. Make sure you are aware of all applicable local laws that may affect the use of electronic devices while driving.

Connect your device.



Press the audio button on the feature bar.



Press **Sources**.



Press the **Bluetooth®** option.



Press to play a track. Press again to pause the track.



Press to skip to the next track.

Press and hold to fast forward through the track.



Press once to return to the beginning of a track. Repeatedly press to return to previous

tracks.

Press and hold to fast rewind through the track.

# Navigation (If Equipped)

## CONNECTED NAVIGATION (IF EQUIPPED)

Your vehicle may have connected navigation as a free trial after purchase. You require a subscription after the trial expires. For additional information, visit [ford.com/connectedservices](http://ford.com/connectedservices).

**Note:** If you do not sign up or renew your subscription, you can still use navigation through a connected device.

## ACCESSING NAVIGATION



**WARNING:** Driving while distracted can result in loss of vehicle control, crash and injury. We strongly recommend that you use extreme caution when using any device that may take your focus off the road. Your primary responsibility is the safe operation of your vehicle. We recommend against the use of any hand-held device while driving and encourage the use of voice-operated systems when possible. Make sure you are aware of all applicable local laws that may affect the use of electronic devices while driving.



Press the button to access Navigation.

**Note:** For optimal reception performance, keep the antenna clear of snow and ice build-up and keep luggage and other material as far away from the antenna as possible. Placing luggage over the antenna may reduce performance.

## NAVIGATION MAP UPDATES

To update your map data over Wi-Fi, your vehicle must be connected to a Wi-Fi access point. For USB updates and other details, contact dealers at 1-866-462-8837 in the United States and Canada, or 800-557-5539 in Mexico.

**Note:** If you find map data errors, you may report them by going to [www.here.com/mapcreator](http://www.here.com/mapcreator).

## ADJUSTING THE MAP

### ZOOMING THE MAP IN AND OUT

You can use pinch gestures to zoom in and out. Place two fingers on the screen and move them apart to zoom in. Place two fingers on the screen and bring them together to zoom out.

### CHANGING THE FORMAT OF THE MAP



Press the Menu button.

1. Press the Map Orientation tile.
2. Select a map orientation.

## LIVE TRAFFIC

### WHAT IS LIVE TRAFFIC

You can observe real-time road congestion when live traffic is on.

### SWITCHING LIVE TRAFFIC ON AND OFF



Press the Menu button.

# Navigation (If Equipped)

1. Press the Traffic on Map tile.
2. Press Traffic on or Traffic Off.

## SETTING A DESTINATION

### SETTING A DESTINATION USING THE TEXT ENTRY SCREEN

1. Press the search bar at the top of the screen.
2. Enter your destination using the keyboard.
3. Press Search.
4. Select a destination from the list.
5. Press Start to begin navigation.

### SETTING A DESTINATION USING THE MAP SCREEN

Press and hold on the map to place a pin at that location. Information about the location of the pin appears on the screen.



Press the button to begin navigation to the pin.

### SETTING A DESTINATION USING A PREDICTIVE DESTINATION

Press the predicted destination card on the screen to navigate to it. These appear when the navigation system has learned your driving habits.

### SETTING A DESTINATION USING A RECENT DESTINATION



Press the button.

Press a destination from the list.

**Note:** You can also use the search button to view recent destinations.

### SETTING A DESTINATION USING A SAVED DESTINATION

Press the star icon next when viewing location details to save the location.



Press the button.

Press a destination from the list.

**Note:** You can also use the search button to view saved destinations.

### SETTING A DESTINATION USING A POINT OF INTEREST

Press a point of interest icon on the map. Information about the location of the point of interest appears on the screen.



Press the button to begin navigation to the point of interest.

**Note:** You can also use the search button to view points of interest.

## WAYPOINTS

### ADDING A WAYPOINT

1. Press the search button during an active navigation session.
2. Enter your destination.
3. Select your destination from the list.
4. Follow the prompts on the screen to add a waypoint.

### EDITING WAYPOINTS

1. Press the waypoint you would like to edit.
2. Select an option to reorder or delete the waypoint.

# Navigation (If Equipped)

---

## ROUTE GUIDANCE

### ADJUSTING THE GUIDANCE PROMPT VOLUME

Turn the volume control when a guidance prompt plays to adjust the volume.

### REPEATING AN INSTRUCTION

Press the turn indicator to hear the last voice instruction.

## ROUTE GUIDANCE SETTINGS

### Avoid 4x4 Roads

#### Before Starting a Navigation Session

Before starting a navigation session you can enable and disable 4x4 roads using the controls on the point of interest detail page. When enabled the system will include 4x4 roads when determining the best route. When disabled the system will avoid 4x4 roads.

#### During a Navigation Session

If you do not wish to have your route take you on 4x4 roads you can remove the turn onto the 4x4 road using the turn list.

1. Tap the chevron below the turn panel.
2. Swipe to the left on the 4x4 road on the turn list that appears.
3. Press the delete button to remove that road from your route.

The system will then re-route you to your destination.

## CANCELING ROUTE GUIDANCE



Press the button to cancel route guidance to the selected location.

# Vehicle Software Updates

Software updates use over-the-air technology to deliver the latest features, software enhancements and quality improvements to your vehicle.

When Automatic Updates is turned on updates are downloaded in the background while you are driving.

Non-drivable updates require your vehicle to be parked. Set a recurring schedule for a time that you know the vehicle will not be driven (like overnight). Non-drivable updates may take up to 45 minutes, however, some can take longer than that. Check the center display screen or the Ford mobile app for the most accurate estimated update time.

Software updates are delivered wirelessly using the vehicle modem or Wi-Fi. To make sure of the most seamless experience. See

## **Connecting the Vehicle to a Wi-Fi Network** (page 466).

### **Software Update Requirements**

The following conditions must be met to receive a non-drivable update:

- Vehicle is parked and not in motion.
- Ignition is off.
- Doors and windows are closed.
- Liftgates/tailgates are closed.
- Parking lights are off.
- Illuminated exit lights are off.
- Hazard lights are off.
- Alarm is not triggered.
- Remote start is not in progress.
- Your vehicle is not DC fast charging.
- Your vehicle is not in 4x4 mode.
- Your vehicle is not in neutral tow mode.
- Your 12V battery is charged.

### **Software Update Limitations**

Once a scheduled update begins you cannot:

- Cancel the update.
- Drive your vehicle.
- Start your ignition.
- Activate the alarm.
- Use the remote control to lock/unlock your vehicle.
- Fast charge your vehicle.
  - If connected to a Level 1 or 2 charger, charging pauses until the update is completed.

**Note:** *If an update is interrupted a notification is sent to your Ford mobile app with instructions to resolve it. If there are no instructions, contact an authorized dealer.*

### **SOFTWARE UPDATE SETTINGS**

To access the Software Updates menu:

1. Press **Settings** on the touchscreen.
2. Press **Software Updates**.

You can do the following in the Software Updates menu:

- Switch Automatic Updates on and off.
- Schedule and install software updates.
- View software update details.



Press the button next to a menu option for more information.

# Vehicle Software Updates

## Switching Automatic Updates On and Off

Your vehicle may come with Automatic Updates switched on. To make sure your vehicle always has the latest software, which could include security or other enhancements, we recommend switching Automatic Updates on.

**Note:** *Software updates require approval to download or install with Automatic Updates switched off.*

## Scheduling and Installing Software Updates

### Scheduling Software Updates

From the Software Updates menu:

1. Press **Recurring Schedule**.
2. Select the days and time for updates.

The more days that updates are scheduled, the more frequently your vehicle installs new updates when available. We recommend selecting a time you normally do not need your vehicle, such as overnight.

Some updates require your vehicle to be switched off.

**Note:** *The schedule you set is recurring. If Automatic Updates is on, every time a non-drivable update is available, it installs on this schedule unless you change it. You are notified on your touchscreen and connected device prior to a non-drivable update, with an option to reschedule it.*

### Installing Software Updates

#### Using the Status Bar

1. Press a Software Update indicator on your touchscreen when it appears.
2. Follow the instructions on the touchscreen.

#### Using the Touchscreen

From the Software Updates menu:

1. Press **Update Details**.
2. Press **Update Now**.

#### Viewing Software Update Details

From the Software Updates menu, press **Update Details**.

## SOFTWARE UPDATE INDICATORS

You can press the indicators in the status bar when they appear for more information.



Vehicle software update reminder, schedule required, confirmation of default schedule required, or consent required.



Vehicle software update canceled, update not successful, or precondition not met.



Vehicle software update successful.



# Vehicle System Reset

---

## PERFORMING A SYSTEM RESET

Performing a system reset allows you to remove all personal information and restore settings to their factory defaults.

1. Press **Settings** on the touchscreen.
2. Press **General**.
3. Press **Reset**.
4. Press **Factory Reset**.
5. Follow the prompts on the screen to complete the reset.

# Accessories

---

For a complete listing of the accessories that are available for your vehicle, please contact your authorized dealer or visit the online store web site:

<b>Web Address (United States)</b>
------------------------------------

<a href="http://www.Accessories.Ford.com">www.Accessories.Ford.com</a>
--

<b>Web Address (Canada)</b>
-----------------------------

<a href="http://www.Accessories.Ford.ca">www.Accessories.Ford.ca</a>
--

We will repair or replace any properly authorized dealer-installed Ford Original Accessory found to be defective in factory-supplied materials or workmanship during the warranty period, as well as any component damaged by the defective accessories.

We will warrant your Ford Original Accessory through the warranty that provides the greatest benefit:

- 24 months, unlimited mileage.
- The remainder of your new vehicle limited warranty.

Contact an authorized dealer for details and a copy of the warranty.

Ford Licensed Accessories are the accessory manufacturer's designs. The manufacturer develops and therefore warrants Ford Licensed Accessories, and does not design or test these accessories to Ford Motor Company engineering requirements.

Contact an authorized Ford dealer for the manufacturer's limited warranty details, and request a copy of the Ford Licensed Accessories product limited warranty from the accessory manufacturer.

Most Ford Performance Parts are sold with no warranty, unless otherwise indicated. Check the Ford Performance Part website: [www.performanceparts.ford.com](http://www.performanceparts.ford.com) or contact the Ford Performance Parts tech-line at (800) FORD788 for the latest limited warranty information on specific products.

For maximum vehicle performance, keep the following information in mind when adding accessories or equipment to your vehicle:

- When adding accessories, equipment, passengers and luggage to your vehicle, do not exceed the total weight capacity of the vehicle or of the front or rear axle (GVWR or GAWR as indicated on the Safety Compliance Certification label). Ask an authorized dealer for specific weight information.
- The Federal Communications Commission (FCC) and Canadian Radio Telecommunications Commission (CRTC) regulate the use of mobile communications systems that are equipped with radio transmitters, for example two-way radios, telephones and theft alarms. Any such equipment installed in your vehicle should comply with Federal Communications Commission (FCC) and Canadian Radio Telecommunications Commission (CRTC) regulations and should be installed only by an authorized dealer.

# Accessories

---

- An authorized dealer needs to install mobile communications systems. Improper installation may harm the operation of your vehicle, particularly if the manufacturer did not design the mobile communication system specifically for automotive use.
- If you or an authorized Ford dealer add any non-Ford electrical or electronic accessories or components to your vehicle, you may adversely affect battery performance and durability. In addition, you may also adversely affect the performance of other electrical systems in the vehicle.

# Auxiliary Switches (If Equipped)

## WHAT ARE THE AUXILIARY SWITCHES

The auxiliary switchboard on the overhead console makes aftermarket customization easier with six prewired switches connected to the power distribution box. Each circuit is individually fused for connection of electrical accessories. For more information on connecting accessories to the auxiliary switches, see your authorized dealer or refer to the Body and Equipment Mounting Manual (BEMM), if available.

For maximum vehicle performance, keep the following information in mind when adding accessories or equipment to your vehicle:

- When adding accessories, equipment, passengers and luggage to your vehicle, do not exceed the total weight capacity of the vehicle or of the front or rear axle (GVWR or GAWR as indicated on the safety compliance certification label). Ask an authorized dealer for specific weight information.
- It is your responsibility to ensure that any equipment you have fitted complies with applicable local legislation.
- An authorized dealer needs to install mobile communication systems. Improper installation may harm the operation of your vehicle, particularly if the manufacturer did not design the mobile communication system specifically for automotive use.
- If you or an authorized dealer add any electrical or electronic accessories or components not produced by us to your vehicle, you may adversely affect battery performance and durability. In addition, you may also adversely affect the performance of the other electrical systems in the vehicle.

## LOCATING THE AUXILIARY SWITCHES

The switches are labeled AUX 1 through AUX 6.



The auxiliary switches only operate when the ignition is in the on or off position and the delay accessory is active, whether the engine is running or not.

We recommend that you leave the engine running to maintain battery charge when using the switches for an extended time or when using higher current draw accessories.

When a switch is turned on, the yellow indicator light on the switch illuminates and the circuit provides power to the device wired to that switch.

# Ford Protect

---

## WHAT IS FORD PROTECT

Ford Protect vehicle service contracts are the only service contracts 100% backed by Ford Motor Company. Protect yourself from unforeseen covered repairs with a Ford Protect extended service plan.

### Ford Protect Extended Service Plans - United States Only

You can drive on with confidence as Ford Protect extended service plans provide more protection beyond the New Vehicle Limited Warranty. When you visit your Ford Dealer, insist on a Ford Protect extended service plan.

### Ford Protect Can Quickly Pay for Itself

One repair bill can easily exceed the price of your Ford Protect extended service plan. With the Ford Protect extended service plan, you have peace of mind from unforeseen covered repairs.

### Up to 1,000+ Covered Vehicle Components

There are four mechanical Ford Protect extended service plans with different levels of coverage to fit your individual needs. Ask your Ford dealer for details.

1. PremiumCARE - Our most comprehensive coverage. With over 1,000 covered components, this plan is so complete it is probably easier to list what is not covered.
2. ExtraCARE - Covers 113 components, and includes many high-tech items.
3. BaseCARE - Covers 84 components.
4. PowertrainCARE - Covers 29 critical components.

Ford Protect extended service plans are honored by all authorized Ford dealers in the United States, Canada and Mexico.

That means you get:

- Ford-authorized parts used for covered repairs.
- Factory-trained and certified technicians.
- Rental vehicle benefits for up to 10 days for covered repairs.

### 24-Hour Roadside Assistance

Roadside assistance includes:

- Tire change, lockout, out-of-fuel and battery jump-start assistance.
- Towing Assistance.
- Emergency Travel Expense.
- Destination Assistance.

### Transferable Coverage

If you sell your vehicle before your Ford Protect extended service plan coverage expires, you can transfer any remaining coverage to the new owner.

### Premium Maintenance Plan

It is more than just a routine oil change. Keep your vehicle running at its optimum performance with a Ford Protect Premium Maintenance extended service plan. The coverage is prepaid, so you never have to worry about the future cost of your vehicle's maintenance.

Premium Maintenance covers these important maintenance items:

- Engine oil and filter changes.
- Multi-point inspections.
- Tire rotations.
- Brake pads and linings.
- Shock absorbers and struts.
- Spark plugs.
- Clutch discs-if equipped.

# Ford Protect

---

- Engine belts, coolant hoses and clamps.
- Wiper blades.

This information is subject to change. Visit your local Ford of Canada dealer or [www.ford.ca](http://www.ford.ca) to find the Ford Protect extended service plan that is right for you.

## More Information

To learn more about Ford Protect plans and financing options, please contact your selling Ford Dealer.

## Ford Protect Extended Service Plan - Canada Only

You can get more protection for your vehicle by purchasing a Ford Protect extended service plan. Ford Protect extended service plan is the only service contract backed by Ford Motor Company of Canada, Limited. Depending on the plan you purchase, Ford Protect extended service plan provides benefits such as:

- Rental reimbursement.
- Coverage for certain maintenance and wear items.
- Protection against repair costs after your New Vehicle Limited Warranty Coverage expires.
- Roadside Assistance benefits.

There are several Ford Protect extended service plans available in various time, distance and deductible combinations. Each plan is tailored to fit your own driving needs, including reimbursement for towing and rental. When you purchase a Ford Protect extended service plan, you receive added peace-of-mind protection throughout Canada, the United States and Mexico, provided by a network of participating authorized Ford Motor Company dealers.

**Note:** *Repairs performed outside of Canada and the United States are not eligible for Ford Protect extended service plan coverage.*

# Scheduled Maintenance

## Intelligent Oil-Life Monitor™

Your vehicle has an Intelligent Oil-Life Monitor that determines when you should change the engine oil based on how you use your vehicle. By using several important factors in its calculations, the monitor helps reduce the cost of owning your vehicle and reduces environmental waste at the same time.

This means you do not have to remember to change the oil on a mileage-based schedule. Your vehicle lets you know when an oil change is due by displaying a message in the instrument cluster display.

The following table provides examples of vehicle use and its impact on oil change intervals. It is a guideline only. Actual oil change intervals depend on several factors and generally decrease with severity of use.

## Maintenance Intervals

<b>At Every Oil Change Interval as Indicated by the Information Display<sup>1</sup></b>
Change the engine oil and filter. <sup>2</sup>
Rotate the tires, inspect tire wear and measure the tread depth.
Perform a multi-point inspection, recommended.
Inspect the automatic transmission fluid level, if applicable with dipstick. Consult your dealer for requirements.
Inspect the brake pads, shoes, rotors, drums, brake linings, hoses and the parking brake.
Inspect the engine coolant system strength and hoses.
Inspect the exhaust system and heat shields.
Inspect the front axle and U-joints. Lubricate grease fittings in applicable.
Inspect the halfshaft boots.
Inspect the steering linkage, ball joints, suspension, tie-rod ends, driveshaft and the U-joints. Lubricate any areas with grease fittings.
Inspect the wheels and related components for abnormal noise, wear, looseness or drag.
Inspect cabin air filter if equipped, service as required.
Inspect engine air filter, service as required.

<sup>1</sup> Do not exceed one year or 16,000 km (10,000 mi) between service intervals.

<sup>2</sup> Intelligent Oil-Life Monitor after engine oil and filter changes. See **Resetting the Intelligent Oil Life Monitor** (page 346).

# Scheduled Maintenance

<b>Brake Fluid Maintenance<sup>1</sup></b>	
Every three years.	Change the brake fluid. <sup>2</sup>

<sup>1</sup> Perform this maintenance item every three years. Do not exceed the designated time for the interval.

<sup>2</sup> Brake fluid servicing requires special equipment available at your authorized dealer.

<b>Other Maintenance Items<sup>1</sup></b>	
Every 32,000 km (20,000 mi)	Replace the cabin air filter.
Every 48,000 km (30,000 mi)	Replace the engine air filter. For severe service, change the front axle fluid. For severe service, change the transfer case fluid.
Every 96,000 km (60,000 mi)	For severe service, replace the spark plugs.
Every 160,000 km (100,000 mi)	Replace the spark plugs.
	Inspect the accessory drive belt(s). <sup>2</sup>
Every 240,000 km (150,000 mi)	Change the automatic transmission fluid and filter.
	Change the manual transmission fluid.
	Change the front axle fluid.
	Change the rear axle fluid.
	Change the transfer case fluid.
At 322,000 km (200,000 mi)	Replace the accessory drive belt(s).
	Change the engine coolant. <sup>3</sup>

<sup>1</sup> Perform these maintenance items within 4,800 km (3,000 mi) of the last engine oil and filter change. Do not exceed the designated distance for the interval.

<sup>2</sup> After initial inspection, inspect every other oil change until replaced.

<sup>3</sup> Initial replacement at 10 years or 322,000 km (200,000 mi), then every 5 years or 160,000 km (100,000 mi).



# Scheduled Maintenance

---

## Exceptions

There are several exceptions to the schedule:

### Axle and Transfer Case Maintenance

The transfer case, front and rear axles in your vehicle do not require scheduled maintenance. They are more likely to require a fluid change if the vehicle has experienced extended periods of extreme or severe duty cycle driving. Changing or checking the transfer case, front and/or rear axle lubricant is not necessary unless the unit has been submerged in water or shows signs of leakage. Contact your authorized dealer for service.

### California Fuel Filter Replacement

If you register your vehicle in California, the California Air Resources Board has determined that the failure to perform this maintenance item does not nullify the emission warranty or limit recall liability before the completion of your vehicle's useful life. Ford Motor Company, however, urges you to have all recommended maintenance services performed at the specified intervals and to record all vehicle service.

### Hot Climate Oil Change Intervals

Vehicles operating in the Middle East, North Africa, Sub-Saharan Africa or locations with similar climates using an American Petroleum Institute (API) Certified for Gasoline Engines (Certification mark) oil of SM or SN quality, the oil change interval is 4,800 km (3,000 mi).

### Engine Air Filter and Cabin Air Filter Replacement

The life of the engine air filter and cabin air filter is dependent on exposure to dusty and dirty conditions. Vehicles operated in these conditions require frequent inspection and replacement of the engine air filter and cabin air filter.

### What Are Considered Severe Driving Conditions

A vehicle that is driven for short trips of less than 5–10 mi (8–16 km), driving in temperatures well below or above average, driving in any dusty conditions, idling more than recommended such as in traffic, and driving with a heavy load or while towing a load are considered severe driving conditions. If the vehicle is driven in any of these conditions, follow the severe service maintenance items listed in the scheduled maintenance chart.

## GENERAL MAINTENANCE INFORMATION

### Why Maintain Your Vehicle?

Carefully following the maintenance schedule helps protect against major repair expenses resulting from neglect or inadequate maintenance and may help to increase the value of your vehicle when you sell or trade it. Keep all receipts for completed maintenance with your vehicle.

It is important that you have your vehicle serviced at the proper times. These intervals serve two purposes: first is to maintain the reliability of your vehicle and the second is to keep the cost of owning your vehicle down.

# Scheduled Maintenance

---

It is your responsibility to have all scheduled maintenance performed and to make sure that the materials used meet the specifications identified in this owner's manual.

Failure to perform scheduled maintenance and regularly inspect your vehicle may result in vehicle damage not covered by the vehicle Warranty.

## Why Maintain Your Vehicle at Your Dealership?

### Our Genuine Replacement Parts

Dealerships stock our parts and our authorized branded remanufactured replacement parts. These parts meet or exceed our specifications. Parts installed at your dealership carry a nationwide 24-month or unlimited mile (kilometer) parts and labor limited warranty.

If you do not use our authorized parts, they may not meet our specifications and could affect emissions compliance.

### Protecting Your Investment

Maintenance is an investment that pays dividends in the form of improved reliability, durability and resale value. To maintain the proper performance of your vehicle and its emission control systems, make sure you have scheduled maintenance performed at the designated intervals.

Your vehicle comes with the Intelligent Oil-Life Monitor system, a message appears in the instrument cluster display at the proper oil change interval. This interval may be up to one year or 16,000 km (10,000 mi), hybrid vehicles could exceed 16,000 km (10,000 mi).

When the oil change message appears in the instrument cluster display, it is time for an oil change. Make sure you perform the oil change within two weeks or 800 km (500 mi) of the message appearing. Make sure to reset the Intelligent Oil-Life Monitor after each oil change. See **Resetting the Intelligent Oil Life Monitor** (page 346).

If your instrument cluster display resets prematurely or becomes inoperative, you should perform the oil change interval at six months or 8,000 km (5,000 mi) from your last oil change. Never exceed one year or 16,000 km (10,000 mi) between oil change intervals.

You can drive your vehicle in such a way that may lead to higher oil consumption including extended time at high engine speeds, high loads, engine braking, hard cornering maneuvers, track and off-road usage. Under these conditions, oil consumption of approximately 1 quart per 500 miles (1 liter per 800 km) is possible. Check the engine oil level at every refueling and adjust to maintain proper levels to avoid engine damage.

You can also drive your vehicle in such a way that dilutes and increases the level of oil by frequent short trips that do not allow the engine to get to operating temperature, extended idling and low speed driving for long periods of time.

It is important to rely upon your dealership to properly diagnose and repair your vehicle.

We strongly recommend only using our genuine or our authorized re-manufactured replacement parts engineered for your vehicle.

### Additives and Chemicals

We do not recommend using chemicals or additives not approved by us as part of your vehicle's normal maintenance. Please consult your warranty information.

# Scheduled Maintenance

## Oils, Fluids and Flushing

In many cases, fluid discoloration is a normal operating characteristic and, by itself, does not necessarily indicate a concern or that the fluid needs to be changed. Have discolored fluids that also show signs of overheating or foreign material contamination checked immediately.

Make sure to change the vehicle's oils and fluids at the specified intervals or in conjunction with a repair. Flushing is a viable way to change fluid for many vehicle sub-systems during scheduled maintenance. It is critical that systems are flushed only with new fluid that is the same as that required to fill and operate the system or using our approved flushing chemical.

## Scheduled Maintenance Service Intervals

For your scheduled maintenance service intervals, visit <https://www.ford.com/support/maintenance-schedule>.

## Owner Checks and Services

Make sure you perform the following basic maintenance checks and inspections.

<b>Check Every Month</b>
The engine oil level.
Function of all interior and the exterior lights.
The tires including the spare for wear and proper pressure.
The windshield washer fluid level.

<b>Check Every Six Months</b>
The battery connections. Clean if necessary.
The body and door drain holes for obstructions. Clean if necessary.
The cooling system fluid level and the coolant system strength.
The door weatherstrips for wear. Lubricate if necessary.
The hinges, latches and outside locks for proper operation. Lubricate if necessary.
The parking brake for proper operation.
The seatbelts and seat latches for wear and function.

## Scheduled Maintenance

### Check Every Six Months

Safety warning lamps, brake, ABS, airbag and seatbelt for operation.

The washer spray and wiper operation. Clean or replace blades as necessary.

The Roof system weatherstrips for wear and dirt. Clean and lubricate if necessary.

### Multi-Point Inspection

It is important to have the systems on your vehicle regularly checked. This can help identify potential issues and prevent major problems. We recommend having the following multi-point inspection performed at every scheduled maintenance interval to help make sure your vehicle keeps running great.

#### Multi-Point Inspection

Accessory drive belt or belts	Hazard warning system operation
Battery performance	Horn operation
Engine air filter	Radiator, cooler, heater and air conditioning hoses
Exhaust system	Suspension components for leaks or damage
Exterior lamps operation	Steering and linkage
Fluid levels <sup>1</sup> ; fill if necessary	Tires including the spare for wear and proper pressure <sup>2</sup>
For oil and fluid leaks	Windshield for cracks, chips or pits
Halfshaft dust boots	Washer spray and wiper operation

<sup>1</sup> Brake, coolant recovery reservoir, automatic transmission and window washer.

<sup>2</sup> If your vehicle has a temporary mobility kit, check the tire sealant expiration Use By date on the canister. Replace as needed.

# Scheduled Maintenance

---

Be sure to ask your dealership service advisor or technician about the multi-point vehicle inspection. It is a comprehensive way to perform a thorough inspection of your vehicle. Your checklist gives you immediate feedback on the overall condition of your vehicle.

## **Severe Driving Conditions**

A vehicle that is driven for short trips of less than 8–16 km (5–10 mi) miles, driving in temperatures greatly below or above average, driving in any dusty conditions, idling more than recommended such as in traffic, and driving with a heavy load or while towing a load are considered severe driving conditions. If you drive your vehicle in any of these conditions, follow the severe service maintenance items listed in the scheduled maintenance chart.

# Customer Information

## ROLLOVER WARNING



**WARNING:** Utility vehicles have a significantly higher rollover rate than other types of vehicles.



**WARNING:** Vehicles with a higher center of gravity (utility and four-wheel drive vehicles) handle differently than vehicles with a lower center of gravity (passenger cars). Avoid sharp turns, excessive speed and abrupt steering in these vehicles. Failure to drive cautiously increases the risk of losing control of your vehicle, vehicle rollover, personal injury and death.



**WARNING:** In a rollover crash, an unbelted person is significantly more likely to die than a person wearing a seatbelt.



**WARNING:** Do not become overconfident in the ability of four-wheel drive vehicles. Although a four-wheel drive vehicle may accelerate better than a two-wheel drive vehicle in low traction situations, it won't stop any faster than two-wheel drive vehicles. Always drive at a safe speed.

Utility vehicles and trucks handle differently than passenger cars in the various driving conditions that are encountered on streets, highways and off-road. Utility vehicles and trucks are not designed for cornering at speeds as high as passenger cars any more than low-slung sports cars are designed to perform satisfactorily under off-road conditions.

## THE BETTER BUSINESS BUREAU AUTO LINE PROGRAM

Your satisfaction is important to Ford Motor Company and to your dealer. If a warranty concern has not been resolved using the three-step procedure outlined earlier in this chapter in the Getting the Services you need section, you may be eligible to participate in the BBB AUTO LINE program.

The BBB AUTO LINE program consists of two parts – mediation and arbitration. During mediation, a representative of the BBB will contact both you and Ford Motor Company to explore options for settlement of the claim. If an agreement is not reached during mediation or you do not want to participate in mediation, and if your claim is eligible, you may participate in the arbitration process. An arbitration hearing will be scheduled so that you can present your case in an informal setting before an impartial person. The arbitrator considers the testimony provided and makes a decision after the hearing.

Disputes submitted to the BBB AUTO LINE program are usually decided within 40 days after you file your claim with the BBB. You are not bound by the decision, and may reject the decision and proceed to court where all findings of the BBB Auto Line dispute, and decision, are admissible in the court action. Should you choose to accept the BBB AUTO LINE decision, Ford is then bound by the decision, and must comply with the decision within 30 days of receipt of your acceptance letter.

**BBB AUTO LINE Application:** Using the information that follows, call or write to request a program application. You will be asked for your name and address, general information about your new vehicle, information about your warranty concerns, and any steps you have already taken to

## Customer Information

---

try to resolve them. A Customer Claim Form will be mailed that needs to be completed, signed and returned to the BBB along with proof of ownership. Upon receipt, the BBB reviews the claim for eligibility under the Program Summary Guidelines.

**You can get more information by calling BBB AUTO LINE at 1-800-955-5100, or writing to:**

**BBB AUTO LINE a Division of BBB National Programs, Inc.  
1676 International Drive, Suite 550  
McLean, VA 22102**

BBB AUTO LINE applications can also be requested by calling the Ford Motor Company Customer Relationship Center at 1-800-392-3673.

For additional information, refer to the Better Business Bureau website.

**Note:** *Ford Motor Company reserves the right to change eligibility limitations, modify procedures, or to discontinue this process at any time without notice and without obligation.*

### **THE MEDIATION AND ARBITRATION PROGRAM**

For vehicles delivered to authorized Canadian dealers. In those cases where you continue to feel that the efforts by Ford of Canada and the authorized dealer to resolve a factory-related vehicle service concern have been unsatisfactory, Ford of Canada participates in an impartial third party mediation/arbitration program administered by the Canadian Motor Vehicle Arbitration Plan (CAMVAP).

The CAMVAP program is a straightforward and relatively speedy alternative to resolve a disagreement when all other efforts to produce a settlement have failed. This procedure is without cost to you and is designed to eliminate the need for lengthy and expensive legal proceedings.

In the CAMVAP program, impartial third-party arbitrators conduct hearings at mutually convenient times and places in an informal environment. These impartial arbitrators review the positions of the parties, make decisions and, when appropriate, render awards to resolve disputes. CAMVAP decisions are fast, fair, and final as the arbitrator's award is binding on both you and Ford of Canada.

CAMVAP services are available in all Canadian territories and provinces. For more information, without charge or obligation, call your CAMVAP Provincial Administrator directly at 1-800-207-0685 or visit [www.camvap.ca](http://www.camvap.ca).

### **REPORTING SAFETY DEFECTS IN THE UNITED STATES**

If you believe that your vehicle has a defect which could cause a crash or could cause injury or death, you should immediately inform the National Highway Traffic Safety Administration (NHTSA) in addition to notifying Ford Motor Company.

## Customer Information

---

If NHTSA receives similar complaints, it may open an investigation, and if it finds that a safety defect exists in a group of vehicles, it may order a recall and remedy campaign. However, NHTSA cannot become involved in individual problems between you, your dealer, or Ford Motor Company.

To contact NHTSA, you may call the Vehicle Safety Hotline toll-free at 1-888-327-4236 (TTY: 1-800-424-9153); go to [www.safercar.gov](http://www.safercar.gov); or write to:

Administrator

1200 New Jersey Avenue,  
Southeast

Washington, D.C. 20590

You can also obtain other information about motor vehicle safety from [www.safercar.gov](http://www.safercar.gov).

### **REPORTING SAFETY DEFECTS IN CANADA**

If you believe that your vehicle has a defect which could cause a crash or could cause injury or death, you should immediately inform Transport Canada and Ford of Canada.

<b>Transport Canada Contact Information</b>	
Website (English)	<a href="http://tc.canada.ca/recalls">http://tc.canada.ca/recalls</a>
Website (French)	<a href="http://tc.canada.ca/rappels">http://tc.canada.ca/rappels</a>
Phone	1-800-333-0510

<b>Ford of Canada Contact Information</b>	
Website	<a href="http://www.ford.ca">www.ford.ca</a>
Phone	1-800-565-3673



# Customer Information

## THIRD PARTY SOFTWARE COPYRIGHT ACKNOWLEDGMENT

Your vehicle could have components that use open source software. For additional information, visit <http://corporate.ford.com/ford-open-source.html>.

## RADIO FREQUENCY CERTIFICATION LABELS

### BLIND SPOT INFORMATION SYSTEM SENSORS

Device	Supplier	Type Designation
SRR5 BLIS Corner Radar (RRU2)	Aptiv	2F5TR

### Argentina

15375-23-12270



### China

CMIIT ID: 2023LJ10407

### Djibouti

AGREE PAR LE MCPT (REPUBLIQUE DE DJIBOUTI)

Numéro d'agrément:

040/DDTIC/2024

Date d'agrément:

16/04/2024

H-28070

### Brazil



# Customer Information

## Europe Union EU

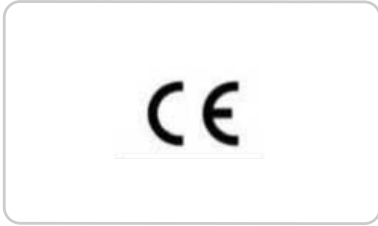

## Mexico

IFT: ROAP2F23-27117

## Morocco

AGREE PAR L'ANRT MAROC

Numéro d'agrément:

MR00036523ANRT2023

Date d'agrément:

30/01/23

## Ghana

NCA APPROVED: 7E6-M0-XDF-TME

## Indonesia

Sertifikat Nomor: 98785/SDPPI/2024  
PLG ID: 13493



## Paraguay



NR: 2022-04-I-0255

## Jamaica

This product has been Type Approved by  
Jamaica: SMA - 2F5TR.

## South Africa

## Mauritania

AGREE PAR L'ANE MAURITANIE

Numéro d'agrément:

1222/ARE/2023

Date d'agrément:

06/02/2023



# Customer Information

---

## South Korea



R-C-1Ap-2F5TR

## Taiwan



CCA123LP0640T2

## United Arab Emirates (U.A.E.)

**TDR** 

ER10085/22  
United Arab Emirates



## United Kingdom



## United States and Canada

FCC ID: L2C2F5TR

IC: 3432A-2F5TR

# Customer Information

This equipment generates, uses, and can radiate radio frequency energy and may cause harmful interference to radio communications. There is no guarantee that interference will not occur in a particular installation. If this equipment does cause harmful interference to radio or television reception, please consult the dealer.

This product is not end-user serviceable.

RF Radiation Exposure Statement: This equipment complies with FCC RF Radiation exposure limits set forth for an uncontrolled environment. This device and its antenna must not be co-located or operating in conjunction with any other antenna or transmitter. This equipment should be installed and operated with a minimum distance of 20cm between the radiator and your body.

This device complies with Part 15 of the FCC Rules and with Innovation, Science and Economic Development Canada's licence-exempt RSS(s). Operation is subject to the following two conditions:

1. This device may not cause harmful interference, and
2. This device must accept any interference received, including interference that may cause undesired operation.

*Le présent appareil est conforme aux CNR d'Industrie Canada applicables aux appareils radio exempts de licence. L'exploitation est autorisée aux deux conditions suivantes:*

- 1. L'appareil ne doit pas produire de brouillage;*
- 2. L'appareil doit accepter tout brouillage radioélectrique subi, même si le brouillage est susceptible d'en compromettre le fonctionnement.*

## BODY CONTROL MODULE

Device	Supplier	Type Designation
BCM GEN1M	Continental	M3NA2C766336

### Argentina



### Brazil



# Customer Information

---

## Ghana

NCA PRODUCT IDENTIFIER: ZRO-M8-7E3-281

## Morocco

AGREE PAR L'ANRT MAROC  
Numéro d'agrément: MR 20148 ANRT 2019  
Date d'agrément: 19/06/2019

## Jamaica

This product has been Type Approved by Jamaica: SMA - M3NA2C766336.

## Paraguay



## Moldova



2019-01-I-000076

## Serbia



# Customer Information

## Singapore

Complies with IMDA Standards

DA 00461

## Ukraine



UA.TR.028

## South Africa



TA-2019/5280

ICASA

APPROVED

## United Arab Emirates (U.A.E.)



ER68566/19

United Arab Emirates



# Customer Information

## United Kingdom



## Vietnam

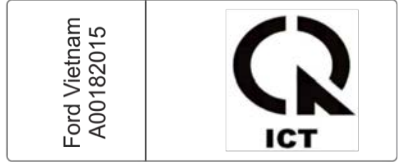

## United States and Canada

 **WARNING:** Changes or modifications not expressly approved by the party responsible for compliance could void the user's authority to operate the equipment. The term "IC:" before the radio certification number only signifies that Industry Canada technical specifications were met.

FCC ID: M3NA2C766336

IC: 7812A-A2C766336

This device complies with Part 15 of the FCC Rules and with Innovation, Science and Economic Development Canada's licence-exempt RSS(s). Operation is subject to the following two conditions:

1. This device may not cause harmful interference, and
2. This device must accept any interference received, including interference that may cause undesired operation.

## Zambia



## CRUISE CONTROL MODULE

Device	Supplier	Type Designation
Mid Range Radar (MRR)	Delphi/Aptiv	L2C0065TR

# Customer Information

---

## Argentina



## European Union EU

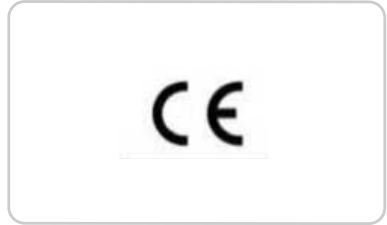

## Brazil



## Ghana

NCA PRODUCT IDENTIFIER: OR2-9H-7E1-x4D

## Djibouti

AGREE PAR LE MCPT (REPUBLIQUE DE DJIBOUTI)  
Numéro d'agrément : 594/dpt/2017  
Date d'agrément : 09/04/2017

## Indonesia

SERTIFIKAT NOMOR : 53104/SDPPI/2017  
PLG ID: 4927





# Customer Information

## Israel

HIDF16000009

1. מספר אישור התאמה מסוג מסדד התקשורת: 51-63483
2. תל אישור לבצע פעולות כמכשיר שיש בהן כדי לשנות את תכונותיו האלחוטיות של המכשיר, ובכלל זה שינוי תוכנה, החלפת אנטנה סקרית או חוספת אפשרות לחיבור לאנטנה חיצונית, בלא קבלת אישור מסדד התקשורת, כשל החשש להפרעות אלחוטיות.

## Mauritania

AGREE PAR L'ANE MAURITANIE

Numéro d'agrément: 0409/ARE/2017

Date d'agrément: 12/04/2017

## Jamaica

This product has been Type Approved  
by Jamaica: SMA - L2C0065TR.

## Malaysia



## Moldova



## Morocco

AGREE PAR L'ANRT MAROC

Numéro d'agrément: MR 13639 ARNT 2017

Date d'agrément: 28/03/2017

# Customer Information

---

## Pakistan



## Singapore

Complies with IMDA Standards  
DA105753

## Paraguay



## South Africa



## Serbia



## South Korea



R-CMM-DLH-L2C0065TR

# Customer Information

---

## Syria

SyTRA  
REGISTERED No:  
FR00085-17

## Ukraine



## Taiwan, China

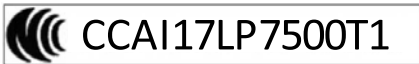

## United Arab Emirates



# Customer Information

---

## United Kingdom



This device complies with Part 15 of the FCC Rules and with Innovation, Science and Economic Development Canada's licence-exempt RSS(s). Operation is subject to the following two conditions:

1. This device may not cause harmful interference, and
2. This device must accept any interference received, including interference that may cause undesired operation.

L'émetteur/récepteur exempt de licence contenu dans le présent appareil est conforme aux CNR d'Innovation, Sciences et Développement économique Canada applicables aux appareils radio exempts de licence. L'exploitation est autorisée aux deux conditions suivantes:

1. L'appareil ne doit pas produire de brouillage;
2. L'appareil doit accepter tout brouillage radioélectrique subi, même si le brouillage est susceptible d'en compromettre le fonctionnement.

**Note:** Changes or modifications not expressly approved by the party responsible for compliance could void the user's authority to operate the equipment.

**Nota:** Tout changement apporté au dispositif sans l'approbation expresse des autorités compétentes pourrait révoquer le droit de l'utilisateur d'en faire usage.

## Zambia



# Customer Information

## PASSIVE KEY

Device	Supplier	Type Designation
Passive Key Transmitter	Continental	A3C108397

## Argentina

*(RAMATEL Isologotype)*



RAMATEL  
H-28042



H-28042



*(RAMATEL Isotype)*



H-28042

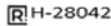

*(RAMATEL Isologotype)*



RAMATEL  
H-29612



H-29612



*(RAMATEL Isotype)*



H-29612

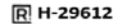

*(RAMATEL Isologotype)*



RAMATEL  
H-30147



H-30147



*(RAMATEL Isotype)*



H-30147

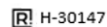

# Customer Information

## Brazil



NR: 2022-03-I-0162

## Serbia

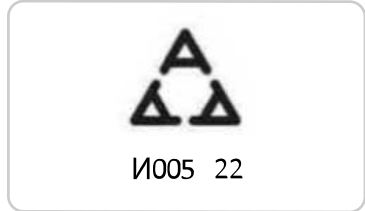

03184-23-06546

## Israel

1. מספר אישור התאמת סטנדרט תקשורת: 51-85634  
2. חל אישור לבצע פעולות במכשיר שישו בהן כדי לשנות את תכונותו האלחוטיות של המכשיר, ובכלל זה שינוי תכונה, החלפת אנטנה סקרית או הוספת אישורת לתיכור לאנטנה חיצונית, כלא קבלת אישור ממשרד התקשורת, ככל הנדרש להסמכות אלחוטית.

## Singapore

Complies with IMDA Standards

Dealer License Number:

DA 00461

## Jamaica

This product has been Type Approved by Jamaica: SMA – M3N-A3C108397

## South Africa



## Paraguay



## Taiwan



# Customer Information

## Thailand

(1) เพื่อแจ้งทราบสถานะและอยู่ภายใต้การดูแลของหน่วยงานที่เกี่ยวข้องของ กทท.

(2) เพื่อแจ้งให้ทราบถึงขั้นตอนการดำเนินการแก้ไขข้อบกพร่องของผลิตภัณฑ์และบริการที่เกี่ยวข้องของ กทท. เพื่อให้สามารถแก้ไขปัญหาได้อย่างมีประสิทธิภาพ

## United Arab Emirates (U.A.E.)



## United Kingdom



## United States and Canada

FCC ID: M3N-A3C108397

IC ID: 7812A-A3C108397

# Customer Information

This device complies with Part 15 of the FCC Rules and with Innovation, Science and Economic Development Canada's licence-exempt RSS(s). Operation is subject to the following two conditions:

1. This device may not cause harmful interference, and
2. This device must accept any interference received, including interference that may cause undesired operation.

L'émetteur/récepteur exempt de licence contenu dans le présent appareil est conforme aux CNR d'Innovation, Sciences et Développement économique Canada applicables aux appareils radio exempts de licence. L'exploitation est autorisée aux deux conditions suivantes:

1. L'appareil ne doit pas produire de brouillage;
2. L'appareil doit accepter tout brouillage radioélectrique subi, même si le brouillage est susceptible d'en compromettre le fonctionnement.

**Note:** Changes or modifications not expressly approved by the party responsible for compliance could void the user's authority to operate the equipment.

**Nota:** Tout changement apporté au dispositif sans l'approbation expresse des autorités compétentes pourrait révoquer le droit de l'utilisateur d'en faire usage.

## RADIO TRANSCEIVER MODULE

Device	Supplier	Type Designation
Radio Transceiver Module (RTM)	Aptiv	FO2-RX433UDA

### Democratic Republic of Congo

Agréé par l'ARPTC

N° d'homologation:

HER - 0151/Septembre/2022

Date d'homologation:

22/09/2022

### Djibouti

AGREE PAR LE MCPT (REPUBLIQUE DE DJIBOUTI)

Numéro d'agrément:

033/DDTIC/2020

Date d'agrément:

07/06/2020



# Customer Information

## Europe Union EU

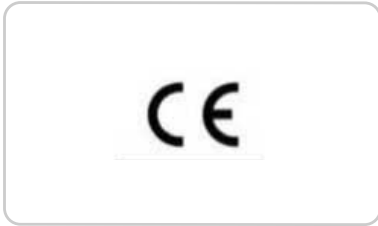

## Israel

1. מספר אישור התאמה מסנים משרד התקשורת: 51-86227
2. חל אישור לבצע פעולות במכשיר שיש בתן כדי לשנות את תכונותיו האלחוטיות של המכשיר, ובכלל זה שינוי תוכנה, החלפת אנטנה מקורית או הוספת אפשרות לחיבור לאנטנה חיצונית, בלא קבלת אישור משרד התקשורת, בשל החשש להפרעת אלחוטיות.

## Ghana

NCA PRODUCT IDENTIFIERS: SRO-1M-7E4-108

1. מספר אישור התאמה מסנים משרד התקשורת: 56-03001
2. חל אישור לבצע פעולות במכשיר שיש בתן כדי לשנות את תכונותיו האלחוטיות של המכשיר, ובכלל זה שינוי תוכנה, החלפת אנטנה מקורית או הוספת אפשרות לחיבור לאנטנה חיצונית, בלא קבלת אישור משרד התקשורת, בשל החשש להפרעת אלחוטיות.

## Jamaica

This product has been Type Approved by Jamaica: SMA – FO2-RX433UDA

## Malaysia

## Independent State of Samoa



HIDF16000009

# Customer Information

## Mauritania

AGREE PAR L'ANE MAURITANIE

Numéro d'agrément:

0803/ARE/2020

Date d'agrément:

03/06/2020

## Morocco

AGREE PAR L'ANE MAROC  
Numéro d'agrément : MR 24102 ANRT 2020  
Date d'agrément : 18/05/2020

## Mexico



IFT: RCPAPFO21-0004

## Pakistan



## Moldova



## Serbia



# Customer Information

## South Africa



## Ukraine



## Taiwan



CCAB22LP1370T1

## Thailand

บริษัท โทรคมนาคมแห่งชาติ จำกัด (มหาชน) ขอสงวนสิทธิ์ในข้อมูลนี้

## United Kingdom



## United Arab Emirates (U.A.E.)



# Customer Information

---

## Zambia



## SYNC

Device	Supplier	Type Designation
SYNC	Ford	SYNC-G4 SYNC-G4L

## Argentina



# Customer Information

---

## Brazil



08657-19-01505

**Este equipamento não tem direito à proteção  
contra interferência prejudicial e não pode causar  
interferência em sistemas devidamente autorizados.**



08658-19-01505

**Este equipamento não tem direito à proteção  
contra interferência prejudicial e não pode causar  
interferência em sistemas devidamente autorizados.**

AGREE PAR LE MCPT (REPUBLIQUE DE DJIBOUTI)  
Numéro d'agrément : 125/DDTIC/2019  
Date d'agrément : 07/08/2019

## European Union EU



## Ghana

## Djibouti

AGREE PAR LE MCPT (REPUBLIQUE DE DJIBOUTI)  
Numéro d'agrément : 124/DDTIC/2019  
Date d'agrément : 07/08/2019

NCA APPROVED: ZRO-1H-7E3-182

NCA APPROVED: ZRO-1H-7E3-180

# Customer Information

---

## Indonesia

Model: SYNC-G4  
Sertifikat Nomor: 80700/SDPPI/2022  
PLG ID: 13493

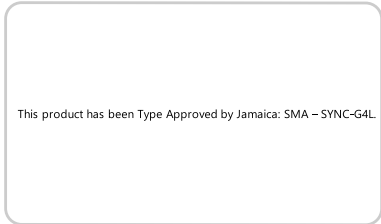

## Malaysia

Model: SYNC-G4L  
Sertifikat Nomor: **81116**/SDPPI/2022  
PLG ID: 13493



## Jamaica

This product has been Type Approved by  
Jamaica: SMA – SYNC-G4.

HIDF16000009

## Mauritania

**AGREE PAR L'ANE MAURITANIE**  
**Numéro d'agrément : 0692/ARE/2018**  
**Date d'agrément : 08/08/2019**

# Customer Information

AGREE PAR L'ANE MAURITANIE  
Numéro d'agrément : 0691/ARE/2018  
Date d'agrément : 08/08/2019

AGREE PAR L'ANRT MAROC  
N° D'AGRÉMENT: MR 20606 ANRT 2019  
07 AOÛT 2019

## Moldova



## Pakistan



## Morocco

AGREE PAR L'ANRT MAROC  
N° D'AGRÉMENT: MR 20608 ANRT 2019  
07 AOÛT 2019

## Paraguay



2020-03-I-00192

2020-03-I-00193

# Customer Information

---

## Serbia



## Singapore

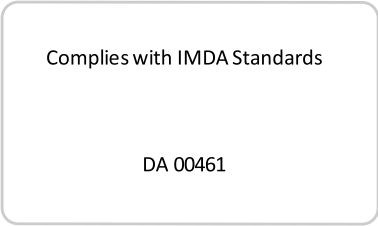

## South Korea



## South Africa



## Taiwan





# Customer Information

---

## Ukraine



CCAB20LP0300T1



UA.TR.028

## United Arab Emirates (U.A.E.)

**TDR**A

ER74903/19  
United Arab Emirates



**TDR**A

ER74902/19  
United Arab Emirates



# Customer Information

## United Kingdom



This device complies with Part 15 of the FCC Rules and with Innovation, Science and Economic Development Canada's licence-exempt RSS(s). Operation is subject to the following two conditions:

1. This device may not cause harmful interference, and
2. This device must accept any interference received, including interference that may cause undesired operation.

## United States and Canada



**WARNING:** Changes or modifications not expressly approved by the party responsible for compliance could void the user's authority to operate the equipment. The term "IC:" before the radio certification number only signifies that Industry Canada technical specifications were met.

FCC ID: KMH-SYNCG4

FCC ID: KMH-SYNCG4L

IC: 1422A-SYNCG4

IC: 1422A-SYNCG4L

## Zambia



## TELEMATICS CONTROL UNIT

Device	Supplier	Type Designation
Telematics Control Unit	Ford	FB5-TCU

# Customer Information

---

## Argentina



C-28150

## Malaysia



HIDF16000009

## Brazil



## Europe Union EU

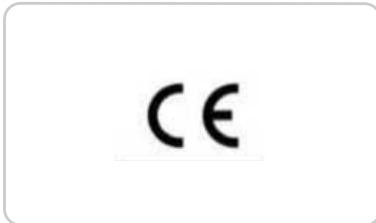

## Mexico



# Customer Information

## South Africa



## Taiwan

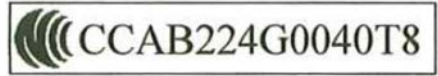

We recommend that the distance between the antenna of the telematics control unit and the user be greater than 35 cm (14 in) when using the telematics control unit.

## United Arab Emirates (U.A.E.)



## United Kingdom



## United States and Canada

FCC ID: KMH-14H074-NA1  
IC: 1422A-14H074NA1

## Customer Information

This device complies with Part 15 of the FCC Rules and with Innovation, Science and Economic Development Canada's licence-exempt RSS(s). Operation is subject to the following two conditions:

1. This device may not cause harmful interference, and
2. This device must accept any interference received, including interference that may cause undesired operation.

L'émetteur/récepteur exempt de licence contenu dans le présent appareil est conforme aux CNR d'Innovation, Sciences et Développement économique Canada applicables aux appareils radio exempts de licence. L'exploitation est autorisée aux deux conditions suivantes:

1. L'appareil ne doit pas produire de brouillage;
2. L'appareil doit accepter tout brouillage radioélectrique subi, même si le brouillage est susceptible d'en compromettre le fonctionnement.

**Note:** Changes or modifications not expressly approved by the party responsible for compliance could void the user's authority to operate the equipment.

**Nota:** Tout changement apporté au dispositif sans l'approbation expresse des autorités compétentes pourrait révoquer le droit de l'utilisateur d'en faire usage.

### Vietnam



### TIRE PRESSURE MONITORING SYSTEM SENSORS

Device	Supplier	Type Designation
Burnell TPM Sensor	Schrader/Sensata	BG2BP4

# Customer Information

---

## Argentina

13309-22-08001



CNC ID: H-28035

## European Union EU



## Brazil



The RED 2014/53/EU (replacing R&TTE Directive 1999/5/EC on 13 June 2016) explicitly states that instructions for intentional radiators include reference to "(a) frequency band(s) in which the radio equipment operates; and (b) maximum radio-frequency power transmitted in the frequency band(s) in which the radio equipment operates," in addition to carrying over the general operational instruction and Declaration of Conformity inclusion requirements from the R&TTE Directive.

Hereby, Schrader Electronics Ltd. declares that the radio equipment type BG2BP4 is in compliance with Directive 2014/53/EU. The full text of the EU declaration of conformity is available at the following internet address:

<https://www.schradertpms.com/en-gb/downloads>

# Customer Information

f=433.92MHz

P<10mW (e.i.r.p)

Schrader Electronics Ltd. 11 Technology Park, Belfast Road, Antrim BT41 1QS, Northern Ireland United Kingdom.

## Israel

1. מספר אישור התאמה מסעם משרד התקשורת: 51-86230  
2. תל אישור לבצע פעולות במשך שיש בהן כדי לשנות את תכונותיו האלחוטיות של המכשיר, ובכלל זה שינוי חובנה, החלפת אנטנה סקורית או חוספת אפשרות לחיבור לאנטנה חיצונית, בלא קבלת אישור משרד התקשורת, בשל החשש להפרות אלחוטיות.

## Jamaica

This product has been Type Approved by Jamaica: SMA - BG2BP4.

## Malaysia



HIDF16000009

## Mexico

IFT: RLVSCBG22-2502

## Moldova



## Morocco

AGREE PAR L'ANRT MAROC

Numéro d'agrément:  
MR00034968ANRT2022

Date d'agrément: 21/12/2022

## Paraguay



# Customer Information

NR: 2022-05-I-0000331

## South Korea

### Serbia

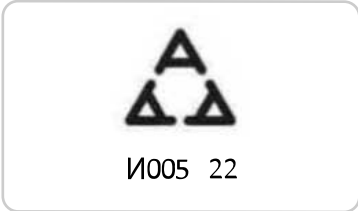

MSIP-R-C-SRD-BG2BP4

### Singapore

Complies with IMDA Standards

DA 00461

## Taiwan



CCAB22LP0730T0

## Thailand

### South Africa



- (1) เครื่องใช้โทรคมนาคมและอุปกรณ์นี้มีความสอดคล้องตามข้อกำหนดของ กทท.
- (2) เครื่องใช้โทรคมนาคมและอุปกรณ์นี้ผ่านการประเมินผลให้เป็นที่สอดคล้องของมาตรฐานความปลอดภัยของสุขภาพของมนุษย์จากการใช้เพื่อวัตถุประสงค์ในการใช้งานที่โทรคมนาคมแห่งชาติประเทศไทย



## Customer Information

---

### Ukraine



### Unites Arab Emirates (U.A.E.)



### United Kingdom



### United States and Canada

FCC ID: MRXBG2BP4

IC: 2546A-BG2BP4

# Customer Information

This device complies with Part 15 of the FCC Rules and with Innovation, Science and Economic Development Canada's licence-exempt RSS(s). Operation is subject to the following two conditions:

1. This device may not cause harmful interference, and
2. This device must accept any interference received, including interference that may cause undesired operation.

L'émetteur/récepteur exempt de licence contenu dans le présent appareil est conforme aux CNR d'Innovation, Sciences et Développement économique Canada applicables aux appareils radio exempts de licence. L'exploitation est autorisée aux deux conditions suivantes:

1. L'appareil ne doit pas produire de brouillage;
2. L'appareil doit accepter tout brouillage radioélectrique subi, même si le brouillage est susceptible d'en compromettre le fonctionnement.

**Note:** Changes or modifications not expressly approved by the party responsible for compliance could void the user's authority to operate the equipment.

**Nota:** Tout changement apporté au dispositif sans l'approbation expresse des autorités compétentes pourrait révoquer le droit de l'utilisateur d'en faire usage.

## TIRE PRESSURE MONITORING SYSTEM SENSORS

Device	Supplier	Type Designation
434 Faraday Gen 6 TPMS Sensor	Schrader/Sensata	FP4

### Argentina



### China

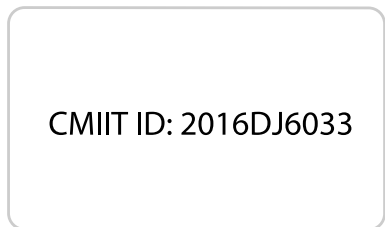

# Customer Information

---

## Democratic Republic of Congo

Agréé par l'ARPTC

N° d'homologation: HIR-0099/09/2016

Date d'homologation: 15/09/2016

## Djibouti

AGREE PAR LE MCPT  
(REPUBLIQUE DE DJIBOUTI)  
Numéro d'agrément : 547/MCPT/DPT/16  
Date d'agrément : 27/09/16

## European Union (EU)

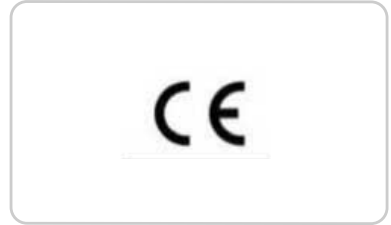

The RED 2014/53/EU (replacing R&TTE Directive 1999/5/EC on 13 June 2016) explicitly states that instructions for intentional radiators include reference to "(a) frequency band(s) in which the radio equipment operates; and (b) maximum radio-frequency power transmitted in the frequency band(s) in which the radio equipment operates," in addition to carrying over the general operational instruction and Declaration of Conformity inclusion requirements from the R&TTE Directive.

Hereby, Schrader Electronics Ltd. declares that the radio equipment type FP4 is in compliance with Directive 2014/53/EU. The full text of the EU declaration of conformity is available at the following internet address:

<https://www.schradertpms.com/en-gb/downloads>

f=433.92MHz

P<10mW (e.i.r.p)

Schrader Electronics Ltd. 11 Technology Park, Belfast Road, Antrim BT41 1QS, Northern Ireland United Kingdom.

# Customer Information

## Ghana

NCA APPROVED: 2R9-8M-7E0-0BE

## Independent State of Samoa



## Israel

1. מספר אישור התאמה מסמך משרד התקשורת: 51-83847
2. חל איסור לבצע פעולות במכשיר שיש בהן כדי לשנות את חבונותיו האלחוטיות של המכשיר, ובכלל זה שינויי חובנה, החלפת אנטנה מקורית או הוספת אנטנות לחיבור לאנטנה חיצונית, כלא קבלת אישור משרד התקשורת, כשל החשש להפרעת אלחוטיות.

## Jamaica

This product has been Type Approved by  
Jamaica: SMA - FP4.

## Mauritania

AGREE PAR L'ANE MAURITANIE  
Numéro d'agrément : 0358/ARE/2016  
Date d'agrément : 04/10/2016

## Moldova



## Nigeria

Connection and use of this  
communications  
equipment is permitted by the Nigerian  
Communications Commission

# Customer Information

---

## Oman

OMAN TRA  
TA-R/3591/16  
D080134

## Pakistan



## Paraguay



## Serbia

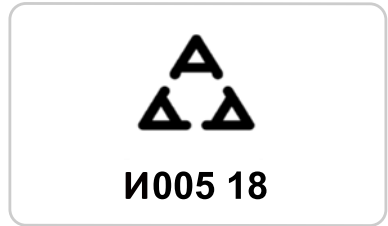

## Sierra Leone



TAN: 2016-002-0035

## South Korea



## Customer Information

---

### Ukraine



### United Arab Emirates (U.A.E.)



### United Kingdom



### United States and Canada

FCC ID: MRXFP4

IC: 2546A-FP4

# Customer Information

---

This device complies with Part 15 of the FCC Rules and with Innovation, Science and Economic Development Canada's licence-exempt RSS(s). Operation is subject to the following two conditions:

1. This device may not cause harmful interference, and
2. This device must accept any interference received, including interference that may cause undesired operation.

L'émetteur/récepteur exempt de licence contenu dans le présent appareil est conforme aux CNR d'Innovation, Sciences et Développement économique Canada applicables aux appareils radio exempts de licence. L'exploitation est autorisée aux deux conditions suivantes:

1. L'appareil ne doit pas produire de brouillage;
2. L'appareil doit accepter tout brouillage radioélectrique subi, même si le brouillage est susceptible d'en compromettre le fonctionnement.

**Note:** Changes or modifications not expressly approved by the party responsible for compliance could void the user's authority to operate the equipment.

**Nota:** Tout changement apporté au dispositif sans l'approbation expresse des autorités compétentes pourrait révoquer le droit de l'utilisateur d'en faire usage.

## PERCHLORATE

Certain components in your vehicle such as airbag modules, seatbelt pretensioners and remote control batteries may contain perchlorate material. Special handling may apply for service or vehicle end of life disposal.

For more information visit:  
[www.dtsc.ca.gov/hazardouswaste/perchlorate](http://www.dtsc.ca.gov/hazardouswaste/perchlorate).

## REPLACEMENT PARTS RECOMMENDATION

We have built your vehicle to the highest standards using quality parts. We recommend that you demand the use of genuine Ford and Motorcraft parts whenever your vehicle requires scheduled maintenance or repair. You can clearly identify genuine Ford and Motorcraft parts by looking for the Ford, FoMoCo or Motorcraft branding on the parts or their packaging.

## Scheduled Maintenance and Mechanical Repairs

One of the best ways for you to make sure that your vehicle provides years of service is to have it maintained in line with our recommendations using parts that conform to the specifications detailed in this Owner's Manual.

Genuine Ford and Motorcraft parts meet or exceed these specifications.

## Collision Repairs

We hope that you never experience a collision, but accidents happen sometimes.

Genuine Ford replacement collision parts meet our stringent requirements for fit, finish, structural integrity, corrosion protection and dent resistance. During vehicle development we validate that these parts deliver the intended level of protection as a whole system. A great way to know for sure you are getting this level of protection is to use genuine Ford replacement collision parts.

# Customer Information

---

## Warranty on Replacement Parts

Genuine Ford and Motorcraft replacement parts are the only replacement parts that benefit from a Ford Warranty.

The Ford Warranty may not cover damage caused to your vehicle as a result of failed non-Ford parts.

For additional information, refer to the terms and conditions of the Ford Warranty.

## MOBILE COMMUNICATIONS EQUIPMENT



**WARNING:** Driving while distracted can result in loss of vehicle control, crash and injury. We strongly recommend that you use extreme caution when using any device that may take your focus off the road. Your primary responsibility is the safe operation of your vehicle. We recommend against the use of any hand-held device while driving and encourage the use of voice-operated systems when possible. Make sure you are aware of all applicable local laws that may affect the use of electronic devices while driving.

Using mobile communications equipment is becoming increasingly important in the conduct of business and personal affairs. However, you must not compromise your own or others' safety when using such equipment. Mobile communications can enhance personal safety and security when appropriately used, particularly in emergency situations. Safety must be paramount when using mobile communications equipment to avoid negating these benefits. Mobile communication equipment includes, but is not limited to, cellular phones, pagers, portable email devices, text messaging devices and portable two-way radios.

## FEDERAL HIGHWAY ADMINISTRATION REGULATION

Regulations such as those issued by the Federal Highway Administration or issued pursuant to the Occupational Safety and Health Act (OSHA), and state and local laws and regulations may require additional equipment for the way you intend to use your vehicle. It is the responsibility of the registered owner to determine the applicability of such laws and regulations to your intended use for the vehicle, and to arrange for the installation of required equipment. The dealer has information about the availability of equipment which can be ordered for your vehicle.



# Customer Information

## END USER LICENSE AGREEMENT

### VEHICLE SOFTWARE END USER LICENSE AGREEMENT (EULA)

- You ("You" or "Your" as applicable) have acquired a vehicle having several devices, including SYNC ® and various control modules, ("DEVICES") that include software licensed or owned by Ford Motor Company and its affiliates ("FORD MOTOR COMPANY"). Those software products of FORD MOTOR COMPANY origin, as well as associated media, printed materials, and "online" or electronic documentation ("SOFTWARE") are protected by international intellectual property laws and treaties. The SOFTWARE is licensed, not sold. All rights reserved.
- The SOFTWARE may interface with and/or communicate with, or may be later upgraded to interface with and/or communicate with additional software and/or systems provided by FORD MOTOR COMPANY.

**IF YOU DO NOT AGREE TO THIS END USER LICENSE AGREEMENT ("EULA") DO NOT USE THE DEVICES OR COPY THE SOFTWARE. ANY USE OF THE SOFTWARE, INCLUDING BUT NOT LIMITED TO USE ON THE DEVICES, WILL CONSTITUTE YOUR AGREEMENT TO THIS EULA (OR RATIFICATION OF ANY PREVIOUS CONSENT).**

**GRANT OF SOFTWARE LICENSE:** This EULA grants you the following license:

- You may use the SOFTWARE as installed on the DEVICES and as otherwise interfacing with systems and/or services provide by or through FORD MOTOR COMPANY or its third party software and service providers.

## Description of Other Rights and Limitations.

- **Speech Recognition:** If the SOFTWARE includes speech recognition component(s), you should understand that speech recognition is an inherently statistical process and that recognition errors are inherent in the process. Neither FORD MOTOR COMPANY nor its suppliers shall be liable for any damages arising out of errors in the speech recognition process. It is your responsibility to monitor any speech recognition functions included in the system.
- **Limitations on Reverse Engineering, Decompilation and Disassembly:** You may not reverse engineer, decompile, translate, disassemble or attempt to discover any source code or underlying ideas or algorithms of the SOFTWARE nor permit others to reverse engineer, decompile or disassemble the SOFTWARE, except and only to the extent that such activity is expressly permitted by applicable law notwithstanding this limitation or to the extent as may be permitted by the licensing terms governing use of any open source components included with the SOFTWARE.
- **Limitations on Distributing, Copying, Modifying and Creating Derivative Works:** You may not distribute, copy, make modifications to or create derivative works based on the SOFTWARE, except and only to the extent that such activity is expressly permitted by applicable law notwithstanding this limitation or to the extent as may be permitted by the licensing terms governing use of any open source components included with the SOFTWARE.

# Customer Information

---

- **Single EULA:** The end user documentation for the DEVICES and related systems and services may contain multiple EULAs, such as multiple translations and/or multiple media versions (e.g., in the user documentation and in the software). Even if you receive multiple EULAs, you are licensed to use only one (1) copy of the SOFTWARE.
- **SOFTWARE Transfer:** You may permanently transfer your rights under this EULA only as part of a sale or transfer of the DEVICES, provided you retain no copies, you transfer all of the SOFTWARE (including all component parts, the media and printed materials, any upgrades, and, if applicable, the Certificate(s) of Authenticity), and the recipient agrees to the terms of this EULA. If the SOFTWARE is an upgrade, any transfer must include all prior versions of the SOFTWARE.
- **Termination:** Without prejudice to any other rights, FORD MOTOR COMPANY may terminate this EULA if you fail to comply with the terms and conditions of this EULA.
- **Internet-Based Services Components:** The SOFTWARE may contain components that enable and facilitate the use of certain Internet-based services. You acknowledge and agree that FORD MOTOR COMPANY, third party software and service suppliers, its affiliates and/or its designated agent may automatically check the version of the SOFTWARE and/or its components that you are utilizing and may provide upgrades or supplements to the SOFTWARE that may be automatically downloaded to your DEVICES.
- **Additional Software/Services:** The SOFTWARE may permit FORD MOTOR COMPANY, third party software and service suppliers, its affiliates and/or its designated agent to provide or make available to you SOFTWARE updates, supplements, add-on components, or Internet-based services components of the SOFTWARE after the date you obtain your initial copy of the SOFTWARE ("Supplemental Components".) SOFTWARE updates may cause you to incur additional charges from your wireless service provider. If FORD MOTOR COMPANY or third party software and services suppliers provide or make available to you Supplemental Components and no other EULA terms are provided along with the Supplemental Components, then the terms of this EULA shall apply. FORD MOTOR COMPANY, its affiliates and/or its designated agent reserve the right to discontinue without liability any Internet-based services provided to you or made available to you through the use of the SOFTWARE.

# Customer Information

---

- **Links to Third Party Sites:** The SOFTWARE may provide you with the ability to link to third party sites. The third party sites are not under the control of FORD MOTOR COMPANY, its affiliates and/or its designated agent. Neither FORD MOTOR COMPANY nor its affiliates nor its designated agent are responsible for (i) the contents of any third party sites, any links contained in third party sites, or any changes or updates to third party sites, or (ii) webcasting or any other form of transmission received from any third party sites. If the SOFTWARE provides links to third party sites, those links are provided to you only as a convenience, and the inclusion of any link does not imply an endorsement of the third party site by FORD MOTOR COMPANY, its affiliates and/or its designated agent.
- **Obligation to Drive Responsibly:** You recognize your obligation to drive responsibly and keep attention on the road. You will read and abide with the DEVICES operating instructions particularly as they pertain to safety and you agree to assume any risk associated with the use of the DEVICES.

## **UPGRADES AND RECOVERY MEDIA:**

If the SOFTWARE is provided by FORD MOTOR COMPANY separate from the DEVICES on media such as a ROM chip, CD ROM disk(s) or via web download or other means, and is labeled "For Upgrade Purposes Only" or "For Recovery Purposes Only" you may install one (1) copy of such SOFTWARE onto the DEVICES as a replacement copy for the existing SOFTWARE, and use it in accordance with this EULA, including any additional EULA terms accompanying the upgrade SOFTWARE.

## **INTELLECTUAL PROPERTY RIGHTS:**

All title and intellectual property rights in and to the SOFTWARE (including but not limited to any images, photographs, animations, video, audio, music, text and "applets" incorporated into the SOFTWARE), the accompanying printed materials, and any copies of the SOFTWARE, are owned by FORD MOTOR COMPANY, or its affiliates or suppliers. The SOFTWARE is licensed, not sold. You may not copy the printed materials accompanying the SOFTWARE. All title and intellectual property rights in and to the content which may be accessed through use of the SOFTWARE is the property of the respective content owner and may be protected by applicable copyright or other intellectual property laws and treaties. This EULA grants you no rights to use such content outside its intended use. All rights not specifically granted under this EULA are reserved by FORD MOTOR COMPANY, its affiliates, and third party software and service providers and suppliers. Use of any on-line services which may be accessed through the SOFTWARE may be governed by the respective terms of use relating to such services. If this SOFTWARE contains documentation that is provided only in electronic form, you may print one copy of such electronic documentation.

**EXPORT RESTRICTIONS:** You acknowledge that the SOFTWARE is subject to U.S. and European Union export jurisdiction. You agree to comply with all applicable international and national laws that apply to the SOFTWARE, including the U.S. Export Administration Regulations, as well as end-user, end-use and destination restrictions issued by U.S. and other governments.

# Customer Information

---

**TRADEMARKS:** This EULA does not grant you any rights in connection with any trademarks or service marks of FORD MOTOR COMPANY, its affiliates, and third party software and service providers.

**PRODUCT SUPPORT:** Please refer to FORD MOTOR COMPANY instructions provided in the documentation for the DEVICES product support, such as the vehicle owner guide.

Should you have any questions concerning this EULA, or if you desire to contact FORD MOTOR COMPANY for any other reason, please refer to the address provided in the documentation for the DEVICES.

**No Liability for Certain Damages:** EXCEPT AS PROHIBITED BY LAW, FORD MOTOR COMPANY, ANY THIRD PARTY SOFTWARE OR SERVICES SUPPLIERS, AND THEIR AFFILIATES SHALL HAVE NO LIABILITY FOR ANY INDIRECT, SPECIAL, CONSEQUENTIAL OR INCIDENTAL DAMAGES ARISING FROM OR IN CONNECTION WITH THE USE OR PERFORMANCE OF THE SOFTWARE. THIS LIMITATION SHALL APPLY EVEN IF ANY REMEDY FAILS OF ITS ESSENTIAL PURPOSE. THERE ARE NO WARRANTIES OTHER THAN THOSE THAT MAY BE EXPRESSLY PROVIDED FOR YOUR NEW VEHICLE.

## **SYNC® Automotive Important Safety Information Read and follow instructions:**

- Before using your SYNC® system, read and follow all instructions and safety information provided in this end user manual ("Owner Guide".) Not following precautions found in the Owner Guide can lead to an accident or other serious injuries.

## General Operation

- **Voice Command Control:** Certain functions within the SYNC® system may be accomplished using voice commands. Using voice commands while driving helps you to operate the system without removing your hands from the wheel or eyes from the road.
- **Prolonged Views of Screen:** Do not access any function requiring a prolonged view of the screen while you are driving. Pull over in a safe and legal manner before attempting to access a function of the system requiring prolonged attention.
- **Volume Setting:** Do not raise the volume excessively. Keep the volume at a level where you can still hear outside traffic and emergency signals while driving. Driving while unable to hear these sounds could cause an accident.
- **Navigation Features:** Any navigation features included in the system are intended to provide turn by turn instructions to get you to a desired destination. Please make certain all persons using this system carefully read and follow instructions and safety information fully.
- **Distraction Hazard:** Any navigation features may require manual (non-verbal) setup. Attempting to perform such set-up or insert data while driving can distract your attention and could cause an accident or other serious injury. Stop the vehicle in a safe and legal manner before attempting these operations.
- **Let Your Judgment Prevail:** Any navigation features are provided only as an aid. Make your driving decisions based on your observations of local conditions and existing traffic regulations. Any such feature is not a

# Customer Information

---

substitute for your personal judgment. Any route suggestions made by this system should never replace any local traffic regulations or your personal judgment or knowledge of safe driving practices.

- **Route Safety:** Do not follow the route suggestions if doing so would result in an unsafe or illegal maneuver, if you would be placed in an unsafe situation, or if you would be directed into an area that you consider unsafe. The driver is ultimately responsible for the safe operation of the vehicle and therefore, must evaluate whether it is safe to follow the suggested directions.
- **Potential Map Inaccuracy:** Maps used by this system may be inaccurate because of changes in roads, traffic controls or driving conditions. Always use good judgment and common sense when following the suggested routes.
- **Emergency Services:** Do not rely on any navigation features included in the system to route you to emergency services. Ask local authorities or an emergency services operator for these locations. Not all emergency services such as police, fire stations, hospitals and clinics are likely to be contained in the map database for such navigation features.

Your Responsibilities and Assumptions of Risk

- You agree to each of the following: (a) Any use of the SOFTWARE while driving an automobile or other vehicle in violation of applicable law or otherwise driving in an unsafe manner presents a significant risk of distracted driving and should not be attempted under any circumstances; (b) Use of the SOFTWARE at excessive volume poses a significant risk of hearing damage and should not be attempted under any circumstances; (c) The SOFTWARE may not be compatible with new or different versions of an operating system, third party software, or third party services, and the SOFTWARE may potentially cause a critical failure of an operating system, third party software, or third party service. (d) Any third party service accessed by or third party software used with the SOFTWARE (i) may charge an additional fee for access, (ii) may not work correctly, on an uninterrupted basis, or error free, (iii) may change streaming formats or discontinue operation, (iv) may contain adult, profane or offensive content; and (v) may contain inaccurate, false or misleading traffic, weather, financial or safety information or other content; and (e) Use of the SOFTWARE may cause you to incur additional charges from your wireless service provider (WSP) and any data or minute calculators that may be included in the software program are for reference only, are not warranted in any way and should not be relied upon in anyway.
- When using the SOFTWARE, you agree to be responsible for and assume the entire risk to the items set forth in Section (a) – (e) above.

# Customer Information

---

## Disclaimer of Warranty

YOU EXPRESSLY ACKNOWLEDGE AND AGREE THAT USE OF THE DEVICES AND SOFTWARE IS AT YOUR SOLE RISK AND THAT THE ENTIRE RISK AS TO SATISFACTORY QUALITY, PERFORMANCE, COMPATIBILITY, ACCURACY AND EFFORT IS WITH YOU. TO THE MAXIMUM EXTENT PERMITTED BY APPLICABLE LAW, THE SOFTWARE AND ANY THIRD PARTY SOFTWARE OR THIRD-PARTY SERVICES ARE PROVIDED "AS IS" AND "AS AVAILABLE", WITH ALL FAULTS AND WITHOUT WARRANTY OF ANY KIND, AND FORD MOTOR COMPANY HEREBY DISCLAIMS ALL WARRANTIES AND CONDITIONS WITH RESPECT TO THE SOFTWARE, THIRD PARTY SOFTWARE, AND THIRD-PARTY SERVICES, EITHER EXPRESS, IMPLIED OR STATUTORY, INCLUDING, BUT NOT LIMITED TO, THE IMPLIED WARRANTIES AND/OR CONDITIONS OF MERCHANTABILITY, OF SATISFACTORY QUALITY, OF FITNESS FOR AN PARTICULAR PURPOSE, OF ACCURACY, OF QUIET ENJOYMENT, AND NON-INFRINGEMENT OF THIRD-PARTY RIGHTS. FORD MOTOR COMPANY DOES NOT WARRANT (a) AGAINST INTERFERENCE WITH YOUR ENJOYMENT OF THE SOFTWARE, THIRD PARTY SOFTWARE, OR THIRD-PARTY SERVICES, (b) THAT THE SOFTWARE, THIRD PARTY SOFTWARE, OR THIRD-PARTY SERVICES WILL MEET YOUR REQUIREMENTS, (c) THAT THE OPERATION OF THE SOFTWARE, THIRD PARTY SOFTWARE, OR THIRD-PARTY SERVICES WILL BE UNINTERRUPTED OR ERROR-FREE, (d) OR THAT DEFECTS IN THE SOFTWARE, THIRD PARTY SOFTWARE, OR THIRD-PARTY SERVICES WILL BE CORRECTED. NO ORAL OR WRITTEN INFORMATION OR ADVICE GIVEN BY FORD MOTOR COMPANY OR ITS AUTHORIZED REPRESENTATIVE SHALL

CREATE A WARRANTY. SHOULD THE SOFTWARE, THIRD PARTY SOFTWARE, OR THIRD-PARTY SERVICES PROVE DEFECTIVE, YOU ASSUME THE ENTIRE COST OF ALL NECESSARY SERVICING, REPAIR OR CORRECTION. SOME JURISDICTIONS DO NOT ALLOW THE DISCLAIMER OF IMPLIED WARRANTIES OR LIMITATIONS ON APPLICABLE STATUTORY RIGHTS OF A CONSUMER, SO THE ABOVE DISCLAIMER MAY NOT FULLY APPLY TO YOU. THE SOLE WARRANTY PROVIDED BY FORD MOTOR COMPANY SHALL BE FOUND IN THE WARRANTY INFORMATION INCLUDING WITH YOUR OWNER GUIDE. TO THE EXTENT THAT THERE IS ANY CONFLICT BETWEEN THE TERMS OF THIS SECTION AND THE WARRANTY BOOKLET, THE WARRANTY BOOKLET SHALL CONTROL.

## Applicable Law, Venue, Jurisdiction

- The laws of the State of Michigan govern this EULA and Your use of the SOFTWARE. Your use of the SOFTWARE may also be subject to other local, state, national, or international laws. Any litigation arising out of or related to this EULA shall be brought and maintained exclusively in a court of the State of Michigan located in Wayne County or in the United States District Court for the Eastern District of Michigan. You hereby consent to submit to the personal jurisdiction of a court in the State of Michigan located in Wayne County and the United States District Court for the Eastern District of Michigan for any dispute arising out of or relating to this EULA.

# Customer Information

---

## **Binding Arbitration and Class Action Waiver**

**(a) Application.** This Section applies to any dispute EXCEPT IT DOES NOT INCLUDE A DISPUTE RELATING TO COPYRIGHT INFRINGEMENT, OR TO THE ENFORCEMENT OR VALIDITY OF YOUR, FORD MOTOR COMPANY, OR ANY OF FORD MOTOR COMPANY'S LICENSORS' INTELLECTUAL PROPERTY RIGHTS. Dispute means any dispute, action, or other controversy between You and FORD MOTOR COMPANY, other than the exceptions listed above, concerning the SOFTWARE (including its price) or this EULA, whether in contract, warranty, tort, statute, regulation, ordinance, or any other legal or equitable basis.

**(b) Notice of Dispute.** In the event of a Dispute, You or FORD MOTOR COMPANY must give the other a "Notice of Dispute", which is a written statement of the name, address, and contact information of the party giving it, the facts giving rise to the dispute, and the relief requested. You and FORD MOTOR COMPANY will attempt to resolve any dispute through informal negotiation within 60 days from the date the Notice of Dispute is sent. After 60 days, You or FORD MOTOR COMPANY may commence arbitration.

**(c) Small claims court.** You may also litigate any dispute in small claims court in your county of residence or FORD MOTOR COMPANY'S principal place of business, if the dispute meets all requirements to be heard in the small claims court. You may litigate in small claims court whether or not You negotiated informally first.

**(d) Binding arbitration.** If You and FORD MOTOR COMPANY, do not resolve any dispute by informal negotiation or in small claims court, any other effort to resolve the dispute will be conducted exclusively by binding arbitration. You are giving up

the right to litigate (or participate in as a party or class member) all disputes in court before a judge or jury. Instead, all disputes will be resolved before a neutral arbitrator, whose decision will be final except for a limited right of appeal under the Federal Arbitration Act. Any court with jurisdiction over the parties may enforce the arbitrator's award.

**(e) Class action waiver.** Any proceedings to resolve or litigate any dispute in any forum will be conducted solely on an individual basis. Neither you nor FORD MOTOR COMPANY, will seek to have any dispute heard as a class action, as a private attorney general action, or in any other proceeding in which any party acts or proposes to act in a representative capacity. No arbitration or proceeding will be combined with another without the prior written consent of all parties to all affected arbitrations or proceedings.

**(f) Arbitration procedure.** Any arbitration will be conducted by the American Arbitration Association (the "AAA"), under its Commercial Arbitration Rules. If You are an individual and use the SOFTWARE for personal or vehicle use, or if the value of the dispute is \$75,000 or less whether or not You are an individual or how You use the SOFTWARE, the AAA Supplementary Procedures for Consumer-Related Disputes will also apply. To commence arbitration, submit a Commercial Arbitration Rules Demand for Arbitration form to the AAA. You may request a telephonic or in-person hearing by following the AAA rules. In a dispute involving \$10,000 or less, any hearing will be telephonic unless the arbitrator finds good cause to hold an in-person hearing instead. For more information, see [adr.org](http://adr.org) or call 1-800-778-7879. You agree to commence arbitration only in your county of residence or FORD MOTOR COMPANY'S principal place of business. The arbitrator

## Customer Information

---

may award the same damages to you individually as a court could. The arbitrator may award declaratory or injunctive relief only to you individually, and only to the extent required to satisfy your individual claim.

### **(g) Arbitration fees and incentives.**

- i. Disputes involving \$75,000 or less. FORD MOTOR COMPANY will promptly reimburse your filing fees and pay the AAA's and arbitrator's fees and expenses. If you reject FORD MOTOR COMPANY'S last written settlement offer made before the arbitrator was appointed ("last written offer"), your dispute goes all the way to an arbitrator's decision (called an "award"), and the arbitrator awards you more than the last written offer, FORD MOTOR COMPANY will give you three incentives: (1) pay the greater of the award or \$1,000; (2) pay twice your reasonable attorney's fees, if any; and (3) reimburse any expenses (including expert witness fees and costs) that your attorney reasonably accrues for investigating, preparing, and pursuing your claim in arbitration. The arbitrator will determine the amounts.
- ii. Disputes involving more than \$75,000. The AAA rules will govern payment of filing fees and the AAA's and arbitrator's fees and expenses.
- iii. Disputes involving any amount. In any arbitration you commence, FORD MOTOR COMPANY will seek its AAA or arbitrator's fees and expenses, or Your filing fees it reimbursed, only if the arbitrator finds the arbitration frivolous or brought for an improper purpose. In any arbitration FORD MOTOR COMPANY commences, it will pay all

filing, AAA, and arbitrator's fees and expenses. It will not seek its attorney's fees or expenses from you in any arbitration. Fees and expenses are not counted in determining how much a dispute involves.

**(h) Claims or disputes must be filed within one year.** To the extent permitted by law, any claim or dispute under this EULA to which this Section applies must be filed within one year in small claims court (Section c) or in arbitration (Section d). The one-year period begins when the claim or dispute first could be filed. If such a claim or dispute is not filed within one year, it is permanently barred.

**(i) Severability.** If the class action waiver (Section e) is found to be illegal or unenforceable as to all or some parts of a dispute, then that portion of Section e will not apply to those parts. Instead, those parts will be severed and proceed in a court of law, with the remaining parts proceeding in arbitration. If any other provision of that portion Section e is found to be illegal or unenforceable, that provision will be severed with the remainder of Section e remaining in full force and effect.

### **Telenav Software End User License Agreement**

Please read these terms and conditions carefully before you use the TeleNav Software. Your use of the TeleNav Software indicates that you accept these terms and conditions. If you do not accept these terms and conditions, do not break the seal of the package, launch, or otherwise use the TeleNav Software. TeleNav may revise this Agreement and the privacy policy at any time, with or without notice to you. You agree to visit <http://www.telenav.com> from time to time to review the then current version of this Agreement and of the privacy policy.



# Customer Information

---

## 1. Safe and Lawful Use

You acknowledge that devoting attention to the TeleNav Software may pose a risk of injury or death to you and others in situations that otherwise require your undivided attention, and you therefore agree to comply with the following when using the TeleNav Software:

- (a) observe all traffic laws and otherwise drive safely;
- (b) use your own personal judgment while driving. If you feel that a route suggested by the TeleNav Software instructs you to perform an unsafe or illegal maneuver, places you in an unsafe situation, or directs you into an area that you consider to be unsafe, do not follow such instructions;
- (c) do not input destinations, or otherwise manipulate the TeleNav Software, unless your vehicle is stationary and parked;
- (d) do not use the TeleNav Software for any illegal, unauthorized, unintended, unsafe, hazardous, or unlawful purposes, or in any manner inconsistent with this Agreement;
- (e) arrange all GPS and wireless devices and cables necessary for use of the TeleNav Software in a secure manner in your vehicle so that they will not interfere with your driving and will not prevent the operation of any safety device (such as an airbag).

You agree to indemnify and hold TeleNav harmless against all claims resulting from any dangerous or otherwise inappropriate use of the TeleNav Software in any moving vehicle, including as a result of your failure to comply with the directions above.

## 2. Account Information

You agree: (a) when registering the TeleNav Software, to provide TeleNav with true, accurate, current, and complete information about yourself, and (b) to inform TeleNav promptly of any changes to such information, and to keep it true, accurate, current and complete.

## 3. Software License

- Subject to your compliance with the terms of this Agreement, TeleNav hereby grants to you a personal, non-exclusive, non-transferable license (except as expressly permitted below in connection with your permanent transfer of the TeleNav Software license), without the right to sublicense, to use the TeleNav Software (in object code form only) in order to access and use the TeleNav Software. This license shall terminate upon any termination or expiration of this Agreement. You agree that you will use the TeleNav Software only for your personal business or leisure purposes, and not to provide commercial navigation services to other parties.

### 3.1 License Limitations

- **(a)** reverse engineer, decompile, disassemble, translate, modify, alter or otherwise change the TeleNav Software or any part thereof; **(b)** attempt to derive the source code, audio library or structure of the TeleNav Software without the prior express written consent of TeleNav; **(c)** remove from the TeleNav Software, or alter, any of TeleNav's or its suppliers' trademarks, trade names, logos, patent or copyright notices, or other notices or markings; **(d)**

# Customer Information

---

distribute, sublicense or otherwise transfer the TeleNav Software to others, except as part of your permanent transfer of the TeleNav Software; or **(e)** use the TeleNav Software in any manner that

- i. infringes the intellectual property or proprietary rights, rights of publicity or privacy or other rights of any party,
- ii. violates any law, statute, ordinance or regulation, including but not limited to laws and regulations related to spamming, privacy, consumer and child protection, obscenity or defamation, or
- iii. is harmful, threatening, abusive, harassing, tortuous, defamatory, vulgar, obscene, libelous, or otherwise objectionable; and (f) lease, rent out, or otherwise permit unauthorized access by third parties to the TeleNav Software without advanced written permission of TeleNav.

## 4. Disclaimers

- To the fullest extent permissible pursuant to applicable law, in no event will TeleNav, its licensors and suppliers, or agents or employees of any of the foregoing, be liable for any decision made or action taken by you or anyone else in reliance on the information provided by the TeleNav Software. TeleNav also does not warrant the accuracy of the map or other data used for the TeleNav Software. Such data may not always reflect reality due to, among other things, road closures, construction, weather, new roads and other changing conditions. You are responsible for the entire risk arising out of your use of the TeleNav Software. For example but without limitation, you agree not to rely on the TeleNav Software for critical navigation in areas where the well-being or survival of you or others

is dependent on the accuracy of navigation, as the maps or functionality of the TeleNav Software are not intended to support such high risk applications, especially in more remote geographical areas.

- TELENAV EXPRESSLY DISCLAIMS AND EXCLUDES ALL WARRANTIES IN CONNECTION WITH THE TELENAV SOFTWARE, WHETHER STATUTORY, EXPRESS OR IMPLIED, INCLUDING ALL WARRANTIES WHICH MAY ARISE FROM COURSE OF DEALING, CUSTOM OR TRADE AND INCLUDING, BUT NOT LIMITED TO, THE IMPLIED WARRANTIES OF MERCHANTABILITY, FITNESS FOR A PARTICULAR PURPOSE AND NON-INFRINGEMENT OF THIRD PARTY RIGHTS WITH RESPECT TO THE TELENAV SOFTWARE.
- Certain jurisdictions do not permit the disclaimer of certain warranties, so this limitation may not apply to you.

## 5. Limitation of Liability

- TO THE EXTENT PERMITTED UNDER APPLICABLE LAW, UNDER NO CIRCUMSTANCES SHALL TELENAV OR ITS LICENSORS AND SUPPLIERS BE LIABLE TO YOU OR TO ANY THIRD PARTY FOR ANY INDIRECT, INCIDENTAL, CONSEQUENTIAL, SPECIAL OR EXEMPLARY DAMAGES (INCLUDING IN EACH CASE, BUT NOT LIMITED TO, DAMAGES FOR THE INABILITY TO USE THE EQUIPMENT OR ACCESS DATA, LOSS OF DATA, LOSS OF BUSINESS, LOSS OF PROFITS, BUSINESS INTERRUPTION OR THE LIKE) ARISING OUT OF THE USE OF OR INABILITY TO USE THE TELENAV SOFTWARE, EVEN IF TELENAV HAS BEEN ADVISED OF THE POSSIBILITY OF SUCH DAMAGES. NOTWITHSTANDING ANY DAMAGES THAT YOU MIGHT INCUR FOR ANY

# Customer Information

---

REASON WHATSOEVER (INCLUDING, WITHOUT LIMITATION, ALL DAMAGES REFERENCED HEREIN AND ALL DIRECT OR GENERAL DAMAGES IN CONTRACT, TORT (INCLUDING NEGLIGENCE) OR OTHERWISE), THE ENTIRE LIABILITY OF TELENAV AND OF ALL OF TELENAV'S SUPPLIERS SHALL BE LIMITED TO THE AMOUNT ACTUALLY PAID BY YOU FOR THE TELENAV SOFTWARE. SOME STATES AND/OR JURISDICTIONS DO NOT ALLOW THE EXCLUSION OR LIMITATION OF INCIDENTAL OR CONSEQUENTIAL DAMAGES, SO THE ABOVE LIMITATIONS OR EXCLUSIONS MAY NOT APPLY TO YOU.

## **6. Arbitration and Governing Law**

- You agree that any dispute, claim or controversy arising out of or relating to this Agreement or the TeleNav Software shall be settled by independent arbitration involving a neutral arbitrator and administered by the American Arbitration Association in the County of Santa Clara, California. The arbitrator shall apply the Commercial Arbitration Rules of the American Arbitration Association, and the judgment upon the award rendered by the arbitrator may be entered by any court having jurisdiction. Note that there is no judge or jury in an arbitration proceeding and the decision of the arbitrator shall be binding upon both parties. You expressly agree to waive your right to a jury trial. This Agreement and performance hereunder will be governed by and construed in accordance with the laws of the State of California, without giving effect to its conflict of law provisions. To the extent judicial action is necessary in connection with the binding arbitration, both TeleNav and you agree to submit

to the exclusive jurisdiction of the courts of the County of Santa Clara, California. The United Nations Convention on Contracts for the International Sale of Goods shall not apply.

## **7. Assignment**

- You may not resell, assign, or transfer this Agreement or any of your rights or obligations, except in totality, in connection with your permanent transfer of the TeleNav Software, and expressly conditioned upon the new user of the TeleNav Software agreeing to be bound by the terms and conditions of this Agreement. Any such sale, assignment or transfer that is not expressly permitted under this paragraph will result in immediate termination of this Agreement, without liability to TeleNav, in which case you and all other parties shall immediately cease all use of the TeleNav Software. Notwithstanding the foregoing, TeleNav may assign this Agreement to any other party at any time without notice, provided the assignee remains bound by this Agreement.

## **8. Miscellaneous**

### **8.1**

This Agreement constitutes the entire agreement between TeleNav and you with respect to the subject matter hereof.

### **8.2**

Except for the limited licenses expressly granted in this Agreement, TeleNav retains all right, title and interest in and to the TeleNav Software, including without limitation all related intellectual property rights. No licenses or other rights which are not expressly granted in this Agreement are intended to, or shall be, granted or

# Customer Information

---

conferred by implication, statute, inducement, estoppel or otherwise, and TeleNav and its suppliers and licensors hereby reserve all of their respective rights other than the licenses explicitly granted in this Agreement.

## 8.3

By using the TeleNav Software, you consent to receive from TeleNav all communications, including notices, agreements, legally required disclosures or other information in connection with the TeleNav Software (collectively, "Notices") electronically. TeleNav may provide such Notices by posting them on TeleNav's Website or by downloading such Notices to your wireless device. If you desire to withdraw your consent to receive Notices electronically, you must discontinue your use of the TeleNav Software.

## 8.4

TeleNav's or your failure to require performance of any provision shall not affect that party's right to require performance at any time thereafter, nor shall a waiver of any breach or default of this Agreement constitute a waiver of any subsequent breach or default or a waiver of the provision itself.

## 8.5

If any provision herein is held unenforceable, then such provision will be modified to reflect the intention of the parties, and the remaining provisions of this Agreement will remain in full force and effect.

## 8.6

The headings in this Agreement are for convenience of reference only, will not be deemed to be a part of this Agreement, and will not be referred to in connection with the construction or interpretation of this Agreement. As used in this Agreement, the words "include" and "including" and variations thereof, will not be deemed to be terms of limitation, but rather will be deemed to be followed by the words "without limitation".

## 9. Other Vendors Terms and Conditions

- The Telenav Software utilizes map and other data licensed to Telenav by third party vendors for the benefit of you and other end users. This Agreement includes end-user terms applicable to these companies (included at the end of this Agreement), and thus your use of the Telenav Software is also subject to such terms. You agree to comply with the following additional terms and conditions, which are applicable to Telenav's third party vendor licensors.

## 9.1 End User Terms Required by HERE North America, LLC

The data ("Data") is provided for your personal, internal use only and not for resale. It is protected by copyright, and is subject to the following terms and conditions which are agreed to by you, on the one hand, and Telenav ("Telenav") and its licensors (including their licensors and suppliers) on the other hand.

© 2013 HERE. All rights reserved.

The Data for areas of Canada includes information taken with permission from Canadian authorities, including: © Her Majesty the Queen in Right of Canada, © Queen's Printer for Ontario, © Canada Post Corporation, GeoBase®, © Department of Natural Resources Canada.

# Customer Information

---

HERE holds a non-exclusive license from the United States Postal Service® to publish and sell ZIP+4® information.

©United States Postal Service® 2014. Prices are not established, controlled or approved by the United States Postal Service®. The following trademarks and registrations are owned by the USPS: United States Postal Service, USPS, and ZIP+4

The Data for Mexico includes certain data from Instituto Nacional de Estadística y Geografía.

## **9.2 End User Terms Required by NAV2 (Shanghai) Co., Ltd**

The data (“Data”) is provided for your personal, internal use only and not for resale. It is protected by copyright, and is subject to the following terms and conditions which are agreed to by you, on the one hand, and NAV2 (Shanghai) Co., Ltd (“NAV2”) and its licensors (including their licensors and suppliers) on the other hand. 20xx. All rights reserved

### **Terms and Conditions**

**Permitted Use.** You agree to use this Data together with the Telenav Software solely for the internal business and personal purposes for which you were licensed, and not for service bureau, time-sharing or other similar purposes. Accordingly, but subject to the restrictions set forth in the following paragraphs, you agree not to otherwise reproduce, copy, modify, decompile, disassemble, create any derivative works of, or reverse engineer any portion of this Data, and may not transfer or distribute it in any form, for any purpose, except to the extent permitted by mandatory laws.

**Restrictions.** Except where you have been specifically licensed to do so by Telenav, and without limiting the preceding paragraph, you may not use this Data (a) with any products, systems, or applications installed or otherwise connected to or in communication with vehicles, capable of vehicle navigation, positioning, dispatch, real time route guidance, fleet management or similar applications; or (b) with or in communication with any positioning devices or any mobile or wireless-connected electronic or computer devices, including without limitation cellular phones, palmtop and handheld computers, pagers, and personal digital assistants or PDAs.

**Warning.** The Data may contain inaccurate or incomplete information due to the passage of time, changing circumstances, sources used and the nature of collecting comprehensive geographic data, any of which may lead to incorrect results.

**No Warranty.** This Data is provided to you “as is,” and you agree to use it at your own risk. Telenav and its licensors (and their licensors and suppliers) make no guarantees, representations or warranties of any kind, express or implied, arising by law or otherwise, including but not limited to, content, quality, accuracy, completeness, effectiveness, reliability, fitness for a particular purpose, usefulness, use or results to be obtained from this Data, or that the Data or server will be uninterrupted or error-free.

**Disclaimer of Warranty:** TELNAV AND ITS LICENSORS (INCLUDING THEIR LICENSORS AND SUPPLIERS) DISCLAIM ANY WARRANTIES, EXPRESS OR IMPLIED, OF QUALITY, PERFORMANCE, MERCHANTABILITY, FITNESS FOR A

## Customer Information

---

PARTICULAR PURPOSE OR NON-INFRINGEMENT. Some States, Territories and Countries do not allow certain warranty exclusions, so to that extent the above exclusion may not apply to you.

**Disclaimer of Liability:** TELENAV AND ITS LICENSORS (INCLUDING THEIR LICENSORS AND SUPPLIERS) SHALL NOT BE LIABLE TO YOU: IN RESPECT OF ANY CLAIM, DEMAND OR ACTION, IRRESPECTIVE OF THE NATURE OF THE CAUSE OF THE CLAIM, DEMAND OR ACTION ALLEGING ANY LOSS, INJURY OR DAMAGES, DIRECT OR INDIRECT, WHICH MAY RESULT FROM THE USE OR POSSESSION OF THE INFORMATION; OR FOR ANY LOSS OF PROFIT, REVENUE, CONTRACTS OR SAVINGS, OR ANY OTHER DIRECT, INDIRECT, INCIDENTAL, SPECIAL OR CONSEQUENTIAL DAMAGES ARISING OUT OF YOUR USE OF OR INABILITY TO USE THIS INFORMATION, ANY DEFECT IN THE INFORMATION, OR THE BREACH OF THESE TERMS OR CONDITIONS, WHETHER IN AN ACTION IN CONTRACT OR TORT OR BASED ON A WARRANTY, EVEN IF TELENAV OR ITS LICENSORS HAVE BEEN ADVISED OF THE POSSIBILITY OF SUCH DAMAGES. Some States, Territories and Countries do not allow certain liability exclusions or damages limitations, so to that extent the above may not apply to you.

**Export Control.** You shall not export from anywhere any part of the Data or any direct product thereof except in compliance with, and with all licenses and approvals required under, applicable export laws, rules and regulations, including but not limited to the laws, rules and regulations administered by the Office of Foreign Assets Control of the U.S. Department of Commerce and the Bureau of Industry and Security of the U.S. Department of Commerce. To the extent that any such

export laws, rules or regulations prohibit HERE from complying with any of its obligations hereunder to deliver or distribute Data, such failure shall be excused and shall not constitute a breach of this Agreement.

**Entire Agreement.** These terms and conditions constitute the entire agreement between Telenav (and its licensors, including their licensors and suppliers) and you pertaining to the subject matter hereof, and supersedes in their entirety any and all written or oral agreements previously existing between us with respect to such subject matter.

**Governing Law.** The above terms and conditions shall be governed by the laws of the State of Illinois [insert "Netherlands" where European HERE Data is used], without giving effect to (i) its conflict of laws provisions, or (ii) the United Nations Convention for Contracts for the International Sale of Goods, which is explicitly excluded. You agree to submit to the jurisdiction of the State of Illinois [insert "The Netherlands" where European HERE Data is used] for any and all disputes, claims and actions arising from or in connection with the Data provided to you hereunder.

**Government End Users.** If the Data is being acquired by or on behalf of the United States government or any other entity seeking or applying rights similar to those customarily claimed by the United States government, this Data is a "commercial item" as that term is defined at 48 C.F.R. ("FAR") 2.101, is licensed in accordance with these End-User Terms, and each copy of Data delivered or otherwise furnished shall be marked and embedded as appropriate with the following "Notice of Use," and shall be treated in accordance with such Notice:

# Customer Information

## NOTICE OF USE

CONTRACTOR (MANUFACTURER/  
SUPPLIER) NAME: HERE

CONTRACTOR (MANUFACTURER/  
SUPPLIER) ADDRESS: c/o Nokia, 425  
West Randolph Street, Chicago, Illinois  
60606

This Data is a commercial item as  
defined in FAR 2.101 and is subject to  
these End-User Terms under which this  
Data was provided.

© 1987 – 2014 HERE – All rights reserved.

If the Contracting Officer, federal government agency, or any federal official refuses to use the legend provided herein, the Contracting Officer, federal government agency, or any federal official must notify HERE prior to seeking additional or alternative rights in the Data.

### I. US/Canada Territory

A. United States Data. The End-User Terms for any Application containing Data for the United States shall contain the following notices:

“HERE holds a non-exclusive license from the United States Postal Service® to publish and sell ZIP+4® information.”

“©United States Postal Service® 20XX. Prices are not established, controlled or approved by the United States Postal Service®. The following trademarks and registrations are owned by the USPS: United States Postal Service, USPS, and ZIP+4.”

B. Canada Data. The following provisions apply to the Data for Canada, which may include or reflect data from third party licensors (“Third Party Data”), including Her Majesty the Queen in Right of Canada (“Her Majesty”), Canada Post Corporation (“Canada Post”) and the Department of Natural Resources of Canada (“NRCan”):

1. Disclaimer and Limitation: Client agrees that its use of the Third Party Data is subject to the following provisions:

a. Disclaimer: The Third Party Data is licensed on an “as is” basis. The licensors of such data, including Her Majesty, Canada Post and NRCan, make no guarantees, representations or warranties respecting such data, either express or implied, arising by law or otherwise, including but not limited to, effectiveness, completeness, accuracy or fitness for a particular purpose.

b. Limitation on Liability: The Third Party Data licensors, including Her Majesty, Canada Post and NRCan, shall not be liable: (i) in respect of any claim, demand or action, irrespective of the nature of the cause of the claim, demand or action alleging any loss, injury or damages, direct or indirect, which may result from the use or possession of such Data; or (ii) in any way for loss of revenues or contracts, or any other consequential loss of any kind resulting from any defect in the Data.

# Customer Information

---

2. Copyright Notice: In connection with each copy of all or any portion of the Data for the Territory of Canada, Client shall affix in a conspicuous manner the following copyright notice on at least one of: (i) the label for the storage media of the copy; (ii) the packaging for the copy; or (iii) other materials packaged with the copy, such as user manuals or end user license agreements: "This data includes information taken with permission from Canadian authorities, including © Her Majesty the Queen in Right of Canada, © Queen's Printer for Ontario, © Canada Post Corporation, GeoBase®, © The Department of Natural Resources Canada. All rights reserved."

3. End-User Terms: Except as otherwise agreed by the parties, in connection with the provision of any portion of the Data for the Territory of Canada to End-Users as may be authorized under the Agreement, Client shall provide such End-Users, in a reasonably conspicuous manner, with terms (set forth with other end user terms required to be provided under the Agreement, or as otherwise may be provided, by Client) which shall include the following provisions on behalf of the Third Party Data licensors, including Her Majesty, Canada Post and NRCan:

The Data may include or reflect data of licensors, including Her Majesty the Queen in the Right of Canada ("Her Majesty"), Canada Post Corporation ("Canada Post") and the Department of Natural Resources Canada ("NRCan"). Such data is licensed on an "as is" basis. The licensors, including Her Majesty, Canada Post and NRCan, make no guarantees, representations or warranties respecting such data,

either express or implied, arising by law or otherwise, including but not limited to, effectiveness, completeness, accuracy or fitness for a particular purpose. The licensors, including Her Majesty, Canada Post and NRCan, shall not be liable in respect of any claim, demand or action, irrespective of the nature of the cause of the claim, demand or action alleging any loss, injury or damages, direct or indirect, which may result from the use or possession of the data or the Data. The licensors, including Her Majesty, Canada Post and NRCan, shall not be liable in any way for loss of revenues or contracts, or any other consequential loss of any kind resulting from any defect in the data or the Data.

End User shall indemnify and save harmless the licensors, including Her Majesty, Canada Post and NRCan, and their officers, employees and agents from and against any claim, demand or action, irrespective of the nature of the cause of the claim, demand or action, alleging loss, costs, expenses, damages or injuries (including injuries resulting in death) arising out of the use or possession of the data or the Data.

4. Additional Provisions: The terms contained in this Section are in addition to all of the rights and obligations of the parties under the Agreement. To the extent that any of the provisions of this Section are inconsistent with, or conflict with, any other provisions of the Agreement, the provisions of this Section shall prevail.



# Customer Information

II. Mexico. The following provision applies to the Data for Mexico, which includes certain data from the Instituto Nacional de Estadística y Geografía (“INEGI”):

A. Any and all copies of the Data and/or packaging containing Data for Mexico shall contain the following notice: “Fuente: INEGI (Instituto Nacional de Estadística y Geografía)”

## III. Latin America Territory

A. Third Party Notices. Any and all copies of the Data and/or packaging relating thereto shall include the respective Third Party Notices set forth below and used as described below corresponding to the Territory (or portion thereof) included in such copy:

Territory Notice

Argentina	IGN “INSTITUTO GEOGRAFICO NACIONAL ARGENTINO”
Ecuador	“INSTITUTO GEOGRAFICO MILITAR DEL ECUADOR AUTORIZACION N° IGM-2011-01- PCO-01 DEL 25 DE ENERO DE 2011” “source: © IGN 2009 - BD TOPO ®”
Guadeloupe, French Guiana and Martinique Mexico	“Fuente: INEGI (Instituto Nacional de Estadística y Geografía)”

## IV. Middle East Territory

A. Third Party Notices. Any and all copies of the Data and/or packaging relating thereto shall include the respective Third Party Notices set forth below and used as described below corresponding to the Territory (or portion thereof) included in such copy:

Country Notice

Jordan “© Royal Jordanian Geographic Centre”. The foregoing notice requirement for Jordan Data is a material term of the Agreement. If Client or any of its permitted sublicensees (if any) fail to meet such requirement, HERE shall have the right to terminate Client’s license with respect to the Jordan Data.

B. Jordan Data. Client and its permitted sublicensees (if any) are restricted from licensing and/or otherwise distributing HERE’s database for the country of Jordan (“Jordan Data”) for use in Enterprise Applications to (i) non-Jordanian entities for use of the Jordan Data solely in Jordan or (ii) Jordan-based customers. In addition, Client, its permitted sublicensees (if any) and End-Users are restricted from using the Jordan Data in Enterprise Applications if such party is (i) a non-Jordanian entity using the Jordan Data solely in Jordan or (ii) a Jordan-based customer. For purposes of the foregoing, “Enterprise Applications” shall mean Geomarketing applications, GIS applications, mobile business asset management applications, call center applications, telematics applications, public organization Internet applications or for providing geocoding services.

# Customer Information

---

## V. Europe Territory

### A. Use of Certain Traffic Codes in Europe

1. General Restrictions Applicable to Traffic Codes. Client acknowledges and agrees that in certain countries of the Europe Territory, Client will need to obtain rights directly from third party RDS-TMC code providers to receive and use the Traffic Codes in the Data and to deliver to End-Users Transactions in any way derived from or based on such Traffic Codes. For such countries, HERE shall deliver the Data incorporating Traffic Codes to Client only after receiving certification from Client of its having obtained such rights.

2. Display of Third Party Rights Legends for Belgium. Client shall, for each Transaction that uses Traffic Codes for Belgium, provide the following notice to the End-User: "Traffic Codes for Belgium are provided by the Ministerie van de Vlaamse Gemeenschap and the Ministère de l'Équipement et des Transports."

B. Paper Maps. With respect to any license granted to Client relating to making, selling or distributing paper maps (i.e., a map fixed on a paper or paper-like medium): (a) such license with respect to Data for the Territory of Great Britain is conditioned on Client's entering into and complying with a separate written agreement with the Ordnance Survey ("OS") to create and sell paper maps, Client's paying to the OS any and all applicable paper map royalties, and Client's complying with the OS copyright notice requirements; (b) such license for selling or otherwise distributing for charge with respect to Data for the Territory of Czech Republic

is conditioned on Client's obtaining prior written consent from Kartografie a.s.; (c) such license for selling or distributing with respect to Data for the Territory of Switzerland is conditioned on Client's obtaining a permit from Bundesamt für Landestopografie of Switzerland; (d) Client is restricted from using Data for the Territory of France to create paper maps with a scale between 1:5,000 and 1:250,000; and (e) Client is restricted from using any Data to create, sell or distribute paper maps that are the same or substantially similar, in terms of data content and specific use of color, symbols and scale, to paper maps published by the European national mapping agencies, including without limitation, Landvermessungämter of Germany, Topografische Dienst of the Netherlands, Nationaal Geografisch Instituut of Belgium, Bundesamt für Landestopografie of Switzerland, Bundesamt für Eich-und Vermessungswesen of Austria, and the National Land Survey of Sweden.

C. OS Enforcement. Without limiting Section IV(B) above, with respect to Data for the Territory of Great Britain, Client acknowledges and agrees that the Ordnance Survey ("OS") may bring a direct action against Client to enforce compliance with the OS copyright notice (see Section IV(D) below) and paper map requirements (see Section IV(B) above) contained in this Agreement.

D. Third Party Notices. Any and all copies of the Data and/or packaging relating thereto shall include the respective Third Party Notices set forth below and used as described below corresponding to the Territory (or portion thereof) included in such copy:

Country(ies) Notice

## Customer Information

Austria	“© Bundesamt für Eich- und Vermessungswesen”	Spain	“Información geográfica propiedad del CNIG”
Croatia Cyprus, Estonia, Latvia, Lithuania, Moldova, Poland, Slovenia and/or Ukraine	“© EuroGeographics”	Sweden	“Based upon electronic data © National Land Survey Sweden.”
France	“source: © IGN 2009 – BD TOPO ®”	Switzerland	“Topografische Grundlage: © Bundesamt für Landestopographie.
Germany	“Die Grundlagendaten wurden mit Genehmigung der zuständigen Behörden entnommen”	E. Respective Country Distribution. Client acknowledges that HERE has not received approvals to distribute map data for the following countries in such respective countries: Albania, Belarus, Kyrgyzstan, Moldova and Uzbekistan. HERE may update such list from time to time. The license rights granted to Client under this TL with respect to the Data for such countries are contingent upon Client’s compliance with all applicable laws and regulations, including, without limitation, any required licenses or approvals to distribute the Application incorporating such Data in such respective countries.	
Great Britain	“Contains Ordnance Survey data © Crown copyright and database right 2010 Contains Royal Mail data © Royal Mail copyright and database right 2010”	VI. Australia Territory	
Greece	“Copyright Geomatics Ltd.”	A. Third Party Notices. Any and all copies of the Data and/or packaging relating thereto shall include the respective Third Party Notices set forth below and used as described below corresponding to the Territory (or portion thereof) included in such copy:	
Hungary	“Copyright © 2003; Top-Map Ltd.”	Copyright. Based on data provided under license from PSMA Australia Limited (www.pasma.com.au).	
Italy	“La Banca Dati Italiana è stata prodotta usando quale riferimento anche cartografia numerica ed al tratto prodotta e fornita dalla Regione Toscana.”		
Norway	“Copyright © 2000; Norwegian Mapping Authority”		
Portugal	“Source: IgeoE – Portugal”		

# Customer Information

---

Product incorporates data which is © 20XX Telstra Corporation Limited, GM Holden Limited, Intelomatics Australia Pty Ltd and Continental Pty Ltd.

B. Third Party Notices for Australia. In addition to the foregoing, the End-User Terms for any Application containing RDS-TMC Traffic Codes for Australia shall contain the following notice: "Product incorporates traffic location codes which is © 20XX Telstra Corporation Limited and its licensors."

## **AT&T Vehicle Network Carrier Telematics Disclosure**

END USER FOR PURPOSES OF THIS SECTION MEANS YOU AND YOUR HEIRS, EXECUTORS, LEGAL PERSONAL REPRESENTATIVES AND PERMITTED ASSIGNS. FOR PURPOSES OF THIS SECTION "UNDERLYING WIRELESS SERVICE CARRIER" INCLUDES ITS AFFILIATES AND CONTRACTORS AND THEIR RESPECTIVE OFFICERS, DIRECTORS, EMPLOYEES, SUCCESSORS AND ASSIGNS. END USER HAS NO CONTRACTUAL RELATIONSHIP WITH THE UNDERLYING WIRELESS SERVICE CARRIER AND END USER IS NOT A THIRD PARTY BENEFICIARY OF ANY AGREEMENT BETWEEN FORD AND UNDERLYING CARRIER. END USER UNDERSTANDS AND AGREES THAT THE UNDERLYING CARRIER HAS NO LEGAL, EQUITABLE, OR OTHER LIABILITY OF ANY KIND TO END USER. IN ANY EVENT, REGARDLESS OF THE FORM OF THE ACTION, WHETHER FOR BREACH OF CONTRACT, WARRANTY, NEGLIGENCE, STRICT LIABILITY IN TORT OR OTHERWISE, END USER'S EXCLUSIVE REMEDY FOR CLAIMS ARISING IN ANY WAY IN CONNECTION WITH THIS AGREEMENT, FOR ANY CAUSE WHATSOEVER, INCLUDING BUT NOT LIMITED TO ANY FAILURE OR

DISRUPTION OF SERVICE PROVIDED HEREUNDER, IS LIMITED TO PAYMENT OF DAMAGES IN AN AMOUNT NOT TO EXCEED THE AMOUNT PAID BY END USER FOR THE SERVICES DURING THE TWO-MONTH PERIOD PRECEDING THE DATE THE CLAIM AROSE.

(ii) END USER AGREES TO INDEMNIFY AND HOLD HARMLESS THE UNDERLYING WIRELESS SERVICE CARRIER AND ITS OFFICERS, EMPLOYEES, AND AGENTS AGAINST ANY AND ALL CLAIMS, INCLUDING WITHOUT LIMITATION CLAIMS FOR LIBEL, SLANDER, OR ANY PROPERTY DAMAGE, PERSONAL INJURY OR DEATH, ARISING IN ANY WAY, DIRECTLY OR INDIRECTLY, IN CONNECTION WITH THIS AGREEMENT OR THE USE, FAILURE TO USE, OR INABILITY TO USE THE DEVICE EXCEPT WHERE THE CLAIMS RESULT FROM THE UNDERLYING CARRIER'S GROSS NEGLIGENCE OR WILLFUL MISCONDUCT. THIS INDEMNITY WILL SURVIVE THE TERMINATION OF THE AGREEMENT.

(iii) END USER HAS NO PROPERTY RIGHT IN ANY NUMBER ASSIGNED TO THE DEVICE.

(iv) END USER UNDERSTANDS THAT FORD AND THE UNDERLYING CARRIER CANNOT GUARANTY THE SECURITY OF WIRELESS TRANSMISSIONS, AND WILL NOT BE LIABLE FOR ANY LACK OF SECURITY RELATING TO THE USE OF THE SERVICES

THE SERVICE IS FOR [END USER'S] USE ONLY AND END USER MAY NOT RESELL THE SERVICE TO ANY OTHER PARTY END USER UNDERSTANDS THAT THE UNDERLYING CARRIER DOES NOT GUARANTEE ANY END USER UNINTERRUPTED SERVICE OR COVERAGE. THE UNDERLYING CARRIER DOES NOT WARRANT THAT END USERS CAN OR WILL BE LOCATED USING THE SERVICE. THE UNDERLYING CARRIER

# Customer Information

---

MAKES NO WARRANTY, EXPRESS OR IMPLIED, OF MERCHANTABILITY OR FITNESS FOR A PARTICULAR PURPOSE, SUITABILITY, OR PERFORMANCE REGARDING ANY SERVICES OR GOODS, AND IN NO EVENT SHALL AT&T BE LIABLE, WHETHER OR NOT DUE TO ITS OWN NEGLIGENCE, FOR ANY: (A) ACT OR OMISSION OF A THIRD PARTY; (B) MISTAKES, OMISSIONS, INTERRUPTIONS, ERRORS, FAILURES TO TRANSMIT, DELAYS, OR DEFECTS IN THE SERVICE PROVIDED BY OR THROUGH THE UNDERLYING CARRIER; (C) DAMAGE OR INJURY CAUSED BY SUSPENSION OR TERMINATION BY THE UNDERLYING CARRIER; OR (D) DAMAGE OR INJURY CAUSED BY A FAILURE OR DELAY IN CONNECTING A CALL TO ANY ENTITY, INCLUDING 911 OR ANY OTHER EMERGENCY SERVICE. TO THE FULL EXTENT ALLOWED BY LAW, THE END USER RELEASES, INDEMNIFIES AND HOLDS THE UNDERLYING CARRIER HARMLESS FROM AND AGAINST ANY AND ALL CLAIMS OF ANY PERSON OR ENTITY FOR DAMAGES OF ANY NATURE ARISING IN ANY WAY FROM OR RELATING TO, DIRECTLY OR INDIRECTLY, SERVICES PROVIDED BY THE UNDERLYING CARRIER OR ANY PERSON'S USE THEREOF, INCLUDING CLAIMS ARISING IN WHOLE OR IN PART FROM THE ALLEGED NEGLIGENCE OF THE UNDERLYING CARRIER.

## **VII. China Territory**

### ***Personal Use Only***

You agree to use this Data together with [insert name of Client Application] for the solely personal, non-commercial purposes for which you were licensed, and not for service bureau, time-sharing or other similar purposes. Accordingly, but subject to the restrictions set forth in the following paragraphs, you may copy this Data only as necessary for your personal use to (i)

view it, and (ii) save it, provided that you do not remove any copyright notices that appear and do not modify the Data in any way. You agree not to otherwise reproduce, copy, modify, decompile, disassemble or reverse engineer any portion of this Data, and may not transfer or distribute it in any form, for any purpose, except to the extent permitted by mandatory laws.

### ***Restrictions***

Except where you have been specifically licensed to do so by NAV2, and without limiting the preceding paragraph, you may not (a) use this Data with any products, systems, or applications installed or otherwise connected to or in communication with vehicles, capable of vehicle navigation, positioning, dispatch, real time route guidance, fleet management or similar applications; or (b) with or in communication with any positioning devices or any mobile or wireless-connected electronic or computer devices, including without limitation cellular phones, palmtop and handheld computers, pagers, and personal digital assistants or PDAs. You agree to cease using this Data if you fail to comply with these terms and conditions.

### ***Limited Warranty***

NAV2 warrants that (a) the Data will perform substantially in accordance with the accompanying written materials for a period of ninety (90) days from the date of receipt, and (b) any support services provided by NAV2 shall be substantially as described in applicable written materials provided to you by NAV2, and NAV2's support engineers will make commercially reasonable efforts to solve any problem issues.

# Customer Information

## **Customer Remedies**

NAV2 and its suppliers' entire liability and your exclusive remedy shall be, at NAV2's sole discretion, either (a) return of the price paid, if any, or (b) repair or replacement of the Data that do not meet NAV2's Limited Warranty and that are returned to NAV2 with a copy of your receipt. This Limited Warranty is void if failure of the Data has resulted from accident, abuse, or misapplication. Any replacement Data will be warranted for the remainder of the original warranty period or thirty (30) days, whichever is longer. Neither these remedies nor any product support services offered by NAV2 are available without proof of purchase from an authorized international source.

## **No Other Warranty:**

EXCEPT FOR THE LIMITED WARRANTY SET FORTH ABOVE AND TO THE EXTENT PERMITTED BY APPLICABLE LAW, NAV2 AND ITS LICENSORS (INCLUDING THEIR LICENSORS AND SUPPLIERS) DISCLAIM ANY WARRANTIES, EXPRESS OR IMPLIED, OF QUALITY, PERFORMANCE, MERCHANTABILITY, FITNESS FOR A PARTICULAR PURPOSE, OWNERSHIP OR NON-INFRINGEMENT. Certain warranty exclusions may not be permitted under applicable law, so to that extent the above exclusion may not apply to you.

## **Limited Liability:**

TO THE EXTENT PERMITTED BY APPLICABLE LAW, NAV2 AND ITS LICENSORS (INCLUDING THEIR LICENSORS AND SUPPLIERS) SHALL NOT BE LIABLE TO YOU: IN RESPECT OF ANY CLAIM, DEMAND OR ACTION, IRRESPECTIVE OF THE NATURE OF THE CAUSE OF THE CLAIM, DEMAND OR ACTION ALLEGING ANY LOSS, INJURY OR DAMAGES, DIRECT OR INDIRECT, WHICH MAY RESULT FROM THE USE OR POSSESSION OF THE INFORMATION; OR

FOR ANY LOSS OF PROFIT, REVENUE, CONTRACTS OR SAVINGS, OR ANY OTHER DIRECT, INDIRECT, INCIDENTAL, SPECIAL OR CONSEQUENTIAL DAMAGES ARISING OUT OF YOUR USE OF OR INABILITY TO USE THIS INFORMATION, ANY DEFECT IN THE INFORMATION, OR THE BREACH OF THESE TERMS OR CONDITIONS, WHETHER IN AN ACTION IN CONTRACT OR TORT OR BASED ON A WARRANTY, EVEN IF NAV2 OR ITS LICENSORS HAVE BEEN ADVISED OF THE POSSIBILITY OF SUCH DAMAGES. UNDER NO CIRCUMSTANCES SHALL NAV2'S OR ITS SUPPLIERS' LIABILITY HEREUNDER EXCEED THE PRICE PAID. Certain liability exclusions may not be permitted under applicable law, so to that extent the above exclusion may not apply to you.

## **Export Control**

You agree not to export to anywhere any part of the Data provided to you or any direct product thereof except in compliance with, and with all licenses and approvals required under, applicable export laws, rules and regulations.

## **IP Protection**

The Data are owned by NAV2 or its suppliers and are protected by applicable copyright and other intellectual property law and treaties. The Data are provided solely on the basis of a license to use, not sale.

## **Entire Agreement**

These terms and conditions constitute the entire agreement between NAV2 (and its licensors, including their licensors and suppliers) and you pertaining to the subject matter hereof, and supersedes in their entirety any and all written or oral agreements previously existing between us with respect to such subject matter.

# Customer Information

---

## **Governing Law.**

The above terms and conditions shall be governed by the laws of the People's Republic of China, without giving effect to (i) its conflict of laws provisions, or (ii) the United Nations Convention for Contracts for the International Sale of Goods, which is explicitly excluded. Any dispute arising from or in connection with the Data provided to you hereunder shall be submitted to the Shanghai International Economic and Trade Arbitration Commission for arbitration.

## **Gracenote® Copyright**

CD and music-related data from Gracenote, Inc., copyright©

2000-2007 Gracenote. Gracenote Software, copyright © 2000-2007 Gracenote. This product and service may practice one or more of the following U.S. Patents 5,987,525; 6,061,680; 6,154,773; 6,161,132; 6,230,192; 6,230,207; 6,240,459; 6,330,593 and other patents issued or pending. Some services supplied under license from Open Globe, Inc. for U.S. Patent 6,304,523.

Gracenote and CDDB are registered trademarks of Gracenote. The Gracenote logo and logotype, and the "Powered by Gracenote™" logo are trademarks of Gracenote.

## **Gracenote® End User License Agreement (EULA)**

This device contains software from Gracenote, Inc. of 2000 Powell Street Emeryville, California 94608 ("Gracenote").

The software from Gracenote (the "Gracenote Software") enables this device to do disc and music file identification and obtain music-related information, including name, artist, track, and title information ("Gracenote Data") from online servers

("Gracenote Servers"), and to perform other functions. You may use Gracenote Data only by means of the intended End User functions of this device. This device may contain content belonging to Gracenote's providers. If so, all of the restrictions set forth herein with respect to Gracenote Data shall also apply to such content and such content providers shall be entitled to all of the benefits and protections set forth herein that are available to Gracenote. You agree that you will use the content from Gracenote ("Gracenote Content"), Gracenote Data, the Gracenote Software, and Gracenote Servers for your own personal, non-commercial use only. You agree not to assign, copy, transfer or transmit the Gracenote Content, Gracenote Software or any Gracenote Data (except in a Tag associated with a music file) to any third party. YOU AGREE NOT TO USE OR EXPLOIT GRACENOTE CONTENT, GRACENOTE DATA, THE GRACENOTE SOFTWARE, OR GRACENOTE SERVERS, EXCEPT AS EXPRESSLY PERMITTED HEREIN.

You agree that your non-exclusive licenses to use the Gracenote Content, Gracenote Data, the Gracenote Software, and Gracenote Servers will terminate if you violate these restrictions. If your licenses terminate, you agree to cease any and all use of the Gracenote Content, Gracenote Data, the Gracenote Software, and Gracenote Servers.

Gracenote, respectively, reserve all rights in Gracenote Data, the Gracenote Software, and the Gracenote Servers and Gracenote Content, including all ownership rights. Under no circumstances will either Gracenote become liable for any payment to you for any information that you provide,

# Customer Information

---

including any copyrighted material or music file information. You agree that Gracenote may enforce its respective rights, collectively or separately, under this agreement against you, directly in each company's own name.

Gracenote uses a unique identifier to track queries for statistical purposes. The purpose of a randomly assigned numeric identifier is to allow Gracenote to count queries without knowing anything about who you are. For more information, see the web page at [www.gracenote.com](http://www.gracenote.com) for the Gracenote Privacy Policy.

THE GRACENOTE SOFTWARE, EACH ITEM OF GRACENOTE DATA AND THE GRACENOTE CONTENT ARE LICENSED TO YOU "AS IS". NEITHER GRACENOTE MAKES ANY REPRESENTATIONS OR WARRANTIES, EXPRESS OR IMPLIED, REGARDING THE ACCURACY OF ANY GRACENOTE DATA FROM THE GRACENOTE SERVERS OR GRACENOTE CONTENT. GRACENOTE COLLECTIVELY AND SEPARATELY RESERVE THE RIGHT TO DELETE DATA AND/OR CONTENT FROM THE COMPANIES' RESPECTIVE SERVERS OR, IN THE CASE OF GRACENOTE, CHANGE DATA CATEGORIES FOR ANY CAUSE THAT GRACENOTE DEEMS SUFFICIENT. NO WARRANTY IS MADE THAT EITHER GRACENOTE CONTENT OR THE GRACENOTE SOFTWARE OR GRACENOTE SERVERS ARE ERROR-FREE OR THAT THE FUNCTIONING OF THE GRACENOTE SOFTWARE OR GRACENOTE SERVERS WILL BE UNINTERRUPTED. GRACENOTE IS NOT OBLIGATED TO PROVIDE YOU WITH ANY ENHANCED OR ADDITIONAL DATA TYPES THAT GRACENOTE MAY CHOOSE TO PROVIDE IN THE FUTURE AND IS FREE TO DISCONTINUE ITS ONLINE SERVICES AT ANY TIME. GRACENOTE DISCLAIMS ALL WARRANTIES EXPRESS OR IMPLIED, INCLUDING, BUT NOT LIMITED TO,

IMPLIED WARRANTIES OF MERCHANTABILITY, FITNESS FOR A PARTICULAR PURPOSE, TITLE, AND NON-INFRINGEMENT. NEITHER GRACENOTE WARRANTS THE RESULTS THAT WILL BE OBTAINED BY YOUR USE OF THE GRACENOTE SOFTWARE OR ANY GRACENOTE SERVER. IN NO CASE WILL GRACENOTE BE LIABLE FOR ANY CONSEQUENTIAL OR INCIDENTAL DAMAGES OR FOR ANY LOST PROFITS OR LOST REVENUES FOR ANY REASON WHATSOEVER. © Gracenote 2007.

## ***Taiwan Territory***

According to the "Technical Specifications for Low Power Radio Frequency Equipment" formulated by the National Communications and Communication Committee of the Executive Yuan: 3.8.2. For the low-power radio frequency equipment that has obtained the verification certificate, the company, firm or user shall not change the frequency, increase the power or change the characteristics and functions of the original design without authorization.

The use of low-power radio frequency equipment must not affect flight safety and interfere with legal communications: when the system detects interference, immediately stop using it until there is no interference.

The aforementioned legal communication refers to the wireless communication operated in accordance with the provisions of the Telecommunications Management Law. Low-power radio frequency equipment needs to endure the interference of legal communication or industrial, scientific and medical radio wave radiation electrical equipment.



# Customer Information

## SUNA TRAFFIC CHANNEL – TERMS AND CONDITIONS

By activating, using and/or accessing the SUNA Traffic Channel, SUNA Predictive or other content or material provided by Intelomatics (together, **SUNA Products and/or Services**), you must accept certain terms and conditions. The following is a brief summary of the terms and conditions that apply to you. To view the full terms and conditions relevant to your use of the SUNA Products and/or Services, please consult:

Website
<a href="http://www.sunattraffic.com.au/termsandconditions/">www.sunattraffic.com.au/termsandconditions/</a>

### 1. Acceptance

By using SUNA Products and/or Services, you will be deemed to have accepted and agreed to be bound by the terms and conditions fully detailed at:

Website
<a href="http://www.sunattraffic.com.au/termsandconditions/">www.sunattraffic.com.au/termsandconditions/</a>

### 2. Intellectual Property

SUNA Products and/or Services are for your personal use. You may not record, or retransmit the content, nor use the content in association with any other traffic information or route guidance service or device not approved by Intelomatics. You obtain no right of ownership in any Intellectual Property Rights (including copyright) in the data that is used to provide SUNA Products and/or Services.

### 3. Appropriate Use

SUNA Products and/or Services are intended as an aid to personal motoring and travel planning, and do not provide comprehensive or accurate information on all occasions. On occasions, you may experience additional delay as a result of using SUNA Products and/or Services. You acknowledge that it is not intended, or suitable, for use in applications where time of arrival or driving directions may impact the safety of the public or yourself.

### 4. Use of SUNA Products and Services while driving

You, and other authorized drivers of the vehicle in which SUNA Products and/or Services are available or installed and active, remain at all times responsible for observing all relevant laws and codes of safe driving. In particular, you agree to only actively operate SUNA Products and/or Services when the Vehicle is at a complete stop and it is safe to do so.

### 5. Service Continuity and Reception of the SUNA Traffic Channel

We will use reasonable endeavors to provide the SUNA Traffic Channel 24 hours a day, 365 days a year. The SUNA Traffic Channel may occasionally be unavailable for technical reasons or for planned maintenance. We will try to perform maintenance at times when congestion is light. We reserve the right to withdraw SUNA Products and/or Services at any time.

Also, we cannot assure the uninterrupted reception of the SUNA Traffic Channel RDS-TMC signal at any particular location.

### 6. Limitation of Liability

Neither Intelomatics (nor its suppliers or the manufacturer of your device (the **"Suppliers"**)) shall be liable to you or to any third party for any damages either direct, indirect, incidental, consequential or otherwise arising out of the use of or inability to use SUNA Products and/or

# Customer Information

Services even if Intelematics or a Supplier has been advised of the possibility of such damages. You also acknowledge that neither Intelematics nor any Supplier guarantees nor make any warranties that relate to the availability, accuracy or completeness of SUNA Products and/or Services, and to the extent which it is lawful to do so, both Intelematics and each Supplier excludes any warranties which might otherwise be implied by any State or Federal legislation in relation to SUNA Products and/or Services.

## 7. Please Note

Great care has been taken in preparing this manual. Constant product development may mean that some information is not entirely up-to-date. The information in this document is subject to change without notice.

## EMISSION LAW



**WARNING:** Do not remove or alter the original equipment floor covering or insulation between it and the metal floor of the vehicle. The floor covering and insulation protect occupants of the vehicle from the engine and exhaust system heat and noise. On vehicles with no original equipment floor covering insulation, do not carry passengers in a manner that permits prolonged skin contact with the metal floor. Failure to follow these instructions may result in fire or personal injury.

U.S. federal laws and certain state laws prohibit removing or rendering inoperative emission control system components. Similar federal or provincial laws may apply in Canada. We do not approve of any vehicle modification without first determining applicable laws.



Tampering with emissions control systems including related sensors or the Diesel Exhaust Fluid system can result in reduced engine power and the illumination of the service engine soon light.

## Tampering With a Noise Control System

Federal laws prohibit the following acts:

- Removal or rendering inoperative by any person other than for purposes of maintenance.
- Repair or replacement of any device or element of the design incorporated into a new vehicle for the purpose of noise control prior to its sale or delivery to the ultimate purchaser or while it is in use.
- The use of the vehicle after any person removes or renders inoperative any device or element of the design.

The U.S. Environmental Protection Agency may presume to constitute tampering as follows:

- Removal of hood blanket, fender apron absorbers, fender apron barriers, underbody noise shields or acoustically absorptive material.
- Tampering or rendering inoperative the engine speed governor, to allow engine speed to exceed manufacturer specifications.

If the engine does not start, runs rough, experiences a decrease in engine performance, experiences excess fuel consumption or produces excessive exhaust smoke, check for the following:

- A plugged or disconnected air inlet system hose.
- A plugged engine air filter element.
- Water in the fuel filter and water separator.

# Customer Information

---

- A clogged fuel filter.
- Contaminated fuel.
- Air in the fuel system, due to loose connections.
- An open or pinched sensor hose.
- Incorrect engine oil level.
- Incorrect fuel for climatic conditions.
- Incorrect engine oil viscosity for climactic conditions.

**Note:** *Some vehicles have a lifetime fuel filter that is integrated with the fuel tank. Regular maintenance or replacement is not needed.*

**Note:** *If these checks do not help you correct the concern, have your vehicle checked as soon as possible.*

## Noise Emissions Warranty, Prohibited Tampering Acts and Maintenance

On January 1, 1978, Federal regulation became effective governing the noise emission on trucks over 4,536 kg (10,000 lb) Gross Vehicle Weight Rating (GVWR). The preceding statements concerning prohibited tampering acts and maintenance, and the noise warranty found in the Warranty Guide, are applicable to complete chassis cabs over 4,536 kg (10,000 lb) GVWR.

## EXPORT UNIQUE OPTIONS

For your particular global region, your vehicle may be equipped with features and options that are different from the features and options that are described in this Owner's Manual. A market unique supplement may be supplied that complements this book. By referring to the market unique supplement, if provided, you can properly identify those features, recommendations and specifications that are unique to your vehicle. This Owner's

Manual is written primarily for the U.S. and Canadian markets. Features or equipment listed as standard may be different on units built for export. **Refer to this Owner's Manual for all other required information and warnings.**

## WARRANTY INFORMATION

The following warranties may apply to your vehicle:

- New vehicle limited warranties.
- Emissions warranties, if applicable. (Note: Fully-electric vehicles are not eligible for emissions warranties.)
- Other warranties, if applicable.

Detailed warranty information specific to your vehicle can be found in the Warranty Guide at [www.owner.ford.com](http://www.owner.ford.com).

The following California Warranty Statement, required by California regulations, applies to vehicles certified to California emissions standards and registered in a state that requires California emissions warranty. If applicable, additional California Emissions Warranties can be found in the Warranty Guide at [www.owner.ford.com](http://www.owner.ford.com).

## CALIFORNIA EMISSION CONTROL WARRANTY STATEMENT

### YOUR WARRANTY RIGHTS AND OBLIGATIONS

The California Air Resources Board and Ford Motor Company are pleased to explain the emission control system warranty on your (year) vehicle. In California, new motor vehicles must be designated, built and equipped to meet

# Customer Information

---

the State's stringent anti-smog standards. Ford Motor Company must warrant the emission control system on your vehicle for the periods of time listed below provided there has been no abuse, neglect or improper maintenance of your vehicle.

Your emission control system may include parts such as the carburetor or fuel-injection system, the ignition system, catalytic converter and engine computer. Also included may be hoses, belts, connectors and other emission-related assemblies. Where a warrantable condition exists, Ford Motor Company will repair your vehicle at no cost to you including diagnosis, parts and labor.

## **MANUFACTURER'S WARRANTY COVERAGE:**

(For 1990 and subsequent model passenger cars, light-duty trucks, and medium-duty vehicles.)

- For 3 years or 50,000 miles (whichever occurs first);

1) If your vehicle fails a Smog Check inspection, all necessary repairs and adjustments will be made by Ford Motor Company to ensure that your emission control system **PERFORMANCE WARRANTY**.

2) If any emission-related part on your vehicle is defective, the part will be repaired or replaced by Ford Motor Company. This is your short-term emission control system **DEFECTS WARRANTY**.

- For 7 years or 70,000 miles (whichever occurs first);

1) If an emission-related part listed in this warranty booklet specially noted with coverage for 7 years or 70,000 miles is defective, the part will be repaired or replaced by Ford Motor Company. This is your long-term emission control system **DEFECTS WARRANTY**.

## **OWNER'S WARRANTY RESPONSIBILITIES:**

- As the vehicle owner, you are responsible for the performance of the required maintenance listed in your owner's manual. Ford Motor Company recommends that you retain all receipts covering maintenance on your vehicle, but Ford Motor Company cannot deny warranty solely for the lack of receipts or for your failure to ensure the performance of all scheduled maintenance.

- You are responsible for presenting your vehicle to a Ford or Lincoln dealer as soon as a problem exists. The warranty repairs should be completed in a reasonable amount of time, not to exceed 30 days.

- As the vehicle owner, you should also be aware that Ford Motor Company may deny you warranty coverage if your vehicle or a part has failed due to abuse, neglect, improper maintenance or unapproved modifications.

If you have any questions regarding your warranty rights and responsibilities, you should contact Ford Customer Service at 1-800-392-3673 or the California Air Resource Board at 4001 Iowa Avenue, Riverside, CA 92507.

## **New Vehicle Limited Warranty**

Your vehicle comes with a New Vehicle Limited Warranty. The express warranties of the New Vehicle Limited Warranty are in substitution for and exclude all other liabilities of any kind whether arising under statute, in tort, by implication of law or otherwise including, to the full extent as may be allowed by law, liability for any other representations respecting the vehicle, statutory warranties or implied warranties or conditions as to its merchantability or fitness.

## Customer Information

---

Download a free electronic copy or order one free printed copy of the most up-to-date Warranty Guide by visiting the Owner Manuals section of [owner.ford.com](http://owner.ford.com) (United States).

For Canada, visit [ford.ca/warranty](http://ford.ca/warranty).

For Limo/Livery/Hearse vehicles: View and download your Warranty Guide by visiting the Warranty Information section of the Fleet website, [fleet.ford.com/limo](http://fleet.ford.com/limo) (United States only).

# Appendices

## ELECTROMAGNETIC COMPATIBILITY



**WARNING:** Do not place objects or mount equipment on or near the airbag cover, on the side of the front or rear seatbacks, or in areas that may come into contact with a deploying airbag. Failure to follow these instructions may increase the risk of personal injury in the event of a crash.



**WARNING:** Keep antenna and power cables at least 10 cm (4 in) from any electronic modules and airbags.

**Note:** We test and certify your vehicle to meet electromagnetic compatibility legislation. It is your responsibility to make sure that any equipment an authorized dealer installs on your vehicle complies with applicable local legislation and other requirements. Installation of some aftermarket electronic devices could degrade the performance of vehicle functions, which use radio frequency signals such as broadcast radio receiver, tire pressure monitoring system, push button start, **Bluetooth®** connectivity or satellite navigation.

**Note:** Any radio frequency transmitter equipment in your vehicle, such as, cellular telephones and amateur radio transmitters, must keep to the parameters in the following illustrations and table. We do not provide any other special provisions or conditions for installations or use.

### Car

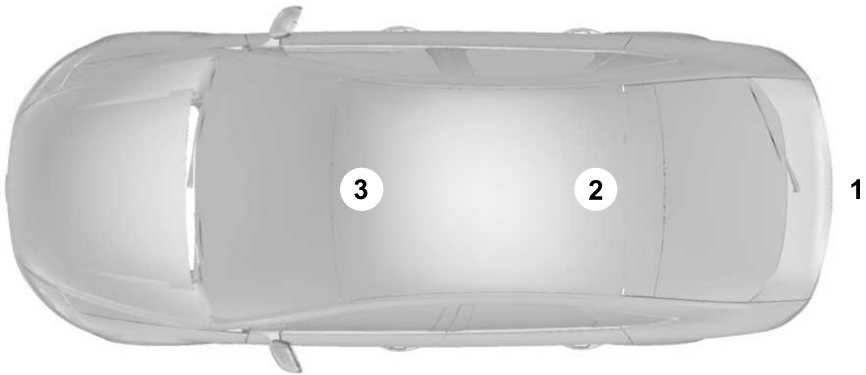

# Appendices

---

## Van

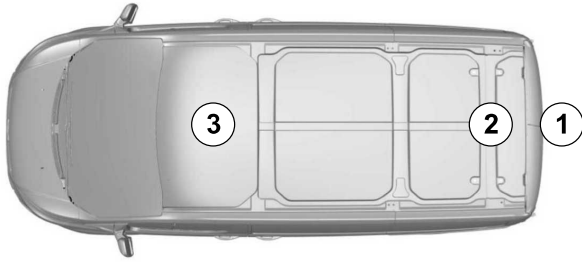

## Truck

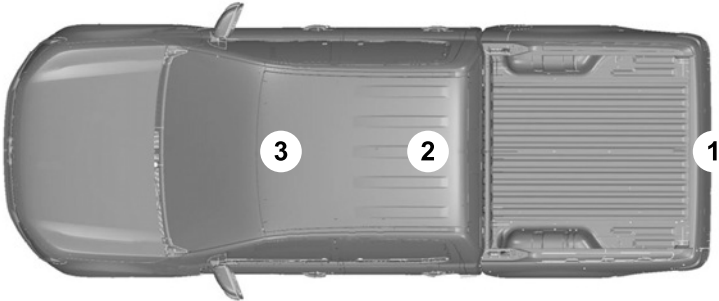

# Appendices

---

<b>Frequency Band MHz</b>	<b>Maximum Output Power Watt (Peak RMS)</b>	<b>Antenna Positions</b>
1-30	50	1
50-54	50	2, 3
68-88	50	2, 3
142-176	50	2, 3
380-512	50	2, 3
806-870	10	2, 3



# Index

## 1

12V Battery.....	359
12V Battery Precautions.....	359
Battery Management System	
Limitations.....	360
Changing the 12V Battery.....	360
How Does the Battery Management	
System Work.....	359
Recycling and Disposing of the 12V	
Battery.....	361
Resetting the Battery Sensor.....	361
What Is the Battery Management	
System.....	359
12V Battery Gauge.....	107
12V Battery – Troubleshooting.....	361
12V Battery – Information Messages.....	362
12V Battery – Warning Lamps.....	361

## 3

360 Degree Camera.....	236
360 Degree Camera Settings.....	238
360 Degree Camera Guide Lines.....	237
360 Degree Camera Precautions.....	236
360 Degree Camera Settings.....	238
Switching the 360 Degree Camera On and	
Off.....	238
Switching the 360 Degree Camera	
View.....	238

## 4

4WD	
See: Four-Wheel Drive.....	182

## 9

911 Assist.....	65
-----------------	----

## A

A/C	
See: Climate Control - Vehicles With:	
Automatic Temperature Control.....	112
See: Climate Control - Vehicles With: Manual	
Temperature Control.....	117
About This Publication.....	18

About Us.....	15
ABS	
See: Brakes.....	200
Accessing Navigation.....	496
Accessing the Passive Key Backup	
Position.....	153
Accessing the Trip Computer.....	110
Accessories.....	502
Adaptive Cruise Control.....	241
Adaptive Cruise Control –	
Troubleshooting.....	247
Adaptive Cruise Control Indicators.....	246
Adaptive Cruise Control	
Limitations.....	242
Adaptive Cruise Control	
Precautions.....	241
Adaptive Cruise Control –	
Troubleshooting.....	247
Adaptive Cruise Control – Information	
Messages.....	247
Adjusting the Exterior Mirrors.....	104
Adjusting the Headlamps.....	363
Adjusting the Instrument Panel Lighting	
Brightness.....	98
Adjusting the Map.....	496
Changing the Format of the Map.....	496
Zooming the Map In and Out.....	496
Adjusting the Seatbelts During	
Pregnancy.....	51
Adjusting the Sound Settings.....	472
Adjusting the Steering Wheel.....	83
Adjusting the Volume.....	472
Aid Mode.....	263
How Does Aid Mode Work.....	263
What Is Aid Mode.....	263
Airbag Precautions.....	58
Airbags.....	56
Front Passenger Sensing System.....	60
Air Conditioning	
See: Climate Control - Vehicles With:	
Automatic Temperature Control.....	112
See: Climate Control - Vehicles With: Manual	
Temperature Control.....	117
Air Conditioning System	
Refrigerant.....	116
Alarm	
See: Connecting a Trailer.....	293

# Index

Alert and Aid Mode.....	263	Autolock.....	71
How Does Alert and Aid Mode Work.....	263	Autolock Requirements.....	72
What Is Alert and Aid Mode.....	263	Switching Autolock On and Off.....	72
Alert Mode.....	262	What Is Autolock.....	71
How Does Alert Mode Work.....	263	Automatically Releasing the Electric	
What Is Alert Mode.....	262	Parking Brake.....	203
Alexa Built-In.....	487	Automatic Crash Shutoff.....	321
Alexa Built-In Requirements.....	487	Automatic Crash Shutoff	
Alexa Built-In Settings.....	487	Precautions.....	321
AM/FM Radio.....	472	Re-Enabling Your Vehicle.....	321
AM/FM Radio Limitations.....	472	What Is Automatic Crash Shutoff.....	321
Selecting a Radio Station.....	473	Automatic Emergency Braking.....	279
Ambient Lighting - Vehicles With:		Switching Automatic Emergency Braking	
Ambient Lighting.....	98	On and Off.....	279
Adjusting Ambient Lighting.....	98	What Is Automatic Emergency	
Switching Ambient Lighting On and		Braking.....	279
Off.....	98	Automatic Engine Stop.....	152
Anti-Theft Alarm System.....	80	How Does Automatic Engine Stop	
Arming the Anti-Theft Alarm System.....	80	Work.....	152
Disarming the Anti-Theft Alarm		Overriding Automatic Engine Stop.....	153
System.....	80	Switching Automatic Engine Stop On and	
How Does the Anti-Theft Alarm System		Off.....	153
Work.....	80	What Is Automatic Engine Stop.....	152
What Is the Anti-Theft Alarm System.....	80	Automatic High Beam Control.....	94
What Is the Perimeter Alarm.....	80	Automatic High Beam Control	
Appendices.....	586	Indicators.....	95
Applying the Electric Parking		Automatic High Beam Control	
Brake.....	203	Limitations.....	95
Applying the Electric Parking Brake in an		Automatic High Beam Control	
Emergency.....	203	Precautions.....	94
Audio System.....	471	Automatic High Beam Control	
AM/FM Radio.....	472	Requirements.....	95
Audio System – Troubleshooting.....	477	How Does Automatic High Beam Control	
Digital Radio.....	473	Work.....	94
Satellite Radio.....	474	Overriding Automatic High Beam	
Audio System Precautions.....	471	Control.....	95
Audio System – Troubleshooting.....	477	Switching Automatic High Beam Control	
Audio System – Information		On and Off.....	95
Messages.....	477	Automatic High Beam Control –	
Auto-Dimming Interior Mirror.....	102	Troubleshooting.....	96
Auto-Dimming Interior Mirror		Automatic High Beam Control –	
Limitations.....	102	Information Messages.....	96
What Is the Auto-Dimming Interior		Automatic Locking Mode.....	50
Mirror.....	102	Disengaging Automatic Locking Mode.....	50
Autolamps.....	90	Engaging Automatic Locking Mode.....	50
Autolamp Settings.....	90	What Is Automatic Locking Mode.....	50
What Are Autolamps.....	90	Automatic Transmission Audible	
		Warnings.....	180

# Index

Automatic Transmission.....	176
Automatic Transmission Positions.....	176
Automatic Transmission Fluid Capacity and Specification.....	180
Automatic Transmission Positions.....	176
Automatic Transmission Position Indicators.....	177
Automatic Transmission Precautions.....	176
Drive (D).....	177
Manual (M).....	177
Neutral (N).....	177
Park (P).....	176
Reverse (R).....	177
Shifting Your Vehicle Into Gear.....	176
Auto Mode.....	114
Auto Mode Indicators.....	114
Switching Auto Mode On and Off.....	114
Switching Dual Mode On and Off.....	115
Auto-Start-Stop.....	159
Auto-Start-Stop – Troubleshooting.....	161
Auto-Start-Stop Indicators.....	161
Auto-Start-Stop Precautions - Automatic Transmission.....	159
Auto-Start-Stop Precautions - Manual Transmission.....	159
Auto-Start-Stop – Troubleshooting.....	161
Auto-Start-Stop – Frequently Asked Questions.....	163
Auto-Start-Stop – Information Messages.....	161
Autounlock.....	71
Autounlock Requirements.....	71
Switching Autounlock On and Off.....	71
What Is Autounlock.....	71
Auxiliary Switches.....	504
<b>B</b>	
Blind Spot Information System.....	267
Blind Spot Information System – Troubleshooting.....	270
Blind Spot Information System Indicators.....	269
Blind Spot Information System Limitations.....	267
Blind Spot Information System Precautions.....	267
Blind Spot Information System Requirements.....	267
Blind Spot Information System – Troubleshooting.....	270
Blind Spot Information System – Information Messages.....	270
Bluetooth®.....	495
Body Control Module Fuse Box.....	336
Accessing the Body Control Module Fuse Box.....	336
Identifying the Fuses in the Body Control Module Fuse Box.....	337
Locating the Body Control Module Fuse Box.....	336
Bonnet Lock	
See: Opening and Closing the Hood - Excluding: Raptor.....	340
See: Opening and Closing the Hood - Raptor.....	341
Booster Seats.....	44
Brake Fluid Specification.....	201
Brake Over Accelerator.....	200
Brake Precautions.....	200
Brakes.....	200
Brakes – Troubleshooting.....	201
Brakes – Troubleshooting.....	201
Brakes – Information Messages.....	202
Brakes – Warning Lamps.....	201
Breaking-In.....	315
<b>C</b>	
Calculating Payload.....	286
Calculating the Load Limit.....	287
Canceling the Set Speed.....	213
Catalytic Converter.....	170
Catalytic Converter – Troubleshooting.....	170
Catalytic Converter Precautions.....	170
Catalytic Converter – Troubleshooting.....	170
Catalytic Converter – Warning Lamps.....	170
Center Console.....	146
Locking the Center Console.....	146
Opening the Center Console.....	146
Center Display.....	481
Center Display Overview.....	481

# Index

Changing a Flat Tire - Excluding: Raptor.....	454
Changing a Flat Tire - Raptor.....	458
Changing a Road Wheel.....	454
Changing the Remote Control Battery.....	68
Charging a Device.....	141
Checking the Brake Fluid.....	200
Checking the Clutch Fluid Level.....	173
Checking the Manual Transmission Fluid Level.....	173
Checking the Seatbelts.....	53
Checking the Tire Pressures.....	442
Checking the Wiper Blades.....	85
Children and Airbags.....	59
Child Restraint Anchor Points.....	37
Locating the Child Restraint Lower Anchor Points.....	37
Locating the Child Restraint Top Tether Anchor Points.....	38
What Are the Child Restraint Anchor Points.....	37
Child Restraints.....	38
Child Restraint Position Information.....	38
Child Restraints Recommendation.....	40
Child Safety.....	36
Child Restraint Anchor Points.....	37
Child Restraints.....	38
Installing Child Restraints.....	40
Child Safety Locks - 5-Door.....	46
Child Safety Precautions.....	36
Cleaning Products.....	423
Cleaning the Exterior.....	424
Cleaning Camera Lenses and Sensors.....	425
Cleaning Chrome, Aluminium or Stainless Steel.....	424
Cleaning Headlamps and Rear Lamps.....	424
Cleaning Stripes or Graphics.....	425
Cleaning the Engine Compartment.....	425
Cleaning the Exterior Precautions.....	424
Cleaning the Hard Top.....	425
Cleaning the Underbody.....	426
Cleaning Wheels.....	424
Cleaning Windows and Wiper Blades.....	424
Cleaning the Interior.....	426
Cleaning Carpets and Floor Mats.....	427
Cleaning Displays and Screens.....	426
Cleaning Fabric.....	426
Cleaning Leather.....	427
Cleaning Plastic.....	426
Cleaning Seatbelts.....	428
Cleaning the Instrument Panel.....	426
Cleaning Vinyl.....	427
Climate Control.....	112
Auto Mode.....	114
Climate Control Hints.....	115
Closing the Tailgate.....	76
Closing the Tailgate From Outside Your Vehicle.....	76
Clutch Fluid Capacity and Specification.....	174
Cold Weather Precautions.....	315
Connected Navigation.....	496
Connected Vehicle.....	466
Connected Vehicle – Troubleshooting.....	467
Connecting the Vehicle to a Mobile Network.....	466
Connected Vehicle Data.....	28
Connected Vehicle Limitations.....	466
Connected Vehicle Requirements.....	466
Connected Vehicle Settings.....	467
Connected Vehicle – Troubleshooting.....	467
Connected Vehicle – Frequently Asked Questions.....	467
Connecting a Bluetooth® Device.....	495
Connecting a Trailer.....	293
Connecting a Trailer – Troubleshooting.....	295
Connecting a Trailer Precautions.....	293
Connecting a Trailer – Troubleshooting.....	295
Connecting a Trailer – Information Messages.....	295
Connecting the Vehicle to a Mobile Network.....	466
Connecting FordPass to the Modem.....	466
Enabling and Disabling the Modem.....	466
What Is the Modem.....	466
Connecting the Vehicle to a Wi-Fi Network.....	466

# Index

Connecting Your Phone.....	489
Contacting Us.....	16
Coolant.....	354
Adding Coolant.....	354
Changing the Coolant.....	355
Checking the Coolant Level.....	354
Coolant – Information Messages.....	358
Coolant – Warning Lamps.....	358
Cooling System Capacity and Specification.....	356
Managing the Coolant Temperature.....	356
Crash and Breakdown Information.....	317
Automatic Crash Shutoff.....	321
Fail-Safe Cooling.....	325
Jump Starting the Vehicle.....	318
Post-Crash Alert System.....	320
Recovery Towing.....	322
Crash Sensors and Airbag Indicator.....	63
Crawler Gear.....	171
Using Crawler Gear.....	172
What Is Crawler Gear.....	171
Cross Traffic Alert.....	271
Cross Traffic Alert – Troubleshooting.....	275
Cross Traffic Alert Indicators.....	274
Cross Traffic Alert Limitations.....	272
Cross Traffic Alert Precautions.....	271
Cross Traffic Alert – Troubleshooting.....	275
Cross Traffic Alert – Information Messages.....	275
Cruise Control.....	239
Cruise Control Indicators.....	240
Customer Information.....	514
Radio Frequency Certification Labels.....	517
Customizing the Instrument Cluster Display.....	109
<b>D</b>	
Data Privacy.....	26
Department of Transportation Uniform Tire Quality Grades.....	431
Digital Interior Mirror – Vehicles With: Digital Interior Mirror.....	102
Digital Interior Mirror Limitations.....	102
Digital Interior Mirror Settings.....	103
Switching Between Normal View and Camera View.....	102
What Is the Digital Interior Mirror.....	102
Digital Radio.....	473
Digital Radio Indicators.....	474
Digital Radio Limitations.....	474
How Does Digital Radio Work.....	473
Switching Digital Radio Reception On and Off.....	474
What Is Digital Radio.....	473
Dinghy Tow	
See: Recreationally Towing Your Vehicle – Automatic Transmission.....	329
See: Recreationally Towing Your Vehicle – Manual Transmission.....	327
Directing the Flow of Air.....	114
Disposing of Airbags.....	64
Doors and Locks.....	71
Autolock.....	71
Autounlock.....	71
Doors and Locks – Troubleshooting.....	72
Mislock.....	72
Operating the Doors From Inside Your Vehicle.....	71
Operating the Doors From Outside Your Vehicle.....	71
Doors and Locks – Troubleshooting.....	72
Doors and Locks – Frequently Asked Questions.....	73
Doors and Locks – Information Messages.....	72
Doors and Locks – Warning Lamps.....	72
Drive Belt Routing Overview – 2.3L.....	358
Drive Belt Routing Overview – 2.7L/ 3.0L.....	358
Driver Alert.....	282
Driver Alert – Troubleshooting.....	283
Driver Alert Indicators.....	283
Driver Alert Limitations.....	282
Driver Alert Precautions.....	282
Driver Alert – Troubleshooting.....	283
Driver Alert – Information Messages.....	283
Driver Assistance Menu.....	483
Driving Economically.....	315
Driving Hints.....	307
Off-Road Driving.....	307
Drowsiness Monitor	
See: Driver Alert.....	282

# Index

## E

Electric Parking Brake Audible	
Warning.....	204
Electric Parking Brake.....	203
Electric Parking Brake –	
Troubleshooting.....	204
Electric Parking Brake –	
Troubleshooting.....	204
Electric Parking Brake – Information	
Messages.....	205
Electric Parking Brake – Warning	
Lamps.....	204
Electric Parking Brake Videos.....	205
Electric Power Steering.....	227
Electric Power Steering Precautions.....	227
How Does Electric Power Steering	
Work.....	227
Electromagnetic Compatibility.....	586
Electronic Locking Differential.....	194
Electronic Locking Differential –	
Troubleshooting.....	198
Electronic Locking Differential	
Indicators.....	197
Electronic Locking Differential –	
Troubleshooting.....	198
Electronic Locking Differential –	
Information Messages.....	198
Electronic Locking Differential	
Videos.....	199
Emergency Call Limitations.....	66
Emergency Call Requirements.....	65
Emergency Call System Data.....	29
Emergency Towing.....	330
Emission Law.....	582
Enabling Apps on a Mobile Device.....	493
End User License Agreement.....	557
Engine Air Filter.....	352
Changing the Engine Air Filter.....	352
Engine Block Heater.....	150
Engine Block Heater Precautions.....	150
How Does the Engine Block Heater	
Work.....	150
Using the Engine Block Heater.....	151
Engine Coolant Temperature	
Gauge.....	107
Engine Oil.....	345
Adding Engine Oil.....	345
Checking the Engine Oil Level.....	345
Engine Oil Capacity and	
Specification.....	346
Engine Oil Dipstick Overview.....	345
Intelligent Oil Life Monitor.....	346
Resetting the Intelligent Oil Life	
Monitor.....	346
Engine Specifications - 2.3L.....	368
Engine Specifications - 2.7L.....	369
Engine Specifications - 3.0L,	
Raptor.....	370
Environment.....	30
Evasive Steering Assist.....	279
Evasive Steering Assist Limitations.....	280
Switching Evasive Steering Assist On and	
Off.....	280
What Is Evasive Steering Assist.....	279
Event Data.....	27
Export Unique Options.....	583
Exterior Bulbs.....	364
Changing a Rear Lamp Bulb.....	366
Exterior Bulb Specification Chart.....	364
Removing a Rear Lamp Assembly.....	365
Exterior Lamps.....	91
Exterior Lamps On Audible Warning.....	93
Switching the Daytime Running Lamps On	
and Off.....	91
Switching the Spot Lamps On and	
Off.....	92
Using the Front Fog Lamps.....	92
Using the Off-Road Driving Lamps.....	92
Using the Turn Signal Lamps.....	91
Exterior Lighting Control.....	89
Exterior Lighting.....	89
Autolamps.....	90
Automatic High Beam Control.....	94
Automatic High Beam Control –	
Troubleshooting.....	96
Exterior Lamps.....	91
Exterior Zone Lighting.....	93
Headlamps.....	89
Headlamps – Troubleshooting.....	90
Exterior Lighting Videos.....	96
Exterior Mirrors.....	104
Exterior Overview - Excluding:	
Raptor.....	32
Exterior Overview - Raptor.....	33

# Index

Exterior Zone Lighting.....	93
Exterior Zone Lighting Settings.....	94
Using the Exterior Zone Lighting.....	93
What Is Exterior Zone Lighting.....	93
<b>F</b>	
Fail-Safe Cooling.....	325
Driving When Fail-Safe Mode Is Activated.....	325
Fail-Safe Cooling Indicators.....	326
How Does Fail-Safe Cooling Work.....	325
What Is Fail-Safe Cooling.....	325
Fastening and Unfastening the Seatbelts.....	49
Feature Bar.....	482
Federal Highway Administration Regulation.....	556
Fender Anchor Points.....	291
Fender Anchor Point Load Capacities.....	291
Locating the Fender Anchor Points.....	291
Flat Tire See: Changing a Flat Tire - Excluding: Raptor.....	454
See: Changing a Flat Tire - Raptor.....	458
Flat Tow See: Recreationally Towing Your Vehicle - Automatic Transmission.....	329
See: Recreationally Towing Your Vehicle - Manual Transmission.....	327
Floor Mats.....	316
Folding the Exterior Mirrors.....	104
Ford Assistant.....	485
Ford Assistant – Frequently Asked Questions.....	485
Ford Assistant Settings.....	485
Using Ford Assistant.....	485
Ford Performance.....	15
Ford Protect.....	505
Four-Wheel Drive.....	182
Four-Wheel Drive Modes.....	186
Four-Wheel Drive – Troubleshooting.....	188
Four-Wheel Drive Indicators.....	187
Four-Wheel Drive Limitations.....	183
Four-Wheel Drive Modes.....	186
Four-Wheel Drive Auto.....	186
Four-Wheel Drive High.....	186
Four-Wheel Drive Low.....	187
Two-Wheel Drive High.....	186
Four-Wheel Drive Precautions.....	182
Four-Wheel Drive – Troubleshooting.....	188
Four-Wheel Drive – Information Messages.....	188
Four-Wheel Drive – Warning Lamps.....	188
Four-Wheel Drive Videos.....	190
Four Wheels Down Tow See: Recreationally Towing Your Vehicle - Automatic Transmission.....	329
See: Recreationally Towing Your Vehicle - Manual Transmission.....	327
Front Axle Fluid Capacity and Specification - Excluding: Raptor.....	191
Front Axle Fluid Capacity and Specification - Raptor.....	191
Front Axle.....	191
Front Parking Aid.....	230
Front Parking Aid Audible Warnings.....	231
Front Parking Aid Limitations.....	231
Locating the Front Parking Aid Sensors.....	231
What is the Front Parking Aid.....	230
Front Passenger Sensing System.....	60
Front Passenger Sensing System Indicators.....	62
Front Passenger Sensing System Precautions.....	62
How Does the Front Passenger Sensing System Work.....	60
What Is the Front Passenger Sensing System.....	60
Front Seat Precautions.....	122
Front Seats.....	122
Heated Seats.....	128
Manual Seats.....	123
Power Seats.....	125
Fuel and Refueling.....	164
Fuel and Refueling – Troubleshooting.....	169
Fuel Quality.....	164
Refueling.....	167
Running Out of Fuel.....	165
Fuel and Refueling Precautions.....	164

# Index

Fuel and Refueling – Troubleshooting.....	169
Fuel and Refueling – Information Messages.....	169
Fuel and Refueling – Warning Lamps.....	169
Fuel Gauge.....	106
Fuel Gauge Limitations.....	107
Locating the Fuel Filler Door.....	107
What Is Distance to Empty.....	107
What Is the Fuel Gauge.....	106
What Is the Low Fuel Reminder.....	107
Fuel Quality.....	164
Selecting the Correct Fuel.....	164
Fuel Tank Capacity.....	169
Fuse Precautions.....	332
Fuses.....	332
Body Control Module Fuse Box.....	336
Fuses – Troubleshooting.....	339
Under Hood Fuse Box.....	332
Fuses – Troubleshooting.....	339
Fuses – Frequently Asked Questions.....	339
<b>G</b>	
G.O.A.T. Mode Control.....	249
G.O.A.T. Mode Control – Troubleshooting.....	258
G.O.A.T. Modes.....	252
G.O.A.T. Mode Control – Troubleshooting.....	258
G.O.A.T. Mode Control – Frequently Asked Questions.....	260
G.O.A.T. Mode Control – Information Messages.....	258
G.O.A.T. Mode Control – Warning Lamps.....	258
G.O.A.T. Mode Control Videos.....	260
G.O.A.T. Modes.....	252
Baja.....	252
Eco.....	253
Mud/Ruts.....	253
Normal.....	253
Off-Road.....	254
Rock Crawl.....	254
Sand.....	255
Slippery.....	255
Sport.....	257
Tow/Haul.....	257
Garage Door Opener Additional Assistance.....	140
Garage Door Opener.....	137
Garage Door Opener Introduction.....	137
Garage Door Opener Precautions and Frequencies.....	137
General Maintenance Information.....	509
Global Opening.....	100
Switching Global Opening On and Off.....	100
Using Global Opening.....	100
What Is Global Opening.....	100
Glossary of Tire Terminology.....	437
Glove Compartment.....	146
Locking the Glove Compartment.....	146
Opening the Glove Compartment.....	146
<b>H</b>	
Headlamp Adjusting See: Adjusting the Headlamps.....	363
Headlamps.....	89
Headlamp Indicators.....	89
Switching Headlamp Exit Delay On and Off.....	89
Using the High Beam Headlamps.....	89
Headlamps – Troubleshooting.....	90
Headlamps – Frequently Asked Questions.....	90
Heated Seats.....	128
Heated Seat Precautions.....	128
Switching the Heated Seats On and Off.....	128
Heating See: Climate Control – Vehicles With: Automatic Temperature Control.....	112
See: Climate Control – Vehicles With: Manual Temperature Control.....	117
Hill Descent Control.....	225
Hill Descent Control – Troubleshooting.....	226
Hill Descent Control Indicator.....	225
Hill Descent Control Precautions.....	225
Hill Descent Control – Troubleshooting.....	226
Hill Descent Control – Information Messages.....	226





# Index

What Is the Interior Lamp Function.....	97
Interior Lighting.....	97
Ambient Lighting – Vehicles With: Ambient Lighting.....	98
Interior Lamp Function.....	97
Interior Lighting – Troubleshooting.....	98
Interior Lighting – Troubleshooting.....	98
Interior Lighting – Frequently Asked Questions.....	98
Interior Mirror.....	102
Auto-Dimming Interior Mirror.....	102
Digital Interior Mirror – Vehicles With: Digital Interior Mirror.....	102
Interior Mirror Precautions.....	102
Interior Overview.....	31
Introduction.....	18
<b>J</b>	
Jump Starting the Vehicle.....	318
Jump Starting Precautions.....	318
Jump Starting the Vehicle.....	319
Preparing the Vehicle.....	319
<b>K</b>	
Keyless Entry.....	74
Keyless Entry – Troubleshooting.....	75
Keyless Entry Limitations.....	74
Keyless Entry Settings.....	74
Keyless Entry – Troubleshooting.....	75
Keyless Entry – Frequently Asked Questions.....	75
Keys and Remote Controls.....	67
Keys and Remote Controls – Troubleshooting.....	70
Keys and Remote Controls – Troubleshooting.....	70
Keys and Remote Controls – Information Messages.....	70
<b>L</b>	
Lane Keeping System Indicators.....	264
Lane Keeping System.....	261
Aid Mode.....	263
Alert and Aid Mode.....	263
Alert Mode.....	262
Lane Keeping System – Troubleshooting.....	265
Lane Keeping System Limitations.....	261
Lane Keeping System Precautions.....	261
Lane Keeping System Settings.....	262
Lane Keeping System – Troubleshooting.....	265
Lane Keeping System – Frequently Asked Questions.....	266
Lane Keeping System – Information Messages.....	265
Launching or Retrieving a Boat or Personal Watercraft.....	299
Live Traffic.....	496
Switching Live Traffic On and Off.....	496
What Is Live Traffic.....	496
Load Carrying.....	284
Fender Anchor Points.....	291
Roof Rack.....	288
Load Carrying Precautions.....	284
Loading Your Trailer.....	297
Locating the 360 Degree Cameras.....	236
Locating the Auxiliary Switches.....	504
Locating the Blind Spot Information System Sensors.....	268
Locating the Brake Fluid Reservoir - 2.3L EcoBoost™.....	200
Locating the Brake Fluid Reservoir - 2.7L EcoBoost™/3.0L EcoBoost™.....	200
Locating the Cross Traffic Alert Sensors.....	273
Locating the Fuel Filler Funnel.....	165
Locating the Power Outlets.....	143
Locating the Pre-Collision Assist Sensors.....	278
Locating the Rear View Camera.....	234
Locating the Safety Compliance Certification Labels.....	285
Locating the Tire label.....	431
Locating the USB Ports.....	141
Locating Your Vehicle.....	68
Locking and Unlocking the Tailgate.....	76
Locking the Rear Window Controls.....	100

# Index

## M

Maintenance.....	340
12V Battery.....	359
12V Battery – Troubleshooting.....	361
Coolant.....	354
Engine Air Filter.....	352
Engine Oil.....	345
Exterior Bulbs.....	364
Interior Bulbs.....	367
Maintenance Precautions.....	340
Making and Receiving a Phone Call.....	491
Manually Dimming the Interior Mirror.....	102
Manually Releasing the Electric Parking Brake.....	203
Manually Shifting Gears - Excluding: Raptor.....	177
Manually Shifting Gears - Raptor.....	178
Manual Seats.....	123
Adjusting the Head Restraint.....	123
Adjusting the Seat Backrest.....	125
Folding the Seats.....	131
Head Restraint Components.....	123
Installing the Head Restraint.....	124
Moving the Seat Backward and Forward.....	124
Removing the Head Restraint.....	124
Unfolding the Seats.....	131
Manual Transmission Fluid Capacity and Specification.....	173
Manual Transmission.....	171
Crawler Gear.....	171
Manual Transmission – Troubleshooting.....	174
Manual Transmission Precautions.....	171
Manual Transmission – Troubleshooting.....	174
Manual Transmission – Frequently Asked Questions.....	174
Map Pocket.....	147
Locating the Map Pocket.....	147
Media Control Buttons.....	471
Mislock.....	72
Mislock Limitations.....	72
Switching Mislock On and Off.....	72
What Is Mislock.....	72

## Mobile Communications

Equipment.....	556
Mobile Device Data.....	29
Motorcraft Parts - 2.3L.....	371
Motorcraft Parts - 2.7L.....	372
Motorcraft Parts - 3.0L, Raptor.....	373
Muting the Audio.....	472

## N

Navigation Map Updates.....	496
Navigation.....	496
Adjusting the Map.....	496
Live Traffic.....	496
Route Guidance.....	498
Setting a Destination.....	497
Waypoints.....	497
Neutral Towing See: Recreationally Towing Your Vehicle - Automatic Transmission.....	329
See: Recreationally Towing Your Vehicle - Manual Transmission.....	327
Neutral Tow See: Recreationally Towing Your Vehicle - Automatic Transmission.....	329
See: Recreationally Towing Your Vehicle - Manual Transmission.....	327

## O

Off-Road Driving.....	307
After Driving Your Vehicle Off-Road.....	314
Basic Off-Road Driving Techniques.....	307
Driving Off-Road.....	308
Driving Through Water Limitations.....	312
Driving Your Vehicle at High Speeds.....	312
Off-Road Driving Aids.....	313
Off-Road Driving Precautions.....	307
What Is Off-Road Driving.....	307
Opening and Closing the Hood - Excluding: Raptor.....	340
Opening and Closing the Hood - Raptor.....	341
Opening and Closing the Windows.....	99
Opening the Tailgate.....	76
Opening the Tailgate From Outside Your Vehicle.....	76

# Index

Operating the Doors From Inside Your Vehicle.....	71
Opening the Doors From Inside Your Vehicle.....	71
Unlocking and Locking the Doors Using the Central Locking.....	71
Operating the Doors From Outside Your Vehicle.....	71
Unlocking and Locking the Doors Using the Remote Control.....	71
OTA	
See: Software Update Settings.....	499
See: Vehicle Software Updates.....	499
Overriding the Set Speed.....	246
Over the air	
See: Software Update Settings.....	499
Over-the-air	
See: Software Update Settings.....	499
See: Vehicle Software Updates.....	499
See: Vehicle Software Updates.....	499
<b>P</b>	
Parking Aid Indicators.....	232
Parking Aid Precautions.....	229
Parking Aids.....	229
Front Parking Aid.....	230
Parking Aids – Troubleshooting.....	233
Rear Parking Aid.....	230
Parking Aids – Troubleshooting.....	233
Parking Aids – Information Messages.....	233
Parking Aids Videos.....	233
Passive Anti-Theft System.....	80
How Does the Passive Anti-Theft System Work.....	80
What Is the Passive Anti-Theft System.....	80
Perchlorate.....	555
Performing a System Reset.....	501
Personal Safety System	
Components.....	55
Personal Safety System™.....	55
Phone Menu.....	489
Phone.....	489
Phone Precautions.....	489
Playing Media Using Bluetooth®.....	495
Playing Media Using the USB Port.....	141
Post-Collision Braking.....	321
Post-Crash Alert System.....	320
How Does the Post-Crash Alert System Work.....	321
Post-Crash Alert System Limitations.....	321
Switching the Post-Crash Alert System Off.....	321
What Is the Post-Crash Alert System.....	320
Power Outlet Indicators.....	143
Power Outlet Limitations.....	143
Power Outlet.....	143
Power Outlet Precautions.....	143
Power Seats.....	125
Adjusting the Head Restraint.....	125
Adjusting the Lumbar Support.....	127
Adjusting the Seat Backrest.....	127
Adjusting the Seat Cushion.....	127
Adjusting the Seat Height.....	127
Head Restraint Components.....	125
Installing the Head Restraint.....	126
Moving the Seat Backward and Forward.....	126
Removing the Head Restraint.....	126
Power-Up	
See: Software Update Settings.....	499
See: Vehicle Software Updates.....	499
Pre-Collision Assist Limitations.....	277
Pre-Collision Assist Precautions.....	276
Pre-Collision Assist.....	276
Automatic Emergency Braking.....	279
Evasive Steering Assist.....	279
Pre-Collision Assist – Troubleshooting.....	280
Pre-Collision Assist – Troubleshooting.....	280
Pre-Collision Assist – Frequently Asked Questions.....	281
Pre-Collision Assist – Information Messages.....	280
Pre-Collision Assist – Warning Lamps.....	280
Preparing Your Vehicle for Storage.....	429
Programming the Garage Door Opener.....	138
Programming the Remote Control.....	70

# Index

Properly Adjusting the Driver and Front Passenger Seats.....	59
Protecting the Environment.....	30
Puncture	
See: Changing a Flat Tire - Excluding:	
Raptor.....	454
See: Changing a Flat Tire - Raptor.....	458
Push Button Ignition Switch.....	148
<b>R</b>	
Radio Frequency Certification	
Labels.....	517
Blind Spot Information System	
Sensors.....	517
Body Control Module.....	520
Cruise Control Module.....	523
Passive Key.....	529
Radio Transceiver Module.....	532
SYNC.....	536
Telematics Control Unit.....	542
Tire Pressure Monitoring System	
Sensors.....	545
Rear Axle Fluid Capacity and Specification.....	193
Rear Axle.....	193
Rear Cargo Area Anchor Points.....	292
Locating the Rear Cargo Area Anchor Points.....	292
Rear Cargo Area Anchor Point Load Capacities.....	292
Rear Cargo Area Anchor Point Precautions.....	292
Rear Cargo Area.....	292
Rear Cargo Area Anchor Points.....	292
Rear Occupant Alert System Audible Warnings - 3-Door, Excluding:	
Raptor.....	135
Rear Occupant Alert System Audible Warnings - 5-Door, Excluding:	
Raptor.....	136
Rear Occupant Alert System Audible Warnings - Raptor.....	136
Rear Occupant Alert System Indicators - Excluding: Raptor.....	135
Rear Occupant Alert System Indicators - Raptor.....	135
Rear Occupant Alert System Limitations - 3-Door, Excluding: Raptor.....	133
Rear Occupant Alert System Limitations - 5-Door, Excluding: Raptor.....	133
Rear Occupant Alert System Limitations - Raptor.....	133
Rear Occupant Alert System Precautions.....	133
Rear Occupant Alert System.....	132
Rear Occupant Alert System Settings - 5-Door, Excluding: Raptor.....	134
Rear Parking Aid.....	230
Locating the Rear Parking Aid	
Sensors.....	230
Rear Parking Aid Audible Warnings.....	230
Rear Parking Aid Limitations.....	230
What is the Rear Parking Aid.....	230
Rear Seats.....	129
Manual Seats.....	129
Rear View Camera Guide Lines.....	234
Rear View Camera Object Distance Indicators.....	235
Rear View Camera Precautions.....	234
Rear View Camera.....	234
Rear View Camera Settings.....	235
Rear View Camera Settings.....	235
Switching Rear View Camera Delay On and Off.....	235
Zooming the Rear View Camera In and Out.....	235
Rebooting the Center Display.....	483
Recommended Shift Speeds.....	172
Recovery Towing.....	322
Accessing the Front Towing Point.....	322
Accessing the Rear Towing Point.....	323
Recreationally Towing Your Vehicle - Automatic Transmission.....	329
Recreationally Towing Your Vehicle - Manual Transmission.....	327
Refueling.....	167
Refueling System Overview.....	167
Refueling Your Vehicle.....	167
Releasing the Electric Parking Brake if the Vehicle Battery Has Run Out of Charge.....	204
Remote Control Limitations.....	67
Remote Start.....	111
Remote Start Settings.....	111

# Index

Removable Doors.....	378	Removing Your Vehicle From Storage.....	430
Doors and Locks Audible Warnings.....	386	Repairing Minor Paint Damage.....	428
Removing and Installing the Doors.....	378	Replacement Parts Recommendation.....	555
Removable Fenders.....	400	Replacing a Lost Key or Remote Control.....	69
Removable Fender Precautions.....	400	Replacing the Cabin Air Filter.....	121
Removing the Fender Flares.....	400	Replacing the Front Wiper Blades.....	85
Removable Front Bumper End Caps - Raptor.....	403	Replacing the Rear Wiper Blades.....	86
Removing and Installing the Front Bumper End Caps.....	403	Reporting Safety Defects in Canada.....	516
Removable Hard Top.....	395	Reporting Safety Defects in the United States.....	515
Removing and Installing the Hard Top.....	395	Resetting the Trip Computer.....	110
Removable Roof Panels.....	386	Restarting the Engine - Automatic Transmission.....	161
Removable Roof Panel Precautions.....	386	Restarting the Engine - Manual Transmission.....	160
Removing and Installing the Center Roof Panel.....	389	Resuming the Set Speed.....	240
Removing and Installing the Front Roof Panel.....	388	Reverse Wipe.....	84
Removing and Installing the Rear Roof Panel.....	389	Reverse Wipe Settings.....	84
Removable Running Boards.....	401	What Is Reverse Wipe.....	84
Removing and Installing the Running Boards.....	401	Roadside Assistance.....	317
Removable Soft Top.....	396	Rollover Warning.....	514
Opening and Closing the Soft Top.....	396	Roof Rack.....	288
Removing and Installing the Soft Top.....	399	Removing and Installing the Roof Rack.....	289
Removable Vehicle Components.....	374	Roof Rack Load Capacities.....	290
Removable Doors.....	378	Roof Rack Precautions.....	288
Removable Fenders.....	400	Route Guidance.....	498
Removable Front Bumper End Caps - Raptor.....	403	Adjusting the Guidance Prompt Volume.....	498
Removable Hard Top.....	395	Canceling Route Guidance.....	498
Removable Roof Panels.....	386	Repeating an Instruction.....	498
Removable Running Boards.....	401	Route Guidance Settings.....	498
Removable Soft Top.....	396	Running-In	
Removable Windows.....	374	See: Breaking-In.....	315
Removable Vehicle Components Videos.....	422	Running Out of Fuel.....	165
Removable Windows.....	374	Adding Fuel From a Portable Fuel Container.....	166
Removable Windows Precautions.....	374	Filling a Portable Fuel Container.....	165
Removing and Installing the Rear Quarter Windows.....	374		
Removing and Installing the Rear Window.....	376	<b>S</b>	
Removing the Key Blade.....	68	Satellite Radio.....	474
		Locating the Satellite Radio Identification Number.....	475

# Index

Satellite Radio Limitations.....	475
Satellite Radio Settings.....	475
Selecting a Channel.....	475
What Is Satellite Radio.....	474
Scheduled Maintenance.....	507
Seatbelt Extensions.....	53
Seatbelt Precautions.....	48
Seatbelt Reminder.....	51
How Does the Seatbelt Reminder Work.....	51
Seatbelt Reminder Indicators.....	51
Switching the Seatbelt Reminder On and Off.....	52
Seatbelts.....	48
Automatic Locking Mode.....	50
Seatbelt Reminder.....	51
Sensitive Locking Mode.....	50
Security.....	80
Anti-Theft Alarm System.....	80
Passive Anti-Theft System.....	80
Security – Troubleshooting.....	81
Security – Troubleshooting.....	81
Security – Frequently Asked Questions.....	82
Security – Information Messages.....	81
Selecting a Four-Wheel Drive Mode - 4x4 with Part Time Engagement.....	184
Selecting a Four-Wheel Drive Mode - Advanced 4x4 with 4A Mode.....	185
Selecting a G.O.A.T. Mode - Excluding: Raptor.....	249
Selecting a G.O.A.T. Mode - Raptor.....	250
Selecting the Audio Source.....	471
Sending and Receiving a Text Message.....	492
Sensitive Locking Mode.....	50
How Does Sensitive Locking Mode Work.....	50
What is Sensitive Locking Mode.....	50
Service Data.....	27
Setting a Destination.....	497
Setting a Destination Using a Point of Interest.....	497
Setting a Destination Using a Predictive Destination.....	497
Setting a Destination Using a Recent Destination.....	497
Setting a Destination Using a Saved Destination.....	497
Setting a Destination Using the Map Screen.....	497
Setting a Destination Using the Text Entry Screen.....	497
Setting a Memory Preset.....	472
Settings Data.....	28
Settings.....	483
Setting the Adaptive Cruise Control Gap.....	245
Setting the Adaptive Cruise Control Speed.....	244
Setting the Blower Motor Speed.....	113
Setting the Clock and Date.....	472
Setting the Cruise Control Speed.....	239
Setting the Hill Descent Speed.....	225
Setting the Temperature.....	113
Setting the Trail Control Speed.....	212
Setting Up a Vehicle Hotspot.....	469
Shifting Into Reverse.....	171
Shifting Your Immobile Vehicle Out of Park (P).....	179
Signing In to Your Account.....	487
Sitting in the Correct Position.....	122
Slide Out Tailgate.....	78
Software Update Indicators.....	500
Software Update Settings.....	499
Software Update See: Software Update Settings.....	499
See: Vehicle Software Updates.....	499
Sounding the Panic Alarm.....	68
Speed Control See: Cruise Control.....	239
Speedometer.....	106
Stability Control Indicator.....	211
Stability Control.....	209
Stabilizer Bar Disconnect Indicators.....	221
Stabilizer Bar Disconnect Precautions.....	219
Stabilizer Bar Disconnect.....	219
Stabilizer Bar Disconnect – Troubleshooting.....	222
Stabilizer Bar Disconnect – Troubleshooting.....	222
Stabilizer Bar Disconnect – Frequently Asked Questions.....	223

# Index

Stabilizer Bar Disconnect – Information Messages.....	222	Stopping the Engine When Your Vehicle is Stationary.....	151
Starting and Stopping the Engine – Precautions.....	148	Storage.....	146
Starting and Stopping the Engine.....	148	Center Console.....	146
Automatic Engine Stop.....	152	Glove Compartment.....	146
Engine Block Heater.....	150	Map Pocket.....	147
Starting and Stopping the Engine – Troubleshooting.....	153	Under Floor Storage.....	147
Starting the Engine.....	149	Storing the Doors and the Roof Panels – 4-Door, Excluding: Raptor.....	410
Stopping the Engine.....	151	Storing the Doors and the Roof Panels – Raptor.....	416
Starting and Stopping the Engine – Troubleshooting.....	153	Storing the Roof Panels - 2-Door.....	422
Starting and Stopping the Engine – Frequently Asked Questions.....	155	Storing Your Vehicle.....	429
Starting and Stopping the Engine – Information Messages.....	154	SVT.....	15
Starting and Stopping the Engine – Warning Lamps.....	153	Switching Adaptive Cruise Control On and Off.....	244
Start in Gear Limitations.....	157	Switching Air Conditioning On and Off.....	112
Start in Gear Precautions.....	157	Switching All of the Interior Lamps On and Off.....	97
Start in Gear.....	157	Switching Android Auto™ On and Off.....	494
Start in Gear – Troubleshooting.....	158	Switching Apple CarPlay On and Off.....	493
Start in Gear – Troubleshooting.....	158	Switching Auto-Start-Stop On and Off.....	159
Start in Gear – Frequently Asked Questions.....	158	Switching Blind Spot Information System On and Off.....	268
Start in Gear – Information Messages.....	158	Switching Climate Control On and Off.....	112
Starting the Engine.....	149	Switching Cross Traffic Alert On and Off.....	273
Restarting the Engine After Stopping It.....	149	Switching Cruise Control On and Off.....	239
Starting a Gasoline Engine.....	149	Switching Driver Alert On and Off.....	283
Status Bar.....	481	Switching Four-Wheel Drive On and Off.....	184
Steering.....	227	Switching From Adaptive Cruise Control to Cruise Control.....	247
Electric Power Steering.....	227	Switching Hill Descent Control On and Off.....	225
Steering – Troubleshooting.....	228	Switching Hill Start Assist On and Off - Automatic Transmission.....	206
Steering – Information Messages.....	228	Switching Hill Start Assist On and Off - Manual Transmission.....	206
Steering – Warning Lamps.....	228	Switching Maximum Cooling On and Off.....	112
Steering Wheel.....	83		
Stopping the Engine - Automatic Transmission.....	160		
Stopping the Engine - Manual Transmission.....	160		
Stopping the Engine.....	151		
Stopping the Engine When Your Vehicle is Moving.....	151		



# Index

Switching Maximum Defrost On and Off.....	112
Switching Parking Aid On and Off.....	229
Switching Pre-Collision Assist On and Off.....	278
Switching Rear Occupant Alert System On and Off - 3-Door, Excluding: Raptor.....	134
Switching Rear Occupant Alert System On and Off - Raptor.....	134
Switching Recirculated Air On and Off.....	112
Switching Stability Control On and Off.....	210
Switching Text Message Notification On and Off.....	493
Switching the Audio Unit On and Off.....	471
Switching the Display On and Off.....	473
Switching the Electronic Locking Differential On and Off - Excluding: Raptor.....	194
Switching the Electronic Locking Differential On and Off - Raptor.....	196
Switching the Front Interior Lamps On and Off.....	97
Switching the Hazard Flashers On and Off.....	318
Switching the Heated Mirrors On and Off.....	113
Switching the Heated Rear Window On and Off.....	113
Switching the Heated Steering Wheel On and Off - Vehicles With: Heated Steering Wheel.....	83
Switching the Lane Keeping System Mode.....	262
Switching the Lane Keeping System On and Off.....	262
Switching the Rear Interior Lamps On and Off.....	97
Switching the Rear Window Wiper On and Off.....	84
Switching the Stabilizer Bar Disconnect On and Off - Excluding: Raptor.....	219
Switching the Stabilizer Bar Disconnect On and Off - Raptor.....	220
Switching Traction Control On and Off.....	207
Switching Trail Control On and Off.....	212
Switching Trailer Sway Control On and Off.....	302
Switching Trail Turn Assist On and Off.....	217
Symbols Glossary.....	20
Symbols Used On Your Instrument Cluster.....	22
Symbols Used on Your Vehicle.....	20
System Update See: Software Update Settings.....	499
See: Vehicle Software Updates.....	499
<b>T</b>	
Tachometer.....	106
Tailgate Precautions.....	76
Tailgate.....	76
Closing the Tailgate.....	76
Opening the Tailgate.....	76
Tailgate – Troubleshooting.....	78
Tailgate – Troubleshooting.....	78
Tailgate – Information Messages.....	79
Tailgate – Warning Lamps.....	78
Team RS.....	15
The Better Business Bureau Auto Line Program.....	514
The Mediation and Arbitration Program.....	515
Third Party Software Copyright Acknowledgment.....	517
Tire Care.....	442
Tire Pressure Monitoring System Limitations.....	451
Tire Pressure Monitoring System Overview.....	450
Tire Pressure Monitoring System Precautions.....	451
Tire Pressure Monitoring System.....	450
Tire Pressure Monitoring System – Troubleshooting.....	452
Tire Pressure Monitoring System – Troubleshooting.....	452
Tire Pressure Monitoring System – Information Messages.....	453

# Index

Tire Pressure Monitoring System – Warning Lamps.....	452
Tire Replacement Requirements.....	438
Tire Rotation.....	448
Towing a Trailer Limitations.....	297
Towing a Trailer Precautions.....	296
Towing a Trailer.....	296
Towing a Trailer – Troubleshooting.....	301
Towing Weights and Dimensions.....	300
Towing a Trailer – Troubleshooting.....	301
Towing a Trailer – Information Messages.....	301
Towing Weights and Dimensions.....	300
Calculating the Maximum Loaded Trailer Weight for Your Vehicle.....	301
Recommended Towing Weights.....	300
What Is the Maximum Loaded Trailer Weight.....	301
Towing Your Vehicle Precautions.....	327
Towing Your Vehicle.....	327
Towing Your Vehicle – Troubleshooting.....	331
Towing Your Vehicle – Troubleshooting.....	331
Towing Your Vehicle – Information Messages.....	331
Traction Control Indicator.....	207
Traction Control.....	207
Traction Control – Troubleshooting.....	208
Traction Control – Troubleshooting.....	208
Traction Control – Information Messages.....	208
Trail Control Indicators.....	213
Trail Control Limitations.....	212
Trail Control.....	212
Trail Control – Troubleshooting.....	216
Trail One Pedal Drive.....	213
Trail One Pedal Drive – Troubleshooting.....	215
Trail Control – Troubleshooting.....	216
Trail Control – Information Messages.....	216
Trailer Brake Precautions.....	296
Trailer Sway Control Precautions.....	302
Trailer Sway Control.....	302
Trailer Towing Hints - Automatic Transmission.....	298
Trailer Towing Hints - Manual Transmission.....	297
Trail One Pedal Drive.....	213
Switching Trail One Pedal Drive On and Off.....	214
Trail One Pedal Drive Indicators.....	215
Trail One Pedal Drive Limitations.....	214
Trail One Pedal Drive Precautions.....	213
What Is Trail One Pedal Drive.....	213
Trail One Pedal Drive – Troubleshooting.....	215
Trail One Pedal Drive – Information Messages.....	215
Trail Turn Assist Indicators.....	217
Trail Turn Assist Limitations.....	217
Trail Turn Assist Precautions.....	217
Trail Turn Assist.....	217
Trail Turn Assist – Troubleshooting.....	218
Trail Turn Assist – Troubleshooting.....	218
Trail Turn Assist – Frequently Asked Questions.....	218
Trail Turn Assist – Information Messages.....	218
Transfer Case Fluid Capacity and Specification.....	187
Transmission Fluid Temperature Gauge - Automatic Transmission.....	107
Transporting the Vehicle.....	325
Trip Computer.....	110
Turbo Boost Gauge.....	107

## U

Under Floor Storage.....	147
Locating the Luggage Compartment Under Floor Storage.....	147
Under Hood Fuse Box.....	332
Accessing the Under Hood Fuse Box.....	332
Identifying the Fuses in the Under Hood Fuse Box.....	333
Locating the Under Hood Fuse Box.....	332
Under Hood Overview - 2.3L EcoBoost™.....	342
Under Hood Overview - 2.7L EcoBoost™.....	343
Under Hood Overview - 3.0L EcoBoost™.....	344

# Index

Unique Features.....	34
USB Ports.....	141
Using Alexa Built-In.....	487
Using Keyless Entry.....	74
Using Progressive Range Selection - Excluding: Raptor.....	180
Using Remote Start.....	111
Using Short Drop Windows.....	101
Using Snow Chains.....	440
Using Start in Gear.....	157
Using the Instrument Cluster Display Controls.....	108
Using the Remote Control.....	67
Using This Publication.....	19

## V

Vehicle Care.....	423
Cleaning the Exterior.....	424
Cleaning the Interior.....	426
Vehicle Hotspot Settings.....	469
Vehicle Hotspot – Troubleshooting.....	470
Vehicle Hotspot – Frequently Asked Questions.....	470
Vehicle Hotspot.....	469
Vehicle Hotspot – Troubleshooting.....	470
Vehicle Identification Number.....	465
Locating the Vehicle Identification Number.....	465
Vehicle Identification Number Overview.....	465
Vehicle Identification.....	465
Vehicle Identification Number.....	465
Vehicle Software Updates.....	499
Vehicle Specifications.....	368
Vehicle System Reset.....	501
Ventilation	
See: Climate Control - Vehicles With: Automatic Temperature Control.....	112
See: Climate Control - Vehicles With: Manual Temperature Control.....	117
Viewing the Tire Pressures.....	452
Visual Search.....	31
Voice Interaction.....	485
Ford Assistant.....	485

## W

Warranty Information.....	583
Washers.....	86
Adding Washer Fluid.....	87
Switching the Courtesy Wipe On and Off.....	87
Using the Rear Window Washer.....	87
Using the Windshield Washer.....	86
Washer Fluid Specification.....	87
Washer Precautions.....	86
Washers	
See: Wipers and Washers.....	84
Waxing Your Vehicle.....	428
Waypoints.....	497
Adding a Waypoint.....	497
Editing Waypoints.....	497
What Are the Auxiliary Switches.....	504
What Is 911 Assist.....	65
What Is a Connected Vehicle.....	466
What Is Alexa Built-In.....	487
What Is Auto-Start-Stop.....	159
What Is Blind Spot Information System.....	267
What Is Cross Traffic Alert.....	271
What Is Cruise Control.....	239
What Is Driver Alert.....	282
What Is Ford Protect.....	505
What Is G.O.A.T. Mode Control.....	249
What Is Hill Descent Control.....	225
What Is Hill Start Assist.....	206
What Is Keyless Entry.....	74
What Is Pre-Collision Assist.....	276
What Is Start in Gear.....	157
What Is the 360 Degree Camera.....	236
What Is the Cabin Air Filter.....	121
What Is the Catalytic Converter.....	170
What Is the Electric Parking Brake.....	203
What Is the Electronic Locking Differential.....	194
What Is the Gross Axle Weight Rating.....	285
What Is the Gross Combined Weight Rating.....	286
What Is the Gross Vehicle Weight Rating.....	285
What Is the Lane Keeping System.....	261

# Index

---

What Is the Maximum Loaded Trailer Weight.....	286
What Is the Personal Safety System.....	55
What Is the Power Outlet.....	143
What Is the Rear Occupant Alert System - 5-Door, Excluding: Raptor.....	132
What Is the Rear Occupant Alert System - Raptor, 3-Door.....	132
What Is the Rear View Camera.....	234
What Is the Stabilizer Bar Disconnect.....	219
What Is the Tire Pressure Monitoring System.....	450
What Is Traction Control.....	207
What Is Trail Control.....	212
What Is Trail Turn Assist.....	217
Wheel and Tire Information.....	431
Wheel Nuts - Excluding: Raptor.....	463
Wheel Nuts - Raptor.....	464
Wi Fi	
See: Connecting the Vehicle to a Wi-Fi Network.....	466
Winching Limitations.....	305
Winching Overview.....	303
Winching Precautions.....	303
Winching Requirements.....	304
Winching - Troubleshooting.....	306
Winching - Frequently Asked Questions.....	306
Winching.....	303
Winching - Troubleshooting.....	306
Winching Your Vehicle.....	305
Window Bounce-Back.....	100
Overriding Window Bounce-Back.....	100
What Is Window Bounce-Back.....	100
Windows.....	99
Global Opening.....	100
Window Bounce-Back.....	100
Wipers and Washers - Troubleshooting.....	88
Wipers and Washers - Frequently Asked Questions.....	88
Wipers and Washers - Warning Lamps.....	88
Wipers and Washers Videos.....	88
Wipers and Washers.....	84
Reverse Wipe.....	84
Washers.....	86
Wipers.....	84
Wipers and Washers - Troubleshooting.....	88
Wipers.....	84
Switching Windshield Wipers On and Off.....	84
Wiper Precautions.....	84



